

100 A1 character used in Lloyd's Register denoting that a sea-going vessel is constructed of steel and is classed with Lloyd's Register **klasa broda 100 A1** **Notation 100 A1 oznaka klase 100A1** {The "100" means that the vessel is considered suitable for sea-going service. The "A" indicates that the vessel is not only built or accepted into class according to LR Rules but is also maintained in good and efficient condition. 1 refers to the anchors and mooring equipment being in good and efficient condition in accordance with the Society's Rules}

AA (always afloat) (*adj*) (*mar law*) a term in Charter-Party which stipulates that the charterer must not order the ship to a port or berth where she would touch the bottom or perhaps be unavailable at any time due to tidal variations (http://www.tkmglobal.net/chartering_A.HTM) **uvijek u plutajućem stanju**. *The charterparty contained the notation AAAA (always afloat, always accessible).*

AAR (against all risks) (*prep phr*) (*mar ins*) an insurance policy that provides coverage against all types of loss or damage rather than specific ones **protiv svih rizika**

A.B. /'ei 'bi:/ (*n*) **1 (seamanship) = able-bodied seaman stariji mornar, iskusni**

mornar: *On the morning of February 22 the chief mate decided that he would inspect the automatic draft gauges which were located in each of the ballast tanks to attempt to get them to work again. He asked the 4-8 watch ABs to put water driven air blowers on 4P and 4S water ballast tanks at the end of their watch. He was assisted by the chief officer and by an AB; both had just taken over the watch.*; **2 (seamanship, mar law) kormilar**: *An AB helmsman, and the second officer, who was on the engine controls, accompanied the master on the bridge. {The main jobs of the AB include: reporting to the Master, Chief Mate, or Deck Watch Officer, stands bridge watch as Quartermaster or lookout when underway.}*

aback (*adj*) (*boating/yachting*) sail with the wind on the fore side, pressing the sail back, slowing the ship, giving it sternway, or driving it to leeward (Mayne 2000) **jedro namjerno prebačeno na stranu vjetrova (radi usporavanja ili zaustavljanja jedrilice)**: *the ship came up into the wind with all yards aback During a tack, the jib was backed and remained aback as the dinghy came onto port tack. Za vrijeme letanja flok smo držali protiv vjetrova i ostao je tako sve dok jedrilica nije došla na lijeve uzde / lijevu škotu. set the sail aback prebaciti glavno jedro protiv vjetrova (radi zaustavljanja jedrilice)*. *The sail was set aback on purpose to slow down the ship. Prebacili smo jedro protiv vjetrova kako bi se brod zaustavio.*

abaft /ə'ba:ft/ (*adv, prep*) (*seamanship*) **1 ANTONYM forward** behind; **iza; 2**

toward or nearer to the stern (relative to some other structure or object on board the ship); a point beyond the midpoint of a ship's length, towards the rear or stern. **prema krmi**: *Thirty containers had been lost overboard while 20 others had shifted and collapsed; all of them had been stowed on the starboard side abaft the superstructures. abaft the bridge iza mosta; 3* the after part of a ship; on the stern or after portion of the ship **krmeni dio broda, na krmi**: *The second mate is abaft, supervising the sailors at the aft mooring station. Drugi časnik palube je na krmi i nadzire mornare na krmenom vezu.*

abaft the beam (*prep phr*) (*navig, seamanship*) something (another ship, tug or object) located more than 90 degrees from dead ahead, i.e. a tug or ship observed on the bearing between own ship's beam and the stern quarter **subočice po krmi**: *Overtaking means approaching another vessel at more than 22.5 degrees abaft her beam, i.e., so that at night, the overtaking vessel would see only the stern light and neither of the sidelights of the vessel being overtaken. Consequently, when a vessel is abaft the beam, it might be out of sight, but it should not be out of mind, particularly when she's faster than you.*

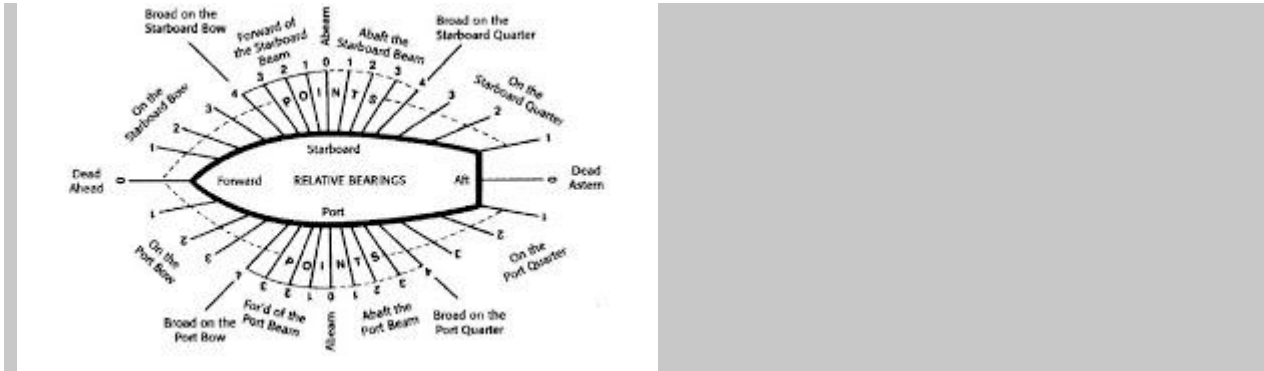

abandon /ə'bændən/ (v) (safety) get away from the ship in an emergency **napustiti (brod)**: The master quickly assessed the seriousness of the situation and decided to abandon ship. Following the broadcast of a distress call at 1125, the 26 crew **abandoned** the vessel in an enclosed lifeboat. **abandon the ship napustiti brod**: Only the Captain shall decide whether and when Abandon Ship procedures are to be undertaken. The captain of the cargo ship sounded an alarm for his crew to **abandon the vessel** shortly before it sank. All crewmembers **abandoned ship** into two lifeboats and were picked up by Royal Navy helicopters. **abandon ship drill vježba napuštanja broda**: At 10551 of 06 January 2013, the master announced an **abandon ship drill**. The accident involved a brake failure on one of the lifeboat winches during a **routine abandon ship drill**. **Abandon ship! Napustite brod!**, **abandon ship to a liferaft**: The crew members on the vessel were unable to extinguish the fire, which spread rapidly throughout its GRP structure, forcing them to **abandon to a liferaft**. **napustiti brod u splavi za spašavanje, prepare to abandon ship pripremiti se za napuštanje broda**: The master ordered the crew to launch the liferaft and to **prepare to abandon ship**. **give order to abandon ship narediti napuštanje broda**: The Master gave the order to **abandon ship** at 2 a.m.

abandon /ə'bændən/ (n) **1 (mar law, navig)** decision by the shipping company to abandon the ship in an emergency because it cannot be saved **napust broda**; **2 (mar law)** A proceeding wherein a shipper/consignee seeks authority to abandon all or parts of their cargo. (US MarAd 2008) **napust tereta**

abandoning ship (n) (safety) **napuštanje broda**

abandonment /ə'bændənment/ (n) (mar law) the voluntary relinquishing of all rights, title or possession of a ship or ship property **napuštaj broda, abandon institut napuštaja broda**: *Authorized abandonment* refers to a condition wherein, at the time the Master decided to abandon ship, there was no hope or intention of returning to the stricken ship.

abandonment /ə'bændənment/ (n) (mar law) **1 (mar law)** prepuštanje osiguranih prava u zamjenu za naknadu za totalnu štetu **napuštaj broda, abandon**; **2 (mar law)** odgovornost brodara do iznosa vrijednosti broda i vozarine (izračunava se nakon sudara) **abandon**

abandonment clause (n) (mar law) klauzula u polici pomorskoga osiguranja u kojoj su navedeni posebni uvjeti pod kojima vlasnik broda može ostvariti pravo na napuštaj **klauzula o napuštajju broda** {valja razlikovati 'napuštaj', što je pojam iz osiguranja, od 'napuštanja', pojava iz sigurnosti plovidbe = abandon ship}

abandon ship (n) (safety) an order given by the senior officer to go to lifeboats and leave the vessel in the face of disaster that is beyond control **napuštanje broda (u pogibli) announce abandon ship objaviti napuštanje broda, prepare to abandon ship pripremiti se za napuštanje broda, instruction for abandon ship upute za napušanje broda**

abandon ship drill (n) (safety) **vježba napuštanja broda**: As far as practicable, each *abandon-ship drill* must be conducted as if there were an actual emergency. On one of our vessels, the lifeboat embarkation ladder rope parted during an *abandon ship drill* conducted in the presence of the US Coast Guard. **routine abandon ship drill** **redovita vježba napuštanja broda**

abandon ship preparation (n) (safety) **pripreme za napuštanje broda**

abate /əˈbeɪt/ (v) (meteorol) **smiriti se (nevrijeme), oslabjeti (vjetar), stišati se, smanjiti se, ublažiti**

abatement /əˈbeɪtmənt/ (n) **1 (meteorol) slabljenje, stišavanje (vjetra, nevremena); 2 (shipping econ) One carrier assumes the charges of another without any increase in charges to the shipper** **preuzimanje troškova (drugog prijevoznika)**

abbreviation /əˌbrɪːviːʃən/ (n) **skraćenica**

abdomen /ˈæbdəmən/ (n) (med) **trbuh, abdomen**: Although it was not immediately apparent, it was likely that the diving gear impacted into the diver's *abdomen* during the fall and caused significant internal injuries.

abdominal /æbˈdɒmɪnəl/ (n) (med) **u trbuhu, trbušnji abdominal pain bol u trbuhu, abdominal injury ozljeda trbuha**: While doing so, the rope suddenly slipped through the stopper, thus tightening, striking the second seaman and causing him *abdominal injuries*.

abduct /æbˈdʌkt/ (v) (safety) **oteti**: The gunmen *abducted* the captain and four other crew members.

abduction /æbˈdʌkʃən/ (n) (safety) **otmica**: The authorities are investigating the *abduction of five crew members* after their vessel was attacked by gunmen in the country's territorial waters.

abeam /əˈbi:m/ (adv) (seamanship) the bearing of an object 90 degrees from ahead, in a line with the middle of the ship; in a line at right angles to the mid-point of the fore and aft line **subočice, po boku, bočno, treso; tal. traverso**: When *the container ship was abeam* the pilot observed that his ship was not answering correctly to the helm. The skipper of the fishing vessel next sighted the other vessel as *it came abeam on the port side*. **be abeam of**: The ship was about 40 meters off and *abeam of the rock* called Cheninic Maillard when he began to turn to starboard. The boats were sailing *abeam of each other* about 150m apart on a parallel course. **biti bočno od, nalazite se po boku, biti subočice**

abeam to port (adv) (navig) **subočice na lijevoj strani**: With the buoy *abeam to port*, the Pilot altered course to 250 degrees.

abeam to starboard (adv) (navig) **ANTONYM abeam to port subočice na desnoj strani, na desnom boku**: at 2018 the south eastern end of Island Breakwater was *abeam to starboard* Once *the ferry was abeam to starboard*, the pilot put the helm hard-to-starboard and asked

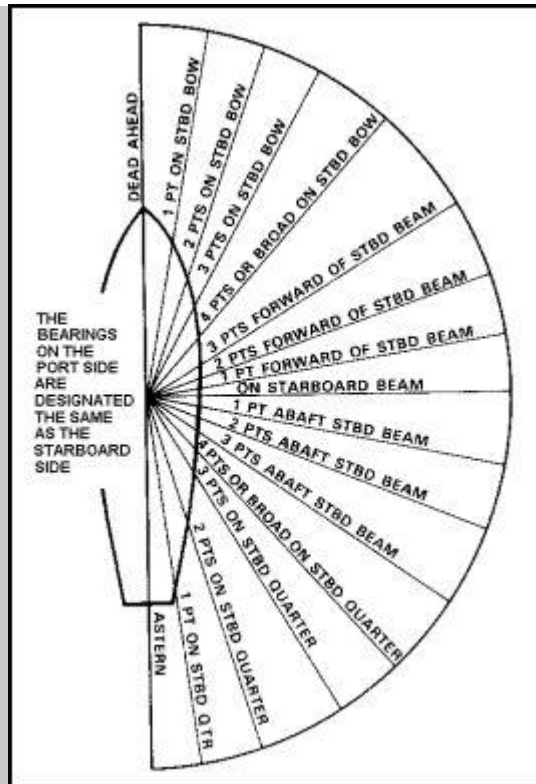

for full ahead on the main engine.

aberration /æbə'reɪʃn/ (n) (navig) A deviation from the proper or expected course **aberacija**

ablation /æb'leɪʃən/ (n) (navig) **ablacija**

ablaze /ə'bleɪz/ (adj) (safety) **koji gori brzo i jako, u plamenu, zapaljen**: Just after midnight, a friend of the skipper was walking along a road high above the small harbour when he noticed that the boat was fiercely ablaze, but still at its mooring.

able-bodied seaman /'eɪblbədɪd 'si:mən/ (n) 1 (seamanship) an experienced deck-department

seaman qualified to perform routine sea duties; a rating between ordinary seaman and leading

seaman or boatswain **stariji mornar, iskusni mornar**: *Able Seaman* works as a watchstander or a day worker, depending on the requirement on the ship. When the ship is not moving, he may be asked to perform security related watches. A Merchant Mariner's Document (MMD) is a must for this position. The able-bodied seaman will be responsible for handling mooring or anchoring duties, carrying out vessel and equipment cleaning, maintenance, and painting duties; 2 (mar law, seamanship) at sea an AB's duties

include standing watch as helmsman and lookout **kormilar**; 3 **zvanje kormilara**

able seaman (AB) (n) = **able-bodied seaman** = **A.B.** 1 **stariji mornar, iskusni**

mornar: The *able seaman* assigned to the watch was absent from the bridge for at least an hour before the vessel grounded. An *able seaman*, the bosun and another able seaman stood in line between the panama lead and the bollard and began to pull the slack of the tow line in by hand. At about 1620, he walked towards the Panama chock to check the spring line, while an *able seaman* close by was preparing a stern line for the mooring tender.; 2 **kormilar**

abnormality /æbnɔ:r'mæləti/ (n) **neuobičajenost, abnormalnost, neispravnost**

aboard /ə'bo:d/ (adv) on or in a vessel **na brodu**: Fortunately, no one aboard the ship has been seriously injured. One of the biggest problems aboard our own boat during the height of the 1979 storm was the ability of objects to break loose. **serve aboard a ship služiti / raditi na brodu (kao pomorac), to come aboard the ship doći na brod, ukrcati se na brod, popeti se na**

brod: A cargo surveyor *came aboard* and attached his cargo sampling equipment to the sampling point of tank No. ..., **fire aboard the vessel požar na brodu**, **safety aboard the ship sigurnost na brodu**: Passage planning must be viewed as an essential and mandatory step that will help to improve the **safety of all aboard** and it must be completed before the first line even slips the dock., **go aboard ići na brod**: At low tide, the skipper rowed out in a dinghy and **went aboard** the boat with a salvage pump., **stow aboard**: All loaded containers have been weighed at the loading facility before being stowed aboard a vessel for export. **ukrcati i složiti na brod**

abort (v) (marine eng, navig, safety) **obustaviti, odustati od, poništiti, anulirati**: A decision was made **to abort the berthing** and return to the anchorage after being told it could take up to 24 hours to clear the whole cooling system. The dangerous cargo shifted while the master was attempting to **abort an approach to** the Firth in heavy seas. **abort a manoeuvre odustati od manovre**: The state of the visibility is key in many operations and it is frequently better **to abort a manoeuvre** early rather than risk being caught out half way through., **abort an anchorage napustiti sidrište**: When considering whether to **abort an anchorage**, the anchor windlass's limitations should be taken into account as part of assessing the risk of remaining at anchor., **abort the berthing**: The **berthing was aborted** unnecessarily by the jetty manager; the problem with the cargo documentation could have been resolved once the vessel was alongside. **obustaviti privezivanje, odustati od manovre privezivanja**

abound /ə'baʊnd/ (v) **obilovati, imati u izobilju**

about (adv) (boating/yachting) on or to the opposite tack; across the wind **na suprotnoj uzdi, na drugoj / suprotnoj strani (vjetar)**: Once the manoeuvre is completed, **the boat is about**. **go about letati, okrenuti (brod) na suprotnu uzdu, prebaciti se na suprotnu uzdu**

above deck (prep phr) (seamanship) **iznad palube, na palubi**: The boat was displaying an anchor ball 3m **above deck level**, and also had a bright orange mizzen sail hoisted to keep her lying into the wind.

abrade /ə'breɪd/ (v) (marine eng) **ohrapaviti, učiniti hrapavim**

abrasion /ə'breɪʒən/ (n) (phys) **abrazija, grebanje, habanje**

abrasion damage (n) (seamanship) **šteta zbog abrazije (konopa, bubnja vitla itd)**: It was concluded that the sample **had suffered abrasion damage** and had lost 34% of its original strength. **internal abrasion damage nutarnja oštećenost zbog abrazije, external abrasion damage vanjska oštećenost zbog abrazije**

abrasive /ə'breɪsɪv/ (adj) **abrazivan**: The **abrasive nature of the cargo** meant that hotwork repairs were regularly required to the hopper and to the hull, which was prone to cracking.

abreast /ə'breɪst/ (adv) **1** abeam of; situated nearby and to the side of the ship **subočice, po boku, bočno**: He stopped the ship's headway **abreast of Le Pot**, a shallow in the south of Le Cochon buoy.; **2** alongside of **usporedno, uz, pokraj**: He was guided by a signalman on deck, positioned **abreast of cargo hold no. 4**.

A.B. seaman /'eɪ bi: 'si:mən/ (n) = **A.B. = able-bodied seaman kormilar**

absorb /əb'sɔ:b; əb'zɔ:b/ (v) (phys) **upijati, apsorbirati**: Pumping was immediately stopped, and the ship's crew attempted **to absorb the fuel** with the oil spill equipment.

absorbant (n) (seamanship) **upijajuće sredstvo, sredstvo koje upija**

abstract /æb'strækt/ (v) **1** izvaditi; **2** sažeti

abstract /'æbstrækt/ (n) **kratak izvadak, kratak sadržaj, izvod, apstrakt, ekscerpt**: No warning was written in the passage plan to inform the bridge team about the expected crossing traffic in the area, even though this information was included in the **sailing direction abstract** which was attached to the passage plan and also marked on nautical chart with a caution symbol. **log abstract izvadak iz broskog dnevnika**: An **abstract of the log** (six copies) covering the period of the heavy weather should be made up.

abuse /əb'ju:z/ (n) **zloporaba, zloraba, zlouporaba alcohol abuse zlouporaba alkohola, nedopuštena uporaba alkohola**: Alcohol abuse is suspected in near collision.

academic awards in ship officer programmes (UK) - Marine

Engineering časnička zvanja, diplome i svjedodžbe u sustavu visokoškolskog obrazovanja i izobrazbe pomoraca (UK) - brodsko strojarstvo: The Academy offers a full engineer officer cadet programme by a Higher National Diploma (HND) route, leading ultimately to the award of a UK Maritime and Coastguard Agency (MCA) Engineer Officer's Certificate of Competency (STCW'95 III/I OOW), and the Higher National Diploma (HND) in Marine Engineering.

(<http://www.warsashsuperyachtacademy.com/courses/engineering/cadetships/engineer-cadet-hnd-programme/course-details.aspx>)

1. Engineer Officer's Certificate of Competency (STCW III/I OOW), and the award of the Higher National Certificate (HNC) in Marine Engineering. potvrdnica o završenom višem stručnom studiju - brodstrojarstvo, viša stručna sprema, 2. Higher National Diploma (HND) in Marine Engineering diploma o završenom visokom stručnom studiju, visoka stručna sprema, 3. Engineer Officer's Certificate of Competency (STCW A-III/I OOW), a Foundation Degree (FdEng) in Marine Engineering and a direct top-up pathway to BEng (Hons) Marine Engineering and Management. prvostupnik brodstrojarstva (Bachelor of Science Degree in Marine Operations / Marine Engineering), akademska sprema; akademski stupanj obrazovanja

academic awards in ship officer programmes (UK) - Navigation (n)

časnička zvanja, diplome i svjedodžbe u sustavu visokoškolskog obrazovanja i izobrazbe pomoraca (UK) - nautičke znanosti DECK OFFICERS časnici palube 1. Deck Officer - Higher National Certificate (HNC) Higher National Certificate (HNC) route leads ultimately to the award of an MCA Deck Officer's Certificate of Competency (STCW'95 II/I OOW), and the Higher National Certificate (HNC) in Nautical Science. A full deck officer cadet programme by a Higher National Certificate (HNC) route, leading ultimately to the award of an MCA Deck Officer's Certificate of Competency (STCW'95 II/I OOW), and the Higher National Certificate (HNC) in Nautical Science.: The scheme consists of five phases (usually over three years), three spent at the Academy and two at sea gaining practical experience. **potvrdnica o završenom višem stručnom studiju - nautika, viša stručna sprema, 2. Deck Officer - Higher National Diploma (HND)** The scheme consists of five phases (usually over three and a half years), three spent at the Academy and two at sea gaining practical experience.: Higher National Diploma (HND) route, leading ultimately to the award of a UK Maritime and Coastguard Agency (MCA) Deck Officer's Certificate of Competency (STCW'95 II/I OOW), and the Higher National Diploma (HND) in Nautical Science. **diploma o završenom visokom stručnom studiju - nautika, visoka stručna sprema, 3. Deck Officer - Foundation Degree (Bachelor of Science Degree in Marine Operations / Nautical Science)** a full deck officer cadet programme by a degree route, leading ultimately to the award of a UK Maritime and Coastguard Agency (MCA) Deck Officer's Certificate of Competency (STCW'95 II/I OOW), a Foundation Degree (FdSc) in Marine Operations and a direct top-up pathway to BSc (Hons) Marine Operations Management. **prvostupnik nautičkih znanosti (B.Sc), akademska sprema; akademski stupanj obrazovanja** . Deck Officer's Certificate of

Deck Officer - Higher National Certificate (HNC) Higher National Certificate (HNC) route leads ultimately to the award of an MCA Deck Officer's Certificate of Competency (STCW'95 II/I OOW), and the Higher National Certificate (HNC) in Nautical Science. A full deck officer cadet programme by a Higher National Certificate (HNC) route, leading ultimately to the award of an MCA Deck Officer's Certificate of Competency (STCW'95 II/I OOW), and the Higher National Certificate (HNC) in Nautical Science.: The scheme consists of five phases (usually over three years), three spent at the Academy and two at sea gaining practical experience. **potvrdnica o završenom višem stručnom studiju - nautika, viša stručna sprema, 2. Deck Officer - Higher National Diploma (HND)** The scheme consists of five phases (usually over three and a half years), three spent at the Academy and two at sea gaining practical experience.: Higher National Diploma (HND) route, leading ultimately to the award of a UK Maritime and Coastguard Agency (MCA) Deck Officer's Certificate of Competency (STCW'95 II/I OOW), and the Higher National Diploma (HND) in Nautical Science. **diploma o završenom visokom stručnom studiju - nautika, visoka stručna sprema, 3. Deck Officer - Foundation Degree (Bachelor of Science Degree in Marine Operations / Nautical Science)** a full deck officer cadet programme by a degree route, leading ultimately to the award of a UK Maritime and Coastguard Agency (MCA) Deck Officer's Certificate of Competency (STCW'95 II/I OOW), a Foundation Degree (FdSc) in Marine Operations and a direct top-up pathway to BSc (Hons) Marine Operations Management. **prvostupnik nautičkih znanosti (B.Sc), akademska sprema; akademski stupanj obrazovanja** . Deck Officer's Certificate of

Competency (STCW'95 II/I OOW), a Foundation Degree (FdSc) in Marine Operations and a direct top-up pathway to BSc (Hons) Marine Operations Management.

accelerate /æk,selə'reit/ (v) (phys) **ubrzati, ubrzavati, povećavati brzinu**: As the vessel continued to accelerate, a forward spring was deployed and placed on a bollard by the shore mooring party, who then moved to safety.

acceleration /æk,selə'reɪʃn/ (n) (phys) **ubrzanje, akceleracija**

accept /æk'sept/ **accept the offer prihvatiti ponudu** (v) **prihvatiti**: Upon class approval of the repair the discharge port agreed to accept the vessel. Never accept fuel leakage on any system: a minor weep may originate from a small crack, which can propagate very quickly under vibration and engine loading

acceptable /æk'septəbl/ (adj) **prihvatljiv, uobičajen**

acceptable risk (n) (mar ins) **prihvatljivi rizik**

acceptable risk criteria (n) (mar ins) **prihvatljivi kriteriji rizika**

acceptance trials (n) (nav arch) a rigorous test process and material inspection carried out underway by the government, in the presence of the representatives ship register, to determine that ships constructed in shipyards are suitable for delivery **tehnička ispitivanja prije primopredaje broda**

accessory /æk'sesəri/ (n) (marine eng) **pribor, dodatak**

access /'ækses/ **access door prilazna vrata, prilazni otvor, prilazni poklopac (kotlu itd.), access to the machinery / engine / tanks prilaz strojarnici, strojevima / stroju / tankovima**: The owner should draw up work risk assessments for any work in the tanks and the access to the tanks., **access opening prilazni otvor/vrata, give access to omogućiti pristup/prilaz (nečemu), to get access to pristupiti (nečemu) naći put do, access to information / charts pristup informacijama / kartama**: The owner's shore based crisis management team did not have access to accurate stability information. The Pilot Station uses appropriate means to ensure that sea pilots engaged in the pilotage area have access to the latest sounding charts at all times. (n) **pristup**:

access /æk'ses/ (v) **pristupiti**: The fixed fire pump could not be started and the emergency fire pump was difficult to access.

access hatch (n) (nav arch) **otvor za ulaz u tank**: The day before the planned maintenance, he instructed the Bosun to open the **access hatch** of the tank and to start ventilating with air so that it would be gas-free before tank entry the next morning.

access holes (n) (nav arch) temporary openings cut in the ship's structure to allow access and shifting of equipment into position during ship's construction **prilazni otvori**

accessible /æk'sesəbl/ (adj) **pristupačan, kojemu se može prići**

access ladder pristupne ljestve, prilazne skale: He had checked each of the tanks visually by taking a few steps down the tank access ladder.

accessorial charges (n) (shipping econ) **dodatni troškovi (uz osnovnu ugovornu cijenu ili tarifu)**

accessorial service (n) (shipping econ) Service rendered by a carrier in addition to transportation services. (e.g. sorting, packing, precooling, heating and storage.) **dopunske usluge**

accessories /æk'sesəriz/ (n, n pl) **1 pribor, pomoćni uređaj; 2 potrepštine; 3 (marine eng) armatura, pripadci, dodatni dijelovi**: Although many boats' fittings and accessories might appear to be secure, this should not be taken for granted.

accessory /ək'sesəri/ (*adj*) pomoćni, dodatni, dopunski

accessory /ək'sesəri/ (*n*) (*marine eng*) pomoćni uređaj

accident /'æksɪdənt/ **1 = marine accident = marine casualty COMPARE**

incident IMO defines two types of undesired events at sea; **MARINE CASUALTY** (largely synonymous to the general concept of 'accident', *nesreća* in Croatian) and **INCIDENT** (*nezgoda* in Croatian, i.e. an undesired event at sea other than 'accident'.); (IMO DEFINITION) A **MARINE CASUALTY** (i.e. an '**accident**') means an event that has resulted in any of the following: **1** the death of, or serious injury to, a person that is caused by, or in connection with, the operations of a ship or; **2** the loss of a person from a ship that is caused by, or in connection with, the operations of a ship; or **3** the loss, presumed loss or abandonment of a ship; or **4** material damage to a ship; or **5** the stranding or disabling of a ship, or the involvement of a ship in a collision; or **6** material damage being caused by, or in connection with, the operation of a ship; or **7** damage to the environment brought about by the damage of a ship or ships being caused by, or in connection with, the operations of a ship or ships. (IMO RESOLUTION A.849(20) adopted on 27 November 1997 - CODE FOR THE INVESTIGATION OF MARINE CASUALTIES AND INCIDENTS); NATIONAL DEFINITION (New Zealand): An ACCIDENT means an occurrence that involves a ship and in which: a person is seriously harmed; the ship sustains damage or structural failure; there is a loss of, or damage to, or movement of, or change in the state of, the cargo of the ship which poses a risk to the ship or other ships; there is a significant loss of, or significant damage to, property (not being the cargo carried by the ship) or the property of any person (whether or not aboard the ship), whether or not the loss or damage arises from an interaction between 2 ships; there is a loss or escape of any substance or thing that may result or has resulted, in serious harm to any person; a person is lost at sea (whether or not subsequently found) or is missing; the ship is foundering, capsizing, being abandoned; stranding; missing or has foundered, capsized, been abandoned, been in a collision, or has had a major fire on board.

(<http://www.maritimenz.govt.nz/commercial/safety/accidents-reporting/definitions.asp>) **fatal**

accident nesreća sa smrtnim posljedicama: *This is another accident involving a fisherman losing his life.* **a nesreća**: *If the safety guardrail had been fitted, this accident would not have occurred.*

Da je bila postavljena zaštitna ograda, ne bi bilo došlo do nesreće. **the accident occurred ...**

nesreće se dogodila ... , do nesreće je došlo ...: *The accident occurred in an area of complex and strong tidal flows where there had been other accidents resulting in damage to vessels and shore infrastructure* *The accident occurred in an area of complex and strong tidal flows where there had been other accidents resulting in damage to vessels and shore infrastructure.*, **accident**

prevention sprječavanje nesreća: *The analysis involved ship condition surveying, material on loss/accident prevention and an extensive seminar programme.*, **accident report izvješće o**

nesreći, izvještaj o nesreći, accident investigation istraga o nesreći: *Post-accident investigation showed that the tripping line had jammed between the cruciform and the jaws of the docking head.*

investigation into an accident istraga nesreće: *The sole objective of the investigation of a safety investigation into an accident under these Regulations shall be the prevention of future accidents through the ascertainment of its causes and circumstances.*, **the accident**

happened ... nesreća se dogodila, do nesreće je došlo ...: *The accident happened because deficiencies in the loading and securing of the deck containers were spotted but not rectified before the ship sailed.*

avoid the accident izbjeći nesreću: *This accident could have been avoided had a suitable safety regime been in operation.* Nesreća bi se bila mogla izbjeći da je bio primijenjen

odgovarajući sustav sigurnosti., **cause of accident uzrok nesreće, prevent an accident**

sprječiti nesreću, lessons from the accident: *The main lesson e can learn from all accidents is: keep alert, think carefully about what you are doing and be prepared for the unexpected.* **pouke iz**

nesreće, serious accident: *There has been no pollution following a collision, grounding, or other serious accident.* **ozbiljna nesreća, teška nesreća, circumstances of an accident:** *The circumstances of this accident are, unfortunately, not uncommon.* **okolnosti u kojima je nastala nesreća, contribute to the accident doprinijeti nesreći:** *There was no suggestion at all of alcohol or drugs contributing to the accident.*; **2 nezgoda occupational accident nezgoda na radu, profesionalna nezgoda** {In its generic use the term 'accident' may refer to any type of maritime accident (=serious consequences) or incident (=minor accidents). For specific use of the terms 'accident' and 'incident' see 'marine casualty.}

accidental /æksɪ'dentl/ (adj) **slučajan:** *There were no shields fitted above the pipe to deflect any accidental release of fuel into the bilges. Accidental release of a lifeboat from the refrigerated cargo vessel ...* **accidental causes (mar ins) slučajni uzroci, accidental damage slučajna šteta, šteta nastala slučajno:** *... failure to keep a proper lookout, faulty maintenance or accidental damage to equipment can all play a part in creating situations which can escalate to dire levels ...*, **accidental release of fuel slučajno ispuštanje, slučajno puštanje:** *There were no shields fitted above the pipe to deflect any accidental release of fuel into the bilges.*

accommodate /ə'kɒmədeɪt/ (v) **1 prihvatiti brod u luci, dati brodu vez u luci, smjestiti brod u luci:** *The terminal is capable of accommodating cruise ships up to 320 metres in overall length. The Ferry Terminal accommodates car ferry services to Britain and continental Europe together with regular shipments of trade vehicles.*; **2 (marine eng) smjestiti, postaviti, primiti:** *Several compression fittings had been used in a very short run of pipe to accommodate valves and changes to the pipe's diameter.* **be accommodated in biti smješten u, nalaziti se u:** *The 22m tail was shortened to 15m to allow it to be accommodated within the test machine.*

accommodation /ə'kɒmə'deɪʃn/ (n) **1 all spaces on a ship, such as living spaces for the officers and the crew, including navigation, radio and similar spaces a smještaj; 2 nastambe časnika i posade na brodu, smještaj časnika i posade na brodu:** *By now, the wheelhouse, the shelter deck, and much of the accommodation were filled with thick black smoke which was spreading and becoming more dense by the minute.* **crew accommodation nastambe posade, accommodation spaces stambeni prostori na brodu:** *Neither the owner nor the skipper permitted smoking in the accommodation spaces, for good reason.*, **accommodation area predio smještaja posade:** *Although this vessel was fitted with a fixed fire detection system, there was no sensor in the accommodation area.*, **accommodation alleyway hodnik u nastambama posade:** *At 0630, a fisherman looked up the accommodation alleyway and saw thick black smoke coming out of one of the cabin doors.*, **accommodation door vrata nastamba posade:** *Three crewmen had been in the mess room, and one of them managed to dive down and out through the open accommodation door to escape from the upturned vessel.*, **accommodation superstructure nadgrađe nastamba posade:** *The tug was made fast to bitts at the aft end of the main deck, by the break of the accommodation superstructure.*; **3 smještaj broda u luci berthing accommodation kapaciteti za privezivanje, luči vezovi; 4 smještaj tereta u luci storage accommodation skladišni kapaciteti (u luci); 5 smještaj tereta na brodu accommodation gangway (n) (nav arch) = accommodation ladder brodski siz, brodska skala:** *As the main deck was level with the quay, the stevedores did not use the after accommodation gangway, which was about 13m further aft.*

accommodation ladder (n) 1 (nav arch) = gangway the portable steps from the gangway down to the waterline or quay **brodski siz, brodska skala, tal. scala reale; scala**

di banda: The AB fell between the container ship and the quay when using a pilot gate in preference to the vessel's accommodation ladder. Uncontrolled descent of an accommodation ladder from the container ship in San Francisco Bay resulted in one fatality. **The pilot requested that the port accommodation ladder be hoisted** by only a few metres and retained there, as he intended to use it for disembarking from the 'sea' side at the next berth. **descend the accommodation ladder**
spuštati se po brodskom sizu, hoist the accommodation ladder podignuti brodski siz: During preparations for berthing the crew were requested to recover the pilot ladder and to **hoist the accommodation ladder** to deck level to be clear of subsequent cargo hose handling operations.



; 2 (nav arch) a staircase suspended over the side of a vessel from a gangway to a point near the water to provide easy access to the deck from a small boat alongside **brodska skala za ukrcaj peljara s peljarske brodice**

accommodations (n) (seamanship) stambene prostorije na brodu, nastambe

accompany /əˈkʌmpəni/ (v) 1 **popratiti (dokumentom), pratiti:** All ropes or wires supplied to the vessel should be accompanied by an individual certificate stating the breaking load (MBL).; 2

biti u pratnji: On the bridge was the chief officer, accompanied by an AB lookout.

accomplish /əˈkʌmplɪʃ/ (v) **postići, izvršiti, obaviti.** They used all the resources available to accomplish or achieve the established goals of safety and efficiency.

according to (prep) **prema, u skladu s**

account /əˈkaʊnt/ **for account of za račun (nekoga), take into account uzeti u obzir, voditi račun o.** Passage plans should take into account all available information so that corrective actions can be taken in good time should things go wrong. 1 (shipping econ) **račun, bankovni račun on buyer's account na kupčev račun, bank account bankovni račun,**

business account poslovni račun: račun firme, **current account tekući račun;** 2 **izvješće, prikaz table account tabelarni prikaz, a short account of kratak prikaz**

accountable to /əˈkaʊntəbəlˈtuː/ (adj) **biti odgovoran nekome:** Although port authorities are accountable to the legislative body that created them, they often have a great deal of flexibility in operation and finance.

account for (v) 1 **iznositi, odgovarati za, odnositi se na:** Transportation accounts for 66 percent of total U.S. oil consumption. 66 posto ukupne potrošnje nafte u SAD-u odnosi se na transport.; 2

biti odgovoran za; 3 uzeti u obzir: The local chart also warned of anomalies due to dredging, and the master ordered a small course alteration to port to account for an offset.

accumulate /əˈkjuːmjəleɪt/ (v) **nagomilati (s), nakupiti (se):** It was concluded that lack of ventilation had allowed hydrogen gas from the batteries to accumulate, to produce an explosive mixture that was ignited by sparks from the angle grinder. With the main engine still running, heat built up, causing soot deposits that had been allowed to accumulate in the EGE to ignite.

accumulator battery akumulatorska baterija, akumulator

accuracy /'ækjərəsi/ (n) **1** točnost, preciznost **determine the accuracy** utvrditi

točnost, **verify the accuracy** provjeriti točnost. Navigators should use all available means to check the position of their vessel, but they must regularly verify the accuracy of positions displayed by electronic position fixing systems by reference to visual bearings and transits whenever available.; **2**

COMPARE availability COMPARE coverage COMPARE reliability

COMPARE fix rate COMPARE fix dimension COMPARE system

capacity COMPARE ambiguity potential točnost (navigacijskog sustava):

Make use of all available navigation aids and do not simply rely on the perceived accuracy of a GPS track plotter as the single source of navigation. **predictable accuracy** predvidljiva pogriješka,

očekivana pogriješka, **relative accuracy** relativna grješka, grješka susreta brodova,

accuracy of ship's position preciznost pozicije broda

accurate /ækjəret/ **1 (adj)** točan, precizan, ispravan **accurate fix** precizna pozicija

broda, **precizno određena pozicija**, **accurate assessment** precizna procjena: He

then attempted to acquire the target on the vessel's ARPA, but was unable to obtain an accurate fix.

There are no excuses for not using navigational aids such as ARPA and compass repeaters to aid the accurate assessment of close quarters situations., **accurate data** precizni podatci

The most accurate data is available only after the target has been tracked for a full 3 minutes., **accurate**

position točna pozicija: When a boat is in difficulty and requests assistance, this cannot be

provided promptly unless an accurate position is available., **accurate navigation aid** precizno

navigacijsko pomagalo: ECDIS is potentially a very accurate and effective navigation and

bridge watchkeeping aid, but it is no more than just that: an aid., **accurate account of** precizan

prikaz nečega: It is not known why the course was altered, and it was possible to establish an

accurate account of events only by analysing the vessel's VDR.; **2** **besprijeoran**

acid /'æsid/ (**marine eng**) (**cargo**) **kiselina:** The inhibited cleaner also contained a colouring agent to indicate the acid strength.

acidimeter (n) (**marine eng**) **acidometar**, **mjerač kiseline**

acidity /ə'sidəti/ (n) (**cargo, marine eng**) **kiselost**, **aciditet**

acid proof (adj) (**marine eng, cargo**) **otporno na kiselinu**, **zaštićeno od kiselina**

acknowledge /æk'nɒlɪdʒ/ (v) **1 a** **potvrditi** **acknowledge receipt of** **potvrditi primitak:**

Kindly acknowledge receipt of this letter. Ljubazno Vas molimo da potvrdite primitak ovog dopisa. The

container ship never acknowledged our ship's VHF calls; **2 a** **priznati**

acknowledgement /ə'knɒlɪdʒmənt/ (n) (**comm**) (n) (**shipping econ**) **potvrda (primitka**

poruke) **obtain acknowledgement** **obtained** **dobiti potvrdu o primitku**

acknowledgement of receipt (n) **1 (shipping econ, mar law)** notification relating to the

receipt of goods **potvrda primitka robe;** **2 (comm)** a notification relating to the receipt of

messages and documents. **potvrda primitka poruke**

acorn nut /'eɪkɔ:n,nʌt/ (n) (**marine eng**) **slijepa matica**

acquainted with /ə'kweɪntɪd 'wɪð/ (adj) **upoznat s:** The OOW had little time to become

fully acquainted with the traffic and navigational situation.

acquiescence /ækwɪ'ɛsəns/ (n) (**shipping econ**) When a bill of lading is accepted or signed by a

shipper or shipper's agent without protest, the shipper is said to acquiesce to the terms, giving a silent

form of consent. **prihvaćanje (teretnice) bez prigovora**, **prešutno prihvaćanje**

acquire the company (v) (*shipping econ*) **preuzeti kompaniju**: Singapore container shipping line Neptune Orient Lines finally agreed to be acquired by France's CMA CGM in a cash deal that values its equity at \$2.4bn.

acquire the contact (v) (*comm*) **uspostaviti kontakt**: We also tried to acquire the contact on the S band radar display.

acquire the target (v) (*navig*) **prihvatiti cilj / objekt (na radaru), uhvatiti cilj / objekt na radaru, označiti cilj / objekt**: The second officer did not acquire the vessel on the ARPA or use the AIS data to determine the vessel's name or status. He then attempted to acquire the target on the vessel's ARPA, but was unable to obtain an accurate fix.

acquittance /ə'kwɪtəns/ (n) (*shipping econ, mar law*) a written receipt in full, in discharge from all claims **potvrda primitka, potvrda namirenja**

A/C rain (FTC) (=anti clutter rain) kontrola za uklanjanje smetnja od kiše i padalina, kontrola za brisanje smetnja od padalina {FTC = fast time constant}

ACR; Anti Clutter Rain (n) (*navig*) = **A/C rain (FTC)** brisanje smetnji s padalina, brisanje radarskih smetnja od padalina, sustav ACR, sustav brisanja smetnja od padalina

A/C sea (STC) (n) (*navig, electr*) kontrola za uklanjanje smetnja od mora i valova {STC = sensitivity time constant}

act /ækt/ (v) **act upon djelovati na djelovati**: It was usual at this berth to take two shore ropes forward and two aft to act as head/stern and breast lines, and to use the ship's lines as springs. The owner on the boat called his friend to the wheelhouse and asked him to go forward and act as lookout. **act accordingly djelovati u skladu s (nečim)**: Furthermore, the handing of a portable radio to one of the mooring team would have identified that person as the supervisor, and enabled them to act accordingly.

act (n) **1 a čin, djelo**: The act of cancelling the alarm was insufficient to rouse the master into effectively monitoring the ship's position.; **2 radnja; 3 (mar law) zakon; 4 (mar law)**

dokument, isprava, akt acts isprave, dokumenti, akta

action /'ækʃn/ (n) **djelovanje, djelo, postupak, radnja (pri manovri za izbjegavanje sudara)**: The managers of the ship have taken action to improve the standard of bridge watchkeeping on board their vessels. **take action**: There are only 20 minutes in which to notice the other radar target, monitor its movement and take action to avoid collision. **poduzeti radnju, take immediate action poduzeti hitne mjere, poduzeti mjere odmah**: Emergency situations require immediate action., **piston action rad klipa / stapa, take appropriate action poduzeti odgovarajuću radnu**: There was very little time for vessels proceeding in the traffic lane to effectively assess the situation and take appropriate action., **take avoiding action poduzeti radnju radi izbjegavanja sudara**: The trawler's skipper failed to detect the gill netter until it was too late to take effective avoiding action., **course of action niz radnji, sve potrebne radnje**: When serving with inexperienced and newly acquainted officers, masters should never assume that they will necessarily carry out a course of action as they would expect., **take corrective action poduzeti popravnu radnju (radi izbjegavanja sudara), poduzeti novu radnju**: However, when fog was present he had to rely on the radar alone, delaying his ability to take effective corrective action to maintain position in the river., **take substantial action poduzeti uočljivu radnju**: In such circumstances, the port's operational procedures require pilots to 'take early and substantial action and make their intentions clear', **take legal action tužiti, podnijetu tužbu**

action in personam (n) (mar law) the writ whereby an action was traditionally instituted against a person, including a corporation, rather than against a thing. (Tetley) **pravni akt u odnosu na osobu, tvrtku itd., pravni postupak u odnosu na osobu, tvrtku itd.**

action in rem (n) (mar law) the writ whereby an action was traditionally instituted against a thing (Tetley) **pravni akt u odnosu na stvar, pravni postupak u odnosu na stvar**

activate (v) (marine eng) **pokrenuti, započeti, aktivirati**: *As the ignition was activated and the fuel sprayed from the open ended pipe, a fire erupted, engulfing the third engineer and also setting fuel alight on the electrician. The vessel was fitted with a bilge alarm, but it had failed to activate.* **activate the device** **pokrenuti uređaj**, **activate the alert** **aktivirati uzbunu**, **activate the emergency transmission** **pokrenuti pomoćni pedajnik**, **activate the epirb** (safety, navig) **aktivirati epirb**

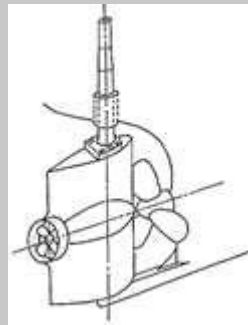

active rudder (n) (nav arch) **aktivno kormilo**

Act of God (n) (mar law) accidents which are beyond human control such as flood, lightning or hurricane; also termed as 'force majeure' **viša sila**

Act of public enemies (n) (mar law) **djelo javnih neprijatelja**

act of war (n) (mar law) **ratni čin**

actual carrier (n) (mar law) any person to whom the performance of the carriage of the goods, or of part of the carriage, has been entrusted by the carrier, and includes any other person to whom such performance has been entrusted. (Hamburg Rules); osoba različita od prijevoznika koja stvarno obavlja dio prijevoza ili prijevoz u cijelosti **stvarni prijevoznik**

actual fault or privity /'privity/ (n) (mar law) A faulty act or omission of a party, or his knowledge of or complicity with the faulty act or omission of another for whose conduct he is responsible (http://www.mindserpent.com/American_History/reference/Tetley_admiralty/a-d.htm) **krivi čin / propust ili skriveno znanje**

actual total loss (n) (mar law, mar ins) **stvarna totalna šteta, stvarni potpuni gubitak broda**

actuate /'æktfueit/ (v) **aktivirati, pokrenuti, potaknuti**

actuating /'æktfueitin/ (adj) (marine eng) **koji pokreće, koji aktivira** **actuating gear** **pokretački uređaj, pokretački mehanizam** **valve actuating** **pokretački mehanizam ventila**: *The valve actuating gear is pressure feed-lubricated from the centralized lubricating system, through the water chamber part and from there into the rocker arm shaft t,* **actuating portion** **dio regulatora za aktiviranje, servomotor**

actuator /'æktfueitə/ (n) **pokretač, aktivator, servoklip**

adaptor; adapter /ə'dæptə/ (n) **1 (electr) strujni adapter; 2 (safety) cijevni adapter (za vatrogasne cijevi drugačijen navoja)**

Adcock aerial (n) (electr, navig) **Adcockova antena**

A/D converter (n) (electr) pretvarač analognih u digitalne signale

ADDCOMM; address commission (n) (shipping econ) Percentage of commission charged by charterers **unajmiteljeva / čartererova provizija, provizija čarterera free of ADCOMM; address commission bez provizije čartereru, bez čartererove**

provizije Free of address, refers to a charter which is not paid the address commission. (The fee paid by vessel owners to charterers, the party who owns cargo and employs a shipbroker who will find a proper ship to deliver the cargo. As a result, the total fees incurred by the charterer are reduced by the amount of the address commission.)

added value (n) (navig) dodana vrijednost (pri planiranju i nadziranju plovidbenog putovanja): By combining and integrating functions and information the INS provides "added value" for the operator to plan, monitor and/or control safety of navigation and progress of the ship.

addition /ə'dɪʃn/ (n) **1 dodatak in addition pored, uz to, osim toga povrh toga:** In addition, all of the fire detectors were of the smoke detection type - there were no flame or heat detectors fitted. In addition, the starboard steering system's hydraulic failure alarm sounded on the bridge console's machinery alarm panel., **in addition to pored, uz:** In addition to the mooring lines, a tug was being used to hold the vessel's stern on the berth while its bow thrusters were being used forward. In addition to watchkeeping, the chief officer was responsible for overseeing cargo operations in port.; **2 (math) zbrajanje, dopuna, dodavanje:** The following changes were made: the raising of gunwales, enlargement of the wheelhouse, the addition of an hydraulic pot-hauler and the fitting of ballast.

address (v) **1 (safety, comm) obratiti se (putnicima):** address the passengers The captain addressed his passengers over the ship's CCTV; **2 raspraviti o pitanju / problemu, osvrnuti se na pitanje / problem, pobrinuti se o problemu, pozabaviti se s (problemom, pitanjem):** If you do not receive the delivery please let us know as soon as possible so that we can address the problem and ensure that your needs are met.

addressee /ædre'si:/ (n) **1 naslovnik, primalac pisma; 2 primalac poruke**

adequate /ædɪkwət/ (adj) **adekvatan, odgovarajući:** The only real protection from fatigue is adequate manning for the work being done. Ensure that an adequate risk assessment procedure is drafted for all its ships and that it addresses specifically the launching of lifeboats. It is therefore essential that adequate safety measures are in place. After the alteration of course was completed, the OOW should have rechecked the situation to ensure that the CPA was still adequate.

adhere to /əd'hɪə'tu:/ (v) **držati se nečega, pridržavati se (uputa, pravila, ugovora):** The officer of the watch was rigidly adhering to the planned navigation track The obligation to keep an effective lookout at sea is fundamental to safe navigation as is the need to adhere to the rule of the road.

adhesion /əd'hɪ:ʒən/ (n) (phys) **prijanjanje, adhezija, ljepljenje:** Polyurethane adhesive sealants normally provide good adhesion, but in this case poor surface preparation had resulted in ineffective adhesion to the deck. **adhesion of cargo to holds/tanks ljepljenje tereta za (nutarnje) strane skladišta/tankova**

adjacent /ə'dʒeɪsnt'tu:/ (adj) **susjedni, pokrajnji, obližnji:** A high speed catamaran (HSC) was scheduled to shift to an adjacent berth. Boundary cooling continued, and adjacent compartment temperatures were monitored. **adjacent to blizu (nečemu, nečega), pokraj tik uz odmah do:** The stowage of lifejackets in a dedicated container on deck adjacent to the liferafts allowed the crew to readily access them. The stowage of lifejackets in a dedicated container on deck adjacent to the liferafts allowed the crew to readily access them., **adjacent berth obližnji vez:** The angle of approach to the berth was more open than 'usual' due to another tanker alongside the **adjacent berth**

adjust /ə'dʒʌst/ **1 (v) namjestiti, regulirati, ugoditi, podesiti, naštelati, naštimati:** If

*the radar controls are incorrectly adjusted the performance of the radar will be adversely affected. Having fetched a screwdriver, he removed the vent diffuser to adjust the flow of air from the vent. **adjust***
general average (mar law) likvidirati generalnu havariju, adjust the transceiver
ugoditi primopredajnik, namjestiti frekvenciju/postaju na radioprijemniku, adjust
the autopilot namjestiti automatsko kormilo, adjust the ship's heading namjestiti
pramčani kut, namjestiti pramčanicu, adjust the course namjestiti kurs. *The master instructed the OOW to adjust course to pass close astern of Target A and ahead of Target B., **adjust***
the passage plan namjestiti plan plovidbe: *Once at sea, the master decided to adjust the passage plan so as to keep the wind and sea fine on the starboard bow.; 2: The skipper therefore relied on hand signals from a deckhand on the dredger to adjust the relative position of the two vessels. prilagoditi*

adjustable /ə'dʒʌstəbl/ (adj) prilagodljiv, podesiv, koji se može namjestiti / regulirati

adjustable spanner (n) (marine eng) francuski ključ

adjuster /ə'dʒʌstə/ (n) 1 a (marine eng) uređaj za namještanje, naprava za reguliranje, uređaj za podešavanje; 2 (mar ins) likvidator šteta, likvidator generalne havarije, procjenitelj šteta **average adjuster** likvidator generalne havarije / štete

adjustment /ə'dʒʌstmənt/ (n) 1 (marine eng, seamanship, electr) namještanje, reguliranje, ugađanje, prilagođavanje, podešavanje: *The correct adjustment of the limit switch allowed for this, and was designed to prevent over tensioning and stretching of the wire. The importance of correct adjustment cannot be over-emphasised. Unfortunately, the adjustment of the linkage caused it to come into contact with other components when the engine was overloaded, which ultimately led to its eventual failure.; 2 ispravak make adjustment ispraviti, izvršiti ispravak, obaviti korekciju:* *The port propeller had spontaneously moved to full astern pitch just as the initial course adjustment was made, as requested by the pilot.; 3 (mar ins, mar law) procjena (štete) **adjustment of general average** likvidacija (generalne havarije), obračun generalne havarije*

adjustment screw (n) (marine eng) vijak za ugađanje, vijak za regulaciju, vijak za podešavanje

administration /əd,mɪnɪ'streɪʃən/ (n) 1 (mar law) vlada; 2 (mar law) ministarstvo

(pomorstva) **maritime administration** ministarstvo pomorstva: *A recommendation has also been made to the flag State Administration to raise the matter at the IMO, with the aim of enhancing local fixed firefighting systems ..., **shipping administration** ministarstvo pomorstva; 3*

(mar law) **nadležno ministarstvo, nadležna uprava:** *Other recommendations were issued to the flag State Administration and to the Lifeboat Manufacturer to ensure an effective lifeboat maintenance regime.; 4 primjena (zakona, propisa, pravila): proper administration of the law; 5*

propisivanje (lijeka), određivanje (lijeka), primjena (medicinskog postupka):

First-aid medical training is essential, and in this case the prompt administration of CPR (cardiopulmonary resuscitation) almost certainly saved the crewman's life.

admiral /'ædmərəl/ (n) (navy) the supreme commander of a fleet or navy; a commissioned officer in the navy with a rank above vice-admiral, designated by four stars in the U.S. Navy **admiral**
of the fleet admiral, admiral mornarice, admiral flote, fleet admiral admiral, admiral mornarice, admiral flote {In ascending order of seniority, Rear Admiral, Vice Admiral, Admiral and Admiral of the Fleet (Royal Navy). Derivation Arabic, from Amir al-Bahr (Ruler of the sea).}

Admiralty anchor; admiralty anchor (n) (nav arch) admiralitesko sidro, sidro s

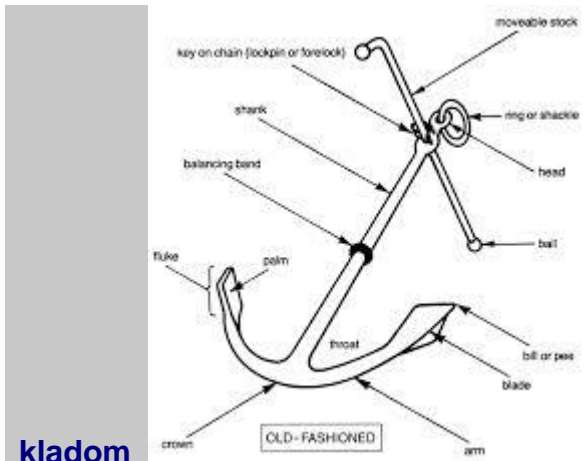

kladom

Admiralty publications; Admiralty publications (n) (navig) publikacije britanskog admiraliteta

Admiral of the Fleet /'ædmərəl/ (n) (navy) admiral flote, admiral ratne mornarice

admiralty; admiralty /'ædmərəlti/ (n) 1 (navy) a high naval authority in charge of a state's navy or a major territorial component **admiralitet**; 2 (mar law) **admiralitetско pravo**; 3 the governing authority of the Royal Navy **Britanski admiralitet (zgrada, Uprava ratne mornarice)**

admiralty brass (marine eng) specijalna mjed, specijalni mesing

Admiralty charts (n) (navig) admiralitetске karte, karte Britanskog admiraliteta:

The approach channel was prone to silting, and a warning to this effect was shown on the appropriate Admiralty chart. Pilotage was not compulsory, but the information shown on the British Admiralty chart of the area was not up to date. Pilotage was not compulsory, but the information shown on the British Admiralty chart of the area lacked detail and was not up to date.

Admiralty law (n) (mar law) body of law that deals with maritime cases **admiralitetско**

pravo: *Admiralty law or maritime law is a distinct body of law that governs maritime questions and offenses.*

Admiralty List of Lights and Radio Signals Popis svjetlosnih signala i radio

signala Britanskog admiraliteta: *The VTS service was listed in maritime publications such as the Admiralty List of Radio Signals Volume 6 (NP286(8)) and the World VTS Guide5.*

Admiralty Manual of Navigation (n) (navig) Navigacijski priručnik Britanskog

Admiraliteta: *The Admiralty Manual of Navigation, Volume 1 provides best practice for plotting a ship's swinging circle at anchor.*

Admiralty Pilot Book (n) (navig) Peljar Britanskog admiraliteta *The Admiralty Pilot book contained a similar warning, but also mentioned that buoyed channels should be used.*

Admiralty Sailing Directions Upute za plovidbu Britanskog admiraliteta, **rute**

Britanskog admiraliteta: *Advice contained in the Admiralty Sailing Directions for this port includes a suggestion to contact the harbourmaster before entry due to changing depths in the harbour.*

admissible /əd'misəbl/ (adj) 1 dopustiv; 2 prihvatljiv

admission /əd'miʃn/ (n) **admission of fresh-air charge** dovod svežeg zraka, punjenje svježim zrakom 1 (marine eng) a ulaz; 2 (marine eng) dovod; 3 (marine eng) pristup

admit /əd'mit/ 1 (v) **pustiti (unutra) admit into** pustiti u; 2 dopustiti; 3 prihvatiti; 4

priznati

adopt /ə'dɒpt/ **1 (v) (mar law) usvojiti**: *It is unrealistic to expect coastal shipping to adopt the navigational practices that would normally be found on deep sea vessels, because of the nature of the trade and the size of the crews.*; **2 (mar law) prihvatiti**; **3 (mar law) uvesti**

adrift /ə'drɪft/ **(adj) vessel adrift** a vessel without power at sea, carried by currents and winds **brod koji pluta nošen strujom (adv)** loose from the moorings, not tied or secured **koji pluta nošen strujom i vjetrom, zanesen (brod), nošen strujom (bez pogona), tal. (nave) alla deriva**: *The U.S. Coast Guard vessels are responding to a vehicle carrier which caught fire and is now adrift approximately 130 miles south of Southwest Pass, with 20 crewmembers aboard. {Afloat and unattached in any way to the shore or seabed, but not under way; the vessel therefore goes where the wind and current take her}*

Ad Valorem /æd'vel'bɔ:rem/ **(n) (mar law) po vrijednosti**

ad valorem freight **(n) (mar law)** freight or customs duties charged (levied) on goods, property, etc. set as a percentage of their value **vozarina obračunata na temelju vrijednosti robe/tereta**

advance /əd'vɑ:ns/ **(n) 1 (navig) COMPARE turning circle** the distance a ship travels in its original heading after putting the helm over for a course change **aksijalni pomak broda pri okretanju, dužina ravnog puta broda pri okretanju, put napredovanja broda (bez djelovanja struje**: *No allowance had been made for the vessel's advance and, unsurprisingly, she grounded on the southern edge of the channel. The container ship was able to complete a 360° turn to starboard with an advance of 770m and transfer of 370m in 2 minutes and 30 seconds.* **speed of advance 1** The average speed in knots which must be maintained during a passage to arrive at a destination at an appointed time. **prosječna brzina putovanja broda (do određene točke, luke ticanja, točke okreta itd.) a** The average speed in knots which must be maintained during a passage to arrive at a destination at an appointed time. **prosječna brzina putovanja broda**; **2 (shipping econ) predujam, avans**

advanced fire fighting **(n) (safety) napredni tečaj protupožarne zaštite**

advance freight **(n) (shipping econ) predujam na vozarinu**

advantage /əd'vɑ:ntɪdʒ/ **(n) prednost, korist**: *This gave the advantage of allowing the tow wire length to be altered without the need for manual intervention on deck.* **take the advantage of iskoristiti**: *The master adjusted the passage plan so as to take advantage of the lee of an off-lying island.*

advection **(n) (meteorol) the horizontal transport of air, moisture or other atmospheric properties advekcija**

advection fog **(n) (meteorol) a type of fog that results from the advection of moist air over a cold surface and the cooling of the air to its dew point that follows advekcijaska magla**

adventure /əd'ventʃə/ **(n) (mar law, shipping econ) maritime adventure pomorski poduhvat, putovanje 1 pustolov, pothvat; 2 (mar ins) pomorsko putovanje (u prošlosti); 3 transport robe na brodarov račun**

adverse effect **(n) (safety) nepoželjan utjecaj, negativan utjecaj, negativno**

djelovanje: *reduced visibility may have an adverse effect on the safety of a towage operation smanjena vidljivost može imati nepovoljan utjecaj na sigurnost operacije tegljenja*

adverse weather /'ædvɜ:s; æd'vɜ:s/ **(n) (meteorol) loše vrijeme, nevrijeme**: *The master expected to encounter adverse weather conditions on the route. The primary cause of the accident was the*

*swamping of the tender boat in adverse weather conditions. **withstand adverse weather izdržati nevjeme**: The outcome depended on the Master's decision making and the information available to him, as well as the ship's capability to **withstand adverse weather conditions**.*

adverse weather conditions (n) (meteorol) nepovoljni vremenski uvjeti, loše vremenske prilike

advertisement /əd'vɜ:tɪsmənt/ (n) oglas, reklama

advice /əd'vaɪs/ (n) 1 (comm) savjet seek expert **advice**: *If in doubt, seek expert advice.*

zatražiti savjet stručnjaka; 2 (shipping econ) obavijest **payment advice obavijest o uplati**; 3 **prijedlog sugestija**: *The VTSO probably assumed that the vessels were manoeuvring in accordance with the pilot's advice.*; 4 (comm) The Message Marker **ADVICE** indicates that the following message implies the suggestion of the sender which the receiver (ship's master) can either follow or decide otherwise. In practice, **ADVICE** is accepted and carried out by the receiver **savjet**

(oznaka poruke u IMO SMCP): **ADVICE**. Anchor in anchorage B 3. SAVJET. Usidrite se na sidrištu B3 **ADVICE**. (Advise you) stand by on VHF Channel six. SAVJET. (savjetujem vam,) budite pripravnici na VHF kanalu šest devet.

advice note 1 a written piece of information e.g. about the status of the goods **obavijest**, **pismena obavijest**; 2 (mar law) isprava cestovnoga prometa s podacima o teretu, pošiljatelju, primatelju, prijevozniku, vozilu i prevoznini **prijevoznica**

advice of payment (n) (shipping econ) obavijest o (izvršenoj) uplati, obavijest o pristigloj doznaci

advice of shipment (n) (shipping econ) a notice sent to a local or foreign buyer advising that shipment has gone forward and containing details of packing, routing **obavijest o otpremi pošiljke (iz luke)** {A copy of the invoice is often enclosed and, if desired, a copy of the bill of lading. (US MarAd 2008)}

advisable /əd'vaɪzəbəl/ (adj) preporučljiv

advise /əd'vaɪz/ 1 (v) (shipping econ) obavijestiti, najaviti: *This is to advise you that the following cargo was damaged by rough and/or improper handling by stevedores* Ovime Vas obavještavamo da je sljedeći teret bio oštećen zbog nevremena i nepravilnog rukovanja od strane slagatelja. *This is to advise you that the quantity of the cargo loaded on the vessel at this port is as follows* Ovime Vas obavještavamo da je količina tereta ukrcana na brod u ovoj luci bila kako slijedi: *the Master advised the Chief Engineer that the anchorage and port approaches were in shallow water* Zapovjednik je obavijestio upravitelja stroja da će se sidrenje i prilaz luci obaviti u uvjetima plitkog mora. *Masters must advise London VTS which approach channel they intend to use. He contacted the ship manager's crisis team and kept them advised of the situation, but did not advise the coastguard. Masters are sometimes reluctant to advise shore authorities to a potential emergency situation.*; 2 **uputiti**; 3 **savjetovati, pomoći**: *At 20501 the pilot boarded to advise the ship's command as she proceeded through the sea canal to her berth in the port.*

advising bank (n) (mar law) A bank operating in the seller's country that handles letters of credit on behalf of a foreign bank. **korespondentna banka (inozemne banke)**

aerial /'ɛəriəl/ (n) (comm, nav arch) antena: *The VHF radio was now useless as the aerial had been at the top of the mast - they had no back-up.* **radio aerial radioantena, main aerial system glavni antenski sustav**

aeronautical light /,ɛərə'no:tɪkəl/ (n) (navig) aeronautičko svjetlo

aerosol /'ɛərə,sɔl/ (n) koloidna suspenzija čvrstih ili tečnih čestica u plinu **aerosol**

AFC; (Automatic Frequency Control) (n) (navig, electr) automatizirano

namještanje lokalnog oscilatora (brodskog radara)

affect /əˈfɛkt/ **1 (v) djelovati na, utjecati na** *A number of factors can affect the lone watchkeeper including fatigue, lack of stimulation, etc.*; **2 štetno djelovati / utjecati na** **affect adversely djelovati nepovoljno**: *such defect may adversely affect the safety of the vessel during transit*

affidavit /ˌæfəˈdeɪvɪt/ (n) **affidavit, izjava, pod zakletvom, o nekoj činjenici pred službenikom koji može (zakonski) primiti tu zakletvi (IG)**

Affirm, Affirmative (comm) Confirm or Yes, used in aviation and navigation **Potvrđujem., Prihvatio., Da.**

afford /əˈfɔːd/ (n, v) **1 pružiti; 2 pripustiti; 3 dopustiti, dozvoliti, dopustiti si** **The message from these statistics is that none of us can afford to be complacent.; 4 priuštiti (si)**

affreightment /əˈfreɪtmənt/ (n) **1 (mar law)** In civil law jurisdictions, affreightment refers to a contract for the chartering of a ship or some principal part of it. (Tetley's Glossary) **ugovor o iskorištavanju broda, ugovor o najmu broda, afretman;** **2 (mar law) ugovor o zakupu broda ili dijela broda;** **3 (mar law) ugovor o zakupu broda, ugovor o iskorištavanju broda, ugovor o prijevozu** **contract of affreightment;** **4 (mar law)** In England, the term is used to refer to the contract for the carriage of goods in a ship, either under a bill of lading or a charterparty (Tetley's Glossary) **ugovor o prijevozu (na temelju teretnice ili ugovora o najmu)**

afloat /əˈfləʊt/ (adj) (navig) **koji pluta**: *He was afloat, semi-conscious and with his lifejacket inflated. When the mate returned to the bridge a short time later, the vessel was afloat.* **remain afloat ostati u plutajućem stanju, ostati plutati**: *Fortunately, his lifejacket gave him the buoyancy to remain afloat and cling onto the side of the boat until the helicopter arrived. The fishing vessel remained afloat and on fire until later that afternoon, at which time the fuel tanks exploded and the vessel foundered.,* **stay afloat ostati u plutajućem stanju, keep afloat**: *The use of both pumps kept her afloat until help arrived in the form of a high capacity salvage pump, provided by the rescue services.* **održati (s) u plutajućem stanju**

afore /əˈfɔː/ **ANTONYM abaft** in, on, or toward the front of a vessel; in front of a ship **blizu pramca, dalje od pramca**

Aframax (n) (nav arch) brod koji mora, zbog velikog gaza, obilaziti Rt Dobre Nade **brod tipa Aframax**

aft /ɑːft/ (adv) **1** toward, at, or near the stern of the ship **prema krmi, The other seaman was swept aft and came into contact with a protection plate for the forward liferaft.:** *The skipper was not aware that either of the crewmen had gone aft. As the chief officer was moving aft, however, the head rope parted and struck him on the leg, which luckily was not broken.*; **2 na krmi:** *The ship was secured with four lines forward and four lines aft. Additionally, in normal operating conditions, the vessel had very little freeboard aft.*; **3 pri krmi, straga, po krmi**: *The aft tug was slower to secure than usual as her secondary towing gear was being used due to her primary gear being defective. The 25t bp tug was made fast aft and the two 10t bp tugs were pushing on the vessel's starboard side. The Master keeps on turning to course 160, in order to pass on the tanker's port side and then to cross on her aft.*

aft (n) (seamanship) the portion of the vessel behind the middle area of the vessel **krmeni dio broda, krma**

aft backspring (n) (seamanship) **krmeni špring, krmena užad**: The master gave instructions for a headline, a forward backspring and an aft backspring to be passed ashore.

aft breast line (n) **stražnje bočno uže, tresina po krmi**

aft bulkhead (n) (nav arch) **stražnja pregrada, krmena pregrada**: Both these spaces were adjacent to the aft bulkhead of the hold.

aft cabin (n) (boating/yachting) **stražnja kabina, kabina na krmi**: As a result, the generator's exhaust fumes filled the engine bay and spread through gaps in an internal bulkhead into the aft cabin where two passengers were asleep.

aft deck (nav arch) **krmena paluba**: Afterwards the Second Officer accompanied the Pilot to the aft deck. A heaving line was thrown down from the ship to the single crewman on the aft deck of the tug, and the tug's messenger line was attached. The buoys were stored on the **aft deck**.

aft draught (n) (nav arch) **krmeni gaz, gaz na krmi**: The forward draught was 4m and aft draught was 6.45 m.

aft end (n) 1 (nav arch) **stražnji dio broda, krmeni dio broda, krma**: The rescue boat and its crane were located at the **aft end** of the vessel. The accelerated corrosion was partly due to the harsh environment in which the rescue boat and its crane were located, at **the aft end** of the vessel.; 2

(seamanship) **stražnja strana, krmena strana**: The AB at the hatch controls was at **the aft end of the hatch** and was not able to see the second officer climbing down. Two water jets, from hoses, were then played at 45° into the air from **the aft end of the bridge**.

aft engine room (n) (nav arch, marine eng) **stražnja strojarnica**: The fire damage to the aft engine room was extensive, and the vessel was out of service for more than a month. ing of the class VI passenger vessel on Mew Stone rocks near tFlooding of aft engine room of passenger cruise ship QE2 on 21/22 May 2002 – escape of steam and hot water on board QE2 in mid-Atlantic,

after (adj) (seamanship) **stražnji**: Looking through the door's observation port they saw a fire around the after end of the port main engine. The second mate took the afternoon watch in the wheelhouse, while an AB carried out maintenance duties at the after end of the cargo hold hatch coaming. **after end of the ship krmeni dio broda, krma**. This was immediately followed by a series of heavy thumps which appeared to come from somewhere around the after end of the vessel. ,

after mast krmeni jarbol, zadnji jarbol

after body (n) (nav arch) hull form aft of the midship section of the ship **krmena rebra broda**

after body plan (n) (nav arch) **uzdužni presjek krmenog dijela broda**

after-cant timber (n) (sailing vessels) **krmeno koso rebro**

after deadwood (n) (sailing vessels) **krmeni umetci**

after deck (n) (nav arch) **krmena paluba**: The boat came astern while the officer on the **after deck** signalled to a man on the winch to slack the rope.

after end (n) 1 (nav arch) **krmeni dio broda**: The thick black smoke had spread throughout **the after end of the vessel** via the open doors and hatches. This is not possible in an enclosed boat as the crew are mainly situated inside during lowering and there is only an opening at the side and at **the after end of the boat**.; 2 (seamanship) **stražnja strana (dijela broda), krmena strana (dijela broda)**: An AB carried out maintenance duties at **the after end of the cargo hold hatch coaming**. Fuel is delivered to the high-pressure main by the multi-plunger pump fitted at **the after end of the engine**. An AB was carrying out maintenance duties at **the after end of the cargo hold hatch coaming**.

afterglow (n) (navig) **nejasna radarska slika (nakon promjene područja)** ,

nefokusirana radarska slika (nakon promjene područja), zadržana slika na radarskom zaslonu (nakon promjene područja), trag cilja (na radaru)

afterguy /'a:ftə,gai/ (n) (boating/yachting) privjetrinska uzda spinakera, škotina tanguna špinakera

after peak /'a:ftə,pi:k/ (=afterpeak) (n) krmeni pik, afterpik

after peak flat (n) (nav arch) palubica krmenoga pika

afterpeak tank (n) (nav arch) **ANTONYM forepeak tank** tank krmenog tanka,

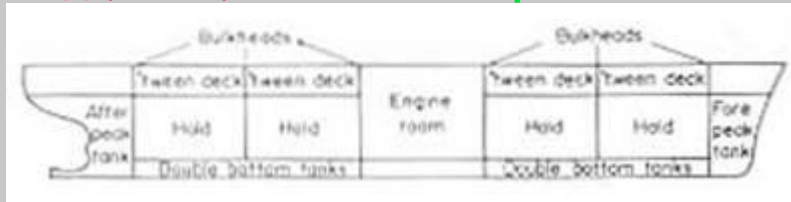

zatežni tank

after perpendicular (n) An imaginary line drawn perpendicularly through the waterline at the edge of the rudder post where it meets the summer load line **krmena okomica**

after spring (n) (seamanship) **ANTONYM forward spring** **krmeni špring**: Arriving on the bridge, he was in time to see the **after spring** part just as the mate was reaching the forecabin.

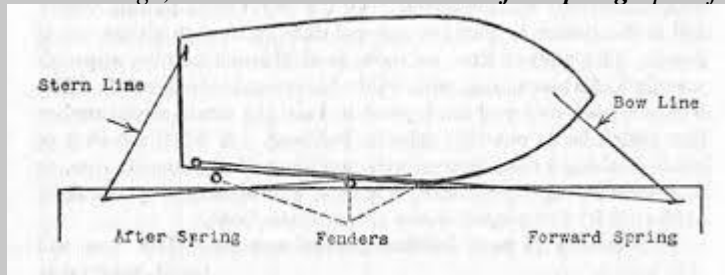

{Note that the term headline is preferred to

the term bow line (see IMO SMCP 2001).}

after station (n) = **aft station** (navig, seamanship) krmena privezna grupa, postaja za privezivanje na krmi, stanica za privezivanje na krmi

aft mooring (n) **ANTONYM forward moorings** krmeni vez, krmeni konopi, krmena užad, **krmeni armiž aft moorings** krmeni konopi, krmena užad, krmeni vez



{A headline (the term headline is preferred to

bow line), B headline, C forward breast line, D forward spring, E after spring, F aft breast line, G stern line, H stern line}

aft mooring lines (n) (seamanship) užad krmenog veza: The vessel's swing to port could not be checked (=stopped) and the aft mooring lines also parted. The forward and after mooring lines were secured in different ways: the forward mooring party used ropes on bights and left them on the winch warping drum so that rope tension

aft mooring party krmena privezna grupa, krmena privezna: The aft mooring party comprised the second officer, the carpenter, a welder and two engine room ratings. The forward and after mooring ropes were secured in different ways: the forward mooring party used ropes on bights and left them on the winch warping drum so that rope tension

aft mooring station (n) (seamanship) krmena privezna postaja, krmena privezna

stanica Crew members were at their forward and aft mooring stations. The officer on the aft mooring station passed a mooring line ashore, which then parted, and could have injured a crewman. Using his VHF radio, the second mate, who was at the after mooring station, shouted to the master that the ship was moving up the jetty.

aft of (prep phr) (seamanship) iza A fire was noticed in the top tier of the deck containers aft of the funnel. The compartments aft of the engine room, for which access was gained via the deck, were all sealed shut.

aft spring (n) (seamanship) krmeni špring: At 0720, the aft spring line parted. The aft spring line slipped as weight came on it because the rope had not been secured correctly.

aft station (n) (navig, seamanship) stanica za privezivanje na krmi: the Master or the Officer of the Watch (OOW) has to tell the officers in charge of the Fore and After (Mooring) Station to single up.

aft trim (n) (nav arch, cargo handling) zatega (broda)

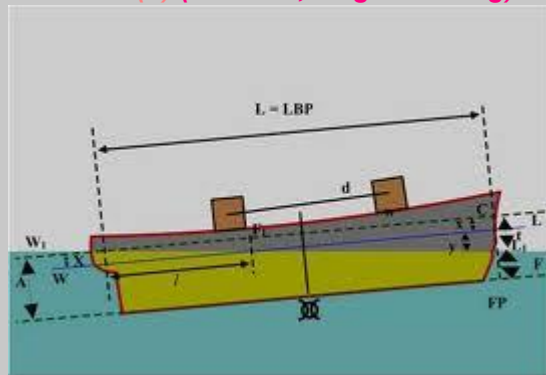

aft tug (n) (seamanship, navig) tegljač na krmi, tegljač po krmi: The pilot twice asked the aft tug to tow right astern, but the tug remained in push mode.

agency fee (n) (shipping econ) troškovi koji se plaćaju agentu za usluge pri osiguravanju smještaja broda i obavljanje carinskih formalnosti, fee payable by a shipowner or ship operator to a port agent
agencijski troškovi, agencijska naknada

agent /'eidʒənt/ (n) **agents agencija, pomorska agencija**: Traffic Service centers; potential distractions associated with making final arrangements for entering port including communications with the ship's agent or sending departure messages, etc. The master was informed by his agent that the pilot was booked for 1315 the following day; the master made arrangements accordingly. **1** A person

authorized to transact business for and in the name of another person or company. Typical jobs and duties of an agent are the following: 1. sales (marketing, acquisition of cargo, issuing quotations, concluding contracts in co-ordination with the shipping company), 2. booking (zaključivanje tereta; booking of cargo in accordance with allotments assigned to the agent for a certain voyage), 3. customs (dealing with the national customs administration for cargo declarations, manifest alterations and cargo clearance on behalf of the shipping company), 4. documentation (timeliness and correctness of all documents regarding the carriage of cargo), 5. handling (taking care of all procedures connected with physical handling of cargo), 6. equipment control (managing of all equipment stock in a particular area), 7. issuing (authorisation to sign and issue Bills of Lading and other transport documents), 8. collecting (authorisation to collect freight and charges on behalf of the shipping company), 9. delivery (the agent who releases the cargo and is responsible for its delivery to the consignee), 10. handling of cargo claims (Handling of cargo claims as per agency contract), 11. husbanding (handling non-cargo-related operations of a vessel as instructed by the master, owner or charterer)

(http://www.iss-shipping.com/cargo/cargo_library_glossarya.asp (P&O Nedlloyd) **agent**; **2 agencija** {Types of agents:(1) brokers,(2) commission merchants,(3) resident buyers,(4) sales agents,(5)

manufacturer's representatives.)

agent (n) (chem) **sredstvo**, **agens**: Cargo holds intended for the carriage of dangerous goods should be equipped such that they contain the possibility to use water as an extinguishing agent or for cooling via a permanently installed system as well. **extinguishing agent** **protupožarno sredstvo**

aggravate /'ægrə, veɪt/ (v) **pogoršati**

aggregate shipment (n) **COMPARE LCL** (mar law, shipping econ) Numerous shipments from different shippers to one consignee that are consolidated and treated as a single consignment. **zbirna pošiljka**

agree 1 **a složiti se**; 2 **dogovoriti se**, **dogovoriti**: Sometimes it may be appropriate to agree a temporary "no go zone" for both ferries and yachts during large regattas. An exchange of factual information should be used by both pilot and the bridge team to establish and agree an effective plan for the passage.; 3 (mar law) **obvezati se**, **ugovoriti**, **sklopiti ugovor**: Both contracting parties fully agree to comply with all the terms and conditions of this Agreement. obje ugovorne stranke obvezuju se da će se u potpunosti pridržavati uvjeta iz ovog ugovora It is agreed between the Master and the undersigned seafarers of the motor vessel ... , owned and operated by ... , that ... Ovime se zapovjednik i nižepotpisani pomorac obvezuju da ...

agreement /ə'grɪmənt/ (n) 1 (mar law) **sporazum** **make an agreement between ... and ...** **sklopiti ugovor između ... i ...**: the Agreement made between the International Transport Workers' Federation (the ITF) and the Owners, Managers, Employers and Contract of that Offshore Vessel/Unit (the Owners).; 2 (mar law) **ugovor** **Articles of agreement** **ugovor o ukrcanju (pomorca)**, **ugovor o zaposlenju na brodu**, **charter agreement** **ugovor o najmu broda**, **ugovor o iskorištavanju broda**: Under the charter agreement the charterer's port captain was responsible for arranging and paying for these extra deck fittings.; 3 (mar law) **dogovor**; 4 (mar law) **pristanak**, **odobrenje**: Regardless of how well intended, individuals should not be permitted to assume control of the party without the prior agreement of the supervisor. The decision to pass the navigation buoy on the wrong hand was taken by the pilot, with the master's agreement, when the vessel being overtaken moved across the channel to keep clear of inbound vessels using it.

aground /ə'graʊnd/ (adv) touching or resting on the bottom when still in the water (i.e. not ashore) (Mayne 2000) **nasukan**: By the time the anchor was finally released, the vessel was already **aground** **go aground** **nasukati se**: the tanker took a sheer to port and went aground The skipper was able to regain control of the vessel before she **went aground**. Cargo Ship **Goes Aground** as Typhoon Meranti Hits China, **run aground** **nasukati se**: The 332-meter containership ran aground at the Port of Santos access channel in Brazil during her departure Monday, December 7th. Approaching the planned anchoring position on a roughly south westerly heading, the vessel ran aground at 1435 on a rock pinnacle charted as an isolated danger., **be aground** **biti nasukan**: The LNG carrier is aground in soft mud off the Bonny Island LNG Terminal A fully-laden Suezmax tanker was hard aground near Istanbul.

AGW (all going well) (n) (shipping econ) **pod uvjetom da sve (prijevoz i ukrcja/iskrcja) dobro prođe**

ahead /ə'hɛd/ 1 (prep, adv) (seamanship) **sprijeda**,: She manoeuvred successfully to avoid a collision with a small craft ahead.; 2 (navig, seamanship) forward of the bow or ship **ispred broda**: Passing close ahead of a ship at anchor is potentially perilous, but if it is unavoidable, the effects of the tidal stream, wind and a ship's manoeuvrability need to be taken into account. A new small target was noted on the radar a little over 4 miles ahead of the ship and about 10° to port of the heading line.; 3 (navig, seamanship) **po pramcu**; 4 (navig) **naprijed**: The master applied

more thrust and the vessel moved slowly ahead.

Ahoy! /ə'hoɪ/ poziv kojim se privlači pozornost mornara na brodu ili drugi brod; a call used in hailing a vessel or boat to attract attention **Pozor! Ship Ahoy!! Pozor svima!**

AHT; (anchor handling tug) (n) (*nav arch*) tegljač za sidrenje

ahull; a-hull (adj) (*boating/yachting*) lying to the wind in heavy weather with no sail set, usually with the wind broadside on the ship or, with the helm a-lee, when the wind is on the quarter (Mayne 2000) **u jakom vjetru bez podignutih jedara**

aid /eid/ (n) with the **aid** of s pomoću, uz pomoć, pomoću pomoć

aid /eid/ (v) (v) pomoći, pomagati

aids to navigation; Aton; aton (n) any device EXTERNAL to a vessel specifically intended to assist navigators in determining their position or safe course, or to warn them of dangers or obstructions to navigation **navigacijsko pomagalo, plovidbena oznaka**: *While electronic charts and GPS feeds to radars are valuable aids to navigation, an unwelcome side effect is that the modern watchkeeper can often seem obsessed with sticking to 'the red line' (his track).* **establish and aid to navigation** uspostaviti plovidbenu oznaku, postaviti plovidbenu oznaku (plutaču, svjetlo itd.), **extinguished light to navigation** a lighted aid to navigation which fails to show a light characteristic **ugašeno svjetlo, ugašena plovidbena oznaka, inoperative aid to navigation** plovidbena oznaka u kvaru, plovidbena oznaka koja ne radi, **rebuilt aid to navigation** obnovljena plovidbena oznaka, obnovljeno navigacijsko pomagalo, **relighted aton** ponovno uspostavljeno svjetlo, **replaced aton** plovidbena oznaka zamijenjena drugom, **reset aton** plovidbena oznaka vraćena na ucrtanu (oglašenu) poziciju, **withdrawn aton** plovidbena oznaka / pomagalo povučeno iz službe {the term Aids to navigation or Atons (navigational aids outside the ship, i.e. along the coast or in the navigational channel; Cro. *navigacijska pomagala na obali i u plovidbenom kanalu*) should be distinguished from the term NAVAID or NAVAIDS (navigation instruments and aids on the bridge; Cro. *navigacijski instrumenti*)}

aim /eim/ (v) **ciljati**: *The use of common terminology is emphasised and MRM training aims to improve coordination, communications and team work.* **aim at 1 ciljati u / prema**: Identify and implement measures aimed at improving the identification of all dangerous and potentially dangerous spaces and increasing compliance with the safe working practices.; **2 imati namjeru, imati za cilj, namjeravati, ciljati, aim for ciljati, usmjeriti se prema, ploviti prema**: *The pilot then advised the master to put the engine to full ahead and aim for the red buoy marking the south side of the entrance to the channel.*

aim (n) **cilj, svrha**: *These procedures should be periodically reviewed with the aim of ensuring that risk is kept as low as reasonably practicable; 14/2014_R4 establish formal familiarisation training for all its personnel, which The helmsman achieved the aim, the electronic chart display data showing him steering between 10 and 15 degrees to starboard of the approach course to counteract the effect of* **The main aim of my latest survey was to answer the question whether sailing generally, and cruising in particular, was safer.**

air /eə/ **air compressor** kompresor zraka, **air-conditioning (system / plant)** 1 klimatizacijski uređaj; 2 klima-uređaj, **air cooler** rashladnik zraka, **air intake** ulaz zraka, **asis** zraka, **air line** cjevovod zraka, **zračni vod, air pipe** cijev za zrak, **zračna cijev, air receiver** 1 spremnik zraka a **boca, air reservoir** spremnik boca, **air start(ing) system** sistem upućivanja zrakom, **air starter** uputni ventil, **air starting valve** ventil za upućivanje zrakom, uputni ventil, **air storage tank** spremnik za

stlačeni (komprimirani) zrak, **air system** sustav zraka, sustav zraka za upućivanje, **air tank** spremnik za stlačeni / komprimirani zrak, **blast of compressed air** ulaz stlačenog zraka, **compressed air** stlačeni zrak, komprimirani zrak, **manoeuvring air** zrak za menevriranje, zrak za upućivanje motora pri manevriranju, **open air** slobodna atmosfera, atmosferski zrak, **pilot air** upravljački zrak, sekundarni zrak, **pilot air control** upravljač sekundarnog zraka, **pilot air filter** filter upravljačkog zraka, pročistač sekundarnog zraka, **starting air** zrak za upućivanje, **starting air distributor** razvodnik zraka za upućivanje, **starting air lever** ručka zraka za upućivanje, **starting air supply** dovod zraka za upućivanje, **blast of air** mlaz zraka, **pressurized air** stlačeni zrak, **compress air** komprimirani zrak (*n*) zrak

air bags (*n*) (*cargo handling*) pneumatske vreće (za ispunjavanje praznih prostora)

airborne /'εə,bɔ:n/ (*adj, adv*) **COMPARE** **seaborne** u zraku, u zrakoplovu, prevožen zrakom **airborne traffic** zračni promet, **airborne cargo** teret prevožen zrakom

air breathing apparatus (*n*) (*med*) **apar**at za disanje: *There will be an air breathing apparatus to provide safety danger from the release of HS gas. The cofferdam lid was re-secured 15 minutes later by a rating wearing full compressed air breathing apparatus.*

air cleaner (*n*) (*marine eng*) **filtrar** zraka (izvanbrodskog morora), **pročistač** zraka **air cleaner element** umetak filtera zraka, umetak pročistača zraka, **element filtera** zraka

air compressor (*n*) (*marine eng*) **kompresor** zraka: *Engineering ratings of a foreign flagged ferry were preparing to move an air conditioning compressor from the auxiliary engine room to the engineer's workshop, for maintenance purposes. He went to investigate and found that both main air compressors were running, but the air receivers were empty.* **main air compressor cooler** rashladnik glavnog kompresora zraka, **main air compressor** glavni kompresor zraka, **emergency air compressor** kompresor zraka za slučaj nužnosti

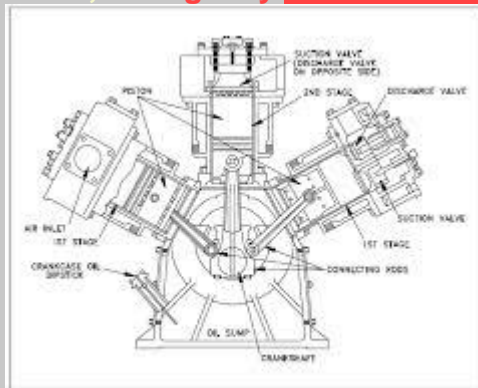

Figure 3 Reciprocating Air Compressor

air conditioner (*n*) (*marine eng*) **klima** uređaj

air conditioning (*n*) (*marine eng*) **kondicioniranje** zraka, **klimatizacija**: *As both fans were running, he switched off the power to number 1 fan, closed the delivery flap and opened the air conditioning unit access panel. Without warning, one of the two bow thrusters stopped, the air conditioning went off and the lights momentarily dimmed as the ferry experienced a partial loss of electrical power.*

air conditioning equipment (n) (nav arch) rashladni uređaj

air conditioning intake (n) (marine eng) usisizraka uređaja za klimatizaciju

air conditioning system (n) (marine eng) sustav kondicioniranja zraka, klimatizacija

air cooler (n) (marine eng) isparivač, evaporator

air-course (n) (sailing vessels) odušnik, produšnik

aircourse-board (n) (nav arch) rešetka za ventilaciju

aircraft carrier (n) (navy) a naval ship with a landing deck for launching and recovering aircraft



nosač zrakoplova, nosač aviona

aircraft search and rescue unit (n) (navig, safety) zrakoplovna spasilačka jedinica

air cushion vehicle (n) (nav arch) = hovercraft lebdjelica



air cylinder (n) (marine eng) zračni cilindar, cilindar zraka: *In the engine room, the reserve compressed air cylinder was opened but there was still insufficient air pressure to re-engage the clutches.*

air density (n) (meteorol) gustoća zraka

air draft; air draught (n) (nav arch) visina (broda) iznad mora, maksimalna visina (iznad mora)

air drier (n) (marine eng) suređaj za sušenje

air duct /'εə dʌkt/ (n) (marine eng) odvod za zrak, zračni vod, vod zraka: *Both fans supplied a common air delivery duct, and the airflow from the running fan caused the fan on number 1 to rotate in the reverse direction.*

air ejector (n) (marine eng) zračni ejektor

air exhaust (n) (nav arch, marine eng) izlaz zraka, ispuh zraka, ispust zraka

air filter (n) (marine eng) filter zraka

air flow (n) (marine eng) **protok zraka, strujanje zraka**: *He decided instead to reduce the air flow by stuffing a towel into the vent trunking.*

air grid (n) (marine eng, nav arch) **rešetka za zrak**

air grill (n) (marine eng, nav arch) **rešetka za zrak**

air inlet valve (n) (marine eng) **usisni ventil zraka, ventil za ulaz zraka**

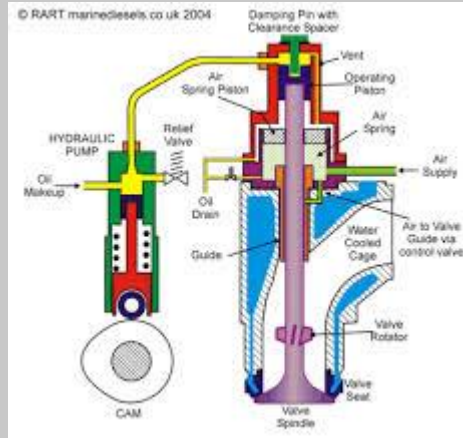

air intake (n) (marine eng) **usis zraka**: *The engine was shut down, and the fuel, ventilation, air intake and exhaust systems were isolated.*

air leak (n) (marine eng) **propuštanje zraka**: *In response, two engineers searched the engine room for a possible air leak.*

airlift /'εəˌlɪft/ (n) (safety) **podići iz mora u helikopter**: *All five crew were later safely airlifted ashore. Sva petorica članova posade kasnije su bila podignuta iz mora u helikopter Three of the crew members were airlifted to safety by the Navy.*

airlift (n) (safety) **podizanje s mora (broda) u helikopter**: *After initial rescue efforts were impeded by bad weather that stopped other ships getting close, Italian and Greek helicopter crews began the airlift on Sunday afternoon.*



air manifold (n) (marine eng) **kolektor zraka**

air masses (n) (meteorol) **zračne mase**

air pipe (n) (nav arch) **zračnik, odzračnik**: *It was found that the small basis bore ventilation air pipes to the engine room were completely blocked by rust flakes.*

air port (n) (nav arch, US) = **porthole** an opening in the side or deck house of a vessel, usually round in shape and fitted with a hinged frame in which a thick glass is secured **brodsko okno**

air pressure (n) (marine eng) **tlak zraka**: *In this case, crushed nut shells were injected into the turbocharger under 7 bar air pressure.*

air pump (n) (marine eng) **pumpa zraka, sidsaljka zraka, zračna pumpa**

air receiver (n) (marine eng) spremnik zraka: No1 compressor was isolated but the engineers soon noticed that the air pressure in the main air receiver was dropping.

air register 1 regulator zraka, registar zraka, uređaj za privod / dovod zraka; 2 privodne lopatice

air start system (n) (marine eng) = starting air system sustav zraka za upućivanje stroja

air start valve (n) (marine eng) ventuil zraka za upućivanje: Accordingly, the air start valves were opened and one of the engineers operated the turning gear control lever with the intention of disengaging the turning gear from The main engine indicator cocks were left open, the turning gear disengaged, the air receiver valves and main air start valve were shut, and the lubricating and cooling water pumps were left running.

air stream (n) 1 (marine eng) zračna struja, strujanje zraka; 2 (meteorol) zračne struje

air supply (n) dovod zraka, opskrba zrakom, dobava zraka: There is no doubt that their swift actions in stopping the engines and isolating the fuel and air supplies to the engine room contributed significantly to extinguishing the fire. **air supply valve**: The engineer then opened the air supply valve to pressurise the reservoir. **ventil dovoda zraka**

airtight /'ɛə,tait/ (adj) zrakonepropusan, zrakotijesan

air trunk otvor za dovod zraka

air vent (n) (nav arch) zračnik, tal. manica a vento: Following an unsuccessful attempt to fight the fire with a portable dry powder extinguisher, the engines were shut down and the air vents



closed.

AIS /,'ei ai 'es/ (n) (navig, safety) Automatic Identification System (AIS) - Used to help identify vessels, to assist in target tracking (based on Global Navigation Satellite System), and to improve quality of information available to OOW. AIS continually transmits the ship's own data to other vessels and VTS stations. It also continuously receives data from other vessels and VTS stations and, when linked to radar or ECDIS, can also display this data. AIS transmits: static data (MMSI number, call sign and name, IMO number, length and breadth, type of ship, location of position fixing antenna), dynamic data (ship's position, position time in UTC, course over ground, speed over ground, heading, navigational status, rate of turn), and voyage data (ship's draught, hazardous cargo, destination and ETA, route plan - waypoints) (Seamanship Notes 2004). **automatski identifikacijski sustav, sustav**

automatske identifikacije brodova, AIS: AIS should be operational at all times AIS system is used to exchange vessel and navigation data including vessel name and call sign, length and beam, position with accuracy indication and integrity status, course, speed, heading and ROT and other specific information, all in real time. Data is shared with other nearby ships as well as coastal VTS (Vessel Traffic Service) stations. Vessels were usually tracked using AIS as manual acquisition and tracking was

generally less reliable. All available equipment should be used by the OOW, whether be it ARPA, AIS or anti-collision alarms (COLREG rule 7 -Risk of collision). The vessel's AIS was switched off. The primary means of navigation was paper charts. **monitor AIS information pratiti informacije iz sustava AIS** The OOW was not monitoring AIS information., **AIS receiver prijemnik sustava AIS, AIS-prijemnik** The target vessel's details were displayed on the AIS receiver but the option to display the target's information on the X-band radar, which was fitted with ARPA, was not taken., **AIS signal signal sustava AIS** However, her AIS signal was logged and recorded onshore, allowing the coastguard to identify the vessel; after about 30 minutes they succeeded in contacting her o, **AIS target, AIS-signal** He then interrogated an AIS target about 6., **AIS transmitter predajnik sustava AIS, AIS-predajnik, AIS track putanja broda u sustavu AIS, trajektorij u susatvu AIS, trag rute broda na pokazivaču sustava AIS** Manual tracks were frequently lost and the information displayed on manual tracks was not as comprehensive or prominent as on AIS tracks., **AIS transponder transponder sustava AIS, AIS-transponder** Although there is no requirement to fit a radar reflector and/ or an AIS transponder, there are distinct advantages in doing so., **AIS display prikaz u sustavu AIS** Based on visual monitoring of the movement of the ship's mark on the AIS display and comparison to another vessel's movement tracking display, it was ascertained that the ship was actually moving west-northwest in the traffic lane {The information provided by AIS is divided into: static information, including the ship's call sign and name; dynamic information, including position, course and speed over the ground and status; voyage related information, including destination, draught, and hazardous cargoes; and short safety related messages. Static and voyage related information is transmitted every 6 minutes, or on request. The reporting interval for dynamic information is dependent on a ship's speed and whether or not it is changing course. The reporting interval for a ship at a speed of between 0 and 14kts and changing course is 4 seconds. (from: MAIB accident report No. 25/2014, p. 4)}

AIS data (n) (navig, comm) podatci iz automatskog identifikacijskog sustava,

podatci dobiveni od AIS-a: The 30,000 DWT containship was underway in the Ligurian Sea as of 11:20 a.m. EDT on Wednesday, according to AIS data from MarineTraffic.com. the speed derived from his GPS fixing and confirmed by AIS data showed the vessel maintained her maximum speed of 12 knots until shortly before the grounding. AIS data and visual observation confirmed that the tanker's speed was not excessive and it was not abnormally close. AIS data as of 15:00 UTC showed the vessel's status as "underway using engine" but with the assistance of six tugs as it continued its voyage to Hamburg. <http://gcaptain.com/capesize-bulk-carrier-breaks-elbe-river-ais/>

AIS recreation (n) (navig) rekonstrukcija (pomorske nezgode) pomoću automatskog identifikacijskog sustava An AIS recreation of the incident from Vessel Finder is provided below

AIS Service Management (n) (navig) Služba upravljanja sustava AIS

AIS static and dynamic information (n) (navig) statički i dinamički podaci o brodu u sustavu AIS: The beam trawler's AIS was transmitting static and dynamic information, including its status (engaged in fishing), SOG and COG.

AIS transmitter (n) (navig, safety) predajnik sustava AIS, AIS-predajnik: AIS transmitters on buoys and beacons provide increased awareness and safety when visibility is poor, regardless of the weather and the situation at sea.

AIS voyage details (n) (navig) podaci o putovanju u sustavu AIS update AIS voyage details ažurirati / osvježavati podatke o putovanju u sustavu AIS

alarm /ə'la:m/ (n) disconnect the alarm isključiti alarm 1 (safety) uzbuna, alarm, upozorenje, znak za uzbunu sound the alarm dati znak uzbune: During this period the general alarm was sounded and the crew were mustered., **raise the alarm dati znak uzbune,**

uključiti alarm: *Twenty-five hours later, the alarm was raised when its upturned hull was sighted by a passing ferry.*, **trigger the alarm** **automatski uključiti znak uzbune:** *Immediately, the bow thruster motor low insulation alarm was triggered and the breaker tripped.*, **audible alarm** **zvučni alarm**, **visual alarm** **vizualni alazm**, **activate the alarm** **aktivirati alarm**, **pobuditi alarm:** *failed to notice that the visual grounding warning alarm had been activated*, **engineering alarm** **alarm iz strojarne**, **inoperative alarm** **neispravan alarm**, **alarm koji ne radi:** *The ECDIS audible alarm was inoperative.*, **general alarm** **opća uzbuna:** *The master immediately sounded the general alarm and altered the course hard to starboard*, **false alarm** **lažna uzbuna**, **lažni alarm;** **2 alarmni uređaj**

alarm message (n) **1 (safety) poruka o opasnosti;** **2 (safety) poruka za uzbunu**

alarm message display (n) (navig) **pokazivač alarma na radaru:** *When trouble occurs the radar generates audio and visual (alarm message display) alarms to alert you.*

alarm signal (n) (safety) **znak uzbune**

alcohol free (n) (med) **negativan test na alkohol:** *Alcohol tests were conducted on all staff on duty shortly after the incident and the results were satisfactory i.e. negative. The vessel is alcohol free.*

alcohol test (n) (mar law) **test na alkohol:** *Alcohol tests were conducted on all staff on duty shortly after the incident and the results were satisfactory i.e. negative. (The vessel is alcohol free);*

conduct an alcohol test **obaviti test na alohol**



Aldis lamp /'ɔːldɪs/ (n) (navig, comm) **aldis lampa**

alee /ə'liː/ (v) (navig) **to the leeward side; on the lee side of a ship** **niz vjetar, u zavjetrini**

a-lee (adj) (navig) = **alee** **u zavjetrini**

alert /ə'lɜːt/ (adj) **budan:** *Moving around the bridge will also keep you stimulated and alert! If the skipper and the deckhand had been more alert and had maintained a good lookout, they would have noticed the vessel was not following her intended course.*

alert /ə'lɜːt/ (v) **uzbuditi, uzbuniti, alarmirati:** *The master was immediately alerted and ordered wheel hard over to port He alerted the coastguard and gave their position.* **alert the pasengers and crew** **uzbuditi putnike i posadu**

alert /ə'lɜːt/ (n) (comm, safety) **uzbuna, znak uzbune, signal uzbune:** *On receiving the alert from VTS, the pilot ordered the engine to full ahead, helm hard- a-port and instructed the tug to pull on the vessel's port quarter.* **DSC alert 1** **znak uzbune putem DSC-a:** *If you have DSC radio, you*

could try a 'securité' DSC alert followed by a voice broadcast.; 2: The MF/HF DSC frequencies are reserved exclusively for DSC alerts associated with distress, urgency and safety messages, **inadvertent distress alert** **greškom poslan signal o pogibli**, **safety alert** **signal uzbune o sigurnosti**, **signal sigurnosti**, **urgency alert** **signal uzbune o žurnosti**, **signal žurnosti**, **alert button** **dugme za uzbunu**: The skipper pressed the Digital Selective Calling (DSC) **distress alert button** on the VHF radio and the coastguard responded immediately., **raise the alert** **podići uzbunu**, **uključiti uzbunu**: Both the RNLi and RYA strongly recommend to raise the alert in the case of an emergency.

alertness /ə'ls:t nis/ (n) (**safety**) **budnost**: Drinking alcohol, especially in combination with being tired, will **reduce alertness** and will affect judgment and perception.

alert phase (n) (**safety, navig**) **stupanj opasnosti koji određuje centar za koordinaciju traganja i spašavanja ako postoji sumnja u sigurnost plovnoga objekta i osoba na njemu, zbog toga što nakon utvrđivanja stupnja neizvjesnosti nije uspio pokušaj uspostavljanja veze s plovnim objektom** **stupanj pripravnosti**

alidada; alidad /'æli, dæd; 'æli, dæd/ (n) (**navig**) a device that allows one to sight a distant object and use the line of sight to perform a task **alidada**

align /ə'lain/ (v) (**marine eng**) **centrirati, poravnati** **align with** **poravnati s**: The master used considerable lateral thrust to try and **align** his vessel **with** the linkspan.

alignment /ə'lainmənt/ (n) (**marine eng**) **centriranje, poravnavanje** **out of alignment**: The port drive unit was found to have been moved **out of alignment** and the drive shaft had sheared, requiring dry dock repairs. **izvan centra, necentriran, alignment tool** **alat za centriranje**: The stowage had a working platform from which the riggers could access the top of the **alignment tool** to connect the slinging arrangements when it was to be deployed.

alleged /ə'ledʒd/ (adj) (**mar law**) **navodni**

alleyway /'æli, wei/ (n) (**nav arch**) vessel's internal passageway or corridor; a passage between two rows of cabins in a ship **brodski hodnik, prolaz, kanižela**: He peered down the access hatch and saw smoke in the main **alleyway** below, but he could not see where it was coming from. Two of the crew, wearing BA, **entered the alleyway** and confirmed that black smoke was coming from a dry store, which was directly under the area where the hot work had been taking place.



all hands (n) (**comm, seamanship**) entire ship's company, both officers and enlisted personnel **svi članovi brodske posade (časnici i mornari)**: The master sounded the fire alarm and made a

public address announcement ordering **all hands** to their emergency muster stations. The master instructed him to contact the pilot 2 hours before the vessel was due to arrive at the pilot station, and to call all hands 30 minutes before the pilot boarded. **All hands! poziv svim članovima posade, pozor svim članovima posade**

all in (prep) (mar law, shipping econ) The total price to move cargo from origin to destination, inclusive of all charges. **prijevoz i ostali troškovi uključeni**

allision /ə'li:ʒən/ (n) (mar law, US) the striking by a moving vessel against a stationary object; an event when a ship strikes a fixed object, such as a reef, dock or piling **sudar broda s čvrstim objektom na moru, udar broda o čvrst objekt na moru, alizija**: The bulk carrier was involved in an allision with the ...-registered container vessel.

allocate /'ælə, keɪt/ (v) **dodijeliti, odrediti dio, raspoređivati**: People ashore alerted the coastguard, which issued a "Mayday Relay" and began to allocate resources. **allocate a berth dodijeliti brodu vez u luci**: A safe berth has been allocated to the ship.

allocate resources (v) (shipping econ) **dodjeljivati sredstva, izdvajati (financijska) sredstva**: People ashore alerted the coastguard, which issued a "Mayday Relay" and began to allocate resources. **rasporediti sredstva**

allot /ə'lot/ (v) (mar law, shipping econ) **doznačiti, isplatiti**: If the Master and a seafarer agree, a portion of such seafarer's earnings may be allotted to such seafarer's spouse, children, grandchildren, parents, grandparents, brothers or sisters or to a bank account in the name of the seafarer.

allotment /ə'lotmənt/ **1 (shipping econ, mar law) a alotman, predviđena partija tereta za brod; 2 (shipping econ, mar law) dio plaće, doznaka (dijela) plaće allotment note doznaka (plaće), priznanica obiteljske doznake**: Any Employee shall be granted an allotment note payable at monthly intervals, of up to 80% of her/his wages; **3 (shipping econ) a share of the capacity of a means of transport assigned to a certain party, e.g. a carrier or an agent, for the purpose of the booking of cargo for a specific voyage dioba prijevoza tereta (na različite brodare, agente itd.), dio tereta u prijevoznikom poslu (dodijeljen drugom brodaru, agentu itd.)**

allowance /ə'laʊəns/ **1 a obzir, razmatranje**: Throughout this process, the vessel was being set to the north of her planned track and no allowance had been made to counteract the tidal stream. **make allowance for uzeti u obzir**: However, no allowance is made for the quality of the crew's rest time, which is assumed to be good.; **2 (shipping econ) naknada, platni dodatak (npr. za dnevnicu), doplatak daily subsistence allowance (DSA) dnevnicu, dodatak za dnevnicu, iznos dnevnica, bonus, naknada**: In such cases the allowance shall be an extra 1.5 of the hourly rate; **3 (marine eng) tolerancija, toleranca**

allow for /ə'laʊ fɔ:/ (v) **1 uračunati, uzeti u obzir**: Sufficient staff must be available to allow for safe working on the manoeuvring stations in connection with the rope operations. **allow for leeway (navig) uzeti u obzir zanošenje broda, uračunati zanošenje broda; 2 omogućiti**: Since this accident, the ferry company, in conjunction with the harbour authority, has amended the passage plan to allow for a wider approach to the entrance.

allowing for 1 uračunavanje, uzimanje u obzir allowing for stream and leeway uračunavanje struja i zanošenja; 2 dopuštanje

alloy /'ælbɪ; ə'bi/ (n) (marine eng) **slitina, legura aluminium alloy aluminijska slitina, aluminijska legura, copper alloy bakrena slitina, copper-based alloy slitina na bazi bakra, ferrous alloy željezna slitina, light alloy lagana slitina, tin-based alloy**

kositrena slitina, **slitina na bazi kositra**

alloyed /'ælbɪd/ (adj) (marine eng) **legiran**, **slitinast**

alloyed steel (n) (marine eng) **legirani čelik**

all-round light (n) (navig) **svjetlo vidljivo sa svih strana**, **svjetlo u 360 stupnjeva**,

okruglo svjetlo: Rule 27 Vessels Not Under Command or Restricted in Their Ability to Maneuver (a) A vessel not under command shall exhibit: (i) two **all-round red lights** in a vertical line where they can best be seen; During the pilotage period, the vessel had been constrained by her draft, and had displayed the appropriate signal of three **all round red lights** in a vertical line.

all standing (n) **to bring up all standing naglo zaustaviti jedrenjak 1**

(boating/yachting) fully rigged s punim jedriljem, potpuno opremljen; 2 (boating/yachting)

sidrenje jedrenjaka pod prevelikom brzinom broda (s punim jedriljem), **kruženje pod punim jedrima, bez pripreme**

almanac /'ɔ:lmə, næk/ (n) (navig) **godišnjak**, **almanah nautical almanac nautički godišnjak**, **nautički almanah**

aloft /ə'loft/ (adv) 1 (navig, boating/yachting) **above the upper deck; overhead or high above; above;**

toward or in the rigging above the deck **gore**: Once the ferry was safely alongside, the chief engineer went aloft to check the uptakes, and found traces of white smoke and a smell of burning oil.; 2

(seamanship) **iznad palube**: It is easy to become distracted when working aloft. Kada se radi iznad

palube lako dolazi do ometanja / svraćanja pažnje. **to work aloft raditi na visini, raditi na**

jarbolu, raditi iznad navigacijskog mosta: Personnel should avoid microwave radiation hazard by keeping clear of an operating scanner. If working aloft on the scanner unit or other equipment near the

scanner unit.; 3 in the rigging **u snasti**; 4 **podignuto (jedrilje)**; 5 **na površini (zemlje), iznad površine zemlje**

alongside /ə'lon, said/ (adv) 1 side to side to a wharf/dock or to another ship **uz bok broda,**

bočno, tal. di fianco: The master then took control and manoeuvred the vessel **alongside**. **depth**

alongside dubina uz lučku obalu: With a minimum **depth alongside** of 13.4 metres at low water, the Ringaskiddy Deepwater Terminal handles fully laden Panamax size vessels (60,000 tons deadweight),

arrive alongside stići na vez, stići u luku: The ship **arrived alongside** in the port at 1100 Brod je

stigao na vez u luci u 1100 sati. **come alongside**: During the evening of 11 February 2015 the

container ship **was alongside** in the port of Jebel Ali. A workboat was **coming alongside** a dredger to

conduct a personnel transfer. **pristati uz / na obalu, tal. accostare, bring a ship alongside**

a pier dovesti brod na vez uz obalu, pristati uz obalu At the end of the evening, the

skipper **brought the vessel back alongside a pier** for the passengers to disembark. **be moored**

alongside biti privezan uz obalu A small gas tanker was moored alongside a terminal berth; all mooring bollards were in use due to bad weather. **moor port side alongside privezati se**

lijevom stranom uz obalu, pristati lijevim bokom uz obalu: The vessel moored port side

alongside another ro-ro berth and discharged her cargo. **be secured alongside biti privezan**

uz obalu A 100m long, LPG tanker was ready to sail from a river jetty, to which she was secured port

side alongside and head upriver. **manoeuvre the ship starboard side alongside pristajati**

desnom stranom uz obalu: The container vessel was being manoeuvred starboard side alongside

with the assistance of a pilot and two attending tugs. **berth alongside pristati uz obalu,**

pristati bokom uz obalu: It was a cold morning with temperatures dipping to freezing as a chemical tanker berthed alongside to discharge its last parcels of cargo before a routine docking. The vessel was

port side **alongside a berth** which was perpendicular to the main shipping channel.; **2 (mar law, shipping econ)** Goods **delivered "alongside"** are to be placed on the dock or barge within reach of the transport ship's tackle so that they can be loaded. **slobodno uz bok broda, franko uz bok broda**

alongside from (n) (mar law) sve troškove dovoza tereta/robe do broda u luci ukrcaja i od broda u luci iskrcaja snosi krcatelj odnosno primatelj **uz bok broda**

aloof /ə'lu:f/ (**adv**) to windward, towards the wind (towards offshore); in the distance or far off **daleko od obale, dalje od obale {archaic}**

alphanumeric keypad (n) (comm) alfanumerička tipkovnica

Altair /'æltɛə/ (**n) (navig)** a first magnitude star often used in celestial navigation; the brightest star in the constellation Aquila **zvijezda Altair**

alteration /,ɔ:ltə'reɪʃən/ (**n) (navig) promjena (kursa):** Accordingly, at approximately 0013, with the bulkcarrier 3.4nm off the trawler's port bow, the trawler's skipper began the first of **several alterations to port** A single, **broad alteration** was not possible because the trawler's manoeuvrability was limited by its fishing gear. The cargo vessel's passage plan was to **alter course by 60 degrees** at the edge of the south-west traffic lane;

alteration of course (n) (navig) promjena kursa: An **alteration of course** of just 10 degrees, when only 3 miles from the other vessel, was not enough to avoid a close-quarters situation. The planned track involved a **40° alteration of course** just one ship's length before the entrance to the channel. **make an alteration of course izvesti promjenu kursa, promijeniti kurs:** However, after **having made an alteration of course** of nearly 30 degrees to port, the port side of the fo'c'sle inevitably collided with the other ship, causing structural damage. The OOW knew that he had to **make a planned 21° alteration of course to starboard** 10 minutes later and, because the ARPA radars would not acquire the contact, he decided that the planned alteration would a **substantial alteration of course značajna promjena kursa, jača promjena kursa:** A short time later, a **substantial alteration of course** was made, which took the vessel from her planned track onto a heading towards the coastline, 45 miles away., **alteration of course to port / starboard promjena kursa u lijevo / desno:** The vessels were very close as they entered a precautionary area where the cargo vessel made a planned alteration of course to port to head towards the next traffic lane. He decided to continue the alteration of course to starboard to place the yacht on the vessel's port bow., **alteration of course from ... to ... promjena kursa sa ... na ...:** Soon afterwards, the second officer plotted the vessel's position on the chart and initiated a **planned alteration of course from 110 degrees to 118 degrees** using the autopilot.

alternating current (AC) /'ɔ:ltə,neɪtɪŋ/ (**n) (electr) COMPARE direct current; DC izmjenična struja alternating current (AC) generator generator izmjenične struje**

alternating light naizmjenično svjetlo

alternative maritime power; AMP (n) (electr) = cold ironing kopneni električni priključak, obalni priključak (na električnu struju)

alternator /'ɔ:ltə,neɪtə/ (**n) (electr) generator izmjenične struje, alternator:** The **diesel alternator** supplying the bow thruster had shut down due to low lubricating oil pressure. **shaft alternator osovinski generator:** Stopping the engine had also stopped the **shaft alternator** which was used to power the bow thrust., **emergency diesel alternator dizel generator za nuždu, pomoćni dizel generator:** The ferry was also provided with an Uninterruptible Power Supply (UPS) and an **emergency diesel alternator;** both were ready to operate automatically when needed.,

engine-driven alternator generator pogonjen glavnim strojem *The mechanic changed the batteries, checked the engine-driven alternator output and restarted the heater.*

although /ɔ:l'ðəʊ/ (**conj**) = **though iako, premda, makar, mada**: *Although a safety discussion took place, no formal risk assessment or permit to work was completed. The vessel was being steered by autopilot and, although a bridge navigation watch alarm system (BNWAS) was fitted, it was not switched on.*

altitude /'ælti,tju:d/ (**n**) (**navig**) (in celestial navigation) the angle a celestial body makes with a point on the horizon vertically below this object **visina (nebeskog tijela, objekta na kopnu, oznake)**

altocumulus /,æltəʊ'kju:mjʊləs/ (**n**) (**meteorol**) **altokumululus**

altostratus /,altəʊ'stra:təs, -'streitəs/ (**n**) (**meteorol**) **altostratus, visoki gusti oblak**

aluminium; (Al) /,æljʊ'miniəm (UK); ə'lu:mi:nəm (US Canadian)/ (**n**) **aluminij**

amber jack (**n**) (**fishing**) = **yellow tail gof**

ambiguity potential (**n**) (**navig**) **višeznačnost očitavanja (u navigacijskom sustavu)**

American Bureau of Shipping; (ABS) (**n**) (**nav arch, mar law**) The American Bureau of Shipping is a U.S. classification society that certifies if a ship is in compliance with standard rules of construction and maintenance. **Američki registar brodova**

amidships /ə'midʃips/ (**adv**) (**n**) In the middle portion of ship, along the line of the keel. **sredina**

broda, srednji dio broda, po sredini, u sredinu *The big tanker struck the smaller vessel amidships, breaching her hull and rupturing a fuel tank. The RIB then circled back into mid-stream and collided with the passenger vessel for a second time, this time amidships on her port side. In the early hours of the morning, the ship was struck amidships on the port side by a large wave. put the wheel amidships staviti kormilo u sredinu: Seconds later, the master saw the cliffs emerge through the fog and, realising he was about to ground, he put the wheel amidships to take the impact on the bow and so minimise the chances of serious damage and pollution.*

amidship(s) (**adv**) In or towards the middle of a ship in regard to length or breadth **u sredini**

broda: *She struck the smaller vessel amidships, breaching her hull and rupturing a fuel tank.*

ammeter /'æm.mi:tə/ (**n**) (**electr**) **ampermetar**

amount /ə'maʊnt/ **amount of rudder** (**navig**) **iznos zakreta kormila, stupanj zakreta**

kormila *The OOW did this while watching the buoy over the timber deck cargo from behind the starboard radar display; he did not monitor the amount of rudder used, or the rate the ship was turning. 1 iznos gross amount ukupan iznos, bruto iznos; 2 količina: On their arrival, the coastguard noticed a considerable amount of pollution in the vicinity of the propeller, and the decision was taken to remove the vessel to a nearby slipway. The skipper told some other fishermen that a significant amount of water had entered the vessel's under deck area, and that he had experienced some problems with a bilge pump. On the return passage from the other harbour, the bridge team discussed the event further, and decided to restrict the amount of cargo they would load in order to produce a shallower draught.*

amount claimed (**n**) (**mar ins**) **traženi iznos (odštete) determine the amount claimed utvrditi iznos odštete**

amphibious craft; amphibian /æm'fibiəs/ (**n**) (**nav arch**) **amfibija:** *A fire broke out inside the hull of the amphibious vessel operated on the River Thames by.....*

amplifier /'æmplɪ,fəɪə/ (**n**) (**electr**) **pojačalo**

amplitude /'æmplɪ,tju:d/ (**n**) (**navig**) a measurement of the arc between true East or West and the

plane of a selected star or planet at a precise moment in time **amplituda**

AMTI; airborne moving target indication (n) (navig) MTI radar na pokretnom objektu

anchor /ˈæŋkə/ (n) (seamanship, navig), **kotva, ankora; tal. ancora**: He always kept his **anchor ready** for such eventualities and was able to let it go without delay. **anchor gear** sidreni uređaj **sidreni uređaj**, **anchor watch** straža na usidrenom brodu. Demonstrating a good **anchor watch**, the chief officer of the anchored vessel ensured that, when the accident happened, the alarm was raised quickly and the crew were able to summon. , **heave up anchor** **podići sidro (i zaploviti)**: **Heave up anchor** and proceed! Podignite sidro i krenite!, **let go anchor** **oboriti sidro, spustiti sidro**: The vessel's starboard **anchor** was **let go** in an attempt to prevent a collision with the berthed ferry. Operating in confined waters, the forward mooring team is normally at hand to let go the anchor if required. , **raise anchor** **podizati sidro, anchor up and down** **sidro okomito u moru, sidro a piko, lower anchor** **spuštati sidro, stow the anchor** **posići sidro u sidreno oko, veer the anchor** **izvući sidro iz sidrenog oka, walk out the anchor** **izvući sidro iz sidrenog oka (tako da visi iznad mora ili u moru)**: The master decided to continue heading for the berth at reduced speed, and to berth without bow thrusters by walking out the starboard anchor. , **drop the anchor** **sputiti sidro, oboriti sidro**: He returned to the bridge to assess the navigational situation, and decided to stop the starboard main engine and **drop the anchor**. Still unable to regain control, the master ordered the starboard anchor to be dropped as well. , **stock anchor** **sidro s kladom, anchor a-peak** **sidro okomito i iznad dna, tal. ancora a picco lungo, secure the anchor** **pričvrstiti i osigurati sidro, ease out the anchor of the hawse-pipe** **izvući sidro iz sidrenog oka, set the anchor** **spustiti sidro, postaviti sidro, starboard anchor** **desno sidro**: The chief mate called the duty seaman and ordered him to proceed forward to heave-in the starboard anchor and, once that was complete, to rig the pilot boarding ladder. , **port anchor** **lijevo sidro**: After weighing anchor, the bosun and a seaman had secured the port anchor and had begun stowing three loose mooring lines down into the forward store room. , **drag the anchor** **orati (o sidru)**: Had the OOW noticed that the ship was **dragging anchor**, and acted quickly and decisively in calling the master and engineer, the grounding could have been avoided. Da je časnik straže primijetio da sidro ore i da je brzo reagirao i pozvao zapovjednika i upravitelja stroja, nasukavanje bi se bilo moglo izbjeći. Despite the two anchors cast off Etel river, the vessel **dragged anchor** and stranded on Kerminihy beach, provoking an oil pollution. , **weigh anchor** **podizati sidro (s dna), podići sidro (i zaploviti)**: The master left night orders for the main engines to be at standby, and to start **weighing anchor** at 1315. After the loading operations were completed, she **weighed anchor** and proceeded seawards, her escort tug letting go and her two pilots disembarking near the entrance to the deepwater bay. , **recover the anchor** **podići sidro (na brod)**: The master over-estimated the ability of the anchor windlass and the crew to **recover the anchor** while the vessel was dragging. , **secure the anchor, pričvrstiti i osigurati sidro**: After **securing the anchor** once again, the passage was resumed to the next port, where repairs had been arranged by the shore management. , **bury the anchor** **ukopati sidro**: The anchor is **buried** in the

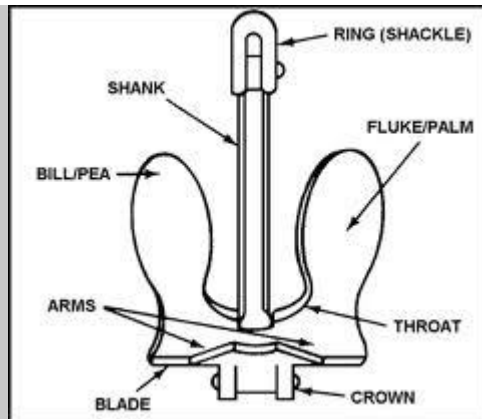

seabed and holding.

{SHIP ANCHOR types: Hall's anchor, Admiralty anchor, patent anchor, stockless anchor; BOAT ANCHORS: Danforth anchor, plough/plow/CQR anchor; mushroom anchor, grapnel; Bruce anchor}

anchor /'æŋkə/ (v) **usidriti se, usidriti brod**: Berthing in this particular harbour was restricted to daylight, therefore on arrival at 0130, the vessel was anchored.

anchorage /'æŋkərɪdʒ/ (n) **1 (navig)** a sheltered place suitable for anchoring in relation to the wind, seas and seabed; area of a port or harbour **sidrište**: The weather deteriorated while the ship was **at the anchorage**, and the ventilators were closed as a result. **working anchorage trgovačko sidrište (za obavljanje operacija ukrcaja/iskrcaja), designated anchorage naznačeno sidrište, propisano sidrište, leave anchorage napustiti sidrište**, during NNE gales (in winter) a vessel could be forced to leave anchorage and seek shelter under the lee of the nearby island Krk., **inner anchorage nutarnje sidrište, outer anchorage vanjsko sidrište, lift the anchorage podići sidro, safe anchorage sigurno sidrište, exposed anchorage nezaštićeno sidrište, otvoreno sidrište, sheltered anchorage zaštićeno sidrište**: Strong winds were being forecast for the coming night so it was decided to find a sheltered anchorage., **anchorage area područje namijenjeno sidrenju, zona sidrenja**: Busan VTS had directed the vessel to drop her anchor in N4 **Anchorage Area**., **short-term anchorage privremeno sidrište**: Navigation within the port limits encompassed the approach channel, the **short-term anchorage** and the pilot boarding area., **anchorage circle krug sidrenja, područje sidrenja**: The position indicated that the vessel (bridge) was still 40 metres inside the **anchorage circle** on the chart., **open anchorage otvoreno sidrište, nezaštićeno sidrište**: The vessel was sent to an **open anchorage** in deep water, but a few days later the wind increased and she dragged anchor twice more., **anchorage position pozicija sidrenja**: The master also saw that there was another vessel anchored and taking on bunkers to the east of his intended **anchorage position**., **safe anchorage sigurno sidrište**: The pilot immediately called for tugs and the vessel was taken to a **safe anchorage** where the crew discovered that the sea water inlet filter of the fresh water cooler was blocked., **designated anchorage područje namijenjeno za sidrenje, područje određeno za sidrenje**: A laden tanker anchored outside the entrance of a traffic separation scheme (TSS) in a designated anchorage to await the next rising tide in order to proceed upriver to discharge her cargo., **leave the anchorage napustiti sidrište, isploviti sa sidrište**: The Master left instructions on when he should be called and when the crew should begin making preparations to **leave the anchorage**., **inner anchorage nutarnje sidrište**: The VTS agreed that the vessel could use the **inner anchorage** since the area of the anchorage is outside the area of compulsory pilotage., **outer anchorage vanjsko sidrište, otvoreno sidrište, assigned**

anchorage dodijeljeno sidrište, mjesto sidrenja određeno brodu: *The master came to the bridge at 0115, and confirmed with the second officer the assigned anchorage.*, **deep-water anchorage** sidrište za brodove s velikom gazom, sidrište za prekoocenaske brodove: *This passage plan should have been changed to pass outside the Humber deep water anchorage.*; **2** Port charge relating to a vessel moored at approved anchorage site in a harbour.
naknada za sidrenje

anchorage dues (n) (mar law) naknade za sidrenje, pristojbe za sidrenje

anchor arm (n) (nav arch) krak sidra

anchor awash (n) (navig, seamanship) the anchor is awash, when it is hove up to the surface of the water **sidro izvan vode, sidro izvučeno na površinu vode**

anchor aweigh (n) (navig, seamanship) said of the anchor when just clear of the bottom **sidro podignuto s morskog dna**: *Following a temporary suspension in operations due to a hydraulic line failure, the anchor was aweigh at 1039.*

anchor ball (n) (navig) round black shape hoisted in the forepart of a vessel to show that it is anchored **kuglasta brodska oznaka za sidrenje**

anchor bed (n) (nav arch) sidrena stjelja

anchor bell (n) (seamanship) a warning bell on the forecastle used while the ship is at anchor in foggy weather **zvono za označavanje broda na sidru u magli**

anchor bend (n) (seamanship, boating/yachting) a very secure knot used to tie rode (anchor

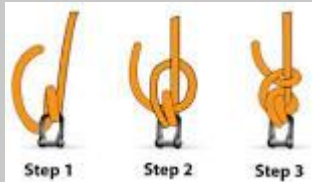

cable) to anchor **uzao za sidro**

anchor bill (n) (nav arch) šiljak lopate sidra

anchor buoy (n) **1** (navig) plutača za sidrenje; **2** a small buoy secured by a light line to an anchor to indicate position of anchor on bottom **oznaka sidra**

anchor cable (n) **veer the anchor cable** puštati lanac putem vitla: *To veer cable is to let it run out under control.*, **surge the anchor cable** puštati da lanac izlazi slobodnim

padom: *To surge cable is to let it run out under its own weight;*, **check the anchor cable**

zaustaviti lanac kočnicom: *To snub or check cable is to stop it running out by putting on the brake.*,

snub the anchor cable zaustaviti lanac kočnicom, **anchor cable is taut lanac je**

napet, anchor cable is slack lanac je labav, pay out the anchor cable puštati

sidreni lanac, ispuštati sidreni lanac: *The failure of the windlass also meant that more anchor cable could not be paid out.*, **anchor cable position pozicija sidrenja, mjesto sidrenja**:

While turning in the anchor position at 16531, the ship suddenly listed to starboard. The master

intended to put the engines astern when 6 cables from the anchor position., **anchor anchor cable**

straža na sidru, gvardija broda na sidru: *The additional benefit of setting an anchor watch is*

that it should enable the other crew to sleep soundly and obtain quality rest., **anchor cable party**

grupa zadužena za sidrenje: *The vessel was dragging her anchor again, so the master called the*

anchor party and ordered the anchor to be heaved in., **secure the anchor cable pričvrstiti i**

osigurati sidreni lanac: *Assisted by two able seamen, the chief officer managed to secure the anchor cables using chain cargo lashings.* (seamanship, nav arch) = **anchor chain** chain

connecting a vessel to its anchor **sidreni lanac**: This now prevented the weight being taken off the **anchor cable** to allow the windlass to be taken out of gear so that the anchors could be let go under gravity. **anchor cable grows sidreni se lanac podiže**: The cable "grows" in the direction it leads outside the hawse pipe. **anchor cable is at short stay lanac je kratak, lanac je napet i ide okomito prema sidru**: When a cable is at short stay, it is taut and leads down to the anchor vertically, **anchor cable is at long stay lanac je dug, lanac je dug i pod kosim kutem prema moru, lanac vodi naprijed**: when it is at long stay it reaches out and makes an acute angle with the level of the water. **ship at anchor cable brod na sidru, usidreni brod**: Passing close ahead of a **ship at anchor** is potentially perilous, but if it is unavoidable, the effects of the tidal stream, wind and a ship's manoeuvrability need to be taken into account.

anchor chain (n) (nav arch) chain connecting the ship to the anchor **sidreni lanac, kadina, kadena**: Twenty four hours later, after dragging the anchor and chain along the sea bed with the rig crane's assistance we were able to recover the grapple to our deck, the tanker's anchor and all of its chain. ... the **anchor chain** has been tensioned beyond the intended safe loading of its windlass. **haul in anchor chain povlačiti sidreni lanac na brod, pay out anchor chain puštati sidreni lanac (kako se brod odmiče od sidra), run out anchor chain izvući sidreni lanac,**

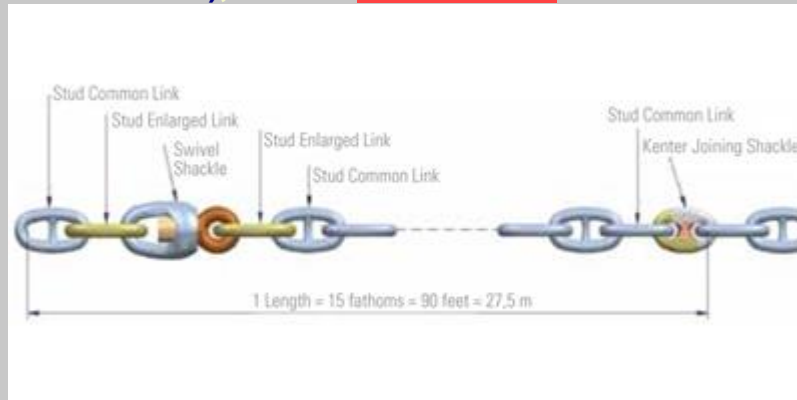

ispuštati sidreni lanac

anchor chain and its accessories (n) (nav arch) sidreni lanac i njegov pribor

anchor chain guide (n) (nav arch) vodilica sidrenog lanca

anchor chain lashing (n) (seamanship) oprema za pričvršćivanje sidrenog lanca

anchor chock

anchor holding efficiency

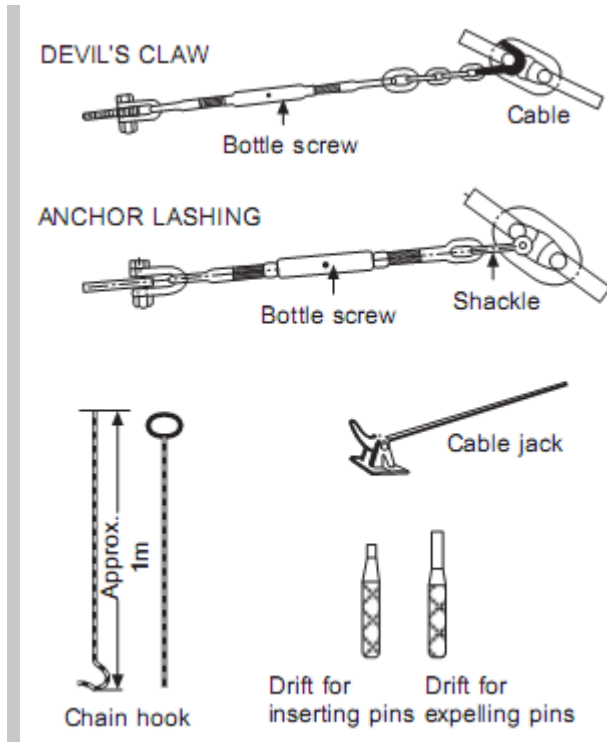

anchor chock (n) (seamanship, nav arch) deck fittings for storing the anchor **palubna oprema za pričvrščivanje sidra**

anchor crown (nav arch) čelo sidra, srce sidra

anchor davit (n) (nav arch) sidrena soha

anchor flukes (n) (nav arch) lopate sidra, krakovi sidra

anchor gear (n) (nav arch) uređaj za sidrenje, sidreni uređaj, oprema za sidrenje

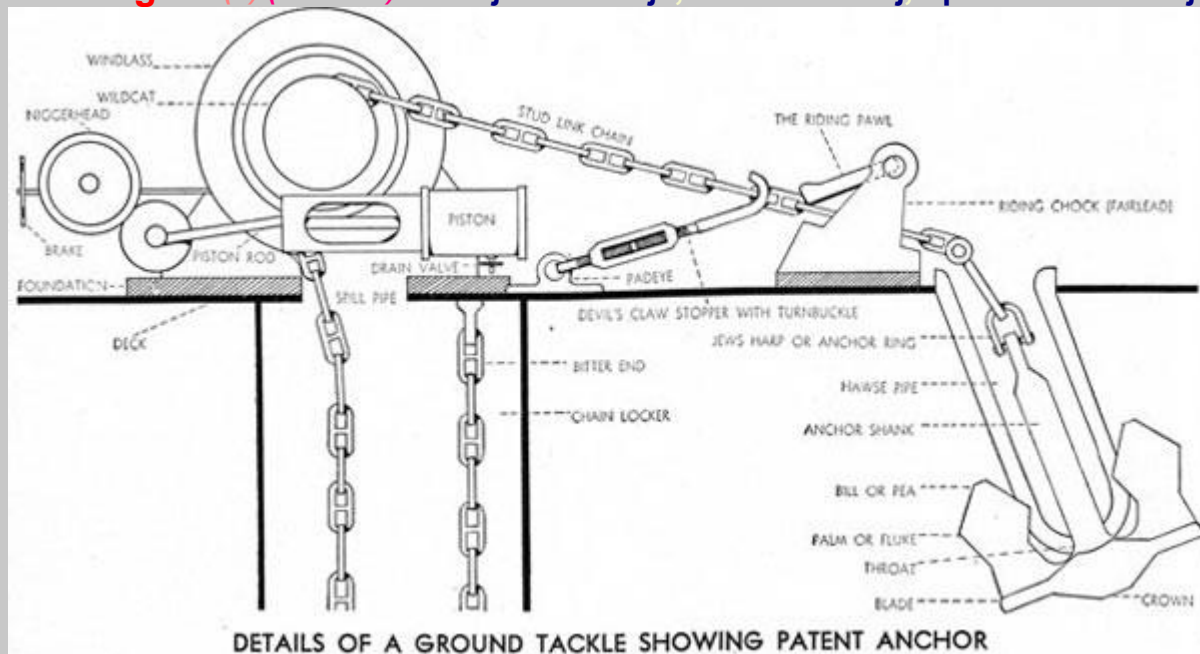

anchor guide (n) (nav arch) vodilica sidra

anchor holding efficiency (n) (navig, seamanship) efikasnost zadržavanja sidra

anchor holding force (n) (navig, seamanship) sila zadržavanja broda

anchor holds well (navig, seamanship) sidro drži dobro

anchor ice (n) (oceanogr) pridneni led

anchoring (n) (navig, seamanship) **sidrenje**: *The master always used the same length of cable when anchoring. In line with instructions from VTIS, Singapore, the vessel then proceeded towards Eastern Boarding Ground for anchoring.*

anchoring arrangements (n) **1** (seamanship) **upute za sidrenje**; **2** **način sidrenja**: *However, the veering loads produced when the wind backed and freshened, might have reduced the effectiveness of this anchoring arrangement.*

anchoring equipment (n) (nav arch) **uređaj za sidrenje, oprema za sidrenje, sidreni uređaj**: *It must be remembered that anchoring equipment is designed and manufactured only for mooring a vessel in moderate sea conditions, and for relatively short periods, while awaiting berth ...*

anchoring gear (nav arch) **uređaj za sidrenje, sidreni uređaj, oprema za sidrenje**

anchoring operation (n) (navig, seamanship) **operacija sidrenja, sidrenje**

anchoring orders **zapovijedi za sidrenje, tal. ordini per manovrare le ancore**

anchoring position (n) (navig, seamanship) **pozicija sidrenja, mjesto sidrenja**:

Approaching the planned anchoring position on a roughly south westerly heading, the vessel ran aground at 1435 on a rock pinnacle charted as an isolated danger.

anchor is apeak (ship handling, seamanship, navig) **sidro okomito ispod pramca**

anchor is clear of water (ship handling, navig) **sidro podignuto iznad vode**

anchor is dragging (navig, ship handling) **sidro ore (zbog sila vjetrova, struje, valova)**:

An anchor is dragging when through stress of wind or tide it does not hold well, and is drawn along the bottom. After a while, the weather deteriorated and the vessel began dragging her

anchor is dredging (navig, seamanship, ship handling) **namjerno orati sidrom / povlačiti sidro**

kako bi uhvatilo sidro hvata: Are you dredging anchor? Yes, I am dredging anchor. / No, I am not dredging anchor. {namjerna radnja oranja sidrom kako bi sidro uhvatilo}

anchor is foul (navig, seamanship, ship handling) **sidro se zaplelo**

anchor is holding (navig, ship handling) **sidro drži**

anchor is home (navig, seamanship, ship handling) **when the anchor is secured for sea sidro je u sidrenom oku, sidro je podignuto**: *the OOW has recognised that the anchor could not be home.*

anchor is in the hawse-pipe (seamanship, ship handling) **sidro je u sidrenom oku, sidro je u padnoj cijevi**

anchor is ready to let go (navig, seamanship, ship handling) **sidro je spremno za obaranje / spuštanje**

anchor is secured (navig, seamanship, ship handling) **sidro je pričvršćeno i osigurano (u sidrenom oku)**

anchor is stowed (navig, seamanship, ship handling) **sidro je u sidrenom oku**: *When the ship is underway, the anchor is stowed in the hawse-pipe.*

anchor is veered out (navig, seamanship, ship handling) **sidro je izvučeno (iz sidrenog oka)**

anchor is walked out (navig, seamanship, ship handling) **sidro je izvučeno iz**

sidrenog oka i visi

anchor lashings (n) (nav arch, seamanship) sredstva za osiguranje / pričvršćivanje sidrenog lanca za vrijeme plovidbe **pričvrsnice sidrenog lanca**, **boce**: *The anchor cable is secured on the forecandledeck by stoppers, devil-claws and anchor lashings*

anchor light (n) (navig) The riding lights required to be carried by vessels at anchor. **svjetlosna oznaka za sidrenje**: *two anchor lights are displayed by a ship over 150 feet (46 m) in length*

anchor ring (n) (nav arch) **sidreni kolut**, **vitica sidra**

anchor rode (n) (seamanship) length of chain, rope or both used to attach anchor to the boat

ispušteni sidreni lanac i konop, **ispušteni sidreni lanac**, **ispušteni sidreni konop**, **dužina ispuštenog sidrenog lanca i/ili konopa**

anchor's acockbill (seamanship) (in sailing ships or old ships) when the anchor is suspended perpendicularly from the cathead, ready to be let go **sidro spremno za obaranje** {obsolete (zastarj.)}

anchor's apeak sidreni je lanac napet i brod je okomito iznad sidra **sidro a picco**

anchor's aweigh (n) (seamanship) Said of the anchor when just clear of the bottom (leaving or moving) (www.USMM.org) **sidro podignuto s dna mora**

anchor scope (n) (boating/yachting, seamanship) **SEE anchor rode** odnos dužine sidrenog lanca ili konopa i dužine broda / brodice / jedrilice, ovisno o dubini; najmanji omjer je 3:1 za lanac i 5:1 za konop **omjer sidrenjaka**: *Catenary will be given every chance to prove itself. We will imagine a 16 m (~52') boat, and simulate 48 m of 12 mm chain. The distance from the seabed to the roller will be 8 m (giving an anchor scope of 6:1).*

anchor sentinel (n) (seamanship) a separate weight on a separate line which is loosely attached to the anchor rode so that it can slide down it easily **uteg na sidrenom lancu** {It is made fast at a distance slightly longer than the draft of the boat. It is used to prevent the anchor rode from becoming fouled on the keel or other underwater structures when the boat is resting at anchor and moving randomly during slack tide.}

anchor shackle (n) (nav arch) **sidreni škopac** **anchor shackle Type D** **škopac sidra u obliku slova D**

anchor shank (n) (nav arch) **struk sidra**

anchor stock (n) (nav arch) **klada sidra**

anchor swivel (n) (nav arch) **vrtulj sidrenog lanca**, **sidreni vrtuljak**, **đogulin**

anchor warp (n) (boating/yachting) **sidreni konop**, **sidrenjak**

anchor watch (n) (navig) making sure that the anchor is holding and the vessel is not drifting **straža na sidru**

anchor well (n) (boating/yachting) **sidreni zdenac**, **otvor sidra**, **sidrena jama**

anchor winch (n) (nav arch) **sidreno vitlo**

anchor windlass (n) (seamanship, boating/yachting) **sidreno vitlo**

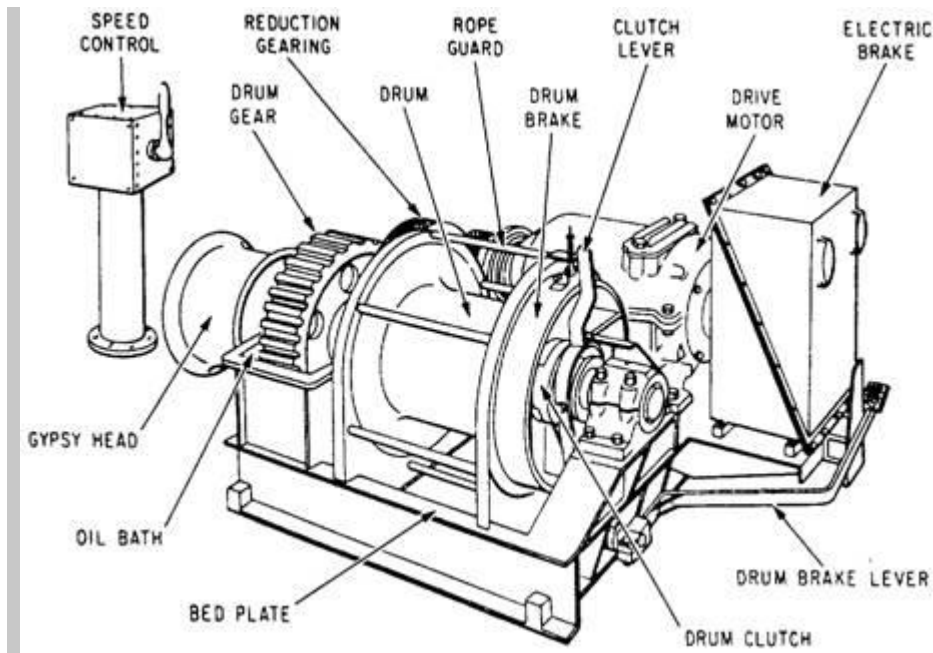

anchor work (n) (seamanship) rukovanje sidrom

anchovy /'æntʃəvi/ (n) (fishing) Lat. *Engraulis encrasicolus* inćun European anchovy inćun

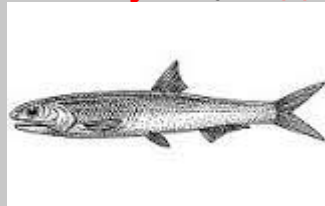

ancillary /æn'siləri/ (adj) pomoćni

ancillary equipment (n) (marine eng) pomoćna oprema

ancillary systems (n) (marine eng) pomoćni sustavi

anemometer /,ani'mɒmɪtə/ (n) (navig) an electronic weather instrument that indicates the speed and direction of the wind **anemometar**, **vjetromjer** **hand-held anemometer** ručni anemometar

aneroid barometer /'æne,rɔɪd be'rɒmɪtə/ **aneroidni barometar** **precision aneroid barometer** (PAB) visoko precizni aneroidni barometar

angels /'eɪndʒəlz/ (n) (navig) učinak/smetnje jata ptica ili kukaca na radarskoj slici **duhovi na radaru**

angle /'æŋɡəl/ (n) **kut**: The vessel was heading away from the line of the berth **at an angle of** about 15°. **at an angle of** **pod kutom od** The tug's tow rope messenger was led through a Panama lead, around the bits **at an angle of 110°** and on to the winch end whipping drum. The vessel heeled to port to **an angle** estimated at more than 50°.

angle (n) (nav arch) **uglovnica** **equal angle** istokračna uglovnica, **unequal angle** raznokračna uglovnica, **bulb angle** gomoljasta uglovnica

angle bar /'æŋɡ əl ba:/: (n) (nav arch) a bar of angle-shaped section used as a stiffener and for attachment of one plate or shape to another **okvirna uglovnica**, **kutni nosač**, **konzola**, **kutno ojačanje**: A horizontal **angle bar** was welded to the tops of the outer stanchions, to tie the

framework together and to stop the cargo shifting outboard. An accidents involving timber deck cargoes, **angle bar**, or flat bar welded to the edge the MAIB carried out a study into the of the hatch cover, or steel uprights subject and, in 2003, published its slo The moment he removed the last screw of the securing **angle bar**, the steel plates shifted towards him. **bulkhead angle bar okvirna uglovnica**

pregrade

angle indicator (n) (navig) pokazivač kuta kormila **rudder angle indicator** pokazivač otklona kormila, pokazivač kuta kormila. The main rudder **angle indicator** mounted on the deck head was not checked.

angle lug uglovnica stringer angle lugs interkostalne uglovnice palubne proveze

angle of approach (n) (navig) prilazni kut (u odnosu na vez) However, the combination of the vessel's speed, which was faster than usual, and her **angle of approach**, resulted in the ferry slightly over-shooting the usual approach track by several meters.

angle of capsize (n) (nav arch) kut prevrtanja

angle of crank (n) (marine eng) kut koljena osovine, kut koljena vratila

angle of elevation (n) kut nagiba, elevacija

angle of flooding (n) (nav arch) kut naplavljivanja

angle of heel (n) 1 (stabil, cargo) kut nagiba broda (zbog slaganja tereta); 2 (cargo) nasipni kut (kod krcanja rasutog tereta); 3 (nav arch, stabil) poprječni kut nagiba broda

angle of inclination (n) (stabil) kut nagiba broda

angle of list (n) (seamanship, nav arch) kut nagiba (uslijed pomicanja tereta): This violent movement resulted in the timber shifting across the vessel about 1 metre, giving the vessel an **angle of list** of about 8° to port.

angle of loll (n) (stabil) **COMPARE angle of heel** the state of a ship which is unstable when upright (ie: has a negative metacentric height (GMt) and therefore takes on an angle of heel to either port or starboard, **kut nagibanja broda u uspravljenom stanju pri negativnoj metacentarskoj visini, kut nestabilnosti broda u uspravljenom stanju (uslijed negativne metacentarske visine)**: Although a vessel at **angle of loll** does display features of stable equilibrium, this is an extremely dangerous situation, and rapid remedial action is required to prevent the vessel from capsizing. This violent movement resulted in the timber shifting across the vessel about 1 metre, giving the vessel an angle of list of about 8° to port. This caused her to assume an **angle of loll**, and manoeuvring back alongside generated forces that made her "flop" from side to side. This change in list, called **lolling** was often 5 degrees or more, which caused havoc with loading arms, hoses,

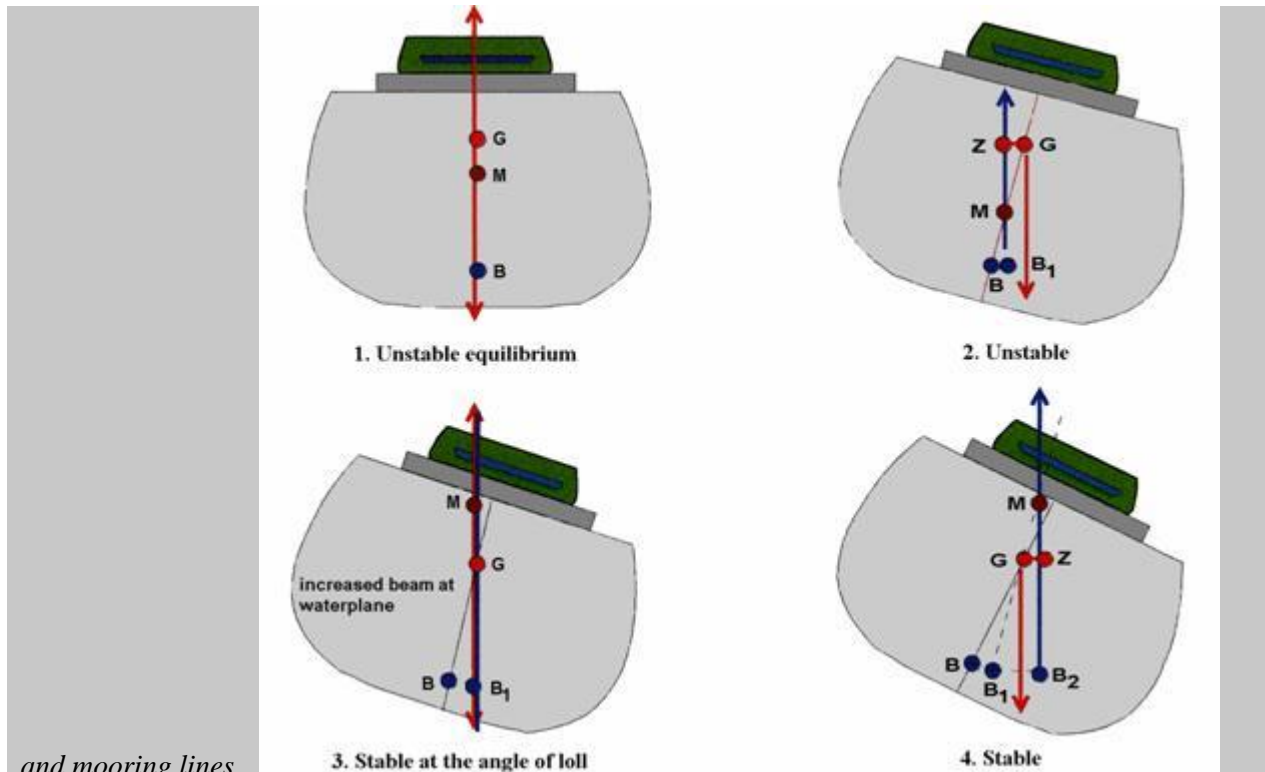

and mooring lines.

{Note the difference between an Angle of List and an Angle of Loll: A angle of list is caused by uneven distribution of weight (distribution of cargo or ballast or of bunkers). An angle of loll is caused by the ship having a negative GM (i.e when G is above M); the ship then heels until the GM becomes zero (because of the increased water plane area as the ship heels) and will roll about that point. (cf. <http://marinenotes.blogspot.hr/2012/06/angle-of-loll.html> etc.) }

angle of repose (n) (cargo handling) **nasipni kut**: Prior to loading bulk cargo, the shipper should declare characteristics & density of the cargo, stowage factor, angle of repose, amounts and special properties.

angle of roll (n) (seamanship, navig) **kut valjanja**: In the early evening, the ship again suddenly rolled violently, reaching an extreme angle of roll of 41° to port. In the early evening, the ship again suddenly rolled violently, reaching an extreme angle of roll of 41° to port.

angle of vanishing stability (AVS) (n) (boating/yachting) **kut nagiba bez mogućnosti ispravljanja jedrilice**

angler /'æŋɡlɚ/ (=black-bellied angler) (n) (fishing) = **anglerfish COMPARE sea devil = frogfish** Lat. *Lophius piscatorius* **grdobina, udičarka, žaba, vrag, rošpo**



{lat. Lophiiformes}

angler (n) (fishing) **udičar**: A large wave then came over the boat's stern and, as the other angler moved aft to assist with the bailing, the boat sank stern-first.

anglerfish (n) (fishing) **grdobina, udičarka, žaba, rošpo**

angling /ˈæŋɡlɪŋ/ (n) (fishing) the art or sport of catching fish with a rod and line and a baited hook or other lure, such as a fly (Collins) **udičarenje, lov udicama**: Three men left harbour on a winter's morning in a small speedboat to go **angling** and to recover some long-line fishing gear they had laid the day before. **angling boat udičarska brodca, udičarska barka, udičar**: Her two occupants were maintaining a lookout from the cockpit, and failed to see a small anchored angling boat, which was obscured by the sails and towards which the yacht was crabbing.

angry sea (n) (oceanogr) **jako valovito more**

ankle /ˈæŋkəl/ (n) (seamanship) **kavilja**

Annual Paid Leave (n) (mar law) **godišnji dopust**

annual survey (n) **godišnji pregled**

annular seabream (n) (fishing) Lat. *Diplodus annularis* **špar**

anode /ˈænoʊd/ (n) **1 (electr) anoda, pozitivna elektroda anode material anodni materijal; 2 (safety, electr) cink-protector**

answering pennant (comm, navig) **ponavljač (zastavica)**

answer to helm (v) (navig) **dobro reagirati na kormilo (o brodu)**

Antares /ænˈtɛəriːz/ (n) (navig) a giant red star located in the constellation Scorpio **zvijezda Antares**

antenna /ænˈtɛnə/ (n) (electr, nav arch) **antena effective aperture on the antenna efektivna površina antene, dielectric antenna dielektrična antena, Luneburg antenna Luneburgova antena, lense antenna lećasta antena, waveguide antenna antena s valovodima, antenna array slog antena, effective array/area antenna antena s usmjeravajućim površinama, antenna amplifier antensko pojačalo**: The necessary **antenna amplifiers** have now been mounted so that the range is complete all over the ship.

antenna array (n) (electr) **slog antena**

antenna depth (n) (navy) **antenska dubina (podmornice), plovidba podmornice na antenskoj diubini**

antenna mast (n) (nav arch) **antenski jarbol**

anticipate /ænˈtɪsɪˌpeɪt/ (v) **predskazati, predvidjeti, reći unaprijed**: Its members will then be able to **anticipate** dangerous situations arising and recognise the development of a chain of errors, thus enabling them to take action to break the sequence".

anti-clockwise; anticlockwise /ˌæntiˈklokˌwaɪz/ (adv) (meteorol) **1 u smjeru suprotnom od kazaljke na satu; 2 lijevokretan**

anti-clutter control (n) (navig) **uređaj protiv radarskih smetnja, sustav za brisanje smetnja**: After tuning the radar switch to the desired range scale and adjust the anti-clutter controls.

adjust the anti-clutter control **namjestiti uređaj protiv radarskih smetnja**

anticorrosive paint /ˌæntɪkəˈrɔʊsɪv/ (n) (seamanship) **antikorozivna boja**

anti-cyclone; anticyclone /ˌantiˈsaɪkləʊn/ (n) (meteorol) a large body of air in which the atmospheric pressure is higher than the pressure in the surrounding air **anticiklona, područje**

visokog tlaka: *The winds blow clockwise around an anticyclone in the Northern hemisphere*

anticyclonic circulation anticiklonsko kruženje, cold anti-cyclone; anticyclone
hladna anticiklona, intensification of anti-cyclone; anticyclone jačanje anticiklone

antifouling paint /ˌæntiˈfaʊlɪŋ/ (n) (nav arch) bottom paint consisting chemicals that inhibit marine growth **protuobraštajna boja, antivegetativna boja, koper, antifouling, tal. antivegetativa selfpolishing antifouling paint** samopolirajuća protuobraštajna boja / **antifouling, selfcleaning antifouling paint** samočisteća protuobraštajna boja, **eroding antifouling paint** erodirajuća protuobraštajna boja, **copper-free antifouling paints** bezbakrene protuobraštajne boje

anti-fouling system /ˌæntiˈfaʊlɪŋ/ (n) (nav arch) protuobraštajni sustavi, sustavi protiv obraštaja (dna broda)

antifriction bearing (n) (marine eng) ležaj bez trenja

anti-grounding warning zone (n) (navig) područje unutar kojega se uključuje alarm za opasnost nasukavanja (na uređaju ECDIS): *an anti-grounding warning zone that covered a narrow arc ahead to a range of about ten minutes' steaming had been set The ECDIS anti-grounding warning zone alarm then activated on the display, but no audible alarm sounded*

anti-heeling system (n) (nav arch) protunagibni sustav broda, sustav protiv nagibanja broda

antiheeling system (n) (stabil) prtunagibni sustav

antimony; (Sb) /ˈæntiməni/ (n) (marine eng) antimon, stibij

antimony; (Sb) /ˈæntiməni/ a toxic metallic element that exists in two allotropic forms and occurs principally in stibnite **antimon**

anti-rain clutter (n) (navig) smanjenje smetnja od kiše (na radaru)

anti-rolling pin (n) (nav arch) protuljuljna peraja

anti-rolling tanks a pair of fluid-filled, usually water, tanks mounted on opposite sides of a ship below the waterline **protuljuljni tankovi**

anti-sea clutter (n) (navig) smanjenje smetnja od mora (na radaru)

anti-slip paint (n) (seamanship) protuklizna boja: *Consider the application of anti-slip paint .*

anti-swinging system (n) (cargo handling) uređaj za umirenje tereta (na dizalici)

anti-syphon swan-neck fitting (n) (boating/yachting) antisifonska cijev (protiv povrata vode za hlađenje u cilindar)

antitrade winds; antitrades (n) (oceanogr) the prevailing westerly winds of the middle latitudes **protupasati**

anvil /ˈænvɪl/ (n) (marine eng) nakovanj

AP; aft perpendicular (n) (stabil, nav arch) krmeni perpendikular, krmena okomica

apeak /əˈpi:k/ (=apeek) (adv) (ship handling, seamanship) perpendicular to the anchor, the cable having been drawn so tight as to bring the ship directly over it **brod okomito iznad sidra, a piko; tal. a picco:** *the anchor is a-peak*

apogee /ˈæpəˌdʒi:/ (n) (oceanogr) **ANTONYM perigee** the point in its orbit around the earth when the moon or an artificial satellite is at its greatest distance from the earth **apogeja**

apogean tides /ˌæpəˈdʒi:ən ,taɪdz/ (n) (oceanogr) tides of decreased range or currents of decreased speed occurring monthly as the result of the Moon being in apogee (farthest from the Earth)

apeogejske mijene, perigejska perioda

aport (*adv*) (*seamanship*) on or toward the port side of a ship **s lijeve strane (broda), prema lijevoj strani (broda)**

apparel /ə'pærəl/ (*n*) (*seamanship*) a vessel's outfit, such as rigging, anchor and lifeboats **brodska oprema**

apparent /ə'pærənt/ (*adj*) **primjetljiv, vidljiv, prividan, jasan**: *As the vessel closed the harbour entrance it became apparent to the master that the aspect of the breakwater was incorrect and that he was too far to starboard. Early action, which is readily apparent to the other vessel, ensures that the vessels involved will pass safely, and avoids any confusion as to actions taken. The vessel increased speed astern at an angle of about 10o from the berth until it became apparent that the bow would not clear the ferry berthed astern.*

apparent wind (*n*) (*boating/yachting*) **COMPARE true wind** a combination of the true wind and the wind produced by our motion **prividan vjetar**

appeal /ə'pi:l/ (*n*) **1 a žalba, apelacija; 2 molba za pomoć**

appendages /ə'pɛndɪdʒɪz/ (*n*) (*nav arch*) konstrukcijski dijelovi izvan brodskega obrisa **privjesci**

appliance /ə'plaiəns/ **1 naprava, uređaj line-throwing appliance naprava za bacanje konopa, life saving appliance oprema za spašavanje, uređaj za spuštanje brodice za traganje i spašavanje; 2 sredstvo**

applicable /'æplikəbəl; ə'plikəbəl/ (*adj*) **primjenljiv, koji se primjenjuje**: *This Agreement is applicable and of full force and effect whether or not the Owners have entered into individual contracts of employment with any Employee*

application /,æpli'keɪʃən/ (*n*) **1 (mar law) molba, zahtjev make an application uputiti**

zahtjev / molbu, zahtijevati, tražiti: *The folder is available on application., file an*

application podnijeti molbu / zahtjev: *Survivors of the ferry disaster have filed more than 50*

applications for compensation from the company., application of starboard / port helm

okretanje kormila u desno / lijevo: *The application of starboard helm was confirmed by*

movement of the main rudder angle indicator.; 2 primjena, uključivanje, postavljanje: *The*

accident occurred due to poor application / knowledge of the COLREGS. The root cause of this accident

was the chief engineer's inadvertent application of propeller pitch. application ashore kopnena

primjena, find application imati primjenu, for marine application za brodske

namjene, za primjenu na brodu: *The effect of these adjustments was to make them considerably*

more suitable for the marine application., pitch application promjena koraka propelera,

namještanje koraka propelera

applications form (*n*) **obrazac prijave (molbe za zapošljavanje itd.)**

applied force (*n*) (*marine eng*) **primijenjena sila**

apply for /ə'plai/ (*v*) **1 tražiti, moliti, zahtijevati; 2 prijaviti se (na natječaj, ...), uputiti / podnijeti zahtjev za**

apply the rudder / helm (*v*) (*navig, seamanship*) **okrenuti kormilo, namjestiti**

kormilo: *Master advised the pilot to apply full astern power. the pilot was surprised that after applying*

port helm, the ship turned to starboard. peljar se iznenadio što je nakon okretanja kormila u lijevo brod

skrenuo u desno apply the rudder / helm the port / starboard helm okrenuti kormilo u

lijevo / desno

appoint /ə'pɔɪnt/ (*v*) **1 a imenovati; 2 postaviti (nekoga na dužnost)**: *The Shipping Line has appointed a new chief executive officer and chief financial officer. appoint as Master*

postaviti za zapovjednika imenovati za zapovjednika

apportion /ə'pɔːʃən/ (v) (shipping econ) raspodijeliti (troškove), rasporediti **apportion blame** (mar law) pripisati krivnju, okriviti: *The role of the MAIB is purely to discover the facts, not to apportion blame or culpability.* Uloga MAIB-a je isključivo da se utvrde činjenice, a ne da okrivljuje.

appraisal /ə'preizəl/ (n) **appraisal of the situation** procjena situacije / stanja, **procjena**: *Rule 5 of the COLREGs requires a proper lookout to be maintained at all times so as to make a full appraisal of the situation and of the risk of collision.*

appraisement /ə'preizmənt/ (n) (mar law) determination of the dutiable value of imported merchandise by a Customs official who follows procedures outlined in their country's tariff **carinska procjena robe**

apprehend /,æpri'hend/ (v) (mar law) uhititi

apprentice /ə'prentis/ (n) (mar law) vježbenik, naučnik **engine-room apprentice** vježbenik stroja

apprentice officer (n) (mar law) = **cadet = navigating cadet** An apprentice officer provides assistance in various duties on a merchant ship, such as maintenance and minor repair duties. This level is necessary for further career development in deck department. **vježbenik navigating apprentice officer** vježbenik palube, kadet, **engineering apprentice officer** vježbenik stroja

apprenticeship /ə'prentisʃip/ **izobrazba (za časnička ili mornarska zvanja), kadetura**: *He served his apprenticeship as a motor mechanic, after which he worked for 8 years on oil rigs in the north sea followed by many years, and still to the present day.*

approach /ə'prəʊtʃ/ (n) (navig) **prilaz**: *The OOW monitored the other ship's approach, and identified her from the AIS.* **approach to the port** **prilaz luci**: *The approach to the port required the vessel to enter an inlet several miles wide and then alter course into a bay in which the port was located.*, **approach route** **prilazni plovni put**, **prilazna ruta**, **approach to the berth** **prilaz vezu**: *The normal approach to the berth took the vessel to the port side of the channel to make a steep approach to the jetty, and this plan was followed.*, **approach to the entrance**: *The approach to the entrance of the river was made on a course of 355° at a speed of 10 knots, aiming to leave a beacon marking the western entrance of the river* **prilaz ulazu (u luku, ušće, rijeku)**, **approach to the anchorage**: *Throughout the approach to the anchorage the echo-sounder had not been monitored.* **prilaz sidrištu**, **angle of approach**: *The angle of approach to the berth was more open than 'usual' due to another tanker alongside the adjacent berth* **kut prilaznja (broda vezu, obali, ...)**

approach: (v) (navig) **prići, prilaziti**: *The vessel's main propulsion had failed as she approached the berth and, although the starboard anchor was let go, the vessel could not be stopped.*

approach channel (n) (navig) **prilazni kanal (luci, tjesnacu), prilazni plovni put**: *At 0300, the ship neared the narrow approach channel of the destination port. The tug at this time was in the approach channel to the harbour, still proceeding at full speed.* **southern limit of the approach channel** **krajnja južna točka/crta prilaznog kanala**, **approach channel buoy** **plutača koja označava prilazni kanal**: *With 1 mile to go, the chief officer called port control again and was instructed to keep east of the outer approach channel buoy.*, **port approach channel** **prilaz luci**, **prilazni kanal u luku**: *Near miss in Port Approach Channel.*

approach course (n) (navig) **prilazni kurs**: *The helmsman achieved the aim, the electronic chart display data showing him steering between 10 and 15 degrees to starboard of the approach*

course to counteract the effect of the tide.

approach downwind (n) (boating/yachting) prilaz (plutači, vezu) niz vjetar

approach upwind (n) (boating/yachting) prilaz (plutači, vezu) uz vjetar

appropriate /ə'prəʊpriət/ (adv) primjeren, odgovarajuć, prikladan, podesan

appropriate measures odgovarajuće mjere: *This helps the crew and the shore side to take appropriate measures, not only for storage but also and especially in the event of damage.*

appropriate precautions odgovarajuće mjere opreza: *Fumigants are dangerous if not handled correctly and appropriate precautions are not taken.*

appropriate action odgovarajuća radnja, primjerena radnja: *Be alert to the problem and take appropriate action.*

They then continued to monitor the situation, and took appropriate action to avoid a collision.

appropriate safety equipment odgovarajuća sigurnosna oprema: *Although tragically one man lost his life, this accident does demonstrate the benefit of carrying appropriate safety equipment.*

appropriate procedures odgovarajući postupci: *Appropriate procedures must then be developed and followed, which reduce the potential for human error.*

appropriate navigation lights odgovarajuća navigacijska svjetla: *Both the tug and the barge were showing appropriate navigation lights, the radar was operating, and from time to time the fog signal for a vessel engaged in towing was being sounded.*

appropriate chart odgovarajuća pomorska karta: *All available information for safe passage of the vessel must be entered clearly in all appropriate charts.*

appropriate alteration of course primjerena promjena kursa, odgovarajuća promjena kursa: *The combination of an early and substantial reduction of speed, together with an appropriate alteration of course, would have safely cleared all vessels.*

approval /ə'pru:vəl/ **odobrenje**, **pristanak**: *The voyage to Brunsbüttel was continued with the approval of traffic control. Immediately on arrival at the Engine Control Room (ECR), both the chief and third engineers stopped the main engines without approval from the bridge and without knowledge of the navigational position.*

give approval: *In this case, the drivers were routinely allowed to retain their vehicle keys and move their vehicles before approval was given by the crew.*

odobriti *The vessel was taken out of service and was given approval to proceed, at slow speed, to her base for repairs before returning to service a few weeks later.*

dati odobrenje, **without approval**

bez odobrenja: *The extended communications chain led to confusion and the later restarting of engines without the master's approval.*

seek prior approval, **tražiti prethodno odobrenje**, **tražiti prethodni pristanak**, **tražiti odobrenje prije (poduzimanja neke radnje)**: *However, the third engineer should have sought prior approval and taken steps to isolate the cooling system.*

gain approval, **dobiti odobrenje**, **ishoditi odobrenje**: *Without gaining prior approval, the two men decided to remove an adjacent thermometer pocket in the engine's cooling water system in order to ease access to the rockers.*

approve /ə'pru:v/ (v) **odobriti**: *A passage plan should be berth to berth, and approved by the master. The vessel remained aground for 11/2 days before the coastal state approved the owner's salvage plan and the vessel was towed off the shore. The port authority approved the hot work, which was conditional upon the contractor complying with the ship's Safety Management System (SMS).*

approved //ə'pru:vd// (adj) (mar law) **priznat (npr. u konvenciji STCW)**, **odobren**: *In particular, access to the upper deck tiers is a problem, even with the approved fire-fighting equipment required by SOLAS. This vessel carried mandatory type approved lifejackets.*

appurtenances /ə'pɜ:tɪnənsɪz/ (n pl) (mar law) **pripadnosti broda**, **pripadci broda**

apron /'eɪprən/ 1 (ports) **The area immediately in front of or behind a wharf shed on which cargo is lifted.** ; **a concrete or planked area immediately in front of or behind a wharf shed on which cargo is**

lifted. **;** a concrete or planked platform at the entrance to a dock, usually extending from the nearby shed/warehouse/rail gauge to the quay edge **operativna obala, lučka obalna površina**: *The area immediately in front of or behind a wharf shed on which cargo is lifted. On the **front apron**, cargo is unloaded from or loaded onto a ship. Behind the shed, cargo moves over the **rear apron** into and out of railroad cars.* **quay apron obala / obalna površina (od ruba obale do obalnog skladišta), front apron operativna obala (između skladišta ili kolosijeka i obalnog zida), rear apron pozadinski obalni prostor (za utovar / istovar vagona i kamiona);**
2 (nav arch, sailing vessels) pramčana protustatva
APS (arrival pilot station) (mar law) dolazak (broda) na peljarsku postaju
apt to /æpt/ (adj) 1 sklon čemu; 2 pogodan, prikladan
arbitral award /'a:bitrəl/ (n) (mar law) arbitražna odluka
arbitral tribunal /'a:bitrəl traɪ'bjʊ:nəl; 'a:bitrəl tri'bjʊ:nəl/ (n) (mar law) arbitražni sud
arbitration /,a:bi'treɪʃən/ (n) (mar law) the process of referring to an agreed person (or body of persons) for judgement on issues of dispute, without requiring the use of courts; a method of settling disputes by one or more arbitrators. Quicker and cheaper than taking a case to court.
 (http://offshore-industry.net/info/Terms_and_Expressions_in_Shipping_and_Offshore.pdf) **arbitraža, izabrani sud**
arbitrator /'a:bitreɪtə/ (n) (mar law) arbitražni sudac
arc /a:k/ 1 (navig) luk: The anti-grounding warning zone covered an arc 1 degree either side of the vessel's track out to a distance equivalent to 10 minutes' steaming. in a wide arc u širokom luku: The ship then turned to port and sailed towards the Langlütjen breakwater in a wide arc.; 2 (navig) sektor kružnice
archipelago /,a:ki'pɛli,gəʊ/ (n) (geogr) otočje
arc of horizon (n) (navig) luk horizonta
arc of visibility (n) (navig) the portion of the horizon over which a lighted aid to navigation is visible from seaward područje vidljivosti, luk vidljivosti
Arcturus (n) (navig) a giant fixed star of the first magnitude in Bootes zvijezda Arcturus
arc welding (n) (marine eng) lučno zavarivanje electric arc welding elektrolučno zavarivanje: A standby vessel was in port waiting for her next tasking, so the opportunity was taken to carry out an electric arc welding repair to the bedplate of an alternator located in the engine room.
arc-welding machine (n) (marine eng) aparat za lučno zavarivanje
area /'ɛəriə/ (n) 1 površina: They evacuated the area and prevented anyone from approaching the distribution box while they contacted shipyard representatives. cros-sectional area poprečna površina, unit area jedinica površine; 2 (meteorol) područje area forecast (meteorol) prognoza za područje, area of restricted visibility područje ograničene vidljivosti: Failure to laid down the actions to be taken when follow the checklist, compounded by a entering an area of restricted visibility, lack of positive reporting by other crew the majority of which had been ignored.; 3 područje plovidbe area of restricted waters područje ograničenih voda za plovidbu: Shortly after a large container ship had cleared an area of restricted waters, involving an extended period of slow speed manoeuvring, a fire was noticed in the top tier of the deck containers aft of the funnel., vessels in the area brodovi u tom području: She was, however, now disabled, and the skipper had to rip the wheelhouse door off its hinges to gain access to issue a "Mayday". Several vessels in the area responded, and she was later safely towed into port., sea area

morsko područje područje na moru: While transiting the inshore route, he used binoculars to search the sea area ahead for the vessel they were to meet. , **port area lučko područje, područje luke**: The VTSO was aware that the ship did not usually transmit on AIS in the port area and therefore had to be tracked manually on the radar display.

area of uncertainty (n) (boating/yachting, navig) nepouzđano područje

areas of navigation (n) (navig, safety) područje kojim brod određene kategorije smije ploviti područja plovidbe

area to be avoided (n) (navig, safety) područja unutar utvrđenih granica u kojima je plovidba posebno opasna područja koja treba izbjegavati

argosy (n) 1 (nav arch, boating/yachting) a Mediterranean trading carrack in the Middle Ages; a ship richly laden; an extremely large ship or fleet of ships, especially merchant ships dubrovačka karaka; 2 jako nakrcan brod {archaic}

argument /'a:ˌgʃmənt/ (n) (mar law) svađa, spor, prepirka

arise /ə'reɪz/ (v) nastati, proizaći: General average arises when a deliberate sacrifice or expenditure is incurred for the common safety of the other cargo interests. Most of these accidents arise because of overheating or spillage. The problems arise when the nature of a fire needs everyone on board to respond effectively.

arise from (v) proisteći, proizaći iz nastati zbog: An accident can be defined as an unexpected hazardous occurrence caused by unsafe practices that arise from inadequate knowledge, improper training, and failure to follow proper procedures, and usually resulting in loss of life or injury to personnel. All personnel need to be aware of the potential health hazards which can arise from both noxious and less obvious fumes.

armed attack (n) (safety) oružani napad

armoured cable /'a:ˌməd ,keɪbəl/ (n) (seamanship) armirano uže: This may be by considering using a fire-resistant/armoured type cable or routeing it outside the engine room so far as this is reasonable.

ARPA /'a:r.pə/ (=Automatic Radar Plotting Ai) (n) (navig) kompjutorizirani radarski sustav pomagala za plotiranje objekata na moru; Automatic Radar Plotting Aid sustav

automatskog radarskog ucrtavanja, sustav ARPA, ARPA radar, ARPA, sustav

automatskog radarskog plotiranja: ARPA functions as a collision avoidance tool, tracking individual Radar targets and plotting their course and speed in order to determine the closest point of approach (CPA) and time to closest point of approach (TCPA) to own vessel. Both vessels were equipped with operational radars, fitted with Automatic Radar Plotting Aid (ARPA), but neither watchkeeping officer used the ARPA to plot any radar targets. **ARPA errors 1 grješke sustava ARPA; 2**

ARPA interpretation tumačenje grješaka u sustavu ARPA, use the ARPA 1: The master selected the container ship's radar target using the automatic radar plotting aid (ARPA), which enabled him to monitor its progress. There are no excuses for not using navigational aids such as ARPA and compass repeaters to aid the accurate assessment of close quarters situations.; **2, ARPA auto**

acquisition automatsko hvatanje cilja / objekta putem ARPA-a: Use the radar functions, including ARPA auto acquisition and CPA warning features, to give warning of other vessels and developing close-quarters situations. , **ARPA radar ARPA radar**: The OOW was sitting in front of an electronic chart system; an ARPA radar screen was to his left. The OOW knew that he had to make a

planned 21° alteration of course to starboard 10 minutes later and, because the ARPA radars would not acquire the contact, he decided that the planned alteration would also suffice as a collision avoidance manoeuvre. , **ARPA data podatci dobiveni putem ARPA-e** Had the handover included

continually checking the latest **ARPA data** of the approaching vessel, more time would have been available to properly assess the situation and take effective action. This included information concerning the small vessel, including the initial **ARPA data** giving a CPA of 1 mile to port., **ARPA display pokazivač na ARPA-i, ekran na ARPA-i**. While the OOW attempted to acquire the contact on the X and S band **ARPA displays**, the pleasure yacht made a 20° alteration of course to port., **monitor the ARPA pratiti sliku na ARPA-i**: The officers's subsequent **monitoring of the ARPA** failed to identify that the ferry's bearing was almost steady., **ARPA radar failed ARPA-radar je zakazao**: Two hours into the passage, the **ARPA radar** also failed., **ARPA target ARPA-cilj cilj / objekt na ARPA-i**: The tanker was also on the radar displays but it was not acquired as an **ARPA target**., **ARPA performance standards standardi učinkovitosti ARPA-e**: The ARPA will then give results which meet the **ARPA performance standards**., **fitted with ARPA opremljen ARPA-om**: The target vessel's details were displayed on the AIS receiver but the option to display the target's information on the X-band radar, which was **fitted with ARPA**, was not taken., **acquired target by ARPA uhvatiti cilj / objekt putem ARPA-e**: ... the two buoys marking the southern limit of the channel were clearly visible on the radar and **had been acquired by ARPA**.

arrange /ə'reindʒ/ (v) **1 urediti; 2 srediti**: The skipper then decided to establish a fire/smoke boundary, and **arranged for** the watertight doors to be closed.; **3 (navig) dogovoriti**. But before doing so, he managed to **arrange a tow** from an offshore support vessel. As the vessel was swinging to port, he reduced the helm order to port 10° and then engaged in a VHF radio conversation to **arrange** passing with an outbound vessel, while the second officer plotted a position on the chart. **arrange a berth dogovoriti vez, rezervirati vez; 4 (navig) organizirati**: The master decided to advance the ETA, and the OOW contacted the pilots to **arrange** an 0540 embarkation. This have might have prompted the pilot to **arrange** tug assistance.; **5 rasporediti; 6 poredati, svrstati; 7 smjestiti; 8 izvesti**

arrangement /ə'reindʒmənt/ (n) **1 (navig) dogovor; 2 (cargo handling, ports) organizacija make arrangements (for discharge / loading) pripremiti (iskrcaj / ukrcaj), organizirati (iskrcaj / ukrcaj); 3 (marine eng) raspored cylinder arrangement raspored cilindra, arrangement of gas flow raspored odvoda plinova; 4 (seamanship) izvedba, sustav, način: working arrangement način rada** to this vessel, which should undoubtedly contributed to the remove the dangers evident from the very serious injuries sustained by initial **working arrangement**. **berthing arrangement način pristajanja, vrsta manovre pristajanja, anchoring arrangement**: However, the veering loads produced when the wind backed and freshened, might have reduced the effectiveness of this **anchoring arrangement**. **način sidrenja, closing arrangement način zatvaranja (grotla, skladišta itd.)**: Therefore no risk control measures had been put in place, such as a hinged barrier or other **closing arrangement**., **mooring arrangement način privezivanja**: The vessel's **mooring arrangement** consisted of two mooring winches forward and two aft, with captive drums and drum ends., **securing arrangement način pričvršćivanja (tereta, sidra, užadi itd.)**: Make sure that the relevant crew are familiar with the anchor chain **securing arrangements**., **senhouse slip arrangement uređaj s samootpusnom kukom, uređaj za automatsko otpuštanje užeta** However, the rope or webbing lashing is also usually fitted with a quick release, **senhouse-slip arrangement** to facilitate rapid deployment of the raft in the event of an emergency., **pilot boarding arrangement način ukrcaja peljara**: Amongst other factors, this safety investigation established that the **pilot boarding arrangement** provided by the ship was not compliant with the relevant SOLAS requirements

due to its close proximity to the ship.; 5 (marine eng) uređaj naprava: In this case, the long-term aim is now to significantly improve the securing arrangement by a permanent modification. **lifting arrangement uređaj za dizanje**: On closer inspection, it was found that the design of the lifting arrangement allowed the lifting wire to chafe on the ramp handrails.

arrange the agreement (v) (shipping econ) dogovarati uvjete ugovora

arrest /əˈrɛst/ (n) (mar law) **COMPARE seizure** The procedure whereby, in common law jurisdictions, a ship (and sometimes cargo and/or freight) may be seized by an admiralty court at the institution of or during an action in rem (infra) to provide pre-judgment security for the plaintiff's maritime claim. (Tetley); opći termin koji znači svako zadržavanje broda/tereta radi osiguranja naplate pomorskih tražbina **zaustavljanje broda, zadržavanje broda**: Arrest of a ship means the detention of a ship by judicial process to secure a maritime claim, but does not include the seizure of a ship in execution or satisfaction of a judgment. *The dispute which led to the arrest of the general cargo ship in the port of Hamilton with 14 seafarers onboard causing damage but no serious injuries among passengers or crew* **court arrest sudsko zadržavanje broda**: The chartered cargo vessel was placed under court arrest after the shipowner filed a civil claim for money it owed by ..., **arrest order nalog za zadržavanje broda**: The owner representative said: We have not seen any arrest orders and we don't have any written official documents, a court ruling, or an arrest order., **arrest of vessel zaustavljanje broda, zadržavanje broda**: Arrest of a vessel is part of the process by which an Admiralty Court gains jurisdiction over the subject matter of a law suit.

(http://www.maritimelawcenter.com/html/arrest_of_vessel.html) **Arrest of a vessel** is the physical process by which, in case of the United States, a U.S. Marshal goes aboard the vessel and \physically takes charge of it. {Note: **arrest the ship= zaustavljanje, zadržavanje broda; seizure = zapljena broda**}

arrest /əˈrɛst/ (v) 1 (mar law) **COMPARE seize COMPARE detain zaustaviti brod, zadržati (brod radi naplate dugovanja); 2 (navig, seamanship) zaustaviti kretanje (broda)**

Although the vessel's engine developed full astern power, this was insufficient to **arrest her headway** in the space available and she made heavy contact with the quay on the opposite bank of the river (see figure). The master attempted to **arrest the vessel's swing** to port using the handwheel. Once on the port bridge wing, the captain adjusted the azimuth propulsion to **arrest the vessel's movement astern**. **arrest the swing zaustaviti okretanje, zaustaviti odmicanje (pramca, krme)**: The master used the engines and thrusters in an attempt to **arrest the swing** but, despite the efforts of the crew, the forward winch brakes also began to render

arrest /əˈrɛst/ **pritor, zatvor**: Failure to comply with certification requirement may result in a heavy fine, arrest or a penalty.

arrest /əˈrɛst/ (v) 1 (cargo handling) **zaustaviti se, blokirati se**: Loose lashings allowing the stacks to tilt and arrest sharply as the slack is taken up.; 2 (marine eng) **zaustaviti, blokirati**: The other engine was stopped, to **arrest** the generation of frictional heat in the clutch, and the water fog fire-fighting system was activated.

arrest of ship (n) (mar law) privremena mjera kojom se brod zaustavlja radi namirenja točno određenih potraživanja **zaustavljanje broda (radi odiguranja naplate), zaustavljanje broda (kao privremena sudska mjera)**

arrival at the port (n) (navig, seamanship) dolazak broda u luku: Prior to **arrival at the next port**, the master and chief officer were woken and called to the bridge. On **arrival at the ship's next port of call**, an underwater survey was carried out and ultrasound measurements of the shell plate were taken in way of the vent

arrival brief (n) (navig) kratak dogovor prije uplovljenja, kratak dogovor o dolasku

broda u luku *Prior to arrival at the pilot station, the master should ensure a **pre-arrival briefing** takes place with the bridge team.*

arrival in port (n) (navig) **dolazak u luku**: *The chief officer has some extra duties **on arrival in port** while the master is dealing with port entry and other paperwork, otherwise the 6-on 6-off routine is maintained. The motorman was in the process of unplugging the power supply to the refrigerated container units on the vehicle deck in preparation for the vessel's **arrival in port**. **arrival in port of a ship / tug dolazak broda / tegljača u luku**: He then awaited the **arrival of a second tug**, which assisted in re-berthing the vessel alongside. All proved satisfactory, and he settled back to await the imminent arrival of the pilot. **arrival in port of the pilot dolazak peljara**: All proved satisfactory, and he settled back to await the imminent **arrival of the pilot**.*

arrival notice (n) (navig, comm) a notification by carrier of ship's arrival to the consignee, the Notify Party; a notice sent by a carrier to a nominated notify party advising of the arrival of a certain shipment or consignment **obavijest o dolasku (broda u luku)**

arrival procedure (shipping econ) **postupak pri dolasku / uplovljenju**: *Make sure your bridge **arrival procedures** actually help the bridge team and that checklist completion adds value.*

arrive at (v) **stići u, doći u**: *The ship **arrived at Svendborg** via the western entrance of Svendborg Sound. **arrive at the port stići u luku**: When the vessel **arrived at the port**, the fumigator appointed to meet the vessel found a very high concentration of phosphine gas in the deceased crewman's cabin and in the **arrive at at the pilot station stići na peljarsku postaju**: The MS Sybille arrived at the **pilot station** of the port of Dublin at 05:15, **arrive at at the destination stići na odredište**: The coastguard then received a report that the ship **had arrived at its destination**. **arrive at at the terminal stići na terminal**: A short time later a lady arrived at the ferry terminal clearly in some distress following an altercation with the person driving her there.*

arrived ship (n) (mar law) klauzula u brodarskom ugovoru i pismu spremnosti **prispjeli brod**: *A vessel is considered to be "arrived ship" as the Pilot comes on board and lay time will commence.*

arriving under power (n) (boating/yachting, seamanship) **pristajanje motorom**

arriving under sail (n) (boating/yachting) **pristajanje pod jedrima**

arriving at a berth (n) (boating/yachting, seamanship) **dolazak na vez, pristajanje**

article /'ɑ:tɪkəl/ (n) 1 (shipping econ, mar ins) **stavka (robe), artikl, pojedini teret**; 2 (mar law) **članak ugovora** **read out the articles** **pročitati stavke ugovora**

articles (n) (mar law, shipping econ) **SEE articles of agreement** (mar law) signed documents (i.e. contract) indicating a crew member's responsibilities, duties, wages, rank and/or position on board a ship **ugovor o ukrcanju pomorca**

articles of agreement (n) (mar law) signed documents (contract) indicating a crew member's responsibilities, duties, rank, wages and/or position on board a ship **ugovor o ukrcanju pomorca, radni ugovor (pomorca) sign the articles of agreement** **potpisati ugovor o ukrcanju pomorca**

articles of association (n) (mar law) **ugovor o osnivanju trgovačkog društva, društveni ugovor**

articulated /ɑ:'tɪkjʊleɪtɪd/ (adj) (cargo handling, marine eng) having a joint or joints; jointed: **zglobni articulated pipe** (cargo handling) **zglobna cijev (za krcanje tekućih tereta)**

artificial respiration (n) (med) = **artificial ventilation** **umjetno disanje**

artificial resuscitation /,rɪsɪ'sɪteɪf(ə)n/ **oživljavanje, reanimacija**: *Half an hour later, an RNLI lifeboat arrived and lifeboat men transferred to the fishing vessel and recommenced **artificial***

resuscitation to the casualty, despite being unable to detect outward signs of life.

artificial ventilation (n) (med) A procedure used to restore or maintain respiration in a person who has stopped breathing. The method uses mechanical or manual means to force air into and out of the lungs in a rhythmic fashion. **umjetno disanje**

as agent only (prep phr) (mar law) odredba u agentskom ugovoru kojom agent navodi da nastupa samo u svojstvu agenta **isključivo u svojstvu aganta**

ascend /ə'send/ (v) 1 **ANTONYM descend dizati se, uzdizati se, penjati se**: *While the crew on the top were engaged in manually hauling up a portable hydraulic pump with a ployprop 'heaving' line, the chief officer began to ascend the access ladder. They were passing through the accommodation and starting to ascend a ladder from the main deck when the ship's dog attacked the Pilot from behind.*; 2 **ulaziti**

ascertain /,æse'tein/ (v) 1 **utvrditi, ustanoviti**: *In this case, the yachtsmen correctly took a series of compass bearings to ascertain if a risk of collision existed. The master was still looking at the engine monitoring system display, attempting to ascertain the reason for the starboard main engine slow response.*; 2 **kontrolirati**; 3 **provjeriti**: *The VTS advised him to call the other vessel to ascertain the information.*

as fast as (as fast as the vessel can receive) (n) (mar law) **tako brzo koliko brod može primiti (o krcanju tereta), predavati teret brzinom kojom brod može primiti**

as from, as of (prep phr) **počevši od (... sati / dana)**

A-shape frame (n) (marine eng) **stalak (motora) u obliku slova A**

ashore /ə'ʃɔ:/ (adv) on the shore, land or beach **na kopnu, na obali, na kraju**: *The propeller may become fouled unless good communication and co-ordination is maintained between the bridge, the mooring parties and the berthing party ashore. The skipper was recovered, landed ashore, and then flown to hospital by air ambulance. land ashore: The rescue operation involving a helicopter, an inshore lifeboat and an all weather lifeboat ensured that the crew and passengers were landed safely ashore. iskrcati se na kopno / obalu, run / pass a mooring line ashore: At 1555 UTC, two headlines were run ashore. The master gave instructions for a headline, a forward backspring and an aft backspring to be passed ashore. poslati privezno uže na obalu, dodati privezno uže na obalu, pass a line over the bollard ashore prebaciti privezno uže preko bitve na obali: Two stern lines had been passed over bollards ashore and their respective winch brakes applied. to drift ashore plutati prema kopnu: With nothing now to restrain it, the yacht continued to drift ashore. transfer crew / passengers ashore prebaciti članove posade / putnike na kopno / obalu: The injured crewman was transferred ashore by the local lifeboat and on to hospital by ambulance. lay-up a boat / ship ashore: The boat had been launched that morning after being laid-up ashore for 6 months. držati brodicu / brod u raspremi na kopnu, come ashore iskrcati se (o pomorcu): prestati ploviti He came ashore in 1992 and worked as Marine Surveyor/consultant with Ltd in Glasgow. assistance from ashore pomoć s kopna: If breathing apparatus is not carried on board, and it really is impossible to wait for assistance from ashore, entry should only be attempted when the space has been thoroughly ventilated with clean air, and all residues of CO2 have been removed. {opposite to to aboard or on board}*

ashore and afloat (prep phr, adv) **na kopnu i na moru, na kopnu i na brodu**: *To address these issues, senior staff, ashore and afloat, must be pro-active in training, supervising and ensuring that rules are adhered to.*

as if (conj) = **as though kao da**: *It sounded as if a cylinder had stopped firing, but they were*

unable to verify.

as long as (conj) **1 sve dok, koliko god**: The master felt he had no option but to maintain power **for as long as** possible. Similarly, when leaving a berth, tugs should remain attached **for as long as** they are needed.; **2 ako, ukoliko**: It can save your life **as long as** you look after it and you understand its features.

as near to as she can safely get (n) (mar law) klauzula kojom brodar, ako je brod trajno spriječen ući u predviđenu luku, može uputiti brod u neku drugu najbližu sigurnu luku radi iskrcaja (IG) **što je bliže moguće**

aspect /'æspɛkt/ (navig) **silueta, izgled (broda)**: A check of the visual **aspect of the inbound vessel** should have raised concerns over the accuracy of the information being provided to the master by the ARPA. The master of Vessel A was also surprised to see a **starboard aspect of Vessel B**, and used his forward speed and his side thrusters to slide his vessel away to cushion the effect of the imminent collision.

aspect (n) (navig) kut upada elektromagn. vala na površinu cilja) **položaj cilja (na radaru) beam-on aspect** horizontalni kut upada EM vala na cilj, **perpendicular aspect** okomit kut upada EM vala na cilj

as presented (n) (mar law) onako kako je podnesena (teretnica)

assault boat (n) (navy) a small portable boat used for military amphibious landings or for crossing rivers **desantna brodica**

assemble /ə'sembəl/ (v) **1 skupljati se**: After the general alarm was sounded, the crew **assembled** on the bridge He returned to the accommodation, alerted the remainder of the crew and told them to **assemble** in the wheelhouse. A deck party **was assembled** and they donned lifejackets and attached themselves to a previously rigged safety line.; **2 (marine eng) to join parts together sastaviti, sastavljati, montirati, sklopiti**

assembly /ə'sembli/ **1 (marine eng) montaža, sastavljanje; 2 (marine eng, nav arch) sklop, Removal of the cylinder head, piston and connecting rod assembly.**: The materials in use for that **assembly** consisted of three different metals, giving rise to accelerated corrosion in the marine environment. The forward **hook assembly** had sustained considerable damage. When the machinery space was entered, the engine's **No 6 cylinder large end bearing assembly** was found to have passed through the port crankcase door, and to have come to rest immediately outside the engine. A dynamic test and examination of the **davit winch and brake assembly** were made in the presence of the class surveyor, ship representative and contractor representative.

assembly area (n) (safety) **područje okupljanja na brodu**: All passengers were wearing lifejackets and waiting in the **assembly areas**.

assembly station (n) (safety) **mjesto za okupljanje na brodu (u slučaju opasnosti, uzbune itd.)**

assess /ə'ses/ (v) **procijenti, prosuditi, utvrditi, ocijeniti**: recognise that the barge would be finally realised the barge lay directly encountered shortly after rounding the ahead, there was very little time to **assess bend** in the channel. However, time should always be taken to properly **assess key factors** such as the vessel's position, damage, the depth of water available, the nature of the seabed and the tide before considering whether **assess the risk**: The display of these lights Sea, Rule 7, identifies the correct way to would have facilitated a more thorough assess risk of collision. The passenger ship's bridge team did not effectively **assess the risk of collision** with the approaching ferry, so took no action as the give way vessel., **assess the damage when the accident happened, the alarm was raised quickly and the crew were able to assess damage, start**

engines and re-anchor without undue delay. **assess the situation:** *When in doubt, reduce speed early or come to a stop to allow time to safely assess the situation.*, **assess whether ...** **Then assess whether it can be operated safely in those areas, without adding to your problems.**, **assess alternative options** by then, however, he had lost the opportunity to properly assess alternative options., **assess compliance:** *It is essential that hotwork controls are strictly adhered to and that auditing procedures assess compliance.*, **assess the fitness:** *Coastal state authorities should ensure that procedures are in place to assess the fitness of a vessel and her crew after an accident, before she is permitted to proceed on passage.*, **assess the implementation:** *Assess the implementation of bridge and engine room resource management ?*, **assess the possible danger** Always assess the possible dangers involved in any tasks, no matter how ., **assess the vessel's stability** A technical working group was therefore commissioned to assess the vessel's stability and to help prevent a recurrence of the accident., **assess the true condition:** *However, in common with many other RIBs, there was no access to the under deck areas, so it was very difficult to assess the true condition of the hull.*

assessment /əˈsɛsmənt/ (n) 1 procjena; 2 proučavanje; 3 prosudba

assessor /əˈsɛsə/ (n) 1 sudski pomoćnik; 2 (mar ins) procjenitelj štete, likvidator štete

assets /æsets/ **assets and liabilities** aktiva i pasiva (u bilanci) (shipping econ) aktiva (u bilanci)

assign /əˈsain/ (mar law) opunomoćenik

assign /əˈsain/ (v) 1 dodijeliti **assign an anchorage** dodijeliti brodu mjesto sidrenja

On contacting the Port Authority at 0045, the ship was assigned an anchorage., **assign duty**

odrediti zadaću, dodijeliti dužnost / zadaću: *He was assigned the duty of OOW.*,

assign someone to carry out the task **odrediti nekoga da obavi zadaću**, **dati**

nekome zadaću da: *The 2nd Engineer assigned the cadet to carry out the task, while he attended to*

other jobs in the engine room.; 2 **odrediti:** *The earlier they are informed the sooner appropriate*

resources can be assigned and the best course of action decided and implemented. The duty AB had just come on duty in port when he was assigned to lashing/unlashing operations.

assigned /əˈsaind/ (adj) 1 (navig) **dodijeljen, namijenjen, raspoređen:** *The able seaman assigned to the watch was absent from the bridge for at least an hour before the vessel grounded.*

assigned position: *However, if a contact or close quarters situation occurs, the mark should be monitored to ensure that it has not been damaged or moved from its assigned position.* **dodijeljena**

pozicija, assigned pilot **dodijeljeni peljar, peljar zadužen za određeni brod:** *The VTSO shall maintain uninterrupted communication with the assigned pilot to facilitate safe passage during the non-pilotage course.*,

assigned anchorage: *The Master and the pilot identified the assigned*

anchorage on the chart and departed the berth with the assistance of two tugs. **dodijeljeno mjesto**

sidrenja; 2 (mar law) opunomoćen; 3 zadužen

assignee /əsaɪˈni:/ (n) 1 koncesionar; 2 opunomoćenik; 3 ovlaštenik

assignment /əˈsainmənt/ (n) 1 a i (mar law) The transfer by a creditor (the assignor) to another party (the assignee) of a debt or right of action which the creditor has against a third party (the debtor).

(Tetley) **prijenos duga ili prava na pravni postupak, punomoć za takav prijenos; b** assignment involves the transfer of rights, title and interest in order to assign goods by endorsing the bill

of lading **prijenos prava (na robu), punomoć za prijenos prava; 2 zadaća, zadatak:** The severity of the damage to the MS ----- led to discontinuation of the **assignment** and to the tug proceeding to the port of Bremen.; **3 posao**

assist /ə'sist/ (v) **1 pomagati, sudjelovati, asistirati:** During the transit, two other seamen, who were stowing loose mooring lines away aft, were sent to **assist forward**. By this stage, all other engineers had arrived to **assist**, and the vessel's full emergency procedures came into play to effectively tackle the fire using the CO2 smothering system. Meanwhile another company vessel, with a more experienced skipper on board, came alongside to **assist**. **assist in:** The ship was asked to **assist in the search**, and one hour later its crew found the missing fisherman in the darkness. A harbour tug was tasked to **assist in the berthing operations** of a 75,000gt bulk carrier. **a pomoći; 2 (navig) pružiti tegljačke usluge, tegliti, pratiti (brod), asistirati, pomoć (brodu) pri ulasku u / izlasku iz luke:** the tug was assisting a ro-ro vessel through the lock brod je pružao tegljačke usluge brodu na putu kroz ustavu A plan had been agreed for using the tug to assist with getting into the lock and onto the berth Dogovoreno je da će se tegljač koristiti za pomoć pri ulasku u ustavu i za privezivanje **The container ship then came to dead slow ahead with the forward tug still secured to assist the vessel to negotiate a nearby bend in the river.**

assistance /ə'sistəns/ (n) **(safety) pomoć:** The ferry suffered substantial hull damage, but was able to return alongside **without assistance**. **With the assistance of** two tugs, a pilot launch, and a fire brigade RIB, the fire was brought under control and eventually extinguished. **render assistance pružiti pomoć, ship in need of assistance brod u nevolji, Maritime assistance Services Pomorska služba za pružanje pomoći (pri IMO-u), arrange tug assistance dogovoriti pomoć tegljača:** The particular characteristics of this ship helped the pilot to **arrange tug assistance**. **make arrangements for tug assistance dogovoriti tegljenje, ugovoriti tegljenje organizirati tegljenje:** The managers were informed of the situation in order to make the necessary **arrangements for tug assistance**., **request assistance zatražiti pomoć:** The master called the pilot station by VHF radio **requesting assistance**, and a pilot and a tug were despatched from the port. About 30 minutes after CO2 flooding began, the master commenced venting the engine room and **requested the assistance of** shore-based firefighters., **provide assistance:** This **obligation to provide assistance** applies regardless of the nationality or status of such persons or the circumstances in which they are found. the Coast Guard Cutter was sent to **provide additional assistance**. **pružiti pomoć, call for assistance pozvati pomoć, zatražiti pomoć:** However, he was fortunate that his personal radio survived the fall and this enabled him to **call for assistance**., **receive assistance primiti pomoć:** The vessel was allowed to enter the Port of Djibouti where **they received assistance** from local firefighters and Dutch salvage experts., **seek assistance tražiti pomoć:** **Seek assistance from** other crew and try and make the person safe., **offer assistance ponuditi pomoć, pružiti pomoć:** At the same time the local all-weather lifeboat (ALB) offered assistance., **prompt assistance brza pomoć, neposredna pomoć:** The activation of the EPIRB resulted in **prompt assistance**., **emergency assistance pomoć u opasnosti, pomoć u nuždi:** When planning to use a tug, whether for **routine or emergency assistance**, the tug's specification must be considered to ensure that it is up to the job., **immediate assistance neposredna pomoć, pomoć smjesta:** After the collision the vessels exchanged details and verified that neither **required immediate assistance**., **medical assistance medicinska pomoć, At 1621, the vessel's agent was informed and he arranged for an ambulance, medical assistance, and first aid to the casualty.** The ship reported the

accident to the coastguard and requested *medical assistance*. , **proceed to one's assistance**
uputiti se u pomoć nekome, krenuti u pomoć nekome: *ip receiving the distress alert is unable or, in the special circumstances of the case, considers it unreasonable or unnecessary to proceed to their assistance, the master must enter in the log-book the reason for failing to proceed to the assistance of the persons in distress, taking into account the reco*, **require assistance**: *The master's night orders instructed the bridge watchkeeping officers to call him if they required his assistance.*
trebati pomoć, **give assistance dati pomoć, pružiti pomoć**: *The vessel requested for assistance from a harbour tug that was on a call-off stand-by situation but it could not give assistance.* , **call for assistance nazvati radi pomoći, nazvati u pomoć**: *The weather was good, with calm seas, and there were no tugs in the area to call for assistance.*

assistant (n) pomoćnik, asistent assistant engineer časnik stroja (US): *The assistant engineer fought the fire aggressively, and a short while later he reported the fire had been extinguished.*

assistant engineer (n) (navig, US) časnik stroja: *The reduction in vessel speed, and interruptions in the electrical supplies alerted the assistant engineer. On entering the engine room, the assistant engineer took the foam extinguisher from the electrician and proceeded forward along the floor plates to fight the fire on the engine.* **1st assistant engineer prvi časnik stroja, 2nd assistant engineer drugi časnik stroja, 3rd assistant engineer treći časnik stroja**
 {Remember: The term US term *assistant engineer* is equivalent to 'engineer officer' in UK English usage and *časnik stroja* in Croatian. The Croatian term *asistent stroja*, however is equivalent to 'engineering cadet' in English, and not to its false pair 'assitant engineer'.}

assistant steward (n) (mar law) pomoćnik glavnog konobara

assist hook (n) (fishing) pomoćna udica na jigu

Associate Degree in Marine Engineering (n) (US) (mar law, marine eng) =

Foundation Degree in Marine Engineering; FdEng visokoškolski stručni studij brodstrojarstva Associate Diploma in Marine Engineering: *The Academy offers a full deck officer cadet programme by a degree route, leading ultimately to the award of a UK Maritime and Coastguard Agency (MCA) Deck Officer's Certificate of Competency (STCW'95 II/I OOW), a Foundation Degree (FdSc) in Marine Operations and a direct top-up pathway to BSc (Hons) Marine Operations Management.*

Associate Degree in Nautical Science (n) (US) (mar law, navig) = Foundation Degree in Marine Operations Management; FdSc; visokoškolski stručni studij nautike Associate Diploma in Nautical Science diploma o završenom visokoškolskom stručnom studiju nautike

assorted spares (n) 1 (boating/yachting, safety) ostali pričuvni dijelovi sail repair kit komplet za popravak jedara, sticky backed sail repair tape ljepljiva vrpca za popravak jedara, piston hanks kukice za jedra, whipping twine špaga za podvezice, bottlescrew zatezač pripona, tirant, stezaljka na navoj, škartoc, ropes - various sizes užad - različite veličine, clevis pins karabini, split pins and rings rascjepke i prstenasti osigurači, bulldog clamps stezaljke za čeličnu užad, marine sealant silikon, underwater epoxy podvodna smola, waterproof grease vodootporni vazelin, petroleum jelly uljna želatina, paint and varnish (minor repairs) boje i lakovi (za manje popravke), epoxy glue and fillers epoksidno ljepilo i kit, glass fibre tape and cloth platno od staklene niti, nails, screws, bolts, and

nuts - assorted čavli, vijci, svornjaci i matice - razni, **wood - assorted pieces** drvo - razni komadi; **2 mainsail slider, klizač glavnog jedra**

assume /ə'sju:m/ (v) **1 pretpostaviti**: Never **assume** – always confirm your vessel's current position and projected track before deciding an appropriate action. Never **assume** that an electrical circuit is dead. Therefore, it was reasonable for the master to **assume that** the tanker would pass down the container ship's port side.; **2 preuzetti**: You should ensure that individual officers are familiar with the vessel and management system before they **assume their duties**. **assume responsibility** **preuzeti odgovornost**: The masters must put in place a bridge organisation that allows them to **assume their responsibilities**.

assume the cost (v) (shipping econ) **preuzeti troškove**

assumption /ə'sʌmpʃən/ (n) **pretpostavka**: There was an **assumption that** the after moorings were the same as the satisfactory ones forward. **make an assumption** **pretpostaviti**: The pilot of the cargo vessel **made an assumption**, based on scanty information, that the ro-ro vessel was increasing speed., **on the assumption that** **pod pretpostavkom da**, **pretpostavljajući da**: However, he delayed doing so and continued towards the fairway buoy **on the assumption that** the cargo vessel would eventually take action to avoid a collision., **be based on an assumption** **zasnivati se na pretpostavci**: The regular master's decision to apply more astern power to the port control was **based on an assumption** that the port azimuth unit was in the same position as the control lever., **false / erroneous assumption** **kriva pretpostavka**: Although ESD valves onboard the ship were tested to ensure their closure rates were acceptable, **there was a false assumption that** the valves were indicating that they were closed.

assured /ə'ʃʊəd/ (n) (mar ins) = **insured** osiguranik **the assured** osiguranik {pretežno UK}

assured (adj) **uvjeren u**, **siguran u**: Once **assured of his position**, the skipper had only to steer a course to keep the vessel within the safe sector to ensure her safe passage into the harbour. **be assured** **biti uvjeren**, **uvjeriti se**: But it is still the responsibility of ship's staff **to be assured that** correct spare parts are being used, and that they are fitted in accordance with manufacturer's instructions and guidance.

astern /ə'stɜ:n/ (adv) **1** the bearing of an object that is 180 degrees from ahead; (behind).; toward the stern of a vessel; an object or vessel that is abaft/behind another vessel or object; position, in the rear of or abaft the stern **po krmi**: Providing there is sufficient sea room, it is safer, and in the spirit of good seamanship, to **pass astern of a ship at anchor**.; **2 u krmu**, **krmom**: the Pilot put the engine astern **peljar je stavio stroj u vožnju krmom** **full astern** **vožnja punom snagom natrag**: The master moved the centre console engine control to **full astern**.

astern operation (n) (seamanship) **vožnja krmom**

astern power (n) (marine eng, nav arch) **snaga za vožnju krmom**: Astern power was applied and three short blasts sounded. **astern power movement** **kretanje prema natrag**: The vessel's **astern movement** due to the currents strained the aft spring line., **astern power of iza**, **po krmi**: After manoeuvring from her berth, she proceeded at slow speed so as to keep sufficiently clear **astern of** another departing ferry. This resulted in the ferry **passing close astern of** the cargo vessel., **astern power pitch** **korak propelera za vožnju krmom**: The chief officer then applied full bow thrust to port and, on the master's suggestion, applied **astern pitch** to the port propeller.

astern propulsion (n) (navig) **vožnja natrag**, **vožnja krmom**: The tug skipper reacted quickly to the grounding by simultaneously **applying astern propulsion** and paying out the towing cable. **operate astern propulsion** **voziti natrag**, **staviti u pogon krmom**

as though (*conj*) **kao da**: The crew felt that the vessel was behaving **as though** the fore peak tank was ballasted, whereas they believed it to be empty. All bare electrical cables pose a threat to life and must be treated **as though** they are live until proven otherwise by a competent person.

as to (*conj*) **što se tiče, u pogledu**: In the event of any doubt **as to** the systems' operational condition, advice should be sought from the maker's service agent, without delay, to ensure that the system remains in good condition. As the master allowed the OOW to keep the con to the berth, he did not specifically enquire **as to** the status of the fins. **so as to tako da, kako bi**: Careful thought should be given to the lead of the lines **so as to** avoid creating sharp angles. After manoeuvring from her berth, she proceeded at slow speed **so as to** keep sufficiently clear astern of another departing ferry.

astray shipment (*n*) (*shipping econ*) **zagubljena pošiljka, zalutala pošiljka**

astrolabe /'æstrəˌleɪb/ (*n*) (*navig*) a historical navigational instrument which consisted of a dial, showing degrees, with an arm (alidade) pivoting through the centre; predecessor of the sextant {the astrolabe's degree markings indicate the celestial object's angle in the sky}

astronomical almanac (*n*) (*navig*) a catalogue of tables showing the location of various celestial bodies at specific moments in time throughout the year **astronomski godišnjak, astronomski almanah**

astronomical navigation /ˌæstrəˈnɒmɪkəl/ (*n*) (*navig*) **astronomska navigacija**

astronomical observation (*n*) (*navig*) **astronomsko motrenje, astronomsko snimanje pozicije**

as yet (*prep, conj*) **do sada**

asylum harbour (*n*) (*navig*) = **port of refuge luka zakloništa**

a-synchronous motor /eɪˈsɪŋkrənəs/ (*n*) (*electr*) **asinkroni motor**

at anchor (*n*) (*navig*) **na sidru, usidren**: A 10m boat was **at anchor** 2 miles offshore with a group of anglers on board. Passing close ahead of **a ship at anchor** is potentially perilous, but if it is unavoidable, the effects of the tidal stream, wind and a ship's manoeuvrability need to be taken into account. Provided there is sufficient sea room, it is safer, and better seamanship, to pass astern of **a ship at anchor**. The master chose to remain **at anchor** when gale force winds onto a lee shore were forecast.

at and from (*n*) (*mar ins, mar law*) osiguranje pokriva teret čim je u brodu, a ne samo od odlaska broda iz luke **u i od ...**

ATDNSHINC; Any time Day or Night Sundays & Holidays Included. (*n*) (*mar law*) **u svako doba dana i noći, uključujući nedjelju i blagdane/praznike**

atmospheric corrosion /ˌætməsˈfɛrɪk/ (*n*) (*marine eng*) **atmosferska korozija**

athwart /əˈθwɔːt/ (*prep*) **1** (*seamanship*) from one side to the other of a vessel at right angles to the keel; across the ship from side to side **poprijeko; 2 subočice, bočno**

athwartships /əˈθwɔːtʃɪps/ (*adv*) at right angles to the fore-and-aft line of the vessel **poprijeko**

broda, s jednog boka na drugi, poprečno: He reacted by turning the main thrusters **athwartships**, the quickest way to stop the vessel. the port quarter fairlead was aligned **athwartships**, with the starboard fairlead angled aft on the quarter.

athwart the hawse (*prep phr*) (*seamanship*) across the stem **poprijeko na pramcu**

Atlantic bonito (*n*) (*fishing*) lat. *Sarda sarda* **palamida**



Atlantic mackerel (n) (fishing) lat. *Scomber scombrus* skuša, škjombar, škombra
ATM; automatic teller machine (n) (US) = cash machine = cashpoint
 bankomat

atmospheric pressure /ˌætməs'fɛrɪk/ (n) (meteorol) atmosferski tlak

atoll /'ætɒl; ə'tɒl/ (n) (geogr) atol

atomization /ˌætəmaɪz'eɪʃən/ (n) (marine eng) raspršivanje, atomizacija

atomizer; atomiser /'ætə,maɪzə/ (n) (marine eng) raspršivač

AtoN; aton; ATON; (Aids to Navigation) /'ei'tu'ɛn/ (navig) = AtoNav; atons
 (aids to navigation) navigacijska pomagala (na plovodbenom putu)

AtoNav; atons (aids to navigation) /'eɪtənæv/ (n) (navig) artificial objects to supplement natural landmarks to indicate safe and unsafe waters. (buoys, beacons, seamarks, landmarks)

navigacijska pomagala (na plovodbenom putu): *The Stockholm local authorities launched a new buoy with the ATON transponder to assist commercial and recreational ships moving in and out of the busy harbor.*

ATON transponder (n) (navig, safety) transponder na navigacijskom pomagalu: *If the buoy becomes detached from the seafloor the AIS transponder will broadcast current position to warn mariners that it is no longer located at the correct marked location.*

at or off the port (prep phr) (mar law) u luci i izvan nje

atrip; a-trip /ə'trɪp/ (adv) (seamanship, navig) = aweigh (of an anchor) no longer caught on the bottom; tripped; aweigh **podignuto s dna (o sidru) ancho's atrip; a-trip sidro je podignuto (s dna) {zastarij.}**

at sea (prep phr) (seamanship) na moru, u plovodbi *It's now well known that around 80% of accidents at sea (and more than 90% in cases of collisions and groundings) involve so-called 'human factors'. Towards the end of his watch at sea, a motorman was tasked by the chief engineer to mop up some hydraulic fluid in the steering gear flat which had been leaking onto the deck from t The junior seaman had only been at sea a few days. It is important that all deck officers have a clear understanding of the International Regulations for Preventing Collisions at Sea and of the manoeuvring characteristics of their vessels. Each issue and the reports they contain are a valuable contribution to*

improving **safety at sea and in port**, so protecting lives, property and the marine environment. By working together, **at sea and ashore** our maritime professionalism can rise to this challenge. A 30m scallop dredger **was at sea** in moderate weather. One of our greatest **dangers at sea** is complacency. In my **career at sea**, spanning just over 47 years, I have seen the use of the word **safety** increase year by year and ... The more **time spent at sea**, the more the mistakes that will be observed or made, and the more the seaman learns.

at shipper's risk (prep phr) (mar law) **na rizik krcatelja**

attach /ə'tætʃ/ (v) **1 (cargo handling) priključiti, prikopčati, vezati**: Was this the only way to **re-attach** a lifeboat to the falls? Regardless of how short the planned journey may be, a powerboat driver should always **attach the kill cord** around his/her leg before the engine is started. As the FRC was still partly suspended over the deck edge, the assistant bosun and the AB left the boat to help **attach a bowsing line** to assist in pulling the FRC around the deck edge. There **the tugboat was still attached** with a loose towline to starboard. **attach a grab / spreader / hook to the crane priključiti grabilicu / spreder / kuku na dizalicu**: A second load of oil, weighing 788kg (within the crane's SWL) **was attached to the crane**. The **hook was attached** by shackles to a 2m length, 32mm diameter polypropylene rope strop, the other end of which was attached to a pad eye welded to the top of the b; **2 (ship handling, seamanship) vezati (uže, konop) attach the line vezati uže / konop, postaviti uže / konop**: When the ship is close to the wharf, mooring lines **are attached** to the bollards.

attached plating (n) (marine eng) **pojasni lim**

attack (n) (safety) **napad**: Pirates have launched a series of attacks in the creeks of the Delta region since last Thursday, abducting at least nine people, security officials said.

attack (v) **napasti attack the fire gasiti požar, upustiti se u gašenje požara**: The chief officer took charge of the deck and approved a two-man team to **attack the fire** with an extinguisher.

attack on fire (n) (safety) **gašenje požara make an attack on fire on fiore gasiti požar, upustiti se u gašenje požara, napasti požar**: Two fire parties **made an attack on the fires** from behind the breakwater bulkhead (Figure 3).

attend /ə'tend/ **1 prisustvovati**: If possible, the Master should attend the survey of damaged cargo himself, or have his Chief Officer attend.; **2 pohadati (tečaj)**: There is a requirement for all navigating officers joining its vessels to **attend** bridge resource and bridge team management refresher **training** if they have not completed this training within the last 5 years. Having recently **attended a fire-fighting course**, the skipper was able to effectively and calmly assess the risks and tackle the fire confidently.; **3 pojaviti se (pred nekim) attend before the notary public (mar law) pojavi se pred bilježnikom; 4 njegovati; 5 opaziti, primijetiti**: Unfortunately one of the deckhands **did not attend** the tug when she sailed at 0415.; **6 paziti na, voditi računa o: Attend to** leaking systems promptly – they will never be resolved on their own. **Attend to** electrical defects promptly. **Attend to** fuel leaks promptly. The starboard main engine was started, then immediately stopped **to attend to** a fuel leak.

attendance /ə'tendəns/ **1 prisustvo**: As OSV2 was available to assist if required, the master of OSV1 decided not to **request the attendance of** a harbour tug. The mooring gang was already **in attendance** so permission to sail was obtained from the VTS service for the port, moorings were let go and the ship left her berth. **in attendance prisutan, u službi, dežuran**: Is there an effective deck watch in attendance on board? Je li spremna brodska straža?; **2 pohadanje; 3 njega; 4 služba, posluživanje, rukovanje; 5 (marine eng) održavanje (stroja)**

attention /ə'tenʃən/ **pozor, pozornost draw attention privući pažnju**: The liferaft was only equipped with hand-held flares and these were not sufficient to **raise the alarm or draw attention** during

the search and rescue. 0, **give attention to obraćati pozornost, pripaziti na nešto, attract attention**: The second officer sounded a short blast on the whistle in an attempt to attract attention, and ordered the AB to place the wheel on hand-steering. , **pay attention obratiti pozornost, posvetiti pažnju**: Plan your passage carefully, paying attention to minimum depths, and make additional allowances when there is a heavy swell. In this case, the skipper failed to pay sufficient attention to the wind conditions and the limitations of the novice crew.

attenuate /ə'tɛnjʊ, ɔɪt/ (v) to weaken or become weak; reduce in size, strength, density, or value **oslabjeti, postati slabijim, oslabiti, smanjiti**: any radar bandwidth of less than 5 MHz will attenuate the SART signal slightly

attenuation /ə, tɛnjʊ'ɛɪʃən/ (n) (electr, navig) Attenuation occurs when part of the radar energy is absorbed by water vapour in the atmosphere.. **slabljenje (radarskog snopa), upijanje (signala)**: Attenuation is greatest in heavy rain and can cause severe reduction in detection ranges but may also occur in hail, snow, sleet and, to a lesser extent, in fog. A 10 cm radar because of its greater power will be less affected by attenuation than a 3 cm radar.

attestor /ə'tɛstə/ (n) (mar law) **svjedok quod attestor kao svjedok**

attribute to /ə'tribju:t'tu:/ (v) **attribute to damage to pripisati štetu (nečemu) pripisati (što nečemu)**: The cause of the winch failure was attributed to a faulty pilot valve in the cursor's winch control system, which prevented the winch brakes from applying once hydraulic power was removed. A visual inspection revealed a hole in the hull, which was attributed to the vessel having made contact with the light float.

auction /'ɔ:kʃən/ (mar law) **dražba, licitacija**

audibility /'ɔ:di'biliti/ (n) (comm) **čujnost**

audible alarm (n) (safety) **zvučni alarm**: The ECDIS anti-grounding warning zone alarm then activated on the display, but no audible alarm sounded. This vessel's two engine room bilge alarms were not audible or visible outside on deck.

audit /'ɔ:dit/ (n) (mar law, shipping econ) **revizija, audit**: The serious shortcomings with the navigation on board the vessel had not been identified during the vessel's recent audits and inspections.

external audit vanjska revizija: An external auditor has been appointed by the company to perform a navigation audit on all company fleet, **perform an audit provesti reviziju, obaviti reviziju,**

izvršiti reviziju, navigational audit revizija od strane stručnog plovodbenog povjerenstva, navigacijska revizija: A navigational audit was carried out by the attending marine superintendent and all the staff were re-briefed on the company's procedures for safe navigation,

carry out an audit provesti reviziju: obaviti reviziju, audit procedures postupak revizije, revizijski postupci: Owners and managers should continually review their audit procedures

to ensure they remain strong and target all areas of the vessel's safe operation. , **internal audit unutrašnja revizija**: Internal audits must be carried out to establish that safety and pollution prevention activities comply with Safety Management System.

auditor /'ɔ:ditə/ (n) (mar law, shipping econ) **revizor external auditor vanjski revizor**

aureole /'ɔ:ɹi, əʊl /'ɔ:ri:ələ/ (=aureola) (n) (meteorol) **aureola**

aurora /ɔ:'rɔ:rə/ an atmospheric phenomenon consisting of bands, curtains, or streamers of light, usually green, red, or yellow, that move across the sky in polar regions. **aurora aurora borealis** the luminous, radiant emission from the upper atmosphere over middle and high latitudes, and centered around the earth's magnetic poles **aurora borealis, aurora australis** a geomagnetic show of lights seen in the far Southern skies at night. **aurora australis**

authorities /ɔ:'θɔritiz/ (n) (mar law) **vlasti, organi vlasti, pomorske vlasti**: državni organi
appointed authorities nadležne vlasti, nadležni organ, **port authorities** lučke / državne vlasti

authority /ɔ:'θɔriti/ (n) (mar law) **1 vlast the Authority vlast (u međunar. pravu mora), harbour authority lučka uprava, navigational authority pomorske vlasti**.

Furthermore, the local council and local navigation authority were not aware that the cruiser sailed in the winter.; **2 uprava port authority lučka uprava**: Once clear of the breakwaters the master reported the accident to the port authority. The port authority sent a tug to assist, however the ship continued to drag her anchor until the wind finally abated and the anchor held in deeper water. In the Port of London Authority, we place great emphasis on reading each safety digest and distilling those lessons learned applicable to port operations ...; **3 ovlast, ovlaštenje, odobrenje on the authority of po odobrenju, uz ovlaštenje**: A distress alert from a vessel may be transmitted only on the authority of the master or skipper, or the person responsible for the safety of that vessel.; **4**

ovlast, moć: He considered the VTSO had more authority and was better placed to resolve the situation quickly and effectively. **exert authority obavljati ovlasti, primjenjivati ovlasti**: It is essential that he or she recognises that responsibility and exerts the necessary authority and leadership to ensure a safe outcome.; **5 ministarstvo, nadležno ministarstvo**: There is a strong obligation to notify the Authority after major changes in order to have stability check-up. **Maritime authority ministarstvo pomorstva**: It is essential that he or she recognises that responsibility and exerts the necessary authority and leadership to ensure a safe outcome. **Danish Maritime Authority Ministarstvo pomorstva Danske**: Prior to the accident, the Danish Maritime Authority has submitted a guidance to enhance safety during transfer operations to the IMO., **competent authority nadležne pomorske vlasti, nadležno ministarstvo, nadležne državne vlasti**: A VTS is a service, implemented by a competent authority, that is designed to improve the safety and efficiency of vessel traffic and to protect the environment. This section includes summaries and safety recommendations extracted from marine investigation reports on casualties involving ships and occupational accidents as produced and published by the National competent Authority, as mentioned in the source from marine investigation reports on casualties involving ships and occupational accidents ...

authorization /ɔ:'θəraɪ'zeɪʃən/ (n) (mar law) **ovlaštenje, odobrenje give authorization ovlastiti, opunomoćiti**

authorize; authorise /ɔ:'θə'raɪz/ (v) **1 (mar law) ovlastiti**: The pilot was authorised by DP World and completed between 60 and 70 ship movements per month. The VTSO also authorised the master to enter the channel as soon as the container ship was clear (Table 3).; **2 odobriti**: When the VTS is authorized to issue instructions to vessels, these instructions should be result-oriented only, leaving the details of execution to the parties involved. The hotwork repair had been authorised by the ship's manager.

auto alarm /ɔ:'təʊ ,əla:m/ (n) **autoalarm**

auto-ignition /ɔ:'təʊ ,ɪg'niʃən/ (n) (marine eng) = **self-ignition samo zapaljenje**: Pure phosphine gas has an auto-ignition temperature greater than 100°C. The principal cause of explosions in starting air manifolds of marine engines is probably the auto ignition of oil deposited on the inner surface of the manifold, not backfire from cylinders as previously thought.

automated /ɔ:'təmeɪtɪd/ (adj) **automatiziran, automatski**: Things have moved along apace and the widespread use of the electronic nautical chart, ECDIS, ECS and wholly automated bridge systems are possibly increasing risks in vessel operation, and complacency. Pressing the DSC distress button for 3 seconds would have transmitted an automated distress message, which would have

included the identity and position of the vessel.

automated bridge system (n) (navig) **automatski zapovjednički most**: In conclusion, an **automated bridge system** is very helpful to the mariner as long as the limitations of the system are known.

Automated Identification System (=AIS) (n) (navig) = **AIS** **sustav automatske identifikacije brodova, sustav AIS, AIS-sustav**

automated satellite tracking (n) (boating/yachting, navig) **automatsko satelitsko usmjeravanje**

automatic bilge pump (n) (nav arch) **automatska kaljžna sisaljka / pumpa**: About 4 hours into the passage, the alarm on the **automatic bilge pump** alerted the skipper to unexpected water in the bilge.

automatic control system /,ɔ:tə'mætik/ (n) (marine eng, navig) **sustav automatskog upravljanja**: The vessel command attributed the engine failure to a defect in the **automatic control system**.

automatic equipment identification tag /,ɔ:tə'mætik/ (n) (cargo handling) **oznake za automatsku identifikaciju kontejnera**: Automatic equipment identification tags similar to bar codes are placed on containers and truck trailers for identification as they go through different stages of their trip.

automatic fire alarm (n) (safety) **automatski požarni alarm**: The watchkeeping engineer was alone in the machinery spaces when the **automatic fire alarm** activated. The **automatic fire alarm** began to sound.

automatic fire detector /,ɔ:tə'mætik/ (n) (safety) **automatski javljač požara**

automatic helm (n) (navig) **automatsko kormilo, autopilot**: When the vessel cleared the approaches to the harbour, the skipper set a course on the **automatic helm** to pass on his port side a small island, which lay about 2 miles to the south-west.

automatic identification (n) (shipping econ) a means of identifying an item e.g. a product, parcel or transport unit by a machine (device) entering the data automatically into a computer (e.g. barcode, radio frequency, magnetic stripes or optical character recognition)

(http://www.iss-shipping.com/cargo/cargo_library_glossary.asp) **automatska identifikacija (pošiljke)**

automatic identification system (=AIS) (n) (navig) **automatski identifikacijski sustav**

automatic keying device /,ɔ:tə'mætik/ (n) **automatsko tipkalo**

automatic plotting (n) (navig) **automatsko ucrtavanje**: **automatsko plotiranje** Facilities such as **automatic plotting**, electronic bearing lines, variable range markers and radar guard alarms, are normally provided to assist the OOW.

Automatic Radar Plotting Aid (=ARPA) (n) (navig) = **ARPA** **sustav automatskog radarskog ucrtavanja**

automatic release hook (n) (safety) **kuka za brzo otpuštanje, samootpusna kuka**: The bowman released the preventer chain and pulled the **Automatic Release Hook (ARH) wire** ...

automatic shutdown (n) (safety, marine eng) **automatsko isključivanje**: The enclosure UV sensors picked up the fire, and the **automatic shut down** and fire extinguishing process activated.

automatic steering (n) (navig) **automatsko kormilarenje**: He immediately **changed from automatic to hand steering**, switched on the second steering motor, and put the helm to port.

automatic trimmer /,ɔ:tə'mætik/ (n) (cargo handling) **uređaj za samoporavnavanje**

tereta, uređaj za samotrimanje tereta

automation /ˌɔːtəˈmeɪʃən/ (n) (marine eng) automatizacija

autopilot; automatic pilot /ˌɔːtəˈpaɪlət/ (n) (navig) an electromechanical device which steers

ships along a preset course **automatsko kormilo, autopilot, automatski pilot**: The 2/O initially made a succession of small alterations of course to starboard using the **automatic pilot**, but then requested the QM to begin hand steering to manoeuvre between the two vessels.

engage the autopilot; automatic pilot uključiti autopilot: the Master instructed the helmsman to engage the autopilot on a heading of 290° The master instructed the helmsman to **engage the autopilot** and then handed the con to the third officer, who stood facing the starboard radar display, with the ECDIS display to his right.

autopilot; automatic pilot control upravljač automatskog pilota: A tanker was transiting a heavily used waterway under VTS control at a speed of about 12 knots and using autopilot control.

gyroscopic autopilot; automatic pilot žiroskopsko automatsko kormilo, žiroskopski autopilot, zvrčni autopilot,

automatsko kormilo na žirokompas, magnetic compass autopilot; automatic pilot

automatsko kormilo na magnetski kompas, adjust the autopilot; automatic pilot

namjestiti automatsko kormilo: Over the next 2 minutes, the ship's OOW adjusted the autopilot to alter the vessel's heading to port and then to starboard.

run on autopilot; automatic pilot ploviti pod automatskim peljarom, ploviti pod autopilotom: The vessel was running on autopilot.

set the autopilot; automatic pilot namjestiti autopilot, adjustment to the

autopilot male promjene na autopilotu, male ispravke na autopilotu: However, because the trawler was towing, this was being done in increments using small adjustments to the autopilot.

steer on the autopilot ploviti pod automatskim peljarom, ploviti pod autopilotom,

kormilariti autopilotom: The boat was steering by autopilot, with the skipper and a deckhand in the wheelhouse and a further crew man resting below in bed. 0

auxiliary /bːgˈzɪljəri; ɔːgˈzɪləri/ (adj) pomoćni

auxiliary boiler (n) (marine eng) pomoćni kotao: A large cargo vessel was alongside in port when the flame in the **auxiliary boiler** went out unexpectedly. The **auxiliary boiler** and EGE were linked, with water being taken from the **auxiliary boiler** to circulate through the EGE.

auxiliary diesel generator (n) (marine eng) pomoćni dizel generator

auxiliary drum (n) (nav arch) pomoćni bubanj vitla: The 4mm control wire was wound onto an **auxiliary drum**, which was connected to the main winch drum.

auxiliary engine (n) (marine eng) pomoćni stroj, pomoćni motor: The inoperable **auxiliary engine** meant that the vessel had lost its main emergency services backup, which severely reduced the vessel's potential pumping capacity. The boat was fitted with two main engines, each driving its own shaft, as well as an **auxiliary engine** for electrical power.

auxiliary engine room (n) (marine eng) pomoćna strojarnica: After releasing CO2 some small fires remained in the **auxiliary engine room**.

auxiliary equipment (n) (marine eng) pomoćni uređaji: Auxiliary equipment in the engine room includes centrifugal type sea water, fresh water, ballast and bilge pumps, all driven by electric motors.

auxiliary generator (n) (marine eng) pomoćni generator: The chief engineer put the ship's engine control lever astern and then went below to change from the shaft to the **auxiliary generator**.

auxiliary machinery (n) (marine eng) ship's machinery other than the main engine(s); e.g., generators, pumps, electric motors, boilers etc. **pomoćni strojevi**

auxiliary power gear (n) (marine eng) pomoćni strojevi

auxiliary radarscope (n) (navig) radarski ponavljač

availability /əˌveɪləˈbɪləti/ (n) **raspoloživost**: *The availability of a suitable tug may well impact on the agreed weather limits for a vessel or a berth. The equipment is designed and manufactured only for mooring a vessel in moderate sea conditions, and for relatively short periods, while awaiting berth availability, orders or change of tide.* **selective availability** selektivna raspoloživost

available /əˈveɪləbəl/ (adj) **na raspolaganju, raspoloživ**: *This investigation revealed that the master did not fully understand the chart plotter controls and was not making best use of the equipment available - particularly a good visual lookout ... Rule 7 of the Collision Regulations requires all available and appropriate means to be used in determining if a risk of collision exists, and warns of the dangers of misinterpretation and of making assumption. There were no pumps immediately available and it was deemed too dangerous to go on board, so the vessel sank alongside, ending up sitting on the harbour bottom. No heavy weather checklist was available and none was required to be completed as part of the vessel's safety management system.*

Avast!; avast /əˈvɑːst/ (v) **1 (boating/yachting, seamanship) (nautical) stop! cease! halt!**; an order to stop or cease hauling (stop action at once) **Stani, Stop!, Zaustavi!**; **2 (seamanship) Veži! (uže, konop), Agvantaj! (uže, konop), Drži! (uže, konop); 3 stati (naredba), prestati {archaic}**

average /ˈævərɪdʒ/ (n) **to adjust general average** procijeniti / riješiti generalnu

havariju (mar law) šteta na brodu ili teretu tijekom pomorskoga pothvata; (in marine insurance) a loss or damage to or in respect of goods or equipment **pomorska šteta, havarija, avarija**
general average opća / generalna havarija, **particular average** partikularna havarija, **average adjuster** likvidator / procjenitelj šteta, **havarijski procjenitelj, average bond** havarijska obveznica

average adjuster /ˈævərɪdʒ əˈdʒʌstər/ (n) (mar law, mar ins) average adjusters are entrusted with the task of apportioning the loss and expenditure over the parties interested in the maritime venture and to determine which expenses are to be regarded as general average

(http://www.iss-shipping.com/cargo/cargo_library_glossary.asp) **havarijski procjenitelj, procjenitelj šteta, likvidator šteta**

average bond /ˈævərɪdʒ ˌbɒnd/ (mar law, mar ins) pravni akt kojim primatelj tereta preuzima izričitu obvezu plaćanja svoga dijela doprinosa u zajedničku havariju, dok se brodar prešutno obvezuje odmah predati teret **havarijska obveznica**: *In a general average situation, all the consignees of the cargoes on board the carrying ship will be notified as soon as possible and those consignees whose cargoes are not sacrificed and thereby indirectly benefited would likely be asked to furnish general average security by way of an average bond together with additional security.*

average speed (n) (navig) prosječna brzina

average undertaking (n) (mar ins) posebna vrsta havarijskog jamstva

average value (n) prosječna vrijednost

avert /əˈvɜːt/ (v) **1 spriječiti**: *Port officials are encouraged to exercise this power in order to avert a major accident.*; **2 (safety) otkloniti (opasnost)**: *... we can all recall similar incidents in which we have been involved but were fortunate that something or someone intervened at a crucial moment to avert an accident.* **avert the casualty** izbjeći nesreću

avoid /əˈvɔɪd/ (v) = **keep clear = keep out of the way = give way** (navig) **izbjeći (brod, sudar), izbjegavati (brod, sudar)**: *They then continued to monitor the situation, and*

took appropriate action **to avoid a collision** when it became apparent that the ship did not intend to do so. **to avoid collision izbjeći sudar**: The ro-ro ship also altered course to port and the vessels narrowly avoided colliding. The two ships were now very close, and the master of the inbound ship then took action **to avoid collision by** turning his vessel hard to starboard and reversing his course. **avoid close-quarters situation izbjeći položaje opasnih blizina**: The master altered course to starboard **to avoid a close-quarters situation** with the first of the vessels while still keeping a safe distance from the sandbank. **avoid a accident izbjeći nesreću, izbjeći nezgodu**: To talk about the problems of rules and regulations, stability and training is all very well, but the most straightforward way **to avoid accidents** is to learn the lessons from those that have impacted on others. **avoid misunderstandings izbjeći nesporazume**: His/her communications should be clear and concise **to avoid any misunderstandings** and he/she should then monitor activities to confirm if they have been understood. **avoid the ship izbjeći drugi brod**: Her master was taking actions **to avoid the west-bound LPG carrier** ... on her port side. When the vessels were 3 miles apart the cargo vessel altered course by 10 degrees **to avoid the trawler**, which was now hauling her nets. Seconds later, the engine was put to full ahead, and the helm put hard to port **to avoid the tanker**. **avoid the buoy izbjeću plutaču / oznaku**: He altered course to port **to avoid the buoys** and, as he did so, the vessel grounded on a rock ledge. **avoid the risk of izbjeći opasnos od**: Classification societies should ensure inconvenience of thoroughly inspecting the components is justified **to avoid the risk of a serious accident**.

await /əˈweɪt/ **čekati na (isplovljenje, uplovljenje, ulaz u kanal, ...)** The number of vessels **awaiting** transit has been reduced to acceptable levels. The vessel proceeded to anchorage **to await** an improvement in weather conditions.

award /əˈwɔːd/ (v) **1 nagraditi; 2 (shipping econ, mar law) nadoknaditi (nekome troškove); 3 (mar law) dobiti posao (na natječaju), sklopiti ugovor (o gradnji broda) be awarded the contract dobiti posao, dobiti ugovor (na natječaju)**: We are delighted to have been awarded the classification contract for these innovative containerships, which draw on our real-world experience classing vessels using LNG as fuel

award /əˈwɔːd/ **arbitral award** The arbitral award which embodies the decision of an arbitral tribunal (Tetley) **odluka arbitražnog suda 1 a nagrada**: He was presented with the Silver Riband Award for his lifetime achievement in the maritime industry.; **2 priznanje**: In 2008 Captain McFadyen was delighted to receive the award of Lloyds List Ship Master of the Year.; **3 rješenje, odluka (sudska); 4 dodjela (diplome, svjedodžbe)**: Undertaking the voluntary training currently on offer, that leads to the award of a Certificate of Competency, is a very useful way for fishermen to refresh and update their navigational skills. This type of training currently on offer leads to the award of a Certificate of Competency.

aware (adj) 1 svjestan (nečeg), znati be aware that biti svjestan da, znati da Watchkeepers **must be aware that** skippers would rather be called 10 minutes too early, than 1 minute too late – “If in doubt, call him out”. As the vessel approached the berth, the pilot **became aware that** the following wind and tide were having a greater effect on its speed than he had expected ..., **be aware of biti svjestan (nečeg), znati (nešto)**: The skipper was acutely **aware of the risks of fire and flood**, so he shut the gas supply valve from the gas bottle to the stove, and isolated the electrical supplies at the main. With the vessel now 20 minutes behind schedule, the pilot boat **became aware of the** high speed on approach, and called the vessel to slow down and swing to starboard to provide a lee for boarding. **be unaware that ne biti svjestan da, ne znati da** The OOW was unaware that the tanker was 511m off his ship's starboard beam.; **2 upoznat; 3 opaziti**: As the vessel approached the

river bank the lookout became aware of flashing white lights ahead but he did not identify the lights or report the sighting to the OOW.

awash /əˈwɒʃ/ (*adv, adj*) **1** (*seamanship*) at a level of the surface of the sea; so low in the water that the water is constantly washing across the surface **izvan vode / mora (o sidru) anchor's awash sidro je podignuto (s dna i nalazi se na površini mora)**; **2** (*seamanship*) **pod vodom, mokat**. The vessel's aft deck was almost constantly **awash** as she rolled in the force 6 seas with the wind on her starboard bow. By this time, the vessel was listing with the deck's starboard side **awash**.

aweigh /əˈwei/ (*adj, adv*) (*seamanship, navig*) position of an anchor just clear of the bottom, also indicating that the ship is under way; (an anchor) no longer hooked into the bottom **podignut s dna (o sidru)**. Following a temporary suspension in operations due to a hydraulic line failure, the anchor was **aweigh** at 1039. **With the anchor aweigh** at 1235, and a maximum speed of 14 knots, allowing time for acceleration and deceleration the vessel was never going to achieve the programmed ETA.

anchor's aweigh sidro podignuto sa dna, sidro slobodno od dna, tal. l'ancora e spedata

awkward cargo /ˈɔːkwəd/ (*n*) (*cargo*) **nezgrapan teret, izvangabaritni teret**

awning /ˈɔːniŋ/ (*n*) (*seamanship, nav arch*) a roof of canvas or other material supported by a frame to provide protection from the weather, esp one placed over a part of a deck of a ship; canopy **strijeha, tenda; tal. tenda**

axial thrust /ˈæksiəl/ (*n*) (*seamanship, marine eng*) **aksijalni / uzdužni poriv propelera**

axillary seabream /ækˈsɪləri ˈsiːbri:m/ (*n*) (*fishing*) **batoglavac** {*ost. hrv. nazivi: divlji arbut, Bajok, Grbić, Batelj, Batokljunac, Rumenac; lat. PAGELLUS ACARNE*}

axle /ˈæksəl/ (*n*) (*marine eng*) **COMPARE shaft** An axle is more specifically used for mounting wheels to any type of carriage, such as an automobile, it does not rotate but it may have power transmission shafts mounted inside the axle to drive the carriage **osovina**

axle of rudder (*n*) (*nav arch*) **osovina kormila**

Aye, aye, Sir!; Ay, ay, Sir! /aɪ ˈaɪ, sɜː/ the reply to an officer's order signifying that he is understood and will be obeyed (I understand). **U redu., Na zapovijed.**

azimuth /ˈæzɪməθ/ (*n*) (*navig*) the angular distance usually measured clockwise from the north point of the horizon to the intersection with the horizon of the vertical circle passing through a celestial body; the azimuth of an object is its bearing from the observer measured as an angle clockwise from true north **azimut**

azimuthal sight (*n*) (*navig*) **smjeralo, alidada**

azimuth circle /ˈæzɪməθ/ (*n*) (*navig*) instrument used to take bearings of celestial objects **azimutni krug, smjeralo, smjerna ploča**

azimuth compass (*n*) (*navig*) an instrument employed for ascertaining position of the sun with respect to magnetic north **azimutski kompas**

azimuth device (*n*) (*navig*) **smjeralo, smjerna ploča**

azimuthing electrical podded propulsor (*n*) (*marine eng, nav arch*) = **azipod**
azimutski električni porivnik, azimutski porivnik

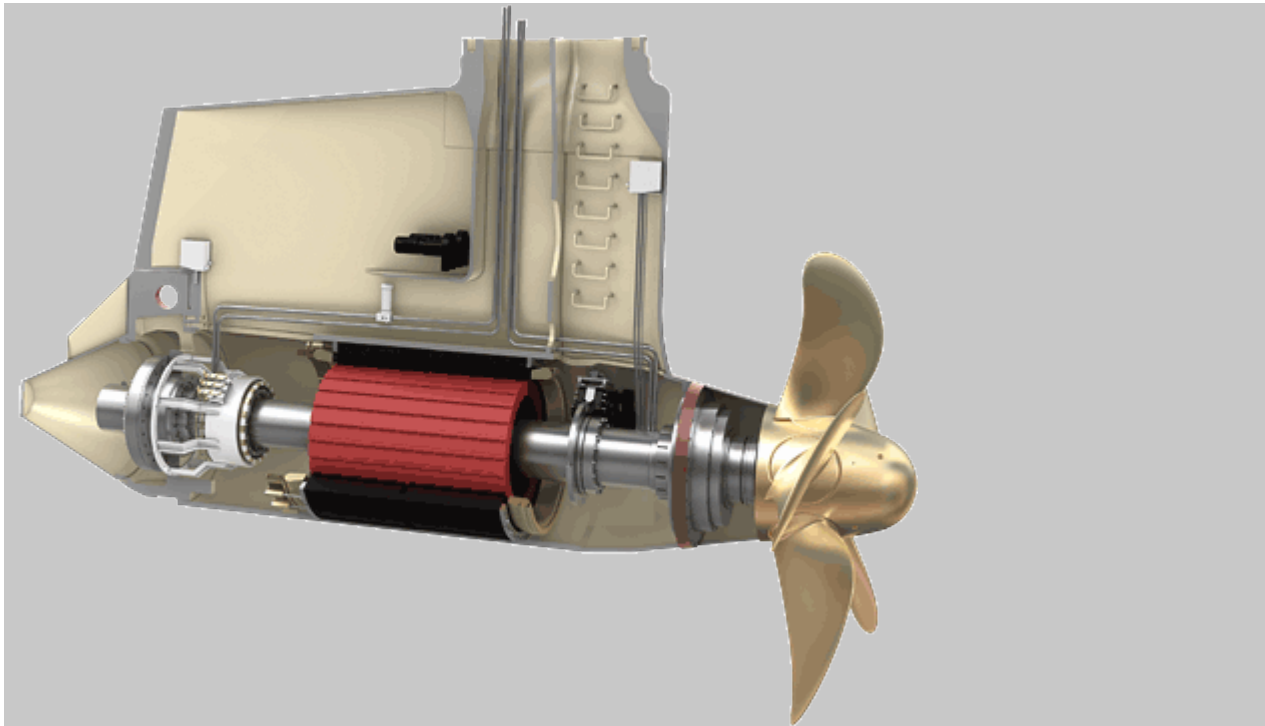

azimuth mirror (n) (navig) zrcalo smjerala

azimuth mirror (n) (navig) smjerna ploča, smjeralo

azimuth thruster (n) (nav arch, marine eng) **azimutski porivnik**: The tugboat features a propulsion package based on twin Rolls-Royce Bergen C26:33L9PG engines and a pair of highly reliable Rolls-Royce US 205 CP azimuth thrusters for maneuvering and strong bollard pull. The chief officer set each azimuth thruster to face 45° outwards for the ship move and proceeded to take the ship through a narrow channel between moored craft.

azipod (n) (nav arch, marine eng) porivnik koji omogućuje poriv i kormilarenje te vožnju krmom; used for a large engine and propeller assembly mounted underneath a ship that can be turned in any direction to provide both propulsion and course changes (<http://www.merriam-webster.com/dictionary/azipod>). The outboard unit can be 360 degrees rotatable for manoeuvring purposes. **azipod**, **usmjerivi propeler**, **propeler-kormilo**, **azimutni porivnik** **azipod control lever** **upravljačka ručica azipoda**, **ručica za upravljanje azipodom**: Three minutes after grounding an engineering alarm sounded and the OOW placed both azipod control levers to zero.

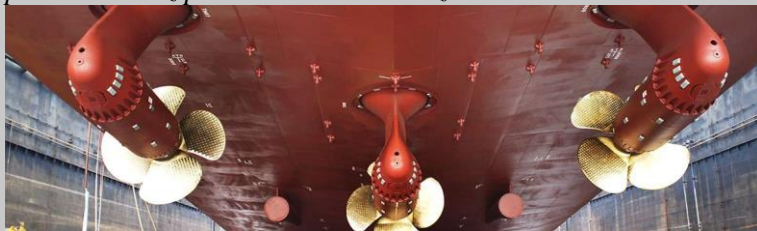

azipod control lever (n) (nav arch, marine eng, navig) **upravljačka ručica azipodnog porivnika**: The OOW moved the starboard azipod control lever to pitch ahead but the ship remained stationary.

azipod electric propulsion system (n) (marine eng, nav arch) **sustav usmjerivog električnog pogona**, **električni pogon putem azipoda**: Since its development by ABB in

1987, the Azipod electric propulsion system, a streamlined steerable pod motor mounted below the ship, with the propeller connected directly to the motor shaft, has become the preferred propulsion system across a range of shipping segments.

azipod propulsion (n) (nav arch, marine eng) a gearless steerable propulsion system where the electric drive motor is in a submerged pod outside the ship hull **sustav usmjerivog pogona, pogon putem azipoda, azipodni pogon, azipodna propulzija**: *Once on the port bridge wing, the captain adjusted the azimuth propulsion to arrest the vessel's movement astern.*

azipod propulsor (n) (nav arch, marine eng) **azipodni porivnik, azipodni propulzor**
babit metal (n) (marine eng) **protutarni metal**

Bachelor of Science (Honours) Degree (n) (UK) (mar law) BSc (Hons) indicates one has completed an Honors Degree Bachelor of Science undergraduate program. An ordinary Bachelor of Science accepts grades on a pass/no pass basis. In contrast, an honors designation requires that students demonstrate *superior academic performance*

(<https://www.reference.com/education/bsc-hons-stand-2db47f34f4ffb3cf>) **akademski stupanj prvostupnika s posebnim uspjehom Bachelor of Science (Honours) Degree in Marine Operations Management akademski stupanj prvostupnika nautičkih**

znanosti s posebnim uspjehom: *This course draws upon the exciting and challenging area of shipping management. It is tailor-made for those seafarers who decide to embrace a new career path, enhancing the qualifications which they have gained, with the quality of excellence of an Honours degree but without the three years of academic study that is necessary for such a degree on a traditional university course.*

(<http://www.warsashacademy.co.uk/courses/course-pages/bsc-hons-marine-operations-management/course-details.aspx>, **Bachelor of Science (Honours) Degree in Marine Engineering and Management akademski stupanj prvostupnika brodstrojarstva s posebnim uspjehom**: *Warsash Maritime Academy offers an academic top-up programme leading to a Bachelor of Engineering (Honours) Degree in Marine Engineering and Management.*

back (v) 1 (meteorol) (of wind) to shift direction counter-clockwise in the Northern hemisphere and clockwise in the Southern hemisphere **skretati suprotno od kazaljke na satu (o vjetru), mijenjati smjer suprotno od kazaljke na satu (o vjetru)**: *However, the veering loads produced when the wind backed and freshened, might have reduced the effectiveness of this anchoring arrangement.*; 2 (boating/yachting) to catch the wind on the forward side of the sail **prebaciti jedro suprotno smjeru vjetra radi zaustavljanja ili usporavanja jedrilice, zaustavljati jedrilicu jedrom**: *During a tack, the jib was backed and remained aback as the dinghy came onto port tack.*

back and spill (n) (seamanship) **korištenje bočnog izboja propelera pri manovriranju**

backboard /'bæk, bɔ:d/ (n) (boating/yachting) **klupa na zrcalu krme (barke ili jedrilice)**

backhaul /'bæk, hɔ:l/ (n) (v) (shipping econ) to haul a shipment back over part of a route which it has already traveled **vratiti dio tereta s putovanja broda**

backhaul (n) (shipping econ) **povratno putovanje broda, povratna vožnja backhaul leg ANTONYM headhaul povratno putovanje broda (od luke odredišta do polazne luke)**: *Headhaul usually refers to the stronger or dominant leg of a round-trip voyage attracting the greater volume of cargo relative to the weaker backhaul leg.*

(<http://www.globalshiplinease.com/glossary.cfm>)

backing /'bækin/ (n) (meteorol) **skretanje vjetra u smjeru suprotnom od kazaljke na**

satu

backing (n) (ship handling) vožnja krmom, vožnja broda nazad **backing astern** vožnja broda krmom, vožnja broda nazad: *The manoeuvre required swinging the vessel 180 degrees and then backing astern to berth port-side to.*

backing plate (n) (navig) potporni lim

backing spring (n) (seamanship) uže za tegljenje unazad

backing wind /'bækiŋ/ (n) (meteorol) wind which shifts in a counterclockwise direction with time at a given location (e.g. from southerly to southeasterly), or change direction in a counterclockwise sense with height (e.g. westerly at the surface but becoming more southerly aloft) **protusatno skretanje vjetra, vjetar u skretanju suprotnom od kazaljke na satu** (npr. sa juga na sjeveroistok)

backlog /'bæk, lɒg/ (n) 1 (shipping econ) velik broj brodova koji čekaju na iskrcaj, zaostatak, čekanje (brodova na ulaz u kanal itd.), čekanje (zbog zakrčenosti luke, prolaza, kanala itd.): *To shorten the backlog, non-critical maintenance was postponed, bookings for priority passage have been reduced twice since mid-October and additional crews have been assigned to increase capacity at the canal's locks. Tanker backlog threatens world oil market gridlock.*; 2

neispunjena narudžba, zaostatak

back-piece of rudder (n) (nav arch, sailing vessels) list kormila

backreach (n) (cargo handling) **ANTONYM outreach** kopneni dohvat dizalice {crane backreach: No. 5}

backstay /'bæk, steɪ/ (n) (boating/yachting) wire or line reaching from the stern of the vessel to the mast head, used to support the mast **stražnje leto, zaputka, krmeni štraj; tal. straglio, tal. paterazzo** {tal.: paterazzo}

backstay bridle račvasti dio na dnu krmelog štraja, fiksni ili s čekrkom/koloturnikom za savijanje jarbola račvasti dio krmelog leta, račvasti dio na dnu krmelog štraja

back the jib (v) (boating/yachting) zategnuti prečku / flok prema vjetru (pri otpadanju, zaustavljanju ili okretanju): *However, the veering loads produced when the wind backed and freshened, might have reduced the effectiveness of this anchoring arrangement.*

back the vessel (v) (ship handling) voziti krmom, voziti brodom unazad: *Once turned successfully, the pilot began backing the vessel;*

back-up arrangements (n) (navig) rješenja za pričuvu, rezervna rješenja (u sustavu ECDIS)

back-up control system rezervni upravljački uređaj, pomoćnu suustav

upravljanja: *It was considered most likely that the button to activate the back-up control system for the starboard propulsion system was inadvertently pressed during the early stages of the entry into the port.*

back-up storage (n) **ANTONYM transit shed** (ports) pozadinsko skladište

backwash /'bæk, wɒʃ/ (n) (navig) a sucking movement of water, such as that of retreating waves usisni val u brazdi broda

backwind (n) (boating/yachting) povratni vjetar, vjetar iza floka, koji prazni jedro

bad wather (n) (meteorol, navig) nevrijeme, loše vrijeme: *A small gas tanker was moored alongside a terminal berth; all mooring bollards were in use due to bad weather. The onset of bad weather the previous day had required the vessel to anchor overnight and await a suitable opportunity*

for passage to its next port of call ... They took a pride in their work, which they carried out carefully and cheerfully, in the most unbelievably **bad weather and sea conditions**. **face bad wather naići na nevrjeme, suočiti se s nevremenom**

BAF; Bunker Adjustment Factor (n) (shipping econ) Used to compensate steamship lines for fluctuating fuel costs. **naknada za fluktuaciju cijena goriva, faktor promjene cijena goriva** (also referred to as **Fuel Adjustment Factor (FAF)**)

bag (n) (cargo) **vreća**: These were stowed in large bags, each holding an estimated one tonne. The cargo was transferred via a chute into **bags** stowed in the hold or on deck. **bag cargo vrećarija, uvrećeni teret**

bagged cargo (n) (cargo) **vrećarija, teret u vrećama**: The following losses may arise from improper stowage of **bagged cargo** in containers: The bags slip out of the container when the container doors are opened. Also the density of the contents determined whether a **bagged cargo** would be considered as bulk or bagged.

bagging (n) (cargo handling) **uvrećavanje tereta**

bail /'beil/ (n) **1 (mar law)** personal security provided by a defendant to the court to prevent the arrest of a ship or to secure its release from arrest. **jamstvo; 2 kaucija**: The skipper was arrested and imprisoned, then released on **bail** pending the results of a blood sample analysis to confirm alcohol levels. **bail bond kaucijska obveznica; 3 (shipping econ) depozit, roba položena na čuvanje**

bail /'beil/ (v) (boating/yachting) to throw or empty water out of a boat, usually by hand **izbacivati vodu iz jedrilice, paljat**. Consequently, the five crew started to **bail out** the water using empty cans. **bail out izbaciti vodu (iz barke, jedrilice), ispaljat**

bail (n) (seamanship) **vjedro, kanta za vodu, sić**

bail (n) (seamanship) = **rung prečka (na ljestvama)**

bailee /bei'li:/ (shipping econ, mar law) **ANTONYM bailor** a person to whom the possession of goods is transferred under a bailment **depozitar**: Before finding out who to blame the consignee or cargo owner should notify the sub-carrier or other **bailee** or their agents where the goods have been shipped or handled by them before delivery to the consignee. Warehousemen and depositories are **bailees**, as well as carriers.

bailee /bei'li:/ (nav arch) **ispolac**: As the buckets and **bailer** were not secured to the boat, they quickly drifted off after the boat capsized, leaving the men no effective means of bailing out.

bailer (n) (seamanship, boating/yachting) a device for removing water that has entered the boat **ispolac, šešula**

bailment /'beilmənt/ (n) (mar law) A bailment is the relationship that exists when the bailor of the goods allows another to have temporary custody of them.; A bailment is delivery of goods by one person to another for some purpose under a contract. **deponirana roba, čuvanje robe kod depozitara (u depozitnom skladištu i sl.)**

bailor /'beile/ (n) **1 (boating/yachting) ispolac; 2 (shipping econ, mar law) deponent**

bait (n) (fishing) **mamac, ješka tal. esca**: The skipper and crewman of a 10 metre fishing vessel were on the aft deck, **preparing bait** and listening to music via a loudspeaker as the vessel headed towards the first string of pots due to be hauled that day. **live bait živi mamac**

bakery/pastry man (n) (mar law) Bakery/Pastry Man is responsible for cooking bakeries and pastries. **brodski pekar/slastičar**

balance /ˈbæləns/ (n) **1 (shipping econ) saldo; 2 ravnoteža, balansiranje**: Of the last three contractors to step onto the gangway, two **lost their balance** when the gangway dropped, and fell into the water. **mechanical balance** mehanička ravnoteža, **mehaničko balansiranje**, **balance weight** balansni uteg, **uteg za ravnotežu**: When the gripe is removed, the tricing pendant will drop down under the suspension hook **balance weight**.

balance (v) **uravnovežiti, držati u ravnoteži**: Although regarded as a capable skipper, those who knew him, found it extremely difficult to **balance this with** his ambivalent attitude towards the condition of his vessel.

balance (n) (boating/yachting) **balans (jedrilice), ravnoteža (jedrilice) maintain balance** održavati ravnotežu, **balansirati**

balanced helm (n) (boating/yachting) **uravnoveženo kormilo (stabilan kurs jedrilice)**

balanced rudder (n) (nav arch) **balansno kormilo**: Ever Smart was fitted with a

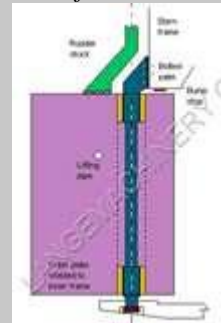

semi-balanced rudder with a maximum angle of 35° to port or starboard.

bale /ˈbeɪl/ (n) **cotton bale** bala pamuka (cargo) bala

bale capacity (n) (stabil) **kapacitet za bale**

bale clamp (n) (cargo handling) **hvataljka za bale**

bale out the water (v) (boating/yachting) = **bail**: **izbaciti vodu (iz barke, jedrilice, splavi)**: They managed to right the raft, board it, **bale it out**, administer sea sickness tablets and release one red hand-held flare, which was immediately spotted by a member of the public who contacted

balisage (n) (navig, navy) **SEE buoyage** a method of marking a sea route **balisaža**: *sustav označavanja plovidbenih poutova {word of French origin; the English term 'balisage' is occasionally used for naval purposes }*

ball (navig) **kugla (oznaka na brodu)**: The boat was displaying an anchor ball 3m above deck level, and also had a bright orange mizzen sail hoisted to keep her lying into the wind.

ballast /ˈbæləst/ (n) **1 (nav arch) heavy weights carried low, i.e. in the bottom of a boat or ship to improve her stability. balast, ta. zavorra**: When the vessel was salvaged, however, an analysis of her stability found that, due to the installation of additional **ballast** and fishing equipment, her operational displacement had increased by over 30% since new. ; **2 (nav arch, stabil, safety, marine eng)**

balastna voda, balast: The engineers **pumped ballast** into the upper starboard wing tanks and pumped out some double bottom tanks on the port side. After **discharging ballast** from the forepeak, the vessel refloated some 5 hours later without the assistance of tugs. **transfer of ballast prijenos**

balasta, prebacivanje balasta: The **transfer of ballast water** commenced. , **discharge ballast**

iskrcati balast: After **discharging ballast** from the forepeak, the vessel refloated some 5 hours later without the assistance of tugs. , **pump ballast pumpati balast**: The engineers **pumped ballast** into the upper starboard wing tanks and pumped out some double bottom tanks on the port side. ; **3**

(shipping econ, stabil) plovdba bez tereta, plovdba u balastu: *At the time of the accident, the vessel was **in ballast** and carrying out sea trials. A 70 metre product tanker was steaming south **in ballast**, having discharged her cargo of gas oil the previous day. A 1568gt general cargo ship **in ballast** was on passage through UK territorial waters on a course of 007° in autopilot, and making good a speed of 7 knots.*

ballast duct (n) (nav arch) **balastni kanal**

ballast keel (n) (nav arch) **balastna kobilica**

ballast leg (shipping econ) **ANTONYM loaded leg :1** dio putovanja u balastu (bez tereta)

ballast passage (shipping econ) **plovdba u balastu, plovdba bez tereta:** *On 11 June 2013, at about 1206(LT), a fire broke out in the engine-room of the tanker, during a **ballast passage** to Antwerp.*

ballast pump (n) (nav arch) **pumpa balastne vode:** *They started the **ballast pump** and began pumping out water. The duty engineer immediately contacted the second officer and told him to stop the **ballast pump** and to close the ballast valves.*

ballast pumping system (n) (nav arch) **pumpni sustav balasta:** *The ballast pumping system comprises a 500 m³/hr centrifugal pump and two main centrifugal self-priming pumps, each of which has a capacity of 1,000 m³/hr*

ballast system (n) (nav arch, safety) **balastni sustav, sustav balasta:** *To transfer the water, the bilge system and the **ballast system** were connected by remotely opening a cross-over valve. This showed all the ballast pumps and ballast valves, but it did not show the cross-over valve connecting the **ballast system** with the bilge system.*

ballast tank (n) (nav arch) **Double bottoms for carrying water ballast and capable of being flooded or pumped out at will. balastni tank, tal. cassa di zavorra:** *A 60cm by 20cm hole was punctured above the waterline **in way of a ballast tank**. The vessel was hove to, and a **starboard ballast tank** was filled to bring her closer to the upright. Work permits had been issued for the **ballast tank and hot work operations**, but not for working aloft as, with the hatches closed, there was no danger of falling more than the specified 2 metr **double bottom ballast tank balastni tank dvodna:** arrangement meant that certain tanks, including **double bottom ballast tanks**, Collectively, these poor practices could not be sounded.*

ballast valve (n) (nav arch) **sisaljka balasta, pumpa balasta, balastna pumpa:** *The duty engineer immediately contacted the second officer and told him to stop the ballast pump and to close the **ballast valves**.*

ballast voyage (n) **1 (navig) plovdba u balastu:** *At 5 am local time, the vessel departed from Rotterdam for a **ballast voyage** to Montreal, Quebec.; 2 (shipping econ) A voyage with no cargo on board to get a ship in position for the next loading port or docking. (http://www.clarksons.com/glossary/)* **povratna plovdba, plovdba bez tereta**

ballast water (n) (nav arch) **balastna voda:** *The fore peak was damaged, causing **ballast water** to drain to sea, but no pollution was caused. Approximately 40 tonnes of **ballast water** had been transferred into the bilge collection tank instead of the forward ballast tank as intended.*

ballast water exchange (n) (stabil) **zamjena balastne vode**

Ballast Water Management Plan (n) (stabil) **plan upravljanja balastnim vodama**

ball bearing (n) (marine eng) **COMPARE roller bearing kuglični ležaj:** *The safety investigation identified poor condition of a **ball bearing** inside the winch as the immediate contributing factor to the uncontrolled descent of lifeboat no.*

ball head (n) (marine eng) **centrifugalni dio regulatora:** *The **ball head** is the speed detecting*

portion of the governor.

ball valve (n) (marine eng) kuglični ventil, kuglasti ventil: the watchkeeping engineer closed the local isolating **ball valve** on the clutch's air system and opened the system's vent.

baloon freight (n) (cargo handling) lagani veliki koleti, lagane velike pošiljke

Baltic Dry Index (BDI) vozarinski indeks / stavovi za suhe rasute terete koje

objavljuje 'The Baltic Exchange': The Baltic's BDI index, which gauges the cost of shipping resources including iron ore, cement, grain, coal and fertilizer, has dropped to 498 points and is over 95 percent down from its all-time high of 11,793 points in 2008 before the financial crisis first hurt the sector.

Baltic Exchange /'bɔ:ltɪk/ (n) (shipping econ) burza čarterskih tereta: The center of the chartering business is the **Baltic Exchange** in London, where brokers representing shippers meet with shipowners or their representatives to arrange the agreements. **The Baltic Exchange Ltd.**, a London-based publisher of shipping rates that shape the cost of hauling everything from iron ore to oil FCA has approved the takeover of London's **Baltic Exchange** aftershareholders gave the green light for the deal last month. **Baltic Exchange freight index vozarinski indeksi koje utvrđuje burza čarterskih tereta (The Baltic Exchange), vozarinski stavovi koje utvrđuje 'The Baltic Exchange'**: This week the **Baltic Exchange's** main sea freight index, which tracks rates for ships carrying dry bulk commodities and seen by investors as a forward-looking indicator of global industrial activity, plunged to an all-time low.

ban (n) (mar law) zabrana lift a **ban** ukinuti zabranu: The Government has lifted a **ban** on 113 vessels entering into the country's territorial waters

banana carrier (n) (nav arch) brod za prijevoz banana, **bananijer**

banana connector (n) (electr) banana konektor, banana

band /bænd/ (n) (comm) pojas (svjetla, frekvencija itd) **VHF marine bands pojas**

brodskih VHF frekvencija, pojas pomorskih VHF frekvencija: Radio telephone on 2 m **band** covering area of N Adriatic sea or by VHF Channel 16., **S band frekvencijski pojas S**: While the OOW attempted to acquire the contact on the **X and S band** ARPA displays, the pleasure yacht made a 20° alteration of course to port., **band X frekvencijski pojas X**: The container ship was fitted with two **X band radars**, and one **S band radar**, but only the **X band radars** were operating., **x band radar radar frekvencijskog područja X, radar x frekvencijskog pojasa**: The target vessel's details were displayed on the AIS receiver but the option to display the target's information on the **X-band radar**, which was fitted with ARPA, was not taken., **s band radar**: The container ship was fitted with two **X band radars**, and one **S band radar**, but only the **X band radars** were operating.

band (n) (marine eng) pojas (kočnice)

band brake (n) (marine eng, seamanship) pojasna kočnica, tračna kočnica: As the port list increased, hydraulic power was lost, resulting in **band brakes** on the automatic trawl winch system activating.

banded dye murex (n) (fishing) volak

bank /bæŋk/ (n) 1 (oceanogr) a large area of elevated sea floor **sprud**: She reached a **mud bank** across the entrance to this river, where the master knew he would be unable to proceed until the tide rose further. The overtaking manoeuvre resulted in her being on the extreme starboard side of the channel, close to **the bank**. The stress levels on the bridge rapidly increased as **the bank** drew ever closer.; 2 the slopes bordering a river **riječna obala, obala kanala**: The boat then made contact with the **canal bank**, and the helmsman was seen to tip over the guard rail, which was at about knee height and fitted round the cruiser style stern. I believe that the bow cushion effect prevented our bow from hitting the **bank of the Canal**. **bank effect učin ruba plovnooga puta (u rijeci, kanalu)**:

Speed is critical, since the magnitude of forces created by both bank effect and squat increases with the square of the vessel's speed through the water.; 3 (meteorol) nakupina oblaka, nagomilani oblaci, gusta naoblaka **bank of clouds** gusta naoblaka: A bank of dark clouds was swiftly moving from inland.

bank effect (n) (navig) utjecaj ruba plovnog puta, učin ruba plovnog puta (u rijeci, kanalu): With the vessel now at the edge of the channel and close to shallow water, she experienced bank effect. Speed is critical, since the magnitude of forces created by both bank effect and squat increases with the square of the vessel's speed through the water.

bankruptcy /'bæŋkrʌptsi/ (n) (financ, shipping econ) stečaj, bankrot: rumours of them filing bankruptcy are "untrue, completely groundless". **bankruptcy protection** zaštita od stečaja / **bankrota file for bankruptcy protection** podnijeti zahtjev za zaštitu od stečaja / **bankrota**: A report carried by ... suggested the Shipping Line will file for bankruptcy protection within the next two weeks. Rumours of the company **filing bankruptcy** are untrue, completely groundless.

banksman (n) (cargo handling) a crane driver's helper, who signals instructions to the driver for the movement of the crane and its jib **signalist, pomoćnik dizaličaru**

bar /ba:.(r)/ (n) 1 (nav arch) profil: The mooring rope had come loose because a steel bar, holding the pallet on which the rope was coiled, had broken free from the deck due to weld failure. **T-bar** T-profil, **T-bulg bar** gomoljasti T-profil, **round bar** okrugli profil, **half-round bar** poluokrugli profil, **channel bar** U-profil, **zed bar** Z-profil, **flat bar** plosnati profil, plosnati čelik; 2 (marine eng) šipka, motka, greda: While the third engineer was applying tension on the chain block, the flange and one bolt on the trolley cheek plate **connecting bar** fractured, causing the chain block and trolley to fall from the "H" beam.; 3 (marine eng) poluga

bar /ba:.(r)/ (v) 1 spriječiti; 2 zabraniti {past participle: barred}

bar /ba:.(r)/ (n) (meteorol) jedinica tlaka = 1 hPa **bar**

bar (n) (oceanogr) sandbar, also called Offshore Bar, submerged or partly exposed ridge of sand or coarse sediment that is built by waves offshore from a beach **nanos (pjeska, šljunka, mulja s obale pri oseki)** **sandbar** pješčani nanos u ušću rijeke, **bar pilot** peljar na riječnom ušću **riječni pilot** {They are mostly found at the entrances of great rivers or havens, and often render navigation extremely dangerous}

bar (n) 1 (marine eng) bar; 2 (marine eng) tlak u barima, tlak ... bara: In this case, crushed nut shells were injected into the turbocharger under 7 bar air pressure. The subsequent investigation revealed that the fire had started as a result of a leak on the main gearbox cooler spraying oil at high pressure (18 bar) onto the engine room deckhead and falling onto the starboard engine exhaust manifold. **bar bar tlak od ... bara**: Attempts were made to refit the sampling valve but the 11 bar pressure of the cargo, and the formation of ice on the connection, made it impossible.



baracuda (n) (fishing) barrakuda

barber (n) (boating/yachting) = **barber haulier** **barber**

barber haulier /'ba:(r)bə(r) ,hɔ:liə(r)/ (n) (boating/yachting) tanki konop kojim se preko klizača uzde i tračnice mijenja kut glavnoj uzdi ; running fairlead for the jib sheet used to adjust the jib flutter (Seatalk Nautical Dictionary) **zateg škotine (na plaubi), barber**

bare a hand (v) (seamanship) pomoći **pružiti ruku pomoći** Tell the Bosun to come on deck and bare a hand. (Seatalk Nautical Dictionary)

bareboat charter party /'beə(r)bəʊt 'tʃɑ:(r)tə(r) ,pa::ti/ (n) (mar law) = **charter by**

demise = demise charter party an agreement on a lease of the ship from the owner to the charterer; where the vessel is usually put at the disposal of the charterer without any crew ; The hire or lease of a vessel from one company to another (the charterer), which in turn provides crew, bunkers, stores and pays all operating costs. (<http://www.clarksons.com/glossary/>) **ugovor o zakupu broda,**

zakup praznog broda, zakup broda A Bavaria 36 was being sailed by five crew on a bareboat charter between various ports. Bareboat charter usually covers a certain period of time, sometimes a very long period, and is often hinged to a management agreement. In a bareboat charterparty the charterer is given full control to the vessel for a specific long-term period, whereas all operating- and voyage costs are covered by the charter. Most tankers are traded under spot or time charter contracts. **commence a**

bareboat charter party **stupiti u zakup praznog broda, započeti plovidbu pod**

ugovorom o zakupu praznog broda The vessel has commenced a 15-year bareboat charter

with a major European container line. {The charterer thus will take over almost all of the owner's functions except for the payment of capital costs. This means that the charterer will have the commercial as well as the technical responsibility for the vessel and pay for maintenance, crew costs and insurance, etc.

(<https://maritimeinfo.wordpress.com/2011/10/28/bareboat-charter-party/>)}

bare poles (n) (boating/yachting) **brod bez postavljenih jedara, brod spuštenih jedara**

bare vessel (n) (mar law) **goli brod (bez posade, goriva, zaliha, hrane itd.)**

bargain /'ba:(r)gin/ (n) **at a bargain** jeftino, u bescjenje, **bad bargain** loša pogodba, **loš posao (shipping econ)** pogodba, jeftina prigodna kupnja

barge /ba:dʒ/ (n) (nav arch) = **lighter** a large, flat-bottomed boat used to carry cargo from a port to shallow-draft waterways **tegljenica, barža, maona, mauna, tal. chiatta** Barges carry dry bulk (grain, coal, lumber, gravel, etc.) and liquid bulk (petroleum, vegetable oils, molasses, etc.). The two men pulled the coil onto the barge and then dropped it down in a suitable area. This effectively made the tug and barge a composite unit in much the same way as a ship. The pulling tug was connected to the barge by a bridle made up of two short polypropylene ropes. **launch a barge** **spustiti teglenicu u**

more (s broda tipa LASH), self-propelled barge **tegljenica s vlastitim pogonom,**

mooring barge **privezivačka maona** The vessel tied up, bows to the pier with engines at idle, to embark passengers, reducing the gap between the mooring barge and the stern of the passenger vessel to about 30 metres.

fuel barge **maona za gorivo** The fuel barge arrived alongside and was secured to the ship.

stores barge **maona za opsrbu brodova** He had a good view of the stores barge below.

crane barge **maona s dizalicom** The large 60 metre-long crane barge has been contracted to transport the linkspan upriver.

barge carrier (n) (nav arch) **tegljeničar, brod za prijevoz teglenica**

barge carrying vessel (n) (nav arch) **brod za prijevoz teglenica**

barge load (n) (shipping econ) **tegljenica (LASH itd.) kao jedinica tereta / jedna pošiljka**

bar keel (n) (nav arch) gredna kobilica

barnacle /'ba:nəkəl/ (n) (seamanship) any of various marine crustaceans, live attached to ship bottoms **školkjice na podvodnom dijelu trupa, podvodni obraštaj na trupu broda:**

Subsequent investigations found that there was extreme mussel and barnacle fouling of the inlet grids, propeller hub, and up to one third of the propeller blade length. Only one was wearing footwear, and he climbed the barnacle-encrusted ladder from the water up to the quayside by the harbour control office.

barograph /'barəgrɑ:f/ (n) (meteorol) barograf

barometer /bə'rɒmɪtə/ (n) 1 (meteorol) barometar aneroid **barometer** aneroidni

barometar; 2 (meteorol) atmosferski tlak, tlak: *The barometer had been falling steadily all afternoon and, as the skipper and crew were turning in, was observed to be falling more rapidly.*

barometric pressure /barə'metrik 'prɛʃə/ (n) (meteorol) barometarski tlak

barque; bark /ba:k/ (n) (nav arch, boating/yachting) **COMPARE full rigged sailing vessel COMPARE full rigged ship - barque** krstaš s tri do pet jarbola, duljine od 40

do 60 metara, nosivosti od 500 do 1500 tona i s 10 do 18 članova posade; a sailing vessel of three or more masts, with all masts but the sternmost square-rigged, the sternmost being fore-and-aft-rigged **bark**

barquentine; barkentine (n) (nav arch, boating/yachting) a sailing vessel with three or more masts; with a square-rigged foremast and all other masts fore-and-aft rigge **barkentin**

barratry /'bærətəri/ (n) (mar law) Loss or damage caused to the ship or cargo by the wilful act of the master or seamen (Tetley); A legal term in admiralty law for the fraudulent act of causing damage to a ship or cargo, including desertion, scuttling and theft (Seatalk Nautical Dictionary, www.seatalk.info)

baraterija, namjerni prijestup (protuzakonitog nanošenja štete brodu ili teretu, napuštanjem, krađom itd.) {an unlawful act or fraudulent breach of duty on the part of a ship's master or crew, going against, and in conflict with the interests of the ship's or cargo's owner. For example, selling a vessel's cargo and subsequently claiming it was lost at sea}

barred by law /ba:d/ (adj) zakonski zabranjen, spriječen zakonom

barrel /'bærəl/ (n) 1 (cargo) = drum a bačva (drvena, rjeđe metalna); 2 (nav arch)

bubanj (vitla), As the ship's crew manually heaved in the messenger, it became apparent that the tow line had become jammed under other turns on the winch barrel.; 3 (marine eng) cilindar

barrel clamp (n) (cargo handling) hvataljka za teret

barrow /'bærəʊ/ (n) (cargo handling) kolica

base /beɪs/ (n) 1 osnova; 2 baza; 3 temelj, In this case, the inboard section of the failed line recoiled a short distance towards the base of the winch., dno; 4 podnožje, postolje

base (n) (fishing) fratar {drugi hrv. nazivi: baraj, crnoguzac, frankul, pop, popić, špar crnorepac; lat. DIPLODUS VULGARIS}

base (n) (shipping econ, cargo handling) home depot of container or trailer **kontejnerska baza, baza kontejnera ili prikolica**

baseline /'beɪs, laɪn/ (n) (mar law) polazna crta **normal baseline** normalna polazna crta, straight **baseline** ravna polazna crta {UNCLOS}

base line /'beɪs, laɪn/ (n) 1 (nav arch) a straight horizontal line at or near the bottom of the moulded

surface from which vertical heights are measured **osnovica**, **osnovna linija broda**, **linija baze broda**; **2 (navig)** **bazna crta** (u hiperboličnoj navigaciji)

baseline plane (n) (nav arch) ravnina osnovice

base metal (n) (marine eng) osnovni metal (u legurama)

base oil (n) **1 (nav arch, marine eng)** lubrication grade oils with a boiling point range between 550 and 1050 F, consisting of hydrocarbons with 18 to 40 carbon atoms.

(<http://globalindustrialsolutions.net/base-oil-definition.php>) **bazno ulje**: *The base oil was a combustible liquid with a flash point of 75°C.* **base oil tank tank baznog ulja**: *After oxygen levels had been checked, three members of the team entered the base oil tank with the suction hose, while other members operated the vacuum equipment ashore.*; **2 (marine eng) vrsta hidrauličnog ulja**: *When transferring flammable liquids by hose, such as fuel oil, lubricating oil, hydraulic or base oil, be aware of the hazards. (The name base oil is given to lubrication grade oils initially produced from refining crude oil (mineral base oil) or through chemical synthesis (synthetic base oil). (<http://globalindustrialsolutions.net/base-oil-definition.php>))*

base plane (n) (nav arch) ravnina usporedna s ravninom projektne vodne linije koja prolazi najnižom točkom broskog obrisa **osnovica**

basic (adj) **1 osnovni**: *Basic damage control measures were taken, but the vessel's pumps only just managed to contain the flooding.* **basic principles osnovna načela**, **osnovni principi**:

Whether a vessel is given 10 days or 10 minutes to plan an anchorage, the basic principles are the same.;

2 temeljni: *The MAIB is currently investigating three serious accidents involving collisions where qualified, seasoned senior officers have ignored the most basic of watchkeeping principles. At we have a policy that all seagoing staff should repeat their basic safety courses every three years.*; **3**

glavni; **4 minimalan**: *The equipment available to the bridge team was quite basic.*

basic life support (n) (med) a sequence of actions aimed at resuscitating a person whose life is in danger **osnovne radnje za oživljavanje / reanimaciju osobe**

Basic Ocean Freight ; (BAS) (n) (shipping econ, mar law) osnovna vozarina za

prekomorski prijevoz: *The basic ocean freight rate is the price determined by varying factors such as the different origin-destination combinations and the cargo type.*

basic ports (n) (mar law) luke predviđene redom plovidbe u linijskoj plovidbi **bazične luke**, **glavne luke**

basic radar system (n) (electr, navig) osnovni radarski sustav, osnovni radarski

uređaj. *The basic Radar system consists of two units: the scanner unit and the display unit. The transceiver unit is normally housed in the scanner unit.*

basic tool kit (n) (boating/yachting, seamanship, marine eng) osnovni alat na brodicima /

jahti / krstašu screwdrivers - all head types and sizes, including

electricalscrewdrivers odvijači - sve vrste glava i veličine, uključujući i električne odvijače, **spanners** viličasti ključevi, **adjustable spanner** namjestivi ključ, ključ na

namještanje, **francuski ključ**, **mole wrench** kliješta za zakovice, **electrical wire**

terminal crimper kliješta za stopice, **wire cutter** kliješta za rezanje žice, **hack saw**

and spare blades pila za metal s pričuvnim listovima, **wood saw** pila za drvo,

socket wrench set komplet nasadnih ključeva, **power drill (12 volts)**, **drill bits and**

screwdriver bits električna bušilica (12 v), svrdla i nastavci za odvijanje, **hand drill**

and bits ručna bušilica sa svrdlima, **brace and bits** teslica s tesarskim svrdlom,

pliers and electrical pliers kombinirana i električna kliješta, **hammers and mallet** čekići i bat, **set of chisels** komplet dlijeta, **files** turpije, **lime**, **torch** ručna svjetiljka, **mirror (to see in confined spaces)** zrcalo (za slabo pregledne prostore), **bolt cutters** noževi

basin /'beis(ə)n/ (n) **1 (ports)** lučki bazen, tal. *bacino*; *darsena*, **bazen**: A container ship was discharging her cargo in a **non-tidal basin**. The inbound vessel inadvertently deviated to the south side of the basin before altering course to starboard and then approaching the berth at a higher speed and at a larger angle than necessary. He would then be able to use the propulsion to move the ship into the middle of the **harbour basin**.; **2 (ports)** a docking facility located along a tidal river or in a harbour **dok**; **3 (geogr)** zaljev; **4 (ports)** unutrašnja luka: After confirming her position, he realised that the vessel had no choice but to continue to proceed down the narrow channel to the **inner basin**.; **5 (ports)** vanjska luka: The port was entered through a channel marked by pairs of lateral buoys numbered from 1 at the seaward end to 16 near the **outer basin**.

basket /'ba:skit/ (n) (**nav arch**) jabolna košara, koš

bass /bæs/ (n) = **sea-bass** luben, lubin, brancin, smudut **European seabass** luben

bathyscaphe /'bæθi,skeif/ (n) (**nav arch**) batiskaf

batten /'bætən/ **1 (cargo)** daska, letva **batten ends** krajevi rezane građe (manji od 2, 5 m dužine); **2 (seamanship)** čelična letva za pričvršćenje platna na grotlu

batten (n) (**boating/yachting**) letvica (u jedru), šteka; tal. *stecca*, *lajsna* **batten pocket** džep letvice u jedru

batten down /,bætən 'daʊn/ (v) (**cargo handling, safety**) to close the hatch watertight; the act of making a hatch watertight by wedging the battens against the tarpaulins, or of wedging shut or dogging down any watertight opening **zatvoriti hermetički (grotlo, brodsko skladište, ventil)**: The hatches were properly **battened down**. The derricks are to be lowered and secured and all the hatches are to be closed and **battened down**. Port holes and access to pump room **battened down**. They should have **battened down** the hatches and vents, and donned lifejackets in case the vessel capsized.

battens /'bætənz/ (n) **1 (nav arch)** letvice; **2 (cargo handling)** = **cargo battens**
bokoštitnice {drvene / plastične letvice za crtanje i uglašavanje brodske forme}

batter (v) (**meteorol**) pogoditi neko područje (ocikloni), sručiti se na (o cikloni): A 200m-long cargo ship has hit a barge full of rocks in the English Channel, as *Storm Angus continues to batter the south coast of England*.

battery /'bætəri/ (n) (**electr**) električna baterija, akumulator, **baterija**: Also, make sure that you carry an EPIRB and that the **battery** in the EPIRB is in date - not everyone will be as fortunate as the crew on board this vessel in this respect. **storage battery** akumulator, **battery capacity** kapacitet akumulatora, **battery terminal** *klema* stezaljka na polovima akumulatora, **starting battery** akumulator za upućivanje motora (brodice, jahte, jedrilice, glisera), **service battery** servisni akumulator, akumulator za dnevnu uporabu (rasvjetu, hlađenje itd. na brodicu), **liquid electrolyte battery** akumulator s tekućim elektrolitom i čepovima, **battery charger** brodski punjač, punjač akumulatora, **punjač baterije**, **AGM battery** (absorbed glass mat) hermetički zatvorena brodska baterija / akumulator (elektrolit apsorbiran unutar staklene vune), **GEL battery** (gel cell battery) hermetički zatvorena brodska baterija / akumulator (elektrolit apsorbiran unutar gela), **deep cycle battery** servisni akumulator, **semi-traction**

battery servisni akumulator, **VRLA battery**; valve regulated lead acid **battery**) akumulator s regulacionim ventilom olovne kiseline, **rechargeable battery** baterija s punjenjem na mrežni napon, akumulator s punjenjem na mrežni napon, **battery booster** pojačivač baterija, pojačivač akumulatora, **battery operation** rad baterije / akumulatora, **battery is flat** akumulator je prazan, baterija je prazna: *He then tried to use the hand-held VHF set, but the battery was flat.*, **battery is out of date** bateriji je isteklo vrijeme trajanja: *Although the EPIRB battery was out of date, the EPIRB had worked and its signal had been received by the coastguard, and a surveillance aircraft was tasked to locate the ves,* **battery alarm** alarm za praznu bateriju / akumulator: *Almost immediately, the battery alarm sounded.*

battery /'bæteri/ (n) (marine eng) skup aparata / uređaja, baterija aparata / uređaja, komplet uređaja

battery charger (n) (electr) 1 punjač akumulatora, punjač baterije: *It was subsequently discovered that a faulty battery charger had overcharged the boat's batteries, which produced the hydrogen sulphide gas.*; 2 ispravljač; 3 brodski punjač

bulk-absorption-float; **loUoU** Bulk - brzo punjenje do 80% kapaciteta, tj.14,2 V; absorption - punjenje konstantnim naponom do 100% kapaciteta; - float - plutanje - faza održavanja kapaciteta
sustav punjenja akumulatora u tri koraka

battery switch (n) (electr) glavni prekidač (na brodicima, jedrilici): *The power for the pump and float switch was derived from the battery side of the battery isolating switch.*

battery voltage (n) (electr) napon baterije, napon akumulatora: *He discovered that the battery voltage had dropped to below the 10.2 Volt threshold required by the heater to operate its safety features.*

battle cruiser (n) (navy) a large warship carrying heavy armament, which is smaller, faster and more manoeuvrable than a battleship **krstarica - bojni brod**

battleship /'bæt(ə)l.ʃɪp/ (navy) a type of large, heavily armored warship of the second half of the 19th century and first half of the 20th century armed with heavy-caliber guns, designed to fight other battleships in a line of battle **bojni brod** {generally considered outdated in modern naval warfare}

baulk /bɔ:k/ (n) (cargo) greda, četvrtača, sljemenjača

bauxite /'bɔ:ksaɪt/ (n) (cargo) boksit

bay /beɪ/ (n) 1 (nav arch) the position where the container is placed along the length of the container ship; section of vessel in which containers are held

(<http://www.maerskline.com/en-jm/help/shipping-glossary>) **bej**, red kontejnera po dužini

kontejnerskog broda (od pramca prema krmi): *Bays are numbered lengthwise from bow to stern with odd numbers for 20' containers and even numbers for 40' containers. The even number between two 20' containers is used to define 40' bays. the bay spaces for 20' containers are numbered throughout fore to aft with odd numbers, i.e. in this case 01, 03, 05 and so on up to 75. The bay spaces for 40' containers are numbered throughout with even numbers: 02, 04, 06 and so on up to 74.*; 2 (cargo

handling) a larger open area belowdecks on a ship, as in cargo bay, sick bay **prostor za teret (pod palubom)**; 3 predio broda **engine bay** predio strojarne: *The company's own investigation identified that the temperatures within the engine bay and surrounding areas were higher following modifications made to accommodate the insertion of the additional foam. {Theoretically, the thirty-eight bays could be numbered continuously from 1 to 38. However, that would only be sensible if only 20' containers could actually be loaded. U svakom skladištu smještena su obično po dva reda (bay), osim u krajnjem pramčanom i krmenom skladištu}*

bay /bei/ (n) (geogr) **COMPARE gulf COMPARE cove** a body of water forming an indentation of the shoreline, larger than a cove but smaller than a gulf

(dictionary.reference.com/browse/bay) body of water partially surrounded by land, usually with a wide mouth to a larger body of water (<http://education.nationalgeographic.org/encyclopedia/gulf/>)

zaljev, tal. baia *The vessel was in a sheltered bay and the conditions were good, so the skipper and his deckhand laid out the ring net. A yacht equipped primarily for cruising in the Caribbean is not necessarily going to be able to handle everything a winter storm in the Bay of Biscay can produce. Once the master had received the day's orders, the launch sailed into the bay to rendezvous with the helicopter for another day of routine training. The vessel was attempting to recover her starboard anchor in adverse weather and sea conditions, off Tees Bay, UK.*

{<http://www.differencebetween.net/science/nature/difference-between-gulf-and-bay/>: 1. In technical terms, both a gulf and a bay are the same things, and the only difference that is distinguishable is the size. 2. A gulf is considered to be larger than a bay. 3. Gulfs are large bodies of water that have only a narrow entrance along a strait. A bay is also a large body of water that has a wider opening than a gulf. 4. A gulf is much more enclosed than a bay. 5. Though it has been said that a bay is smaller than a gulf, there are many exceptions. The Bay of Bengal, about the size of the Arabian Sea, is much larger than the Gulf of Mexico. 6. }

BB; ballast bonus (n) (mar law) special payment above the chartering price when the ship has to sail a long way on ballast to reach the loading port **naknada za plovību u balastu (bez tereta)**

BC Code; Bulk Cargo Code (n) (cargo handling, mar law) **Pravilnik za osiguranje**

krutog tereta u rasutom stanju: *The shipper did not supply information on the characteristics of the cargo as required by IMO's Code of Safe Practice for Solid Bulk Cargoes (BC Code). After consulting the Bulk Cargo (BC) Code, the master determined that the cargo was non-hazardous seed cake and therefore could be carried on board the ship.*

BCO; Beneficial Cargo Owner (n) (mar law) the importer, who physically takes possession of cargo at destination **krajnji primatelj tereta**

BCR (Bow Crossing Range) (n) (navig) **minimalna udaljenost minmoilaženja po pramcu**: *In this case, the OOW was content to accept a bow crossing range/distance of 1 mile with the cargo ship and a considerably reduced CPA with the yacht, without feeling the need to refer to the master.*

beach /bi:tʃ/ (v) (mar ins) **namjerno nasukati brod (brodicu, barku)**: *Once back in the safety of the harbour, the skipper was able to beach his boat and make an inspection at low tide.* **beach a ship namjerno nasukati brod (radi spašavanja pomorskog pothvata)**: *In an extreme emergency, a ship's captain may elect to beach his vessel to keep it from sinking in deep water or for easier rescue of his passengers and crew. To prevent an even greater disaster the SOSREP made the decision to intentionally beach the ship in Lyme Bay.* <http://gcaptain.com/>

beach /bi:tʃ/ (n) a narrow, gently sloping strip of land that lies along the edge of an ocean or a lake (education.nationalgeographic.org/.) **pješčana morska obala, plaža**: ... where it would have been possible to land the passengers with the vessel's tenders onto an appropriate beach. **a gently sloping beach pješčana obala koj se lagano spušta**

beachcomber /'bi:tʃ,kəʊmə/ (n) 1 (UK, seamanship) a person who searches shore debris for anything of worth, esp a vagrant living on a beach **skupljači korisnog ostataka / naplavina na obali nakon brodoloma**; 2 (seamanship, US) A derelict seaman found unemployed on the waterfront, especially in a foreign country (seaman without a ship). (www.USMM.org) **brodolomac, pomorac bez broda, pomorac bez posla**

beaching /'bi:tʃɪŋ/ (n) (mar law, mar ins) deliberately running a vessel aground to prevent a

damaged vessel sinking **namjerno nasukavanje broda (u generalnoj havariji)**: *in an emergency a damaged ship might be beached to prevent it from sinking in deep water. ... he tried to slow down, but the throttle linkage slipped and there was no response from the engine. He was coming in far too fast for **beaching**. He tried again to throttle back, but in his haste he increased the speed.*

beacon /'bi:kən/ (n) **1 (navig)** a lighted or unlighted fixed aid to navigation attached directly to the earth's surface **svjetleća oznaka far, svjetionik, oznaka plićine, tal. meda; boa-radio**: *On approaching **beacon "B"**, the cargo vessel reduced speed and altered course to starboard. The vessel passed close to a detached rocky outcrop on its starboard side, which was **marked by a beacon**.*
articulated / buoyant beacon A floating mark secured to a sinker, either directly through a joint or by a cable that is held in tension by the buoyancy of the mark. The buoyancy chamber is normally below the surface of the sea. (<http://www.iala-aism.org/wiki/dictionar>) **plutajući zglobni far, personal locator beacon (safety) osobni radio lokator (u traganju i spašavanju)**: *The EPIRB was activated along with the **personal locator beacon**.*, **trigger the beacon izazvati uključivanje fara, to erect a beacon postaviti far (oznaku); 2 (navig)** a beacon-like buoyant structure, tethered directly to the seabed and having no watch circle **zglobni far (usidren u moru)**

bead (n) (fishing) **perlica (prame)**

beam /bi:m/ **1 girder greda, nosač**: *When he reached the after end of the port side conveyor belt, he found the wiper's body between the conveyor belt roller and a **supporting beam**. **H-beam nosač od H-profila, H-profil**: the flange and one bolt on the trolley cheek plate connecting bar fractured, causing the chain block and trolley to fall from the "**H**" **beam**. A fixed "**H**" **beam** with a four wheel trolley was fitted directly above the engine.*; **2 (nav arch)** an athwart member or girder supporting the portion of the deck above **sponja, nosač palube deck beam sponja, nošač palube**; **3 (seamanship)** the side of the ship and positions of other ships and objects relative to own ship's side **bok broda, po boku**: *The vessel had no bridge wings, which meant that the sea surface could not be seen from the manoeuvring station within **93 metres%bb of the beam** and 184 metres of the stern. **on the beam po boku, subočice**: --- the westerly cardinal was warning of the danger of a well-charted area of exposed rocks, however the mark was rounded, leaving it just 20-30m **on the beam**. the skipper was heard to pull the engine control back to neutral as a succession of large waves broke over the vessel, which was now **beam onto the sea**.*, **before the beam / forward of the beam subočice po pramcu, abaft the beam subočice po krmi**: *A short time later, the skipper saw the trawler out of the port side wheelhouse window at close range and just **abaft the beam**.*, **before the beam to port subočice po pramcu lijevo, abaft the beam to starboard subočice po pramcu desno, on the starboard beam desno po boku, na desnoj strani broda**: *He then held the ship stationary, stemming the 3-4 knot flood tide, with the port's entrance lock **on his starboard beam**. The other ship, which was now about **50m on the starboard beam**, then altered course to starboard, causing her port quarter to collide with the coaster's starboard side.*, **on the port beam lijevo po boku, na lijevoj strani broda**: *During this manoeuvre, OSV1 also let go all ropes, and as soon as OSV2 was **on the port beam**, she went astern. The wind was **on the port beam** and the stern was swinging quickly towards the stone reinforced riverbank.*, **starboard beam desni bok broda, desna strana broda**: *The tidal stream was flooding at between 3 and 4 knots, and a 20 knot wind was acting **on the vessel's starboard beam**. He did not see the bulk carrier, which had maintained a steady course and speed and was only 0.25nm off the cargo ship's **starboard beam**.*, **port beam lijevi bok broda, lijeva strana broda** *However, as the vessel moved astern into the main shipping channel, the force of the wind acting on her **port beam** was greater*

than the power the tugs could produce to hold the vessel against the wind., **turn the ship beam on to the wind** **okrenuti brod bokom na vjetar, okrenuti brod bokom prema vjetru**: The pilot hurried to the bridge and, with the assistance of one of two tugs in attendance, **turned the ship beam-on to the wind** in readiness for berthing., **forward of the beam** **subočice po pramcu**: The skipper was well into his day's work and was shooting a fleet of creels with the wind and seas just **forward of the beam** when, for some unknown reason, he left the safety of his wheelhouse.; **4 (nav arch) = width, breadth** the width of a vessel at the widest point; the registered breadth of a vessel, measured at the outside of the hull amidships, or at its greatest breadth **širina broda**

beam: (n) (navig) **radarski snop** **beam width** **širina snopa**

beam ends (n) **1 (seamanship)** A vessel lying on her side **strane broda, bokovi broda**: As lowering continued, the rotation increased until the boat was almost **on its beam-ends** and with its stern hanging down.; **2 (seamanship)** on her beam-ends means a ship heeled over on the side so that the deck is almost vertical **nagnuti brod (radi čišćenja dna) on her beam ends** **nagnuti brod (oko 45 stupnjeva tako da se može čistiti dno)**

beam knee (n) (nav arch) a bracket between a frame or stiffener and the end of a beam **koljeno sponje**

beam reach (n) (boating/yachting) **1 s bočnim vjetrom; 2** sailing with the wind coming across the vessel's beam **jedrenje s vjetrom u bok**: The wind was south west force 5-6 and good progress was made, the yacht sailing first **on a beam reach** and then a broad reach.

beam reaching (n) (boating/yachting) **jedrenje bočnim vjetrom**

beam sea (n) (navig) seas (waves) moving perpendicularly to the direction of the ship **bočni val, bočno more**: A small fishing boat was rolling easily while trawling in a moderate beam sea. **beam seas** **bočni valovi**

beams in aft peak (n) (nav arch) **donje sponje u krmenom piku**

beam socket (n) (nav arch) **ležište grede grotlenog poklopca**

beam trawler (n) (fishing) a fishing vessel carrying trawl nets boomed out on both sides from a central mast **bočna kočarica**: On a late winter's afternoon, in calm sea conditions, a **beam trawler** caught her port trawl gear on a fastener. The skipper and 2 crew of a 9.9 metre **beam trawler** had just completed an uneventful passage to nearby shrimp fishing grounds.

beamwidth (n) (navig, electr) the angular width, horizontal or vertical, of the path taken by the radar pulse **kutna širina radarskog snopa** **horizontal beamwidth** **širina radarskog snopa u vodoravnom presjeku**, **vertical beamwidth** **širina radarskog snopa u okomitom presjeku**

beam width distortion (n) (electr, navig) **izobličenje širinom snopa (radara)**

beamwidth error (n) (navig) **grješka zbog širine radarskog snopa**

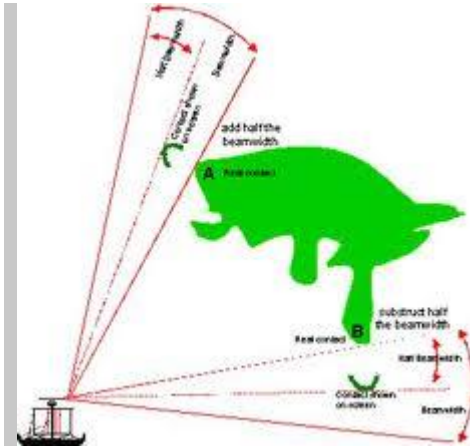

beam wind (n) (meteorol) wind at right angles to the vessel's course **bočni vjetar**, tal. **vento al traverso**. *Beam winds reached 90 knots and it was necessary to offset the ship's heading by 30° to maintain the revised planned track.*

bear /bɛə/ 1 (v) (marine eng) **nositi, pritiskati težinom**. *The 20 tonne weight of the door came to bear on the hydraulic cylinder and the lower hinge assembly. The tanker crew, however, were unable to handle the pennants clear of the bitts, so decided to connect the mooring lines as messengers once again, to bear the weight of the towing gear.* **bear the load podnositi opterećenje**; 2

(shipping econ) **snositi (troškove)**; 3 (boating/yachting, seamanship, navig) to lie in a certain direction **biti u jednom smjeru, ploviti u određenom smjeru, biti na azimutu od**:

During the turn, with the cargo vessel heading 125°(T) and the bulk carrier bearing 082°(T) at a range of 2.04 miles, the master ordered a slow alteration of course to port. During the turn, with the cargo vessel heading 125°(T) and the bulk carrier bearing 082°(T) at a range of 2.04 miles, the bulk carrier's OOW made several calls on VHF radio Channel 16 to clarify the cargo vessel's intentions.; 4

podnositi, trpjeti

bear (n) (seamanship, boating/yachting) **smjer**

bear a hand (v) (seamanship) to assist or help **pomoći, dati ruku**

bear away (v) (boating/yachting) **COMPARE luff up** namjerno otpadati skretanjem jedrilice od vjetra; to steer or turn a vessel away from the wind; to change direction from close hauled to a reach or run **otpadati, okretati od vjetra, pojat, pojati, tal. poggiare**. *The yacht was bearing away with the kicking strap still under tension as the skipper set up for a gybe.*

bear down on (v) (boating/yachting) to head toward and close on another ship **približavati se s privjetrine**

bearer bill of lading (n) (mar law) A bill of lading (supra) providing for the delivery of the goods to whomever holds the bill (Tetley) **teretnica na donositelja, teretnica (koja glasi) na donosioca**

bearing /bɛəriŋ/ (n) (navig) the direction of an object (with reference to you, your ship, another object); the horizontal direction of a line of sight between two objects on the surface of the earth, expressed as the horizontal angle, in degrees, between that direction and north **azimut,**

horizontalni kut, smjer, tal. rilevamento: *In navigation, two or more bearings on stationary objects at wide angles to each other provide a fix. When working close inshore do not rely on a single bearing and range for position fixing: use clearing bearings, use parallel indexes on your radar.*

closing / opening bearings **azimuti koji se približavaju / odvajaju, Meanwhile, on**

the tug, the bearing of the fishing vessel was observed to be opening to port and an assumption was made that no risk of collision existed. Over the next 15 minutes, the true bearing of the target changed by 1°, by which time it had closed to 0. Meanwhile, on the tug, the bearing of the fishing vessel was observed to be opening to port and an assumption was made that no risk of collision existed., **converging / diverging bearings** azimuti koji se približavaju/udaljuju, **to take the bearing of an object** snimiti azimut nekog objekta, **izmjeriti azimut nekog objekta**, **steady bearing** stabilan azimut **on a steady bearing** na stalnom azimutu, **s azimutom / smjerom koji se ne mijenja**: The chief officer saw that the vessel was fishing and, by using the EBL on the radar display, assessed that she was **on a steady bearing**. Ideally, when two ships are closing **on a steady bearing**, each is aware of the other's presence, and action is taken in accordance with the collision regulations. The container ship was approaching **on a steady bearing** from the port beam at high speed, **bearing accuracy** preciznost azimuta, **bearing line** crta azimuta, **linija azimuta**: This had not been detected by the OOW, who was monitoring the ship's position using only a single radar range and bearing line from a fixed beacon. He checked the vessel was on heading for the next alteration of course position, which was indicated by an **electronic bearing line** on the plotter., **leading bearing** vodeći azimut, **visual bearing** vizualno snimljen azimut, **vizualno dobiven azimut**: After steadying on the new course the OOW fixed the position using a **visual bearing** and radar distance, and plotted it on the chart in the chart room., **monitor the bearing** pratiti azimut (drugog broda): The OOW did not monitor her bearing, either visually using an azimuth gyro repeater, or by radar., **true bearing** azimut pravi: Over the next 15 minutes, the **true bearing** of the target changed by 1°, by which time it had closed to 0.

bearing (n) (marine eng) ležaj, tal.: **cuscinetto** **bearing box** kućište ležaja donje glave ojnice, **bearing bush** košuljica ležaja, tuljac ležaja, **bearing cover** poklopac ležaja, **bearing housing** kućište ležaja, vanjsko kućište, **bearing surface** klizna površina ležaja, **ball bearing** kuglični ležaj, **crankpin bearing** leteći ležaj, ležaj osnaca koljena, **crosshead bearing** ležaj križne glave, **gudgeon pin bearing** ležaj osovinice klipa, **main bearing** temeljni ležaj, glavni ležaj, **roller bearing** valjkasti ležaj, kotrljajući ležaj, **large end bearing** ležaj osnaca koljena, leteći ležaj: When the machinery space was entered, the engine's No 6 cylinder **large end bearing** assembly was found to have passed through the port crankcase door, and to have come to rest immediately outside the engine., **ring a bearing** 1 provjeravati ispravnost ležaja kucanjem čekića; 2 **bearing keys and chocks** klinovi za fiksiranje ležaja, **anti-friction bearings** protutarni ležajevi, protufrikcijski ležajevi, **small end bearing** gornji ležaj ojnice, ležaj gornje / male glave ojnice: This blanked the oil supply to the **small end bearing** and cooling oil to the underside of the piston, resulting in overheating and seizure of the piston in the cylinder liner., **bearing failure** zakazivanje ležaja, kvar ležaja: However, a spate of turbo-charger **bearing failures** had been linked to overheating.

bearing (n) (shipping econ) utjecaj, have a **bearing** on the business operation For cargo ships, the properties of cargoes that are permitted to be carried on each ship **have an important bearing on safety**.

bearing away (n) (boating/yachting) turn away from the wind intentionally; turn away from the wind, often with reference to a transit **otpadanje**, **namjerno otpadanje od vjetra**, **pojanje**; tal. **poggiata**

bearing bush (n) (marine eng) ležajni tuljac, **bukula**; tal. **boccola**

bearing cap (n) (marine eng) poklopac ležaja

bearing circle (n) 1 (navig) smjeralo, naprava za smjiranje; 2 azimutski kut

bearing cursor (n) (navig) smjeralo interscan bearing cursor interscan smjeralo

bearing discrimination (n) (navig) razlikovanje objekata / ciljeva na istom ili bliskom azimutu (na radaru), odvajanje objekata / ciljeva na istom ili bliskom azimutu (na radaru): *bearing discrimination governs the radar's ability to distinguish between two targets close together at the same range.*

bearing from a buoy (n) (navig) azimut (snimljen) s plutače: *The 3/O fixed the vessel's position at 1725, a single radar range and bearing from a buoy, which showed that the ship had regained the planned track coincident with a planned 5 degree alteration to port.*

bearing line (n) (navig) linija azimuta, He checked the vessel was on heading for the next alteration of course position, which was indicated by an electronic bearing line on the plotter.

bearing oil (n) (marine eng) ulje za ležajeve

bearing plate (n) (navig) smjeralo, smjerna ploča

bearing resolution (n) (navig) a measure of the capability of the radar to display as separate targets the echoes received from two targets that are at the same range and close together
razdvajanje ciljeva prema kutu, odvajanje ciljeva na istom ili bliskom azimutu, azimutska rezolucija

bearing scale (n) (navig, electr) azimutna skala (na radarskom prikazu)

bearing shell (n) (marine eng) blazinica ležaja

bearing surface (n) (marine eng) ležajna površina

bear off (v) (boating/yachting) = bear away to turn the vessel or boat away from the direction of the wind skretati od vjetra, pojat, ići u poju

bear up (v) (boating/yachting) to change direction toward the wind skrenuti u vjetar, skretati u vjetar

beast-hook (n) (nav arch, sailing vessels) zoja

beat /bi:t/ 1 (v) (boating/yachting) = close-hauled to sail close-hauled to windward jedriti u vjetar, jedriti u orcu; 2 to sail upwind in a sailboat by sailing alternate legs, first on one side then on the other; to zig-zag on alternate tacks letati, kosati, zborđžavati; zborđžat The dinghy was completing its second lap of the fourth race that day, and was beating upwind close by the committee boat when it was hit by a particularly strong gust of wind which caused it to capsize to leeward.

beating /'bi:tiŋ/ (n) (boating/yachting) plovdba/jedrenje višekratnim letanjem u smjeru vjetra prema cilju ili nekoj točki na moru ili kopnu; sailing as close as possible towards the wind (about 60°) in a zig-zag course to attain an upwind direction to which it is impossible to sail directly (Wikip) košenje

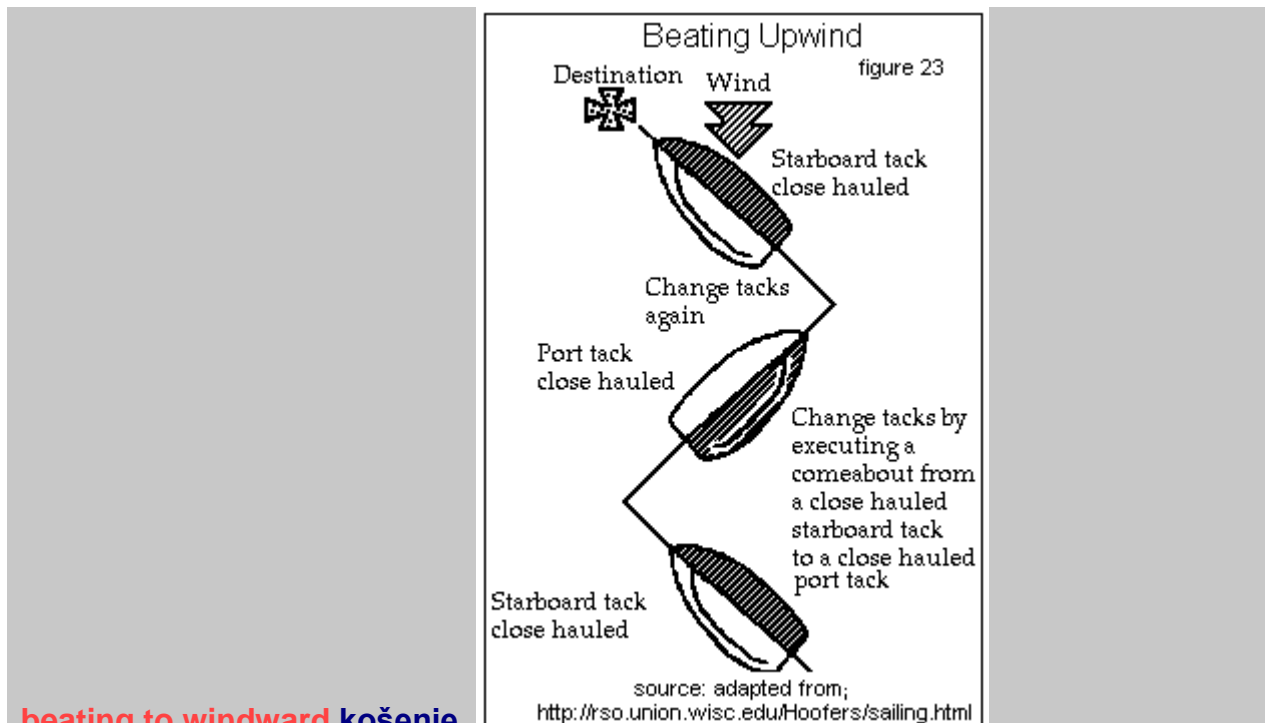

beating to windward košenje

beating straps (n) (boating/yachting) trake za noge (uz kobilicu jedrilice)

beat up (v) (boating/yachting) jedriti protiv vjetra stalnim letanjem, zborđžavati, jedriti u bordadama

Beaufort windforce scale /'bɛʊfə(r)t ,skeil/ (n) (meteorol, oceanogr) a scale that indicates the wind speed using the effect wind has on certain familiar objects **Beaufortova ljestvica** 0 calm tišina, 1 light air lahor, 2 light breeze povjetarac, 3 gentle breeze slabi vjetar, 4 moderate breeze umjereni vjetar, 5 fresh breeze umjereni jaki vjetar, 6 strong breeze jaki vjetar, 7 near gale žestoki vjetar, 8 gale olujni vjetar, 9 strong gale jaki olujni vjetar, 10 storm orkanski vjetar, 11 violent storm jaki orkanski vjetar, 12 hurricane orkan

becalmed /br'ka:md/ (adj) (boating/yachting) a sailing vessel dead in the water due to lack of wind (not moving). **jedrilica bez vjetra**: After a late lunch, the boat was becalmed and the two men decided to row the dinghy back to the shore.

becket bend (n) (boating/yachting) **SEE sheet bend** sheet bend zastavni uzao

bedding compound (n) (seamanship) materijal za kalafatanje, materijal za šuperenje

bedplate /'bed,pleit/ (n) (marine eng, nav arch) the upper surface plating of a foundation platform of an engine **temeljna ploča**: overheating of the bedplate at the main bearing housings; overheating of the piston connecting rods **engine bedplate** temeljna ploča glavnog stroja: The damage sustained necessitated an engine rebuild and the replacement of the bedplate and



crankshaft.

beech /bi:tʃ/ (n) (cargo) bukva, bukovina

beep (n) (electr) kratki zvučni signal (pri startanju ili nekoj naredbi računala,

uređaju), **beep**, **bip** The unit *beeps*, the startup screen appears, and then the equipment checks the ROM and RAM for proper operation and displays program number. The senior member momentarily pressed the VHF radio DSC button, but did not hold it down and did not hear the **acknowledgment** "beep".

beetle /'bi:təl/ (n) (seamanship) bat za kalafatanje: Tom Cunliffe is a lifelong professional sailor who has served before the mast in small sailing ships, skippered yachts for private owners, raced offshore, been to sea as mate on a British-registered coasting vessel and taught

before (prep) ahead of; on the forward side of **ispred (nečeg na brodu)**, **pred**

before the beam (prep phr) **subočice po pramcu**

before the mast (prep phr) (seamanship, boating/yachting) the quarters (accommodation) of

the common sailors, in the forecabin, in the front of the ship; a work station forward of the main mast **U**

potpaljublju pramca {smještaj na jedrenjacima za mornare; most often used to describe men whose living quarters are located in the forecabin, officers being housed behind (abaft) the mast and enlisted men before the mast}

before the wind (prep phr) (boating/yachting) **jedrenje niz vjetar**, **plovidba niz vjetar**:

The vessel was aligned to run *before the wind* with a lookout strategically positioned to give directions to the master in order that the vessel could be steered to provide the repair party with

belay /bi:'lei/ (v) 1 (seamanship) to make fast a rope or line by taking turns round a cleat or belaying

pin; to tie and secure a rope **vezati (konop, uže) na bitvu**, **učvrstiti konop na bitvu ili o**

klin, **omotati konop na bitvu**, tal. *dare volta su una bitta* **belaying pin** bar of iron or hard wood to which running rigging may be secured, or belayed **klin za osiguranje uzla (užeta)**

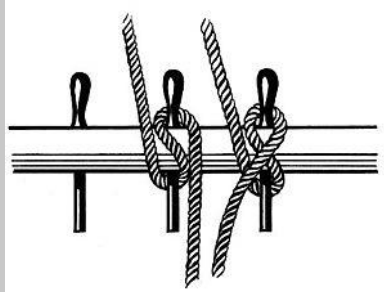

; 2 to rescind an order **opozvati naredbu**, **poništiti naredbu**;

3 zaustaviti

belay (v) (seamanship) **zaustaviti (uže)**, **zavezati (uže)**

bell (n) 1 **zvono**, **brodsko zvono**; 2 (seamanship) **obilježavanje straže zvukom zvona**;

	Starting at 12:00 am/pm, the day is divided into 6 x 4 hour watches		
1	12:30	4:30	8:30
2	1:00	5:00	9:00
3	1:30	5:30	9:30
4	2:00	6:00	10:00
5	2:30	6:30	10:30
6	3:00	7:00	11:00
7	3:30	7:30	11:30
8	4:00	8:00	12:00



3 (*seamanship*) dio dana na brodu (1/8 dana)

bellbook (*n*) (*marine eng*) dnevnik stroja (telegrafa)

bell buoy; bellbuoy (*n*) (*navig*) plutača sa zvonom: *A bell buoy is usually mounted near a rock or shoal to warn of a serious danger to navigation.*

bellmouth (*n*) (*geogr*) velika vodena rupa uz rub rijeke (utječe na smjer strujanja)

belly /'beli/ (*n*) (*boating/yachting*) the fullness of a sail trbuh jedra

belt /belt/ **cooling belt** rashladni pojas, **port belt** pojas kanala (na cilindru), zona otvora, **drive belt** pogonski remen, tal. cinghia (*marine eng*) pojas, zona: *The skipper had been on board during the morning to replace the worn main engine fan belt.*

bench and vice (*n*) (*marine eng*) radionička klupa (stol sa škripom/moršom)

benchmark /'bentʃ,ma:ːk/ (*n*) **1** a mark on a stone post or other permanent feature, at a point whose exact elevation and position is known: used as a reference point in surveying **granična točka, referentna točka, standard**: *These ships will be the new benchmark for the European feeder trades.*; **2** (*oceanogr*) A fixed physical object or marks used as reference for a vertical datum **hidrografska nula**

benchmarking (*n*) (*shipping econ, safety*) the measurement and comparison with a standard or others of efforts and results in the business process for e.g. input, output, reliability, quality and customer satisfaction (http://www.iss-shipping.com/cargo/cargo_library_glossaryb.asp); compare someone or something with the best that can be achieved within a specified field. **utvrđivanje komparativnih standarda, određivanje komparativnih graničnih točaka (za mjerenje razvoja i napretka)**: *Benchmarking is the comparative search for the best practices (processes) that will lead to superior performance of the company.*

bend /bend/ **1** (*v*) (*phys*) **saviti, savijati, iskriviti**: *As the wire continued to try to move to starboard (Figure 3), the bracket began to bend, freeing the shackle. The port skeg was removed, the port propeller shaft was bent and the port propeller blades were badly damaged (Figure 3). While the hull was found to be intact, the Becker rudder was found to be seized and the rudder stock bent by about 20o from the vertical.*; **2** (*seamanship*) The twisting or turning of a rope so as to fasten it to some object, as a spar or ring **vezati, zavezati (uže) bend a line vezati konop / uže, zavezati konop na konop, bend a hitch / knot zavezati uzao / čvor {bend - bent - bent}**

bend /bend/ (*navig*) **zavoj (rijeke), okuka, krivina, zakrivljeni element**: *As the tow approached a bend in the river, it started to set quickly to the south, towards a mooring buoy, under the*

influence of the strong tidal stream. the pilot incorrectly ordered the helm to starboard after the vessel had rounded a **right-handed bend** in the river. **clear the bend** **izaći iz zavoja rijeke**, **proći zavoj rijeke**: the bulkcarrier approached the final bend in the channel before the sea reach, speed was reduced and course altered to allow the inbound ship to **clear the bend**, **negotiate the bend** **ploviti zavojem (rijeke)**, **prolaziti zavojem**: As the vessel was negotiating the long bend before the bridge, the pilot, at the master's suggestion, moved the starboard console to obtain a better view down the side of the ship., **round the bends na zavojima (rijeke)**, **na okukama**

bend /bend/ (n) (sailing vessels) = **wale voj gaza**, **pojas gaza**

bend /bend/ (n) **1 (seamanship)** a hitch or knot; Bends are used to secure two lines together **uzao single-bend zastavni uzao**, **carrick-bend ukrižani uzao**, **unakrsni uzao**; **2 uzao koji spaja dva užeta**

bending force (n) (marine eng) **silav savijanja**

bending moment (n) **1 (marine eng)** the reaction induced in a structural element when an external force or moment is applied to the element causing the element to bend **moment savijanja**; **2 (nav arch)** the result of vertical forces acting on a ship as a result of local differences between weight and buoyancy **moment savijanja**: At sea the bending moment will change as a result of wave impact which than periodically changes the buoyancy distribution. The accident occurred suddenly and without warning when only the vessel's midships tanks were full, creating a maximum **bending moment** in the sagged condition.

bending moment curve (n) (nav arch) **krivulja momenata svijanja**

bending on sails (n) (boating/yachting) **navlačenje i vezivanje jedara za deblenjaka** (na početku sezone) **postavljanje jedara**

bending stress (n) (marine eng) **naprezanje pri savijanju**: the extra bulb weight exacerbated the problem and the keel was unable to withstand the "in service" **bending stresses**, and this led to the conditions of failure.

beneficial owner (n) (mar law) A term usually referring to the registered shipowner, but which may also designate another party having the equitable ownership of the vessel where it is operated under the cloak of a trust. The term may designate some party behind the registered owner, such as a parent corporation or holding company, having some legal or equitable interest in the vessel, including a right to dispose of it **korisnik broda**

beneficiary /,beni'fijəri/ **1 a (mar law)** **naslovník**; **2 primalac (novčane doznake)**; **3 korisnik (vlasnik računa u čiju se korist obavlja uplata)**

benefit /'benifit/ (n) **1 korist**: This case demonstrated the benefit of regular drills. GPS also frequently has the **benefit of cross-track error indication and alarm** which, if used effectively, can provide early warning of a ship deviating from the intended track. **for the benefit of u korist**, **major benefit veća korist / prednost**, **benefit from imati koristi od**: This section provides a unique and invaluable source of information for mariners of all disciplines to learn and **benefit from** the unfortunate experiences of others.; **2 (mar law) naknada**: the Employee shall be entitled to the wages and other benefits of this Agreement; **3 prednost**

benthic /'benθik/ (adj) (fishing) relating to the bottom of the ocean, or the ocean depths **pridneni**

benthos /'benθɔs/ (n) (ports) **COMPARE pelagic fish** common life forms on the ocean floor **morsko dno benthos fish riba s morskog dna**, **pridnena riba**

bergy bits /'bɜ:gi ,bits/ (n) (oceanogr) **male ledene sante**

Bermudan sloop /bə(r),mju:den/ (n) (boating/yachting) **1 bermudski slup a**

one-masted sailing boat with a jib and mainsail rigged fore and aft.

Bermuda rigging /bə(r), mju: də/ (n) (boating/yachting, nav arch) oputa s trokutastim jedrom podignutim kosim debljenjakom privezanim pri vrhu ili na vrhu jarbola; an arrangement of sails and spars featuring a triangular fore and aft sail and a mast with a sharp rake **bermudska oputa**

Bermuda sail /bə(r), mju: də/ (n) (boating/yachting, nav arch) trokutasto jedro podignuto do vrha jarbola s privjetrenim rubom uhvaćenim po cijeloj dužini jarbola i dnom za cijeli debljenjak **bermudsko jedro**

Bermuda triangle /bə(r), mju: də 'traɪ, æŋg(ə)/ (n) (geogr) bermudski trokut

Bernoulli effect (n) (navig) the function of fluid dynamics that tends to draw together two ships moving side by side **Bernoulijeva jednadžba, Bernoulijev zakon**

berth /bɜ: θ/ (n) 1 (ports) Any place where a ship can safely lie alongside a quay, pier or dock, at anchor or a buoy, and where she can carry out loading/discharge operations or embark and disembark passengers; dio vodenoga prostora i dio obale uređen za pristajanje plovniha objekata i opremljen priveznim sustavom **terminal berth vez na terminalu** A small gas tanker was moored alongside a **terminal berth**; all mooring bollards were in use due to bad weather., **adjacent berth**: A high speed catamaran (HSC) was scheduled to shift to an **adjacent berth**. **obližnji vez, boat's berth**: ... and all four were enjoying the fine weather and scenery as they made their way back to the **boat's berth**. **ive** A general cargo vessel loaded with timber, which was stowed in the holds and on top of the hatches, was on a pilotage passage upriver to her **discharge berth**. **vez za brodice, vez za barke, refuelling berth vez za opskrbu gorivom**: The service team boarded the vessel, as the tug's crew were preparing to move to a nearby **refuelling berth**., **repair berth vez za popravak brodova**: Crew safety drills continued apace throughout the duration the vessel remained alongside the **repair berth**, **dedicated berth namjenski vez, brodarov vez, vez koji pripada određenom brodaru / brodu**: A car and foot passenger ferry arrived alongside **her dedicated berth** during the early hours of the morning. **a (ports) vez (za brod u luci), pristan, pristanište, privezno mjesto, privezište, armiz, tal. posto ormeggio, vez za opskrbu gorivom to allocate a berth dodijeliti brodu vez (u luci), leave the berth napustiti vez** isploviti se sa veza A tanker was preparing to **leave her berth** and depart the port by way of a narrow channel. A 30m beam trawler **left her berth** after being given all the necessary clearances from the harbour authorities., **wait for a berth čekati vez, čekati na vez**: While **waiting for berth**, a fully loaded oil product tanker was anchored about 1 mile from the nearest shoal patch., **shift to a berth premjestiti se na drugi vez, prebaciti se na drugi vez**: A high speed catamaran (HSC) was scheduled to shift to an **adjacent berth**., **shift to another berth premjestiti se na drugi vez**: The vessel was shifted to another **berth** and subsequently to dry dock, as originally planned., **reach the berth doći do veza, stići do veza**: The tug was able to **reach her berth** and moor up under her own power after the collision., **turn off the berth okrenuti se s veza i zaploviti**: By 1551, the ship had **turned off her berth** and was heading toward the departure channel., **depart the berth napustiti vez, isploviti sa veza**: A container ship **departed its berth** and was heading on the outward passage with a pilot on board., **approach the berth prilaziti vezu, približavati se vezu**: The vessel's main propulsion had failed as **she approached the berth** and, although the starboard anchor was let go, the vessel could not be stopped., **manouvre the vessel clear of the berth kormilariti (manovrirati) brodom tako da bude podalje od veza**: The master **manoeuvred the vessel clear of the berth** and then headed on a north westerly course at a speed of 4 knots towards a reef, 5

cables away and marked by north and south cardinal marks, **manoeuvre the ship off the berth** **manovrirati brodom tako da se udalji s veza**. The master agreed to the pilot's suggestion that he would **manoeuvre the ship off the berth** and turn her, and then that the pilot would take over to negotiate the locks and the river passage., **pull the ship / stern off the berth** **izvući brod / krmu brod dalje od veza**, **pomaknuto brod / krmu boda s veza**. He then ordered the tug to **pull the vessel's stern off the berth** and operated the bow thruster to move the bow to starboard., **assist the ship on her berth** **pomoći brodu u manovri do veza**: Two tugs were assisting a container vessel onto her berth on a wide river., **give a wide berth** **držati se podalje, zaobići u širokom luku**. This means the fishing vessel was restricted and should be given a wide berth at all times. He then handed over the con to the deep-sea pilot, confirming the need for him to **give the light-float a wide berth** to starboard.; 2 (**seamanship**) a place to sleep on board; a bunk or bed in a ship **ležaj (na putničkom brodu)**

berth /bɜːθ/ (v) **to berth bow on / to vezati se / pristati pramcem na obalu, vezati se u četverovez, to berth stern on / to vezati se / pristati krmom na obalu, vezati se u četverovez, tal. ormeggiare sul lato dritto**: We will berth starboard side to., **to berth port side on / to vezati se / pristati lijevom stranom / bokom na obalu, tal. ormeggiare sul lato sinistro**: the vessel was berthed portside to, facing downstream alongside the Northfleet Hope Container Terminal., **to berth starboard side on / to vezati se / pristati desnom stranom / bokom na obalu**: The plan was for the vessel to berth starboard side alongside in readiness to load cargo., **berth at vezati se uz / na**: We berthed at dock 15., **berth alongside pristati bočno uz obalu, vezati se bočno oz obalu, tal. ormeggiare di fianco alla banchina (ship handling)** to bring a ship to a berth **vezati brod, pristati**: The vessel berthed at the Parker Point ore jetty at 0024 While waiting to berth, a fully loaded oil product tanker was anchored about 1 mile from the nearest shoal patch.

berth /bɜːθ/ (n) (**boating/yachting, seamanship, marine eng**) **ležaj, postjelja saloon berth** **ležaj u glavnoj kabini, krevet u kabini, forecabin berth** **ležaj u prednjoj kabini, aft berth** **ležaj u stražnjoj kabini**

berth /bɜːθ/ (n) (**navig**) **razmak, obilazak give the wreck a wide berth** **zaobiđite podrtinu u širokom luku, držite se podalje od podrtine, Wide berth requested!** **Zaobići u širokom luku!**

berthage /'bɜːθɪdʒ/ (n) (**shipping econ, mar law**) **vezarina, pristojba za korištenje (lučkog) veza ili obale**

berth bow on (v) (**seamanship**) **pristati pramcem prema obali, vezati se u četverovez pramcem prema obali**: A ship may berth port or starboard side on or bow or stem on

berth dues (n) (**shipping econ, mar law**) **vezarina, naknada za korištenje veza**

berth head (n) (**ports**) **glava veza, glava gata**: It was only within the imminent proximity of berth head, just at under half-a-ship's length away and when a bow tug had to cast off the towing line, the master finally realised the danger of the situation These measures were however taken too late to prevent an accident and the vessel, still having headway, contacted the berth head.

berth head-in (v) (**navig**) **pristati pramcem prema obali**: Our handy-size, multi-purpose vessel was berthed head-in, starboard side to and had already singled up with pilot on board. Our handy-size, multi-purpose vessel was berthed head-in, starboard side to and had already singled up with pilot on board. **{(u riječnoj luci, estuaru) vezati se pramcem uzvodno}**

berthing /'bɜːθɪŋ/ (**seamanship, ship handling**) **pristajanje, privezivanje, koštivanje**: A

100m long, liquid petroleum gas tanker was **conducting a routine berthing** at a "T" jetty, which was connected to dolphins by walkways. The master insisted on being on the bridge for the canal transit, and for **berthing** and un-berthing. **berthing manoeuvre manovra pristajanja**: The two men did not discuss the ship's manoeuvring characteristics, the status of the propulsion or how the berthing manoeuvre would be carried out. The vessel was equipped with a bow thrust unit, rated at 20t, to assist with berthing manoeuvres., **preparation for berthing priprema za privezivanje**: On this occasion, when several items of heavy electrical load were started in quick succession in **preparation for berthing**, the generator frequency dropped below 58Hz.

berthing /'bɜːθɪŋ/ (n) (boating/yachting, ship handling) **bočni vez, privezivanje bokom uz obalu**

berthing accommodation (n) (ports) **smještaj na vezovima za brodove u luci, smještajni kapacitet za brodove (u luci), svi vezovi zajedno (u nekoj luci)**

berthing alongside (n) (seamanship, boating/yachting, ship handling) **pristajanje bokom (uz obalu, ponton), bočno pristajanje**: He then awaited the arrival of a second tug, which assisted in **berthing the vessel alongside**.

berthing application (n) (mar law, shipping econ) **zahtjev za dobivanje veza**: Upon receipt of the **Berthing Application** / Notice of Arrival, the Harbor Operations Officer makes an initial evaluation of all **applications for berth space**, taking into consideration the GRT, LOA, and draft of the vessel and the cargo intended to be discharged or loaded.

berthing arrangements (n) **1 (seamanship) upute za privezivanje**: What are my berthing arrangements? Immao li vez po dolasku? Gdje ćemo se vezati?; **2 (ports, seamanship) oprema za privezivanje**; **3 upute za privezivanje**; **4 dobivanje veza u luci to make berthing arrangements arrangements dogovoriti vez za brod u luci, organizirati vez za brod, agree berthing arrangements arrangements dogovoriti vez u luci**

berthing bow-to (n) (boating/yachting, seamanship, ship handling) **vezivanje pramcem prema obali, vez u četverovezu s pramcem pream obali**

berthing guidelines (n) (shipping econ, mar law) **upute za privezivanje broda**

berthing impact energy (n) (seamanship) **udarna energija broda**

berthing in a lock (n) (ship handling, navig) **pristajanje u ustavi**

berthing instructions (n) (mar law, shipping econ) **upute za vez, obavijest o dodjeli veza (u luci)**

berthing manoeuvre (n) (ship handling) (seamanship) **manovra pristajanja**

berthing master (n) (navig, ports) **voditelj privezivanja**: Before boarding the ship, the pilot met the **berthing master** on the jetty.

berthing meeting (n) (shipping econ) **sastanak svih zainteresiranih za dodjelu veza brodu i obavljanje lučkih operacija sastanak lučke koordinacije daily berthing meeting dnevni sastanak lučke koordinacije**

berthing operation (n) (ship handling) (seamanship) **manovra pristajanja,**

manovra privezivanja, manovra dolaska na vez: The chief officer and the officer aft was properly briefed for the **berthing operation**. The **berthing operation** required the vessel to be turned through 180o before mooring port side to. A harbour tug was tasked to assist in the **berthing operations** of a 75,000gt bulk carrier and to pass her tow line from her forward towing winch through a panama lead at the ship's starboard shoulder.

berthing orders (n) (navig, seamanship) **zapovijedi za privezivanje, naredbe za**

privezivanje, tal. *ordini per l'ormeggio* **1 We will berth on the starboard / port side**
 Privezat ćemo se desnim / lijevim bokom., **3 Send out headline! Dodajte pramčani**
 konop., Dobacite pramčani konop., **2 Have heaving lines ready forward and aft!**
 Neka bacala budu spremna na pramcu i na krmi., **4 Send the heaving lines ashore!**
 Dodajte bacalo na obalu., Dobacite bacalo (*pandul*) na obalu., **5 Use the bow lead!**
 Koristite pramčano oko., **6 Heave on the ... line! Natežite ... konopl,** **7 Stop**
heaving! Prestanite napinjati., 8 Heave in easy! Napinjte polako., 9 Slack away
stern line! Popuštajte krmeni konop., Pick up the slack on the ... line(s) / ...
spring(s).. Pritegnite labavi(e) ... konop(e)/... špring(ove), check the ... line
 Zaustavite ... konop., **10 Keep the springs tight! Držite špringove nategnutima., 11**
Make fast fore and aft! Privezat ćemo se lijevim/desnim bokom., 12 Finished with
manoeuvring stations. Privezivanje završeno., Hold on the ... line(s) / ... spring(s).
 Zadržite... konop(e)/špring(ove)., **2 We will moor alongside** Pristat ćemo bokom na obalu.

berthing party (n) (*ship handling*) (*seamanship*) privezivačka grupa, privezivačka skupina, brodoprivezivači: *When this happens, there is always the danger of thrusters or a propeller becoming fouled unless good communication and co-ordination is maintained between the bridge, the mooring parties and the berthing party ashore.*

berthing pilot (n) (*navig, seamanship*) privezivački peljar, peljar ovlašten za

privezivanje broda: *The berthing pilot began the manoeuvre to turn the tanker using a combination of engine, helm and tug movements. The berthing pilot began the manoeuvre to turn the tanker using a combination of engine, helm and tug movements.*

berthing plan (n) (*navig*): *The berthing plan was revised to prevent the unit's failure at a critical stage of the berthing manoeuvre. The berthing plan was discussed between the pilot and the Master but the pilot had not mentioned the restricted room due to the other berthed tanker.*

berthing port/starboard side to the berth (n) (*ship handling, navig*) pristajanje lijevim/lijevim bokom na obalu **berthing port/starboard side to the berth, with / without thruster** pristajanje lijevim bokom uz obalu, s / bez pramčanog porivnika

berthing position (n) (*ship handling*) (*navig*): *Just short of the intended berthing position the vessel stopped. The approach went according to plan until the ferry was about 11 ships' length from its final berthing position, when her three main engine clutches disengaged almost simultaneously.*

berthing procedure (n) (*seamanship, navig*) postupak privezivanja

berthing ropes (n) (*seamanship, ship handling*) užad za privezivanje: *The selection of the sizes and types of berthing ropes used on board ships is largely a matter of commonsense and good practice.*

berthing stern on (n) (*seamanship, ship handling*) = **Mediterranean moor = Mediterranean moor** pristajanje u četverovez, pristajanje krmom prema obali

berthing stern to (n) (*boating/yachting, ship handling*) privezivanje krmom prema obali, vez u četverovezu s krmom prema obali

berth is/not clear (n) (*ports*) vez je slobodan / vez nije slobodan

berth no berth **1** (*mar law, shipping econ*) bez obzira je li brod na vezu ili nije; **2 = whether in berth or not**

berth place (n) (ports) vez broda

berth stern first (v) (navig, ship handling) pristati najprije krmom prema obali: *The Pilot advised the Master that the vessel would berth stern first at No 5 berth*

berth stern on (v) (navig, seamanship, ship handling) = **berth stern to** pristati i vezati se krmom prema obali

berth stern to (v) (navig, ship handling) pristati i vezati se krmom prema obali

berth terms (n) (mar law) the freight rate that includes cost of carriage from end of ship's tackle at load port to end of ship's tackle at discharge port **klauzula o uvjetima prijevoza stvari u skladu s običajima luke ukrcaja**

berth-to-berth route (n) (navig) ruta od početnog do krajnjeg veza (u planiranju plovidbe broda - voyage planning): *Although the route plotted on the chart was berth-to-berth, it lacked the necessary detail.*

beset in ice (adj) (navig) opkoljen ledom, zarobljeni u ledu: *The vessels became beset in ice in Northeast Passage.*

best bower (n) (seamanship) najveće sidro na brodu

bevel gear /'bev(ə)l giə(r)/ (n) (marine eng) stožnik, kosi zupčanik, stožni zupčanik, stožasti zupčanik, zupčanik s kosim zupcima

bevel square (n) pomični kutomjer, škvara, squadra falsa

beyond /bi'jɒnd/ (prep) **1 (mar law) iznad; 2 iza:** *Once beyond a nearby bridge, the vessel continued for several minutes before the skipper turned the vessel around and started to head back downriver.* Kad je brod prošao obližnji most, nastavio je tako ploviti nekoliko minuta prije nego što je zapovjednik okrenuo brod i usmjerio ga niz rijeku.; **3 iznad (moći) beyond control izvan moći, izvan kontrole:** *The wind and the waves are beyond our control and the challenge is often finding the best way to use these elements to our advantage. Instead, we were faced with a series of events that escalated beyond our control.* , **beyond repair koji se više ne može popraviti:** *A new fire tube was fitted to the auxiliary boiler, but the EGE was damaged beyond repair. To make things worse, the VHF radio in the lifejacket pouch had been damaged beyond repair.*

bible /baɪbl/ (n) (boating/yachting) porozni kamen za ribanje palube (na jedrenjacima)

bidder (n) (shipping econ, mar law) ponuđač **preferred bidder** preferirani ponuđač, ponuđač s prednošću: *The dry bulk shipping specialist Korea Line Corporation was named the preferred bidder to take over company's Asia-US and intra-Asia networks*

bifurcation (n) (navig) the point where a channel divides when proceeding from seaward račvanje, bifurkacija

Big Bear (n) (navig) Veliki medvjed

big end (n) (marine eng) **COMPARE upper end donja glava ojnice, donji dio ojnice, pršut** (= large end; = lower end; = bottom end)

bight /baɪt/ (n) (seamanship) **1 (seamanship) any section of line that is bent into a U-shape; a curve or loop in a rope udvojak konopa, polukružna petlja užeta:** *At this point the tail of the rope fouled the propeller and trapped the remaining deckhand in a bight as it whipped overboard. The deckhand on the workboat had passed the line as planned, but he had not noticed that he was standing*

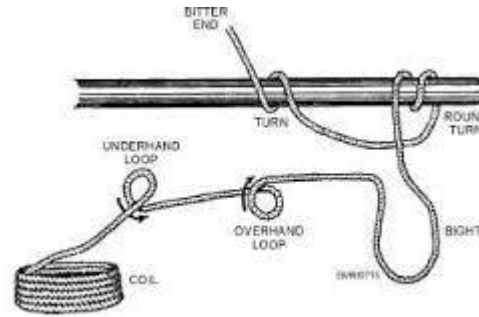

with his foot in a *bight* of the rope.

; 2 (*seamanship*) a curved section or slack part between the two ends of a rope, **labavi dio užeta (između dva kraja užeta)**; 3 (*geogr*) **plitka uvala**

big-scale sand smelt (*n*) (*fishing*) **COMPARE sand smelt** gavun oliga {*drugi htrv. nazivi: batelj, čiga, gaun batelj, gaun hrskavac, grčki, brfun, grima, mahača, ojiga, tupača; lat. Atherina boyeri; tal. latterino capoccione*}

bilge /bildʒ/ (*n*) 1 (*nav arch*) the parts of a vessel's hull where the vertical sides curve inwards to form the bottom and where water collects or drains and must be pumped out of the vessel **kaljuža, santina ston, tal. sentina; assecco**: *The water level in the bow thruster room eventually reached the outside sea level because of undetected holes in the bilge area.* **bilge alarm alarm kaljuža, alarm kaljužnog tanka**: *The vessel was fitted with a bilge alarm, but it had failed to activate. The forward bilge alarm did not sound, and the automatic bilge pump indicator lights had been inadvertently covered.*, **bilge level razina kaljuže, razina tekućine u kaljužnom tanku**: *He then checked the boat over, including the bilge levels and mooring ropes before locking the wheelhouse and making his way home.*; 2 (*nav arch*) **obluk**

bilge (*n*) (*nav arch*) zakrivljeni dio na spoju dna i boka broda **uzvoj**

bilge and ballast system (*n*) (*nav arch*) a piping system located in holds or lower compartments of a vessel and connected to pumps or eductors. **sustav kaljuža i balasta, kaljužni i balstni sustav, cjevovod kaljuže i balasta**: *The bilge and ballast system is used to clear off the accumulated water overboard and also to fill water into the ballast tanks*

bilge bracket (*n*) (*nav arch*) **uzvojno koljeno**

bilge drain (*n*) (*nav arch, seamanship*) **odvod iz kaljuže, kaljužni odvod, škarik santine**

bilge keel (*n*) (*nav arch*) a vane mounted on the outside of a ship at the turn of the bilge perpendicular to the hull to reduce rolling effect **ljuljna kobilica**

bilge keelson (*n*) (*sailing vessels*) **bočna hrptenica**

bilge pipe (*n*) **kaljužna cijev, cijev kaljuže bilge pipe pipe system sustav kaljužnog cjevovoda, kaljužni cjevovod**: *Large sections of bilge pipe system were renewed, and improved routing was introduced.*

bilge piping system (*n*) (*nav arch*) **sustav kaljužnog cjevovoda**

bilge plates (*n*) (*nav arch*) **kaljužni oplatni limovi, oplatni limovi kaljuže**

bilge pump (*n*) (*marine eng*) a hydraulic pump fitted at the lowest inboard part of the hull to bail out water **kaljužna crpka, kaljužna pumpa**: *A significant amount of water had entered the vessel's under deck area and we had experienced some problems with a bilge pump. The primary deck wash and bilge pump ran continuously with no means of disengaging it from the main engine. The cause of the sinking was failure of the electric bilge pump, leading to the bilge slowly flooding.*

manual bilge pump ručna kaljužna pumpa, electric bilge pump električna kaljužna

pumpa, **bilge pump** handl ručica kaljužne pumpe

bilge pumping system (n) (marine eng) **sustav kaljužnih pumpi** : A portable salvage or submersible pump will ensure you can pump out compartments not served by the fixed **bilge pumping system**.

bilges /bildʒiz/ (n) **1** (nav arch) kaljuže, **santine**; **2** kaljužni voj

bilge strake (n) (nav arch) hull plates that form the curved sections that make the transition from bottom shell to side shell **uzvojni voj**, **voj uzvoja**, **ljuljni voj**, **voj obluka**

bilge stringer (n) (nav arch) kaljužna proveza

bilge suction (n) (marine eng, nav arch) **usis kaljuže**: The compartment, immediately forward of the accommodation space, had no fixed **bilge suction**, in order to continue pumping out the water.

bilge system (n) (nav arch) **kaljužni sustav**: The bilge system in all the holds, except Hold 1, incorporates two centrifugal, self-priming pumps rated at 200 m³/hr, and a single piston type bilge pump of 10 m³/hr

bilge water (n) (nav arch) kaljužna voda

bilge well (n) (nav arch) **zdenac kaljuže**: To pump out the lower car hold **bilge wells**, the engineer selected each system in turn, opened the appropriate valves and started the bilge pump.

bill /bil/ **1** (financ) **a račun**; **2** (financ) **novčanica, banknota**; **3** (mar law) **nacrt zakona**

bill /bil/ (n) (nav arch) **oštrica lopate sidra, vrh lopate sidra**

billboard a fitting at the bow of a vessel for securing an anchor **kućište sidra (na pramcu)**

bill-board /'bil,bɔ:(r)d/ (n) (sailing vessels) **štit za sidro**

billed weight (n) (shipping econ) **fakturirana težina (tereta), obračunata težina tereta**

bill of anchor (n) (nav arch) **vršak lopate sidra, vršak krila sidra**

bill of exchange (n) (mar law, shipping econ) an unconditional order in writing, addressed by one party (drawer) to another party (drawee), requiring the drawee to pay at a fixed or determinable future date a specified sum in lawful currency to the order of a specified person. (Glossary of Shipping Terms, US MarAd) **mjenica**

bill of health (n) (mar law) = **maritime declaration of health** a document provided to a ship's master by port health authorities indicating the state of health of the ship's company and of the port from which the ship is sailing, as well as other ports to which the ship intends to sail **pomorski zdravstveni list, zdravstveni list (pomorski)** : When a vessel has free pratique, this means that the vessel has a clean Bill of Health certifying that there is no question of contagious disease and that all quarantine regulations have been complied with, so that people may embark and disembark.

bill of lading /'bil əv,leɪdɪŋ/ (n) **bill of lading to name teretnica na ime / imenovanu osobu ili tvrtku, bill of lading to bearer teretnica na donosioca, (to) order bill of lading teretnica po naredbi / nalogu, booking bill of lading teretnica s kaluzulama o modalitetima ugovora, charter party bill of lading teretnica bez kaluzula o modalitetima ugovora, teretnica u okviru ugovora o prijevozu, claused bill of lading teretnica s opaskama, nečista teretnica, prljava teretnica, dirty bill of lading teretnica s opaskama, nečista teretnica prljava teretnica, unclean bill of lading nečista teretnica, prljava teretnica, clean bill of lading** A B/L which bears no superimposed clause or notation which declares a defective condition of the goods and/or the packaging **teretnica bez opaske, čista teretnica, dirty bill of lading prljava teretnica, foul bill of lading nečista teretnica, teretnica s opaskama / primjedbama, groupage bill of lading**

zbirna teretnica, **received bill of lading** teretnica primljeno na ukrcaj, **shipped bill of lading** teretnica ukrcano na brod, **straight bill of lading** teretnica na ime, **negotiable bill of lading** negocijabilna teretnica, **utrživa teretnica**, **non-negotiable bill of lading** neutrživa teretnica, **through bill of lading** direktna / izravna teretnica, **transshipment bill of lading** teretnica za prekrcaj / razvoz, **razvozna teretnica**, **to complete the bill of lading** ispuniti / popuniti teretnicu, **to endorse the bill of lading** indosirati teretnicu, **ovjeriti teretnicu**, **upisati opasku na teretnicu**, **make out a bill of lading** izdati teretnicu, **sign the bill of lading** potpisati teretnicu, **set of bills of lading** komplet teretnica, **combined transport bill of lading** teretnica za kombinirani transport, **stamp the bill of lading** staviti pečat na teretnicu,, **present the bill of lading** predložiti teretnicu, **prezentirati teretnicu**, **compile the bill of lading** ispuniti teretnicu, **popuniti teretnicu**, **combined bill of lading** B/L that covers cargo moving over various transports **multimodalna teretnica**, **teretnica u multimodalnom prijevozu**, **teretnica u kombiniranom prijevozu**, **intermodal bill of lading** multimodalna teretnica, **kombiniranma teretnica**, **teretnica u multimodalnom prijevozu**, **house bill of lading** = **certificate of shipment** kućna teretnica, **otpremnička potvrda**, **teretnica na jednog primatelja**, **freight bill of lading** a contract of carriage between a shipper and forwarder **vozarinska teretnica**, **consolidated bill of lading** B/L combined or consolidated from two or more B/L's **zbirna teretnica**, **konsolidirana teretnica**, **domestic bill of lading** Non-negotiable B/L primarily containing routing details; usually used by truckers and freight forwarders **domaća teretnica (za cestovni prijevoz/špediciju)**, **straight bill of lading** This B/L indicates that the shipper will deliver the goods to the consignee. It does not convey title (non-negotiable). Most often used when the goods have been pre-paid. **neutrživa teretnica**, **non-negotiable teretnica**, **teretnica na ime**, **shipped on board bill of lading** B/L validated at the time of loading on to the ship **teretnica ukrcano na brod**, **original bill of lading** The part of the B/L set that has value, especially when negotiable; rest of set are only informational file copies. **originalna teretnica** **izvoini primjerak teretnice**, **received for shipment bill of lading** B/L validated at time cargo is received by ocean carrier to commence movement **teretnica primljeno na ukrcaj (mar law, shipping econ)** A document issued by a carrier, or its agent, to the shipper as a contract of carriage of goods. It is also a receipt for cargo accepted for transportation, and must be presented for taking delivery at the destination. (<http://www.businessdictionary.com/definition/bill-of-lading-B-L.html>) ; Originally called a bill of loading, a bill of lading is not necessarily the complete contract of carriage of goods but is usually the best evidence of the contract. It is, as well, a receipt signed by the master or on his behalf indicating in what apparent order and condition the goods have been received on board. Finally, it is also a document of title and thus a document of transfer, but not a negotiable instrument (Tetely); Legal document signed by or for the captain/master, agents, owners of a vessel or the (common) carrier. It is written evidence of the contract of carriage by sea and/or by land. (<http://www.maerskline.com/en-jm/help/shipping-glossary>) ; isprava kojom brodar potvrđuje da je radi prijevoza na brod primio teret te se obvezuje da će poslije završetka putovanja teret predati ovlaštenomu imatelju te isprave **teretnica**, **konosman**, **navao**, **naval** {Among other items of information, a bill of lading contains (1) consignor's and consignee's name, (2) names of the ports of departure and destination, (3) name of the vessel, (4) dates of departure and arrival, (5) itemized list of goods being transported with number of packages and kind of packaging, (6) marks and numbers on the packages,

(7) weight and/or volume of the cargo, (8) freight rate and amount.
(<http://www.businessdictionary.com/definition/bill-of-lading-B-L.html>)

bill of lading to a named person (n) (mar law, shipping econ) = **straight bill of lading** teretnica izdana na ime

bill of lading to bearer (n) (mar law, shipping econ) teretnica na donosioca

bill of lading to order (n) (mar law, shipping econ) teretnica po naredbi

bill of sale (n) (mar law) ugovor o prodaji (broda)

billow /'biləʊ/ (n) (oceanogr) veliki morski val

bimetallic thermometer /,baɪmi'tæɪlɪk θə'mɒmɪtə/ (n) (marine eng) bimetalni termometar

bimini /'bɪmɪni/ (n) (boating/yachting) tenda nad kokpitom jedrilice; awning over cockpit **bimini**, suncobran iznad kokpita **bimini top** cerada biminija



binary storage unit (n) (electr, navig) jednobitna memorija

bind /baɪnd/ (v) (mar law) obvezati, vezati {bind - bound - bound}

blind pilotage (n) (navig) obalna navigacija direktno sa radarskog pokazivača: *Blind pilotage or parallel indexing involves navigating a vessel along a pre-planned track in waters so confined that conventional methods of navigating (transferring visual bearings and radar ranges to the chart) is impractical because it cannot not be done quickly enough. {Here radar comes into its own, with some pre-planning, its graphic presentation, showing the vessels position in the context of its immediate surroundings can be interpreted by the navigator instantly and the vessel conned directly from the radar display in daylight or darkness.}*

binnacle /'bɪnəkəl/ (n) (navig) the stand, usually of brass or non-magnetic material in which the compass rests and which contains the compensating magnets; compass holder **postolje**

magnetskog kompasu, okučje kompasu: *The skipper borrowed a large magnet from the engine room, placed it close to the binnacle and managed to turn the card 180°, but thereafter the compass's reliability was found to be somewhat suspect.*

binoculars /bi'nɒkjʊləz; baɪ'nɒkjʊləz/ (n) (navig) dvogled, dalekozor, **kanoćal**: *Through binoculars, the OOW was able to see the vessel's port side light and its deck lights. While transiting the inshore route, he used binoculars to search the sea area ahead for the vessel they were to meet. a pair of binoculars dvogled, dalekozor, kanoćal*

bipod mast /'baɪpɒd/ (n) (nav arch) dvonožni jarbol, bipod

bird's nest (n) (boating/yachting) **COMPARE crow's nest** a small lookout position, usually round, placed at the masthead (smaller than the crow's nest) **koš za motritelja na jarbolu**

bireme /'baɪri:m/ (n) (boating/yachting, nav arch) an ancient Greek or Roman war galley propelled by two tiers of oars on each side **birema**

Biscay low /'bɪskeɪ/ (n) (meteorol) biskajska ciklona

bite /bait/ (v) (fishing) When a fish strikes or takes your bait / lure also known as a hit and strike.
zagristi (ješku, mamca)

bitt; bitts 1 (seamanship) a pair of vertical wooden or iron heads on board ship, used for securing mooring or towing lines **bitva, kljuna (zastarj.)**: A sternline was led from a roller fairlead, through a set of bitts, around a pedestal fairlead and on to a warping drum. The head line and breast line began to run out around the bitts, and the starboard anchor was let go. They were backed up with only a couple of turns around a single bitt. After securing the first spring on the twin bitt, the second spring line was wound around the winch drum and hauled in taut. **secured on the bitts vezan na bitvu, pričvršćen na bitvu**: Lines should be stoppered off and secured on the bitts., **run around the bitts prebaciti oko bitve, obaviti oko bitve**: The head line and breast line began to run out around the bitts, and the starboard anchor was let go., **make fast on the bitts vezati na bitvu**: The tug was made fast to bitts at the aft end of the main deck, by the break of the accommodation superstructure., **post of the bitts stupić bitve**: Synthetic fibre ropes should be made fast using two round turns around the leading post of the bitts before finishing it off with at least three 'figure of eight' turns., **turn up on the bitts prebaciti preko bitve, prebaciti oko bitve**: the rope was



turned up on the bitts.

; 2 (boating/yachting)

kaštanjoli, bita, bite; tal. bitta

bitter (n) (seamanship) namotaj užeta na bitvi, **volta**: The luffing wire rope had unwound and the bitter end slipped out of the luffing wire rope drum.

bitter end 1 (seamanship) the inboard end of a cable when made fast to the bitts **kraj sidrenog lanca (u spremištu sidra); 2 (seamanship) kraj pričvršćenog užeta, pričvršćeni dio užeta, kruti kraj konopa**

bitumen carrier /'bitʃmin/ (n) (nav arch) tanker za bitumen

bitumen tanker (n) (nav arch) tanker za bitumen

black fish (n) sipa

blackout /'blækaut/ **complete blackout** usljed takvog stanja brod se proglašava nesposobnim za plovidbu **potpun nestanak struje, cause a blackout izazvati / prouzročiti nestanak električne struje**: The rapid escape of gas caused the cylinder to "fly" into the control room, where it hit the switchboard and tripped a breaker, **causing a blackout. nestanak struje, raspad**

elektrosistema: A brief blackout occurred when the shaft generator stopped for several seconds and the emergency generator started, but the main engine continued to run. The water had entered the fuel oil system, causing the fuel pumps to seize, and this led to the **blackout**.

black sea bream (n) (fishing) Lat. Spondyliosoma cantharus **kantar, kantor**

blackspot sea bream

black tail seabream



{lat. SPONDYLIOSOMA CANTHARUS; tal. cantarella}
blackspot sea bream (n) (fishing) **COMPARE red sea bream** lat. *Pagellus bogaraveo* rumenac okan
black tail seabream (n) Lat. *Oblada Melanura* ušata

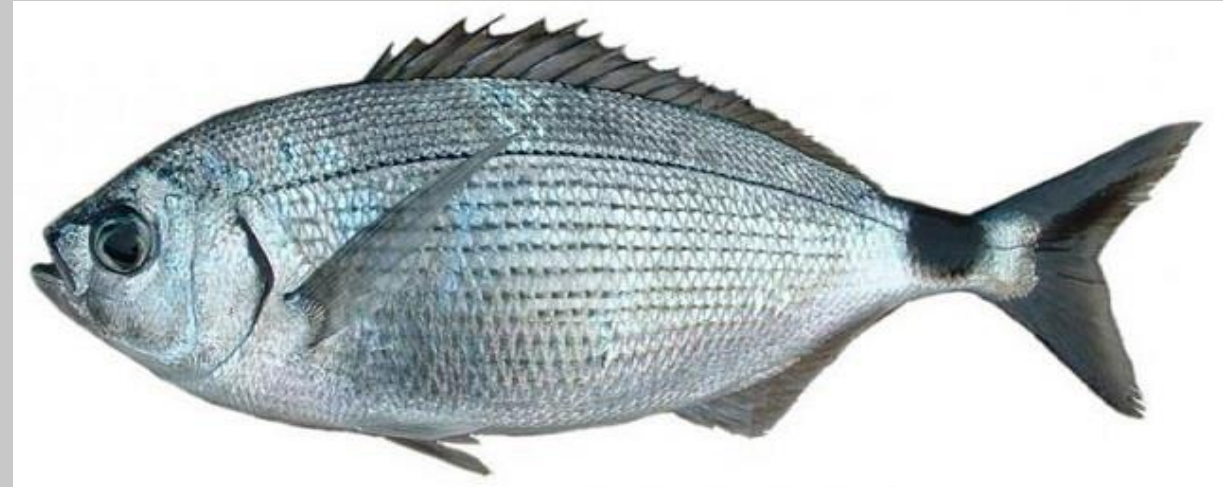

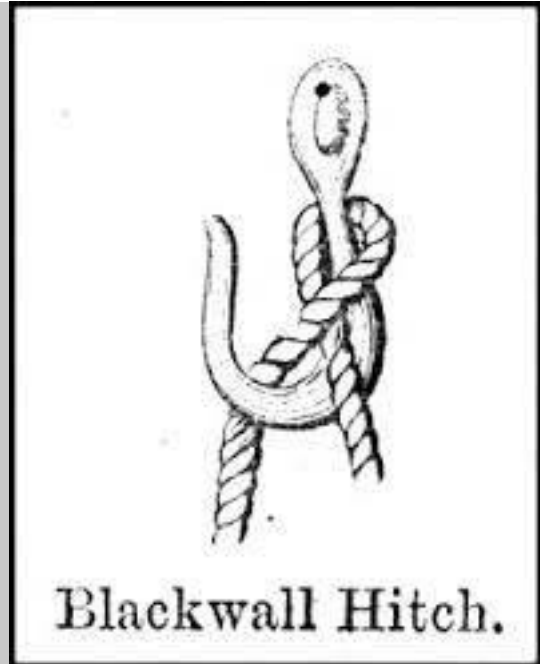

Blackwall hitch (n) (seamanship) uzao za kuku

blackwash /'blæk,wɔʃ/ (n) (navig) brazda, šija

blackwater /'blæk,wɔ:te/ (n) (safety) otpadne vode (iz kanalizacije), fekalne vode: On board a passenger ship, a crossover line between the port and starboard ballast/treated **black water**/grey water tanks passed through an adjacent cofferdam.

black water tank (n) (boating/yachting) Waste water carrying urine and feces from toilet facilities. **crni tank, tank za fekalije**

blade (n) 1 (marine eng) lopatica (rotora itd.), krilo **movingblade** rotorska lopatica, **stationary blade** statorska lopatica, **turbine blade** turbinska lopatica; 2 (seamanship) tanji ravni dio vesla; 3 (nav arch) krilo propelera, lopatica propelera

blading /'bleidiŋ/ (n) (mar law) teretnica (= bill of lading)

blading /'bleidiŋ/ (n) (marine eng) lopatičje **turbine blading** turbinsko lopatičje, turbinske lopatice

blame /bleim/ (n) (mar law) krivnja, krivica **to put the blame on** okriviti (nekoga), **no blame culture** politika kojom se ne traži krivnja pojedinaca, **apportion the blame** odrediti udio u krivnji, **pripisati krivnju**: The role of the MAIB is purely to discover the facts, not to **apportion blame** or culpability.

blame /bleim/ (v) **okriviti, kriviti za nešto**: Before finding out **who to blame**, there is something more important that the consignee or cargo owner should do first. 1. engage a surveyor to ascertain and collate evidence of the loss or damage;

blank /blæŋk/ 1 praznina, prazno mjesto **blank chart** (navig) slijepa karta; 2 (marine eng) slijepa prirubnica: Consequently, there was no verification that the **blank** had been put in place before the duty officer attempted to release the pressure in the cargo line.

blank (v) (marine eng) **zatvoriti (prirubnicom), zatvoriti otvor**: Two ABs, who were keeping watch on the main deck, considered it to be unsafe to **blank** the manifold while working under the cargo hose, and deferred doing so.

blanket /'blæŋkit/ 1 (v) (marine eng) **prekriti blanket the line** obložiti cjev (na mjestu

gdje propušta); 2 (marine eng) spriječiti pristup (zraka); 3 (boating/yachting) to block the wind by sailing on the weather side of another sailboat preuzeti vjetar (drugoj jedrilici tako da joj se stane u privjetrinu)

blanket /'blæŋkit/ 1 (n) (marine eng, safety) pokrivač, prekrivač, deka; 2 (marine eng, safety) prigušnica, prigušivač, pokrivač: *It appears that the foam was incapable of providing the necessary blanket to extinguish a liquid fuel fire. foam blanket prigušnica od pjene: These produced the expected, thick foam blanket, which quickly smothered the fire. fire blanket pokrivač za prigušivanje požara, protupožarni pokrivač: However, the simple precaution of using a suitable fire blanket, which would have prevented this accident, was missed.*

blank flange (n) (cargo handling, marine eng) slijepa prirubnica

blast /bla:st/ (n) 1 (navig) the signal of a ship's whistle zvučni znak, znak brodom sirenom, zvižduk, zvučni signal. *On hearing the continuous blast, he altered course to starboard. prolonged blast dugi zvuk / signal, short / long blast kratak / dugi znak, sound a blast dati znak brodom sirenom: our ship sounded 5 short blasts on her whistle The OOW remained concerned by the movement of the east-bound vessel, which was now within 2nm, so he sounded one blast lasting approximately 3 seconds on the ship's forward whistle.; 2 (marine eng) mlaz blast of compressed air mlaz komprimiranog zraka; 3 (meteorol) udar vjetra; 4 (seamanship) zvuk trublje*

blast furnace (n) visoka peć

blast of air (n) (marine eng) jaki mlaz zraka

B/L; bill of lading (n) (mar law) teretnica, konosman; fr. *connossement*

B/L; bill of lading /'bil əv,leidiŋ/ (n) (mar law) = bill of lading teretnica {The B/L has the following functions: 1. A receipt for goods, signed by a duly authorised person on behalf of the carriers; 2. A document of title to the goods described therein; 3. Evidence of the terms and conditions of carriage agreed upon between the two parties.}

bled steam (n) (marine eng) ispuštena para, ispušna para, para oduzeta iz

(niskotlačne) turbine: *On completion of the work the rams were replaced, the oil reservoir and header tank were replenished, air was bled from the hydraulic system and the steering arrangements were proven.*

bleed /bli:d/ (v) (marine eng) odzračivati, oduzimati paru (iz niskotlačne turbine),

ispuštati (paru, vodu, ...) bleed the pump of air odzračiti pumpu, bleed air: *On completion of the work air was bled from the hydraulic system and the steering arrangements were proven. odzračiti, ispustiti zrak {bleed - bled - bled}*

bleed /bli:d/ (v) (med) krvariti: *With the aid of a torch, they were able to see the AB lying 5m below; he was unconscious and was bleeding from a head wound. After stabilising the situation a "Mayday" was put out on VHF channel 16, and first-aid was administered to the casualty, who was unconscious and bleeding profusely. {bleed - bled - bled}*

bleeding /'bli:diŋ/ (n) (boating/yachting, marine eng) odzračivanje bleeding the fuel system odzračivanje sustava goriva

bleeding /'bli:diŋ/ (n) (med) krvarenje severe bleeding jako krvarenje, internal bleeding unutarnje krvarenje, external bleeding vanjsko krvarenje

bleed screw (n) (marine eng) vijak za odzračivanje

blend /blend/ (n) (n) (marine eng) a mixture of fuel or oil; type of fuel or oil produced by blending mješavina goriva ili ulja, kvalitet goriva blenda goriva cargo blend, mješavina

tekućeg tereta: *Precautions before loading argo blends containing DRI (C) can be identified by their chemical composition, details of which must be requested.*

blend: (v) If you blend substances together or if they blend, you mix them together so that they become one substance. **miješati, blendirati**

blended fuel (n) heavy fuel and distillate fuel mixed in various proportions, usually 70:30 **mješano gorivo, blendirano gorivo:** *Many genset engine builders can now offer designs capable of burning the diesel oil or **blended fuel** either bunkered as an intermediate fuel or blended onboard.*

blending with (adj) (navig) Blending is the mixing of two fuels, usually a heavy fuel and marine diesel oil. The intention is to produce an intermediate-viscosity fuel suitable for use in auxiliary diesels (<http://www.machineryspaces.com/fuel-oil-blenders.html>) **koji se stapa s (npr. pomorsko svjetlo s pozadinom)**

blind /blaɪnd/ (v) (navig) **zaslijepiti:** *The bridge team's vision was blinded by the bright city lights to the south, which were virtually doubled in intensity by the reflection from the calm water. **be blinded by the light biti zaslijepljen svjetlom:** *The bridge team on the product tanker was blinded by the bright deck lights of the anchored vessels, **blind the vision zaslijepiti vidljivost, zakriliti vidljivost****

blind /blaɪnd/ (n) (cargo handling, nav arch) **čep, slijepa priрубnica**

blind pilotage (n) (navig) **COMPARE parallel indexing** Blind pilotage or parallel indexing involves navigating a vessel along a pre-planned track in waters so confined that conventional methods of navigating (transferring visual bearings and radar ranges to the chart) is impractical because it cannot not be done quickly enough. **ucrtavanje dužine paralelne s pramčanicom, obalna navigacija izravno putem radarskog pokazivača:** *In blind piloting the radar comes into its own, with some pre-planning, its graphic presentation, showing the vessels position in the context of its immediate surroundings can be interpreted by the navigator instantly and the vessel conned directly from the radar display in daylight or darkness. As the visibility was about one cable, the bridge*

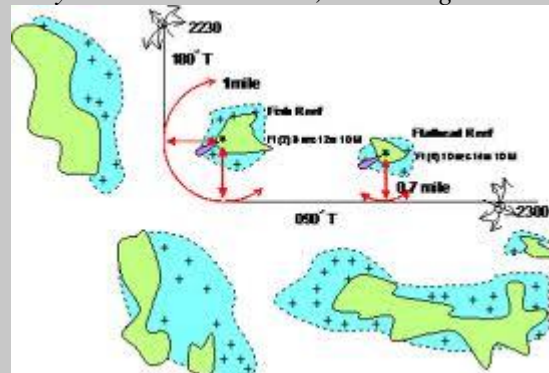

organisation was configured to conduct blind pilotage.

blind sector (navig) **nevidljivo područje, slijepo područje (radara) mrtvi kut:**

*Funnels, stacks, masts or derricks in the path of the antenna may hide Radar targets which are behind them. However, the lowered position seriously increased the forward visual **blind sector** to a point*

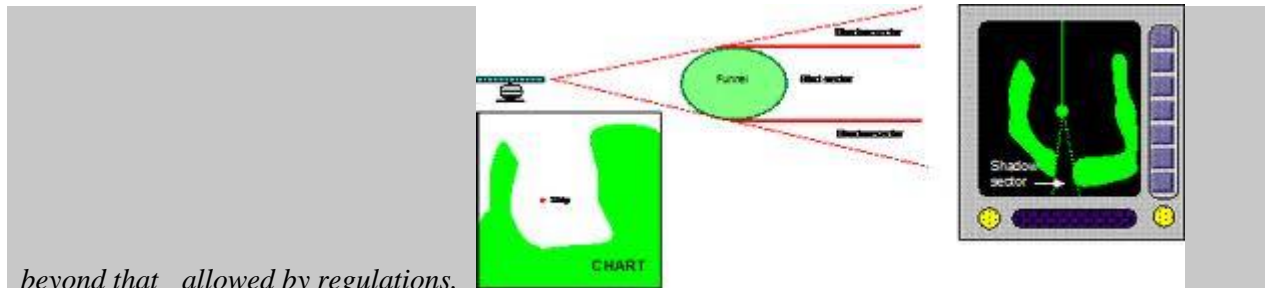

beyond that allowed by regulations.

blinker /ˈblɪŋkə/ (n) (fishing) Generalni naziv za metalnu varalicu koja svojim bljeskanjem privlači predatore. (<https://ribolovnajadranu.hr/ribicki-leksikon/>) **blinker**

blip (n) = **pip** A spot of light on a radar or sonar screen indicating the position of a detected object, such as a ship, an aircraft or a submarine. **odraz na radarskom ekranu, svjetli trag (objekta na radarskom zaslonu), repić (objekta na radarskom zaslonu)**: *The mate, who was on watch, saw a **blip** on the radar and realised that it was a small yacht that he could see about {also called: pip}*

blister (n) (marine eng) blister

block /blɒk/ (seamanship, boating/yachting, cargo handling) a hoisting device in which a rope or chain is passed around a pair of blocks containing one or more pulleys. **kolotur, koloturje, kolut, bucel, tal. bozzello**: *The main trawl wire parted and the trawl **block** and bridle chains fell onto the crewman below. to move the turbocharger from its engine room stowage, through the engine room stores access hatch, and onto the vehicle deck above using a chain **block** attached to the deckhead of the vehicle deck. **cargo block kolotur podigača tereta, cargo purchase block kolotur podigača tereta (na samarici ili brodskoj dizalici), double block dvostruki kolotur, single block jednostruki kolotur, snatch block rasklopivi kolotur, otvoreni kolotur**: *The skipper was guiding the line over a **snatch block** hanging from gallows extending beyond the side of the vessel.*, **upper block gornji kolut koloturnika, lower block donji kolut koloturnika, cat block kolut s kukom, four-sheave block četverostruki kolotur, kolotur s četiri užnice, cargo purchase block kolotura podizača tereta (na samarici ili brodskoj dizalici), four-sheave block kolotur s četiri užnice, snatch block pomični kolotur, chain block lančani kolotur, kolotur za lanac***: *The **chain block** was used at an angle to lift engine components, and the trolley was then used to move them away from the engine.*

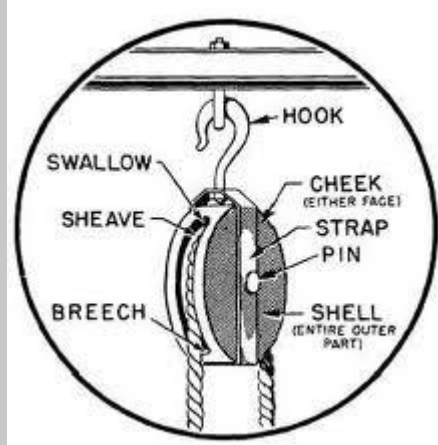

{tal.: bozzello; blocco}

block /blɒk/ (v) (marine eng) **začepiti, blokirati**: *sea water cooling system was blocked*

block (n) (*nav arch*) a section of ship structure which is a three dimensional entity **brodska sekcija, sekcija konstrukcije broda (u odvojenoj gradnji), brodski modul**: *Blocks are built in the sub-assembly area and are combined to form a ship.*

block and tackle (n) (*seamanship, marine eng*) **kolorurnik, čekrk, parank, paranak**
block and tackle rigged to advantage koloturnik kod kojeg je prijenosni omjer veći od nule (s malom silom dobije se veća sila, npr. koloturnik škote **koloturnik na kojem se živi kraj vuče prema gore (npr. kolorutnik škote), block and tackle rigged to disadvantage** koloturnik kod kojeg je prijenosni omjer manji od nule **koloturnik na kojem se živi kraj vuče**

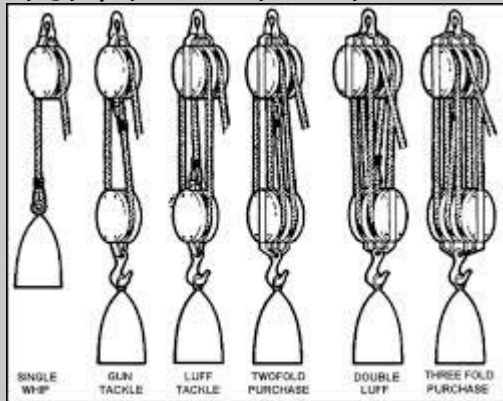

prema dolje

block-diagram /'blɒk 'daɪə,græm/ (n) (*marine eng, navig*) **blok-shema, blok-dijagram**

blocks (*nav arch*) (*nav arch*) blocks made of wood or concrete set under the ship's bottom for support during construction or dry-docking **klade bilge blocks klade ispod kaljužnih tankova, keel blocks klade ispod kobilice**

block train (n) (*shipping econ*) a number of railway wagons (loaded with containers), departing from a certain place and running straight to a place of destination, without marshalling, transhipping or any coupling or de-coupling of wagons **direktni kontejnerski vlak, kontejnerska željeznička kompozicija, blok-vlak, blok-vagoni**

blow /bləʊ/ 1 (v) (*marine eng*) **puhati, propuhavati, upuhavati**: ... in normal circumstances it is good practice to use ventilation fans to **blow** fresh air into the compartment for 24 hours and use analysing equipment to check that the atmosphere is safe to breathe before entering. **blow clear of otrgnuti, iščupati, blow off ispuhati, ispuhnuti, ispustiti, otrgnti, otkinuti, blow off valve ispušni ventil za paru, ventil za ispuhavanje, blow out ispuhati**; 2 (*electr*) **pregorjeti**: As he operated the controls for the solenoid to withdraw the securing pins, the **fuse blew**, leaving the pins engaged.; 3 (*navig*) **zanositi vjetrom, pomjerati silom vjetra**: As the lines were let go, the wind increased and began to **blow the vessel's bow** to the south.

blow (n) (*navig, safety*) **udarac, udar heavy blow jaki udarac, jak udar**: It was noted that the crack was caused by a heavy blow, possibly from a tug during berthing.

blow down (v) (*marine eng*) **propuhati**: Boilers are to be **blown down** at least once per week dependent upon the frequency required to control the level of dissolved solids contained in the boiler water.

blower /'bləʊə/ (n) **scavenge blower puhalo za ispiranje (propuhavanje) (marine eng) puhalo, egzaustor, centrifugalni ventilator**: It was a very basic boiler: an electrically driven **blower** supplied air through a flexible, plastic corrugated hose, and a small pump delivered the diesel fuel. **auxiliary blower pomoćno puhalo, blower motor motor puhala, air blower**

puhalo zraka *Once the water had boiled, the skipper thought that he had switched off the fuel pump, leaving the air blower running to allow any unburned fuel to burn off, and to purge the boiler furnace.*

blow off (v) **otpuhati blow off the berth otpuhati s veza**: *The vessel was blown off her berth when subjected to sudden, unexpected squalls* Brod je bo otpuhan s veza kad je bio izložen iznenadnom neočekivanom olujnom vjetru

blow the gaff (idiom) **izbrbljati, odati tajnu**

Bls.; bales (n) (cargo handling) **bale**

bluejacket (n) (navy) an enlisted man in the navy **mornar (britanske ratne mornarice)**

blue peter (n) (comm) signal flag for the letter P, hoisted by a ship as the indication that it is preparing to leave port **zastavica P signalnog kodeksa**

blueprint (n) (marine eng) bijela slika na modroj karti; a photographic print of plans, technical drawings, etc, consisting of white lines on a blue background (<http://www.collinsdictionary.com>) **modra kopija, kopija, modri nacrt**

blue shark (n) (fishing) **pas modrulj**

blue water (n) (navig) deep water offshore beyond the continental shelf **pučinsko more, otvoreno more**

blue whiting /'blu:,waɪtɪŋ/ (n) (fishing) **molet, ugotica**

bluish cast (n) (marine eng) **plavkasta nijansa**

BML; Longitudinal Metacentric Radius (n) (stabil) the distance between the centre of buoyancy and the longitudinal metacentre **uzdužni metacentarski radijus**: *BML is defined as the moment of inertia of the waterline waterplane about a transverse axis divided by the volume of displacement..* **calculation of BML proračun uzdužnog metacentarskog radijusa**

BM; Transverse Metacentric Radius the distance between the center of buoyancy and the metacenter **poprečni metacentarski radijus**: *BM is defined as the moment of inertia around the longitudinal axis of the waterplane at which the ship is floating divided by the displacement volume.*

board /bɔ:d/ (v) **1 ANTONYM disembark ANTONYM land ukrcati se (pilot):**

Prior to departure from a berth, the pilot boarded the tanker and advised the master that, after clearing the berth, he would leave the tanker and transfer to another (inbound) ship instead of conning th The a pilot **had boarded** the vessel and joined the vessel's master, chief officer and chief engineer on the bridge.

After boarding a 2000gt dry cargo ship, a harbour pilot discussed with the vessel's master his plan for the vessel's first entry to the port.; **2 doći na brod, tal. imbarcarsi**: *The port stevedores boarded the vessel and commenced loading at 14451. Shortly after the release of the CO2, the shore fire brigade boarded the vessel, having been alerted by the master through the port authority. P&I club representatives, surveyors and superintendents boarded the vessel in the morning. the pilot boarded the*

ship at 16:30 peljar je došao na brod u 16.30; **3 popeti se na brod / barku / brodicu / splav:**

Five of them successfully boarded the liferaft; tragically one man was lost. The nine passengers boarded the rescue boat, each having been fitted with manually inflating lifejackets with a crotch strap.; **4**

ukrcati se na brod (kao zaposlenik, časnik, mornar itd.); 5 ukrcati se na brod (kao

putnik): *The vessel berthed, and the passengers boarded. {The term board refers to people (pilots, boarding party, crewmembers, servicemen, etc.), whereas the term load, unload, and discharge is used with cargo. The term land can refer both to people and cargo.}*

board /bɔ:d/ (n) **board foot jedinica mjere za prijevoz / pošiljku drvene građe (cargo) daska (tanja, do 30 mm debljine)**

board (n) (seamanship) the side of a ship **strana broda go by the board letati, okrenuti**

brod s jedne strane vjetra na drugu

boarding /'bɔːdɪŋ/ (n) **1** (*seamanship*) dolazak na brod (članova posade, putnika, servisera itd.), ukrcaj na brod (osoba), tal. *abbordaggio* **boarding of the vessel**

dolazak na brod; **2** (*navig, mar law*) **ukrcaj peljara**: *The pilot boarding of vessels inwards takes place normally between the Breaksea Light and Barry Roads between 6 to 4 hours before High Water at Sharpness by the Bristol Pilot Cutter.* **pilot boarding area područje ukrcanja peljara**: *Poor planning considerations caused the delay in weighing anchor, which in turn required a high speed approach to the pilot boarding area.*

boarding arrangements (n) (*navig*) **oprema za ukrcaj peljara (ljestve, siz, podigač itd.)**: *Details of the vessel's next port of call, pilot boarding arrangements and the number of tugs to be used for departure were exchanged.*

boarding ladder (n) **1** (*nav arch*) **peljarske ljestve, boškaina**: *The chief mate called the duty seaman and ordered him to rig the pilot boarding ladder.*; **2** **brodski siz, brodska skala**

boarding officer (n) (*mar law*) **službena osoba za pregled broda u luci, vlasti**

boarding party (n) (*mar law*) **predstavnici lučkih vlasti koji dolaze na brod radi pregleda dokumenata i izdavanje dozvole za uplovljenje, vlasti (peljar, carinici, pomorsko-pogranična policija, zdravstvene vlasti)**

boarding place **mjesto ukrcaja pilot boarding and landing places** **mjesta ukrcaja i iskrcaja peljara**

boarding position (n) (*navig*) **pozicija za ukrcaj peljara**: *The port control instructed her master that the vessel was to arrive at the pilot boarding position at 0400, and he was then to await further instructions.*

boarding speed (n) (*navig*) **brzina broda pri ukrcaju peljara**

boarding station (n) (*navig*) **peljarska postaja, pilotska stanica**: *Before disembarking, the pilot pointed out an inbound ship to starboard, making for the pilot boarding station.*

board of directors (n) **uprava, upravni odbor (dioničkog društva)**

board the ship (v) (*seamanship*) **to go aboard a vessel (train, aircraft, or other vehicle) ukrcati se na brod, popeti se na brod, doći na brod**: *The pilot boarded the ship at 15:35 hrs. P&I club representatives, surveyors and superintendents boarded the ship in the morning.*

boat /bəʊt/ (n) (*nav arch*) **1** **A boat is any vessel or conveyance that floats on or operates on the water and is under 197 feet (60 meters) length overall (LOA). A boat may be used for pleasure, commercial, or residential purposes. Boat is synonymous with small craft in marine use.** **brodica,**

barka, čamac, tal. barca; imbarcazione; natante, battello: *In the morning, the skipper and his crew tried to locate the boat, but were unable to do so. ... he waited a few minutes until the skipper of a nearby boat came alongside to assist.* **fishing boat ribarica, ribarska brodica**: *Two*

crewmen of a fishing boat were on the deck and had just started to shoot a line of pots.; **2** (*nav arch*) **a**

vessel of any size, especially a large one (OED) brod; **3** **strictly speaking a boat is a small open craft with no decking, usually propelled by oars or an outboard engine, sometimes with a lugsail on a short**

mast (Mayne 2000) brodica, barka, lađica, čamac **(The size breakpoint between boat and ship is necessarily arbitrary; however, Lloyds small-craft division deals with vessels under 60 meters. Experience has also shown that below 60 meters LOA, longitudinal-strength (hogging-and-sagging) calculations are usually trivial, whereas over 60 meters these calculations become important. These are two firm reasons for setting 60 meters as the division between boats and ships)**

boat balance **ravnanje jedrilice, balansiranje jedrilice**

boat care (n) (boating/yachting) održavanje brodice, održavanje jedrilice

boat chock (n) (nav arch) sedlo brodice za spašavanje

boat davit (n) (nav arch) soha za brodicu za spašavanje: *A pin was passed through these holes to secure the life boat davit. Ensure that all devices fitted to boat davit systems to prevent overload are tested on each occasion before a boat is hoisted and that such devices are not relied upon during operation.*

boat deck (n) (nav arch) a deck on which lifeboats are kept paluba za brodice, paluba za čamce: *... the passengers were kept well informed and were mustered on the Boat deck.*

boat drill (n) (safety) vježba spuštanja brodice za spašavanje: *The crew of the ro-ro cargo ship were undertaking a combined fire and boat drill, while alongside a UK port. Boat drills were carried out regularly, often every week.*

boater (n) (boating/yachting) = yachtsman nautičar: *Mariners, recreational boaters and persons are advised to exercise extreme caution in areas in the vicinity around the safety zone due to the dangers associated with a grounded vessel.*

boat falls (n) (nav arch) koloturnici na sohama (za dizanje i spuštanje

brodica/čamaca): *During operation when stowing the boat, it is important to equalise the length of the fore and aft boat falls. After setting the davit arm stopper (cradle stopper), raise the brake lever of the winch slowly and unwind the boat fall wire to allow the boat to lower slightly.*

boat fishing (n) (fishing) COMPARE shore fishing ribolov s barke, ribolov s brodice

boat grip pričvrsnica za brodicu, rica za brodicu

boat gripe (n) (meteorol) priveza za brodicu za spašavanje, kukasta priveza

boat handling (n) (boating/yachting) manevriranje brodicom

boat harbour (n) (ports) lučica, portić

boat hatch (n) (boating/yachting) prozor otvora palube, bokaporta, bukaporta, tambuč

boat hook (n) (seamanship) čaklja, mezomarinier: *He then used a boat hook to retrieve the floating mooring line and brought that inboard and handed it to the mate to shackle the two eyes together.*

boat-hook; boathook (n) (seamanship) čaklja, mezomarinier

boating /'bəʊtɪŋ/ (adj) (boating/yachting) nautički general boating information osnovne nautičke informacije

boating /'bəʊtɪŋ/ (n) 1 (boating/yachting) the leisurely activity of travelling by boat, or the recreational use of a boat whether powerboats, sailboats, or man-powered vessels (such as rowing and paddle boats), focused on the travel itself, as well as sports activities, such as fishing or waterskiing (Wiki) nautički turizam; 2 (boating/yachting) rekreacijska plovdba

boating fees (n) (boating/yachting) naknade za turističke brodice, naknada brodice za sigurnost plovdbе

boating licence (n) (boating/yachting) ovlaštenje za plovdbu brodicom (u nacionalnom moru)

boat-keeper upravitelj brodice, barkajol

boat launching (n) (safety, seamanship) spuštanje brodice za spašavanje: *ALL seafarers have experience, both positive and negative regarding incidents with boat launching and recovery. Svi pomorci imaju pozitivna i negativna iskustva vezana uz spuštanjem i podizanjem*

brodica za spašavanje.

boatman **1** (*shipping econ*) a commercial boat operator **upravitelj brodice, barkajol**; **2** (*seamanship*) person who attends to the mooring and unmooring of vessels **privezivač**

boat note (*n*) (*mar law*) **potvrda o primitku robe sa teglenice**

boat operator (*n*) (*seamanship*) **rukovatelj brodice**: *The brake remote control is a wire connected between the boat operator and the winch brake handle.*

boat owner (*n*) (*mar law*) **vlasnik brodice**: *Boat owners and hire companies should follow equipment manufacturers' instructions and guidance when maintaining equipment.*

boat show (*n*) (*boating/yachting*) **sajam nautike**

boat skipper (*n*) (*seamanship*) **zapovjednik brodice**: *This created problems for the boat skipper in getting the boat near without getting underneath the gangway.*

boat station (*n*) (*nav arch, safety*) **položaj brodica za spašavanje, prostor brodica za spašavanje**: *I wonder what they would have written if they had been called out in the middle of the night to muster at boat stations.*

boatswain /'bəʊsən/ (*n*) **1** (*seamanship*) an unlicensed member of the crew who supervises the work of the deck men under direction of the first mate **vođa palube, noštromo (od koverte / kuverte), tal. nostromo; nocchiero**: *Directly reporting to First Mate, the boatswain acts as a foreman of the unlicensed deck crew. A senior Able Seaman is usually considered for this position. Reasonable English skill is desired for this position.* **boatswain chair** a piece of rectangular board on which a man can sit when working aloft; the board with holes at the sides is suspended by rope arrangement **noštromov stolac, boatswain's pipe noštromova zviždaljka (za davanje zapovijedi posadi)**; **2** (*boating/yachting*) **božman (na jedrenjacima)** {spellings: *boatswain = bosun = bo's'n; Italian: nostromo, nocchiero*}

boat tackle (*n*) (*nav arch*) **koloturnik brodice za spašavanje, čekrk brodice za spašavanje (za dizanje i spuštanje brodice)**

boat trim (*n*) (*boating/yachting*) **trimanje jedrilice**

boat tuning (*n*) (*boating/yachting*) **ugađanje jedrilice prije jedrenja, namještanje jedara, trimanje jedara**

boatwright /'bəʊt,raɪt/ (*n*) (*mar law*) **mali brodograditelj**

boat yard (*n*) (*nav arch*) **brodogradilište za brodice**

bobber (*n*) (*fishing*) The bobber also known as a slip, cork or float serves two angling functions: (a) a surface strike indicator and (b) a controlled depth presentation using live bait or lure. **plovak (za udicu)**

bobcat /'bɒb,kæt/ (*n*) (*cargo handling*) **malo jaružalo, mali katerpillar (za radu brodskom skladištu), bobcat**

bobin knotter (*n*) (*fishing*) a PR knot tying tool, that makes the PR complicated knot easy **naprava za spajanje ribarskog najlona / povraza, bobin knotter** {*Mala spravica za vezanje upredenice i najlonskog predveza kod discipline Vertical Jigging, no ovakvo spajanje je moguće gdje god se koristi upredenica, odnosno ovakav način spajanja je moguć kod svih ribičkih disciplina. (https://ribolovnajadranu.hr/ribicki-leksikon/)*}

bobstay (*n*) (*boating/yachting*) **stay or cable from end of bowsprit to the stem to prevent the former from lifting čelično uže između pramčane statve i kosnika**

bobstay-piece (*n*) (*nav arch, sailing vessels*) **brid kljuna**

body lines (*n*) (*nav arch*) **brodske linije**

body of water (n) (geogr) količina vode

body plan (n) 1 (nav arch) a drawing which shows frame lines in elevation **nacrt linija broda**

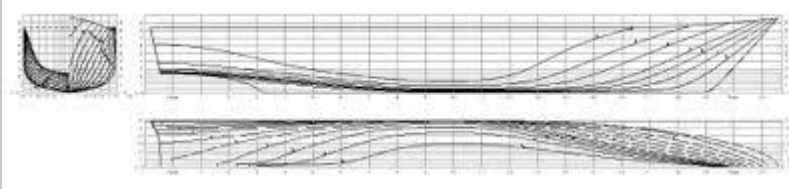

; 2 (nav arch) pregled na teoretsku

fomu broda sprijeda **nacrt rebara**

bogie, boggie /'bəʊgi/ (n) (cargo) a set of wheels built specifically as rear wheels under the container **postolje za kontejner, podvozak za cestovi prijevoz kontejnera, kontejnerska prikolica (šasijska)**

bogue /bəʊg/ (n) (fishing) Lat. Boops boops **bugva, bukva, boba, buba**



{ost.hrv. nazivi: Batelj, Boba, Bugva, Bugvilj, Buba, Bukvina, Bobulina, Buhar, Matan, Matelan, Matijaš, Legumini, Žutuja; lat. BOOPS BOOPS}

boiler /'boɪlə/ (n) **boiler-room** kotlovnica, **kaldaja**; tal. **caldaia**, **oil-fired Scotch boiler** škotski kotao na lož-ulje, **three-furnace boiler** kotao s tri ložišta, **donkey boiler** pomoćni kotao, lučki kotao, **double drum boiler** kotao s dvostrukim bubnjem, kotao s dvostrukom komorom, **double-flow boiler** kotao s dvostrukom dimnom komorom, **fire-tube boiler** vatrocijevni kotao, dimocijevni kotao, **high-pressure boiler** visokotlačni kotao, **horizontal-tube boiler** kosocijevni kotao, kotao s položenim cijevima, **intermediate pressure boiler** srednjotlačni kotao, **low-pressure boiler** niskotlačni kotao, **oil-fuel boiler** kotao ložen naftom, **single-flow boiler** kotao s jednostrukom dimnom komorom, **single-drum boiler** kotao s jednostrukim bubnjem, kotao s jednostrukom komorom, **three-drum boiler** kotao s trostrukim bubnjem, **vertical-tube boiler** strmocijevni kotao, kotao sa strmim cijevima, **water-tube boiler** vodocijevni kotao (marine eng) kotao: *On 06 July 2013, at about 1100, the second engineer on board the oil tanker commenced the overhaul of one of the boiler's main steam valves.*

boiler auxiliaries (n) (marine eng) pomoćni uređaji kotla

boiler casing (n) (marine eng) plašt kotla

boiler feed pump (n) (marine eng) napojna sisaljka kotla

boiler furnace (n) (marine eng) ložište kotla

boiler geed water (n) (marine eng) napojna voda kotla **boiler geed water system** sustav napojne vode kotla

boiler internal corrosion (n) (marine eng) unutrašnja korozija kotla

boiler oil (n) (marine eng) kotlovno ulje **heavy boiler oil** teško loživo ulje

boiler plant (n) (marine eng) kotlovsko postrojenje

boiler room (n) (marine eng) kotlovnica

boiler shell (n) (marine eng) plašt kotla

boiler water drum (n) (marine eng) vodena komora kotla

boil off control equipment (n) (cargo handling) kontrolni uređaj za isparavanje

boisterous weather /'boɪstərəs/ (n) (navig) jako nevrijeme

BoL; bill of lading (n) (mar law, shipping econ) = **bill of lading** teretnica

bollard /'bɒlə:d ; 'bɒləd/ (n) (nav arch) a single post line-securing device on a wharf around which mooring and berthing lines are fastened. **bitva za privezivanje (obično na obali)**, **bitveni**

stup (na obali): *Immediately after the spring was hooked on to the **bollard** ashore, the forward mooring party started heaving up the slack but the vessel still had strong head movement. The breast line **bollard** failed and due to a lack of spread of lines we drifted off of the dock.* **single bitt bollard** **privezna**

bitva s s jednim stupićem, **double-bitt bollard** **privezna bitva s dva stupića**



bollard (n) (nav arch) bitva za ventilaciju

bollard pull (n) (navig) snaga na kuki (za tegljenje), vlačna sila na kuki (tegljača):

*The tugs were made fast at 0808, the forward tug with a **bollard pull** of 30 tonnes and the after tug with a **bollard pull** of 10 tonnes. Svitzerhas ordered two more Damen ASD 3212 tugs with 80 tons **bollard pull** performance for its escort and towing operations on the Thames and Felixstowe. A pilot was embarked and two tugs were assisting: a 53 tonne **bollard pull** Voith Schneider tug was made fast on the centre lead forward and a 66 tonne **bollard pull** b ASD tug was secured on the centre lead aft. **a 43 bollard pull** vlačna sila 43 tone na kuki od, **achieve a bollard pull** postići snagu na kuki: ALP tug Striker **achieved** an impressive and most satisfactory **bollard pull** results of 309.6 tonnes during her sea trials.*

bollard(s) /'bɒlə:dz ; 'bɒlədz/ (n) (nav arch) bitva (u obliku priveznog stupa, na obali ili na brodu), **preza**

bolster /'bɒlstə/ (n) (nav arch) sidreno oko

bolt /bɒlt/ **jack bolt** vijak temeljnog ležaja preopterećen na tlak, **through bolt**

kotveni vijak, prolazni vijak s maticom, **thrust bolt** vijak temeljnog ležaja

preopterećen an tlak, **holding down bolts** pričvrtni vijci (glave, bloka motora),

pritezni vijci (n) (marine eng) vijak, svornjak, tal. **bullone** * *Make sure that the weld has*

been carried out properly and that both the **bolt and the nut** materials are weldable. The Bolt should be fitted with a Butterfly head, in order that the **bolt** can be released from the inside?

bolt /bəʊlt/ (v) (marine eng) pričvrstiti, spojiti vijcima

bolt, washer and nut (n) (marine eng) vijak s podloškom i maticom

bolt down (v) (marine eng) pričvrstiti vijcima: The cylinder cover is **bolted down** with eight studs.

boltrape /bəʊlt.rəʊp/ (boating/yachting) porubni konopac jedra uvlači se u puč (kanal) jarbola i deblenjaka (buma) radi pričvršćivanja jedra **porubni konopac**, **porubnik na obodu jedra**

bona fide /ˈbəʊnə ˈfaɪdi/ (n) (mar law) undertaken in good faith; real or genuine **u dobroj vjeri**, **po načelu dobre vjere**

bonded freight (n) (mar law, shipping econ) cargo moving under a bond to the Customs, to be delivered only under stated conditions. **teret podložan carini**

bonded store /ˈbɒndɪd/ (n) (shipping econ, mar law) place on a vessel where goods are placed behind seal until the time that the vessel leaves the port or country again **zapečaćeno skladište**, **zapečaćeno carinsko skladište**, **siđil**

bonded warehouse (n) 1 (mar law) a port warehouse in which dutiable goods are deposited until duty is paid or the goods are cleared for export **carinsko skladište**; 2 **zapečaćeno skladište (u kojem roba leži dok se ne plate potraživanja)**

Bond of Indemnity /bɒnd/ (mar law) jamstvo (za slučaj neuručene teretnice)

bond port (n) (mar law, shipping econ) port of initial Customs entry of a vessel to any country **prva luka ticanja**

Bonjean curves; Bon-Jean curves (n) (stabil) the curves of cross sectional area for all body plan stations **Bonjeanove krivulje**: Bonjean Curves display the submerged area at a given location (or station) along the length of the ship, for a given draft.

bonus /ˈbəʊnəs/ (n) 1 a (mar law) dodatak, doplatak; 2 **premija**, posebni dodatak na plaću

booby hatch (n) 1 (nav arch, boating/yachting) a special opening through which personal access to a hold through hatch covers is possible **malo grotlo za ulaz osoba u skladište**, **usko**

grotlo: Personal access to a hold through hatch covers is possible via special openings often called **booby hatches**. When a person wants to use them they usually have to hold the **booby hatch** as support for the first few steps as they enter or exit. Mast houses or store spaces which have **booby hatch access** to cargo holds must also be treated as confined spaces on loaded passages.



; 2 **COMPARE spray hood** a raised hoodlike covering over a small hatchway on a boat's deck **natkriveni ulaz u kabinu jedrilice /**



brodice

book /bʊk/ (v) (*shipping econ*) to express in advance a desire for something in order to reserve it e.g. transportation of goods (<http://www.maerskline.com/en-jm/help/shipping-glossary>) **zaključiti**

brodski prostor, rezervirati brodski prostor, bukirati to book the cargo / shipping space zaključiti teretni / brodski prostor

booked vessel (n) (*shipping econ*) naručeni brod; zaključeni brod, brod koji je rezervirao/zaključio vez u luci (prolaz kanalom itd.) **non-booked vessel** nenaručeni brod; nezaključeni brod, brod koji nije rezervirao vez u luci (plolazaknalom itd.)

booking /'bʊkiŋ/ (n) (*shipping econ*) arrangements with a carrier for the acceptance and carriage of cargo; i.e., a space reservation; Act of recording arrangements for the movement/transportation of goods by vessel or other conveyance (<http://www.maerskline.com/en-jm/help/shipping-glossary>)

zaključivanje (tereta ili broskog prostora), bukiranje: *By booking the shipper offers the cargo for transport and the carrier accepts the offering* **suspend booking obustaviti**

zaključivanje / rezervacije: *Beginning November 12th, the Canal Authority says it will further restrict and temporarily suspend booking for certain vessels*

booking note (*shipping econ, mar law*) An undertaking whereby a carrier notifies a shipper that space has been reserved for the carriage of the shipper's goods aboard a particular vessel. (Tetley); isprava u ugovoru o prijevozu stvari koja sadržava pojedine važne dijelove **zaključnica (o rezervaciji broskog prostora za teret) cargo booking note zaključnica**

boom /bu:m/ (n) 1 (*cargo handling*) = **jib krak / grana dizalice krak samarice:** *The derrick topping lift double purchase was disconnected from the derrick head and attached to the derrick boom near the heel with a wire strop, with the intention of using the greater force available to free the heel*

pin.; 2 (safety) = floating boom plutajuća brana, cijev oko broda za sprječavanje onečišćenja (pri ukrcaju/iskrcanju), barijera As a precautionary measure, an oil boom was deployed around the damaged tender boat. oil containment boom brana za suzbijanje



širenja uljne mrlje, protunaftna brana

3 (shipping econ) procvat (prometa itd.); 4 (boating/yachting) a spar used to extend the foot of



a for-and-aft sail deblenjak, bum, lantina, tal. boma

jib: krak / grana dizalice, krak samarice

boom /bu:m/ (v) (shipping econ) cvasti, cvjetati, naglo rasti (npr. promet u luci)

boom fittings (n) (boating/yachting) oprema deblenjaka, oprema buma

boom jack (n) (boating/yachting) = boom vang priteg deblenjaka, vang

boom vang (n) (boating/yachting) a sail control to apply downward tension on the boom,

countering the upward tension provided by the mainsail priteg deblenjaka, vang boom vang tackle koloturnik vanga

boost (v) (shipping econ) jako rasti (vozarine, promet, dobit), jako pojačati boost the net profit naglo povećati dobit: The rise in freight rates could boost the Line's 2016 net profit by as much as \$760 million,

booster /'bu:stə/ (v) (marine eng) pojačati (protok, kapacitet itd.), jačati

booster /'bu:stə/ (n) (marine eng) pojačanje

booster pump (n) (marine eng) dobavna pumpa, pumpa za dodatno pojačavanje tlačenja, pomoćna visokotlačna pumpa, sisaljka za podizanje tlaka, buster pumpa, busterica

boot (n) (boating/yachting) platno oko pete jabola, vodootporna zaštita oko pete jarbola

boots /'bu:ts/ (n) (boating/yachting) čizme za jedrenje breathable boots prozračne

čizme

boot topping /'bu:t/ (n) (boating/yachting) pojas vodene linije, *banjašuga*

bore /bɔ:/ (n) cylinder **bore** provrt cilindra, promjer cilindra, **liner bore** provrt (promjer) košuljice, **control bore** kontrolni kanal, kontrolni otvor (*marine eng*) provrt (cilindra, cijevi), otvor, kalibar, unutrašnji provrt

bore cooling (n) (*marine eng*) hlađenje kroz radijalne kanale, hlađenje kroz zavojne provrte

borehole (n) (*marine eng*) izvrtani otvor, izbušena rupa

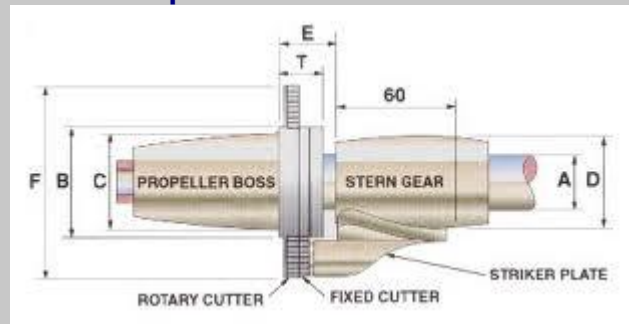

boss /bɒs/ 1 (nav arch) glavčina propelera

2 (nav arch) a curved outboard portion of the ship's hull plating that surrounds **pojačanje provlake**

krmene cijevi; 3 (*marine eng*) an area of increased thickness, usually cylindrical, that strengthens or provides room for a locating device on a shaft, hub of a wheel, etc **podebljani dio cijevi (na**

priključku), tuljak (za spajanje cijevi): *It was also observed that the joint and the fuel pump inlet pipe bosses were not covered with approved splash prevention screening, as required under Solas*

bossed framing (n) (*nav arch*) grbava rebra

bosun; bos'n; bo's'n /'bəʊsən/ (n) = **boatswain** vođa palube, **noštromo assistant**

bosun; bos'n; bo's'n pomoćnik vođe palube: *As the FRC was still partly suspended over the deck edge, the assistant bosun and the AB left the boat to help attach a bowsing line to assist in pulling the FRC around the deck edge. {boatswain = bosun = bo's'n}*

bosun's chair; bo's'n's chair (n) (*seamanship*) sjedalo od platna ili drva, za rad na oputi jarbola **viseća sjedalica (za rad na jarbolu)**

bosun's locker /'bəʊsənz/ (n) (*nav arch, seamanship*) loker vođe palube

bosun's store /'bəʊsənz/ (n) (*nav arch, seamanship*) spremište vođe palube

both-to-blame clause (n) (*mar law*) A clause inserted into some U.S. bills of lading, which required that in the event of a ship collision for which both vessels were at fault, cargo indemnify its carrying vessel for any amount which that vessel had had to pay to the colliding vessel in respect of any claim made by cargo against the colliding vessel. (Tetley) **odredba (u ugovoru, teretnici) o obostranoj krivici**

both to blame collision clause (n) (*mar law*) klauzula o sudaru uslijed obostrane krivnje, **odredba o obostranoj krivnji u sudaru**

bottleneck (n) (*shipping econ, ports*) a condition in a process of transporting cargo which limits or impedes performance **usko grlo (u prometu roba)**

bottlescrew (n) (*cargo handling, seamanship*) = **turnbuckle** stezaljka, **škartoc, tirant**



bottom (n) (nav arch) **dno (broda, barke, brodice)** tal. **carena**: However, the ship's **bottom** remained intact, meaning no oil escaped. **double-bottom** (nav arch) **dvodno (broda)**: This condition remained until de-ballasting of #4 wingtank and **double bottom** in the English Channel., **ship's bottom dno broda**

bottom board (n) (nav arch) **drvena podnica, daska podnice**

bottom centre girder (n) (nav arch) **središnji uzdužni nosač, hrptenica, centralni nosač dna**

bottom dead centre; BDC; BTD (marine eng) **donja nrtva točka**: Stroke 4 - EXHAUST As the piston approaches the bottom of the cylinder (known as **Bottom Dead Centre or BDC**) the exhaust valve starts to open. **bottom dead centre (BDC)**, the inlet valve and the air in the cylinder is and in

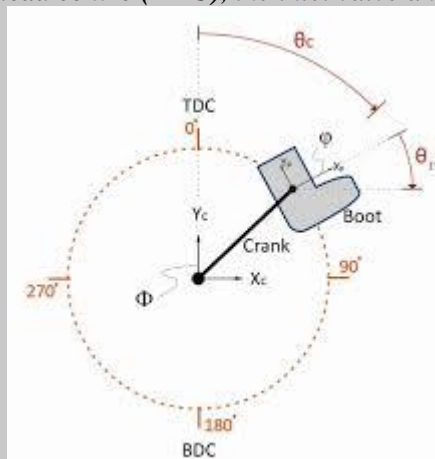

temperature as the piston rises.

bottom end (n) (marine eng) = **large end** **doljnji kraj ojnice**

bottom end bearing (n) (marine eng) **donji ležaj ojnice, leteći ležaj**

bottom end stroke (n) (marine eng) **krajnji donji položaj hoda stapa**

bottom fittings (n) (cargo handling) conical shaped devices inserted between a container and the permanent floor on the deck of a vessel in order to avoid shifting of the container during the voyage of this vessel **kutni umetci za kontejnerei na palubi**

bottom flat line (n) (nav arch) **granica ravnog dna**

bottomline centre girder (n) (nav arch) = **centre girder** **hrptenica**

bottom paint (n) (seamanship) = **antifouling paint** **podvodna boja, koper, antifouling**

bottom planking (n) (sailing vessels) **oplata dna**

bottomry /'bɒtəmri/ (n) **bottomry bond** isprava kojom se zapovjednik obvezuje vratiti zajam ili predujam što ga je uzelo za potrebe broda. zajmodavac ima pravo zaloga na brod (ship mortgage),

teret ili vozarinu ako se zajam ne vrati, ali samo poslije dolaska broda na odredište (IG) **zajmovna obveznica** (*mar law*) pledging a ship as security in a financial transaction; A primitive form of ship mortgage, whereby the master, while away from the ship's home port, by signing a bottomry bond, borrowed money on the credit of the vessel to pay for goods or services needed to preserve the ship or complete the voyage. **založni zajam brodovlasnika (za održavanje broda i putovanja), pomorski zajam za popravak broda**

bottomry bond (*n*) (*mar law*) isprava kojom se zapovjednik broda obvezuje vratiti zajam ili predujam koji je uzeo za potrebe broda **zajmovna obveznica**

bottom shell (*n*) (*nav arch*) oplata dna

bottom side girder (*n*) (*nav arch*) bočni nosač dna

bottom stool (*n*) (*nav arch*) donji oslonac pregrade

bottom strake (*n*) (*nav arch*) voj dna

bottom stringer (*n*) (*nav arch*) proveza dna

bottom web (*n*) (*nav arch*) okvir dna

bound /baʊnd/ (*adj*) **1 COMPARE bind vezan, pričvršćen; 2 (mar law) obvezan be bound to bito obvezan, biti dužan (nešto učiniti):** *A ship at sea which is in a position to be able to provide assistance, on receiving information from any source that persons are in distress at sea, is bound to proceed with all speed to their assistance ...; 3 (meteorol) obuhvaćen, zahvaćen, obavijen fog-bound: 200710 Collision with dredger A coastal tanker completed discharge in the forenoon and was being piloted out in a fog-bound harbour channel. obavijen maglom; 4 (navig) koji se kreće prema outward-bound ship brod koji se kreće prema izlazu (iz luke, kanala) brod na izlasku iz (luke, kanala): Two outward bound ships had been plotted on my ARPA and, after my coursealteration, it was observed that they would both pass astern but far too close for comfort. {inf. bind}*

bound for (*adj*) (*navig*) **brod na putu za, brod na putovanju za, brod u plovidbi za:** *The ship was bound for Port Elizabeth, South Africa. On 7 July 2010, the ship was en route from Port Klang, Malaysia bound for Salalah, Oman.*

bound from /baʊnd/ (*n*) (*navig*) **brod na putovanju iz:** *All vessels in excess of 20 metres in length, bound to or from or passing through the Port of Southampton are required to communicate by VHF with Southampton VTS. Own ship was on a course of 2710T at a speed of 13 knots bound from Greece to Gibraltar.*

bound to /baʊnd/ **1 (adj) (mar law) biti obvezan da, biti dužan da; 2 (shipping econ, navig) brod na putu za, brod u plovidbi za:** *The following morning, the master stated on the manifest that the loading had been done under the rain, then he sailed bound to Rotterdam. the ship (was) bound from the port of ... to the port of ... brod (je bio) na putovanju iz luke ... za luku ...*

Bourdon tube pressure gauge (*n*) (*marine eng*) **manometar s Bourdonovom cijevi**

bow /baʊ/ (*n*) **on the bow po pramcu, ispred broda, on the port / starboard bow lijevo / desno po pramcu:** *The 2nd vessel was 2 points on the starboard bow about 4 miles distance, heading NE but passing well clear to starboard. The OOW is observing a small coaster on the port bow about 0.8 nm., raked bow kosi pramac (nav arch) the forward part of the ship held together by the stem pramac, prova; tal. prora*

bow anchor (*n*) (*nav arch*) **pramčano sidro**

bow chock (*n*) (*nav arch, boating/yachting*) **podloga kosnika**

bow cross range: (BCR) (n) (navig) najmanja udealjenost mimoilaženja brodova po pramcu (u NM)

bow door (n) (nav arch) pramčana vrata (ro-ro broda, trajekta), pramčani otvor: ... *failure of the starboard bow door on motor ferry at Calais on 24 February 2006 It was about 1640 when the first officer started the bow door closing procedure.*

bower anchor (n) (nav arch) the large anchors carried in the bow of a vessel **pramčano sidro**, položajno sidro, obično sidro

bowfast (n) (seamanship) = **painter** pramčani konop splavi, pramčani konop brodice za spašavanje

bow fitting (n) (boating/yachting) pramčani kutni okov (za hvatanje prednjeg leta i đenove), pramčani okov

bow-in berth, wind astern berth vez s pramcem prema unutra, krma u vjetar

bow into tide (n) (boating/yachting, seamanship) struja s pramca, struja u pramac

bow lateral navigation lights (n) (navig) pramčano navigacijsko svjetlo (crveno i zeleno)

bowline /'beulin/ (seamanship) a type of knot, producing a strong loop of a fixed size, topologically similar to a sheet bend **pašnjak (uzao)**, tal. *gassa d'amante* **running bowline** pašnjak

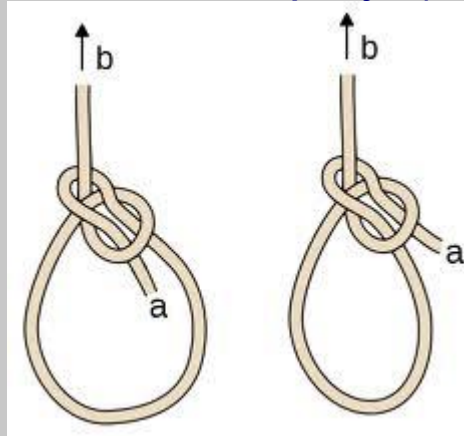

bowline /'baulin/ (n) 1 (boating/yachting) a rope that attaches one side of a sail to the bow of a boat **prednji brac**; 2 **SYNONYM headline** pramčano uže {Today the term HEAD LINE is preferred to BOWLINE!}

bow line (n) (boating/yachting) = **headline** radi izbjegavanja dvosmislenosti u standardnom pomorskom engleskom jeziku preferira se naziv head line **pramčano uže**, **pramčani konop**: *Then, and once the bow line was free, he should increase speed again to clear the ship's side.*

bow line (n) (nav arch) the contour formed by the intersection of any longitudinal vertical plane which is not on the centreline of the ship, with the moulded surface of the hull forward of midship **obris uzdužnoga vertikalnog presjeka broda**

bowline hitch (n) (seamanship) petlja

bowline knot (n) (seamanship) pašnjak, gaša

bowline knot on the bight (n) (seamanship) dvostruki pašnjak

bowline-upon-the-bight (n) (seamanship) dvostruka petlja

bow loading system; BLS (n) (cargo handling, nav arch) The Bow Loading System (BLS) fitted on shuttle tankers, is providing efficient means for offshore loading of crude oil. **sustav**

pramčanog ukrcaja sirove nafte: *The BLS equipment is located On forecastle and on the ship's bridge.*

bow pudding fender (n) (nav arch, boating/yachting) **pramcobran, pramčani brk**

bow rake (n) (nav arch) **pramčana kosina**

bow ramp (n) (nav arch) **pramčana rampa**

bows /bauz/ (n) **on the bows na pramcu (navig) pramac**: *Both vessels suffered major structural damage to their bows but there were no injuries or pollution.*

bow searchlight (n) (nav arch) **pramčani reflektor**

bow section (n) (nav arch) **pramčani dio broda**: *Because of the contact of the vessel with the cap of the eastern breakwater head, the outer shell was damaged on the starboard side in the bow section of the vessel.*

bowsprit /'bəʊsprɪt/ (n) a spar projecting forward over the bow for the purpose of holding the lower ends of the head sails **kosnik, baštun, tal. buttafuori, tal. ompresso bowsprit bed ležište**

kosnika, bowsprit cap glavina kosnika, bowsprit hounding vanjski dio kosnika,

bowsprit housing nutarnji dio kosnika, bowsprit heel-tennon šip kosnika

bowsprit (n) (boating/yachting) **skakalo, špirun teak wood bowsprit špirun od**

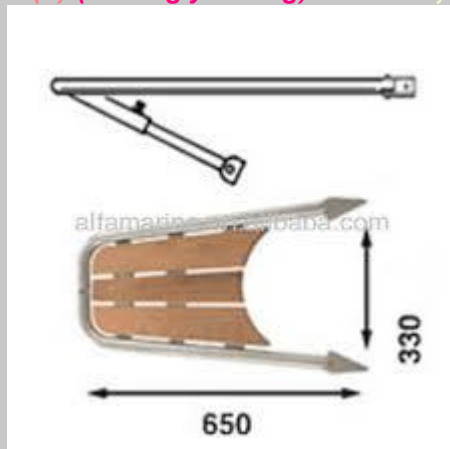

tikovine

bowsprit anchor roller (n) (boating/yachting) **kosnik s valjkom za sidreni lanac**



bow stopper (n) (nav arch) **štoper sidrenoga lanca**: *The brakes were tightened along with the*

bow stopper. A crowbar was temporarily inserted into a link to jam it in the **bow stopper** when the brake could not hold the anchor cable that was under high tension.

bow thruster /'baʊ ,θrʌstə/ (n) (*nav arch*) an auxiliary motor and propeller mounted athwartships at the bow, and employed to maneuver the ship sideways **pramčani porivnik, pramčani**

propeler, manevarski propeler: *This seemed to work and the Master also deployed a **bow thruster** to stop the starboard turn, but it was too late; the vessel made several heavy contacts with the breakwater. The pilot ordered astern propulsion and **bow thruster** to starboard. **operate the bow thruster** koristiti pramčani porivnik, voziti pramčanim porivnikom:* The pilot operated the bow thruster to move the bow to starboard.

bow thruster tunnel (n) (*nav arch*) tunel pramčanoga porivnog uređaja, tunel pramčanog propelera

bow wave (n) val koji brod stvara gibanjem naprijed **pramčani val**

box 1 kutija, sanduk; 2 (*electr*) ormar, rasklopni ormarić; 3 (*marine eng*) kućište bearing **box** kućište ležaja (donje glave ojnice), **console control box** kutija upravljačkog pulta, **emergency control box** upravljačka kutija za slučaj nužde, kutija za ručno upravljanje *He first checked the control box alarms.*; 4 (*shipping econ, seamanship*) box is a maritime jargon and figurative term for container **kontejner, I was on board a 290 meter panamax box ship as harbour pilot and outbound from a major US East Coast container port ...**

box (v) (*seamanship*) gurati (o tegljaču)

box (n) (*mar law, marine eng*) prazan prostor za unos podataka (u obrazac, tablicu, dokument) polje, kutijica, prazan prostor **blank box** prazno polje, prazan prostor (u obrascu, tablici)

box girder (n) (*nav arch*) kutijasti nosač

boxing the compass (n) (*navig*) calling names of the points of the compass in order imenovanje zraka kompasa

box rates (n) (*shipping econ*) kontejnerske vozarine, kontejnerski vozarinski stavovi **box rates inch up** kontejnerske vozarine polako rastu

boxship (n) (*nav arch, shipping econ*) kontejnerski brod: *Evergreen has ordered ten more boxships for Intra-Asia Container Trade*

box spanner (n) (*marine eng*) nasadni cijevni ključ

box the compass (v) 1 (*seamanship, navig*) navoditi (32) zrake ruže vjetrova (u smjeru kazaljke sata), navoditi položaj prema ruži vjetrova; 2 (*boating/yachting*) vjetar koji stalno mjenja smjer

boy (n) (*seamanship*) mladić (kuhinje / kabine), *mali od kuhinje / mali od kamare*

brace /breɪs/ (n) 1 (*boating/yachting*) rope secured near each end of a yard in square-rigged vessels, so as to alter its angle to the fore-and-aft -line (Mayne 2000); a rope (line) used to rotate a yard around the mast, to allow the ship to sail at different angles to the wind **uzda križnog jedra,**

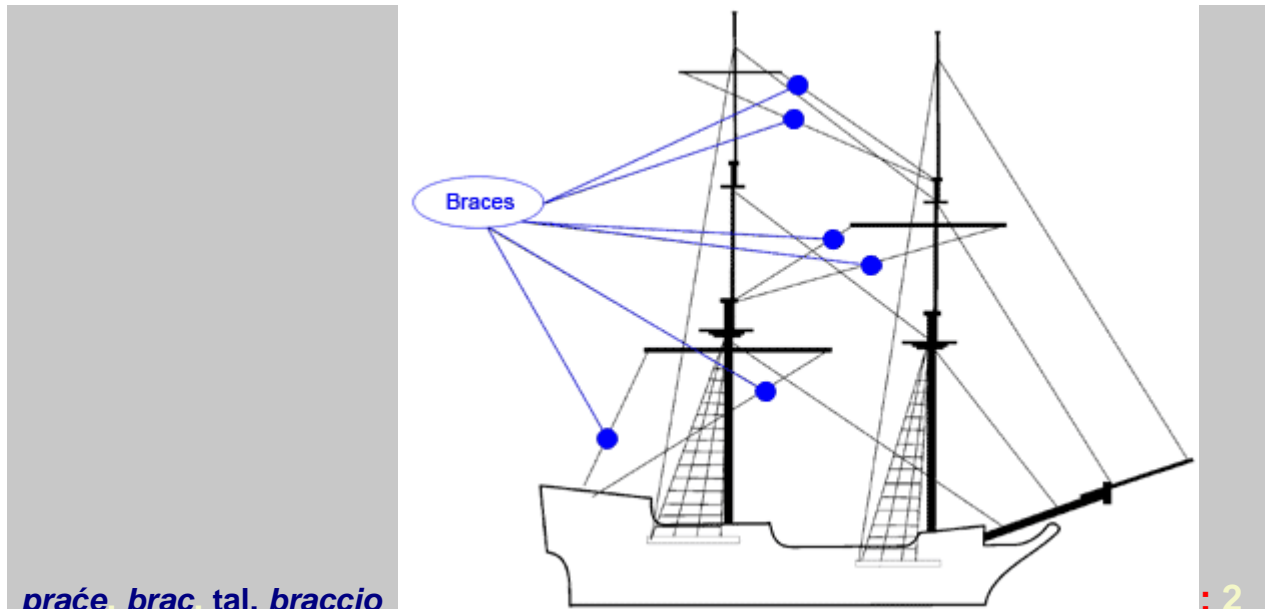

praće, brac, tal. braccio
privjetrinska uzda

brace in (v) (boating/yachting) to trim a squaresail so that it lies more across the beam **popustiti uzdu križnoga jedra**

brace up (v) (boating/yachting) to trim a squaresail so that it lies on a more fore and aft angle **potegnuti uzdu križnoga jedra**

bracket /'brækɪt/ (n) (nav arch) a steel plate, commonly of triangular shape with a reinforcing flange on its free edge, used to connect two parts such as deck beam to frame, frame to margin plate, etc.

koljeno, koljeno sponje

bracket /'brækɪt/ (n) (nav arch) = **console konzola, konzolni nosač**: *The third engineer then thought that the main bracket, which had supported the pipe, also needed to be dismantled. Examination of the other, similar, auxiliary engines revealed that a support bracket for the gauge line was missing on the engine in question and, indeed, appeared never to have been fitted from new.*

bracket /'brækɪt/ (n) (boating/yachting) **okov tanguna**

bracket end (n) (sailing vessels) **koljeno sponje donje plaube**

bracket floor (n) (nav arch) **otvorena rebrenica, okvirna rebrenica**

brackish /'brækɪʃ/ (n) **boćata (voda)**

braid (n) (fishing) pletena nit od 4, 6 9 ili čak 16 tankih niti, kojim je karakteristika velika nosivost, mala ili nikakva istezljivost, što ribiču daje mogućnost brze kontre te velika nosivost.

(<https://ribolovnajadrano.hr/ribicki-leksikon/>) **upredenica, najlon od pletenih niti, povraz od pletenih vlakana, pletena nit**: *The braided fishing line has revolutionised modern day sea angling.*

Kevlar and Spectra braid's unique properties are (a) that it is significantly stronger than either nylon monofilament, or braided Dacron, which some boat anglers were still using then. (b) It has virtually zero stretch, as opposed to mono which can stretch by up to a quarter of its length. **power braid** **jaka upredenica**

braided fishing line /breɪd/ (n) (fishing) one of the of earliest types of fishing line, and in its modern incarnations it is still very popular in some situations because of its high knot strength, lack of stretch, and great overall power in relation to its diameter. (Wiki) **povraz od pletenih vlakana, sukani najlon** {**Braided lines, particularly the newer synthetics, can be successfully used on any type of fishing reel, but are perhaps most well known as excellent lines for bait casting reels, in particular for trolling**

where they remain especially popular among many fishermen. (Wiki)}

braided rope (n) (seamanship) pleteni konop, konop s jezgrom i pletenom ovojnicom

brail /breil/ (n) (sailing vessels) COMPARE **buntline** konopac za odvijanje i ubiranje jedra oko deblenjaka i križeva; small ropes used to haul in or up the leeches and bottoms of a sail for furling; one of a series of lines used to haul a square sail up to the yard and secure it furled **krača ubralja**

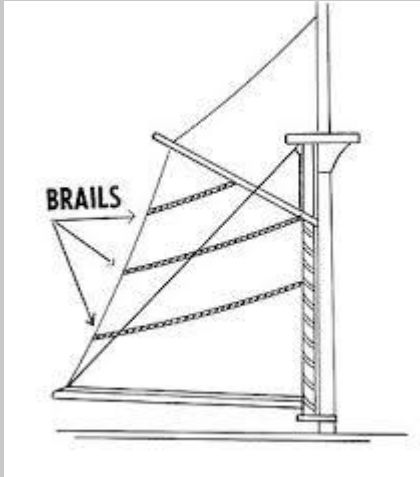

(križnog jedra

brake /breik/ (n) 1 **kočnica**: The accident involved a **brake** failure on one of the lifeboat. The more the boat descended, the more the **brake** was released. **brake lever** ručica kočnice, **poluga kočnice**: Prior to the drill, the **brake lever** was checked and found to be correctly adjusted., **brake failure**, **otkazivanje kočnice**: The accident involved a **brake failure** on one of the lifeboat., **brake handle** ručica kočnice: When outboard and clear of the davits, the remote control **brake handle** was released to stop the movement., **brake lining** kočna obloga, **obloga kočnice**, **feroda**: The **brake lining** had to be renewed as soon as possible as the brake may not have held., **release the brake** otpustiti kočnicu, **osloboditi kočnicu**: From that point onwards the effect of the reducing length of the control wire was to place tension on to the winch brake handle and **release** the brake., **breakdown of the brake** kvar kočnice, **engage the brake** uključiti kočnicu, **operate the brake** kočiti, **uključiti kočnicu**, **upravljati kočnicom**: As an emergency measure, the jibs were housed by **operating the brake release mechanism** manually., **brake shoe / block** papuča kočnice, **kočna papuča**, **tijelo kočnice**: The **brake pad** had become detached from the **brake shoe**., **brake pad** kočna obloga, **tarna obloga**; 2 (nav arch) **kočnica vitla**: Damage occurred to the mooring winch engaging/disengaging handle, **brake** handle, a hydrant and the railings. This placed them in an area of danger because a **winch brake band** could have rendered while they were attaching the centre chain.

brake band (n) (nav arch, marine eng) **tarna obloga kočnice (na vitlu)**: In this situation is the question of burning a **brake band** or losing an anchor important? The Chief Officer investigated the matter and found that the **brake band-tightening stud** was bent and broken.

brake horsepower (n) (marine eng, nav arch) **snaga na kočnici**: Performance: An important parameter for a marine diesel engine is the rating figure, usually stated as **brake horsepower (bhp)** or kilowatts per cylinder at a given revolutions per minute. If the latter is **'brake' horsepower (bhp)**, the *mep* derived is the brake mean effective pressure (*bmep*);

branch off (v) **račvati se**, **granati se**, **dijeliti se (cijev)**

branch office (n) (shipping econ) **filijala**

brass bush /'bra:s, buʃ/ (n) (marine eng) brtvilo, mjedena košuljica

breach /bri:tʃ/ (v) 1 (safety, nav arch) probiti: Fortunately, neither vessel's hull **was breached**, and there was no injury or pollution A number of water ballast tanks and at least one fuel oil tank **were breached** resulting in pollution. The general cargo vessel's port bow collided with the LPG tanker's starboard quarter and the hulls of both vessels **were breached** above their respective waterlines.

breach the hull probiti trup broda, stvoriti otvor u trupu broda: If the hull is breached, or a hatch breaks free, the flooding can be contained to a relatively small area.; 2 (mar law) kršiti (pravilo, propis, zakon, ..., prekršiti: While fishing vessels inevitably have to **breach** their watertight integrity at sea to load fish, this is not an excuse to leave your fishing vessel unnecessarily vulnerable to flooding.

breach /bri:tʃ/ (n) 1 (mar law) kršenje (propisa, ugovora): Although this was **in breach of the company requirements**, it did not in any way contribute towards the accident. In fact, it turned out the officer concerned was **in breach of STCW regulations** relating to the hours of rest due to the nature of the trade. od, due to very high ambient temperature, No 2P COT pressure relief valve opened, releasing inert gas (IG)/cargo vapour mixture to the atmosphere, **in breach of the applicable Annex 6 of Marpol**.

Although there were no injuries, the vessel suffered **breach of two ballast tanks**. **breach of contract kršenje ugovora, breach the obligations under the agreement prekršiti obveze iz ugovora, labour breach kršenje pomoračkih radnih prava**: The bulker was detained six weeks ago by the Maritime Authority **over labour breaches**. Brod za rasute teret zaustavljen je prije šest tjedana od strane Pomorskih vlasti (uprave) zbog kršenja radnih prava pomoraca.; 2 (safety)

breaking an opening or hole in the hull of a ship **proboj trupa broda, rupa u trupu broda hull breach rupa u trupu broda, proboj trupa broda**: A hull breach that flooded river cruise ship MS, and forced the evacuation of 194 passengers and crew may have been caused by the ship running aground in low water, **breach in the hull / tank proboj trupa / tanka, rupa u trupu / tanku**: The collision resulted in a breach in the container vessel's port bunker tank, resulting in an oil spill.

breach /bri:tʃ/ (n) (safety, nav arch) rupa u trupu broda, probijanje trupa: r's note: It must be remembered that the primary purpose of the hold bilge system is to preserve the ship from sinking due to flooding as a result of **breach of the hull**. **sustain breach pretrpjeti probijanje (trupa)**: The vessel sustained breach in its hull and took in water, causing the failure of the ship's main engine.

breached compartment /bri:tʃt/ (nav arch, safety) probijen predio broda, predio

broda u koji je prodrla voda: the Master ordered the breached compartment to be opened at sea and for a party consisting of the C/O, C/E and a seaman to internally inspect the damage.

breach of contract /bri:tʃ/ (n) (mar law, mar ins) kršenje ugovora, ugovorna odgovornost, odgovornost za kršenje ugovora

breadth /brɛdθ/ (n) (nav arch) = width the greatest moulded breadth, measured amidships below the weather deck **širina broda**

breadth moulded (n) (nav arch) the greatest breadth of the vessel measured from heel of frame on one side to heel of frame on other side **širina na vanjskom bridu rebara, baždarna širina broda, širina na glavnom rebru**

break /breik/ (v) **break away otkinuti, break down** 1 pokvariti se (motor), prestati funkcionirati, ispasti iz pogona / sistema, zaustaviti se (zbog preopterećenja), slomiti se, imati kvar / defekt; 2 (shipping econ) podijeliti, razdijeliti (prihod), dijeliti se u, **break out (o požaru) izbiti (marine eng) slomiti, razbit, kidati, prekinuti**: Even under excessive load conditions, the D Shackle on the chain, which is the weaker link, should **break** first. It is highly unlikely that the lashings will **break** in any reasonable circumstances, including heavy weather

navigation. Ropes will **break** when under stress or tension. {break - broke - broken}

break² (v) (nav arch) klasično čišćenje grijanjem (let-lampom) drvene oplata dna **rezati brod za staro željezo**

breakage /'breɪkɪdʒ/ (n) **1 a** (marine eng) lom, slom, prekid; **2** (shipping econ) neiskorišteni prostor u kontejneru

Breakaway! (n) (navig) **Zaustavite manovru!**

break bulk /,breɪk 'bʌlk/ (v) **1** (shipping econ) to begin unloading the cargo; to unload and distribute a portion or all of the contents of a rail car, container, trailer, or ship **započeti**

iskrcaj/ukrcaj raspakirati pošiljku, otvoriti grotla (kako bi počele operacije

iskrcaja/ukrcaja tereta): Under the *before breaking bulk (BBB) clause* freight is to be paid, i.e. the money deposited into the shipping company's account, prior to discharging.; **2** (shipping econ, cargo handling) to strip unitised cargo **prazniti teret (iz kontejnera, s paleta itd.)**

break bulk /'breɪk ,bʌlk/ (n) (mar law) carriage of goods other than by container (Tetley) **klasični teret, generalni teret (osim kontejnera):** Cargo gear is designed for speed and flexibility for handling breakbulk, palletized, or container cargo.

breakbulk cargo, break bulk cargo /'breɪk ,bʌlk/ (n) (cargo) non-containerized general cargo stored in boxes, bales, pallets or other units to be loaded onto or discharged from ships or other forms of transportation **generalni teret (koji nije kontejnerski), klasični teret, komadni**

teret: There is an area of 20000 sq.m for for breakbulk cargo and LCL operations With regard to general cargo (goods, merchandise, commodities), also referred to as break bulk cargo, almost 90 percent of all such cargo in most liner cargo trades today is containerized. {Break bulk cargo usually referes to general cargo conventionally stowed as opposed to unitised, containerised and Roll On-Roll Off cargo.}

break-bulk vessel (n) (nav arch) **brod za generalni teret (novijeg tipa):** * We arrived at the roads of a South American port on a *breakbulk cargo vessel* at 23:00.

break cargo (n) (cargo) **komadni teret:** When carrying *break cargo* (such as steel rolls), there was no risk of any cargo covering the lights.

breakdown (n) (marine eng) **kvar, havarija:** The Captain and all the bridge team thought the ship had a complete electrical *break down* due to the auxiliary engine overheating.

break down /'breɪk ,daʊn/ **1** (v) **pokvariti se, doživjeti havariju (o glavnom stroju) :** A safety device is fitted in case the system *breaks down*. The *pilot boat engine had broken down*. If a vessel *breaks down* and puts into a port for repairs, she is off hire, but hire will be payable again when she is fit to sail again from that place, ... When the ship's main diesel marine *engine breaks down* at sea, it is imperative that the Engineering Officers affect repairs as quickly as possible in order to restore power and steerage. A capesize bulk carrier *broke down* in Elbe River blocked ship traffic in the Elbe River after losing power while inbound to the port of Hamburg.; **2** **rasporediti, podijeliti u;** **3** **prekinuti**

(vezu): Communications *broke down* on a number of levels and played a part in this accident:

breakdown clause (n) (mar law) = **Cesser Clause** **odredba o privremenom prestanku ugovora o najmu/zakupu broda (zbog havarije glavnog stroja itd.)**

breaker /'breɪkə/ (n) (oceanogr) a large wave with a white crest on the open sea or one that breaks into foam on the shore **lomni val, prijelomni val**

breaker² /'breɪkə/ (n) (electr, safety) **automatska sigurnosna sklopka, automatski isklopnik**

breaker³ (n) (nav arch) **rezalište brodova** **breaker's yard rezalište brodova:** The number of container vessels sent to *breakers' yards* so far this year will shortly eclipse the total demolished in 2015

break-even freight rate (n) (shipping econ) prag korisnosti / isplativosti vozarine, najniža ekonomična vozarina

break free (v) 1 (seamanship) okvačiti se (od veza), odvezati se (nenamjerno): *Three barges have broken free from the towing vessel after alliding with the Helena Highway Bridge pier. The crew often connect it directly to the ship's structure so that the raft will not break free should the vessel sink.*; 2 otrgnuti s s veza / sidra: *Super Typhoon Meranti caused a 14,000 teu newbuild container ship break free from its moorings and strike shoreside in cranes*

break ground (v) (seamanship, navig) osloboditi se od dna (o sidru), otpustiti se od dna (o sidru)

breaking force (n) (marine eng, seamanship) prekidna sila fiber average breaking force prekidna sila niti

breaking load (n) (phys, seamanship, ship handling) sila pucanja (užeta, sila kidanja (užeta), opterećenje kidanja (užeta): *The parted fall wire was observed to be in good condition and when tested after the accident, it achieved a breaking load of 137kN. minimum breaking load;* **MBL minimalna sila kidanja, minimalna sila pucanja**: *When the components of the mooring systems were evaluated, one vessel was found to have mooring lines with a Minimum Breaking Load (MBL) of 104 mt when new.*

breaking strength (n) (marine eng) sila pucanja (užeta): *The test certificate stated its minimum breaking strength of 101,6 tonnes when new.*

breaking yard (n) (nav arch) rezalište brodova, brodorezalište

break loose (v) (navig, seamanship) otkinuti se (konop), popustiti (sidro): *The last length of chain had broken loose from the chain locker, and the AB was hit and fatally injured by the bitter end.*

break of forecastle (n) (nav arch) the point where the forecastle changes level to the main deck or shelterdeck **skok kaštela**

break out (v) (safety) izbiti (o požaru): *The fire broke out Friday evening as the ferry was about 34 miles from the coast of Japan*

break up (v) (safety) prelomiti se (brod): *The ship broke up and sank. As the disabled vessel approached the English coast there was a growing concern that the vessel could break up or sink Salvors instead opted to break the ship up on the beach using explosives.*

breakwater /'breik, wɔ:tə/ 1 (nav arch) the structure designed to break the force of the sea and provide shelter for the vesels in harbour **valobran**: *Two fire parties made an attack on the fires from behind the breakwater bulkhead.*; 2 (ports) **lukobran, tal. frangiflutti; frangionde**: *The ship then turned to port and sailed towards the Langlütjen breakwater in a wide arc. On clearing the breakwater, the skipper ordered the helmsman to head in a northerly direction. Another vessel was leaving the harbour and had just passed the breakwater and was in the main channel. breakwater head glava lukobrana, vanjski kraj lukobrana: The ship was anchored in the designated area about eight cables south of the breakwater head., breakwater entrance ulaz kod lukobrana: The heavy swell abeam made the ship roll very heavily all the way to the breakwater entrance, causing us much anxiety., outer breakwater vanjski lukobran: The passage plan for this voyage finished at the outer breakwater.*

breakwater entrance (n) (ports, navig) ulaz u luku kod lukobrana

breakwater head (n) (ports) glava lukobrana, kraj lukobrana (prema moru), vrh lukobrana

breakwater light (n) (navig) svjetlosna oznaka na lukobranu: *the vessel was 1.62 miles*

north of the breakwater light

breakwaters /'breɪk,wɔ:təz/ (n) 1 (ports) lukobran; 2 (nav arch) valobran (na palubi pramčanog kaštela)

bream /bri:m/ (n) 1 (fishing) ribe iz porodice Sparus aurata, arbuni itd.; 2 (fishing) komarča, podlanica, orada, lovrata **gilt-head bream** orada

bream (v) (nav arch) čistiti dno broda od obraštaja

breast hook /brɛst/ (n) (sailing vessels) pramčana vjenčanica

breast line (n) forward **breast line** pramčano bočno uže tal. *traversino di prora*, aft **breast line** krmeno bočno uže tal. *traversino di poppa* (seamanship) bočno uže,

tresina; tal. *traversino*: The vessel was berthed port side to the jetty, heading west, by four headlines, two forward **breast lines**, two forward springs, two aft springs and six sternlines Although most winch manufacturers recommend that auto-tension is used only on **breast lines**, on one of the vessels all the lines were operated in auto-tension mode. The berth only really had one bollard for headlines, one for **breast lines** and one for springs.

breather pipe /'bri:ðə/ (n) (boating/yachting, marine eng) cijev odušnika, odušna cijev

breathing apparatus /'bri:ðɪŋ/ (n) (safety) aparat za disanje: One of the two crew started the hold ventilation fan, and brought a **breathing apparatus** (BA) set and an emergency escape breathing device (EEBD) to the f'ocsle. A fire party in **breathing apparatus** entered the engine room after a further 40 minutes. **compressed air breathing apparatus** aparat za disanje na

komprimirani zrak, **presurize the breathing apparatus** tlačiti aparat za disanje (radi ispitivanja), **don the breathing apparatus** nositi aparat za disanje staviti na sebe aparat za disanje The Chief Officer donned a **breathing apparatus**, and dived from a lifeboat to detect the source of leakage., **refill the breathing apparatus cylinder** napuniti bocu aparata za disanje: a cargo ship suffered burns to his hands and face when he wrongly used a self-contained breathing apparatus (SCBA) air compressor to **refill an oxygen breathing apparatus** (OBA) cylinder, causing it to explode., **wear the breathing apparatus** nositi aparat za disanje: Soon afterwards, crew members wearing **breathing apparatus** rescued the chief officer and seaman.

breech /bri:tʃ/ (n) (mar law) kršenje **breech of C/P terms** kršenje uvjeta iz čartera

breech (n) 1 (seamanship) pomični kolotur u koloturniku; 2 (seamanship) otvor kolotura (kroz koji se provlači uže)

breeches buoy (n) (safety) pojas u obliku trapeza za prebacivanje mornara s broda na brod ili

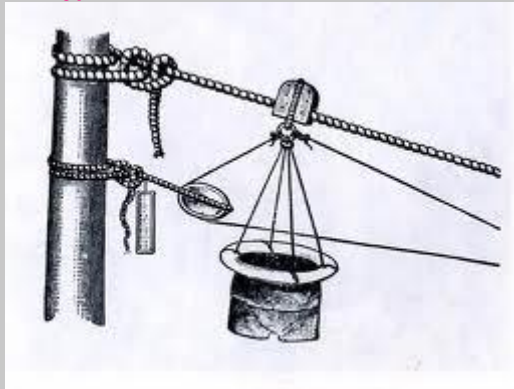

obalu) trapezni pojas

breeze /bri:tz/ (n) 1 (meteorol) lagani vjetar, tal. **brezza**: The weather was fine, with a light breeze and rippled sea. Despite being overcast, a light north-northeasterly breeze and slight seas

meant a pleasant start for a day's fishing. Visibility was good with a **moderate breeze**. **sea breeze** smorac, **land breeze** kopnenjak, **burin a (meteorol) povjetarac**, lahor, lagani vjetar; **2 pasat**

bridge (n) 1 (navig, nav arch) zapovjednički most most: The Master ordered the main engines and bow thrusters to immediate notice, and he and the chief officer remained **on the bridge**.; **2 (cargo handling) mostić (za povezivanje vrhova susjednih kontejnera) bridge piece mostić (za povezivanje vrhova susjednih kontejnera)**

bridge alarm unit; (BAU) (n) (navig) COMPARE VDR; Voyage Data Recorder jedinica za uzbunu na zapovjedičkom mjestu (u uređaju VDR)

Bridge Alert Management System; BAM (n) (navig) Centralni alarmni sustav zapovjedičkog mosta

bridge chair (n) (navig) sjedalo na zapovjedičkom mostu (za časnika straže): The OOW was sitting in the port bridge chair where he had a direct view of both radar and ECDIS displays.

bridge clearance (n) (navig) slobodna visina mosta (za prolaz brodova), najniža visina mosta (za prolaz brodova)

bridge console (n) (navig, nav arch) pult zapovjedičkog mosta: - The layout of the central **bridge console** prevented the chief officer from utilising the ECDIS display to support the Master during pilotage. After the vessel left her berth, her master, who was positioned at the aft-looking **bridge console**, handed control to the chief officer.

bridge control (n) 1 (navig) upravljanje s mosta: The engine control was set to **bridge control** and a helmsman was using manual full follow-up (FFU) steering.; **2 (nav arch) upravljački uređaji na mostu**: The tow line became taut and the mate, who was at the **bridge controls**, stopped the winch as he could no longer pay out the line.

bridge crane (n) (cargo handling) = gantry prekrcajni most (dizalica)

bridge crew (n) (seamanship) posada mosta: - The **bridge crew** was not adequately familiarised with the vessel's steering control system

bridge deck (n) (nav arch) mosna paluba, paluba zapovjedičkog mosta: All essential signalling systems, including SATCOM, were sighted on the upper **bridge deck** and destroyed by the fire.

bridge equipment (n) (navig) oprema na zapovjedičkom mostu: Check if all bridge equipment is logged Provjerite je li stanje sve opreme na mostu uneseno u dnevnik The ship's **bridge equipment** included X and S band radar displays that were set on the 6nm range scale. All **bridge equipment** was functioning normally. **bridge navigational equipment navigacijska oprema mosta**: The OOW focused on finding a visual reference and did not utilise the **bridge navigational equipment** to effectively monitor the vessel's progress.

bridge-fitting (n) (cargo handling) mostić (za spajanje vrhova kontejnera): The Boatswain wanted to send a seaman on top of the containers to place **bridge-fittings**.

bridgehouse (n) (nav arch) nadgrađe navigacijsko mosta, srednje nadgrađe

bridge manning (n) (seamanship) postava posade mosta: A number of factors - predominantly relating to **bridge manning** and management - contributed to the incident.

bridge markings (n) (navig) oznake na mostu

Bridge Navigation Watch Alarm System; BNWAS (n) (navig) sustav uzbunjivanja za navigacijsku stražu na mostu

bridge officer (n) (seamanship) časnik na mostu, časnik straže na mostu: The fundamental requirements of planning and executing a safe navigational passage must be clearly and

fully understood and implemented by all **bridge officers**. After lunch, the **bridge OOW** gave the duty engineers permission to test the main engine.

bridge personnel (n) (seamanship) **osoblje na mostu (časnici i mornari), osoblje zapovjedničkog mosta**: The **bridge personnel** were not functioning as a team on either vessel.

bridge procedures (n) (navig) **postupci na mostu, sustav postupaka na mostu**: The SMS **bridge procedures** provided by the managers were comprehensive and included extensive guidance on the conduct of navigation using ECDIS.

bridge resource management; (BRM) (n) **COMPARE bridge team management; (BRM)** (navig) the study of the material (electronic) and human resources available to the navigator and the exploitation of them in order to conduct safe and efficient voyages.

upravljanje resursima na mostu: Effective **bridge resource and team management** should eliminate the risk that an error on the part of one person could result in a dangerous situation'. The principles of **bridge resource management (BRM)**, such as consultation and cross-checking, are equally applicable to engine room operations, particularly during an emergency. Contributing to the circumstances that resulted in the collision was the inadequate **bridge resource management** between the master and the pilot. {For most, **bridge resources consist of the complete suite of assets available to the navigator including electronic and human, while bridge team management refers only to human assets, except for the pilot, who is normally not considered a member of the team. (Bowditch)}**

bridge roof (n) (nav arch) **krov zapovjedničkog mosta, krov navigacijskog mosta**: Then he used the search light on top of the **bridge roof** and operated by a handle just above the manoeuvring desk.

bridge simulator (n) (navig, nav arch) **simulator**: All the officers involved will attend a Bridge Team/Pilot Relationship course on a full mission ship **bridge simulator**.

bridge team (n) (navig) **tim zapovjedničkog mosta, tim na zapovjedničkom mostu**: the **bridge team** included the OOW, an AB and a deck cadet All members of a **bridge team** should be briefed on the plan, encouraged to actively contribute to the vessel's navigation The **bridge team** consisted of the Master, the pilot, the third officer as the officer of the watch (OOW), and a helmsman.

bridge team management; (BRM) (n) (navig) the management of the human resources available to the etc.—and how to ensure that all members contribute to the goal of a safe and efficient voyage. **upravljanje ljudskim resursima na mostu, upravljanje ljudskim**

potencijalima na mostu: Poor **bridge team management** on the vessel resulted in a lack of accurate vessel **breakdown of bridge team management; (BRM) krah / neuspjeh upravljanja**

ljudskim potencijalima na mostu, effective bridge team management; (BRM)

učinkovito upravljanje ljudskim resursima na mostu: Effective **bridge resource management** should eliminate the risk that an error on the part of one person could result in a dangerous situation. {Neki autori neznatno razlikuju BTM od BRM. Izraz BRM češće se koristi nego izraz BTM.}

bridge telegraph (n) (comm) **telegraf na mostu**: mostni telegraf

bridge watch (n) **straža na zapovjedničkom mostu**: the **bridge watch** consisted of the lookout and the chief officer He undertook only **bridge watches**, leaving all the cargo work to the mate.

bridge watchkeeper (n) (navig, seamanship) **časnik straže na mostu**: A **bridge watchkeeper** should not be alone at night. I was the junior **bridge watchkeeper** on a 9,000 grt cargo liner belonging to a reputable company.

bridge watchkeeping (n) (navig) **držanje straže na mostu**: The managers of the MV ... have taken action to improve the standard of **bridge watchkeeping** on board their vessels. However, the Master and deck officers did not implement the ship manager's policies for safe navigation and **bridge watchkeeping**.

bridge wings (n) (nav arch) **krila mosta**: *The STS superintendent was on the manoeuvring ship and had the con, while standing at the outboard end of the port **bridge wing**. before the non-running generators could come on line to give the demanded additional power, the ship collided with the moored vessel, damaging her **bridge wing** and windows.*

bridle /'braid(ə)/ (n) 1 (seamanship) a length of rope, wire or chain secured at each end to a spar, to the bight at which a purchase can be hooked (in the case of the spinnaker pole, to spread the load of the downhaul) (Mayne 2000) **uže privezano s oba kraja na obalu ili brod, račvasto uže (u obliku slova Y), duplin**: *Tug A was towing from the centre **bridle** to two chaffing chains to Smit brackets. On arrival on scene, the lifeboat offered a tow and the owner rigged a **bridle** to secure the tow line.*; 2 (boating/yachting) **uzde prednjeg leta na katamaranu**

brief /'bri:f/ (v) **održati kratak dogovor (o nekoj radnji ili akciji), dati kratke upute (o nekoj radnji ili akciji), brifanje**: *Engine room and crew **must be briefed** on the mooring manoeuvre posadi stroja i posadi palube moraju se dati kratke upute o manovri privezivanja Before arrival, the Master conducted a meeting to **brief** officers on the mooring plan and the constraints at the port. The 2/O telephoned the master to **brief** him on its content.*

briefing /'bri:fiŋ/ (n) (safety) **kratak dogovor, kratke obavijesti i upute, kratko upoznavanje posade s nekom operacijom na brodu, brifing**: *There was no pre-departure **briefing** and almost no information flow between the officers once the vessel was underway. This is achieved by a good **predeparture briefing** and a commentary from the master during the passage. A **crew briefing** should always take place before each mooring operation, even if the planned manoeuvre may appear routine. **safety briefing upoznavanje sa sigurnošću na brodu**: Take time to give a thorough **safety briefing**. When the surveyor eventually arrived, the lifeboat crew mustered and carried out a **safety briefing**., **arrival briefing kratak dogovor o uplovljenju broda, briefing kratak dogovor o isplovljenju broda***

brig /'brig/ (n) (nav arch) **škuner s dvama jarbolima i s do pet križnih jedara na prednjemu jarbolu**; a two-masted vessel with square sails on both masts, and on the mainmast a lower mainsail with gaff and boom (Mayne 2000) **brik**

brigantine (n) (nav arch, boating/yachting) two-masted sailing vessel square-rigged on the foremast but fore-and-aft rigged on the mainmast (Mayne 2000) **brigantin**

brilliance /'brɪljəns/ (n) (electr, navig) **osvjetljenje radarske slike, svjetlina adjust display brilliance namjestiti osvjetljenje radarske slike, brilliance control kontrola za namještanje osvjetljenja radarske slike**: *The brilliance control on an analogue radar controls the brightness of the rotating trace and will also affect the brightness of the displayed echo.*

brine /'brain/ (n) (marine eng) **rasol, rasolina brine pump pumpa za rasol, brine tank tank rasola**

Brinell hardness (n) (marine eng) **tvrdoća po Brinellu**

bring (v) **bring about prouzročiti, izazvati (kvar), bring into danger dovesti i upasnost, ugroziti, bring into use upotrijebiti, primijeniti koristiti, služiti, pustiti u upotrebu / pogon, bring the ship head to wind (navig) dovesti brod pramcem prema vjetru**: *In an attempt to **bring the vessel's head into the wind**, the master decided to make a broad alteration to starboard.*, **bring the ship alongside (navig, seamanship)**: *... despite the breakdown of the structural barriers, the ship's officers and crew managed to contain the emergency situation and **bring the ship alongside** at the Suez Canal Container Terminal without any personal injury or pollution to the environment. **dovesti brod bočno uz obalu, pristati uz obalu, bring under control dovesti pod nadzor, dovesti pod kontrolu**: *He managed to**

extinguish the fire and bring the situation under control., **bring a ship to the pilot station (navig)**
dovesti brod do peljarske postaje: *Two days ago, I brought a large fast container ship from Hamburg down to the pilot station seven miles off Brixham. donijeti*

bringing to (n) (navig) manovra dovođenja broda do pozicije sidrenja

bringing to (n) (mar law) dovođenje broda na poziciju ukrcaja vlasti

bring the ship's head around (n) (navig, seamanship) okrenuti pramac broda: *As the vessel entered a narrow part of the channel, the pilot requested a slight change of heading to port. The helmsman brought the head around and applied starboard helm to steady her on her new heading. However, the vessel's head continued to pay off to port.*

bring the ship's head to wind (v) (navig) okrenuti pramac u vjetar: *The port main engine tripped due to the excessive list and, with only one engine, there was not enough power to bring the ships head into the wind.*

bring the ship to a stop (v) (navig) zaustaviti brod: *As Captain of a hovercraft, I could bring it to a dead stop from 65 knots in a mere quarter-of-a-mile*

bring to (v) 1 a (navig) dovesti brod na poziciju sidrenja; **2 (navig)** zaustaviti brod okretanjem u vjetar; **3 (mar law)** dovesti brod do mjesta ukrcaja vlasti (carinskih, zdravstvenih, lučkih, pogranične policije itd.)

bring up (v) (navig) dovesti brod na poziciju sidrenja: *The ship is being brought up. Brod dolazi / plovi na mjesto/poziciju sidrenja The ship is brought up. Brod je na poziciji sidrenja However, at 1111, the twist was cleared, the anchor was dropped and the ship was brought up to 9 shackles in the water.*

British thermal unit (n) (marine eng) britanska toplinska jedinica (BTU)

brittle /'britl/ (adj) (marine eng) krt, krhak, lomljiv (materijal), loman

brittleness /'britlnis/ (n) (marine eng) krhkost, lomljivost

broach /brəʊtʃ/ (v) **1 (boating/yachting)** otpadanje nekontroliranim zakretanjem pramca niz vjetar čime se jedrilica/brod izlaže jakim bočnim valovima: *A sailboat broaches when its heading suddenly changes towards the wind due to wind/sail interactions for which the rudder cannot compensate.*

(Wikipedia) **naglo skretanje s opasnošću prevrtanja (jedrilice, broda), bježati u poju**

pa zatim naglo u orcu, bježati od vjetra, štraorcat; tal. straorzare, naglo otvaranje

boka prema valovima i vjetru broach to naglo skretanje s opasnošću prevrtanja

(jedrilice, broda), nekontrolirano otpadati (od vjetra) štrapojat; tal. strapoggiare:

As the crew unloaded their luggage, the fierce current and the weight of the cargo net caused the boat to swing and broach to the current. He managed to cling on to the top guard-rail and as the yacht had almost certainly broached to windward and stayed effectively hove-to, its speed through the water was substantially reduced.; **2 provaliti, probiti (sanduk, kontejner) radi krađe:** *the oil was leaking from the unsecured / broached oil drums.*

broaching /'brəʊtʃɪŋ/ (n) (cargo) provala, provalna krađa (tereta) **broaching of cargo** provalna krađa na teretu

broaching /'bri:ʃɪŋ 'tu:/ (n) (boating/yachting) skretanje jedrilice u vjetar, s opasnim naginjanjem, kada su jedra previše zategnuta, naročito pri jedrenju sa špinakerom **naglo bježanje jedrilice u**

vjetar, tal. straorzata: *A helmsman can react quickly and alter course for individual waves to*

minimise the risk of broaching. **avoid broaching 1 izbjeći bježanje u vjetar; 2 Boat's bow should have been secured to the ship's deck by a painter to avoid broaching.**

broaching to (n) 1 (navig) a sudden movement in navigation, when the ship, while sailing in the

following seas and wind astern, accidentally turns her leeward side to windward, **skretanje (broda) u vjetar, bježanje (broda) u vjetar**; 2 (*boating/yachting*) **bježanje (jedrilice) u vjetar, bježanje u iorcju, štraorcivanje**; tal. **starorzata** {also use to describe the point when water starts to come over the gunwhale due to this turn}

broad /brɔ:d/ (*adj*) **širok** **broad on the bow** at a wide angle to the stem, i.e roughly 45 degrees from dead ahead **široko po pramcu, broad on the quarter** at a wide angle to the stem, i.e roughly 45 degrees from dead astern **široko po kvartiru, broad alteration široko skretanje (kursa)**: *In an attempt to bring the vessel's head into the wind, the master decided to make a broad alteration to starboard.*

broadcast /'brɔ:d,kɑ::st/ (*v*) (*comm*) **odaslati, emitirati**: *The Coast Guard is broadcasting a notice to transiting vessels every 12 hours via VH-F channel 16. broadcast a distress call and message emitirati poziv za pomoć i poruku o pogibli, broadcast the information emitirati informacije / podatke*: *The beam trawler's AIS was transmitting static and dynamic information, including its status (engaged in fishing), SOG and COG. However, no heading information was broadcast.*

broadcast /'brɔ:d,kɑ::st/ (*n*) (*comm*) **emitiranje**

broadcasting system (*n*) 1 (*comm*) **razglas**; 2 (*nav arch*) **koncertni razglas**

broaden /'brɔ:dən/ (*v*) **proširiti (se), raširiti (se), rastegnuti (se)**

broad on (*adv*) (*navig*) **široko po prednjoj strani broda**: *The ship was almost broad on to the wind and rolling up to 35/40 degrees, when she took a few heavy rolls of more than 40/50 degrees. broad on on the starboard beam desno po pramčanom boku, broad on on the bow široko po pramcu*: *When the ferry was 5 miles away and broad on our port bow, she altered about 300 to her port, which considerably worsened the situation. At approximately 2115 I sighted the silhouette of a barge in the moonlight broad on the starboard bow at fairly close range.*

broad reach (*n*) 1 (*boating/yachting*) **s vjetrom u pola krme**: *The skipper, who was helming at the time, handed the wheel to one of the trainee crew and instructed her to keep on a port tack on a broad reach.*; 2 (*boating/yachting*) **jedrenje s vjetrom u pola krme**

broken (*adj*) **slomljen, prekinut, puknut broken line (seamanship) puknuto uže / konop**: *The accident resulting in severe injuries to 2 people caused by three broken lines while making fast the ship. The broken mooring rope was a 70mm diameter polypropylene monofilament 8-strand plaited rope., broken leg / arm / bone / rib skomljena noga / ruka / kost / rebro*: *I then went to my GP (general practitioner) who sent me to hospital for an X Ray where they discovered three broken ribs.*

broken down (*n*) **u kvaru, pokvaren, havariran**: *the pilot boat engine had broken down*

broken image (*n*) (*navig*) **iskrivljena / nejasna slika (na radaru)**

broken stowage (*n*) (*shipping econ*) 1 the spaces between and around cargo units, including dunnage, and spaces not available for cargo stowage because of physical obstructions or ventilation and access requirements **neiskorišteni brodski prostor, izgubljeni prostor**; 2 (*cargo handling*) **ispuna za neiskorišteni brodski prostor**

broker /'brɔ:kə/ person who transacts the business of negotiating between merchants and shipowners respecting cargoes and clearances, or one who effects insurances with underwriters; person who arranges for transportation of loads for a percentage of the revenue from the load **posrednik, mešetar, broker**: *... in 1980 he joined ... Marine in London and operated as a dry cargo broker on the Baltic Exchange until 1985. insurance broker osigurateljski posrednik, osigurateljski*

broker: More specifically **brokers** connected with the maritime industry can be categorised as: **Insurance brokers**, who act as the intermediary between the ship/cargo owner and the underwriters when marine insurance is negotiated. , **loading broker** Company that represents a shipping line at the port of loading ; **brodarov agent / predstavnik u luci ukrcaja, brodarov broker**: The **loading broker's** duties are to advertise the line's sailings, to obtain cargoes and co-ordinate their delivery to the ship and to sign bills of lading on behalf of the master. {Generally, a broker is a person who acts as an agent or intermediary in negotiating contracts}

brokerage (n) (**shipping econ**) freight forwarder/broker compensation as specified by ocean tariff or contract **naknada za posredništvo, špediterska provizija**

brokerage /'brʊkərɪdʒ/ **1 (mar law) brokerstvo, mešetarenje (u pomorskoj trgovini); 2 brokerske usluge brokerage commission brokerska provizija**

bronze /brɒnz/ (n) (**marine eng**) bronca, bronza **aluminium bronze** aluminijaska bronca, **manganese bronze** manganska bronca, **phosphor bronze** fosforna bronca

brought up /'brɔ:t'ʌp/ (n) (**seamanship, navig**) doveden na mjesto sidrenja (o brodu),

usidren: At 0300 it was confirmed the vessel was brought up and holding her position with 8 shackles in the water.

brown meagre /mi:g/ Lat. *Sciaena umbra* **kavala**, It. **corvine di sasso**



brown meagre; brown meager; (n) (**fishing**) **kavala** {drugi hrv. nazivi: konj, krap, hrb, škrapan, vranac, orgo, vrana; lat. **SCIAENA UMBRA**}

brown Venus clam (n) **rumenka**

Bruce anchor (n) (**boating/yachting**) **sidro tipa Bruce, Bruceovo sidro**: The skipper set his new 20kg "look-alike" **Bruce anchor** in calm conditions, with a trip rope to aid recovery, and then retired for the night with no watch set.

brush /brʌʃ/ (n) 1 (seamanship) četka, kefa; 2 (seamanship) kist, pinel

Brussels conventions (n) (mar law) The main international conventions are referred to as Brussels Conventions, because the diplomatic conferences at which they were adopted were held in Brussels and the Belgian Government acted as depositary of the Conventions and of the related instruments of ratification, accession and denunciation **Briselske konvencije**

B.Sc; Bachelor of Science (n) prvostupnik, *baccalaureus*, prvostupnik inženjer, univ. bacc.

BSc Degree Marine Engineering (n) (mar law, marine eng) akademski stupanj

prvostupnika broskog strojarstva (UK): *The Warsash Academy offers a full engineer officer cadet programme by a degree route, leading ultimately to the award of a UK Maritime and Coastguard Agency (MCA) Engineer Officer's Certificate of Competency (STCW A-III/I OOW), a Foundation Degree (FdEng) in Marine Engineering and a direct top-up pathway to BEng (Hons) Marine Engineering and Management.*

BSc Degree Marine Operations Management (UK) (n) (mar law, navig)

akademski stupanj prvostupnika nautičkih znanosti: *The Academy offers a full deck officer cadet programme by a degree route, leading ultimately to the award of a UK Maritime and Coastguard Agency (MCA) Deck Officer's Certificate of Competency (STCW'95 II/I OOW), a Foundation Degree (FdSc) in Marine Operations and a direct top-up pathway to BSc (Hons) Marine Operations Management.*

(<http://www.warsashacademy.co.uk/courses/course-pages/deck-cadet-foundation-degree-programme/course-details.aspx>) **Bachelor of Science (Honours) Degree in Marine Operations**

Management: *Warsash Maritime Academy offers an academic top-up programme leading to a Bachelor of Science (Honours) Degree in Marine Operations Management. BSc (Hons) indicates one has completed an Honors Degree Bachelor of Science undergraduate program. An ordinary Bachelor of Science accepts grades on a pass/no pass basis. In contrast, an honors designation requires that students demonstrate superior academic performance*

BSc Degree Nautical Science (UK) (n) (mar law, navig) akademski stupanj

prvostupnika nautičkih znanosti

BSS (basis) (n) (shipping econ) osnovni uvjeti ponude u charteringu **owners' best BSS (basis) brodarova najbolja ponuda**

bubble /'bʌbəl/ (n) mjehurić

bucket /'bʌkɪt/ (n) (seamanship) kablič, vjedro, bujol. *Before knocking off he suggested that they dip the tape in a bucket of hot water for a few minutes immediately before using it.*

bucket elevator (n) (cargo handling) vjedričar, žličar

bucket grab (n) (cargo handling) vjedrasta grabilica, grabilica u obliku vjedra. **The superintendent informed everyone that the ship's bucket grabs were to be taken ashore.** *However, for bucket grabs connected to the crane for handling bulk cargoes, it is prudent to make a substantial reduction*

bucket wheel dredger (n) (cargo handling) jaružalo vjedričar

buckle /'bʌkl/ (v) (nav arch, safety) saviti se, ulegnuti se (lim): *Bottom plating on port side of keel buckled extensively for a length of about 15 metres from stem and holed in fore peak tank and bow thruster space* Oplata dna s lijeve strane kobilice bila je jako udubljena u dužini od oko 15 metara od pramčane statve i probijena u prostoru tanka pramčanog pika i pramčanog porivnika. *The impact caused the tank frame to buckle and resulted in the release of a small quantity of the tank's contents.*

buckling /'bʌkliŋ/ (n) (nav arch, marine eng) the departure of a plate, shape, or stanchion from its designed plane or axis when subjected to load or to strains introduced during fabrication, thereby

reducing its ability to carry loads **savijanje, uleknucé (limova i konstrukcije pri sudaru)**: *Hull girder strength and **buckling** checks are carried out on all critical sections along the entire length of the hull. The hull failed along the line of a welded deck seam close to the tank hatch coamings, causing **buckling** of the main deck and ship sides. An investigation into the accident determined that, among other contributing factors, the vessel's hull did not have sufficient **buckling strength**.*

buffer tank (n) 1 (marine eng) **SEE settling tank taložni tank**; 2 (marine eng) tank za miješanje goriva, **banana tank**

build **build in** ugraditi (v) (marine eng, nav arch) graditi, izgraditi

builder (n) (nav arch) proizvođač, konstruktor

builders (n) 1 (nav arch) **brodogradilište**: *He left school at 16 and worked in a **boat builders**. The bolts had not been properly tightened up after its first trial inspections in the **builder's** yard.*; 2 **brodograditelji**

builders trials (n) (nav arch) an event conducted by the shipyard/contractor to inspect, test and evaluate a ship's performance underway **pokusne vožnje, probne vožnje**

building slip (n) (nav arch) = **slipway; slipways** navoz

build the pressure (v) (cargo handling) povećati tlak (u cjevovodu tereta)

build-up (n) 1 (navig) rast, narastanje, gomilanje, akumulacija, povećanje **build-up of traffic** povećanje prometa (u kanalu), rast prometa (brodova): *Because of morning fog, there was a **build-up** of slow-moving traffic in the Great Bitter Lake.*; 2 (oceanogr) akumulacija **leda, stvaranje naslaga**; 3 (safety) **nakupljanje, akumulacija**: *The liferaft bowing wires had seized in their aluminium channels, on the ship's side, due to a **build up of corrosion deposits** within the channels.*

bulb /bʌlb/ (n) 1 (nav arch) **kruškolik pramac, bulb stern bulb**; 2 (electr)

žarulja: *The **bulb** was changed but without success and after several bulbs were plugged in with the same result it was found that the electric circuit was broken.*

bulbous bow /'bʌlbəs baʊ/ (n) (nav arch) a part of the bow with a round, bulging shape at the bottom of a ship to improve flow and resistance characteristics **pramčani bulb, bulbasti pramac, bulb pramca, kruška (pramca), pramac s bulbom, bulb**: *The vessel herself sustained only minor damage to her **bulbous bow**. Despite that, the ship continued to move forward with her **bulbous bow** ramming against the dam and only came to a standstill there.*

bulid up (n) (navig) **razvijati brzinu, povećavati brzinu**: *The pilot put the engine astern and was building up through slow and half to full astern to bring the ship to a stop*

bulk /bʌlk/ 1 (adj) **glavni dio, najveći dio**; 2 (n) **rasuti teret**

bulk /bʌlk/ (adj) **in bulk** u voluminoznom stanju, u nepakiranom stanju, **bez ambalaže**: *Traditionally, scrap metal has been carried **in bulk** and is, therefore, subject to the Bulk Cargo (BC) Code. The vessel loaded cement **in bulk** in two small ports in the Mediterranean.* 1

nepakiran, bez pakovanja, u nepakiranom stanju; 2 **voluminozan**; 3 **u rasutom stanju, u sipkom stanju**: *A bulk carrier loaded a full cargo of wheat **in bulk**.*

bulk cargo (n) **break bulk cargo** **komadni teret, generalni teret** 1 (cargo) tereti (suhi i tekući) koji se prevoze u velikim količinama i bez pakovanja; loose cargo (dry or liquid) that is loaded (shoveled, scooped, forked, mechanically conveyed or pumped) in volume directly into a ship's hold; e.g., grain, coal and oil. **masovni tereti**: *Grain, coal and sulfur are usually bulk cargo A coaster,*

recently purchased by new owners, completed unloading her **bulk cargo** at a berth in a small harbour. **liquid bulk cargo** **tekući tereti**, **bulk grain cargo**: Bulk grain cargoes are often fumigated to prevent or to address insect infestation. **teret žita u sipkom stanju**; **2 (cargo)** unpackaged dry cargo such as iron ore, non-ferrous mineral, coal or grain **rasuti teret**, **sipki teret** **dry bulk cargo** **suh rasuti teret** **rasuti teret**

bulk cargo carrier; bulk carrier; bulk-carrier; bulkcarrier (*nav arch*) = **bulk-carrier** **brod za rasuti teret**

bulk-carrier (*n*) (*nav arch*) = **bulk cargo carrier; bulk carrier; bulk-carrier;**

bulkcarrier **brod za rasuti teret**: A large **bulk carrier**, in ballast, embarked a pilot at the entrance to the port and headed upriver on an ebb tide. Own vessel was a handymax **bulk carrier**.

self-unloading bulk-carrier **brod za rasute terete s vlastitim uređajem za iskrcaj tereta**, **geared bulk-carrier** **brod za rasute terete s vlastitom opremom za**

ukrcaj/iskrcaj tereta: Back in 1979, I was Master of a on a long-term charter carrying grain from the USA and Canada to Russia, and this often necessitated a Great Lakes transit.



bulk cement pipeline (*n*) (*ports*) **cjevovod za iskrcaj cementa**

bulk container (*n*) (*cargo*) a container designed for the carriage of free-flowing dry cargoes, which are loaded through hatchways in the roof of the container and discharged through hatchways at one end of the container. **kontejner za sipke terete**: Bulk containers are used in particular for transporting bulk cargo, such as grain, feedstuffs, spices. Some special dry bulk containers resemble tank containers.

bulker rate (*n*) (*shipping econ*) **najamnina za brod za rasute terete**: HANDYSIZE **bulker rates** have continued their cent rally in the past week, supported by a burst of demand in both the Pacific and Atlantic basins.

bulk freight (*n*) (*shipping econ, US*) = **bulk cargo** **masovni teret**

bulkhead /'bʌlkhed/ (*n*) **1** (*nav arch*) the vertical (cross or longitudinal) partitions that divide the ship's hull into separate compartments **brodska pregrada**: The **bulkhead** between the shaft tunnel and the main engine room could not withstand the hydrostatic water pressure ... **transverse**

bulkhead **poprečna pregrada**: On the inclined plates of the hopper tanks and in the lower hold and the lower stool of the **transverse bulkhead**, extensive damage in the shape of groove corrosion was found with depth up to 9mm in places. , **collision bulkhead** **protusudarna pregrada**: The **longitudinal bulkhead** in way of water ballast tank no. 3 Finally, the **collision bulkhead** saved the boat from being

lost. The **collision bulkhead** was not penetrated and there was no pollution. , **longitudinal bulkhead**

uzdužna pregrada, **bulkhead door** **vrata pregrade**, **double skin bulkhead** **dvostruka pregrada**, **watertight bulkhead** **nepropusna pregrada**; **2** a structure used to protect

against shifting cargo and/or to separate the load **pregrada** {*tal.:* **paratia**}

bulkhead deck (*n*) (*navig*) **pregradna paluba**

bulkhead strake (*n*) (*nav arch*) **voj pregrade**

bulkhead stringer (*n*) (*nav arch*) **proveza pregrade**

bulk liquid (n) (cargo) Unpackaged, homogenous liquid goods, without mark or count and usually free-flowing, bought and sold by weight or volume, such as crude oil, oil products etc. **tekući teret**, **tekući masovni teret**. *Sampling is an important part of the **bulk liquid cargo** custody transfer process and can help in protecting the ship's interests in the event of disputes over cargo quality.*

bulk liquid chemicals (n) (cargo) kemikalije u razlivenom stanju

bulk raw material (n) (cargo, shipping econ) sirovine u rasutom stanju, sirovine (koje se prevoze) u velikim masama

bulk unloader (n) (cargo handling) lopatičar

bulk vessel (n) (nav arch) = **bulk-carrier** brod za rasuti teret, brod za suhe

masovne terete: *The **bulk vessel** was now very close and collision could not be avoided; the **bulk vessel** struck the container vessel amidships on the port side.*

bulky /'bʌlki/ (adj) (cargo) velik, glomazan: *The boat had an old **bulky** lifejacket stowed in the bows, and a lifebelt.* **bulky cargo** COMPARE **awkward cargo** **glomazan teret**, **teret veilkog obujma**

bulldozer /'bʌl,dəʊzə/ (n) (cargo handling) buldožer

bullnose /'bʌlnəʊz/ (n) 1 (nav arch) sidreno oko (u pramčanoj statvi); 2 (nav arch, boating/yachting) zjevača za privezno uže

bull ray (n) (fishing) golub

bulwark /'bʌlwərk/ (n) (nav arch) the wall around any deck exposed to the elements. This includes the weather deck, the poop deck, the fore deck, and any deck on the superstructure. On top of the bulwark is a flat rail (or plate) called the rail. **linica**, **partigeta**, **tal. paratia**: *A seaman was told to look over the **bulwark** and to inform the bosun when the breastlines had been released. The tug's deck is obstacle free and with a 1.1 m **bulwark**.* **bulwark rail** šina linice, **rukohvat linice**, **bulwark stay upora linice**

bulwark planking (n) (sailing vessels) oplata ograde

bulwark rail (n) (nav arch) razma

bulwark rail section (n) (nav arch) razma

bulwark stanchion (n) (sailing vessels) izdanak rebra

bulwark stay (n) (nav arch) podporanj ograde

bundle /'bʌndəl/ (n) (cargo) svežanj (tereta), snop

bung /'bʌŋg/ (n) (boating/yachting) čep za ispusni otvor

bunk (n) (seamanship) built-in sailor's bed aboard ship **mornarska postjelja (u kabini)**,

mornarski krevet, **postjelja u kabini**, **tal. cucceta**: *The fishing vessel heeled over considerably, throwing one of the crew out of his **bunk**.*

bunker /'bʌŋkə/ (n) 1 (seamanship, marine eng) fuel used aboard the ship; Compartment for the storage of oil or other fuel.; (in old steam ships) a compartment used for stowage of coal **gorivo**, **pogonsko ulje** **bunker delivery** isporuka / ukrcaj goriva, **bunker consumption** potrošnja goriva, **total bunker cost** ukupna potrošnja goriva, **bunker space** prostor za spremanje goriva, prostor za bunker, **coal bunker** bunker za ugljen, spremište za pogonski ugljen, **fuel oil bunker** a large storage container or tank, originally for coal, but today mainly for fuel oil **bunker za pogonsko gorivo**, **bunker za pogonsku naftu**, **bunker ex barge** opsrb goriva s teglenice-cisterne, **bunker ex pipe** opsrb

goriva iz pumpnih cijevi na terminalu, grades of bunker vrste goriva, bunker barge maona / brodica za opskrbu gorivom: *Just after midnight, a **bunker barge** moored on the starboard side of a bulk carrier at anchor off port limits (OPL), with two lines and a spring forward and aft.*, **bunker pipe cijev za opskrbu gorivom:** *The full length of the **bunker pipe** should then be examined for its condition.*, **bunker hose fleksibilna cijev za opskrbu gorivom:** *On close inspection the **bunker hose** outer core was found cut in two areas - see pictures.*, **bunker requirements potrebe za gorivom:** *The Master was kept busy with the phone calls and frequent internal calls to the engine room about **bunker requirements** and myself (OOW) drawing up the new Passage Plan.*, **bunker tank tank goriva:** *This had resulted from a split between the ballast tank and an adjacent **bunker tank**, which had been caused during the grounding.*, **bunker line cijev za opskrbu gorivom:** *He checked the starboard fuel oil tank to reduce the pressure in the **bunker line**;*
2 compartment for the storage of oil or other fuel spremište za gorivo

bunker /'bʌŋkə/ (v) (marine eng) krcati gorivo

bunker /'bʌŋkə/ (n) (nav arch) ugljenara (na parobrodu), **bunker**

bunker cost (n) (shipping econ) troškovi goriva, troškovi za gorivo: *Bunker cost constituted about 25% of hire cost in 2000.*

bunkering (n) (marine eng, seamanship) krcanje goriva, opsrbljivanje gorivom, bunkeriranje, krcanje **bunkera**, bunker **bunkering facilities** oprema za opskrbu gorivom, kapaciteti / uređaji za ukrcaj i iskrcaj goriva, **bunkering operations** operacija krcanja goriva, proces krcanja goriva: *Cleanup is underway off Spain after a containership spilled fuel oil during **bunkering operations** Tuesday night.*

bunkering barge (n) (nav arch) teglenica za opskrbu brodova gorivom: *Just after midnight, a **bunker barge** moored on the starboard side of a bulk carrier at anchor off port limits (OPL), with two lines and a spring forward and aft.*

bunkering hose (n) (marine eng) fleksibilna cijev za opskrbu gorivom, cijev za opskrbu gorivom: *Have the **bunkering hoses** been satisfactorily connected and suspended on ship and supplier? Jesu li crijeva za snabdjevanje sigurno spojene i osigurane između broda i snabdjevača?*

bunkering supply pump (n) (marine eng) dobavna pumpa goriva za brod: *The **bunkering supply pumps** must be stopped momentarily at a place close to the manifold on supplier. Mora biti omogućeno trenutno prekidanje rada pumpi s mjesta u blizini manifolda.*

bunkers (n) (seamanship) a term referring to fuel used aboard the ship; the quantity of fuel on board a vessel **gorivo, bunker:** *The plan was to take **bunkers** before proceeding to Tacoma, USA.*

bunker tank (n) (marine eng) tank goriva: *When lining up for bunkering, confirm that the **bunker tank** filling valves are fully open according to the bunkering plan.*

bunker vessel (n) (nav arch) tanker za opskrbu gorivom: *monitoring and residual forward movement of the **bunker vessel** significantly contributed to the incidents; 3 Inadequate work planning: The size of the **bunker vessel** required more detailed hazard analysis and planning for the mooring operation ...*

buntline /'bʌntlɪn ; 'bʌnt,lɪn/ (n) (boating/yachting) konopac za odvijanje i ubiranje jedra oko deblenjaka i križeva; one of the lines attached to the foot of a square sail to haul the sail up to the yard for furling **ubralja**

buoy /bɔɪ; US 'bu:ɪ/ (n) (navig) a floating object of defined shape and color, which is anchored at a given position and serves as an aid to navigation; it can also be used to indicate a laid mooring

plutača plovidbena oznaka bova; tal. boa *The VTSO replied: "Proceed to **buoy No1**. Keep*

watch all the time. **floating buoy** plutača, **plutajuća oznaka**, **mooring buoy** privezna plutača, **navigation buoy** navigacijska plutača, **set a buoy** postaviti plutaču na ucrtanu poziciju, **approach the buoy**: On approaching buoy 9, the Pilot initiated the agreed starboard turn anticipating that the westerly set of the current would assist the vessel to swing to starboard. **prilaziti plutači**, **pass the buoy**: At 2334 the master saw the other ship pass between the No1 buoys and became concerned that the container ship had not altered course to port as he had expected. **proći plutaču**, **near the buoy** približiti se plutači, **lateral buoy** lateralna plutača, **bočna plutača**: The mate glanced out of the window and noticed the flashing red light of a lateral buoy ahead., **east / north / south / west of buoy No. ...** istočno / sjeverno / južno / zapadno od plutače br. ..., **distance from buoy No. ...** udaljenost od plutače br. ..., **pair of lateral buoys** par lateralnih plutača, **leave the buoy** napustiti plutaču, **fairway buoy** prilaziti plutači na početku plovidbenog kanala, **prići plutači koja označava plovidbeni kanal**: The cargo vessel's master was alone on the bridge as the vessel approached the fairway buoy. Shortly after leaving the harbour, the vessel was brought up in a position 1 cable from the fairway buoy, 1., **go round the buoy** oploviti plutaču: When approaching No. 1 buoy, go round the buoy and enter in the correct lane., **channel buoy** plutača koja označava plovni kanal: With 1 mile to go, the chief officer called port control again and was instructed to keep east of the outer approach channel buoy., **single point mooring buoy (SPM buoy)** vez na jednu plutaču: An oil tanker was moored to, and discharging to, a single point mooring (SPM) buoy., **cardinal buoy** kardinalna oznaka, **glavna oznaka**: He then altered course to 022° in autopilot to head directly towards a cardinal buoy at the start of the approach channel, the outer limits of which were marked by leading lights., **deploy a buoy** postaviti plutaču: A meteorological and oceanographic data buoy has been recently deployed approximately 60km offshore along the Northern coast of Poland

buoyage /'bɔɪdʒ/ (n) **buoyage system** balisaža, **General Direction of Marks** opći smjer balisažnih oznaka: Around the British Isles the General Direction of Buoyage runs north along the west coast and through the Irish Sea, east through the English Channel and north through the North Sea (the opposite is true in IALA system B, for example in the USA).

(<https://www.trinityhouse.co.uk/mariners-information/navigation-buoys/lateral-marks>) (safety, navig)

označavanje pomorskih plovni putova, **sustav označavanja plovidbenih putova**, **sustav oznaka plovni putova**, **balisaža**, tal. **segnalamento con boe**; **segnalazione**

buoyancy /'bɔɪnsi US 'bu:ʒənsi/ (n) **1 (nav arch)** ability of the ship or boat to float; the supporting effort exerted by a liquid (water) upon the surface of a body, wholly or partially immersed in it **uzgon broda** **center of buoyancy** the geometric center of gravity of the immersed volume of the displacement or of the displaced water, determined solely by the shape of the underwater body of the ship **težište uzgona**, **buoyancy tank** **uzgonski tank**: It is important to realise that both the stern and bow buoyancy tanks must be kept watertight.; **2 (safety)** **plutanje**, **osobina plutanja**: She was overloaded with equipment and fittings, and her freeboard and buoyancy were inadequate as a result. Fortunately, his lifejacket gave him the buoyancy to remain afloat and cling onto the side of the boat until the helicopter arrived.

buoyancy aids (n) (boating/yachting) **uzgonska pomagala**: All were wearing buoyancy aids. The passenger was not a strong swimmer and only had a 50N buoyancy aid on.

buoyancy bag (n) (boating/yachting) **zračna komora od pneumatskih vreća smještenih u bokovima trupa jedrilice zbog kojih jedrilica pluta pri prevrtanju ili potapanju** **uzgonska komora**

buoyancy bags (n) (boating/yachting) uzgoske pneumatske vreće

buoyancy curve (n) (nav arch) krivulja uzgona

buoyancy force; Bf (n) (stabil) the force acting vertically upwards **silu uzgona** *If the lines of Wf and Bf are considered, they will act to return the ship to the upright condition.*

buoyancy reserve (n) (nav arch) rezerva plovnosti, rezerva plutanja

buoyancy tanks (n) (boating/yachting) uzgonske vreće (u trupu sportske jedrilice)

buoyant apparatus (n) 1 (nav arch) uzgonska oprema; 2 (nav arch) splav za spašavanje (zastarjelo)

buoyant lifeline (n) (safety) plutajuće uže za spašavanje

buoyed /UK bɔɪd; US 'bu:ɪd/ (adj) (navig) označen plutacom: *the principal dangers are buoyed*
buoyed fairway označeni plovidbeni kanal: *The vessel came rapidly on port and got out of the buoyed fairway and entangled the buoy chain with her screw.*, **buoyed channel označeni plovidbeni kanal, plovidbeni kanal označen plutacama**: *As the tanker left the buoyed channel, the second ship was only 4 cables fine off the container ship's port bow (Figure 8).*

buoy laying vessel (n) (nav arch) brod za plutace, brod za postavljanje plutaca

buoy mooring (n) (ports) vez na plutaci: *The port lifeboat had been launched while at a sheltered buoy mooring. I am a mooring Master at an offshore oil terminal and regularly berth large tankers to buoy moorings.*

burden; burthen /'bɜ:dn/ (n) 1 (nav arch) the carrying capacity of a vessel **teretni kapacitet broda**; 2 (shipping econ) the weight of a ship's cargo **težina tereta na brodu full reach and burden** the cargo space, which is normally available for cargo, including lawful deck capacity. **sav kapacitet broda za teret, teretni kapacitet broda**; 3 (seamanship) napor, opterećenje **heavy burden veliko opterećenje (za zapovjednika, časnika, posadu)**: *The pressure and demands of a stressful sea passage preceding the berthing had placed a heavy burden on the master and the officers and may have affected their judgement.*

burdened vessel (n) (mar law, navig) = **give-way vessel** brod koji je dužan izbjegavati, brod koji izbjegava {u izbjegavanju sudara}

burden of proof (n) (mar law) teret dokaza, teret dokazivanja

burden of proving (n) (mar law) teret dokazivanja: *The consignee or cargo owner has the initial burden of proving the physical loss or damage.*

burgee /'bɜ:dʒi:/ (n) 1 (boating/yachting) mala zastavica na vrhu jarbola koja pokazuje smjer prividnog vjetrova; a small triangular flag flown at the masthead, useful to indicate apparent wind direction **vjetrulja, vjetrokaz**; 2 a yachting pennant, usually pointed, identifying the shipowner or sailing organisation **zastavica brodovlasnika ili jedriličarskog društva**

burn /bɜ:n/ **burn through progorjeti (v) gorjeti, izgarati** {burn - burnt/burned - burnt/burned}

burn /bɜ:n/ 1 (safety, med) opekline: *One crew member sustained first-degree burns in the fire. The chief engineer staggered backwards and suffered burns to his right forearm, face and chest.*

sustaining burns dobiti opekline, burn injury opekline: *Burn injuries should always be immediately cooled, under clean, cold running water, for at least 10 minutes.*, **convert burn energy pretvoriti toplinsku energiju**: *The nozzle acts to convert heat energy in the steam into kinetic energy.*; 2 (marine eng) izgorjeli dio **burn hole rupa nastala izgaranjem**: *Damaged piston crown: A burn hole of about 10 mm diameter was found in no. 6 piston crown.*, **burn damage šteta**

nastala izgaranjem: *The resulting fire caused substantial **burn damage** to adjacent electrical fittings and paintwork on the deck, vertical surfaces of the bulkhead and a ventilator cowl.*

burner /'bɜ:nə/ (n) (marine eng) gorionik, gorač, plamenik pressure jet burner tlačni gorionik, oil-fuel uljni gorionik, naftni gorionik, rotating burner rotacijski gorionik, steam blast jet burner gorionik s raspršivanjem putem vodene pare, burner barrel tijelo gorionika, tijelo plamenika, burner carrier nosač gorionika, burner tip vrh gorionika, vrh plamenika

burning /'bɜ:nɪŋ/ 1 (adj) koji gori, goreći: *The vessel was later towed into harbour, still burning and with the main engine running. burning surface goreća površina, burning vessel zapaljen brod, brod koji gori: The crew abandoned the burning fishing vessel safely, using the liferaft to transfer to a nearby fishing vessel which had responded to the "Mayday".; 2 (n) gorenje, vatra smell of burning miris gorenja: *There was a smell of burning around the electrical supply breaker panels, and a number of earths were detected, as well as a high temperature bow thruster motor alarm.**

burn out (v) (marine eng) pregorjeti, izgorjeti: *No. 2 blower motor was also burnt out motor puhala br. 2 potpuno je pregorio*

burst /bɜ:st/ (v) (marine eng) prsnuti, puknuti, pući (o cijevi), eksplodirati: *Meanwhile the ETO found the defective box which, when opened burst into flames. Forepeak tank vent heads burst and detached from base due to the shock pressure wave generated by the water inside the fully-ballasted forepeak tank.*

burton /'bɜ:tən/ (n) COMPARE block and tackle (seamanship) a light tackle having double or single blocks, used to hoist or tighten rigging manji čekrk, čekrk manje snage Spanish burton čekrk s tri koloturnika i kukom

6–55. Determine the force P needed to support the 20-kg mass using the *Spanish Burton rig*. Also, what are the reactions at the supporting hooks A , B , and C ?

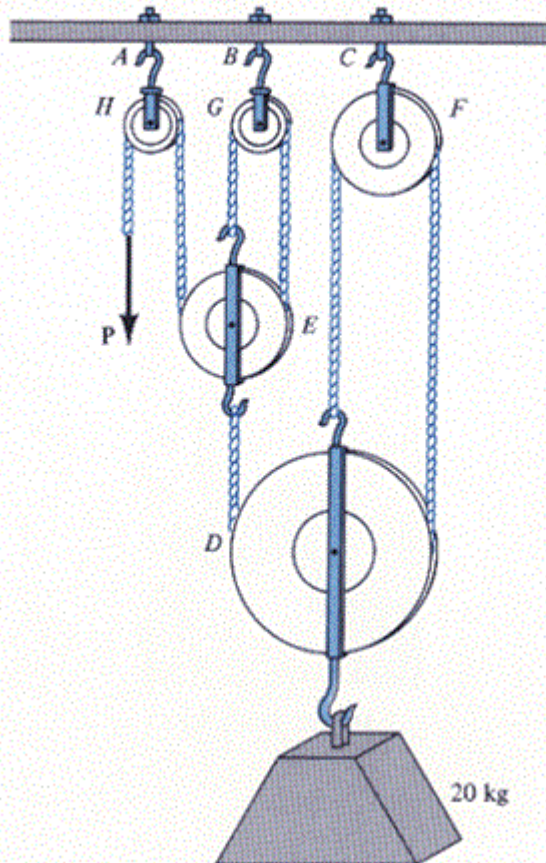

Probs. 6–55 / 6–56

burtoning /'bɜ:təniŋ/ (*cargo handling*) a system of handling a ship's cargo by means of a sling rigging between two derricks or masts **krcanje tereta s dvije samarice, amerikana, udvojene samarice**

bus bar /'bʌs bɑ:.(r)/ (*n*) (*electr*) **sabirnica**: Onboard tests showed that if the **bus bar** frequency dropped from 60Hz to below 58Hz, two of the three generators experienced severe voltage and frequency oscillations.

bush /bʊʃ/ (*n*) **1**: The rotating gland is held in place by a two-piece clamp ring that is tightly mounted on the tail shaft and is also connected to the **bush** by means of bolts, maintaining the forward seal gland in position. **a** (*marine eng*) **ležaj stapnog svornjaka, bukula; tal. boccola; 2 klipna / stapna očica**

bushing /bʊʃɪŋ/ (*n*) **control bushing** razvodna čahura, cilindar razvodnika **1** (*marine eng*) **tuljac, rupa za osovinicu; 2 bukula**

business account (*n*) (*shipping econ*) **poslovni račun (u banci)**

busy ports (*n*) (*navig*) **lukes velikim/ gustim prometom**: *Jebel Ali is a very busy port that deals with a significant number of vessel movements each year.*

busy waters (*n*) (*shipping econ*) **prometne vode, vode s gustim prometom**: *The vessel*

lost her main propulsion engine in restricted and busy waters.

butt /bʌt/ (n) (sailing vessels) a place where two planks or steel plates are joined at the ends without overlapping **štik planking butts štikovi trenica**

butt clearance (n) (marine eng) **zračnost krajeva prstena, razmak krajeva prstena, čelni zazor (prstena)**: *In addition, the butt, or end to end, clearance of the rings was excessively large and the rings were poorly spaced around the piston.*

butt dowel /'bʌt, 'daʊəl/ (n) (sailing vessels) **spojni šip**

Butterfly head **krasta glava (vijka), leptirasta glava (vijka)**: *Is it not possible that within the hatch the Bolt could be fitted with a Butterfly head, in order that the bolt can be released from the inside?*

butterfly nut (n) (nav arch) **krilasta matica, leptirasta matica**

butterfly valve (n) (marine eng) **leptirasti ventil**

Butterworth hatch (n) (nav arch) an opening on the deck of a vessel opened when cleaning or ventilating the tanks **ventilacijsko grotlo, ventilacijsko grotlo tipa Butterworth, ventilacijski otvor**: *it had become normal practice to use the portable washers which were passed through open Butterworth hatches The accompanying seaman, who opened the tank's Butterworth hatch,*



was not protected.

Butterworth hose (n) (cargo handling) water discharge hoses designed and manufactured for the tank cleaning operations **crijevo u sustavu pranja tankova tipa Butterworth**: *Connect two Butterworth hoses to Y piece in front of valve BG... and Fire Main Line. The function of a Tank Cleaning Buterworth Hose is to transport water or a cleaning solution from a water source such as pump*



or hydrant to the inlet of a portable tank cleaning machine

Butterworth machine (n) (cargo handling, nav arch) **stroj za pranje tankova tipa**

Butterworth

butt joint (n) (nav arch) spoj dviju trenica (madira) po dužini: Hence, fillet joints are



susceptible, whereas **butt joints** never have this problem.

buttock; buttocks /'bʌtək/ (n) (nav arch) presjek brodsakoga oblika ravninom usporednom s uzdužnom simetričnom ravninom **uzdužnica broda**, **uzdužnice broda**, **uzdužna vodoravna ploha broda**, **uzdužna ravnina**, **uzdužne ravnine broda**

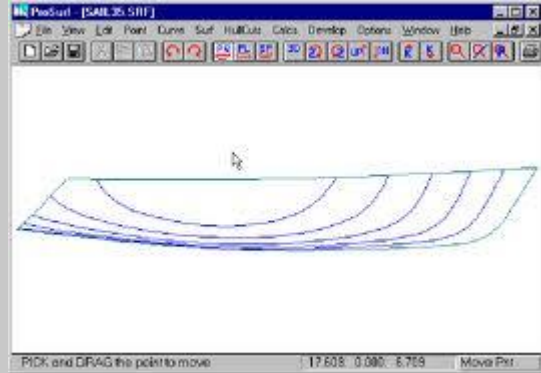

buttress (n) **1** (nav arch) potporni stup (rebro), oslonac, potporanj; **2** (cargo handling) lateral supports acting between the container stacks and the ship's structure **bočni potpornji za vezivanje kontejnera za strukturu broda**

buttress system (n) (cargo handling) on large container ships - a system of large towers (bird cages) attached to the ship at both ends of each cargo hold, esp. deck cell guides on the stern; **sustav palubnih vodilica za vezivanje i pričvršćivanje kontejnera**, **sustav vezivanja i pričvršćivanja kontejnera na brodu**

butt seams (n) (sailing vessels) štikovi trenica

butt sewing (n) (nav arch, seamanship) odvajanje trenica radi šuperenja (kalafatanja)

butt strap (n) (nav arch) stičnica

butt welding (n) (nav arch) čelno zavarivanje **but joint welding** stično zavarivanje

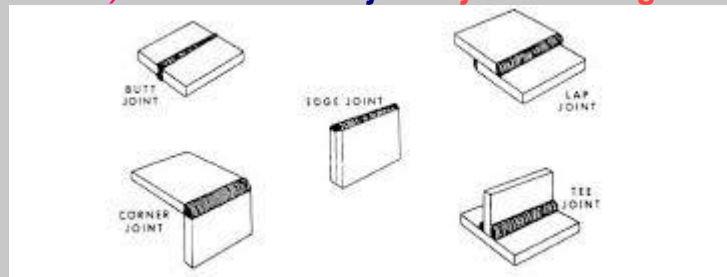

čelno zavarivanje

buyer /baie/ (n) = **purchaser** (shipping econ, mar law) **kupac**

by and large (prep phr) (boating/yachting) sailing somewhat off the wind (about five to seven points off) **jedriti blago od vjetra**

bye-laws /'bai b:z/ (n) **1 (mar law) a lokalni propisi**: Appropriate Byelaws, Regulations and directions for navigating in the Pilotage district; **2 (mar law) statut (tvrtke, trgovačkog društva)**

by-pass /'baipa::s/ (n) **by-pass valve** cirkulacijski ventil, ventil za rasterećenje (marine eng) **mimovod, obilaženje, bajpas, odvod**

by-pass /'baipa::s/ (v) **obilaziti, odvoditi, voditi mimo, mimoilaziti, bajpasirati**

by the board (prep phr) (seamanship) **preko palube, u stranu broda**

by the head (prep phr) **1 (seamanship) deeper forward (front end deepest in water) ispred pramca; 2 (seamanship) duboko na pramcu; 3 (seamanship) pretežan brod (pramac uronjen više od krme)**

by the lee (prep phr) (boating/yachting) **skretanje od vjetar pri jedrenje u krmu (opasnost of kruženja i prebacivanja delenjaka)**

by the mark (prep phr) (seamanship) **lanac (u moru) do oznake**

by the stern (n) (stabil, seamanship) **ANTONYM by the head** **zatežan brod (krma uronjena više od pramca)**

by the wind (prep phr) (boating/yachting) **u vjetar, oštro u vjetar**

C 1 (meteorol) celzij, celzijev stupanj; 2 (chem) ugljik (Celsius, Centigrade; Carbon)

cabin (n) (nav arch) **kabina, mornarska kabina**: Immersion suits must be provided for each member of the crew and be kept in each Seaman's **cabin**. The master was in his **cabin** and the other watch AB was on stand-by in the crew mess room, both were easy to call through the ship's intercom.

cabin boy (n) (seamanship) **mladić sobe, mali od kamare**

cabin cruiser (n) (boating/yachting, nav arch) motor boat with cabin and berths **motorna brodica s kabinom, krstaš (manji)**

cabin sole (n) (boating/yachting) **pod kabine (jedrilice)**

cable /keibl/ (n) **1 = chain cable** A chain or line (rope) bent to the anchor. **sidreni lanac**: Own vessel's Master ordered the anchor party forward and by slacking away the anchor **cable** a collision was avoided. The port anchor was then let go using a similar amount of **cable** as before, but when applying the brake, the windlass catastrophically failed.; **2 (navig) a measure of length or distance - equivalent to (UK) 1/10 nautical mile, approx. 600 feet; (USA) 120 fathoms, 720 feet (219 m) (archaic use) kabel (1/10 nm = 185,2 m)**: The other ship was now at a distance of some 3 cables and approaching at speed on the port side; **3 (electr) električni kabel**: The power **cable** for the grinders was deployed across the deck, which was about two metres above sea level. Damage to **cable** insulation and fittings - speedy actions by the crew were commendable. Lessons Learned * Steel braiding on **electrical cable** is required to be 'earthed' at both ends for safety reasons. **cable armour kabelska armatura, kabelska zaštita, cable gland kabelska uvodnica, cable insulation izolacija električnog kabela**: This caused an electrical short, resulting in sparking and leading to high temperatures which caused damage to the **cable insulation** and fittings., **supply cable dovodni kabel, opskrbeni kabel**: Early in the morning, the crew noticed that one of the distribution boxes appeared to be live, and that the terminals on the **shore supply cable** were not

insulated, were bundled together and were hanging close to a metal grating above the deck.,
electrical cable električni kabel: The heavy *electrical cable* was led parallel to the shore gangway that was hooked on to the ship's side bulwark on the main deck.; 4 (comm) telegram; 5 (seamanship) originally, a thick strong rope or wire **uže (za privezivanje i tegljenje, obično**



deblje)

cable /keibl/ (v) (comm) poslati telegram, telegrafirati

cable connection (n) (electr) **kabelski spoj, kabelski priključak**: Never begin an exercise without first checking that all bolts are tight, cables are not frayed, *cable connections* are secure, rack pins are securely in position, ...

cable crossing (n) (seamanship) **ukrižani konopi, ukrižana užad**

cable gland (n) (electr) **kabelska uvodnica**: The proximity switch was incorrectly fitted with its *cable entry gland* higher than the switch body thereby increasing the possibility of water ingress.

cable laid (n) (seamanship) **konop sukan u devet strukova (3 x 3 struka)**

cable layer (n) (nav arch) **polagač kablova**

cable-laying ship (n) (nav arch) **brod za polaganje kablova, polagač kablova**: A 10 year old *cable laying vessel* was heading for dry dock with a pilot on board.

cable-length 100 fathoms or 600 feet **dužina lanca od 600 stopa (182,88 m)** {6 feet to a fathom}

cable lifter (n) (seamanship, nav arch) = **wildcat** **podigač lanca, nazupčeni bubanj sidrenog vitla** *barbotin*, tal. *barbotin*; *ruota ad impronte*



cable mark (n) (seamanship) **oznaka lanca, mjerilo lanca**

cable party (n) (seamanship) in large ships, a group of hands (sailors) needed forward to handle the chain cable or mooring ropes **grupa za sidrenje**

cable ship; CS (n) (nav arch) a ship specially designed to install and repair telecommunications

cables laid on the seabed **brod za polaganje kabela**

cable sleeve (n) (boating/yachting) završetak konopa, stezaljka užeta tipa **norseman**

cable stopper (n) (nav arch) štoper sidrenog lanca: *On the forecastle, the bosun proceeded to show a newly-joined deck officer the features of the 'guillotine'-type anchor cable stopper bar arrangement.*

cable termination (n) (electr) kabelaška stezaljka, kabelaški priključak, **klema**: *It was also observed that the cable terminations within the socket were loose and there was poor contact within the multiple outlets of the adaptor.*

caboose /kəˈbuːs/ (n) 1 (nav arch) a deckhouse for a galley aboard ship (archaic use) **grotlo brodske kuhinje**; 2 (boating/yachting) any odd corner used as a store **privremeno spremište** {na starim brodovima}

cabotage /ˈkæbətɑːʒ/ (n) (mar law) = **coastal service** shipment and sea transport of cargo

between coastal ports of one state **mala obalna plovodba, kabotaža, obalna plovodba**:

Cabotage is often governed by statutes, requiring, for example, that only ships flying the flag of the coastal state concerned may engage in the coasting trade between ports of that state, unless waivers are obtained from the government of the state. {today, any coastal navigation, irrespective of the ship's flag}

cadet /kəˈdɛt/ (n) 1 **kadet, vježbenik**: *The OOW was accompanied on the bridge by a cadet and a lookout. My seafaring adventures started in 1984 with where I progressed from cadet to master specialising in petro-chemicals. Captain ... commenced his sea-going career with of Leith, working on Line steamers as cadet and second officer between 1972 and 1979 navigating*

cadet kadet, vježbenik palube: *He started as a Navigating Cadet with BP Tanker Company in 1971 serving in crude and product tankers worldwide., engineering cadet asistent stroja,*

vježbenik stroja: *An oiler and an engineering officer cadet were assigned to sound the bunker tanks., dual cadet polivalentni kadet, kadet palube i stroja, deck cadet kadet*

palube, engine cadet vježbenik stroja asistent stroja: *In order to prime the pump, the Third*

Engineer instructed the Engine Cadet to open the lubricating oil storage tank valve., progress from cadet to

napredovati od kadeta do ..: *His seafaring career started in 1981 with ... where he*

progressed from cadet to master specialising in petro-chemicals., oversee the cadet nadzirati

kadeta: *To facilitate their training, the chief officer was overseeing one cadet who was taking charge of the lifeboat drill, while the second mate was overseeing the other cadet who was taking charge of a fire*

drill.; 2 (navy) kadet na ratnom brodu; 3 vježbenik palube, student visoke

pomorske škole: *As the vessel approached the Varne Bank the deck cadet became aware of flashing white lights ahead but he did not identify the lights or report the sighting to the OOW. {In English usage (UK, US, etc.) the term 'cadet' refers to both 'navigating' and 'engineering' cadets whereas In Croatian the corresponding term Kadet (=cadet) only refers to 'navigating cadets'. The word for 'engineering cadet' is 'asistent stroja' or 'vježbenik stroja'.}*

cadetship /kəˈdɛtʃɪp/ (n) 1 (mar law) an officer cadet training programme **kadetura, studijski**

program za pomorske časnike, školovanje prije stjecanja pomorskog časničkog

zvanja: *A cadetship is a great pathway to a career in fields such as marine engineering, navigation,*

surveying, horticulture and even IT. deck cadetships studijski programi za časnika palube

All UK officer cadet training programmes (deck cadetships) are financed or sponsored by a number of shipping companies and maritime recruitment specialists, in order to complete the sea time elements of the training programme. Anyone wishing to undertake an officer cadetship should apply directly to the

shipping companies and their representatives, not to Warsash or UCAS., engineering cadetships

studijski programi za brodstrojarske časnike; 2 čin kadeta navigating cadetship

vježbenik palube, kadet, **engineering cadet** vježbenik stroja, asistent stroja
cage /keɪdʒ/ (n) (marine eng) kavez, kućište **exhaust valve** cage skidljivo kućište
 ispušnog ventila

cargo claim (n) (mar law, shipping econ) zahtjev za naknadu štete na teretu

caique /kaiˈi:k/ originally, a light boat or skiff propelled by one or two oars (used in Turkish waters, the Bosphorus); Later, a small Levantine sailing boat with a lateen rig **lagana brodica na vesla**, **lagani čamac na vesla**, **kaić** today, a small sailing or motor boats plying between the East mediterranean ports and islands (brodica u Bosporskom tjesnacu)

caisson /ˈkeɪsən/ (n) keson

calamari /,kæləˈma:ri/ (n) (fishing) lignja, lignanj

calandraca (n) (seamanship) vrsta brodske hrane - gulaš od krumpira, luka i slane govedine; žgvacet **kalandraka**

calculation (n) **proračun, izračun**: The **calculation** proved that the vessel was loaded precisely to her summer permitted draft and we were then able to complete the matter amicably. A revised **stability calculation** showed that after loading the containers on the hatch covers, the vessel would fail to meet Solas minimum stability criteria.

calibrated /ˈkæɪlɪˌbreɪtɪd/ (n) (marine eng) kalibriran

calibration /kæɪlɪˈbreɪʃən/ (n) (marine eng) kalibracija: During the post-fire sea trial, the technician for the CPP equipment had made an error in adjusting the astern pitch **calibration** settings; astern movements were not tested at the time except during a crash stop test.

caliper /ˈkæɪlɪpə/ (n) (marine eng) šubler, precizni mjerni alat (za promjer itd.), **kaliper**

call (n) (safety) a radio transmission (usually on VHF) calling another ship or a station ashore **poziv**: This **call** alerted the coastguard, who then monitored their AIS display and observed that the vessel was less than 2 miles from the shore. A **call from** the MRSC/VTS Centre informed her that she was running into danger. **make a call** **pozvati**: He sat on the footrest of the port bridge chair to **make the call** and, as a consequence, his view through the wheelhouse window was considerably restricted., **be on call** **odazvati se biti spreman**, **put out a radio call**

poslati poziv radijom, **pozvati putem radija**, **acknowledge the call** **potvrditi poziv**, **potvrditi primitak poziva**: The cargo vessel **acknowledged the call** and replied that they would maintain course and speed and pass ahead of the tug and barge., **VHF radio call** **poziv**

VHF-radijom, **poziv putem VHF-a**: He finished talking to the master 5 minutes later, and then proceeded to fix the vessel's position before **making** a routine **VHF radio call**. When the vessels were approximately 10 nm from each other, the vessel **received a VHF radio call** from the cargo vessel requesting that the former alter course so that the cargo vessel could stand on., **answer the call**

odgovoriti na poziv: He quickly proceeded towards the engine control room to **answer the call**.,

send a MAYDAY call **poslati poziv u pogibli**, **poslati poziv MAYDAY**: The remaining crewman on board also attempted to **send a "Mayday" call**, but realised the yacht's VHF set had

failed., **make a PAN PAN call** **poslati poziv o žurnosti**: The skipper was unable to determine the cause of the flooding so he **made a "Pan Pan" call** by VHF radio, to which the coastguard responded., **DSC call** **poziv za pomoć putem sustava DSC (Digital Selective Callin)**:

son is believed to be at risk but not (yet) in distress; You could call the coastguard (if there is time) and ask them to put out a **direct DSC call** (if the name of the vessel can be ascertained), or ask the

coastguard to make a DSC Sécurité or Pan broadcast on the vessel's behalf., **distress call** **poziv za pomoć u pogibli**, **poziv za pomoć u opasnosti**: Always use the DSC to **raise a distress call**. I

broadcast a distress call on International channels 16 and 74, and also on our company frequency for a period of 3 minutes., **SECURITE call poziv s oznakom SECURITE** ... vessels entering and crossing the TSS in the Singapore area are required to make a Sécurité call on the appropriate VTIS channel and/or channel 16, informing vessels in the immediate vicinity of their intentions., **attempt to call pokušati nazvati**: The mate **attempted to call the cruise ship** a further five times over the next 30 minutes ...

call (n) (mar ins) premija P&I osiguranja, godišnja premija osiguranja broda u P&I osiguranja: Before the policy year is finally closed, the club can decide to cover the claims and to charge an Additional Supplementary **Call**. An Estimated Total **Call** is calculated for any given ship.

call (n) (ports) the visit of a vessel to a port for the purpose of loading or discharging the cargo ticanje, pristajanje u luci: Regular calls are made by all major ro-ro ship owners, with services to the Middle East, the Far East, Australasia, the Mediterranean, USA, Africa, Continental Europe and the Baltic states. **make a call a a port pristati u luci, ticati luku**: 18,000-TEU container ship CMA CGM Benjamin Franklin will make its first U.S. call at the Port of Los Angeles in late December .

call (v) 1 (comm) pozvati: When the overtaking ship was about 7 cables astern, the OOW tried to call her by VHF radio.; **2 (navig) nazvati**: At midnight, the master left instructions for the chief officer to call him 30 minutes before pilot embarkation. The master's night orders instructed the bridge watchkeeping officers to call him if they required his assistance.

call at (v) 1 (shipping econ) ticati luku: We called at the port of Naples on the way to Algeiras. The world's biggest shipping company, Maersk Line, and its affiliated shipping services, SeaLand and Safmarine, has agreed to continue to call at the Port of Houston after APM Terminals, a unit of Maersk Group, said it was permanently terminating its operations there. This ship, a Panamax Bulk Carrier, regularly calls at this port to load coal.; **2 pristajati u luci**: The master was allowed to call at the port again after submitting an undertaking that he would attend an enquiry ...

call by VHF radio (v) (comm, navig) nazvati putem VHF radija, nazvati VHF radijom

call for (v) call for tug assistance pozvati pomoć tegljača tražiti, zahtijevati, iziskivati: The advice to yachtsmen is to ensure you have the equipment necessary to call for help and to survive in the water.

call for tender (n) (shipping econ) javni natječaj, raspis za ponude, poziv za dostavljanje ponuda call for tender documents poziv za dostavljanje natječajne dokumentacije

call on VHF radio (v) (navig) nazvati putem VHF radija, zvati VHF radijom: I made a brief call on VHF and the OOW of the other ship promised to keep well clear.

callout (n) (mar law) izvanredni poziv na dužnost, poziv pomorcu za dolazak na dužnost izvan normalnog radnog vremena

call out (v) (safety, comm) izreći naglas, viknuti: If you detect a fire or smell fumes or smoke act immediately as follows: **Call out Fire!** The helmsman is to repeat the order and **call out** the compass heading on receiving the order. He was passing close to a boat on an adjacent mooring and managed to hold onto its mooring chain long enough to call out for help.

calls (n) (mar law) plaćanje doprinosa (u generalnoj havariji)

call sign (n) (comm) a code published by the International Telecommunication Union in its annual List of Ships' Stations to be used for the information interchange between vessels, port authorities and other relevant participants in international trade

(http://www.iss-shipping.com/cargo/cargo_library_glossaryc.asp) **pozivni znak**: AIS can also assist in the identification of targets, by name or call sign and by ship type and navigational status. When the nearer

one was little over six miles away, I heard a call from one of them, - no name or *call sign*, just a GPS latitude and longitude to four places of decimals, calling the ship on my starboard bow.

call system (n) (comm, safety) pozivni uređaj **hospital call system** pozivni uređaj bolnice, **refrigerated chambers call system** pozivni uređaj rashladnoga spremišta, **steward call system** pozivni uređaj za posluhu

call via VHF radio (v) (comm, navig) nazvati putem VHF radija, nazvati VHF radijom: *As the tanker turned to starboard, the coastguard watch officer called the bulkcarrier via VHF radio, channel 11.*

calm /ka:m/ (n) (meteorol) tišina, *bonaca*; tal. *bonaccia* **calm sea** zrcalno more

cam /kæm/ (n) (marine eng, seamanship) brijeg (razvodne osovine), ekscentar, kvrga, **grba**: *One of the items requiring particular attention from the crew is the cam, which moves the latch to release the hook.* **cam follower** (marine eng) vodilica brijega (kvrge, grbe), **set of cams** (marine eng) red brijegova (kvrge, ekscentara), **separate cam** (marine eng) odvojeno izrađena kvrga (brijeg) navučena na razvodno vreteno, **locking cam** (seamanship) zaporna kvrga, **zaporni jezičac**, **zaporni ekscentar**: *It is likely that the forward hook and locking cam were not engaged correctly when the lifeboat was recovered after launch during the last annual inspection;* , **operating cam** (seamanship) pokretački ekscentar, kvrga za pokretanje (sklopke): *Further examination found that the switch's operating cam had been modified several years previously.* , **integral cam** (marine eng) kvrga (brijeg) u sustavu osovine

camber /'kæmbə/ (n) 1 (nav arch) preluk, poprječno povišenje palube od bokova prema sredini broda; 2 (boating/yachting) trbuh jedra

cam cleat /'kæm,kli:t/ (n) (boating/yachting) COMPARE **clam cleat** cleat for securing a rope by meas of a cam **stoper** (užeta na jedrilici), **patentna hvataljka**, **vodoravan**



stoper, tal. *strozzascotte*

camshaft /'kæm,ʃɑ:ft/ (n) (marine eng) bregasta osovina, razvodna osovina, razdjelna osovina (vreteno) **camshaft drive** pogon bregaste osovine, prijenosnik bregaste osovine: *There is an integral forged coupling flange for the flywheel, and the camshaft drive gear is split to facilitate replacement.*

can /kæn/ (n) (navig) nun; a floating aid to navigation having a flat top **valjkasta plutača**, **cilindrična plutača**

canal /kə'næl/ (n) (geogr) COMPARE **channel** an artificial waterway dredged and constructed to carry commercial vessels **kanal (umjetni)**: *The ship was bound for the Suez Canal,*

and subsequently the Far East. A sufficient number of tugs should be made available along the **canal** at strategic places to assist large vessels regardless of the traffic situation and delays. **canal bank obala kanala strana kanala** .. close to the bank he picked up the mooring rope, a mooring spike, and the mallet and attempted to step across the gap between the stern and the **canal bank**. , **canal boat pomoćna brodica za plovību kanalom**: Ensure you hire a canal **boat** that is suitable for your party. , **canal convoy konvoj brodova u kanalu**: wrecked gangway On a pleasant evening in the 1980s, our large LPG carrier was 12 hours away from Port Said, and scheduled to join the southbound Suez Canal convoy the next day. , **canal pilot kanalski peljar, peljar u kanalu**: Upon consultation with own ship's **canal pilot**, he confirmed that he had agreed with his colleague on the other vessel to pass port to port – which was the logical action. We had rigged the starboard accommodation ladder to facilitate the transfer of immigration, customs personnel, agents, ship chandlers etc and to **embark canal pilots**. , **canal transit prolaz kanalom, plovība kanalom**: Arriving for a **canal transit**, the vessel had rigged the starboard accommodation ladder to facilitate the transfer of immigration, customs personnel, agents, ship chandler The Chief Officer and I were relaxing on the bridge discussing plans for the impending arrival and **canal transit**.

Canal Transit Dues /kəˈnæɪl/ (n) (shipping econ) pristojbe za prolaz kanalom, naknada za prolaz kanalom

cancel /ˈkænsəl/ (v) 1 (mar law, shipping econ) ukinuti; 2 (mar law) brisati (iz upisnika); 3 (mar law) raskinuti (ugovorn čarter); 4 (shipping econ) otkazati, prekinuti, obustaviti: **cancel the alarm otkazati alarm otkazati uzbunu** The watchkeeping officer **cancelled the alarm**. The chief mate was too busy completing ISM papers, entering details in the Log Book and continuously having to **cancel various GMDSS alarms**.

cancelling clause (n) (mar law, shipping econ) a voyage charter party clause providing that if the vessel is not ready to load by a certain date, agreed between the parties, then charterers have the option to cancel. Sometime before the cancelling date it becomes clear that it is impossible for the vessel to arrive at the load port in time. **brisovna klauzula**

cancelling date / day (n) (mar law) A term used in a voyage charterparty, referring to the period of time between the commencement of laytime (being the beginning of the lay days when the charterer must commence loading the cargo), and the cancelling date (being the date after which the charterer may repudiate the charterparty if the ship has not then arrived at the specified port or place of loading). (Tetley) Pravo naručitelja prijevoza da raskine ugovor o prijevozu ako brodar ne osigura da brod bude spreman na ukrcaj/skrcaj u vrijeme predviđeno ugovorom (o iskorištavanju broda na putovanje; voyage charter party) **dan obustave stojnica, dan brisanja vremena stojnica**: **Cancelling Date** - The fixing of a cancelling date in the charterparty merely gives warning to the shipowner that non-arrival by the **cancelling date** may go to the root of the contract ... The Vessel will not be ready to load by the **cancelling date**. The last day of laydays is the **cancelling day**. The **cancelling date** (Box 21, clause 9) defines the other end of this period known as the “laydays” after which the Charterers have the option to cancel the charter party if the ship has still not presented herself for loading.

can hook (n) (cargo handling) kukice (kliješta) za bačve

canoe /kəˈnuː/ (n) (boating/yachting) a light-weight narrow double ended boat, usually fabric stretched over a frame, and propelled by paddles **kanu**

canopy /ˈkænəpi/ (n) (nav arch, seamanship) tenda

cant /kænt/ (n) (cargo) trupac koji je rezan u obliku ploče po dužini tako da konačni tanki dio ima dvije suprotne paralelno ravne strane, a u nekim slučajevima i treću stranu koja je također izrezana

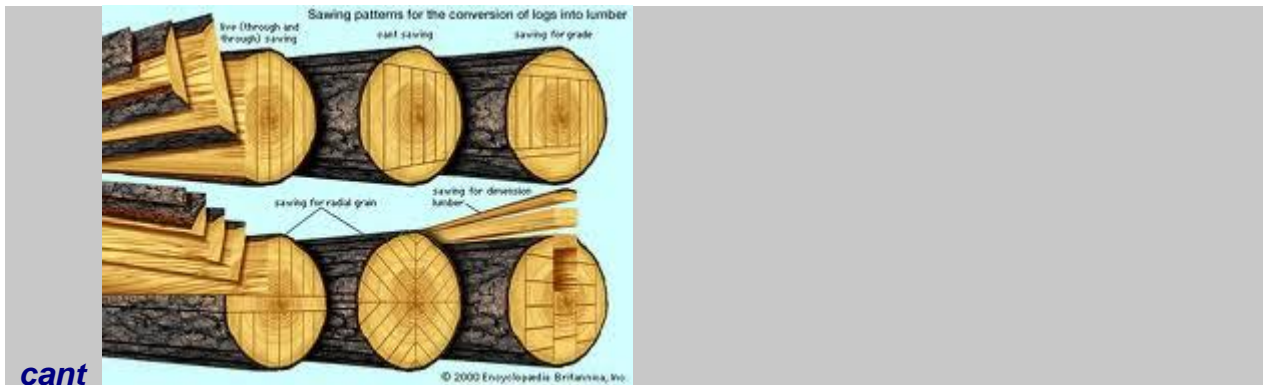
**cant**

cant /kænt/ (v) **1** (navig, seamanship) držati brod koso (prema obali), držati brod koso (prema obali / od obale): *Soon, with the ship's bow **canting** about 80° away from the wharf, it was realised the swing to port was bringing the stern rapidly towards the wharf. I advised the Master to cant easy to port.*; **2** (boating/yachting) nagnuti se: *The yacht was resting on the beach, its deck **canted** to one side.*

cant /kænt/ (n) **1** (n) (navig, seamanship) kosi kut (broda prema lučkoj obali), koso približavanje / udaljavanje (broda u odnosu na obalu): *The vessel then started into a slow **starboard cant** towards the knuckle, at which point I returned to the wheelhouse and asked the Master for more port thrust – which he acknowledged. The rate of cant to starboard then increased and at this point I observed the Bow Thrust controls were set for starboard thrust.*; **2** an inclination of an object (e.g. ship) from a perpendicular **nagib**, **inklinacija**

cant /kænt/ (n) (nav arch) krmena oblina

cant beam (n) (nav arch) radijalna sponja

cant floor (n) (sailing vessels) krmena rebrenica

cant frame (n) **1** (nav arch) radijalno rebro; **2** (sailing vessels) a frame such as stern frame which is not square to the keel lin **krmeno koso rebro**; **3** (sailing vessels) koso rebro krme, rebro krmene obline

cantilever /'kænti.li:və/ (n) (nav arch) a projecting beam supported only at one end **konzolna sponja**

cantilever beam (n) (nav arch) konzolna sponja

canvas /'kænvəs/ (n) **1** (seamanship) a material made of cotton etc. used for making sails **platno (za jedra)**; **2** (boating/yachting) all the sails of a ship **komplet jedara (jedrenjaka)**; **3**

(seamanship) **platnena zaštita**, **platnena ovojnica**: *One seaman placed a securing wire through the starboard anchor cable, while the other two, on the starboard winch platform, were lashing **canvas covers** around the mooring wires.*

canvas cowl /'kænvəs,kau/ (n) (nav arch) platnena vjetrolovka

canvas sling (n) (cargo handling) platneni pasac

cap /kæp/ (marine eng) poklopac, kapa **bearing cap** ležajni poklopac, poklopac ležaja, ležajna kapa

cap /kæp/ (n) (sailing vessels) glavina debla (jarbola)

Capacities of Holds and Tweendecks (n) (stabil) Plan i tablica kapaciteta

capacity /kə'pæsiti/ (n) **1** (marine eng) kapacitet **high capacity pump** pumpa velikog kapaciteta, **snažna pumpa**: *The vessel's main sea water system supplied all sea water pumps,*

including two **high capacity ballast pumps**, drawing from two low sea suction and one high sea suction intakes., **pumping capacity kapacitet pumpanja** operable auxiliary engine meant that the vessel had lost its main emergency services backup, which severely reduced the vessel's potential **pumping capacity**.; **2 (nav arch, cargo handling) zapremnina, sadržina** It was intended to bring Nos 2 and 3 port and starboard double bottom tanks to **90% capacity** by bunkering 85 tonnes in each of the tanks. **carrying capacity nosivost, capacity in CBM and CFT kapacitet u kubičnim metrima i kubičnim stopama**; **3 (cargo handling) nosivost (dizalice) lifting capacity moć dizanja (dizalice) nosivost (dizalice)**: The lifting capacity of the davit was reduced by approximately 90% to around 300 kg. ... all cargo was meant to be loaded and discharged with ship's twin (Gemini) cranes, each of SWL 26 tonnes giving a total **lifting capacity** of 52 tonnes., **handling capacity kapacitet rukovanja (broj koletakontejnera na sat; količina prekrcajnih tona na sat) kapacitet ukrcaja/iskrcaja, prekrcajni kapacitet**: What is the **handling capacity** of the container crane / gantry?; **4 (nav arch, cargo handling) prostor, sposobnost primanja storage capacity skladišni kapacitet, kapacitet uskladištenja**: The vessel's main sea water system supplied all sea water pumps, including two high capacity ballast pumps, drawing from two low sea suction and one high sea suction intakes.

Capacity in which Employed (n) (mar law) zaposlen u svojstvu, kvalifikacija capacity tonnage (n) (stabil) kapacitet broda za teret

cape /keɪp/ (n) (geogr) a promontory or headland protruding into a waterway (The Dictionary of English Nautical Language Database;

<http://www.seatalk.info/cgi-bin/nautical-marine-sailing-dictionary>) **rt, punta**

capsize vessel (n) (nav arch, shipping econ) A dry bulk vessel above 80,000dwt or whose beam precludes passage via the Panama Canal and thus forces them to pass around Cape Horn or the Cape of Good Hope **brod koji zbog svoje širine mora oploviti Rt Dobre Nade ili Rt Cape Horn, capsize**: Capsize vessels generally serve deepwater terminals handling raw materials, such as iron ore and coal.

capital cost (n) (nav arch, shipping econ) cost covering interest and capital repayments on a vessel **kapitalni troškovi broda**: The current market situation, the financial structure of the purchase, and future market expectations affect the level of **capital costs**.

cap nut 1 (marine eng) matica kape (tlačnog gorionika); 2 (marine eng) stezna matica cap shrouds (n) (boating/yachting) vanjske pripone, vanjske sartije

capsize /kæp'saɪz/ **1 (v)** when a ship or boat lists too far and rolls over, exposing the keel; to

overturn when afloat **prevrnuti se**: Around 10 minutes after abandoning the vessel, she **capsized** to starboard and then sank by her stern. Oko 10 minuta nakon napuštanja broda, brod se prevrnuo po desnoj strani i zatim potonuo krmom. The investigation found that ship **capsized** in extraordinarily violent sea conditions caused by gale force winds and a strong, opposing tidal stream. At one point the **lifeboat capsized** due to strong wind and waves.; **2 (boating/yachting, safety) odvezati se (konop, uzao)**

capsize /kæp'saɪz/ (n) (safety, boating/yachting) **prevrtanje capsize recovery ispravljanje prevrnutih jedrilice**

capsizing (n) (stabil) prevrtanje tal. scuffia: The urgency release system for the towing winch on board the tug had operated, but not quickly enough to prevent the tug from **capsizing**.

capstan /'kæpstən/ (n) **1 (seamanship, nav arch)** a vertically mounted winch head used aboard ship when mechanical power is required for raising anchor, lifting heavy weights, or for any similar work.

pritezno vitlo, motovilo, tal. vericello verticale; argano: Crew members should not be allowed to operate a windlass or **capstan** and handle the rope at the same time. He removed the turns from the bits and then three turns from around the **capstan**. **capstan head bubanj motovila, glava motovila:** The slack was taken in using the **capstan head** of the port winch. However, on the port winch it was first necessary to stop the spring still located on the **capstan head** in order for it to be secured



on a bollard on deck.



; 2 (sailing vessels) sidreno vitlo (na

jedrenjacima)

captain /'kæptɪn/ (n) 1 (mar law) senior officer in charge of a ship, regardless of rank; In the British Merchant Navy a Master Mariner who has sailed in command of an oceangoing merchant ship will be titled Captain **kapetan:** The **captain** decided to anchor too close to shallow water. **Captain XY** commenced his sea-going career with ... Co. of Liverpool, working on ... Line steamers as cadet and second officer.; 2 (mar law) master of the ship **zapovjednik broda:** As the vessel passed our stern at 2 cables **the Captain** called the tanker on VHF stating the vessel's name and position and asked the tanker's reason for not giving way. Prior to departure, **the Captain** explained that they had been experiencing problems with the displays.; 3 (navy) in all navies, the rank next below rear-admiral **mornarički kapetan (jednak rangu pukovnika):** He is a **Captain** in the Royal Fleet and has recently finished a three year appointment as Chief Staff Officer (Engineering) ... Am I to understand that **the Captain** of the Warship considers himself to be the give way vessel?

captain of the fleet (n) (navy) a temporary adjutant-general who is responsible for discipline aboard the ships of a fleet (<http://www.seatalk.info/cgi-bin/nautical-marine-sailing-dictionary>)

kapetan flote

captain of the port (n) (mar law, US) = **port captain = Harbour Master** Captains of the Port and their representatives enforce within their respective areas port safety and security and marine environmental protection regulations, including, without limitation, regulations for the

protection and security of vessels, harbors, and waterfront facilities; anchorages; security zones; safety zones; regulated navigation areas; deepwater ports; water pollution; and ports and waterways safety. (Wiki) Employed in this meaning the term is equivalent (in US) to the term harbourmaster which is more frequently used internationally; In the United States, captain of the port is a title held by a United States Coast Guard officer, usually the commander of a United States Coast Guard sector with the rank of captain (O-6). <http://www.maritimetoday.com> **lučki kapetan**: *Captain of the port duties involve enforcing within their respective areas port safety and security and marine environmental protection regulations, including regulations for the protection and security of vessels, harbors, and waterfront facilities; anchorages; security zones; safety zones; regulated navigation areas; deepwater ports; water pollution; and ports and waterways safety.*

captain's cabin (n) (nav arch) kabina zapovjednika

captain's mast (n) (sailing vessels) mjesto preslušavanja članova posade i izricanja disciplinskih mjera {zastarjeli izraz}

Captain's protest (n) (mar law) = **note of sea protest** a document issued by the master upon arrival at a port, which shows conditions encountered during voyage, generally for the purpose of relieving ship owner of any loss to cargo and shifting responsibility for reimbursement to the insurance company **prijava pomorske nezgode**

captain's quarters (n) (nav arch) zapovjednikove prostorije, nastamba zapovjednika

captain's sitting room (n) (nav arch) zapovjednikov salon, predsoblje zapovjednika

captive cargo port (n) (shipping econ, US) regionalna luka, luka za terete iz obližnjeg područja

captivity /kæp'tiviti/ (n) (mar law) **zatočeništvo, držanje u zarobljeništvu**: *the crew was released after six months in captivity* posada je bila oslobođena nakon šest mjeseci zadržavanja u zatočeništvu

capture /'kæptʃə/ (n) (mar law) = **seizure** zapljena, zaplijenjeni brod

caravel /'kærə,vəl/ (n) (nav arch, boating/yachting) ship of the 15th century with three masts carrying a mixture of lateen and square sails, shaped broad in the bow and with a high poop **karavela**

carbon /'ka:bən/ (n) 1 (chem) **ugljik**; 2 (cargo) **ugljen**

carbonaceous matter /,ka:bə'neifəs/ (n) (marine eng) **ugljikove tvari**

carbon deposits (n) (marine eng) **naslage gareža, naslage ugljika**: *Observations made at the 12 000-h overhaul of the first Wärtsilä 64 engine in marine service (a seven-cylinder model) revealed no evidence of heavy carbon deposits on the cylinder head flame deck.*

carbon dioxide; CO2 /,ka:bən daɪ'ɒksaɪd/ (n) (chem, marine eng) **ugljični dioksid**: – accidental discharge of **carbon dioxide**, resulting in serious injury to a shore-based engineer – inadvertent release of **carbon dioxide** and the disabling of the vessel off Wolf Rock on 6 December 2007

carbon monoxide /,ka::bən mən'ɒksaɪd/ (n) (safety) **ugljični monoksid**: *A carbon monoxide detector was also fitted in the wheelhouse. Unfortunately, the atmosphere inside the trunking was only checked some 24 hours after the accident; Oxygen and carbon monoxide levels were found to be normal.*

carbon steel (n) (marine eng) **ugljični čelik**

carboy /'ka:,boɪ/ (n) (cargo) **stakleni spremnik, bocun (za prijevoz kiselina itd.)**

carburetor, carbureter, carburettor /,ka::bjʊ'retə; 'ka::bjʊ'retə; 'ka::bjʊ'reitə/ (n) (marine eng) **karburator, rasplinjač**

car carrier (n) (nav arch) **brod za automobile, brod za prijevoz (putničkih)**

automobila: All targets were being plotted on ARPA, a large *car carrier* was ahead of us at three miles but not visible.

card chassis /'ka:d, 'jæsi/ (n) (cargo handling) prikolica / šasija (na kontejnerskom terminalu)

car deck (n) (nav arch) paluba za automobile: ... the small watertight access hatch into the bow door space from the *car deck* was unbolted.

cardinal buoyage system (n) (navig) kardinalni sustav označavanja (plovnih putova)

cardinal buoys (n) (navig) kardinalne oznake, glavne oznake: It is felt that a separation scheme with precautionary area should be introduced with the dangerous wrecks clearly marked by *cardinal buoys*. ... the vessel continued to be set down onto the *North Cardinal buoy* marking the channel.

cardinal marks (n) (navig) are used in conjunction with the compass to indicate the direction from the mark in which the deepest navigable water lies, to draw attention to a bend, junction or fork in a channel, or to mark the end of a shoal

(<https://www.trinityhouse.co.uk/mariners-information/navigation-buoys/cardinal-marks>) **glavne**

oznake, osnovne oznake, kardinalne oznake: Mariners will be safe if they pass north of a *north mark*, south of a *south mark*, east of an *east mark* and west of a *west mark*.

<https://www.trinityhouse.co.uk/mariners-information/navigation-buoys/cardinal-marks> The ship was heading towards a reef, 5 cables away and marked by north and south *cardinal marks*. *Cardinal Marks* are also used for permanent wreck marking whereby *North, East, South and West Cardinal buoys* are placed around the wreck.

north cardinal marks glavna sjeverna oznaka, **south cardinal marks** glavna južna oznaka, **west cardinal marks** glavna zapadna oznaka, **east**



cardinal marks glavna istočna oznaka

cardinal points (navig) (navig) The four principal points of the compass: North, East, South and West **strane svijeta**

cardiopulmonary resuscitation (CPR) /ka:diəʊ'pʌlmənəri ri,sʌsi'teɪʃən/ (safety)

davanje umjetnog disanja: *Cardio-pulmonary resuscitation* was immediately performed by crew members.

care /kɛə/ (n) **1 briga, skrb, pažnja:** *Care must be taken* to ensure that the grips are properly tightened. This is largely beneficial, but *care must be exercised* to carefully consider and plan each arrival, particularly when responding to changes to the 'normal' routine **proper care of cargo**

(cargo) **ispravna briga (o teretu):** Carriers are required to *take proper care of cargo* throughout their loading, navigating, discharging and delivering operations., **exercise proper care (cargo)**

voditi pažljivo brigu o: If wet, *additional care must be exercised*, and if possible, the cargo surfaces must be wiped dry or the task must be postponed until conditions improve.; **2 (med) medicinska**

skrb, medicinska njega intensive care unit odjel intenzivne skrbi / njege *He was admitted in the local hospital's intensive care unit.*

careen /kəˈriːn/ (n) **1 (seamanship)** cause the ship to tilt on its side, usually to clean or repair the hull below the water line **nagnuti brod (radi čišćenja ili popravka dna), karinat; tal.**

carenare; carenaggio, karinavat *I had no choice but to careen i the next port to fix a packing hose but I am considering it again now for bottom paint.* ; **2 izvaditi barku na suho (radi bojanja i održavanja)**

careening the practice of grounding a sailing vessel at high tide in order to expose one side of its hull for maintenance and repair **nasukavanje barke ili brodice radi održavanja i popravaka, tal. carenaggio** **Careening is the time-honored way of cleaning, painting, maintaining, and repairing boat and ship bottoms.**

car ferry /ˈkɑːfəəri/ (n) **1 (nav arch) trajekt**: *The world's largest car ferry, Irish Ferries' giant ship 'Ulysses' leaves Dublin port, on her way to Holyhead in Wales. She is currently owned and operated by Irish Ferries.* ; **2 (UK) trajekt za prijevoz automobila (i drugih cestovnih vozila); 3 (US) trajekt z prijevoz vlakova** {Spellings and word forms: car ferry; car-ferry; carferry; ferry}

cargo /ˈkɑːɡəʊ/ (n) **break bulk cargo** generalni teret, komadna roba, **containerized cargo** kontejnerizirani teret, **kontejnerski teret, conventional cargo** klasičan teret, **dangerous cargo** opasan teret, **dead weight cargo** težinski teret, **dry bulk cargo** suhi masovni teret, **rasuti teret sipki teret, general cargo** generalni teret, **groupage cargo** zbirni teret, **inward cargo** teret za iskrcaj, teret u uvozu, **liquid bulk cargo** tekući masovni teret, **tekući teret (u velikom količinama), measurement cargo** volumenski teret, **prostorni teret, mass cargo** masovni teret, teret koji se prevozi u velikim količinama, **outward cargo** teret u ukrcaju, teret u izvozu, **wheeled cargo** ro-ro teret, teret na kotačima, **cargo flow** kretanje tereta / roba, **robni tok, cargo handling equipment** uređaji za ukrcaj/iskrcaj tereta, uređaji za rukovanje teretom, **prekrcajna mehanizacija, cargo mixture** mješoviti teret, **miješani teret, cargo net** mreža za teret, **cargo plan** plan krcanja tereta, plan tereta, **cargo procedures** postupci pri preuzimanju i predaji tereta, **cargo stowage** slaganje tereta, **cargo superintendant** nadzornik tereta, inspektor / kontrolor tereta, **cargo surveyor** nadzornik / kontrolor / inspektor tereta, **cargo surveyors** kontrola tereta, kontrolna kuća (za kontrolu tereta), **cargo tray** tava za teret (UK) the goods, merchandise, commodities, or products carried by a ship, barge, train, truck or plane. **teret**: *If a cargo is susceptible to damage by rain, snow or precipitation, the vessel should opt to discontinue cargo operations altogether during inclement weather.* {the term cargo is predominantly used in UK and prevails in international trade. It mainly refers to the technological aspect of the use and meaning of the term cargo; the term freight is used in the same meaning in US; The term goods refers to the economical/commercial aspect of the concept of cargo and is used in international trade; the terms commodity and merchandise refer to various types of cargo carried by sea}

cargo arm (n) (cargo handling) **dizalica (s fleksibilnom cijevi, manigom) za ukrcaj / iskrcaj tankera, maniga**: *The loading was stopped and the cargo arm disconnected.*

cargo battens (n) **1 (nav arch)** wood battens fitted to the inside of the frames in a hold to keep the cargo away from the ship's side and to allow the necessary through ventilation. **bokoštitnice u skladištu, priboj, razdjelne daske**: *The cargo battens are damaged.*; **2 (sailing vessels) letve**

skladišta, bočne letve skladišta

cargo book (n) (cargo handling, safety, nav arch) knjiga tereta

cargo booking note (n) (mar law) isprava u ugovoru o prijevozu stvari koja sadržava pojedine važne dijelove **zaključnica**

cargo boom (n) (cargo handling) a heavy boom used in loading cargo **teretni stup, samarica, derić, delić**

Cargocaire system /ka:ˌgəʊ,kæə/ (n) (nav arch) sustav Cargocaire

cargo claim (n) (shipping econ, mar law) **1** tražbina, zahtjev za naknadu štete: *It is the responsibility of the claimant to file a cargo claim within the prescribed time frame and to respond to any requests from the carrier for supporting documentation.* **file a cargo claim podnijeti**

zahtjev za naknadu štete na teretu; 2 reklamacija

cargo damage (n) (mar law, mar ins) gubitak, manjak, oštećenje i zakašnjenje tereta **šteta na teretu**

cargo damage claim (n) (mar law, mar ins) zahtjev za nadoknadu štete, odštetni zahtjev za štetu na teretu, prijava štet na teratu, protestno pismo (za havariju, štetu)

Cargo Damage Report (n) (cargo handling) izvještaj o šteti na teretu

cargo deadweight (n) (nav arch) korisna nosivost

cargo documentation (n) (shipping econ) robni dokumenti, dokumentacija tereta

cargo documents (n) (shipping econ) prijevozne isprave, robni dokumenti, popratni dokumenti uz teret

cargo dues (n) (mar law, shipping econ) naknada za korištenje lučkih obala i lučke

mehanizacije: *Cargo Dues are charged to the users (exporters, importers or shipping lines) for using the port facilities for movement of the cargo through it.. This fee is generally fixed and published in a tariff by the port for a year*

cargo fastener (n) (cargo handling) **pritega za teret:** *The incident happened after the cargo fasteners broke on a load of large diameter steel pipes.*

cargo gear (n) (cargo handling, nav arch) **teretni uređaj (obično brodski), uređaj za rukovanje teretom:** *Many general cargo vessels have thier own cargo gear that helps them to load and discharge in ports lacking infrastructure. (Swadi) A new ship was discharging steel plates with own cargo gear.*

cargo handling (n) (cargo handling) all procedures involved in the physical handling of goods

rukovanje teretom, manipuliranje tereta: *The handling of cargo is carried out either by the ship's own cargo gear or by shore cranes.*

cargo handling costs (n) (cargo handling, shipping econ) involves loading, stowage, lighterage, and discharging of the **troškovi rukovanja teretom**

cargo handling equipment (n) **1** (cargo handling) sredstva za rukovanje teretom, oprema za rukovanje teretom, uređaji za rukovanje teretom, **teretni uređaj** *Cargo handling equipment includes two modern gantry container cranes and six straddle carriers.*; **2 pribor i alati za rukovanje teretom (kuke, pasci itd.); 3 lučka mehanizacija**

cargo handling gear (n) **1** (cargo handling, nav arch) **teretni uređaj (obično brodski), uređaj za rukovanje teretom; 2 alati za rukovanje teretom**

cargo hatch (n) (nav arch, cargo handling) **grotlo za krcanje tereta, grotlo**

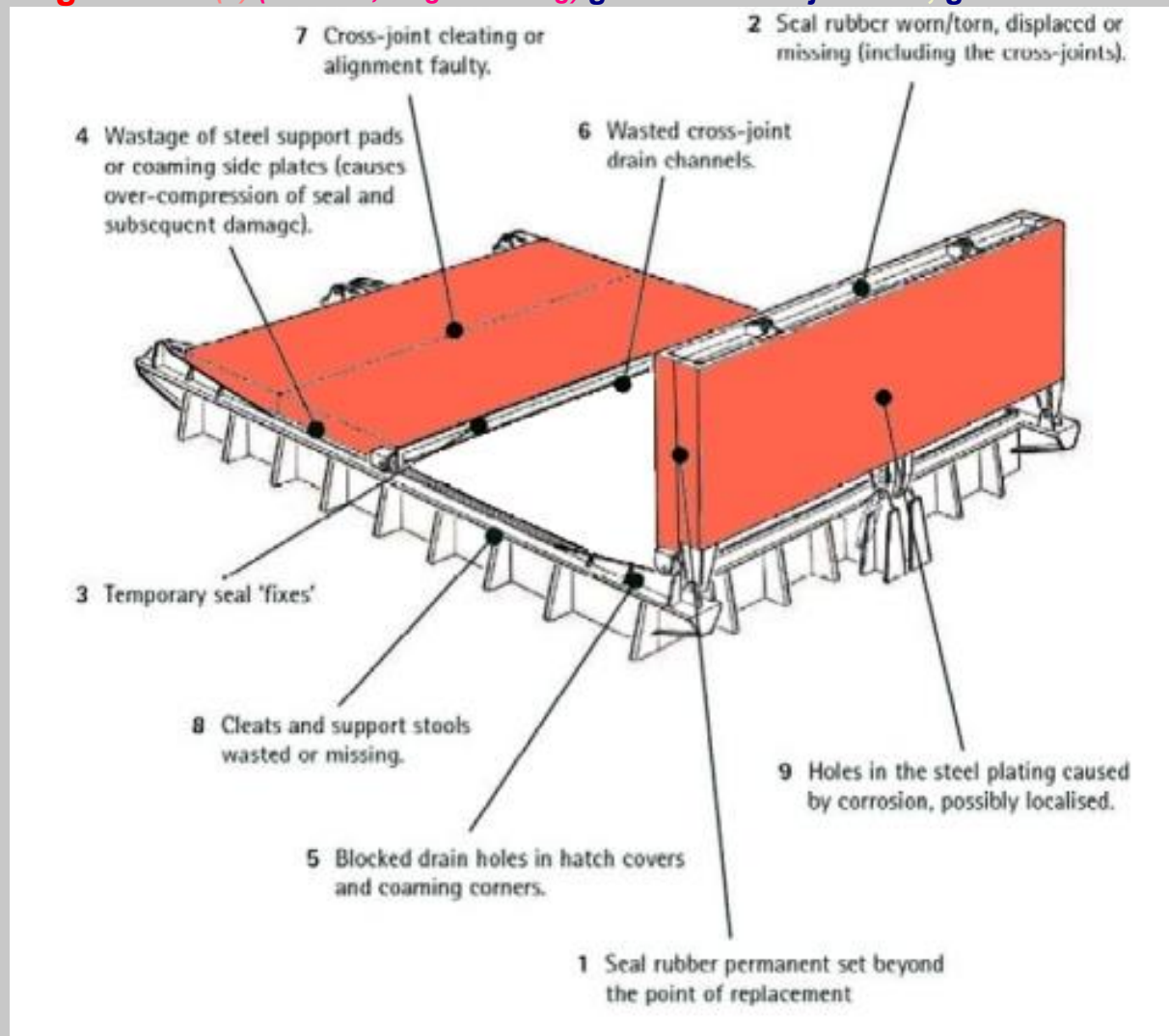

cargo hoist (n) (cargo handling) **dizalo za teret**

cargo hook (n) (cargo handling) **kuka (za teret)**: *cargo hooks should never be used when discharging fragile cargo*

cargo insurance (n) (mar ins) **osiguranje robe, osiguranje tereta**

cargo interests (n) (shipping econ) Parties having an interest in the cargo **zainteresirane**

stranke za teret, vlasnici tereta: *A loading/discharge programme should be planned in advance and agreed with cargo interests and the terminal staff. If a vessel causes loss or damage to her cargo and if the carriers are liable, carriers have to compensate cargo interests for their damages.*

cargo lien (n) (mar law) **privilegij na stvarima ukrcanima na brodu**

cargo liner (n) = **freighter** 1 (shipping econ) **teretni brod, teretnjak**: *I was the bridge watchkeeper on a 9,000 grt cargo liner belonging to a reputable company. A cargo liner carrying a variety of cargo in relatively small consignments would have 'tween decks to facilitate stowage.*; 2 **linijski brod, linijaš**

cargo manifest (n) (shipping econ, mar law) a comprehensive list of all cargo for a destination. It is made up from the information contained within the B/Ls **manifest tereta** (a cargo manifest might be

used for shipments made by sea, air or land, and will generally show the shipment's cosigner and consignee, as well as listing product details such as number, value, origin and destination.}

cargo manifold (n) (nav arch, cargo handling) glavni razvodni ventil za tekuće tereta
na brodu: a unique substance can be loaded / unloaded to /from all tanks by means of the two common line located aft and fore of cargo manifold

cargo marks (n) (cargo handling) oznake na teretu

cargo mast (n) (cargo handling) teretni stup

cargo master (n) (cargo handling, mar law) A Cargo Master is generally seen on a ship where they measure cargo in tonnage and they may have loads from hundreds of different sources that ultimately with go tho hundreds of different destinations. **časnik odgovoran za teret, prvi časnik palube**

cargo net (n) (cargo handling) mreža za teret: *Cargo nets are suitable for mail bags and similar cargoes that are not liable to be crushed when hoisted. Pallets should be lifted within a cargo net.*

cargo oild pump; (COP) (n) (nav arch, cargo handling) pumpa tereta nafte, pumpa za naftni teret

cargo oil tank; (COT) (n) (cargo handling, nav arch) naftni tank, tank za naftu, tank za teret nafte **cargo oil tank; (COT) # 2P/S** naftni tank br. 2 lijevi/desno

cargo owner (n) (shipping econ, mar law) vlasnik tereta

cargo pipes and fittings (n) (nav arch, cargo handling) cijevi i oprema cjevovoda za teret: *Cargo pipes are class II type mild steel pipe. The connections to be of butt welded if possible. The pipelines to be of through cargo tank inside. The pipelines to be arranged with sufficient expansion possibilities.*

cargo plan (n) (cargo handling) plan krcanja tereta

cargo port (n) (nav arch, cargo handling) otvor u trupu broda za krcanje tereta

cargo properties (n) (cargo) svojstva tereta, karakteristike tereta

cargo pump (n) (cargo handling, nav arch) sisaljka tereta

cargo purchase (n) (cargo handling) čekrk za podizanje tereta (na samarici, dizalici), koloturnik za podizanje tereta

cargo runner (n) (cargo handling) podigač tereta (na samarici), teretnica

cargo securing arrangements (n) (cargo handling) uređaji za pričvršćivanje tereta

Cargo Securing Manual (n) (cargo handling) brodska knjiga za osiguranje i slaganje tereta, priručnik za osiguranje i slaganje tereta

cargo shift (n) (cargo handling) micanje tereta, pomjeranje tereta

cargo ship (n) (mar law, nav arch) brod za prijevoz tereta i najviše dvanaest putnika **teretni brod, teretnjak**

cargo ship safety construction certificate (n) (mar law) svjedodžba o sigurnosti konstrukcije teretnog broda

cargo spaces (n) (nav arch, shipping econ) teretni prostori, prostori za teret, **teretnjak:** *Cargo spaces include epoxy coated cargo tanks integrated in the structure separated by longitudinal and transverse corrugated bulkheads and integrated slop tank at fore of cargo space.*

cargo stoppage signal (n) (cargo handling) znak za prestanak ukrcaja/iskrcaja tereta

cargo stowage (n) (cargo) slaganje tereta

Cargo Stowage and Securing Code (n) (cargo handling) **pravilnik o slaganju i pričvršćivanju tereta**

Cargo Stowage Plan (n) (cargo) **plan krcanja tereta**: The break-bulk vessel cargo stowage plan is a complete diagram of a vessel's cargo space showing the location (both on and below deck) of all cargo aboard ship **prepare the Cargo Stowage Plan** 1 **pripremiti plan krcanja tereta**; 2: The cargo stowage plan is prepared by the loading terminal after the ship has been loaded and is used to facilitate the subsequent loading and discharge of cargo at all ports along the voyage.

cargo surveyor (n) (mar law) = **marine cargo surveyor inspektor tereta, inspektor za štete na teretu**: Having taken four samples, the **cargo surveyor** moved aft to the sampling point of tank No. 5 After completion of loading, a **cargo surveyor** boarded to take samples of the cargo. Immediately after completion of line blowing the manifold valves were sealed by the **cargo surveyor**.

cargo system (n) (nav arch) **teretni sustav na brodu**: Cargo system is designed so that 11 different substances can be loaded/ unloaded at the same time.

cargo tank relief valve (cargo handling) **sigurnosni ventili tankova tereta**: Are cargo tank relief valves set correctly and actual relief valve settings clearly and visibly displayed? **esu li sigurnosni ventili tankova tereta ispravno namješteni, a namješteni tlak vidljivo ispisan?** **set the cargo tank relief valve regulirati sigurnosni ventil tankova tereta**

cargo tonnage handled (n) (ports) **total weight of goods loaded and discharged in a port promet tereta u tonama**

cargo tracer (n) (shipping econ, mar law) a document sent by the agent to all relevant parties, stating that certain cargo is either missing or over-landed **potražnica za teretom**

cargo tray (n) (cargo handling) **tava za teret**: Cargo trays and pallets, the latter being wooden or of steel construction, are ideal for cargo of moderate dimensions, which can be conveniently stacked, such as cartons, bags, or small wooden crates or cases. **clamp**

cargo valve (n) (cargo handling) **ventil za tekuće terete**: after ensuring that the cargo valves were closed the chief mate proceeded to the bridge and relieved the third mate as the navigation watch officer

cargo ventilation system (n) (nav arch) **sustav prozračivanja tereta**: In the cargo ventilation system, PV valves setting pressure is 2000 mmWG for pressure, -350 mmWG for vacuum. The lines between PV valves and tanks are so arranged as to permit their self draining to the tanks. Pipe connections are to be full penetration butt welded type.

cargo watch (n) (cargo) **nadzor nad teretom**: keeping an efficient and safe **cargo watch** is a key requirement of and OOW.

cargo winch (n) (cargo handling) **teretno vitlo, manat electric cargo winch električno vitlo, cargo winch drum, motor, gears, shafts, and brakes bubanj, motor, reduktor, vratilo i kočnica električnog vitla, cargo winch barrel bubanj teretnog vitla**

cargoworthiness (n) (mar law) **prikladnost broda za preuzimanje, prijevoz i očuvanje tereta u stanju u kojem je teret primljen na prijevoz prikladnost broda za preuzimanje i prijevoz tereta, sposobnost broda za preuzimanje tereta**: The Master always has the final responsibility for the sea- and cargo worthiness of the vessel.

carpenter /'ka:pintə/ (n) (seamanship) **brodski tesar, meštar**: The **carpenter** asked the second officer to operate the winch, and told the welder and the two ratings to help him push the messenger back onto the rotating drum. The **carpenter** lowered the messenger line to the tug and the tug's mate attached the eye of the steel tow wire to the messenger line. The second officer was in charge of the

operation; however, the **carpenter** was the most experienced member of the team and the de facto leader that morning.

carrack /'kærək/ (n) (nav arch, boating/yachting) a large galleon of the 15th C karaka

carriage /'kæridʒ/ (n) 1 (shipping econ) **prijevoz, transport, prevoženje**: Ships' staff responsible for the loading and **carriage of cargoes** requiring fumigation are fully aware of the potential risks and safety precautions required. The master or owner of a ship shall not accept for **carriage** by the ship any cargo that may liquefy when carried by sea unless the actual moisture content of such cargo is less than its TML. However, to facilitate the **carriage of bulk cargoes** the tank top ceiling had been floored over with steel plates welded together, the bilges having been similarly treated. ; 2 **kolica, podvozak**: The equipment had been installed between decks and was mounted on a **carriage** that slid out from the ship's side.

Carriage of Goods by Sea Act (COGSA), 1992 (n) (mar law) The U.K. Bills of Lading Act. It is a statute which covers bills of lading, sea waybills, ship's delivery orders and, in the future, electronic documents (Tetley) **Zakon o prijevozu robe morem**

carrier /'kæriə/ 1 (nav arch) **brod, vrsta broda**; 2 (mar law, shipping econ) A party who contracts to carry goods or passengers by water (the contracting carrier), or the party who actually performs such carriage in whole or part (the actual carrier). (Tetley) ; any person by whom or in whose name a contract of carriage of goods by sea has been concluded with a shipper. (Hamburg Rules)

prijevoznik, vozar, brodar: A carrier is any person or entity who, in a contract of carriage, undertakes to perform or to procure the performance of carriage by rail, road, sea, air, inland waterway or by a combination of such modes. (Glossary of Shipping Terms, 2014; www.marad.dot.gov) **originating**

carrier **prvi prijevoznik, delivering carrier** **zadnji prijevoznik, prijevoznik isporučitelj robe**; 3 (marine eng) **nosač, greda revolving carrier** **okretni nosač, okretni tanjur**; 4 (nav arch) **nosač**

Carrier Issuing the Bill of Lading (n) (shipping econ) **prijevoznik koji je izdao teretnicu, brodar izdavalelj teretnice**

Carrier's Inspection Report Form (n) (shipping econ) **prijevoznikov obrazac za izvješće o pregledu (štete na teretu)**

carrier's lien (n) (mar law) When the shipper ships goods 'collect', the carrier has a possessory claim on these goods, which means that the carrier can retain possession of the goods as security for the charges due (http://www.iss-shipping.com/cargo/cargo_library_glossaryc.asp) **brodarov privilegij na robu, brodarovo pravo na zadržavanje robe**

carry (v) **be carried** **nalaziti se, biti u, carry away** **odvoditi, odnijeti, carry out** **izvršiti, provesti, izvesti, obaviti** *Carry out a risk assessment before the start of dangerous jobs so that identified control measures can be put in place. Always carry out a full set of CPP tests, both ahead and astern. Avoid carrying out lashing jobs when the vessel is rolling badly.*, **carry through** **provesti (do kraja), carry the firing loads** **podnijeti opterećenja izgaranja, carry the injector** **imati ubrizgač, carry the lubricating oil** **dovoditi ulje za podmazivanje, carry loose** **prevoziti bez ambalaže / pakovanja, prevoziti u rasutom stanju, carry on** **nastaviti** *The master sensed that the coxswain was having difficulties and asked him if it was safe to carry on.* 1 **nositi**: Personnel entering tanks must also carry a CO detector together with O and LEL personal detector, (as per company policy when entering tanks after carrying Crude or Fuel Oil.); 2 **voditi**; 3 **dovoditi**; 4 (shipping econ) **imati (na brodu, na sebi), nalaziti se (na brodu)** in their circular 118 the Panama Maritime Authority states that vessels must carry a minimum of two

Watchstanding Deck Officers or one dedicated Radio Officer. This accident demonstrates the need to carry a means of raising the alarm in the event of an emergency. Should high speed vessels carry additional warning lights to indicate their extra speed? A rescue helicopter carrying a doctor arrived after approximately 45 minutes.; 5 (marine eng) **podnijeti**; 6 (shipping econ)

prevoziti: Do you carry any dangerous goods? The vessel was certified to carry up to 12 passengers. The vessel was carrying 1973 containers on deck, which were stacked seven containers high.; 7 (marine eng) **nositi, imati na sebi**; 8 **podupirati**

carry away (v) (seamanship) the act of breaking loose **otkinuti se, otpustiti se, otkaćiti se** {o konopima, palubnoj opremi, škotinama itd}

carrying weight (n) (shipping econ) **ANTONYM dead weight** korisna nosivost

carrying capacity (n) (nav arch, shipping econ) nosivost, korisna nosivost broda, kapacitet: s cross-section and load carrying capacity;

cart /ka:t/ (n) (cargo handling) **SEE dray** a heavy open vehicle, usually having two wheels, used to transport goods locally **kola, kolica**

cartage /'ka:tidʒ/ (n) 1 (shipping econ) (originally) the process of transporting by cart; in US the term is used for trucking (intra-city hauling on drays or trucks) or for trucking fees. **podvoz, dovoz robe do broda (kolicima / kamionom / prikolicom radi ukrcaja na brod)**; 2 (shipping econ) tarifa za podvoz, tarifa za međugradski kamionski prijevoz

carter's note /'ka:tə/ (n) (shipping econ, mar law) potvrda o primitku robe / tereta sa cestovnog vozila

cartographic ship /,ka:tə'græfik/ (n) (nav arch) kartografski brod

cartography; chartography /ka: 'tɒgrəfi/ (n) (navig) kartografija

carton /'ka:tən/ (n) (cargo handling) kartonska kutija (vrsta pakovanja / ambalaže), **karton**

cartridge gun (n) (marine eng) pištolj za silikonske patrone

carvel-built (adj) (boating/yachting) **COMPARE clinker-built boat** constructed with the hull planks laid edge to edge to make a flush smooth finish **trup s ravnim trenicama (madirima)**

carvel planking (n) (nav arch, boating/yachting) trenice bez preklapanja **ravne trenice**

CAS; collision avoidance system (n) (navig) sustav izbjegavanja sudara

case /keis/ (n) 1 (marine eng) **plašt**; 2 (mar law) slučaj **in case of** u slučaju (da) **ako**; 3 (cargo handling) **kutija, sanduk**

case law (n) (mar law) **sudska praksa, pravo utemeljeno na sudskim slučajevima**: The bill of lading's identity and legal standing is provided for by national and international law, by case law and precedent, and by common usage over many years. Most of the common law countries follow English statute and case law.

cash (n) (financ) **gotovina**

Cashier's Office /kæ'ʃiə/ (n) (shipping econ) **blagajna**

cash machine (n) (UK) **bankomat**

cashpoint (n) 1 (financ) **blagajna**; 2 **bankomat** **cashpoint machine** **bankomat**

casing /'keisɪŋ/ (n) 1 (marine eng) **plašt, kućište, oplata** **cylinder casing** **kućište cilindra, outlet casing** **odvodna (obložena) cijev, boiler casing** **plašt kotla, funnel**

casing oplata dimnjaka, **iron casing** željezna oplata, željezno kućište, **rotor casing** kućište rotora (turbine), **boiler casing** kućište kotla, **twindlass motor casing casing** kućište motora sidrenog vitla: *Soon the windlass motor casing shattered ...*, **engine casing** kućište stroja, **kućište motora**: *This allowed boundary cooling of the engine casing to be started.*, **inner casing** unutarnje kućište: *The inner casing carries the structural load from the HP compressor outer casing to the turbine casing;* ; 2 (**marine eng**) **plašt, oplata**

cask /'ka::sk/ (n) (**cargo handling**) bačva (drvena, za alkoholna pića), drvena bačva

cast /'ka::st/ (v) (**marine eng**) **lijevati** **cast in one piece** lijevan iz jednog komada, **cast iron** lijevano željezo, sivi lijev

cast (v) 1 (**seamanship**) **baciti (konop), dobaciti (konop);** 2 (**seamanship**) **baciti** **cast the anchor** **spustiti sidro** **baciti sidro**: *The MV dragged anchor 2 miles away but did not use enough her propulsion plant to help holding her mooring and did not cast her second anchor.*

castaway /'ka::stə, weɪ/ (n) (**seamanship**) brodolomac

casting /'ka::stɪŋ/ (n) 1 **ljevanje;** 2 **kućište, blok** **cylinder casting** kućište cilindra, **blok cilindra;** 3 (**marine eng**) **odljevak**

casting (n) (**fishing**) **bacanje (ribolovnim štapom)**

casting-off orders (n) (**seamanship**) **zapovijedi za odvezivanje** 1 **Stand by engines!**, 2 **Are you ready to get underway?**, 3 **Stand by for letting go!**, 4 **single up fore and aft!**, 5 **Heave on breast line!**, 6 **Pay out on breast line!**, 7 **Let go head line / ster line / breast line / fore spring / aft spring!**, 8 **Let go towing line!**, 9 **Stand by bow anchor,** 9 **Finished with manoeuvring station!**

cast iron (n) (**marine eng**) = **gray iron** lijevano željezo, sivi lijev, **giza**: *Give extra attention to all valves, especially those made of cast iron.*

cast off (v) 1 (**seamanship**) **let go (line);** to let go the dock lines in order to get under way. To remove the dock lines, or to free them from their cleats, and throw them to the dock (<http://www.seatalk.info/cgi-bin/nautical-marine-sailing-dictionary>) **odbaciti uže (s bitve), tal. mollare (gli ormeggi).** *He was aware that the end of the rope had been cast off from the mooring bitt on the pier and cast into the water. One of the deckhands went on deck to cast the lines off. On pilot's advice, all lines were cast off, and the two tugs began pulling the vessel away parallel from the berth.; 2 (**seamanship**) **odvezati se (brod):** *Three Pilots boarded and the vessel cast off at 0900 with 2 tugs made fast. A single mooring line was put out, the two pilots passed each other on the gangway, and the vessel cast off to continue her passage to the sea.**

cast steel (n) (**marine eng**) **lijevani čelik**

casualties /'kæʒjʊəltɪz/ (n) (**safety**) 1 **a gubici;** 2 **poginuli u pomorskog nesreći, žrtve (u pomorsokj nesreći);** 3 **štete**

casualty /'kæʒjʊəlti/ (n) 1 (**safety**) **nesreća, pomorska nesreća, gubitak:** *In a recent maritime casualty, a vessel sank with loss of many lives. The second tug was quickly alongside the casualty and passed across three charged fire hoses. Type of casualty: Capsizing/Listing EMSA No. ... 3-2008 A recent marine casualty involving a large fishing vessel resulted in multiple fatalities and loss of the vessel. **marine casualty** 'izvanredni događaj na moru koji je prouzročio štetne posljedice kojima su neposredno ugroženi ljudski životi, imovina i okoliš'; In accordance with the RESOLUTION A.849(20) adopted on 27 November 1997 - CODE FOR THE INVESTIGATION OF MARINE CASUALTIES AND INCIDENTS a marine casualty is an event that has resulted in any of the following: 1. the death of, or*

serious injury to, a person that is caused by, or in connection with, the operations of a ship; or 2. the loss of a person from a ship that is caused by, or in connection with, the operations of a ship; or 3. the loss, presumed loss or abandonment of a ship; or 4. material damage to a ship; or 5. the stranding or disabling of a ship, or the involvement of a ship in a collision; or 6. material damage being caused by, or in connection with, the operation of a ship; or 7. damage to the environment brought about by the damage of a ship or ships being caused by, or in connection with, the operations of a ship or ships.

pomorska nesreća serious casualty a casualty which does not qualify as a very serious casualty and which involves: .1 a fire, explosion, grounding, contact, heavy weather damage, ice damage, hull cracking or suspected hull defect, etc., resulting in; .2 structural damage rendering the ship unseaworthy, such as penetration of the hull underwater, immobilization of main engines, extensive accommodation damage etc.; or .3 pollution (regardless of quantity); and/or .4 a breakdown necessitating towage or shore assistance.

ozbiljna nesreća (požar, eksplozija, nasukanje, oštećenje broda)

usljed kojega brod prestane biti sposoban za plovidbu, very serious casualty a

casualty to a ship which involves the total loss of the ship, loss of life or severe pollution **vrlo ozbiljna**

nesreća (s fatalnim posljedicama); 2 (safety) unesrećena osoba, ozlijeđena osoba

The casualty was extremely lucky not to suffer more severe or even fatal injuries. Unesrećeni je imao sreću

što nije doživio ozbiljnije ili čak smrtonosne ozljede. Very soon afterwards another crew member saw the

casualty and alerted the chief officer. The emergency services arrived and stabilised the casualty before

he was craned out of the hold on a stretcher. He immediately instructed the casualty not to move and

contacted the ship's medic. The fishing vessel skipper skilfully manoeuvred the boat alongside the

casualty to enable his colleagues to recover him on board.; 3 (safety) žrtva (u pomorskoj

nesreći): *Number of casualties: four. Number of injured persons: five Broj žrtava: četiri. Broj*

ozlijeđenih osoba: pet. No other casualties have been reported and 20 crew were evacuated to sister vessel.

Fortunately there were no casualties and the damage was limited to the forecastle area.; 4 (safety, mar

law) unesrećeni brod, havarirani brod: *A couple of minutes later the casualty was sighted, it was*

a dis-masted yacht.; 5 (safety, mar law) havarija (stroja, uređaja itd.): *The Navy is investigating*

a casualty to one of the main propulsion diesel engines (MPDE) on board the ship. The MPDE will need

to be removed and rebuilt or replaced altogether.

Catalogue of Admiralty Charts and Publications (n) (navig) Katalog

admiralitetskih pomorskih karata i publikacija

catamaran /,kætəməˈræn/ (n) (nav arch) a vessel with two hulls joined by a deck and bracing

katamaran, dvotrupac: *A large catamaran was fitted with four gas turbine engines, two in each of the hulls.*

catamaran /,kætəməˈræn/ (n) (boating/yachting) jedrilica katamaran

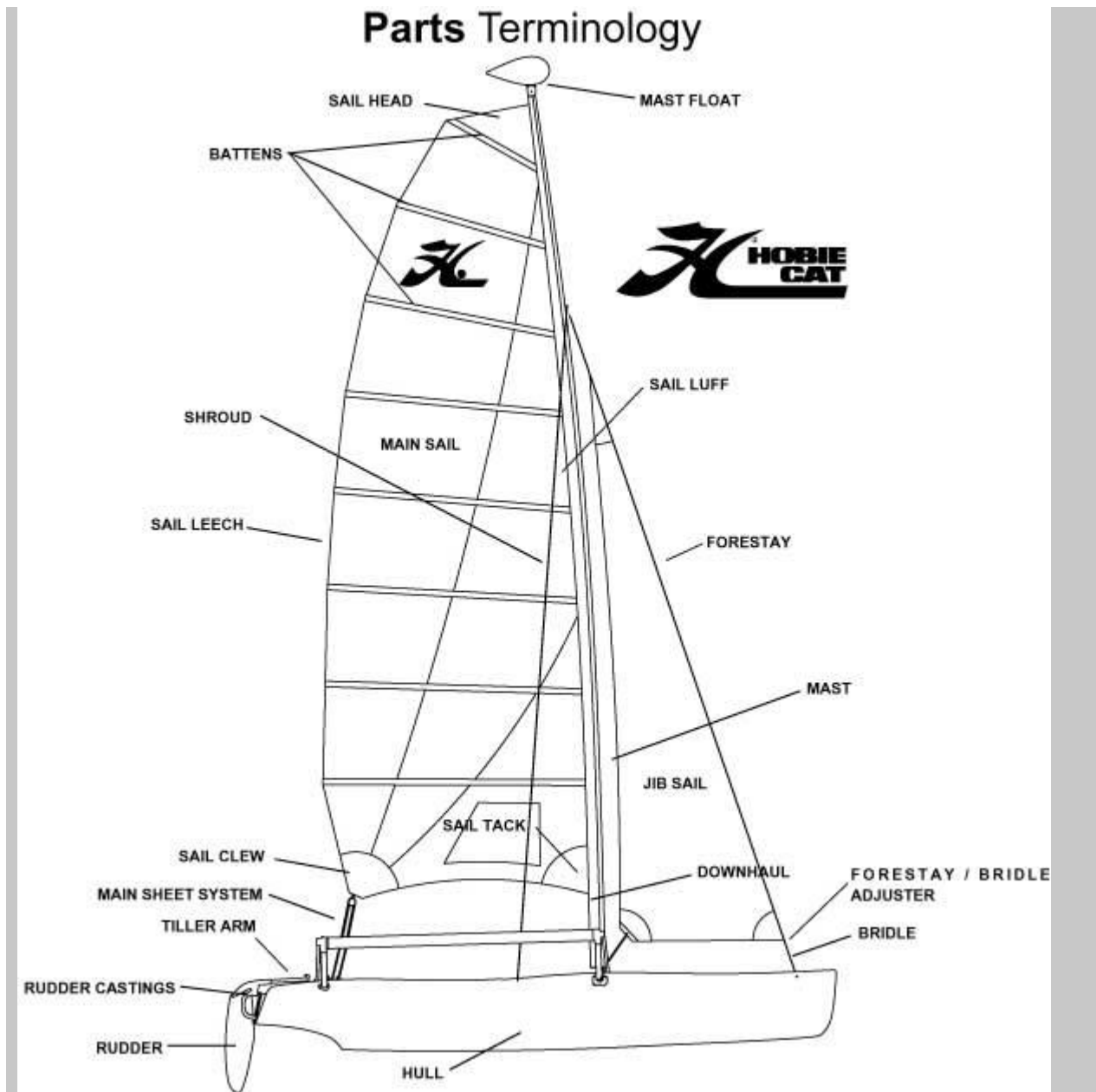

catch fire (v) (*safety*) **zapaliti se (o brodu)** *Four people died in a car ferry that caught fire off the coast of Greece. A product tanker caught fire off Dayangshan Island on 3 August, killing one crew member and injuring five others. The vessel **caught fire** and sank at about 1 a.m*

catenary /kə'ti:nəri/ (*navig, seamanship*) matematička krivulja kojom se opisuje oblik sidrenoga lanca dok je brod usidren, a mathematical term which describes the shape of a flexible line (like chain) hung between two points (like the bow of your boat and the seabed **lančanica, krivulja**

ovješeno lanca: a *catenary* is seen in the real world when a flexible line hangs between two points. It is the effect of gravity, a uniformly directional force, acting along its length. A typical example is the chain and rope connecting your anchor to your boat (<http://www.petersmith.net.nz/boat-anchors/catenary.php>) In moderate winds of 20 knots, *catenary* is obvious and a section of the chain lies on the seabed. A more serious scenario of 50 knots wind – the *catenary* has all but disappeared, and the angle of pull on the anchor is dictated primarily by the scope, not the weight of the chain.

(<http://www.petersmith.net.nz/boat-anchors/catenary.php>) **flexible catenary** fleksibilna lančanica

cater for /'keɪtə/ (v) **1** opskrbljivati, snabdijevati; **2** brinuti se o, skrbiti se o, pobrinuti se za: *The engine control room was informed and the switchboard was then reconfigured with an additional generator to cater for the additional load.*

catering department /'keɪtəriŋ/ (n) (*shipping econ*) The catering or galley department is responsible for preparation and serving of foods to the crew on board of a ship. There are a number of jobs available in this department that includes Chief Steward, Chief Cook, Second Cook, Bakery/Pastry Man, Cleaners and Dish Washers. **opća služba (na brodu), bijelo osoblje, brodski ekonomat**

catering officer /'keɪtəriŋ/ (n) (*mar law*) časnik opće službe

catering staff (n) (*mar law*) **bijelo osoblje, osoblje opće službe**: *The galley extraction fans and principal electrical equipment had been shut down some time earlier by the catering staff ...*

catfish (n) (*fishing*) som

catfish (n) (*fishing*) mačka, mačka mrkulja

cathead (n) (*sailing vessels*) a beam extending out from the hull used to support an anchor when raised in order to secure or 'fish' it **soha sidra** {obsolete (zastarj.)}

cathode corrosion protection (n) (*safety*) katodna zaštita

cathode ray tube; (CRT) /'kæθəʊd/ (n) (*electr*) katodna cijev

cathode tube (n) cold **cathode tube** elektronska cijev s hladnom katodom (*electr*) katodna cijev

cat rig (n) (*boating/yachting*) snast jedrilice, kao kod lasera ili fina; a small sailing boat with a single mast stepped right in the bow **laserska snast**: *A cat-rigged boat has a single mast, stepped well forward, carrying one fore and aft sail, behind the mast.*

catspaw /'kætspɔ:/ (n) (*seamanship*) dvostruki uzao za kuku

cattle (n) (*cargo*) stoka

cattle ship (n) (*nav arch*) = **livestock carrier** brod za stoku, brod za prijevoz stoke

catwalk /'kæɪ, wɔ:k/ (n) **1** (*nav arch*) mostić (za hodanje koji spaja pramac i most na tankeru), **pasarela (na tankeru); 2** (*ports*) finger pier; a narrow dock walkway which provides access to a vessel **pasarela na gatu, gat**

caulk; calk /kɔ:k/ (v) **1** (*nav arch, sailing vessels*) to fill in the bottom or side plank seams with a material (cotton or oakum) to prevent or stop leaks **šuperiti, kalafatat(i), tal. calafatare**



caulking-iron (n) (*boating/yachting, nav arch*) **dlijeto za šuperenje**; **2** (*nav arch, boating/yachting*) brtviti, začepiti

caulking-mallet (n) (boating/yachting, nav arch) drveni bat za šuperenje

cause of accident (n) (safety) uzrok nezgode

caution (n) 1 (safety) oprez, upozorenje to navigate with **caution** (navig) ploviti oprezno, proceed with **caution** ploviti oprezno; 2 (safety) opomena

cavitation /,kævi'teɪʃən/ (n) (nav arch) The effect caused when air is drawn down into the water by a propeller, resulting in loss of power, overspending of the engine and propeller, and pitting of the metal surfaces of the propeller (<http://www.seatalk.info/cgi-bin/nautical-marine-sailing-dictionary>)

kavitacije (propelera)

cavity /'kæviti/ (n) 1 (marine eng) rashladni prostor (motora); 2 (marine eng) šupljina

C (Celsius; centigrade; carbon) /'sɛlsɪəs/ (n) 1 (marine eng) celzijus; 2 (marine eng) ugljik

CCRP; Consistent Common Reference Point (n) (navig) zajednička referentna točka

CCRS; Consistent Common Reference Point (n) (navig) a single consistent common reference point for information in the Integrated Navigational System) **zajednički referentni**

sustav: *The CCRS should ensure that all parts of the INS are provided with the same type of data from the same source.*

cease /si:z/ (v) (mar law) prestati, obustaviti, završiti. *On advice from the terminal we decided to cease discharging and proceed to sea until the typhoon had passed.*

ceiling /'si:lɪŋ/ (n) 1 (nav arch) a term applied to the planking with which the inside of a vessel is sheathed **podnice**, **pajoli ceiling planks** **daske podnica**, **tavaloni podnica**; 2 (marine eng) **strop**, **pokrov**. *As a result of the fire, there was considerable smoke and fire damage to the bulkheads and ceiling.* **ceiling tank pokrov tanka** {!!! **ceiling nu konstrukciji broda nije strop, već podnica**}

ceiling coils (n) (nav arch, marine eng) spiralne cijevi tanka ispod palube, **serpentine tanka ispod palube**

celestial body /si'lestiəl/ (n) (navig) **nebesko tijelo**: *The starting point marks where the Sun crosses the celestial equator in the spring and the angle from it to a celestial body is called the sidereal hour angle, or SHA.*

celestial fix (n) (navig) **nebeska pozicija**, **pozicija dobivena astronomskom**

navigacijom: *Due to the long time it takes to complete a set of celestial observations, advancing and retarding LOPs is a common feature of a celestial fix.*

celestial horizon (n) (navig) an imaginary plane through the observer at right angles to the local vertical horizon (<http://www.seatalk.info/cgi-bin/nautical-marine-sailing-dictionary>) **astronomski horizont**, **nebeski horizont**

celestial navigation (n) (navig) Celestial navigation systems are based on observation of the positions of the Sun, Moon, Planets and navigational stars. Such systems are in use as well for terrestrial navigating as for interstellar navigating. By knowing which point on the rotating earth a celestial object is above and measuring its height above the observer's horizon, the navigator can determine his distance from that subpoint. A nautical almanac and a marine chronometer are used to compute the subpoint on earth a celestial body is over, and a sextant is used to measure the body's angular height above the horizon. That height can then be used to compute distance from the subpoint to create a circular line of position. A navigator shoots a number of stars in succession to give a series of overlapping lines of position. Where they intersect is the celestial fix. The moon and sun may also be used. The sun can also be used by itself to shoot a succession of lines of position (best done around local noon) to determine a

position (Bowditch 2002) **nebeska navigacija**, **astronomska navigacija** **practise celestial navigation** provoditi astronomsku navigaciju **primijeniti astronomsku navigaciju** {Used primarily as a backup to satellite and other electronic systems in the open ocean.}

celestial object (n) (navig) **nebesko tijelo** **take the bearing of a celestial object** snimiti azimut nebeskog tijela

celestial observation (n) (navig) **motrenje nebeskih tijela**, **snimanje nebeskih tijela**

celestial pole (n) (navig) **nebeski pol**: *In this time exposure, stars circle the north celestial pole as Earth turns. Stand on the North Pole, latitude 90° N, and overhead will be the north celestial pole, declination +90°. (<http://www.skyandtelescope.com>)*

cell /sɛl/ (n) (nav arch) **COMPARE container guide** a structural arrangement in container vessels that permits ship containers to be stowed in a vertical line with each container supporting the one above it **ćelija (u brodskom skladištu za kontejnere)**

cell guide (n) (nav arch) steel bars and rails used to guide containers during loading and discharging whilst sliding in the ship **vodilica za kontejnere u skladištu broda** *High cube boxes stowed cumulatively, resulting in the highest container extending well above the top of the cell guides. Cell guides on the sides of the hold ensure that the containers stack properly.*

cell position (n) (shipping econ, cargo handling) **slot**

cellular /ˈsɛljʊlə/ (n) **fully cellular container ship** **kontejnerski brod (samo za prijevoz kontejnera)** (nav arch) **celularan**, **kontejnerski**

cellular vessel (n) (nav arch) a vessel, specially designed and equipped for the carriage of containers **kontejnerski brod**

cement carrier /siˈmɛnt/ (n) (nav arch) **brod za cement**, **brod za prijevoz cementa**

centerboard trunk (n) (boating/yachting) = **centreboard case** **kućište pomične kobilice**

centerline (n) (nav arch) **simetrala**

centerline fairlead (n) (nav arch) **privezno oko (na pramcu)**, **panama aft centerline fairlead** **privezno oko na krmi**, **panama na krmi**

center of gravity (n) (US) (phys) = **centre of gravity; (G)** **sustavno težište broda** {center = US spelling of centre (UK)}

center of gravity in metres from bottom of keel (n) (stabil) **težište u metrima od dna kobilice**

center point method (n) (navig) **metoda traganja i spašavanja s polaskom iz središnje točke** **center point method - rectangular area** **metoda pravokutnoga traganja i spašavanja s polaskom iz središnje točke**, **center point method - circular area** **metoda kružnoga traganja i spašavanja s polaskom iz središnje točke**, **center point method - rectangular area, bearing and distance** **metoda pravokutnoga traganja i spašavanja s polaskom iz središnje točke, s određenim azimutom i udaljenošću**

centigrade /ˈsɛntiˌɡreɪd/ (n) **celzijev stupanj**, **stupanj celzija**

centilane (n) (navig) **pojas frekvencija podijeljen u sto dijelova (u sustavu LORAN C)**

central processing unit; (CPU) (n) (navig) **COMPARE VDR; Voyage Data**

centre

centre of gravity in metres from after perpendicular (Grain)

Recorder središnja procesna jedinica (VDR-a)

centre (n) centre of gravity težište, **bottom dead centre** (BDC) donja mrtva točka, **top centre** gornja točka (marine eng) središte, centar

centreboard case (n) (boating/yachting) kućište pomične kobilice, kućište

centarbota centreboard case trunk kućište pomične kobilice, kućište centarbota

centreboard (UK); centerboard (US) (n) (boating/yachting) **COMPARE**

daggerboard a centreboard pivots on a bolt through the centreboard case and rotates into its case as it is raised while the tip moves aft in the water; pomična kobilica koja se podizanjem ili spuštanjem okreće oko svoje osi, a dno lista peraje koso se diže prema trupu i obratno **pomična kobilica**, **koso pomična peraja**, **centarbot**

centre console (n) (navig) središnji pult, glavni pult: *The master returned to the centre console, where he attempted to re-establish control of the propulsion;*

centre girder (n) (nav arch) hrptenica

centre keelson /'sentə ,kɛlsən; 'sentə ,kl:lsən/ (n) (nav arch) hrptenica

centre lead (n) (nav arch, seamanship) središnje oko, **panama**: *The larger tug was made fast through the centre lead forward to perform the tow The Deck Cadet was passing a mooring rope to the tug from the aft winch drum after taking it around a set of bits and out through the aft centre fairlead.*

centre-line (n) (nav arch) os, središnja linija

centreline fairlead (n) (nav arch) pramčano privezno oko, **panama**%

centreline plane (nav arch) simetralna ravnina

centre of buoyancy; (B) (n) (stabil) the geometric centre of the underwater volume of the ship at a particular instant, and the point through which the total buoyancy force (Bf) is considered to act vertically upwards (Rhodes, Ship's Stability, Seamanship, 2003) **težište istisnine**, **težište**

uzgona, **centar uzgona**: *Ship stability is concerned with the relative positions of G (centre of gravity) and B (centre of buoyancy) as the ship is heeled. The officer in charge of loading the ship must be fully conversant with the way that G moves when shifting, loading and discharging weight.* **longitudinal**

centre of buoyancy; (B) (LCB) **uzdužni centar uzgona**

centre of effort (CoE) (n) 1 (boating/yachting) težište (sila pri jedrenju); 2 (ship handling) težište sila vjetra

centre of flotation (n) (stabil) centar plutanja **longitudinal centre of flotation** (LCF) **uzdužni centar plutanja**: *uzdužni centar plovnosti*

centre of gravity; (G) (n) (nav arch, stabil) the point where the total weight force (Wf) of the ship is considered to act vertically downwards **sistemno težište broda**, **sustavno težište**

broda, **sila teže broda**, **težište broda**, **težište gravitacije** **vertical shift of centre of gravity; (G)** **vertikalni pomak sustavnoga težišta broda**, **virtual centre of gravity; (G)** **virtualni položaj sustavnoga težišta broda**, **longitudinal centre of gravity; (G)**

(LCG) **uzdužni centar gravitacije**

centre of gravity in metres from after perpendicular (n) (stabil) udaljenost težišta prostora od krmene okomice

centre of gravity in metres from after perpendicular (Bales) (n) (stabil) udaljenost težišta teretnog prostora od krmene okomice (za ukrcaja bala tereta)

centre of gravity in metres from after perpendicular (Grain) (n) (stabil)

centre of gravity in metres from bottom of keel (Bales)

certificate of competency; (CoC)

udaljenost težišta teretnog prostora od krmene okomice (za žito)

centre of gravity in metres from bottom of keel (Bales) (n) (stabil) Kg
teretnog prostora od kobilice (za bale)

centre of gravity in metres from bottom of keel (Grain) (n) (stabil) KG
teretnog prostora od kobilice (za žito)

centrifugal /sɛnˈtrɪfʊɡəl; ˈsɛntriˌfjuːɡəl/ (adj) centrifugalan

centrifugal pump (n) (marine eng) centrifugalna pumpa, centrifugalna sisaljka,
centrifugalna crpka

centrifugate /sɛnˈtrɪfʊɡeɪt/ (v) (marine eng) centrifugirati

centrifuge /ˈsɛntriˌfjuːdʒ/ centrifuga

centrifuge pump (n) (marine eng) = **centrifugal pump** centrifugalna pumpa

cephalopod /ˈsɛfələˌpɒd/ (n) (fishing) mekušac

certificate /səˈtɪfɪkət/ (n) (mar law, safety) certificate of competency svjedodžba o

osposobljenosti pomorca, ovlaštenje *patent*, *brevet*, certificate of inspection

svjedodžba (potvrda) o pregledu, **First Mate's certificate of Competency**

svjedodžba o ovlaštenju za prvog časnika palube, classification certificate

svjedodžba o klasi broda, **Master's certificate** svjedodžba o ovlaštenju za

zapovjednika, provisional certificate privremena svjedodžba privremeni

plovidbeni list, Safety certificate svjedodžba o sigurnosti, **Safety Equipment**

certificate svjedodžba o sigurnosnoj opremi, sanitary certificate svjedodžba

sanitarnih organa, tonnage certificate svjedodžba o baždarenju, **Wireless**

certificate svjedodžba o radio-uređuju, certificate of Competence svjedodžba o

osposobljenosti (za pomoračka časnička zvanja prema IMO-konvenciji STCW),

certificate of origin svjedodžba o podrijetlu (robe, materijala), certificate of

qualification svjedodžba o osposobljenosti / stručnosti, certificate of Registry

upisni list, certificate of shipment podteretnica za kontejnere u sustavu LCL (less

than contain er load) (sastavni dio zbirne teretnice), kućna teretnica (House B/L)

diona teretnica, certificate of shipment potvrda o otpremi (robe), **Vaccination**

certificate svjedodžba o cijepljenju, **First Class Engineer certificate** svjedodžba

strojara prve klase, **Second Class Engineer 1** svjedodžba strojara druge klase (=

svjedodžba časnika straže u stroja+u) 1 potvrda; 2 certifikat; 3 svjedodžba

certificate /səˈtɪfɪˌkeɪt/ (v) (mar law) potvrditi

certificated engineer /səˈtɪfɪˌkeɪtɪd/ (n) (mar law) ovlašteni časnik stroja, ovlašteni
strojar

certificated officer /səˈtɪfɪˌkeɪtɪd/ (n) (mar law) ovlašteni časnik (palube)

certificate holder (n) (mar law) nositelj ovlaštenja,

certificate of class (n) (nav arch, safety) svjedodžba o klasi broda **issue a certificate
of class** izdati svjedodžbu o klasi broda

certificate of competency; (CoC) (n) (mar law) svjedodžba o osposobljenosti
pomorca (zapovjednika, upravitelja stroja, časnika palube ili stroja, članova
posade kao sastavnog dijela straže itd.), ovlaštenje, *brevet*, *tiket*: *He held a Chinese*

STCW II/2 certificate of competency (CoC) with a UK certificate of equivalent competency (CEC). IMO
STCW certificate of competency; (CoC) svjedodžba o osposobljenosti pomorca
prema IMO konvenciji STCW (1978/1995/2010) *III/5 - CoC for ratings as able seafarer engine*
in a manned engine-room or designated to perform duties in a periodically unmanned engine-room **II/1 -**
CoC for officers in charge of a navigational watch on ships of 500 gross tonnage
or more *časnik plovidbene straže na brodu od 500 BT ili većem (STCW II/1)*
poručnik trgovačke mornarice (naziv svjedodžbe/ ovlaštenja u uobičajenoj
uporabi prije usvajanja Konvencije IMO STCW 1978/1995) **II/2 - CoC for masters**
and chief mates on ships of 3000 gross tonnage or more *zapovjednik broda od*
3.000 BT ili većeg (STCW II/2, točke 1-2), prvi časnik palube na brodu od 3.000 BT
ili većem (STCW II/2, točke 1-2), zapovjednik duge plovidbe (naziv svjedodžbe/
ovlaštenja u uporabi prije usvajanja Konvencije IMO STCW 1978/1995) **II/3 - CoC**
for officers in charge of a navigational watch and of masters on ships of less
than 500 gross tonnage, engaged on near-coastal voyages *časnik plovidbene*
straže na brodu do 500 BT u priobalnoj plovidbi (STCW II/3, točke 3-4),
zapovjednik broda do 500 BT u priobalnoj plovidbi (STCW II/3, točke 5-6); **II/4 -**
CoC for ratings forming part of a navigational watch *član posade koji čini dio*
plovidbene straže (STCW II/4), **II/5 - CoC for ratings as able seafarer deck** *stariji*
član posade koji čini dio plovidbene straže (STCW II/5), **III/1 - CoC for officers in**
charge of an engineering watch in a manned engine-room or designated duty
engineers in a periodically unmanned engine-room *časnik stroja odgovoran za*
stražu u strojarnici sa strojem porivne snage od 750 kW ili jačim (STCW III/1),
časnik stroja II. klase (naziv svjedodžbe/ ovlaštenja u uporabi prije usvajanja
Konvencije IMO STCW 1978/1995) **III/2 - CoC for chief engineer officers and**
second engineer officers on ships powered by main propulsion machinery of
3,000 kW propulsion power or more *upravitelj stroja na brodu sa strojem porivne*
snage od 3000 kW ili jačim (STCW III/2, točke 1-2), drugi časnik stroja na brodu sa
strojem porivne snage od 3.000 kW ili jačim (STCW III/2, točke 1-2), svjedodžba o
položenoj I. klasi - upravitelj stroja (naziv svjedodžbe/ ovlaštenja u uporabi prije
usvajanja Konvencije IMO STCW 1978/1995) **III/3 - CoC for chief engineer officers**
and second engineer officers on ships powered by main propulsion machinery of
between 750 kW and 3,000 kW propulsion power *upravitelj stroja na brodu sa*
strojem porivne snage do 3000 kW (STCW III/3), drugi časnik stroja na brodu sa
strojem porivne snage do 3.000 kW (STCW III/3), **III/4 - CoC for ratings forming**
part of a watch in a manned engine-room or designated to perform duties in a
periodically unmanned engine-room *član posade koji čini dio plovidbene straže u*
strojarnici (STCW III/4), **III/5 - CoC for ratings as able seafarer engine in a manned**
engine-room or designated to perform duties in a periodically unmanned
engine-room *stariji član posade koji čini dio plovidbene straže u strojarnici (STCW*
III/5) **III/6 - CoC for electro-technical officers** *časnik elektrotehnike (STCW III/6),*
III/7 - CoC for electro-technical rating *brodski električar (STCW III/7)* **IV/2 - CoC**
for GMDSS radio operators *GMDSS radiooperator (STCW IV/2),* **V/1 - CoC for**
masters, officers and ratings on oil and chemical tankers *Svjedodžba o dopunskoj*
osposobljenosti – Rad na tankerima za ukapljene plinove (STCW V/1-2-2) **V/2 -**
CoC for masters, officers, ratings and other personnel on ro-ro passenger ships
Svjedodžba o dopunskoj osposobljenosti – Mjere sigurnosti na putničkom brodu
(STCW V/2).

Certificate of Competency First Class (Deck) (n) (mar law) **SEE Class 1**

Certificate (CoC) svjedodžba o osposobljenosti za prvog časnika palube i zapovjednika broda

Certificate of Competency First Class (Engineering) (n) (mar law) **SEE Class 1 Certificate (CoC)** svjedodžba o osposobljenosti za upravitelja stroja (strojara I. klase)

Certificate of Delivery (n) (mar law) a certificate, indicating the condition of a vessel upon delivery for a charter including ballast, available bunkers and fresh water **isprava o stavljanju broda u najam, isprava o ulasku broda u najam**

Certificate of Inspection (n) (**shipping econ**) **1** (**shipping econ, mar law**) a document certifying that merchandise was in good condition immediately prior to its shipment **Potvrda o pregledu robe (prilikom ukrcaja)**: *Eventually, just prior to departure I received a Shipper's Declaration and a Certificate of Inspection and this was supplied only after contacting the local MSA and requesting them to board vessel for discussions and clarification.*; **2** (**nav arch**) **Svjedodžba o pregledu**

Certificate of Origin (n) (mar law, **shipping econ**) a certified document used in international trade showing the origin of goods **Svjedodžba o podrijetlu robe**

certificate of pratique (n) (mar law) = **free pratique** slobodni promet

certificate of redelivery (n) (mar law) **COMPARE Certificate of Delivery** certificate, indicating the condition of a vessel upon redelivery from a charter including ballast, available bunkers and fresh water **isprava o izlasku broda iz najma**

certificate of registration (n) (mar law, **nav arch**) isprava kojom se dokazuje državna pripadnost broda, njegova namjena i područje plovidbe **upisni list** **provisional certificate of registration** **privremeni plovidbeni list, temporary certificate of registration** **privremeni upisni list**

certificate of shipment (n) (mar law, **shipping econ**) otpremnička potvrda, kućna teretnica

Certificate of Test and Thorough Examination of Lifting Appliances (n) (**safety**) **Svjedodžba o ispitivanju i cjelovitom pregledu prekrcajnih sredstava**

certified officer /'sɜ:ti,faɪd/ (n) (mar law) **ovlašteni časnik, časnik s ovlaštenjem**

certify /'sɜ:ti,fai/ (v) (mar law, **safety**) **potvrditi**: *This is to certify that ... Ovime se potvrđuje da ... It is the master's responsibility to verify that the vessel is properly certified and equipped for carrying any intended cargo as soon as he is told about it by the charterers or owners. The vessel was in good condition, had been certified by the MCA 6 weeks earlier, and was manned by an experienced skipper and two crew. The lifting gear and sling were duly certified for the load and had not been subjected to any severe loads since new;*

Cesser Clause /'sɛsə ,kɛ:z/ (n) (mar law) A clause in a charterparty which releases the charterer from his personal liability to the shipowner and substitutes the bill of lading holder as the debtor. The substituted bill of lading holder thus becomes personally liable for the charges and the shipowner waives his rights against the charterer.; **naručitelj/čarterer je oslobođen snošenja prijevoznih troškova nakon što je teret ukrcao** **klauzula o prestanku odgovornosti naručitelja, odredba o privremenom prestanku ugovora o najmu/zakupu broda, odredba o privremenom prestanku čartera**

cession /'sɛʃən/ (n) (mar law, **shipping econ**) **ustupanje, ustup, ustupanje prava**

cetane number /ˈsiːteɪn/ (n) (marine eng) **cetanski broj**

CEU; ceu; car equivalent unit (n) (cargo handling) **jedinica za prijevoz**

automobila, CEU jedinica: A 6,500 ceu Pure Car/Truck Carrier (PCTC) berthed in Mombasa yesterday afternoon for a regular discharge operation.

cf. /kənˈfɜː/ **usp., usporedi, isporodi** {lat confer}

CFAR; constant false alarm rate (n) (navig) **broj lažnih alarma sveden na konstantnu veličinu (o ARPA-i)**

C.&F (cost and freight) (n) (mar law, shipping econ) **COMPARE C.F.R. (cost and freight)** term of sale meaning "cost/cargo and freight" whereby Seller pays for cost of goods and freight charges up to destination port **cijena (robe) i vozarina C.&F (cost and freight) (named port of destination) cijena i vozarina (s naznakom luke odredišta)** {In July, 1990 the International Chamber of Commerce replaced C&F with CFR.}

C.F.R. (cost and freight) (n) (shipping econ, mar law) A trade term requiring the seller to arrange for the carriage of goods by sea to a port of destination, and provide the buyer with the documents necessary to obtain the goods from the carrier. Under CFR, the seller does not have to procure marine insurance against the risk of loss or damage to the goods during transit.

vanjskotrgovinski uvjet (INCO) koji uključuje cijenu robe i vozarina

chafe /tʃeɪf/ (n) **habanje (konopa), trošenje trenjem**

chafe (n) (seamanship) To wear the surface of a rope by rubbing against a solid object **habati se (o konopu)**: *Mooring lines may chafe or get caught in the area of locks.*

chaff (n) (electr) **metalni listići za radarske protumjere**

chafing (n) (cargo) wear away, rub, cause friction **trenje**: *Number 4 cylinder fuel injector leak-off pipe suffered extensive chafing because of its inadequate bracketing arrangements.* **chafing gear materijali za zaštitu od trošenja trenjem, chafing plate** a bent plate, which minimizes the chafing of ropes as at hatches **zaobljeni lim (za ublažavanje trenja užadi) protutarni lim, chafing guards protutarne vodilice**: *The mooring teams were fitting chafing guards to the lines.*

chain (n) **1 lanac drive chain (marine eng) lančani pogon, lančani prijenos; 2**

(seamanship) **sidreni lanac**: ... *the windlass hydraulic motor suddenly failed and the entire 11 shackles of chain ran out ...*

chain block (n) (seamanship, cargo handling) **lančani čekrk, lančani koloturnik,**

lančani parank *The bowl was being lowered on to the shaft by the rating using a chain block. The chain block was used at an angle to lift engine components.*

chain-bolt (n) (sailing vessels) **svornjak spreznjaka puta**

chain cable (n) (seamanship, nav arch) **sidreni lanac**: *The starboard anchor was quickly let go using about 10m of chain cable.*

chain drive (n) (marine eng) **lančani pogon, lančani prijenos**

chain guide (n) (nav arch) **vodilica lanca**

chain hook (n) (seamanship) **kuka za slaganje lanca**

chain link (n) (nav arch) **oko lanca, karika, maja**: *Just as the skipper stopped heaving, the hook opened up under load, causing it to be released from the chain link. Suddenly, a chain link parted*



and the tugger wire instantly became slack.

chain locker (n) (nav arch) a forward compartment below deck where the anchor chain is stowed

lančanik, prostor za lance, tal. pozzo delle catene: The last length of chain had broken loose from the **chain locker**, and the AB was hit and injured by the bitter end.

chain mark (n) (seamanship) oznaka duljine lanca

chain pipe (n) (nav arch) pipe leading from the forecastle deck to the chain locker **cijev lanca lančanika, cijev lanca**

chain plate (n) (nav arch) uglava

chain pulley (n) (seamanship, nav arch) podigač sidrenog lanca

chain sling (n) (cargo handling) lančani pasac: Stevedores were securing containers on board a vessel with **chain slings**.

chain slip (n) (nav arch) otpusna kuka lanca

chain stopper (n) (nav arch) zapor lanca, štoper sidrenog lanca: The vessel approached the single point mooring (SPM) to pick up the chafing chain from the buoy and secure it to her bow **chain stopper**. A **chain stopper** was subsequently applied to the tug topline (48mm diameter wire) in order for the

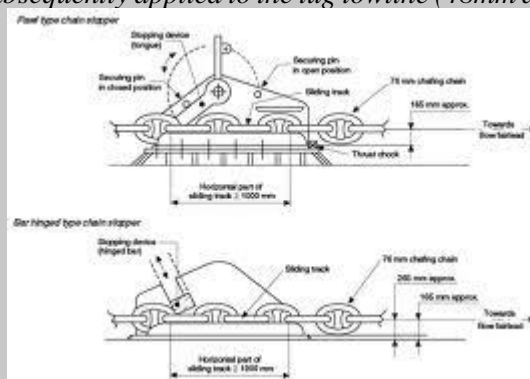

eye to be placed over the bits.

chain well (n) (nav arch) zdenac sidrenog lanca

chainwheel (n) (nav arch) = cable lifter = gipsy; gipsey = wildcat podigač lanca

chamber (n) combustion **chamber** komora izgaranja, komora za sagorjevanje, ionization **chamber** jonizacijska komora (marine eng) komora

Chamber of Commerce /'tʃeɪmbə/ (n) trgovinska komora

chamfer /'tʃæmfə/ (v) (nav arch) to cut off the sharp edge at an angle of 90 degrees **odrezati pod kutom od 90 stupnjeva (u brodogradnji)**

chandler /'tʃɑːndlə/ (n) (shipping econ) a company providing the ship supplies to operate and serve its crew, such as groceries; paper products; engine parts; electronics; hardware; etc. A chandler sells these supplies to the ship's agent. **brodoopsrbijivač** (Originally, chandlers (candle makers) provided

illumination to ships.}

chandlery /ˈtʃɑːndləri/ (n) **1** (ports, shipping econ) skladište brodske opreme (u luci), spremište brodske opreme; **2** (seamanship) brodske i pomoračke potrepštine

change of trim at aft end (n) (cargo handling, nav arch) promjena trima na krmi

change oil (n) (marine eng) izmjena ulja

change over (v) (marine eng) prebaciti (s jednog sustava na drugi): *the engineers changed over from the low to the high sea water cooling suction*

change over (n) (marine eng, navig) prebacivanje **changeover from automatic to manual steering** prebacivanje s automatskog na ručno kormilarenje {also: **changeover**}

change scale (n) (navig) promjena mjerila (u sustavu ECDIS)

changing over the watch (seamanship) zamjena straže, smjena straže

channel /ˈtʃæneɪl/ (n) **1** (navig) plovidbeni kanal, kanal: *As the east channel is narrow, and weather conditions were poor, I slowed down to allow the other vessel to clear the channel before we entered it.*

narrow channel uski kanal, **navigable channel** plovni / plovidbeni kanal: *Vessel A was southbound in the channel while Vessel B was approaching the channel entrance on a northerly course. 5 cables from the channel entrance, course was adjusted on the autopilot to 345° in accordance with the passage plan.*, **channel entrance** ulaz u plovidbeni kanal, **buoyed channel** kanal označen plutačama, **approach channel** prilazni kanal, **leave the channel** isploviti iz kanala, **enter the channel** uploviti u kanal, **clear the channel** napustiti kanal, **isploviti iz kanala**: *While the tanker waited for the cargo ship to clear the channel, no action was taken to stop the tanker from slowly moving towards the channel's entrance.*, **exit the channel** isploviti iz kanala, **izaći iz kanala**, **approach the channel** prići kanalu, **približiti se kanalu**, **cross the channel** ploviti preko kanala, **presijecati kanal**, **a busy shipping channel** prometni plovidbeni kanal, **main channel** glavni kanal, **navigate in the channel** ploviti kanalom, **ploviti u kanalu**, **wait outside the channel** čekati izvan plovidbenog kanala, **channel buoy** oznaka plovidbenoga kanala: *After passing the last channel buoy before the breakwater entrance at very close range, the pilot ordered hard-a-starboard.*, **deep-draught channel** plovidbeni kanal za brodove dubokog gaza: *The ship decided to take the deep-draught channel, turned to port and scraped down our port side less than 2 cables off.*, **close the channel** zatvoriti plovidbeni kanal: *The incident cause the Channel to be closed for three days.*; **2** (comm) radio-kanal, komunikacijski kanal **listen to the channel** pratiti kanal, **slušati kanal**, **biti na kanalu**, **radio channel** radio-kanal, **be on the channel** biti na kanalu; **3** (geogr, oceanogr) prirodni kanal

channel /ˈtʃæneɪl/ (n) (sailing vessels) polica **lower channel** donja polica, **upper channel** gornja polica

channel marked by bouys (n) (navig) plovidbeni kanal označen plutačama: *The ship entered the port through a channel marked by pairs of lateral buoys numbered from 1 at the seaward end to 16 near the outer basin.*

channel marker buoy (n) (navig) oznaka plovidbenoga kanala: *However, due to the combined effects of a tidal stream and loss of steering due to decreased speed, the vessel drifted on to the channel marker buoy, which got fouled briefly with the rudder.*

channel pilot (n) (navig) morski peljar, peljar za plovidbu kanalom

channel transit (n) (navig) plovidba kanalom: *As a Master of VLCCs and ULCCs with*

many *Channel transits* behind me, I am certainly not against alterations to port in certain circumstances.

chanty; chanty /ˈʃæntɪ; ˈtʃæntɪ/ (n) (*seamanship*) merchant seamen's work song used when working the capstan or halyards **mornarska radna pjesma**

chaplain /ˈtʃæplɪn/ (n) **kapelan port chaplain lučki kapelan, svećenik za pomorce:**

Using ship movement data from MarineTraffic, chaplains will be able to see when ships are due to come into port and plan their ship visits accordingly. They can then provide care to the seafarers.

characteristic of Aton (n) (*navig*) the audible, visual, or electronic signal displayed by an aid to navigation to assist in the identification of an aid to navigation. Characteristic refers to lights, sound signals, RACONS, radio beacons, and daybeacons (Seasources.net) **karakteristika plovidbene oznake, obilježje plovidbene oznake (plutače, svjetla itd.)**

charge (n) **1 punjenje (baterije); 2 nadležnost, briga person in charge nadležna (odgovorna, zadužena) osoba** *At the poop deck, the second mate was in charge of the mooring operations.*, **be in charge biti nadležan (zadužen, odgovoran za): Complacency, familiarisation, and perhaps over confidence, spreads to the Master, Chief and others in charge aboard the vessel.** **na dužnosti, officer in charge dežurni časnik, časnik straže, odgovorni časnik Complacency, familiarisation, and perhaps over confidence, spreads to the Master, Chief and others in charge aboard the vessel.** *When I asked the Officer in charge his intentions he responded by asking me why, I had not taken action earlier to avoid the original close quarters situation. The officer-in-charge instructed the crewman controlling the winch to start heaving slowly to pull the tug's tow wire on board.*; **3 (mar law) optužba; 4 iznos vozarine; 5 zaduživanje**

charge (v) (*electr*) **puniti charge the battery puniti akumulator:** ... *the vessel's emergency generator battery charging system was wrongly set up in such a way that two chargers could be charging the battery simultaneously.*

charge (v) (*shipping econ*) **obračunati, naplatiti charge a fee obračunati pristojbu / proviziju**

charge (n) (*shipping econ*) an amount to be paid for carriage of goods based on the applicable rate of such carriage, or an amount to be paid for a special or incidental service in connection with the carriage of goods **iznos vozarine, prevoznina**

charge air cooler (n) (*marine eng*) **rashladnik zraka za punjenje cilindra**

charges (*shipping econ*) **troškovi:** *The area off the Nippa lighthouse has been used by ships to refuel and to take on stores, mainly to avoid having to pay port charges. The USCG was satisfied by the vessel's responses to the spill and no charges were brought against the vessel.* **collect charges naplatiti troškove, ubrati iznos za troškove**

charge with (v) (*mar law*) **optužiti, tužiti**

charging (n) **pressure (marine eng) prednabijanje (electr, marine eng) punjenje:** *All charging systems should be checked to ensure that the charging current cannot exceed the specified safe range;*

chart (n) (*navig*) **karta, mapa:** *The chart used was Admiralty Chart 323, a copy of the relevant area being enclosed. This resulted in the use of inappropriate settings with regard to depth contours, and chart and depth alarms.* **large / small-scale chart karta velikom / malog mjerila:** ... *the 2nd Mate had plotted the position on a small scale chart and not on the large scale chart that was used by the 3rd Mate for coastal navigation when arriving SE of the Canary Islands.*, **up-to-date chart ažurirana karta, correct the chart ispraviti kartu:** *Correct all applicable charts through the latest Notice to Mariners, Local Notice to Mariners, and Broadcast Notice to Mariners.*, **latest edition of the chart**

najnovije izdanje karte, zadnje izdanje karte, paper chart papirnata karta, **klasična karta**: *The principles and requirements of passage planning on ECDIS are no different than when using a paper chart, and a master's responsibility to cross-check the work of his officers still remains.*, **electronic chart** **elektronička karta**: *As the vessel reached the southern end of the box, the deckhand selected a new course from the electronic chart and is reported to have dialled it into the automatic helm, expecting the vessel to turn onto a northerly heading.*, **hydrographic chart** **hidrografska karta**: *We had a look at the latest hydrographic chart,*, **position on the chart** **pozicija na karti**: *It is also required to check the position by GPS, compare it with DR positions on the chart and change course on the autopilot at predetermined positions.*, **consult the chart** **pogledati u kartu, provjeriti na karti**: *Although you may think you are familiar with a harbour, consult the chart and fisherman's pilot as part of your passage planning, to ensure you are fully aware of a harbour's aids to navigation.*, **Admiralty chart** **admiralitetaska karta, highlight on the chart** **pojačano obilježiti na karti, naglasiti na karti**: *The shoal been highlighted on the chart and the second officer was consulted with respect to the tanker's position and track.*, **plot the position on the chart** **ucrtati poziciju na karti**: *Soon afterwards, the second officer plotted the vessel's position on the chart and initiated a planned alteration of course from 110o to 118o using the autopilot.*

chart box (n) (navig) **kutija za pomorske karte, ladica za pomorske karte**

chart correction (n) (navig) **ispravljanje karata, korekcija karata**: *The published chart correction revised the charted depth of the bank to be 7. The OOW was undertaking passage planning and chart corrections when on watch ...*

chart data (n) (navig) **podatci na karti, informacije na karti**: *r in systems and to allow operators to see whether their ECDIS software is up to date and conforms to the latest ECDIS standards for displaying chart data.*

chart datum /'tʃɑːt,deɪtəm; 'tʃɑːt,daːtəm/ (n) (navig) **the tidal datum to which soundings on a chart are referred** **hidrografska nula, tal. livello zero delle carte**: *The dredged depth of the channel at Chart Datum is 21. Information regarding river depth/chart datum shown on the plan used by pilot was different from the BA chart in use by bridge team; The dredged depth of the channel at Chart Datum is 21.5 metres. {It is usually taken to correspond to a low water elevation of the tide, and its depression below mean sea level is represented by the symbol Zo (Seasources.net)}*

chart depth (n) (oceanogr) **dubina na karti, dubina karte**

charted area (n) (navig) **područje ucrtano na karti, područje označeno na karti**: *The amended voyage plan had taken the vessel across a charted area of shallow water.*

charted depth (n) (navig) **ucrtana dubina, dubina ucrtana na karti**: *Both pilot and Master determined that the shallowest charted depth along the course line was to be 22 m.*

charted height (n) (navig) **visina (mosta) na karti**

charted rock (n) (oceanogr) **ucrtana hrid**: *The vessel passed abeam of the charted rocks at a speed of approximately six knots and on a heading of nearly 227° T.*

charter /'tʃɑːtə/ (n) (mar law) **1** **The hire of a ship for a specified period of time or a particular voyage to carry a cargo from a loading port to a discharging port.**

(<http://www.globalshiplease.com/glossary.cfm>) **ugovor o najmu broda (EUdict), ugovor o iskorišćivanju brodova na moru, najmovni ugovor za brod (EUdict), čarter, čarter-partija, tal. noleggio** **the charter is expected to commence** **očekuje se da će ugovor o najmu (čarter) započeti 20. siječnja 2017.**: *The charter is expected to commence on*

January 20, 2017.; **2 brodarski ugovor, pomorski ugovor o prijevozu**

charter (v) (*mar law*) zakupiti brod, unajmiti / iznajmiti brod, uzeti brod u zakup / **čarter, čartirati** *In 1982 the ship was chartered to a private company*

charter by demise /'tʃɑːtə baɪ di'maɪz/ (n) (*mar law*) **COMPARE bareboat charter party** ugovor o zakupu broda (s brodovlasnikovom posadom) zakup broda

chartered in vessel cost (n) (*mar law*) cijena broda u čarteru

chartered owner (n) (*mar law*) = **disponent owner** brodar raspolagatelj

chartered vessel (n) (*mar law, shipping econ*) unajmljeni brod, brod u čarteru: *The Shipping Line has begun returning chartered vessels to their owners and had been trying to secure funds to help unload ships*

charterer /'tʃɑːtərə/ (n) (*mar law*) **1** ugovorna osoba koja od prijevoznika naručuje prijevoz stvari, osoba, tegljenje odnosno potiskivanje i obavljanje drugoga plovidbenog posla (PZ); Cargo owner or another person/company who hires a ship. (<http://www.clarksons.com/glossary/>); the party that hires a ship for a period of time or for a voyage **a naručitelj unajmitelj broda, zakupac broda (u ugovoru o najmu golog broda), zakupnik broda, zakupoprimac, čarterer; 2 naručitelj prijevoza**

charterer's agent (n) (*mar law*) naručiteljev agent, čartererov agent

charterer's bill of lading (n) (*mar law*) teretnica koja se izdaje iz brodarskog ugovora demise ili bareboat charterparty

charterers legal liability coverage (n) (*mar law, shipping econ*) A type of marine insurance designed to provide coverage for the liabilities including those of care, custody, and control (CCC) assumed by a party chartering a vessel when the vessel's operation remains in the control of the vessel's owner.

(<https://www.irmi.com/online/insurance-glossary/terms/c/charterers-legal-liability-coverage.aspx>)

pokriće odgovornosti unajmitelja / zakupnika broda

charterer's liability /'tʃɑːtərəz ,laɪə'biliti/ (n) (*mar law*) naručiteljeva odgovornost,

odgovornost naručitelja prijevoza, odgovornost zakupnika broda: *Since claims between an owner and a charterer frequently concern hull damages the cover may also include Charterer's Liability to Hull. The Club can provide cover for Charterer's liabilities where cargo is discharged or delivered at a place other than that named on the bill of lading.* **charterer's liability insurance**

osiguranje odgovornosti naručitelja prijevoza, osiguranje odgovornosti

unajmitelja broda, osiguranje odgovornosti zakupnika broda: *Charterer's Liability insurance is a P&I cover primarily, but for charterers with a fixed premium.*

charter hire (n) (*mar law, shipping econ*) A sum of money paid to the shipowner by a charterer for the use of a ship **najamnina za brod:** *Charterhire paid under a voyage charter is also known as freight ... the offshore oil and gas group is suing its Ltd for over USD140,000 of alleged unpaid charter hire.*

chartering broker (n) (*mar law*) = **shipbroker agent posrednik, broker**

charter owner (n) (*mar law, shipping econ*) A company that owns container vessels and charters out its vessels to container shipping companies rather than operating the vessels for liner services; also known as shipowner. (<http://www.globalshiplease.com/glossary.cfm>) **brodovlasnik**

charterparty, charter party /'tʃɑːtə ,paːti/ (n) **1** (*mar law*) a contract of lease of a ship in whole or in part for a long or short period of time or for a particular voyage. It has been said that its origin lies in the mediaeval Latin carta partita or charta partita or charta divisa, where an agreement

was torn into two pieces and one half was given to each party. Proof of the whole contract was no doubt difficult if one party was obstinate - modern methods of photocopying the contract for each party seem preferable. A charterparty is part contract of hire (affreightment (supra)) and part contract of transport (carriage). The proportion of affreightment decreases as one moves from a demise charter, to a time charter and then to a voyage charter, while the proportion of carriage increases from a demise charter through a time charter to a voyage charter. Affreightment is essentially placing a ship at the disposal of another party, while transport is essentially the carrier (supra) taking charge of goods. Hire (infra) is the consideration paid under demise and time charterparties; freight (infra) is the consideration paid under voyage charterparties and bills of lading .

ugovor o najmu broda, pomorski ugovor o najmu, ugovor o iskorištavanju broda, čarter, čarter-partija *The typical tramp operates under a charter party, that is, a contract for the use of the vessel.*; **2 ugovor o prijevozu**

charterparty bill of lading (n) (mar law) **teretnica uz brodarski ugovor, teretnica koja izdaje uz čarterpartiju**

charterparty by demise (n) (mar law) = **bareboat charter party** A charterparty by demise is a contract by which the lessor (shipowner) places a ship in the hands of the lessee (the demise charterer) who assumes possession and control. The consideration paid by the charterer is hire, which is payable at specified intervals during the term of the charter. Under a demise charterparty, the shipowner appoints the master and the crew, although they are paid and controlled by the demise charterer (Tetley) **ugovor o zakupu broda, ugovor o zakupu (golog) broda (bez posade)**

charter party (C/P) (n) **Bareboat charter party (C/P) ugovor o zakupu cijelog / golog broda (bez posade, goriva i zaliha), Demise charter party (C/P) ugovor o zakupu cijelog / golog broda (bez posade, goriva i zaliha), Time charter party (C/P) ugovor o najmu broda (brodskog prostora) na vrijeme, ugovor o iskorištavanju broda (brodskog prostora) na vrijeme, Voyage charter party (C/P) ugovor o najmu broda na vrijeme, ugovor o iskorištavanju broda na vrijeme** **1 (mar law)** The contract for a charter is commonly called a charterparty. **brodarski ugovor, ugovor o iskorištavanju brodova, čarter partija, čarter, ugovor o najmu / zakupu broda; 2 ugovor o prijevozu** {charter party; charter-party; charterparty (most recently used spelling)}

charter rates (n) **1 (shipping econ, mar law) iznosi najma broda, zakupnine, najamnina broda, dnevna najamnina broda, najamnina broda po danu:** *Charter rates are also affected by various other circumstances, such as crop failures and political crises. Under TC (time charter) contracts, vessels are hired for a specific period at a pre-decided daily rate. MidEast VLCC rates fall nearly 30 Worldscale points this week TC rates for dry bulk vessels have fallen considerably over the last few months. Chartering rates for Suezmaxes and very large crude carriers (VLCCs) have recovered rapidly in recent weeks after plunging to their lowest in more than year this summer. The gross charter rate is US\$12,000 per day, minus a 4.75% commission paid to third parties, for a period of about twelve (12) months to maximum fifteen (15) months. Maritime Today <update@maritimetoday.com>; 2 (shipping econ, mar law)* The rate charged by charter owners normally as a daily rate for the use of their container vessels by container shipping companies. **dnevna najamnina (kontejnerskog broda), dnevna vozarina (za kontejnerski brod):** *Charter rates can be on a time charter, voyage charter or bareboat charter basis. The average-weighted time charter rate was at \$5,036 per day, up by 8.6%, compared with \$4,639 a week earlier. This was the highest since end-October 2015. Charter rates for an 80,000-dwt Aframax tanker from Southeast Asia to East Coast Australia were almost unchanged at W66.75 on Thursday compared with around W67.50 last week*

charter yacht (n) (nav arch) A charter yacht is a yacht employed primarily for recreational

purposes, that is principally operated by a professional crew for paying passengers who themselves will primarily use the yacht for pleasure. Charter yachts are really commercial vessels even though the word yacht applies to them. Charter yachts must meet commercial requirements for passenger-carrying vessels. **čarter-jahta**

chart house (n) (nav arch, navig) kabina za pomorske karte, prostorija za pomorske karte

chart lattice /'tʃɑ:t, lætɪs/ (n) (navig) mreža karte

chart locker (n) (nav arch) ladica za pomorske karte

chartography /ka:'tɒgrəfi/ (n) (navig) kartografija

chart plotter (n) (navig) karta za ucrtavanje, ploter karta, karta za plotiranje: *Make sure you are acquainted with any chart plotter fitted to your vessel and ensure you can use the features available. He was primarily using an electronic chart plotter with a GPS input, although he had two radars and a magnetic compass at his disposal. chart plotter display, prikaz karte za ucrtavanje* He glanced at the chart plotter display in front of him to confirm his location and then headed the vessel towards the south cardinal light at a reduced speed of 11-12kts.

chart reader (n) (navig) čitač karte

chartroom /'tɑ:t, ru:m/ (n) (navig) prostorija za karte, navigacijska kabina,

navigacijska prostorija, **čartrum**: *At about 05.10, the OOW went inside the chart room to plot the vessel's position. Meanwhile the 2nd Mate was busy correcting the charts in the chart room.*

chart table (n) (navig) navigacijski stol, stol za pomorske karte: *During his watch, the OOW spent long periods of time at the chart table correcting and preparing the newly delivered charts.*

chart title (n) (navig) naziv karte

chassis /'ʃæsi/ (n) (cargo handling) a road transport frame with wheels and container locking devices in order to secure the container for movement **kamionska šasija** {šasija za prijevoz kontejnera}

Chassis Sublease Agreement (n) (shipping econ) Sporazum o podnajmu prikolica, Sporazum o najmu kontejnerskih podvozaka (šasija)

cheating (n) (mar ins, cargo) varanje **cheating by stevedores** varanje od strane slagatelja tereta

check (v) **check the cable** zaustavljati lanac ili konop (na kočnici vitla): *11 shackles of chain ran out at such speed that the brake was damaged as the crew tried desperately to check the cable.*

anchors checked and ready sidra provjerena i spremna (za obaranje), **check for damages** provjeriti štete **1 (seamanship)** to ease out a rope in short lengths, maintaining the strain; to ease off gradually (go slower and move carefully) to stop a vessel with an anchor or a mooring line **popuštati (konop, uže) polako**; **2 (seamanship)** zaustavljati, zaustaviti: *The vessel's swing to port could not be checked (=stopped) and the aft mooring lines also parted.*; **3 provjeriti, kontrolirati**: *the master went inside the chart room to check the vessel's position. Crew member was sent forward to check anchor cable. Check the watertight door control and report . Check the anchor position every ... minutes. check that ... provjeriti da ...: Check that electric circuits are in good condition and that fuel pipes are free from chaffing.*; **check whether** provjeriti ako ... : *When reviewing risk assessments, check whether there is an alternative, safer way to do the job.*

check (n) **provjera, kontrola**: *A check of the visual aspect of the inbound vessel should have raised concerns over the accuracy of the information being provided to the master. Maintain continuous visual check overside while ballast is being discharged overboard;* 5. **conduct a check** obaviti

provjeru *The chief engineer was informed and he quickly **conducted a check** of his machinery, finding nothing untoward.*

check for (v) (safety) provjeriti *A simple **check for signs of corrosion** or weeping pipework, culminating in the repair or replacement of the piping, might well save your vessel. Noting a loss of Freon in the system, he decided to **check for leaks**. Any vessel in a collision with another is required to: stop; **check for damage**; communicate with the other vessel involved and with the authorities; and, provided it does not endanger their own vessel, render assistance.*

checklist (n) (safety) kontrolna lista, popis za provjeru *Pre-loading **check list** has been amended to include the closing of all tank cleaning line valves, drain cocks/caps; On arrival, the **ship/shore check list** was completed and the terminal foreman signed it. The fire drill is carried out, the fire is extinguished or the oil is contained and then everybody will attend the boat drill with the **check list** of duties, starting the boat's engine and some brief explanation on boat's equipment and launching carried out.*

check-mark (v) označiti, podcrtati, obilježiti

check the line (v) (seamanship) to check the line means to allow only enough of it to render around the bitts to prevent the line from parting **popustiti užu na vitlu / bitvi (kako ne bi puklo)**

check valve (n) (marine eng) zaporni ventil

cheek (n) (sailing vessels) = hound-piece čeljust debla (donjeg dijela jarbola)

chemical carrier /'kemikəl/ (n) (nav arch) **COMPARE zz_chem_tanker** tanker za kemikalije, brod za prijevoz kemijskih proizvoda: 96036 *Own vessel was a 15,000 dwt **chemical carrier** of very basic construction.*

chemical properties (n) (cargo) kemijska svojstva

chemical tanker (n) (nav arch) Chemical tankers are modern parcel tankers with either full or partial stainless steel tanks that cover the sophisticated end of the chemicals market, for which IMO Grade I/II is required. **tanker za kemikalije** *On 24 February the oil product and **chemical tanker** loaded with a full cargo of 35,000t of jet fuel. An **oil/chemical tanker** was berthed at a shipyard for routine dry docking.*

chemical treatment (n) (chem) kemijska obrada

chest (n) škrinja slop chest (seamanship) siđil

chickson (us) = loading arm dizalica (s fleksibilnom cijevi, manigom) za ukrcaj / iskrcaj tankera, maniga

chief cook (n) (mar law) The chief cook oversees all the food preparation and quality control in the Steward's department of a ship. **glavni brodski kuhar** *In this case the **chief cook** should have trained the messman, who was relatively inexperienced, about the correct procedures to be followed.*

Chief Engineer /'tʃi:f, ɛndʒi'niə/ (n) (mar law) the senior engineer officer responsible for the mechanical propulsion and the operation and maintenance of the mechanical and electrical installations of the ship (STCW 2010); The Chief Engineer is responsible for maintenance, operation, and repair of all vessel electrical and mechanical systems onboard ships. (<http://jobsite.gcaptain.com>)

upravitelj stroja, kapo; tal. capo; direttore di macchine *The **chief engineer** onboard a ship oversees the entire operations of the engine department. **He/she** is responsible for operations and maintenance work of all engineering equipment throughout the ship. **He/she** reports to the captain of the ship. Extensive experience with minimum 5 to 8 years in subordinate positions on board ships is required for this position. Fluency in English language is a must. A rapid rise in the temperature of the EGE was noticed, and the **Chief Engineer** realised there was a fire inside the EGE casing. However, the clutch*

appeared to be performing correctly and the **chief engineer** decided the problem was due to an instrumentation fault. The second engineer was instructed to leave the control room and, with heavy smoke now issuing from the engine room, the master and **chief engineer** considered it unsafe to enter. {UK system of manning: **Chief Engineer, 2nd Engineer, 3rd Engineer; 4th Engineer**}

Chief Engineer Unlimited (n) (UK, US, mar law, marine eng) **upravitelj stroja na brodovima s pogonom neograničene snage (u neograničenoj plovidbi s**

pogonom): Skills: A **Chief Engineer Unlimited** must have a US Coast Guard MMC (Merchant Marine Credential) with Chief Engineer Unlimited; Must have a valid Medical Certificate; Must have a valid TWIC (Transportation Worker Identification Credential) card ; Must have a Valid US passport; Must have STCW Gap closing classes. (ERM - Engineeroom Resource Management) (L&M - Leadership and Management) Management of electrical and electronic control equipment.; Must have VPDS security endorsement ((MEECE). Sailing on a US flagged container ships as **Chief Engineer unlimited** sailing stateside and international to many different ports. Maintaining bow thruster's, Pumps, generators, water purifying system and main engine. Primary propulsion (Wartsila)
<https://www.maritimejobs.com/jobs/job/chief-engineer-unlimited-433108>

chief mate (n) (mar law) = **chief officer prvi časnik palube**: As a fairly experienced **Chief Mate** onboard a handy size product tanker I was standing the 04:00 - 08:00 watch as we steamed along the South coast of a large island chain,

chief mechanic (n) (mar law) An engine room rating responsible for the maintenance and repairs of the entire engine systems onboard the ship. He also supervises a team of mechanics in carrying out the daily maintenance and repair tasks of the engines. **stariji mehaničar, viši mehaničar**

chief officer (n) (mar law) = **First Mate; 1st Mate prvi časnik palube, prvi (od koverta / kuverta), čif, čif, primo**: Working as the head of the deck department, he/she is second in charge of the ship after the Captain. The **chief officer** supervises the deck crew and ensures that personnel are working in coordination. **He/she** is also responsible for the safety of the ship and the crew. Total deck crew comprises a **chief officer**, two duty officers, three ABS, one OS, pump man, bosun and two cadets.

chief steward (n) (mar law) Chief Steward oversees the entire operations within the catering department of a ship. He/she assigns daily duties to catering personnel such as preparing and serving food, cleaning the catering area, and receiving, issuing, and inventorying the stores. He/she is also responsible for preparing daily food menu. **prvi konobar, glavni konobar, prvi od kamare**

chilblain /'tʃil,blein/ (n) (med) an inflammation of the fingers, toes, or ears, caused by prolonged exposure to moisture and cold **ozeblina**

chilled cargo (n) (cargo) **rashlađeni teret, pothlađeni teret (+8 st. do - 12st.)**: During transport of **chilled cargo** and frozen goods, water ingress may lead to cargo spoilage or to ice formation in the door area.

chinagraph pencil /'tʃaɪnə,grɑːf; 'tʃaɪnə,græf/ (n) (navig) **olovka (u boji) za pisanje po ekranu / pokazivaču draw a chinagraph pencil across the screen ucrtati crtu na ekranu**: By drawing line with a **chinagraph pencil** parallel to the heading marker, the vessel is assured to travel along the intended track. This technique is known as blind pilotage or parallel indexing.

chine /tʃaɪn/ (n) **1 (nav arch) crta presjeka dviju ploha brodskega obrisa zgib; 2 (marine eng) koljeno, kutni zglob**

Chinese lugsail (n) (boating/yachting) **kineska o glavna oputa**

chip (v) (seamanship) **skidati rđu, tući rđu, piketati**

chippy (n) (seamanship) **brodski tesar**

chip rust (v) (seamanship) **skidati rđu, tući rđu, piketati(i)**

chisel /ˈtʃiːzəl/ (n) (nav arch) **dlijeto, škarpel**

chit (n) (shipping econ) **potvrda, dokument, pismeni nalog, pool, chit, nalog, ukrcaja**

chock /tʃɔk/ (n) **1 (nav arch, US, seamanship) = fairlead** heavy fittings secured to the deck. Lines are passed through them to bollards on the pier. The types of chocks used are closed, open, roller, and double roller. **oko za privez (u oplati broda), zjevača, pasakavi (tal. passacavo), open roller, chock, otvorena zjevača s valjcima, 3-roller, closed, chock, zatvorena zjevača s tri valjka, Panama, chock, oko Panama, zjevača Panama, središnja zjevača na pramcu:** *At that moment, the spring line The head line held on the winch drum came under extraordinary load and parted at the Panama chock. At about 1620, he walked towards the Panama chock to check the spring line.*; **2 (cargo handling) wedge; secure with wedges, klin za sprječavanje pomjeranja složenog tereta**

chock (n) (sailing vessels) **umetak okvira za jarbol**

choke /tʃəʊk/ (v) **1 (marine eng) zagušiti, prigušiti, začepiti; 2 (marine eng, boating/yachting) dodavati/oduzimati zrak u mješavini (izvanbrodskog benzinskog motora), otvoriti/zatvoriti zrak:** *choking off air from the outboard engine carburetor thereby making the gas/air mix richer;* **3 (med) gušiti se:** *The pumpman and the cadet came out choking.*

choke (n) (marine eng, boating/yachting) The outboard motor features an adjustable **choke** that changes the amount of fuel in the fuel and air mixture. **čok, zrak, ručica za dodavanje i oduzimanje zraka u mješavini s gorivom (na izvanbrodskim motorima):** *Do not use the choke when the engine is warm or the air temperature is high. Without a choke, an outboard internal-combustion motor may not start up when cold. When the operator activates the choke through a pull handle, button, or knob, the choke solenoid, a coil, expands, restricting the area through which air enters the carburetor. choke lever, polužica čoka, polužica zraka, ručica leptira, rasplinjača:* *Move the choke lever to the CLOSED position.*

choking (n) (marine eng) **prigušivanje**

choose /tʃuːz/ (v) **birati, izabrati {choose - chose - chosen}**

chop (n) (oceanogr) **mareta, valovito more (s kratkim valovima):** *Despite the worsening conditions and heavy chop to the surface of the sea, the instructor did not consider cancelling the exercise although this had been done on previous occasions.*

choppy sea (n) (oceanogr) a sea state having short steep wave **valovito more, živo more (s kratkim valovima), jaka marena, marena; tal. maretta viva**

chord /kɔːd/ (n) (boating/yachting) **ravnocrtna udaljenost između prednjeg i stražnjeg poruba jedra, razmak među prednjeg i stražnjeg poruba jedra**

christening /ˈkrɪstənɪŋ/ (nav arch) a ceremony in which the ship's sponsor (usually a woman) breaks a bottle of champagne across the bow and grants the ship its name **krštenje boda, davanje imena brodu**

chromium (Cr) /ˈkrəʊmiəm/ (n) (chem) **krom**

chronometer /krəˈnɒmɪtə/ (n) (nav arch) an instrument for measuring time with great accuracy **kronometar**

chuk /tʃʌk/ (n) (seamanship) **škrip, morša**

chum (n) (fishing) bait consisting of chopped fish and fish oils that are dumped overboard to attract fish **brum, torilo:** *the best chum is a mixture of large and small particles and predominately made of liquid.*

chumming (n) (fishing) the practice of luring fish such as sharks, by throwing chum into the water.

Chum often consists of fish parts and blood, which attract fish **primama, mamljenje ribe bacanjem ješke, brumanje**

CIF, C.I.F. (cost, insurance, freight) /,si: ai 'ef/ (n) (shipping econ, mar law) a term of the contract of sale whereby the seller undertakes to pay the cost of the insurance and transport of the goods to the named port of destination. Legal delivery occurs when the goods cross the ship's rail in the port of shipment. The purchaser takes actual delivery (possession) of the goods at the quay or other place named in the contract, as the place of destination. (The insurance premium and freight charges are included in the price of the goods.) (Tetley); Prodavatelj je dužan sklopiti ugovor o prijevozu do odredišne luke, snositi vozarinu i osigurati robu za vrijeme prijevoza **cijena s osiguranjem i**

vozarinom: *Cost of goods, marine insurance and all transportation (freight) charges are paid to the foreign point of delivery by the seller.* **CIF, C.I.F. (cost, insurance, freight) (named port of destination) cijena s osiguranjem i vozarinom (označena luka odredišta)** {jedan od trgovinskih uvjeta INCOTERMS}

circle /sɜ:kəl/ (n) 1 **krug**; 2 **kružnica**

circular error probable; (CEP) (n) (navig) **kružnica vjerojatne pogreške (navigacijskog sustava)**

circuit /'sɜ:kit/ (n) 1 (electr) **električni krug, strujni krug, krug**: *Figure 2: Circuit diagram for the main engine cooling system* **circuit breaker(s) kontaktor, platine, close circuit**

zatvoreni krug, electric circuit električni strujni krug, short circuit kratki spoj: *the source of smoke was a short circuit on the electric heater for the lubricating oil purifier, probably resulting from loose electrical connections.*; 2 (marine eng) **krug kotla, kotlovni krug**

circuit breaker (n) 1 (electr) **kontaktor, platine**: *The circuit breaker on the main switchboard was also tripped. All the affected reefer power sockets and circuit breakers were repaired or changed by the crew.*; 2 **automatski prekidač**

circular radiobeacon (n) (navig) **kružni radiofar**

circulate /'sɜ:kjʊ,leit/ (v) **kružiti, cirkulirati, optjecati**

circulating connection (n) (marine eng) **kružni spoj, protočni vod**

circulating tube (n) (marine eng) **cirkulacijska cijev, protočna cijev**

circulation /,sɜ:kjʊ'leɪʃən/ (n) (marine eng) **cirkulacija, kruženje, protok, optok**: *Careful control must be maintained over fuel and lubricating oil quality, and associated purification and circulation systems.*

hot water circulation **protok tople vode, forced circulation prisilna cirkulacija, natural circulation prirodna cirkulacija**

circumference /sə'kʌmfərəns/ (n) **external circumference vanjski obujam 1 opseg; 2 obujam; 3 periferija**

circumnavigate /,sɜ:kəm'nævi,geɪt/ (v) 1 (navig) **to sail around a body of land and return to the starting point oploviti; 2 (navig) oploviti Zemlju**

cirrocumulus /,sɪrəʊ'kjʊ:mjʊləs/ (n) (meteorol) **cirokumulus**

cirrostratus /,sɪrəʊ'stra:təs, -'streɪt/ (n) **cirrostratus, višeslojni oblak**

cirrus cloud /'sɪrəs/ (n) (meteorol) **cirrus, oblak cirrus, tanki visoki oblaci**

citizenship (n) (mar law) **državljanstvo**

citrus fruit /'sɪtrəs,fru:t/ (n) (cargo) **južno voće, agrumi**: *citrus fruit, i.e. oranges, lemons, grapefruit and mandarins, are a relatively simple cargo to carry.*

city port (n) (*shipping econ*) obično putnička ili koja više ne obavlja usluge ukrcaja i skrcaja tereta
gradska luka, stara gradska luka

civil law (n) (*mar law*) legal tradition which has its origin in Roman law, as codified in the Corpus Juris Civilis of Justinian (528 to 534 A.D.), and as subsequently developed in Continental Europe and around the world. ... Civil law is highly systematised and structured and relies on declarations of broad, general principles, often ignoring the details. (Tetley) **građansko pravo**

civil procedure (n) (*mar law*) parnični postupak (EUdict), **građanski postupak**

civil proceedings (n) (*mar law*) **građanskopravna tužba**

civil status (n) **bračno stanje (oženjen/udana / neoženjen/neudana) single**
 neoženjen / neudana, **married** oženjen / udana, **separated** ko/koja živi odvojeno,
divorced razveden/a, **widowed** udovica

claim /kleim/ **establishment of a claim** podnošenje / uspostavljanje zahtjeva / tužbe,
note of a claim odštetni zahtjev, **claim release** prenošenje zahtjeva **ustupanje**
 zahtjeva, **claims Department** odjel / služba za reklamacije, **assess a claim** ocijeniti /
 proučiti zahtjev, **deal with a claim** rješavati / obrađivati zahtjev / reklamaciju,
defeat claim against the ship pobiti reklamaciju / zahtjev, **file a note of claim**
against podnijeti zahtjev za odštetu prema nekome, **lodge a claim** podnijeti zahtjev
 / reklamaciju / potraživanje, **make a claim** uputiti / podnijeti zahtjev / reklamaciju:

This claim for \$ 45,000 is made against your company for damage / loss in connection with the following described shipment: ..., **meet a claim** udovoljiti zahtjevu, **pay a heavy claim** uložiti oštru

reklamaciju, **postaviti velik / visok (odštetni) zahtjev, raise a claim against** podići /
 uložiti tužbu / zahtjev protiv, **settle a claim** riješiti / likvidirati (odštetni) zahtjev /
 potraživanje / reklamaciju, **support a claim** poduprijeti zahtjev / potraživanje **1 (mar**

law) tužba; 2 (mar law) obveznim pravom zaštićen zahtjev vjerovnika da mu dužnik izvrši određeno
 davanje ili činidbu; a charge made against a carrier for loss, damage or delay **tražbina, zahtjev**

(osiguravajućem društvu) za naknadu štete: *In order to defend any future claim against short-loading or deadfreight, the terminal obtained a signed declaration from the Master stating that he did not want to load any more cargo, The ship had to be placed off-hire for three days for removal and disposal of the damaged cargo and a heavy cargo damage claim had to be settled with the consignee. Indeed, the Master of the vessel did admit that a port had filed a claim for fender damage against another sister ship.*; **3 (shipping econ)** A claim is a demand in writing for a specific amount of money that

contains sufficient information to identify the shipment received by the originating carrier, delivering carrier, or carrier on whose line the alleged loss, damage, or delay occurred within the time limits specified in the B/L contract.; a demand made for payment on account of a loss sustained through its

alleged negligence **tražbina, potraživanje, zahtjev, reklamacija**: *I was called to attend a 499 GRT coaster trading in the North Sea on behalf of the Cargo Underwriters to investigate a claim that the cargo had been contaminated with salt water, ostensibly from the vessel's bilges. file a claim podnijeti*
tražbinu, podnijeti zahtjev za naknadu (štete): *Time limit for filing a claim is 9 months from date of delivery, or in the event of non-delivery, 9 months after a reasonable time for delivery has elapsed.*, **claim form** obrazac za prijavu tražbine, **deny a claim** odbiti tražbinu, **odbiti**

zahtjev za naknadu štete, odbiti reklamaciju, acknowledge a claim potvrditi
 primitak tražbine, **potvrditi primitak zahtjeva za naknadu štete, receipt of claim**

primitak zahtjeva za naknadu štete, submit a claim podnijeti tražbinu, **dostaviti**

tražbinu, **lawful claim** zakonita tražbina, zakonit zahtjev, **bring a claim against (an owner; carterer etc.)** podnijeti tražbinu od (brodovlasnika unajmitelja broda itd.), podnijeti zahtjev za naknadu protiv (brodovlasnika, unajmitelja)

claim /kleim/ (v) **1 (mar law) potraživati**; **2 (mar law) imati pravo na, tražiti naknadu za (štetu, gubitak)**: *Lack of proper paperwork for landed parts has made it impossible to claim the losses from the barge company.*; **3 (shipping econ) reklamirati**; **4 (shipping econ) žaliti se**; **5 tvrditi**: *Many ships are now sailing with unsafe one man bridge watchkeeping routine - a six hour watch being accepted as the norm - because shipowners claim that they cannot afford an extra officer or have ratings on lookout, even at night. If a power driven vessel is not restricted by its draft to stay in the main channel, it surely cannot claim to have the right of way outside the channel?*

claim (n) tvrdnja

claim adjuster /'kleim ə'dʒʌstə/ (n) (shipping econ, mar law) likvidator tražbina, likvidator zahtjeva za naknadu štete

claimant (n) (mar ins, mar law) podnositelj zahtjeva, podnositelj odštetnog zahtjeva

claiming value (n) (mar law) vjerovnička masa

claim notice (n) (shipping econ) obavijest o tražbini, obavijest o zahtjevu za naknadu štete

claim notice (n) (cargo, mar ins) obavijest o (nstalnoj) šteti

Claim Procedure (n) (shipping econ) Postupak o naknadi štete

claims (n) (mar ins, mar law) tražbine **claims for loss of life or personal injury** tražbine zbog smrti i tjelesnih ozljeda, **claims for damage to property** tražbine zbog materijalnih šteta

clam /klæm/ (n) (fishing) **SEE grooved carpet shell** Lat. *Venus spp.* prnjavica, kućica



vongola clamshell prnjavica, kućica

clam cleat (n) (boating/yachting) okomit stoper, okomit stoper konopa



clamp /klæmp/ **1** (*cargo handling*) hvataljka za teret (bačve itd.), kliješta **plate lifting clamps** kliješta za limove; **2** (*marine eng*) škrip, škoba, moršet; **3** štipaljka

clamp /klæm/ (*n*) (*sailing vessels*) dopodspojak

clamp down (*v*) pritegnuti, stisnuti, vezati, učvrstiti sponu (štipaljku itd.)

class approval (*n*) (*nav arch, mar law*) odobrenje klasifikacijskog društva: *With company's and class approval, the vessel continued on its short passage towards the discharge port, where, after unloading, she entered drydock to effect permanent repairs.*

class certificate (*n*) (*nav arch*) svjedodžba klase broda: *The lifeboat manual and class certificate, which gives the details of life saving appliances/fire fighting appliances, gave the correct diameter.*

Class 1 Certificate (CoC) (*n*) (*mar law*) Deck Officer Class 1 (Master)

Certificate svjedodžba o osposobljenosti za zapovjednika (u sustavu britanskih i srodnih pomoračkih ovlaštenja) (*mar law*) svjedodžba o osposobljenosti za pomorskog časnika I. klase (u sustavu britanskih i srodnih pomoračkih

ovlaštenja): *The Institute of Marine Engineering, Science and Technology (IMarEST) is supporting the professional development of seafarers by mapping Class One Certificates of Competency (unlimited) and Master Mariner Certificates to a Chartered Status qualification. (<http://www.imarest.org/>) Officers in your crew must have the necessary certificates of competency (CoCs).* **Class 1 Deck Officer Certificate**

SEE certificate of competency; (CoC) ekvivalent za A-II/2 Management Level Deck

Department (STCW 1995/2010) svjedodžba o osposobljenosti za prvog časnika palube

(časnika palube I. klase, u sustavu britanskih i srodnih pomoračkih ovlaštenja),

IMO STCW: Svjedodžba o osposobljenosti za zapovjednika broda od 3000 BT ili većeg (STCW II/2): *The OOW, who had recently gained a Class 1 Certificate, was new to the trade but*

had undertaken a period of training and appeared to be willing and able. During the first night, the Barge Master, an Australian who has been Master on supply vessels and has a Master's Class 1 certificate,

instructed my 2/O to put on our red/white/red lights, which he did, thinking the Barge Master on the rig was in charge. The Combined Class 1 & 2 (Deck Officers) course will lead to the issue of Class 1 & 2

Certificate of Competency (CoC), issued by the Maritime & Port Authority (MPA) of Singapore, upon

successful completion of written examinations at SMA and oral examinations at MPA. **Class 1**

Certificate (Engineering) SEE certificate of competency; (CoC) (marine eng) =

Certificate of Competency First Class (Engineering) SEE academic awards in ship officer programmes (UK) - Marine Engineering ekvivalent za A-III/2 Management Level

Engine Department (IMO STCW 1995/2010) svjedodžba o osposobljenosti za upravitelja

stroja (strojara I. klase, u sustavu britanskih i srodnih pomoračkih ovlaštenja) **IMO**

STCW: Svjedodžba o osposobljenosti za upravitelja stroja na brodu sa strojem

porivne snage od 3000 kW ili jačim (STCW III/2): *The OOW, who had recently gained a Class 1 Certificate, was new to the trade but had undertaken a period of training.*

Class 2 Certificate (CoC) (*n*) (*mar law*) **Class 2 Certificate of Competency**

(Deck) ekvivalent za A-II/1 Operational Level Deck Department (IMO STCW 1995/2010) **IMO**

STCW: Svjedodžba o osposobljenosti za časnika plovidbene straže na brodovima

od 500 BT ili većima (STCW II/1) svjedodžba o osposobljenosti za časnika palubne

straže (u sustavu pomoračkih ovlaštenja Vel. Britanije), Class 2 Certificate of

Competency (Engineer) (mar law, marine eng) COMPARE second engineer ekvivalent za

A-III/1 Operational Level Engine Department (IMO STCW 1995/2010) svjedodžba o

osposobljenosti za časnika straže u stroju (2. časnik stroja; strojar II. klase, u

sustavu pomoračkih ovlaštenja Vel. Britanije) IMO STCW: Svjedodžba o

osposobljenosti za časnika stroja odgovornog za stražu u strojarnici sa strojem porivne snage od 750 kW ili jačim (STCW III/1): *He holds a Class 2 Certificate of Competency which he obtained in 1992. The Combined Class 2 & 1 Engineer Officers course will lead to the issue of Class 2 & 1 Certificate of Competency (CoC), issued by the Maritime & Port Authority (MPA) of Singapore, upon successful completion of written examinations at SMA and oral examinations at MPA.*

(mar law) svjedodžba o osposobljenosti za pomorskog časnika II. klase (u sustavu pomoračkih ovlaštenja Vel. Britanije)

Class 3 Certificate of Competency svjedodžba o osposobljenosti za časnika III. klase (u sustavu britanskih i srodnih pomoračkih ovlaštenja) Class 3 Certificate of Competency A-III/2 CoC for Management Level Deck Department (with restrictions such as near coastal or low tonnage) **svjedodžba o osposobljenosti za časnika palube III. klase - za obalnu plovidbu (u sustavu britanskih i srodnih pomoračkih ovlaštenja) Class 3 Certificate of Competency A-III/2 Engineer** CoC for Management Level Engine Department (with restrictions such as near coastal or low hp/kw) **svjedodžba o osposobljenosti za časnika stroja III. klase - za obalnu plovidbu (u sustavu britanskih i srodnih pomoračkih ovlaštenja)**

classification (n) (nav arch) klasifikacija broda

classification society (n) (nav arch, mar law) Classification societies are institutions (often non-profit) which inspect, study and report on the seaworthiness and the general and particular condition of individual ships. They also often perform port state control inspections. Finally, they may provide surveying services to national maritime administrations by contract with the governments of those countries. They issue a certificate of "class" of the ship. (Tetley); An independent organization that certifies that a ship has been built and maintained according to the organization's rules for that type of ship and complies with the applicable rules and regulations of the country of the ship's registry and the international conventions of which that country is a member.

(<http://www.globalshiplease.com/glossary.cfm>) **klasifikacijsko društvo:** *The company dispatched the technical superintendent to the vessel and classification society and underwriters' hull and machinery surveyors attended for a joint survey and investigation. They should contact their lashing equipment manufacturer and classification societies for advice and take appropriate action to reduce the risk of further incidents.*

class inspection (n) (nav arch) klasifikacijski pregled, pregled za dobivanje klase broda: *Subsequently, the vessel berthed for class inspection and after no damage was found, she was allowed to sail.*

class notation (n) (nav arch) oznaka klase (broda): *class notation: BV, I + HULL, + MACHINERY, OIL TANKER, CHEMICAL TANKER, IMO II, ESP, UNRESTRICTED NAVIGATION, + AUT-UMS, CLEAN SHIP, ICE CLASS IC, VCS, IG, INWATERSURVEY, MONSHAFT Class notation DNV+AI Tanker for oil ESP NAUTICUS E0 COAT*

class of ship (n) (nav arch) klasa broda, dodijeljena klasa brodu: *A condition of class was issued which allowed the vessel to sail to another port for permanent repairs.*

class society (n) (nav arch, mar law) klasifikacijsko društvo: *Hull Maintenance: Owners, Class Societies and Repair Yards are to be re-alerted of the risks of introducing residual stresses in hull structure ...*

class survey (n) (nav arch) klasifikacijski pregled, pregled od strane

klasifikacijskog društva, pregled za izdavanje klase broda: *A void space in a gas vessel was opened up for inspection by ship's staff prior to a Class Survey.*

class surveyor (n) (safety, nav arch) registarski vještak, registarski inspektor,

inspektor iz registra brodova: *A class surveyor with divers attended before midnight and after an underwater survey, issued a conditional certificate of class to sail to the nearest major port. Later that morning, in the presence of the **class surveyor**, the same lifeboat was lowered, when the forward fall wire parted and the empty lifeboat fell into the water.*

class the ship (n) (nav arch) **dati brodu klasu:** *International classification society ABS has been selected to class 11 ultra-large containerships (ULCs) for Denmark's Maersk Line A/S.*

clause /kɒːz/ (n) (**mar law**) **breakdown clause** **klauzula o privremenom prestanku / prekidu ugovora o iskorištavanju broda (čartera), najčešće uslijed havarije stroja, cesser clause** **klauzula o privremenom prestanku ugovora o iskorištavanju broda (čartera)** (**mar law**) = **provision** **odredba (konvencije, ugovora, pravilnika),**

klauzula, zaporka: *Does it comply with STCW 95 Section A-VIII/2 part 3.1 clause 14 or 26? The IMO has given the clue for solving the problem in clause 16.8 for all seafarers to see. Such incidents may impinge on the **safe berth' clause** in the charter party, if applicable.*

clausal bill of lading /kɒːzd/ (n) (**mar law, shipping econ**) = **unclean bill of lading** **nečista teretnica**

claw /kɒː/ **kliješta**

claw cleat (n) (UK) = **cam cleat** **stoper (užeta na jedrilici), patentna hvataljka, vodoravnio stoper**

claw hammer (n) (**seamanship**) **čekić s procjepom (za vađenje čavala)**

clay /'klei/ (n) (**cargo**) **glina, ilovača**

clayish /'kleiʃ/ (adj) **glinen, od ilovače:** *the piping was blocked with a mixture of fine sand and mud of a **clayish** texture*

clean (adj) **čist:** *Prior to taking a tanker to dry dock, the major job is to **clean** the tanks. **keep clean** čistiti, držati čistim, **clean the anchor** (v) (**seamanship**) **otpetljati sidro, otplesti sidro, osloboditi sidro, clean up the oil** počistiti prosutu naftu / mrlju od ulja. *The master raised a general alarm and the crew immediately proceeded to **clean up the spilled fuel oil** on deck.**

clean bill of health (n) (**mar law, med**) a certificate issued by a port indicating that the ship carries no infectious diseases **čisti zdravstveni list**

clean bill of lading (n) (**mar law, shipping econ**) The face of a clean bill of lading bears no notation of the bad or questionable order of the goods. It means that the goods have been received on board in apparent good order and condition and stowed under deck. (Tetley) **čista teretnica,**

teretnica bez primjedaba: *If the charter party requires the master to issue **clean bills of lading**, he must ensure, from the very beginning, that only cargo in apparent good order and condition is allowed to be loaded. {A Bill of Lading which does not contain any qualification about the apparent order and condition of the goods to be transported (it bears no stamped clauses on the front of the B/L). It bears no superimposed clauses expressly declaring a defective condition of the goods or packaging (resolution of the ICS 1951). (http://www.iss-shipping.com/cargo/cargo_library_glossaryc.asp)}*

cleaner (n) (**marine eng**) **čistač (u službi stroja)**

Clean Hold Certificate (n) (**mar law**) **Potvrda da je (brodsko) skladište čisto**

cleaning /'kliːniŋ/ (n) (**seamanship**) **čišćenje:** *Tank cleaning involves manual cleaning after an initial pre-wash to remove traces of the last cargo. **thorough cleaning** temeljito čišćenje*

cleaning brush (n) (**marine eng**) **četka za čišćenje**

cleaning gun (n) (**marine eng**) **pištolj za čišćenje**

cleanliness /'kleɪnlɪnəs/ (n) (**cargo**) **čistoća** **cleanliness of the tanks** **čistoća tankova**

cleanse /'kleɪnz/ (v) čistiti, ispirati

cleanup čišćenje **cost of cleanup** troškovi čišćenja: *the cost of the cleanup of the spilled oil was about 1.85 billion USD*

clear (adj) 1 **jasan, bistar**: *The visibility was bright and clear and the channel was clear of outward traffic. Our position was very clear - a vessel cannot take bunkers using a substandard hose. It was a clear and bright day, and on arrival at 1430 the wind was northeasterly between 30 – 35 knots. Ensure clear instructions for operating CO2 extinguishing systems are displayed near the distribution control valves and near the gas cylinders. Review the procedures on your vessel to ensure that measures exist to ensure personnel are clear of the danger areas before hatch cover securing pins or locks are released and power applied. When the situation become too serious and when it was quite clear that fully laden container vessel was not aware how serious the situation was, ...;* 2

(seamanship) **slobodan, oslobođen, bez zapreke, bez smetnje, otvoren, nezakrčen, otkvačen, otpleten (lanac, sidro), otpetljan (lanac, sidro) clear anchor = founder slobodno sidro, nezapetljano (otpetljano) sidro**: *0506 Resumed heaving anchor 0512 Anchor up and clear. 0514 Dead slow ahead. Rudder 10 degrees to starboard, heading at this time around 2900. (extract from ship's logbook),*

clear cable slobodan lanac, nezapetljan (otpetljan) lanac, clear line oslobođen konop, otpetljan konop, clear propeller (seamanship)

oslobođen propeler, otpetljan propeler, clear of the davits dalje od soha: *When outboard and clear of the davits, the remote control brake handle was released to stop the movement.;*

3 (navig) **slobodan (po pramcu; od zapreka; prostor)**: *The cargo vessel's engine was then put astern and she slid aft, along the ro-ro vessel's hull, until she came clear of the larger vessel. clear entry slobodan ulaz*: *This then allowed us a clear entry into the deep water lane., clear ahead slobodan po pramcu*: *We passed clear ahead of the first ship which seemed to be making about 25 knots in a SW'ly direction.,*

clear area slobodan prostor: *The vessel was fitted with a large wavebreaker right forward, which meant that the forecastle deck had very little clear area., be clear of the channel biti izvan plovidbenoga kanala, proći plovidbeni kanal*: *The master realised that the other ship would not be clear of the channel for some time and at 2314 he set the engine telegraph from 'dead slow ahead' to 'stop'.,*

come clear of the vessel biti dalje od drugog broda: *The cargo vessel's engine was then put astern and she slid aft, along the ro-ro vessel's hull, until she came clear of the larger vessel. VTS reiterated that the VLCC was eastbound in the deep water lane, and to keep well clear of the vessel. biti udaljen od drugog broda, clear of the buoy biti dalje od plutače, proći plutaču*: *The pilot turned to guide the master in manoeuvring the ferry clear of the buoy.;* 4 (safety) **izvan mora / vode, iz vode / mora clear of the water izvan mora / vode hoist the boat clear of the water izvući brodicu iz mora**: *The boat returned to the falls, was hooked on and hoisted clear of the water.,*

keep the head clear of the water: *This additional buoyancy would have helped the casualty to keep his head clear of the water, thus substantially increasing his likely survival time. iznad mora*

clear (v) 1 (navig) **to pass safely by a danger to navigation obići (mjesto ili oznaku opasnosti);** 2 (navig) **isploviti (iz luke), proći (oznaku, objekt na moru, plovidbeni kanal), napustiti**: *As the vessel cleared the bend the master contacted the pilot station Kad je brod prošao zavoj na rijeci zapovjednik je nazvao peljarsku postaju After clearing the harbour and when heading in a northerly direction, the skipper engaged the autopilot, set the radar at 1.5 miles range. clear*

the port napustiti luku, isploviti iz luke, izaći iz luke: *The master held a Pilot Exemption Certificate (PEC), so no pilot was required to manoeuvre the ship off the berth or clear the port. We had*

by now managed to turn east **to clear the port**. After unberthing, under pilot's advice we commenced to swing to port to **clear the harbour** in an easterly direction., **clear the ship zaobići drugi brod, proći drugi brod**: The vessel increased speed astern at an angle of about 10o from the berth until it became apparent that the bow would not **clear the ferry** berthed astern., **clear the traffic lane izaći iz plovidbene staze (u shemi odvojene plovidbe), izaći iz plovidbenoga smjera** : Although the fishing vessel had started to alter course in order to **clear the traffic lane** and avoid impeding the safe passage of the two larger vessels, this alteration was not seen by the general cargo vessel's OOW for ov, **clear the buoy proći plovidbenu oznaku**) and, on seeing the buoy, the Master ordered hard to port in order to **clear the buoy**.; **3 (mar law) obaviti to clear customs** to carry out customs and immigration formalities before leaving port **obaviti carinski pregled, obaviti carinske formalnosti, clear a ship obaviti carinske formalnosti za brod**; **4 (mar law) riješiti**; **5 (marine eng) očistiti, pročistiti**: the engineers tried to clear the blocked cooling system; **6 (seamanship) osloboditi (zapatljano uže, lanac) clear the line**: Preparations were undertaken to **clear the lines**; **otпустiti privezno uže, clear the propellers osloboditi propelere**: The tug began to recover the slack in the tow and moved ahead to **clear the propellers**.

clear abreast (adj) (navig) slobodan po boku

clear ahead (adj) (boating/yachting) jedrilica slobodna po pramcu, tal. libero di prua: The offending vessel **passed clear ahead** at 4 cables. In the meantime, I had already altered course to starboard and we passed well **clear ahead**.

clearance /'kliərəns/ (n) (meteorol) provedrica

clearance /'kliərəns/ (n) **1 (mar law) dozvola za uplovljenje / isplovljenje broda u luku (od strane carinskih vlasti) inward clearance (clearance inwards) dozvola za uplovljenje**: After obtaining **inward clearance**, we unberthed and anchored in the waiting area., **outward clearance (clearance outwards) dozvola za isplovljenje, odlazeći klirens, Port clearance Office lučki carinski ured, lučka carinarnica, to apply for a clearance uatražiti dozvolu za uplovljenje / isplovljenje, to issue a clearance izdati dozvolu za isplovljenje / uplovljenje, izdati klirens, obtain clearance dobiti dozvolu (za uplovljenje ili isplovljenje), ishoditi dozvolu**: Vessels must also inform London VTS before the vessel navigates the Thames and **obtain clearance** from the relevant VTS centre so to do., **clearance from the last port of call dozvola za isplovljenje iz zadnje luke ticanja**; **2 (marine eng) zračnost, zazor, razmak diametrical clearance zračnost po promjeru (cilindra)**; **3 (navig) razmak**: The other ship then veered off very sharply to port at such an angle that the final **stern to stern clearance between** the two ships was very minimal. With only about **two cables clearance**, the Pilot ordered full astern and emergency dropping of starboard anchor. **underwater clearance razmak između dna broda i morskog dna, request clearance from the engine room zatražiti odobrenje službe stroja**: The OOW requested clearance from the engine control room to deploy the stabiliser fins., **under keel clearance (UKC) dubina pod kobilicom**: Once aboard, the draught and other information can be added to enable the pilot to give the master minimum **under keel clearance** and other relevant information. A loaded tanker was outward bound along an estuary at about 10 knots with an **underkeel clearance** of about three metres.; **4 odobrenje, dozvola**: While awaiting **clearance** to stow the lifeboat, two crewmen placed the manual winding handle into position on the winch, at poop deck level, and readied themselves to begin w The OOW, who was part way through a compass error calculation, **requested clearance** from the engine control room to deploy the stabiliser fins. **request clearance zatražiti odobrenje, obtain clearance dobiti odobrenje**,

ishoditi odobrenje *After obtaining inward clearance, we unberthed and anchored in the waiting area.*, **grant clearance** **dati odobrenje**, **izdati odobrenje**, **odobriti**

clearance agents (n) (mar law) carinska agencija

clearance inwards (n) (mar law) odobrenje za uplovljavanje, dozvola za

uplovljenje, **dolazeći klirens**, **dolazeći clearance**: *Make a list of all the documents used in clearing the ship outwards, and compare them with the corresponding ones used for the clearance inwards, i.e. GENERAL DECLARATION ON ARRIVAL - ENTRY OUTWARDS AND DECLARATION*

clearance outwards (n) (mar law) odobrenje za isplavljavanje, dozvola za isplavljenje, **odlazeći klirens**%

clearance procedures (n) (mar law) postupak carinske kontrole broda, carinska kontrola broda, obavljanje carinskih formalnosti **port clearance procedures** obavljanje carinskih formalnosti u luci

clear anchor slobodno / otpetljano sidro

clear astern (adj) (navig, boating/yachting) slobodan po krmi, jedrilica slobodna po krmi, tal. **libero di poppa pass clear astern** **proći po krmi**: *Her relative track showed that she would pass clear astern of us with a CPA of 1 mile and no other traffic astern of us to worry her. The vessel's doors were battened down and engines put to half ahead to clear position, give more sea room and allow target vessel to pass well clear astern.*

clear customs (v) (mar law) obaviti carinske formalnosti, proći carinu, rascariniti

clear deck (n) (seamanship) slobodna paluba, paluba bez zapreka

cleared **cleared without examination (CWE)** carinski otpremljeno bez pregleda **1 a** riješen, odobren, dopušten; **2** ocarinjen, koji je prošao carinu **goods cleared** roba koja je prošla carinsku kontrolu; **3** brod koji je dobio dozvolu za uplovljenje / isplavljenje

clearing (n) (mar law) obavljanje carinskih formalnosti

clearing agent (n) (mar law) carinski agent, agent koji obavlja carinske formalnosti za vlasnika tereta

clearing line (n) (navig) siguran put

clearing mark (n) (safety) oznaka sigurnosti

clear key (n) (comm) tipka za brisanje (na VHF uređaju)

clear of the berth (adj) (navig) oslobođen od veza, brod koji je upravo napustio vez, brod koji se upravo odvezao, brod udaljen od veza, biti odmaknut od veza: *Soon afterwards, the pilot told London VTS that the vessel was clear of the berth, passing the bellmouth and heading towards the south side of the river.*

clear of the berth (adj, adv) (navig) **sa veza, dalje od veza**: *The master manoeuvred the vessel clear of the berth and then headed on a north westerly course at a speed of 4 knots towards a reef*

...

clear skies (n) (meteorol) vedro nebo

clear the anchor (v) (seamanship) otpetljati sidro, osloboditi sidro

clearview screen (n) (navig) kružni prozor (na staklu kormilarnice) s električnim rotacionim brisačem

clear zone (n) (navig) sigurna zona, slobodna zona

cleat /kli:t/ (n) (nav arch, seamanship) a fitting of metal, plastics or wood with horns, used for securing

lines **bitvica**, **kljuna**, **rog**, **žabica**, **bita**, tal. **galloccia** **cam cleat** 1 stoper; 2 bitvica,



kašanjola; tal. **castagnola**

cleat /kli:t/ (v) (boating/yachting) zaustaviti konop u stoperu

cleat /kli:t/ (v) (seamanship) prebaciti uže oko bitvice

clerk /kla:k/ (n) (mar law) pisar, činovnik, službenik **Master clerk** brodski pisar



clevis pin (n) (nav arch) klin škopca (s osiguračem), štift

clew /klu:/ (n) (boating/yachting) rogalj na slobodnome stražnjem kraju glavnoga ili prednjega jedra za hvatanje pritega baze jedra uz deblenjak ili za hvatanje uzde prednjega jedra; the after lower corner of a sail in the fore-and-aft rig; the two lower corners in the square rig **uzdeni rogalj**, **rogalj škote**, **zatezni rogalj jedra**, **stražnji rogalj jedra** **clew outhaul** konop za zatezanje stražnjeg roglja jedra

clew (v) (boating/yachting) to haul a squaresail up the the yard using lines secured to the clews **prikupljati križno jedro**

cliff (n) (geogr) **stijena**, **hrid**, **skoljera**: *it was next to impossible to monitor your course, let alone see rocks or a cliff face. The vessel ran aground minutes later when the bulbous bow struck the cliff face* 182 metres south-east of the harbour entrance. As the boat approached the entrance, it made a sharp turn to starboard and crashed into an **unlit low cliff**.

climatic chart /klai'mætik/ (n) (meteorol) **klimatološka karta**

climb down (v) (seamanship) **spustiti se**: *He then moved to the forward end of the port hatch cover to climb down. As soon as the pilot had climbed down the first few steps, the right side ropes parted*

without any warning and an instant later, the left side ropes parted as well.

cling to the lifeboat (v) (safety) držati se za brodicu za spašavanje, uhvatiti se za brodicu za spašavanje: Three other sailors managed to *cling to the overturned lifeboat* and were later rescued by a fisherman and brought to shore.

clinic for seamen (n) (med) ambulanta za pomorce

clinker-built boat (n) (boating/yachting) hull construction in which the lower edge of each plank overlaps the upper edge of the one below it **preklopna građa brodice, klinker**

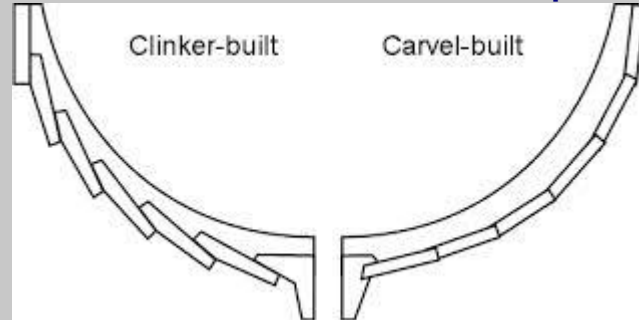

clinometer /klaɪ'nomɪtə/ (n) (navig) inklinometar

clip (n) (boating/yachting, seamanship) stezaljka, škrip, moršet

clipper (n) (nav arch) a fast sailing ship **brzi jedrenjak, kliper**

clinker (n) (boating/yachting) voj preko voja, **klinker, madir preko madira**

clock-notation system (n) (boating/yachting) sustav kazaljke na satu: *the other boat is at 9 o'clock* druga nam je jedrilica ravno po desnom boku (tj. u poziciji 9 sati na satu)

clockwise /'klɒk,waɪz/ (adv) (meteorol) u smjeru kazaljke na satu, **desnokretan**

clog (n) (marine eng) začepljenje (cijevi)

clog (v) (marine eng) začepiti (cijev itd.)

close (v) **1 zatvoriti, pokriti**: A prompt decision was made to *close the engine room ventilation*, shut the fuel isolating valves and flood the space with CO₂.; **2 (seamanship, navig) to move nearer to približiti se (drugom brodu, oznaci, točki javljanja itd.)**: When the ship exited the buoyed channel at 1915, the master adjusted the course on the autopilot from 112° to 065°, **to close a waypoint** marked on the paper chart. The cargo ship **started to close a dredger** that was working on the opposite side of the dock basin, so the pilot told the master to go 'ahead'.

close (adv) (navig) near **blizu** **close the bow blizu pramca**: Initially her bearing was 2 points on the port bow but her course took her uncomfortably **close across our bow**., **close ahead**

blizu po pramcu: As the vessel came **close to the entrance** the skipper, who was on the bridge alone, noticed two small marker **buoys close ahead**; Target vessel passed **close ahead of** own vessel and proceeded towards the 'HA' buoy to embark his pilot., **close astern blizu po krmi**: At about 2050 I returned to the Bridge and the Third Mate reported that target x was standing on and would still pass **close**

astern of us. This resulted in the ferry passing **close astern of** the cargo vessel., **close by u blizini**,

blizu: The master expected to see the pilot boat **close by**, and asked the chief officer where it was. For his part, the Master expressed his fear that the vessel was in danger of hitting another **mooring buoy close by**., **close on the beam blizu po boku**: 4 in the convoy overtaking us very **close on our port beam** and at this moment I ordered hard starboard., **close on the bow blizu po pramcu**: Unfortunately,

he did this without looking out, and thus failed to see the other vessel very **close on the port bow**., **stay as close to as ... držati se što bliže ...**: As I could see that the other vessel was intent on

overtaking on my port side, I stayed as close to the south mark as was safe, given that the prevailing set was predicted to be between 1270T and 1360T at that time., **close to blizu nečemu**: *As the vessel approached the inner harbour entrance, the pilot realised that she was getting close to the southerly pier head, which was on the vessel's port bow. The mate would direct the master via VHF radio as the ship got close to the buoy. At minimum steerage way we were keeping close to the breakwater head.*

close-coupled towing (n) (nav arch) **tijesno povezano tegljenje, tegljenje s dva tegljača**

close down (v) (safety) **zatvoriti**: *The need to close down the engine room and use CO2 was also poorly considered. Despite this, no attempt was made to close down the engine room, or isolate the ventilation or fuel supplies.*

closed sea (n) (mar law) **morski prostor spojen s otvorenim morem tjesnacem ili uskim prolazom i kojemu su obale i tjesnaci pod suverenosti jedne države zatvoreno more**

close-feed system (n) (marine eng) **zatvoreni napojni krug**

close-hauled /,kləʊs'ho:ld/ (adj) **1 (boating/yachting) COMPARE close reach,**

broad reach, beam reach, run, no-sail zone oštro uz vjetar, sasvim uz

vjetar, jako u orcu, tal. bolina: *At this time it is believed that the yacht was sailing close hauled*

in a south-south-westerly direction. Two Wayfarer class sailing dinghies were crossing the Solent,

close-hauled in a fresh breeze and good visibility.; **2 (boating/yachting) jedrenje uz vjetar {tal. andatura di bolina stretta}**

close-hauled sailing (n) (boating/yachting) **jedrenje oštro uz vjetar**

close-hauling /,kləʊs'ho:liŋ/ (n) (boating/yachting) **prihvaćanje, jedrenje oštro uz vjetar,**

jedrenje oštro u orcu: *The wind was north-west at 20 knots, and the yacht was on a close haul, heading in a westerly direction.*

close quarter/s situation /,kləʊs'kwɔ:təz/ (n) **1 (mar law, navig) položaj brodova u kojemu postoji opasnost od sudara, lying so near another ship that there is no room to maneuver and therefore**

causing the risk of collision položaj opasne blizine, položaj opasnih blizina close quarter/s situation developed položaj opasnih blizina razvio se / nastao je ...: *A*

close-quarters situation developed. But the tanker continued on her original heading and a close-quarters situation was quickly developing. A close quarters situation was developing with a cargo

vessel to starboard, close quarter/s situation occurred ... položaj opasnih blizina

nastao je ...: *A recent close quarter situation that occurred in the early hours of a spring morning in the southwest bound lane of the Dover Strait traffic separation scheme highlighted several areas of*

concern in the bridge team operations on one of the vessels involved., be involved in a close

quarter/s situation nalaziti se u položaju opasnih blizina: *This was the second close-quarters situation that this ship had been involved in since it started cross-Channel*

operations., avoid the close quarter/s situation izbjeći položaj opasnih blizina: *Had he altered course when it first became clear that a risk of collision existed, a close-quarters situation*

could have been avoided., close quarter/s situation exists postoji stanje opasnih blizina, nastalo je stanje opasnih blizina: *... when the inevitable bunching of ships that occurs means one*

has to zig-zag through gaps, then alterations could not always be made before the close-quarters situation was deemed to exist ... The bulk carrier's subsequent alteration of course to 160° meant that a close

quarters situation now existed between the two vessels.; **2 (marine eng) zatvoriti (uređaj, ventil**

...): *Crew member failed to close the drop valve of No 1 stbd tank correctly after completion of sampling.*

The ABs on deck told the duty officer by radio to close the manifold valve, which he did immediately,

but he was unaware of the spill until a terminal representative went on board to make enquiries abo; **3**

(navy) položaj za blisku borbu

close reach (n) 1 (boating/yachting) sailing with the wind on the bow, but not close hauled otvoreno uz vjetar; 2 jedrenje otvoreno uz vjetar {tal. andatura di bilina larga}

close reaching (n) (boating/yachting) jedrenje uz vjetar

closest point of approach; (CPA) (n) (navig, mar law) najbliža točka mimoilaženja

(u NM) najmanja udaljenost mimoilaženja, najbliža točka susreta, CPA: SHIP A:

Container vessel, Course 140T, Speed. 23kts, CPA 0.5nm, TCPA 18min. SHIP B: LPG carrier, Course 140T, Speed. 20kts, CPA zero, TCPA 21min. At 1000 the OOW noticed on the AIS receiver that **the general cargo vessel was 3.0nm astern with a CPA of zero.** With the ARPA showing a CPA of close to zero, we altered course. At this time vessel B was fine on the starboard bow and the OOW had predicted a CPA of 0.8 nm. Own vessel altered course 55 degrees to starboard to 0900T thus opening the CPA of the target to 1.5 nm astern of own vessel. **with a closest point of approach; (CPA) of ...** An

overtaking vessel was coming up from the starboard quarter on a course of 2800 at 18.5 knots and intending to pass ahead with a CPA and bow crossing range of 0.4nm. **With a CPA of 0.2 miles** in ten minutes I decided that we had no choice but to alter to port and come round behind him. **s najbližom**

točkom mimoilaženja od ..., give the **closest point of approach; (CPA) of ... dati**

CPA pokazati CPA: A shortwhile later the target vessel altered course again, this time 300 to

STARBOARD, giving a CPA of 0.5 nm, **increase the closest point of approach; (CPA) to ...**

povećati CPA na ...: Finally, in an effort to **increase his CPA to a minimum of 0.** over. The

contact's CPA was still closing in, crossing ahead, with no sign that he was taking avoiding action. Finally, in an effort to increase his CPA to a minimum of 0.2nm ahead, we slowed down and monitored his

crossing., **indicate a closest point of approach; (CPA) of ... naznačiti / pokazivati**

CPA: The ARPA indicated a CPA of zero and a TCPA of 2125, target vessel on a course of 1030 T with a

speed of 10 knots., **show a closest point of approach; (CPA) of ...**: I saw the tanker cross the general cargo vessel's bow, standing on and now showing a CPA of 0.1 nm at 10 minutes.

close to the wind (adv) (navig) sasvim uz vjetar

close up (v) 1 (navig) približiti se; 2 (seamanship) to hoist a flag to, or in, its highest position podignuti zastavu do vrha

closing (n) (navig) približavanje (obali, objektu)

closure /'kləʊʒə/ (n) 1 (mar law) zatvaranje (luke, terminala, usluge): In April 13 m swells and heavy rain forced the **closure** of Sydney Harbour and every commercial port across NSW. The ferry was on a fixed service between Dover and Calais, and the occasional **closure** of either port was a feature of the run, especially during winter months.; 2 (shipping econ) = **shutdown zatvaranje (linije,**

terminala), prestanak rada (terminala, linije): The **closure** of the terminal was expected to

impact over 100 jobs.; 3 (marine eng) **zatvaranje (vodova, ventila itd.):** Watertight integrity Inspect all watertight decks and bulkheads periodically to verify that progressive flooding cannot occur and that **closure devices** (such as watertight doors (WTDs) and duct **closures**) are in place and in working order. The **closure** timings of the ship's ESD valves were regularly tested and found to be satisfactory.

clothing (n) (safety) odjeća: The crew were **wearing heavy clothing.**

cloudy (adj) (meteorol) oblačno: South Atlantic. Daytime. **Cloudy.** Good visibility. - Report No.

..006. My vessel was en route from Necoehia in Argentina to the Persian Gulf in October . . **cloudy**

weather oblačno vrijeme: The **weather was cloudy** with good visibility, and the wind was

west-south-westerly Force 3 ..., **partly cloudy djelomično oblačno:** It was a **partly cloudy** day, with light winds.

clove hitch /'kləʊv,hɪf/ (n) (seamanship) vrzni uzao, vrzin uzao, tal. mezzo collo da

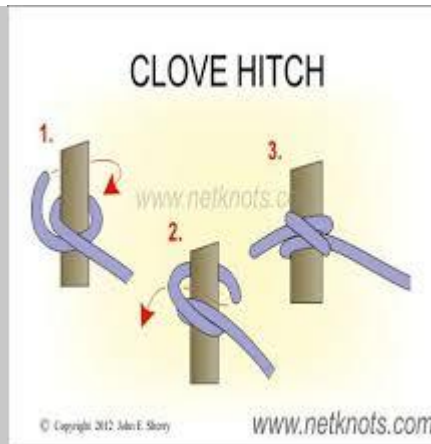

incappare; nodo di cabestano

cluster /'klʌstə/ (n) **1** a number of things growing, fastened, or occurring close together **skup, grozd**: Radar picture: Crossing vessel suddenly emerging from **cluster of anchored ships** echoes about 1.5 on starboard bow Soon afterwards, her skipper saw a **cluster of lights** ahead and adjusted course by several degrees to port to avoid them.; **2 grupa (ljudi); 3 (navig) grupa zvijezda, skup sazvežđa; 4 cluster, klaster**

clutch /klu:tʃ/ (n) (marine eng) **spojka, kopča, kvačilo** **clutch lever** **poluga spojke, ručka kvačila**: After completing the job they intended to disengage the clutch by shifting the **clutch lever**., **clutch control ručica spojke**: a routine maintenance of all filters in the **clutch control** and reduction gearbox lubricating oil circuits was conducted as per ship's PMS., **clutch housing kućište spojke**: Checks of the gearbox found that there was damage to the gearbox pinions and **clutch housing**., **dog clutch zupčasta spojka** ... the main engine stopped, resulting in the loss of hydraulic power and a consequent inability to disengage the winch **dog clutch**., **gearbox clutch spojka reduktora spojka prijenosnika**: Shortly after the pilot boarded, a signal on the machinery monitoring system indicated a fault with one main engine to **gearbox clutch**.



{tal. frizione, innesto a frizione}

clutch coupling (n) (marine eng) **izvrstiva spojka**

clutch in (v) (seamanship) **spojiti se, uključiti se**: The self-tensioning system was unable to **clutch in and out** fast enough to render all the lines before they parted. Samozatezni privezni uređaj nije se mogao dovoljno brzo uključiti i isključiti kako bi uže moglo popustiti. The engine would only **clutch in** the ahead mode occasionally and at high engine revolutions.

clutch out (n) (seamanship) **isključiti se (o vitlu), odspojiti se**: The self-tensioning system was unable to **clutch in and out** fast enough to render all the lines before they parted. Samozatezni privezni uređaj nije se mogao dovoljno brzo uključiti i isključiti kako bi uže moglo popustiti.

clutter /'klʌtə/ (n) (navig) smetnje (u radarskoj slici), radarske smetnje **sea clutter** smetnje nastale utjecajima valova, smetnje od mora, smetnje s mora i valova. *In rough weather, returns from the sea surface, called sea clutter, are received over several miles around own ship and mask nearby targets. 5 miles and the sea and rain clutter had been adjusted as the vessel gathered speed and settled at 23kts.*, **rain clutter** smetnje nastale utjecajima kiše, smetnje od kiše, smetnje od padalina. *Radar range scale and tuning (gain, sea clutter, rain clutter) should be regularly adjusted throughout the watch in order to detect weak radar targets.*, **anti clutter unit** uređaj za ublažavanje smetnji od mora, **suppress the clutter** ukloniti smetnje od valova i mora, **suppress the clutter** ukloniti smetnje od kiše

CMI (Comite Mariitime Internationale) (n) (mar law) The Comité Maritime International (CMI) has attempted to bring about an international convention on the responsibility of classification societies without success so far. In May 1998, the CMI Assembly adopted Principles of Conduct for Classification Societies. These principles imposed certain duties and procedures and outlined standards of practice and performance for societies which adopt them. A year later, the CMI Assembly adopted Model Contractual Clauses for Use in Agreements between Classification Societies and Governments and Classification Societies and Shipowners, which define and clarify, subject to national law, the circumstances under which civil liability of the classification societies and their employees and agents should be regulated or limited. ... The classification societies have been in serious negotiation with European Union (EU) authorities to produce, if possible, a mutually acceptable directive on liability of classification societies. ...instrumental in the adoption of many important international conventions, e.g. 1) Collisions between Vessels, 1910. (Tetley) **Međunarodni pomorski odbor**

coach roof (n) (boating/yachting) krov kabine

coach screw (n) (marine eng) vijak sa četvrtastom glavom

coal-burner (n) (nav arch) parobrod na ugljen

coal carrier (n) (nav arch) brod za ugljen

coal-fired (adj) (marine eng) s pogonom na ugljen

coaming /'kəʊsmɪŋ/ (n) (nav arch, safety) the raised frame work around deck openings, and cockpit of open boats, the raised edge of a hatchway used to help keep out water **pražnica grotla**, **solijer**, **soljera**: *Hatches are surrounded by coamings to reduce the risk of flooding in heavy seas.* **transverse hatchway coaming** **poprečna pražnica grotla**, **longitudinal hatchway coaming**

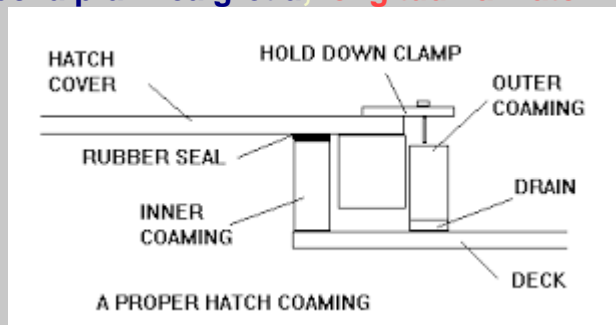

uzdužna pražnica grotla

coast /'kəʊst/ (n) (geogr) the entire extent of land area adjacent to the sea or ocean **morska**

obala, **obala**: *If you ever travel to Europe, you must visit and spend as much time as you can on the Adriatic coast. We spent a very vigilant night at anchor in deep water off the coast. Fortunately, the vessel was near the coast and medical evacuation was effected promptly, and he was repatriated home after a brief hospitalisation. An eight-metre pleasure craft was struck by a passing bulk carrier while anchored for the night in a shipping lane off the north east coast of Australia ...*

coastal /kəʊstəl/ (adj) **obalni**

coastal authorities (n) (mar law) **državne obalne vlasti, obalne vlasti (neke države)** MIN 231 (M+F) requires **coastal authorities** and shipping to inform vessels of erroneous vessel data being transmitted. Report incident to **coastal authorities** and to MARS (The Nautical Institute).

coastal navigation (n) (navig) = **terrestrial navigation** the safe conduct of a ship where the navigator has the land on one side of his course and the open sea on the other **obalna navigacija**: Mariners should use GPS in ocean navigation to check the Astronomical position, but in **coastal navigation** they must be very prudent with the GPS position.

coastal passage (n) (navig) **dužobalno putovanje broda, putovanje uz obalu**: A 5500 teu container ship was on a **coastal passage** off southern China. The skipper had planned a **coastal passage** that allowed several port visits en route, enabling him and his two crew members to get adequate rest.

coastal service (n) great / short **coastal service** **velika / mala obalna plovidba (shipping econ) obalna plovidba, kabotaža**

coastal state (n) (mar law) **obalna država**: Under Marpol regulations, vessels with faulty pollution prevention/control systems or related deficiencies must report the situation to the nearest **coastal state** immediately on such fault(s) being discovered.

coastal station (n) (comm) **obalna radiopostaja**: If in doubt, consult a **Coast Station/RCC** before sending a DSC Distress Acknowledgement. The initial message came via the **Coast Station** from an unknown MMSI.

coastal tanker (n) (nav arch) **tanker obalne plovidbe**: A **coastal tanker** was on passage with a cargo of gas oil.

coastal trade (n) (mar law, shipping econ) **obalna plovidba, kabotaža**

coastal vessel / ship (n) (mar law) **brod obalne plovidbe**: A 58-metre **coastal cargo vessel** was steaming south in the early hours of a February morning. This is partly due to a language barrier but also a reluctance by the **coastal ships** to answer calls on VHF.

coastal waters (n) (navig, mar law) the area from a line approximating the mean high water along the mainland or island as far out as 25 miles including the bays, harbors and sounds (Seasources.net) **obalne vode, priobalne vode**: In **coastal waters** or in traffic separation schemes, the restricted nature of the available sea room, and the high density of traffic, necessarily reduces the margins of safety Test manual steering before entering **coastal waters**.

coast earth station (CES) (n) (comm) **obalna stanica u satelitskoj komunikaciji**

coaster /kəʊstər/ (n) (nav arch) a ship that trades or operates from port to port along a coastline **brod obalne plovidbe**: As is common in very busy ports, most **coasters**, fishing and small craft do not report to VTS or port authorities,

Coast Guard /kəʊst.gɑːd/ (n) (safety, mar law) **obalna straža**: Shortly afterwards **Dover Coast guard** called the bulk carrier on channel 18 by name and call sign, asked him to change to channel 80 and ... The crewmember was evacuated by the **Netherland's Coast Guard** and brought to hospital. The **coastguard** was alerted and the motorman was airlifted to the nearest hospital.

coastguard (CG) (n) (safety, mar law) A branch of the government with a mission to protect the coastal waters of a country, administer and enforce legal and safety regulations in the nation's waterways, maintain aids to navigation, and provide rescue service for mariners in distress (<http://www.seatalk.info/cgi-bin/nautical-marine-sailing-dictionary>) **obalna straža**

coasting (n) (mar law) = **cabotage** **mala obalna plovidba, kabotaža**

coasting trade (n) (mar law) **obalna plovidba, kabotaža**

coastline /'kəʊst, laɪn/ (n) **1** (geogr) obala; **2** (shipping econ) obalna linija, obalna pruga
coast radio station; (CRS) (n) (comm) obalna radiostanica, obalna radiopostaja
coast station (n) (comm) obalna radiopostaja, obalna radiostanica

coastwise /'kəʊstwaɪz/ (adj) (adv) = coastal service obalni, uz obalu, obalom
coastwise shipping obalna plovidba, priobalna plovidba

coast with off laying dangers (n) (navig) opasnosti za navigaciju pred obalom
When passing along coasts with off lying dangers a radar range can be used to pass a danger at a safe distance.

coat /keɪ/ (v) **1** (seamanship, marine eng) pokriti, obložiti, prevući; **2** premazati (bojom)

coating /'kəʊtɪŋ/ (n) (seamanship) premaz, zaštitna boja *In 2006 IMO adopted regulations on the coating of ballast tanks. When the ship came into the drydock the ecoshield coating was still in very good condition and did not need to be replaced or repaired. The Polar Code recommends the application of abrasion resistant, low friction coatings to vessels operating in ice-covered waters. When the survey ship was drydocked after navigating 2.5m thick ice with a high content of gravel and volcanic lava, the original coating, applied seven years ago, was virtually intact, undamaged*

CO2; carbon dioxide /,kɑːbən daɪ'ɒksaɪd/ (n) (safety, marine eng) ugljični dioksid **CO2 emission** ispuštanje ugljičnog dioksida

cock /kɒk/ (n) **cock drain** odvodni pipac, drenažni pipac, **shut-off cock** pipac za isključivanje, **zatvorni pipac** (marine eng) pipac

cocked hat /'kɒkt, hæɪt/ (n) (navig) a triangle produced by plotting three bearings on a chart **trokut**

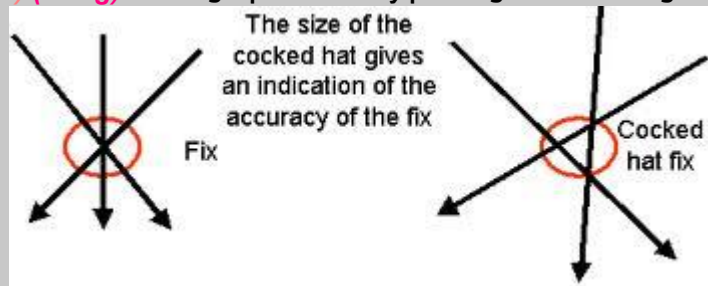

pozicije, **trorogi šešir**

cockpit /'kɒk, pɪt/ (n) **1** (nav arch) the well of a sailing vessel, especially a small boat, for the wheel and steerman **zdenac, brodski zdenac, tal. pozzo**



; **2** (boating/yachting) **kokpit jedriice**

cockswain; coxswain /'kɒksən; 'kɒk, sweɪn/ (n) (seamanship) kormilar brodice za spašavanje, kormilar brodice

cocktailshaker (n) (marine eng) koktelnikser (način rashlađivaja klipa)

cocoa /'kəʊkəʊ/ (n) (cargo) kakaovac

code /'kəʊd/ (n) **1** (mar law) zakonik, skup zakona; **2** (marine eng, mar law) pravilnik

code alerts and identifiers (n) (navig) obvezni alarmi zapovjedničkog mosta

code flag (n) (comm) = **signal flag** signalna zastavica, zastavica signalnog kodeksa

Code of Practice for Ships Carrying Timber Deck Cargoes (n) (cargo handling) Pravilnik za osiguranje tereta drva na palubi broda

Code of Practice for the Carriage of Live Animals Pravilnik za prijevoz živih životinja

Code of Practice for the Safe Carriage of Grain in Bulk (Grain Code) Pravilnik za prijevoz žitarica u rasutom stanju

Code of Practice for the Safe Loading and Unloading of Bulk Cargoes (BLU Code) (n) (cargo handling) Pravilnik za ukrcaj i iskrcaj rasutog tereta

Code of Safe Practice for Cargo Stowage and Securing (n) (cargo handling) IMO kodeks/pravilnik o sigurnom slaganju i učvršćenju tereta

Code of Safe Practice for Solid Bulk Cargoes (n) (cargo handling) = **BC Code; Bulk Cargo Code** Pravilnik za osiguranje krutog tereta u rasutom stanju

code sign /'kəʊd,sain/ (n) (comm, navig) signalni kod

codfish (n) (fishing) bakalar

coefficient /,kəʊi'fɪjənt/ coefficient of performace koeficijent učina, učin koeficijent

coefficient of expansion koeficijent rastezanja

CO2 extinguisher (n) (safety) prijenosni aparat za gašenje ugljičnim dioksidom

coffee watch (n) (seamanship) = **morning watch** jutarnja straža, jutarnja gvardija

cofferdam /'kɒfə,dæm/ (n) **1** (nav arch) marrow space between two bulkheads set close together, especially between fuel tanks (two walls separated to use for drainage or safety). **loska, pregradak, koferdam**. Cofferdams are also used for insulation purposes

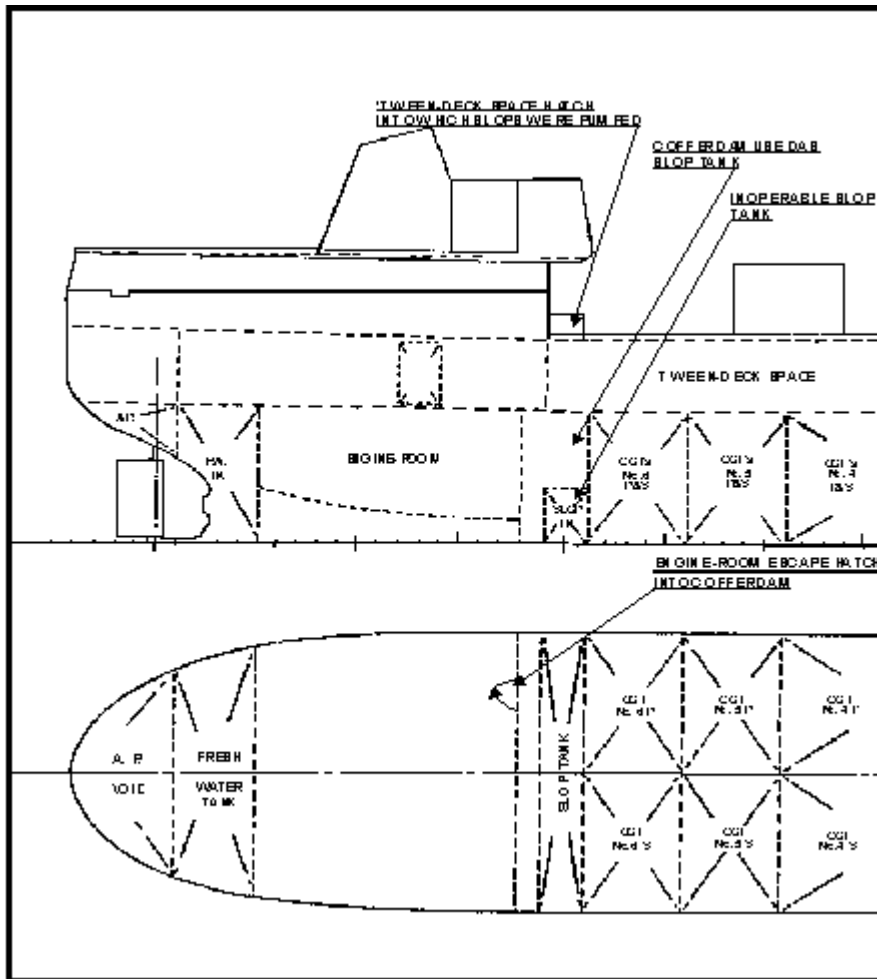

; 2 koferdam osovine

kormila pregradak struka kormila

COGSA (Carriage of Goods by Sea Act) (*n*) (*mar law*) U.S. federal codification which standardizes carrier's liability under carrier's bill of lading; U.S. enactment of The Hague Rules **Zakon o prijevozu robe morem**

cogwheel (*n*) (*marine eng*) zupčanik

coil /kɔil/ 1 (*electr*) zavojnica, *bobina* deflection **coils** otklonske zavojnice (katodne cijevi); 2 (*marine eng*) zavojnica, spiralna zavojnica heating **coil** grijaća zavojnica, serpentina za zagrijavanje; 3 cijevna spirala cooling **coil** rashladna spirala, rashladni radijalni kanal, serpentina, *serpentina*; tal. *serpentina*; 4 (*cargo*) svitak (tereta); 5 (*electr*) *bobina*

coil /kɔil/ (*v*) 1 **namatati**; 2 (*boating/yachting*) To prepare a line for stowing by turning it in equal loops so that it is neat and orderly and ready for use

(<http://www.seatalk.info/cgi-bin/nautical-marine-sailing-dictionary>) **slagati konop coil the rope** namatati konop, *kojit skojit*, **coil down** slagati konop, **coil a rope in Flemish** flake namatati konop spiralno

coils /kɔilz/ serpentine (rashladnog uređaja)

coil spring (*n*) (*marine eng*) spiralna opruga

cold cranking amps; CCA (*n*) (*electr, boating/yachting*) struja hladnoga stara

(motora brodice)

cold ironing (n) (*electr*) shore connection, or alternative maritime power (AMP), is the process of providing shoreside electrical power to a ship at berth while its main and auxiliary engines are turned off
obalni priključak (na električnu struju), kopneni električni priključak

cold start (n) (*marine eng, navig*) upućivanje iz hladnog pogona

cold starting (n) (*marine eng*) startanje iz hladnog stanja

cold storage skladište-hladnjača (u luci), rashladno skladište

cold store brodski frižider, *jacera*

collapse /kə'leɪps/ (n) (*cargo*) rušenje **cargo collapse** rušenje tereta, raspad složenog tereta, **collapse of the stack** rušenje reda (kontejnera)

collar /'kɒlə/ (n) (*boating/yachting*) otvor za jarbol (u palubi / kabini) {na manjim jedrilici; partners na većem brodu/jedrenjaku}

collate /kə'leɪt/ (v) (*shipping econ*) prikupiti i urediti (dokumentaciju): *engage a surveyor to ascertain and collate evidence of the loss or damage;*

collect skupiti, prikupiti, ubrati (novac) **collect freight** ubrati vozarinu, naplatiti vozarinu

Collector of Customs carinski blagajnik

college-based education (n) školovanje u višoj školi

collide /kə'laɪd/ (v) (*navig*) **sudariti se**: *the container ship collided with the a fishing vessel at the junction of the Vlieland and Texel TSS In the evening of 29 January, COSCO's container ship Fei He collided with Cido Shipping's chemical tanker Lime Galaxy off Jurong Island. collide with sudariti se s, vessel X and vessel Y collided ... brod X i brod Y sudarili su se ...*: *The tanker and the bulk carrier collided Monday night at about 11:30 p.m. approximately 8 nautical miles from the northern entrance in the Bosphorus Strait. Cruise ship with hundreds of passengers and a chemical tanker carrying flammable naphtha collided in the Dardanelles Strait, causing damage but no injuries At 0027 on 11 December 2014, the general cargo vessel and the tanker collided in the south-west lane of the Dover Strait Traffic Separation Scheme.*

collier /'kɒliə/ (n) (*nav arch*) = **coal carrier** brod za ugljen

collision /kə'liʒən/ (n) (*navig, safety*) **sudar**: *Both vessels were damaged in the collision and assisted to an anchorage outside the strait. to avoid collision* **izbjeci sudar, direct collision** **izravni sudar, indirect collision** **neizravni sudar, a collision** **occured between ... and ...**

došlo je do sudara, dogodio se sudar, ... i sudarili su se: *At about 0854 on 9 March, a collision occurred between the 9.96m fishing vessel and the 49,424 gt vehicle carrier ----- The collision between the 623-foot bulk carrier and 600-foot tanker occurred on a foggy morning on March 9 ...,*

prevent the collision **spriječiti sudar, imminent risk of collision** **neposredna**

opasnost od sudara, prior to the collision **prije sudara, following the collision**

nakon sudara, poslije sudara, collision avoidance **izbjegavanje sudara, collision**

between ship X and ship Y: *Report on the investigation of the collision between the container ship and the oil tanker sudar između broda X i broda Y, take action to prevent*

collision **poduzeti radnju kako bi se spriječio sudar, on collision courses**: *It was extremely difficult for the VTSO to identify that the vessels were on collision courses. on kursevima*

sudara, collision resulted from several factors **sudar je nastao iz nekoliko razloga, investigation of the collision** **istraga sudara, ispitivanje sudara, the collision**

occurred due to ... sudar se dogodio zbog ... *The collision occurred as a result of the general cargo ship ... turning into the path of the motor tanker*

collision avoidance (n) (navig) **izbjegavanje sudara**

collision avoidance tool (n) (navig) **pomagalo za izbjegavanje sudara**

collision bulkhead (n) (nav arch) **the foremost transverse watertight bulkhead sudarna**

pregrada, tal. paratia d'abbordo *The tanker sustained considerable structural damage forward of its collision bulkhead.*

afterpeak collision bulkhead sudarna pregrada kod stražnjeg

pika, forepeak collision bulkhead sudarna pregrada kod pramčanog pika

collision course (n) (navig) **kurs sudara, sudarni kurs, kurs koji vodi k sudaru**

Considering distance and ship's speed he was on a collision course. While the two trailing vessels took action to avoid an imminent collision, the nearest fishing vessel continued on a collision course. He was writing his log and did not notice that he was on a collision course.

Collision Regulations; (COLREGS) (n) (navig, safety) **pravila o izbjegavanju sudara** **contrary to the Collision Regulations; (COLREGS) suprotno pravilima u suprotnosti s pravilima**

collision risk (n) (navig) **opasnost od sudara**

Collision Rules (COLREGS) **Pravila o izbjegavanju sudara na moru** **adhere to**

Collision Rules (COLREGS) držati se pravila o izbjegavanju sudara, poštivati

pravila o izbjegavanju *Collision regulations should be adhered to at all times and verbal agreements over VHF radio which contradict the collision regulations, and can cause confusion, should be avoided.*

collision warning (n) (navig) **alarma upozorenja za sudar (na ARPA radaru)**

colours (n) (seamanship) **the national ensign flown by a ship nacinalna zastava broda, zastave države broda**

colours and symbols (n) (navig) **boje i simboli (na radarskom prikazu, u sustavu ECDIS itd.)**

colour (UK); color (US) (n) **boja** **witish in colour (UK); color (US) bjelkaste boje**

colour vision test **ispitivanje sposobnosti raspoznavanja boja**

COLREGS /'kɒlregz/ = **Regulations for Preventing Collisions at Sea**

(COLREG, COLREGS) = rules of the road = Collision Regulations;

(COLREGS) International Regulations for the Prevention of Collisions at Sea, annexed to the

Convention on the International Regulations for the Prevention of Collisions at Sea, adopted by the IMO

at London, October 20 Pravila o izbjegavanju sudara: the COLREGS are to be strictly followed

Pravila o izbjegavanju sudara valja strogo poštivati. comply with the COLREGS poštivati

pravila o izbjegavanju sudara, observe the COLREGS poštivati pravila o

izbjegavanju sudara, držati se pravila o izbjegavanju sudara, violate the COLREGS

kršiti pravila o izbjegavanju sudara, break the COLREGS kršiti pravila o

izbjegavanju sudara, adhere to the COLREGS pridržavati se pravila o izbjegavanju

sudara, strictly follow the COLREGS strogo se pridržavati pravila o izbjegavanju

sudara, misunderstand the COLREGS krivo protumačiti pravila o izbjegavanju

sudara, as required by the COLREGS kao što se zahtijeva pravilima o izbjegavanju

sudara, under the COLREGS prema pravilima o izbjegavanju sudara, u smislu

pravila o izbjegavanju sudara: Steering and Sailing Rules are the most important rules under

COLREGS. They have been designed to keep vessels apart when they approach each other. laid down

by the **COLREGS** propisano u pravilima o izbjegavanju sudara, zacrtano u pravilima o izbjegavanju sudara: *The most important group of rules are the steering and sailing rules, which lay down the procedure to be followed when ships approach each other and there is a danger of collision.*, **amandments to the COLREGS** izmjene i dopune pravila o izbjegavanju sudara

column¹ /'kɒləm/ stup (svjetla)

column² /'kɒləm/ **A-form column** stalak u obliku slova A, **engine column** stalak motora stup, stupac, stalak (motora), kolona

column of engine (n) (marine eng) stalak motora

combat /'kɒmbæt/ (v) suzbiti, boriti se protiv **combat fire** boriti se protiv požara: *Crew members attempted to combat the fire but it quickly spread to the main deck, reaching the midship section where combustible cargoes were stored.*

combat ship (n) (navy) ratni brod

comber¹ (n) (oceanogr) a long, breaking ocean wave val koji se ruši, val na početku rušenja

comber² (n) (fishing) Lat. *Serranus cabrilla* kanjac, lt. sciarriano cabrilla

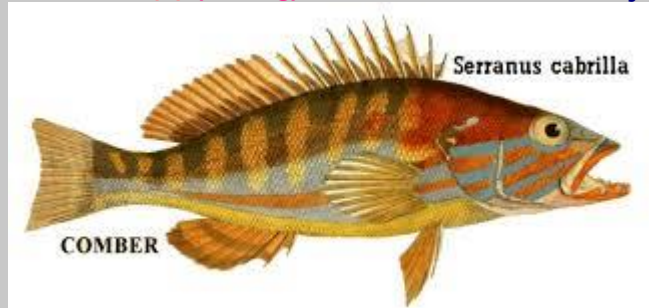

{drugi hrv. nazivi: gričar, kanj, kanj od sike,

pljucavac, rubnjak, zubuša; lat.SERRANUS CABRILLA}

combi carrier (n) (nav arch) = **combination carrier** brod za mješoviti teret, brod za prijevoz mješovitog rasutog tereta

COMBICONBILL teretnica za mješoviti (kombinirani) prijevoz

combination carrier (n) (nav arch, shipping econ) Ship capable of carrying oil or dry bulk cargoes, thereby increasing the productivity of the vessel. Typically termed OBO or Ore/Oiler.

(<http://www.clarksons.com/glossary/>) brod za mješoviti teret, brod za mješovite tekuće i rasute terete, OBO brodovi

combination spanner (n) (marine eng) kombinacija viljuškastog i okastog ključa **ključ (vrsta alata)**

combined transport (n) (shipping econ) prijevoznopravni posao koji se odvija unutar najmanje dviju grana prometa te za koji postoji jedinstveni ugovor za cijelu prijevoznu relaciju i jedna jedinstvena prijevozna isprava; intermodal transport where the major part of the voyage is by one mode such as rail, inland waterway or sea and any initial and/or final leg carried out by another mode such as road **mješoviti prijevoz, kombinirani prijevoz, multimodalni prijevoz**. *Where the Carriage is Combined Transport, the Carrier undertakes to perform and/or in his own name to procure performance of the Carriage from the Place of Receipt or the Port of Loading, whichever is applicable, to the Port of Discharge or the Place of Delivery, whichever is applicable*

Combined Transport Bill of Lading (n) (mar law, shipping econ) A type of Bills of Lading for shipments carried by more than one means of transport (e.g. by a door-to-door

freight-forwarding service). **teretnica za kombinirani prijevoz**, **teretnica za mješoviti prijevoz**, **teretnica za multimodalni prijevoz**

combined transport carrier (n) (mar law) **poduzetnik mješovitog prijevoza**, **operator mješovitog prijevoza**

combined transport operator (n) (shipping econ) **poduzetnik mješovitoga prijevoza**

combustible gas indicator (n) (safety) **indikator zapaljivog plina**

combustion /kəmˈbʌstʃən/ **combustion chamber** **izgarna komora**, **komora za sagorijevanje**, **combustion gases** **plinovi izgaranja**, **produkti sagorijevanja**, **combustion space** **izgarni prostor**, **combustion stroke** **radni takt**, **takt sagorijevanja (eksplozije)**, **products of combustion** **produkti izgaranja**, **spontaneous combustion** **samozapaljenje**, **internal 1** **unutarnje izgaranje izgaranje**, **sagorijevanje**

combustion chamber (marine eng) **izgarna komora**, **komora izgaranja**: *The combustion chamber is enclosed between the cylinder head and the piston and the most of it contained in the top of the piston.*

come about (v) (boating/yachting) **SYNONYM Ready about.** to change tacks with the boat turning through the wind; to tack: to change tack **letati**, **okretati (jedrilicu)**, **napraviti bordadu**

come alongside (v) (seamanship, navig) **pristati uz obalu**, **pristati bokom uz obalu**, **koštat**

come around (v) (boating/yachting) to bring a sailing vessel into the wind and change to another tack **okrenuti jedrilicu (drugom stranom prema vjetru)**, **letati**

Come in, please (v) (comm) frequently said on VHF radio by the station calling another station/ship and waiting for response **Prijam.**: *Ship on may port side, three point three miles away, steering 2-3-6. Come in, please.* {This is a frequently used phrase in VHF communications, though not recommended by IMO SMCP. Simply, using the phrase Over. would do.}

come to rest **zaustaviti se**

come to touch **doći u dodir**, **dirnnuti**, **taknuti**

comfortable /ˈkʌmfətəbəl/ (adj) **udoban**, **ugodan**

coming alongside (n) (navig, seamanship) **pristajanje uz obalu**

Comite Maritime International (CMI) **Međunarodni pomorski odbor**

comity /ˈkɒmɪti/ (n) **1** (mar ins) They agree in particular to strengthen their links with the member countries of the Council of Europe and with other democratic European countries with which they have friendly relations and close co-operation.(EuroTerm); The doctrine requiring courts of one state to recognize the laws of foreign states and judgments of competent courts of such states, in order to secure the reciprocal recognition by that foreign state of the laws of the first state and the judgments of its courts.(Tetley); **2 reciprocitet**, **priznavanje zakona i sudskih odluka na bazi reciprociteta**

commander /kəˈmɑːnde/ (n) **1** (navy) naval officer next below captain **kapetan fregate**; **2** the master of a merchant ship **zapovjednik**

command of the English language **vladanje engleskim jezikom**: *there is reason to doubt that the bridge staff have a sufficient command of the English language to be able to respond*

correctly and without delay to the Pilot's directions.

commence /kəˈmɛns/ (*shipping econ*) **ANTONYM** **cease** **započeti, početi**: *laydays commence to count as of May 15th* stojnice se započinju računati od 15. svibnja *Wages shall commence no later than on the day specified and agreed to in these Articles* Zarada/plaća se počinje računati najkasnije od dana navedenog i dogovorenog u ovom radnom ugovoru *Like the voyage charter there is a clause stipulating when time shall commence to count.*

commencement /kəˈmɛnsmɛnt/ **početak**

commercial invoice (n) (*shipping econ*) **poslovni račun, poslovna faktura**

commission /kəˈmɪʃən/ (*shipping econ*) **provizija**: *The gross charter rate is US\$12,000 per day, minus a 4.75% commission paid to third parties, for a period of about twelve (12) months to maximum fifteen (15) months.* Maritime Today <update@maritimetoday.com>

commission /kəˈmɪʃən/ (v) (*shipping econ*) **to place / put a ship, crane etc. in service predati u službu / eksploataciju, pustiti u rad**: *The vessel was commissioned as the first seagoing container ship in 1968. Houston Authority has commissioned the first of four new Super Post-Panamax STS cranes at its Barbours Cut Container Terminal Furthermore, expired certificates need to be renewed before the vessel can be re-commissioned.*

commissioned light **ponovno osposobljena plovidbena oznaka**

commissioning of the ship (n) (*nav arch*) **an elaborate ceremony that officially places the ship in service puštanje broda u plovidbu, svečanost puštanja broda u plovidbu**: *Although commissioning places the ship in service, much work usually remains to be done by the crew to bring the ship to its full operational capability. Keel laying is one of the four specially-celebrated events in the life of a ship; the others are launching, commissioning, and decommissioning. re-commissioning of the ship ponovno puštanje broda u plovidbu*: *Depending on the length of lay-up, three weeks or more should be expected for re-commissioning.*

commit /kəˈmɪt/ (v) **izvršiti, počiniti krivično djelo to commit crime**

committed (adj) **odan, vjeran, posvećen**: *We remain committed to serving all of our customers.*

commodities /kəˈmɒdɪtɪz/ **roba, tereti, tereti u prijevozu morem**: *The Baltic Exchange's main sea freight index tracking rates for ships carrying dry bulk commodities was unchanged on Tuesday, as rising demand for capesize or large vessels typically carrying iron ore and coal was countered by falling demand elsewhere.*

commodity /kəˈmɒdɪti/ (*shipping econ*) **any article/goods shipped; Indication of the type of goods**; **A commodity is a basic good used in commerce that is interchangeable with other commodities of the same type.** (<http://www.investopedia.com/>) **roba (u transportu), teret**: *Usually tramps carry shipload lots of the same commodity for a single shipper. Commodities are basic because they have simply been grown or extracted from their natural state and brought up to a minimum grade for sale in a marketplace - there is no extra value added to them by the producer.*

commodore /ˈkɒməˌdɔːr/ (n) **1 (navy) najniži admiralski čin u ratnim mornaricama SAD-a i Velike Britanije; naval officer between the ranks of captain and rear admiral komodor; 2 the senior officer of a yacht club komodor (jedriličarskog društva)**

common benefit (n) (*mar law, mar ins*) **zajednička korist**

common bower (n) (*nav arch*) **obično sidro, pramčano sidro**

common carriage (n) (*mar law*) **Carriage performed by a common carrier, who undertakes to transport the public's goods from and to places advertised and at times advertised, usually on regular, liner (infra) routes and under liner bills of lading, in consideration of the payment of freight (infra) by the**

shipper (infra). **linijski prijevoz, linijska plovidba, javni prijevoz**

common carrier (n) 1 (mar law) A shipping company which provides service to the general public at published rates **javni prijevoznik, linijski prijevoznik**. *The Port Authority has had a lengthy landlord-tenant relationship with Maersk at its Barbour's Cut container terminal, and the company is now free to call there or at the Port Authority's Bayport container terminal as a common carrier, the port authority said.* **Non-Vessel Operating common carrier; NVOCC** Carrier offering an international cargo transport service through the use of underlying carriers and under their own rate structure in accordance with tariffs filed with the Federal Maritime Commission in Washington D.C. (<http://www.maerskline.com/en-jm/help/shipping-glossary>) **linijski prijevoznik koji prevozi teret brodovima podugovornih brodara;** 2 (shipping econ, US) **domaći prijevoznik**

common-carrier service (n) (shipping econ) a person or company that transports goods or people for any person or company and that is responsible for any possible loss of the goods during transport.[2] A common carrier offers its services to the general public under license or authority provided by a regulatory body. **usluge javnog prijevoza roba i putnika, javni prijevoz:** *Until the 19th century, ships were owned by the merchant or by the trading company; common-carrier service did not exist.*

common dentex (n) (fishing) = **pink dentex** Lat. *Dentex dentex* **zubatac, lt. dentice:** *For many people common dentex (Dentex dentex) is the most valuable specie of fish that can be caught in Mediterranean Sea. (<http://www.medfish.com/ezine/?p=135>)*



zubatac okrunjeni, muški pagar;}

{drugi hrv. nazivi: pagar, zubatac barjaktar, zubatac krnaš,

common eel (n) **jegulja**

common law (n) (mar law) the legal tradition which evolved in England from the 11th century onwards. Its principles appear for the most part in reported judgments, usually of the higher courts, in relation to specific fact situations arising in disputes which courts have adjudicated. The common law is usually much more detailed in its prescriptions than the civil law. (Tetley) **običajno pravo, anglo-saksonsko pravo:** *Under common law the force and authority of the law derives from precedent, custom and usage rather than from statutes, particularly with reference to the laws of England and the United States Most of the common law countries follow English statute and case law.* **common law obligations obveze iz običajnog prava, obveze prema anglo-saksonskom pravu:** *The terms under which a private carrier contracts out of his common law obligations must be clearly stated if they are to protect him in law.*

common lobster (n) (fishing) Lat. *Homarus gammarus* **hlap spiny common lobster rakovica, spinous common lobster rakovica** {also known as *European lobster*}

common pandora (n) **pandora** (fishing) Lat. *Pagellus erythrinus* **arbut, lt. Pagello Fragolino**

common rail injection system (n) (marine eng) **sustav ubrizgavanja goriva sa zajedničkom sabirnicom**

common rail system (n) (marine eng) **sustav goriva sa zajedničkom sabirnicom**

(goriva): In the *common rail system* a single pump supplies fuel at high pressure to a common manifold feeding the cylinders.

common risk (n) (*mar ins, mar law*) opasnost u pomorskom pothvatu koja se odnosi najmanje na dva posebna interesa **zajednička opasnost**

common safety (n) (*mar law, mar ins*) zajednički spas



common seabream (n) (*fishing*) Pagrus pagrus **pagar**

common sole (n) (*fishing*) = **sole fish list** **švoj, šfolja**



common spiny lobster (n) (*fishing*) **jastog, Ital. aragosta**

common two-banded seabream (n) (*fishing*) Lat. *Diplodus vulgaris* **fratar**

common-user berth (n) (*mar law, ports*) **COMPARE single-user berth** a berth whose use is not restricted to the ships of any one line or shipping company **otvoreni vez, vez za brodove svih brodara, vez za sve lučke operatore**

common user facility (n) (*mar law, ports*) **lučki kapacitet za sve korisnike, lučki vez / kapacitet u vlasništvu lučke uprave**

common user terminal (n) (*mar law, ports*) terminal open to any vessel that makes arrangements to call at this terminal **otvoreni terminal, terminal na raspolaganju svim zainteresiranim brodarima**

common venture (n) (*mar law*) = **joint venture** A basic concept in maritime law, reflecting the understanding of maritime commerce as a joint undertaking on the part of shippers, carriers and consignees ; shipowners and charterers; and their respective insurers, who (directly or indirectly) confront the perils of the sea together, and who should therefore share both the profits and the risks attendant upon their combined operation. **zajednički pothvat, pomorski poduhvat**

communication (n) **communication system** uređaji za komunikaciju, sustavi za dojavu **1 (comm) a priopćenje, obavijest, komunikacija, poruka, vijest; 2 sporazumijevanje**

communicational equipment (n) (*comm*) uređaji veze, komunikacijski uređaji

communication hatch (n) (*cargo handling, comm*) **doglasni otvor**

communications (n) (comm) komunikacije

communications desk (n) (comm, navig) komunikacijski pult, pult za veze:

communications desk on the after port side of the bridge

communication signals znakovi za komuniciranje: *Before entering confined spaces check that communication signals are agreed*

communications satellite (n) (comm) komunikacijski satelit

companion (n) (nav arch) poklopac kabine, poklopac ulaza (u brod, skladište, jedrilicu), *tambuć*

companion ladder (n) (nav arch) = **companionway** a staircase fitted as a means of access from a deck to the quarters **stubište ulaza (u potpalublje, kabinu jedrilice)**



companionway /kəmˈpænjən, weɪ/ (n) **1** (nav arch) a raised and windowed hatchway in the ship's deck, with a ladder leading below and the hooded entrance-hatch to the main cabins; a stairway on a ship leading from one deck to another **palubne stepenice, unutrašnje stubište (na brodu)**



; **2** (boating/yachting) silazne stepenice u jedrilici, stubište ulaza u (potpalublje, skladište)

company /'kʌmpəni/ (n) **1 (mar law)** trgovačko društvo, poduzeće, kompanija **limited liability company** dioničko društvo, d.d., **joint stock company** društvo s ograničenom odgovornošću, d.o.o., **private limited company (LTD.)** privatno dioničko društvo, **public limited company (plc)** javno dioničko društvo; **2 (mar law, shipping econ)** the owner of the ship or any other organization or person such as the manager, or the bareboat charterer, who has assumed the responsibility for operation of the ship from the shipowner and who, on assuming such responsibility, has agreed to take over all the duties and responsibilities imposed on the company by these regulations; (STCW 2010); (= shipping company) **brodarsko društvo, brodovlasnik**; **3 (seamanship)** all the officers and crewmembers with assigned duties on a ship **posada broda**

company procedures (n) (safety) **obvezni postupci brodarskog poduzeća:**

Company procedures have been amended instructing masters to keep safe distance from anchorages.

company security officer; CSO (n) (safety) **osoba odgovorna za sigurnosnu zaštitu u brodarskome društvu**

company's standing instructions (n) **trajni nalozi brodarskog društva:** *This decision was contrary to his company's standing instructions that required its vessels to use the east Solent route when arriving or sailing from Southampton.*

compartment /kəm'pɑ:tənt/ (n) **1 (nav arch)** a subdivision of space or room in a ship **predio (dio konstrukcije na brodu), dio brodskog skladišta, odjeljak, odjeljenje:** *Damage to the ship was contained to two flooded compartments.*; **2 (stabil)** **brodski prostor**

compass /'kʌmpəs/ (n) (navig) **kompas, busola; tal. bussola steering compass (boating/yachting) kormilarski kompas, magnetic compass magnetski kompas, marine compass brodski kompas, conventional compass konvencionalni kompas, gyro compass zvrčni kompas, žiroskopski kompas, žirokompas, hand bearing compass ručni kompas, compass adjustment ispravljanje kompasa, compass**

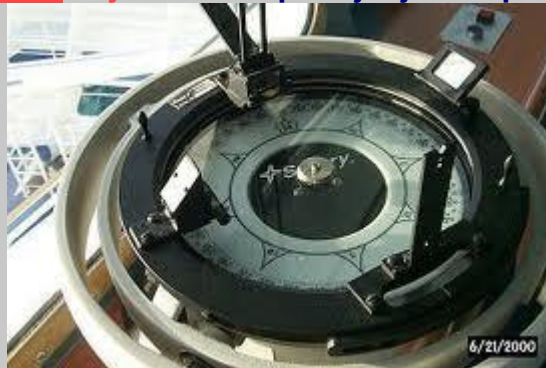

deviation devijacija kompasa

compass (n) (navig) **navigacijski šestar, navigacijski šestar pair of compasses**

compass bearing (n) (navig) **kompasna snimak, kompasni azimut, tal.**

rilevamento con bussola: *The radar was set up to be sea stabilised, compass bearing, rather than relying on but the log input was reading zero knots.*



compass binnacle (n) (navig) stalak kompasu

compass-box (n) (navig) kutija kompasu

compass card (n) (navig) A flat disc mounted on the needle of a ship's magnetic compass so as to swing freely, having the 32 points of the compass or the 360 degrees of a circle printed around the perimeter (<http://www.seatalk.info/cgi-bin/nautical-marine-sailing-dictionary>) ruža kompasu, tal. *rosa dei venti*

compass correction (n) (navig) kompenzacija kompasu

compass course (n) (navig) kurs kompasni, kompasni kurs

compass error (n) (navig) The total of all factors which might cause a particular compass to show inaccurate readings. (<http://www.seatalk.info/cgi-bin/nautical-marine-sailing-dictionary>) grješka

kompasu, greška kompasu **determine the compass error** utvrditi grješku kompasu

compass heading (n) (navig) kompasni kurs, tal. Iprora bussola

compass north (n) (navig) kompasni sjever

compass points (n) (navig) strane svijeta oko broda, položaji oko broda

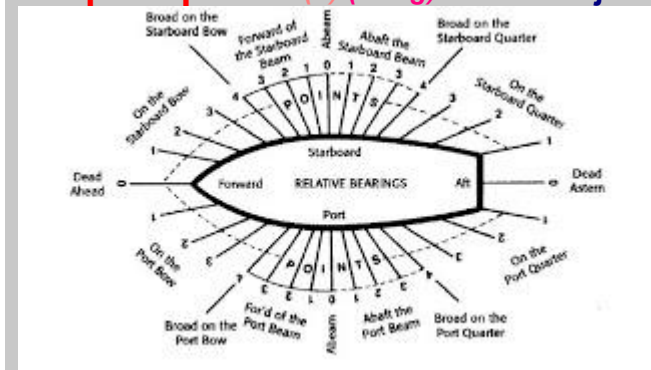



compass repeater (n) (navig) **kompasni ponavljač**

compass rose (n) (navig) the circular design on the compass card illustrating the 32 points of

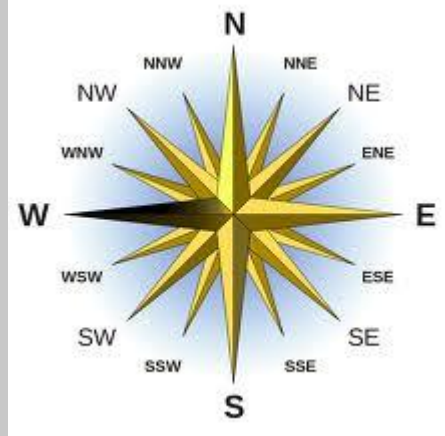

sailing or the 360 degree gradations of a circle **ruža kompas**

compass stabiliser **kompasni stabilizator, stabilizator kompas**

compatibility (cargo) **združivost, kompatibilnost**

compatible /kəm'pætəbl/ (adj) (cargo) **kompatibilan, teret koji se može slagati uz drugi**

compensate for (n) (mar ins) **nadoknaditi** if carriers are held liable, carriers would have to compensate cargo interests for their damages **compensate for loss nadoknaditi gubitak**

compensation /,kɒmpən'seɪʃən/ (n) **1 (navig) kompenzacija kompas; 2 (mar ins) osigurina**

compensation weights (n) (navig) **kompenzacijske kugle (kompasa)**

competency (n) **1 sposobnost:** The officer of the watch was very inexperienced and he had not yet developed sufficient competency to keep a bridge watch in the Dover Strait at night by himself.; **2**

(navig) **osposobljenost certificate of competency (CoC) (mar law) svjedodžba o osposobljenosti, ovlaštenje**

competent authority (n) (mar law) any national regulatory body or authority designated or otherwise recognised as such for any purpose in connection with IMO code **nadležne vlasti, nadležni organ vlasti, nadležno ministarstvo**

compile /kəm'pail/ (v) **compile an abstract sastaviti abstrakt (izvadak, sažetak), compile a summary sheet of information ispuniti obrazac i glavnim informacijama**
1 (mar law, shipping econ) sastaviti, napisati, popisati; 2 prikupiti (podatke)

complacency /kəmˈpleɪənsi/ (n) (safety) a feeling of satisfaction, esp. extreme self-satisfaction; pretjerana ležernost i samouvjerenost kao rezultat dugogodišnje prakse i iskustva odnosno rutiniranosti **samozadovoljnost, samodovoljnost, samodopadnost, smanjen oprez zbog ustaljenih navika**. *This whole incident reflects complacency on the part of the officers in addition to a blatant disregard for the rules designed to prevent collisions occurring at sea* **Complacency** is a major cause of maritime casualties

complain /kəmˈpleɪn/ (v) **žaliti se, uputiti reklamaciju**

complaint /kəmˈpleɪnt/ 1 **žalba, pritužba**; 2 **reklamacija to make complaint** **uložiti žalbu / reklamaciju**

complement /ˈkɒmplɪmənt/ (n) (mar law) A ship's company. The entire crew of a ship when it is fully manned. (<http://www.seatalk.info/cgi-bin/nautical-marine-sailing-dictionary>) **brodska posada**: *The vessel had a complement of seven crew members in accordance with her Minimum Safe Manning Document.* Brod je imao posadu od sedam članova u skladu s Ispravom o minimalnom sigurnom postavu posade. **ship's complement** **brodska posada, bridge complement** **posada na zapovjedničkom mostu**. *Her bridge complement was a second officer and a lookout.*

complete /kəmˈpli:t/ (v) 1 (mar law, safety) **ispuniti (obrazac)**; 2 **dovršiti, završiti**

complete /kəmˈpli:t/ (adj) **potpun, dovršen**

completion /kəmˈpli:ʃən/ (n) 1 a (shipping econ) **izvršenje, završetak (ukrcaja, projekta, itd.), dovršenje**: *Ullage and temperature measurement of all the vessel's cargo tanks should be carried out upon completion of loading and immediately prior to discharge.*; 2 a (mar law) **ispunjavanje (dokumenta, obrasca)**

compliance /kəmˈplaɪəns/ **ispunjavanje, ispunjenje, pridržavanje, poštivanje (konvencije, zakona, ugovora) in compliance with** u skladu s, sukladno

comply with /kəmˈplaɪ/ (v) **ispunjavati (zahtjeve), biti u skladu s, poštivati (propise, zahtjeve)**: *Ensure the vessel complies with the fire and safety regulations* **to comply with with the regulations** **ispunjavati / poštivati propise, comply with rule 19 of COLREGS** **pridržavati se pravila broj 19 Pravila o izbjegavanju sudara, failure to comply with the regulations** **neispunjavanje propisa, nepridržavanje propisa, comply with the STCW requirements** **pridržavati se Konvencije IMO-a o standardima za obrazovanje, izdavanje ovlaštenja i držanje straže pomoraca**

component /kəmˈpəʊnənt/ (n) (nav arch, marine eng) **sastavnica, sastavni dio, komponenta, konstrukcijski element** **additional component** **dodatni dio, dodatna komponenta, running component** **pokretni dio, stationary component** **nepomični dio, fiksni dio**

composition 1 **sastav (pismeni), sastavak**; 2 (chem) **sastav** **chemical composition** **kemijski sastav**

compound /ˈkɒmpaʊnd/ 1 **složenica**; 2 (safety) **izdvojena jedinica, agencija, formacija** **IMO compound** **agencija IMO-a, izdvojena jedinica IMO-a**

compress **stlačiti, sabiti, komprimirati, sabijati**

compressed air cylinder (n) (marine eng) **boca s komprimiranim zrako**

compressed air system (n) (marine eng) **sustav komprimiranoga zraka**

compression (n) **compression ring** **kompresijski prsten, maintain compression**

održavati kruti spoj, čvrsto povezati, **compression stroke** tlačni takt (motora), kompresijski takt (motora), **compression ratio** omjer kompresije (*marine eng*) tlačenje, kompresija, pritisak

compression ignition engine (*n*) (*marine eng*) motor u kojem do paljenja dolazi uslijed tlačenja, motor na paljenje kompresijom

compression rate (*n*) (*marine eng*) omjer kompresije

compressor 1 *a* (*seamanship*) štoper sidrenog lanca; 2 (*marine eng*) kompresor **air compressor** kompresor zraka, zračni kompresor, **centrifugal compressor**

centrifugalno puhalo, **steam driven air compressor** kompresor zraka na parni pogon, **turbine-driven air compressor** zračni kompresor na turbinski pogon

compress the chest (*safety*) pritiskanje grudnog koša (u davanju umjetnog disanja)

comprise /kəm'praiz/ (*v*) sastojati se of, uključiti, obuhvatiti

compulsory /kəm'pʌlsəri/ (*adj*) 1 obvezan, obligatan: *Pilotage shall be compulsory within the area described in paragraph 2 below for all vessels* **be compulsory** biti obvezan, morati, **vessel subject to compulsory pilotage** brod koji obvezno mora imati / uzeti peljara; 2 prinudan, prisilan

computation računanje, izračun, obračun (vozarine)

con /kɒn/ (*n*) 1 (*navig*) The position of responsibility and authority for the operation and steering of a ship (<http://www.seatalk.info/cgi-bin/nautical-marine-sailing-dictionary>) **kormilarenje**,

zapovjedanje brodom / brodicom / čamcem za spašavanje, komanda (nad brodom, brodicom): *the vessel continued her passage through the west Solent with the master conning from his forward console chair at the starboard radar. by 2112 the vessel was clear of the berth and the pilot began conning the vessel toward the harbour entrance* do 12:12 sata brod se udaljio od veza i peljar je preuzeo

vođenje broda prema izlasku iz luke **take over the con** preuzeti zapovijedanje nad brodom, **preuzeti kormilarenje brodom, preuzeti komandu nad brodom:** *the master took over the con* 0 Who has the con?, **hand over the con** predati kormilarenje broda, predati

zapovijedanje brodom: *The Master handed over the con to the 3/O.*, **have a con** upravljati brodom, **kormilariti:** *On the bridge were the master, who was on the port wing and had the con, the OOW and a quartermaster. Who has the con?* Tko upravlja / kormilari brodom?, **take the con**

preuzeti kormilarenje, preuzeti kormilo, preuzeti upravljanje brodom: ... eventually, *the mate took the con and set a course clear of the coast and back towards the vessel's intended track.*;

2 the place where a person who cons a vessel is stationed **mjesto upravljanja brodom /brodicom**

con /kɒn/ (*v*) 1 (*navig*) to direct the steering of (a vessel); to direct the helmsman **davati naredbe kormilaru, kormilariti** **con the ship / vessel** davati naredbe za kormilarenje: *The Master/Pilot exchange took place between the Master and the pilot who was to con the vessel.*; 2 **upravljati brodom / brodicom**

concealed damage (*n*) (*cargo handling, mar law*) damage that is not evident from viewing the unopened package **skriveno oštećenje (tereta)**

concealed loss or damage /kən'si:ld/ (*n*) (*shipping econ, mar law*) When damage is discovered after the delivery receipt is signed and the cartons are opened, it is termed concealed

damage. **skriveni gubitak ili oštećenje, nevidljivi gubitak ili šteta**: *When concealed loss or damage occurs, the carrier should be immediately contacted at the delivering terminal, to request an inspection.*

concern /kənˈsɜːn/ (n) (*navig*) **zabrinutost, sumnja, briga**: *In May 2004, the Chemical Distribution Institute (CDI) carried out an inspection of the vessel during which four areas of concern with respect to bridge operations were highlighted. The navigator's primary concern is the safe navigation of his/her vessel to its destination. raise concern pobuditi zabrinutost, izazvati zabrinutost. the recent collisions in the Singapore Strait have raised concern among the city-state's shipping community*

concerned /kənˈsɜːnd/ 1 **koji se tiče all the concerned svi zainteresirani, sve zainteresirane strane; 2 zabrinut**

concession /kənˈseʃən/ 1 **dopuštanje to make a concession to dopustiti; 2 (shipping econ) koncesija**

concession approval (n) (*mar law, ports*) **koncesijsko odobrenje**

concessionary deed (n) (*mar law, ports*) **koncesijsko odobrenje**

condensate /kənˈdɛnsɪt/ (n) **kondenzat de-aerated condensate odzračeni kondenzat, otplinjeni kondenzat**

condensate (v) **kondenzirati (se), pretvoriti paru u vodu**

condensate extraction pump (n) (*marine eng*) **sisaljka kondenzata, kondenzatna pumpa**

condensation **kondenzacija, ukapljivanje**

condense /kənˈdɛns/ **condense out kondenzirati, pretvoriti u tekućinu, ukapljivati kondenzirati**

condenser 1 **kondenzator**: *The Chief Engineer was called to the engine room as the deck steam condenser had overheated and was releasing a lot of steam. steam condenser kondenzator pare*

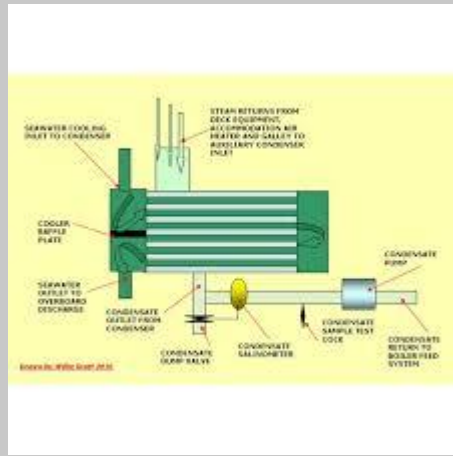

; 2 (*electr*) **kondenzator**

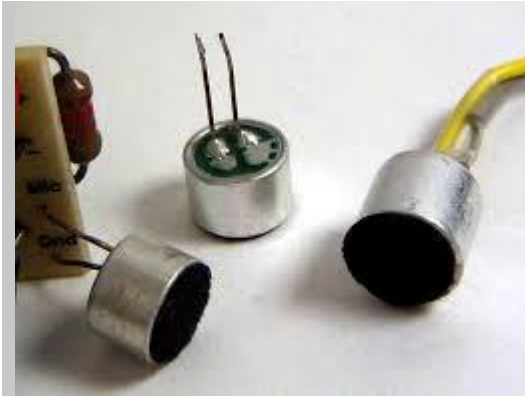

condition condition of machinery stanje stroja, stanje postrojenja, **operating condition** režim rada, uvjeti rada **1** uvjet, okolnost, stanje, prilike; **2** on condition that, pod uvjetom da, ako

condition **1** a uvjet to fulfill the condition ispuniti uvjet; **2** stanje **conditioned air** kondicionirani zrak

conditioning (n) **1** (marine eng) priprema (kotlovene vode); **2** (marine eng) kondicioniranje (zraka) **air-conditioning** klimatizacija

condition precedent (n) (mar law) osnovni / bitni uvjet ugovora o prijevozu

conditions of stability (n) (stabil) stanja stabilnosti broda **stable condition** brod u stabilnoj ravnoteži, stabilno stanje, **neutral condition** indiferentna ravnoteža, neutralno stanje, **unstable condition** labilna ravnoteža, stanje nestabilnosti, nestabilno stanje

conduct /kən'dʌkt/ (v) **1** odvoditi conduct away odvoditi; **2** voditi, provoditi to conduct an operation voditi (operaciju), provoditi (operaciju); **3** dovesti; **4**

ponašati se: *Seafarers shall conduct themselves in an orderly, faithful, honest and sober manner, and shall at all times be diligent in their respective duties and obedient to the lawful commands of the Master*

conduct oneself ponašati se

conduct /'kɒndʌkt/ **1** a izvršenje; **2** ponašanje **code of conduct** pravila ponašanja

conductivity /,kɒndʌk'tiviti/ (n) (electr, marine eng) vodljivost, provodljivost **electrical conductivity** električna vodljivost, **thermal conductivity** toplinska vodljivost

conductor /kən'dʌktə/ (n) (electr) provodnik, vodič električne struje

cone /kəʊn/ apex of a cone vršak stošca stožac, konus

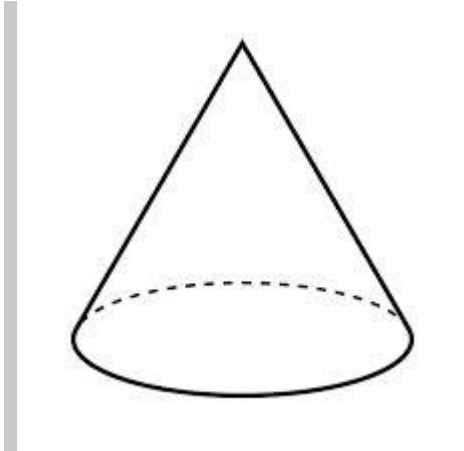

conference (n) (mar law, shipping econ) an association of ship owners operating in the same trade route who operate under collective conditions and agree on tariff rates **brodarska konferencija**, **konferenca**: Competition in liner service is regulated generally by agreements, known as **conferences**, among the shipowners. **steamship conference** **brodarska konferencija**, **member of the conference** **brodarska društvo - članica (brodarske) konferencije**, **conference rate** **konferencijski vozarinski stav**, **liner conference** **linijska konferencija**

confined spaces /kən'faɪnd/ (n) (safety, nav arch) Confined spaces are tanks, cofferdams, void spaces, CO2 chambers and cold storage chambers **zatvoreni prostori**, **skućeni prostori** **enter confined spaces** **ući u zatvorene prostore**

confined waters /kən'faɪnd/ (n) (navig) **zatvorene vode**, **skućene vode**

confirm (n) **1 (shipping econ) potvrditi**: We hereby confirm receipt of this letter Ovime potvrđujemo primitak Vašega dopisa; **2 utvrditi**

confirmation **1 a potvrda**; **2 dokaz**

confirming bank (n) (mar law, shipping econ) **potvrđujuća banka**

confiscate /'kɒnfɪ'skeɪt/ (v) (mar law) **konfiscirati**, **oduzeti**, **zaplijeniti** **confiscate the ship** **konfiscirati brod**

conflict of laws (n) (mar law) **sukob prava**, **sukob pravnih sustava**

conform /kən'fɔ:m/ (v) **odgovarati**, **biti u skladu s** **to conform with the rules** **biti u skladu s pravilima**, **odgovarati pravilima**

confused sea /kən'fju:zd/ (n) (oceanogr) = **CROSS SEA** waves progressing in several directions



at once **križano more**, **nemirno more**

confused swell (n) (oceanogr) **križano mrtvo more**

CONGENBILL teretniza za uporabu uz brodarski ugovor (čarter partiju)

conger /'kɒŋgə/ (n) (fishing) ugor **European conger** murina, **conger eel** murina {drugi hrv. nazivi: Grongo, Školjar, Gruj, Grug, Grunj, Škanjas, Kušac; lat. CONGER CONGER}

congested /kən'dʒɛstɪd/ zakrčen, začepjen, s gustim prometom **congested TSS** zona odvojene plovidbe s gustom prometom

congested port (n) (shipping econ) zakrčena luka

congestion (shipping econ) accumulation of vessels at a port to the extent that vessels arriving to load or discharge are obliged to wait for a vacant berth **zakrčenost (luka, prometa)**

kongestija: *The greatest amount of delay in a trip often occurs at a terminal, usually because of congestion or inadequate capacity. The congestion to enter the Canal has been getting progressively worse since late September when a high number of arrivals coincided with scheduled dry-chamber maintenance of the locks.*



conical buoy (n) (navig) stožasta plutača

CONLINEBILL (n) (mar law) teretnica za linijski prijevoz

conn (n) zapovjedno mjesto

connect /kə'nekt/ 1 spojiti; 2 priključiti

connecting rod **connecting rodfoot** peta ojnice, **connecting rod** shank tijelo ojnice, **connecting rod with Marine large (big) end** ojnica s brodskom izvedbom donje glave, **fixed centre connecting rod** ojnica s fiksnim središtem ojnica,

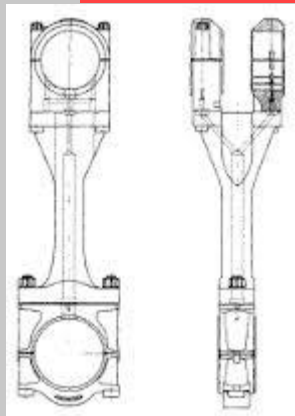

klipnjača, tal. **biella**

connection (n) (electr, marine eng) spoj, veza **recirculation connection** priključak optoka / optjecanja (u zatvorenom krugu)

connector snap-in **connector** STORZ-spojka spojka



connexion (n) (navig) spoj, veza

conning officer (n) (navig) časnik koji upravlja brodom, časnik koji kormilari brodom

conning position (n) (navig) upravljačka pozicija na zapovjedničkom mostu, mjesto upravljanja brodom ili brodicom, mjesto kormilarenja brodom ili brodicom

ConRo (n) (nav arch) kombinirani kontejnerski i ro-ro brod. *Matson, Inc has placed an order for two new combination container and roll-on/roll-off vessels to add to its Hawaii fleet. The two ConRos will be built on a 3,500 TEU platform, with enclosed garage space for up to 800 vehicles.*

consecutive /kən'sɛkjʊtɪv/ (adj) neprekidan, kontinuiran, konsekutivan, uzastopan

consecutive voyage charter (n) (mar law) ugovor o najmu broda za nekoliko uzastopnih putovanja

consecutive voyage charter (n) (mar law) brodarski ugovor za više uzastopnih putovanja

consecutive voyages (n) (shipping econ, mar law) ugovor u kojemu se brodar može obvezati da će obaviti više unaprijed određenih putovanja uzastopna putovanja

consent (n, v) 1 a pristati; 2 suglasiti se

consent pristanak, suglasnost

conservation point for conservation predmet za razmatranje 1 zaštita (od korozije) **conservation of the ship** zaštita broda (od korozije itd.); 2 (mar law) očuvanje živih bogatstava (u međunar. pravu mora)

consideration /kən,sɪdə'reɪʃən/ (n) take into **consideration** uzeti u obzir, with due **consideration** given to s posebnim obzirom na obzir, razmatranje

consideration /kən,sɪdə'reɪʃən/ (n) (mar law) payment for a service; recompense; fee **naknada**,

novčana naknada, kompenzacija *In consideration of this service, to be duly performed, the Master agrees to pay the undersigned seafarers the wages expressed herein and/or set forth in supplemental provisions and/or agreements.* Kao naknadu taj posao, koji se valja uredno obaviti, zapovjednik se obvezuje platiti nižepotpisanim pomorcima zarade navedene u ovom ugovoru i/ili propisane odredbama u dodatku i/ili drugim ugovorima. **in consideration of kao naknada za, u zamjenu za**

consign /kən'saɪn/ (v) dostaviti (pošiljku), postali, otpremiti

consignee /,kən'saɪ'niː ; ,kɒnsaɪ'niː/ (n) (mar law) = **receiver** The party to whom delivery of the goods is to be made under a contract for the carriage of goods by water. (Tetley); the person entitled to

take delivery of the goods.(Hamburg Rules) **primatelj primatelj tereta**

consignee mark (n) (*shipping econ, mar law*) a symbol placed on packages for identification purposes; generally a triangle, square, circle, etc. with letters and/or numbers and port of discharge **primateljeva oznaka, oznaka primatelja (robe)**

consignment /kən'sainmənt/ (n) (*mar law, shipping econ*) **SYNONYM shipment** goods sent for shipment; a separate identifiable number of goods (available to be) transported from one consignor to one consignee via one or more than one modes of transport and specified in one single transport document (http://www.iss-shipping.com/cargo/cargo_library_glossaryc.asp) **pošiljka (tereta), robna pošiljka** {Consignment is the same as a shipment of goods. The buyer of this shipment is called the consignee; the seller of the goods is called the consignor}

Consignment Note (n) (*mar law, shipping econ*) document prepared by the shipper and comprising a transport contract. It contains details of the consignment to be carried to the port of loading and it is signed by the inland carrier as proof of receipt

(http://www.iss-shipping.com/cargo/cargo_library_glossarya.asp) **najava ukrcaja, krcateljeva obavijest o prijevoznom ugovoru**

consignment note /kən'sainmənt nɔ:t/ (*shipping econ*) (*mar law*) **željeznički tovarni list, tovarni list**

consignor /kən'sainə ; ,kɒnsai'nɔ:/ (*shipping econ, mar law*) a person or company shown on the bill of lading as the shipper **pošiljatelj, otpremnik, dostavljač**

consist consist of **sastojati se od / iz sastojati se**

console /kən'səʊl/ **1 konzola, nosač; 2 pult, upravljački pult, konzola control**



console **upravljački pult**

consolidate (v) (*shipping econ*) to group and stuff several shipments together in one container **grupirati teret (za slaganje u kontejner)**

Consolidated Freight Station; (CFS) (n) (*shipping econ*) = **Container Freight Station; (CFS)** zbirno skladište kontejnerske robe, konsolidacijsko skladište, zbirna postaja / stanica / centar (za kontejneriziranu robu), centar za punjenje i pražnjenje kontejnera

consolidated pack ice /kən'sɒli,deɪt/ (n) (*oceanogr*) područje konsolidiranog leda

consolidation (n) (*shipping econ, cargo handling*) cargo containing shipments of two or more shippers or suppliers, usually involving goods for stowing into containers **razvrstavanje tereta po primateljima, konsolidacija tereta, skupljanje tereta (radi prijevoza u kontejnerima)**

consolidation shed (n) (*shipping econ*) zbirno skladište (za kontejnerski teret)

consolidator (n) (*oceanogr, cargo handling*) **COMPARE Consolidated Freight Station; (CFS)** The person or firm that consolidates (combines) cargo from a number of shippers into a

container that will deliver the goods to several buyers. **operator konsolidacijskog skladišta, operator konsolidacijskog centra, operator kontejnerskog zbirnog skladišta**
consort /'kɒnsɔ:t/ (n) (US, navig) tegljeni brod (na Velikim Jezerima), brod u teglju
conspicuous /kən'spɪkjʊəs/ (adv) uočljiv, raspoznatljiv, koji se ističe, upadljiv
conspicuous point uočljiva točka, **conspicuous radar features** obilježja uočljiva na radaru
The crucial factor in radar navigation is to correctly identify radar conspicuous features that are recognisable on the chart as well as on the radar screen. Towers, monuments, buildings and other prominent features that are favourites with compass navigation will not be visible on radar. However, objects such as headlands, islands, buoys and beacons will, with the added advantage that they will be equally useable by day or night.

constant pressure (n) (marine eng) stalan tlak, konstantan pritisak

constrained by draught /kən'streɪnd/ (seamanship) (brod) ograničene sposobnosti

manevriranja zbog svog gaza: *The vessel was on harbour manoeuvring mode under bridge control, displaying the appropriate signals to indicate her 'constrained by draught' status. The vessel was constrained by her draft and displayed the required signals in the deep water route.*

constraint /kən'streɪnt/ (n) (mar law) ograničenje **operational constraints** ograničenja za rad

construction 1 konstrukcija, struktura; 2 gradnja, izgradnja; 3 izvedba

constructive total loss (n) (mar law, mar ins) izvedeni potpuni gubitak roda, izvedena totalna šteta

construe /kən'stru:/ tumačiti to **construe the rules** tumačiti pravila

consular /'kɒnsələ/ (n) (mar law) an official appointed by a sovereign state to protect its commercial interests and aid its citizens in a foreign city **konzul**

consular (adj) konzularni

consular fees (n) (mar law) konzularne pristojbe

consular invoice (n) (mar law, shipping econ) an invoice covering shipment of goods certified by a consular official of the destination country, and used normally by customs or officials concerned with foreign exchange availability to ascertain the correctness of commercial invoice values

konzularna faktura, račun potvrđen od strane konzula

consulate (n) konzulat

consume /kən'sju:m/ (v) trošiti

consumer /kən'sju:mə/ (n) (shipping econ) potrošač, klijent

consumers (n) (electr) električni potrošači

consumption /kən'sʌmpʃən/ (n) potrošnja, potrošak in port **consumption** potrošnja (goriva) u luci, **consumption of fuel** potrošnja goriva

contact (v) 1 obratiti se, stupiti u vezu s, kontaktirati; 2 udariti (u obalu, lučki

objekt), dodirnuti: *At 1254 on 22 June 2013, the ferry Sirena Seaways made heavy contact with berth 3 at Harwich International Port. make contact with the quay* 1 udariti u obalu,

dodirnuti obalu: *Shortly thereafter the pilot ordered full astern, but the vessel's starboard bow made contact with the quay.; 2: As the pilot manoeuvred the vessel around Tilburyness, he lost control of the vessel and she contacted the quay at Northfleet Terminal. Dok je peljar vodio brod oko Tylurnessa, izgubio je kontrolu nad brodom pa je prod udario u obalu terminala Northfleet.*

contact (n) 1 (navig, safety) dodir, kontakt: *the tanker could not avoid a glancing contact on her*

starboard quarter with the crossing vessel **make contact with** **dodirnuti**, **udariti u** the cargo vessel's port quarter made heavy contact with the lock gate, **heavy contact** **jak dodir**, **jak kontakt** : However, this was too late to prevent the vessel **making heavy contact with the quay**.. This seemed to work and the Master also deployed a bow thruster to stop the starboard turn, but it was too late; **the vessel made several heavy contacts with the breakwater.** ; **2 (electr, marine eng) spoj**, **kontakt** **contact brushes (electr) četkica/e**, **contact-welding** **točkasto zavarivanje**, **touch-contact welding** **točkasto zavarivanje**, **close contact** **tijesan dodir** **a** **stvoriti električni spoj** **contactor (n) (electr) teleprekidač**

contagious disease /kən'teidʒəs/ (adj) (med) **zarazna bolest**

contain /kən'tein/ (v) **1 a sadržavati**, **sadržati**; **2 uključiti(va)ti**; **3 obuhvaćati**; **4 (safety) obuzdati (vatru)**, **sputati**, **blokirati**, **suzbiti** **contain fire** **obuzdati požar**, **suzbiti požar**, **ograničiti požar**: The ship's fire suppression system was immediately activated, which contained and extinguished the fire. , **contain the emergency situation** **obuzdati izvanredno / opasno stanje**: ... despite the breakdown of the structural barriers, the ship's officers and crew managed to **contain the emergency situation** without any personal injury or pollution to the environment.

container (n) 1 (cargo) SYNONYM freight container SYNONYM shipping

container A box made of aluminum, steel or fiberglass used to transport cargo by ship, rail, truck or barge. Common dimensions are 20' x 8' x 8' (called a TEU or twenty-foot equivalent unit) or 40' x 8' x 8', called an FEU. Variations are collapsible containers, tank containers (for liquids) and rag tops (open-topped containers covered by a tarpaulin for cargo that sticks above the top of a closed box). In the container industry, containers are usually simply called boxes.

(<http://www.aapa-ports.org/Industry/content.cfm?ItemNumber=1077>) **kontejner (od 20 ili 40 stopa, po ISO standardima)** **reefer container** **hlađeni kontejner**,

kontejner-hladnjača, **open-top container** **kontejner s otvorenim krovom**, **otvoreni kontejner**, **closed-top container** **kontejner sa zatvorenim krovom**, **container**

Loading Report **Izvešće o ukrcanim kontejnerima**, **20 ft standard 20' x 8' x 8'6'** **standardni kontejner dužine 20 stopa širine 8 stopa visine 9 stopa i 6 inča**, **hired container** **unajmljen kontejner**, **self-owned container** **vlastiti kontejner**, **brodarov kontejner**, **dry container** **dry containers are used to carry solid dry goods like coal, grain, steel**

products, ore and other similar products in loose form **kontejner za sipke terete** **kontejner za suhe rasute terete**, **deck container** **palubni kontejner**, **kontejner složen na palubi**

forward ends of seven deck containers on bay 01 port and starboard outboard stacks set in due to impact of swell waves; ; **2 (marine eng) spremnik** **air container** **spremnik zraka**

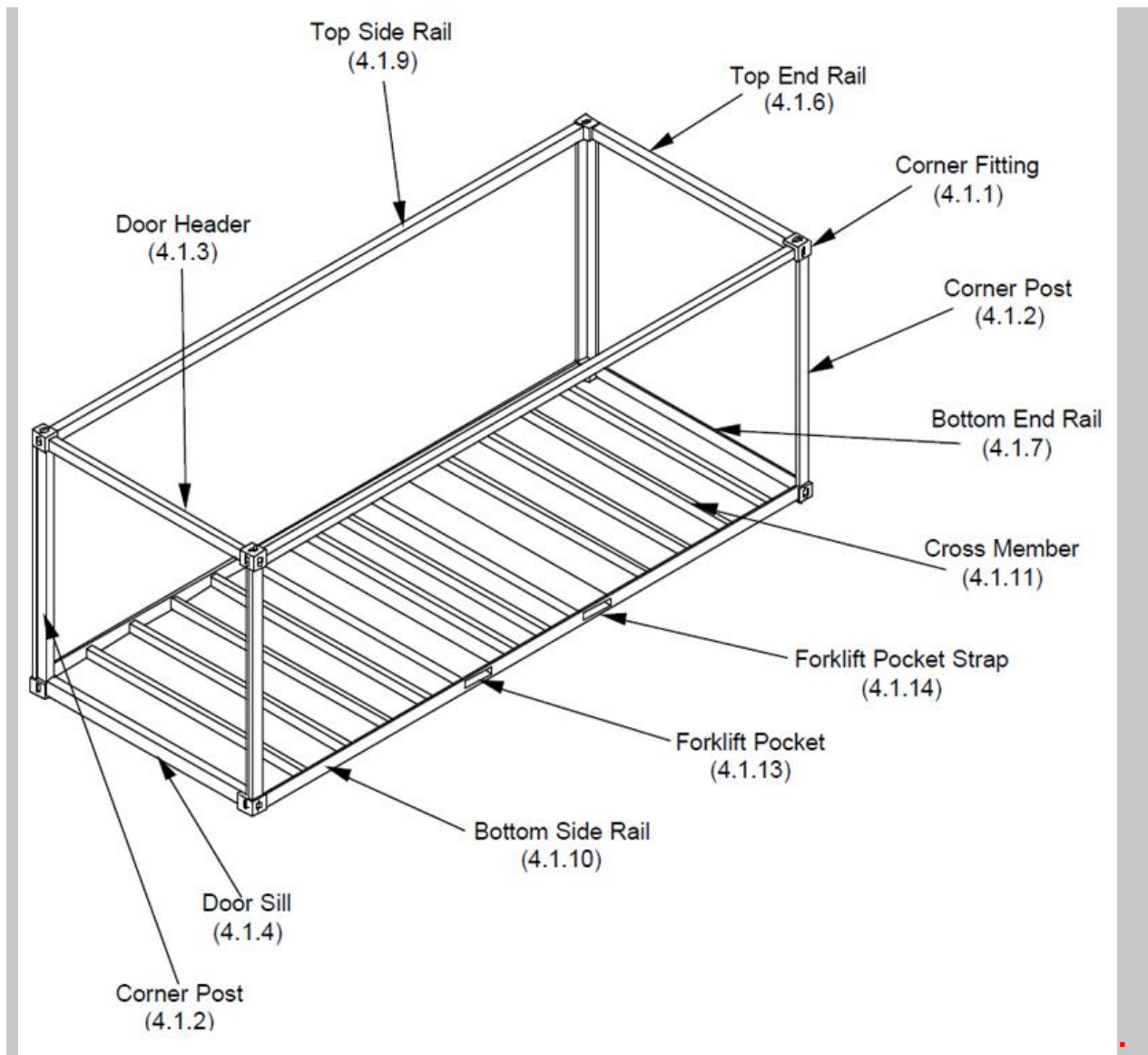

3 (cargo) vrsta spremnika (staklenog itd.) **glass container** bocun (za kiseline), stakleni spremnik **glass container** (cargo) bocun (za kiseline itd.)

container bay (n) (nav arch) COMPARE **container tier** dio broskog skladišta

za uzdužno slaganje kontejnera, bay, bej {svako skladište kontejnerskog broda obično se sastoji od dva baya osim krajnjeg skladišta na pramcu i krmu}

container chassis (n) (cargo handling) A piece of equipment specifically designed for the movement of containers by road to and from container terminals. **kontejnerska šasija**, **kontejnerska prikolica**, **kontejnerski podvozak**

container crane (n) (cargo handling) a rail-mounted gantry crane located on a wharf for the purpose of loading and unloading containers on vessels. **kontejnerska dizalica**, **obalni**



kontejnerski most

Container Freight Station; (CFS) (n) 1 (ports, shipping econ) The facility for stuffing and stripping a container of its cargo, especially for movement by railroad.; a place or warehouse on the dock or a container terminal where cargo is loaded ("stuffed") into or unloaded ("stripped") from containers **zbirno skladište, konsolidacijski centar, centar za punjenje i pražnjenje kontejnera, zbirna postaja / stanica / centar (za kontejneriziranu robu);** 2 (n) (ports) a port that is used for the loading of containerized cargo from boats (also called container terminal) **kontejnerski terminal** {Generally it involves less than containerload shipments}

container guide (n) (nav arch) vodilica za kontejnere (u brodsomom skladištu)



containerisation, (US) containerization (n) 1 (shipping econ) a technique of using a container to store, protect and handle cargo while it is in transit. This shipping method has both greatly expedited the speed at which cargo is moved from origin to destination and lowered shipping costs.

kontejnerizacija; 2 (cargo handling, shipping econ) stowage of general or special cargoes in a container for transport in the various modes **slagannje robe u kontejnere**

containerizable cargo (n) (cargo handling) cargo that will fit into a container and result in an economical shipment **teret koji se može prevoziti u kontejnerima, kontejnerski teret**

container lashings (n) (cargo handling) vezovi za pričvršćivanje kontejnera, **rice**

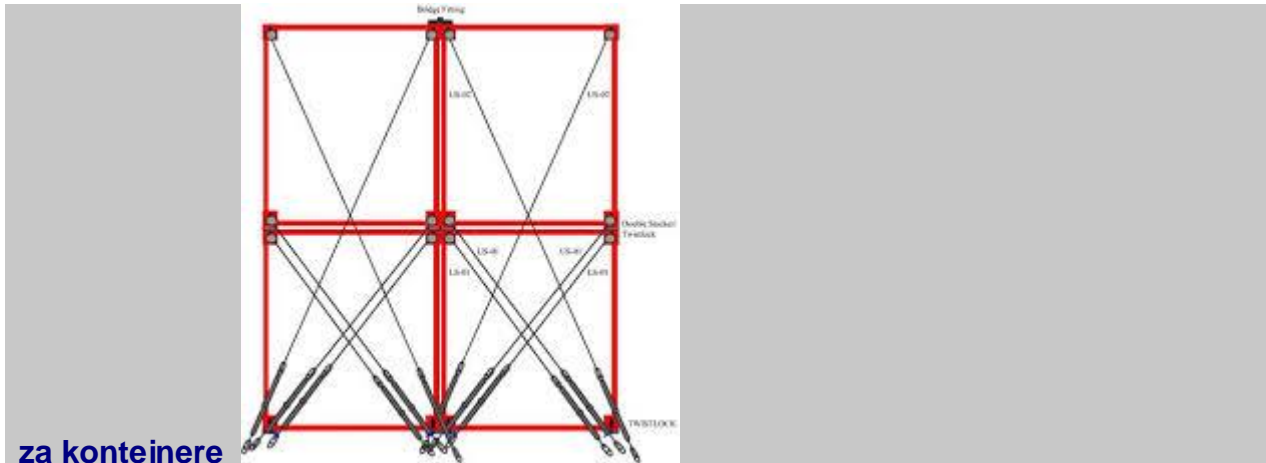

za kontejnere

container lease (n) (*shipping econ*) the contract by which the owner of containers (lessor) gives the use of containers to a lessee for a specified period of time and for fixed payments. **iznajmljivanje kontejnera, najam kontejnera**

container load (n) (*cargo handling, shipping econ*) a load sufficient in size to fill a container either by cubic measurement or by weight **teret za jedan kontejner full container load; FCL = F.C.L. (full container load)** sav teret u kontejneru glasi na jednog, tj. istog primatelja **izravna kontejnerska pošiljka (sav teret u kontejneru glasi na istog primatelja), less-than-container load; LCL = LCL** kontejner s robom koja glasi na više različitih primatelja **zbirni kontejner**

container load plan (n) (*cargo handling*) plan krcanja i slaganja tereta u kontejner, a list of items loaded in a specific container and where appropriate their sequence of loading.

Container on Flat Car; (COFC) (n) (*cargo handling*) A container placed directly on a railroad flatcar without chassis. **kontejnerski ravni vagon, flat**

container-on-flatcar (COFC) (n) (*cargo handling*) kontejnerski vagon (nakrcan s kontejnerom)

container parts (n) (*cargo*) sastavni dijelovi kontejnera

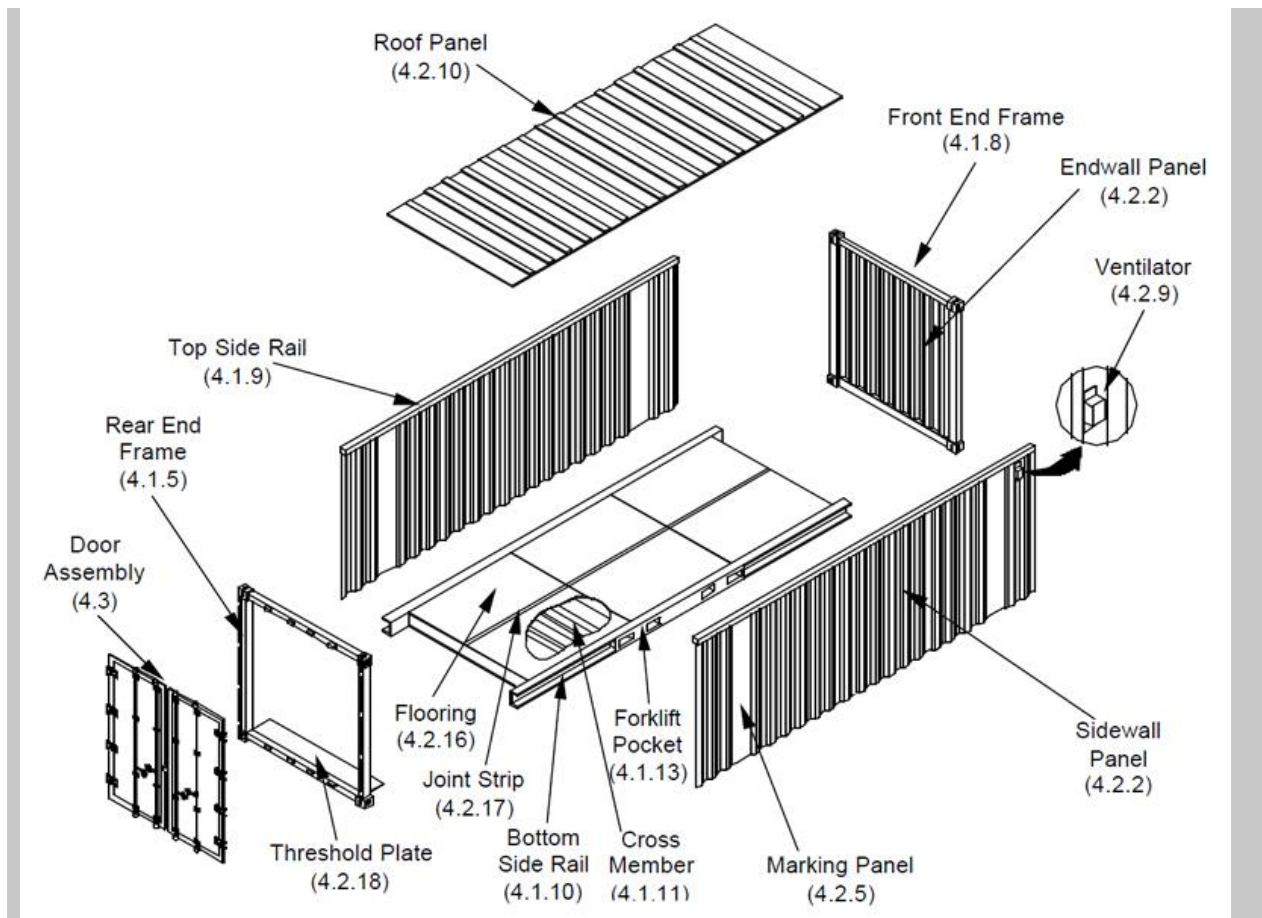

container row (n) (nav arch, cargo handling) **COMPARE** container tier red kontejnera po širini broda

container securing system (n) (cargo handling) sustav za vezivanje i pričvršćivanje kontejnera

MacGregor and Maersk Line have agreed to cooperate on the development of the next generation of container securing systems.

container shifting charges (shipping econ) troškovi premještaja kontejnera (brod-brod, brod-obala-brod, na obalnom skladištu) **troškovi premještaja kontejnera**

container ship (n) (nav arch) kontejnerski brod, kontejneraš **third / fourth / fifth / sixth generation container ship** kontejnerski brod treće / četvrte / pete / šeste generacije: The Pudong Container Terminal has a total quay length of 900 meters and is able to



accommodate the fifth and sixth generation container ships.

container shipping (n) (shipping econ) kontejnersko brodarstvo: 'Container shipping, which moves 95% of all manufactured goods, is estimated by industry executives to be worth \$1 Trillion a

year (gCaptain <info=gcaptain.com@mail83.atl51.rsgsv.net>)

container stacker (n) (cargo handling, ports) **kontejnarski prijenosnik**

Container Sublease Agreement (n) (shipping econ) **Sporazum o podnajmu kontejnera**

container terminal (n) (ports) A specialized facility where ocean container vessels dock to discharge and load containers, equipped with cranes with a safe lifting capacity of 35-40 tons, with booms having an outreach of up to 120 feet in order to reach the outside cells of vessels. Most such cranes operate on rail tracks and have articulating rail trucks on each of their four legs, enabling them to traverse along the terminal and work various bays on the vessel and for more than one crane to work a single vessel simultaneously. Most terminals have direct rail access and container storage areas, and are served by highway carriers. (<http://www.aapa-ports.org/Industry/content.cfm?ItemNumber=1077>)

kontejnarski terminal

container throughput (n) (shipping econ) **promet kontejnera (u luci)** **kontejnarski promet** {broj prometnutih kontejnera u luci}

container tier (n) (nav arch, cargo handling) **COMPARE container row red**

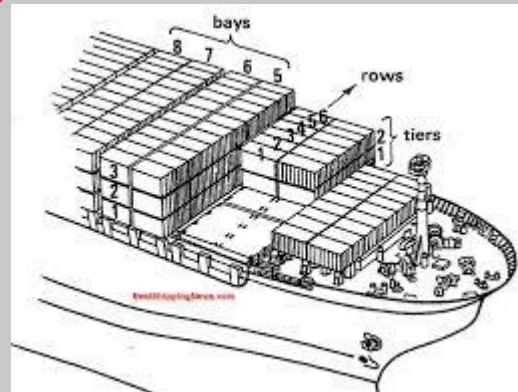

kontejnera po visini broda (ili skladišta)

container trade (n) (shipping econ) **kontejnarski promet**: *Will container trade continue to grow as long as world GDP remains positive (in any measurable amount)?*

<http://gcaptain.com/the-future-of-trade>

Container Transport Operator; (CTO) **naručitelj u intermodalnom transportu**, **kontejnarski operator**, **kontejnarski vozar**

container weight verification (n) (shipping econ) **ovjera težine kontejnera**,

provjera težine kontejnera: *The imminent enforcement of mandatory container weight verification is causing widespread fear of disruption among shippers and freight forwarders, according to a new customer survey by INTTRA, the ocean shipping e-marketplace.*

Container Weight Verification Requirements (n) (mar law, safety, cargo)

Obvezna provjera bruto težine kontejnera u transportu: (SOLAS Treaty) **Container Weight Verification Requirements** - *The new mandatory regulations applicable to shippers were released on July 1, 2016, and require that every shipper must verify the gross weight of all containers before they are loaded on board.*

container yard ; CY (n) **1** (ports) a materials-handling/storage facility used for completely unitized loads in containers and/or empty containers. **kontejnarsko skladište**, **kontejnarsko slagalište na terminalu**: *The terminal land area is 500,000m² with a container yard of 8,200 flat container slots capable to stack 30,000 TEUs at the same time.*



; 2 kontejnerski terminal

contaminant (n) (safety) sredstvo zagađenja, blato

contaminate (v) zagađiti

contaminated water (n) onečišćena voda, zagađena voda: *The vessel was also regularly pumping contaminated water directly overboard.*

contamination (n) 1 a zagađenje, prljanje, miješanje vode s uljem za

podmazivanje; 2 (cargo handling) mješanje tereta s drugim teretom cargo

contamination 1 škodljivo miješanje tereta; 2 cargo **contamination claim** zahtjev za naknadu štete zbog miješanja tereta, **reveal contamination** otkriti mješanje tereta:

Often samples are taken at the commencement of loading after a small quantity has been pumped, in order to check if any contamination is revealed.

contamination claim (n) 1 (mar ins, mar law) odštetni zahtjev zbog onečišćenja; 2 odštetni zahtjev zbog mješanja tereta

contention (n) (mar law) sporenje, spor: *Over the years, the main point of contention in the ongoing case has been the poor state of the 26-year-old tanker.* **point of contention** točka sporenja, sporna točka

contents (n) 1 a sadržaj, sadržina, količina, primjesa; 2 sadržaj (knjige)

contents unknown (n) (mar law, shipping econ) sadržaj nepoznat (u teretnici)

contest (v) 1 osporavati, suprotstaviti se: *Much of the documentation and evidence required for shortage claims is also necessary to contest contamination claims.*; 2 natjecati se

contiguous /kən'tɪgjuəs/ (adv) (mar law) touching along the side or boundary; in contact koji dodiruje (granice, krajnje crte), koji dotiče, obližnji

contiguous zone /kən'tɪgjuəs/ (n) (mar law) a zone contiguous to a country's territorial sea where the coastal State may exercise the control necessary to: (a) prevent infringement of its customs, fiscal, immigration or sanitary laws and regulations within its territory or territorial sea; (b) punish infringement of the above laws and regulations committed within its territory or territorial sea.

(UNCLOS) **vanjski pojas** {The contiguous zone may not extend beyond 24 nautical miles from the baselines from which the breadth of the territorial sea is measured. (UNCLOS)}

continental shelf (n) (mar law) The continental shelf of a coastal State comprises the seabed and subsoil of the submarine areas that extend beyond its territorial sea throughout the natural prolongation of its land territory to the outer edge of the continental margin, or to a distance of 200 nautical miles from the baselines from which the breadth of the territorial sea is measured where the outer edge of the continental margin does not extend up to that distance. (UNCLOS) **kontinentni**

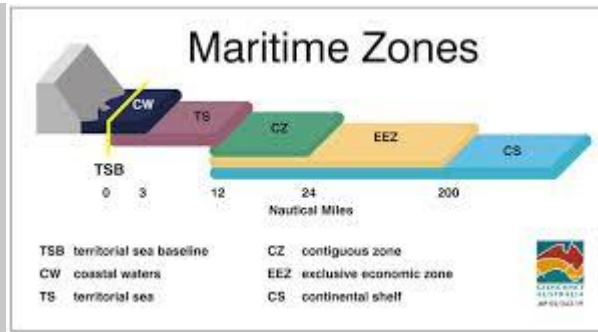

pojas, kontinentalni pojas, šelf

contingency plan /kən'tɪndʒənsi/ (n) (safety) plan za opasnost

continuation clause (n) (mar ins) klauzula o nastavku (osiguranja), klauzula o automatskom produljenju osiguranja

continue (v) nastaviti, n e prekidiati, ostati i dalje

continuous air supply (n) (marine eng) neprekidna dobava zraka, stalni dovod zraka

continuous output (n) (marine eng) kontinuirana snaga (stroja)

continuous survey (n) (safety) postupni pregled

continuous synopsis record; (CSR) (n) (mar law) trajni zapis o brodu (u upisniku brodova)

continuous tracking radar (n) (navig) radar za neprekidno praćenje cilja

contour /'kɒntʊə/ (n) (navig) kontura (na karti), obris: *The ECDIS would then have defaulted to the nearest deeper contour on the chart in use, the 20m contour.*

contraband /'kɒntrə,bænd/ (n) (mar law) goods prohibited in trade (e.g. weapons; smuggled goods) krijumčarenje to secure **contraband** otkriti / utvrditi krijumčarenje

contract /'kɒntrækt/ (mar law, shipping econ) ugovor **contract rate** iznos ugovora, **CIF**

contract ugovor po uvjetima c.i.f. (cost, insurance, freight), **sign the contract**

potpisati ugovor, **draft the contract** sastaviti nacrt ugovora, **make up the contract**

sastaviti ugovor, **to be awarded the contract** dobiti ugovor, dobiti posao, **award**

the contract dodijeliti posao, povjeriti posao, dati nekome ugovor (om poslu, usluzi)

contract /kən'trækt/ (v) 1 (shipping econ) sklopiti posao: *the IPA contracted us to test the equipment;* 2 sklopiti ugovor o spašavanju, angažirati (spasilački brod, tegljača), **On**

scene are two tugs contracted by the ship owner: *On scene are two tugs contracted by the ship owner.*

contracting carrier (n) (mar law) ugovorni prijevoznik

contract labour radna snaga po ugovoru, ugovorni zaposlenici (na određeno vrijeme, putovanje): *66 staff from nine offshore ships and will be replaced with contract labour.*

contract of affreightment; COA (n) (mar law) An agreement to transport a defined amount of cargo at an agreed freight rate, with the shipowner choosing the ship.

(<http://www.clarksons.com/glossary/>); An agreement whereby the shipowner agrees to carry goods by water, or furnishes a vessel for the purpose of carrying goods by water, in return for a sum of money called freight. There are two forms: the charter party and the contract contained in the Bill of Lading.

(http://www.iss-shipping.com/cargo/cargo_library_glossaryc.asp); A term used in English-speaking

countries to refer to a tonnage contract (infra), also known as a volume contract, being a contract comprising an undertaking to ship a certain quantity of goods, during a given period of time, by ships or other means, usually to be designated later. The COA must not be confused with the contract of affreightment, which is a charterparty. (Tetley) ; Contract for the carriage of goods by sea in return for payment **ugovor o prijevozu robe, ugovor o prijevozu robe (za određenu količinu i na određeni rok, npr. godišnji ugovor)**: *Many oil companies maintain large fleets of deep-sea tankers, towboats, and river barges to carry petroleum to and from refineries. The ships often operate under contracts of affreightment. COA is an agreement on which the ship owner agrees to transport a series of cargoes on a fixed price per tonne within a specified period of time. {An agreement by an ocean carrier to provide cargo space on a vessel at a specified time and for a specified price to accommodate an exporter or importer.}*

contract of carriage (n) (mar law) **ugovor o prijevozu robe**

contract of carriage of goods by sea (n) (mar law) **ugovor o prijevozu stvari morem**

contract of carriage of goods by ship (mar law) **ugovor o prijevozu stvari brodom**

contract of employment **govor o zaposlenju (npr. pomorca) enter a contract of employment with 1 sklopiti ugovor s, zaključiti ugovor s; 2: the Owners have entered into an individual contract of employment with the Employee**

contract of marine insurance (n) (mar ins, mar law) **ugovor o pomorskom osiguranju**

contract of sale (n) (shipping econ, mar law) **kupoprodajni ugovor**

contract of towage (n) (mar law) **ugovor o tegljenju**

contractor (n) **1 (mar ins) ugovaratelj, spasavani brod; 2 (shipping econ, mar law) a person or firm that contracts to supply materials or labour, esp for building izvođač radova, dobavljač; 3 (seamanship) serviseri na brodu, servisne tvrtke (uposlene na brodu za vrijeme boravka u luci)**: *Be sure to know where contractors and ship staff are working on the vessel*

contractual carrier (n) (mar law, shipping econ) **ugovorni prijevoznik**

contravene /kɒntrəˈvi:n/ (v) (mar law) **prekršiti**: *This showed a lack of precautionary thought and contravened Article 98 of the United Nations Convention on the Law of the Sea, which requires the master to render assistance ...*

contribution (n) **make a contribution pridonijeti, doprinjeti 1 (shipping econ) doprinos, prilog pension contribution mirovinski doprinos, sickness contribution doprinos zdravstvenom osiguranju; 2 (mar law, mar ins) doprinos (učesće) u generalnoj havariji**

contribution share (n) (mar ins) **postotak doprinosa (u zajedničkoj havariji)**

contributory (adj) **koji doprinosi (nečemu) contributory to the accident 1 koji doprinosi nezgodi; 2: The cargo vessels' stern ramp and aft fairlead arrangements were certainly contributory to these accidents** Krmna rampa teretnjaka i raspored zjevača na krmu svakako su doprinijeli nezgodi

contributory amount (n) (mar law) = **contributory value** dužnička masa

contributory value (n) (mar law) **dužnička masa**

contrivance /kənˈtraɪvəns/ (n) **naprava, aparat, sprava**

control /kənˈtrəʊl/ (n) **to bring under control staviti pod kontrolu, obuzdati, fire**

control obuzdavanje vatre, **control selector** naprava za odabiranje načina upravljanja, **stand control** upravljački pult 1 a upravljanje **bridge control** upravljanje s mosta; 2 (*marine eng*) regulator; 3 (*marine eng*) upravljačka ručica **control valve** upravljački ventil, **control lever** upravljačka ručica / poluga, **control panel** kontrolna ploča; 4 (*marine eng*) kontrola; 5 (*marine eng*) nadzor, kontrola **to lose control of** izgubiti kontrolu / nadzor nad

control (v) upravljati, regulirati, kontrolirati

control and monitoring system (n) (*marine eng*) sustav upravljanja i nadzora: *The engine room is arranged with a control and monitoring system, that meets LR class requirements for a periodically unmanned engine room.*

control box (n) (*marine eng, electr*) upravljačka kutija

control head (n) (*marine eng*) upravljačka glava (ventila): *The control head of the valve has a slot that lines up with either the 'set' or the 'released' position ...*

controllable forces (n) (*marine eng*) upravljive sile

controllable pitch propeller; (CPP) /kən'trəʊləbəl/ (n) (*nav arch*) = **variable pitch**

propeller = c.p.p.; controllable pitch propeller ANTONYM fixed

propeller prekretni propeler, propeler s promjenjivim korakom (kutom) krila:

These tugboats have 2,800mm controllable-pitch propellers in combination with special render recovery winches.

control lever (n) (*marine eng, nav arch*) upravljačka poluga, upravljačka ručka,



upravljačka ručica

control of the engine room (n) **wing control** upravljački uređaj na krilu mosta, **bridge control** mosni upravljački uređaj za strojeve (*navig, marine eng*) upravljački

uređaj za brodске strojeve: *At 0945, control of the main engine was transferred to the port bridge wing.*

control panel (n) (*marine eng*) upravljačka ploča, kontrolna ploča **local control panel** kontrolna ploča u upravljačkoj kabini strojarnice, **remote control panel** kontrolna ploča daljinskog upravljača (na mostu)



control room (n) 1 (nav arch, marine eng) kontrolna kabina strojarnice, kontrolna prostorija strojarnice, control room, kontrolrum



; 2 (marine eng) kontrolna kabina, kontrolna prostorija

control system upravljački sustav

convention (mar law) konvencija

conventional cargo (n) (cargo) = breakbulk cargo, break bulk cargo klasični teret, generalni teret **conventional cargo ship** brod za generalni teret, brod za klasični teret *Metal drums were being loaded on to a conventional cargo ship and, in the process, had to be slung over bales of greasy wool.*

conventional direction of buoyage (n) (navig) the general direction taken by the mariner when approaching a harbor, river, estuary, or other waterway from seaward, or proceeding upstream or in the direction of appropriate nautical documents (normally following a clockwise direction around land masses) (Seasources.net) konvencionalni smjer plovidbenih oznaka, uobičajeni smjer plovidbenih oznaka

conventional ship (n) (nav arch) klasični brod, konvencionalni brod

converging courses konvergentni kursovi, kursovi koji se spajaju / približavaju

conversion /kən'vɜ:ʃən/ (n) 1 a (nav arch) preinaka (broda), preinačen / prenamijenjen brod; 2 konverzija

convert /kən'vɜ:t/ (v) 1 a pretvoriti, konvertirati; 2 adaptirati

converter (n) (marine eng) konverter

convey /kən'vei/ (v) 1 a prenositi, prevoziti, transportirati; 2 prenijeti, dovesti

conveyance /kən'veiəns/ (n) means of conveyance transportno sredstvo, sredstva transporta (shipping econ) transport of goods from one place to another transport, prijevoz,

prijenos

conveyor /kən'veiə/ (*cargo*) transporter (tračni) **conveyor belt** tračni transporter, transportna traka, transporter, **conveyor system** transportni sustav, sustav transportera, **ship unloading conveyor** iskrcajni transporter, **ship loading conveyor** ukrcajni transporter

conveyor belt (n) (*cargo handling*) a mechanical device in the form of a continuous belt for transporting cargo, mainly dry bulk cargo **transporter**, **transportna traka**: *The amount of cargo remaining on the conveyor belt which will be loaded onboard the ship after a cargo stoppage signal has been given by the ship. The chief officer activated the emergency **conveyor belt** stop system and called for*



help.

convict /kən'vɪkt/ to pronounce (someone) guilty of an offence **osuditi**, **kazniti** *The shipping company was convicted of violating the Act to Prevent Pollution from Ships Also convicted at trial were two senior officers who worked aboard the vessel,*

convoy /kən'vɔi/ (n) (*navig*) a group of ships sailing together for mutual guidance or protection

konvoj: *The situation became complicated because the ship had just initiated a passage in a **convoy** through the Suez Canal. **join the convoy pridružiti se konvoju**: Vessels arrive 0300 hrs till 0400 hrs and can join the Convoy*

cook (n) (*seamanship*) **brodski kuhar**, **kogo assistant cook** **hukarski pomoćnik**, **chief cook** **glavni kuhar**, **second cook** **drugi kuhar**, **ship's cook** **brodski kuhar**

cool (v) **hladiti**, **rashladiti**

coolant (n) (*marine eng*) **rashladno sredstvo**, **rashladni medij** *The coolant used for removing and conveying the heat from a piston may be either fresh water, distilled water or lubricating oil.*

cool down (v) (*marine eng, cargo handling*) **ohladiti**: *Every month, at the turnaround port, it was a routine for the engine crew to isolate, **cool down** and open the economiser (also known as waste heat or exhaust gas boiler) to clean out the accumulated soot and unburnt carbon particles. The area around cargo hold 4 was to be **cooled down** later.*

cooler (n) **charge air cooler** **međurashladnik 1** (*marine eng*) **rashladnik**, **hladnjak**: *The central coolers, the main engine cylinder cooling fresh water cooler, and the main engine lub oil cooler are all plate type, and were manufactured by Alfa Laval, Sweden.; 2 **rashladno sredstvo***

cooling /'ku:lɪŋ/ (n) (*marine eng*) **hlađenje**, **rashlađivanje** **bore cooling** **klađenje kroz zavojne / radijalne kanale**

cooling cargo chamber (n) (*nav arch*) **stanica za hlađenje tereta**

cooling coils (n) (*nav arch*) **serpentine** (rashladnog uređaja)

cooling control (n) (*marine eng*) **regulator hlađenja**

cooling down (n) (*cargo handling, marine eng*) **pothlađivanje**

cooling fan (n) (marine eng) rashladni ventilator, ventilator

cooling medium (n) (cargo handling, marine eng) rashladno sredstvo

cooling piping (n) (marine eng) cjevovod sustava za hlađenje

cooling pump (n) (marine eng, cargo handling) rashladna pumpa

cooling system (n) (marine eng) rashladni sustav

cooling water (n) (marine eng) rashladna voda **cooling water system** sustav rashladne vode

cool out (v) rashladiti

Co-ordinator of Surface Search (CSS) (n) (safety, navig) koordinator traganja i spašavanja na mjestu nesreće

copal (n) (seamanship) lak za drvo, verniž

cope with (v) 1 uhvatiti se u koštac, izići na kraj; 2 biti dorastao, svladati poteškoće, ići u korak s

copper (Cu) /'kɒpə/ (n) (chem) bakar

copper tube (n) (marine eng) bakrena cijev

copra /'kɒprə/ (n) (cargo) the dried, oil-yielding kernel of the coconut **kopra**, suhe koštice kokosova oraha

Copy. SEE Roger. Razumio., Primio.

copy not negotiable (n) (mar law) prijepis teretnice nije prenosiv, neprenosiva teretnica



coral reef (n) (geogr) koraljni greben

corb (n) (fishing) grb {drugi hrv. nazivi: Hama, dronj, harba, koraf, korbel, salamun, šarac; lat. UMBRINA CIRROSA}



cord /'kɔ:d/ (n) 1 (seamanship) konopac, uže

; 2 žica

cordage /kɔːdɪdʒ/ (n) (boating/yachting) all the ropes used aboard ship, esp. all the lines of the rigging **oputa**

core /kɔː/ (n) (seamanship) jezgro konopa

cork /kɔːk/ (n) 1 (cargo) pluto; 2 (nav arch) izolacijsko pluto

corned beef (n) (cargo) konzervirana govedina, konzervirano meso

corner casting (n) (cargo) fittings located at the corners of containers providing means of supporting, stacking, handling and securing the container **kutni okov / odljevak (na dnu i vrhovima kontejnera)**: *The corner castings are used in conjunction with twist locks to secure containers when traveling on road vehicles or stack and fasten them securely to the deck of ocean-going*



vessel.

corner fittings (n) (cargo handling) kutni okovi / odljevci (na dnu i vrhovima kontejnera) **top corner fittings** gornji kutni okovi kontejnera, **bottom corner fittings** donji kutni okovi kontejnera

corner method (n) (navig) metoda traganja i spašavanja u zoni određenoj koordinatama kutova

corner post (n) (cargo) vertical frame components fitted at the corners of the container, integral to the corner fittings and connecting the roof and floor structures **kutni stup kontejnera**: *A corner post is a vertical structural member at either side of an 'end frame' of a container joining a top and a bottom corner fitting.*

correspondent (n) (mar ins) Representatives of the Association who are based in all major and minor ports throughout the world. Correspondents can be maritime lawyers, ship's agents or in some cases surveyors **korespondentni P&I osiguravatelj, predstavnik korespondentnog P&I osiguravajućeg društva (u luci)**

correspondent bank (n) (shipping econ) a bank that, in its own country, handles the business of a foreign bank **korespondentna banka**

corrode /keˈrəʊd/ (v) korodirati, podlijevati korodiranju

corrosion /keˈrəʊʒən/ (n) (marine eng, seamanship) korozija, hrđanje **internal boiler corrosion** unutarnja korozija kotla

corrosion removal (n) (marine eng) skidanje rđe

corrosion resistance (n) (marine eng) otpornost na koroziju

corrosion-resistant (adj) otporan na koroziju **corrosion-resistant steel** čelik otporan na koroziju

corrosive (adj) **corrosive action** djelovanje korozije, **corrosive acids** korozivne kiseline korozivan

corrosive substances (n) (cargo) korozivne tvari {klasa 8 opasnih tereta}

corrugated plate /'kɒrəgeɪtɪd/ (n) (nav arch, marine eng) valoviti lim, rebrasti lim



corrugation /,kɒrə'geɪʃən/ (n) nabor, rebrasti materijal

corsair /'kɔːseɪ/ (n) (mar law) gusar {archaic}

corvette /kɔː'vet/ (n) (navy) a fast, highly manoeuvrable warship, somewhat smaller than a destroyer (<http://www.seatalk.info/cgi-bin/nautical-marine-sailing-dictionary>) korveta



Cosine theory /'kəʊ,sain/ (n) kosinsov poučak

cospas-sarsat system (n) (navig) sustav traganja i spašavanja COSPAS-SARSAT

cost /kɒst/ (n) (shipping econ) 1 trošak (npr. prijevoza) **cost of transport**

prijevozni troškovi, cijena transporta, **cost incurred** trošak nastao uslijed, troškovi nastali uslijed, **maintenance cost** troškovi održavanja, **operational cost** pogonski troškovi, **raise costs** povećati troškove, **reduce costs** smanjiti troškove; 2 cijena (proizvoda, robe, tereta u transportu) **cost of commodity** cijena robe, vrijednost robe

cost and freight (n) (mar law) međunarodni trgovinski uvjet prema kojemu je prodavatelj dužan platiti troškove i vozarinu kako bi se roba dopremila do luke odredišta, ali rizike gubitka ili oštećenja robe i povišenje cijene snosi kupac od trenutka kada roba prijeđe brodsku ogradu u luci ukrcaja **troškovi i vozarina**

Cost and Insurance; C&I (n) (mar law) a price that includes the cost of the goods, the marine insurance and all transportation charges except the ocean freight to the named point of destination (Glossary of Shipping Terms, www.marad.dot.gov) **cijena robe i transportno osiguranje**

cost of shipment (n) 1 (shipping econ) cijena prijevoza; 2 troškovi prijevoza

CO2 system /,si:əu'tu:/ (n) CO-2 sustav, sustav gašenja ugljičnim dioksidom

portable CO2 system prijenosni CO-2 sustav, **fixed CO2 system** fiksni CO2 sustav

cotter pin /'kɒtə,pɪn/ (n) (marine eng, boating/yachting) rascjepka, šplinta

cottonwood (*cargo*) pamučika

count /kaʊnt/ (v) 1 a brojati; 2 računati; 3 uzeti u obzir

counter /kaʊntə/ (v) (*navig*) suprotstaviti se, spriječiti: *the tug was connected to the port quarter to counter winds gusting to force 5 The helmsman was leaving his throttle ahead to counter the tide and then removing the kill-cord from his wrist in order to hold on to the barge.* **counter the prop walk spriječiti efekt smjera okretanja propelera, counter the crosswind spriječiti efekt poprečnog vjetra**

counter /kaʊntə/ (n) (*nav arch, sailing vessels*) oblina krme **counter timbers** rebra krmene obline, **side counter timbers** kukovi krmenog okvira

counteract /ˌkaʊntərˈækt/ (v) djelovati u suprotnom smjeru, nastojati spriječiti,

osujetiti, djelovati suprotno: *The helmsman achieved the aim, the electronic chart display data showing him steering between 10 and 15 degrees to starboard of the approach course to counteract the effect of the tide. The master intended to use the bow thruster to counteract the onshore wind and hold the bow steady; the tug, under the direction of the pilot, would hold the stern.* 0

counter current (n) (*oceanogr*) protustruja: *There is a counter current flowing westerly in Bonita Cove at that time.*

counter-flow (n) (*geogr*) protutok vode, protustrujanje: *A contributing factor was the vessel's bow entering an area of counter-flow while her stern remained in the main ebb flow, causing her bow to unintentionally pay off to starboard.* Dodatni faktor nezgode bio je ulazak broda u područje protutoka vode dok je istodobno krma broda ostala u toku glavne struje od oseke, što je izazvalo neželjeno otpadanje njegova pramca u desno.

counter rudder (n) (*navig*) determines the amount of opposite helm to be applied
protukormilo

countersign (v) supotpisati, potpisati s druge strane

countless (adj) bezbrojan

country damage (n) (*mar law*) Damage to baled or bagged goods (e.g. cotton) caused by excessive moisture from damp ground or exposure to weather, or by grit, dust or sand ashore. (Tetley)
zemljane štete

country of origin (n) (*shipping econ*) country in which the goods have been produced or manufactured, according to criteria laid down for the purpose of application of the customs tariff, of quantitative restrictions, or of any other measure related to trade. **zemlja podrijetla (robe, tereta) zemlja proizvodnje robe**

Country of Provenance (n) (*shipping econ*) the country from which goods or cargo are sent to the importing country **zemlja otpreme robe**

coupled to /ˈkʌpəld/ (adj) spojen na, priključen na, prikopčan na: *The anchor was coupled to a short length of chain, which was intended to be attached to the boat's painter to form the anchor cable.*

coupling /ˈkʌplɪŋ/ (n) 1 (*marine eng*) spojka, tal. **innesto:** *A hydraulic coupling on the mooring winch gave way, squirting a jet of hot hydraulic oil all over the mooring station. The ship was towed from the River Thames following the failure of a drive shaft universal coupling in her engine bay. Unfortunately, on the next occasion, the left sleeve of his jacket became entangled with a coupling on the rotating propeller shaft.* **coupling nut spojna matica, matica steznog vijka, navojna stezn a spojka, coupling dog zupčasta spojka, flexible coupling izvrstiva spojka, fleksibilna spojka:** *A flexible coupling is always fitted between the turbine rotor and the gearbox pinion. The membrane-type flexible coupling is made up of a torque tube, membranes and adaptor*

plates., **friction coupling** tarna spojka, frikcijska spojka: The motor drive is equipped with a



friction coupling to prevent overload.

prirubnica

coupling bolt (n) (marine eng) svornjak

coupling nut (n) (marine eng) protumatica

courier service (US) /'kʊəriə/ (n) (shipping econ) poštanski prijevoz

course /kɔ:s/ (n) 1 (navig) **COMPARE heading** the intended direction of movement of a

vessel through the water (SMCP) **kurs**, kurs koji je naređen kormilaru (za razliku od

pojma heading = kurs pravi), namjeravan kurs, **rota**: Target vessel 20 degrees on port bow,

course 225, speed 11. A 1,700gt products tanker was on a **southeasterly course** 3 miles off the Yorkshire coast. Own ship, a 4,000 grt container feeder, proceeding from south of Lamma anchorages on a **course of 088 degrees** to pass some 0. She was heading on a **north-westerly course** at a speed of 8 knots. **to alter**

the course **promijeniti kurs**: Please alter your course 20 degrees to starboard., **to follow the**

course **slijediti kurs**, **ploviti kursom**: The ship was following a course of 110° in hand steering,

at a speed of 11 knots .., **to keep the course** **držati kurs**: ... we made an agreement that he would alter course to starboard and pass my stern, in other words we would follow the COLREG so I kept my

course and speed., **to maintain the course** **držati kurs**: Whilst an overtaken vessel has a duty to

maintain course and speed, this does not mean that she should ignore the safe channel and stand into

danger., **to make good the course** **ploviti kursom**, **preći put pod određenim kursom**:

The container ship was making good a course of 240° at a speed of 18kts., **to lay off the course**

ucrtati kurs, **to plot the course** **ucrtati kurs**, **on crossing courses** u križanim

kursovima, **on reciprocal (opposite) courses** u nasuprotnim kursovima: ARPA

showed one vessel ahead on reciprocal course, speed 23knots., **converging courses**

konvergentni kursovi, kursovi koji se spajaju, **diverging courses** divergentni

kursovi, kursovi koji se odvajaju, **opening courses** kursovi koji se otvaraju,

divergentni kursovi, **closing course** 1 kursovi koji se spajaju a konvergentni

kursovi, **parallel courses** paralelni kursovi: At 1810, the bulk carrier was overhauling us on

our port side on a parallel course and having a speed of around 13 knots., **set the course** **namjestiti**

kurs **postaviti kurs**, **ucrtati kurs**: When the vessel cleared the approaches to the harbour, the

skipper set a course on the automatic helm to pass on his port side a small island, which lay about 2

miles to the south-west., **steer a course** **ploviti u kursu od ...**, **kormilariti na kursu od ...**,

držati kurs: At approximately 0735 own ship was steering a course of 266 T for Falmouth Pilot Station.,

original course početni kurs, prvotni kurs, prethodni kurs: *Starboard helm was maintained whilst a full turn was taken out of the vessel before resuming our original course of 3140.*, **planned course** planirani kurs, predviđeni kurs: *Soon thereafter the OOW indicated to the Master that they had drifted from their planned course and the Master affirmed.*, **steady course** stalni kurs, stabilni kurs: *For ARPA to display reliable target information, the observer's ship must maintain a steady course and speed for at least 3 minutes.*; **2 tečaj refresher course** tečaj obnove znanja, **advanced course** napredni tečaj, **to follow the course** pohađati tečaj, **to attend the course** pohađati tečaj; **3 a tijek** tok in due **course** pravovremeno, pravodobno, **a matter of course** naravna stvar, normalni postupak **course** /kɔ:s/ **1 a tečaj**; **2 seminar**; **3 predmet**, kolegij (na visokoj školi, fakultetu) **course** /kɔ:s/ (n) (meteorol) promjena meteorološkoga elementa tijekom vremena **hod course** (boating/yachting) najniže križno jedro **course alteration** (n) (navig) promjena kursa: *when about two and a half points forward of the beam, they started a course alteration to STARBOARD as if to try and cut across our bows. The decision to make the normal course alteration to port (as per the passage plan) was a bad one and should have been delayed.* **course change** (n) (navig) promjena kursa: *my Mates that there is absolutely no reason to come within five cables in an overtaking situation in open waters, and by altering early only a small course change is required.* **course line** (n) (navig) linija kursa: *By the time she had drawn abeam, I was already 1 mile northeast of my proposed course line. Once the vessel was on a steady course to the anchorage, the Master used the vessel's paper chart to plot a direct course line from the assigned anchorage back to the vessel's position* **course made good (CMG)** (navig, boating/yachting) kurs postignut nakon uračunavanja zanošenja **kurs preko dna**, **prijeđeni (prevaljeni) kurs**: *During the time while trying to get the light on, the Master was using the radar for guidance and the course made good was displayed on the GPS screen. The chemical tanker is in the North-East Lane of the Dover Strait TSS, course made good 0430, speed 14 knots close to "South-East Ridens" buoy.* **course over ground (COG)** (navig) = **ground track** **kurs preko dna**: *By now, the tanker was 1.058nm from No1 buoys, making good a course over the ground of 126° at 22 knots. The vessel was making approximately 10 knots and a course over ground of approximately 027°.* **course recorder** (n) (navig) pisač kursa, kursograf: *'Course Recorder', 'Bell Book' entries and interviews with Master, watch Officers and Helmsman have verified the above manoeuvres of the*



vessel

courses (n) (boating/yachting) ohe mainsail, foresail, and the mizzen, osnovno jedrilje **course steered** (n) (navig) zadani kurs, održavani kurs

course through the water (n) (navig) kurs kroz vodu

course to steer (n) (navig) kurs plovidbe: *The ... was not given a helm order, or a course to steer, and instead was given broad directions on what he should do. When the officer of the watch requires a course to be steered by compass, the direction in which s/he wants the wheel turned should be stated followed by each numeral being said separately,*

course up (n) 1 (navig) Course-up: Compass-stabilized relative to ship's orientation. The bearing scale rotates to place ship's heading (course set) at the screen top at the moment the course-up mode is selected. **trenutačni kurs gore (na pokazivaču radara) course up orientation of radar display orijentacija radarske slike trenutačni kurs gore, course up mode** The course-up mode is an azimuth stabilized display in which a line connecting the center with the top of the display indicates own ship's intended course, **način pokazivanja trenutačni kurs gore; 2 kurs prema sjeveru:** *The course up the Strait of Gibraltar to Cabo de Sao Vicente TSS is approximately 290 T.*

court sud: *The court found the seafarer innocent and acquitted him from all accusations but imposed an administrative fine.* **court ruling sudska odluka, sudsko rješenje, presuda, court of justice sud, sudnica, court of law sud, sudnica, court summons poziv na sud, court case sudski slučaj, sudski predmet:** *A court case, aimed at establishing the cause of the accident, reviewed the reliability of sea charts mapping the seabed where the vessel is believed to have been.*, **court hearing sudska rasprava, ročište, saslušanje:** *The court hearing is pending and it is entirely inappropriate for anyone to speculate if the masters had made a mistake resulting in the incident.*, **court of enquiry istražni sud, sud istrage:** *I am sure that, in a court of enquiry, our actions, if they had resulted in accidents, would have appeared irrational or incompetent.*, **court order sudski nalog** *The U.S. Marshals Service has blocked a chartered vessel carrying up to 600,000 barrels of crude oil from leaving the port in connection with a civil court order.* <https://gcaptain.com/>, **court arrest sudsko zadržavanje broda** *The cargo vessel was placed under court arrest here on June 25 after a civil claim had been filed by*

courtesy flag /'kɜːtisi/ (n) (mar law) zastava zemlje domaćina, zastava zemlje u čijim se vodama brod nalazi

court of appeal /,kɔːt əv ə'piːl/ (n) (mar law) prizivni sud, drugostupanjski sud, drugostepeni sud, apelacioni sud

court of law (n) (mar law) = law court sud: *A decision made by an arbitration tribunal in an arbitration proceeding. It is analogous to a judgment in a court of law.*

court receivership (n) (mar law) sudsko preuzimanje (kompanije) *The shipping line filed for court receivership last Wednesday after the shares of the shipping company fell by the daily limit of 30%.*

COVE /kəʊv/ (n) (geogr, navig, boating/yachting) a small bay or sea inlet, usually between rocky headlands **uvala, tal. insenatura:** *During his absence, the vessel ran aground in a deep cove to the south of the box drawn on the electronic chart. There is a counter current flowing westerly in Bonita*



Cove at that time.

COVER /'kʌvə/ (n) bearing **cover** kapa ležaja, poklopac ležaja, **cylinder cover** poklopac cilindra, **cylinder cover insert** uložak poklopca cilindra, unutarnja glava, **cylinder cover of double deck construction** dvokatni poklopac cilindra, **outer cylinder cover** vanjski poklopac cilindra, vanjska glava (*marine eng*) poklopac, pokrov, kapa,

zaštitna kapa: *The bilge cover was opened up and the bilge was found to be half full of salt water ... As soon as he cracked open the dome cover, hot condensate water (at about 80°C) escaped from the opening and spilled over the oiler.*

coverage (n) (*navig*) pokrivenost, područje pokriveno navigacijskim sustavom, frekvencijom itd., područje pokrivanja (navigacijske opreme): *In instances such as these, which may be out of VTS coverage, it is suggested that other endangered ships be empowered to report such rogue vessels to the coastal authorities, Make sure that before setting sail, full chart coverage and associated publications for the intended passage are held on board. The display was in relative motion and was off-centred to extend the coverage ahead of the vessel to about 4..5 nm.*

coverage factor (n) (*navig*) faktor pokrivenosti (u SAR-u)

covering /'kʌvəriŋ/ (n) (*marine eng*) zaštita, oblog: *Tiger stripes have now been painted on the deck and a soft protective covering placed around the flange.*

covering-board (n) (*sailing vessels*) **ANTONYM planksheer** The wider outermost plank of the deck mounted over the tops of the frames and covering the sheer stake of a decked boat. (<http://www.seatalk.info/cgi-bin/nautical-marine-sailing-dictionary>) **nutarnja sržnica**

covering note (n) (*mar ins*) = **slip** ceduljica / bilješka s podacima o riziku

cover letter (n) (*shipping econ*) an accompanying letter sent as an explanation, introduction, or record **popratno pismo, popratni dopis**

COWL /kaʊl/ (n) (*nav arch, boating/yachting*) a hood shaped top or end of a natural ventilation trunk or pipe that may be rotated to cause wind to blow air into or out of the trunk **palubla ventilacijska cijev, šijun, tal. cuffia; manica a vento**: *The fire caused substantial burn damage to adjacent electrical fittings and paintwork on the deck, vertical surfaces of the bulkhead and a ventilator cowl. ... fire damage was limited to the paintwork on the forecastle break bulkhead, a reefer electrical supply cable, light fittings and a hold ventilation cowl.*

cowl ventilator (n) (*nav arch*) (*boating/yachting*) **palubna ventilacijska cijev, šijun**



coxswain; cockswain /'kɒksən; 'kɒk,sweɪn/ (n) (seamanship) the helmsman of a lifeboat or launch, the helmsman or crew member in command of a boat **vođa brodice, kormilar brodice za spašavanje, zapovjednik brodice, tal. capobarca**: *Meanwhile, the rescue boat coxswain and assisting crew member continued to investigate the cause of the engine failure. The pilot boat coxswain contacted the bridge by VHF to enquire the reason for the delay. At this stage, the lifeboat coxswain decided that the risk to the yacht's crew was too great, and they were evacuated from their vessel by helicopter.*

CPA (closest point of approach) /,si: pi: 'ei/ (n) (navig) **najbliža točka**

mimoilaženja, najbliža točka susreta: *The closest point of approach (CPA) between the vessels was 0.5nm in 88 minutes time. A CPA of 0.8nm was predicted with own ship whilst CPAs of less than 0.3nm were predicted between the ferry and two other vessels. CPA (closest point of approach) limit prostorna granica točke mimoilaženja, CPA (closest point of approach) data početni podatci o najbližoj točki mimoilaženja: *The initial CPA data is displayed after 1 minute of tracking.**

c.p.p.; controllable pitch propeller (n) (marine eng, nav arch) **prekretni porivnik,**

prekretni propeler: *The controllable pitch propeller (CPP) was turning at full manoeuvring speed of 130 rpm in neutral pitch, as was usual on this vessel when manoeuvring. CPP can move its blade in the desired position by changing the pitch of the blades. A general cargo vessel suffered an accident when its CPP malfunctioned.*

CPR; cardiopulmonary resuscitation (n) (med) an emergency procedure for manually preserving brain function until further measures to restore spontaneous blood circulation and breathing in a person who is in cardiac arrest. **masaža srca**: *The AB was given oxygen and CPR was started. The two men carried out cardio-pulmonary resuscitation (CPR) until he began to cough and eventually breathe freely.*

CQD (customary quick despatch) uobičajenom brzinom / kapacitetom (ukrcaja/iskrcaja)

CQR anchor (n) (boating/yachting) **SYNONYM plough anchor plužno sidro,**



sidro plug

crab (n) 1 rak, rak crveni, rak od kože **swimming crab** rak crveni; 2 rakovica



spinous spider crab rakovica, grancigula

crack (n) (nav arch) pukotina, napuklina: *A crack had developed in the fuel injection pipe, and fuel may have spurted from the crack onto a hot surface. Furthermore, he had encountered water in the tank several months previously due to a crack in the deck; on that occasion the vessel made shore safely, whereupon the water was drained from the tank, pumped overboard and the deck repaired crack of shell plate napuklina na oplati broda*

cracking /'krækiŋ/ (n) (marine eng, nav arch) napuknuće, istna pukotina, prslina: *There was also evidence of the likelihood of fine cracking in the steel adjacent to the fillet weld, but this went undetected by the repairer ...*

cradle /'kreidəl/ (n) 1 (boating/yachting) a woden or steel frame built to support a vessel when it is hauled out **postolje za brodicu, važ, kavalet**; 2 (nav arch) saonice na navozu

craft /kra:ft/ (n) 1 (nav arch) any vessel or conveyance that operate in a fluid medium or a vacuum. Thus, boats are craft; aircraft are craft; and spaceships, spacecraft, and space capsules are craft. When applied to vessels or conveyances that float on the water, a craft is any boat or ship of any size or type and of any use.(http://www.westlawn.edu/student_center/definitions.asp) **plovilo, plovni objekt, brodovlje naval craft ratni brod, ratni brodovi, non-displacement craft bezdeplasmansko plovilo (npr. jedrilica), water craft plovilo, plovni objekt, plutajući objekt, survival craft plovilo za spšavanje i pružanje prve pomoći:** *Crew members responsible for launching the survival craft should practise and be able to launch with their immersion suits on.*, **high-speed craft brzi putnički brod:** *brzo plovilo*, **small craft malo plovilo:** *mali brodovi* *There were not many problems as the barge and small craft traffic was mostly resting for the night. Numerous small craft were moving around in the anchorages, and there was a steady flow of vessels transiting the east bound lane.*, **fast rescue craft (FRC) brza brodica za spašavanje:** *The manoverboard drill requires the launch and recovery of the vessel's fast rescue craft (FRC) to simulate the rescue and recovery of a person from the water.*, **pleasure craft brodica za razonodu, gliser:** *The sole occupant of the pleasure craft, which had no radar reflector, had seen the*

fishing vessel approaching and had managed to jump clear before the impact. , **recreational craft brodica za razonodu, gliser, leisure craft brodica za razonodu**: Using a *leisure craft* while under the influence of alcohol is dangerous and puts your and others' lives unnecessarily at risk. ; **2 vještina** {'craft' is both the singular and plural form of the noun}

crane /krein/ **dizalica**: What is the safe working load of the *crane*? Do not approach the crane slings/hook until the *crane* is fully stopped and ensure all is safe and secure prior to approaching. **bridge crane mosna dizalica, container crane kontejnerska dizalica, kontejnerski most, dockside crane obalna dizalica, quay / wharf crane obalna dizalica, floating crane plutajuća dizalica, plovna dizalica, gantry crane mosna dizalica (npr. kontejnerski most)**: Each gantry crane was fitted with warning devices that operated automatically whenever the *gantry crane* travelled along the length of the deck. , **mobile crane autodizalica, crane rails staze za kretanje dizalice duž obale kranske staze (na lučkoj obali), kranske šine (na lučkoj obali), shore crane obalna dizalica**: The vessel had berthed and commenced discharging, with a *shore crane*, a load of 72,000 metric tons of steaming coal. , **ship's crane brodska dizalica**: The officers and the crew should make a thorough assessment of the condition of *ship's crane* and derrick wires at regular intervals. , **deck crane palubna dizalica, shipboard crane brodska dizalica, cargo crane teretna dizalica, dizalica za teret**: A shore stevedore operating a *ship's cargo crane* used the bypass key to override the jib luffing lower limit cut-off switch, so that the cargo sling could be landed at the desired spot on the wharf. , **crane hook kuka dizalice**: The pumpman was stationed at the manifold, monitoring the cargo hoses still attached to the *deck crane hook*. , **hatch crane dizalica iznad broskog skladišta**: Operate the *hatch crane* only if there is a person on each side to check whether the hooks are connected properly. , **hose-handling crane dizalica za rukovanje fleksibilnim cijevima (na tankerima)**: Shortly after our tanker arrived at the designated berth, the bosun was operating the *hose-handling crane* to position the vessel's gangway to provide safe access to the ship. , **mobile crane autodizalica**: The *mobile crane* lifted the lifeboat and suspended it below the davit heads while the crewmen attached the



falls.

crane driver (n) (ports) dizaličar: At 0530 the cargo loading *crane driver* arrived, and an hour later he started to remove the cargo to the dockside.

crane hook block (n) (cargo handling) koloturnik kuke na dizalici: A crew member was attempting to hook on a wire rope to the swinging *crane hook block* when his gloved hand got trapped between the wire and the swinging hook.

crane operator (n) (ports) dizaličar: at 0450, the *crane operator* at crane no. 2, simultaneously lifted the grab and the crane jib.

crane ship (n) (nav arch) brod dizalica

crank /kræŋk/ (n) 1 (marine eng) a koljeno osovine, koljeno vratila; 2 ručka, ručica; 3 ručica za pokretanje motora, kurbla

crankcase /'kræŋk,keɪs/ (marine eng) kućište koljenaste osovine, kućište vratila,

karter: A couple of weeks later, there was a main bearing failure in number 8 cylinder and a **crank case** explosion. **crankcase door** vrata kućišta koljenaste osovine, vrata **kartera** The resulting secondary explosion was large enough to tear the **crankcase door** from its mounting points.

crank handle (n) (marine eng, boating/yachting) ručka za pokretanje motora, ručica za pokretanje vitla, **kurbla**: This final closed position allowed the winch motor to be started with the **crank handle** in place.

cranking power (n) (fishing) snaga prijenosa (role)

crankpin /'kræŋk,pɪn/ (n) (marine eng) osnac letećeg ležaja: As No. 5 **crankpin** was seriously damaged, the crankshaft was found beyond use and had to be scrapped. {tal.: spinotto}

crankshaft /'kræŋk,ʃɑ:t/ **crankshaft journal** oslonac temeljnog ležaja, osnak, rukavac koljenaste osovine, **crankshaft journal pin** oslonac letećeg ležaja oslonac koljena, osno koljeno, čep ručice, **fully-built crankshaft** potpuno sastavljena koljenasta osovina, **semi-built crankshaft** polusastavljena koljenasta osovina, **heavily bent crankshaft** jako savijena koljenasta osovina, **revolution of the crankshaft** okret koljenaste osovine, **crankshaft bearing** ležaj koljenaste osovine: If a crankshaft bearing is running hot, oil is heated and an oil mist produced which can lead to a crankcase explosion. (marine eng) koljenasto vratilo, koljenčasta osovina, koljenasta osovina (**vratilo**): The slow-speed diesel engine rotates at this low speed and the crankshaft is thus directly

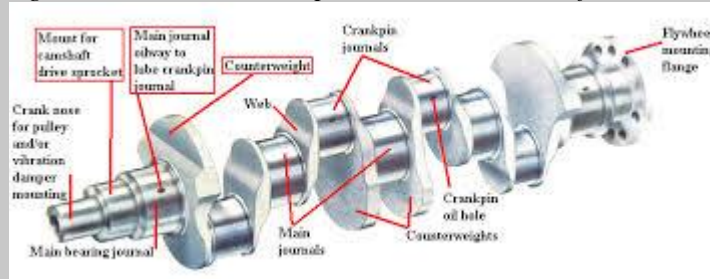

coupled to the propeller shafting.

crankthrow /'kræŋk,θrəʊ/ ručka koljenastog vratila

crankweb /'kræŋk,web/ koljeno, rame koljenastog vratila, **pršut**: The plan was to position

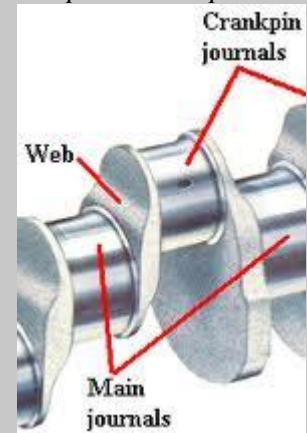

the crank shaft in such a way that the **crank web** was in the horizontal position.

crash stop (n) (safety, boating/yachting) **zaustavljanje u nuždi, trenutačno**

zaustavljanje (radi spašavanja osobe u moru): *The master conducted a **crash stop** and turned on the vessel's deck lights.*

crash-stop (n) (safety) **zaustavljanje u nuždi**

crate /kreɪt/ (n) (cargo handling) niski otvoreni sanduk **krletka, letvarica, gajba, kašeta:**

*Crates of uniform size and weight should be stacked directly one atop another. ... the spare part was inadequately secured inside the **crate** and as the crate tilted, the internal shift of weight assisted the 'tipping' motion;*

crawler crane /'krɔːlə/ **dizalica na gusjenicama**

crayfish (n) **jastog**

crayon /'kreɪən; 'kreɪɔn/ (n) (marine eng) **kreda za obilježavanje**

credit note **izvješće o odobrenju (financijskih) sredstava**

creditor /'kredɪtə/ (n) (mar law) **vjerovnik** *This is one a handful of major global ports where the troubled line's ships can freely unload cargo without threat from **creditors** Top priority debt means claims for public interests, which are paid first to **creditors** and include cargo owners' damages and unpaid charter fees ...*

credit rating (n) (shipping econ) **kreditno vrjednovanje, kreditni rejting:** *The shipping company's **credit rating** was put under review for a downgrade by Moody's in June. The shipping company may consider selling assets or cutting dividends as it seeks to **retain its credit rating**,*

creek /kri:k/ (n) **1 (geogr) (UK) a narrow inlet or bay, esp of the sea; a small stream or tributary**

riječno ušće, uvala: *They ordered the Master to take the ship into a **creek** but he managed to*

*persuade them that the draught was too deep to comply with their orders.; 2 (US, AUS) a small stream or tributary **rukavac (u delti rijeke), tal. cala** two speed craft will monitor the creeks of the Niger*

*Delta; 3 **pritoka***

creosote /'kriə, səʊt/ (n) (cargo) **kreozot**

crescent wrench /'kresənt, rɛntʃ/ (n) (marine eng) **francuski ključ, ključ s kotačićem za namještanje**

crest /krest/ (oceanogr) **the highest point of a sea wave **krijesta vala:**** *... we were overtaken by a single, huge swell that rolled past the ship just above deck level, the **crest** breaking on to the main deck on both sides. **crest of the wave krijesta vala***

crew /kruː/ **1 the entire ship's company:** *A ship can only operate safely if the relationships among her **crew** are open and honest. An effective and safe mooring arrangement is fundamental to the safety of the vessel and her **crew**, and indeed to other vessels. The rescue boat and its **four crew** fell nearly 29m into the water below. a **brodska posada (sve osobe zaposlene na brodu), tal.***

equipaggio:** At 0620, the **crew** on deck started to single up to one forward spring line. **crew list

popis posade, krulista, **crew effects declaration** prijava / popis osobnih stvari

članova posade, engagement of **crew** ukrcanje / zapošljavanje posade, discharge

of **crew** iskrcanje posade (po završetku ugovora), otpuštanje posade / mornara (po

završetku ugovora), **crew management** zapošljavanje posade, **crew recruitment**

regrutiranje pomoraca (radi zapošljavanja), **crew retention** produžavanje službe

pomoraca na brodovima, zadržavanje pomoraca u službi na brodu, **crew**

***repatriation** vraćanje pomoraca u domovinu (nakon završetka ugovora, nakon*

nesreće itd.), **crew welfare** blagostanje pomoraca, standard pomoraca, **crew**

change zamjena posade, lifeboat crew posada brodice za spašavanje: *The lifeboat crew started the engine and released the falls.*, **engine room crew posada stroja:** *At the same time, the engine room crew saw small flames and smoke rising from the after exhaust manifold and cylinder heads of the running main engine.*; **2 niža posada broda (ne uključuje zapovjednika i časnike);** the subordinate members of a ship's company; all ratings together **niža posada:** *Encourage your officers and crew to use the full protection that overalls provide.*; **3 an individual member of the ship's company; usually non-licensed (i.e. other than officers) član posade;** **4 (boating/yachting)** yachtsmen who help the skipper of a sailboat **flokist, član posade jedrilice {tal.: equipaggio}**

crew changes (n) (shipping econ) razmjena posada, izmjena posada

Crew Declaration (n) (mar law) Prijava posade

crew level broj članova posade

crew list, crew's list (n) (mar law) A document required by customs and immigration officials detailing the name, age, rank and nationality of all crewmembers.
(<http://www.seatalk.info/cgi-bin/nautical-marine-sailing-dictionary>) **popis posade, tal. ruolo dell'equipaggio:** *Will you show me the Port Sanitary Statements from the previous ports and your fumigation certificate, one copy of the Crew List, a Passenger List and also the Cargo Manifest.*

Crew List of Lights popis posade, krulista

crewman /'kru:mən/ (n) član posade, mornar **The crew man immediately raised the alarm, and the lube oil pump was stopped.**

crewmember (n) 1 any member of the ship's company **član brodske posade (svaki član: časnik ili mornar):** *The Master reacted immediately and despatched one of the crew-members to meet the boarding party.*; **2** a rating, i.e. non-licensed member of of the ship's company **mornar, član niže posade**

crew quarters /'kru:,'kwɔ:təz/ (n) (nav arch) nastambe posade

crew's quarters (n) (nav arch) nastambe za posadu, prostor za posadu, kabine za posadu

crew's weight (n) (boating/yachting) težina posade (potrebna za ravnanje jedrilice)

criminalisation (n) (mar law) kriminalizacija, krivično optuživanje criminalisation of seafarers kriminalizacija pomoraca: *This case was one of the worst examples of the unjustified criminalisation of seafarers.*

crimping (n) (fishing) krimpanje, vezivanje predveza

cringle /'kriŋgəl/ (n) (boating/yachting) = lacing eye očica jedra, plastična ili metalna očica ušivena u jedru {tal.: brancarella}

criterion /krai'tiəriən/ (n) mjerilo, kriterij {pl. criteria (krai'tiəriə)}

crockery /'krɒkəri/ (n) posuđe

crop /krɒp/ (n) (shipping econ) godišnji urod (žitarića itd.)

cross /krɒs/ (v) 1 prijeći, prelaziti, presjecati *The Savannah crossed the Atlantic under steam propulsion for part of the voyage, pioneering the way for the British ship Sirius, which crossed the Atlantic entirely under steam in 1838. Their vessel was crossing the tanker bow from starboard to port. **to cross the channel prijeći kanal, ploviti preko kanala** the vessel was crossing the channel before grounding, **cross ahead prelaziti ispred (drugog broda)** *The OOW sighted a vessel crossing ahead from starboard to port at a very close range. The master decided to make a further alteration of**

course to starboard in the hope that he could **cross ahead** of the two vessels and clear the end of the sandbank. A few minutes later the green vessel was observed to be **crossing ahead** at a range of four cables., **cross the traffic lane** presjeći stazu u plovnom kanalu, **cross the traffic lane** presijecati plovdbenu stazu, presijecati plovdbeni smjer, **cross the traffic separation scheme (TSS)** prijeći zonu odvojene plovidbe, presjecati zonu odvojene plovidbe: A cargo vessel was on a regular service that required her to routinely **cross a Traffic Separation Scheme (TSS)**.; **2 križati se (o kursovima)**

cross bar (n) (nav arch) greda, nosač

cross bearings (n) (navig) križane crte azimuta, linija azimuta koje se presijecaju **cross bearings position** pozicija dobivena presjecanjem dviju crta azimuta, pozicija opažanjem dva ili više objekata

cross-channel service (n) (shipping econ) plovidba preko kanala: The ship was cleared to continue her **cross-channel service**.

cross-check (v) (navig) višestruko provjeriti, provjeriti na više načina: The ship's position should be monitored and **cross-checked** using more than just one method, and the track projected ahead to ensure detection of any possible dangers.

Cross Clot Space Charter Party (n) (shipping econ) Ugovor o međusobnoj razmjeni dijela broskog prostora

crosshead /'krɒs,hɛd/ (marine eng) **crosshead bearing** ležaj križne glave: *erm performance and reliability tests were also conducted, and the first installation made on a large two-stroke engine to measure **cross-head-bearing** temperatures.* **križna glava, tal. testa a croce**: The designs of the crankshaft, **cross-head**, bearings and exhaust valve actuating gear are, in the

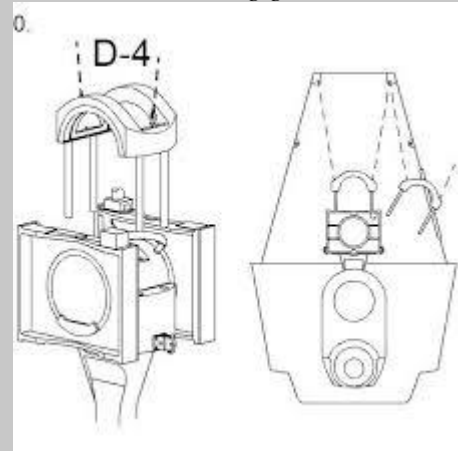

main, similar to the components introduced with the K-GF series.
{tal.: testa a croce}

crosshead engine (n) (marine eng) motor s križnom glavom

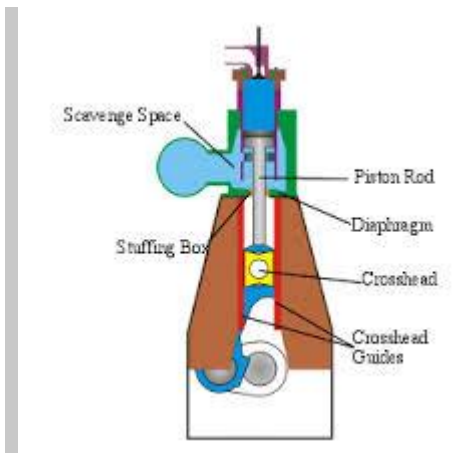

crossing (n) **1** (navig) **prijelaz (poprijeko, npr. kanala, plovnog puta)**: A passenger ferry, on a southerly heading in daylight and good visibility, was **crossing a TSS**. A small taxi boat with two passengers on board was **crossing a navigation channel** in dense fog.; **2** (navig, mar law)

presijecanje crossing situation križanje kursova (u Pravilima o izbjegavanju

sudara): The red vessel, being a stand-on vessel in a **crossing situation**, failed to comply with Rule 17 (Action by stand-on vessel) of the COLREGS but [reduced speed and] altered course to port to avoid collision ... both vessels were now heading in the same direction when the other vessel again altered to port and created a **crossing situation.**, **crossing vessel 1 brod koji presijeca kurs**

(drugom brodu): The **crossing vessel** came into close quarters situation with a group of ships ahead and then steered a course of 1700T towards the 2CZ buoy. The OOW noted the crossing vessel's name on the AIS and attempted to alert the **crossing vessel** on the VHF about the impending danger, without success.; **2 brod koji plovi prijelaz kanala**

crossing courses (n) (navig) **križani kursovi, ukrižani kursovi**

crossing situation (n) (navig) **križanje kursova**

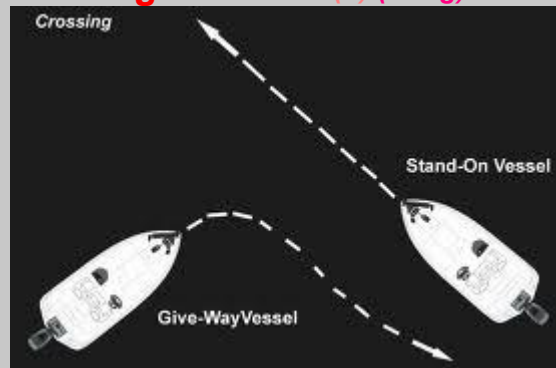

crossing turn (n) (boating/yachting) **oko (pri slaganju) konopa**

crossing vessel (n) **brod koji presijeca kurs (drugom brodu), brod koji prelazi**

kurs drugog broda: Whilst on passage off the South Coast we had a port side **crossing vessel** on a steady bearing. Lack of communication: the **crossing vessel** failed to inform VTS and other traffic about her intention to leave the anchorage and cross the traffic lane.

crossover /'krɒs.əʊvə/ (n) (cargo handling) **prebacivanje (s jedne strane na drugu),**

prebacivanje s jednog cjevovoda na drugi manifold crossovers 1 prebacivanje s

jedne ventilske jedinice na drugu; 2 prespajanje s jednog manifolda na drugi; 3: All crossover must remain isolated to each other., bottom crossovers prespajanje s jednog

cjevovoda/linije na dnu na drugi, **crossover valve** ventil za prespajanje: *However, the cross-over valve connecting the ballast and bilge systems was left open.*

CROSS SEA (n) (oceanogr) = **confused sea** križano more, bibavica



CROSS SEA (n) (oceanogr) ukrižano more, tal. onde incrociate

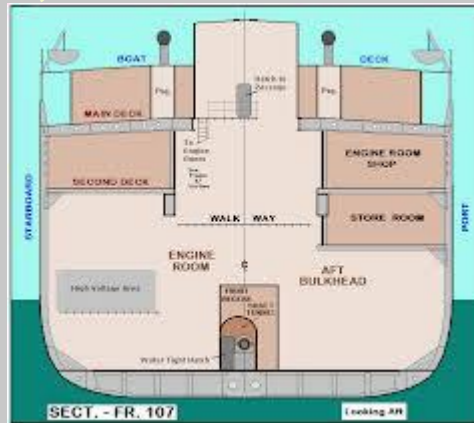

CROSS-SECTION (n) poprečni presjek

CROSS-SECTIONAL AREA (n) (marine eng) površina poprečnog presjeka: *Due to the number of containers the vessel was carrying on deck, her cross sectional area at the time of the accident was 6,750 m², which in a wind speed of 15m/sec equated to a force of approximately 120t acting on the vessel.* **uniform cross-sectional area** jednolična površina poprečnog presjeka

CROSS TIE /'krɒs ,tai/ (n) (nav arch) prečka

CROSS TRACK ERROR (XTE) (n) (boating/yachting) greška bočnog otpadanja od kursa: *After the turn, the vessel slowly diverged from her planned track and, eventually, the GPS alarm sounded as she strayed outside of the 2 cable cross track error (XTE) margin.*

CROSS TRACK MEASURE a boat's or ship's distance from the intended track **udaljenost od željenog puta**: *The second officer monitored Paula C's position using the cross track error facility on the Global Positioning System (GPS) receiver.* udaljenost od željene putanje kretanja broda

CROSS-TRADE (shipping econ) slobodna plovidba, tramperska plovidba, slobodno (brodarsko) tržište, otvoreno tržište (brodovima trećih zemalja)

crosstree /krɒs,tri:/ (n) (nav arch) either of a pair of wooden or metal braces on the head of a mast to support the topmast, etc **okov vrha stupa samarice, okov vrha jarbola, tal. crocetta**

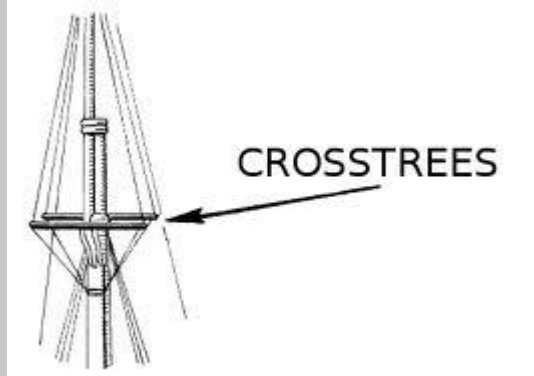

{tal.: crocetta}

crosswind (n) (meteorol) **poprječni vjetar**

crosswise /krɒs,waɪz/ (n) **crosswise tightening unakrsno stezanje (vijaka) poprijeko, unakrsno**

crow bar /'krəʊ,ba:/ (cargo) željezna poluga s ojačanim račvastim dnom za podizanje jedne strane teških komada tereta od dna **čelična poluga - podigač, pralica, štangulin, ćuskija, pajsl, praseća noga** Dockers working in the ship's holds also use pinch or crowbars for moving heavy packages, and hand hooks for manoeuvring packages into position.



crown /kraʊn/ (n) (seamanship) **COMPARE anchor** kruna sidra

crown gear (n) (marine eng) zupčanik s nazubljenom krunom

crown shackle (n) (nav arch, seamanship) škopac na kruni / čelu sidra

crow's nest /'krəʊz,nest/ (n) (nav arch) **COMPARE bird's nest** the platform or tub on the mast for the look-out; larger than the bird's nest **koš za motritelja pri vrhu jarbola**



{tal.: coffa di vedetta}

crucifix /'kru:sifiks/ (n) (nav arch) križasti stup

crude oil /kru:d/ (n) (cargo) sirova nafta, neprerađena nafta: The movement of liquid bulk cargo, crude oil and derivatives, from the tanker is undertaken by means of pipelines connected to the shore-based storage tanks. **crude oil cargo teret sirove nafte**: Recently one of our tankers discharged an excess of nearly 150,000 barrels (bbls) of **crude oil cargo**.



crude oil carrier (n) (nav arch) tanker za naftu

Crude Oil Washing; COW (n) (cargo handling) pranje tankova sirovom naftom
crude oil washing system sustav za pranje tankova sirovom naftom

crude tanker (n) (nav arch) Crude tankers move large quantities of unrefined crude oil from its point of extraction to refineries. **tanker za prijevoz sirove nafte**

cruise (v) (boating/yachting) to sail to and fro over a particular area **krstariti**

cruise line (n) (shipping econ) brodara za kružna putovanja: Almost all **cruise lines** offer an Internet Café complete with pay-as-you-use options for guests to stay connected. ... two important agreements were made: with the US group Carnival Corporation for the construction of two cruise ships for the Holland America Line —and Carnival **Cruise Lines**, and with Viking Ocean Cruises for another two cruise ships. **cruise line sailing kružno putovanje, kružni servis**: In July, the port signed a new five-year agreement with Carnival, keeping the world's biggest **cruise line sailing** at least two vessels from the city year-round through 2019., **cruise line service kružna plovidba kružni servis**

cruise liner A cruise ship or cruise liner is a passenger ship used for pleasure voyages, where the voyage itself and the ship's amenities are a part of the experience, as well as the different destinations along the way. **linijski brod za kružna putovanja**: Dedicated transport oriented ocean liners typically transport passengers from one point to another, rather than on round trips.

cruise operator (n) (shipping econ) brodara za kružna putovanja: Fun, luxury, experiences — that's what **cruise operators** sell, and by all accounts, it is selling well. www.maritimeprofessional.com

cruise passenger (n) (shipping econ) putnik na brodu za kružna putovanja, putnik

na kružnom putovanju: *In 2014, Port of New Orleans terminals handled more than one million cruise passengers, based on embarkations and www.maritimeprofessional.com.*

cruise port /kru:z/ **luka za kružna putovanja:** *Dubrovnik is Croatia's premier cruise port. Southampton is the UK's premier cruise port, handling almost half a million passengers.*

cruiser /'kru:zə/ (n) **1 (nav arch) = cruise ship** brod za kružna putovanja, tal **crociera**



; **2 (navy) krstarica; 3 (boating/yachting) krstaš**

cruiser clothing (n) (boating/yachting) odjeća za krstarenje

cruiser fittings (n) (boating/yachting) oprema krstaša

cruiser stern /'kru:z/ (n) **1 (nav arch) krstarička krma; 2 (boating/yachting) krstaška krma**

cruise ship /'kru:z/ (n) (nav arch) a cruise ship or cruise liner is a passenger ship used for pleasure voyages, where the voyage itself and the ship's amenities are a part of the experience, as well as the different destinations along the way. **brod za kružna putovanja, kročera:** *A cruise ship in Dubrovnik*

cruise terminal /'kru:z/ (n) (ports) terminal za brodove za kružna putovanja

dedicated cruise terminal namjenski terminal za brodove za kružna putovanja

cruise trade /'kru:z/ (n) (shipping econ) plovdba brodova za kružna putovanja

cruising /kru:ziŋ/ (n) (boating/yachting) a journey by sea, especially as a holiday/vacation or recreation **krstarenje:** *The vessel's autonomous cruising capability ensure she is globally capable and able to tackle challenging, far-reaching itineraries*

cruising power (n) (nav arch) brzina krstarenja

cruising range (n) (navig) maksimalna udaljenost u morskim miljama koju brod može ostvariti do ponovnog krcanja goriva **doseg plovidbe, autonomija broda, autonomija plovidbe**

cruising speed (n) (navig, nav arch) brzina u normalnoj plovidbi, brzina krstarenja

cruising yacht (n) (nav arch) brodica za krstarenje

crush /kraʃ/ (v) **1 zdrobiti; 2 zgnječiti; 3 pritiskati**

crushing (cargo) drobljenje (tereta, pakovanja), gnječenje, šteta nastala drobljenjem

crustacean /kra'steɪʃən/ rak s plavim obrubima

crutch /kraʃ/ (n) (sailing vessels) krmena vjenčanica **crutch bolts** svornjaci krmene vjenčabice

cubbies (n) (boating/yachting) lokeri za hranu i osobne stvari

cube root /'kju:b,ru:t/ (n) (math) treći korijen

cubic capacity (n) (nav arch) kubična zapremnina, zapremnina u kumičnim

metrima give added **cubic capacity** povećati kubičnu zapremninu

cubic foot (n) (math) kubična stopa (=0,028317 kub. metara)

cubic meter (US) kubični metar

cubic metre (n) (UK) (math) kubični metar

cu.; **cubic** (adj) kubični, kubni

Cumulonimbus /,kju:mjʊləʊ'nɪmbəs/ (n) (meteorol) kumulonimbus

Cumulostratus /,kju:mjʊləʊ'streɪtəs/ (n) (meteorol) kumulostratus

Cumulus /'kju:mjʊləs/ (n) (meteorol) komulus

cunningham /'kʌnɪŋəm/ (n) (boating/yachting) priteg jedra za palubu, nateg prednjeg

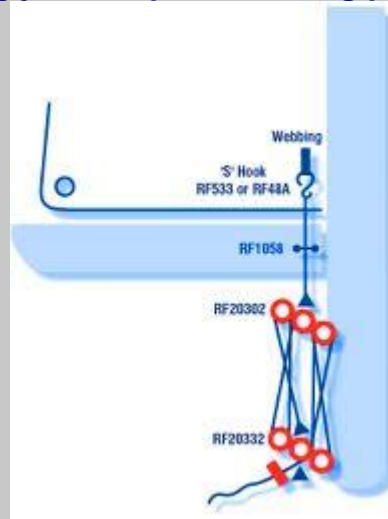

poruba jedra, nateg cunningham, cunningham

currency /'kʌrənsi/ sredstva plaćanja, valuta **foreign currency** strana sredstva plaćanja, strana valuta, **domestic currency** domaća sredstva plaćanja, domaća valuta, devize

current /'kʌrənt/ **drift of current** brzina struje, **set(ing) of current** smjer struje, **tidal current** tidal currents are caused by gravitational interactions between the Sun, Moon, and Earth and are a part of the same general movement of the sea that is manifested in the vertical rise and fall, called /tide **plimna struja**, **struja morske mijene**, **nontidal current** nontidal currents include the permanent currents in the general circulatory systems of the sea as well as temporary currents arising from more pronounced meteorological variability **nemijenske struje** (oceanogr) a horizontal movement of water **struja**, **morska struja**, **kurenat ocean current** oceanska struja

current price tekuće cijene, aktualne cijene (goriva, zaliha)

cursor /'kɜ:sə/ **pokazivač**, **uputnik**, **cursor radar display cursor** The cursor functions to find the range and bearing (default function) to a target or the latitude and longitude position of a target **pokazivač na radarskom zaslonu**, **cursor data podatci o kursoru** *Cursor data can be shown as latitude and longitude or range and bearing from own ship to the cursor. Position and heading bearing signal are required*

cursor pad (n) (electr, navig) = **trackball** kuglica (radarskog) kursora, kuglica za upravljanje kursorom

curtail /kɜ:'teɪl/ (v) uskratiti

curvature /'kɜ:vətʃə/ (n) (geogr) zakrivljenost **curvature of the Earth** zakrivljenost

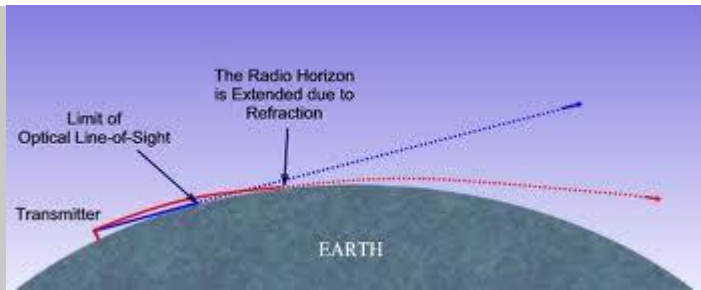

Zemlje

curve /kɜːv/ **1** zavoј, okuka; **2** krivulja

curve /kɜːv/ (v) zavijati, svinuti, iskriviti, zakriviti

curved /kɜːvd/ (adj) zakrivljen, skrivljen, svinut

curve fitting (n) (math) prilagodba krivuljom

curve of sectional areas krivulja površine rebara

curve of statical stability (n) (stabil) krivulja statičke stabilnosti

custody /ˈkʌstədi/ **1** (mar law) pritvor **keep in custody** pritvoriti, držati u pritvoru; **2**

(shipping econ) čuvanje (robe, tereta): *Sampling is an important part of the bulk liquid cargo*

custody transfer process and can help in protecting the ship's interests in the event of disputes over cargo quality. in custody na čuvanju (roba, teret)

custody of the law (n) (mar law) troškovi za čuvanje broda za vrijeme dok je zaustavljen ili zadržan sudskom odlukom

custom /ˈkʌstəm/ **običaj, uzanca**: *It had become custom and practice to remove the gangway stanchions and guardrails while the gangway was in its rigged position. port custom lučke uzance*

Custom Authority (n) (ports) carinske vlasti, carinski organi **custom authorities** carinske vlasti

custom boat (n) (nav arch) carinski brod

custom duty (mar law) = **duty** carinska pristojba

customer (n) (shipping econ) kupac, kiljent: *The Epirb was later condemned by the manufacturer and the customer was notified.*

Custom House, custom-house = **customs** :1 carinarnica

Custom Inspector carinski inspektor

custom manifest (n) (mar law) carinska prijava, carinski manifest

custom of the port (n) (shipping econ) local rules and practices in a port which may impact upon the costs borne by the various parties **lučke uzance, lučki običaji**

custom port (n) (mar law) carinska luka

customs Collector of **customs** carinski blagajnik, to collect **customs** naplatiti carinu, ubrati carinu, to clear **customs** 1 srediti carinske formalnosti; 2 proći carinske formalnosti, to comply with **customs formalities** ispuniti carinske formalnosti **1** A duty or tax on imported goods. **a carina**: *Arriving for a canal transit, the vessel had rigged the starboard accommodation ladder to facilitate the transfer of immigration, customs*

personnel, agents, ship chandlers etc and to embark canal pilots. I am a Third Officer and assist the Master with the port paper work and in dealing with the authorities (Customs, Immigration, Port Health).; 2 the department of the Civil Service that deals with the levying of duties and taxes on imported goods from

foreign countries and the control over the export and import of goods e.g. allowed quota prohibited goods (http://www.iss-shipping.com/cargo/cargo_library_glossaryc.asp) **carinarnica**

customs allowances (n) (mar law) količina artikala dopuštena od strane carine (cigarete, pića itd.) po pojedinom pomorcu na brodu **carinsko dopuštenje**

Customs Bonded House (n) (mar law) a warehouse authorized by Customs to receive duty-free merchandise **carinsko skladište**

customs clearance (n) **1** (mar law) carinsko odobrenje; **2** obavljanje carinskih formalnosti

customs clearance agent(s) (n) (mar law, shipping econ) customs broker or other agent of the consignee designated to perform customs clearance services for the consignee **agencija za obavljanje carinskih formalnosti**

customs declaration (n) (mar law) carinska prijava

Customs entry (n) (mar law) declaration on incoming foreign goods **carinska prijava, carinska deklaracija**

customs entry (n) (mar law) carinska prijava, carinska deklaracija

customs officer carinski službenik

cut (n) (med, safety) posjekotina

cut and run (v) (seamanship) prerezati konope, ispustiti lance i žurno isploviti (u opasnosti)

cut off isključiti, obustaviti dovod (goriva, vode, struje): *The switch was intended to cut off power to the winch when the davit closed to within approximately 12mm of the sensor. This handle was quickly re-fitted to the valve spindle and the valve was repositioned, with a result that the hydraulic pressure was cut off, causing the brake to activate. The ship speed was reduced and power supply cut off to Decks 3 and 4.*

cutout **1** a udubljen, izdubljen, urezan; **2** nazupčan

cut out isključiti, prekidati

cut out **cut out the fuel supply** prekinuti dovod goriva, isključiti dobavu goriva
prekinuti, isključiti: *the alternators were cut out*

cut-out (n) (nav arch) prolaz za ukrepe

cutter /ˈkʌtə/ (US) peljarski brod, peljatska brodica, **pilotina**: *The pilot then advised the master that he was disembarking into the pilot cutter, and that the master should put the engine to full ahead, and aim for the red buoy marking the south side of the entrance to the channel as soon as this was seen by the pilot following in the cutter astern, and he immediately repeated his previous advice to the master via VHF radio. pilot cutter peljarska brodica: Another inward vessel came up astern of me and asked the pilot cutter if he should slot in behind me or continue towards the cutter, he was advised to do the latter*

cutter /ˈkʌtə/ jedrilica s jednim jarbolom, glavnim jedrom i dvije prečke, koja služi uglavnom za



kružna putovanja i razonodu **krstaš**

cutter /ˈkʌtə/ (n) (marine eng) **rezalica, freza**

cutting disc (n) (marine eng) **rezač, disk za rezanje**. *Because of excessive corrosion on the fasteners, he unilaterally decided to fit a 5mm **cutting disc** on the angle grinder instead of the wire wheel,*



and then proceeded to cut off the nuts of the studs securing the manhole cover.

cutting machine (n) (marine eng) **rezalica, strojni alat za rezanje** **sparkless cutting machine** rezalica bez iskrenja

cutting oil (n) (marine eng) **ulje za rezačke strojeve, ulje za freze**

cutting tool (n) (marine eng) **rezní alat, alat za rezanje**

cuttlefish (=common cuttlefish) (n) Lat. SEPIA OFFICINALIS **sipa tackle and leader**

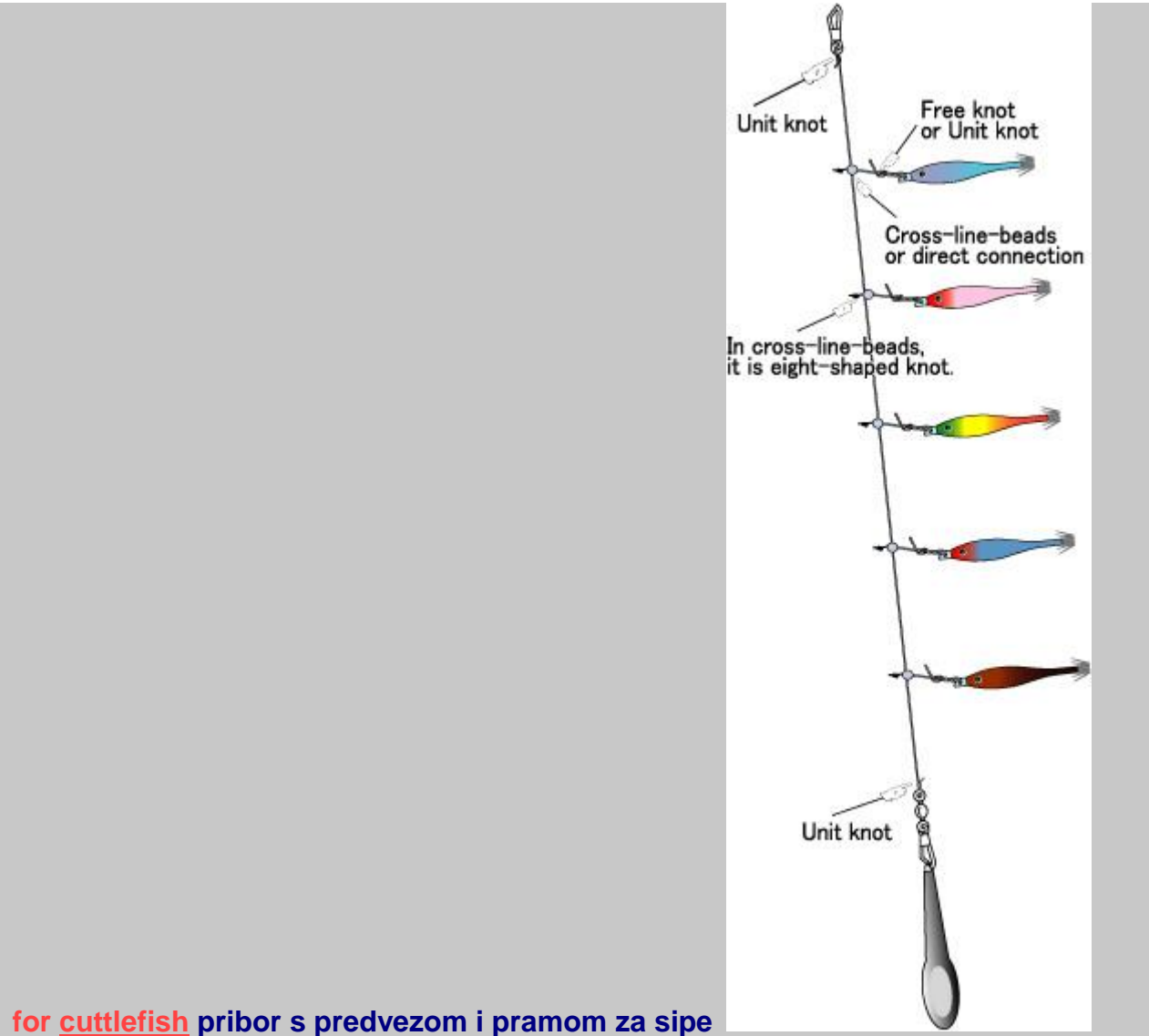

for cuttlefish pribor s predvezom i pramom za sipe



cutwater /kʌt, wɔ:tə/ (n) **1** (nav arch, sailing vessels) the foremost part of the stem, cutting the water as the vessel moves ahead **brid pramca (u dodiru s morem); 2** (sailing vessels) **brid pramčane statve**

cv; C.V. ; (container vessel) /,si:'vi:/ (n) (nav arch) **kontejnerski brod**

cv; CV; (curriculum vitae) /,si:'vi: / kə'ɪkju:ləm ,vi:tai/ (n) **(UK) životopis, cv**

CW; constant wave (n) (navig) **neprekinuta amplituda (smetajućeg signala na radaru)**

CW radar; continuous wave radar (n) (navig) **radar s neprekinutim valom FM CW radar; continuous wave radar; frequency modulated continuous wave radar** **frekvencijski modulirani CW radar**

cyanotype /sar'ænə, taɪp/ (n) (marine eng) = **blueprint** **modri nacrt, modra kopija, kopija**

cyber-attack /'saɪbə .../ **kibernetski napad, informatički napad, napad putem**

interneta: *Now there is a new kind of threat – that of the cyber-attack with the ability to do everything from stealing data to changing the course of a ship, and possibly to steal the cargo as well.*

cycle /'saɪkl/ (n) **1** (marine eng) **ciklus, kružni proces, kružni tijek re-heat cycle** **krug dogrijavanja, complete the cycle** **dovršiti krug, završiti krug; 2** (navig) **perioda (u sustavu LORAN C)**

cycle of events (n) **ciklus zbivanja**

cyclone /'saɪkləʊn/ (n) (meteorol) **ciklonsko vrijeme frontal cyclone** **frontalna ciklona, cyclone rain** **ciklonska kiša, cyclone wind** **ciklonski vjetar, tropical cyclone**

tropska ciklona: *The latest tropical storm warning is as follows: Tropical storm warning at ... UTC. Hurricane... (name) / tropical cyclone / tornado / willy_willy / typhoon ... (name) with central pressure of ... millibars / hectopascals located in position ... Present movement... (card (name) / tropical cyclone / tornado / willy_willy / typhoon .*

cyclonic circulation /sai'klɒnik/ (n) (meteorol) ciklonsko kruženje

cylinder /'silində/ (n) (marine eng) 1 cilindar, stublina: A couple of weeks later, there was a main bearing failure in **number 8 cylinder** and a crank case explosion. When the machinery space was entered, the engine's No 6 **cylinder large end bearing** assembly was found to have passed through the port crankcase door, and to have come to rest immediately outside the engine. **cylinder block blok cilindra, blok motora, cylinder cover poklopac cilindra, glava cilindra, cylinder head glava cilindra, cylinder liner košuljica cilindra, cylinder lubricators mazalice cilindra, cylinder top vrh cilindra, wall stijenka cilindra, working cylinder radni cilindar**

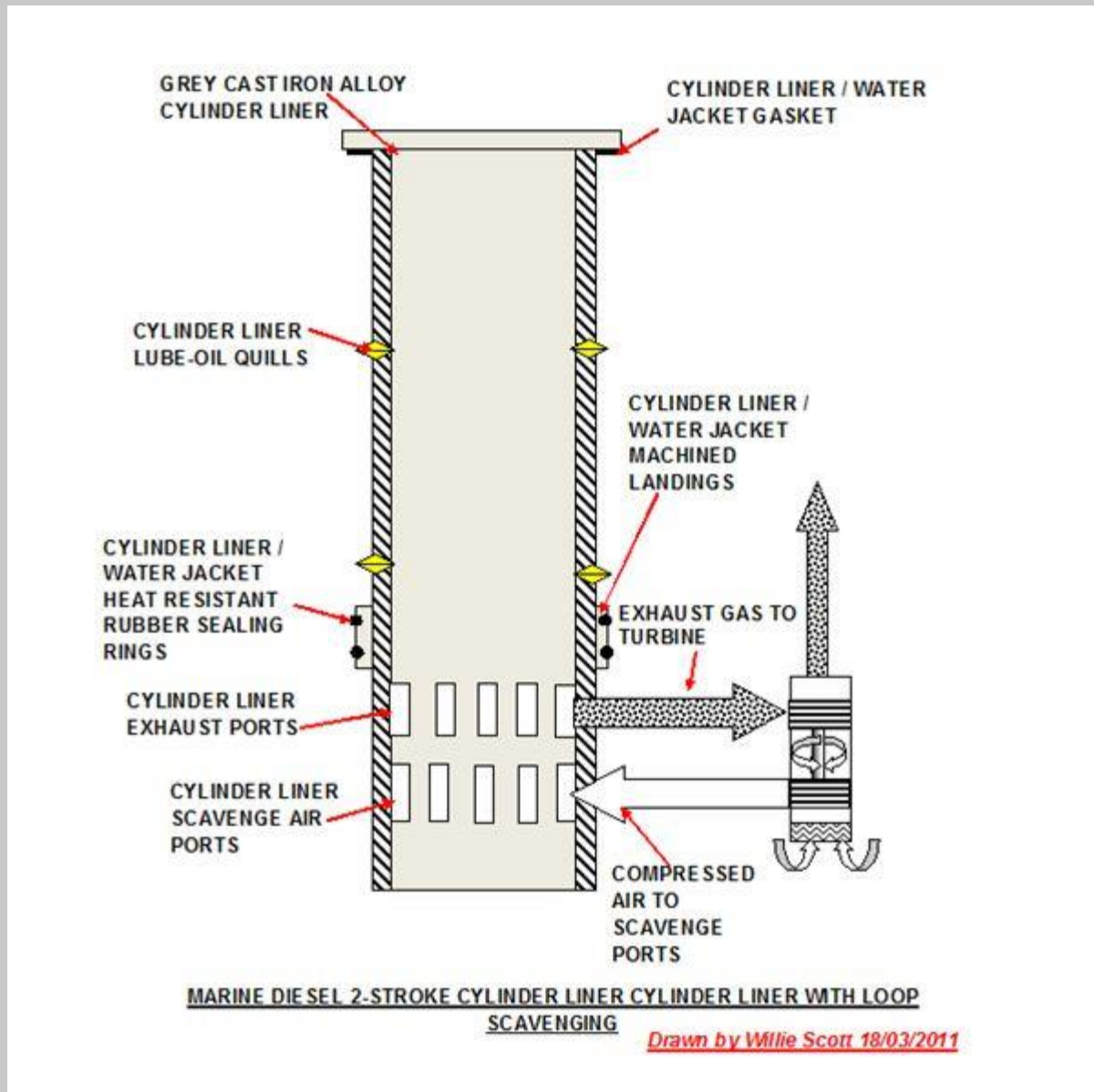

(marine eng) boca (kisika, plina): The CO₂ system's pilot and gang release bottles did not appear to operate correctly and thus each **cylinder** had to be individually activated, using its valve handle. ; 2

(cargo handling) bubanj ; 3

cylinder bore (n) (marine eng) provrt cilindra

cylinder head (n) (marine eng) **glava cilindra**, tal. **testata**: The seat of the fire was between the turbocharger and **cylinder head** no. 1 The fire was the result of a defective high pressure fuel pump spraying fuel over a hot indicator cock on a **cylinder head**. Exhaust system: modular and compact, the system comprises single cylinder units bolted to the **cylinder head** and connected to the next unit with expansion bellows. A unit fuel pump injector with removable nozzle is arranged in each **cylinder head** and operated from the camshaft by the fuel cam via cam follower, pushrod and lever in a similar manner to the inlet and exhaust valves. 2 stroke engines with an exhaust valve mounted in the **cylinder head** are known as uniflow scavenged engines. The **cylinder head** is provided with replaceable valve seat rings of heat-resistant steel, and the exhaust valve seat rings are water cooled. The **cylinder head**, water jacket, cylinder liner, piston and connecting rod can be withdrawn from the engine as one assembly ... A drilled passage is provided in the **cylinder head** to allow an adaptor and indicator cock to be fitted for performance checks. **cylinder head valve ventil na glavi cilindra**

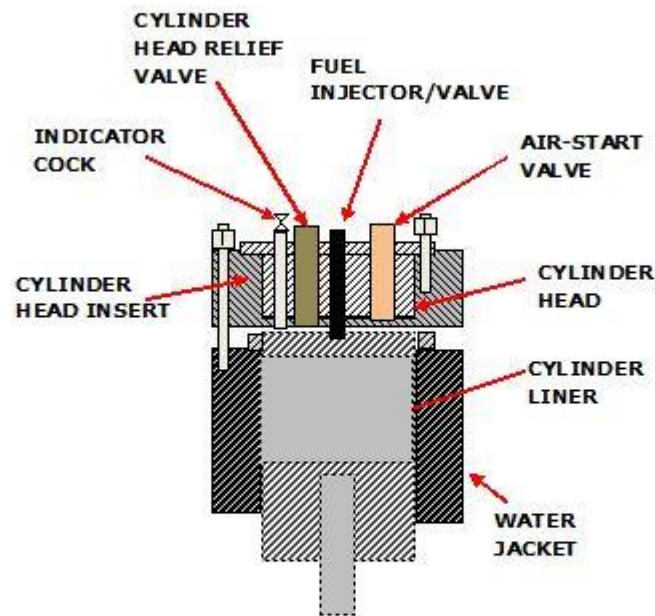

**SECTIONS THROUGH CYLINDER HEAD AND
INSERT ON SULZER RD ENGINE**

Drawn by Willie Scott 26/09/2010

cylinder jacket (n) (marine eng) **plašt cilindra**, vodeni plašt cilindra

cylinder liner (n) (marine eng) **košuljica cilindra**: The piston and severely distorted

connecting rod were hanging from the **cylinder liner**. Once the **cylinder liner**, piston, and connecting



rod were removed, the full extent of the damage could be assessed.

cylindrical /siˈlɪndrɪkəl/ (adj) valjkast, cilindričan

cylindrical buoy (n) (navig, comm) valjkasta plutača

dacron (n) (boating/yachting) synthetic material used in sail manufacture dakron

daggerboard /ˈdædʒəˌbɔːd/ (n) (boating/yachting) pomična kobilica čiji se list spušta i diže okomito
okomito pomična kobilica

daily operating costs (n) (shipping econ) The costs of a vessel's technical operation, crewing, insurance and maintenance, but excluding costs of financing. (<http://www.clarksons.com/glossary/>)

dnevni operativni troškovi broda, dnevni troškovi eksploatacije broda

daily service tank (n) (nav arch) COMPARE fuel oil system tank dnevne

službe: After passing through centrifuges the cleaned, heated oil is pumped to a **daily service tank**. From the **daily service tank** the oil flows through a three-way valve to a mixing tank.

daily tank (n) (marine eng) dnevni tank, tank za dnevnu potrošnju: ... the maximum consumption of the diesel engine plus a margin of about 18 per cent to ensure that separated fuel oil flows back from the **daily tank** to the settling tank.

daily vessel capital cost (shipping econ) dnevni kapitalni trošak broda

dairy produce (n) (cargo) mječni proizvodi

dam /dæm/ (n) (ports) zaštitni nasip, nasip, brana, diga; tal. diga

damage /ˈdæmɪdʒ/ (n) (mar law, shipping econ, cargo) 1 oštećenje broda, šteta na brodu, havarija broda, tal. avaria: Throughout the night, checks were made for flooding or signs of **damage**. The team's prompt action prevented excessive **damage**. slight **damage** lako /

nezatno oštećenje, cause of **damage** uzrok štete: Petroleum-based solvents, with the potential to destroy lubricant oil film and cause **damage** to the rubbing parts of fuel pumps and engine

cylinders., **damage** report izvještaj o havariji / kvaru / šteti, **damage** repairs popravak oštećenja, serious **damage** jako / teško oštećenje, to suffer serious **damage**

pretrpjeti teško oštećenje: A luxury cruise ship has suffered **damaged** after running aground in a

marine preserve off Panama's Pacific coast., extent of **damage** veličina / obim / stupanj

štete, to cause **damage** izazvati / prouzročiti štetu, to give rise to **damage** dovesti

do štete, **damage** sustained: pretrpljeno oštećenje, **damage** sustained pretrpljeno

oštećenje *the damage sustained to the stern of the vessel*, **structural damage šteta na konstrukciji broda oštećenje konstrukcije broda**; **2 (mar ins, cargo) oštećenje tereta, šteta na teretu**: *Prior to loading the cargo it should be inspected for damage* Prije krcanja tereta valja ga ispitati radi otkrivanja oštećenja **cargo damage at loading port šteta na teretu nastala u luci ukrcaja mechanical damage, liable to damage 1 sklon / podložan oštećivanju (o teretu) ; 2 koji se lako oštećuje; 3 osjetljiv na oštećenje, to sustain damage pretrpjeti oštećenje, subject to damage (o teretu) sklon / podložan oštećivanju, cargo damage šteta na teretu, damage claim odštetni zahtjev, zahtjev za naknadu štete, damage feared moguća šteta, to avoid damage izbjeći štetu, to claim damage tražiti odštetu, to prevent damage spriječiti štetu, to protest against the damage caused prijaviti nastalu štetu, to suffer damage pretrpjeti štetu, biti oštećen, to sustain damage pretrpjeti štetu, damage sustained pretrpjela šteta / havarija, nastala šteta, nature of damage priroda štete, vrsta štete a fizičko / mehaničko oštećenje; **3 (marine eng) havarija stroja, kvar stroja****

damage /'dæmɪdʒ/ (v) (mar law) oštetiti, prouzrokovati štetu: *If you suspect that your cargo may have been damaged during the voyage, inform your owners. Both vessels were damaged but there were no injuries and there was no pollution.*

damage assessment (n) (safety) procjena oštećenja, prosudba štete: *The findings were revealed in a damage assessment of the vessel which was submitted to the Coast Guard by Marine Construction. A thorough initial damage assessment was made and it was decided that our ship was not endangered.*

damage caused (n) 1 (mar ins) prouzročena šteta, izazvana šteta; 2 šteta izazvana (nečim)

damage claim (n) (shipping econ, mar law) zahtjev za naknadu štete, tražbina za štetu: *The ship had to be placed off-hire for three days for removal and disposal of the damaged cargo and a heavy cargo damage claim had to be settled with the consignee. The ship had to be placed off-hire for three days for removal and disposal of the damaged cargo and a heavy cargo damage claim had to be settled with the consignee.*

damage control team (n) (safety) jedinica za sprječavanje prodora vode, protuhavarijska grupa: *Damage control team must have following outfit(s): protective clothing, safety helmets, lifejackets.*

damaged (adj) 1 oštećen; 2 havariran (brodski stroj)

damaged cargo (n) (cargo handling, cargo) oštećen teret: *About 40 tonnes of damaged cargo was found in nos. 1 and 2. holds. The ship had to be placed off-hire for three days for removal and disposal of the damaged cargo and a heavy cargo damage claim had to be settled with the consignee.*

damage for detention (n) (mar law) pravo na naknadu zbog zadržavanja broda

damage report (n) (mar ins) izvješće o šteti, izvještaj o šteti, izvješće o havariji

damages (n) 1 (mar law) naknada za štetu, odšteta: *US\$ 25,000 was paid in damages* Na ime odštete isplaćeno je 25000 dolara *He is also entitled to damages unless the breach was caused by an excepted peril or if the venture has been frustrated. The shipowner is liable in damages to the owner of goods jettisoned if he delivers the rest of the cargo without obtaining general average security.* **pay damages platiti odštetu**: *They seem willing to pay damages.*, **damages for detention naknada za zadržavanje broda**: *The carrier shall have a lien over the goods for all freight,*

prime, charges, demurrage, **damages** for detention.; **2 štete, oštećenja** I hereby note my protest against all losses, **damages**, etc and reserving my right to claim against parties concerned and extend same at time and place convenient. Both vessels suffered minor **damages**.

damage stability (n) (nav arch, stabil) **COMPARE intact stability stabilnost**

broda u oštećenome stanju the IBC/BCH Code is amended by Res. MSC.369(93) and the IGC Code is amended by Res. MSC.370(93) requiring tankers to be fitted with an approved stability instrument capable of handling both intact and **damage stability** cases <http://www.amc.gr/amcLoadingSoftware.htm>

damage stability booklet knjižica stabilnosti broda u oštećenom stanju As per today's requirements from some IACS members it is not enough just to enter the prede ned damage cases that are presented in the vessel's **damage stability booklet**. Therefore the loading computer has been extended to include damage cases that incorporate a complete survey of the intact condition in accordance with MARPOL, IBC or IGC. <http://www.sateco.it/loadmaster>

damage survey of the ship (n) (safety) **pregled broda poslije havarije** After re-floating, the **damage survey** showed the vessel had sustained damage to its bottom plating in way of the forepeak and ballast tanks 1, 2, and 3.

damp /'dæmp/ (adj) **vlažan**: Two packages were wet / **damp** / mouldy.

damper /'dæmpə/ (n) **1 (marine eng) zaklopka, zasun control damper regulacijska**

zaklopka, upravljačka zaklopka; 2 amortizator: An appropriate axial **damper** is fitted to all MC engines to minimize the effects of the axial vibrations.

dampness /'dæmpnis/ (n) (meteorol) **vlažnost (zraka)**

damsel fish (n) (fishing) **crnelj** {drugi. hrv. nazivi: crnjul, čančol, indijanac, kaliger, prajčić, šćoka, crnac, miš, kosić: lat. CHROMIS CHROMIS}

dan buoy (n) (navig) buoy with a staff and a flag, indicating the location of a work site **lokacijska**



plutača ronilačka plutača

Danforth's anchor (n) (boating/yachting) **Danfortovo sidro**



danger /'deɪndʒə/ (n) (**safety**) **opasnost, pogibelj**: He determined that the vessel was stable and not in **danger** of sinking. The OOW realised that the ferry was heading into **danger**, and alerted the master. Later in the evening he assessed that the weather no longer posed an immediate **danger to** the ship. **immediate danger neposredna opasnost**: There is no **immediate danger to** our passengers or the ship and there is no reason to be alarmed. **high danger velika šteta, danger area opasno područje, područje opasnosti**: The ship was then navigated clear of the **danger area**, allowing her to berth safely soon afterwards. **pose a danger predstavljati opasnost**: Later in the evening he assessed that the weather no longer **posed** an immediate **danger to** the ship. **avoid danger izbjeci opasnost**: the Colregs require all vessels to 'avoid entering a separation zone' unless it is necessary to **avoid immediate danger**. **imminent danger neizbježna opasnost**: At about the same time, the outbound pilot boat identified the vessel on radar, realised that she was in **imminent danger** of grounding, and called on VHF to warn the master. **run into danger ući u opasnost, srljati u opasnost, ići ususret opasnosti**: You are **running into danger**. Shallow water to the south of your vessel. **potential danger potencijalna opasnost**: moguća opasnost All forms of cracks are a **potential danger** and are totally unacceptable. **be aware of the danger biti svjestan opasnosti, shvatiti opasnost**: The master must **be aware of the danger** in the port named and exercise his right of proceeding to the nearest safe port.

dangerous and hazardous cargo; D&H (n) (**cargo handling, cargo**) **opasan teret**

dangerous cargo (n) (**cargo**) **opasni teret**: The ship was displaying navigation lights appropriate to its length and a local signal, a flashing red light at the masthead, to indicate it was carrying a **dangerous cargo**. A specialist cargo ship was in port loading a **dangerous cargo**.

dangerous course /'deɪndʒərəs/ (n) (**navig**) **opasan kurs**: You are steering a **dangerous course**.

dangerous goods (n) (**cargo**) goods are considered dangerous if the transport of such goods might cause harm, risk, peril, or other evil to people, environment, equipment or any property whatsoever (http://www.iss-shipping.com/cargo/cargo_library_glossaryd.asp) **opasan teret, opasni tereti**: aying navigation lights appropriate to its length and a local signal, a flashing red light at the masthead, to indicate it was carrying a dangerous cargo. In this case the container must be treated as **dangerous goods** and should be marked properly and stowed in accordance with the IMDG Code.

dangerous goods declaration Document issued by a consignor in accordance with applicable conventions or regulations, describing hazardous goods or materials for transport purposes, and stating that the latter have been packed and labelled in accordance with the provisions of the relevant conventions or regulations (http://www.iss-shipping.com/cargo/cargo_library_glossaryd.asp) **prijava opasnih tereta na brodu, izjava o opasnim teretima na brodu**

Dangerous Goods Certificate (n) (**safety, cargo handling**) **Svjedodžba o prijevozu opasnih tereta**: Those responsible for the packing of dangerous goods into a freight container or vehicle should provide a signed dangerous goods container or vehicle packing certificate, stating that the provisions of paragraph 5.4 of the IMDG Code have been met, and the original or a copy should be handed over to the vessel operator.

Dangerous Goods Declaration (n) (**mar law**) Document issued by a consignor in accordance with applicable conventions or regulations, describing hazardous goods or materials for transport purposes, and stating that the latter have been packed and labelled in accordance with the provisions of the relevant conventions or regulations (http://www.iss-shipping.com/cargo/cargo_library_glossaryd.asp) **Deklaracija o opasnim teretima na brodu, izjava o opasnim teretima na brodu**: The shipper of dangerous goods

should provide a **dangerous goods declaration** embodying the relevant details listed in section 9 of the general introduction to the IMDG Code and the original or a copy should be placed aboard the ship. **This** is a signed certificate or declaration that the consignment, as offered for carriage, is properly packaged, marked, labeled or placarded as appropriate and in proper condition for carriage ...

Dangerous Goods Manifest (n) (mar law) **Manifest opasnih tereta na brodu**: The *Dangerous Goods Manifest* lists the weight, quantity, packaging, class and stowage of all hazardous cargo on the vessel. It is compiled by the agent and signed by the Master.

Dangerous Goods Packing Certificate (n) (cargo handling, cargo) A document as part of the dangerous goods declaration in which the responsible party declares that the cargo has been stowed in accordance with the rules in a clean container in compliance with the IMDG regulations and properly secured (http://www.iss-shipping.com/cargo/cargo_library_glossaryd.asp) **svjedodzba o pakovanju opasnih tereta**

dangerous obstruction (n) (navig) **opasna prepreka, opasna zapreka, opasna smetnja**: A safer option would have been to leave far more sea room before altering course, and carefully monitoring their position as they sailed around a **dangerous obstruction**.

dangerous quadrant (n) (navig) **opasan kvadrant**

dangerous situation (n) (safety) **opasno stanje, opasna situacija**: Besides taking care to control the heating of fuel oil tanks, the recommendations of the IMSBC Code must be strictly followed to prevent a **dangerous situation** from developing as well as to avoid cargo damage.

dangerous substances (n) (cargo, safety) **opasne tvari**: Brief all crew members / passengers on the symptoms caused by **dangerous substances**.

dangerous target (n) (navig) **opasna jeka (na radarskom ekranu)**

danger zone (n) (navig) **zona izbjegavanja, zona uklanjajnja s puta (drugim brodovima)**: We held a special safety drill prior to entering the **danger zone**.



dashboard /ˈdæʃ.bɔːd/ (n) (navig) **ploča s instrumentima, nadzorna ploča**

data /ˈdeɪtə ; ˈdɑːtə/ (n) **podaci operating data radni podaci, data processing obrada podataka, technical data tehnički podatci, tehnički opis {sg. datum}**

data acquisition unit; (DAU) (n) (navig) **COMPARE VDR; Voyage Data Recorder jedinica za prikupljanje podataka (VDR-a)**

data capsule unit; (DCU) (n) (navig) **COMPARE VDR; Voyage Data Recorder podatkovna kapsula (VDR-a)**

data collection unit; (DCU) (n) (navig) **COMPARE VDR; Voyage Data**

Recorder jedinica za prikupljanje podataka (VDR-a)

data logger (n) (marine eng, navig) uređaj za automatsko registriranje podataka

data-logging (n) (marine eng) registriranje podataka, bilježenje podataka

data-logging equipment uređaj za bilježenje podataka

date /deɪt/ (n) **1** datum, nadnevak; **2** sadašnost, sada **out of date** zastario: *The flares*

carried on board the RIB were found to be out of date., **up to date** moderan, osuvremenjen,

najnoviji. *The ship may have to go off-hire in order to keep up to date with and avoidance of any*

breakdowns The management needs to keep the Accounting Department up to date with

operational proceedings at all times, with changes and corrections when necessary., **to date do**

danas, osvježen, ažuriran, moderan, korigiran: *This document, containing safety lessons, has*

been produced for marine safety purposes only, on the basis of information available to date., **in date**

ažuriran: *Also, make sure that you carry an EPIRB and that the battery in the EPIRB is in date.*

Date and Place Signed off Articles (n) (mar law) datum i mjesto iskrcanja,

datum i mjesto završetka radnoga ugovora

Date and Place Signed on Articles (n) (mar law) datum i mjesto potpisivanja

radnoga ugovora

date line (n) (oceanogr) meridian 180 degrees from Greenwich and representing the change of the

day **antimeridijan**, tal. **antimeridiano**

date of casualty (n) (safety) vrijeme pomorske nesreće, datum pomorske nesreće:

Date of the casualty: 22 August 2013 Source : Marine Safety Investigation Unit (MSIU) ...

date of expiry /ɪk'spaɪəri/ datum istjecanja važnosti (isprave, dokumenta)

date of inspection (n) (mar law) datum pregleda

date of issue datum izdavanja (isprave, dokumenta)

date shell (n) prstac

datum /'deɪtəm ; 'da:təm/ **1 a** (safety) the most probable location of the search object corrected for

movement over time **zadana točka** (u SAR najvjerojatnija pozicija od koje počinje

traganje); **2** (oceanogr) a base elevation used as a reference from which to reckon heights or depths

zadana točka (referentna ravnina za iskaz dubine mora), **hidrografska nula**: *The*

predicted time of high water was 2012, with a height of 3M above datum

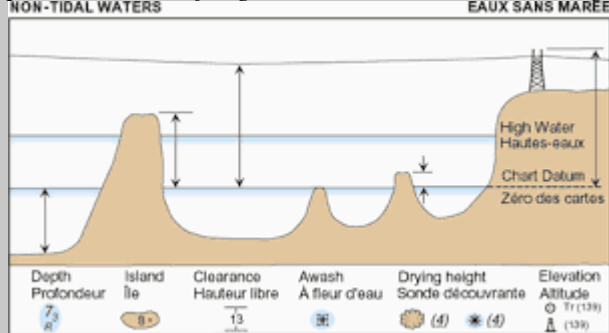

; **3** pretpostavljena pozicija broda u

pogibli (u traganju ispašavanju), pretpostavljena pozicija unesrećenog broda

(odakle počinje traganje i spašavanje)

datum /'deɪtəm ; 'da:təm/ **podatak datum processing** obrada podataka {pl. data}

davit /'davit, 'deɪvt/ a crane, often working in pairs and usually made of steel, used to lower things over

the side of a ship, including launching a lifeboat over the side of a ship. **soha** (za brodice za

spašavanje), tal. gru: The bosun proceeded to open up the brake unit on the port **lifeboat davit**. Following a final examination, each lifeboat was then returned to its **davit** and stowed away. **davit winch vitlo sohe, vitlo za spuštanje i podizanje brodice za spašavanje:** Both the electrician and the seaman rushed to the lifeboat **davit winch** and applied the brake., **boat davit soha za brodicu za spašavanje:** Ensure that all devices fitted to **boat davit** systems to prevent overload are tested on each occasion before a boat is hoisted and that such devices are not relied upon during operation., **ordinary davit obična soha, radijalne sohe, obične sohe, radial davit** one of a set of davits of the type that swings out a boat one end at a time by rotation of the davits **radijalna soha, lifeboat davit soha brodice za spašavanje:** Preliminary information indicated that preparations were being made to test the **free-fall lifeboat davit**., **stores davit soha za spremu i zalihe:** The **stores davit** was unsuitable for the task of lowering the workboat to the water with personnel embarked., **davit arm krak sohe, grana sohe** Adjust the limit switch so that the **davit arm** stops just 50 to 100 mm from the stowing position. The **forward davit arm** had only moved a short distance along the track way, while the **aft davit arm** traversed the full distance., **davit head glava sohe, vrh sohe** Stowed with the bow 20 meters, and the **davit head** 35 meters, above the load



waterline, it was an impressive structure.

davit socket (n) (nav arch) čašica sohe

davit winch (n) (marine eng, seamanship) vitlo sohe: A dynamic test and examination of the **davit winch** and brake assembly were made in the presence of the class surveyor, ship representative and contractor representative.

dawn mist (n) (meteorol) sumaglica u zoru

day (n) (mar law, shipping econ) dan excepted days (shipping econ) izuzeti dani, running days tekući dani (svi danu uzastopce bez obzira na subote, nedjelje i blagdane), weather working days radni dan (za ukrcaj/iskrcaj) ukoliko to dopuštaju vremenske prilike u luci, working days radni dani (u tjednu), SHINC (Sundays and holidays excluded) nedjelje i praznici isključeni (npr. iz stojnica), SHEX (Sundays and holidays included) nedjelje i praznici uključeni (npr u stojnicama)

daybeacon (n) (navig) unlighted, fixed structures (buoys etc.) that are used during the day to help mariners navigate by day; often they are numbered and either red or green dnevna oznaka, oznaka bez svjetla

dayboard (n) (navig) shapes (square, triangle, rectangle) and colours used as information signs on aids to navigation marking channels, obstructions etc. dnevna oznaka

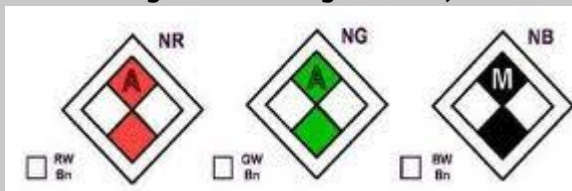

daylight /'deɪ, laɪt/ (n) (navig) danje svjetlo, dan: Berthing in this particular harbour is restricted to daylight Narrative A merchant vessel collided with a fishing vessel in clear visibility and broad **daylight** while on passage at full sea speed on autopilot steering. **in daylight danju, po danu**

daylight marks (n) (navig) **dnevne oznake**

daylight shapes (n) (navig) **dnevne oznake**

daylight signalling lamp **aldis lampa**, **signalna lampa za rad na dnevnom svjetlu**

day mark; day marker (n) (navig) the daytime identifier of an aid to navigation **dnevna oznaka** (tal.: meda)

Day of the Seafarer (n) (seamanship) **Međunarodni dan pomoraca**: *Day of the Seafarer is an official United Nations observance held each year on June 25th in honor of the world's 1.5 million seafarers and the contributions they make in the name of world trade and development.* **Day of the Seafarer celebration** **proslava Međunarodnog dana pomoraca**

daysailer (n) (boating/yachting) **manja jedrilica (za razonodu)**

day shape (n) (navig) **oznaka (kugla, stožac) za uporabu danju, oblik za uporabu danju**: *Time limitations prevented hoisting the 'Restricted in Manoeuvrability' day shapes.*

day signal (n) (navig) **dnevni signal**: *We were displaying navigation lights, day signals (ball, diamond, ball) plus red white red lights for a vessel restricted in its ability to manoeuvre throughout. The ship was displaying the appropriate day signal.*

day worker; dayworker (n) (shipping econ) **nadničar**: *the day worker shall observe the eight (8) regular working hours during the period from 0600 hours to 1800 hours.*

DBB (deals, boards and battens) /di: bi: b:/ (n) (cargo) **teret drva koji se sastoji od tavalona, dasaka i letava tavaloni, daske i letve, drvena građa (brodski teret), drvena građa (brodski teret)**: *While the use of chain sling is permissible for handling deals and battens, rope or webbing slings should be used for boards, box boards, slats laths and similar classes of timber as well, of course, as*

dead ahead (adv) (navig) **directly ahead on the extension of the ship's fore and aft line ravno po pramcu**: *0506 Resumed heaving anchor 0512 Anchor up and clear. 0514 Dead slow ahead. Rudder 10 degrees to starboard, heading at this time around 2900. 0515 Our vessel was drifting to port so I ordered to increase the speed*

dead astern the direction exactly opposite the course of the vessel **ravno po krmi**

dead calm (n) (meteorol) **no wind at all mrtva tišina**

dead centre (n) (marine eng) **mrtva točka bottom dead centre donja mrtva točka, top dead centre; (TDC) gornja mrtva točka**: *... diesel fuel is injected at high pressure into the combustion chamber just before the top dead centre (TDC). By the time the piston is approaching the top of the cylinder (known as Top Dead Center or TDC) the pressure is over 100 bar and the temperature over 500°C.*

dead cover (n) (nav arch, marine eng) **a metal cover fitted inside a porthole, to prevent the entrance of water if the porthole leaks, or the glass becomes broken metalni poklopac (u oknu, vidniku)**

dead end (n) (seamanship) **mrtvi kraj konopa**: *The bridge of the grip should be fitted on the working part of the rope and the U bolt on the rope tail or dead end of the rope.*

dead-eye /dɛd.aɪ/ (n) **1 (seamanship) a wooden block with holes (but no pulleys) which is spliced to a shroud. It is used to adjust the tension in the standing rigging of large sailing vessels, by lacing through the holes with a lanyard to the deck drveni koloturnik sa zaporom**



; 2 (sailing vessels, nav arch) **steznica** {tal.: bigotta}

dead freight; deadfreight /'dɛd ,freɪt/ (n) (mar law, shipping econ) A sum of damages payable by the charterer to the shipowner or intermediate charterer where the charterer loads less cargo than promised in the charterparty. (Tetley); vozarina koja se plaća za neispunjeni brodski prostor ili neukrcanu količinu ili masu tereta; cargo slots paid for but not used **vozarina prazno za puno, prevoznina prazno za puno, mrtva vozarina, naknada vozarine za neiskorišteni brodski prostor**: *Otherwise the Carrier shall be relieved of any obligation to load such cargo and the vessel may leave the port without further notice and **dead freight** is to be paid.*

deadhead (n) (shipping econ) a case when a truck returning from a delivery has no return cargo on the back haul (return journey) **kamion bez povratnog tereta**

dead in the water (prep phr) (navig) **bez kretanja, bez abrive, zaustavljen brod**

deadlight /'dɛd ,laɪt/ (n) 1 (nav arch) a strong shutter fitted over a porthole or other opening that can be closed in bad weather **poklopac broskog okna, čep broskog okna**: *Attention!*



*Close all **dead lights** and storm doors.*

; 2 a watertight glass

mounted in the deck or cabin top which lets light below **svjetlarnik, špiraj**

deadline /'dɛd ,laɪn/ (n) (shipping econ) **datum istjecanja, krajnji rok**

deadman (n) (seamanship) A line that has come free of its cleat and is thrashing in the wind or dragging in the water, a very embarrassing example of poor seamanship.

(<http://www.seatalk.info/cgi-bin/nautical-marine-sailing-dictionary>) **odvezani konop (koji se vuče u moru)**

deadman alarm button (n) (navig, safety) **alarmno dugme u slučaju smrti (časnika)**

straže): The 'dead man' bridge alarm system was disengaged;

deadman alarm panel (n) (navig, safety) alarmna ploča u slučaju smrti (časnika straže)

dead man switch (n) (navig, safety) sigurnosni prekidač u slučaju smrti (časnika ili mornara u straži)

These included 'hard' barriers such as more effective guards and a *dead man switch*, and 'soft' barriers such as risk assessment and understanding of proper operating procedures; This boat was not fitted with a "dead man's" switch, and in the event of the helmsman being tipped overboard would have run on in an uncontrolled manner, putting the individual at risk

dead reckoning /,dɛd ˈrɛkənɪŋ/ (n) (navig) Dead reckoning or DR, in which one advances a prior position using the ship's course and speed. The new position is called a DR position. It is generally accepted that only course and speed determine the DR position. Correcting the DR position for leeway, current effects, and steering error result in an estimated position or EP. An inertial navigator develops an extremely accurate EP (Bowditch 2001) **zbrojena plovidba, zbrojena navigacija:** The GPS which fed the ECDIS, had lost its signal and gone into *Dead Reckoning (DR) mode* shortly after assuming this course. **dead reckoning navigation zbrojena navigacija, dead reckoning position zbrojena pozicija, dead reckoning fix zbrojena pozicija**

dead reconning position (n) (navig) zbrojena pozicija, pozicija dobivena zbrojenom navigacijom, tal. *posizione stimata*

deadrise (n) (nav arch) the design angle between the keel and horizontal, i.e between the keel to the full breadth of the turn of the bilge **nagib dna**

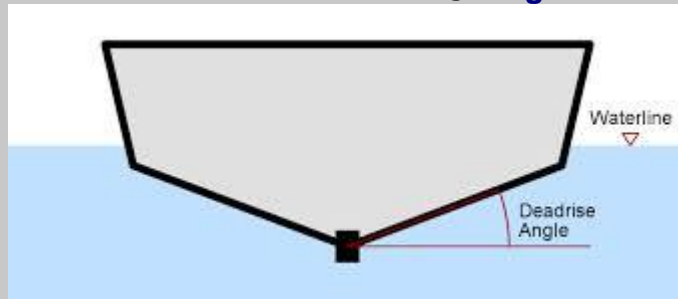

dead run (n) (boating/yachting) jedrenje niz vjetra, niz vjetar

Dead slow ahead! (navig, seamanship) Sasvim lagano naprijed! {naredba za upravljanje strojem}

Dead slow astern! (seamanship, navig) Sasvim lagano krmom! The superintendent asked the master for "dead slow ahead" but the latter relayed the order as "dead slow astern", which was executed by the officer in the wheelhouse. While weighing up the anchor, the master ordered engines on 'dead slow astern' but found himself in close quarter situation with a bunker-barge. {naredba za upravljanje strojem}

dead water (n) (seamanship) vrtlog u brazdi broda

deadweight /ˈdɛd, weɪt/ (n) (nav arch) the weight of a ship's cargo, stores, fuel, passengers, and crew when the ship is fully loaded **nosivost.** *Deadweight* of modern general cargo liners ranges from 9,000 to 25,000 tons At a summer draught of 13.291 m, the ship has a deadweight of 70,181 tonnes. What is the *deadweight* of the vessel? The *deadweight* is 256,386 dwt. {The total weight of cargo, cargo equipment, bunkers, provisions, water, stores and spare parts which a vessel can lift when loaded to her maximum draught as applicable under the circumstances. (http://www.iss-shipping.com/cargo/cargo_library_glossaryd.asp)}

dead weight (n) (shipping econ) mrtva masa

dead weight capacity (n) (shipping econ) **ANTONYM** carrying weight mrtva

masa

deadweight capacity (n) (nav arch) ukupna nosivost broda

deadweight coefficient (n) (nav arch) iskoristivost istisnine

deadweight tonnage (DWT) /'dɛd, weɪt .tʌnɪdʒ/ (n) (nav arch) the actual calculated weight in tonnes of the cargo which can be carried by a ship

(<http://www.seatalk.info/cgi-bin/nautical-marine-sailing-dictionary>) nosivost

deadwood (n) (sailing vessels) a wooden part (vertical timbers or planking) of the centerline structure of a boat, usually between the sternpost and amidships. It is used to fill the spaces where, owing to the shape of the vessel, the floor-timbers have to be discontinued krmeni umetci mrtvog ugla

de-aerate /di:'ɛəreɪt/ (v) (marine eng) otpliniti, odzračiti

de-aerated condensate /di:'ɛəreɪtɪd/ (n) (marine eng) otplinjeni kondenzat

de-aerating tank (n) (marine eng) tank za otplinjavanje, tank za odstranjivanje zraka

de-aeration process /,di:'ɛər'eɪfən/ (n) (marine eng) postupak otplinjavanja, postupak odzračivanja

de-aerator /di:'ɛəreɪtə/ (n) (marine eng) otplinjač, deaerator de-aerator tank rezervoar otplinjača, tank deaeratora

deal /di:l/ 1 a (cargo) daska (debljine najmanje 2 inča), 250x50 cm deals daske, teret dasaka, drvena građa (brodski teret), drvena građa (brodski teret); 2 jelovina (vrste tereta u transportu)

dealer /'di:lə/ (n) (shipping econ) trgovac, prodavač, isporučitelj, predstavnik

proizvođača: *If normal operation is not possible, contact your dealer for advice*

deals and boards (DB) (n) (cargo) = **timber** tavaloni i daske, rezana građa (tert dva u prijevozu morem), **drvena građa:** *A good composition for cargoes is two-thirds deals and battens and one-third boards, and the vessel with clear holds should stow this at about 225 cubic feet per standard.*

deal with /di:l/ (v) (safety) **pozabaviti se s, pobrinuti se za:** *Do not concentrate on other matters, such as recovering the fishing gear: deal with the flooding first.* Nemojte se usredotočiti na druge stvari kao što su podignuti ribarsku opremu: pobritite se prvo za zaustavljanje naplavlivanja / prodora vode. Drills are the very best method on board to ensure that crews **deal with** an emergency in an instinctive and competent manner.

de-ballasting (n) (marine eng, seamanship) **debalastiranje, iskrcaj balastnih voda:**

De-ballasting, excluding stripping, can be undertaken in eight hours. Vessels are not permitted to interrupt loading operations for more than 8 hours for de-ballasting%. As de-ballasting will normally be carried out concurrently with loading, ensure that adequate records are kept of each operation

debenture /di'bɛntʃə/ 1 (mar law) carinska izjava, carinska deklaracija; 2 dugoročna obveznica debenture bond dugoročna obveznica; 3 zaduženje

debit note /'dɛbɪt,nəʊt/ **COMPARE credit note** izvješće o dugovanju / zaduženju

debris /'deɪbrɪ; 'dɛbrɪ/ (n) 1 (safety) **ostaci (od eksplozije nesreće):** *All of a sudden, the aft turbocharger exploded and debris flew all over the engine room.*



; 2 (safety) ostaci nakon brodoloma: The NTSB

launched its investigation into the sinking of the MV on October 5th after floating debris from the vessel was located by Coast Guard searcher and rescue crews. That day, only the EPIRB and **debris** were found. The following morning, the liferaft was recovered, inflated but with a severed painter.

debt /dɛt/ (n) (shipping econ, mar law) dug Lien is the right to hold property until a **debt** is paid off. **Top priority debt** means claims for public interests, which are paid first to creditors and include cargo owners' damages and unpaid charter fees ... **bad debts nenaplativa potraživanja**

debtor /'dɛtə/ (n) (mar law) **ANTONYM creditor** dužnik

debunkering (n) (safety) iskrcaj goriva (radi rasterećenja broda): The debunkering of the ship that sunk in may has been completed and all leaks sealed.

decanting /di'kæntɪŋ/ (n) (safety) discharging the slop liquid overboard iskrcaj iz taložnog tanka u more, iskrcaj pročišćenog sadržaja taložnog tanka u more: Decanting of Slop Stbd will be carried out after enough time has been given to slops to settle. Although the **decanting line** between these tanks should have been drained of naphtha during tank washing, this was overlooked. The owners do not give enough time for **decanting** which takes about 24/36 hours and express their concern over any time delays.

decay /'di:keɪ/ (n) (cargo) propadanje (tereta), truljenje, gnjiljenje

deciduous fruits /di'sɪdʒʊəs/ (n) (cargo) voće bjelogoričnih biljaka, listopadno voće: Optimum transit temperatures for deciduous fruit vary greatly per type and variety, but mostly range between -1 and +4°C.

decision odluka make a **decision** donijeti odluku, odlučiti: Given the tug's rapidly closing distance to the pipeline gantry, he was conscious of the limited time available in which to **make his decision.**, **decision-making** donošenje odluka: Fatigue affects a person's alertness, comprehension, **decision making abilities**, judgment, awareness of danger and many other capabilities essential to the OOW.

deck (n) **deck** Cargo Memo Izjava o palubnom teretu, for on **deck** carriage teret primljen za prijevoz na palubi, **below deck** ispod palube, **above deck** iznad palube, **boat deck** paluba brodica za spašavanje, **navigating bridge deck** paluba zapovjedničkog mosta, **poop deck** paluba krmice, krmica paluba kasara, paluba krmenog nadgrađa, **main deck** glavna paluba, **vehicle deck** paluba za teretna vozila, **car deck** paluba za putničke automobile, **forecastle deck** paluba kaštela, **bridge deck** paluba navigacijskog mosta, **clear deck** slobodna paluba, paluba bez prepreka, **flush deck** ravna paluba paluba bez prepreka, **on deck** na palubi: Once the helicopter winchman was **on deck**, he discussed the situation with the crew. The lashings of the grab loosened and the grab shifted away from its position **on deck**. (**nav arch**) the structures or structural parts

of a ship forming the approximately horizontal surfaces in the ship's general structure **paluba**, **koverta** (na sjevernom Jadranu) **kuverta** (u Dalmaciji), tal. **ponte**; **coperta**. Decks are usually designated by their location, as boat deck, bridge deck, upper deck, main deck, etc.

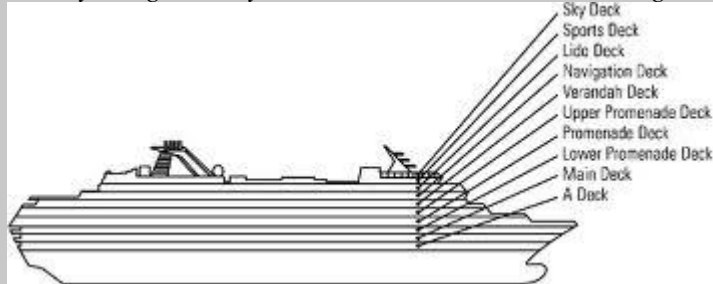

{{abbr.} Dk}

deck beam (n) (nav arch) **palubna sponja**. It was also noted that the hold, in general, was in poor condition with heavy scaling on all surfaces and large wasted holes in the **deck beams**, especially

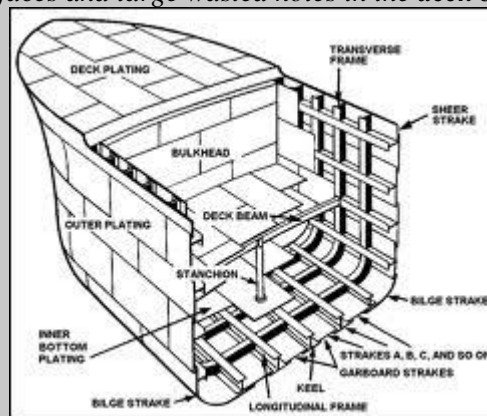

those adjacent to the former hold bulkhead.

deck boy (n) (mar law) **mladić palube**. the **deck boy** standing near the tank entrance entered the hatch to help his colleagues

deck cadet (n) (mar law) **kadet**, **vježbenik palube**. The **Deck Cadet** was passing a mooring rope to the tug from the aft winch drum after taking it around a set of bits and out through the aft centre fairlead.

deck cargo (n) (cargo) **palubni teret**, **teret na palubi**. The list could not be significantly reduced by adding ballast, so the decision was made to jettison some of the **deck cargo**. The vessel managed to make her way to a safe anchorage, where the **deck cargo** could be removed and complete packages eventually re-stowed. **secure deck cargo for sea pričvrstiti palubni teret za režim plovidbe**

deck centre girder podveza, **bočni nosač palube**

deck crane (n) (nav arch) **palubna dizalica**. The C/O and **deck crew** held a toolbox meeting and prepared the port (weather) side combination ladder first. The bosun, with the assistance of a deck cadet and five seamen, had just completed changing the cargo wire on a **deck crane**.. I was overseeing a bulk



carrier self-discharging cargo by **deck cranes** and grabs.

deck crew (n) (seamanship) **posada palube**: Simultaneously, the **deck crew** was taking fresh water from a shore connection through tank filling pipes located on the poop deck. As the vessel's propulsion was going astern in order to stop the vessel the Master reported by VHF radio to the **deck crew** that the vessel was 'in position'.

deck department (n) (mar law, seamanship) **služba palube**: The **deck department** onboard a ship offers a wide range of jobs from ordinary seamen to the captain. Job positions in this department include Captain, Chief Officer, 2nd & 3rd Officers, Boatswain and Seaman. All shipboard personnel and, in particular, the **deck department**, must be advised to report any deficiencies immediately.

deck equipment (n) (cargo handling) **palubna oprema, prekrcajna oprema na plaubi**: Three container vessels have recently suffered heavy-weather damage to **deck equipment**, bow structure, anchor and containers.

deck erection (n) (nav arch) **palubno nadgrađe**

deck fittings (n) **1** (nav arch) **pribor (oprema) za vezivanje tereta na palubi**: Several areas of the vessel were damaged, these included the **deck fittings**, hatches and coamings. ; **2** (boating/yachting) **palubna oprema**

deck gear (n) (nav arch) deck machinery, deck fittings, running rigging, and standing rigging. **palubni strojevi, uređaji i oprema**

deck girder (n) (nav arch) **podveza palube**

deckhand /'dɛk,hænd/ (n) (seamanship, mar law) = **seaman** a person whose job involves aiding the deck supervisor in (un)mooring, anchoring, maintenance, and general evolutions on deck **mornar, stariji mornar**: After a short while the **deck hand** reported that he was unable to close the brake.

efficient deckhand (E.D.H.) **iskusni mornar, stariji mornar**

deck hatch **1** **palubni otvor; 2 poklopac palubnog otvora, bokaporta ; bukaporta**
deck deck hatch **poklopac palubnog otvora**: The planks were bound and stacked in three tiers on top of the **deck hatch covers**.

deckhead (n) (boating/yachting) **pregrada strop potpalublja, strop palube**: A ro-ro ferry was fitted with moveable car decks which could be raised to a stowage position at the **deck head**, or lowered for use.

deck height (n) (nav arch) the vertical distance between the moulded lines of two adjacent decks **visina palube, visinski razmak između dvije palube**

deck-hook (n) (sailing vessels) **zoja** {tal.: gola prodiera di coperta}

deckhouse (n) (nav arch) an enclosed structure built on the ship's upper or main deck **palubna kućica, tal. tuga**: A deckhouse is commonly composed of spaces that are used for crew accommodations and control of the ship (bridge, radio room, etc.) **poop deckhouse krmena**



kućica kućica na krmici

deck lashings (n) (cargo handling) **palubna oprema za učvršćivanje (tereta)**

palubne rice: Deck lashings were removed and crew stood by to remove the support trestle at the front of the trailer.

deck leak (n) (boating/yachting, nav arch) **propuštanje na palubi, propuštanje palube**

deck level (n) (seamanship) **razina palube**: Before I reached the deck level I noticed that below the top step one rope was partly torn off.

decklight (n) (nav arch, seamanship) = **deadlight** špiraj **svjetlarnik**

deck lighting (n) (nav arch) **palubna rasvjeta, rasvjeta plaube**: It took a while before I could clearly distinguish the towing lights, due to the bright deck lighting of the tug.

deck lights (n) (nav arch) **palubna svjetla, radna svjetla na plaubi**: The weather and sea conditions were good, but it was dark, so navigation lights and aft deck lights were switched on.

deck line (n) (nav arch) **linija palube, oznaka palube**

deck load (n) (cargo handling) **teret na plaubi**: A general cargo/container vessel was on passage in heavy weather with a full deck load of containers.

Deck Logbook (=deck log) (n) 1 (navig) This log is the legal record of the passage.

Dnevnik palube: In any event, the officer having the conn must be clearly indicated in the ship's deck log at all times. The deck log combined with the bearing log should constitute a complete record of the passage. At the time of the collision, the container ship's OOW was at the chart table completing the hourly entries into the deck log. In deck log book all the entries regarding navigation and charts are mentioned.;

2 (cargo handling) **Dnevnik ukrcaja tereta na palubu**: Cargo Lashing Deck Log

deck logbook (n) (seamanship) **dnevnik palube**: As everything was quiet, the master took the opportunity to inspect the deck logbook and found that the entries were incomplete.

deck machinery (n) (marine eng, nav arch) All sorts of machinery which is located on various decks of a ship used for mooring, anchoring etc., such as windlasses, winches etc. **palubni strojevi**: The steam supply to the deck machinery was shut down and the Master informed of the situation ... the insulation readings returned to normal and power supply was restored to the deck machinery.

deck officer = mate **časnik palube, oficir palube**: Deck Officers maintain watches on the bridge at sea and about the ship in port. They are responsible for passage planning, the safe navigation of the ship, cargo loading and discharge, ship stability, communications and the maintenance of the hull and deck equipment. The duty deck officer flashed the Aldis lamp five times in the direction of the overtaking ship – but no response. **deck officer trainee student nautike**: At the conclusion of the initial training the successful trainee will have attained: HNC/HND, Foundation Degree or Honours Degree in Marine Operations. (eg. in UK, Ireland)

deck party (n) (seamanship, safety) **palubna skupina (za izvanredna stanja), plaubna**

grupa: A *deck party* was assembled and they *donned* lifejackets and attached themselves to a previously rigged safety line. The Master was quick with his order to put rudder hard to port and to order the *deck party* to deploy a lifebuoy.

deck planking (n) (nav arch) **oplata palube drvenog broda**

deck plate (n) (nav arch) **palubni lim, lim palube:** The poop *deck plate* buckled in way of sheared Panama fairlead.

deck plating (n) (nav arch) **oplata palube:** The fairlead detached from the *deck plating*. Whilst this was being heaved tight the complete structure of the Old Man suddenly broke away from the *deck plating*.

deck railings (n) (nav arch) **ograda plaube:** Once clear of the upper *deck railings*, the load on the crane hook continued to swing dangerously and was impacting heavily on fittings around the manifold area,

deck rating (n) (seamanship) **mornar plaube:** At one point, the chief officer and another *deck rating* lost sight of the two crew detailed to remove the tarpaulins.

deck scuppers (n) (nav arch) **palubne izljevnice, manikele:** All *deck scuppers* were to be sealed and sawdust or other absorbent material provided. Although *deck scupper plugs* could have contained the overflow, prevailing rain made oil spill over the shipside.

deck scuttle (n) (nav arch) **palubno okno, palubni otvor, manikela:** In preparation for



loading, the fish room hatch and a *deck scuttle* were opened.

deck-stanchion (n) (nav arch, sailing vessels) **upora glavne palube**

deck stepped mast (n) (nav arch, boating/yachting) **jarbol oslonjen na palubi**

deck store (n) (nav arch) **palubna sprema, palubno spremište**

deck strake (n) (nav arch) **voj palube**

deck stringer (n) (nav arch) a girder and strake of deck plating that runs along the outboard edge of the deck **proveza palube**

deck transverse (n) (nav arch) **okvirna sponja**

deck traverse (n) (nav arch) **okvirna sponja**

deck web (n) (nav arch) **okvir palube**

declaration (n) 1 (mar law) **deklaracija** **General declaration on Arrival** **Opća izjava o**

dolasku broda, Opća prijava dolaska broda: When reporting at the Custom House, inward light dues are paid and **GENERAL DECLARATION ON ARRIVAL** (or *Inward Entry*) is

completed by the Master or Agent., **General declaration on Departure** **Opća izjava o**

odlasku broda, Opća prijava odlaska broda, Hazardous Cargo declaration **Prijava**

opasnog tereta, General declaration of Health Opća zdravstvena izjava, cargo declaration prijava tereta: *In addition, a copy of the cargo declaration will need to be provided., false declaration lažna prijava, neispravna prijava* There are heavy penalties for making a false declaration and the person signing the forms is declaring that the particulars entered or accompanying the forms are true and complete., **Crew declaration Prijava posade, Stores declaration Prijava zaliha; 2 (mar law) izjava**

Declaration of Dangerous or Polluting Goods (n) (safety) Deklaracija o opasnim ili onečišćujućim tvarima

Declaration of General Average (n) (mar law, mar ins) proglašenje generalne havarije

declaration of origin (n) (mar law, shipping econ) appropriate statement as to the origin of the goods, made in connection with their exportation by the manufacturer, producer, supplier, exporter or other competent person on the commercial invoice or any document relating to goods. **Izjava o porijeklu robe**

declaration of security (n) (safety, mar law) sporazum između dvaju brodova ili između luke i broda kojim se utvrđuju mjere sigurnosne zaštite koje će primijeniti pojedine stranke **deklaracija o sigurnosnoj zaštiti**

declare (v) 1 (mar law) izjaviti: *I declare to the best of my knowledge, that these cargo details are correct for the cargo carried in*; **2 (mar law) prijaviti, dati izjavu o:** *Prior to loading bulk cargo, the shipper should declare characteristics & density of the cargo, stowage factor, angle of repose, amounts and special properties.*; **3 (mar law) proglasiti**

declination (n) 1 (navig) The angular distance North or South of the celestial equator measured along a great circle passing through the celestial poles (<http://www.seatalk.info/cgi-bin/nautical-marine-sailing-dictionary>) **deklinacija (u astronomskoj navigaciji); 2 (navig)** The angle between the compass indication of magnetic north and the closest meridian (<http://www.seatalk.info/cgi-bin/nautical-marine-sailing-dictionary/>) **deklinacija (na kompasu)**

declivity /di'kliviti/ (n) 1 (boating/yachting) nagib jedrilice; 2 (nav arch) inclination of the slipways on which ships are built and down which they slide during their launching **nagib navoza**

decommission /,di:kə'mɪʃən/ (n) (shipping econ, mar law) taking a ship out of service **rasprema broda, povlačenje broda iz plovidbe, stavljanje broda izvan pogona:** *Keel laying is one of the four specially-celebrated events in the life of a ship; the others are launching, commissioning, and decommissioning.*

decommission /,di:kə'mɪʃən/ (v) (shipping econ, mar law) to take or put a ship out of service **raspremiti brod, povući brod iz plovidbe:** *The company has decided to decommission its jack-up rig.*

deconsolidation point (n) (shipping econ, cargo handling) skladište za dekonsolidaciju tereta (radi isporuke pojedinim primateljima)

dedicated (adj) namijenjen samo za ..., namjenski: *The frameworks also meant the use of a dedicated "tipping" winch, emergency stop button could no longer with a remote control.* **on dedicated reefer ships na brodovima građenim isključivo za hladene terete, dedicated service** a service specially designed for the use by one or more particular customers. **strogo namjenske usluge, dedicated lookout posebni motritelj strogo namijenjen motritelj** *The MAIB considers that a dedicated lookout is required during the hours of darkness.,*

dedicated engineer posebni časnik stroja, posebni strojar: *This vessel did carry a dedicated engineer, who was able to deal with the flooding.*

dedicated berth (n) (mar law, ports) = single-user berth, brodarski vez, vez za jednog korisnika, vlastiti vez: *A car and foot passenger ferry arrived alongside her dedicated berth during the early hours of the morning.*

deduct /diˈdʌkt/ (v) 1 izvesti, zaključiti; 2 oduzeti, odbiti: *If the shipowner wrongly and in breach of contract deprives the charterer for a time of the use of the vessel, the charterer can deduct a sum equivalent to the hire for the time so lost.*

deduction /diˈdʌkʃən/ (n) (mar law) odbitak (od plaće) **deductions** from the wage odbici of plaće: *The only deductions from such wages shall be proper statutory deductions as recorded in the Special Agreement and ... , statutory deductions zakonski odbici*

deem (v) 1 držati, smatrati, misliti: *Freight including charges shall be deemed fully earned on receipt of the Goods by the Carrier and shall be paid and non-returnable in any event. By the time the other vessel was a mile off, it was deemed that there was a risk of collision. This Agreement shall be deemed to be terminated in the case of the sale of the Vessel or, if the Vessel becomes a total loss or is declared as a constructive total loss. ... There were no pumps immediately available and it was deemed too dangerous to go on board, so the vessel sank alongside, ending up sitting on the harbour bottom. the risk shall be deemed to exist if ... valja držati da rizik postoji ako ...; 2 suditi; 3 vjerovati: *The bridge team on the ferry deemed the fishing vessel to be on the wrong side of the fairway.**

deep draft (n) (navig) duboki gaz: *As the displaying of the deep draft signal is voluntary (Colreg 28), it was suggested that it should be made mandatory. As we are a deep draft vessel, we have to alter course at the buoy SE of Pyramid Shoal in order to go South (180 degrees). {Said of ships with deep draft and therefore restricted in their ability to manoeuvre}*

deep draft channel (n) (navig) plovidbeni kanal za brodove s dubokim gazom: *She was tracking well clear of us until, at a mere 8 cables range, she decided to take the deep-draught channel, turned to port and scraped down our port side less than 2 cables off.*

deep draft vessel (n) (mar law) = vessel constrained by her draught, brod ograničen svojim gazom: *Large deep-draught vessels are requested to stay at least 1 nautical mile eastward of the Light Buoy for pilot boarding because of the strength and proximity of Own vessel, a large, deep-draught loaded tanker, was proceeding to anchorage at night under VTS instructions. Deep-draught vessels advised to use the channel between the One Fathom Bank beacons.*

deepening low (n) (meteorol) dolina koja se produbljava

deep flange (n) (marine eng) deblja prirubnica, deblja flanda: *Several designs of high output engines have cylinder liners with deep flanges in which a large number of small passages is drilled to carry coolant close to the cylinder bore.*

deep laden (adj) (seamanship) jako nakrcan (brod): *Vessel Traffic Services (VTS) made several calls to the bulker warning that there was a deep laden VLCC tanker in the eastbound lane and they needed to give it a wide berth.*

deep port (n) (shipping econ) luka za koje se tereti krcaju dublje u brodsko skladište, kasnija luka ticanja: *Thus, cargo for later or deep ports on the voyage has to be loaded first, and that for earlier ports loaded last.*

deep sea (n) (oceanogr, mar law) pertaining to offshore ocean areas

(<http://www.seatalk.info/cgi-bin/nautical-marine-sailing-dictionary>) otvoreno more, područje prekomorske plovidbe, deep sea vessel, prekoocenski brod, prekomorski brod, brod prekomorske plovidbe: *This residual fuel is the heavy fuel oil (HFO) traditionally supplied to*

ships as bunkers and used in the main engines of most **deep-sea** and some coastal vessels.

deep-sea navigation = **ocean navigation** duga plovidba, oceanska plovidba, prekomorska plovidba: During **deep sea navigation** at full sea speed, with the chief engineer's approval, the Electrician was engaged in isolating each of the four engine room supply fans for routine inspection, maintenance and operation.

deep sea pilot (n) (navig) peljar za peljarenje na otvorenom moru: The OOW received a call from a **deep sea pilot** on board a nearby tanker, warning him of a developing close-quarters situation.

deep-sea service (n) (shipping econ) duga plovidba, prekoceanska plovidba, prekomorska plovidba: This practice is on the increase, usually involving the use of containers in **deep sea container services**.

deep-sea tanker (n) (shipping econ) prekoceanski tanker: Low-speed engines are dominant in the mainstream **deep sea tanker**, bulk carrier and container ship sectors while medium-speed engines are favoured for smaller cargo ships, ferries, cruise

deep-sea trade (n) (shipping econ) duga plovidba, prekoceanska plovidba, prekomorska plovidba: The largest vessels, which typically are around 80,000 cubic meters, are used in the **deep-sea trade**, for example from the Arabian Gulf to Japan.

deep-sea tug oceanski tegljač

deep six (idiom) (seamanship) to throw an article overboard **bacati stvari u more**

deep tank (n) (nav arch) tank extending from the shell plating, or inner bottom to the lowest deck

duboki tank, **diptank**: Deep tanks are often fitted with hatches so that they may also be used to store dry cargo instead of fuel oil, ballast water, or liquid cargo. About 130 tonnes of fuel were to be taken into No 2 **deep tank**, which had a 360 tonnes capacity.

deep tank bulkhead (n) (nav arch) pregrada dubokoga tanka

deep V hull (n) (nav arch) trup u obliku slova V: 74 MAIB Safety Digest 2/2008 _ CASE 24 CASE 24 Great Fun Until it all Goes Wrong Narrative A new model of a 7m long, stepped **deep V hull powerboat** had been acquired by a leisure craft sales office. {tal. carena a V}

deep water (n) **duboko more**, **duboka voda**: All vessels should walk out the anchor when anchoring in **deep water**. The normal course in this area entails a dog leg to pass the beacons and keep in **deep water**.

deep water anchorage (n) (navig) sidrište za brodove s dubokim gazom: This passage plan should have been changed to pass outside the Humber **deep water anchorage**.

deepwater berth (n) (ports, shipping econ) privezište izvan doka, vez u dubokoj vodi

deep water channel (n) (ports) plovidbeni kanal za prekomorske brodove: The deep water channel from Fawley to the Container Terminal is maintained to a depth of 10.2m below Chart Datum

deep water port 1 a luka za prekoceanske brodove; **2** luka s dubokom obalama (za privez brodova)

deep water route (n) **1** (navig) plovidbeni pravac za brodove dubokoga gaza: The larger vessel was in a **deep water route**, recommended for vessels with a draught of 16m or more, but her draught was only 6m. The vessel was proceeding along the designated east-bound **deep water route**, close to the separation zone of the TSS.; **2** (shipping econ) prekomorska ruta, prekomorski plovidbeni pravac

deep water terminal (n) (ports) terminal za prekoceanske brodove, terminal za

prekomorske brodove *The Port of Salalah, a major Arab Gulf regional gateway port and transshipment hub on the Arabian Sea, has inaugurated a new deep-water General Cargo and Liquid Bulk Terminal,*

default /di'fɔ:lt/ (n) **1 početna postavka / vrijednost, nulta postavka (računalni programi)**: *The OOW was resetting the transponder and it had reverted to **default settings** in the process.*

factory default value tvornička nulta postavka tvornička nulta vrijednost: *The safety contour had been left at the factory default value of 30m. The safety contour on the ECDIS display for the voyage was set at 30m.*

2 greška, mana, nedostatak: *The stevedores, agents or manager of the vessel shall be under any liability whatsoever to the Merchant for any loss damage or delay arising or resulting directly or indirectly from any act, neglect or **default on his part** while acting in the course of or in connection with his employment and, but without prejudice to the generality of the foregoing provisions.*

defect /di'fɛkt; 'di:fɛkt/ **1 oštećenje (tereta) a kvar, defekt, mana, nedostatak**: *Vessels with structural, mechanical or equipment defects affecting their ability to navigate safely, must inform the Harbourmaster of the **defect**. Although the crew were aware of this **defect** (i.e. inoperative alarm), it had not been reported.*

free from defect bez greške bez nedostataka; 2 grješka, greška defective manjkav, neispravan, defektan, nepotpun, oštećen: *The root cause of the spill in the MARS report appeared to be a **defective bunker hose**. High-pressure CO2 fire-extinguishing systems also warns against inadvertent discharge, due to **defective cylinder valves**. Against his better judgement the Master sailed with a **defective engine** into a Southerly gale. B/L bears no clauses or endorsement as to the **defective condition** of the goods or packaging, etc. There was no heading readout available because of the **defective satellite compass**. Serious damage may be caused by water leaking from **defective turbo-blower casings** into the cylinders via the exhaust manifolds. The fire was caused by hydraulic oil, at about 100 bar, being sprayed from the **defective seal**. Further investigations on board other vessels revealed more such **defective lifebuoys** that were accompanied by valid type-approval certificates. The findings revealed the following: absence of rubber gaskets in hatch covers * leaking double bottom tanks * draft marks and load lines not readable * lifeboat launching arrangements defective and inoperative * **lifeboat engines inoperative**.*

Defence Mapping Agency (DMA) Kartografska agencija Ministarstva obrane (US)

defendant /di'fɛndənt/ (mar law) **tuženik, tuženi, optuženik, optužena stranka, okrivljenik, okrivljeni**

Defense Mapping Agency Hydrographic/Topographic Center (DMAHTC)

(n) (navig, mar law) **Kartografska agencija Ministarstva obrane SAD**: *Defense Mapping Agency Hydrographic/Topographic Center creates or produces charts to determine the fix position of the vessel by the lighthouses, headland, and buoys indicated in their charts.*

defer /dɪ'fɜ:/ (v) (safety, mar law) **odgoditi, otkazati defer sailing odgoditi isplovljenje, otkazati isplovljenje**: *A further assessment of the risks should be made and, if necessary, sailing **deferred** until the equipment is repaired.*

deferred rebate /di'fɜ:d 'ri:beɪt/ (n) (shipping econ) **naknadni rabat**

deficiency /di'fɪjənsi/ **1 (safety) neispravnost, nedostatak, manjak**: *deficiencies found and follow up actions utvrđeni nedostaci i naknadne radnje / akcije The agency team found the **deficiencies** on the 85,300 dwt bulkcarrier while conducting a routine inspection on 28 September. The Chief Officer is responsible for any **deficiency in the number** on the discharge of the goods. **severe deficiency ozbiljni nedostatak, rectify the deficiency ispraviti nedostatak**: *The defective tachometer was duly renewed and the **deficiency rectified** at the next port., **make up any****

deficiency, **nadoknaditi nedostatak ispraviti nedostatak** *To make up for any leaks in the system there is a header tank, which automatically makes up any deficiency.*;

2 nestašica; 3 oštećenje tereta

deficient /di'fɪənt/ **neispravan, manjkav, defektan, nedovoljan**: *Deficient fire safety equipment has led US Coast Guard (USCG) inspectors to detain a bulker at the Port of Tacoma until the issues can be resolved The atmosphere in any enclosed space may be deficient in oxygen and/or contain flammable and/or toxic gases or vapours.*

deflection /di'flekʃən/ (n) **1 (marine eng) otklon, deflekcija rudder deflection otklon kormila; 2 (marine eng) izvijanje, savijanje deflection of the webs izvijanje / savijanje koljena, deflekcija koljena**: *To ensure efficient and reliable operation the crankshaft should be checked periodically for alignment by measuring the deflection of the webs., crankshaft deflection*

iskrivljenost koljenastog vratila: *The main engine crankshaft deflection was to be measured and recorded at the anchorage, a routine job completed every three months.*

deflection coils (n) **(navig, electr) otklonske zavojnice (radara)**: *The focused electron beam is deflected by a magnetic field that is generated by current flow through a set of deflection coils.*

deflection indicator (n) **(navig) pokazivač otklona (kormila)**

deflection system (n) **(electr, navig) COMPARE flow of radar signal otklonski sustav (radara)**

deflector (n) **deflector plate pločice deflektora deflektor**

deflexion; see: deflexion (n) = **deflection otklon, defleksija**

deformation (n) **(marine eng) izobličenost, deformacija**: *The ship sustained a minor deformation of the outer structure of the bridge wing. A modified vee-clamp, improved gasket and E-ring were able to compensate for the higher axial deformation. The upper two compression rings were increased in thickness to withstand the higher combustion pressure and reduce torsional deformation..*

permanent deformation trajna deformacija, cause deformation prouzročiti

deformaciju, resist deformation oduprijeti se deformiranju

deformed ice (n) **(oceanogr) led u komadanju, raskomadani led**

defray /di'frez/ to furnish or provide money for (costs, expenses, etc); pay **platiti (troškove)**,

nadoknaditi (troškove): *The Owner shall be liable to defray the expense of medical care and maintenance until the sick or injured person has been cured or ... defray the expense osigurati novac za izdatke / troškove*

defrost damage (n) **(cargo) šteta nastala odleđivanjem**

defrosting (n) **(marine eng) odleđivanje**: *records of inert gas and venting operations; records of reefer defrosting and temperature control; reefer defrosting odmrzavanje hladnjaka*

defruitor /di'fru:tə/ (n) **(navig, electr) integrator s vodom za kašnjenje (impulsa u raconu)**

degauss /di:'gaʊs ; di:'gɔ:s/ (v) **(electr, comm) demagnetizirati**

degaussing /di:'gaʊsɪŋ ; di:'gɔ:sɪŋ/ (n) **(electr) demagnetiziranje**

de-glaze /'di:gleiz/ (v) **(marine eng) odstraniti glazuru, skinuti / kidati glatkoću, ohrapaviti de-glaze cylinder liners skidati glazuru na košuljicama cilindra**

degree (n) **(mar law) diploma o završenom akademskom studiju / stupnju**

obrazovanja: *He holds a degree in Nautical Studies from the University of Southampton. B.Sc*

degree / Bachelor of Science degree diploma o završenom preddiplomskom

studiju; (prvostupnik; univ. bacc.) **B.Sc degree in Marine Operations / Nautical Studies** diploma o završenom preddiplomskom studiju nautike / nautičkih znanosti, **B.Sc degree in Marine Engineering** diploma o završenom preddiplomskom studiju brodstrojarstva, **B.Sc degree in Marine Electrical/Electronic Engineering** diploma o završenom preddiplomskom studiju brodske elektrotehnike/elektronike, **B.Sc degree in Management and Logistics of Maritime Transport** diploma o završenom preddiplomskom studiju magementa i logistike u pomorstvu, **M.Sc degree /Master of Science degree** diploma o završenom diplomskom studiju / magisterij, **Ph.D degree** diploma o završenom poslijediplomskom / doktorskom studiju, doktorat, doktor znanosti; (dr. sc.)

degrees compass (n) (navig) kompasni stupnjevi

degrees magnetic (n) (navig) magnetski stupnjevi

degrees true (n) (navig) pravi stupnjevi: *The ARPA plot showed the ship to be steering 188 degrees true at a speed of about 12.*

degroupage /'di:gru:prɔʒ/ (n) (shipping econ) splitting up shipments into small consignments
pregrupiranje tereta, razdvajanje tereta (iz jednoga kontejnera u druge)

dehumidifier /,di:hju:'mɪdi,faiə/ (n) (cargo handling) **odvlaživač**: *Regular draining of control air bottle as well as main air bottle is to be included in the regular watch routine; Control air drier or dehumidifier, if fitted in the system, must also be checked and maintained at all times.*

delay /di'lei/ (shipping econ) **1** (n) **kašnjenje (dolaska broda, ukrcaja, iskrcaja, isporuke tereta itd.), zakašnjenje, zastoje**. *Serious delays to load and unload vessels at Venezuela's main crude port started to create a backlog of tankers The ship sailed from the terminal without any delay. Expecting a long berthing delay at the discharge port, the charterers ordered the vessel to anchor outside the limits (OPL) of the port.* **delay in the vessel's departure kašnjenje broda u odlasku**: *Another vessel was due onto the berth to discharge cargo, and the pilot was aware that a delay in departure may adversely affect commercial operations in the port.,* **delay in delivery zakašnjenje isporuke tereta** *No compensation shall be payable for loss resulting from delay in delivery unless a notice has been given in writing to the carrier within 60 days ... ,* **cause delay prouzročiti zakašnjenje, izazvati kašnjenje**: *Anchoring and returning alongside following mechanical problems inevitably causes delays. The whole process caused a considerable delay to the vessel.,* **give rise to delay dovesti do kašnjenja, izazvati kašnjenje**: *Accidents give or may give rise to delay to the Vessel or claims or disputes involving third parties. ; 2 odlaganje*: *Therefore, all reports and statements should be completed with the least possible delay.*

delay /di'lei/ (v) **1** (navig) **odgoditi za kasnije**: *The Master did not exercise his overriding authority for the safety of the vessel to delay sailing until his watchkeepers and lookouts were adequately rested. The vessel's owners and DPA were aware of the conditions and asked the master if he planned to delay the voyage, and shelter.* **delay departure odgoditi isplovljenje**: *Initially, the fog had been quite thick and had delayed departure. ; 2 (shipping econ) kasniti, zakasniti*

delay line (n) (navig) **vod za kašnjenje (radarskog signala) delay line canceller sklop za brisanje nepokretnih ciljeva**

deletion of a ship /di'li:ʃən/ (n) (mar law) **brisanje broda (iz upisnika brodova)**

deliberate (adj) **ANTONYM accidental namjeran**: *Ships can roll heavily for numerous reasons such as heavy weather, inadvertent use of the helm or deliberate avoiding action. General average also arises when a deliberate sacrifice or expenditure is incurred for the common safety of the*

other cargo interests.

deliberation /diˌlibəˈreɪʃən/ (n) (mar law) odluka (suda, nadležnog tijela)

deliver /diˈlɪvə/ (v) 1 (shipping econ) predati, isporučiti deliver the goods / cargo /

consignment predati robu / teret / pošiljku, isporučiti robu / teret / pošiljku: *The carrier undertakes to deliver the goods against surrender of the document and the consignee undertakes to take over the goods from the carrier. Prijevoznik se obvezuje predati robu uz predočenje robnih dokumenata, a primatelj se obvezuje istu preuzeti od prijevoznika. We shall take necessary action on the arrival of the ship and deliver your consignment at your address.;* 2 (marine eng, cargo handling)

snabdjeti; 3 (marine eng) osigurati, pružiti, opskrbiti: *the turbochargers cannot deliver the minimum required scavenge pressure turbopuhala ne mogu osigurati potreban minimum tlaka ispiranja*

Two high-pressure pumps deliver fuel to the common rail system.; 4 dostaviti; 5 (nav arch)

isporučiti brod, predati brod (brodovlasniku) deliver the ship isporučiti brod: *The MV Greenland was delivered to JT Cement in December and is already in service. The chemical and product tanker Stena Imperative has been delivered from the Chinese shipyard CSSC Offshore & Marine Engineering. Dutch shipbuilder Ferus Smit has delivered the world's first LNG-powered cement tanker, MV Greenland.*

Delivered Ex Quay (adj) (mar law, shipping econ) COMPARE INCOTERMS 2000 isporučeno s lučke bale

Delivered Ex Ship (n, adj) (mar law, shipping econ) COMPARE INCOTERMS 2000 isporučeno s broda

Delivering Carrier (n) (mar law, shipping econ) the carrier who delivers the consignment to the consignee or his agent **prijevoznik - isporučitelj tereta, konačni prijevoznik**

deliver the goods (n) (shipping econ, mar law) predati robu, isporučiti robu

delivery /diˈlɪvəri/ 1 (shipping econ) The physical and legal transfer of a shipment from consignor to carrier and from carrier/ transport agent to consignee

(<http://www.maerskline.com/en-jm/help/shipping-glossary>); The process of delivering the consignment to the consignee at the agreed place. **isporuka (tereta, robe), predaja (tereta, robe),**

dobava short delivery manjak pri isporuci tereta, nekompletna predaja tereta: *All torn, slack or empty bags or packages should be carefully collected whilst discharging is in progress, delivered (against tally) along with the cargo, otherwise claim for short delivery is likely to follow.,* **make delivery to predati / uručiti (teret), delivery**

order 1 bez zapreke, nalog za iskladištenje, izručnica; 2 diobna teretnica, diona teretnica, on delivery po isporuci, po predaji (tereta), refuse to take delivery of the

cargo odbiti preuzeti teret, date and place of delivery vrijeme i mjesto predaje tereta:

If no Place of Delivery is named on the face hereof, the Carrier shall be at liberty to discharge the Goods at the Port of Discharge, without notice at or onto any wharf, If no Place of Delivery is named on the face hereof, the Carrier shall be at liberty to discharge the Goods at the Port of Discharge, without notice at or onto any wharf,; **take delivery of the cargo preuzeti robu / teret** *The Merchant shall take delivery of the Goods upon discharge. Naručitelj je dužan preuzeti robu po njenu iskrcaju s broda.,* **delivery of the cargo:** *Loading, Discharging and Delivery of the cargo shall be arranged by the Carriers Agent unless otherwise agreed.,* **on delivery po isporuci, prilikom isporuke:**

Freight must be paid, under common law, on delivery of the cargo to the consignee or his receiver at the agreed destination, in the absence of any term to the contrary.; 2 (nav arch) the date when all systems have been tested and discrepancies corrected to the government's satisfaction **primopredaja**

primopredaja

primopredaja

primopredaja

(broda), isporuka broda (od starne brodogradilišta brodovlasniku): *The delivery was preceded by an extensive program of trials and tests in which the proper working and safety of all systems was verified* **take delivery of the ship preuzeti brod, obaviti primopredaju broda; 3 (marine eng) dobava (tekućine, plina, goriva) delivery valve dobavni ventil, tlačni ventil** *A thermocouple sensor is installed close to the pumping chamber to detect delivery valve leakage; if the delivery valve were to leak, fuel from the rail would be re-pumped, causing a temperature increase in the pumping chamber With the spill passages closed, fuel is forced through the delivery valve to the injector.* **delivery pressure dobavni tlak** *Diesel had filed a patent as early as 1905 covering a concept for the solid injection of fuel, with a delivery pressure of several hundred atmospheres.*

delivery /di'livəri/ (n) (mar law) **ANTONYM re-delivery predaja broda u najam, predaja broda unajmitelju (čartereru), predaja broda (čartereru) prilikom početka ugovora o najmu/zakup, stupanje broda u najam (čarter):** *Our vessel let go her starboard anchor at an exposed roadstead at night in a near gale (30-33 knot wind), awaiting delivery on a new charter.*

delivery note (n) (shipping econ, mar law) **A document accompanying a shipment of goods that lists the description, and quantity of the goods delivered. A copy of the delivery note, signed by the buyer or consignee, is returned to the seller or consignor as a proof of delivery.; A document recording the delivery of products to a consignee (customer).** **obavijest o predaji/isporuci robe (brodu ili primatelju):** *Ship operators are encouraged to stipulate that the bunker supplied is 'fit for its intended use' on the delivery note.*

delivery of the ship (n) **1 (shipping econ) isporuka broda; 2 (nav arch) primopredaja broda:** *Hyundai Heavy Industries (HHI), the world's biggest shipbuilder, announced today the delivery of the MV Black Lion.*

delivery order /di'livəri,ɔ:də/ (shipping econ) = **ship's delivery order** **isprava kojom brodar potvrđuje da je primatelj podmirio sve obveze iz teretnice te može preuzeti teret. primatelj se legitimira prezentacijom originala teretnice zapovjedniku broda. U praksi se najčšće primatelj s teretnicom javi prijevoznikovu agentu. Nakon što je primatelj podmirio sve obveze iz teretnice, agent povlači teretnicu i u zamjenu za nju izdaje posebnu priznanicu kojom se potvrđuje da je osoba navedena u ispravi zakoniti primatelj teretnice i da ne postoje zapreke da joj se teret preda. Ta se isprava naziva bez zapreke. (cf. D. Pavić); isprava kojom agent posrednik potvrđuje da je primatelj ispunio sve obveze iz teretnice; A document from the consignee, shipper, or owner of freight, ordering a terminal operator, carrier or warehouseman to deliver freight to another party.**

(<http://www.globalnegotiator.com/international-trade/dictionary/delivery-order>); **An order from the consignee, shipper or owner of freight to a terminal operator, carrier or warehouse to deliver freight to another party. On imports, it may also be known as a pier release**

(<http://www.maerskline.com/en-jm/help/shipping-glossary>); **A carrier's delivery order (negotiable document) is used for splitting a B/L (after surrender) in different parcels and have the same function as a B/L. (http://www.iss-shipping.com/cargo/cargo_library_glossaryd.asp)** **izručnica, bez zapreke,**

nalog za iskladištenje / izručenje tereta s broda, nalog za iskrcaj, delivery order,

nulla osta (lat. = bez zapreke): *In the liner trade it is usual for the to present his B/L to the Carrier and receive in exchange a Delivery Order.. This is the consignee's authority to take of the goods from the ship or wharf or warehouse.* **{- Delivery order should be clearly distinguished from bill of lading: the delivery order is not a negotiable document, nor does it evidence receipt of goods, nor does contain the provisions of the transport contract under which the goods are shipped.(**

<http://www.globalnegotiator.com/international-trade/dictionary>); **- a carrier's delivery order (negotiable**

document) is used for splitting a B/L (after surrender) in different parcels and have the same function as a B/L. (http://www.iss-shipping.com/cargo/cargo_library_glossaryd.asp); -}

delivery party (n) (*shipping econ, mar law*) The party to which goods are to be delivered.
primatelj (robe, pošiljke, tereta)

delivery time (n) (*shipping econ*) The time between order and delivery. rok isporuke

delivery valve (n) (*cargo handling, marine eng*) dobavni ventil

delivery van (n) (*cargo handling*) dostavno vozilo



delta mast (n) (*boating/yachting*) jarbol s delta križom

delta spar (n) (*boating/yachting*) delta križ

demersal gear /di'mɜ:səl/ (n) (*fishing*) pridnena ribolovna oprema

demesne /di'mein; di'mi:n/ (n) **maritime demesne** pomorsko dobro, pomorsko javno dobro 1 (*mar law*) dobro, zemljišno vlasništvo; 2 javno dobro, državno dobro

demise charterer (n) (*mar law*) zakupac broda, zakupac cijelog broda s posadom:

It is usual for claims to be brought against the contractual carrier as named in the bill of lading, who is likely to be the shipowner or the demise charterer.

demise charter party /di'maiz/ (n) (*mar law*) zakup broda s posadom, zakup broda s

bodovlasnikovom posadom, ugovor o zakupu broda: *Under both demise and time*

charters, the charterer pays charter hire for the use of the vessel at a specified daily or monthly rate. In a demise charter the ownership to all intents and purposes changes hands for the period of the contract. In the case of time and demise charters, both of these contain a contract whereby the vessel is actually hired for a specific period of time, ...

demulsibility (n) (*marine eng*) The demulsibility of an oil refers to its ability to mix with water and then release the water in a centrifuge. demulzivnost

demurrage /di'mʌrɪdʒ; dɪ'mɜ:ɪdʒ; dɪ'mə:ɪdʒ; / COMPARE dispatch money

COMPARE laydays, lay days kašnjenje broda ili tereta za početak operacija

ukrcaja/iskrcaja u odnosu na ugovorom/čarterom utvrđenu obvezu : In a voyage charterparty, an agreed amount payable to the shipowner by the charterer in respect of delay in loading or discharging the vessel beyond the laytime, for which the owner is not responsible (Tetley) fee is applicable when the customer holds carrier equipment in the terminal for longer than the agreed amount of free time

(<http://www.maerskline.com/en-jm/help/shipping-glossary>) prekosojnice, danguba,

kontrastalije; tal. *contrastallie*, vrijeme prekosojnica, tal.: *contrastallie*: Each

Merchant shall be liable towards the Carrier for a proportionate part of the total demurrage due, based upon the total freight on the goods to be loaded or discharged at the port in question. demurrage rate

naknada / iznos kao kazna za prekosojnice, on demurrage u prekosojnicama /

dangubi (brod ili čarterer) : *Provided that if the delay is due to causes beyond the control of the Merchant, 24 hours shall be deducted from the time on demurrage.*

demurrage rate /di'mʌrɪdʒ ,reit/ (*mar law*) iznos prekosojnica

dense (*adj*) **gust dense fog (meteorol) gusta magla**: Two ships collided **in dense fog** in the Kiel Canal's inland port of Brunsbüttel. **There was dense fog** throughout the area when a pilot boarded a large bulk carrier which had discharged its cargo at a riverside berth., **dense traffic (navig) gust promet**: The OOW should not be distracted to carry out the duties of safe navigation especially within such **dense traffic areas**. It should also include other precautions such as a reduction in speed - due to factors such as the proximity of dangers, the likelihood of **dense traffic** or poor visibility., **dense smoke (safety) gusti dim**: As he opened the door he was immediately confronted by **dense smoke**.

density /densiti/ (*n*) **1 (stabil)** (for ship stability purposes) density of any given substance is its mass per unit volume; tonnes per cubic metre (t/cubic metre) **gustoća relative density** te ratio of the density of the substance in question to that of fresh water; the density of fresh water is 1.000 t/cub. m; salt water density is 1.025 t/cub.m **relativna gustoća**; **2 zgusnutost / zbitost**; **3 specifična težina**

density of traffic (n) (navig) gustoća prometa: A combination of wind direction, restricted sea room, **traffic density** and routeing prevented a change of heading to provide sufficient lee for rigging the combination ladders; When aware that crossing traffic is expected in the region, **density of traffic** is fairly high, and the size and speed of vessels is are high, then it is all the more reason that extreme caution is exercised.

dent udubina (na trupu/limovima nakon sudara), udubljen dio (broda): The only visible damage was a **dent to the starboard bow**. The barge whipped around and struck the shell plating on the port bow of the anchored ship, **causing a large dent**. There were slight personal injuries and **the**



hull was dented.

dentex (n) (fishing) = common dentex Lat. Dentex dentex **zubatac**

deny entry (v) odbiti ulaz broda (u luku, državu): The port is now struggling to accommodate vessels **denied entry** elsewhere and forced to sail home

depart /di'pa:t/ (*v*) (**shipping econ, navig**) **isploviti, napustiti luku**: on April 5, 2007 the vessel **departed** Fort Lauderdale for a 16-day cruise to Valetta, Malta **depart from isploviti iz, depart the port isploviti iz luke**: A tanker was preparing to leave her berth and **depart the port** by way of a narrow channel. We **departed** at 18.00 and by 18.45 had disembarked the pilot.

Department /di'pa:tmənt/ (*n*) (**mar law**) **Department of Navigation ministarstvo pomorstva ministarstvo Department of Trade minstarstvo trgovine, Department of Transport minstarstvo prometa, ministarstvo transporta, Mercant Marine**

Department ministarstvo trgovačke mornarice, ministrastvo pomorstva, Marine Department ministarstvo pomorstva: In the report dated February 12 **the Marine Department** states that on a rainy day in June 20__, a stevedore was found with a heavy head injury on board a container ship., **Navigation Department ministarstvo pomorstva**: ... the surveyor from the Australian **Navigation Department** ordered, no one is to enter the lower hold until the cargo has been

discharged and the rubbish has been properly cleared., **Fisheries Department** ministarstvo ribarstva

department /di'pa:tment/ **1 služba (na brodu) catering department služba bijelog osoblja, brodski ekonomat, deck department služba palube, engine-room department služba stroja, radio department služba veze, radio-služba, steward department bijelo osoblje; 2 odjel, odsjek (ustanove, tvrtke, fakulteta) Head of the department predstojnik odjela, voditelj službe:** Always inform head of department of any hazardous condition and never to attempt an unauthorized job or task or hazardous task alone; **purchasing department nabavni odjel, nabavna služba:** This ensured that management could instruct the purchasing department to replace the lost items and the fleet team could make the necessary arrangements for additional support during the discharge and the various inspec, **technical department tehnički odjel, tehnička služba:** It is the responsibility of the ship owner/manager's technical department to ensure that ships' engineers are aware of oil stress, the symptoms to look for and how to prevent it occurring., **operational department operativni odjel:** Regular reports are prepared for each operational department, each ship and for the company as a whole., **Insurance department služba pomorskog osiguranja:** First of all, fill out the required form sending one copy to your insurance department., **accounting department računovodstveni odjel, računovodstvo:** The management needs to keep the Accounting Department up to date with operational proceedings at all times, with changes and corrections when necessary., **chartering department čarterska služba (brodarskog društva) služba iznajmljivanja/unajmljivanja brodova:** A chartering department does not consist entirely of brokers., **engineering department tehnička služba (brodarskog društva):** The engineering department investigated and found the port stabiliser head severely damaged.; **3 ministarstvo (US)**

departure /di'pa:tʃə/ (n) (**seamanship**) **polazak (broda na putovanje), isplavljenje, partenca; tal. partenza:** Ensure that checklists include the requirement to prove propulsion controls before arrival and before letting go mooring lines on departure. The day after departure from a turnaround port, the chief officer began deep-sea ballast water exchange. **At the time of departure,** my VHF radio was tuned to Ch 16 and the appropriate Harbour Channel. 20 minutes after departure the cargo vessel's main engine oil mist detector alarm sounded while the engine was at full ahead. The chief officer came to the bridge just before departure and was not fully briefed. **delay in departure kašnjenje u polasku broda:** Fortunately no one was on the gangway when it failed and the incident resulted only in equipment damage and a minor delay in departure., **departure checks provjere pri isplavljenju:** Prior to weighing anchor the chief mate had started to test the gear, and when the master arrived on the bridge he finished off the pre-departure checks., **departure checklist popis provjera pri isplavljenju:** The poor use of the departure checklist is most likely to have contributed to this failure., **departure manoeuvre manovra isplavljenja:** The master and pilot exchanged information on the vessel's status and briefly discussed the planned departure manoeuvre., **departure report izvješće / izvještaj o isplavljenju, izvješće / izvještaj o polasku iz luke:** Instructions from the charterer may indicate that arrival and departure reports for all ports be turned in on completion of the voyage., **departure time vrijeme isplavljenja, vrijeme polaska broda iz luke:** The Master set the vessel's departure time to midnight that same day., **vessel's departure isplavljenje broda, polazak broda iz luke:** To assist the vessel's departure, the head lines were tightened, to swing the stern off the quay.

departure arrangements (n) (navig) **dogovoreno isplavljenje broda, operacija isplavljenja broda**: As the problem could not be immediately detected and rectified, the scheduled **departure arrangements** had to be postponed resulting in off hire and commercial loss.

departure briefing (n) (navig) **kratak dogovor o isplavljenju broda**: Despite this familiarity, the master ensured that the presailing checklist had been fully completed and he **held** a full **pre-departure briefing with the bridge team**, discussing the manoeuvre, the environmental conditions, and ... A pilot boarded and **was in the pre-departure briefing with the Master and bridge team** ...

departure brief (n) (navig) **kratak dogovor prije isplavljenja broda**: Although **departure and arrival briefs** might occasionally seem repetitive and unnecessary, they do help to ensure that everyone is aware of where the vessel should be

departure draught /di'pa:ːtʃə/ (n) (navig) **gaz pri isplavljenju**

departure port (n) (shipping econ) **luka polaska, luka isplavljenja, polazna luka na putovanju**: In this occurrence, 41 passengers embarked at the initial **departure port** and received the briefing; on the other hand 219 other passengers, who embarked at later ports, did not receive the briefing.

departure procedure (n) (navig) **postupak pi odlasku/isplavljenju (broda iz luke)**: Ballasting operations should be part of the vessel's standard **departure procedures** and safety management system. **Departure procedure**, as agreed with the pilot, was to tow the vessel upstream against the current, then turn the vessel at a distance that would allow the vessel to gain minimum steerage speed ...

dependant /di'pendənt/ (n) (mar law) **član obitelji (zaposlenog pomorca)**

deploy /di'plɔɪ/ (v) **1 rasporediti (ljudu na dužnosti)**: For any work more than two metres above the deck, it is advisable to **deploy another crewmember** to continuously supervise, monitor and assist the worker aloft. **2 upotrijebiti, postaviti, rasporediti (tegljače, opremu itd)**: They poorly considered the deployment of tugs, which ideally should have made fast on the starboard side before passing the breakwater. Loše su rasporedili tegljače (oko broda), jer su oni, u idealnoj situaciji, trebali biti uhvaćeni s desne strane broda prije nego što je brod prošao lukobran. The skipper was concerned that the vessel would capsize, so instructed the crew to **deploy a liferaft** without delay. **Deploy standby vessel to patrol safety zone of a two mile radius and warn vessels in vicinity.** **deploy on the service uvrstiti u linijsku plovidbu, uključiti brod u plovidbu (servis)**: The ship is **deployed on Maersk Line's service**. Both newbuildings are planned to **be deployed** in the company's route network on the North Sea.

deployment (n) (navy) **raspored (ratnih brodova), zadaća routine deployment rutinska zadaća, rutinski raspored**: a naval destroyer entered the Sea a few days ago on a **routine deployment**

deposit /di'pɒzɪt/ (v) **1 položiti (novac / dokument); 2 taložiti, nanositi**

deposit (n) **1 (financ) polog (novca u banci / dokumenta itd.)**: If a general average deposit is required, the consignees will have to pay the amount demanded in return for a receipt for it. **2**

(marine eng) **talog, naslaga, talozi čađe**: Such engines will obviously be more sensitive to the mechanism of piston crown **deposit** build-up than older designs having much lower mechanical and thermal load levels. By spraying a certain amount of water into the compressor, the **deposit** can be removed, provided it has not already become too hard. Clean the gear housing and the spindle parts thoroughly and remove all **deposits** before filling the new oil. **carbon deposits naslage ugljika, scale deposit naslage kamenca**: To reduce the corrosive action and inhibit the formation of **scale deposit** in the system it is usual to provide some form of water treatment.

depot /'dɛpəʊ ; US 'di:pəʊ/ (cargo) **skladište**: A discarded marine flare ignited on the picking line at a **depot** where ship's garbage is sorted. **to release a container from depot izdati kontejner sa**

skladišta, container depot kontejnersko skladište

depreciation /di.pri:ʃi'eɪʃən/ (n) (shipping econ) **amortizacija (broda)**

depression /di'prɛʃ(ə)n/ (n) (meteorol) a region of low atmospheric pressure that is usually

accompanied by low clouds and precipitation **ciklona, područje niskog tlaka, depresija**: *The weather forecast indicated that the **centre of the depression** and the ship's intended course were converging, so the officers and crew had been ordered to secure the ship for heavy weather. Some two days into the ocean crossing, the **frontal depression** had deepened into a severe storm. The **depression** was tracked and, in an effort to avoid the worst of the weather, the ship altered course. **cold depression***

hladna ciklona, deep depression duboka ciklona: *Due to a **deep depression** producing severe gales, the vessel remained within the lee of the land for most of her voyage.*

depression angle (n) (navig) **radarska depresija**

depth /dɛpθ/ 1 **dubina**: *The vessel was passing directly over an area of water with less depth than the draught of the vessel. By the time he was on deck, the depth sounder was showing **minimal depth**, and almost immediately the keel touched the bottom. When the **depth decreased** to 38 metres, the anchor took some of the weight and the ship's head swung into the wind. **depth alongside dubina veza,***

dubina lučke obale: *Check the minimum **depth of water alongside**, the berth and in the fairway channels., **depth at the berth dubina uz vez broda, depth taken by sounding dubina***

izmjerena ultrazvukom, depth unknown dubina nepoznata, depth of the water

dubina mora: *This route took the vessel across Haisborough Sand, where the **charted depth of water** was considerably less than the vessel's draught. The pilot ordered the port anchor to be let go and to be held at 3 shackles on deck as the **depth of water** was only 15 meters., **depth of the bank dubina***

rječne obale: *The published chart correction revised the **charted depth of the bank** to be 7.1 m.,*

charted depth dubina ucrtana na karti: *The **charted depth** at the position of the grounding was shown to be greater than 20m, with the closest sounding on the chart showing a depth of 26m., **chart***

depth dubina na karti: *It passed over the narrowest part of a sandbank where the least **chart depth** was between 8 and 9 metres., **minimum depth minimalna dubina**: Subsequently, the harbour*

*pilot confirmed that the **minimum depth** in the area was 20 m at low water., **sufficient depth***

dostatna dubina: *dovoljna dubina As the incident occurred close to the time of high water, there was **sufficient depth of water** available for the container ship to pass outside the main channel.; 2 **razmak***

*od dna broda do gornje palube; the distance [m] measured vertically on the midship transverse section, from the base line to the top of the deck beam at side on the uppermost continuous deck **teorijska***

visina broda, visina trupa broda

depth alarm (n) (safety, navig) **alarm dubine mora**: *In most collisions and groundings, electronic aids such as ARPA, CPA and TCPA alarms, waypoint alarms and **depth alarms** had not been used.*

depth alongside (n) (ports) **dubina uz lučku obalu, dubina lučke obale**

depth charge (n) (navy) an explosive device launched from a ship to attack a submerged submarine (<http://www.seatalk.info/cgi-bin/nautical-marine-sailing-dictionary>) **dubinske bombe**

depth contour (n) (navig) **izobata**: *This resulted in the use of inappropriate settings with regard to **depth contours**, and chart and depth alarms. t, with the datum shift applied, and the position correctly plotted, the vessel was 240 metres outside the circle, and already across the **20-metre depth contour**, putting the bow 90 metres from a charted 10.*

depth finder dubinomjer

depth sounder (n) (navig) = **fathometer, echosounder** an instrument for measuring

the depth of the water **ultrazvučni dubinomjer, tal. ecoscandaglio**: *I immediately went to the Bridge and discussed my concern with the Chief Officer as to what was happening with the tides, then I looked at the **depth sounder** - it said 2.8 metres! A vessel's position as displayed on an ECS can and should be crossreferenced using radar, Loran, visual, **depth sounder** etc.*

depth soundings (n) (navig) **snimanje dubine, mjerenje dubine take depth soundings snimiti dubinu, izmjeriti dubinu**: *At the same time, **depth soundings** were taken by one of the assisting tugs.*

deratisation /di:ræti'zeifən/ **deratizacija**: *It has to be borne in mind however, that whilst **deratisation** by fumigation, or otherwise, may destroy all rats when on board its efficacy is only temporary ...*

de-ratting /di:'rætiŋ/ **deratizacija**: *... the master should have ready for production the Maritime Declaration of Health as well at the **Deratting (or Exemption) Certificate**. **de-ratting certificate svjedodžba / potvrda o deratizaciji***

derelict /'derilikt/ (n) (safety) an abandoned vessel floating at sea and therefore presenting a danger to navigation **olupina, napušteni brod**: *Derelict Vessel still afloat, abandoned at sea. Unlit **derelict***



vessel adrift in vicinity.

derick support (n) (cargo handling, nav arch) **hajmica samarice, upornica**

derivative /di'rivetiv/ (n) 1 (cargo) **derivat**; 2 (cargo) **naftni derivat, naftni proizvod**: *The movement of liquid bulk cargo, crude oil and derivatives, from the tanker is undertaken by means of pipelines connected to the shore-based storage tanks.*; 3 (marine eng) **inačica, izvedba**: *A V18-cylinder **derivative** of the 3600 series was jointly developed by Caterpillar with the Spanish enginebuilder Bazan Motores to target high-speed ferry propuls*

derrick /'derik/ (n) 1 (cargo handling, nav arch) a lifting device composed of one mast or pole and a boom or jib which is hinged freely at the bottom **samarica, teretnica, tovarnica, derić, delić**: *The derricks are the ship's cranes, and their lifting capacity can vary from 3 tonnes to 50 tonnes or more. Derricks are used for raising or lowering heavy weights, cargo, stores, etc. **single swinging derrick jednostruka samarica, union purchase derrick udvojene samarice, samarice u paru, Hallen derrick samarica s teretnim stupom u obliku polegnutog slova D Hallenova samarica, Stuelcken heavy lift derrick samarica tipa Stuelcken za teške terete, derrick heel peta kraka samarice, peta samarice**. *The **derrick heel** had not lifted and the wire strop was unstressed.*, **derrick head vrh kraka samarice**: *As soon as a container is lifted off an anchored vessel it starts swinging, the degree of swing depending upon the state of sea; as the **derrick head** swings together with the barge, so does the container.*, **Velle derrick samarica tipa Velle s teretnim stupom u obliku slova T samarica tipa Velle, head of the derrick glava samarice, vrh derića, rig the derrick pripremiti samaricu za rad***

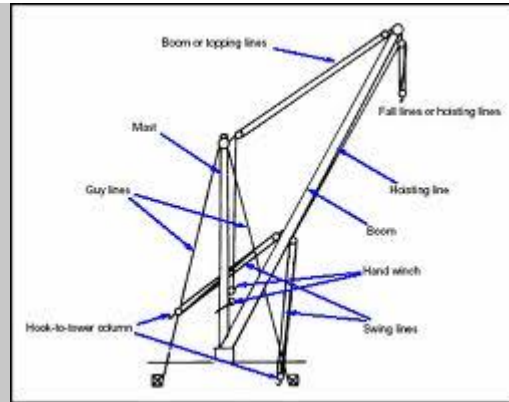

; 2 krak dizalice

derrick boom (n) 1 (cargo handling) samarica, krak samarice, deblo, grana: *The derrick topping lift double purchase was disconnected from the derrick head and attached to the derrick boom near the heel with a wire strop, with the intention of using the greater force available to free the heel*

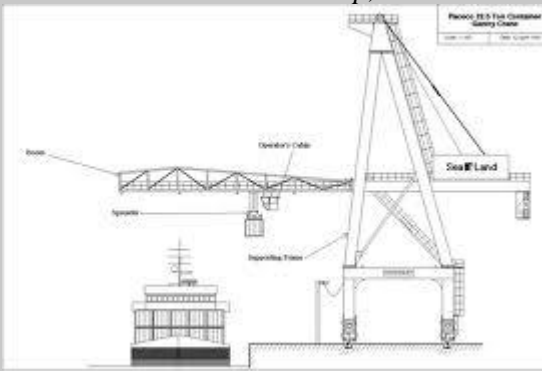

pin.

; 2 krak dizalice

derrick chock (n) (cargo handling, nav arch) hajmica samarice, upornica

derrick equipment (n) (cargo handling) oprema samarice

derrick guy brk samarice

derrick heel (n) (cargo handling) peta samarice

derrick hoist (n) (cargo handling) brzina dizanja kraka dizalice

derrick pin (n) (cargo handling, nav arch) osnac samarice

derrick post (n) (cargo handling) teretni stup

derrick winch (n) (cargo handling) vitlo samarice: *Worst of all, the port derrick winch auto-tensioner had frequently failed, causing the port derrick to suddenly drop directly in the area where the crew member was positioned.*

desalination (n) (marine eng) desalinizacija morske vode sea water desalination system sustav desalinizacije morske vode, desalination system uređaj za

desalinizaciju: *Wärtsilä's delivery comprises a total of 10 large MSF distillation systems with unit capacities spanning from 115 tons/day to 900 tons/day, and 4 Single Stage Desalination systems (SSD) with unit capacities of 30 tons/day.*

desalinator /diːˈsæli,neɪtə/ (n) (marine eng) desalinator manual desalinator ručni desalinator (za brodice, jahte), power desalinator električni desalinator (za brodice, jahte)

descend /diːˈsɛnd/ (v) 1 ANTONYM ascend silaziti, spuštati se: *Never descend into a confined space to save a victim unless you are equipped with proper breathing apparatus and have support from other personnel. However, when the brake was applied, it failed and the boat continued to descend.*

The Pilot managed to **descend** the remaining two metres to the boat deck.; **2 (marine eng) spuštati se (o klipu motora)**

description of goods (n) (mar law) opis robe (u teretnici)

desertion /di'zɜ:ʃən/ (n) **1 (mar law) the act of purposely and unlawfully abandoning the ship by the crew neodgovorno napuštanje broda;** **2 (mar law) a crewmember unlawfully leaving his duties on a vessel neodgovorno napuštanje dužnosti na brodu (npr. straže itd.)**

design /di'zain/ **1 plan, nacrt, crtež design drawings izvedbeni nacrt;** **2 (nav arch) projektiranje, projekt:** *Deltamarin's scope of work includes basic and detail design of the hull outfitting, machinery and cargo areas.*

<http://www.marinelink.com/news/deltamarin-molslinien414939.aspx> **design services usluge**

projektiranja projektne usluge *Deltamarin Ltd is to provide the Finnish Rauma Marine Constructions Oy shipyard with design services for a ro-pax vessel to be built for the Danish Mols-Linien A/S.* <http://www.marinelink.com/news/deltamarin-molslinien414939.aspx>; **3 izvedba:** *A special inlet port design and engine control system ensures a homogeneous and lean mixture of air and gas. Improved hull design and the use of ships with larger cargo carrying capacities have led to a reduction in emissions and an increase in fuel efficiency.*; **4 konstrukcija**

design /di'zain/ (v) **1 projektirati, konstruirati:** *The new 158-metre ro-pax vessel will be designed and optimised to carry passengers and cargo between the Danish islands of Bornholm and Sjaelland.*; **2 kreirati**

designated anchorage (n) (navig) **A protected waterway clearly marked on local charts, lying clear of navigation channels and offering adequate depth and good holding ground where boats may anchor.** (<http://www.seatalk.info/cgi-bin/nautical-marine-sailing-dictionary>) **označeno sidrište, područje određeno za sidrenje, područje obveznog sidrenja:** *A laden tanker anchored outside the entrance of a traffic separation scheme (TSS) in a designated anchorage to await the next rising tide in order to proceed upriver to discharge her cargo.*

designated area (n) (navig) označeno područje, područje određeno za (sidrenje itd.): *One of our tankers was proceeding with a Pilot on board to anchor in the designated area for bunkering in a large Asian port.*

designated person /'dɛzɪg, neɪtɪd/ (n) **(mar law, safety) (u pravilniku ISM) osoba koja ima izravan pristup najvišoj razini upravljanja zadužena osoba, nadređena osoba designated person ashore; (DPA) zadužena osoba na kopnu**

Designated Person Ashore; DPA (safety) zadužena osoba na kopnu (u sustavu SMS brodarskog društva), osoba na kopnu zadužena za sustav upravljanja sigurnošću, zadužena osoba brodarske kompanije (u sustavu ISM):

The Designated Person Ashore (DPA) was informed and began an investigation immediately. We arranged for the vessel's bridge officers, and company's Designated Person (DPA) and marine / nautical superintendent to attend an equipment-specific training course on the ECDIS type fitted on board;

designated route (n) (navig) zadana ruta, zadani smjer, obvezna ruta: *At about 2100 hrs, after reaching her waypoint, the vessel altered course to 070°T and was proceeding along the designated east-bound deep water route*

design criteria (n) (nav arch) konstrukcijska obilježja (broda): Design criteria: *Ice-strengthened, single decked, single screw motor ship with double bottom and double skin with coated cargo tanks. No steel structure facing into the cargo tanks. The hull form is designed for minimum resistance, overall design provides an environmentally friendly, cost-effective, reliable and flexible unit. One deep-well pump for each tank and complete segregation for each cargo tank, one vapour return line.*

designed /di'zaind/ **1 konstruiran:** 70 BN cylinder oil and an engine series is well designed against corrosive wear and with no need for excessive BN. It must be remembered that anchoring equipment is **designed and manufactured** only for mooring a vessel in moderate sea conditions, and for relatively short periods, while awaiting berth availability **designed for namijenjen za**,

konstruiran za, designed to konstruiran za, namijenjen za, In the 1950s, as trade volume increased, the industry started to develop special tankers designed to carry up to 40 parcels of different chemicals within a single ship.: Siemens' SINOx SCR system is **designed to** reduce the emissions of different exhaust gas pollutants simultaneously—notably NOx, HC and soot—as well as to achieve a sound attenuation Fuel feed lines are integrated in the pump housing, and the fuel system is **designed to** keep pressure pulses low. The anchor gear is **not designed to** stop a ship.;

2 namijenjen: Among the **measures designed to** ease inspection and maintenance are: cylinder heads hydraulically tightened with four stud screws on the cylinder block; and ... The manoeuvre was **designed to** make best use of a strong south-westerly wind.;

designed for /di'zain/ (adj) **1 (marine eng) projektiran za:** The injector was also **designed for** robust safety in the event of a fault condition.;

2 (nav arch) namijenjen za: These vessels have multiple decks **designed for** the carriage of cars, and a high cubic in order to maximize the number of vehicles which can be loaded.

designed output (n) (marine eng) nazivna snaga (motora), projektirana snaga

designed waterline (n) (nav arch) projektna vodna linija

designer /di'zaine/ **1 (marine eng) projektant:** A pioneering Danish **designer and builder** of low-speed two-stroke crosshead engines, Burmeister and Wain (B&W) focused in the post-War era on high-pressure turbocharged single-acting uniflow-scavenged models with one centrally located exhaust valve. CatErpillar A wide programme of high-speed engines from the US **designer** Caterpillar embraces models with bore sizes ranging from 100 mm to 170 mm. The A55 benefited from GMT's technical collaboration with New Sulzer Diesel, permitting elements of the Swiss **designer's** successful ZA40S medium-speed engine to be exploited. **engine designer projektant stroja, graditelj strojeva:** MTU Friedrichshafen, the German high-speed **engine designer**, was a pioneer in adopting the technology in the modern era and worked on CR systems in conjunction with specialist fuel injection partners ...;

2 (marine eng) konstruktor

design feature /di'zain/ (n) (nav arch, marine eng) konstrukcijsko obilježje,

konstrukcijska osobina, detalj konstrukcijske izvedbe

design speed /di'zain/ (n) (nav arch) projektirana brzina broda

desmoking (n) (safety) odvodnja dima, odimljenje

despatch /di'spætf/ (n) **1 (shipping econ, mar law) otprema:** In order that we may effect customs clearance and **despatch**, we would feel obliged if you would let us have the Bill of lading duly endorsed together with a letter addressed to customs & Excise authority The carrier shall be paid demurrage at the daily rate of 45\$ per ton of the vessel's GT if the vessel is not loaded or discharged **with the despatch set out in** Clause 8; and delay in waiting for berth or off the port to count. **quick despatch**

brza otprema (tereta), brz ukrcaj (tertea): ... the C/P may state that the cargo is to be loaded with 'customary despatch' or 'customary quick despatch' or 'as fast as the vessel can receive', **with**

the utmost despatch najbrže moguće: The Master should prosecute all voyages **with**

the utmost despatch., with due despatch pravovremeno, na vrijeme: On the other hand,

the merchant may make a protest (i.e. Letter of Protest) against the master, for misconduct, drunkenness, etc., for not proceeding to sea **with due despatch**, for not signing bills of lading in the customary form,

and other irregularities. ; **2 slanje (brodice ili helikoptera u pomoć):** The skipper's early call

to the coastguard and the swift **despatch of the rescue helicopter** ensured that the injured fisherman received the required medical attention as quickly as possible.

despatch³ (v) (safety) **poslati (brodicu u pomoć)**: Thai marine police dispatched a patrol boat to reach the lifeboat, but were unsuccessful as the lifeboat was dangerously close to rocks. **despatch a patrol boat for help poslati brodcu za ophodnju u pomoć**

despatch³ (n) (mar law, shipping econ) = **despatch money naknada za ušteđeno vrijeme**

despatch money (n) (mar law, shipping econ) **nagrada za ušteđeno vrijeme (pri ukrcaju/iskrcaju)**: *Despatch is the money payable by the owner of the ship to the charterer if the ship completes loading or discharging before the laytime has expired. Commercial Management (c) voyage estimating and accounting and calculation of hire, freights, demurrage and/or **despatch monies** due from or due to the charterers of the Vessel;*

despite /diˈspait/ (conj) **usprkos**: *Despite all three of the vessel's own pumps running, the situation continued to deteriorate, and the skipper issued a "Mayday" on Channel 16 about an hour. The speed was about nine knots, **despite** a speed limit of five knots that should have been observed at this point.*

destination /ˌdɛstiˈneɪʃən/ (n) (shipping econ, mar law) **odredište**: *The freight was short or damaged **at destination**. On being cleared by the coastal state authorities, the tanker continued on her voyage, **arriving at her destination** after two days. **port of destination odredišna luka, luka odredišta** In the evening, in order to adjust the ETA at the **destination port** the following morning, the Master decided to stop and drift for an hour in open water before resuming passage at full speed. Separate manifests must be made out for each **port of destination**., **get to the destination doći do odredišta** Through bills of lading: In many cases it is necessary to employ two or, more carriers **to get the goods to their final destination**., **final destination konačno odredište, krajnje odredište** In the event, all units were discharged safely at the berth and **reached their final destination**., **country of destination zemlja odredišta**: *When no such enactment is in force in the country of shipment, the corresponding legislation of the **country of destination** shall apply.**

destroyer (n) (navy) A small fast warship armed with missiles, mines, torpedoes, depth charges and guns, usually employed as an escort to protect larger ships, and to attack submarines.
(<http://www.seatalk.info/cgi-bin/nautical-marine-sailing-dictionary>) **razarač stealth destroyer nevidljivi razarač neprimjetljivi razarač**



guided missile destroyer razarač s navodljivim raketama: *The guided missile destroyer departed the shipyard on Monday for its first at-sea tests and trials in the Atlantic Ocean.*

destroyer turn (n) (navig, safety) **skretanje u opasnosti, devijacija u opasnosti** (tal. *accostata d'emergenza*)

detach /di'tætʃ/ (v) **odijeliti, odvojiti, isključiti:** *The damaged wire had been removed from the jetty bollard, and work was underway to detach the wire from the winch drum when the chief officer arrived at the after mooring deck.*

detachable /di'tætʃəbəl/ (adj) (marine eng) **odijeljiv, odvojiv, skidljiv, koji se montira:** *The head incorporates four valves whose seats are detachable; the exhaust valve seats are water-cooled. The large exhaust gas inlet casing is of two-piece construction comprising a detachable inner casing fitted with the turbine nozzle assembly and a fixed outer casing containing the rotor shaft fitted with the turbine wheel.*

detain /di'tein/ (v) (mar law) **zadržati brod u luci, zaustaviti brod u luci (kao mjera osiguranja naplate):** *The ship described as a repeat offender for breaches of seafarer welfare and ship maintenance – was detained in Tauranga after Maritime New Zealand found 14 deficiencies, with 11 to be rectified before it can leave. Australian authorities have detained a bulk carrier over several crew labor violations including non-payment of wages. Australaska vlada zadržala je brod za rasute terete zastave zbog višestrukog kršenja radnih prava posade, uključujući i neisplatu zarada. Port State Control officers have the power to detain foreign ships in port if they do not conform to international requirements. A ship was detained recently by the port authority due to a lack of onboard ECDIS familiarization*

detect /di'tekt/ (v) **1 naići na; 2 pratiti; 3 otkriti:** *The cylinder condition monitoring system is intended to detect faults such as blow-by past the piston rings, cylinder liner scuffing and abnormal combustion. A thermocouple sensor is installed close to the pumping chamber to detect delivery valve leakage; if the delivery valve were to leak, fuel from the rail would be re-pumped, causing a temperature increase in the pumpin*

detection /di'tɛkʃən/ **otkriće, otkrivanje, pronalaženje:** *This led to an early detection of the leakage, quick response and averted a pollution incident. The controller covers sequencing, steady state and transient control, surveillance, fault detection and protection. fire detection (safety)*

otkrivanje požara: *The fire detection and fixed suppression system suffered early damage in the fire, which prevented its operation. The use of fire detection devices is, therefore, increasing particularly in view of reduced manning and unmanned machinery spaces.*, **elektronička navigacijska pomagala za otkrivanje ciljeva:** *Electronic detection aids, such as automatic target acquisition and radar guard zones, can only help bridge watchkeepers if they are used.*, **gas detection equipment (safety) oprema za otkrivanje plina:** *Before departing the ship, the fumigator-in-charge briefed the chief officer, and issued him with two gas masks and some phosphine gas detection equipment.*

detector /di'tektər/ **electro-pneumatic detector** elektropneumatski detektor, **flame detector** detektor plamena, **heat detector** detektor topline: *Heat detectors can use any of a number of principles of operation, such as liquid expansion, low melting spot/post/point materials or bimetallic strips.*, **smoke detector** dimni detektor, **dimni otkrivač požara:** *A cheap smoke detector, effective firefighting and early alerting of the coastguard proved invaluable.*, **thermal detector** detektor topline, **fire detector** detektor požara: *Shortly afterwards, the fire detector head in the passageway was activated.*, **gas detector** detektor plina: *The master was carrying a walkie talkie as well as a personal gas detector (combined O and LEL) and the chief mate and pump man were standing on deck.*, **oil mist detector** detektor naftne maglice: *An oil mist detector gives advance warning of an impending major failure.*, **fuel leakage detector** detektor propuštanja goriva: *Fortunately the fuel leakage detector activated so that fuel leakage and attendant risks were minimal.*, **CO2 detector** detektor ugljičnog dioksida: *Personnel entering tanks must also carry a CO detector together with O and LEL personal detector, (as per company policy when entering tanks after carrying Crude or Fuel Oil.*, **water detector** detektor vode, **detektor prisustva vode u sustavu:** *The installation comprises the separator, an automatic control panel, water detector, water detector controller and discharge detector.* **detektor, otkrivač**

detent (n) (seamanship) A catch on a mechanical capstan which keeps it from rotating. A notch in a ratchet. (<http://www.seatalk.info/cgi-bin/nautical-marine-sailing-dictionary>) **zaporni zubac na vitlu**

detention /di'tenʃən/ (n) 1 (mar law) **COMPARE seizure COMPARE arrest**
zadržanje broda, zadržavanje broda u luci (kao mjera osiguranja naplate potraživanja), zadržavanje broda u luci, zaustavljanje broda: *Thus any irregularities in such documentation may result in fines, detention or other such serious implications for the vessel. Port State Control inspectors issued a detention deficiency against one of our vessels for a defective tachometer on an auxiliary engine.* **damages for detention** 1 **naknada za zadržavanje;** 2 **prekostonice zbog zadržavanja broda u luci, release from detention** osloboditi (brod) nakon zadržavanja: *The vessel, which had passed through the Great Barrier Reef on its journey, was released from detention upon completion of her crew training.*, **temporary detention of ship** privremeno zaustavljanje broda, **detention of ship** zadržavanje broda; 2 **The fee applicable to all containers that remain in the customer's possession longer than the agreed free time.** <http://www.maerskline.com/en-jm/help/shipping-glossary> **držanje tereta (duže od roka predviđenog ugovorom)** *Detention days are counted from pick-up empty containers to gate-in full minus free days.* **detention fee - export** naknada za držanje tereta pri ukrcanju, **detention fee - import** naknada za držanje tereta pri ukrcanju na brod

detention of cargo (n) = **right of detention** (mar law) **pravo pridržaja tereta**
detention of ship's equipment (n) (**shipping econ**) **penalty charge against shippers**

or consignees for delaying carrier's equipment beyond allowed time. **penali za zadržavanje brodske ukrcajno/iskrcajne opreme** {Demurrage applies to cargo; detention applies to equipment}

detention tank (n) (safety) tank za zadržavanje prolivenog ulja/nafte (pri ukrcaju/iskrcaju)

deteriorate /diːtɪəriəˈreɪt/ **1 pogoršati (s)**: the situation continued to **deteriorate** stanje se stalno pogoršavalo *Despite all three of the vessel's own pumps running, the situation continued to deteriorate, and the skipper issued a "Mayday" on Channel 16 about an hour after the flooding was discovered.*; **2 (v) kvariti se (o teretu), pokvariti se; 3 (meteorol) pogoršati se (vrijeme, vidljivost)**: the weather **deteriorated** and the anchor chain began to render vrijeme se pogoršalo i sidreni je lanac počeo popuštati *Weather conditions have further deteriorated since Saturday, with winds of 50 km/h and waves of 6 meters.* **the visibility deteriorates vidljivost se smanjuje, vidljivost se pogoršava** *When visibility appears to be improving, stay on your guard, it can deteriorate twice as quickly and without warning.*

deterioration /diːtɪəriəˈreɪʃən/ **1 kvarenje (tereta), pogoršanje stanja (tereta)**: Hay, wool, pepper, cocoa - if wet or damp, are very liable to spontaneous combustion, sweat damage and **deterioration**. **to suffer deterioration pogoršati se (npr. stanje tereta); 2 (marine eng) pogoršanje (stanja)** *Root cause/contributory factors Improper maintenance: Erosion and deterioration of the piston crown were not acted upon at the time of periodic overhauls and routine inspections;*

deviate /diːvi'eɪt/ **(v) skrenuti (s kursa)**: During the blackout, the rudder unexpectedly turned to port, causing the vessel to **deviate sharply from its course** and toward the tug and tow. **to deviate from the course skrenuti s kursa** *What time does the off-hire period cover when the ship must deviate from her course and put into a port of refuge? On 13th October 20__ , I, _____, Master of the M/V Sea Crest, (relative) had to deviate to the port of _____ as port of refuge on account of fire in the engine room on 10th October 19__ , and herewith declare*

deviation /ˌdiːviˈeɪʃən/ (n) **1 (navig) magnetska devijacija, devijacija (kompasa) magnetic deviation magnetska devijacija, deviation table tablica devijacije, add easterly / westerly deviation dodati istočni / zapadnu devijaciju, subtract easterly / westerly deviation oduzeti istočnu / zapadnu devijaciju; 2 (navig) skretanje s kursa, skretanje s puta; 3 (mar law, shipping econ) skretanje s puta / putovanja**: Any **deviation** in saving or attempting to save life or property at sea or any reasonable **deviation** shall not be deemed to be an infringement or breach of the Rules or any contract of carriage. **deviation from the planned route skretanje s planirane rute, deviation limit granično skretanje (s putanje/rute), granična devijacija** *The ECDIS was set with the following safety parameters: a safety contour of 10 metres; a cross-track deviation limit of 0.2 either side of the planned track.*

deviation clause (n) (mar law) A departure by the carrier of goods by sea from the agreed or customary geographic route, done without the consent of the cargo interests **klausula o skretanju s plovidbenog puta, klausula o devijaciji s plovidbenog pravca, klausula o devijaciji, privremeni prekid pomorskog ugovora o prijevozi zbog skretanja u luku zakloništa ili na popravak, devijacija, kršenje ugovora zbog skretanja s rute**: *Deviation clause allows the shipowner to proceed on a course other than usual and reasonable to save property.*

deviation report (n) (navig, comm) **izvješće o skretanju**

device **1 naprava, sprava, uređaj, mehanizam, aparat fail-safe device**

besprijeckorna naprava / uređaj uređaj koji ne može zatajiti / otkazati / zakazati, sprava koja radi bez greške, **explosion device** eksplozivna naprava, **explosion detection device** uređaj za spječavanje eksplozije, **control device** upravljačka naprava (ručka itd, kontrolni uređaj, regulacijski uređaj) *The governor, which is the principal control device in any engine, is so termed as it controls the engine speed at some fixed value.*, **safety device** sigurnosni uređaj *A safety device is fitted in case the system breaks down.*, **release device**: *If the main release device fails to launch the lifeboat, the assigned crew member operates the emergency lifeboat release lever.* **otpusna naprava**; **2 sredstvo**
devices to measure and indicate speed and distance uređaji mjerenje i pokazivanje brzine i prijeđenog puta
devil's claw (n) (nav arch) stezni zapor, osigurač sidrenog lanca

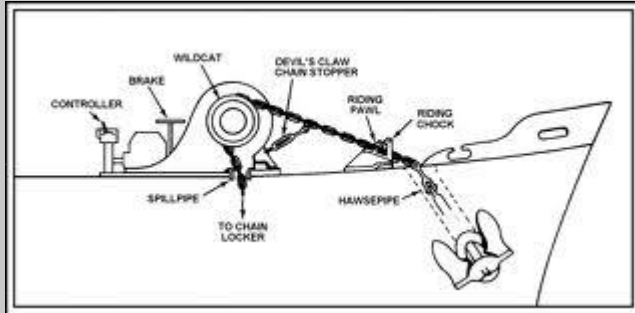

dew /'dju:/ (n) (meteorol, cargo) **rosa** *It was early morning and the rungs on the fixed stanchions were moist with dew.*

de-watering (n) (seamanship) izbacivanje vode, isušivanje

dew condensation (n) (cargo) kondenzacija od rose

dewpoint /'dju:point/ (n) **1** (cargo handling) **rosište**, **temperatura rosišta**: *Because charge air from the turbocharger never falls below the dew point, there is no danger of water condensation in the cylinders. ... where the metal temperatures are below the acid dew point (160°C), these vapours condense as sulphuric acid, resulting in corrosion.*; **2** (meteorol) **rosište**

dew-point readings (n) (cargo) **1** očitavanje rosišta; **2** očitana rosišta: *Record relevant dew-point readings in the cargo spaces and outside.*

DGPS and GLONASS maritime radio beacon receiver equipment (n) (navig) brodski DGPS i GLONASS prijamnik

DGPS - block-diagram (n) (navig) blok-shema navigacijskog sustava DGPS

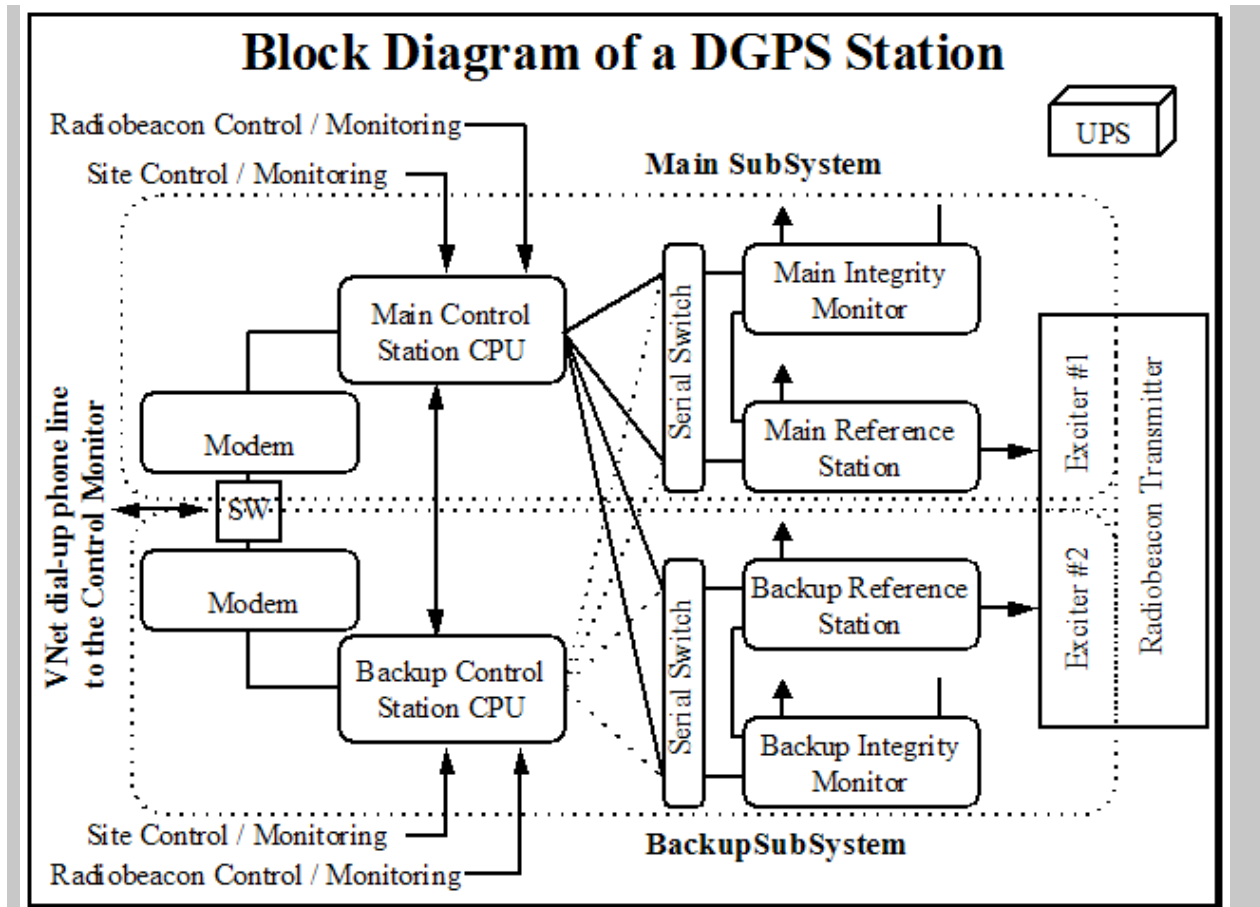

DGPS; (Differential Global Positioning System) (n) (navig) diferencijalni

globalni sustav za određivanje pozicije: A position obtained by DGPS gave her position as being on a 20 metre contour on the chart. The only option available to the master was to hold station by monitoring his DGPS. **wide area DGPS; (Differential Global Positioning System)**

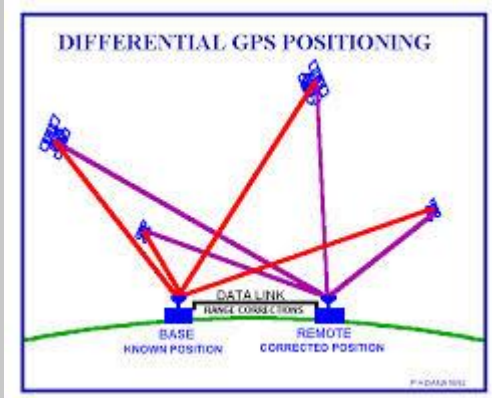

široko-prostorni DGPS (WADGPS)

dhow /dau/ a lateen-rigged coastal Arab sailing vessel with one or two masts **dava**, **brza arapska brodica s latinskim jedrom**

diagonal /dai'ægənəl/ (n) (nav arch) presjek brodskoga obrisa s ravninom položenom koso na uzdužnu simetralnu ravninu i okomito na ravninu teorijskoga rebra **širnica**

diagram /'daɪə græm/ 1 **crtež**; 2 **grafički prikaz, graf, grafikon**: The above diagram shows the watchkeeping arrangements in each of those groundings. This diagram shows the cashflow in the

shipping market. As can be seen on the **diagram** the vessel actually came within less than 10nm of land more than once leading up to the grounding.; **3 shema, dijagram, blok-shema**: The two stroke cycle can also be illustrated on a **timing diagram**. In the system shown in the **diagram** above, the oil is stored in tanks in the double bottom from which it is pumped to a settling tank and heated. Fuel line: Figure 8.6 shows a typical **fuel line pressure diagram** and also the **needle lift diagram** for an engine having a camshaft speed of 300 rev/min, both at high load (Figure 8. **complete the diagram** dovršiti shemu, dopuniti dijagram, **stress-strain diagram** dijagram naprezanja, izduženje, **timing diagram** razvodni dijagram, **firing diagram** dijagram paljenja

diagrammatic /ˌdaɪəgrəˈmætɪk/ (**adj**) **shematski, dijagramatski**: The cargo plan shows in **diagrammatic form** the longitudinal section of the ship and each hold with its respective decks, with main consignments marked off by coloured blocks

diagram of steam cycle /ˌdaɪəˈgræm/ (**n**) (**marine eng**) **dijagram parnog procesa**

diagram of watertube boiler /ˌdaɪəˈgræm/ **shema / nacrt vodocijevnog kotla**

dial /ˈdaɪəl/ (**n**) **1 brojčanik**: Fit a **dial indicator** in a support and fasten it in position as illustrated.; **2 skala (instrumenta)**

dial /ˈdaɪəl/ **birati (broj, vrijednost na instrumentu)**: The owner's shouts were heard by his son on the helm, who promptly stopped the engine and immediately used his mobile telephone to **dial 999** and ask for coastguard assistance.

diameter /ˈdaɪˌæmɪtə/ (**n**) **promjer, dijametar**: For example, 0.5 tonne of water per hour will flow through a hole of just 18mm in **diameter** assuming a constant head of 25mm. The tug's steel tow wire was 44mm in **diameter** and weighed 7.8 kg/cm.

diamond /ˈdaɪəmənd/ **brodska signalna oznaka romboidnog oblika romb**: Dangerous cargo/goods/commodity are often indicated by **diamond-shaped** signage. We were displaying navigation lights, day signals (ball, **diamond**, ball) plus red white red lights for a vessel restricted in its ability to manoeuvre throughout. The first and the last poles were marked with a **black diamond** each. Both **diamonds** and poles, as well as tube, were perfectly visible on the tug's radar screen in all scales.



diamond plate /ˈdaɪəmənd/ (**n**) (**nav arch**) **križna ploča**

diaphragm /ˌdaɪəˈfræm/ **to deflect diaphragm deformirati dijafragmu, diaphragm seal membranska brtva dijafragma, membrana, ovojnica**

diaphragm plate /ˌdaɪəˈfræm/ **dijafragma na dnu tanka (za mjerenje tanka)**: The Piston rod passes through a stuffing box which is bolted into the **diaphragm plate**.

diaphragm pressure gauge /ˌdaɪəˈfræm/ (**n**) (**marine eng**) **manometar s membranom, tlakomjer s dijafragmom**

diesel /ˈdiːzəl/ (**n**) (**marine eng**) **dizelski motor, dizel-motor**: Before a large **diesel** is started it must be warmed through by circulating hot water through the jackets, etc.

diesel-alternator (n) (*electr*) **dizelski generator**: The ferry was also provided with an Uninterruptible Power Supply (UPS) and an emergency **diesel alternator**; both were ready to operate automatically when needed.

diesel drive (n) (*marine eng*) = **diesel propulsion** **dizelski pogon**

diesel-driven (adj) (*marine eng*) **pogonjen dizelskim motorom**: A **diesel-driven**, portable salvage pump was placed on board.

diesel-driven ship (*marine eng*) **brod s pogonom na dizel-motor**

diesel-electric drive (n) (*marine eng*) **dizel-električni pogon**: A number of vessels are built with **diesel-electric** or **turbo-electric** drive.

diesel electric hybrid engine (n) (*boating/yachting*) **hibridni dize-električni motor**

diesel-electric vessel (n) (*nav arch*) **brod na dizel-električni pogon**: Four 6-cylinder models (each developing 5700 kW) are specified to drive the main gensets of a **diesel-electric LNG carrier**.

diesel engine (n) (*marine eng*) **dizelski stroj, dizelski stroj, dizel motor**: The first merchant ocean-going liner driven by a **diesel engine** was the *Selandia* in 1912. A **diesel engine** may be designed to work on the two-stroke or four-stroke cycle. The four-cycle **Diesel engine** is easier to reverse than the two-cycle **Diesel engines** as there are fewer moving parts to be changed in direction of rotation.

The most powerful **diesel engines** in the world are two stroke crosshead engines. **marine diesel engine** **brodski dizelski stroj, brodski dizel stroj, brodski dizel motor, brodski stroj**: An important parameter for a **marine diesel engine** is the rating figure, usually stated as brake horsepower (bhp) or kilowatts per cylinder at a given revolutions per minute. **inboard diesel engine**

nutarnji dizel motor, outboard diesel engine izvanbrodski dizel motor, 2

strokediesel engine **dvotaktni dizelski stroj**: A slow-speed **two-stroke diesel** is usually arranged to operate continuously on heavy fuel and have available a diesel oil supply. The **2 stroke diesel crosshead engine** works on exactly the same principle and cycle as the **2 stroke diesel trunk piston engine**. Unlike the 4 stroke engine, a **two stroke diesel engine** does not use the piston to push out the exhaust gas, instead, air enters the cylinder around bottom dead centre and sweeps out the exhaust gas from the cylinder.

4 stroke diesel engine **četverotaktni dizelski stroj**: In a **four stroke trunk piston engine** of 1100 kW output, a hole was (burn) through a piston crown. **medium speed diesel engine**

srednjohodni dizelski stroj: On a **medium speed 4 stroke engine** the oil is supplied to the main bearings through drillings in the engine frame to the crankshaft main bearings. **high speed diesel engine**

brzohodni dizelski stroj: These ancillaries need electrical power which is usually provided by generators driven by **medium- or high-speed diesel engines**. **low speed diesel engine**

sporohodni dizelski stroj: The 130 TBN lubricant was evaluated for 3 months in the Sulzer 6RLB90 **low-speed engine** of a container ship, which operated at 85–90 per cent maximum continuous rating. Medium- and **low-speed** gas-burning engine designs are offered by the MAN Diesel group, which cites

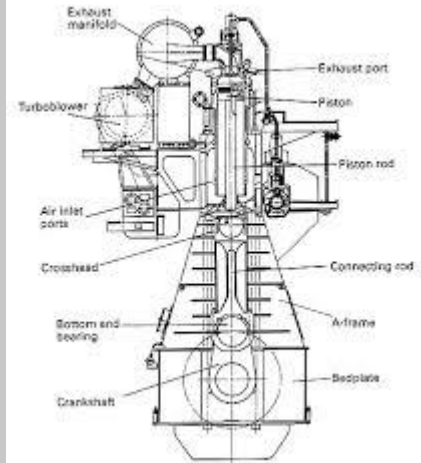

successful experience with a Holeby 16V28/32-G (gas injection)

diesel fuel (n) (marine eng) **dizel gorivo**, tal. **gasolio**: An average diesel fuel should comprise in percentages, carbon 86–87; hydrogen 11.0–13.5; sulphur 0.5–2; oxygen and nitrogen 0.5–1.0. To secure low NO_x emissions, it is essential that the amount of injected diesel fuel is very small.

diesel-fuelled (adj) (marine eng) **na dizelski pogon**: As the group went ashore, the diesel-fuelled heater located in the engine room was running and the radiators were noted to be on.

diesel generator (n) (marine eng) **dizel-generator**: Two diesel generators were sharing the electrical load and the engine speed had been reduced to 60 rpm ...

diesel genset (n) (marine eng) **dizel-generator**: These small gas turbines are also in service in integrated systems linking steam turbo-alternators, shaft alternators and diesel gensets;

diesel oil (DO) **dizelsko gorivo**, laka nafta, **dizel**: Low-, medium- and high-speed diesel engines are designed to burn marine diesel oil (ISO 8217, class DMB or BS 6843, class DMB) while low-speed. The engine was released for operation on marine diesel oil (ISO 8217, F-DMX to FDMB). The engine can be started up and manoeuvred on diesel oil or even a blend of diesel and heavy fuel oil.

diesel oil line (n) (cargo handling) **cijev dizel goriva**, **cjevovod dizel goriva**

diesel propulsion (n) (marine eng) **dizelski pogon**, **pogon na dizel-motor**: The marine diesel propulsion market is dominated by direct-coupled low-speed two-stroke crosshead engines and geared high-/medium-speed four-stroke trunk piston

diesel unit (n) (marine eng) **dizelski stroj**, **dizelska jedinica**

diffraction (n) (navig) **ogib radarskog signala (na oštrom bridu prepreke)**

diffuser; diffusor /di'fju:zə/ (n) (marine eng) **difuzor**, **razdjelnik**: The air exits the impeller radially and passes through a diffuser, where some of the kinetic energy gets converted to pressure energy. A diffuser or volute is then used to convert most of the kinetic energy in the liquid into pressure.

digital processing unit /didʒitəl/ **digitalni procesor**

digital selective call (DSC) /'didʒitəl/ **digitalni selektivni poziv (u sustavu GMDSS)**

Digital Selective Calling; (DSC) /'didʒitəl/ (n) (comm, safety). DSC is a semi-automated means of establishing initial contact between stations. Once this contact has been established, normal radiotelephony is used for subsequent communications. The main use of DSC by small vessels is for distress, urgency, and safety purposes **digitalni selektivni poziv (DSC)**, **digitalno selektivno**

pozivanje: Although there is no regulatory requirement for a vessel of this size to carry an EPIRB, liferaft or Digital Selective Calling (DSC) capable VHF radio, all are recommended. The captain

contacted the coastguard via **Digital Selective Calling** who alerted the rescue helicopter and two lifeboat stations. The skipper pressed the **Digital Selective Calling (DSC)** distress alert button on the VHF radio



and the coastguard responded immediately.

dihedral corner reflector /daɪˈhiːdrəl/ (n) (navig, electr) dvostrani kutni radarski reflektor

dildo (n) (seamanship, boating/yachting) = thole-pin; tholepin palac za veslo, škeram

diligence /dɪlɪdʒəns/ (n) marljivost, revnost with due diligence s pažnjom (dobrog privrednika, stručnjaka itd.) Inspection, lubrication, renewals of parts including the wire and rigging must be carried out with due diligence., act with due diligence poslovati s pažnjom dobrog privrednika raditi u skladu s pravilima dobre pomoračke prakse, raditi kao dobar stručnjak-pomorac, exercise due diligence poslovati u maniri dobrog gospodarstvenika / stručnjaka: The carrier shall be bound before and at the beginning of the voyage to exercise due diligence to make the ship seaworthy, properly man, equip and supply the ship and make all parts in which cargo is to be carried, fit an To surveyors or repairers) but he will be responsible if they fail to exercise due diligence in carrying out their work., practise due diligence poslovati pažnjom dobrog gospodarstvenika / privrednika

Dilution of Precision; DOP (n) (navig) raspršenje točnosti horizontal dilution of precision; HDOP horizontalna komponenta raspršenja točnosti

dimension /diˈmɛnʃən; daɪˈmɛnʃən/ (n) 1 mjera, dimenzija; 2 izmjere (broda)

diminish /diˈmɪnɪʃ/ diminish in thickness stanjiti se: It consists of a disc on the side of which are a number of radial vanes which diminish in thickness as they approach the periphery., diminishing

depression ciklona u slabljenju smanjiti se: The use of ECDIS does not diminish the importance of keeping a good lookout.

dimmer (DIM) /ˈdɪmə/ (n) (comm) prigušivač (svjetla na VHF uređaju)

dinghy /ˈdɪŋgi/ (n) (boating/yachting) 1 a small boat for recreation or racing, especially an open boat with a mast and sails; also used as a tender boat jedrilica, sportska jedrilica, jedrilica za razonodu, mala jedrilica general-purpose dinghy jedrilica opće namjene; 2 a rowboat or small sailboat (in India) dingi; 3 a small boat carried on a larger vessel as a launch or lifeboat, usually powered by oars, sail, or small outboard motor pomoćna brodica / čamac, bajbot

dining room (n) (mar law) blagovaonica

dink /ˈdɪŋk/ dingi {skraćeno od: dinghy}

dip (n) (cargo handling) mjerna šipka take the dips of the cargo tanks izmjeriti razinu

tereta u tankovima mjernom šipkom: *When loading crude oil cargoes, **dips** should be taken of all the vessel's cargo tanks upon completion of loading to check for the presence of free water.*

dip (n) 1 (navig) position of a flag when lowered part way in salute ; method of salute between vessels
zastavica za pozdrav, zastava djelomice spuštена u znak pozdrava; 2 (navig)
pozdravljanje brodova zastavom

dip (v) 1 (navig, comm) to lower the flag and immediately raise it again as a salute **spustiti**
(signalnu zastavicu) **dip the flag** spustiti i podignuti (zastavicu u znak pozdrava
drugom brodu); 2 (navig, comm) spustiti zastavicu djelomice; 3 (cargo handling)

izmjeriti uranjanjem šipke: *On completion of discharge all tanks, including empty ballast tanks, should be dipped and, where possible, visually inspected in the presence of a representative of the terminal or cargo interests ...;* 4 **umočiti, uroniti (nešto u vodu)**

dipstick (n) (marine eng, cargo handling) **mjerni štap, mjerni štapić:** *Investigations found that when the mate did his pre-sailing checks, he wiped the engine sump **dipstick** on a rag, which he casually left on a tank top above the engine exhaust manifold. With no level on the **dipstick**, it was clear that the 220 litre oil charge was being lost or was not being returned from the sump by the oil scavenge pump. {štap za mjerenje visine tekućine (nafte, ulja) u tanku, karteru itd.}*

direct /diˈrɛkt; daiˈrɛkt/ (v) 1 **a usmjeriti; 2 uputiti**

direct action (n) (mar law) The right of a third party who has a liability claim against an insured to proceed directly by suit against the insurer, usually because the insured has been declared bankrupt or has become insolvent. In most jurisdictions, **direct action** is permitted only by statute.(Tetley) **izravni odštetni zahtjev, izravni zahtjev za naknadu štete**

direct-contact heater (n) (marine eng) **dodirni zagrijač**

direct-coupled engine (n) 1 (marine eng) **direktno spojeni motor (na osovinu):** *A **direct-coupled propulsion engine** cannot operate unaided since it requires service pumps for cooling and lubrication, and fuel/lube oil hand The three layouts involve the use of **direct-coupled slow-speed diesel engines**, medium-speed diesels with a gearbox, and the steam turbine with a gearbox drive to the propeller. According to the way the main engine is joined to the shafting, they may be classified as **direct coupled engines**, i.e. coupled directly to the propeller shafting (also called direct drive) and **geared engines**, i.e. coupled to a reduction gearing (indirect drive). ; 2 **direktini priključak***

direct coupling (n) (marine eng) **neposredni spoj, direktni priključak**

direct current; DC (n) (electr) **istosmjerna struja**

direction /diˈrɛkʃən ; daiˈrɛkʃə/ (n) **smjer, pravac** **opposite direction** suprotan smjer, **anticlockwise direction** u smjeru suprotnom od kazaljke na satu, **clockwise direction** u smjeru kazaljke na satu

directional light (n) (navig) a light illuminating a sector or very narrow angle and intended to mark a direction to be followed **svjetlo pokrivenog sektora**

direction finder; DF (n) (navig) A radio receiver with a directional coil antenna mounted over a compass card, used in navigation to determine the bearing of a radio signal.

(<http://www.seatalk.info/cgi-bin/nautical-marine-sailing-dictionary>) **goniometar radio direction finder; DF radiogoniometar**

directions /diˈrɛkʃəns ; daiˈrɛkʃəs/ (n) **upute:** *Pilotage Exemption Certificates may be applied for in accordance with the provisions of Section 8 of the Pilotage Act 1987 and Schedule 2 to these Directions.*

direct reversing engine (n) (marine eng) **stroj s direktnim prekretom:** *For direct*

reversing main engines >230 mm bore flame arresters or bursting discs are required for each cylinder fitted between the cylinder start air valve and the manifold.

direct supervision (n) neposredni nadzor (broda)

drifting (n) (navig) zanošenje broda (zbog struje, vjetra): As a result, my tanker was only able to keep slow ahead against that weather, **drifting astern to the shore** and was actually hardly controllable by the rudder. Many of these vessels exhibit NUC lights while **drifting**. Evidence suggests that the ship was never 'brought up' to five shackles and was continuously dragging anchor and **drifting** in a NE'ly direction. 0515 Our vessel **was drifting to port** so I ordered to increase the speed to slow ahead and increase helm to 20 degrees to starboard.

dirty oil (n) (shipping econ) Less refined oil products such as fuel oil. **gorivo niskoga stupnja rafiniranosti, prljava nafta**

disability /,disə'bilɪti/ (n) **onesposobljenost**: The compensation provided under this paragraph for 100% **disability** shall not exceed US\$150,000 for officers and US\$100,000 for ratings, with lesser degrees of disability compensated for pro-rata.

disabled vessel /di'seɪbəld/ (adj) (navig) = **vessel not under command (NUC)**

onesposobljen brod, brod nesposoban za manevriranje: The vessel **was disabled** and had to be towed to port. The multipurpose vessel ... was in the vicinity of the **disabled vessel** as of 1150. German media reports say the disabled vessel blocked shipping traffic on the Elbe for several hours. <http://gcaptain.com/capesize-bulk-carrier-breaks-elbe-river-ais/>

disagreement /,disə'grɪ:mənt/ (n) **nesporazum, neslaganje**: If in doubt, query his intentions, and in case of **disagreement**, ensure that conflicting intentions / interpretations are resolved before continuing with the operation. **After a slight disagreement** about the stowage factor the surveyor confirmed that the vessel was within the stability criteria required by SOLAS.

disassemble /,disə'sembəl/ (v) (marine eng) **rastaviti, demontirati**

disassembly /,disə'sembli/ (n) (marine eng) **rastavljanje, razmontiranje, demontaža**: Replacement or inspection of the piston rings is possible without **disassembly** of the liner: the piston can be partially removed from the liner for this purpose. For easy **assembly/disassembly**, the parts are connected to each other with slide connections.

disaster (n) (safety) **nesreća**: The tragedy is considered the worst maritime disaster in the country in over 30 years.

disbursements /dis'bzɜ:smənts/ (n) (shipping econ) **izdaci disbursements account** obračun svih izdataka pomorskoga agenta za račun broдача u luci pristajanja broda **račun**

otpreme, troškovi otpreme, port disbursements Payments incurred for a variety of port expenses embracing fresh water, bunkers, customs fees etc. **lučki izdaci (za takse, pristojbe, tegljenje, peljarenje itd.), master's disbursements zapovjednikovi izdaci** Master's disbursements are expenses by the master for items that are necessary for the navigation of the ship and the prosecution of the voyage).

disc 1 kolo, pločica; 2 disk



disc cutter (n) (marine eng) **rastavni rezač**

discharge (n) 1 (shipping econ, cargo handling) **iskrcaj broda**: The following procedures are recommended to ensure that a proper record is made of the loading, carriage and **discharge**: At the time of the incident, the vessel was passing Ile d'Ouessant (Ushant), France, en route for **discharge** at Rotterdam.

complete discharge **završiti iskrcaj** *A vessel was preparing to sail from port after completing discharge when multiple alarms sounded.*; **2 (cargo handling) iskrcaj (ereta (nafte, rasutih tereta itd))** *Samples should be taken from the vessel's bunker tanks upon completion of loading and prior to discharge.* **cargo discharge iskrcaj tereta**: *When the cargo discharge was almost completed, the master and 2 other crew members entered the tank with the intention to carry out the required squeezing as described above.*; **3 (mar law) iskrcaj pomorca, otpust (nakon završetka ugovora)**: *Any seafarer may request his immediate discharge on grounds of injury or illness Svaki pomorac može zatražiti hitan iskrcaj s broda uslijed ozljede ili oboljenja Any seafarer may request his or her immediate discharge on grounds of injury or illness, and such discharge may be granted in the Master's reasonable discretion at the next appropriate port.* **time and place of discharge vrijeme i mjesto iskrcaja (pomorca) s broda**: *The Master shall give to a seafarer discharged from his vessel either on his discharge or on payment of his wages, the Seafarer's Identification and Record Book as issued by the office of the Maritime Administrator, with an entry specifying the period of his service and the time and place of his discharge.* ; **4 (nav arch, marine eng) odvod, ispušt, pražnjenje, ispuštanje**: *Ensure that the water in ballast tanks is uncontaminated prior to discharge, by sighting of the surface and sample drawn from each tank;* **engine discharge odvod iz motora ispušt iz motora, overboard discharge ispuštanje u more (balasta, nafte itd.) iskrcaj u more (balasta, nafte itd.)**: *Should any overboard discharges occur, they must be documented in an oil record book, a log that is regularly inspected by the U.S. Coast Guard*

discharge (v) **1 (nav arch, seamanship) ispuštati, prazniti, iskrcati, odvoditi** **discharge ballast iskrcati balast ispuštiti balast**: *After discharging ballast from the forepeak, the vessel refloated some 5 hours later without the assistance of tugs.*; **2 (shipping econ, mar law, cargo handling) iskrcati (teret)**: *It is the duty of the First Mate to receive and discharge cargoes. it is advisable for the master to note a protest whenever the consignees failed to discharge cargo or take delivery thereof, and pay freight in accordance with C/P or B/L terms. The ship duly moved to the container berth to discharge her cargo. The vessel was discharging a cargo of steel plates with shore cranes alongside a quay.*; **3 (electr) isprazniti se (akumulator, baterija)**: *After discharging ballast from the forepeak, the vessel refloated some 5 hours later without the assistance of tugs.*

discharge (n) (environ) **ispuštanje (nafte, ulja) u more**: *Dumping oil-contaminated water overboard is almost always followed by an attempt to cover the illegal dumping up by failing to record these discharges in the ship's oil record book* **illegal discharge protuzakonito ispuštanje (onečišćene vode, ulja) u more**

discharge book (n) (mar law) = **seaman's book pomorska knjižica, matrikula**: *It is important that those signing on should have all the necessary documents such as Certificate of Competence, or Certificate of Qualification, Discharge Book (or Seaman's Book, Seaman's Passport) and Yellow Book (Vaccination Certificate).*

discharge hose (n) (cargo handling) **iskrcajna fleksibilna cijev, iskrcajno crijevo**: *Each pump had a discharge hose passing through the port side freeing port leading to one of the tanks.*

discharge line (n) (cargo handling, nav arch, marine eng) **cjevovod iskrcaja, odvodni cjevovod, odvodna cijev, iskrcajna linija**: *Frequently, overboard discharge lines are fitted with non-return valves to reduce the risk of backflooding. Although some ESD valves appeared to have been pressure tested by ship's staff, those on the cargo discharge lines were not, as there was no readily available method to do so.*

discharge operations (n) (shipping econ, cargo handling) **operacija iskrcaja, iskrcaj**:

After re-checking the complete cargo system, **discharge operations** were resumed with all standard Company and Industry procedures in place. Later, the **discharge operations** were also suspended at shore request.

discharge rate = unloading rate kapacitet iskrcaja (nafte, rasutih tereta),

brzina iskrcaja (u tonama): ... the maximum venting capacity is well below the designed **discharge rate** of the pumps! This should cover the order in which tanks are to be loaded/discharged, tank/pump/pipe work allocation and **loading/dischARGE rates** in order to minimise the stress on the vessel and the risk of cross-contamination of different grades of cargo. What is the maximum **loading rate / discharging rate**?

discharge strainer (n) (marine eng) tlačni pročistač

discharge under pressure (v) (marine eng) ispustiti pod tlakom, stlačiti

discharge valve (n) (cargo handling, marine eng) ventil za iskrcaj (tereta): The pump system consists of an expansion bellows, a suction valve, the pump itself and a **discharge valve** with non-return function. The cargo **discharge valve** of cargo tank 3S had stuck during the previous discharge and could only be used with a limited rate.

discharging (n) (shipping econ, mar law) iskrcaj: Loading, Discharging and Delivery of the cargo shall be arranged by the Carrier's Agent unless otherwise agreed.

discharging port (n) (cargo, shipping econ) luka iskrcaja: Demurrage at the loading and **discharging port** is payable by the Charterers at two (2) per cent to cover insurance and other expenses.

discharging rate (shipping econ) brzina iskrcaja, kapacitet iskrcaja

disciplinary proceedings /'disi.plineri/ (n) (mar law) stegovni postupak, disciplinski

postupak: The Master shall comply with the following **disciplinary procedures** against an erring seafarer:

disconnect (v) iskopčati, isključiti, otkvačiti, otpojiti There is also often a need for a clutch to **disconnect the engine from the gearbox**. Shore party reboarded vessel and managed to **disconnect cargo hose** and lower it to the water.

discontinue (v) obustaviti: When grabs are in use, it is strongly suggested that, if a cargo is susceptible to damage by rain, snow or precipitation, the vessel should opt to **discontinue** cargo operations altogether during inclement weather and avoid working cargo through partially open hatchways. **traffic discontinued obustavljena plovidba**

discount /'diskaunt/ (n) (shipping econ) popust: The original invoice must disclose all discounts and allowances, if any.

discrepancy /di'skrɛpənsi/ (n) 1 (shipping econ) razlika (u broju, količini, opisu, ...

tereta) nepodudarnost: Whereas the said discrepancy is beyond vessel's control, the Owners, the Master, the Vessel and the Crew are not responsible for any dispute S obzirom da je spomenuta razlika iznad naše moći, brodovlasnik, zapovjednik i posada ne mogu biti odgovorni u slučaju bilo kakvog spora Believing the original plan to be incorrect, he amended the ullages in the discharge plan; The C/O did not discuss the **discrepancy** and revised stopping ullages with the OOW and Master, resulting in a one-man error. **Discrepancy between both figures razlike između brojaka (količina tereta); 2**

(navig) failure of an aid to navigation to maintain its position or function as prescribed in the Light List odstupanje plovidbene oznake od objavljenih podataka

disease /di'zi:z/ (med) bolest: a ship clean and free from any disease brod na kojem name nikakve (zarazne) bolesti **infective disease zarazna bolest, contagious disease zarazna bolest** This is to certify that the ship is free from any **contagious disease**, **infectious disease zarazna bolest**

disembark /ˌdɪsmˈbɑːk/ (v) (v intr) **ANTONYM** embark iskrcati se (o peljaru, putniku, osobi): *The pilot disembarked soon after unberthing, and the vessel proceeded at Full Ahead The heading was chosen to create a lee for the sea pilot to disembark safely, and the drift rate increased substantially under this beam wind situation until the ship became wind-rode at about 14:55. The package must be presented to the CBSA prior to any persons being allowed to disembark or embark the vessel, or any cargo being discharged. A pilot was about to disembark from a small cargo vessel in benign weather conditions, with a good lee, and the pilot launch alongside and under control. disembark a pilot iskrcati peljara: A 16m, twin screw pilot launch was tasked to disembark a pilot from an 81m general cargo ship. disembark a vessel / ship iskrcati se s broda: It has taken measures to ensure its required radio procedures are followed, and has changed the point at which pilots disembark outbound vessels. disembark the lifeboat 1: All crew, except the assigned operating crew, disembark the lifeboat. ; 2 iskrcati se s brodice za spašavanje, disembark the passengers iskrcati putnike: Sirena Seaways was subsequently moved to another berth to disembark the passengers and vehicles. disembark the casualty iskrcati unesrećenu osobu: the ship deviated to the nearest port to disembark the casualty. disembark the animals iskrcati životinje: Permission to disembark the animals will be granted only once authorization to do so is received from CFIA and once all necessary animal health permits are pr*

disembark the pilot (v) 1 (v tr) = drop the pilot iskrcati peljara: *The ship had then altered course to 2300 T to head for Cherbourg, either for cargo or to disembark the pilot. ; 2 (v tr) iskrcati se: The pilot disembarked at the East Lepe Buoy.*

disengage /ˌdɪsɪnˈɡeɪdʒ/ (v) (marine eng, seamanship, cargo handling) isključiti (pogon, stroj), otkvačiti, osloboditi, tal. **disinnestare**: *When the 20 foot container was lifted during discharge, the automatic midlocks securing the container to the tank container did not immediately disengage as designed. safe and permission given by the bridge the engine should be tried – ahead or astern – on starting air. Prior to that it is necessary to disengage the turning gear. On engines with bridge control the control selector must be switched to the desired position. The engine is now ready After completing the job they intended to disengage the clutch by shifting the clutch lever. e skipper tried to pay out the port trawl wire but the main engine stopped, resulting in the loss of hydraulic power and a consequent inability to disengage the winch dog clutch.*

dish (n) (comm) parabolična antena

disinfect /ˌdɪsɪnˈfekt/ (v) (cargo handling) dezinficirati

disinfectant /ˌdɪsɪnˈfektənt/ (n) (cargo handling) sredstvo za dezinfekciju

disinfection /ˌdɪsɪnˈfɛkʃən/ (n) (cargo handling, med) disinfekcija

disk (n) disk, kolo, pločica

dismantle /dɪsˈmæntəl/ (v) demontirati, rastaviti, rasklopiti

dismasting (n) (safety, navig) lom jarbola, pad jarbola

dispatch /dɪˈspætʃ/ (n) 1 = despatch isporuka; 2 (mar law) In a voyage charterparty, an agreed amount payable by the shipowner if the vessel completes loading or discharging before the laytime has expired (Tetley) nagrada za uštedeno vrijeme, ušteta, dispač; 3 (shipping econ) otprema (robe), isplavljenje (broda): *Check every load to ensure nothing is loose or damaged before dispatch. Prije isplavljenja provjerite svaki teret kako biste se uvjerali da nije neučvršćen ili oštećen. quick dispatch brza otprema, with due dispatch pravodobno, u dogovorenom roku / vremenu: ... the merchant may make a protest (i.e. Letter of Protest) against the master, for misconduct, drunkenness, etc., for not proceeding to sea with due despatch, for not signing*

bills of lading in the customary form, and other irregularities.

dispatch /di'spætʃ/ (v) **1 otpremiti; 2 isporučiti**

dispatch /di'spætʃ/ (n) (*mar law*) = **dispatch money** nagrada za uštedeno vrijeme

dispatch money /di'spætʃ/ (n) (*shipping econ, mar law*) iznos koji brodar plaća krcatelju ili primatelju tereta za ranije ukrcan ili iskrcan teret u odnosu na vrijeme stojnica **nagrada za**

uštedeno vrijeme (pri ukrcaju/iskrcaju): *Should a vessel load and/or discharge in less than the prescribed time, owners of a ship pay dispatch money as a "reward" for time saved. The rates for demurrage and dispatch money are stated in dollars per day in the charter-party.*

dispensary /di'spensəri/ (n) (*safety*) **brodska ljekarna:** *Oxygen flasks from a dispensary are often white, whilst breathing apparatus is seen filled in flasks with all sorts of colours, including white. His workmates rushed him to the nearest eye wash stand in the paint store, and rinsed out his eyes, before escorting him to the ship's dispensary, where the second officer applied eye drops.*

dispersant /dis'pɜ:sənt/ (n) (*safety*) **otapalo, disperzivno sredstvo:** *An important function of the cleaning agent is to be a good solvent for the gypsum in the sludge. It should also act as a dispersant and emulsifier for oil.* **oil dispersant otapalo za zauljene vode**

displace /dis'pleis/ (v) **1 (marine eng) istisnuti; 2 pomaknuti s mjesta, premjestiti**
displace axially premjestiti uzdužno / aksijalno

displaced volume (n) (*nav arch*) **istisnuta zapremnina**

displacement /dis'pleismənt/ (n) **1 (nav arch)** the volume of fluid displaced by a freely floating and unrestrained vessel, the weight of which exactly equals the weight of the vessel and everything on board at the time the displacement is recorded. **istisnina broda, deplasman:** *There are two factors that affect the displacement of the ship, the weight of the ship components that can be transformed (DWT) and the weight of the ship components that can not be changed (LWT). Triple E class container ship Mærsk Mc-Kinney Møller - General characteristics: Type: Container ship; Tonnage: 165,000 DWT; Displacement: 55,000 tonnes (empty); Length: 400 m (1,312 ft); Length 400 m (1,312 ft); Beam: 59 m (194 ft); Draft: 16 m (52 ft)* **displacement tonnage** Displacement or displacement tonnage is the weight of water that a ship displaces when it is floating, which in turn is the weight of a ship (and its contents). It is usually applied to naval vessels rather than commercial ones, and is measured when the ship's fuel tanks are full and all stores are aboard. (Wikip.) **istisnina**

displacement hull A hull design that achieves buoyancy by displacing a volume of water equal to its weight. (<http://www.seatalk.info/cgi-bin/nautical-marine-sailing-dictionary>) **deplasmanski**

trup, standard displacement standardni deplasman, full load displacement pun

deplasman, displacement table tablica istisnine, tablica deplasmana; **2 a**

premještanje, micanje; 3 (marine eng) zapremnina cilindra

displacement coils (n) (*electr*) **COMPARE deflection coils** zavojnice za pomak slike (na radaru)

displacement; DISP. (n) (*nav arch, stabil*) **istisnina**

displacement from draught readings (n) (*stabil*) **istisnina dobivena iz očitavanja gza**

displacement pump (n) (*marine eng*) **volumetrijska pumpa, istisninska pumpa**

display /di'splei/ (n) (*navig*) **radarski pokazivač, pokazivač, ekran (radara), displej**

The navigating officers on board the ferry had a preference for interrogating AIS targets on the radar display. **radar display radarski zaslon, radarski ekran:** *The chief officer saw that the vessel was fishing and, by using the EBL on the radar display, assessed that she was on a steady bearing. The master went to the bridge and, on examining the port radar display, found the*

automatic tuning facility was not operating correctly. We tried to acquire the contact on the S band radar display., **display instrument** pokazni instrument, naprava za prikaz, pokazivačka naprava, **display unit** jedinica prikaza (radara), **alphanumeric display** alfanumerički pokazivač, **Select display** odabir cilja / objekta (radarskog motrenja), **display history** raniji položaji ciljeva / objekata (radarskog motrenja), **relative vectors of display** relativni pomak cilja (radarskog motrenja), **shift the display** pomaknuti poziciju broda na pokazivaču radara: *Own ship position, or sweep origin, can be displaced manually or automatically to expand the view field without switching to a longer range.*, **set up the display** postaviti radarski prikaz, **odrediti osnovne postavke radarskog pokazivača**, **shipborne radionavigation display** prikaz radionavigacijskih informacija, **standard display** standardni prikaz, **Multifunction display; MD** višenamjenski zaslon, **graphic display** grafički prikaz *The relevant data is processed by the system, which provides the operator with a graphic display of current status and trends.*, **heading display** prikaz pramčanice, **pokazivač pramčanice**: *The traffic lanes trend west-northwest to east-southeast, while the heading display for this ship (reportedly outbound for Longview, Washington) indicated it was heading northeast at about 14 knots.*

display /diˈspleɪ/ (v) **1 isticati, vijati (signalnu zastavu) display flags istaknuti zastavice, display lights istaknuti svjetla, pokazivati svjetla**: *The side trawler was displaying the appropriate lights for a power-driven vessel underway and engaged in trawling. However, the ship continued to display all deck lights and anchor lights.*, **display shapes istaknuti oznake na brodu, display the signals isticati signale, isticati znakove, pokazivati signale, imati uključene signale (znakove)**: *The vessel was on harbour manoeuvring mode under bridge control, displaying the appropriate signals to indicate her 'constrained by draught' status. In some cases, vessels erroneously or falsely display NUC signals when their main engines or ancillary machinery are shut down for reasons other than breakdown or necessary maintenance.*; **2 prikazivati (na ekranu), pokazati** *the reports showed the ECDIS would not be able to display a 'new object' properly ... This is an extension of US Coastguard directives which required all tonnage visiting US ports to display diagrams of their fuel loading, transfer and storage systems.*

display base (n) (navig) **osnovni prikaz podataka (u sustavu ECDIS)**

display console (n) = **plan position indicator; (PPI)** pokazivač radara

display contrast (n) (navig) **kontrast slike radarskog pokazivača, oštrina slike radarskog pokazivača** **adjust display contrast** namjestiti oštrinu radarskog pokazivača

display control panel (n) (navig) **The CRT control panel contains the CRT, optional plotting board, and some of the controls for the console. upravljačka ploča (na radarskom**

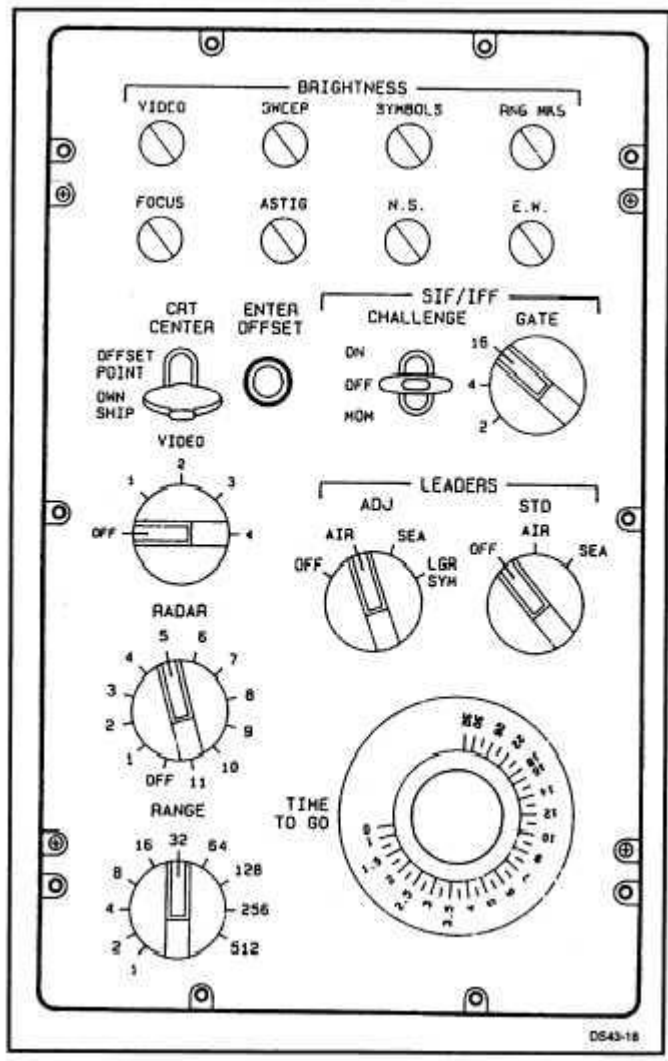

pokazivaču)

display orientation (n) (navig) orijentacija radarskog prikaza

display resolution (n) (electr) COMPARE radar resolution razlučivost

(radarskog itd.) pokazivača, rezolucija zaslona / ekrana

disponent owner /dis'pəʊnənt/ (n) 1 brodara koji nije vlasnik broda, ali prema određenoj

pravu raspolaže njime radi zaključivanja prijevoza stvari trećih strana; a person or company which has commercial control over a vessel's operation without owning the ship as in a bareboat charter **brodara**

raspolagatelj: This is done by taking the ships they require on time charter or another form of long term lease known as a bareboat charter, in which event they may be referred to as the disponent owner.

The definition of a **disponent owner** is "deemed to be the owner but not actually the owner". The registered or **disponent owner** of the vessel named herein (or substitute) only shall be liable for any damage or loss due to any breach or non-performance of any obligation arising out of the contract

of carriage, whether or not relating to the vessels seaworthiness. ; 2 (mar law) A person, such as a bareboat or time charterer, who, while not being the registered owner of a ship, nevertheless has the right to dispose of it (i.e. to control its commercial operation), notably by sub-chartering it to a third party. Although lacking title to the vessel, the disponent owner may have many of the rights and responsibilities of the owner **zakupnik broda, korisnik broda, čarterer, brodara,**

podnajmitelj broda

disport (discharging port) /dis'po:t/ (*shipping econ*) luka iskrcaja, iskrcajna luka

disposal /di'spəʊz/ (n) **at disposal na raspolaganju**: A skipper must monitor his passage using all appropriate means **at his/her disposal** and not be over reliant on just one method. In other words, the shipowner puts **at the charterer's disposal** a fully equipped vessel and operates her for the benefit of the charterer., **place the ship at the disposal of the charterer staviti brod na**

raspolaganje unajmitelju 1 odbacivanje, otpad: An official *disposal certificate* was issued by the authorities but there was no mention that the cargo removed was damaged.; **2 (shipping econ) raspolaganje**

dispose of /di'spəʊz/ (n) **ukloniti, odbaciti, oslobititi se (čega)**: *Disposal of fumigant residues* MSC Circular 1264 requires that 'all waste and residues are disposed of in an appropriate manner, either by incineration or by disposal on shore, as recommended by the manufacturer. Much discussion took place on alleged poor condition of the drums, the subsequent **disposal of their contents** etc. **Disposal of bilge water** through the oily bilge separator was not attempted for a prolonged period as the vessel was in coastal waters and the ship's staff had 0

disposition /,dispə'zifən/ **1 razmještaj, raspored**: The true weights and the *disposition* of the vessel's cargo were not known.; **2 (shipping econ, mar law) odobrenje, nalog, dispozicija**: Salvage must be retained until the claim is resolved, or until the claimant is given *disposition* by the carrier.

dispute /dis'pju:t/ (n) (*mar law*) **spor**: Any *dispute arising out of this Charter Party* shall be referred to arbitration **in dispute sporno, pod znakom pitanja**: He issued a protest to the terminal stating that the water content was **in dispute** and might increase on the loaded passage. We reject all liability for this **amount in dispute** and hold you fully responsible for all consequences which may arise. ..., **industrial dispute radni sporovi, civil dispute građanski spor**: The vessel will not be allowed to leave the port until a **civil dispute** originating in federal court involving a payment disagreement is resolved

disrate (v) (*mar law*) **degradirati**

dissemble /di'sɛmbəl/ (v) **1 (marine eng) rastaviti, rasklopiti, demontirati; 2 (shipping econ, cargo) distribuirati, razvrstati (kontejnersku robu, teret)**

dissolve /di'zɒlv/ (v) **otopiti, rastopiti**: A chemical cleaning agent must *dissolve* the deposits quickly without attacking the material of the separator parts.

dissolved air /di'zɒlvd/ (n) (*marine eng*) **otopljeni zrak**

dissolved gas /di'zɒlvd/ (n) (*marine eng*) **otopljeni plin**

distance (n) (*navig*) **udaljenost, razmak**: Ships have to keep the maximum distance possible from crowded anchorages **at a distance of na udaljenosti od**: The bearing remained steady until 2120 when, **at a distance of 2 miles**, the Master ordered Hard a Starboard. A vessel was observed at 6 points on the port bow **at a distance of 6 miles**, showing green and on a steady bearing., **safe distance sigurna udaljenost**: The master altered course to starboard to avoid a close-quarters situation with the first of the vessels while still **keeping a safe distance** from the sandbank., **at a close distance na vrlo maloj udaljenosti, vrlo blizu**

distance counter (n) (*navig*) **brojilo prijeđenog puta**

distance division (n) (*navig*) utvrđivanje najmanje udaljenosti između brodova koji plove istim smjerom **raspodjela udaljenosti**

distance made good (DMG) (*navy*) **prijeđeni put (broda u plovdbi)**

distance off (*prep phr*) (*navig*) **udaljenost od (oznake)**: When our vessel had turned to

starboard and was passing parallel through the target vessel's intended course, she was now on the port quarter, the **distance off** was 4 cables.

distance piece (n) (marine eng) **umetak, uložak, distancer**. A *distance piece*, known as compression plate or shim, is interposed between the foot and the box to permit the piston to be moved ...

distance run (navy) **prijeđeni put, prijeđena udaljenost**

distance tables (n) (navig) **daljinar**

distance washer (n) (marine eng) **podloška**

distilled water /dis'tild/ (n) (marine eng) **destilirana voda**

distilling plant (n) (marine eng) **postrojenje za pripremu pitke vode**

distilling system (n) (marine eng) **sustav za destiliranje vode**

distinguishing flag (n) (navig) **zastava brodovlasnika**

distorsion; distortion /di'stɔ:ʃən/ (n) **1 (marine eng, nav arch) iskrivljenje, izobličenje, iskrivljenost, deformacija, distorzija**. The resulting low thermal *distortion* as well as the high mechanical stiffness fosters good valve seat sealing with optimum heat transfer to the exhaust valve seats. The boat suffered *distortion* to longitudinals and to hull plates near to the port side of the keel.; **2 (med) uganuće**

distort /di'stɔ:t/ (v) **izobličiti, iskriviti, iskriviti, deformirati**. If the surface was uneven, then when the bolts were tightened the bedplate would be distorted, which in turn would *distort* the crankshaft, causing unacceptable stresses to be set up when the engine was running.

distraintment proceedings (n) (mar law, mar ins) **ovršne radnje**

distraintment proposal (n) (mar law) = **execution proposal** **prijedlog za ovrhu**

distraint /di'streint/ (n) **1 (mar law) COMPARE execution** the seizure and holding of property as security for payment of a debt or satisfaction of a claim **ovrha, pljenidba, zabrana**
distraint law **ovršni zakon**; **2 (mar law) zaustavljanje broda radi ovrhe**

distress /di'stɪs/ **1** a situation at sea when a station (ship, floating object, etc.) is threatened by grave and imminent danger and requests immediate assistance; Examples: fire, explosion, flooding, collision, grounding, list - danger of capsizing, sinking, vessel disabled and adrift, undesignated distress, abandoning vessel, person overboard; a state of danger to the lives of the passengers and crew of a vessel **tal. pericolo a pogibao, pogibelj**; **2 nesreća, opasnost**

distress acknowledgement /ək'nɒlɪdʒmənt/ (n) (comm, safety) **potvrda primitka**

poruke o pogibli: This 'auto acknowledge' should be disabled so that any DSC *Distress Acknowledgement* must be sent manually. If in doubt, consult a Coast Station/RCC before sending a DSC *Distress Acknowledgement*.

distress alarm (n) (comm, safety) **signal pogibli**. The watchkeeping officer sent the DSC *Distress Alarm*.

distress alert (n) (comm) **signal pogibli (u GMDSS-a), znak pogibli DSC** **distress alert** **signal pogibli putem DSC-a**: Some DSC equipment is programmed to automatically acknowledge a DSC *Distress Alert*. **send the distress alert** **poslati signal pogibli**, **repeat the distress alert** **ponoviti signal pogibli**, **terminate distress alert** **završiti slanje signala pogibli**. Once selected and initiated, a DSC distress alert will continue to be automatically repeated until terminated by the operator, **initiate the distress alert** **započeti slanje signala pogibli**, **poslati signal pogibli**, **cancel the distress alert** **otkazati signal o pogibli**, **genuine distress alert** **stvarni znak pogibli**: Unfortunately, some *genuine distress alerts* often

go unheeded., **false distress alert** **lažni signal pogibli** *False distress alerts already impose a considerable burden on Rescue Co-ordination Centres (RCCs) and divert SAR resources away from real distress situations and therefore also reduce the confidence of seafarers*

distress alert button (DIST) (n) (comm) **dugme za uključivanje alarmnog signala u pogibli**

distress call (n) **poziv za pomoć u pogibli**, **poziv u opasnosti**, tal. *chiamata di soccorso* *Always use the DSC to raise a distress call.* **transmit the distress call** **poslati poziv za pomoć u pogibli**

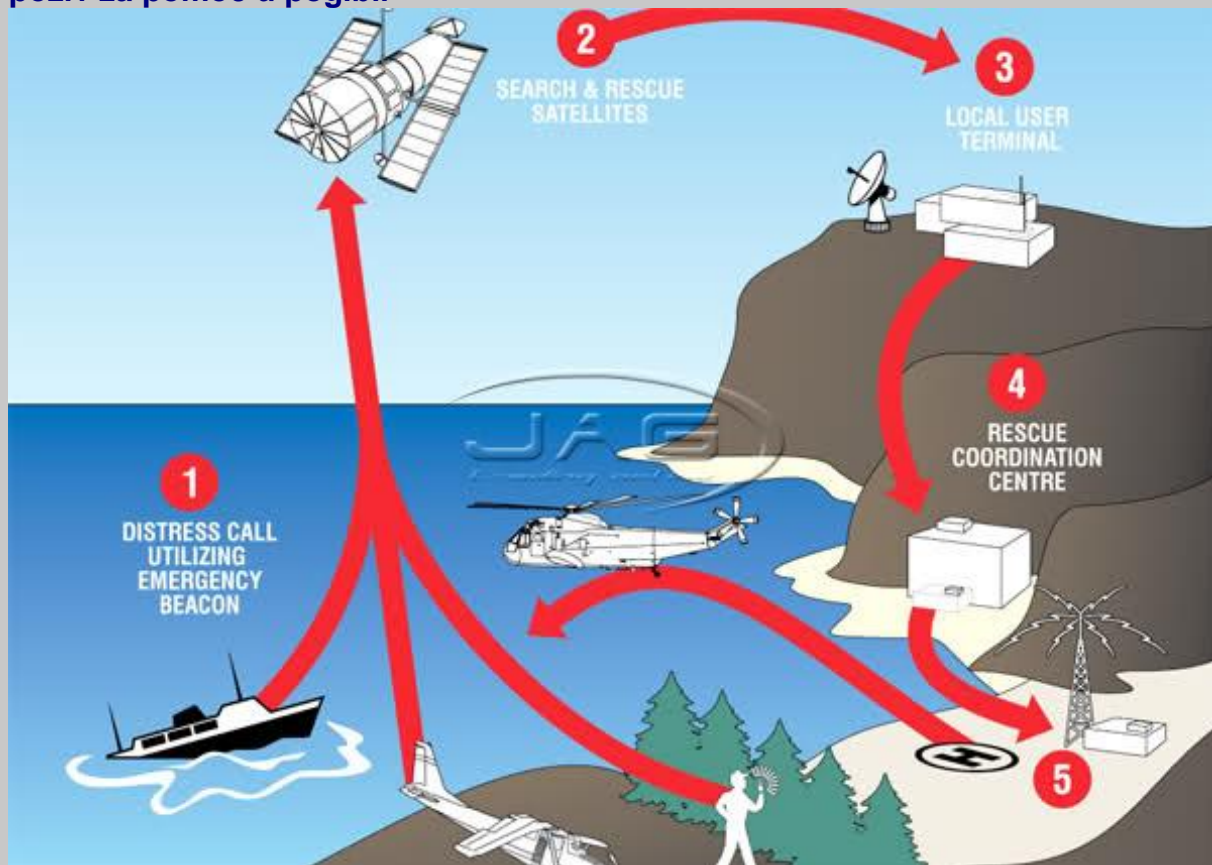

send out a distress call **poslati poziv za pomoć u pogibli** *The vessel was located about 100 kilometers from Mumbai when it sent out the distress call. Sending a distress call by digital selective calling or by VHF channel 16 when an emergency arises is the right action to take.* **transmit a distress call** **poslati poziv za pomoć u pogibli**, **odaslati poziv za pomoć u pogibli** *The skipper transmitted a distress call on VHF radio, which was answered by other vessels also sheltering in the bay.* **send a distress distress call by DSC** **poslati poziv za pomoć u pogibli** **putem sustava DSC** *Sending a distress call by digital selective calling or by VHF channel 16 when an emergency arises is the right action to take. The skipper immediately notified his crewman of the situation and sent out a distress call.* **broadcast a distress call** **poslati poziv za pomoć u pogibli** *After broadcasting a distress call at 1125, the 26 crew abandoned the vessel in an enclosed lifeboat.* **make a distress call** **poslati poziv za pomoć u pogibli** *The other deckhand was roused, while the skipper made a distress call to the coastguard.* **receive a distress call** **primiti poziv za pomoć u pogibli** *Whilst on watch recently, I received a DSC distress call. 0538 Ship X to Coast Station - I have received distress call and am*

proceeding to position 0552 Ship X to Coast Station - I am now 4nm away.

distress flare (n) (safety) **baklja za upozorenje o pogibli**

distress message (n) (comm, safety, navig) **poruka pogibli, poruka o pogibli, poruka o opasnosti**: As a result of this, the coastguard issued a **distress message** on behalf of the vessel, and an RNLI lifeboat and two helicopters were tasked to the scene. Pressing the DSC distress button for 3 seconds would have transmitted an automated **distress message**, which would have included the identity and position of the vessel.

distress phase (n) (safety, navig) **stupanj opasnosti koji određuje centar za koordinaciju traganja i spašavanja ako je primljena sigurna obavijest da su plovni objekt i osobe na njemu u ozbiljnoj i neposrednoj opasnosti i potrebna im je hitna pomoć stupanj pogibelji**

distress position (n) (safety, navig) **pozicija broda u pogibli**: I was about 8 hours steaming distance from the **distress position** and there were several ships nearer. What is your ETA at **distress position**?

distress relay (n) (comm, safety) **prenesena poruka s oznakom mayday, prenesena poruka o pogibli**: Within minutes I had received a **Distress Relay** from USCG in Miami, then another, and another, and another. **Do not send a DSC Distress Relay** to 'All Ships/All Stations' before consulting a Coast Station/RCC, unless you have been appointed 'On-Scene Co-ordinator - OSC' by the RCC.

distress signal (n) (navig, safety) **a radio signal, flag display or a sound, light used in calling for assistance in distress or emergency znak pogibli, signal pogibli**: The Coast Guard Maritime Rescue Coordination Centre (MRCC Mumbai) received a distress call Sunday night at approximately 11:00 p.m. from the MV reporting that the vessel was listing by about 20 degrees. ... at 04:05h, an **EPIRB distress signal** has been received at Varna MRCC from Nothing else was heard from the vessel, and **no distress signal was received. false distress signal lažni signal pogibli, genuine distress signal stvarni signal pogibli**: Sometimes it may happen that **genuine distress alerts** will go unheeded.

distress traffic (n) (comm, safety) **radiopromet u pogibli**: A **distress traffic** always has to commence with stating the position of the vessel in distress as specified in "GENERAL 11 Positions /13 Bearings" ... The **distress traffic** controlling station/other stations may impose radio silence on any interfering stations by using the term "Seelonce Mayday/Distress", unless ... **control of distress traffic kontrola radioprometa u pogibli, upravljanje radioprometom u pogibli, monitor distress traffic pratiti radiopromet u pogibli, cease distress traffic obustaviti radiopromet u pogibli**

distress vessel (n) (safety) **brod u pogibli**: Various vessels asked **distress vessel** to repeat position and other details.

distribute /,dis'tribjut/ (v) **rasporediti (teret u štivi), raspodijeliti, razmjestiti, razdijeliti**: stination, another agent working in close liaison with the agent forwarding the cargo will break bulk the consignment and **distribute the goods** to the various consignees. When dunnaging use boards placed 750 to 1000 mm apart so as to **distribute the weight** evenly over the beams.

distribution (n) **1 (cargo handling, shipping econ) raspored (tereta), otprema (tereta)**: The cargo plan plan shows the **distribution** and position of the cargo in the ship's holds or on deck However, it was afterwards confirmed by sounding that there had been considerable **asymmetrical distribution of ballast** before the ship listed.; **2 (marine eng) razvod, razvođenje**: Connections are provided on the accumulators for the injection valves and for the **fuel distribution** and injection-control components. Result of investigation 1 It was

established that despite being shut, the **steam distribution** and inlet valves were not holding. Atomisation is the usual term to indicate the proper **distribution** and penetration of fuel in the combustion chamber. ; 3

(marine eng) raspored (sila, opterećenja): The mean indicated pressure is determined as a check on cylinder load **distribution** as well as total engine output. The higher number of bolts allowed for a more even **distribution of the stresses** at the joint line and facilitated a slimmer connecting rod than with the two-bolt design. **even distribution ravnomjeran raspored**: Two pairs of studs are said to give the most **even distribution of holding-down load**, and also allow the tie rods to be located close to the bearing for efficient transfer of firing pressure load.

distribution box /,distri'bjɜ:fən/ (n) (electr, marine eng) **razvodna stanica, razvodna**

kutija: Fortunately, the breakers on the shore **distribution box** tripped automatically and there was no fire or injury.

distribution panel /,distri'bjɜ:fən/ (n) (electr) **razvodna ploča**: The 220 volt **electrical distribution panel** outside the engine room access was totally destroyed.

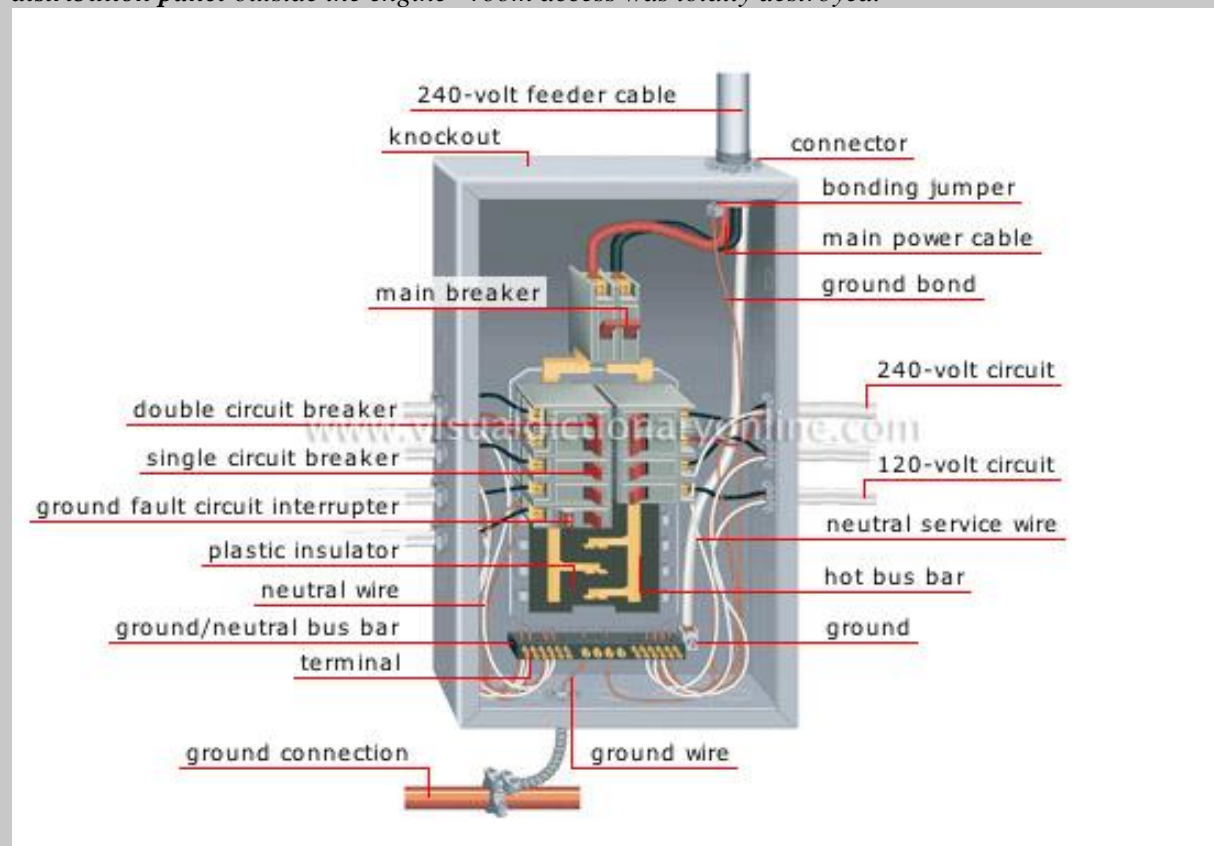

distribution system (n) (electr) **razvodni sustav**: Trained shipboard personnel should be assigned to check and approve all SPDs in use or brought on board for compatibility with the vessel's **electrical distribution system** prior to use.

distribution valve /,distri'bjɜ:fən/ (n) (marine eng) **razvodni ventil**: Before commencing the task, he isolated the line by shutting off the main **distribution valves** as well as the inlet valve for the steam heating coil from where the return line issued.

distributor /,dis'tribju:tə/ (n) (marine eng) **razvodnik, razdjelnik distributor cap poklopac**

razvodnika, kapa razvodnika, distributor valve razvodni ventil: The **distributor valves** provide air to operate each starting valve in the correct order and timing. , **air start distributor**

razvodnik zraka za upućivanje stroja: The **Air Start Distributor**: The **air distributor** normally

consists of a series of pilot valves, one for each cylinder arranged radially ...

disturb /di'stɜ:b/ (v) **1 (comm) ometati; 2 (cargo) dirati (teret, kolete); 3 (navig) ometati (promet, druge brodove):** Always pass at a safe distance. Try to avoid crossing ahead. Do not disturb the vessel being overtaken. This can all be summarised very easily by the application of Good Seamanship and Common Sense. ; **4 smetati:** He did not want to **disturb the master** and did not contact the bridge.

disturbance /di'stɜ:bəns/ (n) **1 smetnja, ometanje; 2 (meteorol) a disruption of the atmosphere that usually refers to a low pressure area, cool air and inclement weather poremećaj, tal. perturbazione:** The night was dark and there was a 25 knots wind blowing in the opposite direction to the tidal current, causing some disturbance on the river.

ditch (v) to land (an aircraft) on water in an emergency **prisilno sletjeti na vodu**

ditching (n) (safety) **prisilno slijetanje na more, ditching**

diurnal /dai'ɜ:nəl/ (adj) having a period or cycle of approximately 1 tidal day **dnevni, jednom na dan**

diurnal wind /dai'ɜ:nəl/ (n) (meteorol) **dnevni vjetar**

dive /daiv/ (v) **roniti, uroniti:** He **dived** underneath, but found it very difficult to free the skipper. No salvage is to be dumped / **dived** / jumped / thrown without written authorization from the carrier.

dive boat (n) (nav arch) **ronilačka brodica, pomoćna brodica za ronjenje:** flares would reduce the chance of flare reports being made to the coastguard from vessels out of sight of the situation; Divers and commercial **dive boats** should consider the overall risk when operating in busy shipping lanes.

dive equipment (n) **ronilačka oprema:** The group managed to remove their **dive equipment** to lighten the RHIB, which had been holed in a number of areas.

dive fishery (n) (fishing) **ronilački ribolov:** Dive fisheries typically involve hand collection of the target species with the aid of a breathing device.

diver /'daivə/ (n) **ronilac:** Subsequent survey of underwater hull by a **diver** and internal inspection of bottom and peak tanks did not show any damage. The **diver** made a positive indication that he wished to continue with the dive and then he entered the water unaided. Following suspected damage, a **diver's examination** can, at best, give only an indication of the condition of the external hull ...

diverge (v) (navig) **skrenuti (s kursa):** After the turn, the vessel slowly **diverged from her planned track** and, eventually, the GPS alarm sounded as she strayed outside of the 2 cable cross track error (XTE) margin. Your vessel is **diverging from** the reference line.

divergence /dai'vɜ:dʒəns/ (n) (meteorol) **širenje vektorskog polja, a u meteorologiji služi za opis vodoravnih strujanja zraka divergencija:** The actual track was then reconstructed to show the **divergence** of the two tracks.

diverging /dai'vɜ:dʒiŋ/ (adj) **divergentan (kurs), koji se odvaja**

diverging courses /dai'vɜ:dʒiŋ/ **divergentni kursovi, kursovi koji se otvaraju**

diverging limiters /dai'vɜ:dʒiŋ/ (n) (navig) **divergirajući graničnici**

diversion /dai'vɜ:ʃən/ (n) (navig) **skretanje, On proceeding to the bridge, I discovered that my vessel was only 13 miles from the indicated position and required only a small diversion to arrive in 45 minutes.:** Further engine problems necessitated a second **diversion** for repairs. oute to the berth; Despite the fact that the direct safe route to the berth was obstructed, the pilot convinced the master that it was safe to **take a diversion** and pass to the side of the warship that was obstructing the direct passage; **diversion of route mijenjanje rute**

divert /dai'vɜ:t/ **skrenuti, ovoditi, odvratiti**: *If practicable, divert the vessel to the nearest suitable port that can cater for the vessel and provide fast access to the container; We had received a message to say that we were to divert to Singapore for bunkers.*

dive site (n) (navig) **mjesto ronjenja, pozicija ronjenja**: *Skippers should not let their dive support boats drift far from the dive site.*

dive support vessel (n) (nav arch) **prateći ronilački brod, prateća ronilačka**

brodica: *Dive support vessels should not rely too heavily on other vessels seeing and identifying an "A" flag correctly.*

divided by (adj) **COMPARE multiplied by podijeljen s, dijeljeno s**

dividers /di'vaɪdəz/ (n) (navig) **navigacijski šestar**: *The position of the buoy is taken off the chart*



by dividers and entered in the GPS and saved as a waypoint.

diving /'daɪvɪŋ/ (n) **ronjenje**: *The swell had increased, the weather was closing in, and it was decided that the conditions would make diving unsafe.*

diving equipment /'daɪvɪŋ/ (n) **ronilačka oprema**

diving inspection (n) (safety) **ronilački pregled**: *A diving inspection was necessary to untangle the messenger line from the starboard pod; no damage to the pod was found.*

diving operations (n) (safety, navig) **ronjenje, ronilačke operacije**: *The dive boat was displaying an International Code 'A' flag to denote diving operations in progress.*

diving survey (n) (safety) **ronilački pregled dna broda**: *After a diving survey of the vessel's hull, rudder and propeller, the attending Classification Surveyor found the vessel in all respects capable of continuing on her voyage.*

diving vessel /'daɪvɪŋ/ (n) (nav arch) **ronilački brod**: *The diving vessel was displaying clearly and conspicuously the international code flag Alpha, drawing attention to the fact that it was engaged in diving operations. diving support vessel prateći ronilački brod*: *Modifications were being carried out on the diving bell recovery system of a diving support vessel.*

division /di'vɪʒən/ (n) (math) **dijeljenje**

division wall /di'vɪʒən/ (n) (nav arch, marine eng) **pregradna stijena**

DLOSP (dropping last outwards sea pilot) (mar law) **iskrcaj zadnjeg peljara pri isplavljenju broda**

DO, D.O. (diesel oil) dizel gorivo

dock /dɒk/ (n) **on the docks na lučkoj obali, leave the dock isploviti, napustiti luku**:

On the day the vessel was scheduled to leave the dock, all the ship's Officers and Crew were busy for the whole day attending various jobs., on the dock u luci, na lučkoj obali: *Incoming cargo should*

be carefully examined - which is best done **on the dock** or wharf rather than on board - and every unsound or suspicious package rejected until its contents have been ascertained., **in dock u luci** About 5 years ago I was appointed as Captain to a ship during the first voyage after it had been **in dock** for repairs. **1** The designated water area, alongside or between piers, intended for ships to tie up for the purpose of loading or unloading cargo and passengers.

(<http://www.seatalk.info/cgi-bin/nautical-marine-sailing-dictionary>) **lučka obala**: The designated water area, alongside or between piers. On the day the vessel was scheduled to **leave the dock**, all the ship's Officers and Crew were busy for the whole day attending various jobs. While sailing further into the port, we came closer to the **dock** and saw a docked bulker. All packages which are found broken during discharge should be laid aside on board, or if **discharging on to the dock**, and the damaged cargo locked up (a lock-up should always be provided and carefully recovered, etc. The breast line bollard failed and due to a lack of spread of lines we drifted off of the **dock**.



; **2 pier; jetty gat**: When a ship broke away from a **dock** in Portland, Oregon, it was found that her ropes had been too slack. contact between two vessels, **King George Dock**, Hull on 13 November 2007 Published 30 May _ Viking Islay – loss of three lives, 25 miles off the East Yorkshire coast on 23 September 2007 Publi This may be an area such as a river or port, or a precise place such as a particular berth, wharf, **dock** or mooring.; **3 berth; quay pristan, vez**: The ship was secured **alongside the dock** within 15 minutes.; **4** originally, the term dock denotes an area of water that can accommodate a ship and can be closed off by locks to allow regulation of the water level.; the water space between adjacent piers or wharves or the space in a drydock **dokovska luka** Once the lock had filled, the vessel **entered the dock** and made her way towards the berth. Previously, they had operated from a sheltered enclosed **dock**, but the new pontoon was located in a more exposed position within the harbour. contact between two vessels, **King George Dock**, Hull on 23 November 2008; **5 lučki bazen, tal. bacino; darsena**: An **enclosed dock**, with limited manoeuvring space and other vessels in close proximity, is not the ideal place to get to grips with a vessel's handling characterist The master has applied for a pilot to bring the ship to the berth or **dock**. She then proceeded **into the second dock** without further incident.; **6** In US it often indicates a small landing pier for accommodating boats in a river or lake creek. **mali gat (za brodice, jahte, glisere), mali pristan**; **7 in the docks u luci** {Sometimes the whole wharf is informally called a dock.}

dock /dɒk/ (v) **1 (ship handling, navig) = berth a** to navigate a vessel to tie up at a wharf **uploviti u luku, uploviti u dokovsku luku** The vessel remained afloat and was able to **dock**.; **2 (seamanship, ship handling) privezati se, pristati**: She floated free with the rising tide and finally **docked** about 3 hours late. Our ship was docked in Sydney and, at around 11. Double-checking the computer, he saw that the ship/AIS was still **docked**. The Terminal wanted the vessel to **dock and undock** with holds open.

dockage /ˈdɒkɪdʒ/ (n) (mar law, shipping econ) a charge by a port authority for the length of water frontage used by a vessel tied up at a wharf. **naknada za korištenje vezova u luci**: *Vessels engaged in foreign trade that berth at any port of call shall also be charged DOCKAGE at BERTH per GRT per calendar day or fraction thereof, as follows, provided that, for purposes of computation, a maximum of 50,000 GRT shall be used: dockage at berth naknada za korištenje veza uz lučku obalu, dockage at anchorage naknada za korištenje veza na sidrištu*

dock basin (n) (ports) a space between two wharves or piers for the mooring of ships **lučki bazen**: *The cargo ship started to close a dredger that was working on the opposite side of the dock basin, so the pilot told the master to go 'ahead'.*

dock dues (n) (ports, mar law) **dokovske pristojbe, pristojbe za korištenje veza**: *The Dock Master will require to sight the Dock Pass issued by the authority when dock dues have been paid before he will permit the vessel to leave. The buyer will be responsible for the charges involved in getting the goods off the ship to his warehouse, such as lighterage, dock dues and custom duties.*

dock entrance (n) (ports, navig) **prilaz vezu, prilaz lučkom bazenu**

docker /ˈdɒkə/ (n) = **power distribution** (ports, shipping econ) **lučki radnik, doker**

dock gate (n) (ports, navig) **ustava lučkog bazena, dokovska usatva, brana za u lučki bazen**

docking /ˈdɒkɪŋ/ **1 pristajanje; 2 privezivanje**

docking bracket /ˈdɒkɪŋ/ (n) (nav arch) **koljeno za dokovanje**

docking communicator /ˈdɒkɪŋ/ (n) (navig, comm) **dvosmjerni razglasni uređaj između zapovjedničkoga mosta i manevarskih mjesta manevarski razglas, komandni razglas za pristajanje broda**

docking head (n) (nav arch) **A docking head is linked to a cone in the boat and keeps the boat steady during all operations with the davit (when the boat is at its upper position in the davit)**

protunjihajuća glava sohe (za brodice): *The ship was fitted with a "Caley" type davit, consisting of a single fall running through a docking head to a single release hook in the boat. A docking head fixed to the davit is triaxially operated via three hydraulic cylinders and fits directly onto a*



cone in the boat.

docking master (n) (mar law, navig) = **dock master** **upravitelj dokovskog veza, zapovjednik lučkog bazena**: *upravitelj lučkog veza/terminala After a nine-hour, all-night river transit, the vessel was approaching the discharge terminal, where the river pilots disembarked and the docking master boarded.*

dock(ing) pilot /ˈdɒkɪŋ/ (n) (mar law, navig) **lučki pilot (za privezivanje broda)**: *The crew*

were rigging the pilot ladder to receive the Hamburg **dock pilot** and preparing to make fast the tugs. Once the **docking pilot** boarded, the river pilot disembarked on the pilot launch.

docking signals /ˈdɒkɪŋ/ (n) (navig) signali za privezivanje broda

docking survey /ˈdɒkɪŋ/ (n) carry out a **docking survey** obaviti pregled broda u remontnom brodogradilištu (safety) pregled broda u doku, pregled broda u remontnom brodogradilištu: After an underwater survey a conditional certificate of class was issued for the ship to sail to the nearest major port in order to carry out a docking survey. Result of investigation: It was concluded that after the last tail end shaft and **docking survey** two months ago, the shipyard staff had failed to fully tighten the bolts of the two-piece clamp ring (shaded in red) on the tail shaft,

docking telegraph /ˈdɒkɪŋ/ (n) (comm, navig) komandni razglas za pristajanje

dock master (n) (ports, navig) = wharfinger upravitelj lučkog veza,

zapovjednik dokovskog veza, zapovjednik lučkog bazena: I should also mention that in many well-managed terminals, it is customary for an experienced berthing or **dock master** to control the shoreside operation in close liaison with the pilot. At 0430, VTS informed the vessel that the **dock master** was prepared to allow the vessel to berth and that the fire and rescue services would attend on her arrival.

dock pass (n) 1 (mar law) dozvola (pomorcu) za izlaz u grad; 2 dozvola (brodu) za

uplovljenje u dokovsku luku: But if the ship is in an enclosed dock, the Dock Master will require to sight the **Dock Pass** (issued by the authority when dock dues have been paid) before he will permit the vessel to leave.

dock pilot (n) (ports, navig) peljar za vezivanje broda, peljar za pristajanje uz vez

dock receipt (n) (mar law, shipping econ) A receipt issued by the carrier attesting to the delivery of the goods to the dock prior to their loading aboard the ship. It contains all relevant information about the cargo such as weight, volume, number of pieces etc. It is also used to calculate freight and other handling costs for the cargo. potvrda o uskladištenju (u luci), potvrda (luke) o primitku

tereta na ukrcaj: When the cargo consignment is delivered to the terminal a dock receipt is issued to the person delivering it. When delivery of a foreign shipment is completed, the dock receipt is exchanged for a bill of lading with the transportation line.

dock regulations (n) (ports) lučki propisi

dockside /ˈdɒksaɪd/ (adj) on the **dockside** na (lučkoj) obali 1 (ports) obalni: Despite his injuries, the bosun managed to swim around the stern of the ship to a **dockside ladder**, from where he was assisted out of the water and given medical treatment.; 2 (ports) the land area immediately adjacent to the dock lučki

dockside /ˈdɒksaɪd/ (n) (ports) lučka obala: At 0530 the cargo loading crane driver arrived, and an hour later he started to remove the smoking cargo to the **dockside**, where it was cooled down once more. As the master put the engines astern to clear the linkspan, he dragged the pontoon away from the **dockside**.

dockside crane /ˈdɒksaɪd kreɪn/ (n) (cargo handling, ports) obalna dizalica, dizalica na lučkom doku: Are **dockside cranes** available? Yes, **dockside cranes** are available.

dockside manoeuvring (n) (navig, seamanship) manovra pristajanja broda, pristajanje broda

dock trials (n) (nav arch) events conducted at the shipyard to determine the ability of the ship, from a material standpoint, to conduct sea trials safely ispitivanja broda u brodogradilištu ili na opremnom vezu prije primopredaje

dock wall (n) (ports) **obalni zid**: A dredger was clearing a shoal, close off the next berth downstream, between the **dock wall** and the centre of the fairway.

dock warrant (shipping econ) a document acknowledging that the goods have been deposited with a dock or port **potvrda o uskladištenju (tereta s broda u lučko skladište)**: Along with the Bill of Lading the **Dock Warrant** and Delivery Order are some of the most important documents of title to the goods.

dock water (n) (stabil) water density that lies between the two extremes, i.e. fresh water and salt water **mješana voda**, **stvarna gustoća vode (između gustoće slatke i slane vode)**
dock water allowance (DWA) the number of millimeters by which the mean draught changes when a ship passes from salt water to dock water, or vice versa, when the ship is loaded to the Summer displacement (Rhodes, Ship's Stability, Seamanship, 2003) **iznos promjene gaza pri ulasku u područje različite gustoće vode, krcanje u mješanoj vodi**

dock worker (n) (ports) **lučki radnik**: On the whole this well-intentioned article was a good one illustrating the type of incident that kills hundreds of seamen and **dock workers** every year around the world, including the odd surveyor. Offshore vessels 'units' crews shall not be required or induced to carry out cargo handling and other work traditionally or historically done by **dock workers** without the prior agreement of the ITF dockers' union ...

dockyard /'dɒk.jɑːd/ **1** (ports, nav arch) **opremni vez, remontni vez**: Dockyards are sometimes more associated with maintenance and basing activities than shipyards There was no fire watch, either by the **dockyard** or the ship because nobody realised he was working through.; **2** (nav arch) **remontno brodogradilište**; **3** (navy) a naval establishment with docks, workshops, etc, for the building, fitting out, and repair of vessels **vez u ratnoj luci, vez za opremu i popravak ratnih brodova**; **4** a shipyard or plant where ships are constructed or repaired **brodogradilište**

Doctor / Physician (n) (med, mar law) person responsible for the treatment of crew members.

brodski liječnik, brodski doktor: The position of a doctor / physician requires current license and extensive experience within primary care, trauma, internal, cardiac, and emergency medicine. If in port, and it is thought necessary, a **doctor** should be called or the injured person should be sent to a hospital.

documentary credit any arrangement, however named or described, whereby a bank (the Issuing Bank) acting at the request and on the instructions of a customer (the Applicant) or on its own behalf, (Tetley) **dokumentarni akreditiv, akreditiv, bankovni komercijalni kredit, komercijalni akreditiv**: Standard form bills of lading, charterparties, marine insurance policies and sales contracts are good examples of common forms and the accepted meaning of the terms, as well as the York/Antwerp Rules on general average and the Uniform Customs and Practice for **Documentary Credits**.

document of compliance (n) (marine eng, cargo) **potvrda o uskladenosti**: This enabled the local Lloyd's Surveyor to complete the survey and issue a **Document of Compliance** for Carriage of Dangerous Goods in Bulk. The vessel must be in possession of a valid **Document of compliance** with special requirements for ships carrying dangerous goods.

document of title (n) (mar law) isprava koja navodi tko je vlasnik tereta odnosno tko ima pravo primiti teret **isprava koja daje naslov na teret**: The voyage charter remains the governing contract of carriage; the bill of lading serves only as a receipt and as a **document of title** to the goods. Contract of carriage applies only to contracts of carriage covered by a bill of lading or any similar **document of title**, ...

dog¹ (v) (seamanship) **pričvrstiti grotleni pokopac (leptirastim vijcima)**

dog² (n) (seamanship, nav arch) **zapor, zaporna poluga (na vratima, poklopcima grotla,**

šahata, otvora itd.): *The Quick Acting 4-dog watertight hatches also feature a new 4 dog latching system of securing the hatch cover to the deck. The 4 dog system is a proven mechanism for hatch*



engagement

dogbolt /'dɒg, bəʊlt/ (n) (nav arch) leptirasta matica za zatvaranje poklopca brodskog okna

dog clutch (n) (marine eng, cargo handling) zupčasta spojka: *In order to remove the dried old grease around the dog clutch and shaft, it was necessary for the seaman to extend his arm between the drum and the winch drive gear and clear it manually. He then attempted to remove the old grease from the dog-clutch arrangement. ay out the port trawl wire but the main engine stopped, resulting in the loss of hydraulic power and a consequent inability to disengage the winch dog clutch.*

dogfish (n) 1 COMPARE nursehound morska mačka spotted dogfish COMPARE small-spotted catshark morska mačka; 2 piked dogfish pas kostelj

dogs (n) (marine eng, boating/yachting) leptiraste matice

dog's teeth (n) zubatac

dog vane (n) (boating/yachting) pokazivač smjera vjetrova, muštravent; muštravenat

dog watch (n) 1 (seamanship) a short watch period, generally half the usual time (e.g. a two hour night watch between two four hour ones) polusmjena, pola vremena straže: *Under the new system, by just doing one of the 2 hour dog watches in the morning, I can make sure that each of the officers gets a break one day in three.*; 2 (seamanship) n marine or naval terminology, is a watch, a period of work duty or a work shift, between 16:00 and 20:00 (4 pm and 8 pm) brodska straža (na našim starim brodovima) od 00:00 do 04:00 sata, pasja gvardija first dog watch brodska straža od 16:00 do 18:00, last dog watch brodska straža od 18:00 do 20:00

doldrums /'dɒldrəmz/ (n) (meteorol) SYNONYM equatorial trough = horse latitudes COMPARE trade winds the belt on each side of the Equator in which little or no



wind ordinarily blows ekvatorijalna tišina

dolphin /'dɒlfɪn/ (n) **1 (ports)** a large wooden pile or a block of wood piles with a ring bolt at each end, used as a mooring post or for mooring a buoy **privezni stup, stup za vez (izvan lučke obale)**, **dolphin**: *At this point the vessel's bow was 440M (just over 2 ship's lengths) from the dolphin of the bulk berth The vessel was to moor to a fixed jetty forward, stern ramp onto a floating pontoon, and rest alongside an isolated dolphin amidships, which was also used for a spring from aft. One man was standing on the dolphin ready to throw a heaving line down to take the spring from the boat. mooring dolphin* a cluster of pilings to which a boat or barge ties up **privezni stup**: *The Port Authority had built a mooring dolphin especially for cruise ships for this purpose and assured us that it was strong enough for all of the headlines. Instead of moving into the river, the pilot manoeuvred the ship close and parallel to the jetty, and as she approached the upriver mooring dolphin, he placed the engine full astern.*

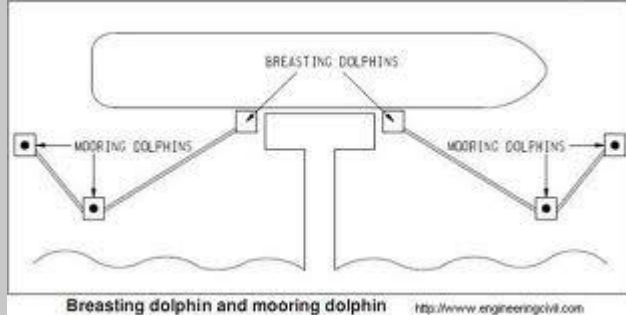

2 A minor aid to navigation structure consisting of a number of piles driven into the seabed or riverbed in a circular pattern and drawn together with wire rope **plovidbena oznaka na stupovima u moru**

domain /də'mein/ (n) (**navig**) područje oko broda u plovidbi koje časnik straže želi zadržati slobodnim od drugih brodova i nepomičnih objekata poduzimanjem odgovarajućih manevara izbjegavanja sudara na moru **domena**

domestic navigation (n) (**mar law**) nacionalna plovidba

don (v) (**safety**) **odjenuti, obući don a lifejacket odjenuti prsluk za spašavanje, staviti prsluk za spašavanje**: *After the general alarm was sounded, the crew assembled on the bridge and donned the lifejackets He alerted the crew, asking them to don lifejackets and prepare to haul the net. The coastguard were alerted quickly by DSC alert; the liferaft was deployed manually and kept alongside until needed; the crew donned lifejackets; As the vessel started to list to starboard, the skipper broadcast a "Mayday" on VHF radio Channel 16 and instructed the crew to don lifejackets and deploy the liferaft. The two crew donned extra clothing and lifejackets., don the immersion suit obući odijelo za spašavanje (u moru)* *After the general alarm was sounded, the crew assembled on the bridge and donned immersion suits collected from two decks below., don the breathing apparatus staviti aparat za disanje*: *The engineer on watch left the control room to don breathing apparatus, as the smoke was becoming heavier.*

donkey (n) **1 (marine eng)** a small boiler **pomoćni kotao**; **2 (marine eng)** a small engine used to operate deck machinery such as winches and derricks.

(<http://www.seatalk.info/cgi-bin/nautical-marine-sailing-dictionary>) **mali parni stroj donkey engine mali parni stroj**

donkey boiler (n) **1 (marine eng)** **pomoćni kotao, kotao za lučke službe**: *The donkeyman attends a donkey, auxiliary boiler, especially when the ship is in port.*; **2 pomoćni kotao**

donkeyman /'dɒŋkɪmən/ (n) (**marine eng**) **vođa stroja, noštro (od) makine, tal.**

caporale di macchina: *The propulsion plant department can also include some petty officers, such as the donkey man and the storekeeper and, if the ship is a tanker, there may also be the pump man. The*

donkey man took a few recordings and noted them in the Engineer's Log. {tal.: caporale di macchina}

donkey pump (n) (marine eng) pomoćna pumpa pare

door watertight door vodonepropusna vrata: Water flooded through an open watertight door and into the accommodation. Lessons learned * Always fully open a watertight door before passing through the doorway when the door is in the remote-close mode., **hinged door** vrata sa šarkama:

The lower frame box is on the front of the engine provided with a large hinged door for each cylinder.,

door operating handle ručka za otvaranje vrata: The door operating handle protruded farther inside the watertight doorway space than was necessary., **access door** prilazna vrata: On

opening the access door to the hold, the officer saw that the first mate was unconscious, about three metres from the door., **bow door** pramčana vrata Ro-Ro ferry bow door failure in port Bow door

operating panel on car deck valves was found in the correct sequence., **cabin door** vrata kabine:

Looking down into this hatch, he saw flames and smoke coming from the open cabin door., **ramp door**

vrata rampe (ro-ro broda, trajekta): 200850 Ramp door near miss During her maiden voyage,

the CO of a new ro-ro ship was preparing to set the stern quarter ramp door for cargo operations., **side**

door bočna vrata (ro-ro broda): Whilst a Pilot was disembarking from the side door of a Ro-Ro

vessel departing port, both the side ropes of the pilot ladder parted once the full weight of the pilot was on

the first rung of the ladder., **sliding door** klizna vrata: The sliding door opened and the two

passengers were just about to step through the door when, to their alarm, they found that there was no deck outside the door, (nav arch) vrata

door-to-door service 1 prijevoz od skladišta otpremnika (prodavatelja) do

skladišta primatelja; 2 (shipping econ) prijevoz tereta pod istom teretnicom od

prodavaočeva/proizvođačevog do kupčeva/potrošačevog skladišta usluga / služba / servis

vrata -vrata, izravan / direktan prijevoz

DOP (dropping last pilot) (mar law) iskraj peljara pri isplavljenju broda

Doppler effect (n) (navig) A change in the observed frequency of a wave, as of sound or light,

occurring when the source and observer are in motion relative to each other, with the frequency

increasing when the source and observer approach each other and decreasing when they move apart.

The motion of the source causes a real shift in frequency of the wave, while the motion of the observer

produces only an apparent shift in frequency. Also called Doppler shift. **Dopplerov efekt**

Doppler frequency oscillator (n) (navig) podesivi oscilator

Doppler log (n) (navig) ultrazvučni brzinomjer, snimalica dubina, uređaj za

ultrazvučno snimanje dubina, **Doppler-log** ... , an increase in current reading from 2.2kts to

3.2kts, and a Doppler log reading of 4.5kts were all immediately observed. A visual sighting of the clump

weight wires showed it to be streamed astern, also DP observation It was assumed, wrongly as it turned

out, that in shallow water the Doppler Log goes automatically into ground tracking mode and gives speed

over the ground.

dormant period (n) (navig) razdoblje mirovanja (u sustavu BNWAS)

dory (n) kovač, šampjer

double (v) (seamanship) COMPARE Single up! to place a second dockline alongside the

existing one udvostručiti (privezno uže)

double-acting (n) (adj) (marine eng) dvoradni double-acting pump dvoradna

pumpa, double-acting piston dvoradni stap, double-acting engine dvoradni stroj

double bottom (n) (nav arch) the space between the inner and outer skins of a vessel called

respectively the inner bottom and shell, usually extending from bilge to bilge and for nearly the whole

length of the vessel fore and aft, and subdivided into water or oil tight compartments

(<http://www.seasources.net/>) **dvodno, tal. doppio fondo**: In the system shown in the diagram above, the oil is stored in tanks in the **double bottom** from which it is pumped to a settling tank and

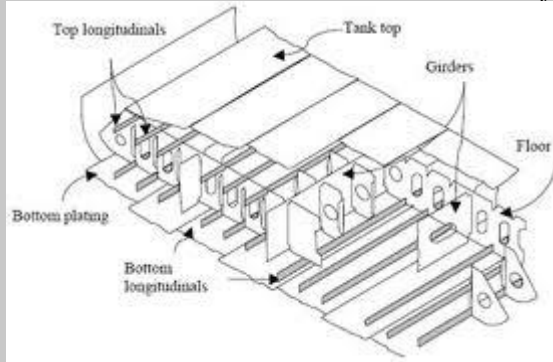

heated.

double bottom strut (n) (nav arch) element koji povezuje i prenosi vertikalno opterećenje između uzdužnjaka oplata dna i pokrova dvodna **razupora dvodna**

double bottom tank (n) (nav arch) **tank dvodna**: The next morning, the chief officer resumed the operations by deballasting one of the after **double bottom tanks**. This prudent practice is to avoid any damage to cargo by water which may potentially enter the hold via leaking **double-bottom tank manhole lids**, sounding and air pipes and cracks or holes in tank plating.

double casing (n) (marine eng) **dvostruki plašt (kotla)**: The boiler is also provided with a **double casing** which allows the passage of combustion air to the air control register surrounding the burner.

double-check (v) **provjeriti dvaput**: *Double check all line-ups before pressing 'pump on'.*

double-decked cylinder head (n) (marine eng) **glava cilindra s dvostrukom stijenkom**

doubled line (n) (seamanship) **uvojak, duplin**

double-drum marine watertube boiler (n) (marine eng) **brodski vodocijevni kotao s dvostrukim bubnjem**

double-ended boat (n) (boating/yachting, nav arch) a boat or vessel with a pointed shape to the hull both bow and stern **brodica sa zaoštrenim pramcem i krmom, brodica u obliku guca**

double-flow (n) (marine eng) **dvostruka dimna komora**

double-hull tanker (n) (nav arch) **tanker s dvostrukom oplatom**: The vessel, a **double hull product tanker**, berthed starboard side to at high water tide in the terminal to discharge a cargo of oil products.

double planking (n) (nav arch) **dvostruka drvena oplata**

double plated rudder (n) (nav arch) **strujno kormilo**

double-seater (n) (boating/yachting) **dvosjed**

double sheet bend (n) (seamanship) **dvostruki zastavni uzao**

double skin (n) (nav arch) **dvobok double skin bulkhead dvostruka pregrada**

double the line

down by the head

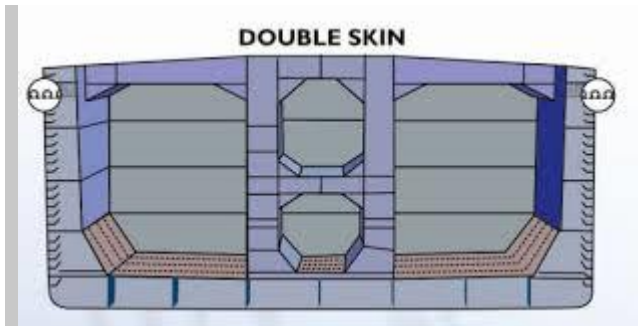

double the line (v) (ship handling, seamanship) udvostručiti uže / konop, postaviti dva užeta: Mooring lines are then doubled if necessary.

double up (v) 1 (seamanship) COMPARE singled up pojačati vez, udvostručiti vez; 2 (navig) udvostručiti stražu: Double up watches and listen!

doubt /daʊt/ (n) (safety, navig) sumnja, dvojba: Good listening watch to be kept on VHF and, in case of any doubt about intentions of another vessel, seek clarifications after positively identifying her and inform VTS/port control. There is no doubt that plotters and autopilots have eased the burden of wheelhouse watchkeepers in recent years. if in doubt ako se sumnja, ako postoji sumnja: The master must be called if the watch officer is in doubt as to the existence of the collision When in doubt as to weight, quantity and condition, Mate's receipts as well as the bills of lading should be caused weight, quality, quantity and condition unknown.

doubt /daʊt/ (v) sumnjati, dvojiti: My own vessel is a very manoeuvrable and responds very well to course and speed alterations but I doubt whether the Master of the container ship can say the same!

douse; dowse /daʊs/ (v) 1 (boating/yachting) to take down a sail quickly brzo spustiti jedra; 2 (seamanship) popustiti konop; 3 (comm) spustiti zastavu, spustiti signalnu zastavicu; 4 (safety) ugasiti vodom: Without further questioning he decided to use water to douse the fire. the skipper opted to engage the main engine-driven deckwash pump so that the crew could fill a bucket with water for him to douse the flames.

dowel /'daʊəl/ (marine eng) cap-locating dowel zatik za postavljanje poklopca / kape, dowel pin zatik dowel pins were used mainly because the tightness of the shrink fit could not



be guaranteed

dvosjedni zatik, postavni zatik

down below (prep phr) (seamanship) pod palubom, potpalublje, u dnu broda: The fire started down below, in the ship's engine spaces. Half an hour after coming on watch, the 2/O sent the lookout down below to 'stand-by' in the crew mess.

down by the head (n) (seamanship) a vessel with the bow riding deeper than the stern pretežan brod: By the time Boat B's skipper had stepped across on to Boat A, his vessel had started

to go **down by the head** and list to port. The ship is 2.3 metres down by the head.

down by the stern (n) (seamanship) **ANTONYM down by the head** a vessel that is overloaded astern and riding deeper aft **zatežan brod**: The ship is 1.8 metres down by the stern at present.

downcomer /ˈdaʊn,kʌmə/ (n) (marine eng) silazna cijev (u odvodu itd.)

downdrain (n) (geogr) strujanje vode prema ušću rijeke: During a flood tide, an outward flow of water known as the 'downdrain' near the face of Northfleet Hope Container Terminal interacts with the inward tidal stream to create a counter-flow off the berth,

downhaul /ˈdaʊn,hɔ:l/ (n) (boating/yachting) a line used to control either a mobile spar, or the shape of a sail **priteg tanguna, karikabaso**; tal. **caricabasso** **spinnaker pole** **downhaul** **priteg tanguna špinakera, karikabaso**

down haul /ˈdaʊn,hɔ:l/ (n) (boating/yachting) pritega tanguna špinakera

down-payment (n) (shipping econ) plaćanje unaprijed, avans

down rigger spuštač ribolovnog udičarskog sistema (kod panule)

downstream (adv) nizvodno, niz rijeke: Having asked his two passengers if they were holding on, he commenced a turn to starboard to head **down stream**.

down time (n) (marine eng) period izvan rada (stroja): This result in the shortening of lubricant life, lower lifetime of key components, reduced reliability and increased **downtime**.

downwind (adv) (sailing) with the wind astern **niz vjetar, šotovento**

dowse; douse /daʊs/ (v) 1 (boating/yachting) to take in, or lower a sail; to lower, smother and

hold down a sail quickly **spustiti jedro, ubrati jedro**; 2 **prigušiti svijetlo, pogasiti svijetlo**

Do you read me? (comm) Čujete li me? **How do you read me?** Kako me čujete?

draft = **draught** depth of a loaded vessel in the water taken from the level of the waterline to the

lowest point of the hull of the vessel **gaz broda**: Our **draft** at the time was 5.7M forward and 9.8M aft

I was OOW on a loaded bulk carrier **with a draft** of 9.9 metres making 8 knots at Half Ahead. **calculate**

draft **izračunati gaz**: The ship's **draught** was calculated by the Chief Officer. It was 12.69m forward

and 12.72m aft., **take the draft** **izmjeriti gaz, departure draft** **gaz prije isplovljenja,**

arrival draft **gaz pri dolasku (broda u luku), laden draft** **gaz nakrcanog broda, draft**

aft **gaz na krmi, draft forward** **gaz na pramcu**: My **draft forward** is 5.2 metres., **after draft**

gaz na krmi: The **after draft** had been reduced to 9M., **air draft** **visina broda iznad mora**: What

is your **air draft**? My **air draft** is ... metres., **loaded draft** **gaz nakrcanog broda**: Own ship was

a 300,000 dwt tanker with a **loaded draft** of 21.6 metres., **maximum draft** **najveći gaz,**

maksimalni gaz: What is your present **maximum draft**? I was recently on a bulk carrier passing

through the Suez Canal in a northbound convoy on a **maximum Suez draft** of 56 feet., **permissible**

draft **dopušteni gaz**: The maximum **permissible draft** was 11.8 m., **draft read out** **očitanje**

gaza, očitani gaz, očitano stane gaza: The **remote draft read outs** were inoperative and,

reportedly had been for several years., **sailing draft** **gaz u plovidbi**: The final **sailing draft** was 11.7

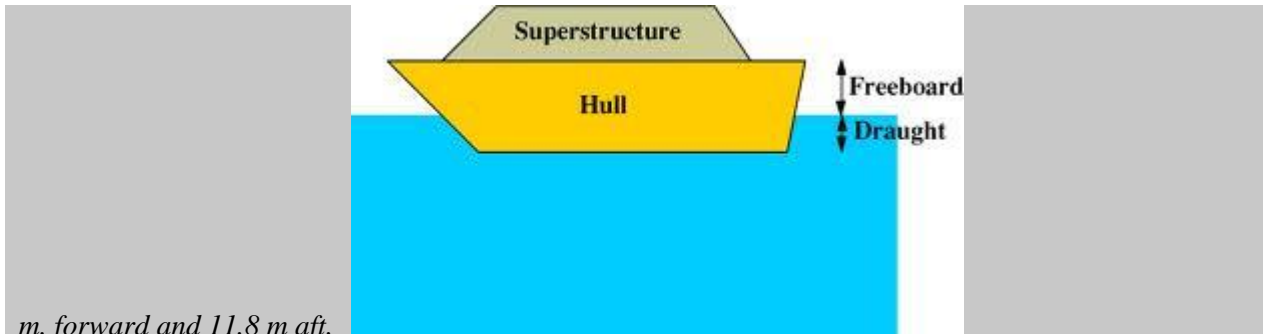

m. forward and 11.8 m aft.

draft: napraviti nacrt / prijedlog **draft** a firm offer sastaviti nacrt ponude

draft³ (n) (boating/yachting) = belly trbuh jedra

draft⁴ (n) (mar law, shipping econ) = bill of exchange an unconditional order in writing, addressed by one party (drawer) to another party (drawee), requiring the drawee to pay at a fixed or determinable future date a specified sum in lawful currency to the order of a specified person; A signed, written order by one party that instructs another party to pay a third party a specific amount. It can also be called a bill of exchange. (<http://www.maerskline.com/en-jm/help/shipping-glossary>) **mjenica**

bank draft an order issued by a seller against a purchaser; directs payment, usually through an intermediary bank **bankovna mjenica**

draft calculations (n) **izračun gaza**: *The draft calculations made by the master were on the basis that the vessel was floating in sea water, however, the specific gravity at the time was in fact 1015.*

draft indicator (n) (navig) **pokazivač gaza** **remote draft indicator** **daljinski**

pokazivač gaza: *All bulk carriers should have reliable remote draft indicators.*

draft marks (n) (nav arch) numerals applied vertically to the sides of a ship fore and aft indicating the depth of the keel (<http://www.seatalk.info/cgi-bin/nautical-marine-sailing-dictionary>)

zagaznice, oznake gaza borda: *draft marks and load lines not readable*



draft of cargo (cargo) **teret složen u pasac, braga tereta**

draft of sail (n) (boating/yachting) **zakrivljenost plohe jedra, projektirani trbuh jedra**

draft reading (n) (seamanship) **očitanje gaza**: *Access to the shore for draft reading is often difficult.*

draft read out **očitanje gaza, očitani gaz, očitano stane gaza**: *The remote draft read outs were inoperative and, reportedly had been for several years.*

draft restriction (n) (navig) **ograničenje gaza**: *Two days before arrival at a river entrance, a Company Vessel was advised by the agent of a draft restriction of 36.1 ft (11.00 m) due to the low water flow in the river.*

draft signals (n) (navig) **oznake gaza**: *We were navigating in the appropriate traffic lane, following the designated deep-water route at a speed of about 12 knots, displaying deep draft signals.*

draft survey (n) (cargo handling) **određivanje količine tereta na brodu pomoću gaza**

kontrola gaza: On completion of the first parcel, a **draft survey** was **taken** by the Chief Officer and the quantity of cargo calculated by himself and a surveyor.

draft surveyors kontrolori gaza, tvrtka za kontrolu gaza: They are also used by **draft surveyors** to read the offside marks and stern readings where launches are not available.

drag /dræg/ **1 (v intr) (navig)** to fail to hold to the ground, i.e. to lose control of an anchored vessel because of heavy seas, currents, wind or a foul bottom, so that the anchor cannot hold its ground **orati (na sidru), tal. spedare (ancoraggio)**: the anchor is dragging sidro ore, sidro ne drži A decision to pay out another shackle of cable was taken to try and stop the vessel **dragging her anchor**. The crew weighed anchor and then re-anchored, but to no avail as they **continued to drag** with six shackles out.

drag anchor orati (sidrom): Ensure engines are available in case vessel starts to drag anchor Pazite da strojevi budu spremni za upućivanje u slučaju da brod počne orati As the squall passed, own vessel started to **drag anchor**. At 0936, the ship began to **drag her anchor** to the north and towards the shore line. According to reports the container ship **dragged anchor** and ran aground on the southwest tip of Kinmen island.; **2 to drag a net vući / potezati mrežu**

drag (n) (nav arch) razlika između gaza na pramcu i gaza na krmi **zatega**

drag (n) (fishing) **kočnica (role ribolovnog štapa)**

dragging /drægiŋ/ (n) (navig) **oranje sidra**: Beware of **dragging**, especially when in an area of strong tides / current. Unfortunately, none of the bridge team realised the slow **dragging of the anchor**, having monitored the ship's position by distant radar ranges, which failed to change appreciably.

dragging anchor (n) (navig, seamanship) **sidro koje ore, tal. ancora arante**: Are you dragging anchor? Yes, I am dragging anchor. A tanker in ballast at anchor in a storm **began dragging her anchor** in Tees Bay, UK. Plotting the anchor position and estimating a bridge swinging circle is necessary to determine whether a vessel is **dragging anchor**.

dragnet (n) (fishing) **mreža potegača**

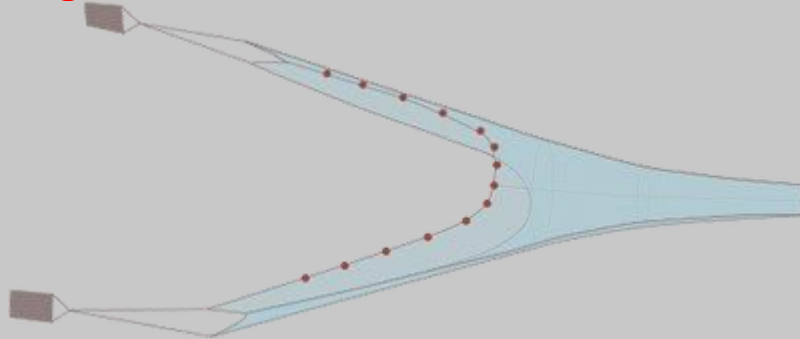

drain /drein/ (v) (marine eng, seamanship) **drain the daily fuel tank odstraniti talog i vodu iz dnevnog tanka goriva, drain the water off odvodniti, ispustiti vodu, isušiti tank 1 ispustiti, ispuštati (vodu, ulje, tekućinu)**: in Figure 4 Forward hook assembly showing damage The second mate then remained on the boat while it was lifted clear of the water, allowed to **drain**, and then hoisted to the embarkation level. **drain away ispustiti** ...l, and as water was still coming on to the deck, he opened one of the freeing port shutters to try and **drain it away**.; **2 otjecati, slijevati se; 3 isušiti**. A hydraulic pipe bulkhead gland was found to be leaking, which had allowed the hydraulic oil to **drain away** and air to enter the system during the lay up period.; **4 odvoditi**

drain /drein/ (n) **air drain odušni otvori na zračnom vodu, drenažni kanali na vodu zraka**: The CO2 line's **air drain** in the engine room was checked and found to be in order., **gravity drain otjecanje slobodnim padom, ispuštanje samotokom**: From the sump the oil is

drained into the lubricating oil tank for re-use. In most cases this is a **gravity drain** to a tank in the double bottom. , **oil drain otvor za ispuštanje ulja**: The bearing covers are each fitted with an oil filter, an **oil drain** opening and an oil gauge glass., **drain hole ispusni otvor**: A double seal arrangement is provided at each branch point with a **drain hole** to detect leakage and prevent intermixing or contamination. **odljevni otvor, otvor za drenažu**: Clear glass sample bottles rinsed with boiling water should be used to **take drain or bottom samples** from service, header and storage tanks.

drainage /'dreɪnɪdʒ/ (marine eng, cargo handling) **odvod (kondenzata), pražnjenje**:

Emergency **drainage** of Hold 1 is also possible using the engine room bilge pumps. Always ensure that freeing ports are kept clear, and that containers on deck have adequate **drainage holes**. When the drain valves from the main air receiver were opened, the condensate flowed into the **drainage pot** in sufficient quantity to cover the bottom of the pot and the **discharge hole**. **drainage pump cijevi za odvod kondenzata**

drain channel (n) (marine eng) **ispusni kanal, ispusni žljeb**: The tube also acts as a **drain channel** to ensure that any leakage from the fuel valve and the HP pipe is drained off.

drain cock (n) (marine eng, nav arch) **ispusni pipac**: The crew found that cargo was coming out through the open **drain cock** on the tank cleaning line branch to 5 Starboard Cargo Oil Tank (COT). The **drain cock** of the tank cleaning line was kept open as a precaution against freezing.

drain hole (n) (marine eng, nav arch) **ispusni otvor**: **Drain holes** were blocked and none had non-return valves.

draining plug (n) (nav arch) **čep izljeva**

drain off /'dreɪn ɔf/ (v) (marine eng) **ispustiti, iscijediti, isušiti**: The engineers had to work rapidly to **drain off** this water before it got into the engines.

drain pipe (n) (nav arch, marine eng) **odljevna cijev**: The leaking oil from the holed bunker pipe found its way through a **drain pipe** in the side channel into the overboard discharge line causing the oil pollution.

drain plug (n) (nav arch, boating/yachting) **odvodni čep**: Although the boat was fitted with a **drain plug** on the transom, the internal compartments were not interconnected. The capsized boat was later towed to the jetty, where it was found that the **hull drain plug** was missing.

drain system (marine eng, seamanship) **odljevni sustav**: Consequently, the shipyard did not conduct appropriate engineering analysis or testing of the condensate **drain system** prior to fitting it. Both the shipyard and the owner's representative considered the **drain system** to be open and therefore not prone to pressure accumulation.

drain tank (n) (marine eng) **drenažni tank, sabirni tank, odljevni tank**: □ The oil in the **drain tank** is being constantly circulated through a centrifugal filter / purifier / strainer. He proceeded to stop the transfer pump locally and shut the inlet valve of the **drain tank**. The oil then drains from the crankcase into the **drain tank** or sump. **atmospheric drain tank drenažni tank pod atmosferskim tlakom**

drain tap (n) (boating/yachting, marine eng) **ispusni pipac**

drain valve (n) (marine eng, nav arch, cargo handling) **ispusni ventil**: **odvodni ventil** The cargo then passed through the partially opened tank cleaning valve and fully opened **drain valve** on to the deck, resulting in the oil cargo spilling on deck; 5. Prior to the changeover, he opened the **drain valve** at the bottom of the tank being put into service and started to drain off water.

draught /dra:ft/ 1 (nav arch, stabil) the distance measured vertically on the midship transverse section, from the base line to the load waterline; the distance from the keel to the waterline (WL), as measured at the forward and aft ends of the ship **gaz broda, tal. pescaggio**: The vessel, loaded to

a *draught* of 13.5 metres, was upbound in a river estuary. **draught aft** gaz na krmi, **take the draught** izmjeriti gaz, **snimiti gaz**, **departure draught** gaz u odlasku, **arrival draught** gaz u dolasku, **maximum draught** najveći gaz, **draught forward** gaz na pramcu, **draught on departure** gaz pri isplavljenju, **draught on arrival** gar pri dolasku / uplovljenju, **sailing draught** gaz u plovidbi. *Maximum sailing draught and minimum draught for safe manoeuvring permitted by the port authority.*, **designed draught** projektni gaz, **minimum draught** najmanji gaz, **minimalni gaz**, **anticipated draught** predviđeni gaz, **gaz nakon ukrcaja / iskrcaja**: ... the actual time, particulars of draught, information regarding the tonnage and type of cargo she will work, and the maximum **draught anticipated** when loading has been completed., **recommended draught** preporučeni gaz. *The vessel had transferred cargo and ballast in order to meet the recommended draught, however this proved insufficient.*, **vessel constrained by her draught** brod ograničene sposobnosti **manevriranja zbog svojega gaza**: 'Any vessel... shall... avoid impeding the passage of a vessel constrained by her draught exhibiting the signals in Rule 28., **light draught** gaz bez tereta, **gaz nenakrcanog boda**: The vessel was *light draught* and had a large windage area, and was yawing substantially., **fresh water draught** gaz u slatkoj vodi. *During the master pilot exchange of information, the master declared that the vessel's fresh water draught_n was 4.1 m.*; **2 (marine eng) propuh**, **cirkulacija zraka induced draught** usisna cirkulacija zraka, **natural draught** prirodna cirkulacija zraka, **prirodni propuh**, **mechanical draught** prisilna cirkulacija zraka, **umjetni propuh** {draught=draft}

draught aft /dra::ft/ (n) (nav arch, seamanship) krmeni gaz, gaz na krmi

draught amidships /dra::ft/ (n) (nav arch) gaz na sredini broda

draught and trim calculation (n) (stabil) proračun gaza i trima

draught forward /dra::ft/ (n) (nav arch, seamanship) pramčani gaz, gaz na pramcu

draught indicator /dra::ft/ pokazivač gaza

draught marks /dra::ft/ (n) (nav arch) zagaznice, **bale check the draught marks** provjeriti zagaznice, **očitati zagaznice**

draught signals (n) (navig) **SEE vessel constrained by her draught**

oznake gaza: ... the *deep draught signal* was being displayed, visibility was in excess of 10 miles, wind w'ly force 4. The target vessel was a westbound tanker of about 80 to 90,000 tonnes in ballast, *she was not displaying deep draught signals* and her name and call sign are not known.

draw (v) **1** to require sufficient depth of water necessary to move the ship without grounding **gaziti**

(o brodu), **imati gaz**: the vessel is *drawing* 17.6 meters brod ima gaz od 17,5 metara *How much does your boat draw?* Koliki je gaz vašega broda? *Own ship was a bulk carrier drawing 17.7m, heading up the southern North Sea bound for Rotterdam and using the Sandettie Deep Water Route.*; **2**

(boating/yachting) to fill with wind and begin propelling a sailboat **povući vjetar (o jedru)**

draw (v) **draw money** **podići novac** (mar law, shipping econ) **povući**, **podignuti (novac)**

draw a part of the net wages **podići dio plaće**: on the vessel's arrival in port the Employee shall be entitled to **draw all or part of the net wages** due to her/him in respect of the current calendar month, **draw a cheque** To write out in due form an order to pay money on the writer's account; to write out (a bill, cheque, or draft). **ispuniti ček**

draw (v) (navig) **približiti se**, **prolaziti blizu**. *The two vessels wer drawing too close. Simultaneously, and rudder was moved to hard-a-port and, to our great relief, the drift net slowly began to*

draw astern and was cleared about two cables off. Now **drawing ahead of the tanker**, and some distance to the north-east of the track, the pilot ordered 'Full Ahead' and 'Hard a Starboard' ...

draw attention (v) **privući pažnju, skrenuti pažnju, upozoriti**: *I wish to draw your attention to the fact that* owing to the negligent and careless handling by the stevedores, during discharge of the above cargo, heavy damage has been caused to the goods. Cylinder heads are fitted with relief valves **in order to draw attention to** any abnormally high firing pressure.

drawback (n) (**marine eng, nav arch**) **nedostatak**: Owners should seek expert professional advice, and wherever possible, reference should be made to **design drawings**, and the designer/builder consulted to check construction details and suitability of the modification.

drawing board (n) (**nav arch**) **crtaići stol**

drawings /ˈdrɔːɪŋz/ (n) (**marine eng, electr**) **nacrti**: List of manuals and **drawings** available on board. The information and **drawings** available on board the vessel at the time included the final (approved) drawing for the compressed air system but did not mention the modified drainage system.

design drawings izvedbeni nacrt: Owners should seek expert professional advice, and wherever possible, reference should be made to **design drawings**, and the designer/builder consulted to check construction details and suitability of the modification., **technical drawings tehnički nacrti**: Although **technical drawings** were not supplied, the company used an experienced contractor to undertake the work, which was overseen by an independent consultant.

draw knife (n) (**seamanship**) **nož s dvije oštrice**

draw off (n) (**navig**) **spuštanje razine mora (zbog prevelike brzine broda u kanalu)**: damage caused by wash or draw off due to excessive speed

draw out a lesson (v) **povući pouku**: There is a need to inform the shipping and fishing industries, the pleasure craft community and the public of the general circumstances of marine accidents and to **draw out the lessons** to be learned.

draw up (v) (**shipping econ, mar law**) **sastaviti, napisati**: Draw up a Statement of Facts covering the time the breakdown occurred and deviation commenced ... **draw up a report sastaviti izvješće, draw up a document sastaviti / napisati dokument, sastaviti / napisati ispravu, draw up a contract sastaviti ugovor, napraviti nacrt ugovora, draw up instructions napisati upute**: Shipyards and repair yards should draw up clear instructions for each type of vessel , **draw up a passage plan sastaviti plan putovanja**: The Master was kept busy with the phone calls and frequent internal calls to the engine room about bunker requirements and myself (OOW) drawing up the new Passage Plan., **draw up the cargo stowage plan sastaviti plan krcanja, napraviti plan krcanja**

dray /dreɪ/ (n) (**cargo handling**) cart or for local haulage or carriage of cargo, eg. on the dock or within the port) **kola, kolica**

drayage /ˈdreɪdʒ/ (n) **1 (cargo handling) = cartage prijevoz kolicima; 2 (shipping econ) naknada za podvoz, naknada za prijevoz kolicima; 3 (shipping econ) Inland transportation from vendors to the port of shipment, and from discharge port to the point of stripping the ocean container kopneni prijevoz (od prodavatelja do luke ili od luke do primatelja/kupca na kopnu)**

dredge /dredʒ/ (v) **1 (seamanship, navig) to use an anchor to help maneuver large vessels in close quarters manevrirati oranjem sidra**: Dredging anchors is a method which is used to assist a ship in maneuvering during unavailability or inability of tugs to assist as required **Do not dredge anchor**. Concerned that the vessel might sink, the Master released the tow and put both engines full ahead in an attempt to **dredge the anchor** into shallower water. **a (v tr) (navig, seamanship) zavlaciiti sidrom**

(kako bi se ukopalo / kako bi uhvatilo / držalo), namjerno oranje sidra; 2 (ports) to dig up the bottom in order to deepen the channel; process of removing sediment from harbour or river bottoms for safety purposes and to allow for deeper vessels **jaružati, produbljivati plovidbeni kanal / more uz vez, bagerirati dredge the fairway jaružati plovidbeni kanal; 3 (fishing) to fish using a fishing dredge kočariti, vući koći, orati po dnu:**

dredge (n) 1 (nav arch) = **dredger** A ship or barge that specialises in deepening channels by digging up and moving the bottom.

(<http://www.seatalk.info/cgi-bin/nautical-marine-sailing-dictionary>) **jaružalo, bager, dredža; 2**

(fishing) = **dredge net** At about 1415, the fishing vessel returned to the mussel beds and started dredging again. After a few tows, when the vessel was heading into shallower water and turning to starboard to haul the

starboard dredge: At about 1415, the fishing vessel returned to the mussel beds and started dredging again. After a few tows, when the vessel was heading into shallower water and turning to starboard to haul the starboard dredge



dredge net povlačna mreža, mreža potegača

dredger /'dredʒə/ (n) (cargo handling) **jaružalo, bager grab dredger jaružalo grtalica, suction dredger jaružalo usisavač, dipper dredger jaružalo žličar, bucket wheel**



dredger jaružalo žličar

dredging /'dredʒɪŋ/ 1 (ports) **jaružanje, bageriranje** The crew of a twin beam scallop dredger had hauled the beams inboard and had secured them in position with the safety chains ready to empty the catch of scallops. **dredging disposal odlaganje iskopa s dna mora; 2 (navig)**

zavlačenje sidrom, oranje sidrom

dredging /'dredʒɪŋ/ (n) (seamanship) namjerno oranje sidrom kako bi sidro uhvatilo **oranje**

sidrom: *The vessel was yawing and rolling heavily and **dredging her anchor** at the anchorage due to strong winds and heavy sea, now coming from the southeast.*

dredging (n) (fishing) **koćarenje po dnu mora, ribolov oranjem po dnu mora:** *Dredging is a technique primarily targeting bottom dwelling molluscs such as scallops and clams. The weather conditions were good, and **dredging took place** until 0930 when there was insufficient water over the mussel beds to continue. **dredging operations ribolov povlačnom mrežom / koćom, dredging gear oprema za koćarenje povlačnom mrežom / koćom***
dredging anchor (n) (navig, seamanship) **sidro kojim se ore, tal. ancora dragante**
dredging buoy (n) (navig) a buoy indicating the boundary of an area that is being dredged
oznaka za jaružanje

dressed full (adj) (seamanship) all flags sent up for decorating the ship **brod potpuno ukrašen galom, gran pavese**

dress ship (v) (seamanship) to decorate a ship with flags; flying all the flags of the ship in port to celebrate a special event **ukrasiti brod galom**. *Dressing Ship is done with the International Code*



Signal Flags. Officer's flags, club burgees and national flags are not used.

dress the wound (v) (safety) **povezati ranu:** *He then used the boat's first-aid kit to **dress his father's arm**, using a wooden spatula from the galley as a splint and cottonwool pads to stem the flow of blood.*

dribbling (n) **kapanje, curenje**

drift (n) 1 (oceanogr) **COMPARE set:** the speed and flow of a moving mass of water or current

struja, jačina struje: *We failed to realise that as we were traversing a gap between the islands, a strong current was flowing that induced sudden and strong **set and drift**. **effect of drift utjecaj***

brzine struje, zanošenje strujom / vjetrom, jačina struje: *Navigation in boyed channel, with regular alterations of course, requires the bridge team to closely monitor the vessel's position so that **the effects of set and drift** on differing headings can be assessed and appropriate action taken to ensure the safety of the vessel.;* 2 (navig, ship handling) a vessel's lateral movement caused by ocean

currents, one of the variables employed to calculate a reliable course over the bottom **zanos broda,**

zanošenje broda, tal. scarroccio: *We continued to monitor the tanker's **drift** and it was ascertained that she would probably miss the jack up rig but collide with the other rig. The autopilot was set in 'heading mode', which meant that the **drift** was to be corrected manually. **drift angle kut***

zanošenja: *We tried to alter the **drift angle** by rapidly putting the helm over from port to starboard, but to little avail. , **drift rate brzina otpadanja, brzina zanošenja:** *The weather deteriorated and the **drift rate** increased to 37 miles per day. , **counter drift suprotstaviti se zanošenju, spriječiti zanošenje djelovati protiv zanošenja****

drift (v) 1 (navig) leeward movement of a ship/boat caused by currents when not under power

plutati (bez pogona), biti nošen strujom i vjetrom: *the vessel drifted midstream in the freshening breeze. the vessel was located 150 nautical miles west of La Rochelle on Friday and was drifting east at east at 1 knot. The tide was turning and the stern of the vessel started to **drift away**, opening up a gap between it and the pier. The boat then **drifted**, downwind without power, towards the far side of the bay. I could see the coast, and had no reason to suspect that the ship might **drift off course**. The vessel is*

currently on emergency power and **drifting** in the Gulf of Mexico as it awaits the arrival of a tugboat.

<http://gcaptain.com/american-vehicle-carrier-adrift-in-gulf-of-mexico-after-fire>; 2 **zanositi se,**

otpadati: I went out on to the boat deck to see what was happening and saw that the ship was **drifting** away from the berth and was already about 2 metres off the fenders.

drift angle (n) (ship handling) **kut zanošenja (pri okretanju)**: The maximum turning moment of the hull resistance is reached at a **drift angle** of about 45 degrees.

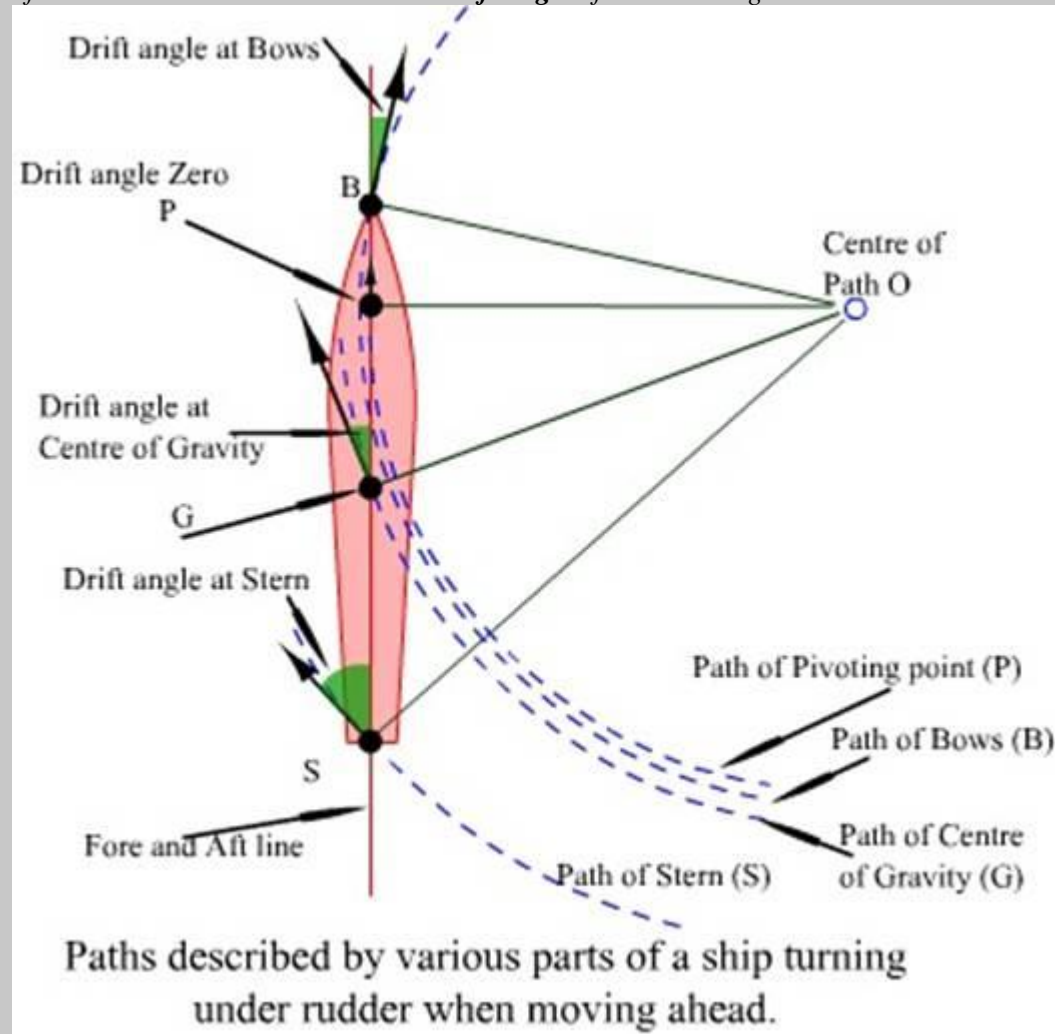

drift current (n) (oceanogr) **struja od plime i oseke**

drifter /'driftə/ (n) (boating/yachting) tanka genova iznimno duga po bazi **drifter**

drift ice (n) (oceanogr) **putujući led, led nošen strujom**



drifting (n) 1 (navig) **zanošenje**: * Sailing vessels are very susceptible to drifting due to the considerable amount of windage on the sails. Finally, after about two days' drifting, the fire burnt itself out and the barge was towed to a repair facility.; 2 (electr, navig) **brzina pomaka (osi zvrka)**

drifting (n) (fishing) fishing from the boat carried (drifted) by current and wind; Ribolov iz neusidrenog broda pomoću balona ili bez njih, koji vodene struje i vjetar lagano nose.

(<https://ribolovnajadrano.hr/ribicki-leksikon/>) **ribolov s brodice nošene strujom i vjetrom, driftanje, drifting**

drift net (n) (fishing) **plutajuća površinska mreža**: Simultaneously, and rudder was moved to hard-a-port and, to our great relief, the drift net slowly began to draw astern and was cleared about two cables off. Around midnight, a long line of weakly lit buoys came into view, indicating the existence of drift nets.

drift of current (n) (oceanogr) **brzina struje, jačina struje**

drift of tide (n) (oceanogr) **jačina struje, brzina struje**

drill (n) (safety) **vježba**: After the drill was completed the crew were dismissed. **perform a fire, lifeboat or other emergency drill** **izvoditi protupožarnu vježbu, vježbu spuštanja brodice za spašavanje i ostele vježbe u slučaju opasnosti, abandon ship drill**

vježba napuštanja broda: This was the immediate contributing factor to the uncontrolled descent of lifeboat no. 1 during the routine abandon ship drill at sea. On one of our vessels, the lifeboat embarkation ladder rope parted during an abandon ship drill conducted in the presence of the US Coast Guard.

boat drill vježba spuštanja brodice za spašavanje: Narrative The crew of a UK registered 5300gt ro-ro cargo ship, built in 1970, were undertaking a combined fire and boat drill, while alongside a UK port. **fire drill protupožarna vježba, vježba gašenja požara**: During an engine room fire drill, the crew practised an evacuation through the emergency escapes. The alarm was sounded, and the crew were split so as to cover the fire drill and the lowering of the boat.

lifeboat drill vježba spuštanja brodice za spašavanje: On a Sunday morning with good weather conditions and the ship steaming at 14 knots in ballast, the crew prepared to conduct a lifeboat drill.

man overboard drill vježba osoba/čovjek u moru Last man overboard drill was on October 12th.

drill (n) 1 (marine eng) **svrdlo, tal. punta**: This task involved drilling holes through the deck plate with a magnetic drill. **spot weld drill sjekač zavara, sjekač vara, pneumatic spot weld drill pneumatska bušilica za zavarivanje; 2 bušilica straight drill štapna bušilica, angle drill kutna bušilica**

drill bits (n) 1 (marine eng) svrdlo za bušilicu insert the drill bits umtnuti svrdlo u bušilicu, remove the drill bits odstraniti svrdlo bušilice



; 2 svrdla i odvijači bušilice

drilled (adj) rifle-drilled spiralno probušen, vijčano probušen bušen, probušen: *The fuel line consists of channels drilled in cast parts which are clamped firmly on the engine block ...*

drilling rig (n) (nav arch) naftna platforma, bušotina za naftu: *A drilling rig was engaged in operations in a designated offshore oilfield. Our offshore supply vessel was holding station close to a drilling rig, with two hoses connected, delivering bulk barite and fuel.*

drilling ship (n) (nav arch) brod za bušenje nafte

drill press (n) (marine eng) okomita bušilica, bušilica na vertikalnom stupu

drinking water system (n) (nav arch) sustav pojne vode, sustav pitke vode

drip (v) kapati, cijediti: *Care should be taken that there is not too much oil on the torch which could drip and possibly cause a fire;*

drip tray (n) 1 (marine eng) nakapnica; 2 (safety) posud za prikupljanje prolivene

tekućine: *Check that drip trays are in position and empty .. some 100 litres of cargo spilled into the manifold drip tray and approximately 20 litres overflowed on to the main deck.*

drive /draiv/ (n) 1 (marine eng) pogon diesel drive 1 dizelski pogon a: *Today practically all vessels use a diesel drive., diesel-electric drive dizel-električni pogon: A combination of geared diesel and diesel–electric drive is exploited in some offshore support vessels., direct drive =*

direct-coupled engine direktan pogon (bez reduktora): *The direct drive of a fixed pitch propeller by a low-speed two-stroke engine remains the most popular propulsion mode for deep sea cargo ships., indirect drive posredni pogon (s reduktorom),*

turbo-electric drive turbo-električni pogon, camshaft drive pogon bregaste

osovine: *On a two stroke crosshead engine lubricating oil is supplied to the main bearings and camshaft and camshaft drive. The lost-motion clutch or servo motor uses a rotating vane which is attached to the camshaft but can move in relation to the camshaft drive from the crankshaft., electric drive motor*

stroj na električni pogon, stroj s elektropogonom: *A podded propulsor (or pod) incorporates its electric drive motor in a hydro-dynamically optimized submerged housing., genset drive pogon*

generatora, pogon agregata: *First introduced in 1971, the 250 mm bore/300 mm stroke K-engine was designed mainly to be a genset drive but numerous propulsion plant*

applications have been logged in tugs, offshore supply ships and fishing vessels., hydraulic drive system hidraulički pogonski sustav: The fire pump was in operation to provide cooling water for the windlass hydraulic drive system.;

2 prijenos chain drive lančani prijenos: *The frame section for the four- and five-cylinder engines consists of one part with the chain drive located aft.*

drive (v) (marine eng) pogoniti, pokretati, tjerati: *... practically all modern engines use up to*

25 per cent of that heat **to drive** a turbocharger. All MC engines can be arranged **to drive** shaft generators. The skipper was unable **to drive the** vessel off the shoal and he decided to wait until high water before making further attempts to refloat. {drive - drove - driven}

drive belt (n) (boating/yachting, marine eng) **pogonski remen**: The crew member was wiping clean the base of the scaler with the air motor running, when his glove became entangled in the moving

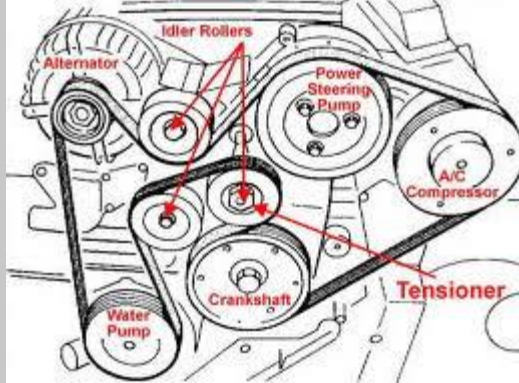

drive belt, trapping his fingers.

drive gear (n) (marine eng) **pogonski prijenosnik reduktor**: In order to remove the dried old grease around the dog clutch and shaft, it was necessary for the seaman to extend his arm between the drum and the winch **drive gear** and clear it manually. There is an integral forged coupling flange for the flywheel, and the **camshaft drive gear** is split to facilitate replacement.

drive shaft (n) (nav arch, marine eng) **pogonska osovina**: The port drive unit was found to have been moved out of alignment and the **drive shaft** had sheared, requiring dry dock repairs.

drive unit (n) (marine eng, nav arch) **pogonska jedinica pogonski uređaj**: The **port drive unit** was found to have been moved out of alignment and the drive shaft had sheared, requiring dry dock repairs.

driving force (n) (boating/yachting) **potisak**

driving gear (n) (marine eng) **pogonski uređaj pogonski zupčanik**: The relative movement between **driving gear** and camshaft is via a helically toothed sleeve integrated in the gearwheel, meshing with the corresponding counterpart on the camshaft.

driving generator (n) (marine eng) **pogonski generator**: Diesel engines are used as main propelling machinery and frequently as auxiliary for **driving generators** to provide electric power for shipboard use.

driving motor (n) (marine eng) **pogonski elektromotor, pogonski motor**: The emergency generator must be rated to provide power for the **driving motors** of the emergency bilge pump, fire pumps, steering gear, watertight doors and possibly fire fighting equipment.

driving turbine (n) (marine eng) **pogonska turbina**

driving wheel (n) (marine eng) **pogonski zupčanik, pogonsko kolo**

drizzle /ˈdrɪzəl/ (n) (meteorol) small, slowly falling water droplets, with diameters between 0.2 and 0.5 millimeters **kišica**

drogue /ˈdrʊɡ/ (n) (safety) a sea anchor **zavlačno sidro**: The master and crew of this vessel deserve praise for practising good seamanship by using the anchor and cable as a **drogue** and preventing what would have been a potential calamity to both the vessel and local fishermen.

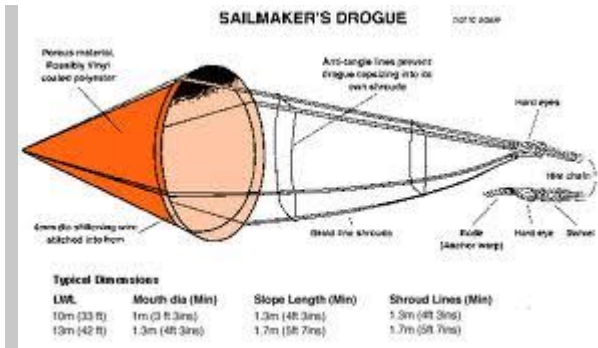

drone /drəʊn/ (n) (nav arch, navy) **bespilotno plovilo, plovilo-dron, dron mine-hunting**

drone **bespilotni minolovac, underwater drone** **podvodno bespilotno plovilo, marine drone** **bespilotno istraživačko plovilo, plovilo-dron, plutajući dron**: *Marine Drone - is an Unmanned Surface Vehicle, catamaran type, with tele-operated and/or autonomous modes. Ultra portable (50 kg), it is the ideal platform for all kinds of investigations in shallow waters,*

drone /drəʊn/ (n) (safety, navig) **bespilotna letjelica, dron**: *Shortly after the drone had been launched the Master was contacted by the Suez Canal Authority and told to drop anchor. The national authorities confiscated the drone and its memory card and the vessel was detained in anticipation of further investigations*

droop (n) (marine eng) Droop is the variation in engine speed following a load change, approximately 4% for a full load change. **variranje brzine stroja pri promjeni opterećenja**

drop (n) (marine eng) **pad, smanjenje, opadanje**: *An inexplicable drop in radar performance can often be traced to water in the waveguide. A voltage drop caused large, but equal errors in both gyros.*

temperature drop pad temperature: *Cycle thermal efficiency is approximately the same as that of a simple-cycle engine, as additional fuel is required to offset the drop in compressor exit temperature. There was a sudden drop in cooling water pressure: engine jacket temperatures were shooting up and automatic main engine slow-down or shut-down trips would operate suddenly.*

drop in pressure: *Earlier that day there had been intermittent main engine problems due to a drop in lubricating oil pressure, but the exact cause of the reduced oil pressure was not yet known.* **pressure drop**: *Thanks to the double lap joint, the pressure drop will be almost constant irrespective of the wear on the liner and rings. (It may also be useful to use the term 'anchoring' rather than 'drop anchor' to avoid misunderstanding.)*

drop (v) **1 ispustiti, baciti; 2 = let go oboriti sidro**: *The vessel was advised by the VTS to drop anchor at anchorage "B". Until recently, tankers and other vessels were always dropping anchor in the area between the westbound and eastbound lanes, South and West of Nippa, in order to carry out above mentioned operations safely. drop port anchor Oborite lijevo sidro!; 3 otpustiti (uže, konop) drop the headline! Otpustite pramčani konop!; 4 drop off a sling (o teretu) ispasti iz pasca; 5 (navig) iskrcati (peljara)*: *After dropping the pilot we made a second attempt to head East, again a coaster heading South tried to cross our bows, this time at 2 cables range.; 6 (marine eng) padati, opadati*: *At about 0330 the watchkeeper noticed that the engine revolutions were dropping and that the engine was making a strange noise.*

drop an anchor (v) (seamanship) = **let go oboriti sidro**: *The Master then sent the helmsman to the bow to drop anchor as requested by the river pilot. Busan VTS had directed the vessel to drop her anchor in N4 Anchorage Area. (tal.: ammainare)*

drop astern (v) (navig) **pustiti se po krmu broda (o tegljaču)**: *A tug assisted the unberthing by pushing on the inshore (port) bow, and was then ordered to drop astern and escort the vessel out.*

drop back 1 (v) (navig) to increase the distance from the vessel ahead by reducing one's own speed
Digital Selective Calling (in the GMDSS system) Em

povećati razmak po krmi drugog broda: You must **drop back** from the vessel ahead of you.; **2 (navig) usporiti;** **3 (seamanship) pasti natrag (o užetu):** However, the messenger kept slipping off the warping drum, causing the tow wire to **drop back** onto the tug.

drop-keel (n) (nav arch) a keel that can be pivoted up into a well for sailing in shallow waters
pomična kobilica

drop light (n) (seamanship) prijenosna svjetiljka sa zaštitnom rešetkom

drop line (n) (cargo handling, nav arch) the pipelines which drop oil cargo to the bottom of the tanks vertically from the pipeline on deck – thus bypassing the pump room. **vertikalna cijev za punjenje tankova:** The combined pipeline system of the shore and the ship deliver the oil to the cargo oil tanks directly via the **drop lines**. This tank also had the **drop line** blocked at the bottom.

drop the pilot (n) (seamanship) iskrcati peljara: The ship had slowed to **drop the pilot**. After clearing the Panama canal en route to Guayaquil my vessel **dropped the pilot** at Balboa and had just passed the seaway buoy southbound. {Not recommended! Say disembark the pilot instead.}

drought /draʊt/ 1 (meteorol) suša; 2 (navig) isušenje (kanala ili tjesnaca) uslijed

vjetra, pad razine vode zbog isušenja vjetrom: The Panama Canal Authority (ACP) says it will set temporary draft restrictions on vessels transiting the Canal because of drought caused by El Niño.

drown /draʊn/ 1 utopiti se: Two seafarers are presumed drowned after a container ship sank in the Sea on 5 September. Without this additional buoyancy a person can quickly tire and **drown**. Wearing a lifejacket when it is rough makes sense, but most fishermen **drown** in calm conditions when they least expect to find themselves in the water.; **2 (v) utopiti, potopiti {tal.: annegare; British English: drown: When someone drowns, or when they are drowned, they die because they have gone under water and cannot breathe. Forty-eight people drowned after their boat capsized. He walked into the sea and drowned himself. draun VER}**

drowning /ˈdraʊniŋ/ (n) (safety) utapanje, tal. annegamento: He died from a combination of hypothermia and **drowning** about 10 minutes after the initial capsiz. Fishermen had been fishing for many years they did not wear lifejackets, and when they were suddenly thrown into the water they were at serious risk of **drowning**.

drug test (n) (med) test na drogu: As part of routine drugs testing of our crews, all crewmembers recorded negative tests, Several crew members aboard the MV have been suspended and may end up getting fired after **testing positive for drugs** **pass the drug test uspješno proći na testu na droge, fail the drug test pasti na testu na droge, negative drug test negativni test na drogu, positive drug test pozitivni test na drogu, non-negative drug test pozitivni test na drogu**

drum 1 a (cargo) bačva; 2 (seamanship, nav arch) bubanj (vitla); 3 (marine eng) komora
lower drum donja komora, donji bubanj, main drum glavna komora, upper drum gornja komora, gornji bubanj, water drum vodena komora

dry bulk cargo (n) (cargo) suhi masovni tereti, rasuti tereti, sipki tereti: During self-discharging of a **dry bulk cargo**, the engine room rating on watch informed the cargo control room by portable radio that he was proceeding to the conveyor belt tunnels. All **dry bulk cargoes** must be transported strictly according to the recommendations in the bulk carrier (BC) Code.

dry bulk market (n) (shipping econ) tržište suhih rasutih tereta, tržište rasutih

tereta: There is COA business in the **dry bulk market** carrying cargoes of iron ore and coal and the major customers are the steel mills of Europe and the Far East.

dry cargo (n) (cargo) suhi tereti

dry cargo brokering posredništvo u trgovanju suhim (rasutim) teretima,

brokerstvo na tržištu suhих (rasutih) tereta: A brokerage (commission) of 1¼% to each of the brokers involved in the fixture is usual in **dry cargo chartering**.

dry cargo carrier brod za rasute terete, brod za suhe (rasute) terete: A small **dry cargo carrier** was en route in a vessel traffic services (VTS) controlled restricted waterway and, because of her size, was without a pilot.

dry chemical (n) (safety) suha pjena: Small fires can be extinguished with **dry chemical**, soda

ash or lime. **dry chemical extinguisher** aparat za gašenje suhom pjenom: Several attempts were made during the next two hours to extinguish the fire, first with portable foam and **dry chemical extinguishers**, then with a fire hose before the decision was made to flood the engine room with CO₂.

drydock (n) 1 (nav arch) a type of dock consisting of a rectangular basin dug into the shore of a body of water and provided with a removable enclosure wall or gate on the side toward the water, used for major repairs and overhaul of vessels **suhi dok**, tal. **bacino di carenaggio**: after unloading **the ship entered drydock** to effect permanent repairs During the short passage to **drydock**, all tanks were monitored and the ballast pump was continuously discharging the ingress into the fore peak tank. **In the drydock**, it was observed that apart from the large hole punched in the shell plating in way of the fore peak tank, there was no other damage. With company's and class approval, the vessel continued on its short passage towards the discharge port, where, after unloading, **she entered drydock** to effect permanent



repairs

; 2 (safety, nav arch) remontni vez, vez za

opravke brodova u brodogradilištu

dry dock (n) (nav arch) = **drydock** suhi dok: After the incident, the vessel had to go to **dry dock** due to an excessive stern tube oil leak; The ship was instructed by the Maritime and Coastguard Agency (MCA) to proceed directly to a **dry dock repair facility**. The port drive unit was found to have been moved out of alignment and the drive shaft had sheared, requiring **dry dock repairs**. The vessel then discharged all cargo and proceeded to **dry dock** for repairs. A ship was **in dry dock** undergoing an extensive refit which included the overhaul of the main engine, main shaft alternator and its integral cooling fan. {tal.: bacino di carenaggio}

dry-dock /'drai, dɒk/ (v) 1 (nav arch) popravljati brod u luci: The vessel was **dry docked** a week after the accident as part of the Continuous Class Survey schedule.; 2 (nav arch) staviti brod u

suhi dok, dokovati

drydocking (n) 1 (nav arch) The removal of a ship from the water for inspection and repair of those parts of a ship that are below the water line.; Putting a vessel into a dry dock for inspection, repair and maintenance. **suho dokovanje**: A product tanker was proceeding on a long voyage after the completion of **drydocking** and associated surveys. **During drydockings**, which are required to be carried

out periodically, certain mandatory classification society inspections are carried out and relevant certifications are issued. **Drydockings** for containerhips are generally required once every three to five years.; 2 (nav arch) popravak broda u luci; 3 (nav arch) remont

dry-dock refit (n) (seamanship) održavanje u suhom doku

dry freight (n) (shipping econ) suha roba (u transportu) suhi teret

drying height (n) (geogr) suhi greben, visina mora pri kojoj greben viri iznad površine

dry marina (n) (boating/yachting) suha marina

dry off (v) posušiti, isušiti

dry out alongside (n) (boating/yachting) ostati na suhom na vezu (u lukama s plimnim režimom)

dry powder (n) (safety) suhi prah: *The attending firefighters employed dry powder extinguishers to quench the 'fire' in each drum.* **dry powder extinguisher** aparat za gašenje suhim prahom: *Both teams were able to locate the source of the fire at the main engine and it was soon put out using portable dry powder extinguishers.*

dry powder piping (n) (safety, nav arch) cjevovod praša za gašenje

dry storage (n) (boating/yachting) zimovanje jedrilice, jedrilica na kopnu

dry tank certificate (n) (cargo handling, mar law) potvrda da je tank suh i čist,

potvrda o ispražnjenom tanku: *The terminal or cargo interests' representative should be requested to sign a dry tank certificate and only after this has been signed should shore hoses be disconnected. A dry tank certificate is issued on completion of discharge,. This should be signed by the consignees.*

dry wipe (n) (marine eng) čišćenje na suho, čišćenje suhim sredstvom

DSA (daily subsistence allowance) /,di: es 'ei/ (n) (mar law) iznos dnevnice

DSC; (Digital Selective Calling) (n) (navig) digitalno selektivno pozivanje,

digitalni selektivni poziv: *At about 0630 our vessel received a DSC alert on 16MHz for a vessel in position 01°25'N 103°54'E - somewhere in the region of the Singapore Straits. When this, too, did not get a response, I sent them a DSC call. Whilst on watch recently, I received a DSC distress call. Although a Mayday message was broadcast on VHF radio channel 16, Digital Selective Calling (DSC) was not used.*

DSV; (diving support vessel; deep submerged vessel) (n) (nav arch) brod za

ronilačke radove: *Failure to Recognise a Suspended Load Results in Death Narrative Modifications were being carried out on the diving bell recovery system of a diving support vessel.*

dual channel watch (n) (comm) dvokanalno osluškivanje, dvokanalna radijska straža

dual control (n) dvostruko upravljanje, duple komande

dual-fuel engine; DF engine (n) (marine eng) stroj na dvije vrste goriva, stroj s

alternativnim gorivima: *The new low-pressure dual-fuel engine provides CAPEX reductions of 15% to 20% through a substantially simpler and lower cost LNG fuel gas handling system.*

dual-fuel propulsion (n) (marine eng, nav arch) pogon na dvije vrste goriva,

alternativni pogon: *The 1,400 teu vessels will feature dual-fuel propulsion enabling them to burn LNG and conventional bunker fuel.*

dual-fuel ship (n) (nav arch, marine eng) brod s pogonom na dvije vrste goriva (naftu

i ukapljeni prirodni plin), brod s dvovrsnim pogonom, brod s alternativnim pogonom

dual-fuel technology tehnologija pogona na dvije vrste goriva: *Both the main and at least one auxiliary engine will use dual-fuel technology, providing cleanly generated electricity for the ship's 300 reefer containers.*

dual purpose crew (n) (mar law) posada dvojne namjene (za rad na palubi i u stroju): *Ratings are trained to perform the duties of the dual and general purpose crew.*

dual watch key (D/W) (n) (comm) tipka za uključivanje / isključivanje rada na radnom kanalu i istovremenog praćenja kanala 16

duct /dʌkt/ (n) 1 (nav arch) kanal: *The connection between the duct arid containers is made by couplings which are pneumatically controlled.*; 2 (marine eng) vod, cijev: *The charge air duct, for example, is integrated in the crankcase.*; 3 (electr) kanal za električni kabel

ductile /'dʌktail/ (adj) (marine eng) rastezljiv, pružljiv: *The monobloc crankcase is made of ductile cast iron, the side walls extending far down below the crankshaft centreline. Casing material was changed from grey (laminar) cast iron to ductile (nodular) cast iron and the turbine enclosed in a protective shroud.*

ductility /dʌk'tiliti/ 1 (marine eng) pružljivost, rastezljivost: *Factors to be considered when designing cylinder liners include material composition, strength, ductility, heat transfer coefficient and wear properties.*; 2 vodljivost

ducting (n) 1 (electr) vođenje (signala); 2 (electr, navig) An extreme form of super-refraction is known as ducting, when the radar beam is conducted for long periods within a duct formed by air layers. vođenje (radarskog signala) zračnim kanalom

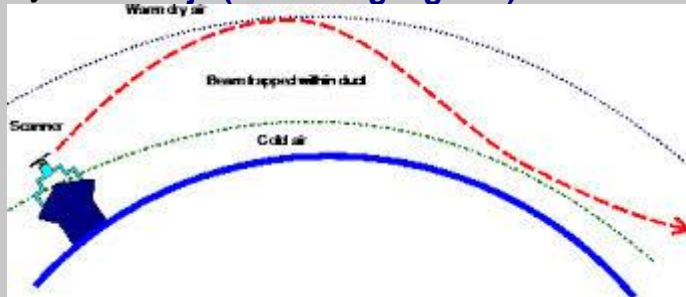

duct keel (n) (nav arch) tunelska kobilica

due /dju:/ be due koji stiže na naplatu, naplativ: *Acknowledge the receipt of your letter of the 18th instant, enclosing the bill of lading in connection with the consignment on board Jawahar, which is due on 23rd February - 20--...* seamen who are due wages pomorci kojima dospijeva isplata plaća pomorci kojima trebaju dobiti plaću 1 biti obvezan / dužan; 2 predviđen, planiran

due care /dju:/ (n) (navig) dužan oprez, dužna briga: *Masters are advised that navigating without due care and attention, or navigating in a manner liable to injure or endanger persons, other vessels or structures*

due date (n) 1 (mar law, shipping econ) dogovoreni nadnevak, ugovoreni dan: *The terms will be set out in a charter-party and, if all goes well, the ship arrives on the due date, loads the cargo, transports it to Tilbury, discharges and the transaction is complete.*; 2 (shipping econ) dan dospijevanja (plaćanja), dospjeće: *In the event of payment after the due date of any outstanding sums the Manager shall be entitled to charge interest at the rate stated in Box 13.*

due diligence /,dju: 'dɪlɪdʒəns/ (n) **1** proper attention or care; the degree of care required in a given situation **dužna pažnja**: *Due diligence must be exercised, particularly when calling at an unfamiliar port or when operating within tight parameters.* **act with due diligence poslovati pažnjom dobrog privrednika, exercise due diligence raditi pažnjom dobrog privrednika (zaposlenika, poslodavca itd.): *These provide that when the carrier, who could be the shipowner or a charterer, exercises due diligence before and at the beginning of the voyage to make the ship seaworthy ...* ; **2** Due diligence means taking all reasonable precautions to see that the vessel is fit for the voyage contemplated. The carrier is not obliged to give an absolute guarantee of seamanship **dužna pažnja urednog broдача**: *Due diligence and planning should be utilised when attempting to lift a heavy or bulky object and it is not recommended to carry or manhandle heavy object. Under English law, if the latent defect is not discoverable by due diligence, the carrier is apparently not liable even if he failed to exercise due diligence in attempting to discover latent defects.* ; **3 (mar law, shipping econ)** comprehensive appraisal of a business undertaken by a prospective buyer, especially to establish its assets and liabilities and evaluate its commercial potential ; an investigation or audit of a potential investment **ocjena / revizija potencijalnog kupca ili investitora o poslovanju odnosno preuzimanju tvrtke (na temelju temeljitog snimanja i ispitivanja tvrtke)**: *Due diligence serves to confirm all material facts (e.g. balance sheets etc.) in regards to a sale***

due investigation (n) (mar law) **propisna istraga, pravilna istraga**: *After due investigation, which included a rigorous testing and calibration of the equipment, it was determined that, in all probability one or more of the non return valves of the cargo compressors had failed in service*

dues /dju:z/ (shipping econ) **pristojbe, naknade, dadžbine, takse** *What dues must be paid in order to clear the ship outwards?* **port dues lučke pristojbe, canal dues pristojbe za korištenja plovnog puta / kanala, dock dues 1 pristojbe za korištenje ustava / brana dokovske luke; 2 = port dues lučke pristojbe** *The buyer will be responsible for the charges involved in getting the goods off the ship to his warehouse, such as lighterage, dock dues and custom duties.* , **berth dues pristojbe za korištenje veza, vezarina, harbour dues lučke pristojbe**: *The officer issuing the clearance must also satisfy himself that harbour and light dues have been paid, and that emigration and port health regulations have been carried out.* , **light dues pristojbe za korištenje plovnih putova / oznaka**: *Where are the inward light dues paid? The master or the agent must go to the Custom House and first pay the outward light dues unless these dues have already been fully paid for the current financial year.* , **to levy the dues nametnuti / propisati / zahtijevati naplatu pristojba, to pay the dues platiti pristojbe, to charge dues obračunati pristojbe, canal dues kanalske pristojbe**: *naknade za plovību kanalom ... the charterer directs the commercial operations of the vessel and pays all voyage expenses (i.e. bunkers, port charges and canal dues) and cargo handling costs.* , **dues levied on nametnute naknade / pristojbe**: *Taxes/dues levied on the cargo shall be paid by charterers and taxes/dues levied on the vessel shall be paid by owners.. naknade / pristojbe koje se nameću / obračunavaju na*

due time (n) (mar law) = **maturity date dospelost**

due to 1 zbog, uslijed *The Pilot Boat would come on the starboard side of A due to the fresh southerly wind and sea. Due mainly to moisture, rain, fresh or salt water, and sweat (and the presence of oxygen) rust is a corrosion producing red discolouration ... The auxiliary engine abnormal condition alarm was not activated, due to drive gear overheating; The crew was unable to determine the integrity of all parts to be reused during the last routine overhaul of the pump.* ; **2 planiran, biti dužan (nešto**

učiniti), predviđen: *the ship is due to leave*

duly /dju.li/ **1 valjano, kako treba, prema propisima, na propisan način:** *In consideration of this service, to be **duly performed**, the Master agrees to pay the undersigned seafarers the wages expressed herein and/or set forth in supplemental provisions and/o Extracts can be published without specific permission providing the source is **duly acknowledged**. In order that we may effect customs clearance and despatch, we would feel obliged if you would let us have the Bill of lading **duly endorsed** together with a letter addressed to customs & Excise authorities, appointing us to act on your behalf.; **2 pravovremeno:** *The electrician **duly arrived** in the engine room and the two men discussed the problem, consulted the boiler instruction manual and ...**

dump /dʌmp/ **(v) bacati (teret) u more:** *The officer was sentenced for ordering the crew members to **dump** overboard several barrels containing some hydraulic oil. use of the quantities of water involved and the chemical treatment, it is not economically viable or environmentally responsible to **dump the treated water overboard** each time. A large cargo vessel that was responsible for **dumping** tons of oily waste into the Pacific Ocean last year.*

dump barge (n) **(nav arch) plovni objekt bez vlastitoga poriva za prijevoz i iskrcavanje kamena prevrtaljka**

dumping /'dʌmpɪŋ/ **(n) 1 (mar law) 1. any deliberate disposal of wastes or other matter from vessels, aircraft, platforms or other man-made structures at sea; 2. any deliberate disposal of vessels, aircraft, platforms or other man-made structures at sea; potapanje (u međunar. pravu mora)**

namjerno potapanje stvari u more: *Convention on the prevention of marine pollution by **dumping of wastes and other matter** 1972*

dumping ground morko područje za potapanje / odlaganje otpisanih brodova: *After a detailed investigation, it was realised that the vessel ran aground in an **uncharted dumping ground**, where local barges had been discharging mud, sand and/or other unknown spoil; No information relating to this activity was circulated.; **2 bacanje stvari u more, ispuštanje (onečišćene vode, nafte, ulja) u more:** *Surely, there is some convention which precludes **dumping** waste of this sort at sea! **Dumping** oil-contaminated water overboard is almost always followed by an attempt to cover the illegal **dumping** up by failing to record these discharges in the ship's oil record book**

dungarees /,dʌŋgə'ri:z/ **(n) (seamanship) plavo radno odijelo, plava tuta, trliš**

dunnage /'dʌnɪdʒ/ **(n) (cargo handling) material (usually lumber) used to secure cargo in containers and ships' holds in order to prevent shifting and resulting damage during the voyage (to protect goods and their packing from moisture, contamination or mechanical damage and to prevent shifting of cargo); izolacija i sredstva za izolaciju tereta od štetnog utjecaja oplata i strukturnih elemenata broda, od izvora topline na brodu, te od drugih tereta**

materijal za podlaganje (tereta), daske za

podlaganje, razdjelne daske, separacijski materijal, duniđ, dunić, duneđ: *Any*

***dunnage** must be inspected and unusable **dunnage** is to be disposed off. **Dunnage** is the material used around cargo to prevent breakage or shifting, normally provided by shipper. Its weight is included in the rating. **Dunnage** should not be disturbed before the surveyor sights it, and pay the cost of removing their **dunnage** after discharge of the cargo When necessary, **dunnage such as wood planks, plastic foam and paper boards** should be used to protect against mechanical damage, such as the damage caused by the container corner post, or corrugation of the container wall or by the uneven surfaces of the load next to it. **inflatable dunnage** pneumatski materijal za podlaganje tereta,*

pneumatske vreće, vreće za napuhavanje (vrsta duniđa), dunnage bags vreće za

podlaganje / zaštitu tereta, dunnage laid postavljen / umetnut materijal za

podlaganje, lay dunnage postaviti / umetnuti materijal za podlaganje: *The Charterers shall provide and lay all **dunnage material** as required for the as required for the*

proper stowage and protection of the cargo on board., **remove dunnage** ukloniti materijal za podlaganje, **floor dunnage** podni materijal za podlaganje, **podne daske za podlaganje**, **dunnage boards** daske za podlaganje: *Before commencing to load scrap iron, the lower strakes of spar ceiling should be well protected from damage by covering with dunnage boards, ...*, **permanent collapsible dunnage (PCD's)** trajne sklopive daske za podlaganje, **interlayer dunnage** materijal za međusobno separiranje tereta, **top dunnage** vršni materijal za podlaganje, **air filled dunnage** separacijski materijal na napuhavanje zrakom, **improper dunnage** neispravan materijal za podlaganje, **neodgovarajući materijal za podlaganje**: *A large proportion of cargo claims arise from lack of or improper dunnage.*, **dunnage material** sredstvo za podlaganje tereta, **materijal za podlaganje tereta**, **remove the dunnage** ukloniti materijal za podlaganje: *The Charterers shall be responsible for and pay the cost of removing their dunnage after discharge of the cargo.*, **place dunnage** umetnuti duneđ: *Place dunnage between the tiers.*, **timber dunnage** drveni materijal za podlaganje tereta *Timber dunnage from temperature regions may harbour eggs or larvae, so that some countries have developed strict safeguard*, **wet dunnage** mokri materijal za podlaganje tereta: *Wet dunnage may*



cause damage to the cargo in the vicinity.

dunnaging (v) (cargo) **podlaganje tereta**: *When dunnaging under a deck cargo of timber, use rough 25 mm boards placed diagonally 750 mm to 1,000 mm apart, so as to distribute the weight evenly over the beams, When dunnaging use boards placed 750 to 1000 mm apart so as to distribute the weight evenly over the beams.*

duplexer (n) (electr) **antenska skretnica**

duplicate tank (n) (marine eng) **dvostruki tank**, **udvostručeni rezervoar**

dusky grouper (n) (fishing) **kirnja**

dusky serranus (n) (fishing) **kirnja**

dust storm (n) (meteorol) **an area where high surface winds have picked up loose dust, reducing visibility to less than one : half mile** **pješčana oluja**

dutch bollard (n) (nav arch) **bitva u oplati broda (za bočno tegljenje)**

Dutchman's log (n) (navig) **a buoyant object thrown overboard to determine the speed of a vessel** **plavčica (za mjerenje brzine broda)** *Dutchman's log.*

dutiable (adj) (mar law) **koji podliježe carini (o teretu)**

duty (n) **1 služba** **look-out duty** služba motrenja, **služba opažanja**; **2 posao**: *They*

remained **fit for duty**. **auxiliary duty** pomoćna služba, pomoćni posao; **3 (mar law, seamanship) dužnost**: It is the **duty** of the watchkeeping engineers to fill out and sign the log book at the end of every watch. **be on duty** **1 biti na dužnosti, biti u službi, biti dežuran**: The master **had been on duty** for 19 of the previous 24 hours.; **2 biti u straži, biti na straži, biti u gvardiji, off duty izvan službe, slobodan, koji nije u službi**: Make the best of **off duty periods** for resting, should not drink alcohol and try to eat good nutritious food regularly. 10 hours of rest may be broken into no more than two periods, one of which shall consist of at least 6 (six) consecutive hours **off duty**.; **assign the duty dodijeliti dužnost / zadatak / posao**: The OOW was joined by the deck cadet who **was assigned lookout duties**. All persons who are **assigned duty as officer in charge of a watch** or as a rating forming part of a watch shall be provided a minimum of ten (10) hours of rest in every 24-hour period.;; **take over the duty preuzeti dužnost, have the duty to biti dužan, biti obvezan, imati dužnost**: As per rule 13, the overtaking vessel **had the duty to keep clear**, even after we made our alteration to port. Port state control already **has the duty to investigate cases of unsafe navigation**. Bridge officers **have a duty to support** the pilot and to monitor his actions.;; **4 namjena**: Engines for genset duty (designated S20U) were offered with a higher rating to cover power demands up to 1575 kW at 1000 rev/min (Figure 26. **engine for genset duty stroj namijenjen za pokretanje generatora**

duty (n) a government tax on imported merchandise **carina, iznos carine pay duty platiti carinu**

duty AB (n) (navig, mar law) **kormilar u straži, stariji mornar u straži**: At 19:00, in anticipation of a manoeuvre to avoid collision, the third officer placed the **duty AB** on manual steering. At about 0235, the **duty AB** detected a small fire in the open hold.

duty deck officer (n) (navig, mar law) **dežurni časnik palube, časnik palube u straži**: The **duty deck officer** flashed the Aldis lamp five times in the direction of the overtaking ship – but no response.

duty engineer (n) (marine eng) **dežurni časnik stroja**: The **duty engineer** immediately contacted the second officer and told him to stop the ballast pump and to close the ballast valves.

on-call duty engineer časnik straže u stroju na poziv: ... one of the oilers reported to the fitter that there had been a lubricating oil spill in the engine room and this was immediately reported to the **on-call duty engineer**.

duty free (n) (shipping econ) **oslobođen carine**

duty officer (n) **1 (mar law) časnik straže, dežurni časnik**: On chemical tankers, an additional **duty officer**, who can assist the chief officer in tank cleaning operations, is a must.;; **2 dežurni časnik (službe VTS, Obalne straže itd.)**: The ship's movements were also seen on radar by the duty Dover Coastguard watch officer.

dye marker /dai/ (n) (comm, navig) **signal u boji**

dyke /daik/ (n) (ports) **zaštitni lukobran, zaštitni nasip, diga**

dynamical stability arm curve /dai' næmik ə/ (n) (nav arch) **krivulja poluga dinamičke stabilnosti**

dynamic load /dai' næmik/ (n) (nav arch) **dinamičko naprezanje**: The final tightening of wire falls must be always done manually and only efficient sea lashings must bear the **dynamic loads** at sea.

dynamic positioning (n) (navig) a computer-controlled system to automatically maintain a vessel's position and heading by using its own propellers and thrusters. Position reference sensors, combined with wind sensors, motion sensors and gyrocompasses, provide information to the computer pertaining to the vessel's position and the magnitude and direction of environmental forces affecting its

position (Wiki) **dinamičko pozicioniranje**: Examples of vessel types that employ DP include ships and semi-submersible Mobile Offshore Drilling Units (MODU) Since the development of **Dynamic Positioning** which incorporates the usage of SONAR, Radar and other comprehensive detection, ships have started finding it easy to maintain their pace and steady their being in the deeper parts of the oceanic and sea waters. The installation of an upgraded **dynamic positioning system (DPS)** fitted to a platform supply vessel (PSV), while alongside a quay, had proceeded well.

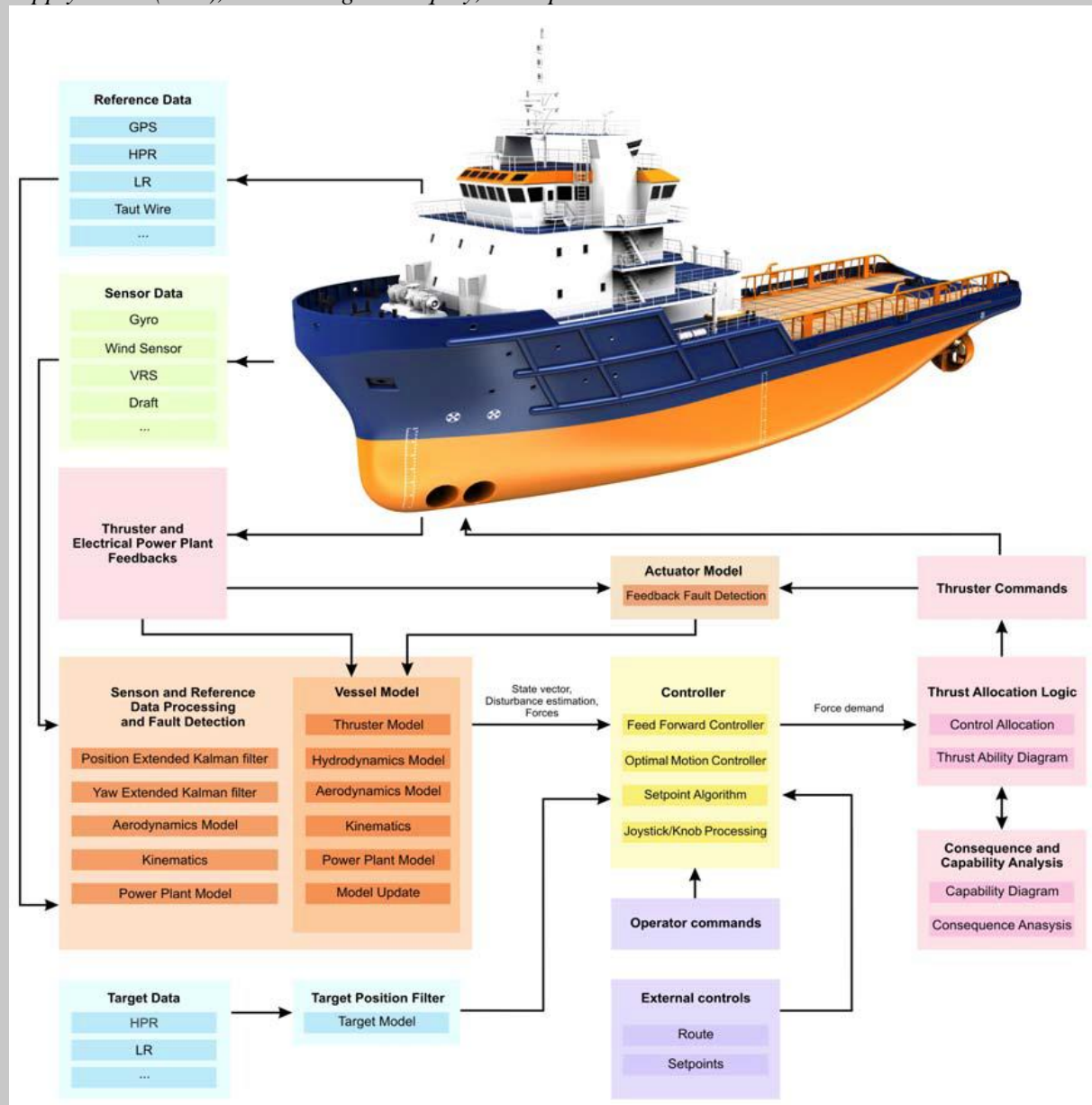

{The computer program contains a mathematical model of the vessel that includes information pertaining to the wind and current drag of the vessel and the location of the thrusters. This knowledge, combined with the sensor information, allows the computer to calculate the required steering angle and thruster output for each thruster. This allows operations at sea where mooring or anchoring is not feasible due to deep water, congestion on the sea bottom (pipelines, templates) or other problems. (Wiki)}

eagle flies (n) (seamanship, figurative) dan isplate plaća

eagle ray (n) (fishing) golub {drugi hrv. nazivi: biskup, ćuk, kulumbul, kosir, ororaža, sokol; lat. MYLIOBATIS AQUILA}

earmuff /'ie,mʌf/ (n) (safety) prigušivač za uši

earn /ɜ:n/ (v) **zaraditi**: To **earn lump sum freight**, either the ship must complete the voyage, or the cargo must be transhipped and delivered by the ship **to earn freight (shipping econ) zaraditi vozarinu, ostvariti pravo na vozarinu**

earnings /ɜ:niŋz/ (n) (**financ**) **zarada**: The cost of repairs and **loss of earnings** was about L4 million. If the Master and a seafarer agree, a portion of such **seafarer's earnings** may be allotted to such seafarer's spouse, children, grandchildren, parents, grandparents, brothers or sisters, or to a bank account in the name of the seafarer. **freight earnings zarada od vozarine**

ear protectors (n) (**safety**) **SYNONYM earmuff prigušivač za uši**: Ear protectors should be worn when the noise level is more than ... db

earth (n) (**electr**) **zemlja, masa**: About 10 minutes later, the chief engineer noticed the **earth fault alarm** had cleared. At 0215, the chief and third engineers, who were in the engine control room (ECR), noticed an **electrical earth** on the vessel's calorifier sited in the bow thruster compartment. The liners had been found to have suffered severe electrolytic corrosion as a result of poorly maintained electrical equipment and a non-attached **earth strap** to the main engine. **earth circuit uzemljenje, sustav uzemljenja, earth connection priključak na zemlju, uzemljenje, earth wire vodič uzemljenja**

earthed (adj) (**electr**) **uzemljen**: Are the ship's main radio transmitter aerials **earthed**? Je li antena glavne radijske postaje uzemljena? It also appears that the connection box **was not earthed** due to the use of plastic cable ties instead of solid metal fasteners.

ease /i:z/ (v) **1 (seamanship, navig)** to allow the helm to turn back after being put hard over **smanjiti (kut kormila za nekoliko stupnjeva), vratiti (kormilo za nekoliko stupnjeva)**: **Ease to five! The helm was eased** when passing through 1800 T until the ARPA showed that the ferry had returned to her original course.; **2** to slacken or pay out the line slightly; to loosen the tightness of a line **popustiti (konop, lanac, škotu), tal. allentare ease the strain on the cable smanjiti opterećenje lanca**: The master reduced the rate of the dragging, thereby **easing the strain on the cable** so that the anchor could be recovered and allowing time for tug assistance to arrive.; **3 (med) olakšati bol, umanjiti bol**: After looking at the International Medical Guide for Ships, the second officer gave the coxswain medication to **ease the pain**. {zapovijed kormilaru}

ease (n) **lakoća ease of maintenance lakoća održavanja**: lako održavanje In the Series 4000 engine the designers focused on high reliability and **ease of maintenance** without compromising compactness., **ease of access lakoća pristupa**: For **ease of access**, the quills are positioned in dry spaces instead of in the way of cooling water spaces., **ease of installation lakoća ugradnje, lakoća montiranja, ease of inspection lakoća pregleda**: lakoća provjere

ease off (v) (**seamanship**) **popustiti (konop, lanac)**

ease out /i:z/ (v) (**navig, seamanship**) **podići sidro s dna, pinelat!; pinelati** {tal.: appennelare, filare l'ancora}

ease the sail out (v) (**boating/yachting**) **popustiti jedro, laškat**

ease the sheet (v) (**boating/yachting**) **popustiti škotu / škotinu / uzdu**

Ease the wheel! (v) (**navig, seamanship**) **Smanji (kut kormila)!**

easing wire (n) (**seamanship**) **čelično uže za spuštanje sidrenog lanca**

eastbound /i:st.baʊnd/ (adj, adv) (**navig**) **ANTONYM westbound prema istoku, u**

smjeru istoka: On my last tour of duty I was towing a crane barge from Singapore using the **East bound lane** of the TSS. We were a loaded VLCC, **eastbound** along a narrow and busy sea lane. ... the inshore traffic zone is effectively closed to larger vessels **proceeding eastbound** from Tanjung Pelepas and

Singapore.

easterlies (n) (meteorol) istočni vjetar, istočnjak

easterly (n) (meteorol) istočnjak **easterly wind** istočni vjetar

easterly (adj, adv) 1 (navig) koji se kreće prema istoku, prema istoku **easterly course** na istočnom kursu, u kursu prema istoku: *VTIS East was informed about close*

quarter situation after own vessel was clear and back on an easterly course., **easterly heading**

istočni smjer: *The ship made steady progress on an easterly heading into strong north-easterly winds and heavy swells. The ship was now on a south easterly heading, and as she continued to be set to the north by wind and swell.*; 2 (meteorol) istočni (vjetar), s istoka **northeasterly winds**

sjeveroistočni vjetar, sjeveroistočnjak, vjetar iz sjeveroistoka: *The ship made steady*

progress on an easterly heading into strong north-easterly winds and heavy swells., **easterly winds**

istočnjak, vjetar s istoka: *Overnight the ship experienced easterly winds in excess of*

90 knots, and a swell height of more than 5 metres.; 3 (oceanogr) **struja prema**

istoku: *The tidal stream was easterly about 0.9 knots* **easterly stream struja prema istoku**: *He*

was aware that the predicted tidal stream was easterly at 3 knots, but considered that his intended course would result in his ship passing clear.

Easy! (seamanship) Carefully (watch what you're doing) **Polako!, Lagano!** {An order for work conducted on board. ; naredba pri obavljanju poslova na brodu, rukovanja priveznom užadi itd.}

ebb /ɛb/ (v) (oceanogr) the period when the tidal current is flowing from the land **spuštati se (o**

moru, mijenama), **opadati, tal. flusso (di marea); marea calante** *the tide was ebbing at*

about 0.3 knots towards the northeast The tide was on the ebb. Unknown to them, the increasing ebb

caused the yacht's anchor to drag.

ebb (n) 1 (oceanogr) **oseka**: *Unknown to them, the increasing ebb caused the yacht's anchor to*

drag.; 2 (oceanogr) **struja uslijed oseke**: *Unknown to them, the increasing ebb caused the yacht's*

anchor to drag.

ebb current (n) (oceanogr) **struja oseke, struja uslijed oseke**: *Due to the ebb current and*

her loss of manoeuvrability, the ship ran aground outside the fairway level with buoy 30 after the

collision.

ebb tide /ɛb/ (n) (oceanogr) a state of low water; period of time during which the tide is falling

oseka: *The ebb tide was causing the ship to set to starboard, and because of her slow speed and poor*

manoeuvrability she did not return to her planned track. The vessel slipped from her berth on the ebb

tide and made her way along the short, straight, narrow channel to open water.

e-bill of lading (n) (mar law, shipping econ) = **electronic bill of lading** **elektronička teretnica**

EBL; (electronic bearing line) /iɛk'trɒnik; ,i:ɛk'trɒnik/ (n) (navig) **elektroničko**

smjeralo: *To take the bearing of an object simply adjust the EBL until it cuts through the centre of the*

object and read off the bearing from the EBL readout on the display. Modern radars incorporate an

improvement on the EBL by using a electronic cursor. The cursor is usually a cross which can be moved

around the screen by using a trackball or other pointing device. **EBL; (electronic bearing line)**

readout očitavanje putem elektroničkog smjerala, EBL; (electronic bearing line)

reference očitavanje putem elektroničkog smjerala, offset the EBL; (electronic

bearing line) prebacivanje smjaranja na drugu točku / cilj (na radarskom

pokazivaču)

ebony /'ɛbɒni/ (n) (nav arch) **ebanovina**

ECDIS display /'ɛkdis/ (n) (navig) prikaz elektroničke karte: The OOW looked at the **ECDIS display** and reported to the master that there was no cause for concern. A few minutes later, after having been contacted by VTS, the OOW zoomed in on the **ECDIS display** and realised that the vessel was



aground.

ECDIS (Electronic Chart Display Information System) (n) (navig) sustav pomorskih karata s elektroničkim pokazivačem, informacijski sustav i prikaz elektroničkih karata, elektronički kartografski sustav, sustav ECDIS: The intended route had been prepared using the ship's **electronic chart display and information system (ECDIS)** and the OOW selected the scale on the **ECDIS display** that closely aligned with the 12 nm range scale. The intended route had been prepared using the ship's **electronic chart display and information system (ECDIS)** and the OOW selected the scale on the **ECDIS display** that closely aligned with the 12 nm range scale ... **ECDIS chart elektronička karta**

EC (Electronic Chart) (n) (navig) elektronička karta

echo /'ɛkəʊ/ (n) (navig) the reflection of a radar signal from an object; the display of the reflected signal on the radar screen **jeka, odraz (na radarskom ekranu)**: the target ship's echo appeared on the radar at 3 miles **multiple echoes višestruke jeka (od jednog objekta)**: Multiple echoes can occur when a strong, short-range echo is received from a target. **echo strength jačina jeka, false echo lažna jeka, unwanted echo neželjena jeka, lažna jeka, sea echo smetnej od mora i valova, smetnje s mora, indirect echo indirektna jeka**: Indirect echoes may be returned from either a passing ship or from a reflecting surface on your own ship, such as a stack. **echo enhancement pojačavanje odraza /jeka, echo stretch izdužavanje odraza, pojačavanje odraza, echo expansion povećanje odraza, echo strength jačina odraza**: The echo strength depends on the peak power of the transmitted pulse and the characteristics of the target. **weak echo slab odraz**: Remember! The weakest echoes, or those not seen at all may be the most dangerous.

echosounder (n) (navig) An instrument which transmits sound through the water and receives reflected signals from the bottom, and which, by measuring the elapsed time, computes and displays the depth. (<http://www.seatalk.info/cgi-bin/nautical-marine-sailing-dictionary>) **ultrazvučni dubinomjer** **check echosounder provjeriti zvučni dubinomjer, hydroacoustic echosounder 1 ultrazvučni dubinomjer; 2 ehlot**

echo stretch kontrola na radaru za izduživanje manjih odraza / jeka, kontrola za pojačavanje slabijih odraza / jeka na radaru: The object of echo stretch or expansion is to make small targets look bigger.

echo stretch kontrola na radaru za izduživanje manjih odraza / jeka, kontrola za pojačavanje slabijih odraza / jeka na radaru: The object of echo stretch or expansion is to make small targets look bigger.

echo trail (n) Echo trails are the afterglow of target echoes that represent their movements relative

to own ship. They are useful for monitoring or zoom or shift is activated. **trag cilja na radarskom ekranu, zadržana slika na radarskom zaslonu (nakon promjene područja): Echo trails are useful for assessing target movement and collision possibility**

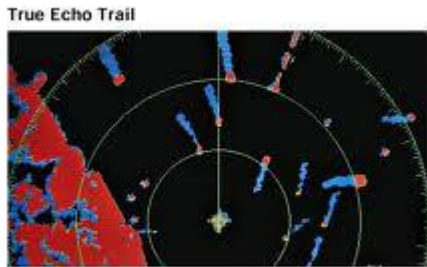

{This feature shows the past position of echoes and therefore the movement of each echo by displaying their previous positions at regular intervals.}

eclipse /i'klɪps/ (n) (navig) an interval of darkness between appearances of a light **tama, pomrčina, eklipsa, period tame (plovidbene oznake)**

economiser; economizer /i'kɒnə,maɪzə/ (n) (marine eng) a device that uses the waste heat from a boiler flue to preheat the feed water **zagrijač napojne vode, ekonomajzer** *At the same time, the exhaust temperature was not reduced too low, so retaining the potential for waste heat recovery from an economizer.*

economy of scale; economies of scale (n) (shipping econ) a condition/theory of economy which encourages the production of larger volumes of a commodity to reduce its unit cost by distributing fixed costs over a greater quantity. **ekonomija velikih brojeva, ekonomija**

razmjera: *The flexibility, critical mass, economies of scale and the availability of manpower for the ships are some of the factors that are considered important in making the "outsourcing" or "inhouse" Economies of scale will tend to give figures higher than the flat rate of the Worldscale for smaller vessels and lower than this for larger vessels.*

eddies /'ɛdɪz/ (n) (navig) **vrtožna struja, virovi**: *I went into the chartroom and had a look at the chart - and there were numerous symbols of eddies in the vicinity of our position. This is particularly so at night, when the presence of turbulent water and eddies in the vicinity of obstructions such as bridge buttresses might not be readily apparent until their effects are experienced.*

eddy current /'ɛdɪ/ (n) (electr) **vrtožna struja, Foucaultova struja**

eddy water /'ɛdɪ/ (n) (nav arch) **povratna voda (od propelera)**

edible cockle (n) **kapica srčanka**

edible oil /'ɛdɪbəl/ (n) (cargo) **jestivo ulje**

EDI; electronic data interchange: (n) (shipping econ) an interactive electronic system that enables a supplier and a customer to communicate easily **elektronička razmjena podataka,**

sustav EDI: *The customs broker sends his import or export declaration via the customs web application or an EDI message.*

educational qualification **školovanje, školska kvalifikacija name of institute / college naziv školske ustanove / visoke škole**

educt /'i:ɢkt/ (n) (V) separate a substance from another substance without chemical change; separirati edukcijom **odvoditi, odvajati**

educator (n) (marine eng) In most turbo-charged engines, crankcase fumes are not removed by direct suction as in the normally aspirated engines. Instead a venturi principle is used. This is commonly called

an educator. **eduktor, ejektor** A certain amount of coking takes place in the stack around the rim of the educator tube where more oxygen is available. Blocked Sea Suction Prevented Engine Room Flood Vessel's educator system valve. He found that the starboard main engine bilge educator system valve, which was out of sight, behind the engine, had completely sheared off from the sea water suction pipe.

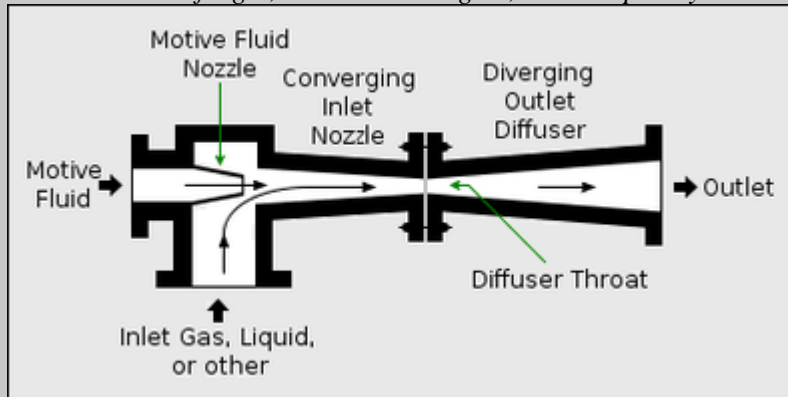

educator room /i:ˈdʌktɔː/ (n) (marine eng, cargo handling) a pump room to transfer liquid cargo
 prostorija edukatora, prostorija / tank za prijenos tekućeg tereta

eel /i:l/ (n) (fishing) jegulja {drugi hrv. nazivi: angulja, bižat, čapor, kajman, kračica, žutica; lat. ANGILLA ANGILLA}

effect /iˈfekt/ (n) have an effect on utjecati na 1 (mar law) učinak, djelovanje, zakonska snaga, posljedica, efekt with effect from ... until ... počevši od ... do ..., s punovažnošću od ... do ..., have effect on utjecati na, djelovati na, imati učin na: Although the engine telegraph had been set from full ahead manoeuvring to half ahead, this had no effect on the engine speed ..., adverse effect on nepovoljan učin na, negativan utjecaj na: Such mixing may have an adverse effect on the running condition., immediate effect neposredni učin. This had an immediate effect as he then made a large alteration to starboard and passed clear., full force and effect punopravni učin: This Agreement is applicable and of full force and effect whether or not the Owners have entered into individual contracts of employment with any Employee., side effect popratno djelovanje, popratna posljedica, take effect (navig, marine eng) djelovati, početi djelovati: Astern movements were given in time to stop the vessel, but the movement failed to take effect., take effect (mar law) stupiti na snagu (propis, zakon, pravilo, norma, ugovor itd.) početi važiti: Orders at Japanese shipyards rocketed 186% in October as shipowners rushed to build ships that will comply with the International Maritime Organization's (IMO's) new standards, which will take effect from July 2016., to come into effect stupiti na snagu, sealing effect brtveni učin, učin brtvljenja: To assist in the sealing effect, air from the compressor volute casing is led into a space within the gland., desired effect željeni učin, željeno djelovanje, željeni efekt: Miraculously this had the desired effect and she altered just in time to port passing us at a CPA of less than 0.1 mile., in effect na snazi: Regulation currently in effect.; 2 posljedica

effect /iˈfekt/ (v) 1 izvršiti effect payment platiti (račun), izvršiti plaćanje, effect a repair popraviti, obaviti popravak, izvršiti popravak There were enough spares and bits and pieces to effect a temporary repair.; 2 djelovati

effective /iˈfektiv/ (adj) učinkovit, djelotvoran, efikasan: The fishing vessel's skipper's last-minute avoiding action was too late to be effective. take effective action poduzeti

efikasnu radnju: *the speed was too high to take effective action to avoid collision It is therefore important when manoeuvring to know how a vessel's CPP will behave on failure so that effective action can be taken.*, **effective 1 January 2015 koji stupa na snagu 1. siječnja 2015.**, **effective means učinkovito sredstvo, djelotvorno sredstvo:** *ECDIS provides the bridge team with an efficient and effective means of navigation.*, **effective Bridge Team and Resource Management učinkovito upravljanje ljudskim resursima na mostu** *Effective bridge resource management should eliminate the risk that an error on the part of one person could result in a dangerous situation.*, **effective protection učinkovita zaštita, efikasna zaštita:** *Pipelines for fire-fighting purposes (monitor supply, foam, water spray, etc.) installed on open deck should have effective protection against corrosion.*

effective dates of contract (n) (mar law, shipping econ) datumi stupanja na snagu početka / završetka ugovora: *Effective dates of contracts can be amended, even orally There's nothing to preclude parties from agreeing to modify the effective date of a transportation contract. Such agreement would be an amendment to the contract itself. As long as there was no conflict between the parties, such an amendment could even be an oral one.*

effective plating area /i'fektiv/ (n) (nav arch) sunosiva širina lima

Effect of wind and rolling (n) (stabil) učin vjetra i ljuljanja broda, utjecaj vjetra i ljuljanja broda: *The generic risk assessment for STS (Ship-to-Ship) operations – which is also applicable to bunkering operations – was reviewed and revised to take into consideration the effect of wind and sea on the other ship at anchor.*

efficiency /i'fifənsi/ (n) 1 a djelotvornost, efikasnost; 2 (marine eng) iskoristivost, korisni učinak thermal efficiency termički stupanj djelovanja, combustion efficiency korsini učinak izgaranja, degree of efficiency stupanj iskoristivosti, plant 1 stupanj iskoristivosti pogona / postrojenja, increase tge efficiency povećati stupanj iskoristivosti

efficient /i'fifənt/ (adj) 1 a učinkovit, efikasan, uspješan; 2 sposoban

efficient deckhand (E.D.H.) /i'fektiv/ (n) (mar law) strariji / iskusni mornar

efficient speed /i'fektiv/ (n) (marine eng) korisna brzina

effort /'ɛfət/ (n) napor, pokušaj to make every effort pokušati sve, učiniti sve: *If there is an unusual discrepancy between the shipper's figure and that disclosed by the vessel's loading ullages, every effort should be made to have the latter inserted in the bill of lading.*, **make a good effort potruditi se jako:** *The crew made a good effort in tackling the fire but their work was hampered by containment difficulties.*

e.g. (eg.; eg) /i: 'dʒi:/ npr., na primjer {lat exempli gratia}

egging /'ɛgiŋ/ (n) (fishing) lov na lignje s obale, lignjолоv s obale

ejector /i' dʒɛktə/ (n) (marine eng) a static pum for ejecting liquid, as from a sump; induces fluid flow by entraining the liquid in the flow of a stream of air, steam, or water. ejektor, potiskivač, strujna vakuumska sisaljka: *The ejector can be used for all suction purposes. Ellehammer Ejectors are ejector pump strujna vakuumska sisaljka*

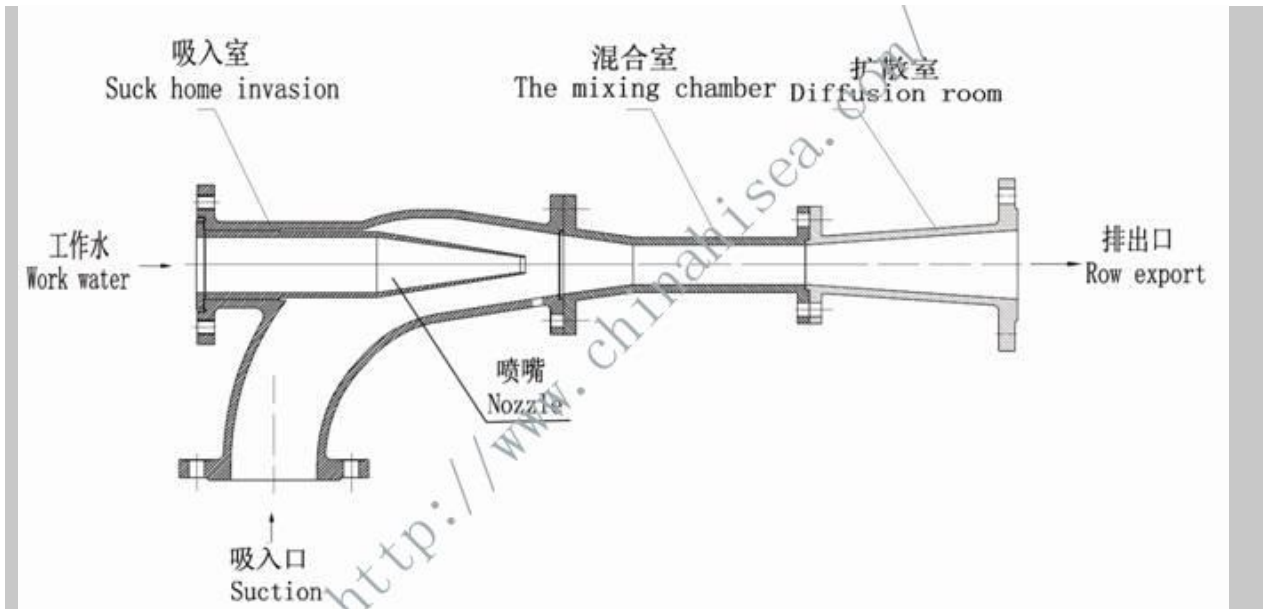

eking /'ɛkiŋ/ (n) (sailing vessels) umetak pod zojom

elapse (v) 1 **istjeći, isteći**: An audible signal is usually given when the 5 seconds have elapsed and a message is sent. Only 30 minutes had elapsed from the vessel striking the quay wall to it sinking.

time for delivery has elapsed rok za isporuku je istekao: Time limit for filing a claim is 9 months from date of delivery, or in the event of non-delivery, 9 months after a reasonable time for delivery has elapsed.; 2 (mar law) **istjeći (o roku), isteći (o roku), proći (o roku)**: During the course of a voyage if your vessel is or has experienced bad weather or any nature of extraordinary damage or loss that may be caused to your vessel and/or cargo you must prepare a Note Of Protest and upon arrival and/or never after 24 hours having elapsed (not including holidays, Saturdays and Sundays) have it notarized at Notary Public.

elastic coupling (n) (marine eng) elastična spojka, opružna spojka, elastična

spojnica: Elastic or flexible couplings allow slight misalignment and damp out or remove torque variations from the engine. The system comprises a compact unit with a step-up gear coupled directly to the generator, which is located above the elastic coupling.

elastic curve krivulja elastičnih deformacija: The line in the right-hand diagrams connecting the maximum amplitudes reached simultaneously by each mass on the shaft system is called the 'elastic curve'. The most significant masses in any mode of vibration are those with the greatest amplitude on the corresponding elastic curve.

elastic limit /i'læstik/ (n) (marine eng) granica elastičnosti

elastic steel /i'læstik/ (n) (marine eng) elastični čelik, rastezljivi čelik

electric /i'lektrik/ (adj) (electr) električni {For the difference between 'electric' and 'electrical' see: <http://english.stackexchange.com/questions/31649/what-is-the-difference-between-electric-and-electrical-and-their-usage>): 1. Electric is used to describe things pertaining to electricity. It can also be used metaphorically: the evening was electric. 2. Electrical can be used nearly everywhere that electric is used when pertaining to electricity (aside from some set phrases). It is not generally used metaphorically in the way electric is.. 3. So, in the case of electric(al) machine from your question, since you are talking about something that runs on electricity, the two words are essentially identical in meaning. }

electrical /i'lektrikəl/ (adj) (electr) električni **electrical engineer inženjer elektrotehnike elektroinženjer** {'electrical engineer' (not *'electric engineer'); 'electrical officer' (not 'electric officer')}

electrical cable (n) (electr) električni kabel The fire was caused either by a short circuit where the electrical cables were draped over the non-continuous bulkheads, or by an overheating

electrical device belonging to one of the crew.

electrical conductivity (n) (*electr*) **električna provodljivost, električna vodljivost**

electrical fault (n) (*electr*) **električni kvar**: All the indications suggest that the fire was probably caused by an **electrical fault** on the bilge pump or high bilge level float switch circuit which were the only circuits that were live while the boat was at the mooring. Lack of attention, spontaneous combustion and **electrical faults** are the major causes of shipboard fire.

electrical motor (n) (*electr*) **elektromotor**: Root cause/contributory factors Incorrect layout of sea-water piping directly over steering pump **electrical motors**; The **electrical motors** and components were successfully cleaned out with solvents, dried out and made fully operational in the anchorage by ship's staff ...

electrical officer **časnik za električne uređaje i instalacije, brodski**

elektro-časnik: Electrical engineer is responsible for maintenance of all the electrical equipment on a ship such as motors, switchboards, fire detectors, navigational lights, batteries etc. He assists ship's deck officer and engineer in all kind of electrical malfunctions. The third engineer, who may or may not hold a certificate of competency, keeps the 2x2 watch and where an **electrical officer (electrotechnical officer)** is not carried usually maintains the ships electrical equipment. In our fleet, we now require **electrical officers (E/O)** to examine carefully all radar antennas, cable penetrations and junction boxes on the compass deck and masts once a month ...

electrical panel (n) (*electr*) **strujna ploča, električni ormarić**: A lifeboat should never be hoisted by operating the winch motor from a **remote electrical panel** as this may by-pass the safety cut-outs, can result in loss of control due to communication difficulties and also pose an electrocution hazard.

electrical plant (n) **1 (electr) električni uređaj; 2 električno postrojenje, elektrana**

electrical power (n) (*electr*) **električna struja, električno napajanje**: The heavy seas washing over the deck rendered about 130 reefer containers without **electrical power**. The engine room responded promptly to a 'low insulation' alarm and upon seeing the sea-water leak in the steering gear room, immediately **turned off the electrical power** to the motors and informed the bridge. **Electrical power** was isolated throughout the ship with the exception of the emergency fire pump, which had been started to provide fire-fighting water. At the time, all **electrical power** was being supplied by the main engine driven shaft generator, and so with the main engine shutting down, all electrical power was also lost.

electrical shortcut (n) (*electr*) **kratki spoj** This caused an **electrical short** (cut), resulting in sparking and leading to high temperatures which caused damage to the cable insulation and fittings.

electrical socket (n) (*electr*) **električna utičnica**: Overloaded **electrical socket** and defective adaptor.

electrical spares (n) (*boating/yachting, electr*) **pričuvni dijelovi za električne**

instalacije fuses osigurači, bulbs žaruljice, terminal fittings stopice, soldering iron and solder nit za lemljenje i lemilica, tape - insulating and self-amalgamating vrpce - izolirajuće i samostapajuće, battered for torches baterijsski ulošci za svjetiljke, distilled water for topping uo batteries destilirana voda za dolijevanje akumulatorskih ćelija, hydrometer (for checking battery cells) hidrometar (za provjeru akumumatora), connecting blocks spojnice

electrical spark (n) (*electr*) **električna iskra**: Do check the Product and Material the halogen lamp. Either the hot lens or bulb, Safety Data sheets of materials to or an **electrical spark** from the lamp ignited identify if there are dangers associated the mixture, causing the explosion.

electrical storm (n) (*meteorol*) **oluja s električnim pražnjenjem, električna oluja**:

*elines for completing the ship/shore safety checklist: The operations should be suspended and all deck and vent openings closed on the approach of an **electrical storm**.*

electrical supply (n) (*electr*) **napajanje električnom energijom**: About 40 minutes after leaving the berth the ship experienced a series of short power failures which interrupted the steering gear **electrical supplies**.

electrical system (n) (*electr*) **električni sustavi**: A complete failure of the vessel's **electrical system** with the navigation equipment and the radio set is considered probable in view of the arrangement of the load batteries. After salvage, the main engine could be restarted, but all the **electrical systems** were damaged.

electrical tape (n) (*electr*) **izolacijska traka, električna traka, električna vrpca**: Following the incident the school's instructors examined the flare firing mechanism and decided to place a **band of electrical tape** around it to help prevent inadvertent firing of the flare.

electrical wiring (n) (*electr*) **električni vodovi, električno ožičenje, električna mreža**: The insulation of **electrical wiring** should be checked at regular intervals. A short circuit occurred in the **electrical wiring**.

electric arc welding (n) (*electr*) **elektrolučno zavarivanje**: A standby vessel was in port waiting for her next tasking, so the opportunity was taken to carry out an **electric arc welding repair** to the bedplate of an alternator located in the engine room.

electric charge (n) (*electr*) **električni naboj**

electric circuit (n) (*electr*) **strujni krug**: Check that **electric circuits** are in good condition and that fuel pipes are free from chaffing.

electric device (n) (*electr*) **električni uređaj, električni aparat**

electric generation (n) (*electr*) **generiranje električne energije, proizvodnja električne energije, proizvodnja električne struje**

electric generator (n) (*electr*) **električni generator, generator električne struje D.C. electric generator generator istosmjerne struje**

electric heater (n) (*electr*) **električni grijač**: The oil is heated by steam (although thermal oil or **electric heaters** are used on other systems).

electrician /i'lek'triʃən/ (n) (*electr, marine eng*) **električar, struja**

electricity (n) (*electr*) **elektricitet, električna struja generate electricity proizvoditi električnu struju**

electricity usage fee (n) (*shipping econ*) **naknada za korištenje električne energije (za napajanje brodova, hladjenih kontejnera itd.)**

electric motor (n) (*electr*) **elektromotor**: There is at least one good solution where the boat has a single point hoisting/lowering system with an **electric motor**. The turning gear on a turbine installation is a reversible electric motor driving a gearwheel which meshes into the high-pressure turbine primary pinion. An **electric motor** can provide a drive with very low-vibration characteristics, a quality valued for warships, research vessels and cruise ships ...

electric power (n) **1** (*electr*) **električna struja**: Loss of the ship's own propulsion, **electric power**, steerage and manoeuvrability could be foreseen and eventually occurred. ; **2** **električna energija provide electric power opsrbiti električnom energijom**

electric-power unit /i'lektrik/ (n) (*electr*) **agregat električne energije**

electric pre-heating coil (n) (*marine eng*) **električni predgrijač**

electric propulsion (n) (*nav arch*) **električni pogon**: Diesel electric propulsion allows the engines to be placed wherever is most suitable, as they no longer have to be aligned with

reduction gearing .. Another example of the flexibility facilitated by an **electric propulsion system** is a semi-submersible rig installation whose gensets are mounted on the main deck

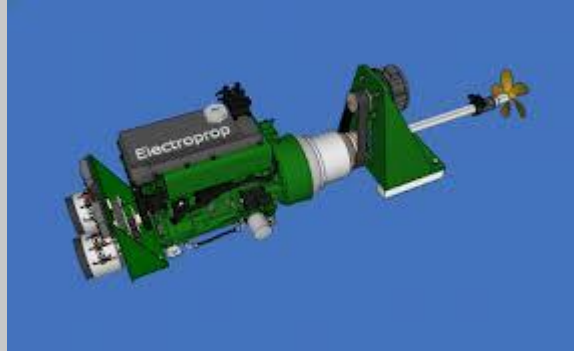

and propulsion motors in the pon

electric pump (n) (electr, marine eng) **električna pumpa, električna crpka, električna sisaljka**: After fitting the new propeller, the contractor cast off and, while leaving the marina, pumped the bilges using the **electric pump**.

electric ray (n) (fishing) **COMPARE ray** Lat. Torpedinidae **drhtulja, drhtulja šarulja**



{lat. **Torpedo marmorata**}

electric shock /i'lektrik/ (n) (electr) **električni udar, elektrošok**: Another crew member who went to his aid also received an **electric shock** from the same source and sustained a serious injury.

electric welding /i'lektrik/ (n) (electr) **električno zavarivanje**: ... a lack of maintenance or bad watchkeeping practices . They are usually caused by fuel spills, overheating components or careless use of **electric welding** or gas brazing gear. The officers became curious, seeing the **electric welding cable** leading from the engine room along the upper deck, and followed it to the hot work site in hold no. 3

electric winch (n) (cargo handling, seamanship): The bosun operated the **electric winch** briefly, and the manual winding handle, in the hands of the two other crewmen, swung rapidly and struck one of them on the head.

electric wiring /i'lektrik .waiəriŋ/ (n) (electr) = **wiring** **električni vodovi** **electric wiring diagram** **elektroschema**

electrode /i'lektroʊd/ (n) (electr) **elektroda** **electrode holder** **nosač elektrode**

electromagnetic wave; (EM) /i,lektroʊmæg'netik/ (n) (electr) **elektromagnetski val**
ground electromagnetic wave; (EM) **površinski valovi**, **sky electromagnetic wave; (EM)** **prostorni valovi**

electronic aids (n) (navig) **elektronička navigacijska pomagala**: The bulk carrier's officer of the watch did not effectively use the **electronic aids** available to maintain a proper lookout. In

most collisions and groundings, **electronic aids** such as ARPA, CPA and TCPA alarms, waypoint alarms and depth alarms had not been used.

electronic bearing line; EBL (n) (navig) **elektroničko smjeralo**: We have monitored or plotted their radar targets using the cursor or ARPA facility; taken a series of compass bearings using the radar's **electronic bearing line**; and/or taken a series of visual compass bearings using the azimuth ring. Facilities such as automatic plotting, **electronic bearing lines**, variable range markers and radar guard alarms, are normally provided to assist the OOW. He checked the vessel was on heading for the next alteration of course position, which was indicated by an **electronic bearing line** on the plotter.

electronic bearing marker (EBM) /ilek'trɔnik/ (n) (navig) **elektronička oznaka**

azimuta: The ARPA is non-functional and the **electronic bearing marker** is about 20 degrees out.

electronic bill of lading /ilek'trɔnik/ (mar law, shipping econ) **elektronička teretnica**

electronic chart /ilek'trɔnik/ (n) (navig) **elektronička karta**: The mate was alone on the bridge, navigating with the aid of an **electronic chart system** while seated on the wheelhouse chair. The intended route had been prepared using the ship's **electronic chart display** and information system (ECDIS) and the OOW selected the scale on the ECDIS display that closely aligned with the 12 nm range scale set. He was primarily using an **electronic chart plotter** with a GPS input, although he had two radars and a magnetic compass at his disposal.

Electronic Chart Display and Information System; (ECDIS) (n) (navig)

elektronički navigacijsko-informacijski sustav, sustav ECDIS: The OOW was monitoring the vessel's position on the **Electronic Chart Display (ECDIS)** but was not plotting the position on the paper chart. We have developed the Electronic Navigational Charts for the Strait (and our port) which can be used together with the **Electronic Chart Display and Information System (ECDIS)** for real-time navigation without the use of paper charts.

electronic circuit /ilek'trɔnik 'sɜ:kɪt/ **elektronički krug**

Electronic Data Interchange; (EDI) exchange of information through an electronic format
elektronička razmjena podataka

electronic device (n) (electr) **elektronička naprava, elektronički uređaj**: It is recommended to thoroughly check the vessel's equipment, especially for the arrangement, configuration and adjustment of **electronic devices** so that errors in installation can be recognized in time and if need be already be dealt with during the sea trial.

electronic navigation (n) any method of position fixing using electronic means, including: radio navigation, radar navigation, satellite navigation. **elektronička navigacija**: Although she was equipped with an **Electronic Navigation System**, which would have provided waypoint alarms, this was not in use because the crew were not sufficiently trained in its use.

electronic navigation aids /ilek'trɔnik/ (n) (navig) **elektronička navigacijska**

pomagala: It is essential that all mariners are not only trained in the operation of **electronic navigation aids**, but understand the weaknesses and how these aids should be used as a decision support system rather than a decisionmaking system.

electronic navigational chart; (ENC) /ilek'trɔnik/ (n) (navig) compiled from a database of information this chart presents the OOW with a vector chart. Information is built up in layers so the OOW can decide to exclude certain features in order to keep the view clear and simple **elektronička navigacijska karta, elektronička karta**

electronic position fixing system /ilek'trɔnik/ (n) (navig) **sustav elektroničkog**

određivanja pozicije: Navigators should use all available means to check the position of their vessel, but they must regularly verify the accuracy of positions displayed by **electronic position fixing**

systems by reference to visual bearings and transits whenever available.

electronic range and bearing line; ERBL (n) (navig) **elektroničko smjeralo za mjerenje udaljenosti i smjerova**

electronic range marker; ERM /ɪlɛk'trɒnɪk/ **elektronički daljinomjer**

electronics (n) (electr) **elektronika, elektroničko traženje tereta**

electronic tracking /ɪlɛk'trɒnɪk/ (shipping econ) **elektroničko praćenje tereta**

electrotechnical officer; ETO /ɪlɛk'trɒnɪkəl/ (n) (mar law) = **electrical officer** časnik elektrotehnike i elektronike na brodu, brodski elektrotehnički časnik:

Electro-Technical Officers are specialist officers working within the Engineering Department where they take particular responsibility for the maintenance of on board control engineering and electronic systems including propulsion control, radio communications and electronic navigation aids.

Marine Electrotechnical Officer; METO brodski časnik elektrotehnike/elektronike

electrotechnical rating (n) (mar law, marine eng) **elektrotehničar član posade**

elevation /ˌɛlɪ'veɪʃən/ (n) **1 visina:** *At an elevation angle of about 35 degrees and a height of about 40 metres, the pipe suddenly slipped out of the grab and fell with great force back onto the deck ... the satellite is at such an elevation for Inmarsat that the signal from the ship is beamed up at a perfect angle to intercept the GPS antenna.*; **2 presjek, profil side elevation bočni profil, bokocrt, pogled sa strane:** *Side elevation of typical ballast hold shows how lamellar tear is caused*; **3 okomita vertikalna projekcija; 4 vertikalni profil**

elevation of focal plane above datum (n) (navig) **visina žarišta svjetla iznad srednje razine mora visina svjetla**

elevator /ˌɛlɪ'veɪtə/ (n) **1 (cargo handling) elevator, pneumatski uređaj (za ukrcaj/iskrcaj tereta u silosu):** *Elevators (US) or silos are normally associated with grain. They may be operated by pneumatic suction which sucks the grain out of the ship's hold.*; **2 nagnuti transporter:** *Some hoppers have an elevator for depositing the cargo into heaps on the quay side for later onward transportation.*

elongated spreader **produženo gazište pilotskih ljestava**

elongation /ˌiːlɒŋ'geɪʃən/ (n) **1 produljenje:** *... on a rare day at anchor, we worked the ramp door in and out several times and eliminated diverse causes such as possible wrong rigging, elongation of wire ropes, malfunction or wrongly adjusted limit switches etc.*; **2 istežanje:** *... the control valve is adjustable which can be used to allow for fuels of varying ignition qualities and changes in the camshaft timing due to chain elongation.*

embankment /ɪm'bæŋkmənt/ (n) **1 (ports) izgrađena riječna obala; 2 (ports) nasip, diga**

embark /ɛm'ba:k/ (v) **ANTONYM disembark** to go on board a ship; to board the ship

ukrcati se (pilot, putnik): *A fast modern container vessel was preparing to embark a pilot during the early hours of the morning. The bridge team became distracted and lost their situational awareness while maneuvering the ship to rendezvous with the pilot vessel or while preparing to embark or disembark a pilot. The vessel tied up, bows to the pier with engines at idle, to embark passengers, reducing the gap between the mooring barge and the stern of the passenger vessel to about 30 metres.*

embarkation /ˌɛmbɑː'keɪʃən/ (n) (seamanship) **ukrcaj, ukrcavanje embarkation deck (nav arch) paluba za ukrcaj putnika:** *The boats were brought to the Embarkation deck without incident.*, **pilot embarkation area (navig) područje ukrcaja peljara:** *The vessel's approach to the pilot embarkation area was being monitored by VTS.*

embody /ɪm'bɒdi/ (v) **1 uključiti:** *... and the necessary changes were mainly those relating to the*

increase in piston stroke and modifications to components to **embody thermodynamic improvements**. Turbocharging is based on the constant pressure system and **embodies** low flow resistance air and exhaust piping with suitable diffusers between the ports and the manifolds.; **2 (mar law)**

utjeloviti, ostvariti

emergency /i'mɜ:dʒənsi/ (**safety**) **1 hitan slučaj; 2 opasnost**: *In an emergency raise the alarm, call the master and instigate measures to prevent damage I can confirm that the lack of a common language in the event of an emergency is a serious risk to crew and vessel safety. When you have an emergency on board, it is sensible to let the coastguard know, even if you do not require assistance.*

deal with an emergency nositi se s opasnošću: *This is especially important in the highly stressful situation when dealing with an emergency.; **3 izvanredno stanje, kritično stanje**: *If you have DSC radio, you could try a 'securité' DSC alert followed by a voice broadcast; During an emergency, a DSC Pan alert should be made, followed by a VHF voice broadcast stating the situation and danger.; **4 nepredviđen događaj****

emergency alarm (n) (safety) alarm za slučaj opasnosti: *The container ship's engine telegraph was set to 'stop' and the emergency alarm was sounded. The bridge and nearby crew were alerted and the emergency alarm was activated. Immediately the emergency alarm was sounded and a full rescue team prepared to muster near the tank. general emergency alarm alarma za opću uzbunu*: *Operate the general emergency alarm.*

emergency anchorage /i'mɜ:dʒənsi/ (**n) (navig) sidrište za slučaj opasnosti, pomoćno sidrište**: *He then ordered the OOW and the bosun to the forward mooring station for an emergency anchoring.*

emergency communication /i'mɜ:dʒənsi/ (**n) (comm) komunikacija u opasnosti**: *Some of the findings related to passenger briefings and emergency communication brought to light by the investigation were: The failure to notify those on board of an emergency situation delayed emergency response*

emergency diesel generator /i'mɜ:dʒənsi/ (**n) (marine eng) generator za slučaj opasnosti / nužde**

emergency drill (n) (safety) vježba za slučaj opasnosti, vježba za izvanredna stanja: *– The frequent crew changes also meant that individual crew members had not carried out emergency drills on all the vessels they were expected to operate. Emergency drills should be designed so that crews become familiar with all that they may be required to do. Emergency-related activities may include personal safety familiarisation and training, planning and conduct of emergency drills, proper response to actual emergencies.*

emergency equipment (n) (safety) oprema za slučaj opasnosti: *Ensure that everyone on board is very familiar with the emergency equipment carried: both location and use. Most of the emergency equipment, including ventilation shut-off valves and the emergency fire pump, were not properly maintained and no-one could remember when they were last tested*

emergency escape /i'mɜ:dʒənsi/ (**n) (safety) izlaz za slučaj opasnosti, nužni izlaz**: *Is there provision for emergency escape? Postoji li izlaz za slučaj opasnosti? The skipper took an extinguisher from the wheelhouse and operated it through the emergency escape hatch. emergency escape breathing device; EEBD dišni aparat za izlaz u slučaju opasnosti, dišni aparat za izlaz u nuždi*: *He donned an Emergency Escape Breathing Device (EEBD) and escaped into fresh air.*

emergency fire pump (n) (safety) protupožarna pumpa za slučaj opasnosti, protupožarna pumpa za izvanredna stanja: *During a fire drill, the second engineer entered the emergency fire pump room to operate the emergency fire pump: this involved negotiating a vertical*

ladder section within a straight access trunking.

Emergency full ahead! /i'mɜːdʒənsi/ (n) (navig, safety) **Punom snagom naprijed zbog opasnosti!**

Emergency full astern! /i'mɜːdʒənsi/ (n) (safety, navig) **Svom snagom krmom zbog opasnosti!** *reason, this pilot simply did not seem to appreciate the problem of our approach speed relative to the proximity of the wall and I put the engines on emergency full astern. Residual headway of own vessel despite the emergency full astern manoeuvre.*

emergency generator /i'mɜːdʒənsi/ (n) (electr, safety) **generator za slučaj nužnosti, generator za slučaj opasnosti** *Automatic start up of the emergency generator at a low voltage value is usual on modern installations. The emergency generator had failed to start automatically because it had been left in hand control. Any faults or defects in the emergency generator/alternator, its prime mover and associated equipment, must be rectified and immediately reported to the appropriate management office. At some stage the ship's emergency generator started, after the ship's main diesel generators stopped as a result of lack of cooling water. It was not until 15 minutes later that the emergency generator was started and the generators were cooled down sufficiently to enable them to be re-started.*

emergency lighting /i'mɜːdʒənsi/ (n) (nav arch) **pomoćna rasvjeta, rasvjeta u nuždi:** *Emergency lighting for occupied areas, navigation lights, communications systems and alarm systems must also be supplied.* **emergency lighting system** **sustav pomoćne rasvjete, sustav rasvjete u nuždi / opasnosti**

emergency lights (n) (safety) **svjetla u nuždi, pomoćna svjetla** *Emergency lights came on, and the vessel stopped rolling and adopted a list of about 45 degrees to starboard.*

emergency muster station (n) (safety) **pomoćno zborni mjesto, zborni mjesto u nuždi, mjesto za okupljanje u nuždi:** *The master sounded the fire alarm and made a public address announcement ordering all hands to their emergency muster stations.*

emergency party (n) (safety) **skupina za djelovanje u opasnosti, grupa/tim za djelovanje u nuždi, protuhavarijska grupa:** *The master immediately mustered the emergency parties. Meanwhile, the ship's emergency party was activated and the passengers advised of the situation by the captain. Other members of the crew cooled down the area as the emergency party then entered the hold and confirmed it to be clear.*

emergency plan (n) (safety) **plan u slučaju opasnosti:** *The vessel's emergency plan for grounding incidents was activated.* **Shipboard Marine Pollution emergency plan; (SMPEP) Brodski plan za slučaj onečišćenja mora:** *Repeatedly practise ship's emergency and reporting procedures as outlined in the shipboard oil pollution plan (SOPEP) and shipboard marine pollution emergency plan (SMPEP).*

Emergency Position Indicating Beacon; (EPIRB) /i'mɜːdʒənsi/ (n) (navig, safety) **uređaj koji omogućuje određivanje položaja broda ili ljudi u nezgodi ili autonomno određuje položaj broda u nevolji te o njemu izvještuje mjerodavne ustanove na kopnu uređaj za otkrivanje položaja, Radioplutača koja odašilje poziciju broda u opasnosti, epirb** {Osnovne frekvencije uređaja za otkrivanje položaja su 406.025 MHz te 121.5 MHz.}

emergency power (n) (safety, marine eng) **pomoćni pogon, pomoćno napajanje, pogon u nuždi:** *The vessel is currently on emergency power and drifting*

emergency power plant /i'mɜːdʒənsi/ (n) (marine eng) **pomoćni generatorski sustav**
emergency power supply /i'mɜːdʒənsi/ (n) (marine eng) **napajanje strujom za slučaj nužde:** *Where the rudder stock is greater than 230 mm an alternative power supply is to be provided*

automatically from the *ship's emergency power supply* or from an independent source of power located in the steering gear compartment. The *emergency power supply* is operational.

emergency procedures (n) (safety) **postupci u opasnosti**: By this stage, all other engineers had arrived to assist, and the vessel's full *emergency procedures* came into play to effectively tackle the fire using the CO2 smothering system. A drill will be held to familiarize passengers with their assembly stations, with their life-saving equipment and with *emergency procedures*. Crews were regularly exercised in *emergency procedures*, including fire drills, and could refer to the vessel's comprehensive Fire Action Drill checklists.

emergency release (n) (safety) **otpuštanje u nuždi, oslobađanje u nuždi, pogon u nuždi**: Procedures for *emergency release methods*, time delays and release speed shall be established and this information shall be displayed at the conning position. Additionally, ensure your *derrick head block emergency release* is operational and that the crew know how to activate it. **emergency release system** **sustav za oslobađanje u nuždi, uređaj za oslobađanje / otpuštanje u nuždi**: The lack of an accepted international industry standard for tug tow line *emergency release systems*. The investigation has identified a number of factors which contributed to the accident, including: The *emergency release system* for the towing winch on board Flying Phantom had operated, but not quickly enough to prevent the tug from capsizing.

emergency repairs /i'mɜ:dʒənsi/ (n) (safety) **popravci u nuždi**

emergency response and rescue vessel (ERRV) /i'mɜ:dʒənsi/ **brod (brodica) za hitne intervencije i spašavanje**: An *emergency response and rescue vessel* was operating offshore during a period of heavy weather. Jade Traffic coordinated the initial *emergency response*. The Master was immediately called and the *oil spill emergency response plan* was activated.

emergency response team (n) (safety) **skupina za reakcije u nuždi**: After the ship's *emergency response team* provided air to the stricken crew via in-line breathing apparatus, the motorman recovered and was able to leave the tank.

emergency services (n) (safety) **služba za pomoć u slučaju opasnosti, služba za pomoć u slučaju nužde, interventna služba, služba za hitne intervencije**: The *emergency services* arrived on the scene within minutes and several pumps were quickly rigged to try and prevent further flooding. The skipper raised the alarm immediately with the *emergency services*, and a full air and sea search was conducted. Approximately 15 minutes after the spillage, the local *emergency services* arrived and established an exclusion zone around the vessel.

emergency shutdown system /i'mɜ:dʒənsi/ (n) (cargo handling, nav arch) **sustav za brzo zatvaranje u nužni**

emergency shutdown /i'mɜ:dʒənsi/ (n) **1 (safety) obustava rada u slučaju opasnosti, zaustavljanje (stroja) u nuždi**: ... a lubricant header tank is incorporated in the structure for effective lubrication of the turbocharger rotor following *emergency shutdown of the engine*. The Master, upon arrival on the bridge, activated the *Emergency Shut Down* and the main engine stopped. ; **2 brzo zatvaranje u nužni**: Our deck crew raised the alarm immediately and cargo discharge was stopped using the *emergency shutdown (ESD) button*. The chief officer saw and heard a leak and activated the *emergency shut down (ESD) valves*.

emergency signal /i'mɜ:dʒənsi/ (n) (safety) **signal za slučaj opasnosti**: No *emergency signal* was sounded on the ship's whistle.

emergency situation (n) (safety) **izvanredno stanje, opasnost**: Despite the breakdown of the structural barriers, the ship's officers and crew managed to *contain the emergency situation* and bring the ship alongside at the Suez Canal Container Terminal without any personal injury or pollution.

to the environment. If passengers are to be embarked on your vessel, for whatever reason, ensure they are aware of what to do **in an emergency situation**. The coastal state should always be informed of any **emergency situation on board**.

emergency station (n) (safety) **postaja za slučaj opasnosti, postaja za slučaj**

izvanrednog stanja: The Captain said he had everyone go to their **emergency stations** for a head count and if it was determined that an evacuation was required.

emergency steering /i' mɜ: dʒənsi/ (n) (nav arch) **kormilarski uređaj za slučaj nužde,**

pomoćni kormilarski uređaj: Subsequent investigation revealed that none of the Officers knew how to operate the **emergency steering**. The master changed over to **emergency steering**.

emergency steering gear drill /i' mɜ: dʒənsi/ **vježba isprobavanja kormilarskog uređaja za opasne situacije**

emergency stop /i' mɜ: dʒənsi/ (n) (safety) **zaustavljanje u slučaju opasnosti**: Shutdown

functions for lube oil pressure, overspeed and **emergency stop** are provided as standard. It was observed that the automatic **emergency stop system** for the engine room supply fans had already tripped the blowers and the fixed CO2 gas release alarm had been activated. **emergency stop**

button **dugme za zaustavljanje u slučaju opasnosti**: Fit audible and visual alarms on new deck cranes, which activate automatically when the **emergency stop button** is pressed. **emergency**

stop system **sustav za zaustavljanje u slučaju opasnosti**: It was observed that the automatic **emergency stop system** for the engine room supply fans had already tripped the blowers and the fixed CO2 gas release alarm had been activated.

emergency switchboard /i' mɜ: dʒənsi/ (n) (electr) **rasklopna ploča za slučaj nužde,**

razvodna ploča za slučaj nužde, razvodna ploča za slučaj opasnosti, pomoćna

razvodna ploča: Never forget that your **emergency switchboard** is always on and ready to feed the

more important systems in the ship. A quick look showed that the breaker on the **emergency switchboard** was open; this was immediately rectified and the fire pump re-started.

emergency system (n) (safety) **sustav za nuždu, uređaj za slučaj opasnosti**:

Nowadays, when joining a new vessel I not only quickly make myself familiar with the operation of **emergency systems** (steering, fire pump, total smothering etc. Also, DMA demanded that independent systems for the supply of control air to **emergency systems** are established.

emergency team (n) (safety) **skupina za djelovanje u nuždi, grupa/tim za**

djelovanje u opasnosti, protuhavarijska grupa: An **emergency team** was struggling to

overcome the leak. The **emergency team** removed the casualty to the ship's hospital, where it was noticed that his blood pressure was low and he was showing signs of dizziness and... The fire alarm was activated

and speed was reduced while the **emergency team** proceeded to the location, with two crewmembers wearing breathing apparatus.

emergency transmitter /i' mɜ: dʒənsi/ **predajnik za nuždu**

emergency transmitter /i' mɜ: dʒənsi/ **predajnik za nuždu, predajnik u slučaju opasnosti**

emergency turn (n) (safety, navig) **okret u nuždi, okret u opasnosti**: With a distance of

less than one mile between our two rapidly-closing vessels, we executed an **emergency turn to starboard** with engine going full ahead. The Ferry was approximately 3 miles astern of the crossing vessel and just prior to our **emergency turn** had altered course to starboard to pass clear of own ship.

Emergency Escape Breathing Apparatus; EEBA (n) (safety) **dišno aparat za izlaz u nuždi**

Emergency Escape Breathing Device; EEBD (n) (safety, marine eng) **dišno**

aparatus za izlaz u nuždi *He donned an Emergency Escape Breathing Device (EEBD) and escaped into fresh air. The chief engineer also donned an EEBA and remained in the control room as back up.*

emission (n) (marine eng) **ispuštanje (plinova u zrak), emisija**: Staged pre-mixed combustion allows NOx emission levels to be reduced without the need for expensive selective catalytic reduction systems typically required by diesel engines to meet the CO2 emission **ispuštanje ugljičnog dioksida, NOx emission ispuštanje dušičnog monoksida**: The Bergen C26:33 gas engines reduce CO2 emissions by 25 percent and NOx emissions by up to 90 per cent.

employ /im'plɔi/ (v) **1 koristiti, iskoristiti**: Because the tie bolts are so close to the crankshaft, some engines employ jack bolts to hold the crankshaft main bearing cap in position instead of conventional studs and nuts. MAN two-stroke engines employ constant pressure turbocharging. **Employing** radar within a wind farm is not reliable; therefore, the decision by the captain not to employ the radar while transiting the wind farm was understandable.; **2 primijeniti**: Skippers and engineers employ routine checks such as checking engine and gear oil levels, inspecting bilges for unusual water levels and ensuring bilge pumps are serviceable etc.; **3 uposliti**: The vessel's size, and that she was not carrying passengers, meant there was no requirement for the master to employ a pilot for this entry.

employee /em'plɔi; ,emplɔ'i/ (n) (mar law) **zaposlenik, pomorac (u ugovoru o zaposlenju)**

employment /im'plɔimənt/ (n) **1 upotreba; 2 zaposlenje**: Hand transmitted vibration (HTV) is one of the hazards that seafarers face in the course of employment on board ships. **contract of employment ugovor o zaposlenju, ugovor o ukrcanju; 3 služba; 4 korištenje, iskorištavanje**

empty (v) **isprazniti**: The forward tanks were emptied and refilled without incident, except that the day's operations ended with an overflow.

empty (adj) **prazan empty tank prazan tank**: The Coast Guard was notified immediately of the grounding and the sounding of all empty tanks and void spaces including verification of cargo tank ullages commenced.

emulsifier (n) (seamanship, safety) **emulzivno sredstvo**: An important function of the cleaning agent is to be a good solvent for the gypsum in the sludge. It should also act as a dispersant and emulsifier

enable (v) **omogućiti**: He was confident that his "twin-screw" experience was sufficient to enable him to safely manoeuvre the ship off the berth. The additional benefit of setting an anchor watch is that it should enable the other crew to sleep soundly and obtain quality rest.

e-navigation (n) (navig) **elektronička navigacija, digitalna navigacija, e-navigacija**: Administration (NCA) has initiated the first full-scale trial of e-navigation in Norwegian waters in conjunction with e-navigation technology and services company NAVTOR. The first e-navigation test involves the ferry MS Stavangerfjord digitally sharing its routing information with NCA via NAVTOR's NavStation 'digital chart table'.

encase /in'keis/ (v) **zatvoriti u kućište, sadržati u kućištu**

ENC data (n) (navig) **podatci ENC**

ENC (Electronic Navigational Chart) /,i: en 'si:/ (n) (navig) **elektronička**

navigacijska karta: Navigation was conducted by eye and by reference to an electronic navigational chart display (ENC). None of the bridge team had been trained in the use of ENC, and the settings were inappropriate, such that key dangers would not have been displayed; **dual ENC (Electronic Navigational Chart) dvojni prikaz elektroničke karte, single ENC (Electronic**

Navigation Chart) jednokratni prikaz elektroničke karte, ENC (Electronic Navigation Chart) display prikaz na elektroničkoj karti: *Navigation was conducted by eye and by reference to an electronic navigational chart display (ENC).*

encircle (v) okružiti, zaokružiti

enclosed (adj) 1 zatvoren; 2 priložen

enclosed spaces (n) (nav arch) zatvoreni prostori (u brodu): *Tragically, accidents in enclosed/confined spaces continue to be one of the most common causes of work-related fatalities on board ships today. enclosed spaces entry ulazak u zatvorene prostore:* *Investigation findings : Enclosed Space Entry checks were not carried out. The tanks were washed, made gas free and, after enclosed space entry permits had been issued, the crew could enter for mopping., enclosed spaces lifeboat zatvorena brodica za spašavanje* *Following the broadcast of a distress call at 1125, the 26 crew abandoned the vessel in an enclosed lifeboat. While undertaking a routine maintenance check of an enclosed lifeboat an officer detected a strong odour when he opened the boat's access door.*

enclose; inclose /in'kleuz/ (v) 1 okružiti; 2 priložiti (privitak pismu, mailu); 3 ograditi, opkoliti; 4 zatvoriti

encounter /in'kauntə/ (v) susresti, naići (na): *Although neither master was on the bridge, standing/night orders were not used to alert the watchkeepers to the risks they were likely to encounter during their bridge watch. encounter boisterous weather (meteorol) naići na olujno*

nevrijeme, close encounter (navig) blizak susret: *While I wished to bear away from the flood current in mid channel, I was reluctant to put myself in a close encounter with the ship. Inevitably, this can lead to dangerous close encounters., encounter adverse weather naići na nepovoljne vremenske uvjete, naići na nevrijeme:* *The master expected to encounter adverse weather conditions on the route.*

end 1 kraj, zadnji dio, krajnji dio; 2 (nav arch, ship handling) kraj broda (pramac, krma) meet end on sresti se u protukursu, sresti se pramcem prema pramcu, forward end (seamanship) = forward end prednji dio broda pramac, after/aft end = after end = aft end stražnji dio broda, krma; 3 (marine eng) glava ojnice large / big end glava letećeg ležaja: *Connecting rod large ends are basically either of "marine" type or fixed centre design ., small end gornja glava ojnice, gornji kraj ojnice:* *It conducts oil from the big end to the small end for lubrication and to the inside of piston for its cooling., top end of connecting rod gornja glava ojnice, crankpin end glava letećeg ležaja:* *In the marine type design the rod large end, called "crankpin end", consists of a separate bearing housing (or box) divided in two parts, bolted to a foot on the rod shank ., diagonally split large / big end koso podijeljen donji kraj ojnice*

endanger /in'deɪndʒə/ (v) (safety) ugroziti: *In case of a dangerous cargo vessel even a minor misjudgement in conning the vessel or the occurrence of a breakdown of critical equipment would seriously endanger both vessels, lives on board, port facilities and the environment. Leaks from oil and fuel systems are fire hazards which endanger vessels and their crews.*

endeavour /in'devə/ (v) pokušati: *It is very rare for watchkeepers to give the name of their own vessel or to endeavour to identify the other party by name. He then saw his crewmates but, despite his best endeavours to assist them, they were beyond help.*

endeavour (n) pokušaj, nastojanje: *The foul propeller disabled the vessel and prevented further endeavours at rescue. to use the best endeavours učiniti sve, pokušati sve*

end of wire (n) (*seamanship*) kraj čeličnog užeta

end on ... (adv) **end on ... collision** (*navig*) sudar pramac u pramac: *The pilot altered course hard a starboard to avoid an end on collision, then full ahead and hard a port to clear the stern.* 1 (*navig*) pramac prema pramcu drugog broda **two vessels meeting end on ...** two ships meeting head on **dva broda koja se susreću u nasuprotnim kursovima (pramac prema pramcu)**: *I recognised my mistake in sufficient time to take appropriate action for two vessels meeting end on or nearly end on and an incident was averted, however, the incident made a lasting impression on me., passing end on ...* 1 (*ship handling*) passing on reciprocating courses **mimoilaženje na suprotnim paralelnim kursovima (pramcem prema pramcu)**: *On most occasions when they are passing, either end on or overtaking, they think nothing of trying to pass as close as 0.4 miles and ...;* 2 (*ship handling*) two vessels passing close on the bow or stern **mimoilaženje na vrlo maloj udaljenosti**; 2 (*ship handling*) pramac (krma, bok) na vrlo maloj udaljenosti od drugog broda, obale itd.; 3 (*navig*) pramcem prema, prednjim/stražnjim dijelom (broda) prema ...: *The port anchor is let go and the ship turned to port to take the beach end on.*

endorse /in'dɔ:s/ (v) (*mar law*) 1 (*mar law*) indosirati (mjenicu, teretnicu, ček itd.); 2 potvrditi (svjedodžbu), ovjeriti svjedodžbu / ovlaštenje (pomorskog časnika): *The Master in question had a full certificate issued and endorsed for STCW 95 by the MSA of a very reputable authority. The only fault he could find was that the Master's Bahamian certificate had not been endorsed for STCW 95.*; 3 pribilježiti / ovjeriti na poledini; 4 upisati opasku / bilješku (u teretnicu, časničku potvrdu); 5 ovjeriti, potvrditi: *Bills of lading should wherever possible be endorsed to show that the volume and weight measurements are not provided, ascertained or warranted by the carrier. Gdje god je moguće, teretnicu valja ovjeriti kako bi se dokazalo da prijevoznik (vozar) nije pružio ili ne jamči za podatke o količini i težinama tereta. The plan was endorsed by the second engineer and the Terminal representative.*

endorsed bill of lading (n) 1 a (*mar law*) indosirana teretnica; 2 teretnica s opaskom

endorsee /in,dɔ:'si; ,ɛndɔ:'si/ (n) (*mar law*) A party to whom an order bill of lading (supra) is endorsed by the original consignee (supra) or a previous endorsee of that same bill of lading. See Tetley naslovník (teretnice)

endorsement /in'dɔ:smənt/ (n) 1 (*mar law*) bilješka na poledini dokumenta, naleđenje; 2 (*mar law*) ovjera, potvrda: *The vessel was quite old but held valid certificates and the Load Line annual endorsement had been signed three months previously. Being on a Bahamian ship, he also had a Bahamas certificate and application had already been made for the new endorsement.*; 3 (*mar law*) prijenos prava iz teretnice po naredbi: izjava zakonitog posjednika teretnice kojom on naređuje prijevozniku da umjesto njemu teret preda drugoj osobi. Obično se upisuje na naličju teretnice (D. Pavić); the transfer of the right to obtain delivery of the goods of the carrier by means of the consignee's signature on the reverse side of a bill of lading **indosman, indosament, prijenos prava iz teretnice endorsement in blank bjanko indosament, special endorsement puni indosament**; 4 opaska / primjedba (u teretnici itd); 5 ovlaštenje pomorca, pomoračko ovlaštenje; 6 ovjera {If the name of the new consignee (transferee) is not stated, the endorsement is an open one which means that every holder of the document is entitled to obtain delivery of the goods.}

endorsement of the bill of lading (n) (*mar law*) prenošenje prava iz teretnice po naredbi ili drugih vrijednosnica s prethodnoga imatelja na novoga vlasnika **indosiranje (teretnice)**

endorsing (n) (mar law) indosiranje

ends (n) (cargo) kratki komadi drvene građe **short ends** kratki komadi drvene građe

end switch (n) (electr) krajnji prekidač, granični prekidač

endurance /inˈdjʊərəns/ (n) (marine eng) izdržljivost, autonomija: *The high-pressure fuel system was designed and endurance tested at 2000 bar; an actual injection pressure of around 1400 bar thus represents a substantial safety margin.* **endurance limit** granica izdržljivosti

energy (marine eng) energija **kinetic energy** kinetička energija: *The kinetic energy in the exhaust gas rotates the valve a small amount as it passes.*, **chemical energy** kemijska

energija, **heat energy** toplinska energija: *The temperature of the droplets rise rapidly as they absorb the heat energy from the hot air in the cylinder, and they ignite and burn before they can hit the relatively cold surface of the liner*, **mechanical energy** mehanička

energija, **thermal energy** toplinska energija: *In the internal combustion engines the energy is converted from thermal to mechanical energy.*, **convert energy** pretvoriti energiju: *The four stroke cycle is so called because it takes four strokes of the piston to complete the processes needed to convert the energy in the fuel into work.*

enforce /inˈfɔːs/ to ensure observance of or obedience to (a law, regulatio, rule, etc) **primijeniti**

(propis, zakon, pravilo), **provesti** (zakon, propis, pravilo): *Cargo interests and authorities should also oversee shipments and ensure the fitness of both cargo and vessel before loading, and proper stowage and securing and adequate stability before departure, enforcing all applicable regulations and observance of best industry practices. That they have to enforce COLREG 72 rules, particularly those related to the conduct of vessels in restricted visibility conditions (safety speed).* **enforce the law / regulation** provesti zakon / propis

enforcement /inˈfɔːsmənt/ (n) 1 (mar law) ovrha, prisilna naplata **enforcement debtor ovršenik**, **enforcement creditor ovrhovoditelj**, **law enforcement** provedba zakona, provedba prava: *The adverse effect of alcohol on performance is becoming increasingly recognised by national enforcement authorities and ship owners, with alcohol testing following an accident becoming more widespread.*; 2 ovrha na brodu

engage /inˈgeɪdʒ/ (v) 1 (marine eng) zahvatiti, ukliniti; 2 (marine eng) spojiti **engage with keys** spojiti klinovima; 3 (mar law) zaposliti se: *with effect from the date on which the Seafarer is engaged until the date on which s/he signs off*; 4 (marine eng) uključiti (stroj, kvačilo, kočnicu itd.), tal. **innestare**: *Several fruitless attempts were made to engage the brake but this was all to no avail. In the engine room, the reserve compressed air cylinder was opened but there was still insufficient air pressure to re-engage the clutches.*; 5 (shipping econ) biti u plovidbi, (o brodu) ploviti **vessel engaged in coastal trade** brod (koji plovi) u obalnoj plovidbi; 6 angažirati

engine /ˈɛndʒɪn/ (n) **compression ignition engine** motor s paljenjem na kompresiju, dizel-motor: *The diesel engine is a compression ignition engine, that is to say a type of engine in which air is compressed to a pressure sufficient to produce a high temperature ...*, **crosshead engine** motor / stroj s križnom glavom: *A two stroke crosshead engine must be supplied with air above atmospheric pressure for it to work.*, **exhaust ported engine** motor s ispušnim kanalima: *In a two-stroke exhaust ported engine, both inlet and exhaust port timings are symmetrical about bottom dead centre (BDC) and these will be identical when the engine is reversed ...*, **high-speed engine** brzohodni / brzokretni motor: *The connecting rod must be strong, yet must not be too heavy*

because of inertia forces, especially in **high speed engines.**, **in-line engine** motor s vertikalnim u liniji postavljenim cilindrima, motor u L- izvedbi. As an option for particularly difficult applications, the **in-line engine** can be specified with control of the turbocharger turbine surface by MaK's Variable Multi-Pulse (VMP) system., **large bore engine** motora cilindrima velikog promjera: Wear rates vary, but as a general rule, for a **large bore engine** a wear rate of 0.05 - 0.1mm/1000 hours is acceptable , **marine engine** brodski motor: Turbocharger is an integral part of the ship's **marine engine** as it reuses the exhaust gases in order to increase the overall efficiency of the engine., **medium-speed engine** srednjohodni / srednjokretni motor: SWD decided to develop a high-powered **medium-speed engine** t, **multi-cylinder engine** motor s više cilindara, **non-reversible engine** neprekretno motor (za vožnju u jednom smjeru): Two-piece replacement cams were introduced for **non-reversible engines** to simplify renewal., **outboard engine** izvanbrodski motor: The **outboard engine** had a maximum power rating of 225kW (300hp), and had been supplied with a mid-range 21., **reversal of the engine** preketanje motora, **preket stroja**: **Reversal of the engine** will be unnecessary if variable-pitch propellers or reversible gearboxes are used., **reversing the engine** preketanje stroja / motora , the vessel is proceeding at full speed, only when speed is considerably reduced blast of compressed air will be applied for stopping and **reversing the engine.**, **single-acting engine** jednorani motor / stroj The four Sulzer six-cylinder ST70 two-stroke **single-acting engines** (700 mm bore/990 mm stroke) developed a total of 9560 kW at 127 rev/min., **slow-speed engine** sporohodni / sporokretni motor: The **slow-speed diesel engine** rotates at this low speed and the crankshaft is thus directly coupled to the propeller shafting., **turbocharged engine** motor s turbopuhalom: In the **exhaust turbocharged engine**, the necessary scavenging is obtained by providing a satisfactory pressure difference between the air manifold and the exhaust, **trunk piston engine** klipni motor, **motor bez križne glave**: In the 2 stroke **trunk piston engine**, the side thrust caused by the angularity of the connecting rod is transmitted to the liner by the piston skirt or trunk., **unidirectional engine** istosmjerni motor: In case of a controllable pitch propeller an **unidirectional engine** is sufficient., **Vee engine, V-engine** motor u V-izvedbi, **V-motor**: The **V-engine** big ends run side-by-side on the crankpin., **prepare the engine for sea** pripremiti stroj za plovidbu, **reverse the engine** preketati motor, **mijejati smjer okretanja stroja**: To reverse the direction of the **engine**, pressure oil is led to one side of a hydraulic piston which is coupled to the camshaft. Where a controllable pitch propeller is in use there is no requirement to **reverse the main engine.**, **run the engine** upravljati strojem / motorom, **rukovati strojem**: However, when it is necessary to **run the engine in reverse** it must be started in reverse and the fuel injection timing must be changed., **slow down the engine** usporiti (stroj): This gave the engineer enough time to **slow down the engine** allowing it cool.on the port side of the bank, in which there was no traffic present at that time., **try the engine** isprobati stroj □ **Try the engine** in port on starting air only when situation external to the ship is quite safe., **speed up the engine** ubrzati stroj Whilst we were in the process of altering course to starboard, ship B made a sudden alteration of course hard to port and began to **speed up** even more, (own ship speed was 23 knots)., **turn the engine** okretati stroj: After opening the indicator cocks the Engineer should **turn the engine** through at least one complete revolution by means of the turning gear ., **warm up the engine** through zagrijavati motor, **put the engine on slow / half / full speed ahead** prebaciti stroj na polagano / pola snage / punom snagom naprijed, **auxiliary engine** pomoćni motor: The **auxiliary engine** and the engine

bilge pump were renewed., **direct-coupled engine motor s izravnim pogonom propelera motor bez reduktora, double-acting engine dvoradni motor / stroj** 9 A B&W 662-WF/40 two-stroke **double-acting engine**, first installed as a six-cylinder model in the Amerika (1929), **external combustion engine stroj s vanjskim izgaranjem, four-stroke engine četverotaktni motor**: For a four-stroke engine, the exhaust and suction strokes are shown by the horizontal line at C, and this has no effect on the cycle., **free piston engine motor sa slobodnim klipom, gasoline engine (US) benzinski motor, geared engine motor s posrednim pogonom propelera, motor s reduktorom, lifeboat engine motor brodice za spašavanje**: Even though adequate spares for the lifeboat engine and the air motor were available on board, the ship's staff was unaware of its inventory and location., **main engine glavni stroj glavni porivni stroj**: Where CPP is in use there is no requirement to reverse the main engine After reaching the planned position, we disengaged the main engine and put our AIS on 'not under command' mode., **marine propelling engine brodski pogonski stroj, opposed-piston engine motor s protuhodnim klipovima** The opposed piston two-stroke engine in service today is single-acting., **reversible engine prekretni motor / stroj** In large diesel engines, the main engines must be reversible and should be able to produce thrust efficiently in both the directions (ahead and astern). The RTA72U is a single-acting, low-speed, two-stroke reversible marine diesel engine manufactured by New Sulzer Diesel Ltd. , **two-stroke engine dvotaktni motor**: A slow-speed two-stroke diesel engine is usually arranged to operate continuously on heavy fuel and have available a diesel oil supply for manoeuvring conditions., **steam-reciprocating engine parni stapni stroj**: In the steam reciprocating engine, the up and down movement of the pistons is converted into rotary movement by piston rod and crankshaft., **unidirectional engine neprekretni stroj / motor, jednosmjerni stroj**: In case of a controllable pitch propeller an unidirectional engine is sufficient. Most medium speed engines are unidirectional. (marine eng) stroj, brodski stroj, brodski motor, pogonski stroj **engine apprentice vježbenik stroja, asistent stroja**

engine block (n) (marine eng) blok motora, tal. blocco motore: The BV design is based on a single-piece engine block cast in GGG500 nodular iron carrying two banks of cylinders in a 55° V-configuration. The engine block combines crankcase and cylinder housing in one rigid casting with an integral camshaft housing and charge air manifold.

engine book (n) (marine eng) = engine log dnevnik stroja

engine boy (n) (marine eng, mar law) mladić stroja

engine breakdown (n) (marine eng) kvar motora, havarija motora, tal. avaria del motore: An engine breakdown could occur as a result of a human error or machine failure. Following a breakdown of a ships main diesel marine engine, it is the job of the Engineering Officers to locate the fault and carry out repair as soon as possible. il pressure damaged the bottom end bearing; Evidence suggests that the lube oil pump had been running in a damaged condition for some time before the engine breakdown led to the pump's failure being discovered. **suffer engine breakdown pretrpjati havariju stroja**: Shortly after, the tanker suffered main and auxiliary engine breakdown and a full black-out in the Malacca Strait, resulting from sticking fuel pumps and clogged filters.

engine casing (n) 1 (nav arch) the walls or partitions forming trunks above the engine and boiler spaces, providing air and ventilation and enclosing the uptakes grotlo strojarnice, kućište strojarnice: This allowed boundary cooling of the engine casing to be started.; 2 (nav arch) grotlište strojarnice (na starim brodovima)

engine control (n) 1 (marine eng) uređaj za upravljanje strojem, ručka za upravljanje strojem: *The OOW woke up and, sensing something was wrong, he immediately moved the engine control to neutral, and then full astern, but the vessel grounded nonetheless.*; 2 upravljanje strojem

engine control console (n) (marine eng) upravljački pult strojarnice

engine control room; (E.C.R.) (n) (marine eng) upravljačka kabina strojarnice: *The oil mist detector has remote monitoring from the engine control room.*

engine control system (n) (marine eng) sustav upravljanja strojem: *The pilot fuel pump transmits the prevailing fuel pressure to the engine control system.*

engine damage 1 havarija stroja, kvar motora: *A 292-meter suffered "engine damage" which left the ship adrift in the Elbe River for about a half hour before tugs arrived to provide assistance.*; 2 šteta na stroju

engine data (n) (marine eng) podatci o stroju, informacije o stroju: *RTA60C engine data: Bore 600 mm; Stroke 2250 mm ... An optional Customer Communications Module translates engine data to standard ASCII code for transmission to a PC or via satellite to remote locations.*

engine department (n) (mar law) = engine-room department služba stroja: *The Officer of the watch on the Bridge must give the Engine Department at least one hours notice before Stand By for manoeuvring. I am the head of the Engine Department and am responsible for personnel and the proper operation, maintenance, and safety of the vessel's propulsion system, power generation, ...*

engine drive 1 pogon motora: *The gearing arrangement used to reduce the medium-speed engine drive down to suitable propeller revolutions .*; 2 pokretanje motorom

engineer /,ɛndʒiˈniə/ (n) engineer officer časnik stroja, strojarski časnik, engineer officer in charge dežurni časnik stroja, dežurni strojar, First Assistant engineer (US) prvi časnik stroja, prvi strojar, Junior engineer mlađi strojar, Senior engineer 1 stariji / viši strojar; 2 viši strojarski inspektor, engineer superintendent strojarski inspektor, watch engineer časnik stroja u straži, strojar u službi, watchkeeping engineer časnik stroja u straži, ovlašteni časnik stroja, 1st engineer prvi časnik stroja, 2nd engineer drugi časnik stroja, chief engineer upravitelj stroja, kapo, reefer engineer časnik stroja za rashladne uređaje, certificated engineer ovlašteni časnik stroja, osposobljen časnik stroja, licensed engineer ovlašteni časnik stroja, 3rd engineer treći časnik stroja, 1st assistant engineer (US) prvi časnik stroja, 2nd assistant engineer (US) drugi časnik stroja, 3rd assistant engineer (US) treći časnik stroja (mar law, marine eng) časnik stroja, strojarski časnik, oficir stroja, makiništa

engineering /,ɛndʒiˈniəriŋ/ (n) 1 tehnika; 2 strojarstvo marine engineering brodsko strojarstvo, brodstrojarstvo; 3 inženjerstvo

engineering cadet (n) 1 (marine eng) vježbenik stroja, asistent stroja, asistent engineering cadetship školovanje prije stjecanja zvanja časnika stroja: *The Maersk Engineering Cadet Educational Programme is a world-class training opportunity equipping you with the skills and qualifications you need to be a marine engineer.*; 2 (marine eng) asistentura

engineering material (n) 1 tehnički materijal, tehnološki materijal; 2 industrijski

materijal

engineering officer (n) (marine eng) = **marine engineer** časnik stroja,

brodstrojarski inženjer: Engineering Officers are responsible for the maintenance and operation of the ship's main propulsion machinery, deck machinery, air conditioning plants, refrigeration plants, and domestic and electrical services. Depending on the type of ship and operational circumstances, Engineer Officers will be required to keep watches in the ship's Engine Room.

engineering plant (n) postrojenje **marine engineering plant** (marine eng) **brodsko postrojenje**

engineer officer (n) (marine eng) časnik stroja, strojarski oficir:

engine failure (n) (marine eng) kvar na stroju, zakazivanje stroja, havarija motora:

The vessel command attributed the **engine failure** to a defect in the automatic control. Meanwhile, the rescue boat coxswain and assisting crew member continued to investigate **the cause of the engine failure**.

engine fittings (n) (marine eng) oprema stroja

engine foundation (n) (marine eng) temelj stroja: The bedplate is mounted on chocks and is securely bolted to the **engine foundation plate** on which it sits and which forms part of the structure of the hull. These forces, if not in themselves necessarily damaging, create objectionable vibration and noise in the **engine foundations**, and through them to the ship (or building) in which the engine is operating.

engine frame (n) (marine eng) stalak motora, okvir motora: The camshafts are mounted in bearing bushes fitted in bores in the **engine frame**. Lubricating oil for the main bearings is supplied through holes drilled in the **engine frame**.

engine housing (n) (marine eng) kućište motora: The crankshaft damper is mounted outside the **engine housing** for optimum cooling and accessibility; bolted covers and replaceable nylon bearings permit rebuilding of the damper on site.

engine indicator (n) (marine eng) The Engine Indicator is used to record the cylinder pressure of an engine and piston travel in an X - Y graph, where pressure forms the vertical axis and piston travel forms the horizontal axis **pokazivač indicirane snage stroja, indikator motora**:

Engine indicator is the device used to take the indicator diagram, which can be considered as a 'stethoscope' for diesel engines. **engine indicator diagram** dijagram indikatora motora, **engine indicator**

cock pipac indikatora motora: This involved the fuel being shut off, the main **engine indicator cocks** being left open, the turning gear being disengaged, the air receiver valves and main air start valve being shut, ...

engine inlet (n) (boating/yachting, marine eng) dovod za motor, usis rashladne vode za

motor: Approximately two-thirds of the flow pass through a HT circuit and returns directly to the **engine inlet**, while the remainder is fed into a thermostatically controlled LT circuit. From the **main engine inlet rail** the fuel enters each fuel pump (one per cylinder). The air is cooled before passing to the **engine inlet manifold** or scavenge air receiver.

engine load (n) (marine eng) opterećenje motora, opterećenje stroja: Pulsating compressor noise, typically registered at around 30–50 per cent **engine load**, can be an issue due to today's higher power outputs. The maximum efficiency measured at near-70 per cent **engine load** was around 69 per cent.

engine log (n) (marine eng) dnevnik stroja: Any such loss of water must be recorded in the **Engine Log Book** and reported to the Chief Engineer. The chief engineer will examine the **Engine Log** when he has time. **engine logbook** 1 dnevnik stroja; 2 **engine log abstract** izvod iz dnevnika stroja

engine maintenance (n) (marine eng, boating/yachting) održavanje stroja, održavanje

motora: *A planned lifeboat drill was carried out on a coastal tanker while she was alongside in port for engine maintenance.*

engine manufacturer (n) (marine eng) **proizvođač motora:** *By working with a prospective operator, the engine manufacturer is then able to make an accurate assessment of the maintenance costs. The ship remained at the anchorage as the main engine manufacturers were arranged to attend the vessel to repair the air start valve.*

engine operation (n) (marine eng) **rad motora, rad stroja, upravljanje strojem, rukovanje strojem:** *The resulting flexibility allows engine operation to be adjusted and optimized for fuel economy or low NOx emissions.*

engine orders (n) (marine eng) **zapovijedi stroju, tal. ordini andatura macchine:** *Any engine order given should be repeated by the person operating the bridge telegraph(s) and the officer of the watch should ensure the order is ca At 1015, the transfer of stores was completed and an engine order of 80 rpm was executed. **standard engine orders standardne naredbe za upravljanje strojem, Full ahead / astern! Svom snagom naprijed / krmom!, Half ahead / stern! S pola snage naprijed / krmom!, Slow ahead / astern! Lagano naprijed / krmom!, Dead slow ahead / astern! Sasvim lagano naprijed / krmom!, Stop port / starboard engine! Zaustavite lijevi / desni stroj!, Emergency full ahead! Hitno punom snagom naprijed / krmom!, Stand by engine! Pozor u stroju!, Finished with engine(s)! - No more manoeuvring! Svršeno u stroju - Završeno s manevriranjem!, Bow thruster full / half / to port / starboard! Pramčani porivnik svom snagom / pola snage lijevo / desno!, Stern thruster full / half / to port / starboard! Krmeni porivnik svom snagom / pola snage lijevo / desno!***

engine order telegraph (n) (marine eng) **strojarski telegraf** 1 Stand by with engine/s!, 2 Start engines!, 3 Dead slow ahead!, 4 Slow ahead!, 5 Half ahead!, 6 Full ahead!, 7 Dead slow astern!, 8 Half astern!, 9 Full astern!, 10 Finished with engine - no more manoeuvring!

engine output (n) (marine eng) **snaga motora:** *For engine outputs of up to 8000 kW, only one turbocharger is used.*

engine performance (n) (marine eng) **radne karakteristike, performanse stroja, radni učin stroja:** *The controllable injection timing (CIT) pumps also ensure that engine performance is improved at the service load. The computer-controlled fuel injection system opens up possibilities to optimize engine performance, thanks to the freedom to choose key parameters: injection timing, injection pressure independent of engine speed, maximum injection quantity ...*

engine power (n) (marine eng) **snaga motora, snaga stroja:** *Using full rudder and engine power, and transmitting appropriate signals on the air horn and VHF radio, the master just managed to turn the ship's head into the wind and... An engine power range from 20 000 kW to 28 000 kW per turbocharger is covered by the TPL-91B.*

engine problems (navig) **problemi sa strojem, poteškoće sa strojem:** *the ship was having some engine problems and drifted midstream in a strong breeze brod je imao problema sa strojem i otpadao (plutao) u jakoj struji po sredini kanala i pri jakom vjetru On boarding, it was discovered that the loaded vessel had engine problems and the Master had ordered spares which would arrive the following morning. After several days at sea a serious engine problem occurred in number 7 cylinder.*

engine readiness (n) (navig) **spremnost stroja za pokretanje / manovru state of engine readiness stanje spremnosti stroja za manovru, stupanj spremnosti stroja**

za manovru

engine ready for immediate manoeuvre (n) (navig) **stroj spreman za**

neposrednu manovru: *Own ship quite rightly in my opinion had her engine ready for manoeuvre, but, does not appear to have had any intention to use it.*

engine repairs (n) (marine eng) **popravci na stroju**: *My technical department at the time was fully engaged in carrying out a major engine repair ... The sea conditions were slight and the vessel continued to drift in a southeasterly direction towards the Moroccan coast while engine repair work continued.*

engine revolution (n) (marine eng) **broj okretaja stroja**: *About 10 minutes afterwards, the main engine revolutions dropped from 1400 rpm to about 1100 rpm.*

engine room access (n) (nav arch, marine eng) **prilaz strojarnici**: *At 1450, the engine room alarm panel repeater sounded in his cabin, so he immediately ran the short distance to the engine room access where the panel was situated.*

engine room alarm (n) (marine eng, safety) **alarm u strojarnici**: *As the lift was being prepared, the engine room alarm sounded.*

engine room bilges (n) (nav arch) **kaljuže strojarnice**: *The duty engineer opened the overboard valve to prevent the system from potentially overflowing into the engine room bilges.*

engine room bulkhead (n) (nav arch) **pregrada strojarnice**: *Smoke was filtering through the engine room bulkhead and filling the wheelhouse, making it impossible to use the main VHF radio set.*

engine-room cadet (n) (marine eng) **vježbenik stroja, asistent stroja**

engine-room casing grotlo strojarnice: *On leaving his office, he saw flames rising from the stairwell around the engine room casing.*

engineroom component (n) (marine eng) **sastavni dio strojarnice**

engine room CO2 system (n) (marine eng, safety) **sustav za gašenje strojarnice**

ugljičnim dioksodom: *The master decided it would be necessary to operate the engine room CO2 system to extinguish the fire.*

engine room crew (n) **1** (marine eng) **posada stroja**: *Whilst the other engineer officers were engaged on various jobs, one of the engine room crew was cleaning the lube oil filters.; 2 (marine eng)*

član posade stroja: *An engine room crew attempted to call the bridge, but received no response. An exhausted engine room crew once again opened, cleaned and boxed up the sea suction (again filled with tiny fish) and the ship sailed from the terminal without any delay,*

engine-room department (n) (marine eng) **služba stroja**: *The Engine Department onboard a merchant ship is responsible for all maintenance and repairs of engines, electric motors, pumps, winches and other mechanical and electrical equipment. Job positions, on board a (US / Croatian, etc.) ship, within this department include Chief Engineer, 2nd, 3rd and 4th Engineer, Trainee Engineer, Chief Mechanic, Mechanic, Fitter, Oiler, Wiper and Engine Utility Man. Engine-Room Department - The modern ship's propulsive unit, whether steam turbine or diesel engine, is run on oil, and the engine-room department is composed of a team of engineer officers and ratings controlled by the chief engineer, who ranks after the master. The modern ship's propulsive unit, whether steam turbine or diesel engine, is run on oil, and the engine-room department is composed of a team of engineer officers and ratings controlled by the chief engineer, who ranks after the master.*

engine room door (n) (nav arch, marine eng) **vrata strojarnice**: *He shut the engine room door, informed the master of the fire and recommended that both main engines be shut down. It was initially assumed that the smoke was coming from the open engine room door. He shut the engine room door, informed the master of the fire and recommended that both main engines be shut down.*

engine room double bottom tank dvodno u strojarnici

engine room; engine-room; engineroom (n) 1 (marine eng) = **machinery**

room = machinery strojarnica, brodska strojarnica: *The duty engineer entered the engine room at 06:50 to man the engine room. The chief engineer entered the engine room at the upper level, without BA, to guide the fire brigade.*; 2 (marine eng) strojarnica, tal. sala macchine; locale motore {tal.: sala macchine}

engine room escape hatch (n) (nav arch, safety) grotlo strojarnice za izlaz u nuždi

The engine room escape hatch was locked from the outside. Assuming this was an Engine Room escape hatch then it would be best secured from the inside, thus allowing those attempting to get out to achieve their escape.

engine room fan (n) ventilator u strojarnici: *Conscious of the need to isolate the oxygen supply, and potential fuel supply to the fire, he blocked the engine room ventilators, and shut down the engine room fans, main engine and generator.*

engineroom fire (n) (safety, marine eng) požar u strojarnici: *The fuel is supplied to the injectors through drillings in the cylinder head, dispensing with high-pressure fuel lines and removing a potential cause of engineroom fire. By now the crew, who had regularly exercised fighting an engine room fire, had blocked off the engine room vents, carried out boundary cooling on the deck using the hand-operated deckwash pump, and ...*

engine room hatch (n) (nav arch, marine eng) grotlo strojarnice: *Back in the wheelhouse, the skipper closed the engine room hatch and instructed the crew to haul in the fishing gear and don their lifejackets. The engine room hatch was opened, and a hose was discharged into the engine room. The engine room hatch was opened, and a hose was discharged into the engine room.*

engine room log book (n) (marine eng) dnevnik stroja: *Marine engineers are required to keep a log of all important machinery parameters such as pressure, temperatures, revolutions etc. in the engine room log book.*

engine-room personnel (n) (marine eng): *Engine-room personnel is fully ready to manoeuvre and bridge manned to relay engine orders.*

engine-room rating (n) (marine eng) mornar stroja, član nižeg osoblja stroja

engineroom space (n) prostor strojarnice: *If engineroom space allows, the complete cylinder unit (cylinder head, water collar, liner, piston and connecting rod) can be withdrawn as a single assembly.*

engineroom staff (n) (marine eng) osoblje strojarnice, personal stroja: *Two of the engine room staff remained in the engine room and two went to the vehicle deck. The second engineer distributed the day's work to the engine room staff, verbally instructing the junior wiper to burn the garbage in the incinerator.*

engineroom telegraph (n) (marine eng) veza između zapovjedničkog mosta i strojarnice za upravljanje strojem; A mechanical signaling device for communicating propulsion orders and acknowledgements between the bridge and the engine room.

(<http://www.seatalk.info/cgi-bin/nautical-marine-sailing-dictionary>) strojarski telegraf, telegraf za stroj

engine room vent (n) (nav arch, marine eng) zračnik u strojarnici, ventilacijski otvor u strojarnici: *..., the tug master and chief engineer went back on board and "cracked" open the engine room vents before returning to the rescue vessel.*

engine skylight (n) (nav arch) vidnik strojarnice: *I sent my watchman to close the engine room skylight and inform the crew of the rain.*

engine spares (n) (boating/yachting, marine eng) pričuvni dijelovi motora **spark plugs** svjeće (benzinski motor), **injector** ubrizgač (dizelski motor), **repair kit for fuel and water pumps with seals and impellers** komplet za popravak pumpe goriva i pumpe rashladne vode s brtvama i impelerima, **set of hoses** komplet gumenih cijevi, **oil filters** fltri ulja, **fuel filters** filtri goriva, **set of gaskets, seals, and O-rings** komplet brtava i brtvenih prstena, **fuel** gorivo, **oil and grease** ulje i mast za podmazivanje, **fuel antibacterial additives** antibakterijski aditivi za gorivo, **spare ignition key** rezervni ključ za paljenje motora

engine speed (n) (marine eng) broj okretaja / obrtaja motora, **brzina stroja**: *Engine speed is controlled by a mechanical or electronic governor with hydraulic actuator. The 'heart' of the system was a microprocessor to which the actual engine speed and crankshaft position were transmitted as output signals. Full load can be accepted swiftly and smoothly at any engine speed, says EMD, and a 10 per cent overload capability can be exploited for two out of every 24 h of running. A reduction in engine speed compared with the BL550 limited the mean piston speed and yielded the increased output with virtually the same brake mean effective pressure. Although a late order to increase engine speed and helm was given, the vessel made contact with the buoy.*

engine stores (n) 1 (nav arch) spremište strojarnice; 2 (marine eng) zalihe i materijali za strojarnicu

engine switch (n) (marine eng, boating/yachting) prekidač motora (za dovod i zatvaranje goriva na izvanbrodskom motoru)

engine telegraph (marine eng) strojarski telegraf: *At 2340, the master moved the engine telegraph from 'dead slow ahead' to 'slow ahead'; the tanker's speed was about 2kts and it remained on an easterly heading. A load programme led to a delay between the setting of the engine telegraph and the engine achieving the speed intended. The Master was quickly on the bridge and moved the engine telegraph to stop. If the engine telegraph printer for some reason does not function, movements shall be recorded manually, in this case in the Bridge and Engine Bell Books.*

engine trials (n) (marine eng) strojarske probne vožnje, strojarske pokusne vožnje: *it would have been prudent to retain at least one escorting tug; 2 The outward pilot was apparently unaware that the vessel was intending to conduct engine trials off port limits (OPL) and was scheduled to return and anchor in the waiting area;*

engine utility man (n) (marine eng, mar law) a rating who provides assistance in various duties within the engine room, such as maintenance and minor repair tasks. **mornar stroja**

English law (n) (mar law) All law applicable in England. The major sources of English law are: 1) the common law of England; 2) the rules of equity; and 3) statutes and regulations of the United Kingdom applicable to England. Other sources of English law include English admiralty (i.e. maritime) law, the Law Merchant, the ecclesiastical law (of the Church of England) and custom **pravo Ujedinjenog Kraljevstva, englesko pravo (izvori/vrela engleskog prava)**

enlarge /in'la:dʒ/ (v) povećati, proširiti

enlist /in'list/ (v) upisati se, prijaviti se, pristupiti {o posadi broda}

enrol; (US) enroll /in'rɒl/ (v) upisati se, prijaviti se, pristupiti {o posadi broda}

en route (prep phr) (navig) na putu za: *The MV was transiting the Indian Ocean en route to Fremantle, Western Australia on March 1, 2014 when its freefall lifeboat was inadvertently released during a routine inspection. A tug is en-route to assist your vessel.*

ensign /'ɛnsain/ (n) 1 (mar law) a flag flown by a ship, branch of the armed forces, etc, to indicate nationality, allegiance; ship's national flag **zastava, zastava pripadnosti, nacionalna**

zastava broda **red ensign** zastava britanske trgovačke mornarice, **national ensign**
 zastava državne pripadnosti broda; **2 (navy)** the entry level rank of a young naval officer
 mlađi časnik, zastavnik (ratne mornarice)

ensue /in'sju:/ (v) **uslijediti, nastati nakon nečeg**: *As a result, the salvage pump quickly emptied the foc'sle space and air locked, allowing uncontrolled flooding to ensue.*

ensure (UK;); (US) insure /ɛn'ʃʊː; ɛn'ʃʊə/ (v) **1 omogućiti**: *All these features ensure a free choice of the most appropriate bearing material. Never leave the wheelhouse unattended, and always monitor alterations of course to ensure the vessel turns as expected.; 2 provjeriti, utvrditi*: *The two owners visited the vessel during the day to ensure that the auxiliary engine was running.; 3 (mar ins) osigurati*

entablature The entablature is the name given to the cylinder block which incorporates the scavenge air space and the cooling water spaces. **gornji dio (stalka) motora**: *The entablature forms the air receiver from which the cylinders are supplied with air, ... The cylinders are secured to the entablature by means of a flange on the jacket passing over studs and secured with nuts.*

entangled (adj) (seamanship) = fouled zapleten (uže, lanac, mornar): *The free end of the messenger line then became entangled in 'riding turns', causing it to be heaved back into the warping drum with the part under tension. Out on deck the skipper became entangled in the back rope, possibly as a result of being unbalanced by the heavy rolling, and he was dragged overboard. In an attempt to prevent injury he jumped into the water as he was being pulled towards the deck edge, but his leg remained entangled in the rope.*

entail (v) podrazumijevati, povlačiti za sobo, uključivati

entangle (n) (seamanship) zaplesti (se), zapetljati (se), zakvačiti, zahvatiti: *The vessel came rapidly on port and got out of the buoyed fairway and entangled the buoy chain with her screw.*

enter /'ɛntə/ (v) **enter inwards (mar law) prijaviti dolazak broda (carinskim i lučkim vlastima), enter outwards prijaviti odlazak broda (carinskim i lučkim vlastima) 1 prodrijeti, prodirati (o vodi, moru)**: *Sea water also entered the engine room.; 2 unijeti (podatak)*: *If the cargo is discharged in a different condition, or in a lesser quantity, than that entered on the B/L, the shipowners may be held liable for the damage or shortfall.; 3 unijeti u dnevnik / zapisnik; 4 ući u luku: the accident occurred while the ro-ro vessel was entering the lock; 5 ući*

enter a ship to clear customs and perform other administrative duties upon arrival at a foreign port before allowing passengers or crew to go ashore

(<http://www.seatalk.info/cgi-bin/nautical-marine-sailing-dictionary>) **prijaviti dolazak brod lučkim vlastima**

entered goods (mar law) prijavljena roba / teret

enter key (ENT) (n) (comm) tipka za izvršenje (na VHF uređaju)

enter the port; enter the harbour (v) (navig) ući u luku, uploviti u luku: *The vessel entered the port with a Pilot on board but the Pilot could not read the draft outside the harbour as the sea was rough. As the vessel entered the harbour, the mooring teams closed up and made ready to come alongside starboard side to.*

entitle (v) 1 (mar law) ovlastiti be entitled to biti ovlašten, imati pravo na: *I turned 45-60 degrees to port, allowing other vessel to maintain current heading so she would notice my alteration and see that she could stand on as she was entitled to do.; 2 nasloviti (knjigu, članak), nazvati*: *Another incident in this Digest caught my eye, described in the article entitled Important Fire- Fighting*

Tool Overlooked; the equipment that apparently was not used was the water fog.

entitled (adj) (mar law) **ovlašten, koji ima pravo na person entitled to the goods** 1 **osoba koja ima pravo na robu, osoba ovlaštena da primi robu**; 2: *An Employee, in accordance with Article 1 above, shall be entitled to the wages and other benefits of this Agreement U skladu s gornjim člankom 1 Pomorac/zaposlenik ima pravo na zaradu (plaću) i ostale naknade (beneficije) iz ovog ugovora*

entrance (n) (navig, ports) 1 **pristup**; 2 **ulaz port entrance** a passage which allows safe access to a harbour **ulaz u luku**: *A pilot boarded a fully loaded product tanker as it approached the port entrance.*, **access entrance ulaz za uplovljenje (u luku), width of entrance širina ulaza u luku, depth at entrance dubina mora na ulazu u luku**

entry 1 (mar law) **bilješka (u dnevniku, upisniku brodova itd.) zapis (u dnevniku, upisniku brodova itd.)**: *It is wise to put a position on the chart or make an entry in the log book when there are other vessels or hazards in close proximity. He also has to make entry in the Radio Log with timings, so he will use a small source of light and lose his night vision for a few minutes every time he uses a light. make an entry in the logbook unijeti zabilješku u brodski dnevnik*; 2 (mar law) **prijava entry form obrazac prijave**; 3 (navig, ports) **ulaz (u luku)**: *After boarding a 2000gt dry cargo ship, a harbour pilot discussed with the vessel's master his plan for the vessel's first entry to the port, which was accessed from the open sea via a 30m wide river. entry to the Rijeka Bay ulaz u Riječki zaljev*; 4 **unos (podatka)**; 5 (nav arch) **ulaz**: *The enclosed space was safe for entry, having been visited only 30 minutes earlier by the inspection team. Thus, an entry into the tank was not necessary for making the tank dry before tank inspection.*

entry (n) (mar law) **upis broda re-entry of a ship ponovni upis broda, entry of a ship upis broda (u upisnik brodova), first entry into the register of ships prvi upis u upisnik brodova, entry into a registry / register of ships upis u upisnik brodova**: *the mere submission of an application does not ensure that a vessel will be accepted for entry into the registry or flag.*, **eligibility for entry on to the register pravo prijave za upis u registar borodova**: *Eligibility for entry on to the AISR (Australian International Shipping Register) is that ships are at least 24 metres in tonnage length and ...* <https://www.amsa.gov.au/vessels/shipping-registration/>

enumerate /i'nju:mə, reit/ (v) **nabrojiti, specificirati**

envelope (n) 1 **omotnica, kuverta**; 2 (electr) **ovojnica signal envelope ovojnica signala**

environment /in'vairənmənt/ (n) **protection of the environment zaštita okoliša okoliš affect the environment utjecati na okoliš (negativno), marine environment morski okoliš**: *Specialized coatings are applied where necessary for protection against the marine environment. The vessel was left in the lurch with crew on board and as a potential danger to safety of lives as well as marine environment as she had lost one anchor in a storm when anchored. This demonstrates the susceptibility of exposed engines/fuel tanks in a harsh marine environment, highlighting the requirement for extra diligence by operators in respect of maintenance and inspection.*

environmental award (n) (environ) (mar ins) **nagrada za ekološko spašavanje, ekološka nagrada**

environmental awareness (n) (environ) **svijest o skrbi za okoliš, svijest o zaštiti okoliša**: *First of all we would like to complement the ship's staff, especially the Chief Engineer and the Master for their safety and environmental awareness.*

environmental conditions (n) (environ) **ekološki uvjeti**: *Environmental conditions at the time were good; there was hardly any swell or wind.*

environmental damage (*environ, safety, mar ins*) **ekološka šteta**: While many believe that the bulk of this **environmental damage** is done by major spills, such as the Exxon Valdez or the Deepwater Horizon events, in reality, every spill matters. No **environmental damage** was reported / sustained.

environmental harm (*n*) (*mar ins, safety, environ*) **šteta zbog onečišćenja**

environmental impact (*n*) (*environ*) **utjecaj na okoliš**: There is growing concern regarding the **environmental impact** and associated costs of petroleum based fluid discharges. Oil pollution response plans and drills are not frequently required to be used in anger, but when an incident does occur their value is immense and can significantly reduce the **environmental impact** of a spill.

environmental impact statement **izvješće o utjecaju na okoliš**

environmentally-friendly (*adj*) **u skladu s okolišem, ekološki prolagođen**: The ships represent a new generation of **environmentally friendly** ro-ro ships as they comply with the latest environmental rules of the new IMO-standard EEDI (Energy Efficiency Design Index),”

environmental pollution (*n*) **onečišćenje okoliša**: The vessel grounded in a violent storm, without injuries or loss of life but causing **environmental pollution** to the sea and coastal areas.

environmental salvage (*n*) (*mar ins*) = **environmental award** **ekološka nagrada, nagrada za ekološko spašavanje**

environmental status (*n*) (*safety*) **ekološko stanje morskog okoliša** **good**

environmental status **dobro ekološko stanje morskog okoliša**

EPFS: Electronic Positioning Fixing System (*n*) (*navig*) **sustav za elektroničko određivanje položaja**

ephemerides /ˌɛfɪˈmɛrɪˌdiːz/ (*n*) (*navig*) an annual publication giving the positions of the sun, moon, and planets during the course of a year, information concerning eclipses, astronomical constants, etc **efemeride** {*sg. ephemeris*}

ephemeris /iˈfɛmərɪs/ (*n*) (*navig*) table of the positions of celestial bodies at regular intervals, often with supplementary information. **efemerida**: In the USA, an official (and initially separate) series of ephemeris publications began with the issue for 1855 as The American **Ephemeris** and Nautical Almanac {*pl. ephemerides*}

epicontinental sea (*n*) (*mar law*) **SEE continental shelf** That portion of the sea lying upon the continental shelf, and the portions which extend into the interior of the continent with similar shallow depths. Also known as epeiric sea; inland sea.

(<http://encyclopedia2.thefreedictionary.com/epicontinental+sea>) **epikontinentalno more**

EPIRB; emergency position indicating radiobeacon /ˈiː pəːb/ (*safety, navig*) a radio transmitter that emits a distinctive distress signal to aircraft and satellite receivers supplying an exact position for search and rescue missions

(<http://www.seatalk.info/cgi-bin/nautical-marine-sailing-dictionary>) **radio plutača za**

označavanje pozicije u slučaju opasnosti ili potonuća, epirb: The **EPIRB** alerted the coastguard and enabled the recovery to be initiated. No matter where you are in the world, an **EPIRB** sends a signal to emergency responders through a satellite system called Cospas-Sarsat. An **EPIRB** is used to alert search and rescue services in the event of an emergency. It does this by transmitting a coded message on the 406MHz distress frequency. The owner also provided an **EPIRB** and one of the crew



had a personal locator beacon.

epoxy /i'pɒksi/ (n) (nav arch) a polymer resin used for coatings and adhesives **epoksidna smola, epoksi-smola**: After approximately two hours of painting, using a spray gun to apply **epoxy paint** with thinners, there was an explosion which blew the tank apart.

epoxy filling (n) (boating/yachting) **epoksi kit**

epoxy resin /i'pɒksi ,rɛzin/ (n) (nav arch) **epoksidna smola, epoksi-smola**: After alignment of the bedplate, **epoxy resin** chocking material is poured around the sleeves.

equation /i'kweɪʒən ; i'kwefən/ (n) (math) **jednadžba**

equator /i'kweɪtə/ (n) (geogr) **ekvator**: AREA VIII NORTH OF EQUATOR PART-I: NO STORM WARNING PART-II: THE LOPAR OVER NW BAY AND ...

equatorial trough (n) (meteorol) **ekvatorijalno područje zatišja**

equinox /'i:kwɪ ,nɒks ; 'ɛkwɪ ,nɒks/ (n) (navig) The day, twice each year, when the sun is perpendicular to the earth's equator, causing day or night to be exactly 12 hours anywhere on the earth.

(<http://www.seatalk.info/cgi-bin/nautical-marine-sailing-dictionary>) **ekvinocij**

equip (v) **1 opremiti; 2 snabdjeti**

equipment (n) **fire-fighting equipment** **protupožarna prema**: The port operator must inspect the work site and issue the required work permits after ensuring that there is no combustible material in the vicinity, **fire fighting equipment** is readily available and a fire watch is being maintained.

The main **portable means of fire fighting equipment** are the different types of hand held extinguishers.,

safety equipment **sigurnosna oprema, zaštitna oprema**: During **fire safety equipment verifications**, the fixed CO2 cargo hold line identified as number five hold was tested by blowing compressed air into the system line. Seafarers should always **wear safety equipment** where appropriate, and be alert for any hazards caused by the presence of oil, grease or water on deck. The emergency generator is a vital part of ship's **safety equipment** and it is the most vulnerable engine onboard.,

cargo handling equipment **oprema za rukovanje teretom, mehanizacija**: **Cargo handling equipment** will be arranged on deck and there will be large hatch openings closed with steel hatch covers.,

mooring equipment **uređaj za privezivanje broda**: Lessons learned The limitations of the vessel's **anchor and mooring equipment** are of paramount importance.,

anchoring equipment **uređaj za sidrenje**: It must be remembered that **anchoring equipment** is designed and manufactured only for mooring a vessel in moderate sea conditions, and for relatively short periods,

..., **ancillary equipment** **pomoćna oprema**: Attention was also paid to the weight of the **ancillary equipment** serving the engine. **dodatna oprema, electrical equipment** **električni uređaji**: We urge all our vessels to check areas with switchboards and **electrical equipment** and ensure that CO2 extinguishers are placed in these areas.,

bridge equipment **oprema navigacijskog mosta**: Prior to weighing anchor, the master had **completed the bridge equipment checklist** in the deck

logbook, with no defects noted., **cargo equipment** uređaj za rukovanje teretom: Investigations revealed that several pieces of the vessel's **cargo equipment**, some navigation equipment, and the watch alarm were defective., **emergency equipment** oprema za slučaj opasnosti, oprema za nužnu uporabu, **lifting equipment** uređaji za ukrcaj i iskrcaj tereta, **vertikalna lučka mehanizacija** *Lifting equipment should always be in date for survey or test before it is used.*, **life-saving equipment** oprema za spašavanje života: This incident involved the vessel's rescue boat, a key item of **life-saving equipment** which must be ready for deployment at any time (SOLAS Chapter III – Life Saving Appliances - , **control equipment** upravljački uređaj uređaj za upravljanje: All **control equipment** and alarms should be examined for correct operation., **fuel injection equipment** uređaj za ubrizgavanje goriva: The combination of an ineffective oil mist detector, poorly adjusted **fuel injection equipment** and an unknown maintenance history meant that this was an accident waiting to happen., **lashing equipment**: A part of the **lashing equipment** fell and injured a stevedore. **oprema za vezivanje tereta, navigation equipment** navigacijski uređaji, **navigacijska oprema** The captain was relying solely on the turbine safety lights and didn't make good use of the lookout and **navigation equipment** on board., **navigational equipment** navigacijski uređaji, **navigacijska oprema**: The safety investigation concluded that bridge **navigational equipment**, in particular the ECDIS, was not utilised to its full potential., **protective equipment** zaštitna oprema, uređaji za zaštitu: The crew should wear appropriate **protective equipment** and clothing when on mooring stations., **personal protective equipment; PPE** osobna zaštitna oprema, oprema za osobnu zaštitu: Both were properly fitted with appropriate **personal protective equipment (PPE)**, including approved full body harnesses and fall arrest equipment., **release equipment** uređaj za otpuštanje (kuke), **otpusna naprava**: Fortunately the Lifeboat Onload **Release equipment** manual was clear, complete and satisfied the requirements of SOLAS for onboard instructions of maintenance., **rescue equipment** spasavalačka oprema, oprema za spašavanje: The company had not considered the need to provide any **rescue equipment** such as harnesses, lifelines or lifting equipment or other appropriate emergency arrangements., **survival equipment** oprema za preživljavanje: However, the level of **survival equipment** within the raft came as a surprise to them as they were expecting more. (**nav arch, marine eng, safety, cargo handling**) oprema (broda), **tal. equipaggiamento**, uređaj (npr. za sidrenje, privezivanje, navigacijski itd.): All available **equipment** should be used by the OOW, whether be it ARPA, AIS or anti-collision alarms (COLREG rule 7 -Risk of collision).

equipped with (adj) opremljen s, koji sadrži / ima: The tanker was **equipped with** ground stabilised radar, log and GPS, all of which indicated that she was making sternway. The vessel was **equipped with** a bow thrust unit, rated at 20t, to assist with berthing manoeuvres. Each vessel was **equipped with** azimuth stern thrusters and a bow thruster, but the bow thruster fitted to OSV1, which was the easterly of the two vessels, was defective. Both TCA and TCR series turbochargers are available optionally with VTA technology, whereby a nozzle ring **equipped with** adjustable vanes replaces the fixed vane ring used in the standard turbochargers.

equity (n) (mar law) A principle of fundamental fairness and justice applied by admiralty courts and arbitrators in maritime disputes where the circumstances of the case warrant doing so (e.g. altering the normal order of ranking of maritime claims **načelo poštenosti**)

equity (n) 1 (financ) Any right to an asset or property, held by a creditor, proprietor, or stockholder (shareholder). **kapital**; 2 (financ, shipping econ) On a balance sheet, equity represents funds contributed by the owners (stockholders) plus retained earnings or minus the accumulated losses.

(<http://www.businessdictionary.com/definition/equity.html>); Net worth of a person or company computed by subtracting total liabilities from the total assets. In case of cooperatives, equity represents members' investment plus retained earnings or minus losses.

(<http://www.businessdictionary.com/definition/equity.html>) **vlasnički kapital (EuroTerm)**: *The Norwegian operator attracts private equity. Norveški brodar privlači privatni vlasnički kapital (radi kupnje brodova). Private equity firm pays \$7.29bn to privatise Melbourne port. QIC Private Capital has beaten out plenty of competition to buy the Port of Melbourne, paying A\$9.7bn (\$7.29bn) to take the port private via a 50-year lease. Splash24/7 <splash=asiashippingmedia.com@mail244.atl21.rsgsv.net>; 3*

(shipping econ) temeljni kapital, osnivački kapital

ERM; electronic range marker (n) (navig) an electronic means of measuring the radar bearing of a target with a rotating radial line on the radar screen **elektronički daljinomjer**: *The ship's position was monitored by GPS waypoint navigation and the helmsman maintained a distance of 1.5 to 2 miles off the coast using the radar electronic range marker.*

erosion /i'ərəʒən/ (n) (marine eng) **erozija**: *Look carefully for any signs of erosion damage.*

erosion-resistant otporan na eroziju

error (n) (safety) **human error ljudska grješka, ljudski faktor**: *Human error accounts for the majority of accidents. the fault performed without intention, purpose or desire; errors may be based on skills, decision and perception of errors. grješka, greška: Effective bridge resource management should eliminate the risk that an error on the part of one person could result in a dangerous situation. compass error grješka kompas: Magnetic compass error is se / gyro compass course / magnetic compass course is ... degrees. Gyro compass error is ... degrees plus / minus.*

, error of the sextant grješka sikstanta, assess an error utvrđivanje

pogreške, plot an error ucrtati grešku, mean error srednja pogreška, gross

navigational error gruba navigacijska pogreška, gruba pogreška, systemic error

sistemska pogreška, navigational error navigacijska pogreška pogreška položaja

broda; accidental error slučajna pogreška, square error kvadratna pogreška

mean error srednja kvadratna pogreška, vector error vektorska pogreška,

navigational error navigacijska pogreška, repeatable error grješka ponavljanja,

yaw error grješka određivanja radarskog azimuta zbog zaošijavanja

error correction unit (n) (navig) **korektor grešaka**

escape (v) (safety) **1 izbjeći, pobjeći**: *The third engineer was fortunate to escape serious injury. Crew members gathered to fight the fire while the Chief Navigating Officer rang the Master from his cabin to seek advice on how to escape the fire. He was advised to escape through the starboard aft accommodation door.; 2 izaći: Floodwater was trapped in the shelter, and the vessel capsized before the water could escape through the freeing ports.; 3 istjeći: This had allowed heated fuel and vapour to escape where it was ignited, probably by the engine's hot exhaust manifold.; 4 propustiti*

escape (n) (safety) **1 izlaz emergency escape izlaz u slučaju opasnosti, escape hatch otvor za izlaz u nuždi, grotlo za izlaz u opasnosti**: *Without stating his intentions, he entered the lift car, climbed through the escape hatch on the top, and shut the hatch behind him. The skipper took an extinguisher from the wheelhouse and operated it through the emergency escape hatch., escape route put za izlaz u nuždi / opasnosti*

All passengers are requested to follow the escape routes shown.; 2 curenje, istjecanje: *This led to undue pressurising of cargo lines for all cargo tanks loaded with MTBE cargo and No 1 stbd tank filling up causing escape of cargo onto the deck through the PV Valve. This may result in an explosion if a flammable phosphine:gas:air mixture ignites*

spontaneously, accompanied by the continuing escape of toxic phosphine gas.; 3 propuštanje; 4 bijeg narrow **escape** izbjeći za malo, jedva izbjeći: The superintendent, who was on the jetty inspecting the ship side at that time, had a narrow escape.

escape route (n) (safety, nav arch) izlaz u opasnosti: The cargo hold had only one escape route;

escape slide (n) (safety) tobogan za izlaz u opasnosti

escort (n) (navy, navig) pratnja, brodovi u pratnji: The company ordered two tugs with 80 tons bollard pull performance for its escort and towing operations on the Thames and Felixstowe.

escort (v) (navig) pratiti: The two ships were given pilots and were escorted to a safe anchorage The bulk carriers are being escorted by the Russian icebreakers. **escort the vessel pratiti brod**

e-shipping (n) 1 (shipping econ) elektroničko brodarstvo; 2 (shipping econ) sustav elektroničke dokumentacije u transportu

establish communications (n) (comm) uspostaviti vezu, uspostaviti

komunikacije: Vessels outbound from the Port of Southampton should establish communications at least 30 minutes prior to leaving berth and obtain permission from Southampton VTS before letting go The vessel's radar echo was acquired and tracked by the VTS officer, who made several attempts to establish communications with the unknown contact which was heading downstream. The third officer attempted to establish communication with the other ship but neither he nor the container ship's master knew the tanker's name.

established direction of traffic flow marks (n) (navig) oznake utvrđenoga plovidbenog smjera

establish the risk of collision (v) (navig) utvrditi opasnost od sudara: A quick and easy method to establish whether or not a risk of collision may be developing with another vessel on radar, is to position the EBL over the centre of the contact, as if to take a bearing of it. If after two or three minutes the contact appears to be moving towards the centre of the display and along the EBL, a risk of collision maybe developing.

estimate /'estimit/ (n) 1 **procjena**: ... the amount of ballast transferred was based on the master's estimate. With the PRU value, stating the external moment relative to the engine power, it is possible to give an estimate of the risk of hull vibrations for a specific engine.; 2 ocjena; 3 proračun; 4 mišljenje

estimate /'esti, meit/ (v) 1 **procijeniti**: If we use that as a factor, we can estimate the total reported incidents were 715 in 11 years or about 65 a year. The passing distance was estimated at less than 100m. It was estimated that about 2.5 gallons of sea water were entering the bilge every 15 minutes. Tug A can tow at 5 to 6 kts solo, with all the problems encountered with tug B, a safe speed was estimated to be 4 to 4.8 knots.; 2 prosuditi; 3 proračunati; 4 ocijeniti

estimated position (EP) (n) (navig) procijenjena pozicija (broda): After the alteration of course to 270°, the OOW did not effectively monitor the vessel's position; no fix was taken when steady on the new course, no estimated position (EP) was calculated and radar parallel indexing was not used.

Estimated Time of Arrival; (ETA) procijenjeno vrijeme dolaska (broda), ETA:

After the initial contact with the pilots regarding our Estimated Time of Arrival and pilot boarding arrangements, no further contact was made. **notice of Estimated Time of Arrival; (ETA)**

obavijest o ETA-i, notify Estimated Time of Arrival; (ETA) poslati obavijest o ETA-i

Estimated Time of Departure; (ETD) Procijenjeno vrijeme polaska (broda):

Warming through is to commence, not less than 12 hours prior to the estimated time of departure.

estimate tidal heights (v) (oceanogr) procijeniti visinu plime

estuary (n) (geogr) an area of waterway where river water flows into the sea **estuar**, **riječno**

ušće: The vessel, loaded to a draught of 13.5 metres, was upbound in a **river estuary**. A loaded tanker was outward bound along an **estuary** at about 10 knots with an underkeel clearance of about three metres. The vessel was guided by a radar pilot from Elbe Approach East Radar to the **estuary** of the river Elbe.

ETA (estimated time of arrival) /i: ti: 'ei/ (shipping econ) = **ETA Notice**

procijenjeno vrijeme dolaska (broda), **procijenjeno vrijeme dolaska u luku**

odredišta Passage planning had identified that one of the year's strongest spring ebb tides was running and the **estimated time of arrival** was at low water, but that sufficient safe water still existed in the dredged channel for a safe entry to be made. To achieve the **ETA** at the pilot station, minimum speed was selected, but the stronger than expected flood tide left the OOW with the choice of either advancing his What is your **ETA** at ...(name) Pilot Station in local time? My **ETA** at...(name) Pilot Station is ... hours local time.

confirm the ETA (estimated time of arrival) **potvrditi očekivani vrijeme dolaska broda** Masters of vessels bound for Chepstow, Lydney and Sharpness boarding a pilot from the Barry Roads Station must give at least 24 hours confirmation of their **ETA** off the Breaksea

Light, **advance the ETA (estimated time of arrival)** **ranije procijenjeno vrijeme**

dolaska broda: The master decided to **advance the ETA**, and the OOW contacted the pilots to arrange an 0540 embarkation., **amend the ETA (estimated time of arrival)** **ispraviti**

procijenjeno vrijeme dolaska: The pilots were called up and **the ETA was amended** to 0830.,

adjust the ETA (estimated time of arrival) **prilagoditi procijenjeno vrijeme dolaska**: In the evening, in order to **adjust the ETA** at the destination port the following morning, the Master decided to stop and drift for an hour in open water before resuming passage at full speed.

ETA Notice obavijest o očekivanom dolasku broda u luku

ETD (Estimated Time of Departure) /i: ti: 'di:/ (n) (shipping econ) **procijenjeno**

vrijeme odlaska iz luke: Masters of vessels outward bound from Sharpness and sailing before 1300 hours must agree, either directly or through their Agent, their **ETD** with the Duty Pilot by telephone before 1730 hours on the previous day. the agreed **ETD** must be confirmed by the Master directly to the Sharpness Pierhead

European cockle (n) (fishing) **kapica prugasta**

European date mussel (n) (fishing) **prstac**

European lobster (n) (fishing) Lat. Homarus gammarus **hlap**, Ital. **astice**



evacuate /ɪ'vækju, eɪt/ (v) (safety) **evakuirati** **spasiti i odvesti na sugurno mjesto**: The chief officer was **evacuated immediately** and provided with resuscitation treatment, but could not be rescued. Emergency services were very quickly on scene, with helicopter and lifeboat both available to **evacuate the casualty**. **evacuate the crew** **evakuirati posadu**: The Indian Navy helped **evacuate** all 20 crew from a sinking containership off Mumbai early Monday. When the lifeboats arrived, they were unable to approach the stricken vessel to **evacuate the crew** because of rocks located astern and the swell waves breaking over them., **evacuate the vessel** **evakuirati sve ljude s broda**: ... the skipper continually monitored the flooding boundary, the crew donned their lifejackets, and the liferaft was deployed in case they had to **evacuate the vessel**.

evaporation /i, væpə'reɪfən/ **isparivanje, evaporacija**: Conradson Carbon value is the measure of the percentage of carbon residue after **evaporation** of the fuel in a closed space under control.

evaporation rate 1 omjer isparivanja; 2 brzina isparivanja

evaporator **evaporator, isparivač**: The pressure in the **evaporator** is below atmospheric (i.e. a vacuum) so that the water boils at a lower temperature (about 65°C). Each primary refrigerant circuit has its own **evaporator** within the brine chiller which results in totally independent gas systems. The **fresh water generator** (or **evaporator**) uses the heat from the main engines in the cooling water to produce fresh water from sea water.

even (adj) 1 **jednak, ravnomjeran**; 2 **ravan even surface ravna površina**; 3 **gladak evening star** (n) (navig) as bright star or planet clearly visible in the west just after sunset when the horizon is still clearly visible **večernja, večernja zvijezda, Venera**

even keel (n) (nav arch, cargo handling) ship in a state of stability **ravna kobilica**: The vessel was loaded with coal and the draft was 16m **even keel**. At the time of the accident, the ship was approximately **at even keel** with a draft of about 9m. **on even keel na ravnoj kobilici**: The passage of my vessel drawing 20.6m **on an even keel** with the cargo of crude oil was planned for the end of last year.

evenly (adv) **ravnomjerno**: This enables the lateral thrust of the short connecting rod to be distributed **evenly** over the full depth of the skirt. Studs should be **evenly** tightened so that a satisfactory joint can be provided.

even number (n) (math) **ANTONYM odd number parni broj**

event 1 **dogodaj**: The crew responded properly to the **event** and quickly extinguished it.; 2 **zbivanje**; 3 **zгода**; 4 **radnja**

eventually /i'ventʃʊəli/ (adv) 1 **na kraju, konačno**: **Eventually**, after another hour, the men were winched off and conveyed to a shore hospital. the ship, the cargo underwent liquefaction; By ballasting incorrectly to correct the list, the ship's staff made the problem worse, until the vessel **eventually** capsized.; 2 **naknadno, kasnije**: When the surveyor **eventually** arrived, the lifeboat crew mustered and carried out a safety briefing. {**eventually ne znači eventualno, već konačno!!! Hrvatskoj riječi eventualno odgovara possibly u engleskom**}

evidence (n) (mar law, shipping econ) **dokaz**: There was **evidence** that the use of rope slings to lift the jumper hose in the past had probably caused the coiled wire sleeve to be displaced, causing the hose to kink. This could then be used **as evidence** to the IMO committees that there are still problems with DSC.

documentary evidence dokazna dokumentacija, pismena dokumentacija: This clearance is not given until the Collector of Customs is satisfied that **documentary evidence** has been produced to testify that the cargo is in order, the necessary permits have been procured, and ..., **in his evidence u svojoj izjavi u svoju obranu, produce the evidence predočiti / predati dokumentaciju / dokazni materijal, dati na uvid dokaze, take photographic evidence snimiti dokaz**: Once with the Harbour Master the vessel's Master was shown **photographic evidence** that clearly showed ballast water being discharged from the ship. **provide evidence pružiti dokaz, dati dokaz**: Histograms of engine operation can also be produced to **provide evidence** of performance over time.

examination /ig,zæmi'neɪʃən/ 1 **ispit**; 2 **istraživanje, istraga**: Furthermore, **close examination** of the selected track showed that it did not in fact pass between the rock and the island, but to the other side of the rock and over other obstruction .. During **examination** it was found that the hose and discharge horn had been replaced. **a thorough examination iscrpna pretraga / istraga**: The vessel was later raised to enable a **thorough examination** to be made, including an assessment of

her stability. , **detailed examination** iscrpna pretraga, detaljna pretraga: *Detailed examination of the fore peak found that of the four frames, two had waste and come away from the shell plating completely, ; 3 pregled, pretraga: Regular examination and testing of lifting equipment is an essential element of safety management and risk reduction. medical examination liječnički pregled: First aid was administered for cuts and bruises and subsequent medical examination ashore declared the seaman fit for duty after a few days' rest.*

examine /ig'zæmin/ (v) 1 **pregledati**: *The chief engineer will examine the Engine Log when he has time.; 2 provjeriti, ispitati Regularly examine upper deck, non- watertight hatch arrangements. The voyage was longer than usual, so the crew had no opportunity to examine or to clean the scavenge air or exhaust trunkings. The local P&I club correspondent and/or an independent surveyor should also be called upon to examine the cargo and to witness the loading and discharge should there be subsequent claims.*

exceed /ik'si:d/ (v) 1 **prevršiti, premašiti, preći, biti veći od**: *The interval between consecutive periods of rest shall not exceed 14 (fourteen) hours. razmak između dva perioda odmora ne smije preći 14 sati; 2 prebaciti, prekoračiti (dozvoljenju količinu), prijeći mjeru: The water velocity inside suction pipes shall normally not exceed 2 m/s and inside delivery pipes not exceed 4 m/s.*

excepted days (n) (mar law) **izuzeti dani (nedjelja i praznici)**

excepted perils (n) 1 (safety) **izuzetne opasnosti, izuzeti slučajevi; 2 (mar law) iznimni slučajevi**

exception (n) **izuzetak, iznimka**: *I would like to stress again that these examples are the norm and not the exception and I have plenty more photographs to prove it. with the exception of osim, izuzevši, s izuzetkom: As the wind continued to increase, the stern lines, with the exception of the spring, began to pay out as the winch brakes began to render.*

excessive /ik'sesiv/ (adj) 1 **prekomjeran**: *Excessive wear will take place if the crosshead guides are out of alignment or if the guide clearances are excessive. excessive pressure prekomjerni tlak: However, due to excessive pressure (estimated to be 6 bar), about 500 litres of DO was pushed out of the port tank vent, some of it overflowing over the upper edge of the drip; 2 pretjeran excessive wear pretjerano habanje: Increased surface temperature means that the material strength is reduced, and the oil film burnt away, resulting in excessive wear and increased thermal stressing.; 3 prevelik, previsok excessive speed prevelika brzina: Fundamental to the vessel being too close to the edge of the bank and at an excessive speed was the decision to overtake the barge at the entrance of the smaller channel., excessive heat prevelika toplina, previsoka temperatura: The engine crankshaft was damaged and the entablature probably distorted due to the excessive heat generated as a result of the overspeed., excessive vibration previsoke vibracije: The turbochargers are provided with a connection for Disatac electronic tachometers, and prepared for signal equipment to indicate excessive vibration of the turbochargers.*

exchange (n) **izmjena radio exchange (comm) razgovor putem radija, razmjena radijskih poruka**: *Editor's note: In this context, 'lookout by all available means' includes the use of VHF, as the radio exchange made it apparent to the stand-on vessel that the give-way vessel was not intending to take appropriate action.*

excluded spaces (n) (shipping econ) **izuzeti / isključeni (brodski) prostori**

exclusive economic zone (n) (mar law) **an area beyond and adjacent to the territorial sea, subject to the specific legal regime established in this Part, under which the rights and jurisdiction of the coastal State and the rights and freedoms of other States are governed by the relevant provisions of this**

Convention. **isključivi gospodarski pojas**: In the *exclusive economic zone*, the coastal State has sovereign rights for the purpose of exploring and exploiting, conserving and managing the natural resources, whether living or non-living, of the waters superjacent to the seabed and of the seabed and its subsoil, and with regard to other activities for the economic exploitation and exploration of the zone, such as the production of energy from the water, currents and winds; (UNCLOS)

excursion ship (n) (nav arch) **izletnički brod**

execution /ˌɛksɪˈkjuːʃən/ (n) **1 provedba, izvršenje**: Poor planning / **execution** of the mooring manoeuvre. It is appropriate to emphasise the critical nature of the Master/Pilot relationship, and the Master's obligation to monitor the pilot's performance and **execution** of the vessel's passage plan at ALL times. Inadequate work planning and **execution**; **2 (mar law) ovrha, izvršenje (sudske odluke)**

execution on a ship (n) (mar ins, mar law) **ovrha na brodu**

execution proceedings (n) (mar law, mar ins) **ovršne radnje**

execution proposal (n) (mar law) **prijedlog za ovrhu**

executive /ɪgˈzɛkjʊtɪv/ (n) **rukovoditelj, izvršni službenik**: Mr XY joined the Insurance Association as **Chief Executive** in 2005. He was appointed **Chief Executive** in October 2012.

exemption /ɪgˈzɛmpfən/ (mar law) **izuzeće**: This vessel had missed two annual **Load Line Exemption surveys**. **pilot exemption certificate izuzeće od obveze uzimanja peljara (u luci)** However, due to the frequency of visits to the port, one officer did have a **pilotage exemption certificate**. The master, **who held a Pilotage Exemption Certificate**, decided to swing the vessel at the berth because he did not wish to depart stern-first in such conditions., **exemption clause** a clause in a contract, which relieves the carrier's responsibility for certain events **zaporka o izuzeću, odredba o izuzeću, klauzula o izuzeću (od odgovornosti), request for exemption zahtjev za izuzeće** The Flag State's process for managing requests for exemptions from international safety regulations was also found to lack rigour., **exemption from izuzeće od Exemption from Deratisation Certificate izuzeće od obveze predočenja svjedodžbe o deratizaciji**

exercise /ˈɛksəˌsaɪz/ (n) **1 vježba, vježbanje**: The evening before the **exercise**, a team briefing was held, during which an alternative **exercise** to the crossing was briefly discussed. **revision exercise vježba ponavljanja; 2 upotreba, primjena**

exercise /ˈɛksəˌsaɪz/ (v) **1 vježbati, uvježbavati**: The general health of officers has improved since they now have time to **exercise** and sleep more regularly; The retention of personnel is significantly higher as officers get better job satisfaction and are more willing to continue; **2 primjenjivati, praktimirati**: As the vessel approached a precautionary area at 21 knots, Vessel Traffic Services (VTS) advised the vessel to **exercise caution** as three outbound vessels were ahead and intending to cross the TSS.

exhaust /ɪgˈzɔːst/ (n) **exhaust system ispušni sustav / sistem**: A simple yet efficient **exhaust** layout designated Daihatsu single-pipe (DSP) exhaust system recovers gas energy effectively by allowing a good match to the turbocharger., **exhaust arrangement raspored ispuha, ispušni sustav, exhaust line ispušni vod, ispušni cjevovod**: It is desirable that the engine room air should be able to circulate inside the **exhaust line**, the air outlet being located as close as possible to the end of the **exhaust line**. **1 (marine eng) ispuh, ispust, škarik**: ... airborne noise is generated from the air intake, the structure and the **exhaust**. Flames came out of the main **engine exhaust** at the funnel and ignited waste oil that was lying on the funnel top.; **2 ispušni plin**

exhaust /ɪgˈzɔːst/ (v) **1 ispuštai; 2 isprazniti**

exhaust and inlet system (n) (marine eng) **sustav ispuha i dovoda zraka**

exhaust gas (n) (marine eng) **ispušni plin**: The passages for the inlet air and **exhaust gas** are incorporated, as are the cooling water passages and spaces. As well as these, most oiltankers install inert gas generators which may continuously produce an **exhaust gas** containing nitrogen and carbon dioxide for fire extinguishing. **exhaust gas emission emisija ispušnih plinova, ispuštanje**

ispušnih plinova: Because of the need to minimise **exhaust gas emissions** in this area, the ferry will operate primarily on LNG using two 9-cylinder Wärtsilä 20DF medium-speed dual-fuel engines.

exhaust manifold (n) (marine eng) **ispušni kolektor, razvodna cijev ispuha**: Drain cocks in **exhaust and inlet manifolds** are to remain open when machines are at rest and should be regularly tested and proved clear of blockages. The engine room fire was probably caused by the ignition of lubricating oil that sprayed from a fatigue-fractured fitting on one of the main engine's pre-lubrication oil pumps onto the hot surface of the main engine's **exhaust manifold**.

exhaust pipe (n) (marine eng) **ispušna cijev**: If the oil mist meets a hot spot it can be ignited; it is therefore important to keep the insulation around the **exhaust pipes** in good condition.

exhaust port (n) (marine eng) **ispušni kanal, ispušni otvor**: As the piston uncovers the **exhaust ports** on the power stroke, the exhaust gas starts to leave the cylinder. The opening and closing of the **exhaust and air inlet ports** are shown diagrammatically in the typical timing diagram.

exhaust silencer (n) (marine eng) **prigušivač ispuha**: Exhaust gas is conducted away from the turbocharger through the outlet casing via **exhaust pipes** to the exhaust silencer, then out into the open air through the stack or through the exhaust gas boiler.

exhaust steam (n) (marine eng) **ispušna para**

exhaust valve (n) (marine eng) **ispušni ventil**: The two **inlet and two exhaust valves** seat on renewable inserts in the head, those for exhaust service being intensively cooled and sealed with Viton O-rings. A nodular cast iron cylinder head, hydraulically bolted to the crankcase at four points, incorporates two **inlet and two exhaust valves**. **exhaust valve cage kućište ispušnog ventila**: All water flowing across the cylinder head runs through the **exhaust valve cages**, significantly reducing the valve seat temperature. **exhaust valve gear polužje ispušnog ventila, uređaj ispušnog ventila**

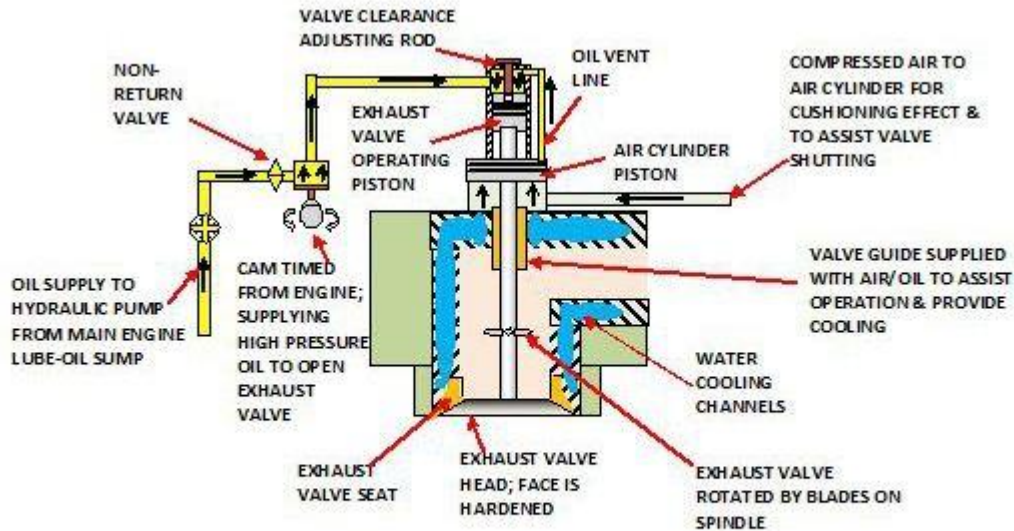

SECTION THROUGH TYPICAL EXHAUST VALVE USED ON MODERN TWO-STROKE MARINE DIESEL ENGINES

Drawn by Wilfie Scott 23/09/2011

exhaust ventilator (n) (nav arch, marine eng) odvod ventilacije, odušnik: The vessel had been towing her twin rig gear for about 3 hours when the skipper saw smoke coming from the outlet of the engine room exhaust ventilator.

exhibit /ig'zibit/ (v) 1 (navig) istaknuti (svjetlo, signal), izvijesiti, podići (zastavicu): Many of these vessels exhibit NUC lights while drifting. Rule 3(g)(vi) allows towing vessels to exhibit restricted ability to manoeuvre signals if circumstances permit. In many regions, local regulations require vessels carrying dangerous cargoes to exhibit a flashing red light. ; 2 (marine eng) pokazivati (karakteristike, obilježja): Smaller turbochargers exhibit better acceleration and vibration behaviour. Another synthetic lubricant, Castrol 778, is claimed to exhibit excellent anti-wear and rust-protection properties supported by superior oxidation stability.

exit /'egzit ; 'ɛksit/ (n) (navig) izlaziti, exit the lock, ići iz ustave: As soon as the tanker had exited the breakwater, the pilot's launch transferred the pilot to the container ship. Čim je tanker izašao iz ulaza pri lukobranu, peljarska brodica prebacila je peljara na kontejnerski brod. , emergency exit, izlaz u slučaju opasnosti, nužni izlaz, exit the port, ići iz luke, isploviti iz luke: They should develop such procedures for preparation of the vessel to exit port that would ensure that the vessel would not be able to exit port not fully ballasted and they would allow the captain to conduct ballasting operation ... , exit the tank, ići iz tanka

exit (n) (safety) izlaz: The ferry's exit from the harbour was delayed. exit door, izlazna vrata, vrata za izlaz (u nuždi): Engineers and ratings should be fully familiar with all exit doors of the engine room so that in an emergency, they can evacuate safely. , exit channel, izlazni plovodbeni kanal: The exit channel from the terminal had a draught restriction and sailing was subject to a narrow tidal window. Vessels with a draught of over 10m must enter and exit the channel between the No1 buoys.

exonerate /ig'zɔnə'reit/ (v) (mar law) osloboditi od (obveze, odgovornosti): ... if a stevedore is injured on board, the vessel will be subjected to a very harsh inquiry/investigation and the authorities will likely exonerate the stevedore company of any blame and instead unfairly hold the ship liable for damages.

exoneration clause odredba / klauzula o povlastici, Klauzula o oslobađanju rizika / odgovornosti

expand /ik'spænd/ (v) **1 širiti se, proširiti se**: The gases **expand** forcing the piston down on the power stroke. The liner will **expand** more and is free to **expand** diametrically and lengthwise. The clear description of the accidents, the analysis and conclusions, enable seamen to **expand their knowledge**.; **2 povećati (volumen)**: These pistons have dish-shaped crowns that give a spherical form to the combustion space and are designed to be free to **expand** without causing undue stresses.

expanded square search (n) (navig, safety) **traganje po proširenome četverokutu**

expansion /ik'spænfən/ (marine eng) **1 rastezanje coefficient of expansion koeficijent rastezanja**: The parts made of brass have a larger **coefficient of expansion** than the other parts of the valve. ; **2 ekspanzija**: A header tank allows for **expansion** and water make-up in the system. One benefit is that smaller turbochargers are required for the reduced gas flows; the lower scavenge ports also allow greater **expansion** in the cylinder and thus improve fuel consumption. ; **3 povećanje, širenje, proširenje**: A major difference with the Miller cycle compared with a normal diesel cycle is the decreased compression due to the additional **expansion of the cylinder load** after IVC before BDC.

expansion bellows (n) (marine eng) **rastezljiva spojnica, valoviti kompenzator, valoviti prigušivač**: The company investigation found that the rupture of the **expansion bellows** was caused by an overpressure in the pump system between the suction valve and the delivery valve.

expansion piece (n) (marine eng) **rastezljiva spojnica, dilatacijski umetak**: After slowing down, the leak was located in the **expansion piece** between the manifold and the blower in the top inlet, an extensive fracture of the bottom of one of corrugation.

expansion pressure (n) (marine eng) **tlak ekspanzije**: The scavenge air pressure, exhaust gas temperature and compression, combustion and **expansion pressures** are continuously monitored. **initial expansion pressure početni tlak ekspanzije**

expansion ratio (n) (marine eng) **ekspanzijski omjer, stupanj širenja**: The cycle efficiency is a function of the **compression ratio** (or more correctly the effective expansion ratio of the gas-air mixture after combustion).

expansion stroke (n) (marine eng) **ekspanzijski takt (u radu motora)**: Slow or late combustion of fuel during the **expansion stroke** commonly referred to as afterburning may cause the engine to lose power considerably. The opening of the exhaust valve can be delayed about 15°, thereby lengthening the **expansion stroke** and improving the efficiency and reducing the fuel consumption.

expansion tank (n) (nav arch) **overflow tanks used to provide for expansion, overflow, and replenishment of oil in stowage or cargo tanks ekspanzijski tank, ekspanzioni tank**: A header or **expansion tank** is placed at a sufficient height to allow the venting and water make-up in the system.

expansion valve (n) (marine eng) **ekspanzijski ventil, prigušni ventil**: It was reported that while this system was operating, the piping near the **expansion valve** began constricting flow due to freezing hydrates.

expel /ik'spæl/ (v) **1 istjerati, odstraniti; 2 istiskivati (tlačenjem)**: Intermittent rotation of exhaust valves is caused by the flow of burnt gases **expelled from** the cylinder. i e lower piston, so allowing air under pressure, which is delivered to the scavenge space by the turbocharger, to flow through the cylinder and **expel the remaining burnt gases**. As the piston moves up the cylinder, the hot gases (consisting mostly of nitrogen, carbon dioxide, water vapour and unused oxygen) **are expelled from the cylinder**.

expenditure **izdatak, trošak**: As a result of the ship's staff's not observing the maker's maintenance instructions and poor engineering practice, the company incurred an unplanned **expenditure** of nearly US\$ 100,000.

expense izdatak, trošak: ..., maximize the exploitation of the waste heat available in ships whose operating profiles and revenues can justify the added **expense** and complexity. He recommended that it should be renewed, but the owners were reluctant to **take on the extra work and expense**, and delay the vessel's return to service. To avoid **overtime expenses**, few shipowners provide any assistance to the Duty Officer on the bridge at night. **expenses incurred (from) nastali troškovi, troškovi nastali uslijed:** In addition to the **extra expenses incurred**, the vessel arrived at the discharging port three days late., **out-of-pocket expenses džeparac, at the expense of na trošak / račun (nekoga):** Significantly lower NOx emissions are reported, as well as reduced smoke and even carbon monoxide, but **at the expense of a slightly higher fuel consumption.** ..., the mate's receipt was signed with the note, 'Shipped on deck **at shipper's/receiver's risk and expense.**, **operational expenses operativni troškovi, pogonski troškovi**

experience /ik'spiəriəns/ (safety) doživjeti, proživjeti, iskušati, pretrpjeti: Shortly after the contact with the foundation the ferry **experienced a blackout.** The ship left port in the early evening and, once clear of land, started to **experience** significantly stronger winds than were originally forecast, prompting the master to adjust the passage plan ... It was a last resort action as he **had not previously experienced** a similar situation and remained unaware of the fact that the port unit was misaligned. **experience fire (safety) pretrpjeti požar, zapaliti se, experience rough / heavy weather (navig, meteorol) proći kroz / doživjeti / pretrpjeti nevrjeme:** ... the instructor of one of the RIBs decided to close on a cardinal mark post, where the water was confused, so that the trainees could **experience** the influence of rougher water.

experienced /ik'spiəriənst/ iskusan, vješt An **experienced and responsible deck officer** shall be in charge of the forward station when connecting/disconnecting chafe chain; The **experienced crew member** leaned back to get a better view of what had become entangled, and, in doing so, his left foot slipped on the footrope.

experience fire (v) (safety) doživjeti požar, zapaliti se, doći do požara: The ship **experienced a fire** in a mechanical space as she was pulling into Falmouth, Jamaica. While underway a towing vessel with six crewmembers on board **experienced an engine room fire.**

expiration /,ɛkspi'reiʃən/ (n) (mar law) termination of a certain period istjek (ugovora)

expire /ik'spaɪə/ (v) (mar law) istjeći (ugovor): the contract has **expired** rok ugovora je istekao

expired certificate svjedodžba kojoj je istekao rok važenja: Furthermore, **expired certificates** need to be renewed before the vessel can be re-commissioned.

expiry /ik'spaɪəri/ (n) 1 (mar law) istjek (ugovora) expiry date datum istjeka roka (akreditiva, tarifa itd); 2 (safety, ship handling) istjek roka (trajanja): We recently replaced some of the sealed spare batteries and decided to test the old ones to see if they still worked. The **expiry date** on them is 2014.

explosion (n) (safety) eksplozija the explosion occurred došlo je do eksplozije, nastala je eksplozija: Shortly afterwards, **the first explosion occurred**, spreading throughout the crankcase, blowing off the crankcase doors and igniting the whole of the lower engine-room atmosphere. Locked doors on a tanker mean horrific accidents **should a fire or explosion occur.** Approximately 25 minutes after the last tank was loaded, an **explosion occurred** and fire developed near the forward part of the cargo area., **explosion relief valve otpusni ventil za slučaj eksplozije:** **Explosion relief valves** are fitted to the crankcase to relieve any build-up of excess pressure inside the engine;

explosion-proof (adj) (safety) protueksplozijski, siguran od eksplozije: A cargo light was used to illuminate the work area, which was not intrinsically **safe/explosion proof.**

explosives (n) (cargo) eksplozivi: Other 'illegal' goods or possessions can include weapons, **explosives**, pets, drugs in any form other than for medical purposes. {Klasa 1 opasnih tereta}

exponentiation /ˌɛkspəˌnɛnʃiˈeɪʃən/ a mathematical operation, written as b^n , involving two numbers, the base b and the exponent (or index or power) **potenciranje**: 3 raised to the power of 5 3^5 na petu 3 squared 3^2 na kvadrat 3 cubed 3^3 na kub / 3 na treću {**b raised to the n-th power, b raised to the power of n, or b raised by the exponent of n, most briefly as b to the n. Some exponents have their own pronunciation: for example, b^2 is usually read as b squared and b^3 as b cubed.**}

export (n) (shipping econ) **izvoz**: The MAIB has already pointed out that there is a strong case for weighing unaccompanied lorry trailers before they are loaded for export.

export declaration (n) (shipping econ, mar law) **izvozna deklaracija, prijava robe za izvoz**

export(ed) cargo (n) **1** (shipping econ) **izvozni teret**; **2** (ports) **teret u ukrcaju**

export licence (n) (mar law, shipping econ) a government document which permits the licensee to engage in the export of designated goods to certain destinations **izvozna dozvola, dozvola za izvoz**

export rate (n) (mar law, shipping econ) a (freight) rate published on traffic moving from an interior point to a port for transshipment to a foreign country **izvozni vozarinski stav, vozarinski stav za izvoz (u luku druge države)**

exposed port (n) (ports, navig) **luka izložena valovima i vjetru, nazašćena luka**: A high-sided ro-ro vessel was berthed in an exposed port, waiting to load cargo.

expose (to) **1 izložiti (nečemu)**: ... under extreme sea conditions and when vessels sail in ballast, the vessel and (deck) cargo are not only **exposed to a risk** arising from excessive speed, but that reducing the speed, Another explanation could be that our berth, being the first one inside the breakwater, was **more exposed to the ocean swell**. In both these cases wires which usually rested in not easily accessible blocks **were exposed to the elements**. However, the location of her destination port meant that she would have to eventually transit **more exposed waters**. Thus bare steel **was exposed to attack** by the corrosive cargo.; **2 izvrgnuti (nečemu)**

exposure (n) **exposure to weather** (navig) **izloženost vremenskim prilikama / nevremenu / atmosferilijama** Although both men had been wearing lifejackets that had inflated, neither was able to survive their **exposure to the heavy weather conditions**. (**safety**) **izloženost**: **Exposure to detrimental environmental conditions** e.g. salt, moisture, airborne sand and dust; Improper winding under load; It was thought that **exposure to hot, high pressure fuel oil over a long period** had caused the fitting to suffer from fatigue or stress corrosion cracking.

extend (v) **1 protezati se, širiti se**: The water jackets does not usually **extend** below the port belt.; **2 produžiti, protezati (se), ispružiti**: A deep sump provides a large oil capacity to reduce ageing of the lubricating oil and **extend intervals** between oil changes. The Safety Investigation Authority decided, in accordance with the Safety Investigation Act, to **extend the investigation** to include the procurement of traffic services and contract related issues ... Risk assessment training **must extend to** all stevedores and seamen, particularly those in charge of other workers.

extension (n) **1 (marine eng) produžetak, proširenje**: They inserted the fan **extension hose** into the tank and vacated the area. Winch brakes need to be applied tightly, and using a wheel spanner or **extension bar** to get added purchase may be necessary. This is an **extension of US Coastguard directives** which required all tonnage visiting US ports to display diagrams of their fuel loading, transfer and storage.; **2 (shipping econ) produženje (vremena, roka)**: A further **extension of maintenance intervals** can be secured by plasma (ceramic) coating or chrome plating the surface of the uppermost piston ring.

extent (n) **to a greater extent u velikoj mjeri** **1 obim**: To determine the **extent of flooding**,

the skipper checked the fish room and found water at the same level as that in the engine room.; **2 veličina; 3 razmjer; 4 stupanj; 5 opseg obim**: The full extent of the damage to the smaller vessel was not realised until some time after the collision.; **6 mjera to some extent u izvjesnoj mjeri, donekle**: ... the pilot was left with little room for manoeuvre or time for critical decision making, and the grounding of the vessel became **to some extent** inevitable., **to such an extent that do te mjere da, toliko da**: The bolts were wasted **to such an extent that** the threaded parts were reduced to 50% of their original diameter., **to the extent that do te mjere da**: The OOW had become over-confident in his ability, **to the extent that** he was prepared to stretch the parameters within which the master had permitted him to operate autonomously. The bolts were wasted **to such an extent that** the threaded parts were reduced to 50% of their original diameter., **to the full extent u punoj mjeri**: In such situations, the use and handling of AIS information becomes more difficult, and the AIS can not be used **to its full extent**, thus losing its meaning to the navigator.

externally (adv) (marine eng) izvana, s vanjske strane: Modern turbochargers with **externally lubricated journal bearings** have uncooled casings. The chamber is drained **externally** by a tap and cleaned without risk of contaminating the lubricating oil system.

extinguish /ik'stingwif/ (v) (safety) ugasiti, pogasiti extinguish fire ugasiti požar: The fire on board **has been extinguished** by crewmembers. The fire **was fully extinguished** within about an hour. The master decided it would be necessary to operate the engine room CO2 system to **extinguish the fire**. Attempts to **extinguish fires** in accommodation and engine room failed., **extinguish the light ugasiti (navigacijsko) svjetlo**: The question of whether or not to **extinguish the side lights** once the vessel was no longer making way then arose.

extinguished light (n) (navig) ugašeno svjetlo, pogašeno svjetlo

extinguisher /ik'stingwifə/ (n) (safety) aparat za gašenje požara, protupožarni

aparat: The chief engineer attempted to fight the fire using an **extinguisher**, but was quickly driven back into the ECR. The skipper took an **extinguisher** from the wheelhouse and operated it through the emergency escape hatch. **portable extinguisher prijenosni protupožarni aparat, ručni aparat za gašenje**: The ETO immediately grabbed the closest **portable extinguisher**, which happened

to be the 45ltr foam extinguisher, and put the fire out., **water extinguisher protupožarni aparat na vodu**: The second engineer had more success, and tackled the fire with a **water extinguisher**.,

foam extinguisher protupožarni aparat na pjenu: The AB immediately unplugged the fan

and fought the fire using a **foam extinguisher** located in the adjacent alleyway., **CO2 extinguisher; carbon dioxide extinguisher protupožarni aparat na ugljični dioksid**: They were able to enter the compartment and discharge their **CO2 extinguisher**, but they were beaten back by the smoke.

The crew put out the fire by using a portable **CO2 extinguisher**., **dry powder extinguisher protupožarni aparat na suhi prah**: The fire was subsequently extinguished using a **dry-chemical fire extinguisher**. Following an unsuccessful attempt to fight the fire with a portable **dry powder extinguisher**, the engines were shut down and the air vents closed.



, **fire extinguisher** aparat za gašenje požara, protupožarni aparat: He fetched a fire extinguisher from the forepeak and with 3-4 blasts put the fire out. The brake shoe on one of the aft captive drums caught fire as the winch paid out, and it had to be tackled with a fire extinguisher.

extinguishing (n) (safety) **extinguishing agent** sredstvo / agens za gašenje: At least the cargo holds intended for the carriage of dangerous goods should be equipped such that they contain the possibility to use water as an **extinguishing agent** or for cooling via a permanently installed system as well., **dry chemical extinguishing system** sistem za gašenje požara suhom pjenom. Dry chemical extinguishing systems are designed to combat Class B (flammable liquids and gases) and Class C (electrical) fires., **foam extinguishing system** sistem gašenja požara pjenom. Fixed foam extinguishing systems are used to smother flammable liquid fires., **gas extinguishing system** sistem gašenja požara plinovima. Gas extinguishing systems have proved to be most efficient in enclosed spaces, such as machinery rooms, electrical panels and cargo holds., **fire extinguishing appliances** uređaji za gašenje, protupožarni uređaji: What fire extinguishing appliances are available on board ship? **gašenje**

extract (v) 1 **izvaditi, ekstrahirati**; 2 **istisnuti**; 3 **izvući**: Heating of sludge oil tanks, waste oil and oily water bilge tanks in order to **extract** water. Their surfaces are curved to **extract the maximum amount of energy** from the exhaust gases and transfer it to the turbine shaft.

extraordinary event (n) (safety) događaj na brodu koji nisu planirali zapovjednik ni posada i može rezultirati opasnošću za ljudske živote, imovinu ili okoliš **izvanredni događaj**

extreme breadth (n) (nav arch) **najveća širina, maksimalna širina**

extreme length (n) (nav arch) **najveća duljina**

Ex Works (n) (shipping econ, mar law) an INCOTERM of sale meaning the seller delivers to the buyer at seller's named premises; free from manufacturer's premises. Including charges only up to the seller's factory or premises. All charges from there on, such delivery, distribution, and commissions, are to be borne by the buyer. **slobodno iz tvorničkog skladišta, franko tvornica**

eye 1 (*nav arch*) oko za privez, oko za prolaz konopa, očet, tal. *occhiello*



; 2 (*marine eng*) a hole through the head of a needle, pin, bolt, etc. or a loop forming a hole or opening through which something is intended to pass, such as a hook, pin, shaft, or rope (SeaSources.net) očica, oko **rod eye** oko / očica ojnice

eye (n) (*meteorol*) the low pressure center of a tropical cyclone **središte** (ciklone)



eye-bolt (*marine eng*) vijak s maticom na očicu

eye plate uška veza (rica na palubi), očet

eye protection device (n) (*seamanship*) očna zaštitna pomagala

eye splice (n) (*seamanship*) oko konopa s upletkom

facets /'fæsɪts/ (n) (*electr, navig*) smetajuća radarska jeka na malim površinama mora **male** površine (radarske jeke)

facilitate /fə'siliti/ (v) 1 **olakšati**: *As the boat had to approach stern first in order to be picked up, two lines were passed to the crew to facilitate her positioning.*; 2 **omogućiti**: *This was to facilitate easy access for the ship's personnel to continuously monitor the after-draft while cargo loading was nearing completion.*; 3 **pomoći**

facilities /fə'silitiz/ (n) 1 **usluge**; 2 **kapaciteti** **port facilities** lučki kapaciteti; 3 **postrojenje** obalna postrojenja; 4 **sredstva**, **oprema** **cargo handling facilities** prekrajna sredstva, sredstva za prekraj

facility /fə'siliti/ (n) 1 (*ports*) **postrojenje**, **kapaciteti** **reception facility** prihvatna postrojenja: *The water has to be properly treated before discharge into the sea, and the sludge must be disposed of at reception facilities ashore.*, **bunkering facilities** kapaciteti za ukrcaj goriva, **port facilities** lučki kapaciteti, **lučka postrojenja**: *The vessel hit the quay, and then the link span, causing significant damage to both the ferry and the port facilities.*, **cargo handling facilities** kapaciteti za prekraj (ukrcaj i iskrcaj) tereta, **ukrcajno-iskrcajni kapaciteti**, **storage facilities** skladišni kapaciteti, **extend the facilities** proširiti / povećati

kapacitete, prožiti sve pogodnosti / pomoć, shoree facility obalno postrojenje: *They also cannot accept the fact that they have to land large amounts of slops to shore facilities as this costs them money.*, **loading facility ukrajno postrojenje:** *arly there is growing pressure in some quarters for the IMO to establish a legal requirement that all loaded containers are weighed at the loading facility before being stowed aboard a vessel for export.*; **2 uređaj:** *The ARPA facility would have made this task easy.*

facsimile receiver /fæk'simili/ **faksimil prijamnik, faks**

factory ship (n) (nav arch) **brod-tvornica**

fade /feid/ (v) (navig, comm) **gubiti se, slabjeti (signal)**

fading /'ferdn/ (n) (electr, navig) **slabljenje (signala, elektromagnetskog vala, svjetla), gubljenje:** *As they made their way across the water, in fading light, the tender was rocked by the wash of another craft and it capsized, throwing all three men into the water.*

fail /feil/ (v) **1 propustiti (učiniti):** *Too often mariners fail to appreciate the importance of frequent fixes while navigating in restricted visibility. If the crew fail to re-secure the painter before launching, this liferaft will certainly be lost along with the painter. fail to inform propustiti obavijestiti o:* *the crossing vessel failed to inform VTS and other traffic about her intention to leave the anchorage and cross the traffic lane, fail comply with the regulations ne poštivati propise, ne pridržavati se propisa:* *The othre ship failed to comply with a number of regulations to keep his and other vessels safe, including failing to make his vessel's radar operational, failing to make sound signals, and failing to ensure all the navigation lights were working. <http://gcaptain.com/>;* **2 zatajiti, otkazati:** *The engine remains manoeuvrable even if one cylinder fails: in such a case the relevant fuel pump is set to the zero index position. fail to work ne raditi (o uređaju, opremi), prestati raditi, zatajiti:* *All flares must be periodically checked and renewed when past their "use-by" date. Otherwise they may fail to work, when needed. CASE 22 _Narrative The owner of a high powered, rigid inflatable boat (RIB) was well known to have been a keen and compete;* **3 ne uspjeti:** *A vessel can travel several hundred yards, especially if the operator fails to reduce speed, in the time it takes for the track line to update on an electronic chart.*; **4 pokvariti se, biti u kvaru / defektu;** **5 popustiti (materijal)**

fail-proof /'feilpru:f/ (n) (safety) **besprijekporan:** *Hatch lid modified to incorporate safer lifting and permanent fail-proof securing arrangements;*

fail-safe /'feilseif/ **nepokvarljiv, poudan, siguran, bez kvara, samoisključujući:** *In the case of bridge operations, it is prudent to have fail safe procedures in place, such as the testing of manual steering, before entering any harbour ...*

failsafe operation (n) (safety) **besprijekoran rad**

failure /'feiljə/ **rudder failure zakazivanje kormila, power failure nestanak električne energije:** *'In the event of a power failure to any one of the steering gear power units, an audible and visual alarm shall be given on the navigating bridge.*, **failure to report ne izvijestiti, propustiti izvijestiti, main engine failure otkazivanje glavnog stroja:** *The vessel command attributed the main engine failure to a defect in the automatic control.*, **steering failure otkazivanje kormilarskog uređaja:** *The cause of the sudden steering failure could not be established; however the following contributory factors were noted.;*, **brake failure otkazivanje kočnice, zakazivanje kočnice:** *The accident involved a brake failure on one of the lifeboat.*, **catastrophic failure strašno zakazivanje, strašan propust zakazivanje (stroja, uređaja) s ozbiljnim posljedicama:** *There have been many reported instances of sudden and catastrophic failure of roller fairleads on ships due to ineffective inspection and maintenance.*, **hull**

failure pucanje trupa broda, napuknuće trupa: *The ship encountered heavy seas during a passage of the English Channel, causing catastrophic hull failure.* 1 kvar, havarija sudden failure of the main engine iznenadna havarija glavnog stroja; 2 prekid u radu; 3 propust, neizvršenje, neispunjavanje: *Failure to comply with certification requirement may result in a heavy fine, arrest or a penalty and loss of insurance The basic errors here seem to be the failure of the other vessel to comply with the Collision Regulations, particularly with reference to Rule 13 (overtaking) and Rule 18, d.;* 4 otkazivanje (materijala, uređaja, konstrukcije), zakazivanje: *Corrective/preventative actions Following the failure of the hose, all the other hoses were hydraulically pressure-tested.*

fairing (n) (nav arch) izgladivanje brodskih linija i privjesaka

fairlead (n) (nav arch, UK) = eye a fitting or device used to preserve or to change the direction of a rope, chain, or wire so that it will be delivered fairly or on a straight lead to a sheave or drum without the introduction of extensive friction zjevača, oko za sidrenje, oko za privez s valjcima, pasakavo; tal. passacavo roller fairlead zjevača s valjcima: *A sternline was led from a roller fairlead, through a set of bitts, around a pedestal fairlead and on to a warping drum.*, Panama fairlead oko za privez (po sredini pramca ili krme), panama: *The master ordered to heave on the forward backspring and to slacken the headline, which had been passed from the centre mooring winch through the vessel's centreline Panama fairlead.*, centreline fairlead oko za privez (po sredini pramca): *A Voith Schneider tug was attached through the forward centreline fairlead, with the (now repaired) ASD tug from Case 1 pulling on the vessel's port quarter to try to counter a strong cross-tide and force 6 winds.*, aft fairlead oko za privez (po sredini krme) *The cargo vessels' stern ramp and aft fairlead arrangements were certainly contributory to these accidents. contributory*



to the accident.

fairway (n) (navig) navigable channel for entering or leaving a port, usually marked by port and starboard buoys, seamarks etc. plovibeni put, plovni kanal: *The vessel came rapidly on port and got out of the buoyed fairway and entangled the buoy chain with her screw. I joined the westbound lane and was able to have a clear run past the Jong Fairway and get up to about 17 knots. Last year I was sailing as Third Officer transiting the Galveston to Freeport coastal fairway at night. Large vessel is leaving the fairway - keep clear of the fairway approach.*



fairway buoy (FB) (n) (navig) plutača na početku plovidbenog kanala (smorske strane): Several minutes later, another fairway buoy fitted with a Racon was detected at a range of 6nm fine on his starboard bow. Due to my ship's draft, the fairway buoy must be passed on our port side.

fairway depth (n) (navig) dubina plovnog kanala

fairway speed (n) (navig) obvezna brzina u plovidbenom putu / kanalu: What is the fairway speed?. Fairway speed is 7 knots.

fair weather (n) (meteorol) weather in which there is less than 4/10ths of cloud cover, no precipitation, and there is no extreme visibility, wind or temperature conditions **lijepo vrijeme**,

vedro vrijeme: A vessel with low freeboard is susceptible to ship seas on deck even in relatively fair weather. The trawler was returning to her home port, in fair weather and good visibility, but it was dark.

fake /feik/ (n) (seamanship) one complete circle of a coil of rope **red složenog konopa (u krugu)**

fall (n) 1 (seamanship) handling rope end of a block and tackle; dio užeta između dva kolotura u čekrku/koloturniku **radna struna koloturnika, uže koloturnika / čekrka**; 2 (seamanship) = **hauling line; hauling part** the end of tackle rope to which the power is applied in lifting cargo **živi kraj užeta (na koloturniku/čekrku), radni kraj užeta (na koloturniku/čekrku), radna struna koloturnika/čekrka**; 3 (boating/yachting) **podigač jedra, gindac**

fall (n) (seamanship) čekrk, **parank; paranak** **forward fall** **pramčani čekrk (na brodici za spašavanje) prednji čekrk (na brodici za spašavanje)**: The second mate was designated to be the cox'n of the starboard lifeboat, and two ABs were tasked with releasing the forward and aft falls. **aft fall** **krmeni čekrk (na brodici za spašavanje) stražnji čekrk**: The aft falls block chain ring had been placed in the hook securing bracket, and the safety pin pushed though it, as shown in figure 3. **fall block koloturnik čekrka, blok čekrka**: He re-attached the aft falls block chain ring correctly to the hook, and lashed the hook securing arrangement. **fall arrest zaustavljač koloturnika (čekrka)**: The seaman was not using any kind of fall arrest systems.

fall due (v) (mar law) **dospijeti, dospijevati**: Demurrage shall fall due day by day and shall be payable as per Charter Party.

fall off (v) (seamanship, navig) **otpasti (o brodu, jedrilici), otpadati od vjetro**: the effect of the wind on the starboard quarter caused the vessel to fall off to starboard vjetar desno po krmu izazvao je otpadanje broda u desno

fall upon (v) pasti na teret (o troškovima)

false pogrešan, kriv, netočan

false echo lažna jeka (na radaru), lažni odjek (na radaru): *The radar operator should become familiar with the appearance of false echoes so as not to confuse them with echoes from legitimate contacts.*

false echoe (n) (navig) lažna jeka (na radaru)

false keel (sailing vessels) zaštitni kilj, falšakilja

false keelson (n) (nav arch) zaštitna kobilica, zaštitni kilj

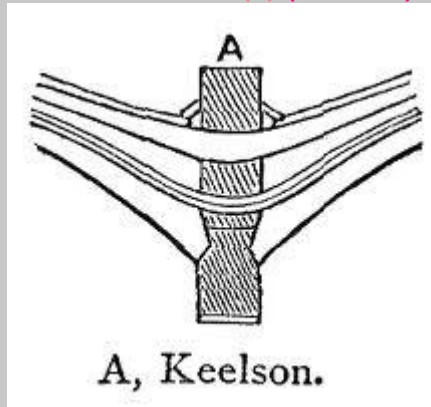

A, Keelson.

familiarization /fə'mɪljə, ri'zation/ (n) (navig) upoznavanje, prilagodba **familiarization training** izobrazba za upoznavanje: *The consequences of ECDIS deficiencies are due to a lack of onboard familiarization training in the use of ECDIS.*

familiar with dobro upoznat s, upućen

fan (n) (marine eng) ventilator **fan belt** remen ventilatora

fan mussel (n) periska

fare /fɛə(r)/ (n) (shipping econ) the money that a person pays to travel by bus, plane, taxi, etc **cijena putničkog prijevoza, prevoznina**

F.A.S. (free alongside) (mar law, shipping econ) (jedan od trgovinskih uvjeta INCO) cijena uključuje dopremu tereta za ukrcaj na lučku obalu (do ispod broda ili brodskog čekrka). Free Alongside Ship means that the seller delivers when the goods are placed alongside the vessel at the named port of shipment. This means that the buyer has to bear all costs and risks of loss of or damage to the goods from that moment. (Tetley) **franko uz bok broda, franko lučka obala (pod čekrk broda) F.A.S. (free alongside) (named port of shipment) franko uz bok broda (s naznakom luke ukrcaja), F.A.S. (free alongside) port of Rijeka franko uz bok broda u luci Rijeka**

fashion timber (n) (sailing vessels) međurebro krme

fast (adj) (seamanship) vezan, privezan: *A ro-ro vessel was exiting the lock with a Voith Schneider tug fast forward and an Azimuth Stern Drive tug fast on the starboard quarter.* Jedan ro-ro brod izlazio je iz ustave s tegljačem s Voth-Schneiderovim pogonom privezanim po pramcu i jednim tegljačem s krmenim azimutskim pogonom privezanim bočno po krmi. **made fast** **privezan, vezan, make fast** **vezati (brod)**

Fast Daughter Craft (FDC) (n) (nav arch) prateće brzo plovilo (za popravke, spašavanje itd.) *A FDC's function is to operate away from the mother ship or offshore installations for extended periods of time. The primary function is to search for and rescue persons lost at sea.*

fasten (v) 1 vezati, privezati; 2 pričvrstiti

fast ferry (n) (nav arch) brzi trajekt

FASTON connector (n) (electr) faston konektor (s maticom za pritezanje stopice, kabela), ženski dio konektora

fast timer constant; (FCT) kontrola radara za otklanjanje smetnja od padalina

fatality (n) 1 (safety) smrtni slučaj, smrtno stradala osoba: *MAIB has also recently published reports into a triple fatality on board Viking Islay and a double fatality in Sava Lake. Parting of a mooring line alongside at berth in the port resulted in one injury and one fatality.*; 2 nesreća sa smrtnim posljedicama

fathom /'fæðəm/ (n) (seamanship, navig) a unit of length equal to 6 feet (1.8 m), roughly measured as the distance between a man's outstretched hands **sežanj (1,829 m), fadom, paš, tal.**

braccio {Comes from the Dutch word fadom which was the distance between fingertips of outstretched hands (www.USMM.org)}

fathometer (n) (navig) = **echosounder** A trade name for an instrument that measures water depth by emitting an electronic signal through the water and measuring the elapsed time for the signal to reflect off the bottom and return

(<http://www.seatalk.info/cgi-bin/nautical-marine-sailing-dictionary>) **dubinomjer** {US}

fatigue /fə'ti:g/ (n) to weaken as a result of constant strain and movement **zamor (materijala),**

zamorenost (materijala) resistance to fatigue otpornost na zamor materijala,

fatigue limit granica zamora, **fatigue-resistant** otporan na zamor **fatigue steel** čelik

otporan na zamor, **effect of fatigue** učin zamora, djelovanje zamora, efekt zamora

fault /fɔ:lt/ (n) 1 kvar, mana, defekt, havarija, neispravnost, poremećaj, mana **fault in**

the scavenge system defekt sustava ispiranja, **incipient fault** početna greška, kvar

na samom početku; 2 grješka, greška; 3 krivnja **be at fault** biti kriv: *When a cargo is lost or damaged, it is not at all easy to determine who has been at fault and who should be liable.*

faulty (adj) neispravan, loš, pokvaren, manjkav

fax 1 faks, dokument primljen putem faksimil uređaja; 2 faksimil uređaj

faximile recorder faksimil pisač

F.C.A. (free carrier- (named place)) (n) (mar law, shipping econ) Free Carrier means that the seller fulfils his obligation to deliver when he has handed over the goods, cleared for export, into the charge of the carrier named by the buyer at the named place or point. If no precise point is indicated by the buyer, the seller may choose within the place or range stipulated where the carrier shall take the goods into his charge. When, according to commercial practice, the seller's assistance is required in making the contract with the carrier (such as in rail or air transport) the seller may act at the buyer's risk and expense. **slobodno morski prijevoznik (s navednim mjestom preuzimanja robe), franko morski prijevoznik, franko brodar, franko vozar**

FCC (first class charterer) (shipping econ) prvoklasni čarterer

F.C.L. (full container load) (n) (mar law, shipping econ) **ANTONYM LCL**

COMPARE container load In a FCL shipment the shipper usually packs its goods in the container and seals it.; sav teret u kontejneru glasi na istoga primatelja **izravna kontejnerska pošiljka, direktna kontejnerska pošiljka**

fear (v) **fear damage to cargo** bojati se / strahovati da je teret oštećen **strahovati, bojati se**

feathering (n) (boating/yachting) jedrenje preostro uz vjetar (jedra lepršaju)

feature (n) osobina, obilježje, karakteristika, crta, svojstvo, posebnost

fee 1 a pristojba, dadžbina **clearing fees** carinska dadžbina; 2 provizija; 3 honorar

feed **feed the fire** podržavati vatru (v) napajati, opskrbljivati, snabdijevati

feed (n) **feed piping** napojni cjevovod, 1 **linkage** povratna veza povratno polužje spojni cjevovod

feedback 1 a povratna sprega; 2 povratna informacija

feeder (n) (marine eng) napajač, fider

feeder (n) (nav arch, cargo handling) zdenac oko grotla

feeder (n) 1 (shipping econ) Transportation conveyance utilised to relay cargo from the mother vessel to ultimate destination or from first receipt port to mother vessel

(<http://www.maerskline.com/en-jm/help/shipping-glossary>); Vessels of under 2,500 teu which distribute containers regionally between hub ports. (<http://www.clarksons.com/glossary/>) **razvozno**

prijevozno sredstvo (manji brod, teglenice, kamion itd.); 2 (shipping econ) brod za razvoz kontejnera, **feeder**

feeder port (n) (ports) razvozna luka

feeder service (n) (shipping econ) sea transport system involving use of centralized ports to assemble and disseminate cargo and carry it to and from smaller ports within a geographic area.

razvoz (tereta brodovima iz velike u manje luke), **feeder servis** {Commodities are transported between major ports, then transferred to feeder vessels for further transport to a number of additional ports.}

feeder ship (n) (shipping econ, mar law) a short-sea or coastal vessel which transfers cargo

between a central "hub" port and smaller ports (also known as feeder ports **brod za razvoz**, **brod u razvozu**, **feeder**

feed heater (n) (marine eng) zagrijač napojne vode **direct contact feed heater** vosokotlačni zagrijač napojne vode

feed pump (n) (marine eng) napojna pumpa, napojna sisaljka, dobavna pumpa

boiler feed pump napojna pumpa kotla, **main feed pump** glavna napojna pumpa

feedstuff (n) (cargo) = **foodstuff** životinjska hrana: *Most of the Port's considerable trade in animal feedstuffs is discharged here where there is large – scale private sector investment in specialist warehousing.*

feed sysetm (n) (marine eng) napojni sustav, dobavni sustav, sustav napajanja (gorivom, vodom, uljem itd.)

feed tank (n) (marine eng) rezervoar napojne vode **make-up feed tank** dolijevni tank napojne vode

feed water (n) (marine eng) napojna voda **boiler feed water** napojna voda kotla,

supply of feed water dobava / dovod napojne vode, **supply feed water** pretičak / višak napojne vode

feed-water unit (n) (marine eng) uređaj napojne vode, napojni uređaj

fender (n) (seamanship) rubber, PVC, canvas, wood or rope used over the side to protect a vessel from chafing when alongside another vessel or a dock. **bokobran**, **stičnica boka**, **pajet**

parabordo; tal. **parabordo**: *Four fenders are mounted on four breasting dolphins which form the*

fender line, with which the moored ship will be in contact. **rig the fenders** postaviti bokobrane,



floating fender plutajući bokobran

fendering odbojnici (na obali in na brodu)

fender line (n) (ports) linija odbojnika, red odbojnika: *The fender line is approximately 280 feet from the shore line*

fender spar (n) (seamanship) plutajući odbojnik

feright rate (mar law) vozarinski stav

ferrous metal /'fɛrəs/ (n) (marine eng) željezni metal **non-ferrous metal** obojeni metal

ferrum; (Fe) (n) zeljezo

ferry (n) (nav arch) A vessel of any kind which is used to transport passengers and goods on a relatively short passage across a body of water, and which operates on a regular schedule similar to that of a train or bus (<http://www.seatalk.info/cgi-bin/nautical-marine-sailing-dictionary>) **trajekt**: *A ro-ro passenger ferry left port with the second officer on watch. The foot passengers and vehicles were loaded on the ferry's main car deck. Once parked up, the vehicle occupants made their way up to the passenger lounge and the ferry sailed on her short crossing.* **ferry route** trajektna linija, **ferry ticket** karta za trajekt, **ferry port** trajektna luka, **ferry operator** trajektni brodar: trajektna kompanija

ferry (v) (navig) prevoziti preko rijeke, kanala itd., prevoziti trajektom: *They, along with winchmen, signalmen and tallymen worked in 12-hour shifts and the tugs would ferry them to and from land twice daily.*



ferry-boat (n) (nav arch) trajekt, tal. traghetto

fertilizers /'fɜːtəlaɪzə(r)z/ (n) (cargo) umjetna gnojiva

fetch (n) (boating/yachting) dostizati oznaku do trenutka u kojemu jedrilica može proći drugu jedrilicu u njezinoj privjetrini i ostaviti je na zahtijevanoj strani bez mijenjanja uzda **dosezati**

fetch (n) (meteorol) duljina otvorenoga morskog područja ili razmjerno jednolikoga kopnenog

terena na kojemu je mjerena od određene točke u smjeru uz vjetar; the area in which ocean / sea waves are generated by the wind; the length of the fetch area, measured in the direction of the wind
privjetrište **fetch length** dužina privjetrišta

few /fju:/ (adj) malo a **few** nekoliko, nekolicina (ljudi), **quite a few** priličan broj {few + brojive imenice; little + nebrojive imenice}

fibres /faibə/ vlakno

fiddle (n) (boating/yachting) izdignuti rub (stola, police)

F.I. (free in) (shipping econ) troškove ukrcaja snosi primatelj **slobodno u**, **franko ukrcaj**

figure 1 (n) brojka, broj; **2** slika (u stručnom tekstu)

figure-head (n) (nav arch, sailing vessels) pulena, pramčani kip

figure-of-eight knot (n) (seamanship) osmica, tal. *nodo a otto*



file /fail/ **1** fascikl, mapa; **2** datoteka, **fajl**; **3** (mar law) brodska mapa, **fajla** **file holder** **registrator s brodskom mapom**: *A file holder with the written voyage plans of past voyages is just a piece of unnecessary ballast, but excellent documentary evidence of resources ...*

file /fail/ (v) **podnijeti** (zahtjev, molbu, tužbu, tražbinu itd.) **file a claim** **podnijeti tražbinu**, **podnijeti zahtjeva za naknadu štete**, **file a claim with** **podnijeti zahtjev kod**: *The claim may be filed with the delivering carrier.*, **file an application** **podnijeti molbu**, **podnijeti zahtjev**

file /fail/ (n) (marine eng) turpija, **lima rough-cut file** gruba turpija, **round file** okrugla turpija

fill (v) **1** (marine eng, seamanship) **puniti**, **ispuniti**, **unijeti**: *A short time later, the engine well started to fill with water from the stern. The third engineer used the diesel oil (DO) transfer pump to fill up the emergency fire pump diesel oil header tank.*; **2** **ispuniti** (obrazac, dokument itd.) **fill in** (mar law, safety) **ispuniti / popuniti obrazac**: *He then started to collect information required to fill in the deck log.*, **fill out** (mar law, safety) **ispuniti / popuniti obrazac**: *The Officer on watch was busy filling out his overtime request slips. The Senior DPO was at the console carrying out the movement whilst the junior DPO was filling out a Permit to Dive next to the DP console.*

filler cap (n) (boating/yachting, marine eng) poklopac cijevi dovoda (na palubi)

fill in (v) (mar law, safety) = **complete** **ispuniti** (obrazac)

filling chocks (n) **1** (nav arch, sailing vessels) umetci kljuna; **2** krmni umetci

filling material **COMPARE** **dunnage** materijal za ispunjavanje (praznih prostora)

filling transom (n) (sailing vessels) prečanica krme

fill out (v) = **fill in** **ispuniti** (obrazac)

film (n) (marine eng, seamanship) tanak sloj, tanka prevlaka, opna, mrena, **film oxide** **film** tanki sloj oksida

F.I.L.O. (free in, liner out) (n) (mar law) **franko ukrcaj**, **iskrcaj na teret brodara**

filter lube oil **filter** filter / čistilac ulja za podmazivanje, dvostruki pročistač, indicator **filter** kontrolni filter, **filter** element filterarski uložak / umetak, clean the **filter** očistiti filter, change the **filter** promijeniti filter, replace the **filter** zamijeniti filter novim 1 pročistač; 2 (marine eng) filter; 3 čistilac; 4 filter

fin (n) 1 peraja, pomična kobilica jedrilice **fin keel** pomična kobilica jedrilice; 2 (nav arch) stabilizator

findings (n) nalaz (inspektora, stručnjaka): the survey report was based on **findings** Some of the **findings** and lessons learned from the official report are as follows:

find out (v) 1 a otkriti; 2 ustanoviti; 3 odgonetnuti

fine (n) (mar law) novčana kazna, globa be liable for a **fine** podlijegati kazni: Any seafarer bringing weapons or narcotics on board shall be liable for such **fin** as the Master may direct Svaki pomorac koji donese oružje ili droge na brod podliježe kažnjavanju ovisno o zapovjednikovoj naredbi, **fine levied against the ship** kazna nametnuta / određena brodu, levy a **fine** nametnuti kaznu / globu, odrediti kaznu / globu: Failure to comply with certification requirement may result in a heavy **fine**, arrest or a penalty., heavy **fine** velika globa, teška globa, teška novčana kazna, be punished by a **fine** of kazniti globom od .. A person responsible for any pollution as described in Articles 1 and 2 shall be punished by a **fine** of not less than US\$ and not more than US\$...

fine (v) (mar law) globiti, kazniti novčano, odrediti globu, izreći globu, osuditi na globu: After **fining** the the masters US\$ 5,000 each, the district judge also ordered Captain XX to pay US\$ in costs.

fine-grained (adj) sitnozrnate strukture **fine-grained steel** čelik sitnozrnate strukture

fine particles (n) (marine eng) sitne čestice break the oil into **fine particles** rspršiti naftu u sitne čestice

finer mesh (n) 1 (marine eng) gušće očice filtra; 2 gušća mreža

finger (n) (ports) a narrow dock or pier which protrudes into the seaway uski gat

finger jetty (n) (ports) izduženi gat (za prihvat brodova/brodica s obje strane)

finger pier (n) (ports) gat (izgrađen okomito na obalnu liniju)



finished goods (n) (cargo) finalni proizvodi

Finished with engines - no more manoeuvring! (comm, marine eng) Svršeno u stroju - završeno s manevriranjem!, tal. *Basta col motore!*; *Finito in macchina!* {naredba za upravljanje strojem}

Finished with the wheel, no more steering! (*navig, seamanship*) **Svršeno s ručnim kormilarenjem!** {zapovijed za kormilarenje}

finishing (*boating/yachting*) položaj jedrilice u regatnome natjecanju pri kojemu bilo koji dio njezina trupa, posade ili opreme u normalnome položaju presijeca ciljnu crtu u smjeru kursa od posljednje regatne oznake **završavanje**

fin keel (*n*) (*boating/yachting*) fiksna kobilica s utegom

finn (*n*) (*boating/yachting*) fin, jedrilica tipa *finn*

F.I.O. (free in and out) (*n*) (*shipping econ*) A term of a charterparty. It means that the charterer controls and pays for loading and discharge of the cargo (which is therefore free of charge to the shipowner). (Tetley); troškove ukrcaja i iskrcaja snosi naručitelj **franko ukrcaj i iskrcaj, slobodno u i iz**; *under f.i.o. terms the cost of loading and unloading a vessel is borne by the shipper or charterer*

F.I.O.S. (free in and out stowed) (*shipping econ*) the charterer controls and pays for loading, discharge and stowage of the cargo; naručitelj snosi troškove ukrcaja, slaganja i iskrcaja tereta **franko ukrcaj i iskrcaj te slaganje tereta, slobodno u i iz, složeno**

F.I.O.S.T. (free in/our, stowed and trimmed) (*n*) (*shipping econ, mar law*) charterer pays for cost of loading/discharging cargo, including stowage and trimming; naručitelj snosi troškove ukrcaja, slaganja, ravnanja i iskrcaja **franko ukrcaj/iskrcan, složen i triman (uvjet prijevoza tereta), slobodno u i iz, složeno i poravnato**

F.I.O.T. (free in and out trimmed) (*shipping econ*) slobodno u i iz, poravnato

fir (*n*) (*cargo*) jelovina

fire **fire alarm** požarni alarm / uzbuna, **fire detection device** uređaj za otkrivanje požara, **fire extinguisher** aparat za gašenje požara, **fire fighting** protupožarna zaštita, **fire fighting appliances** protupožarna oprema, **fire fighting equipment** protupožarna oprema, **fire hydrant** protupožarni hidrant, **fire main** glavni protupožarni cjevovod, **electric fire** electric fire, **fire protection** protupožarna zaštita, **fixed fire installations** fiksni / ugrađeni uređaji na gašenje požara, **flammable liquid fire** požar zapaljive tekućine, **gas fire** požar plinova, **liquid fire** požar tekućine / kapljevine, **fight the fire** gasiti požar, **fire the fuel** zapaliti gorivo, **set on fire** zapaliti požar, **vatra set fire to** podmetnuti požar, **fire broke out in the hole** požar je izbio u skladištu, **extinguish fire** ugasiti požar, **put out the fire** pogasiti požar, **smother fire** prigušiti vatru, **confine fire** lokalizirati požar, **fire fighting brigade** vatrogasna jedinica, **fire precautions** protupožarne mjere, **catch fire** zapaliti se *Five people were confirmed to have died in the car ferry that caught fire off the coast of Greece.*

fire (*n*) (*navy*) pucnjava, **vatra return fire** uzvratiti vatru, **uzvratiti pucnjavu, gunfire** pucnjava vatrenim oružjem **exchange if fire** razmjena pucnjave

fire (*v*) ispaliti, lansirati (signalnu raketu)

fire alarm control panel (*n*) (*safety*) vatrodojavna stanica

fire alarm system sustav protupožarne uzbune

fire blanket (*n*) (*safety*) azbestni protupožarni pokrov, azbestna protupožarna

fire damper

fire-extinguisher



zaštita

fire damper (n) (safety) prigušivač vatre, protupožarna zaklopka, *protupožarna*



trapola

fire detection and alarm system sustav otkrivanja i dojave požara

fire detection panel (n) (safety) alarmna ploča za slučaj požara, vatrodojavna stanica

fire detection system (n) (safety) sustav dojave požara, sustav otkrivanja požara

fire detector (n) (safety) javljač požara **manual fire detector** ručni javljač požara



fire drill vježba gašenja požara

fire-extinguisher (n) (safety) protupožarni aparat, tal. *estintore* **portable**

fire-extinguisher prijenosni uređaj za gašenje požara



fire-extinguishing equipment protupožarni uređaji

fire-extinguishing system protupožarni sustav

fire fighting appliances (n) (nav arch) uređaji za gašenje požara **state of fire fighting appliances** stanje uređaja za gašenje požara

fire-fighting equipment (n) (safety) protupožarna oprema

fire fighting ship (n) (nav arch) vatrogasni brod

fire-fighting system (n) (nav arch) protupožarni sustav **deck fire-fighting system** palubni protupožarni sustav

fire-fighting team (n) (safety) protupožarna grupa, vatrogasni tim

fireguard 1 (safety) protupožarni stražar; 2 protupožarna straža

fire hose (n) (safety) protupožarna cijev, protupožarno fleksibilna cijev, **maniga**. Are fire hoses and fire fighting equipment on board and ashore positioned and ready for immediate use? Je li protupožarna oprema pravilno postavljena i spremna za upotrebu?



fire main (n) (safety) vodovod protupožarnog sustava, cjevovod za gašenje požara vodom **fire main line** cijev protupožarnog vodovoda

fire mains (n) (safety) vodovod protupožarnog sustava, cjevovod za gašenje požara vodom

fireman 1 (marine eng, mar law) ložič (u brodskoj strojarnici); 2 (safety) a rating responsible for maintenance and handling of firefighting equipment onboard the ship **vatrogasac**

fireman's outfit (n) (safety) vatrogasno odijelo

fire monitor vodeni top (na tegljaču), protupožarni top

fire partrol protupožarna ophodnja
fire plug (n) (nav arch, safety) hidrant
fire-proof door (n) (nav arch) protupožarna vrata
fire pump (n) (safety) protupožarna pumpa
fire regulations (n) (safety) protupožarni propisi
fire-resisting door (n) (nav arch, safety) vatronepropusna vrata, protupožarna vrata
fire roll (n) (safety) raspored za gašenje
fire suit (n) (safety) protupožarno odijelo
fire suppression system (n) brodski sustav za suzbijanje požara: *The ship's fire suppression system was immediately activated, which contained and extinguished the fire.*
fire tube (n) (marine eng) plamena cijev, dimocijev
fire tube boiler (n) (marine eng) vatrocijevni kotao
fire watchman (n) (safety) vatrogasni čuvar
firing /'faɪərɪŋ/ 1 (marine eng) paljenje; 2 loženje
firing order (marine eng) redoslijed paljenja
firing practice and exercise area (n) (navig) područje vojnih gađanja i vježbi
firing stroke (n) (marine eng) eksplozivni takt (motora), takt ekspanzije
first aid (n) (safety) = WHO (World Health Organization) COMPARE International Medical Guide for Ships prva pomoć **render first aid** pružiti prvu pomoć, **basic life support** sequence of actions aimed at resuscitating a person whose life is in danger **osnovne radnje za oživljavanje osobe**, **Cardio-pulmonary resuscitation (CPR)** kardiopulmonarna reanimacija **kardiopulmonarno oživljavanje**, **shake and shout** prodrmaj i viči, **airway** dišni putovi, **dovod zraka**, **breathing** disanje, **mouth-to-mouth rescue breathing** disanje usta na usta, **mouth-to-nose breathing** disanje usta na nos, **to administer oxygen** davanje kisika, **chest compression** kompresija prsa, **pritisakanje prsnog koša**, **take the pulse** izmjeriti puls, **choking** gušenje, **bleeding** krvarenej
first-aid-kit (n) (boating/yachting) komplet za prvu pomoć **assorted sterile dressings** razne sterilne gaze, **sterile gauze pads** sterilni jastučići od gaze, **assorted plasters** razni flasteri, **crepe and conforming bandages** krep zavoji, **triangular bandages** zavoj - trokutasta marama, **bandage clips, tape, and safety pins** kvačice za zavoje, **ljepljiva vrpca i igla sigurnica**, **scissors and tweezers** škare i pinceta, **sterile wipes for wound cleaning** sterilni rupčočići za čišćenje rana, **latex-free disposable gloves** rukavice za jednokratnu upotrebu, **diarrhoea medication** lijekovi protiv proljeva, **painkillers** lijekovi protiv bolova, **antiseptic cream** antiseptička krema, **eye bath and lotion** kapi za oči i krema, **thermometer** toplomjer, **good first-aid manual** dobar priručnik za prvu pomoć
First Assistant Engineer (US) prvi časnik stroja, prvi strojar {US system of manning: Chief Engineer; 1st Assistant Engineer; 2nd Assistant Engineer; 3rd Assistant Engineer;}
first come first served tko prvi dođe taj prvi dobiva (vez itd.), tko dođe prvi, taj ima prvenstvo: *All other vessels are on a "first come first serve" basis*

First Engineer Officer (n) (mar law, marine eng) prvi časnik stroja

First Engineer (1st Engineer) (n) (mar law, marine eng) = **First Assistant**

Engineer (US) prvi časnik stroja, prvi strojar, prvi oficir stroja, prvi makine; prvi od makine (Non-British system of manning: Chief Engineer; 1st Engineer; 2nd Engineer; 3rd Engineer (u Hrvatskoj trgovačkoj mornarici))

First Mate; 1st Mate (n) (mar law, navig) prvi časnik palube, čif, prvi (od koverta / kuverta), čif, primo (=1st Mate; =Chief Officer)

first watch (n) (navig) straža od 20:00 do 24:00 sati prva straža, prva gvardija

fish (n) to clean **fish** čistiti ribu, to fillet **fish** rezati ribu za konzerviranje, to gut **fish** čistiti iznutricu ribe, to skin **fish** ljuštiti ribu, prati ribu, pelagic **fish** pelagična riba, pučinska riba (plava), benthos **fish** pridnena riba (bijela), oily **fish** plava riba,

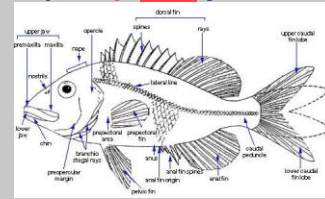

white-flesh(ed) **fish**; white **fish** (UK) bijela riba 1 riba

fish anatomy (n) (fishing) anatomija ribe

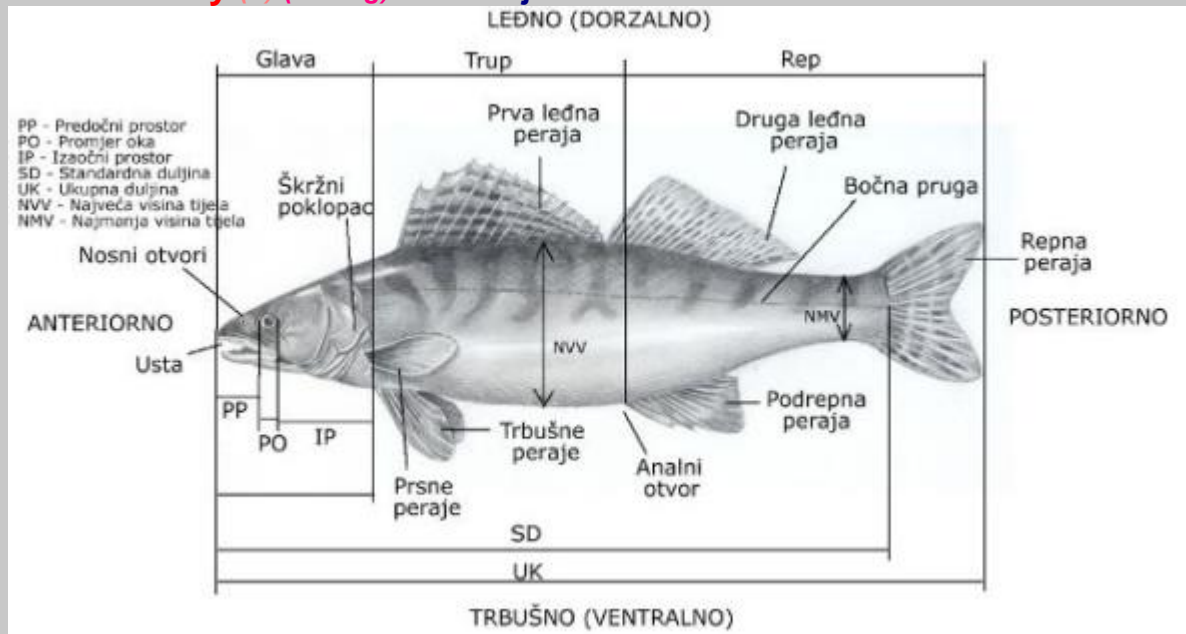

fish carrier (n) (nav arch) brod za prijevoz ulova ribe

fisherman's anchor (n) (seamanship, boating/yachting) **SYNONYM** Admiralty anchor; admiralty anchor admiralitetsko sidro

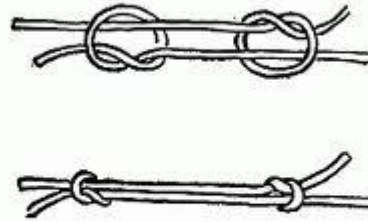

fisherman's knot (n) (seamanship) ribarski uzao

fisherman's wharf (n) (ports) ribarski vez, ribarska obala

fish factory ship (n) (nav arch) brod za preradu ulova ribe

fishing apparatus ribastki pribor, sredstvo za ribolov

fishing area (n) (navig) ribolovno područje, područje ribolova: *They could therefore either remain in port and wait for the weather to abate, or steam for 2 days to another fishing area where the forecast was more favourable.*

fishing boat (n) 1 (nav arch) ribarska brodica, ribarica, tal. *peschereccio*: *We met a fishing boat on a reciprocal course. Two crewmen of a fishing boat were on the deck and had just started to shoot a line of pots.*; 2 ribarski brod

fishing gear = fishing tackle oprema za ribolov, pribor za ribolov: *In the late evening, the port fishing gear became snagged on an underwater obstruction. When the fishing gear fouled the propeller, the boat would have become anchored at its stern and vulnerable to being swamped and ultimately capsizing. Back in the wheelhouse, the skipper closed the engine room hatch and instructed the crew to haul in the fishing gear and don their lifejackets. After further checks, the main engine was started, fishing gear recovered and, under her own power, the trawler returned to her home port.*

fishing ground (n) ribolovno područje, područje ribarenja: *The skipper had just hauled his lines onboard and was heading for another fishing ground.*

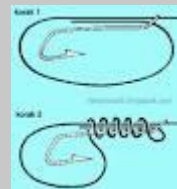

fishing knot (n) (fishing) ribarski čvor, čvor za udicu

<http://www.gogaspe.com/salmon/knots/fishknot2.htm>

{see:

fishing lights (n) (navig) svjetla ribskog broda

fishing line (n) (fishing) povraz, struna, tunja, kančenica, najlon, krena, fildešpanj, silk, svila fluorcarbon **fishing line**; monocarbon line fluorkarbonski povraz: *For a perfect presentation and increased hook setting, this fluorocarbon is invisible underwater and offers the ideal balance between stiffness, strength, sensitivity and stretch and thereby an outstanding abrasion-resistance. Fluorocarbon fishing line has, in recent years, become a popular option for anglers in many situations.*, mono **fishing line** = monofilament line povraz od jedne niti,

jednovlaknasti najlon / povraz, monofil: *a sensitive line with an extreme shock absorber build-in to the monofilament. How To tie braided fishing line to monofilament or fluorocarbon leader-*

easy and atrong fishing knot ?, **braided fishing line; braided line najlon od pletenih**

vlakana, sukani povraz: *The braided line is super sensitive and accurately passes every single nibble*

to the bait, alerting the angler to strike.

fishing line knot (n) (fishing) = **fishing knot** čvor za udicu, **ribarski čvor**

fishing rig (n) 1 **predvez**: The basic types of fishing rigs are: Texas rig, Carolina rig, drop shot rig, sliding sinker bottom rig, split shot rig, three way rig, stream rid, bottom bouncers, bait walkers, slip bobbers.; 2 (fishing) = **fishing tackle** ribolovni pribor

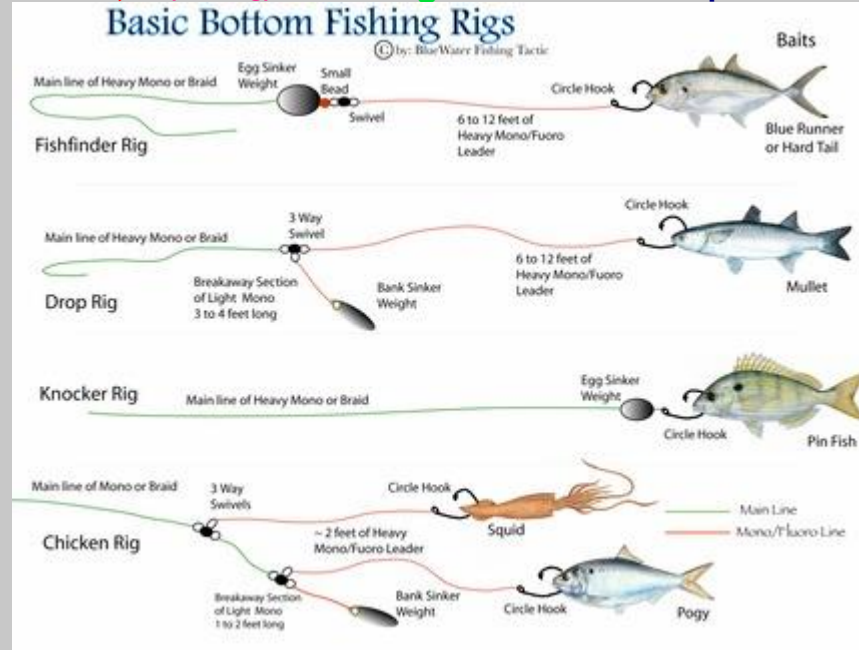

{members of fishing rig: bobfloat

/ bobber / cork / bob = a small float usually made of cork; **fishhook** = a sharp barbed hook for catching fish; **fishing line** = length of cord to which the leader and float and sinker and hook are attached; **fishing pole / fishing rod** = a rod of wood or steel or fiberglass that is used in fishing to extend the fishing line; **gaff** = an iron hook with a handle; **harpoon** = a spear with a shaft and barbed point for throwing; used for catching large fish or whales; **landing net** = a bag-shaped fishnet on a long handle to take a captured fish from the water; **reel** = winder consisting of a revolving spool with a handle; **fishgig / fizgig / lance / spear / gig** = an implement with a shaft and barbed point used for catching fish; **spinner** = fisherman's lure}

fishing rod (n) (boating/yachting) A long lever, usually made of fiberglass, graphite or composite materials and used to catch fish. **ribolovni štap** {Different types are available, such as rods for spinning, fly fishing, spincast, bait casting, boat fishing, offshore trolling, surf fishing, jetty/pier fishing, etc. Most rods have a reel-holding clamp and guides through which the line runs.}

fishing spoon (n) (fishing) **SYNONYM blinker blinker**

fishing tackle (n) (fishing) oprema za ribolov, oprema ribolovnog štapa, ribolovni pribor, The suggested tackle for Texas rig: rods: 6-6-7 foot medium heavy fast action bait casting; reel: low profile bait casting reel 6:3:1 gear ratio, thumb bar releasew medium line capacity; line: 10 lb to 14 lb testlow stretch monofilament.

fishing techniques (n) (fishing) tehnike ribolova **pole and line fishing** ribolov primamljivanjem (*brumanjem*) i štapom, **dive fisheries and hand collection** ronilački ribolov, **pots and traps** ribolov vršama, **dredging** kočarenje, ribolov kočama, **purse seine** ribolov mrežom plivaricom, plivaričarenje, **pelagic longlining** ribolov površinskim / pučinskim parangalom, površinski parangal, **demersal longlining** ribolov parangalom na morskome dnu, pridneni parangal, **pelagic trawling** površinsko kočarenje, ribolov površinskom kočom, **demersal trawling** kočarenje na morskome dnu, ribolov kočom na morskome dnu, **ghost fishing** štetni i

nepoželjni lov napuštenim mrežama i drugim ribarskim alatima (hvatanje nepredviđenih organizama u mrežu), ribe uhvaćene u napuštenim mrežama, **drifting gillnet**; **pelagic gillnet** ribolov pučinskom površinskom mrežom posebnog oka, **demersal gillnet** ribolov na morskom dnu mrežom posebnog oka

fishing vessel (n) (nav arch) ribarski brod

fish searching vessel (n) (fishing) tragač ribe

fish the anchor (v) (seamanship) secure the anchor in the cat head **učvrstiti sidro** (podignuto na sidrenoj sohi)

fit (v) **fit between** umetnuti, **fit over** montirati / postaviti na / preko, **fit slack** ugraditi / postaviti labavo, **fit together** sastaviti, sklopiti, spojiti, **fit with** opremiti, opskrbiti / snabdjeti **1** (marine eng) a staviti, postaviti; **2** opremiti, *armat*; **3** ugraditi, montirati; **4** namjestiti, prilagoditi, podesiti

fit (n) **be a close fit** dobro pristajati / sjedati, tijesno ležati, prijanjati **1** a pristajanje, stavljanje; **2** prilagodba; **3** ugradak

fit (adj) **1** a pogodan, prikladan; **2** spreman

fitness (n) (mar law) prikladnost broda (za preuzimanje i prijevoz tereta)

fit out (v) (seamanship, boating/yachting) opremiti, *armat*; *armati*

fitted with (adj) **be fitted with with** biti opremljen (s), imati, sadržavati opremljen (s), koji ima / nosi na sebi, koji sadrži

fitter (n) **1** (marine eng) a rating responsible for daily maintenance and minor repairs of all mechanical equipment onboard the ship **monter**: *The fitter began the job by unscrewing the securing bolts of the angle bar at one end of the plates, then moved to the other end.*; **2** mehaničar; **3** strojobravar

fitting okov na palubi za hvatanje vezova za teret **hvataljka, okov**

fittings (n) **1** (marine eng) a small part on or attached to a piece of piping, furniture or equipment **oprema, sitna oprema, ventili, zasuni, pipci itd., fitinzi pipeline fittings** oprema



cjevovoda ; **2** sitna oprema male jedrilice

small-boat fittings sitna oprema male jedrilice, okovi male jedrilice (hvataljke, bitvice, pramčani okov, stoperi, vodilica škote i škotine, tračnica vodilice)

fix (n) **running fix** pozicija dobivena u razmaku vremena, **make a fix** odrediti

poziciju, to obtain a fix dobiti / odrediti poziciju broda: *The usual method of obtaining a fix on the chart from radar ranges is to use a pair of compasses and draw "position circles" of at least three,*

widely-spaced identified conspicuous objects. **C, plot a fix ucrtati poziciju** If ECDIS is in use, fix frequency is not an issue. Nevertheless, it is reasonable to plot fixes at less frequent intervals when using an ECS, checking the system with a hand-plotted fix at prudent intervals. **, satellite fix pozicija broda određena pomoću satelitske navigacije (npr. GPS), electronic fix pozicija broda određena pomoću sustava elektroničke navigacije, mark a fix on the chart označiti poziciju na karti** No fixes were marked on the chart, and even the normal recording of GPS positions in the log was not carried out. **(navig) the intersection of two or more lines of position pozicija broda (dobivena snimanjem) opaženi položaj, položaj broda snimanjem jednog ili više terestričkih objekata tal. punto**

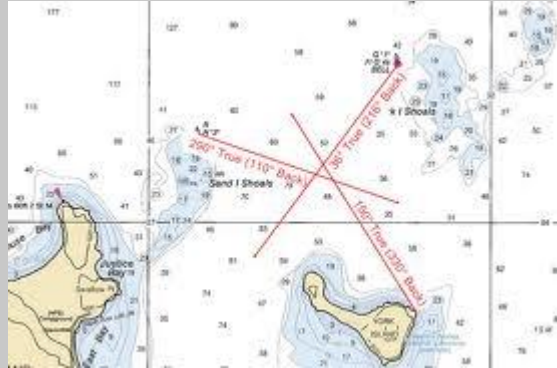

fix accuracy točnost pozicije / snimke / položaja

fix a position (v) (navig) odrediti poziciju broda, utvrditi poziciju broda

fix by soundings (n) (navig) pozicija dobivena mjerenjem dubine

fix dimension (n) (navig, electr) dimenzije očitavanja (navigacijskog sutava)

fixed fittings (n) (cargo handling) Fixed container fittings include: Deck and hatch cover foundations, Lashing points, - In hold installations, - Tank top fittings **nepomična oprema za pričvršćivanje kontejnera fixed container fittings fixed fittings on deck nepomična oprema za pričvršćivanje kontejnera na palubi, fixed fittings in hold fixed fittings u skladištu nepomična oprema za pričvršćivanje kontejnera**

fixed light (n) (navig) a light showing continuously and steadily, as opposed to a rhythmic light stalno svjetlo, fiksno svjetlo

fixed offshore facility (n) nepomični odobalni objekt

fixed pitch propeller; f.p.p. (n) (nav arch, marine eng) = fixed propeller prekretni propeler. The engine drives a fixed pitch propeller and, at sea, is run at 83 rpm to give the ship a speed of about 12 knots⁵.

fixed propeller (nav arch, marine eng) COMPARE controllable pitch propeller; (CPP) fiksni propeler fixed pitch propeller prekretni propeler, prekretni porivnik

fixed route stalni pravac / ruta / brodska linija, utvrđena ruta, ustaljena linija, redovita linija

fixing by radar ranges (n) (navig) određivanje pozicije s radarskim mjerenjem udaljenosti

fix rate (n) (navig, electr) interval očitavanja (mjernih podataka)

fixture /'fɪkstʃə/ 1 (mar law, shipping econ) sklopljeni ugovor o iskorištavanju broda, ugovarateljski posao; 2 (mar law, shipping econ) sklopljena vozarina, sklopljena

najamnina broda, ugovorena vozarina *May and June fixtures are in the \$7.50 to \$7.80 per tonne range for some operators” for a Brazil to China voyage, said a Shanghai-based capesize broker on Thursday*

fix update rate (n) (navig) vremenski period između dvije pozicije

flag (n) (navig, mar law) zastava **hoist a flag** izvijesiti zastavu, istaknuti zastavu, **display the flag** istaknuti zastavu: *These vessels are required to display a red flag by day and an all round red light by night.*, **courtesy flag** zastava zemlje u čijim vodama brod plovi

flag (n) 1 zastava, zastavica; 2 (navig, mar law) država pripadnosti (broda)

flagged ship (n) (mar law) brod nečije zastave, brod nečije državne pripadnosti: *The vessel is flagged in the Marshall Islands.* **UK flagged ship** brod britanske državne pripadnosti, **Croatian flagged ship** brod hrvatske zastave, brod hrvatske državne pripadnosti: *The was sailing under the Croatian flag.*

flag of convenience (n) (mar law) jeftina zastava

flag of ship (n) (mar law) država pripadnosti broda, zastava broda

flag pole (n) (seamanship) zastavni jarbol, jarbolet

flagstaff (n) 1 (nav arch) jarbol za isticanje države zastave broda; flag pole, usually at the stern of a ship; carries the ensign **zastavni jarbol**, tal. *asta di bandiera*; 2 jarbolet (na pramcu), **aštulin**

flag state (n) (mar law) država zastave broda **Law of the flag state** pravo države

zastave broda: *The provision of such crew management services includes the following services, (ii) ensuring that the applicable requirements of the law of the Flag State in respect of rank, qualification and certification of the Crew and employment regulations, such as Crew’s tax and social insurance are satisfied.*

flag state requirements (n) (mar law) inspekcijski nadzor domaćih brodova, propisi države zastave broda

flake /fleik/ (n) (boating/yachting, seamanship) **COMPARE flake; fake** to lay a rope or chain down in long bights side by side or in coils in regular order so that it will run out clear or can be easily and rapidly paid out **slagati konop**: *The Figure 8 Flake allows the rope to be pulled rapidly off the deck with minimal risk of kinking, twisting, or knotting. Before making the flake, start at the cleat and work your way to free the end shaking out any twists.* **flake down** složiti konop

flake catfish (n) (fishing) **mačka mrkulja** {drugi hrv. nazivi: mačka kamenjarka, mačka purićanka, parda, rijanka, šarka, šćedrovača, mačka pjegavica, mrka morska mačka; lat. **SCYLIIORHINUS STELLARIS**}

flake; fake /fleik; feik/ (n) (seamanship) složeni konop, namotaj konopa, uredno složeni konop **Flemish flake; fake** spiralno složen konop



www.animatedknots.com

{both pronunciations are acceptable}

flame (n) (**safety**) **flame arrester** zaustavljač plamena, osigurač plamena: The relief valves are made with an approved **flame arrester function**. For direct reversing main engines >230 mm bore **flame arresters** or bursting discs are required for each cylinder fitted between the cylinder start air valve and the manifold., **flame plate** plamena ploča: Individual cylinder heads, incorporating a thick bore-cooled **flame plate**, are held down by four hydraulically tightened studs., **flame trap** odvajač plamena, prigušivač plamena: In an attempt to reduce the effects of an explosion, **flame traps** and relief valves are provided in the pipelines. **plamen**: The base oil ignited and a **sheet of flame** and dense smoke enveloped the area.

flame detector (n) (**safety**) **javljač plamena**, **detektor plamena**: Flames, as opposed to smoke, are often the main result of gas and liquid fires and **flame detectors** are used to protect against such hazard.

flameproof enclosure (n) (**safety, electr**) **neprodorni oklop** (el. spoja)

flammable (adj) **flammable cargo** zapaljiv teret, **flammable gas** zapaljiv plin, **flammable liquid** zapaljiva tekućina, **flammable vapours** zapaljive pare zapaljiv

flammable cargo (n) (**cargo**) **zapaljivi teret**: After carrying a **flammable cargo**, always assume that the atmosphere within a tank is flammable. Oil tankers, carrying various **flammable cargoes**, experience a real danger of explosion when vapours remain in emptied tanks.

flammable gases (n) (**cargo**) **zapaljivi plinovi**: A container packed or loaded with flammable gases or liquids having a flashpoint below 23°C c.c. should only be stowed under deck. Ventilate properly, and ensure that the atmosphere is correctly tested for both toxic and **flammable gases**, and that the atmosphere is certified as being safe.

flammable liquids (n) (**cargo**) **zapaljive tekućine**: Dry chemical extinguishing systems are designed to combat Class B (**flammable liquids and gases**) and Class C (electrical) fires. Adjacent to the store was a designated storage arrangement for chemicals and **flammable liquids**. {Klasa 3 opasnih tereta}

flammable solids (n) (**cargo**) **zapaljive krute tvar** {Klasa 4 opasnih tereta}

flange (n) **deep flange** deblja prirubnica, **liner flange** prirubnica košuljice: The cylinder liners are short single-piece units with intensive cooling of the upper part achieved by bore cooling of the **liner flange**. (**marine eng**) **prirubnica**, **flanda**: They had difficulty in removing bolts from a **flange** and so decided to cut them off, using gas cutting equipment. **blank flange** slijepa

prirubnica: Take off the assembly and replace it with a **blind flange**, **bolt the flange** spojiti **prirubnicu vijcima**, **flange connection** prirubnički spoj Although the vessel had been in operation for less than six months since the last dry-docking, it was evident that excessive vibrations caused some **flange connections** to become loose; 3., **pipeline flange** prirubnica cjevovoda: It was soon established that the leak originated from a failed joint at a **pipeline flange** on a fuel pump oil

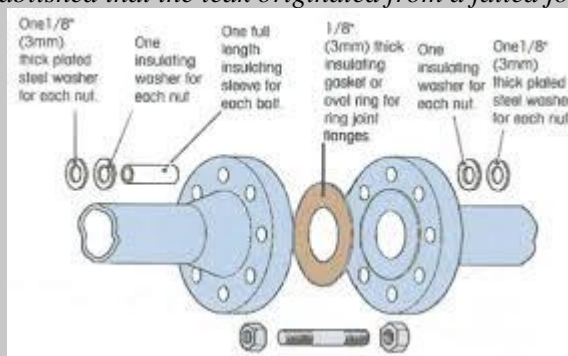

return line .

flap (v) (boating/yachting) treperiti (o jedru), lepršati, tresti se

flare /fleə/ (n) (safety) baklja: At 0500 another **flare** was sighted approximately 2nm ahead of own vessel and the Coastguard was advised. **parachute flare baklja s padobranom, white flare bijela baklja, hand-held flare ručna baklja, mini-flare mini-baklja, orange smoke flare baklja narančastog dima, red flare crvena baklja**: During the twilight hours of the morning a **red flare** was sighted on a northerly bearing, approximately two minutes later, a second flare was sighted. **buoyant flare plutajuća dimna baklja, fire the flare ispaliti baklju, zapaliti baklju**: The crew members of the vessel had abandoned the ship and fired flares for help from a lifeboat, alerting other vessels. **distress flare baklja za slučaj pogibli**: The skipper contacted the coastguard by mobile telephone and a deckhand ignited a **distress flare**.



flare /fleə/ (n) (nav arch) the spreading out from a central vertical plane of the body of a ship with



increasing rapidity as the section rises from the water line to the rail **kosina pramca**

flash (n) thin **flash of tanak sloj / obloga 1 (navig)** a relatively brief appearance of a light **bljeskajuće svjetlo, svjetlo; 2 (marine eng) sloj obloge, sloj zaštitnog materijala**: The **tin flash** also functions as an effective dry lubricant when new bearings are installed and the engine is barred over.

flash (v) (comm, safety) bljeskati, signalizirati bljeskajućim svjetlom: The 3rd Officer used the Aldis Lamp to **flash** him and the Pilot attempted to call him on VHF. After Dover Coastguard were informed, they requested that we continued to call on VHF and **flash** the bulk carrier.

flashback (n) (safety) povratni plamen

flashing light (n) (navig) a light in which the total duration of light in each period is clearly shorter than the total duration of darkness and in which the flashes of light are all of equal duration

bljeskajuće svjetlo: A deckhand released a second flare when they spotted the **blue flashing lights** of emergency service vehicles on the shore, and a third flare on hearing the approach of the local lifeboat. Suddenly he sighted a **flashing light** twice within a short space of time on the port bow and very

flash light

flat rack; flat rack container

close to the ship. In many regions, local regulations require vessels carrying dangerous cargoes to exhibit a flashing red light. **FI single flashing na bljeskove**, **long flashing dugi bljeskovi**, **group flashing bljeskovi 3 u grupi**, **FI (2+1) composite group flashing bljeskovi 2+1 u grupi**, **continuous quick flashing kratki bljeskovi**, **Q(3) group quick kratki bljeskovi u grupi**, **IQ interrupted quick kratki bljeskovi na prekide**, **VQ continuous very quick flashing light ultrakratki bljeskovi**, **flashing light signalling signalizacija bljeskajućim svjetlom**

flash light (n) (safety) ručna svjetiljka: During this turn, there was a short flashing with an



orange flashlight from the other vessel, but nothing else.

flashpoint (n) (marine eng) plamište: Use only clean oil with a flash point above 250 °C. The fuel can be dangerous to handle and store; this is especially so if the pour point is high, making it necessary to heat the HFO close to its flash point.

flat (n) (cargo handling) vagon bez stranica (vagon bez stranica) flat

flat (adj) ravan, plosnat: The engine must also be bolted to a flat surface.

flat bottom (n) (nav arch, marine eng) ravno / plosnato dno

flat car; flatcar (n) (cargo handling) a rail car without a roof and walls plato-vagon



vagon bez stranica

flat container (n) (cargo) = flat rack; flat rack container ravni kontejner,
kontejnerska platforma, flat kontejner

flathead grey mullet (n) (fishing) cipal od porta

flathead mullet (n) (fishing) Lat. Mugil cephalus cipal blataš {Other Croatian names: mulj, glavaš, babaš, skakavac, javra}

flat oyster (n) (fishing) (fishing) kamenica, oštriga

flat rack; flat rack container (n) (cargo handling) a container with no sides and frame members at the front and rear.; container can be loaded from the sides and top ravni kontejner,
kontejnerska platforma, flat kontejner: The unit affected was an empty flat rack with a wooden



floor.

flat rate (n) (shipping econ, mar law) Flat rate reflects the costs in USD of transporting a tonne of cargo for a standard vessel on a route-specific round voyage. The standard vessel is of 75.000 dwt, traveling at 14.5 knots with a consumption of 55 tonnes of 380cst fuel oil. **referentna vozarina:** The reference rate, also known as the **flat rate**, is reported as *Worldscale 100 (WS100)*,

flaw /flɔː/ (n) 1 **neispravnost**; 2 **grješka, greška**: This **design flaw** seems to have existed from the time of construction of the ship and apparently had not been rectified; ; 3 (mar law) **pogreška u proceduri**; 4 (nav arch) **pukotina, napuknuće**

flawless /flɔːləs/ (adj) **bez greške, bez smetnji**

flax oil (n) (cargo, marine eng) **laneno ulje**

fleet /fli:t/ (n) 1 (shipping econ) **brodovlje**: The incident was reviewed by the management office, and shared with all vessels in the **fleet**; **owner's fleet** **brodovlje nekog brodovlasnika**: This incident report will be circulated to the **owner's fleet** and to the industry to increase safety awareness; In future, the vessel is to verify the condition of the entire cargo-hose string with the terminal The information was promulgated to class, the shipyard and throughout the **owner's fleet** and offices. A campaign on mooring safety has been carried out in the **company fleet**.

fishing fleet **ribarska flota** The Scots **fishing fleet** is the third biggest in the European Union., **company fleet** **brodarova flota, flota brodara**: A campaign on mooring safety has been carried out in the **company fleet**.; 2 **mornarica**

merchant fleet **trgovačka mornarica**; 3 (navy) **flota**

Flemish flake (n) (seamanship) **COMPARE flake**; **fake** **spiralno namotan konop, spiralno namatanje užeta**

Flemish horses (n) (sailing vessels) **uže nogostupa na križu**

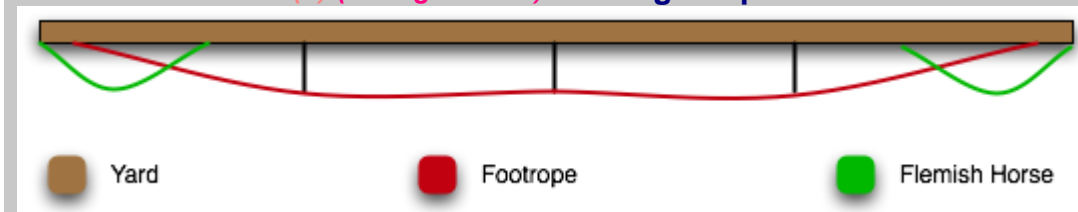

flexibility /fleksɪ'biliti/ (n) (marine eng) **savitljivost, opružnost, elastičnost,**

prilagodljivost: The propulsion plant must therefore allow **flexibility** in operation over a range of power levels while maintaining operating efficiency with respect to fuel and lube oil consumptions.

Operational flexibility and power output are fostered by the single-stage sequential turbocharging system which is based on two turbochargers **load flexibility of the engine** **prilagodljivost stroja svim opterećenjima**

flexible /fleksɪbəl/ (adj) **savitljiv, elastičan, fleksibilan**: The false metal tank top was extremely

flexible and water could be heard moving when this was walked on. **flexible pipe elastična cijev**: As the fire spread, it is possible that *flexible pipes* in the engine room failed, thus allowing more water into the vessel., **flexible hose elastična cijev (gumena, platnena, sintetička)**: The chief engineer decided to recharge the system, using a *flexible hose* linking a full Freon cylinder and the recharging valve located on the compressor. During this operation, a *flexible hose* on the crane came adrift from its coupling and hydraulic oil under high pressure sprayed out, some of it entering the bosun's eyes.

float /fləʊt/ (n) **1 (marine eng) plovak**: The power for the pump and **float switch** was derived from the battery side of the battery isolating switch.; **2 (fishing) plovak, gavitel**

float /fləʊt/ (v) (safety) = **refloat odsukati (brod)**

float /fləʊt/ (n) (nav arch) **plutajući objekt**: Having passed abeam of the **light float**, the other vessel altered course to port.

float /fləʊt/ (v) **plutati**: A liferaft's ability to **float free** is pivotal to its usefulness in an emergency. The rope, being stiff and heavy did not **float**, the excess slack went straight down into the ship's propeller. The draft calculations made by the master were on the basis that the vessel **was floating** in sea water, however, the specific gravity at the time was in fact 1015

float (n) (fishing) A term also for bobber, used as a strike indicator for live bait fishing. **plovak (za udicu)**

floating (n) **plutanje**

floating **koji pluta, plutajući floating container plutajući kontejner, kontejner koji pluta**: Ships have been alerted to the danger of floating containers near the scene of the disaster, although no pollution or hazardous cargo have been reported.

floating boom (n) (safety) **plutajuća brana, barijera (za sprječavanje širenja onečišćenja mora) (plutajuća)**

floating craft **plutajuće plovilo, plutajući objekt**

floating crane **plutajuća dizalica, plovna dizalica, pontonska dizalica**



floating dock (n) (nav arch) **plutajući dok, plovni dok, tal. bacino galleggiante**



floating ice (n) (oceanogr) **plutajući led** The draft calculations made by the master were on the basis that the vessel was floating in sea water, however, the specific gravity at the time was in fact 1015.

floating mark (n) (navig) **plutajuća oznaka**

floating object (n) (nav arch) **plutajući objekt**: *The echo was weak and occasionally disappeared, giving the impression that it was interference or a **floating object** drifting in the sea.*

floating policy (n) (mar law) **otpisna polica**

floating smoke signal (n) (navig) **plutajući dimni signal**

float low in the water (v) (navig) **biti duboko uronjen u vodi**

float off (v) (seamanship, safety) **odsukati se**: *With the engine still going astern, she **float off** on her own. Sa strojem koji je još uvijek vozio nazad brod se sam odsukao.*

float out (v) (nav arch) **zaplutati (iz doka)**: *... the world's biggest cruise ship, was **float out** of dry dock*

float out (n) (nav arch, navig) **isplovljenje iz doka**: *The **float out** was conducted June 18 and 19 under perfect conditions*

floe (n) (oceanogr) **plutajući led** **big floe** **veća plutajuća ledena masa**

flog /flog/ (n) (boating/yachting) **lamatanje jedra**

flood (n) 1 (oceanogr) the period when a tidal current is flowing landward **plima, visoka voda, tal. flusso** **flood tide** **plima, plimna struja, p'limni val**: *The vessel had been in that position for several minutes when the **flood tide** caught the stern and pushed her to one side of the narrow channel.*

flood stream **plimna struja**: *Slack water was at 0926 and so the passage was made with a 2 - 4 knot **flood stream**, which in some sections of the narrow channel was directly abeam.*; 2 (seamanship)

naplavina (u kaljuži, tanku): *The master went into the engine room and saw **flood water** rising in the bilges. **flood water** **naplavna voda, flood level** **razina naplavlivanja, razina***

naplavne vode: *After divers had partially plugged the puncture and a high capacity shore pump had been rigged, the **flood level** in the pump room was reduced to below floor plate level, enabling a cement box to be constructed to prevent further **flooding**.*

flood (v) (oceanogr) **rasti (o moru, morskim mijenama)**: *The wind was force 2 from the north north east and the tide was **flooding** at 3 knots from the north.*

flood /flʌd/ (v) (seamanship) **naplaviti, poplaviti**: *The accommodation space started to **flood**, but instead of investigating the source of the **flooding** further, the skipper instructed the crew to retrieve the nets.*

flooded (adj) **naplavljen (skladište, strojarnica; radi gašenja požara)**

flooding (n) (safety) **naplava, naplavlivanje (skladišta itd.) prodor vode**: *The exact cause of the **flooding** is unknown. The accommodation space started to **flood**, but instead of investigating the source of the **flooding** further, the skipper instructed the crew to retrieve the nets. last passage and conducting ballast exchange operations when a large gate valve in the engine room on the ballast/bilge system failed, causing severe **flooding**.*

flooding of ship's spaces (n) (safety) **naplavlivanje brodskih prostora**: *Some **flooding of forward spaces** was caused by wave damage to ventilation pipes when the vessel was hove to, but she reached port without further problems.*

flooding tide (n) (oceanogr) **plimna struja, plima**: *running astern with main engine and bow thruster, the wind and the **flooding tide** were slightly on the vessel's port side.*

flood light (n) (nav arch) **reflektor**: *The main deck, including the pilot ladder, was well illuminated by the deck **flood lights** and the bridge wing lights.*

flood tide (n) **plima, plimna struja, tal. marea montante**: *Soon after the onset of the **flood tide**, the tension on the forward ropes increased and the bow was set slowly off the wharf. Although*

there was a **flood tide** and the westerly wind was blowing at 15 knots, a tug was not considered necessary.

floor /flɔː/ (n) **1 (nav arch)** poprječni nosivi element dna broda koji se proteže od uzvoja do uzvoja; transverse member fitted to the bottom structure; vertical transverse plate immediately above the bottom shell plating, often located at every frame, extending from bilge to bilge. (Ship Terms

Glossary.html) **rebrenica, rebro na dnu brodske konstrukcije**: *The investigation later found that halfway down the ladder to the forecastle tweendeck, oxygen concentrations were in the order of 10% and only 5-6% at floor level. The Third Officer heard a cry and a thud on the floor of the hold, looking down, he saw the seafarer lying at the bottom of the hold.* **djelomična rebrenica, watertight floor nepropusna rebrenica, deep floor visoka rebrenica, bracket floor okvirna**

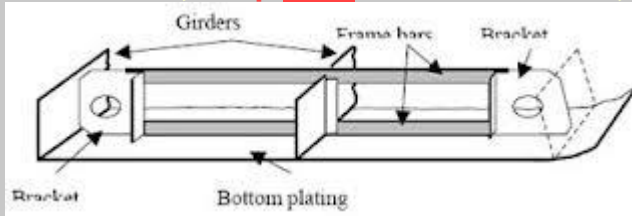

rebrenica; **2 (nav arch)** dno brodskog

skladišta: *That aluminum floor plating in the engine rooms are exchanged with plating of steel.* **floor plates podni limovi, limovi dna skladišta**: *As the chief engineer went onto the bottom floor plates to check the freedom of the propeller shaft he saw there was about 40cm of water in the bilge., floor plating podni limovi, limovi rebrenice, limovi dna skladišta {In wood ships, the lowest frame timber or the one crossing the keel is called the floor}*

floorboard (boating/yachting) podnica, pajol

floor ceiling (n) (sailing vessels) the planking with which the inside of a vessel is sheathed **nutarnja oplata dna, pajol, tal. pagliolo; paliolato**

floor grating (n) (nav arch, marine eng) podne rešetke, gradele, gradelaj: *Air is delivered into the bottom opening and rises through a floor grating over the cargo and returns via another section of the plenum to the top port.*

flooring (n) (nav arch) podne daske (užljebljene), pajoli: *A few days into the voyage, with the ship pitching heavily in gale force winds and high seas, two crewmen were repairing the cabin flooring in a crew cabin.*

floor plate (n) (nav arch) podni lim, podna ploča: *Safely carry out necessary modifications to any similar deficiencies and/or deformed floor plate(s).*

flotsam, jetsam, ligan (lagan) and wreck (n) (mar law) Particular categories of property which may be salvaged. Flotsam refers to things found floating after a ship has perished. Jetsam refers to things thrown overboard to lighten a ship. Ligan (lagan) refers to things thrown overboard with a buoy to mark where they are. Wreck refers to an abandoned vessel or part of a vessel which is still afloat, stranded or aground. (Tetley) **spašena imovina, plutajuća, izbačena s broda, izbačena i označena plutacom te napušteni brod koji pluta**

flounder /'flaʊndə/ (n) (fishing) Lat. Platichthys flesus **iverak, iver, ploča, pašara**



{drugi hrv. nazivi: jezik zlatni, kalkan, morska ploča, pašara, platka, zlatopjeg, viverka, obliš; lat. PLATICHTHYS FLESUS}

flour /'flaʊə/ (cargo) brašno

flow /fləʊ/ (v) **flow by gravity** protjecanje / istjecanje slobodnim padom /

samotokom, flow through propuštati **protjecati** The blower impeller, as it rotates, accelerates the air flow through the impeller, and the air leaves the blower with a velocity that is convertible into a pressure at the diffuser. **teći, kolati, strujati, izlijevati se:** When the system is working properly, the water should **flow** across the tanktop. {flow - flew - flown}

flow /fləʊ/ **traffic flow** 1 (ports, shipping econ) promet tereta (u luci); 2 (navig) kretanje prometa brodova: The other vessel crossed the south bound traffic lane on a course of 0750T and not at right angles to the **traffic flow**. 1 (marine eng) **protjecanje, protok, tijek, tok:** There are thermostatic valves to regulate the **flow of** either the sea or the fresh water. **heat flow** (marine eng) **strujanje topline:** This is particularly important because the exhaust seat insert incorporates a water-cooled cavity to maximize **heat flow** from the valves., **flow meter** mjerac protoka: A **flow meter** is fitted into the system to indicate fuel consumption., **air flow** protok zraka, **strujanje zraka** The blower impeller, as it rotates, accelerates the **air flow** through the impeller, and the air leaves the blower with a velocity that is convertible into a pressure at the diffuser., **gas flow** protok plina: The new bearing arrangement facilitates the use of axial and radial exhaust **gas flow** into the turbocharger, extending the options for the enginebuilder., **flow rate** brzina protoka: The so-called fuel-stop valve interrupts the fuel supply to the relevant injector in cases of excessive fuel **flow rates**.; 2 **strujanje**; 3 (navig) **kretanje (prometa)**

flow of radar signal (n) (electr, navig) tok radarskog signala u predaji i prijemu

FLT (fork lift truck) viličar: At all times around 250 new and refurbished used **forklift trucks** and

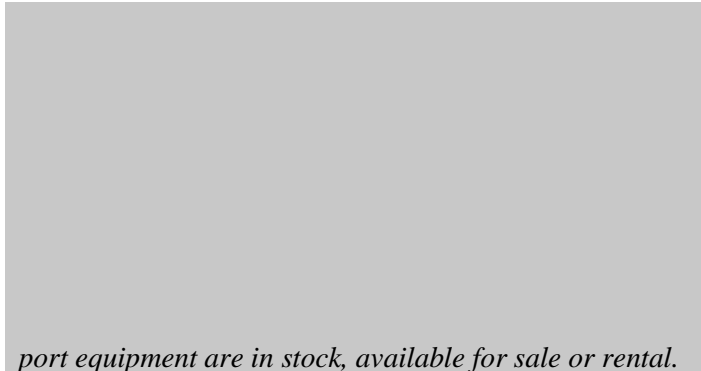

port equipment are in stock, available for sale or rental.

fluke (n) (seamanship, nav arch) **lopata sidra, krak sidra, pata**: As the anchor was lifted the bosun informed us that one **fluke** was missing.

flurries (n) (meteorol) light snow falling for short durations **lagani kratkotrajni snijeg**: Newfoundland: Sea-effect **flurries** forecast for the island, with western portions seeing heavier amounts in the 10-15 cm range. **snow flurries** a brief instance of snow with thin, single flaked showers **lagane snježne padaline**: *Snow flurries tend to come from stratiform cloud.*

flush deck (n) (nav arch) **paluba bez nadgrađa, ravna paluba (bez prepreka), kontinuirana paluba**: Taking hold bilge and tank soundings is very important at sea for the safety of the vessel. However, is it really possible to do this with the **flush deck** sounding caps when shipping seas over the decks? No, it is not possible.

flush deck vessel (n) (nav arch) **brod bez nadgrađa**

flush face (n) (cargo) **ravni rub daske**

flush joint (n) (nav arch) **spoj sa stičnicom, dodirni spoj**

fly /flai/ (v) **1 letjeti, poletjeti**: A search and rescue helicopter **flew out** to the vessel, and a portable pump was lowered.; **2 (navig, seamanship) vijoriti**: The vessel, on which I was Chief Officer, was managed and owned by a reputed Japanese company, **flying a FOC** and manned by multinational Asian crew. **to fly a flag vijoriti zastavu**: The correspondent does not mention if the warship **was flying a flag hoist**. The vessel **flew the flag** of a European State and, for the puposes of operating and chartereing, had managers in that Country.; **3 (navig, seamanship) izvjesiti (zastavu), istaknuti, dići {fly - flew - flown}**

flybridge (n) (boating/yachting) **nadkabinski most (na gliseru, jahti, brodici)**,

flybidge: This liferaft had not yet been stowed in its permanent location on the **flybridge**.



flying bridge (n) (nav arch) **krilo navigacijskog mosta**

flying jib (n) (boating/yachting) **protuflok**

flyweight (n) (marine eng) **zamašni uteg**: It consists of revolving carrier on which are mounted

two weights (the **flyweight**) having cranked levers.

flywheel /'flaɪ,wɪ:l/ (n) (**marine eng**) **zamašnjak, tal. volano**: There is an integral forged coupling flange for the **flywheel**, and the camshaft drive gear is split to facilitate replacement. The valve gear is actuated by side-loaded camshafts driven from the **flywheel** end through nitride-hardened gears.

foam /fəʊm/ (n) (**safety**) **pjena (za gašenje požara)**: We carried out a test on a sample foam extinguisher following servicing, to ensure it is capable of laying an effective **foam blanket**. **air foam mehanička pjena, mechanical foam** foam produced by mixing a foam concentrate with water to produce a foam solution: **mehanička pjena, foam extinguisher protupožarni aparat na pjenu**: He briefly entered the space and rapidly discharged a portable CO2 and a **foam extinguisher**, **foam monitor top za gašenje pjenom, protupožarni top na pjenu**: Soon afterwards, an offshore supply vessel arrived on scene and began to fight the fire with a powerful **foam monitor**.

foam monitor extinguisher (n) (**safety**) **protupožarni aparat na pjenu**

foam system (n) (**safety**) **sustav gašenja pjenom**: ... it specifies only CO2 and halon systems, with no mention of the high-expansion **foam systems** which are being installed more frequently these days

F.O.B. (free on board) (**mar law, shipping econ**) (jedan od trgovinskih uvjeta INCOTERMS)

cijena uključuje ukrcaj tereta na brod; a term of the contract of sale. INCOTERMS: Free on Board means that the seller delivers when the goods pass the ship's rail at the named port of shipment. This means that the buyer has to bear all costs and risks of loss of or damage to the goods from that point. The FOB term requires the seller to clear the goods for export. This term can be used only for sea or inland waterway transport. If the parties do not intend to deliver the goods across the ship's rail, the FCA term [free carrier] should be used.; Prodavatelj je dužan predati robu u ukrcajnoj luci uz bok broda na

mjestu ukrcaja u luci koje je označio kupac ili u teglenici (D. Pavić) **franko ukrcano na brod,**

franko brod F.O.B. (free on board) (named port of shipment) franko brod (s

naznakom luke ukrcaja), F.O.B. (free on board) Freight Allowed the same as **FOB**

named inland carrier, except the buyer pays the transportation charge and the seller reduces the invoice

by a like amount **franko brod (kupac plaća transport do luke), F.O.B. (free on board)**

(Freight Prepaid) Freight Prepaid: The same as FOB named inland carrier, except the seller pays

the freight charges of the inland carrier (Glossary_of_Shipping_Terms.pdf) **franko brod**

(prodavalac/izvoznik prijevoz do luke), F.O.B. (free on board) (named port of

exportation); (US) F.O.B - seller is responsible for the cost of placing the goods at a named point of

exportation (Glossary_of_Shipping_Terms.pdf) **franko brod (prodavalac plaća prijevoz do**

imenovane luke), F.O.B. (free on board) vessel Seller is responsible for goods and

preparation of export documentation until actually placed aboard the vessel

(Glossary_of_Shipping_Terms.pdf) **franko brod (prodavalac je dužan pripremiti izvozne**

dokumente)

fo'c'sle; =forecastle /'fəʊksəl/ (**seamanship**) **prednji kaštel fo'c'sle; =forecastle head**

prednji kraj kaštela: One of them had come aboard with the night stevedores un-noticed and sneaked

inside the **fo'c'sle head** when a crew member was inside sorting out light clusters. It was estimated by those

at harbour stations on the **fo'c'sle head** that the tug passed no more than 10 - 15 meters ahead. {fo'c's'le or

fo'c's'le; fo'c's'le;}

FO; F.O.; (fuel oil) (**shipping econ, marine eng**) **brodska nafta, brodsko gorivo**

gorivo: Signs to be placed on both **FO** and **DO service tanks** and in vicinity of activation point outside

the engine room, warning crew of the risk of blackout if QCVs are shut; gineer and a company

superintendent who was on board to carry out an inspection of the vessel, planned to test the operation of

QCVs in the **fuel oil (FO)** and **diesel oil (DO) tanks**.

F.O. (free out) (n) 1 (mar law, shipping econ) A term of a charterparty which obliges the charterer to control and pay for discharging the cargo. The term is sometimes also found in contracts of sale of goods, often in combination with one of the Incoterms. (Tetley) **franko iskrcaj tereta, cijena prijevoza uključuje i troškove iskrcaja tereta, slobodno iz a (shipping econ, mar ins) troškove iskrcaja snosi primatelj franko iskrcaj**

fog (n) 1 (meteorol) visibility to less than one kilometer **magla**: Also, the navigation lights were switched on, a fog lookout was positioned on the forecastle, engines were ready for immediate manoeuvre and speed was moderated to 8 knots. yards. It was dark and visibility was reduced by fog; both factors requiring the presence of an additional lookout on the bridge. **radiation fog** A common type of fog, produced over a land area when radiational cooling reduces the air temperature to or below its dewpoint. **radijacijska magla, advection fog** fog that is produced when damp air is moved across a surface that is cooler than the air. It is most commonly seen over seas or other bodies of water. When the temperature of the air is lowered to its dew point, changes start to happen. First, saturation occurs. Then, fog **adveksijska magla, frontal fog** Fog associated with frontal zones and frontal passages **frontalna magla, fog forming stvaranje magle, formiranje magle, fog increase jačanje fronte, coastal fog obalna magla, dense fog gusta magla**: In the dense fog, one of the tugs managed to identify the vessel and transfer a crew member across onto her deck.; 2 **magla - vidljivost manja od 1000 metara**

fog bank (n) (meteorol) **gusti sloj magle, gusta magla**: When crossing the Traffic Separation Scheme a fog bank developed, giving visibility of 10 to 20 yards.

fog-bound (n) (navig) Said of a vessel when forced to heave to or lie at anchor due to fog. **u magli, zahvaćen maglom**: Collision with dredger A coastal tanker completed discharge in the forenoon and was being piloted out in a fog-bound harbour channel.

fog detector (n) (navig) instrument za otkrivanje i upućivanje alarma za maglu; An electronic device used to automatically determine conditions of visibility which warrant the activation of a sound signal or additional light signals **detektor magle**

fog dissipation (n) (meteorol) **rasplinjanje magle**

fog gong gong za maglu

fog horn (n) (boating/yachting) a sound signal device used in case of fog **rog za maglu**: ..., and started taking evasive action by switching the steering from autopilot to manual, going hard to port and sounding the fog horn.

fog patches (n) (meteorol) **male odvojene naslage magle**: The weather forecast was for Force 6 and good visibility apart from isolated fog patches.

fog signal (n) (seamanship) zvučni znak sa svjetionika i/ili brodova koji upozorava na maglu **upozorenje za maglu, signal za maglu**: The vessel was making way at near nine knots in order to match the speed of the pilot boat and was sounding the prescribed fog signal.

fog signalling appliances (n) (navig) **uređaji za signaliziranje magle**

fog siren sirena za maglu

fog whistle (n) 1 (nav arch) **zviždaljka za maglu**; 2 (safety) **sirena za maglu**

foils (n) (boating/yachting) **sve vrste kobilica**

follower (n) (marine eng) **vodlica podizača ventila, podizač**: Rollers are arranged at the lower end of the push rod and are fitted to run on the cam surface with the purpose of reducing friction The fuel pump **cam follower** is moving up the rise of the cam on the delivery stroke. In the simple arrangement the lower end of the push rod carries a **head** or a "follower" which rides on the cam.

hinged cam follower zglobni podizač brijega podizač u obliku šarnira: *In many engines side thrust on the push rod is prevented by using a hinged cam follower ...*, **lever form follower** podizač u obliku poluge, **sliding klizni podizač**, **tappet form follower** podizač u obliku cilindra: *Followers may be of lever form or of tappet form.*

following sea (n) (oceanogr, navig) wave or tidal movement going in the same direction as a ship **valovi u krmu**, **krmani valovi**: *The vessel was proceeding in following seas at a speed slightly slower than that of the following wave train.*

following wind (n) (navig) vjetar koji puše u krmu, 10° lijevo i 10° desno od uzdužne osi broda **vjetar u krmu**, **uzdužni vjetar**: *As the vessel approached the berth, the pilot became aware that the following wind and tide were having a greater effect on its speed than he had expected, ...*

FONASBA (Federation of National Associations of Ship Brokers and Agents) (n) (mar law) Međunarodna udruga nacionalnih udruženja pomorskih agencija

food store (n) (nav arch) spremište hrane

foodstuff /'fu:dstʌf/ (cargo) hrana (kao vrst tereta), prehrambeni artikli: *Always unpack cartons containing canned beverages and foodstuffs, ...*

foot (n) **1 stopa (jed. mjere)**, **noga**: *Recently, a freight ship was underway in 15 foot seas when the forepeak flood alarms activated.*; **2 (marine eng) donji kraj / dio**: *The foot of the piston rod is bolted to the crosshead pin.* **connecting rod foot** peta ojnice; **3 (boating/yachting) donji porub jedra**; **4 (boating/yachting) peta jarbola**

foot (v) **popustiti jedro/flok** (kako bi jedrilica dobila na brzini pri jedrenju uz vjetar)

footing (n) (boating/yachting) povećavanje brzine laganim otpadanjem

foot of pier (n) (ports) dno gata (prema obali)

foot of sail (n) (boating/yachting) the bottom of a sail **osnovica jedra**, **doljnji rub jedra**, **doljnji porub jedra**

footpump (n) (electr, boating/yachting) nožna pumpa

foot-ropes (n) (sailing vessels) nogostup od konopa (na križu jarbola)

for and on behalf of (n) (mar law) odredba brodarskog ili agencijskog ugovora: za i u ime (brodara) **za i u ime**

for'ard /'fɔ:əd/ (adv, adj) = **forward** **1 prema pramcu**; **2 sprijeda (=forward)**

Forbes log (n) (navig) **Forbesov dnevnik**: *A Forbes log consists of a small rotator in a tube projecting below the bottom of the vessel, and suitable registering devices.*

force /fɔ:s/ (n) **1 (phys, marine eng) sila centrifugal force** centrifugalna sila: *When the flyweights are rotated the centrifugal force throws the weights outwards.*, **inertia force** inercijska sila, **sila inercije**, **sile tromosti**: *The first-order inertia force from the lower piston is balanced against the corresponding force from the upper pistons, and a well-balanced engine is obtained.*,

stretching force vlačna sila, **torsional force** torzijske sile, **sila torzije**, **to exert force**

vršiti pritisak, **pritiskati**, **exercise force** primjenjivati silu, **amount of force** veličina

sile, **internal force** unutarnja sila, **tensile force** vlačna sila, **resist a force** oduprijeti

se sili; **2 (meteorol) jačina (vjetra)**: *The weather was fine but overcast, and it was very dark, there was a force 3-4 wind and it was low water. ... southerly wind speeds were peaking between midnight and 0300 at force 7 with gusts of force 9.*; **3 (mar law) snaga**, **punovažnost** **come into**

force doći na snagu, postati punovažan, **enter into force** stupiti na snagu

force /fɔ:s/ (v) **force against** pritiskati, stlačiti, natjerati, **force out** izbaciti, istjerati,

istisnuti: *In this way any water which may have collected in the cylinders will be forced out.* **1 stlačiti**;

2 ubaciti pod pritiskom; **3 prisiljavati, siliti**: *The worried harbour authorities forced the barge to cast off from the berth, leaving it to drift in the harbour with no assistance.*

forced /fɔ:st/ (adj) **1 (marine eng) prisilan forced circulation prisilna cirkulacija, prisilno kruženje, forced draught fan ventilator za tlačnu cirkulaciju**; **2 (mar law) prinudan**

force majeure (n) (mar law) = **Act of God** a common clause in contracts, exempting the parties for non-fulfillment of their obligations as a result of conditions beyond their control, such as earthquakes, floods or war **viša sila**

force of wind (n) (meteorol) **jačina vjetra**: *As the vessel moved astern into the main shipping channel, the force of the wind acting on her port beam was greater than the power the tugs could produce to hold the vessel against the wind.*

fore /fɔ:/ **1 (adv)** a term used in indicating portions or that part of a ship at or adjacent to the bow **sprijeda, na pramcu**: *On the pilot's advice, all headlines and sternline(s) were first let go, retaining only the backsprings fore and aft. Stations were called fore and aft, preparatory to making fast tugs.*; **2**

(n) prednji dio (broda): *The impact caused considerable damage to the fore end of the vessel, including penetrations below the waterline.*; **3 (adj) prednji, pramčani**: *Once the towline was secured to the customer vessel, the initial part of the inward passage was uneventful, with the tug maintaining a fore/aft position with no weight in the towline.*; **4 prema pramcu**: *They were stowed at floor level at the fore end of cargo hold No. 3.*

fore-and-aft bridge (n) (nav arch) **prijelazni most, mostić, pasarela** {tal.: passerella}

fore and after (n) (sailing vessels) **uzdužna greda grotla**

fore-and-aft rigged ship (n) (boating/yachting) a ship with a rig in which the principal sails are fore-and-aft **brod s uzdužnim jedrima, brod s uzdužnom snasti**

fore-and-aft sails (n) (boating/yachting) **uzdužna jedra**

fore body plan (n) (nav arch) **uzdužni presjek pramčanog dijela broda**

forecabin /'fɔ:kæbin/ (n) (boating/yachting) **prednja kabina**

forecast /'fɔ:kɑ:st/ (n) (meteorol) description of the most significant weather conditions expected during the current and following days **prognoza, tal. previsione coastal forecast**

COMPARE offshore forecast a forecast of wind, wave and weather conditions between the coastline and 25 miles offshore (Seasources) **obalna prognoza, prognoza vremena za priobalje**

forecast (v) (meteorol) **prognozirati vrijeme**: *When bad weather is forecast during a port call, it is important to ensure that it is safe to remain in port. Strong northerly winds had been blowing in the preceding days, and were again forecast for the coming day when the yacht set sail to the east.*

forecastle /'fɔ:ksl/ (n) **1 (nav arch)** The section of the upper deck of a ship located at the bow

forward of the foremast **kaštel, pramnica, tal. castello di prora**: *Fortunately, the fire damage was limited to the paintwork on the forecastle break bulkhead, a reefer electrical supply cable, light fittings and a hold ventilation cowl.*; **2 pramčano nadgrađe** {fo'c's'le; fo'c'sle}

forecastle deck (n) (nav arch) **paluba kaštela**: *Damage to Ship or Equipment 19-473 AP MOELLER Accident to seafarer 19 December 2009 The accident occurred on the*

forecastle deck during the mooring operation at departure from Singapore.



forecastle head (n) (nav arch) **prednji kraj kaštela**: The two Third Officers monitored the vessel's position, the Helmsman and bridge telegraph, and one Ordinary Seaman remained **on the forecastle head** as required by USCG regulations. It was discovered towards dawn that the fo'c'sle head escape door on deck was not in its original locked position, whereupon the fo'c'sle head area was searched. the clock, it was discovered towards dawn that the fo'c'sle head escape door on deck was not in its original locked position, whereupon the %fo'c'sle head area was searched.

fore-cent timbers (n) (sailing vessels) **umetci uz očna rebra**

fore-deadwood (n) (nav arch, sailing vessels) **pramčani umetci mrtvog ugla**

foredeck (n) (boating/yachting) **prednja paluba, tal. ponte di prua**: These tugs have a spacious foredeck with plenty of working space, making it easier to handle the ropes from a large ship. The incident was immediately reported to the bridge and the fore deck was evacuated.

fore end **pramčani dio broda, prednji dio broda, pramac**: The majority of the damage however, was noted in the fore end and it was observed that there was water leaking into the hold at the junction of the main deck and the forward hold / forepeak bulkhead.

foreguy (n) (boating/yachting) = **downhaul** **priteg** kojim se tangun povlači dolje ili naprijed **priteg tanguna**

foreign exchange (n) (financ) **strana sredstva plaćanja, strana valuta**

foreign-going vessel (n) (shipping econ, mar law) **prekomorski brod, brod međunarodne plovidbe**

foreign matter (n) (marine eng, safety) **strane tvari, strano tijelo, nečistoća**

foreign trade (n) 1 (mar law) **ANTONYM coastal trade** **međunarodna plovidba;**
2 (shipping econ) **međunarodna trgovina**

Foreign Trade Zone; (FTZ) (n) (US, shipping econ, mar law) = **Free Trade Zone;**

(FTZ) a free port in a country independent of Customs authority but under government control

slobodna zona, slobodna carinska zona: In a free trade zone goods may be stored in the zone without being subject to import duty regulations.

forelock of anchor stock (n) (nav arch) **zatic klade sidra**

foreman /'fɔ:mən/ (mar law) **predradnik, nadglednik, vođa grupe, tal. capo squadra**:
Overnight, I had delegated my chief foreman to oversee the discharging under my guidance.

foremast (n) (nav arch) **prednji rabol, pramčani jarbol, tal. albero di trinchetto**

fore peak flat (n) (nav arch) **palubica pramčanog pika**

fore peak; forepeak /'fɔ:,pi:k/ (n) (nav arch) the section of the hold of a ship that is within the angle made by the bow and is used for trimming or for storage of cargo **pramčani pik, forpik,**

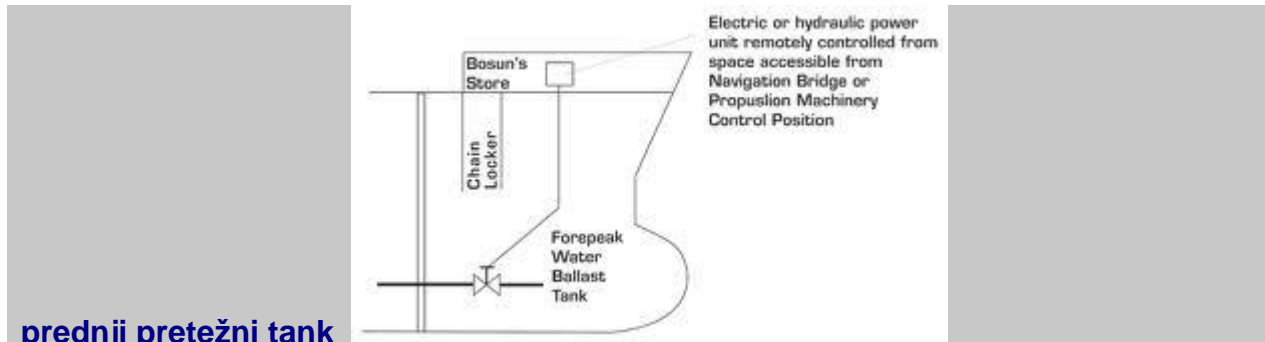

prednji pretežni tank

forepeak tank (n) (nav arch) **ANTONYM afterpeak tank tank pramčanog pika,**

pretežni tank: *Fortunately, the collision bulkhead, at the aft end of the fore peak tank, was in good condition and saved the vessel from flooding uncontrollably. The crew felt that the vessel was behaving as though the fore peak tank was ballasted, whereas they believed it to be empty. After securing to the shore with unusually long lines, it was discovered that the empty fore peak tank was holed below the waterline.*

foresail /'fɔːseɪl/; (naut: 'fɔːsəl)/ (n) (boating/yachting) **COMPARE jib prednje jedro, flog**

fore spring (n) (ship handling) **pramčani špring** *As the chief officer made his way to the forecabin to see what was happening, the fore spring parted. When she sailed past at about 19:13, the fore spring of the MV ... broke.*

fore station = forward station ANTONYM aft station stanica za privezivanje na pramcu

forestay (n) ¹ (boating/yachting) **ANTONYM backstay** a steel wire attached either at the very top of the mast, or in fractional rigs between about 1/8 and 1/4 from the top of the mast. The other end of the forestay is attached to the bow of the boat. **prednje leto, proveni štraj tal. strallo;**

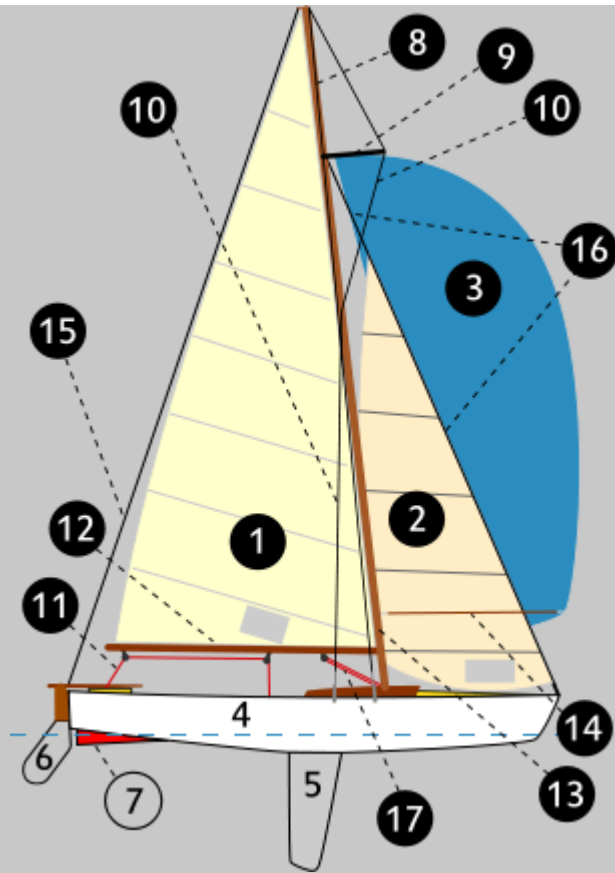

2 kraće pramčano leto, mali štraj

{1. main

sail (glavno jedro), 2. jib (prečka, flok), 3. spinnaker (špinaker), 4. hull (trup), 5. keel/centreboard (pomična kobilica), 6. rudder (kormilo), 7. skeg (produžena peta kormila, skeg), 8. mast (jarbol), 9. spreader (križ), 10. shroud (pripona, sartija), 11. mainsheet (škota jedra, uzda jedra), 12. boom (deblenjak, bum), 13. mast (jarbol), 14. spinnaker pole (tangun špinakera), 15. backstay (krmeni štraj, krmeno leto), 16. stay (prednje leto, proveni štraj), vang (priteg deblenjaka/buma, vang)}

forest product carrier (n) (nav arch) brod za drvo i drvne prerađevine

fore tack prednji rogalj (floka, jedra)

forfeit /'fɔːfɪt/ (v) izgubiti pravo

forfeit (n) (mar law) something that a person has to pay, or something that is taken from them, because they have done something wrong **guibitak prava**

forfeit clause (n) (mar law) forfetni stavak

forfeit rate (n) (shipping econ, mar law) način otpreme pri kojemu je ukupna svota za ispunjavanje naloga određena ugovorom **fiksna naknada**

forfeit shipment (n) (mar law) špedicija u kojoj se naknada ugovara u fiksnom iznosu i koja obuhvaća sve naknade i sve troškove realizacije ugovora; **forfetna otprema**, **forfetna špedicija**

forfeiture /'fɔːfɪtʃə(r)/ (n) 1 (mar law) gubitak prava; 2 gubitak, gubljenje; 3 **konfiskacija**

forge (v) kovati

forged iron (marine eng) kovano željezo: *The cylinder cover comprises a stiff grey cast iron cap fitted with a thinwalled forged heat-resistant steel bottom.*

forged steel (n) (marine eng) kovani čelik

forked shape viličasti / rašljasti oblik, oblik U-profila

fork lift (n) (cargo handling) = **fork lift truck (FLT)** viličar: Occasionally containers are hoisted aloft while standing on the forks of a fork lift truck.

forklift pockets (n) (cargo handling) džepovi u dnu kontejner: Some bulk containers are equipped with forklift pockets, which allow handling by forklift trucks

fork lift truck (FLT) (n) (cargo handling) viličar, viljuškar: Fork lift trucks (FLT) are mechanically or electrically operated and fitted in front with a platform in the shape of two prongs of a fork. Container handling at the terminal comprises container lift trucks, reach stackers, **fork lift trucks** and all the attachments needed. Test certificates, maintenance reports and pre-operation checks of the gear they provide and intend to use, eg **fork-lift trucks**, cranes, slings and ladders.



form (n) (mar law) obrazac, formular fill out / fill in / complete a **form** ispuniti obrazac

formality (n) (mar law) formalnost complete the formalities ispuniti / obaviti

formalnosti: A container vessel *had completed its departure formalities* and it just remained for the gangway to be brought inboard and secured and the lines let go before she could make her way to her next port.

formal safety assessment; FSA (n) (safety) metoda formalne procjene sigurnosti

form coefficients /'fɔ:m,kəʊ'i'fɪənts/ (n) (stabil) koeficijenti brodskih oblika, koeficijenti brodskih formi / linija

former 1 **prvi (od dva)**: *the former ... , the latter ... --- (e.g. vessel) prvi brod ... , potonji ... (npr. brod) The two vessels were approximately 10 nm from each other, and now in sight, the private vessel received a VHF radio call from the cargo vessel requesting that the **former** alter course so that the cargo vessel could stand on.*; 2 **prethodni, prijašnji**: As a marine consultant and surveyor I visit merchant ships from time to time and as a **former shipmaster** I take an interest in the way in which shipping is conducted nowadays.

form stability (n) (stabil) stabilitet forme

forward /'fɔ:wəd; 'fɔ:rid; 'fɔ:rəd/ (adv, adj) 1 (adv) in front; towards the bows of a ship; in the fore part of a ship **prema pramcu, naprijed**: The vessel was required to **move forward** about 30 meters to load the after hatch. He was standing just outside the after door to his wheelhouse, **facing forward** and to starboard.; 2 (adv) **sprijeda (na brodu), ispred forward of ispred**: My father, who was skipper, decided to take the ropes out of the cage roller on the starboard quarter and let the boat pivot on the shooting bar **forward of midships.**, **forward of the beam subočice po pramcu.**

1045: Target observed at about one point **forward of the port beam**, distance approx 4.6 miles.; 3 (adj)

prednji, pramčani: Crew educated on the snap back zones at **forward and aft mooring stations**. On impact, the container ship's OOW felt a sudden and unusual vibration from the **forward part of the vessel**.

forward (v) (*shipping econ, mar law*) **poslati, dostaviti**: *The Master is busy with emails, communicating to all parties the results of the inspection and forwarding all relevant documents.*

forward body (n) (*nav arch*) **pramčana rebra broda**

forward breast line (n) (*seamanship*) **bočno pramčano uže, prednje bočno uže**: *The ship pivoted about the forward port shoulder causing one of the forward breast lines to part.*

forward end (n) 1 (*nav arch*) **prednji dio broda, pramčani dio broda**: *The seaman at the forward end jumped across the gap to the embarkation deck. The forward end of the lifeboat fell to the water but it was undamaged and there were no injuries to the crew.;* 2 (*seamanship*) **pramčana**

strana (dijela broda), prednji dio (dijela broda): *He then moved to the forward end of the port hatch cover to climb down. There were two three-furnace oil-fired Scotch boilers at the forward end of the engine room, the starboard boiler could be operated on the main engine exhaust gases. The fire continued to spread rapidly throughout the forward end of the wheelhouse, filling it with thick black smoke.*

forwarders /'fɔːwədəz/ (n) (*mar law*) the party arranging the carriage of goods including connected services and/or associated formalities on behalf of a shipper or consignee **otpremnik, špedicija, otpremnička tvrtka, špediter**: *..., by signing declarations, a forwarder confirms that the goods have been correctly classified and that the packing and labelling conforms to the appropriate regulations. It has been noted with alarm that there is an increasing tendency for freight forwarders to sign dangerous goods declarations.* **international forwarders međunarodna špedicija (tvrtka)**

Forwarder's Certificate of Receipt (FCR) Špediterska potvrda o primitku tereta (šedicijski vrijednosni papir)

forwarding otpremništvo, špedicija

forwarding agent/s (*mar law*) pravna ili fizička osoba koja se obvezuje da radi prijevoza određene stvari sklapa u svoje ime i za račun nalogodavca ugovor o prijevozu i ostale uobičajene poslove i radnje u vezi s otpremom robe za što mu nalogodavac plaća odgovarajuću naknadu

otpremnik, otpremnička agencija, špedicija: *The IMDG prompt ships to revisit their relevant risk Code is quite clear in its instructions to assessments and realise the need for shippers, forwarding agents and road specific equipment.*

forwarding instruction (n) (*shipping econ, mar law*) document issued to a freight forwarder, giving instructions to the forwarder for the forwarding of goods described therein **nalog za otpremu, nalog za ukrcaj**

forward line (n) (*seamanship*) **pramčano uže**: *High tides and strong winds caused the ship to surge along the berth, causing the forward lines to slacken.*

forward mooring lines (n) (*seamanship*) **pramčana privezna užad, privezna užad na pramcu, pramčani konopi**

forward moorings **pramčani vez, pramčani konopi, proveni armiž**: *The master was able to view the forward moorings from the bridge, but the after moorings were obscured. The vessel was engaged in loading Naphtha when, in a sudden strong squall, three of the rope tails on the forward moorings parted. The remaining forward mooring ropes then parted as the vessel's bow started to swing away from the quay.*

forward of (adv) 1 (*seamanship*) = **afore ispred (vlastitog broda)**: *This was unsuccessful, and a short time later the ship made contact, at over 3 knots, with a concrete dolphin which was about 70 metres forward of the ship's berth.;* 2 (*seamanship*) **ispred (dijela broda)**: *The two remaining crew members decided that they should relocate the pumps to the adjacent compartment, immediately forward of the accommodation space, which had no fixed bilge suction, in order to continue pumping.*

forward perpendicular an imaginary line drawn perpendicularly through the waterline where the forward edge of the stem meets the summer load line **pramčana okomica**

forward ropes (n) (seamanship) **pramčani konopi**: Soon after the onset of the flood tide, the tension on the **forward ropes** increased and the bow was set slowly off the wharf.

forward spring (n) (seamanship) **pramčani špring**, **prednji špring**: During the shift, the **forward spring lines** became too long. They agreed that the **forward spring** would be the last mooring rope to be let go and that the vessel would then move stern first into the fairway. The ship was manoeuvred off the berth as normal using the **forward spring**.

forward station (n) (seamanship, navig) grupa mornara, obično na čelu s prvim časnikom, na pramcu broda pri manevriranju brodom **stanica za privezivanje na pramcu**: the Master or the Officer of the Watch (OOW) has to tell the officers in charge of the Fore and After (Mooring) Station to single up.

forward store (n) (nav arch) **pramčana sprema**: Ventilation openings to the **forward store** were still closed in the seagoing position,.

forward tank (n) (nav arch) **pramčani tank**: The **forward tanks** were emptied and refilled without incident, except that the day's operations ended with an overflow. The skipper preferred to use fuel from it is essential to be alert for subtle the **forward tanks** before the aft tanks changes that can make a big difference.

forward trim (n) (cargo handling) **pramčani trim**

forward tug (n) (ship handling) **tegljač po pramcu**, **tegljač na pramcu**: The **forward tug** was also the vessel was minor and she was able to requested to push on the starboard bow.

foul /faʊl/ (v) 1 (seamanship, ship handling) **zaplesti**, **zaplesti se (o užad, lanac itd.)**, **zakačiti**, **zapetljati se**, tal. **impigliare**: We must be sure that there are no lines, small boats, or obstructions which would be likely to foul the rudder or propeller. We were concerned that the lines could foul the boat's **rudder or propeller**. Eventually, while the tug barely managed to clear the bow of the anchored ship, the towline fouled her anchor cable ... **foul the anchor zaplesti sidro**, **zapetljati sidro**, **zapeti sidrom o**: on, the Pilot's assessment was 2-3 knots * The reader of the MARS report may be left with the impression that the Pilot was aware that the anchor was fouled by a heavy and probably very long wire rope., **foul the propeller zaplesti se o propeler**: The master of the tug became concerned that the large amount of slack in the starboard side of the bridle could foul his propellers, so he moved his tug to the port bow of the tanker, Fortunately, the propeller was not fouled and after tugs were fast, the ship sailed without further incident. Damaged bollard Narrative While securing alongside, a ferry's bow thrusters became fouled by her own mooring lines., **foul the line zaplesti se o uže / konop**: The fishing vessel was concerned that the cargo vessel would cross pot line and foul one of the riser lines., **foul the fender zaplesti se o odbojnik**: ..., as a result of variations in water levels due to tides and in vessels' draughts due to changes in displacement, such steel fenders can foul the fenders on the berth from above or below, and potentially damage/dislodge them., **foul the ladder zaplesti se o brodski siz**: When berthed in ports with high tidal range, or when obstructions on the quay could foul the ladder, it may be more prudent to leave it suspended so that the crew can tend it continuously., **be fouled with zapetljati se s**, **zaplesti se o**: As the crew tried to heave anchor once again they noticed that their anchor appeared to be fouled with the ground tackle of the second tanker. Once the anchor was clear of the water, the seaman reported that it was home but fouled with some lashing wire.; 2 (navig) **oštetiti**, **udariti u**, **zahvatiti (plutaču, lanac, konop itd.)**: The ship's starboard quarter fouled a lock gate. desni kvartir broda udario je u vrata ustave i oštetio ih; 3 **onečistiti (more, obalu)**, **zagaditi (more, obalu)**: The tanker sank off US east coast and

fouled thousands of miles of coastline.

foul /faʊl/ (adj) a piece of equipment that is jammed or entangled; not clear **zapleten, zapetljan, zakačan** **foul anchor** **zapetljano sidro**, **foul rope** **zapleten konop**

foul (adj) **1 (seamanship)** **zapleten, zakačen, zapetljan** **foul anchor** **zapleteno sidro, zapetljano sidro, foul propeller** **zapleteni propeler, zapetljanoi propeler, foul line** **zapleten konop; 2 obrašteno, blatno, šporiko** **foul bottom** **obrašteno dno**

foul an anchor (v) (seamanship) **zakvačiti nečije sidro / sidreni lanac**

foul anchor /faʊl/ (n) (seamanship) anchor with chain wrapped about a fluke or the stock or with some other encumbrance entangled about it **zapleteno sidro, zaglavljeno sidro**

foul bill of lading a bill of lading, i.e. receipt for goods, issued by a carrier with an indication that the goods were damaged when received **nečista teretnica, teretnica s opaskom**

fouled /faʊld/ (adj) (seamanship) jammed, not clear **zapleten (konop, lanac), zapetljan, zamršen** **fouled anchor** **zapetljano sidro, zapleteno sidro, zapelo sidro**: *In light of this experience, a procedure will be established whereby attempts to clear a fouled anchor should be made by letting go the brake and manoeuvring until the anchor is cleared.*

foul propeller /faʊl/ (n) (seamanship) **zapleten vijak / propeler**

foul rudder /faʊl/ (n) (seamanship) **zapleteno kormilo, zapetljano kormilo**

foul tide /faʊl/ **plimna struja iz nepovoljnog smjera**

foul weather (n) (meteorol) **nevrijeme, tal. maltempo; cattivo tempo**: *The vessel deviated from its route but evacuation was delayed by foul weather and darkness. Importantly, and as would prove to be lifesaving, the skipper had opted to wear a two-piece foul weather suit with buoyant sections.*

foundation (n) (nav arch, marine eng) a structural support for equipment and machinery in a ship **temelj, oslonac**: *The structural support for the boilers, main engines or turbines, and reduction gears are called the main foundations.* **auxiliary foundation** the support for auxiliary machinery **temelj pomoćnog stroja**

Foundation Degree; FdSC; (UK) A foundation degree is a vocational qualification in higher education, introduced by the government of the United Kingdom in September 2001, which is available in England, Wales and Northern Ireland. This makes it similar in level to the associate's degree awarded in the United States, and sometimes in the United Kingdom. It is below the level of an honours degree (Bachelor of Science, Bachelor of Arts, Bachelor of Laws etc.). Courses are typically two years full-time study or 3 to 4 years part-time study and are offered both by universities and colleges of higher education. **visokoškolski stručni studij (temeljni studij - niži od BSc), diploma o**

završenom visokoškolskom stručnom studiju: *A foundation degree is a degree level qualification which combines academic study with work place learning. Foundation degrees are ideal if you're unsure about taking a full degree or if you want to study while you work.*

(<https://www.ucas.com/ucas/undergraduate/getting-started/what-study/foundation-degrees>)

Foundation Degree in Marine Engineering; FdEng (n) (UK) (mar law, marine eng) = Associate Degree in Marine Engineering **visokoškolski stručni studij brodstrojarstva i tehnologije pomorskog prometa - brodsko strojarstvo (temeljni studij), diploma o završenom visokoškolskom stručnom studiju brodstrojarstva i tehnologije pomorskog prometa - brodsko strojarstvo (temeljni studij)**: *The Warsash Academy offers a full engineer officer cadet programme by a degree route, leading ultimately to the award of a UK Maritime and Coastguard Agency (MCA) Engineer Officer's Certificate of Competency (STCW A-III/I OOW), a Foundation Degree (FdEng) in Marine Engineering and a direct top-up pathway to BEng*

(Hons) Marine Engineering and Management.

Foundation Degree in Marine Operations Management; FdSc; (n) (UK)

(mar law) visokoškolski stručni studij nautike i tehnologije pomorskog prometa - (temeljni studij), diploma o završenom visokoškolskom stručnom studiju nautike i tehnologije pomorskog prometa

Foundation Degree in Marine Operations Management - Nautical

Science; FdSc (n) (UK) (mar law, navig) = Foundation Degree in Marine Operations Management; FdSc; = Associate Degree in Nautical

Science visokoškolski stručni studij nautike i tehnologije pomorskog prometa - (temeljni studij), diploma o završenom visokoškolskom stručnom studiju nautike i tehnologije pomorskog prometa:

The Warsash Academy offers a full deck officer cadet programme by a degree route, leading ultimately to the award of a UK Maritime and Coastguard Agency (MCA) Deck Officer's Certificate of Competency (STCW'95 II/I OOW), a Foundation Degree (FdSc) in Marine Operations and a direct top-up pathway to BSc (Hons) Marine Operations Management.

founder /'faʊndə(r)/ **1 (v tr)** to fill with water and sink; to sink out of control **potopiti se,**

potonuti. *In darkness and heavy seas, a small general cargo ship began to founder. About an hour after the vessel **foundered**, a rescue helicopter arrived on scene Very soon afterwards, the barge collided with the pulling tug, overrunning her and **causing her to capsize and founder.**; **2 (v tr) (navy) potopiti (drugi brod)***

foundering /'faʊndərɪŋ/ (n) (navig, safety) **potonuće:** *However, there was very little time to consider the options, because the capsize and **foundering** were very rapid.*

four-stroke engine (n) (marine eng) **čtvorotaktni motor:** *The four-stroke engine usually rotating at medium speed, between 250 and 750 rev/min) is used for auxiliaries such as alternators and for main propulsion with gearbox to provide a propeller.*

Fourth Engineer (n) (marine eng, mar law) **treći časnik stroja (UK), treći strojar:**

*An engine cadet was assigned to note down the readings and the **fourth engineer** was to operate the main engine turning gear remote control.*

F.P.A. (free of particular average) (n) (mar law) **cijena prijevoza ne uključuje troškove nastale zbog partikularne avarije**

FP; forward perpendicular (n) (stabil, nav arch) **pramčana okomica, pramčani perpendikular**

fractional rig (n) (boating/yachting) **oputa s nižim vršnim hvatištem leta dijeljena oputa, sedamosminska oputa jarbola**

fracture /'fræktʃə/ (n) **extensive fracture** **prijelom / napuknuće većih razmjera ili**

dimenzija. *After slowing down, the leak was located in the expansion piece between the manifold and the blower in the top inlet, an **extensive fracture** of the bottom of one of corrugation. (nav arch, marine eng, safety) lom, prijelom, napuklina, napuknuće: they identified a 3-metre longitudinal **fracture** in the hull bottom plating The chief engineer identified that the fire had been caused by a **fracture** in a low pressure fuel sensor pipe coupling, which had resulted in oil spraying onto the unshielded, main engine exhaust drain cock.*

fragile /'frædʒaɪl; US 'frædʒdʒəl/ (adj) **lomljiv:** *Fragile cargo is only accepted for shipment provided that it is adequately stored in solid packaging materials (grades, wooded boxes), preferably new.*

fragility /frə'dʒɪlɪti/ (n) (marine eng, cargo handling) **lomnost, lomljivost**

frame (n) **1 (nav arch)** one of the transverse members, the rib-like part of the skeleton of a ship

rebro, tal. ordinata: *The frames act as stiffeners holding the outside plating in shape and maintaining the transverse form of the ship.* **main frame glavno rebro, reverse frame proturebro; 2 (marine eng) okvir, okvirna konstrukcija:** *These shoes are lined with white metal, a bearing material and they reciprocate against the crosshead guides, which are bolted to the frame of the engine.* **stalak motora** *The shells are held in position and shape by seatings of the bedplate or frame.* **frame structure okvirna konstrukcija:** *The frame structure of the cylinder does not come into contact with water.*, **frame section sekcija stalka motora, okvirna sekcija:** *The frame section is attached to the bedplate with bolts.*, **engine frame stalak stroja, stalak motora:** *The crankshaft vibration was coupled to the engine frame and double bottom which, in turn, transferred vibration energy back to the crankshaft.*; **3 kostur; 4 postolje**

frame antenna (n) (nav arch, comm) okvirna antena

frame line (n) (nav arch) linija rebra

framework (n) okvir: *One such regulation gave us the ISM Code, an excellent framework for robust safety management which requires that each company's objectives include the continuous improvement of safety management skills.*

framework tower (n) (safety, navig) toranj, rešetkasta kula (za svjetlo)

framing (n) 1 (nav arch) rebro; 2 (nav arch) rebra

franchise (n) (mar ins) (in marine insurance) a sum or percentage stated in a policy, below which the insurer disclaims all liability franšiza deductible franchise odbačna franšiza, non deductible franchise integralna franšiza

franchise (n) 1 (US) koncesija, zastupstvo; 2 povlastica, privilegij

fraying (n) (cargo) struganje, ribanje

free alongside ship (mar law, shipping econ) slobodno uz bok broda, franko uz bok broda free alongside ship (named port of destination) slobodno uz bok broda (naznačena luka odredišta) {jedan od trgovinskih uvjeta INCOTERMS}

freeboard /'fri:bo:d/ (n) timber freeboard nadvođe za teret drva (nav arch) the distance measured amidships from the water line to the main deck of a vessel. This is normally the uppermost continuous deck in a ship with one or more decks. However, in a shelter deck vessel it would be the next deck below. nadvođe, tal. bordo libero: *A pilot ladder was securely rigged by the ship's staff and inspected by the duty OOW; the ship's freeboard at the time was 7.6 m. A vessel with low freeboard is susceptible to ship seas on deck even in relatively fair weather. However, due to the freeboard of the assisted ship, no one on board the tug could see past the ship's main deck hand rails. The tanker, in ballast, had a freeboard of about 16 metres.* **summer freeboard ljetno nadvođe, summer fresh water freeboard ljetno nadvođe za slatku vodu, summer timber freeboard ljetno nadvođe za teret drva, summer fresh water timber freeboard ljetno nadvođe za teret drva za slatku vodu, minimum freeboard najmanje nadvođe, winter freeboard zimsko nadvođe, winter timber freeboard zimsko nadvođe za teret drva, high freeboard visoko nadvođe:** *The wind caught the beam of the high-freeboard and low draught vessel, and started setting her on to the lee shore, less than two miles downwind.*, **low freeboard nisko nadvođe:** *The boat had a low freeboard at its stern, which was further reduced by a poorly fitted patch where the engine control cables passed through the transom.*

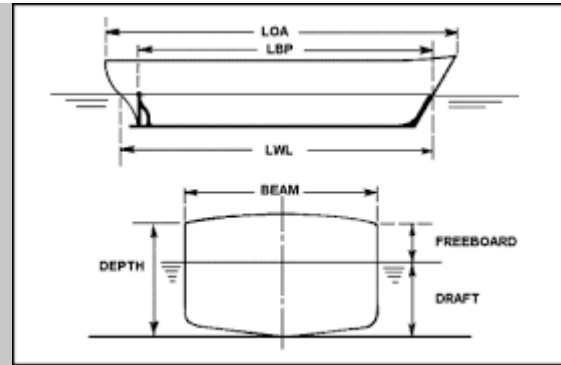

freeboard deck (*nav arch*) the uppermost continuous deck exposed to the weather and sea

paluba nadvođa: The BEAmer reminds all concerned that watertight doors to compartments *below the freeboard deck* must remain closed and dogged down at all times when the vessel is at sea;

freeboard mark (*n*) (*navig*) oznaka nadvođa

freeboard ring (*n*) (*navig*) krug nadvođa

Free Carrier ... (*n*) (*mar law, shipping econ*) franko prijevoznik

free days (*n*) (*mar law*) vrijeme ili rok odobren za punjenje / pražnjenje kontejnera

freedom of navigation (*n*) (*mar law*) sloboda plovidbe

freedom of passage (*n*) (*mar law*) sloboda prolaska equal **freedom of passage**
jednaka sloboda prolaska, jednako pravo prolaska

free end (*n*) (*seamanship*) = **working end** **ANTONYM bitter end** slobodni kraj
užeta, radni dio konopa, radni kraj konopa, tal. *filo libero*

free fall boat; FFB (*n*) (*nav arch, safety*) brodica za spašavanje na slobodan pad,

gravitacijska brodica za spašavanje: While at anchor, an inspection of the *free fall boat (FFB)* was to be carried out, among other things. There is no standard procedure for launching *free-fall lifeboats*, as design and fittings vary considerably.



free from general average (n) (mar law) posebna klauzula u ugovoru o prijevozu ili u teretnici prema kojoj se stranke uzajamno odriču prava na kontribuciju iz zajedničke havarije tako da sve štete i troškove snosi stranka koja ih je pretrpjela **slobodno od zajedničke havarije, uzajamno franko od zajedničke havarije**

free in (n) (mar law, shipping econ) klauzula u ugovoru o prijevozu stvari morem kojom se određuje da troškove ukrcaja snosi krcatelj **slobodno u, franko u** {jedan od trgovinskih uvjeta INCOTERMS}

free in and out (f.i.o.) klauzula u ugovoru o prijevozu stvari morem kojom se određuje da troškove ukrcaja i iskrcaja snosi krcatelj ili primatelj tereta **slobodno u i iz, franko ukrcaj i iskrcaj**

free in and out stowed and trimmed; (FIOST) (n) (mar law, shipping econ) **slobodno u i iz, složeno i poravnato, franko u i iz, složeno i poravnato**

freeing port (n) (nav arch) freeing ports or scuppers are openings in ship sides or bulwarks, allowing for the draining of accumulated water from the decks. **odljev, izljevni otvor u ogradi**: Each pump had a discharge hose passing through the port side **freeing port** leading to one of the tanks. The insertion of **freeing ports** above a non-watertight deck would also have increased the probability of water

free on board; (FOB)

free the vessel



accumulating in the bilge.

free on board; (FOB) (n) (mar law, shipping econ) međunarodni trgovinski uvjet prema kojemu je prodavatelj dužan predati robu na brod u luci ukrcanja naznačenoj u ugovoru o prodaji **slobodno brod, slobodno ukrcano na brod free on board; (FOB) (named port of shipment) slobodno brod (navedena luka ukrcanja) {jedan od trgovinskih uvjeta (INCOTERMS)}**

free out; (FO) (n) (mar law, shipping econ) klauzula u ugovoru o prijevozu stvari morem kojom se određuje da troškove iskrcanja snosi primatelj **slobodno iz (luke), franko iskrcaj {jedan od trgovinskih uvjeta INCOTERMS}**

free piston engine (n) (marine eng) motor sa slobodnim klipom: *Why haven 't gas turbines, free piston engines enjoyed wide application on merchant vessels?*

free port zone (n) (mar law, shipping econ) slobodna carinska zona (u luci)

free pratique /fri: præ`ti:k/ (n) (mar law) dozvola zdravstvenih vlasti u luci za uplovljenje broda u luku **slobodni promet, dozvola zdravstvenih vlasti za uplovljenje, slobodan saobraćaj, Permission given to a ship to use a port after it has been certified free of disease by competent health authorities. (Tetley): Vessels arriving from countries not suspect of epidemical diseases can ask and receive Free Pratique by radio obtain free pratique dobiti / ishoditi slobodan promet, grant free pratique dati / odobriti (brodu) slobodan promet, be in free pratique imati slobodan promet, obtain free pratique ishoditi / dobiti slobodan promet, receive free pratique dobiti slobodan promet, request for free pratique zatražiti slobodan promet**

free storage period (n) 1 (ports, shipping econ) ležarina; 2 teret oslobođen plaćanja skladišnine u luci

free surface correction (n) (nav arch) ispravak za utjecaj slobodnih površina

free surface effect (n) (navig) utjecaj na stabilnost broda koji prilikom nagnuća broda stvaraju slobodne površine **učinak slobodnih površina, utjecaj slobodnih površina: Partially filled cargo tanks with no longitudinal bulkheads may cause large free surface effects to the extent that the initial metacentric height (GM) becomes negative. calculate the free surface effect izračunati učinakslobodnih površina**

free surface I value (n) (stabil) moment inercije slobodnih površina prostora za određeni prostor broda

free surfaces (n) (cargo handling, safety) nepokrivene tekućine u brodskim tankovima ili rasuti teret u brodskim skladištima **slobodne površine**

free the vessel (v) (safety) odsukati brod, osloboditi nasukani brod: *AIS data from*

MarineTraffic.com showed that *the vessel was freed* with help of tugs at 12:30 p.m. local time on Friday.

free time (n) (mar law) slobodno vrijeme između prihvaćanja pisma spremnosti i početka računanja stojnica **vrijeme predaha**

Free Trade Zone; (FTZ) (n) (**shipping econ**) a site within a country where foreign and domestic goods are held until they ready to be released into international commerce. **slobodna**

zona, slobodna carinska zona {If the final product is imported into the U.S., duties and taxes are not due until the goods are release into the U.S. market. Merchandise may enter a FTZ without a formal Customs entry or the payment of Customs duties or government excise taxes. In the zone, goods may be: stored; tested; sampled; repackaged or relabeled; cleaned; combined with other products; repaired or assembled, etc.}

free turn (n) (mar law, shipping econ) slobodno od čekanja na red

freeze, froze, frozen (v) **smrznti, zamrzavati**: Any delay in squeezing can cause the cargo to **freeze** at the bottom and this can lead to residue on board or delay by several hours in discharge of cargoes.

freezing (n) **zamrzavanje**: The drain cock of the tank cleaning line was kept open as a precaution against **freezing**.

freezing point (n) (marine eng) **ledište, točka zamrzavanja**: It was dark and the air temperature was **at freezing point**.

free zone (n) (mar law) dio kopnene i vodene operativne površine pomorske luke ili riječnoga pristaništa u kojemu se slobodno obavljaju gospodarske operacije robom bez carinskih ograničenja zemlje kojoj pripada ta luka ili pristanište **slobodna zona**

freight (**shipping econ**) ¹ (mar law, shipping econ) The amount of money due for the carriage of goods and payable either in advance or upon delivery. ; [Fr.: fret] [Span.: flete] [Ital.: nolo] [Gr.: Fracht] - the remuneration payable for the carriage by the vessel of property or passengers or for the use of the vessel (Tetley); Freight includes all charges payable to the Carrier in accordance with the applicable Tariff and the Bill of Lading. **vozarina, prevoznina, brodarina, nolo; tal. nolo**: Rates for the Brazil-China route rose to \$7.49 per tonne on Wednesday, against \$6.73 per tonne last week.

freight rate **vozarinski stav, freight due** **dospjela vozarina, vozarina dospjela na naplatu, Ad Valorem freight** **vozarina (izdana) na vrijednost tereta, to assess the freight** **odrediti / utvrditi vozarinu, to charge the freight** **obračunati / zaračunati vozarinu, dead freight** **mrtva vozarina, to settle the freight** **platiti vozarinu, srediti plaćanje vozarine, to pay freight** **platiti vozarinu, freight prepaid** **vozarina plaćena unaprijed, freight carried forward** **vozarina plativa po isporuci, on payment of freight** **nakon plaćanja vozarine, charter freight** **charter hire paid under a voyage charter najamnina za brod u ugovoru za iskorištavanje broda na putovanje; 2 najamnina broda (u ugovorima za putovanje - Voyage Charter Party): Freight rates for Capesize dry bulkers remain firm. Freight rates for large capesize dry cargo ships on key Asian routes could stay around current levels next week, supported by stable cargo volumes and firm bunker prices, ship brokers said**

freight: (n) (US, cargo) **teret**: The carrier received the **freight** in good condition at origin. U polaznoj luci prijevoznik je primio teret u dobrom stanju *The freight was short and damaged at destination* Na odredištu je teret bio manjkav i oštećen. *However, passengers and freight were stranded on board for 28 hours, before she could be safely re-floated and berthed alongside.* **freight lifter** **viličar**

(1000-3000 kg), **air freight** **avionski teret, movement of freight** **promet tereta, teretni promet, types of freight** **vrste tereta**

freight all kinds (n) (shipping econ) **paušalna vozarina**

freight bill (n) (shipping econ) Carrier's invoice for freight charges applicable to a shipment. Also called freight invoice; Destination (Collect) Freight Bill: Prepaid Freight Bill. (1) Bill rendered by a transportation line to consignee containing description of freight shipper name, point of origin and weight charges (if not prepaid). (2) Bill rendered by a transportation line to shipper containing description of freight, consignee, destination and weight charges.

(<http://www.maerskline.com/en-jm/help/shipping-glossary>) **vozarinski račun, faktura za**

vozarinu, račun za prevozninu: *Freight bill - Carrier's invoice for freight charges applicable to a shipment. Also called freight invoice.* **original paid freight bill originalni naplaćeni vozarinski račun, originalna naplaćena faktura za vozarinu**

freight carriage paid to (n) (mar law) međunarodni trgovinski uvjet prema kojemu prodavatelj plaća vozarinu do ugovorenoga mjesta odredišta, ali rizik za gubitak ili oštećenje prelazi s prodavatelja na kupca u trenutku kada je roba isporučena prvomu prijevozniku, a ne kada prijeđe brodsku ogradu **vozarina plaćena do**

Freight Carriage paid to ... (named point of destination) (n) (mar law, shipping econ) **vozarina plaćena do ... (označeno mjesto odredišta)**

freight carried forward (n) (shipping econ, mar law) **vozarina s plaća po isporuci (u luci iskrcaja)**

freight carrier (n) (nav arch) **teretnjak, teretni brod**: *Medium-speed four-stroke diesel engines are dominant in the propulsion engines of smaller ships as well as larger specialist tonnage such as cruise vessels, car/passenger ferries and ro-ro freight carriers.*

freight collect (n) (shipping econ, mar law) freight and charges to be paid by the consignee/receiver/importer **vozarina po primitku tereta (od strane primatelja tereta)**

freight conference (n) (mar law) = **liner conference = shipping conference**
linijska konferencija

freight container (n) (cargo handling, cargo, US) = **container kontejner**: *Those responsible for the packing of dangerous goods into a freight container or vehicle should provide a signed dangerous goods container or vehicle packing certificate. The drums were then secured on wooden pallets and these were finally stacked inside a standard marine freight container.*

freight contractor (n) 1 (mar law) = **disponent owner = chartered owner**
brodar raspolagatelj; 2 ugovaratelj tereta

freighter (US) = cargo liner a ship designed to carry all types of general cargo **teretnjak, linijski brod, linijaš**

freighter cruiser (n) (nav arch) **teretno-putnički brod**

freight forward (n) (shipping econ, mar law) **vozarina se plaća po isporuci, vozarina po isporuci**

freight forwarder (n) (mar law) = **forwarding agent/s** A party who arranges for the carriage of other people's goods by sea, for a fee, usually calculated as a percentage of the freight charge plus expenses. At times, the freight forwarder acts as a principal contractor in respect of the shipper and bears the responsibilities of a common carrier. At other times, the freight forwarder acts merely as an agent of the shipper, with the obligation to exercise reasonable care and skill. (Tetley); a person acting as an agent in the transshipping of freight to or from foreign countries and clearing freight through federal customs. (<http://www.maerskline.com/en-jm/help/shipping-glossary>) **špediter, otpremnik**: *It has been noted with alarm that there is an increasing tendency for freight forwarders to*

sign dangerous goods declarations. With the best will in the world, no **freight forwarder** can make such a declaration honestly. {An individual or company that prepares the documentation and coordinates the movement and storage of export cargoes}

freight forwarder's bill of lading (n) (mar law) špediterska teretnica

freight forwarding (n) (mar law, shipping econ) špedicija, otpremništvo

freight hauler (n) (US) cestovni prijevoznik, kamionski prijevoznik

freight lifter viličar (manje nosivosti)

freight liner (n) (shipping econ, US) linijski brod, linijaš, teretnjak: As opposed to **freight liners**, tramp ships trade on the spot market with no fixed schedule or itinerary/ports-of-call(s).

freight market. (n) 1 (shipping econ) vozarinsko tržište: Downturn in dry freight market started in 2008.; 2 (shipping econ) tržište tereta, burza tereta

freight movement (US) (n) (shipping econ) kretanje tereta, kretanje pošiljke

freight prepaid (n) (shipping econ, mar law) freight and charges to be paid by the consignor/shipper/exporter **vozarina se plaća unaprijed**

freight rate /freit reit/ (n) (shipping econ) = **freight** cijena prijevoza stvari iz jedne luke u drugu određena po jedinici mjere; The agreed charge for the carriage of cargo expressed per ton(ne) of cargo (also Worldscale in the tanker market) or as a lump sum. (<http://www.clarksons.com/glossary/>); The amount charged by container shipping companies for transporting cargo, normally as a rate per 20-foot or 40-foot container; the charge per unit (as per hundred pounds or per ton) by a carrier for the transportation of cargo generally published in a freight tariff

(<http://www.merriam-webster.com/dictionary/freight%20rate>) **vozarinski stav**, **iznos vozarine**,

cijena prijevoza robe morem, **vozarina**: Factors that can either increase demand for tankers or lead to excess supply will clash for the balance of 2016, leading to great fluctuations in oil tanker freight rates.

set a freight rate **odrediti vozarinu**, **utvrditi vozarinu**, **freight rates plummet**

vozarine jako padaju, **freight rates plunge vozarine jako padaju**, **freight rates fall**

vozarine padaju Container freight rates fell in August after two months of gains and came close to their 20-month low. Freight rates **will subsequently fall** due to increased vessel supply as newly built and repaired ships are delivered to owners by shipyards., **freight rates soar vozarine rastu**: Oil tanker rates soar as supplies surge from Iraq, Saudi Arabia etc., **freight rate surge**: Rates for the world's biggest oil tankers **surged to the highest** since January as shipments accelerated from Saudi Arabia and Iraq, the two biggest suppliers in the Persian Gulf. **vozarine naglo rastu**, **freight rates rise**

vozarine rastu: Shipping freight rates for transporting containers from ports in Asia to Northern Europe rose by 2.7 percent to \$573 per 20-foot container (TEU) in the week ended on Friday. **Freight rates** for very large crude carriers (VLCCs) **are set to rise** further next week, fuelled by a raft of cargoes from West Africa and the Middle East **Rates for VLCCs from West Africa to China soared** to W50 on Thursday against W43 on the same day last week., **freight rates climb vozarine s penju**, **vozarine rastu**: Freight rates for very large crude carriers (VLCCs), which **climbed** to a nine-month high this week, are set to **remain firm** on tight tonnage supply and strong cargo volumes, **freight rates hit the**

the highest level vozarine VLCC brodova dostigle su najvišu razinu: VLCC freight rates from the Middle East and West Africa to Asia **hit their highest level** since March 16 on March 22.

freight service providers (n) (shipping econ) Freight service providers transport cargo, such as manufactured products, raw materials, and food, and are generally hired by businesses. **teretni prijevoznici**, **transportna poduzeća za prijevoz tereta**

freight terminal (n) (shipping econ) Privately run terminals, such as freight terminals run by

railroads, have similar organizational structures to those of publicly operated terminals but generally focus on commercial operation and managing the arrival and desired departure times of cargo.

teretni terminal

frequency shift keying; (FSK) (n) (navig) digitalna modulacija pomakom frekvencija (u sustavu AIS)

fresh air trunk (n) (nav arch) dovodnik svježeg zraka

fresh breeze (n) (meteorol) vjetar jačine pet bofora i brzine od 29 do 38 kilometara na sat umjereno jak vjetar

fresh water (n) (marine eng) **slatka voda, svježa voda**: *Lubricating oil coolers using sea or fresh water as the cooling medium, must also be periodically checked for oil leakage.* **fresh water allowance; FWA COMPARE dock water** the number of millimeters by which the mean draught changes when a ship passes from salt water to fresh water, or vice versa, when the ship is loaded to the Summer displacement (Rhodes, Ship's Stability, Seamanship, 2003) **koeficijent promjene gaza pri prijeasku iz morske u slaku vodi i obratno**

fresh water generator (n) (marine eng) **generator slatke vode**: *The Wärtsilä Serck Como fresh water generators produce the fresh water needed onboard a cruise ship for deck washing, laundry, cabins, swimming pools, and technical applications that need high quality water. Minor repairs had just been completed on the shell plate of the fresh water generator (evaporator) by a shore workshop while in port..*

fresh water pump **pumpa slatke vode**: *On most engines the fresh water and sea water pumps are both of the centrifugal type.*

fresh water system **sustav pojne vode**

fresh-water system (n) (boating/yachting) **sustav slatke vode, susutav svježe vode**: *As the entire fresh water system relied on a single cooler, the loss of sea water to this cooler resulted in the ship losing its main engine.*

fresh water tank **tank svježe / slatke vode**: *The fresh water tanks and the DO header tank overflowed within a few seconds of each other ... {(abbr) FWT}*

friction /'frikʃən/ **low coefficient of friction** **niski koeficijent trenja** (marine eng, seamanship) **trenje, frikcija**: *The propeller shaft friction in the stern tube is excessive. The ropes are mainly subject to internal friction and corrosion.*

frigate /'frigit/ (n) (navy) **fregata**

frogfish (n) **žaba, grdobina, grdobina žutka, rošpo** {drugi hrv. nazivi: hrnja, hudobina, raćina, rošpo, vražica, žaba; lat. LOPHIUS PISCATORIUS}

frogman (n) (safety) **čovjek žaba**

front (n) (meteorol) the boundary or transition zone between two different air masses **fronta**: *As the vessel proceeded down the loch, a weather front began to pass through the area and the wind direction veered.* **warm front** **topla fronta, cold front** **hladna fronta, occluded front** result of the meeting of a warm and cold front **okluzivna fronta, zatvorena fronta, main front glavna fronta, sharpening of a front** jačanje fronte

frontal disturbance (n) (meteorol) **frontalni poremećaj**

front end amplifier (n) (electr) **malošumno pojačalo**

front loader (n) (cargo handling) **čelni viličar, čeoni viličar**



frostbite (n) (med) **smrzotina**: Skin contact with liquid Freon can cause **frostbite**.

froth system (n) (safety) **sustav gašenja prahom**

frozen (adj) **smrznut**: A fitter and the deck crew worked many long hours for two days to open the **frozen manholes** and there was much stress due to this unforeseen complication.

frozen cargo (n) (cargo) **smrznuti teret (-12 st. i niže), smrznuti teret**: The cargoes comprised perishable, **frozen** and chilled cargoes.

FRT (freight per tonne) (mar law) **vozarina po toni**

fruit (n) (cargo) **voće green fruit** nedozrelo voće, **citrus fruit** južno voće, agrumi

fruit carrier (n) (nav arch) **brod za voće, brod za prijevoz južnog voća**

FSM; free surface moment (n) (stabil) **moment slobodnih površina**

FTC; Fast Time Constant (n) (navig) **COMPARE ACR; Anti Clutter Rain**
visokopropusni filter male vremenske konstante (kod radara), sustav brisanja smetnji s padalina

fuel (n) **fuel cam** brijeg (kvruga) pumpe za gorivo: The exhaust and **fuel cams** are made of steel with a hardened roller race and are shrunk on the shaft., **fuel charge** 1 **dobava goriva; 2 ispušt**

goriva, fuel delivery **dobava goriva**: Caterpillar's ECM manages **fuel delivery**, air supply and other fundamental engine processes to achieve an optimum balance of performance and emissions., **fuel**

discharge 1 **odvod goriva; 2 ispušt goriva, fuel handling equipment** **oprema za rukovanje gorivom, fuel pump** **pumpa za gorivo, sisaljka za dovod goriva Bosch**

pumpa, fuel transfer **pretakanje goriva**: ..., following a review of the mooring manoeuvre and evaluation of the prevailing and expected sea conditions, it was decided to proceed with the **fuel transfer** operation., **fuel valve** **ventil goriva**: In the cylinder cover, there are three **fuel valves**: a starting

valve, a safety valve, and an indicator valve., **low grade fuel** **gorivo slabe kakvoće, full fuel**

position **položaj pune dobave goriva, no fuel position** **prekid dobave goriva, multi**

položaj polužja za gorivo, rate of fuel supply **omjer (količina) dobave goriva, to admit fuel** **dovoditi gorivo, pustiti gorivo (u sistem, cilindar), to break up fuel**

raspršiti gorivo, to run on fuel **raditi na određenoj vrsti goriva (o motoru), pokretati**

se na određenoj vrsti goriva (o motoru): The fuel system can be changed over so that the engine

run., **to supply fuel** **opskrbiti / snabdjeti gorivom, dobiti gorivo**: The mixing tank is used

to collect recirculated oil and also acts as a buffer or reserve tank as **it will supply fuel** when the daily service tank is empty., **fuel injection system** **sistem ubrizgavanja goriva, heavy fuel oil**

(HFO) teško gorivo, teška nafta, mazut: The main problem in burning **heavy fuel oil** in small high-speed engines is **ignition delay**. In order to reduce maintenance costs, at some time prior to the

incident, the company had approved a change of fuel from **heavy fuel oil (HFO)** to marine gas oil (MGO) for the heater, but the crew failed to make the necessary changes to the fuel pre-heating circuit and the auto-start pr, **intermediate fuel oil (IFO) nafta (37 Ct)**, **inferior fuel nedovoljan dotok goriva**, **marine fuel brodsko gorivo**: As marine fuel oil normally contains a small quantity of water, it is necessary to prime the bowl each time that it is run, ..., **solid fuel kruto gorivo**, **synthetic fuel sintetičko gorivo**, **umjetno gorivo**, **availability of fuel mogućnost dobivanja goriva**, **fuel oil nafta (kao gorivo kod dizel motora)**, **gorivo (marine eng, shipping econ) gorivo**

fuel (v) **1 opskrbiti / snabdjeti gorivom, napajati gorivom**: At about 1230, the boat tied up alongside and, throughout the afternoon, she was re-fuelled and re-stored, the catch landed, and ice loaded for the next trip.; **2 (figurative) nadolijevati (na vartu), poticati požar**: Foam in the area was found to be heavily contaminated with grease and had fuelled the fire, generating thick black smoke.

fuel cap (n) (marine eng, boating/yachting) **čep goriva (na izvanbrodskom motoru) fuel cap vent lever polužica / ručica zraka na čepu motora**

fuel consumption (n) (marine eng) **potrošnja goriva**: The change from K-GF to L-GF resulted in a 2 per cent improvement in the specific fuel consumption, and the lower speed accounts for a 5 per cent improvement in propeller efficiency.

fuel filter (n) (marine eng) **filtar goriva**: Replicated fuel leakage from main engine duplex fuel filters. **replace the fuel filter zamijeniti filtar goriva novim**

fuel injection (n) (marine eng) **ubrizationje goriva fuel injection pump pumpa za ubrizationje goriva**: Each cylinder is individually served by a fuel injection pump, HP pipe and injection valve with uncooled nozzle., **time the fuel injection regulirati vrijeme ubrizationje goriva**, **tempirati ubrizationje goriva**: An electronically controlled system optimally times fuel injection and the opening and shutting of exhaust valves., **fuel injection system sustav**

ubrizationja goriva: The very high standard of reliability and lifetime now attained by modern fuel injection systems is the result of considerable investment in R&D and production technology by designers and equipment manufacturers.

fuel injector (n) (marine eng) **ubrizač goriva, raspršač goriva**: The fuel injectors deliver the atomised fuel to the cylinder.

fuel line (n) (boating/yachting) **dovodna cijev goriva, dovod goriva**: Double-walled HP fuel lines distribute the fuel from the pumps along the engine to each cylinder.

fuelling (n) (marine eng) **opskrba gorivom**: The move to electronic control of fuelling brings advantages in accuracy of delivery and timing ... **ease of fuelling lakoća opskrbe gorivom**

fuel oil (FO) (n) **1 (marine eng) gorivo, pogonska nafta, brodska nafta**: Double-walled HP fuel lines distribute the fuel from the pumps along the engine to each cylinder. **heavy fuel oil (FO) (HFO) 1 teška nafta**: Operation on Heavy Fuel Oil Main engines designed to manoeuvre on heavy fuel oil are to be operated according to the manufacturer's instructions.; **2 mazut, intermediate fuel oil (FO) (IFO) nafta (37 Ct), store fuel oil (FO) spremi gorivo, transfer fuel oil (FO) prebaciti gorivo, supply fuel oil (FO) dovesti gorivo, dovoditi gorivo; 2 loživo ulje (kod kotla)**

fuel-oil supply (n) **1 (marine eng) dobava goriva**: The diesel fuel oil supply on the engine is divided into two systems: one for the pilot fuel and one for the back-up fuel. **fuel-oil supply system dovodni sustav goriva; 2 dovod loživog goriva**

fuel oil system (n) (marine eng) **sustav pogonskog goriva**: *The fuel oil system for a diesel engine can be considered in two parts: the fuel supply and the fuel injection systems. The fuel oil system is checked and circulated with hot oil.*

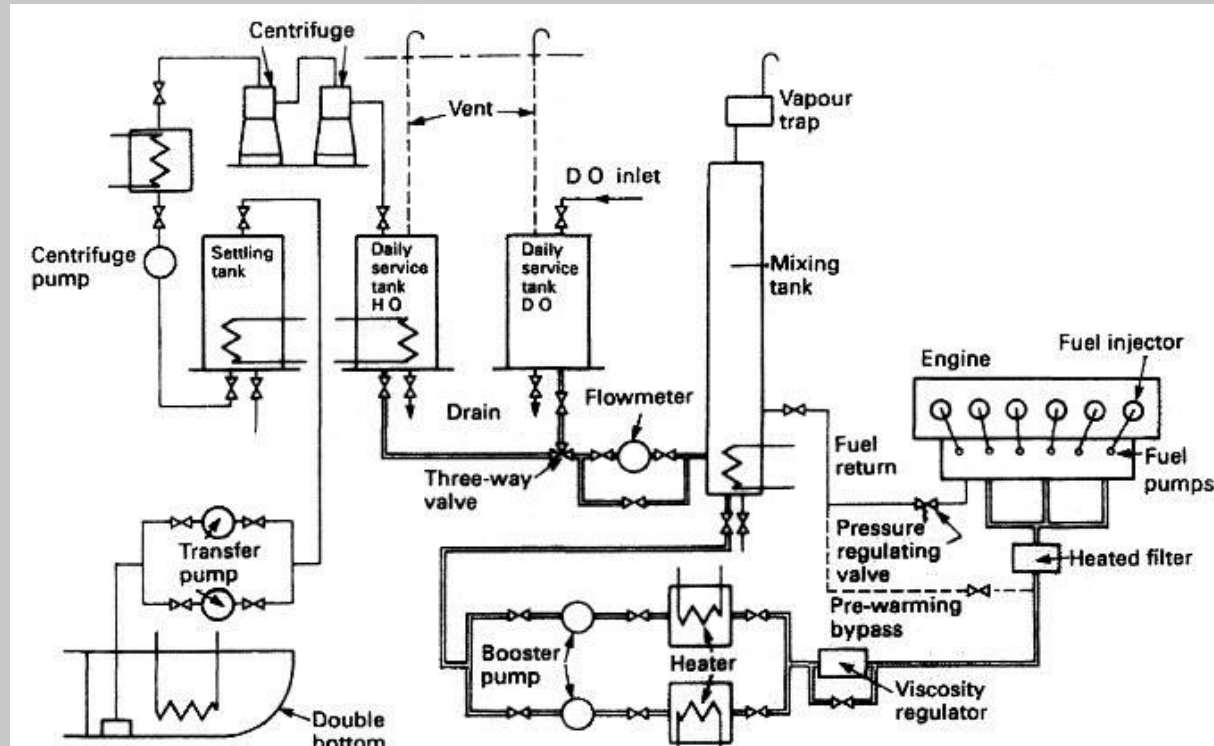

fuel pump (n) (marine eng) **pumpa goriva, sisaljka goriva**: *It is also very important that the fuel pump and exhaust valve operate at exactly the right time, so the camshaft is driven by the crankshaft.*

fuel return line (n) (boating/yachting) **povratna cijev goriva**

fuel supply (n) (marine eng) **dovod goriva, dobava goriva**: *At that point, the chief engineer started isolating the engine room ventilation and fuel supplies.*

fuel system (n) (marine eng) **sustav goriva**: *The fuel system can be changed over so that the engine can be run on diesel fuel. If the HFO is unstable, the asphaltenes will precipitate from the fuel and block filters and/or cause deposits in the fuel system, as well as lead to excessive sludge formation in the fuel separator.*

fuel tank (n) (marine eng) **tank goriva, tank, serbatoio della nafta**: *An investigation of the fuel tanks found that the fuel pick-up tubes within both tanks had become detached from the tank top fuel hose fittings. They tried swapping the two fuel tanks and supply hoses, but this failed to rectify the fault.*

fulcrum (n) (marine eng) **uporište poluge**: *A cast iron rocker housing supports the fulcrum for the fuel and valve levers, encloses the valve gear and also forms the cylinder head water outlet connection ...*

fulfill (v) **1 ispuniti, izvršiti**: *As a result, the deck watch was effectively composed of a single person who was expected to fulfill all of the tasks of navigation, maintaining a lookout and steering. ; 2 udovoljiti*

Full ahead! (adv) (seamanship, navig) **Svom snagom naprijed!**: *The pilot ordered full ahead, hard to port and requested one of the tugs to assist. 2235 Pilot away at southern boarding ground 2236 Full Ahead 2240 Half Ahead, course 125 deg, crossing the west bound lane at almost right angles to the separation scheme. Seconds later, the engine was put to full ahead, and the helm put hard to port to*

avoid the tanker. {naredba za upravljanje strojem}

full and by (prep phr) (boating/yachting) sasvim u vjetar (ali bez trešnje jedara)

Full astern! (adv) (seamanship, navig) Svom snagom krmom!, Svom snagom nazad!

At 2019 as the vessel passed the tanker berth the pilot ordered **full astern**, rather than his usual slow or half astern The master immediately applied **full astern pitch** and full port thrust. Consequently, **although full astern was ordered**, this only increased the power ahead on the starboard propeller. Manual DP was immediately selected (with yaw control), **full astern thrust was applied** and the vessel's movement stopped. {naredba za upravljanje strojem}

full-away (adv) (marine eng) punom snagom naprijed: After every economiser cleaning, for the first hour after **Full Away**, it became standard practice to deploy an additional seaman on the upper deck, ... I switch off the MF/HF DSC at the end of passage and only switch it on again at **full away**. The container ship's third officer returned to the bridge and, on instruction from the master, **he rang 'full away'** with an engine setting of 80rpm. At the time the **FULL – AWAY** is received the auxiliary scavenge air blower should be stopped, the starting air stop valve closed and all drains opened.

full cargo (n) (cargo, shipping econ) jedini teret na brodu, sav teret na brodu: The ship had departed Gladstone at 1054 that day after loading a **full cargo** of coal destined for Bayuquan, China. A large bulk carrier was unberthing **after loading a full cargo of coal**.

Full Container Load (FCL) (mar law, shipping econ) teret u kontejneru samo za jednog naručitelja (u direktnom prijevozu, door-to-door): The German-flagged **full container ship** was en route back from the east coast of the United States to Europe. At about 0218 on the morning of 17 September 2011, a very serious marine casualty occurred on board the **full container vessel** ...

full load (n) (marine eng) puno opterećenje: For modern engines, the optimum injection duration is around 18–20° crank angle **at full load**, and the maximum firing pressure is reached in the second half of that period. Droop is the variation in engine speed following a load change, approximately 4% for a **full load change**.

full load (n) (cargo handling, shipping econ) cjeloviti brodski teret, sav brodski teret iste vrste: Own vessel, a 21,310dwt multipurpose vessel with a **full load of containers** and a draught of 9.5 m. They finished loading at 1500 and sailed at 1510 with a **full load** for Monstera in Kalmar Sound, Sweden.

full mission bridge simulator (n) (navig) navigacijski simulator sa svim

funkcijama zapovjedničkog mosta: ... the Master and Deck officers involved will attend a Bridge Team/Pilot Relationship course on a **full mission ship bridge simulator**.

full operational capability (n) (navig, electr) COMPARE initial operational capability: vrijeme rada u punoim pogonu (navigacijskog sustava)

full power (n) (nav arch) punom snagom, svom snagom: ... the engines had been running **at full power** for some six-and-a-half hours ... **At full power** the turbocharger may be rotating at speeds of 10000RPM

full reach and burden of the ship (n) (nav arch, mar law) sav prostor i nosivost broda

full reverse svom snagom natrag

full rigged sailing vessel (n) (boating/yachting) jedrenjak, nava

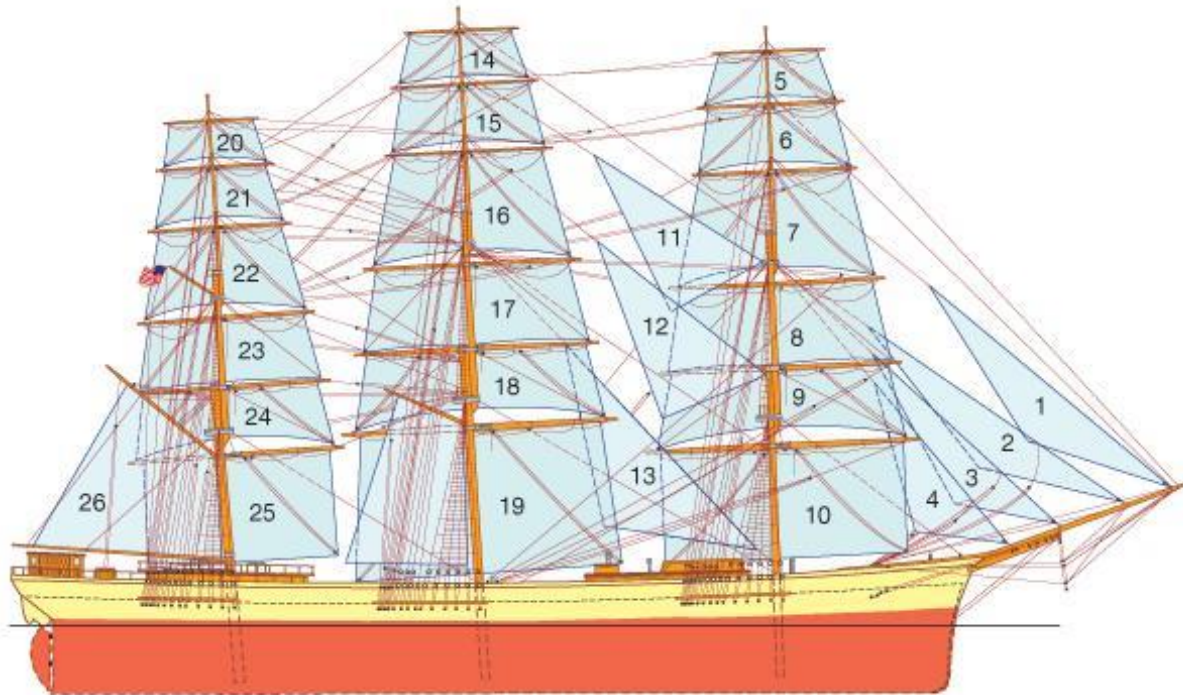

(1) flying jib. (2) outer jib. (3) inner jib. (4) jib. (5) fore skysail. (6) fore royal. (7) fore topgallant sail. (8) fore upper topsail. (9) fore lower topsail. (10) foresail. (11) main royal staysail. (12) main topgallant staysail. (13) main topmast staysail. (14) main skysail. (15) main royal. (16) main topgallant sail. (17) main upper topsail. (18) main lower topsail. (19) mainsail. (20) mizzen skysail. (21) mizzen royal. (22) mizzen topgallant sail. (23) mizzen upper topsail. (24) mizzen lower topsail. (25) crossjack. (26) spanker or driver.

© 2011 Encyclopædia Britannica, Inc.

full rigged ship - barque (*boating/yachting*) a sailing vessel with three or more masts, all of which are square rigged **jedrenjak tipa bark, bark**

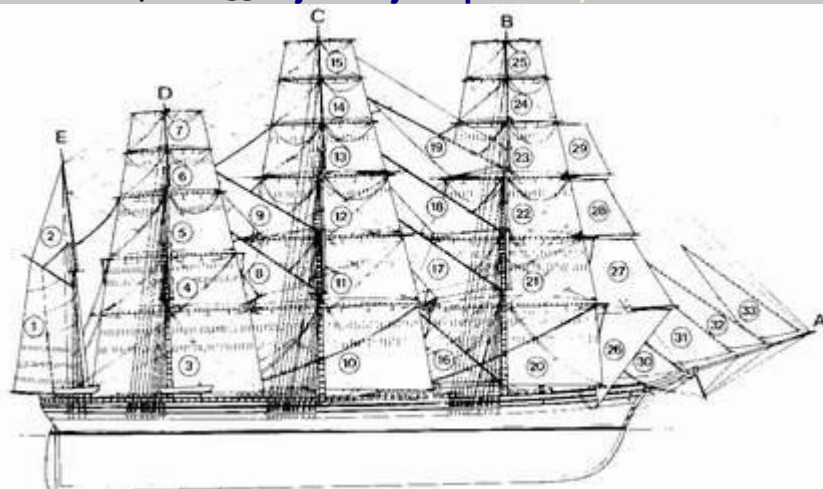

{1. šturnjača ili krmena sošnjača; 2. vrška; 3. stražnja debljača; 4. stražnja donja košnjača; 5. stražnja gornja košnjača; 6. stražnja sljemenjača; 7. stražnja vršnjača; 8. stražnja letka; 9. stražnja letkica; 10. glavna debljača; 11. glavna donja košnjača; 12. glavna gornja košnjača; 13. glavna donja sljemenjača; 14. glavna gornja sljemenjača; 15. glavna vrhovnjača; 16. glavna letnjača; 17. glavna letka; 18. glavna letkica; 19. glavna gornja letkica; 20. prednja debljača; 21. prednja donja košnjača; 22. prednja gornja košnjača; 23. prednja donja sljemenjača; 24. prednja gornja sljemenjača; 25. prednja vrhovnjača; 26. debleno pršno jedro (pršnjača, boneta); 27. donja košna pršnjača; 28. gornja košna pršnjača; 29. donja sljemena pršnjača; 30. letnjača; 31. prečnjača; 32. prečka; 33. prečkica.}

full rudder (*navig, seamanship*) kormilo do kraja (lijevo ili desno) kormilo sve lijevo

ili sve desno: *At the same time the tanker also altered, apparently **under full rudder**, to starboard. Using **full rudder** and engine power, and transmitting appropriate signals on the air horn and VHF radio, the master just managed to turn the ship's head into the wind and execute the 180-degree turn and head out to open sea. {naredba korimlaru}*

full scantling vessel (n) (nav arch) **brod s punim dimenzijama elemenata, brod građen s punim dimenzijama materijala**

Full speed! (n) (marine eng, comm) **Svom snagom Full speed! ahead Svom snagom naprijed, Full speed! astern Svom snagom natrag**

full speed (n) (navig, nav arch) **puna brzina**: *Following this discussion my pilot advised me that as we were proceeding further up the harbour we should enter first and so we should **maintain full speed**.*

at full speed punom brzinom: *After disembarking the pilot, the vessel proceeded out to sea at full speed. A little later, we saw a vessel approaching at full speed from the south heading towards the Western Boarding Ground.*

Full speed ahead / astern! (navig, comm) **Punom snagom naprijed / natrag!**

fully automated unattended machinery space (n) (marine eng) = **UMS (unattended machinery space)** **automatska strojarnica (rad bez osoblja u stroju)**

fully battened sail (n) (boating/yachting) **jedro s letvicama po cijeloj širini jedra**

fully laden (adj) (navig) **nakrcan (brod), pod punim teretom**: *A fully laden 80,000 tonnes deadweight tanker was manoeuvring to go alongside when a total power loss occurred as a result of the sea water cooling system becoming blocked. The ship left the port of Riga fully laden with timber three days earlier.*

fully loaded (adj) (navig) = **fully laden nakrcan (brod), pod punim teretom**: *A pilot boarded a fully loaded product tanker as it approached the port entrance.*

fully manned (adj) (navig, mar law) **sa svom propisanom posadom**: *The bridge and engine room was fully manned with a Bosun and AB stationed on the bow for lookout and emergency anchor purposes. I had always reduced my speed and kept the engine room fully manned when transiting these areas.*

fully pressurised liquid gas cargoes (n) (cargo) **potpuni stlačeni ukapljeni plinovi**

fully refrigerated liquefied gas cargoes (n) (cargo) **potpuno rashlađeni ukapljeni plinovi**

fully-rigged (adj) **1 (sailing vessels) jedrenjak (obično trojarbolni) s punom snasti i jedrima; 2 (seamanship) potpuno opremljen i postavljen (brodski siz)**

: *Do not leave the gangway unattended once the lashings are removed until the gangway is fully rigged or secured. They left the gangway suspended outboard, fully rigged and secured horizontally at main deck level, ready to be lowered for the pilot next morning.*

fume (n) (safety) **dim, zagušljiva para**: *This grinding created significant amounts of fumes. ... four seamen were sent to check the lashings and they were all overcome by the fumes in one of the holds. The OS who had removed the plug received some phenol fumes inside the face shield and inhaled a small amount of fumes.*

fumigation (n) (cargo) **fumigacija**: *The contractor who carried out the fumigation of the cargo provided the master with documentation that named the fumigant, defined the dosage rate, outlined the fumigation plan and the safety precautions. Before commencing any fumigation, a thorough briefing is provided by the suppliers of the fumigant covering safety and gas monitoring procedures plus any additional control measures.*

fumigation certificate (n) (cargo) svjedodžba o fumigaciji

function /'fʌŋkʃən/ (n) **1 funkcija**: The oil feed rate is controlled according to engine load and is adjustable as a function of engine condition.; **2 namjena**: Connected to the SSV is an empty space in the fuel outlet channel, whose function is to dampen the pressure waves when the SSV is opened.

primary function prva / temeljna namjena

function /'fʌŋkʃən/ (v) **raditi, djelovati, funkcionirati**: The coupling may in addition function as a clutch or disconnecting device. The fire detection system **did not function** correctly.

funds (n) (mar law, shipping econ) **financijska sredstva** **secure funds** **osigurati**

sredstva **pribaviti sredstva**: ... dozens of ships remain anchored off ports while the Company tries to secure funds to unload cargo.

fungi /'fʌŋɡai; 'fʌŋdʒai; 'fʌŋdʒi/ (cargo) **gljivice (štetočine na teretu)**: Amongst the most familiar fungi affecting citrus fruit are green and blue penicillium mould growth which is accelerated by high storage temperatures. {fungi (pl); fungus (sg)}

funnel /'fʌnəl/ (n) (nav arch) = **stack** **brodski dimnjak, ciminjera; fumaiolo**: A significant area on every deck between the funnel and the machinery spaces is thus released for other purposes. Only the uptake was burning inside the funnel, probably because the inside bulkheads were too caked with carbon to burn. High density black smoke was then seen coming from the funnel.

funnel casing (n) (marine eng, nav arch) **kućište dimnjaka, oplata dimnjaka**

funnel down (v) (meteorol) **stuštiti se (o vjetru), sručiti se**

funnel smoke (n) (marine eng) **dim iz brodskog dimnjaka**

furl (v) (boating/yachting) to roll up snugly and secure, as a sail or awning **namatati (prečku, jedro), to roll or wrap a sail around the mast, spar or forestay to which it is attached, rotati, tal. imbrogliare**

furler (n) (boating/yachting) **naprava za namatanje (prečke ili jedra)**

furl genoa sail (n) (boating/yachting) **roll genova**

furling (n) (boating/yachting) **namatanje jedara** **furling headsails** **namatanje prednjeg jedra, rolanje floka, furling the mainsail** **namatanje (glavnog) jedra**

furling system (n) (boating/yachting) **sustav za namatanje (jedra, prečke/floka), roll-sustav**



furl jib (n) (boating/yachting) **roll flok**

furl sail (n) (boating/yachting) **roll-jedro, jedro na namatanje (u jarbol ili deblenjak)**

furnace /'fɜ:nɪs/ (n) (marine eng) **ložište, plamenica**: The hot gases produced in the furnace are used to heat the feedwater to produce steam and also to superheat the steam from the boiler drum. **boiler furnace** **ložište kotla**: The chief engineer then purged the boiler furnace for about an hour after the

incident.

furthermore /fɜːðərmɔː/ (*adv*) **osim toga, još, nadalje**: *Furthermore, all crewmembers, especially those who may not have attended formal firefighting training, should be instructed on how to react in such situations.*

fuse /fjuːz/ (*n*) **1 upaljač (eksploziva, bombe); 2 (electr) osigurač, tal. fusibile**: *As he operated the controls for the solenoid to withdraw the securing pins, the fuse blew, leaving the pins engaged. On investigation, it was found that the plug had a 13A fuse not the 2A which was required, upon investigation all other fans were found to be the same and withdrawn from service until correctly rated*
fuse box ormarić s osiguračima kutija osigurača: *Because the fuse boxes were in the forward auxiliary generator hold, the skipper went out on deck and opened the access hatch to the space.*

fusibility /ˌfjuːzəˈbiliti/ (*n*) (*marine eng*) **topljivost, rastopivost high fusibility laka topljivost**

fusion (*n*) **welded by fusion zavaren taljenjem (phys, marine eng) fuzija, taljenje, stapanje, spajanje**

futtock /ˈfʌtək/ (*n*) (*nav arch*) **obluk, obluk rebra ((dio drvenog rebra u jedrenjaka))**

futtock-rigging (*n*) (*sailing vessels*) **kosne pripone**

futtocks /ˈfʌtəks/ (*n*) (*sailing vessels*) **rebro 1st futtockss donji dio rebra, 2nd futtockss obluk rebra, 3rd futtockss obluk rebra, 4th futtockss gornji dio rebra**

futtock shrouds (*n*) (*sailing vessels*) **kosne priponice ((u jedrenjaka))**

futures /ˈfjuːtʃəz/ (*n*) (*financ, shipping econ*) = **futures contract ročnice, rokovni ugovori, ugovori s naknadnim datumom izvršenja**

futures contract (*n*) (*shipping econ*) **A futures contract is a legal agreement, generally made on the trading floor of a futures exchange, to buy or sell a particular commodity or financial instrument at a predetermined price at a specified time in the future. ročnica, burzovni ugovor o kupoprodaji roba ili financijskih instrumenata (vrijednosnica, teretnica) po prethodno dogovorenim cijenama ali s naknadnim datumom izvršenja, rokovni ugovor, futures ugovor**

futures exchange (*n*) (*shipping econ*) **burza ročnica, burza rokovnih ugovora**

futures market ANTONYM spot market **A futures market is an auction market in which participants buy and sell commodity and futures contracts for delivery on a specified future date.**

(<http://www.investopedia.com/terms>) **tržište roba (tereta) i ugovora o prijevozu s**

naknadnim datumom izvršenja, tržište ročnicama, tržište rokovnih ugovora

FV; (fishing vessel) (*n*) (*nav arch*) **ribarski brod**: *Later that evening, loaded with the bagged cockles, the fishing vessel anchored, to wait for the next rising tide to enable her to return to harbour. At that instance, the master on the coaster returned to the forward part of the bridge and detected the fishing vessel 5 to 6 cables ahead. The remaining crew held onto the upturned hull, until they were seen by a passing fishing vessel, and recovered on board.*

FW (fresh water) slatka voda: *Lubricating oil coolers using sea or fresh water as the cooling medium, must also be periodically checked for oil leakage. According to the fresh water capacity tables, we were using 14 tonnes per day, which for 11 men is way over the mark (usually 3-5 tonnes is standard).*

F.W. pump (fresh water pump) pumpa slatke vode: *On most engines sea water and fresh water pumps are fitted.*

gaff /gæf/ (*n*) **1 (fishing) a long hook with a sharp point to haul fish in ribarska kuka, harpun,**

kučma, ganač, kučva **blow the gaff** odati tajnu, izbrbljati; **2 (seamanship)** mornarska kuka, **mezomariner** {tal. mezzo marinaio;}

gaff /'gæf,seil/ (n) (boating/yachting) duga oblica, koso podignuta i privezana pri vrhu jarbola, o koju je uhvaćen gornji dio četvrtastog uzdužnog jedra ili privjetrinska strana trokutastog uzdužnog jedra; a spar to which the head of a fore-and-aft sail is bent **sošnjak, pik, pilun gaff jaw** rašlje

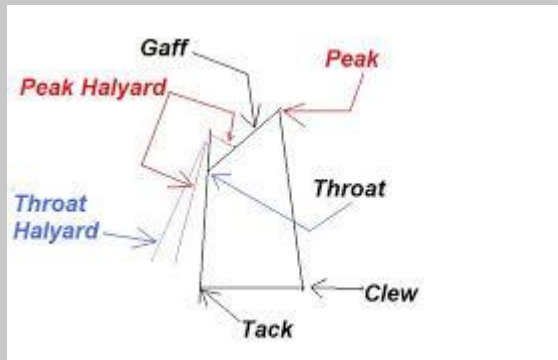

sošnjaka

{tal.: picco}

gaff rig (n) (boating/yachting) snast s četvorkastim glavnim jedrom

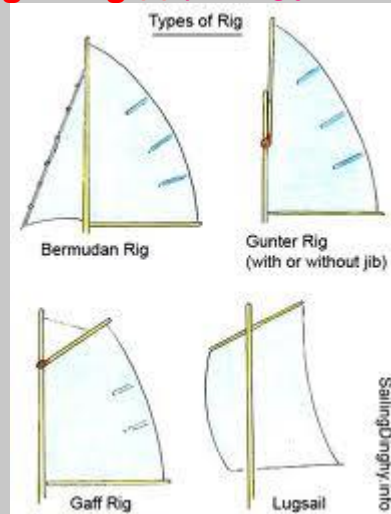

gaff-rigged ship (n) (boating/yachting) brod sa sošnim jedrom: *6m gaff-rigged wooden sailing yacht was on passage between two German ports in the Baltic, with four people on board.*

gaffsail /gæ/ (n) (boating/yachting) sošno jedro

gaff-sail boom (n) (boating/yachting, sailing vessels) deblenjak sošnog jedra

gage /geɪdʒ/ (US) mjerilo, mjerni instrument {gage = gauge}

gain /geɪn/ (n) (navig) The gain functions to adjust the receiver sensitivity for the best reception of signals of widely varying amplitudes. **intenzitet odraza na (radarskom) ekranu, osjetljivost radara namještanje pojačanja prijamnika**: *Gain may be adjusted automatically or manually. Push the GAIN control to choose automatic or manual adjustment alternately.* **adjust the gain**

namjestiti osjetljivost radara, gain level razina osjetljivosti **set the gain** namjestiti razinu osjetljivosti odraza na radarskom pokazivaču

gain /geɪn/ (n) (navig) pojačavanje osjetljivosti radara

gain control (n) (navig) kontrola za namještanje osjetljivosti radara: *The gain control affects the receiver and not the display as the brilliance does. Turning up the gain will increase the*

amplification of the incoming signal, making weak echoes look stronger, but confusing the display with background speckle or noise, similar to the background crackling of an ordinary radio.

gale (n) **near gale jak vjetar**: 201235 Anchor cable rendered in severe gale Our vessel let go her starboard anchor at an exposed roadstead at night in a **near gale** (30-33 knot wind), awaiting delivery on a new charter. , **severe gale vrlo jak vjetar**: The wind overnight was south-west force 6 to 7, and the morning's forecast predicted south-west winds of force 7 to **severe gale 9**, occasionally storm force 10, decreasing 4 at times. , **whole gale olujni vjetar, gale force (wind) vrlo jak vjetar, olujni vjetar**: he conditions alongside were calm, although the wind was predicted to be between force 3 and 4, increasing to 5 to 7 and perhaps **gale force 8** later. Once out of the harbour, very rough weather was encountered with a heavy swell and **gale force winds**. **1 (meteorol) wind of at least force 8 Beaufort**; sustained wind speeds from 34 to 47 knots (39 to 54 mph) **vrlo jak vjetar (po Beaufortovoj ljestvici), tal. burrasca** The weather forecast for the planned voyage predicted **gale and storm**, ... Expecting to berth the following day, the Master paid out a scope of 6 shackles of chain on the port anchor **in gale conditions.**; **2 (meteorol) oluja**

gale warning (n) **(meteorol) oluja, jaki vjetar, nevrijeme**: A panamax container vessel sailed just after midnight, with approaching **gale warning** in force. **issue a gale warning izdati upozorenje o oluji / nevremenu**: The BOM issued **marine gale warnings** and hazardous seas to continue tomorrow until midnight Eastern Standard Time Thursday 24 September, with further disruptions to shipping expected. The following day, a **gale warning** was issued for the port area.

galleon /'gæliən/ (n) **(nav arch)** A large three-masted sailing ship with a square rig and usually two or more decks, used from the 15th to the 17th century **galijun, galija**

gallery /'gæləri/ (n) **(marine eng)** uzdignuta platforma u strojarnici oko glavnog stroja za smještaj pomoćnih strojeva **platforma (u strojarnici), galerija**

galley /'gæli/ (n) **1 (nav arch)** a cookroom or kitchen of a ship **brodska kuhinja, fogun**: The superstructure was two decks high, and consisted of the bridge above a mess room and **galley**. There was also heavy smoke damage to the accommodation, **galley** and wheelhouse. Hot cooking oil splashed into cook's eye The cook was shallow frying vegetables in the **galley**. **galley deck paluba brodske kuhinje**: During subsequent routine washing down of the **galley deck**, the cook noticed the wires and, assuming they were isolated from the supply, he lifted them clear of the deck.; **2 (nav arch, sailing vessels) antička galija**

galley boy mladć kuhinje, mali od kuhinje, mali od kužine: The ratings in the Catering Dept. are the Ship's Cook, Assistant Cook, Baker, Pantry and **Galley Boy**, Messman etc.

galley counter (n) **(boating/yachting) predio kuhinje (na brodici, jedrilici)**: ... sharp edges can potentially exist in pressed stainless steel or aluminium fittings around the living and common spaces onboard ship, eg air louvres, **galley countertops** and sinks, insulated bulkhead claddings, deckhead panelling, corrugated / perforated shelving, gratings etc.

galley stores (n) **(seamanship) namirnice, zaliha hrane, provišta**

galvanic corrosion (n) **(boating/yachting, nav arch) elektroliza, korizija uslijed**

galvanskih struja: Layers of paint which had built up over the years had masked the **galvanic corrosion**, thus hiding the actual condition of the clamping screw. To avoid areas of **severe galvanic corrosion**, redundant hull fittings on GRP hulls should, ideally, be removed and appropriate repairs made to the GRP. **prevent galvanic corrosion sprječavanje elektrolize**

galvanized /'gælvə,naizd/ (adj) **(nav arch, safety) pocinčan, galvaniziran**: The exhaust gas receiver and exhaust pipe are provided with insulation covered by a **galvanized steel plate**.

galvanize; galvanise /'gælvə,naiz/ (v) **(marine eng) pocinčati, galvanizirati, prevući**

cinkom

gammoning-piece (n) (nav arch, sailing vessels) platnica kljuna

gang /'gæŋ/ (n) **1** (cargo handling) brodska ruka, grupa lučkih radnika, **ganga**, **škvadra** **stevedore** **gang** **štivadorska ruka**, number of **gangs** on board broj ruku na brodu, **ship gang** waiting time čekanje brodskih ruku, **shore gang** obalna ruka, lučka ruka, **un/lashing gang** grupa za od/vezivanje tereta / kontejnera: *On arrival at the vessel's home port an unlashing gang immediately boarded and released the lower lashing bars and twist locks that connected the bottom two containers in each stack stowed on deck.*; **2** radna skupina, radna grupa **mooring gang** privezivačka grupa, **privezivački tim**: *As there was a lot of weight on the spring and the mooring gang had not taken sufficient turns of the gantline, the gantline parted.*

gangboard (n) (nav arch) **SYNONYM** **gangplank** **pasarela**, **mostić** {**mostić od dasaka ili tavalona za hodanje, koji spaja pramac i most**}

gangplank (n) (nav arch) **pasarela**; tal. **passarella**, **mostić**, brodska skala (tavalon): *In winter, with ice and snow on the gangplank it was a sheer balancing act at times.* {**mostić od tavalona za hodanje, koji spaja pramac i most na brodu**}

gangway /'gæŋ,wei/ (n) **1** (nav arch) = **accommodation ladder** the opening in a bulwark including the ship's accommodation ladder; a passageway, side shell opening, and ladderway used for boarding of a ship **siz**, **brodski siz**, **brodska skala**, **skala reale**; tal. **scala reale**, **otvor u linici sa sizom**: *Several crew members left the vessel via the port side gangway and the gangway was then returned to the stowed position.* **rig the gangway** **postaviti brodski siz (po boku broda)**, **spustiti brodski siz (po boku broda)**: *Please rig a combination of the pilot ladder and the gangway on the port/starboard side. Update and keep inspection and maintenance records as per PMS; Do not leave the gangway unattended once the lashings are removed until the gangway is fully rigged or secured.*, **gangway fall** **čekrk brodskog siza**, **koloturnik brodskog siza**, **parank brodskog siza**: *Gangway fall wire parted. At this time, the Master and duty officer who were on the bridge saw the gangway fall wire rope part.*, **gangway watch** **straža pri broskom sizu**: *Shortly after, the OS was relieved for a break by the duty AB, whose duties included the gangway security watch.*, **shore gangway** **brodski obalni siz**: *Immediately, our crew safely re-moored the vessel and the shore gangway was repositioned and secured.*, **hoist / lower the gangway** **spuštati / podizati brodski siz**: *Having removed all the stanchions and guardrails, the AB started to hoist the gangway.*, **heave up the gangway** **podići bodski siz**: *The gangway was also heaved up.*; **2** the opening in a bulwark that gives access to a gangplank or accommodation ladder **otvor u linici za brodski siz**; **3** (navig) **mali mostić (za ulaz u brod)**, tal. **passarella** {**'The opening in a bulwark including the ship's accommodation ladder' (Croatian: otvor u linici sa sizom) is the original meaning of the term gangway in Maritime English but in modern use gangway is synonymous to accommodation ladder**}

gangway watch (n) (safety) **straža pri broskom sizu**: *Protect your owners' interests by posting a gangway watch.*

gantlet (n) (safety) **zaštitna rukavica**

gantline /'gænt,laɪn; 'gæntlɪn/ (n) **1** (boating/yachting) a line rove through a sheave for hoisting standing rigging, boatswain's chair, men or gear **podigač dijelova opute (na jedrenjaku)**, **podigač sjedala mornara na jabol**: *The gantline is secured to the bosun's chair with a 'rolling hitch'*; **2** (seamanship) **1**. A rope to throw ashore as messenger for a mooring line. **2**. A rope for mooring

a lifeboat. **uže za prihvaćanje i povezivanje priveznih konopa**: A forward back spring was passed and secured to a dolphin ring by means of a **gantline**. As there was a lot of weight on the spring and the mooring gang had not taken sufficient turns of the **gantline**, the **gantline** parted.

gantry /ˈɡæntri/ (n) (cargo handling) **mosna dizalica, granik**: ... containers are not meant to be handled by a single point suspension system such as a derrick fixed to a dumb lighter, but by a **shore gantry**. These **gantries** move not only parallel to the quay, but also run back for considerable distances, and so cover a large stacking area, and are able to plumb the ship's hold. The handling capacity of **container gantry** is 29 TEUs per hour. Apart from slewing deck cranes, corrosion, wastage and cracks can affect the structurals and components of monorail hoists, overhead and **travelling gantry cranes**, derricks and other lifting gear.

gantry crane (n) (cargo handling) track-mounted, shoreside crane utilized in the loading and unloading of general cargo, containers and heavy lift cargo. **mosna dizalica (na obali), granik, okvirna dizalica**: The West Basin Container Terminal currently includes 13 post-Panamax **ship to shore gantry cranes**, 19 transtainers, 39 tophandlers, and more than 170 yard hustlers, helping move more than 800,000 containers per year Each **gantry crane** was fitted with warning devices that operated automatically whenever the **gantry crane** travelled along the length of the deck. **shipboard gantry**



crane brodska mosna dizalica

gap (n) 1 (marine eng) **rascjep, praznina, raspon**: The 12 mm **gap** between the safety pin and its brake release lever, and the less-than-adequate maintenance on the brake-lever mechanism, contributed to the unexpected release of the lifeboat down the davit cradle. The **gap** between the turning gear's worm and the flywheel.; 2 (navig) **razmak**: There was a 5m **gap** between the ship and the quay. The vehicle carrier continued her south-easterly approach with the pilot now aiming for a **gap** between the inbound tanker and an outbound container ship.

garbage (n) (shipping econ) **smeće, brodsko smeće delivery of garbage predaja smeća**: The ship's Master stopped **delivery of the garbage** to the barge and requested the crew of the barge to cast off and collect the bags., **garbage discharge iskrcaj smeća, poslovi iskrcaja i prihvata smeća s bodova**

garboard strake (n) (nav arch) the strake of bottom shell plating adjacent to the keel plate (running fore and aft). **dokobilični voj, dokiljni voj**

garfish (n) (fishing) **iglica** {drugi hrv. nazivi: Aguc, đingula, igla, jagla, jigla, žigulja, angužigula, iglac; lat. BELONE BELONE}

gas /gæs/ (n) 1 (cargo) **plin (teret)**; 2 (marine eng) **plin burnt gases izgorjeli plinovi, exhaust gase ispušni plin**: The rotation force is provided by **exhaust gas** acting on vanes fitted to the valve stem. Some of the **exhaust gas** is cooled and cleaned before recirculation to the scavenge air side., **combustion gases plinovi izgaranja**: This gap provides a leakage path for the **combustion gases** so that one piston ring alone is insufficient to seal adequately., **escaping gases ispuh plinova**: The ship's crew made several attempts to refit the sampling valve, but due to the high pressure of the **escaping gas** and the formation of ice on the pipe, these were unsuccessful., **inert gas generator generator inertnog plina, uređaj za proizvodnju inertnog plina, inert gas inertni plin**: Line clearance was undertaken for a 45-minute period during which the **inert gas system (IGS)** was not run. Fires in the engine internal spaces can be attacked and extinguished using **inert gas** such as CO ,

foam, or water ., **boiler exit gases** izlazni plinovi kotla, **burning gases** gorući plinovi, **izgarajući plinovi**: *As the piston passes tdc, the **burning gas** expands, driving the piston toward bdc, rotating the crankshaft and its attached weighted flywheel.*

gas (n) (US) = **petrol** benzin **gas oil** (marine eng) gorivo, mazut, **marsh gas** oil zemni plin, **gas station** (US) pumpna stanica

gas bottle (n) 1 (marine eng, seamanship) **plinska boca**: *Look for the less obvious fire risks: cable insulation, heat transfer to the other side of bulkheads/decks, and the possible release of gas from nearby **gas bottles**. The acetylene ignited because the **gas bottle valves** were open.*; 2 (boating/yachting) **plinska aboca** **gas bottle fittings** pribor plinske boce (ventili, pipci, brtve), **gas bottle piping** plinski cjevovod

gas cargo container (n) (cargo) spremnik za prijevoz plina

gas carrier (n) (nav arch) **brod za prijevoz plina**: *A fully pressurised **gas carrier** had just completed loading liquefied propane at an oil refinery.*

gas detection equipment (n) (cargo handling, nav arch) uređaj za detekciju

propuštanja plina: *Before departing the ship, the fumigator-in-charge briefed the chief officer, and issued him with two gas masks and some phosphine **gas detection equipment**.*

gas detector (safety) **detektor plina**: *The master was carrying a walkie talkie as well as a personal **gas detector** (combined O and LEL) and the chief mate and pump man were standing on deck.*

gases (n) (cargo) **plinovi pod tlakom, ukapljeni ili otopljeni pod tlakom, plinovi** {klasa 2 opasnih tereta}

gas-flow (n) (marine eng) **strujanje plinova, odvod plinova**: *A nodular cast iron cylinder head was configured to achieve improved air and **gas flow rates** for the PA6B STC version. **arrangement of gas-flow** raspored odvoda plinova (iz komore izgaranja do dimnjaka)*

gas freeing (n) (cargo handling) **otplinjavanje tanka, oslobađanje tanka od plina**: *After **gas freeing** and one of the crew entering the tank, the leak was found and the hydraulic line repaired.*

commence gas freeing započeti otplinjavanje

gas-fuelled vessel (n) (nav arch) **brod na plinski pogon, brod s pogonom na plin**
LNG-fuelled vessel brod s pogonom na ukapljeni prirodni plin

gas jetty (n) (ports) **gat za brodove za ukapljeni plin, vez za brodove za ukapljeni plin**

gasket (n) (seamanship) **brtva, brtvilo, tal. guarnizione** **rubber gasket** gumena brtva: *Wear to rubber door **gaskets** or improper handling may result in the doors no longer closing correctly, so that they are no longer sealed against rainwater and the like.*, **door gasket** brtva za vrata, **head gasket** brtva glave cilindra: *A **cylinder head** with significantly increased safety factors is achieved with a wall supported by the **head gasket**, a thicker flame deck, optimized placement, larger exhaust seat ring cooling bores and smooth transition areas to avoid stres*

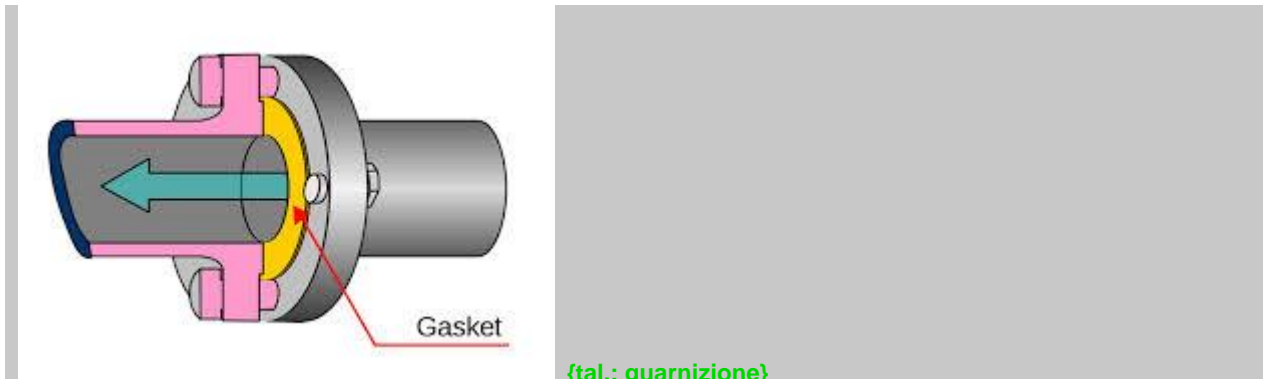

{tal.: guarnizione}

gas leak (n) (safety, marine eng) propuštanje plina, curenje plina: The ignition heat source was a hot gas leak from around the “plenum seal”.

gas leakage (n) (safety, marine eng) propuštanje plina, curenje plina: A control bore is provided in the cylinder cover to enable possible gas leakage to be detected between the two parts of the cover.

gas locker (n) (boating/yachting) spremnik za plinsku bocu self-fraining gas locker spremnik plinske boce samopražnjem

gas mode (n) (marine eng, nav arch) rad (stroja) na plin, način rada na plin run in gas mode raditi na plin (o brodskom stroju) raditi u plinskoj verziji / modusu: When running in gas mode, the engine instantly switches over to diesel operation if the gas feed is interrupted or component failure occurs.

gas oil (n) (marine eng) plinsko ulje, lako dizelsko gorivo, laka nafta marine gas oil brodsko plinsko ulje, laka brodska nafta The ship was running at slow speed on one diesel generator, which was being supplied with marine gas oil (MGO) from one of two fuel oil service tanks.

gasoline engine (n) (US) (marine eng) = petrol engine benzinski motor

gasoline; gasolene /gæsəli:n/ (n) (US) = petrol benzin

gas-tight door (n) (nav arch, safety) plinotijesna vrata: Access to the modules was through a water and gas tight door which incorporated a viewing port.

gas-tight seal (n) (marine eng) plinotijesna brtva, plinonepropusna brtva: A piston ring is a spring tensioned ring set in grooves in the circumference of a piston that push out against the walls of the cylinder forming a gas tight seal.

gas turbine /gæs ,tɜ:bin; 'gæs ,tɜ:bain/ (n) (marine eng) plinska turbina: A large catamaran was fitted with four gas turbine engines, two in each of the hulls. The main candidates for gas turbine propulsion in commercial shipping are cruise ships.

gas welding (n) (marine eng) plinsko zavarivanje, autogeno zavarivanje: Before a gas welding operation is carried out, all equipment and connections are to be checked and verified they are in safe condition;

gate (n) 1 (ports) vrata ulaza u lučki bazen brana u ustavi: After the lock gate in the direction of the Elbe was opened, the TMV, which was moored on the opposite side, was the first vessel to sail out of the lock. dock gate brana u ustavi, ustava, lock gate brana ustave A coastal tanker was berthed 150m ahead of a lock gate while waiting to enter



port to discharge her cargo.

security gate sigurnosna zaštitna vrata An additional *security gate* was being installed at the top of the gangway in way of the pilot boarding access.

gather (v) 1 skupljati, skupiti, okupljati se: At the centre they are formed to *gather the air* which enters at the eye of impeller. They expected to make the short transit to the *sandy area* and then *gather in the forward part* of the boat to discuss the next part of the exercise. Water was pouring into the engine bay and all the people on board *gathered at the stern* to help bail out the water.; **2 (navig)** o attain headway / stern way; to get going or pick up speed **kretati se u jednom smjeru (o brodu) to gather sternway kretati se krmom, kretati se nazad (o brodu)** The ship started *gathering sternway* Brod se počeo kretati krmom / u krmu The skipper engaged the engines astern, and the boat started to *gather sternway*. At 0212, the master, still misled by the 0210 plotted position, noted that the vessel was still *not gathering sternway*, and increased to half astern., **gather headway kretati se pramcem (brod) , kretati se naprijed (brod):** The ferry continued to *gather headway*. With the ship *gathering headway*, it was observed that the head was swinging very quickly to starboard, and accordingly, hard port rudder was applied., **gather way** To attain headway or sternway (to get going or pick up speed). **početi ploviti prema naprijed ili nazad (o brodu), početi se kretati:** Coming immediately onto their course of 160°, the combination of excessive leeway as the yacht was *gathering way*, and the onshore swell, quickly placed them in danger., **gather speed dobivati na brzini:** ... the sea and rain clutter had been adjusted as the vessel *gathered speed* and settled at 23kts.

GATT (General Agreement on Tariffs and Trade) Opći sporazum o trgovini i carinama

gauge /geɪdʒ/ (n) (UK) 1 (marine eng, safety) = gage mjerilo, mjerni instrument, mjerač, pokazivač: The lub-oil tank's contents gauge indicated that the tank was empty; approximately 10000 litres of oil had apparently 'disappeared'. A *level gauge* gives a local read-out of the drain tank contents. **deflection gauge komparator, diaphragm pressure gauge barometar s membranom, pneumatic gauge pneumatski pokazivač sadržine tanka, below pressure gauge barometar s valovitom komorom, pressure gauge manometar, tlakomjer:** They also showed that the pressure reading on the differential *pressure gauge* for the on-line oil filter remained low, indicating that the filter did not require changing., **gauge tube cijev manometra, gauge glass vodomjerno staklo, pokazivač razine (tekućine), manifold gauge tlakomjer na ventilskoj jedinici, manometar na manifoldu, level gauge mjerač razine, pokazivač razine, gauge glass mjerno staklo, staklo mjerila:** The bearing covers are each fitted with an oil filter, an oil drain opening and an *oil gauge glass*. The bearing covers are each fitted with an oil filter, an oil drain opening and an *oil*

gauge glass, **contents gauge** mjerilo sadržaja (tekućine u tanku): *The lub-oil tank's contents gauge indicated that the tank was empty; approximately 10000 litres of oil had apparently 'disappeared'.*, **tide gauge** pokazivač razine mora (plime i oseke): *To assist approaching ships in assessing the depth of water available, MAIB has suggested to the harbour authority that a tide gauge is placed at the entrance to the port.*; **2 kalibar, šablona**

gauge (v) **1 mjeriti šablonom, mjeriti**; **2 kalibrirati**

gauge stick (n) (marine eng, cargo handling, nav arch) mjerni štap, mjerni štapić

gauntlet /'gɔ:ntlit/ (n) (safety) zaštitna rukavica

Gaussian maximum shift keying; (GMSK) (n) (navig, electr) digitalna modulacija minimalnog pomaka faze (u sustavu AIS)

gear /'gɪər/ **1 (marine eng) zupčanik, tal. ingranaggio camshaft gear zupčanik bregaste osovine**: *The camshaft gear drive at the free end of the crankshaft and the auxiliary drive hub are fitted on a taper using the oil injection method.*, **idle gear međuzupčanik**: *Type of drive: gear(state approximate ratio between crankshaft and camshaft gears, number of idle gear(s), etc.*, **intermediate gear međuzupčanik**: *The intermediate gear wheels of the camshaft drive can be aligned more quickly than before by means of a built-in device to move the wheels vertically and horizontally.*, **set of gears niz zupčanika, train of gears niz zupčanika, worm gear pužni zupčanik, pužno kolo, pužni prijenos, gear ratio omjer zupčanika, odnos zupčanika**: *These pumps are integrated in the gear drive at the front side of the engine and driven by the crankshaft with a gear ratio of 1.65 at speeds of up to 1800 rev/min.*, **gear wheel zupčanik**: *The use of gear wheels for the camshaft drive allows the thrust bearing to be very short and stiff, and to be carried in a closed rigid housing.*, **idler gear međuzupčanik**: *The camshaft drive is located at the free end of the engine; the crankshaft gear drives via a compound idler gear for each camshaft.*; **2 (marine eng) uređaj, mehanizam jack gear uređaj za okretanje motora, running gear pogonski mehanizam**: *The upper piston of the engine requires its own running gear and crank throws.*, **reversing gear prekretni uređaj prekretni prijenosnik**: *This oil is also used to operate the hydraulic reversing gear for the engine.*, **timing gear razvodni mehanizam**: *The camshaft timing gear is attached to the front end of the engine, positioned between the crank gear and cam gear.*, **turning gear uređaj za okretanje**: *Accordingly, the air start valves were opened and one of the engineers operated the turning gear control lever with the intention of disengaging the turning gear from the main engine flywheel.*, **gear drive zupčani prijenos**: *A flange is provided for the vibration damper at the end, opposite to the coupling; a gearwheel for the gear drive is flanged on the coupling end. Timing is controlled by cams or gear drive from the engine camshaft.*; **3 (marine eng) prijenosnik auxiliary drive gear prijenosnik pomoćnog pogona**; **4 (safety) sigurnosna oprema, sigurnosni uređaj**: *Everything was labelled, panic bags were clearly marked and every crew member briefed on the location of safety gear.*

gear (n) (cargo handling) = **cargo gear** A comprehensive term in general use on shipboard signifying the total of all implements, apparatus, mechanism, machinery, etc., appertaining to and employed in the performance of any given operation, as cleaning gear, steering gear, anchor gear, etc. (SeaSources-US.dict.net) **brodski uređaj za krcanje tereta, oprema za dizanje/spuštanje tereta**

gearbox /'gɪəbɒks/ (n) (marine eng) **reverse gearbox prekretni uređaj, prekretna**

kopča, reversing gearbox prekretna spojka, prekretna kopča, **gearbox drive** pogon zupčanog prijenosnika, **reduction gearbox** reduktor, **marine gearbox** brodski reduktor **1** zupčani prijenosnik, tal. *invertitore*; **2** reduktor; **3** kutija mjenjača; **4** zupčani mjenjač

gear-driven (*adj*) (*marine eng*) **na zupčasti pogon, sa zupčastim prijenosom**: *The camshaft is either chain or gear driven from the crankshaft. The PTO at the free end accepts either gear-driven or belt-driven pumps and alternators.*

geared container ship (*n*) (*nav arch*) **Containerships that are equipped with cranes or derricks for loading and unloading containers and other cargo operations. kontejnerski brod s opremom za ukrcaj/iskrcaj tereta**

geared engine (*n*) (*marine eng*) **ANTONYM direct-coupled engine** motor s prijenosnikom, brodski stroj s reduktorom, motor s posrednim pogonom

propelera: *According to the way the main engine is joined to the shafting, they may be classified as direct coupled engines, i.e. coupled directly to the propeller shafting (also called direct drive) and geared engines, i.e. coupled to a reduction gearing (indirect dr.*

geared ship (*n*) (*nav arch*) **brod s vlastitim uređajem za ukrcaj/iskrcaj tereta**

gearing /'giəriŋ/ (*n*) (*marine eng*) **zupčanici, sustav zupčanika**: *The resulting damage to the shaft and gearing and to the turning gear casing disabled the ship for a month and cost a six-figure sum to repair. reduction gearing reduktor* Torsional vibration involves the whole shaft system of the propulsion plant, engine crankshaft, intermediate shafts and propeller shaft, as well as engine running gear, flywheel, propeller and (where appropriate) **reduction gearing**, flexible couplings, clutches and PTO drives.

gearless bulk carrier (*n*) (*nav arch*) **brod za rasutev terete bez uređaja za ukrcaj/iskrcaj tereta**

gear pump (*n*) (*marine eng*) **pumpa pokretana zupčanicima**: *A chain-driven rotary-gear pump provides lubricating oil to the main bearings and through internally drilled passages in the crankshaft to both connecting rod bearings.*

gears /'giərz/ (*n*) (*marine eng*) **bevel gears** konični zupčanici, **stožnici,**

double-helical gears zupčanici sa strjelastim zupcima, **herringbone gears** zupčanici sa strjelastim zupcima, **intermeshing gears** međusobno zahvatanje zubaca zupčanika, **single-helical gears** cilindrični zupčanici s kosim zupcima, **spur gears** čeoni zupčanici, **čelni zupčanici, cilindrični zupčanici s ravnim zupcima, valjkasti zupčanici zupčanici**: *The crankshaft drives the camshaft by a train of gears and the cams lifts the pushrods, thus transferring the motion to the rocker arms, which swing on pivots.*

gearshift (*n*) (*marine eng*) **ručica prijenosa**

gear wheel (*n*) (*marine eng*) **zupčanik, zupčasti kotač**: *If the gear wheels are misaligned, shock loading will result, which can lead to broken teeth. The camshaft was raised to be close to the cylinder covers and is driven via gear wheels.*

gelcoat /'dʒɛkəʊt/ (*n*) (*nav arch, boating/yachting*) **staklasti zaštitni sloj, đelkot repairing gelcoat** damage **popravak štete na đelkotu**

general alarm (*n*) (*safety, navig*) **opća uzbuna, znak za opću uzbunu**: *The master raised a general alarm and the crew immediately proceeded to clean up the spilled fuel oil on deck. sound the general alarm dati znak za opću uzbunu* *The master sounded the general alarm and the well practised fire-fighting organisation swung into action. The master sounded the general alarm to*

*muster the crew members. After the **general alarm** was sounded, the crew assembled on the bridge and donned immersion suits collected from two decks below.*

general alarm bell (n) (safety) zvono za opću uzbunu, zvono opće uzbune **sound the general alarm bell** uključiti zvono za opću uzbunu

general arrangement plan (n) 1 (nav arch) opći nacrt broda, generalni plan broda; 2 situacijski nacrt

general average (n) (mar law, mar ins) havarija koja pogađa sve sudionike pomorskoga pothvata **zajednička havarija, generalna havarija, generalna avarija**

General Average act (n) (mar law) There is a general average act when, and only when, any extraordinary sacrifice or expenditure is intentionally and reasonably made or incurred for the common safety for the purpose of preserving from peril the property involved in a common maritime adventure.

(York/Antwerp Rules 1994) **čin generalne avarije, nastupanje čina generalne avarije**

general average act (n) (mar law) čin zajedničke havarije

general average adjuster (n) (mar ins) likvidator zajedničkih havarija

general average adjustment (n) (mar ins) obračun zajedničke havarije, likvidacija generalne havarije

general average clause (n) (mar law) klauzula o generalnoj havariji

General Average contribution (n) (mar law) The monetary contribution required of shipowners and cargo owners (or their respective insurers) in respect of general average expenditures and general average sacrifices. (Tetley) **financijsko učešće u generalnoj avariji**

general average contribution (n) (mar law) doprinos u zajedničku havariju

general cargo (n) (cargo) general cargo consists of both containerized and breakbulk goods, in contrast to bulk cargo. **generalni teret, komadni teret, opći teret:** *General cargo is handled by cranes on the quay, floating cranes or by the ship's own cargo gear (deck cranes, derricks, etc.). The container ship arrived in Esbjerg, Denmark, from Larvik, Norway for discharging and loading **general cargo** in containers.*

general cargo ship (n) (nav arch) brod za opći teret, brod za generalni teret,

teretnjak: *A 1680gt **general cargo ship** in ballast was on passage to Sweden, course was 132° in autopilot and speed was 10 knots. A 2500 grt **general cargo ship**, carrying a timber deck cargo, was heading towards the entrance to a 300m wide buoyed channel, on a course of 004° in autopilot. A 79-metre **general cargo vessel** was on passage through UK waters in the early hours of a winter's morning. A **general cargo ship** arrived with an import cargo that was stacked high on the hatch covers,*

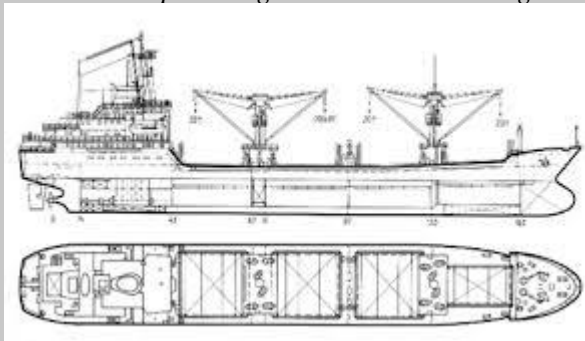

exposing a large lateral wind area.

General Characteristics (n) (nav arch) opći podaci o brodu

general compressed air system for deck (n) (nav arch) sustav zraka opće službe za palubu

General Declaration (n) **1** (mar law) opća izjava, opća prijava (tereta); **2** (mar law) Opća carinska deklaracija

general electric maintenance (n) (electr) opće održavanje električkih sustava
insulation izolacija, **test equipment** ispitna oprema, oprema za testiranje

general emergency alarm (n) (safety) uzbunjivanje u slučaju opće opasnosti

*Remain calm when you hear the **general emergency alarm**. When the **general emergency alarm** is sounded, which consists of seven short blasts and one prolonged blast, all passengers have to go to their assembly station.*

general practitioner (GP) liječnik opće prakse: *It was some time before I got home, I then went to my **GP** who sent me to hospital for an X Ray where they discovered three broken ribs.*

general purpose container (n) (cargo) kontejner opće namjene

general purpose crew (n) (mar law) posada opće namjene (za rad na plaubi i u strojarnici): *Ratings are trained to perform the duties of the dual and **general purpose crew**.*

general purpose manning (GP manning system) sustav posade opće

namjene, **polivalentna posada**: *In the **GP manning system** officers and ratings are trained to have knowledge and skills common to all departments in*

general service pump (n) (nav arch) pumpa opće namjene: *ballast, condenser sea water, fire and general service (GS), and IG scrubber pumps.*

general service system (n) (nav arch) sustav opće službe

general synopsis (n) (meteorol) stanje vremena, vremenska situacija, opis stanja vremena

general terms (n) (shipping econ) opći uvjeti poslovanja **general terms and conditions** opći uvjeti poslovanja

generate /'dʒɛnə, reɪt/ (v) stvarati, proizvoditi, generirati **generate steam** (marine eng) proizvoditi paru: *He suggested that overall plant efficiencies of 57–58 per cent are possible from a combi-cycle exploiting waste heat to **generate steam** for a turbo-alternator.*

generate power (marine eng) proizvoditi struju

generating plant (n) (marine eng) brodska elektrana, brodski generator: *Three 14 000 kW azipod propulsors power royal Caribbean Cruises' voyager-class liners **generating plant**. Integrated energy-saving **generating plants** have been developed over the years for application mainly to large container ships.*

generating set; genset (n) (marine eng) generatorski sklop, generator: *Diesel gensets have even been installed in containers on deck to provide propulsive power, and other vessels equipped with a 10 000 kW generator mounted in a block at the stern above the RoRo deck.*

generating tubes (n) (marine eng) isparne cijevi, isparivačke cijevi: *The D type boiler also has a two stage superheater - primary and secondary, located below the **generating tubes**.*

generating unit (n) (electr, marine eng) brodska elektrana, brodska električna centrala

generator /'dʒɛnə, reɪtə/ (n) **1** (electr) električni generator, generator, generator struje: *Diesel gensets have even been installed in containers on deck to provide propulsive power, and other vessels equipped with a 10 000 kW **generator** mounted in a block at the stern above the RoRo deck. The economic attraction of the **main engine-driven generator** for electrical power supplies at sea is that it exploits the high thermal efficiency, low specific fuel consumption and low grade fuel-burning ...*

drive the generator pokrenuti generator: *It seems somewhat illogical to use **electric generators**, switchgear and motors between prime movers and propeller when*

direct-coupling or coupling or geared transmission to the shaft may be all that is necessary., **emergency generator pomoćni generator, generator za rad u nuždi**: Any faults or defects in the **emergency generator/alternator**, its prime mover and associated equipment, must be rectified and immediately reported to the appropriate management office. The **emergency generator started**, but did not run for long because its ventilation openings were left shut, causing it to overheat., **auxiliary generator pomoćni generator**: Power was restored quickly using an **auxiliary generator**, and when the main engine was restarted, the main engine low lube oil pressure alarm sounded again., **shaft generator osovinski generator**: Since the electrical systems on board the vessel were linked to the main engine via the **shaft generator**, the electricity failed as well and for a short period of time the vessel suffered a blackout. The **shaft generator** was designed to provide some emergency propulsion, but this was faulty and could not be used., **generator room prostorija generatora**: To gain access to the control room from the **generator room**, the crew had to negotiate two steps and a doorway with a raised sill before stepping down into the room., **generator uptake odvod ispuha generatora (u brodskom dimnjaku)**: On both occasions, one of the **generator uptakes** inside the funnel caught fire., **main generator glavni generator**: All emergency stops were operated, however the **main generator** continued to run., **portable generator prijenosni generator, prijenosni agregat**: A “suitcase” type **portable petrol-driven generator** had been installed in the motor cruiser’s engine bay to supply the boat with 240v power., **generator engine motor generatora**: Although the engineers reacted correctly and quickly stopped both **generator engines**, the lube oil priming pumps continued to operate, powered by the emergency power source., **generator power snaga generatora, jačina struje iz generatora**: **Generator power** was lost not long afterwards, and with only their portable pump running, they abandoned, about 3 hours after discovering the flooding.; 2 (marine eng) **fresh water generator SEE evaporator uređaj za proizvodnju slatke vode, destilator**: The **fresh water generator** (or evaporator) uses the heat from the main engines in the cooling water to produce fresh water from sea water. A **fresh water generator (FWG)** which is used to produce fresh water from sea water is also incorporated.; 3 (marine eng) **generator plina, plinski generator**: **Gas generator**, power turbine and all ancillary systems are mounted on a common bedplate to form a self-contained unit for ease of installation The **gas generator** of the GT35 is a two-shaft engine equipped with a 10-stage LP compressor, an eight-stage HP compressor, seven can-type combustion chambers, ...

generator protection (n) (electr, marine eng) zaštita generatora

generator set (n) (marine eng) generator: Each 59 000 kWe outfit comprises a pair of GE LM2500 gas turbine-generator sets, rated at 25 000 kWe apiece, and a 9000 kWe non-condensing steam turbine-generator.

gennaker (n) (boating/yachting) asimetrični špinaker čiji je o glavni rogalj uhvaćen za palubni okov prednjeg leta; asymmetrical, lightweight reaching jib **denaker**

genoa car (n) (boating/yachting) klizač đenove

genoa; Genoa jib (n) (boating/yachting) = Genoa sail jib whose clew overlaps the mast or



shrouds **genova**, **đenova**; tal **genoa**

Genoa sail (n) (boating/yachting) **genova**

genset (n) (marine eng, electr, nav arch) = **generator set generator, agregat**: *The running speed was determined by the frequencies in genset applications, focusing on 900 rev/min to 1000 rev/min for 60 Hz and 50 Hz requirements. Yanmar Diesel is a prolific Japanese producer of high-speed and smaller medium-speed engines for genset and propulsion drives. For lower power demands, MTU's Series 396 engine is long established as a propulsion and genset drive, the 165 mm bore/185 mm stroke design delivering up to 2560 kW at 2100 rev/min from V90° configuration 8-, 12- and 16-cylinder models.*

gentle breeze (n) (meteorol) **vjetar** jačine tri bofora i brzine od 12 do 19 kilometara na sat **slab vjetar**: *The weather was good, with a gentle breeze and slight sea.*

genuine link (n) (mar law) **stvarna veza**, **bitna / istinska veza** (između države i broda)

geographical position (GP) (n) (navig) **geografska pozicija**: *Geographical position of any future STS operations should be thoroughly appraised and discussed with all participating parties (commercial operators included).*

Geographic Information System; (GIS) (n) (navig) **geografski informacijski sustav, GIS**

geography (n) (navig, ship handling) **geografski oblik** **geography** of the basin **oblik lučkog bazena** (radi pristajanja / isplovljavanja), **geografski** **geography of the body of water** **geografski oblik akvatorija**

geometrical dilution of precision; (GDOP) (n) (navig) **geometrijsko raspršenje preciznosti** (u sustavu GPS)

geometry of anchoring system (n) (navig) **geometrija sustava sidrenja**

germinate (v) (cargo) **klijati, proklijati**

get afloat (v) **zaplutati**

get back on course (v) (navig) **vratiti se na kurs**

get off (v) (seamanship) **iskrcati se (s broda)**, **iskrcati(teret) s broda**: *... the good news is that all the crew got off safely.*

get on board (v) **1** (seamanship) **ukrcati se (na brod)**: *He appeared to be in quite a hurry to get on board and started climbing up the pilot ladder as soon as it was confirmed to him by the 2nd Officer*

on deck that it was secured.; **2 (cargo handling) ukrcati (teret) na brod**

get the line across (v) (seamanship) dobaciti uže, prebaciti konop

get the line ashore (v) (seamanship) dobaciti uže do obale, baciti uže na obalu

get the line on board (v) (seamanship) dobaciti uže na brod

getting underway (n) (ship handling, navig) isplavljanje: *And, most importantly, that masters should not hesitate to **get underway** or to seek a more sheltered anchorage should the forecast or actual weather and sea conditions warrant it. The ferry finally **got underway** again 5 hours after the duty engineer first noticed the low pressure alarm. A Master/Pilot exchange, including the prevailing and probable weather conditions forecast for the transit was conducted in accordance with Company Passage Planning procedures prior to **getting underway**.* **getting underway port/starboard side to the berth/quay/wharf/pier/dock, with / without a bow thruster isplavljanje broda vezanim lijevim/desnim bokom uz obalu, s ili bez pramčanog porivnika**

get trapped (v) (marine eng) zaustaviti se (o plinu, pari, zraku), biti zaustavljen, blokirati se, hvatati se

get underway (v) (ship handling, navig) isplovati, zaploviti (nakon manovre

odvezivanja, dizanja sidra): *Be ready to get underway Pripremite se za isplavljanje The decision was taken to **get underway**, and the starboard anchor was weighed. A container feeder vessel was lying to her starboard anchor, preparing to **get underway** to embark a pilot. The Master informed him that, after completion of cargo work, the vessel needed to carry out pre-departure check lists tests before **getting underway**.*

GGh; horizontal component (n) (stabil) **horizontalna komponenta** *Free couples of mass forces and the torque variation about the centre lines of the engine and crankshaft (Wärtsilä): m_V is the first-order couple having a vertical component. m_h is the first-order couple having a horizontal component. m_V is the second-order couple having a vertical component.*

GGv; vertical component (n) (stabil) **vertikalna komponenta** **GGv; vertical component of the shift of G** **vertikalna komponenta sistemskog težišta broda**

ghost fishing (n) (fishing) Ghost fishing is the term used to describe the capture or entanglement of organisms in lost or discarded fishing gear. **štetni / nepoželjni ribolov napuštenim mrežama i drugim ribarskim alatima**

GH; transverse statical stability (n) (stabil) **ships' ability to return to upright position after being disturbed by a force that rotates it around longitudinal axis, poluga poprečne statičke stabilnosti**

giant goby (n) (fishing) glavič pločar

gig; fishgig /gɪg/ (n) (fishing) **SYNONYM trident** **osti (bez zubaca na oštricama) fishing gig; fishgig** **osti**

gillnet /ˈɡɪl, nɛt/ (n) (fishing) Gillnets are large, rectangular mesh nets that are positioned either on the sea floor or float within the water column depending on the target species. **mreža posebnog oka (za hvatanje na bodlje i kosti škruga) bottom gillnet** **pridnena mreža posebnog oka**

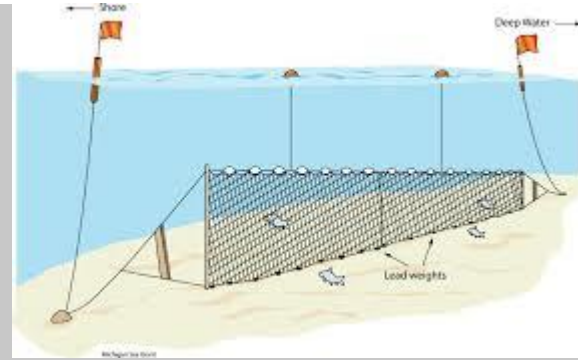

, **pelagic gillnet** pučinska površinska mreža

posebnog oka, **drift gillnet** pučinska površinska mreža posebnog oka: *Drift gillnets, commonly referred to as drift nets, are kept at higher depths with buoys. {A net either pulled behind a boat or set from shore with floats on top and weights on the bottom to make it hold it upright in the water. As fish swim into the net they are caught on there gill plates.}*

gills (n) (fishing) škrge

gilt-head bream (=gilt-head sea bream) (n) (fishing) podlanica, komarča, orada, lovrata, lt. *orata*; *cagnina*



wiseGEEK

{drugi hrv. nazivi: komarča, dinigla, lovrata, podlanica, sekulica, zlatulja, štrigavica ; lat. SPARUS AURATA L.}

gilthead sea bream (n) (fishing) orada, komarča, podlanica, lovrata, ovrata

gimbals /'dʒɪmbəlz; 'ɡɪmbəlz/ (n) **1** (boating/yachting) ljuljačka kuhala; **2** a device, consisting of two or three pivoted rings at right angles to each other, that provides free suspension in boats and ships for an object such as a gyroscope, compass, chronometer, etc **kardanski ovjes kompas**



gipsy; gipsey (n) 1 (nav arch, seamanship) = **gypsy = cable lifter = wildcat** a drum of a windlass for heaving in cable or line **podigač sidra (na sidrenom vitlu), tamburin**; 2 (nav arch, seamanship, UK) a drum of a windlass for heaving in cable or line; **bubanj priteznog vitla (na krajevima sidrenog vitla)**

girder /'gɜːdə/ (n) 1 (nav arch, marine eng) a structural member which provides support for more closely spaced members, such as beams, frames, stiffeners, etc., which are at right angles to it and which either rest upon it or are attached to its web **nosač, greda, traversa bridge girder** a structural member holding a portion of the deck **nosač palube mosta, deck girder nosač palube, greda plaube, potpalubni nosač, box girder kutijasti nosač, centre girder hrptenica, bottom side girder bočni nosač dna, transverse girder poprečni nosač**. Instead there are two pairs of tie bolts fitted either side of the single plate A frame and screwed into the bedplate **transverse girder, hull girder nosač trupa broda, nosač u trupu broda: Hull girder strength** and buckling checks are carried out on all critical sections along the entire length of the hull., **crane jib girder nosač kraka dizalice**: It was determined that if the other A/B had positioned himself on the **crane jib girder** by climbing on to it from the crane pedestal, he could have safely secured the casualty's lifeline.; 2 **jaki nosač** {tal.: **paramezzale; trave**}

GIS (Geographic Information System) (n) (navig) **geografski informacijski sustav, sustav GIS**

give off (v) (**cargo**) 1 (marine eng) **lučiti, izlučivati, oslobađati (paru, plin itd.)**: The test determines the temperature at which the fuel will **give off** sufficient vapours to ignite when a flame is applied. Flames **give off** ultraviolet and infra-red radiation and detectors are capable to respond to either. The fire consumed the oxygen in the space and **gave off** toxic fumes.; 2 **ispuštati**

give rise to (v) (**mar law, marine eng, navig**) **dovesti do, prouzročiti, izazvati**: The forecast **did not give rise to** concern. Prognoza nije izazivala zabrinutost. The electrically driven compensator **will not give rise to** distorting stresses in the hull, but it is more expensive than the engine-mounted compensators. The actions of other vessels **gave rise to** concern. The total stress level is high and varies with time, **giving rise to** the risk of fatigue. I believe watch officers ought to call the master before using the VHF for close quarters or collision avoidance as it can **give rise to** doubts and misunderstandings and can be a distraction.

give way (v) (**navig**) **dati pravo puta, ukloniti se s puta drugom brodu, dati pravo prolaza drugom brodu**: Failure of the tanker to **give way** caused me to reduce speed as action to avoid collision. Within a few minutes he realised his assessment was wrong so he altered course to starboard attempting to **give way** and pass clear. As the area was clear of shipping it was expected that the

other vessel would **give way** at about 2nm range in accordance with rules 15 and 16.

give way (to) (v) (navig) **dati pravo puta (drugom brodu), izbjegli drugi brod**: Another vessel in the SW Lane had to alter course to **give way to** the NE bound vessel, still maintaining its course in the SW Lane. I believe that HSC do generally **give way to** other vessels.

give-way vessel **ANTONYM stand-on vessel** **brod koji ustupa put, brod koji izbjegava, brod koji je dužan izbjegavati drugi brod, brod koji daje pravo puta**: The cargo vessel was undoubtedly the **give way vessel**, and recognised this fact from a relatively early stage. Since own vessel was now the **give way vessel**, appropriate action was taken by altering course to starboard. Concerned that the **give way vessel** was still standing on, the OOW started to try and attract the other vessel's attention using the Aldis lamp.

giving-way ship = give-way vessel **brod koji izbjegava, brod koji je dužan izbjegavati (drugi brod)**

gland (n) 1 (marine eng) **brtva, brtvilo, brtvenica, očnica**: This oil is prevented from entering the crankcase by the **piston-rod gland**, and is drained into the dirty oil tank. A vent to atmosphere at the end of the labyrinth gives a guide to the efficiency of the **turbine end gland**. The two-part **gland seals** for the piston rod, and telescopic piston cooling pipes can be inspected while the engine is

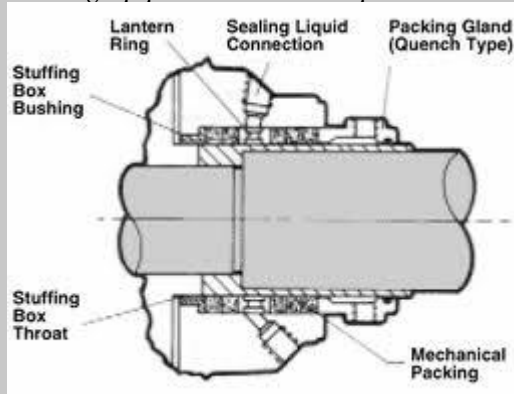

running and can be dismantled

; 2 (nav arch)

šupernica: During this relatively short run, the owner decided to again check the **stern gland**. {tal.: premistoppa}

gland steam (n) (marine eng) **para koja izbije / pušta iz brtvenice**: With the lubricating oil supply maintained, low vacuum, and **gland steam** on the turbines are to be turned on ahead steam for approximately 2 propeller revolutions every five minutes, using astern steam as appropriate.

glass (n) 1 (marine eng) **kontrolno staklo**: The first stage required the **glass panel** to be broken, and depressing the button activated the selected space visual and audio alarm, stopped the ventilation fans and ... They are of the 'sight feed lubricator' type, and each lubricating point has a **glass**. **sight glass kontrolno staklo (za razinu ulja, vode, ...)**: The **sight glass** shows the oil level in the oil sump.

, **break glass fire alarm staklo za uključivanje protupožarne uzbune**: They then activated a 'break glass' fire alarm., **gauge glass cover poklopac mjernog stakla**: Where

required to be fitted, the **gauge glass cover** should always be in place when the glass is under pressure., **oil**

gauge glass: The bearing covers are each fitted with an oil filter, an oil drain opening and an **oil gauge glass**.; 2 (navig, meteorol) **tlakomjer, barometar**; 3 **toplomjer**

glass fibre (n) 1 (nav arch) **stakloplastika**: As the fishing vessel was swinging to port, the ice-strengthened bow of the cargo vessel collided with her starboard quarter, causing severe damage to her **glass fibre hull**.; 2 **stakleno vlakno**

glass wool (n) (nav arch) **staklena vuna**

glassy sea (n) (meteorol, oceanogr) zrcalasto more, more kao zrcalo: *The wind was Force 2, the sea glassy calm, visibility was excellent and the swell was negligible.*

glaze (n) to break the glaze skidati glatkoću, ohrapaviti (nav arch, marine eng) glazura, pocakljenje, caklina: *When the piston rings are renewed the glaze on the liner bore should be broken by honing to provide the surface suitable for rapid running-in.*

glint (n) (navig) pomicanje srešišta radarskog odraza duž cijelog cilja / objekta

Global Maritime Distress Safety System (n) (safety) Svjetski pomorski sustav

pomoći u pogibli i opasnosti: *Some merchant vessels have sunk without a single DSC Distress Alert sent either by terrestrial or satellite links (sometimes even the EPIRB was not used) despite full GMDSS installations in duplicate on board and all Deck Officers (including the Master) in possession of valid GMDSS GOC qualifications.* Global Maritime Distress Safety System requirements

u skladu sa zahtjevima sustava GMDSS: *-Use of radio equipment Practically all fishing vessels are now equipped in compliance with GMDSS requirements.* **in compliance with the Global Maritime Distress Safety System**

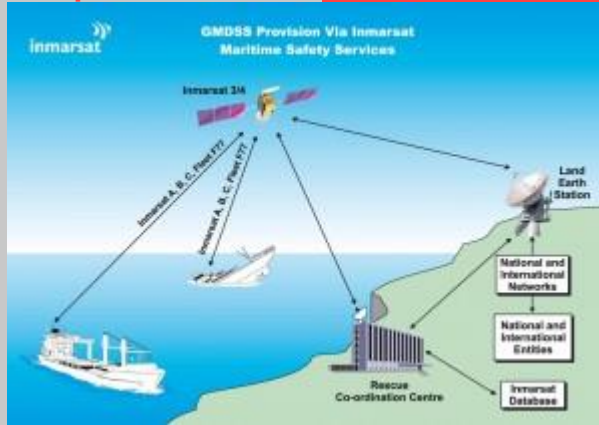

global navigational satellite system (GNSS) (n) (navig) globalni navigacijski satelitski sustav

Global Positioning System (n) (navig) a space-based global navigation satellite system (GNSS) that provides reliable location and time information in all weather and at all times and anywhere on or near the Earth when and where there is an unobstructed line of sight to four or more GPS satellites. **sustav globalnog pozicioniranja, Globalni sustav određivanja pozicije, sustav GPS monitor Global Positioning System pratiti sustav plovidbe GPS, check Global Positioning System provjeriti sustav globalnog pozicioniranja, Differential Global Positioning System; DGPS diferencijalni globalni sustav za određivanje pozicije broda, Global Positioning System system**

global positioning system (GPS) svjetski sustav (satelitskog) određivanja pozicije broda

globe Zemlja, Zemljina kugla, globus

globe valve (n) (marine eng) kugličasti ventil

GLONASS; (Global Navigation Satellite System) (n) (navig) a space-based satellite navigation system operated by the Russian Aerospace Defence Forces **Globalni sustav satelitske navigacije**

glossy sea (n) (meteorol) zrcalno more

glue /glu:/ (n) ljepilo, kola martine glue morsko ljepilo

glued /glu:d/ (adj) zalijepljen, prislonjen

GMDSS (n) (navig, safety) = **Global Maritime Distress Safety System** svjetski sustav pogibelji i sigurnosti, sustav GMDSS, **GMDSS alarm** alarm putem

GMDSS-a **GMDSS alarm**: *Recently I was on watch and the GMDSS alarm went off, in the following hour and three minutes I logged 25 alarms consisting of two distresses, one over 3,000 nm away and the second 1,600, GMDSS alert poziv u pomoć putem GMDSS-a, uzbuna putem*

GMDSS-a: *Not only must the OOW perform his primary function of safe navigation, he must listen to the GMDSS alerts and attend to radio and telex correspondence either on watch or do this work in his rest period which means he is getting insufficient rest, GMDSS equipment uređaj GMDSS*

The practical outcome of GMDSS equipment fitting is that most A3 ships are fitted with Inmarsat-C (to give them SafetyNET coverage, and Distress Alerting ship-to-shore. The installation of the GMDSS equipment plus telex, fax and telephone and other alarm sounds on the bridge are an additional headache to the officer on duty, GMDSS call poziv putem GMDSS-a: How to Reduce Unnecessary GMDSS

Calls?, GMDSS course tečaj GMDSS-a, GMDSS DSC alert digitalni selektivni poziv

u pomoć putem GMDSS-a: The GMDSS DSC alert system was not used because we were not in danger. Does anybody use their GMDSS DSC correctly to get the right response?, false GMDSS alert lažni alarm putem GMDSS-a: The problem of false GMDSS alerts has been with us for some time

now and I feel that it has become a nuisance that we have learned to live with, GMDSS installation

ugradba uređaja GMDSS, uređaj GMDSS: The GMDSS installation is located on the rear bulkhead of the bridge and the OOW is unable to maintain his navigation watch so long as he is attending the radi For increased safety the IMO is stressing on duplication of all essential gadgets including the

GMDSS installation, ..., GMDSS message poruka putem GMDSS-a, GMDSS radio

signal radio signal putem GMDSS-a, GMDSS regulation propisi o ugradnji i

uporabi sustava GMDSS: Regarding the (written) Radio Log: under GMDSS regulations, vessels are required to log a summary of Distress (Mayday), Urgency (Pan Pan) and Safety (Securité) traffic

(Page 24 of 'The Guide')., GMDSS rules pravila o uporabi GMDSS-a: Maintaining a written log of 'routine' calls is not required under GMDSS rules (though company/ship's rules may require such items to be logged), response to GMDSS odgovor na pozivu pomoć / poruku putem

GMDSS-a, GMDSS distress signal signal o pogibelji putem sustava GMDSS: The chemical tanker stood by the stricken yacht, which transmitted a GMDSS distress signal.

GMDSS equipment (n) (comm, safety, navig) uređaj GMDSS: *The standard GMDSS training course, on its own, is not enough to fully equip most candidates to use effectively GMDSS equipment that is very often 'non user-friendly'. check the GMDSS equipment provjeriti uređaj GMDSS*

GMDSS ship (n) (comm, nav arch) brod opremljen s uređajem GMDSS: *I have now completed six months on my first full GMDSS ship. Officers on full GMDSS equipped vessels may consider that VHF Channel 16 is redundant through lack of training, lack of experience or lack of responsibility.*

GML; Longitudinal Metacentric Height (n) (stabil) the distance between the height of the center of gravity and the longitudinal metacenter measured in feet **uzdužna metacentarska visina**

GM; metacentric height (n) (stabil) = **metacentric height; (GM)** transverse

metacentric height above centre of gravity; the distance between the points G and M stability for small angles; **metacentarska visina**: *This measurement is calculated by subtracting KG from KM (GM = KM - KG). GM is a measure of the ship's initial stability. A ship whose metacenter lies above the center of*

gravity has a **positive metacentric height** and is stable; conversely, a ship with the metacenter below the center of gravity has **negative metacentric height** and is unstable. {The metacentric height GM means the stability for small angles and is given by the following equation: $GM = KMT - KG$ }

GMT; transverse metacentric height (n) (stabil, nav arch) = **KMT; transverse metacentric height** poprečna metacentarska visina

gnomonic /nəʊ'mɒnɪk/ (adj) (navig) gnomonski

gnomonic chart (n) (navig) gnomonska karta, karta gnomonske projekcije

gnomonic projection /nəʊ'mɒnɪk/ (n) (navig) gnomonska projekcija

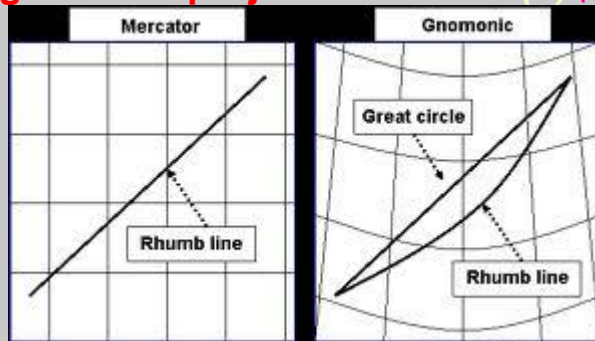

go about (v) (boating/yachting) to tack a vessel, boat; to change the course of a ship by tacking

okrenuti jedrilicu (tako da se promijeni strana izložena vjetru), letati, tal. **virare di bordo**

go adrift (n) (seamanship) break loose **otkinuti se (od veza ili sa sidra)**: On 2:12 AM the ship completely stopped and went adrift.

go alongside (n) (navig, seamanship) **pristati**: The person in control of the boat had to decide quickly whether to let go the dinghy or to **go alongside** the jetty adjacent to the bridge. We put out the few small rope fenders that we had and **went alongside**. About 1 1/2 hours later, the vessel momentarily **went alongside** a berth to change pilots. We had all hands on stand-by for **going alongside** the approach wall and mooring there temporarily prior to entering the lock. While **going alongside** an outward bound ferry, the pilot boat approach was a little ahead of the ideal position.

goatfish (n) (fishing) lat. *Mullus spp.* **trlja, trilja**

goby (n) (fishing) **glavoč** {drugi srv. nazivi: fortunaš, glavoč šari, gulj kamenski, pliskavac, šarunjić, ugvat; lat. *GOBIUS COBITIS*}

goggles (n) (safety) **zaštitne naočale**: Ensure proper PPE in good condition is used at all times including appropriate gloves, helmets, boiler suits, safety shoes, **safety goggles**, ear muffs etc. During the meeting, particular attention was paid to the use of personal protective equipment (**full-vision goggles** and respiratory particle filters) to protect against exposure to dust during loading. **cutting goggles**



zaštitne naočale za rezanje i zavarivanje

the goggles on staviti zaštitne naočale: After estimating the quantity drawn and deciding to

, put

pour out more chemical, the engineer failed to put the goggles back on; , **night vision goggles** **naočale za gledanje noću**. *They were supplied with the latest technology in search equipment such as the ability to home to all types of beacons, a Thermal Imaging (FLIR) camera, Night Vision goggles and powerful search lights.* , **remove the goggles** **skinuti naočale**. *On completion, he removed the goggles to view the quantity and seeing it was slightly less than the required amount, proceeded to pour a further 0.5 litre in.*

goldfish (n) (fishing) **orada, komarča, podlanica, lovrata, ovrata**

goldline (n) (fishing) **salpa**

gong (n) (navig) **gong**

good faith (n) (mar law) [Lat. bona fide; Fr.: bonne foi] [Sp.: buena fe] [It.: buona fede] [Gr.: guter Glaube]- A principle found throughout the civil law, to the effect that parties must negotiate and carry out a contract honestly and fairly. (Tetley) **u dobroj vjeri, s dobrom namjerom**: *He purchased the RIB, and operated it in good faith, believing that it had been built to the European Recreational Craft Directive (RCD) standards. I have written this in good faith (confidence) as I have a continued watch-keeping arrangement on other vessels ...*

goods (n) (shipping econ, cargo, mar law) **SEE cargo** Goods means the whole or any part of the cargo and any packaging accepted from the Shipper and includes any Container not supplied by or on behalf of the Carrier. **roba, stvari (u prijevozu), teret** **dangerous goods = dangerous cargo opasni teret**: *... it is mandatory for every dry cargo vessel to carry copies of the relevant IMO publications – the IMDG Code for packaged dangerous goods and the IMSBC Code for dry bulk cargoes. They did not overtly document or declare the dangerous goods in the recommended fashion.* ,

dangerous goods container opasni teret u kontejneru, kontejner s opasnim

teretom: *A special team discharged the four dangerous goods containers affected as a priority, thus eliminating the ensuing hazardous situation.* , **hazardous goods opasni teret, opasna roba**: *An expert found that the drums being used had been refurbished but, as they had not been re-certified for the movement of hazardous goods, their use was illegal.* , **heavy goods teški teret, storage of**

goods skladištenje tereta, stowage of goods slaganje tereta

gooseneck (n) **1** (boating/yachting) universal joint that attaches the boom to the mast **vratni**

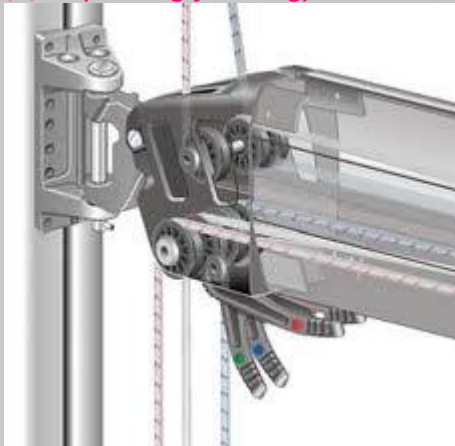

okov, zglob i prikolice

2 (cargo handling) **zglobni spoj kamiona**

gooseneck bearing (n) (cargo handling, nav arch) **oslonac samarice**

goosewinged sails (n) (boating/yachting) **jedra u leptiru, tal. vele a farfalla**

goosewinging /sailing before the wind with the jib held out to the opposite side of the mainsail/ (n)

(boating/yachting) jedrenje u položaju leptira, leptir

go to sea (v) 1 postati pomorcem, zaposliti se kao pomorac, ploviti (u svojstvu pomorca) *All I want to do in my future life was to go to sea. All of us who go to sea as a profession, have confidence in our boats, and do not want to think about the unthinkable. This is very worrying to the people who have to maintain and go to sea in the vessel. Experience can only be gained by going to sea, watching, listening and learning, and building up a 'database' from which we can draw when things start going wrong or ... He first went to sea in 1968 with Lines until obtaining masters in 1975.*; 2 (navig) ploviti, isploviti: *Under the SOLAS V regulations, passage planning is a legal requirement for all craft that 'go to sea'. Going to sea alone, on any type of boat, presents its own hazards and challenges.*

govern (v) 1 (mar law) uređivati, odrediti, propisati: *Legislation governing the design and use of watertight doors should be flexible enough to achieve appropriate procedures for the use of any watertight door in any mode. Maritime law governs many of the insurance claims relating to ships and cargo, civil matters between shipowners, seamen and passengers, and piracy.*; 2 (marine eng)

upravljati: *The valves are controlled by a rotary air distributor driven from the camshaft to govern the timing and duration of opening for starting the engine ahead or astern.*

government agencies (n) (shipping econ) državna poduzeća, državna trgovačka društva: *Government agencies often operate important terminals, especially in countries other than the United States.*

government regulation (n) (mar law) državna regulativa, državni propisi: *The United States has an extensive system of government regulation, but, in contrast to what happens in other countries, most U.S. transportation services are privately owned and operated.*

governor /ˈɡʌvənə/ (n) governor droop variranje broja okretaja (marine eng) regulator motora, automatski regulator: *The camshafts and governor are driven by the main gear train at the flywheel end of the engine, rotating at a speed half that of the crankshaft. An engine-driven fuel-pressurizing pump supplies fuel via a filter to the fuel supply main and is controlled conventionally using an electronic governor and electric actuator. The rack is connected to the engine governor. HYDRAULIC GOVERNOR Woodward governor is commonly used on board. A hydraulic amplifier amplifies the governor's signal to the fuel pump. governor control upravljanje regulatora: A new 'programmable droop' capability allows precise governor control for load-sharing applications.*



GPS (n) (navig) = **Global Positioning System** sustav globalnog pozicioniranja,

globalni sustav određivanja pozicije, sustav GPS **GPS aerial** **antena sustava GPS**, **GPS alarm** **alarm sustava GPS**, **GPS alarm**: After the turn, the vessel slowly diverged from her planned track and, eventually, the **GPS alarm sounded** as she strayed outside of the 2 cable cross track error (XTE) margin. Everything appeared to be secure and the **GPS alarm** was set to 0.03 mile **Initial GPS alarm was cancelled** when going into DR mode but no action taken, and the fact was not handed over or investigated., **GPS chart** **karta u sustavu GPS**, **GPS karta**: The track of the yacht and the waypoints being used were stored in the **GPS/chartplotter**, and were analysed by the MAIB., **GPS check** **provjera GPS-om**: Only 2 fixes were made on this chart, about 30 minutes apart, each time using a single radar range and bearing from a headland, backed up with a **GPS check**., **GPS cross-track error** **greška bočnog otpadanja od kursa u sustavu GPS**: In practice, the actual method employed was to monitor the **GPS cross track error**, and to use a 0., **GPS display** **pokazivač uređaj GPS**: No speed indication was available on the bridge wings because the **GPS display** was only available in the wheelhouse; , **GPS position** **pozicija dobivena putem GPS-a**: Nowadays we have very good radars which have GPS inputs and we can determine the exact **GPS position** of the other vessel and also its SOG and COG etc. The declared primary method of navigation was by using paper charts, and watchkeepers were required to **plot a GPS position** on the chart every 2 hours., **GPS receiver** **prijamnik** : The Master plotted the position displayed on the **GPS receiver** onto the paper chart and thus confirmed that the vessel was in very shallow water., **GPS set** **uređaj GPS**, **GPS uređaj** The two independent **GPS sets** were not routinely compared., **GPS signal** **signal sustava GPS**: After much trial and error and experimenting, we determined that the **GPS signals** were not being received on those particular headings only when a voice telephone call via Inmarsat A was being conducted from ship to shore ... , **GPS track** **putanja broda u sustavu GPS**: All I can think of is that **we were on the GPS track** and, after a change of watch, the OOW did not want to be deviated from his track and took the shortest way back to it, 5 mile range scale, and a track for the destination was selected from the **GPS track plotter**., **GPS waypoint** **točka promjene kursa u sustavu GPS**, **međutočka u navigacijskom sustavu GPS**, **međutočka u GPS-u** The ship's position was monitored by **GPS waypoint** navigation and the helmsman maintained a distance of 1.5 to 2 miles. The passage plan consisted of a series of **GPS waypoints** which

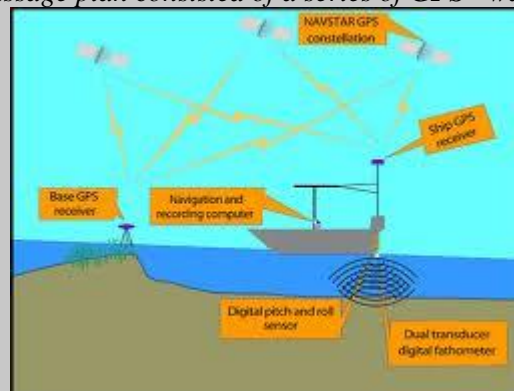

terminated in the vicinity of the pilot station.

GPS buoy (n) (navig) **plutača s GPS signalom**: With connection of a GPS radio buoy locator, **GPS buoy** position can be monitored on the radar. One application of a **GPS buoy** is to tether it to a fishing net to monitor net position on the radar screen. **GPS buoy position** **pozicija GPS plutače na radaru**

GPS data (n) (navig) **podatci iz navigacijskog sustava GPS**: the recovered **GPS data** confirmed that no alteration was made to the vessel's course or speed during the passage towards the harbour.

GPS display (n) (navig) prikaz u navigacijskom sustavu GPS: *The GPS display would also have shown the course and speed over the ground ...*

GPS fix (n) (navig) pozicija dobivena putem GPS-a: *At 1515 the OOW took a GPS fix but incorrectly plotted it one mile to the south of the vessel's actual position.*

GPS receiver (n) (navig, electr) prijamnik GPS-a, GPS prijamnik: *it was only after information gleaned from the boats track plotter computer and GPS receiver that we found the position of the final leader.*

GPS receiver block diagram blok shema GPS prijamnika
preamplifier and down converter predpojačalo (širokopojasni modul) i konverter prema dolje, **mixer** mikser, **data bit demodulation and core control** demodulator i kontrolni modul, **C/A code measurement** mjerenje C/A koda

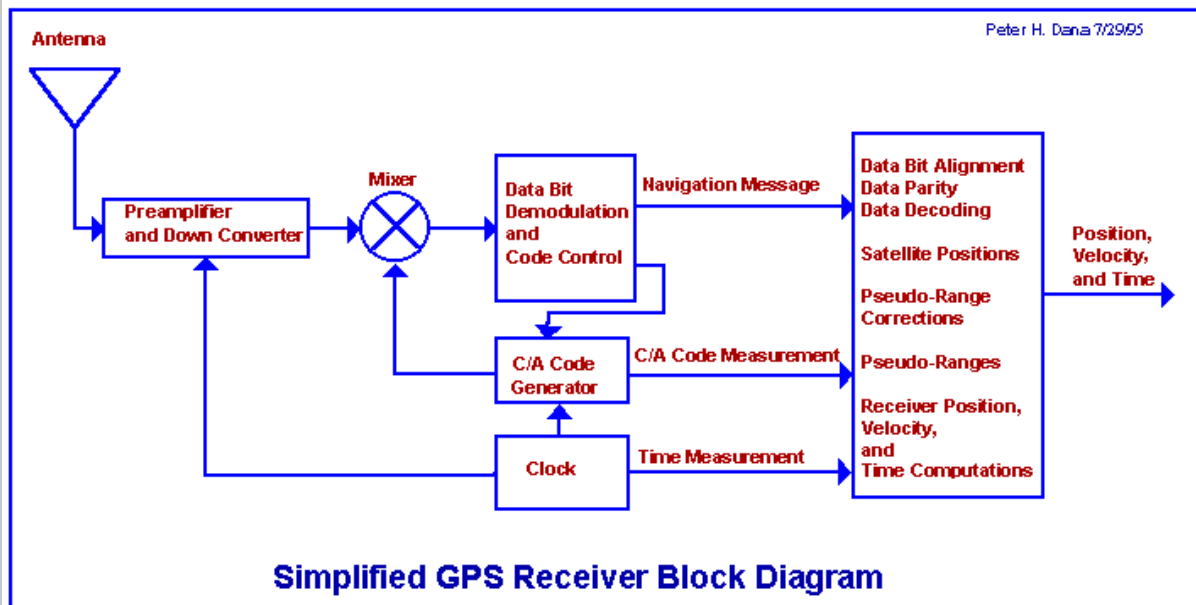

GPS receiver input ulazni podaci iz GPS-a: *He was primarily using an electronic chart plotter with a GPS input, although he had two radars and a magnetic compass at his disposal.*, **GPS receiver Navigator** navigacijski uređaj GPS: *The correct courses were plotted on the charts, and the correct waypoints were programmed into the GPS Navigators.*

GPS satellite signals (n) (navig) signal GPS-a, GPS signal carrier L1 veza L1, C/A



Code C/A kod, **P/A Code P/A kod**

gps satellite signal structure (n) (navig) struktura GPS signala carrier veza, navigation message navigacijska poruka (u signalu GPS), GPS navigacijska poruka, **fundamental frequency** središnja frekvencija

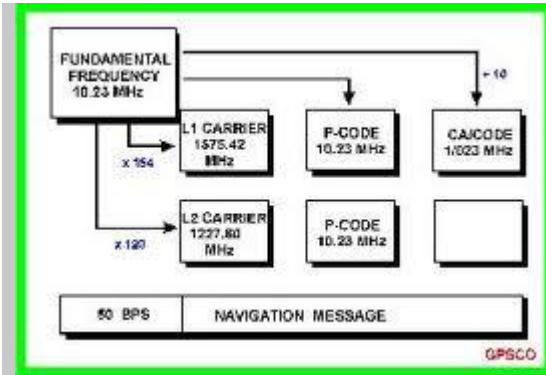

GPS transmitter (n) (navig) predajnik GPS-a, GPS predajnik. For good reason, PLBs are marked to show where the GPS transmitter is located, with an instruction "do not obstruct".

grab (n) (cargo handling) grabilica. Soon afterwards, the two pockets of smouldering cargo were removed from the hold with a grab and placed on the wharf. **hydraulic grab hidraulička grabilica**. In executing this task, the upper end of pipe, which was lying alongside, was grasped by the heavy crane by means of a hydraulic grab and raised on one side. **cargo grab grabilica (za sipki tereti), grab hopper dredger jaružalo s lijevcima, bager s lijevcima**

grab (ship handling) uhvatiti (uže, konop). Due to the large dimensions of this section of the jib girder, the A/B had to lean out from his precarious perch to grab the free end hook of the line.



grab crane (n) (cargo handling) dizalica s grabilicom

grab dredger (n) (cargo handling) jaružalo s grabilicom, bager s grabilicom

grab hold (v) (sailing vessels, ship handling) uhvatiti (uže, konop). The man overboard managed to grab hold of the trawl wire, which was quickly hauled up in an attempt to recover him.

grab rail (n) (boating/yachting) = handrail ručka na kabini (za držanje pri nagibu brodice)

grab rail (n) (nav arch, boating/yachting) žica ograde, zaštitna ograda. It is possible that when the deck cadet stationed in the bow held the grab rail fitted on the boat's bow cover to steady himself, he inadvertently also pulled the wire lanyard that was lying under the grab rail and unknowing. However, as he reached for the grab rail his lifejacket automatically inflated and he was pushed away from the yacht.

grade (n) 1 (marine eng) vrsta kvaliteta goriva (nafte). All grades of fuel are available by

pipe-line or barge at anchorage **grade of bunker vrsta goriva, kvalitet goriva, grade of oil vrsta ulja, grade of fuel oil vrsta kvaliteta goriva**: Many genset enginebuilders can now offer designs capable of burning the same **heavy fuel grade** as the main engine as well as marine diesel oil or blended fuel (heavy fuel and distillate fuel mixed in various proportions, ...) Daily Entry for all the lube oil ROB (Rest or Remaining onboard); Daily entry for all **grade of Fuel Oil Remaining onboard**; ; **2 vrsta tereta (uglja itd.)**: Recommended safe handling procedures for loading and transport of intended **grade of coal**. entry is not allowed into cargo tanks if CO content concentration has not been checked and shown as 0ppm irrespective of whether present or previous **grade of cargo** carried is a Hydrocarbon or not. 23 Oil cargo spill from tank washing line drain cock During a ballast voyage, a product tanker completed tank cleaning operations for change of **cargo grade.**; **3 stupanj, kakvoća; 4 razred; 5 stupanj; 6 ocjena**

grades of cargo (n) (shipping econ) fine podvrste tereta, različite kakvoće istog

tereta: A loading/discharge programme should be planned in order to minimise the stress on the vessel and the risk of cross-contamination of different **grades of cargo**

gradient /'greɪdɪənt/ (n) (marine eng, navig) **gradijent**: ... gradient A exceeds the **turbine pressure gradient** G by the amount of the **scavenge gradient**.

grain /greɪn/ (n) (cargo) **žito, žitarice**: The vessel is fully loaded with **grain** in its cargo holds. A cargo of **grain** became contaminated with salt water in the final stages of discharge. Experience has shown that **grain**, soya bean meal and many other kinds of agricultural produce are prone to damage if they come in contact with heated surfaces.

grain capacity (n) (nav arch, stabil) kapacitet za žito, kapacitet broda za prijevoz

žitarica: What is the **grain capacity** of the vessel? The **grain capacity** of the vessel is ... cubic metres.

grain carrier (n) 1 (nav arch) sipki tereti - nekohezijski tereti čiji je nasipni kut do 30 stupnjeva (HRB) brod za sipki teret; 2 brod za prijevoz žitarica

grain elevator (n) (cargo handling, US) port facility at which bulk grain is unloaded, stored, weighed, cleaned, blended, and exported. prekrcajni uređaj za žito: The handling capacity of the **grain elevator** is cubic metres per hour / tonnes/hour.

grain silo (n) (ports, UK) silos

grant (v) take for granted uzeti zdravo za gotovo: Where ropes are in the water near propellers something can always go wrong - **take nothing for granted**. **1 dodijeliti, odobriti grant**

scholarship odobriti školarinu / stipendiju, grant Free Pratique (mar law) dodijeliti slobodan promet, odobriti slobodan promet, grant permission izdati dozvolu, dopustiti, dati dopuštenje: Permission was **granted** and the fins were extended, after which the OOW returned to his calculations.; **2 (figurative) priznati**

granule (n) (cargo) zrno, granula

graph (n) grafikon, grafički prikaz

graphic display (n) 1 grafički prikaz: The relevant data is processed by the system, which provides the operator with a **graphic display** of current status and trends.; **2 mimički dijagram**

grapnel (n) (seamanship) A small anchor with several arms used for dragging purposes sidro mačak, sklopljivo sidro, kišobran sidro, sidarce, tal. grappino

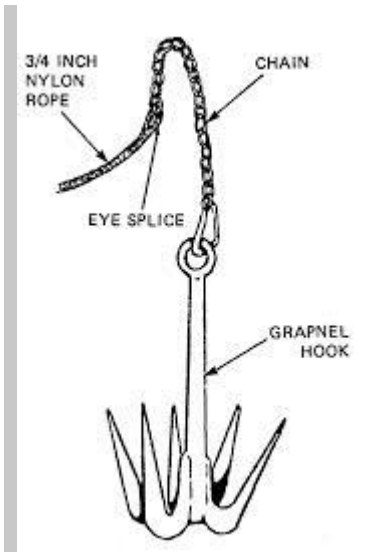

grappling anchor (n) (navig) povlačno sidro

graticule /'græti kju:l/ (n) (navig) rešetka, mreža (u hiperboličkoj navigaciji)

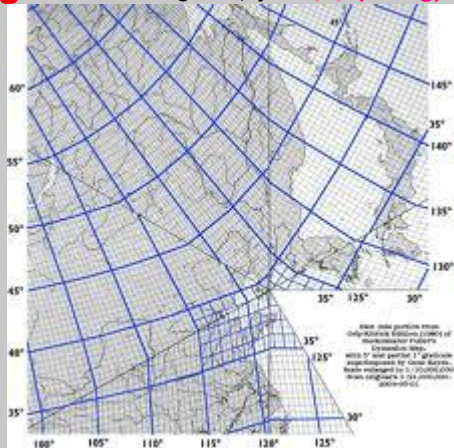

grating (n) (marine eng, nav arch) rešetka, gradelaj: Protective **grating** before turbocharger may be fouled. The larger of the two openings was fitted with a removable **grating** to allow for another specialist tool to be stowed. **gratings** rešetka

gravel (n) (geogr) šljunak, valutice

graveyard watch (n) (seamanship) the middle watch on a ship, from midnight to 4 a.m.

ponoćna straža, straža od ponoći do 4 sata u jutro: The **graveyard watch** was always bad but extended for an extra two hours.

gravity (n) sila teže, gravitacija: The return from these flows **by gravity** to the supply tank. **under gravity** (seamanship) pod vlastitom težinom: The vessel's anchor was run out **under gravity** to 6 shackles, checked and finally adjusted to 9 shackles on deck. The windlass was taken out of gear so that the anchors could be let go **under gravity**. **specific gravity** specifična težina: When test data are not available, the **specific gravity** of a fuel will provide an approximate guide to its calorific value: **specific gravity** at 15°C 0.85

gravity davit (n) (nav arch) gravitacijska soha: Shortly after reaching the deck he heard a noise; he then saw the lifeboat sliding down the cradle of the roller **gravity davits**. With the davit winch brake disengaged, the corroded lashing line failed to hold the weight of the port **gravity davits** and the suspended lifeboat, allowing the assembly to slide down the davit cradle, knocking the bosun overboard.

gravity tank (n) (cargo handling, nav arch) gravitacijski tank, samopražnjajući tank
gray iron /grei/ (n) (marine eng, US) = **gray iron** sivi lijev, **giza** Cylinder block: A one-piece casting of heavily ribbed, weldable grey iron alloy.

grease (v) (marine eng) mast za podmazivanje

greaser /'gri:zə/ (n) 1 (marine eng) mazač; 2 mazalica, pantigana

great circle = **orthodromic curve** ortodroma, tal. *curva ortodromica*

great circle sailing plovidba po ortodromi

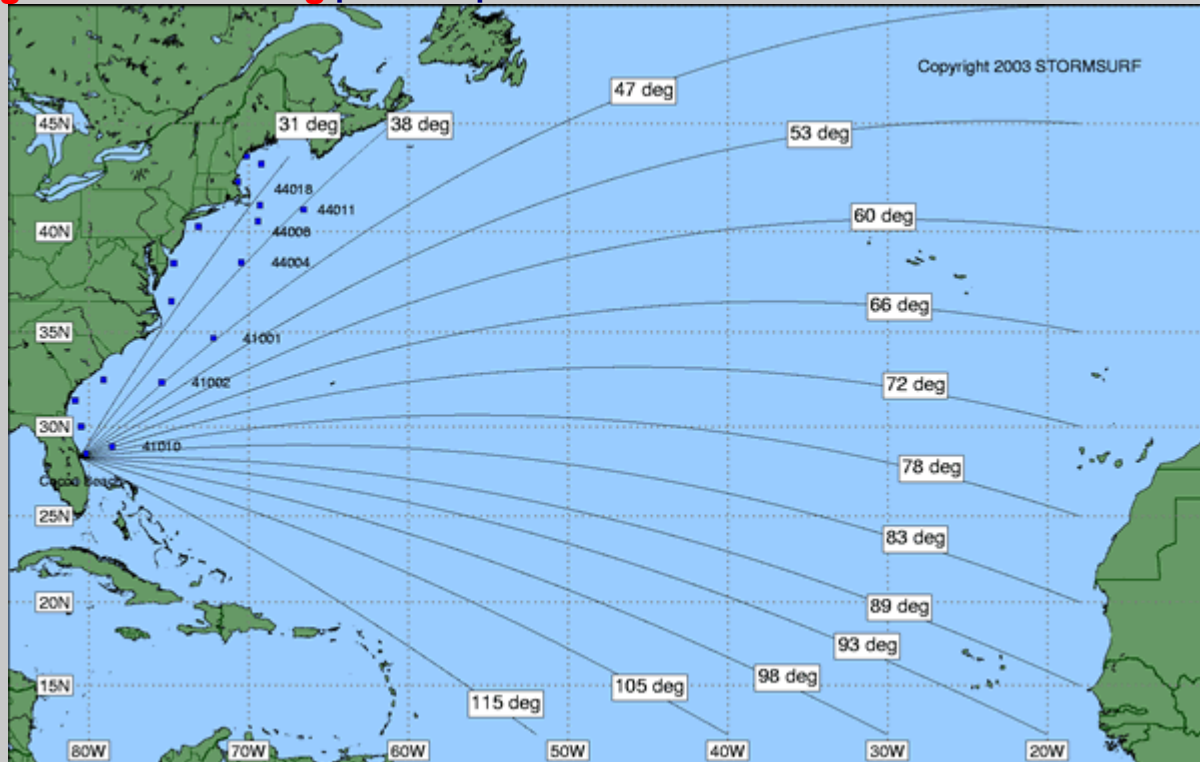

great coastal navigation (n) (shipping econ, mar law) velika obalna plovidba

great coastal service area (n) (mar law) velika obalna plovidba

greater amberjack (n) (fishing) lat. *Seriola dumerili* gof, orhan

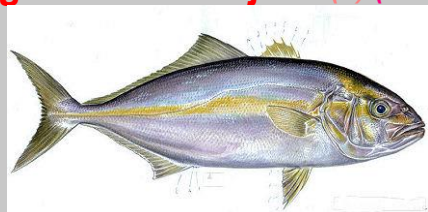

Greenwich Hour Angle (GHA) satni kut po Greenwichu

green wrass (n) (fishing) drozak {drugi hrv. nazivi: Čvrljak, lenica, laenača, pop, frnacez, govno, zelena smokvica; lat. *LABRUS VIRIDIS*}

grey ice (n) (oceanogr) led na vodi debljine deset do petnaest centimetara sivi led

grey iron (n) (marine eng, UK) = **gray iron** sivi lijev, ljevanoi željezo

grey mullet (=golden grey mullet) (n) (fishing) za nazive riba vidi:

http://www.srd-luben.hr/luben_ribe.htm cipal, cipla **thin lip grey mullet** cipal balavac, **flathead grey mullet** drugi hrv. nazivi: babaš, glavaš, javra, mulj, skakavac, žuc;

lat. **MUGIL CEPHALUS**, **leaping grey mullet**, **sharpnose grey mullet** **cipal mržnjak**, **golden grey mullet** **cipal zlatac**



{ost. hrv. nazivi:

plavić, brena, crnac, šupljak, samac; lat. **LIZA RAMADA**}

greywater (n) (safety) **otpadne vode (iz brodske kuhinje itd.)**: An inspection revealed that the damage was confined to the bow thruster compartment and in way of the **grey water tank**. As with many other such vessels, it is common practice to proceed sufficiently far from shore to discharge food waste and **grey water**.

grid (n) (marine eng) **mreža, rešetka, rashladne cijevi hladnjaka**: A **grid** is fitted at the inlet to prevent broken piston rings from damaging the turbocharger. There is a **protection grid** between the exhaust gas receiver and each turbocharger.

grind, ground, ground (v) **brusiti**: Special grinding equipment is used to **grind** the seat and spindle to the correct angles. The nozzle and injector body are manufactured as a matching pair and **are accurately ground** to give a good oil seal.

grinder (n) (marine eng) **brusilica**: If the rated speeds of the **grinders** are different, and the lower RPM disc is inadvertently used on the higher RPM **grinder**, there is great danger of disc shattering and causing injury / damage. **angle grinder** **kutna brusilica** Part-way through the work, while the **angle grinder** was in use, there was an explosion in the compartment.

grinding (n) (marine eng) **brušenje** **grinding disc** (marine eng) **brusni disk** **brusna ploča**: The definition of hot work (previously only gas-cutting and welding) is expanded to include burning, brazing, **grinding**, soldering, thermal resistance heating, etc; 4. Suddenly, the **grinding disk** rotating at high speed jammed between two adjacent studs. During the operation, the **grinding disk**



shattered, resulting in multiple injuries to the fitter's hand.

grinding-in (n) **grinding-in equipment** **oprema za brušenje** (marine eng) **brušenje**: These valves seats become damaged during the operation and from time to time they have to be reconditioned by **grinding-in** the valves.

grinding machine (n) (marine eng) **brusilica**: The reconditioning of the valves can be effected with the help of **grinding machines**. **sparkless grinding machine** **bušilica bez iskrenja**

grip (v) **stisnuti, čvrsto držati, uhvatiti rukom**: *Do not grip machine handles more tightly than necessary as intensive gripping increases blood pressure; Never begin an exercise without first checking that all b At first he was unable to pull himself on board as the freeboard was too large and he had nothing to grip onto.*

grip (n) (seamanship) **hvataj, zahvat rukom**: *Work place and tools were not wiped clean of the oil resulting in poor hand grip; He was standing next to the open hatch when he lost his grip on the bin and fell down the open hatch. The force of the wave washed them overboard and caused the safety crew to release their grip on the lifelines.*

gripe (n) 1 (nav arch, sailing vessels) **obluk pramčane statve**; 2 (nav arch, safety) **potpas (sohe)**: *Disengage lashings, gripes, etc. installed to secure the lifeboat for sea or for maintenance, except those required for simulated free-fall; The gripes were slipped and the winch brake was released to begin the launch. The order was then given to release the lifeboat gripes, which, although done simultaneously, allowed the aft gripe to clear first.*

grit (n) (marine eng) **straps which attach to the ends of the boat and are secured to the davits** **krupni pijesak, krupnozrnati pijesak, zrnce, kamenčić**: *Carry out routine marine grit cleaning on the turbine side. Filters are fitted in the lubricating and fuel oil systems to remove grit and foreign matter. grit blasting pjeskarenje krupnim pijeskom*: *At the end of the day on a vessel at sea, two crewmembers were engaged in securing the grit blasting equipment on deck for the night.*

grog (n) (seamanship) **watered-down pusser's rum consisting of half a gill with equal part of water, issued to all seamen over twenty**; **vrsta mornarskog pića, razrijeđeni rum** **grog**

groove (n) **helical groove kosi žljeb, kosi izrez (prorez)**: *A helical groove (or helix) extends from the top of the plunger part way down its cylindrical surface.*, **relief groove kontrolni kanal, odušni kanal**: *There is a relief groove between the two rings to allow, in the event of leaks, water or oil*

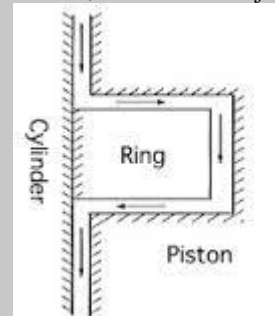

to pass outside., **top ring groove utor gornjeg prstena, ring groove utor prstena, žljeb prstena**: *Piston undercrown deposits reduce the life of the crown; ring groove deposits shorten the life of liners and piston rings and reduce reliability; and an increase in the viscosity of the oil shortens its life.*, **piston ring groove**: *The flange cooling provided for heavy fuel-burning versions reduces the top piston ring groove temperature. In order to extend the interval before reconditioning of the piston ring grooves is required, the chromium layer has been introduced.* **utor klipnog prstena, annular groove okrugli utor, okrugli žljeb**: *The plunger has a helix machined into it which also forms a vertical groove and an annular groove at the base of the helix.* 1 (marine eng) **utor**: *The bush is provided with an inner circumferential groove and a pocket or distributing oil in the bush itself and for supplying oil to the pin bosses. The first groove collects the leaking fuel. Where there are two grooves, the second will spread lubrication,* ; 2 **žljeb, kanal, kanalić** **grooved carpet shell** (n) (fishing) **Lat.. Ruditapes decussatus**; **clam or bivalve mollusc in the**

family Veneridae **kućica**



gross error (n) (navig, seamanship) **velika greška**: Failure to recognise the over-reliance on a single system and it's equipment resulted in a **gross error**;

gross negligence (n) (mar law) **grub nemar, gruba nemarnost**: Lack of maintenance or unsafe rigging of gangways will be construed as **gross negligence** on the part of the responsible officers on board.

gross/net register tonnage **bruo/neto registraska tonaža**

gross ton; gross tonne /grəʊs,tɒn/ (n) (nav arch) a unit of measurement for the total enclosed space within a ship equal to 100 cubic feet or 2.831 cubic meters **bruto tona**: .. on 17th September a tanker of 7,973 **gross tonnes** with a cargo of 11,000 metric tonnes of gas oil sailed from the port ...

gross tonnage (n) (nav arch) mjera ukupnoga zatvorenog brodskog prostora; a function of the moulded volume of all enclosed spaces of the ship; the entire internal cubic capacity of a vessel expressed in tons taken at 100 cubic feet each **bruto tonaža**

ground (v) (navig) **nasukati se, tal. incagliarsi**: the vessel **grounded** on the coasts of Northern Ireland the ship took a sheer to port which the tugs were unable to control and at 0930 **grounded** forward in soft mud The 2016-built, 16,856 teu boxship **grounded** just after midnight yesterday as it made its way to Southampton on the UK's south coast. The Main Engine could not develop full power for more that 3 days until the vessel **grounded** in a violent storm. Fortunately, **the vessel had grounded** very shortly after low water, and, as the tide rose, she refloated without tug assistance after about 3 hours. **take the ground nasukati se(namjerno)**: The car carrier was intentionally grounded on the Bramble Bank after developing a severe list. The ship was intentionally grounded and broken up off the east coast.

ground (n) 1 (navig) seabed or shore **dno, morsko dno, tal. fondale** **ground scope** the length of cable / chain under water between two anchors used as moorings **dužina lanca u moru (za brod usidren s dva sidra), holding ground dno dobro za sidrenje, dno koje drži dobro**: Five shackles of cable were deployed on a **holding ground** of sand., **poor holding ground dno koje ne drži dobro**: Furthermore, the anchorage has **poor holding ground** and ships have tended to drag anchors under these conditions., **good holding ground dno koje drži dobro**: The anchoring equipment is designed to hold a ship in **good holding ground** in conditions such as to avoid dragging of the anchor., **boarding ground mjesto ukrcavanja peljara**: Own vessel was a multipurpose cargo vessel of 11900 grt. 2226 Stop engines 2233.5 Half Ahead 2235 Pilot away at southern **boarding ground** 2236 Full Ahead 2240 Half Ahead, course 125 deg, crossing the west bound lane at almostright angles to the separation scheme. I was eastbound, about 4 miles SW of the **Southern Boarding Ground** at 0300 when I noticed that the radar plot indicated a large stationary target right in the middle of the eastbound lane., **ground track putanja broda preko dna**: The ship's **ground track** from leaving her berth until 1630 is show at Figure 2., **speed over ground (SOG) brzina preko dna**: The other shio only managed 6.5 kts **speed over ground** and 9 kts speed through water, despite proceeding at full speed ahead., **make a speed over ground ploviti brzinom od ... milja preko dna**: The inbound vessel was running with the tide at about 7 knots over the ground, while the outbound vessel was **making 5 knots over the ground** against the 4 knot tide. The inbound vessel was running with the tide at about 7 knots over the ground, while the outbound vessel was **making 5 knots over the ground** against the 4 knot tide., **make a course over ground ploviti u ... kursu preko dna**: The vessel was making approximately 10 knots and a **course over ground** of approximately

027°.; 2 (*electr*) **uzemljenje, zemlja, masa ground connection uzemljenje, spoj na zemlju** {length of one scope = length of boat}

grounded vessel (n) (*navig, safety*) **nasukani brod**: U.S. Coast Guard has established a 500 yard safety zone around the grounded vessel in the vicinity of buoy number 3. Later, the passengers were evacuated from the **grounded vessel** to her sister vessel and were returned safely to the harbour.

grounding (n) (*navig*) running ashore; to hit the seabed, a rock etc. **nasukanje, nasukavanje, tal. incaglio** The Transportation Safety Board of Canada (TSB) says it has deployed a team of investigators to determine the circumstances of the grounding. Following the Monday's **grounding**, the vessel was refloated and anchored in the vicinity. At this point, the OOW did not yet realise that the vessel was aground. Three minutes after **grounding** an engineering alarm sounded and the OOW placed both azipod control levers to zero. He then informed the Master of the alarm and also rang the engine **soft grounding meko nasukavanje, powered grounding nasukanje pri radu porivnoga sustava, drift grounding nasukanje zanošenjem, hard grounding tvrdo nasukanje, suffer grounding nasukati se, pretrpjeti nasukanje**: Giant boxship suffered grounding off Southampton.

ground lock (n) (*navig*) dodatna stabilizacija radarske slike

ground stabilization (n) (*navig*) stabilizacija radarske slike preko dna

ground-stabilized display (n) (*navig*) stabilizirana radarska slika preko dna

ground strabilized picture (n) (*navig*) radarska slika stabilizirana u odnosu na morsko dno, stabilizirana radarska slika preko dna

ground tackle (n) = **anchor gear** (*nav arch*) the anchor, chain and rode (anchor rope); a general term for all anchors, cables, ropes, etc., used in the operation of mooring and unmooring a ship **sidreni uređaj uređaj za sidrenje**: It is prudent practice when in drydock to carefully examine all **ground tackle** for defects. As the crew tried to heave anchor once again they noticed that their anchor appeared to be fouled with the **ground tackle** of the second tanker.

ground terminal (n) (*electr*) **stezaljka uzemljenja, priključak uzemljenja**

ground track (n) (*navig*) **kurs preko dna**: The ferry was steering 098°(T) and her GPS **ground track** was correctly displayed on the radar screen.

group (v) (*cargo*) **grupirati (teret), sabirati (teret)**

groupage (n) (*cargo, shipping econ*) **grupiranje tereta groupage Depot skladište za grupiranje tereta, groupage shed zbirno / konsolidacijsko skladište, skladište za pražnjenje i punjenje kontejnera**

Groupage Bill of Lading (n) (*mar law*) teretnica koja se izdaje krcatelju radi uštede troškova, a vrijedi za ukrcanu robu različitih vlasnika tereta i treba je isporučiti većemu broju primatelja **zbirna teretnica (za kontejnere u sustavu LCL), skupna teretnica, grupna teretnica Groupage Bill of Lading depot / shed zbirno skladište (za kontejneriziranu robu), konsolidacijsko skladište (za kontejneriziranu robu)**

grouper /'grəupe/ (n) (*fishing*) **kirnja dusky grouper kirnja, giant grouper kirnja** {drugi hrv. nazivi: finka, galinjača, kerna, kraja, tenka, vrančić, manjacevuli, kjerna, mandaljenaca; lat. *EPINEPHELUS GUAZA*, *Epinephelus lanceolatus*}

grow (v) (*seamanship*) **rasti (o sidrenom lancu, dok se napinje)**: How is the cable growing? The cable is slack / tight / coming tight. The cable is **growing ahead / astern**. The cable is growing to port / to starboard / round the bow / up and down.

GRP deck (n) (*boating/yachting*) GRP = glass-reinforced plastics **paluba od stakloplastike**:

The canvas and plywood coverings, **GRP deck**, and hull and outboard motor petrol tank contents would all have provided the fuel for this intense and fatal fire.

GRP (glass reinforced plastic) (n) (nav arch, boating/yachting) **stakloplastika**: She was built of **GRP** and had a wheelhouse forward, with the hauler and additional engine and steering controls on the starboard side.

GRP hull (n) (boating/yachting, nav arch) **trup od stakloplastike**: To avoid areas of severe galvanic corrosion, redundant hull fittings on **GRP hulls** should, ideally, be removed and appropriate repairs made to the **GRP**. OOW of a cargo vessel was expected to see a (small) yacht, in a swell, wind waves or rain, radar clutter and spray, night-time and dull white sails, **GRP hull** and alloy mast.

GRP lifeboat (n) (nav arch) **plastična brodica za spašavanje, brodica za spašavanje od stakloplastike**: The vessel was equipped with two open, 40- person **GRP lifeboats**, which were suspended from independent forward and aft hooks.

GRP vessel (n) (nav arch) **plovilo od stakloplastike**: At about the same time, a **GRP fishing vessel** left the port with the intention of laying her pots in her usual fishing grounds.

GT (gross ton) (n) (nav arch) **bruto tona**: There have been many accidents involving merchant vessels of over 500 **gross tons** dragging their anchors and subsequently grounding. A 1600 **GT** vessel built in 2006 was fitted with a MARIOFF high pressure water mist fire suppression system throughout the vessel.

GTS; (gas turbine ship) (n) (nav arch) **plinski turbinaš, brod s pogonom na plinske turbine**

guarantee (n) (mar law) **jamstvo, garancija**: A **guarantee** had to be placed to allow the ship to sail. ... there was also no evidence on board of the managers having submitted a **guarantee** claim against the shipbuilder for this defect. **letter of guarantee jamstveni list, garantno pismo**

guarantee (v) **jamčiti, garantirati**: It is impossible to position a liferaft to **guarantee** that it will float free when a vessel is lost, so do not hesitate to release it manually if you have time. Uninterrupted power supply in confined waters is essential in order to **guarantee** a ship's manoeuvrability and should be considered a best practice.

guard (n) (safety) **čuvati, stražariti**: **Guarding** your ship shall always be in accordance with the ISPS code.

guard (n) (nav arch, safety) **zaštita**: Although the fan was a small piece of equipment, the missing **front guard** should have been replaced. It is suggested that the requirement for a **propeller guard** will depend on the exact role and particular operational conditions that a safety boat is likely to encounter.

guard rail (n) 1 (nav arch, safety) **zaštitna ograda**: The bosun climbed up onto the starboard platform using the deck **guardrails** and then waited for the deckhand to appear on the opposite platform. During operations, an O/S climbed onto the 2.2 metre hatch coaming and used the **guard rail** for foot



support.

jedrilice

; 2 (boating/yachting) **zaštitna ograda**

guard ship (n) (safety) **brod obalne straže, stražarski brod** *The guard ship in the area was able to identify the supply vessel and put me in contact with him on VHF ... Our practice is to station one Guard Ship ahead and the other one at the end of the cables and share radar and visual watch on all sectors of the surrounding area, ...*

guard zone (n) (navig) *The guard zone defines an area which, when targets enter or leave as per user settings, an audible alarm is triggered to alert the user to the change.* **zona alarma (na radaru)** *Most modern radars have a facility to incorporate a guard zone on the display which sounds an alarm whenever a contact enters a predetermined section of the display. The guard zone is set up using the EBL and VRM. Guard zones can be set up for many reasons, but a common one would be to give early warning of the approach of another vessel. I observed an echo on my radar screen that was passing*



through the preset Guard Zone of 1.5 nautical miles.

gudgeon /ˈɡʌdʒən/ (n) **1 (nav arch) a samica lower gudgeon donja samica; 2 (nav arch) eyes set in the stern or the rudder post to receive the pintles of the rudder štenac kormila očnica kormila**

gudgeon pin /ˈɡʌdʒən ,pin/ (n) (marine eng) **osovinica klipa, bolcen** *The piston is joined to the connecting rod by a gudgeon pin. A gudgeon pin is said to be “fully floating” when it is secured in the piston and the bearing is held in the rod end. The oil is then led up the connecting rod to the piston or gudgeon pin and from there to the piston cooling before returning to the crankcase*

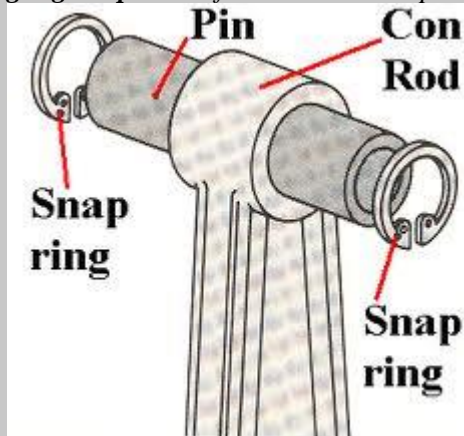

guest briefing (n) (safety) **uvodno informiranje o plovidbi (na brodovima za kružna putovanja)**

guide (n) **1 (marine eng) vodilica** *The link connecting the roller guide and the roller is self-locking in the ahead and astern positions. The chain drive is provided with a chain tightener, and guide bars support the long chain strands. Valves: both inlet and exhaust valves have a tight guide bush and the exhaust valves feature a turning device. To ensure that the crosshead reciprocates in*

alignment with the piston in the cylinder, **guide shoes** are attached either side of the crosshead pin.; **2 (nav arch, cargo handling) kontejnerska vodilica (u brodskom skladištu), okomite klizne staze (za pozicioniranje kontejnera) u skladištu broda cell guides kontejnerske vodilice (u brodskom skladištu)**: *It was not possible to fit twist locks on the aft corners of these containers because they rested in the cell guides on the accommodation front.*

gulf (n) (geogr) COMPARE bay a portion of the ocean that penetrates land. Gulfs vary greatly in size, shape, and depth. They are generally larger and more deeply indented than bays.

(<http://education.nationalgeographic.org/encyclopedia/gulf/>) **zaljev (obično veći)**: *A VLCC loaded parcels of Arab light and Arab medium crude oil from a large export terminal in the Arabian Gulf. Our vessel is a first generation containership and we were en route from the Persian Gulf to Singapore. A vessel was recently loading a gaseous chemical cargo in a U.S. Gulf port. The ship was in the Gulf of Aden, underway from Tanjung Pelepas, Malaysia to Rotterdam, the Netherlands.*

Gulf Stream (n) (geogr) Gofska struja: *Large deep-draught vessels are requested to stay at least 1 nautical mile eastward of the Light Buoy for pilot boarding because of the strength and proximity of the Gulf Stream current.*

gun boat (n) (navy) topovnjača

gunmetal /'gʌn,metəl/ (n) (marine eng) a type of bronze containing copper (88 per cent), tin (8–10 per cent), and zinc (2–4 per cent): used for parts that are subject to wear or to corrosion, esp by sea water (Collins on-line Dict.) **topovska bronca**

gun-missile boat (n) (navy) raketna topovnjača

gunnel /'gʌn(ə)/ (n) (nav arch, boating/yachting) = **gunwale** upper edge of the hull **žuljnica, vanjski rub palube**: *The skipper reports that the port gunwale was under the water and that water reached the level of the fish hatch. The fishing vessel sustained damage to its prow and gunwale; the tanker a little paint damage to her hull. When there was sufficient of the rope in the boat, it was secured by a stopper attached to the gunwale of the boat.*

gunwale /'gʌn(ə)/ (n) (nav arch, boating/yachting) the top of the side of a boat or the topmost plank of a wooden vessel **žuljnica, vanjski rub palube, razma**

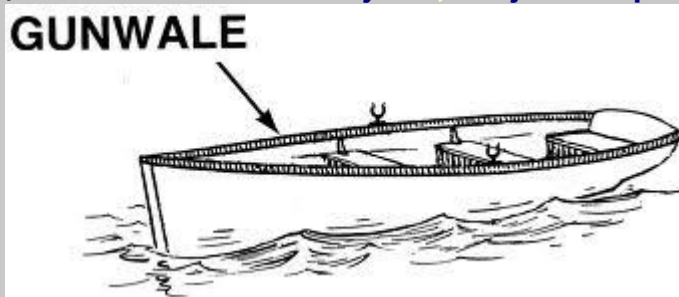

gurnard /'gɜ:nəd/ (n) (fishing) **kokot, lastavica yellow gurnard lastavica, kokot**

gusset /'gʌsɪt/ (n) (nav arch) triangular plate fitted to distribute forces between two structural members **križna ploča, trokutasti spojni element, trokutasta spojna ploča**

gusset plate /'gʌsɪt,pleɪt/ (n) (nav arch) a bracket plate lying in the horizontal or nearly horizontal plane **križna ploča**

gust /gʌst/ (n) (meteorol) a brief sudden increase in wind speed **nalet vjetra, mah, reful; tal. raffica; colpo di vento**: *Tropical Storm Julia, carrying winds of 40 mph (65 kph) with higher gusts, was expected to cause rip currents and hazardous wave conditions along the southeastern coast through the weekend. When the gust hit, the helmsman was not fully aware of what was happening to the yacht, or the consequences of leaving full starboard helm on ... At 2105 there was a gust of 45 knots*

recorded by port control. After a short time **the gust subsided**, but with the helm still hard over, the yacht quickly came round to starboard and continued into a rapid and uncontrolled gybe ... **wind gusts vjetar na mahove** (tal. raffica; Generally the duration is less than 20 seconds and the fluctuation greater than 10 mph (Seasources.net))

gust /gʌst/ **easterly winds gusting to 40 knots sjeveroistočni vjetar (bura) s naletima (na mahove) do 40 čvorova** As forecast, the wind was **gusting up to 40 knots**. Maritime Prefect reported at 11:00 Sunday that the ship was located at 59 nautical miles west Arcachon and winds were **gusting to 80 km/h.** **(v) puhati na mahove:** The weather was very poor with driving rain and winds **gusting force 7-8**,

gusty wind (n) (meteorol) **mahoviti vjetar, vjetar na mahove:** The vessel subsequently moved out of position **in the gusty wind conditions** during which time the mooring teams were fitting chafing guards to the lines. **The wind was force 3 to 4, but quite gusty** and shifting 10-15 degrees either side of the mean direction.

guy /gai/ (n) (cargo handling) wire or hemp ropes or chains to support booms, davits, etc., laterally, employed in pairs **brk (samarice), sinjalet slewing guy brk za zakretanje samarice u stranu, slewing guy blocks kolature brka samarice, standing guy nepokretni brk samarice, rinforc guy pendants fiksni (nepokretni) dio brka samarice**

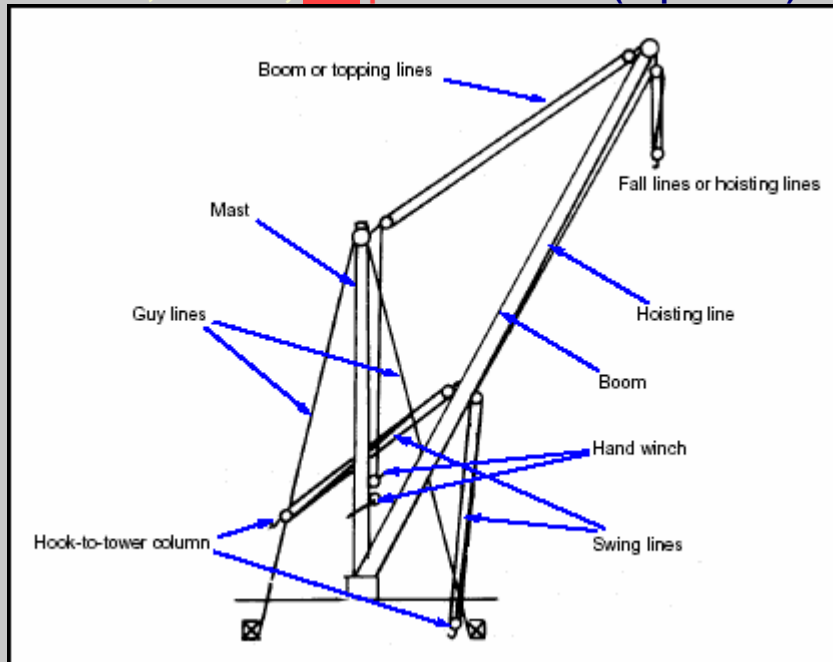

guy (n) (boating/yachting) privjerinsko uže kojim se namješta kut tanguna prema vjetru **privjetrinska uzda špinakera, brac špinakera, škotina tanguna špinakera**

guy winch (n) (cargo handling) vitlo brka

gybe /dʒaɪb/ (=jibe) (v) (boating/yachting) turning the stern (back) of the boat up through the wind **kružiti, okrenuti niz vjetar, prebaciti jedro s jedne strane na drugu, napraviti pojalabandu**. After attempting to **gybe** on two occasions without success, the boat suddenly did **gybe** and heeled heavily to port. **accidental gybe slučajno kruženje, slučajna pojalabanda** (tal. strambare, abbattere)

gybe /dʒaɪb/ (=gibe; jibe) (n) (boating/yachting) **kruženje, manovra kruženja, okret niz vjetar, tal. strambata**. The yacht did an **emergency gybe** to run off in a SSE direction. During a

gybe crews need to maintain an awareness of the risk of injury from being hit by the mainsheet, and the mainsheet fine tuning blocks where these are fitted. The yacht quickly came round to starboard and continued into a rapid and uncontrolled gybe until the boat settled close to head to wind. At about 300 yards I executed a 360° buttonhook to starboard, **crash jibe**, flapping sails and all. A **jibe** can be dangerous in a fore-and-aft rigged boat because the sails are always fully filled by wind during the maneuver. **accidental gybe slučajno kruženje**

Gybe Ho! a warning that a gybe has started, given by the helmsman **Pojalabanda!**

gybing /dʒaɪbɪŋ/ (n) (boating/yachting) turning the stern of the boat through the wind using the rudder, sails, and crew weight **kruženje okretanje niz vjetar**, **pojalabanda**: I altered course to starboard, **gybing** through the wind onto a south westerly course, allowing the other vessel to cross astern before tacking and resuming course. **roll gybing kruženje s njihanjem**, **gybing with a**

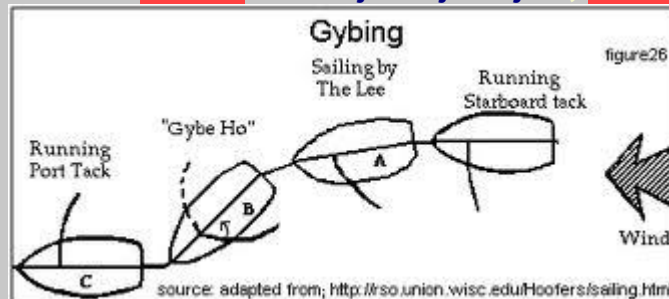

trapeze kruženje s trapezom

gypsy /ˈdʒɪpsɪ/ (n) = **wildcat COMPARE anchor windlass** a small auxiliary drum usually fitted on one or both ends of a winch or windlasson which the turns of a line or wire are taken for heaving **bubanj za uže (na sidrenom vitlu)**: An offshore supply vessel was mobilising for a project which required the use of an 84mm chain wheel (**gypsy**) instead of the 105mm unit already installed. The anchor party, comprising the third officer, bosun and one AB, could not fully house the anchor in the hawsepipe, as a twist in the cable between the **gypsy** and the guide roller prevented the anchor from orientating properly. The plan was to temporarily take the weight of the anchor on its lashing (wire sling) by 'walking back' the windlass in gear, and then rotate the slack chain between **gypsy wheel** and the guide roller to remove the twist;

gyrocompass /ˈdʒaɪrəʊˌkɑmpəs/ **žiroskopski kompas**, **žirokompas**, **zvrčni kompas**,

džajro: At this time, a **gyro compass heading** of 021° was being steered. Information was exchanged between pilots and the Master, among others, that the **gyro-compass** was 3° high.

gyrocompass repeater ponavljač žiroskopskog kompasu: The master saw from the **gyro repeater** that the vessel was altering course to port, and quickly moved to the steering console and applied starboard helm.

correct the gyrocompass for latitude and speed error ispraviti geografsku širinu i brzinu na žiroskopskom kompasu, **master gyrocompass glavni žiroskopski kompas**, **check gyrocompass provjeriti žiroskopski kompas**: During this phase of the transit, **checking and verifying the gyro** occupied the bridge team to a great extent.

gyro error /ˈdʒaɪrəʊ/ (n) (navig) **greška žirokompasa**: The **gyro error** distracted the bridge team during a critical period of the berth approach. **check the gyro error provjeriti grešku žirokompasa**, **take a gyro error snimiti grešku žiroskopskog kompasu**

gyro heading (n) (navig) **pramčanica na žiroskopskom kompasu**: ... the vessel was felt to ground moments later on a **gyro heading** of 330°.

gyro-pilot (n) (navig) **zvrčni kompas**, **žiroskopski kompas**

gyroscopic compass /ˌdʒaɪəʊsˈkɒpɪk/ **žiroskopski kompas**, **žirokompas**

GZ curve (n) (stabil) = **curve of statical stability** The area under the curve up to any

given angle, multiplied by the displacement, represents the energy needed to heel the ship to that angle. It is referred to as the ship's dynamical stability and is a measure of the ability of the ship to absorb the energy imparted by waves and gusting winds **statička stabilnost**

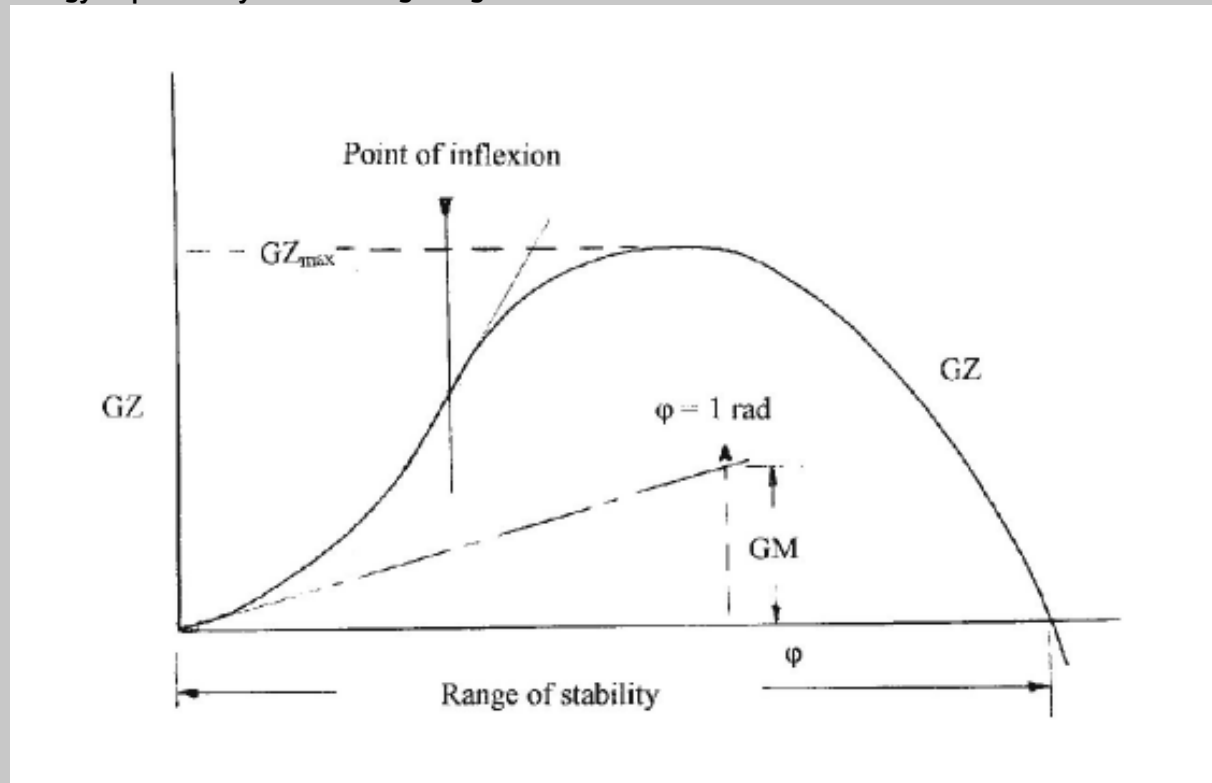

GZ; righting arm the distance between the lines of action of the weight acting through the center of gravity and the force of buoyancy acting through the center of buoyancy at any angle of inclination

poluga uspravljanja broda The length of the righting arm varies with the angle of inclination.

Operators of such vessels must bear in mind that the maximum **righting arm (GZ-max)** may occur at angles of heel as low as 15 degrees and that the working deck immerses at very small angles of heel. 0

GZ values (n) (stabil) vrijednosti statičke stabilnosti **calculating GZ values**

izračunavanje vrijednosti statičke stabilnosti Calculating the value of GZ at specified angles of heel for a ship's particular condition of loading will allow a curve of statical stability, or GZ curve, to be produced.

Hague Rules /'heig ,ru:lz/ (n) (mar law) The International Convention for the Unification of Certain Rules of Law relating to Bills of Lading - Brussels, August 25, 1924 (adopted at the instigation of the CMI and in force as of June 2, 1931).; pravila Međunarodnoga pomorskog odbora donesena kao uzorni akt o odgovornosti brodara na temelju jednoobraznoga tipa teretnice **Haška pravila (o teretnici), dopunjena i izmijenjena s Hague/Visby Rules**

HA (hatch) (shipping econ) grotlo, brodsko skladište, štiva

hail /heil/ (n) (meteorol) precipitation composed of balls or irregular lumps of ice with diameters between 5 and 50 mm **tuča**

hail (v) 1 (comm) to address a vessel, to come from, as to hail from some port (call). **dozivati, dovikivati; 2 osloviti**

hailer

hake



hailer /'heile/ (n) (comm) **doglas, megafon, portavoče**

hair rig (n) (fishing) **COMPARE rig** The hair rig is piece of fishing tackle which allows a bait to be presented without sitting directly on the hook. **predvez s dlakom (jelenjom, sintetičkom ...), prevez** *Hair rigs will improve your catch rate because the hook point isn't masked in the bait.*

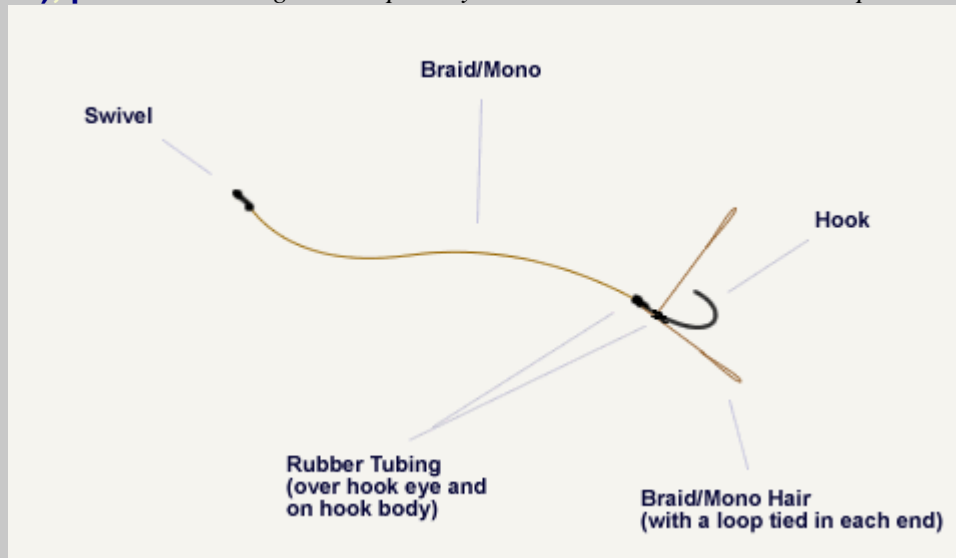

hake (n) (fishing) Lat. *Merluccius Merluccius* **oslić** **European hake** **oslić**

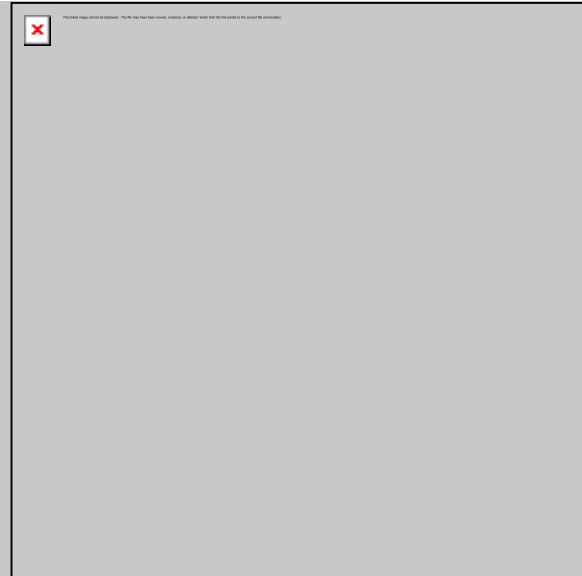

half ahead (*navig, seamanship*) pola snage naprijed

half astern (*navig, seamanship*) pola snage nazad

half-beams (*n*) (*sailing vessels*) polusponje grotla

half-breadth plan (*n*) (*nav arch*) pogled na teoretsku formu broda odozgo; a plan or top view of one-half of a ship divided by the middle vertical plane **nacrt vodnih linija** {obično se prikazuje samo lijeva polovina broda; A plan or top view of one-half of a ship divided by the middle vertical plane (SeaSources.net)}

half cardinal points (*navig*) međustrane svijeta

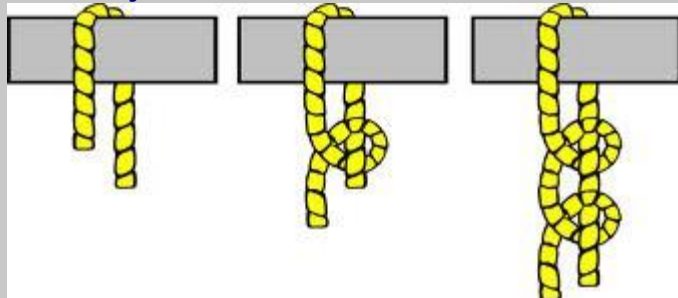

half-hitch (*n*) (*seamanship*) poluuzao

half-mast (*n*) (*comm*) zastava na pola jarbola

Half speed ahead / astern! (*navig, comm*) pola snage naprijed / natrag!

halliard /'hæljəd/ (*n*) = **halyard** 1 (*boating/yachting*) a line used to raise the head of any sail **podigač jedra, gindac**; 2 (*boating/yachting*) originaly, ropes used for hoisting a spar with a sail attached **podigač križa (jedrenjaka)**

Hall's anchor (*n*) (*nav arch*) = **patent anchor = stockless anchor** Hallovo sidro

halo /'heɪləʊ/ (*n*) (*meteorol*) a ring or arc that encircles the sun or moon **halo, skup svjetlosnih pojava oko Sunca ili Mjeseca u obliku prstenova ili svjetlosnih točaka**

halon /'hæln/ (*n*) (*safety*) halon **halon extinguisher** vatrogasni aparat na halon

halyard (*n*) 1 (*boating/yachting*) ropes, wires or tackle used for hoisting sails, gaffs and signal flags, ensigns etc. **podigač jedra, gindac, tal. drizza halyard swivel vrtulj genove, jib halyard**

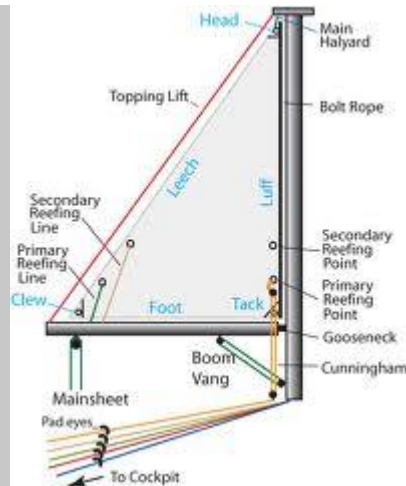

podigač floka, podigač prečke
podigač tereta; 3 podigač pika

; 2 (cargo handling)

Hamburg Rules (n) (mar ins) The United Nations Convention on the Carriage of Goods by Sea, adopted at Hamburg on March 30, 1978 and in force as of November 1, 1992.; pravila o prijevozu stvari prema kojima je prijevoznik odgovoran za svu štetu na teretu bez obzira na uzrok i bez ograničenja za sve vrijeme dok se za teret brinuo prijevoznik **Hamburška pravila (o prijevozu rob/stvari morem)**

hammering /'hæməriŋ/ (n) (marine eng) kovanje

hampered vessel /'hæmpəd/ (navig) brod ograničene sposobnosti kretanja (u SMCP-u)

hand (n) 1 (cargo handling) grupa lučkih radnika zaposlenih na ukrcaju / iskrcaju tereta iz jednog brodskog skladišta **brodska ruka, ruka (lučkih radnika)**; 2 a member of the ship's company, crew member **član posade deck hand mornar, efficient deck hand stariji mornar, priučeni mornar**

hand barrows (cargo) (cargo) ručna kolica

hand cranking (n) (marine eng) ručno upućivanje motora



hand flare (n) (safety) ručna baklja

handgrip (n) (boating/yachting) rukohvat, pašaman

handheld radio (n) (comm) ručni radio

handle (n) (marine eng) ručka, ručica, manica; tal. maniglia **direction handle** ručica za određivanje smjera, **bring the handle to the stop position** postaviti ručicu u položaj STOJ, **push the handle over to FUEL** prebaciti ručicu u položaj za dobavu goriva, **set the handle to START** postaviti ručku u položaj upućivanja, **shift the handle from starting to fuel position** micati ručku iz položaja za upućivanje u

položaj dobave

handle 1 rukovati (teretom, uređajem, priveznom užadi), manipulirati (teretom):

one AB was handling the lines on the stern jedan je mornar slagao konope (rukovao užadima) na krmi; 2 **prometovati** handle the cargo **prometovati (teretom)**, **obavljati promet (tereta)**. *In 2007, over 13.7 thousand vessels entered the Port of Busan, and the port handled a total of 13.3 million TEUs of containerized cargo. In addition, the Deepwater Terminal handles other dry bulk cargoes, such as molasses, cement and steel scrap.*; 3 rukovati priveznom užadi, rukovati priveznim

konopima: *These tugs have a spacious foredeck with plenty of working space, making it easier to handle the ropes from a large ship.*

handle (n) (shipping econ) **obraditi (brod)**: *the port agents handle the ship on behalf of the shipowner*

hand lead (n) (navig) **olovnica**

handling /'hændlɪŋ/ (n) (cargo handling) rukovanje cargo handling rukovanje teretom, manipulacija teretom, **ship handling** (seamanship, navig) rukovanje brodom, manevriranje

handling under power (n) (boating/yachting) manevriranje motorom

handover /'hænd,əʊvə/ (n) 1 (seamanship) zamjena straže, predaja straže, razmjena časnika brodske straže. *In the early morning hours there was a handover of OOWs.*; 2 (nav arch) predaja broda (od strane brodogradilišta brodovlasniku)

hand over (v) 1 (mar law) uručiti (teret, dokument), isporučiti, predati; 2

(seamanship) predati stražu, zamijeniti brodsku stražu, razmjeniti brodsku stražu

handrail (n) 1 (nav arch) razma; 2 (nav arch) ograda s drvenim drškom, **passaman**, **tal. mancorrente**: *However, due to the freeboard of the assisted ship, no one on board the tug could see past the ship's main deck hand rails.*

handsomely (adv) (seamanship) with a slow even motion **polako i oprezno** (npr. u rukovanju užadima)

hand starting (n) (marine eng) ručno upućivanje

hand steering (n) (navig) ručno kormilarenje. *As the vessel approached the channel at full sea speed, the master took the con, switched the helm to hand steering and, against company instructions, started to steer the vessel himself towards and through the narrow entrance.* **change to**

hand steering **prebaciti na ručno kormilarenje**: *Immediately after ship's OOW had finished talking to Dover Coastguard, he changed to hand-steering and instructed his lookout to take the helm.,*

switch the helm to hand steering **prebaciti kormilo na ručno kormilarenje**

hand taut (adj) (seamanship) zategnut rukom (o konopu)

hand torch (n) ručna svjetiljka, ručna lampa

handwheel (n) ručno kolo

handycap (n) (boating/yachting) A race or contest in which contestants are given advantages or compensations to equalize the chances of winning. **hendikep** (u regatama), **prednost u vremenu** (u izračunu rezultata regate)

handy size tanker (n) (nav arch, shipping econ) handy size tankers carry clean or refined products, although some may carry black oil, chemicals and, occasionally, bulk grain. **tanker prilagodljiv za razne vrste tekućih**, **handy size tanker**. *The handy size tanker carries 6,000 to 35,000 cargo DWT, or approximately 48,000 to 280,000 BBLs.*

hanger beams (n) (cargo) **vješalice u kontejneru za odjeću**: *hanger beams allow transport of garments on hangers without further packing*

hang off an anchor (v) (**seamanship**) To remove the anchor out of the hawse pipe and enable the vessel to be moored to a buoy or towed using the anchor chain through the hawse pipe.
izvući sidro i pripremiti se za privezivanje broda ili tegljenje

hank (n) **jib hanks** **karabini floka 1** (**boating/yachting**) a plastic or metallic fastener attached to the luff of the headsail that attaches the headsail to the forestay **karabin, karabinka, patentna**



kuka (za hvatanje prečke za prednje leto), kaništel
klizač prednjeg poruba jedra

harbor /'ha::bəl/ (n) (**US**) = **harbour** a port or haven where ships may anchor.; a type of harbour used in literature or in names and adds the idea of refuge **luka, zaštićena luka**

harbour (v) **pružati utočište**

harbour /'ha::bəl/ (n) (**UK**) (**ports**) a place of security and comfort, a small bay or other sheltered part of an area of water, usually well protected against high waves and strong currents, and deep enough to provide anchorage for ships and other craft **luka, zaštićena luka well sheltered**

harbour dobro zaštićena luka, harbour limit granice luke: *The outbound general cargo vessel collided with the inbound ferry, in the vicinity of the fairway buoy that marks the harbour limit of the harbour.*

harbour authority (n) (**ports, mar law**) = **Port Authority lučka uprava**

Harbour Master (n) (**safety**) an official responsible for enforcing the regulations of a particular harbour or port, in order to ensure the safety of navigation, the security of the harbour and the correct operation of the port facilities **lučki kapetan**: *The harbour master generally manages the port's pilotage service (in some cases required to pilot vessels into berth), and enforces the port's regulations to ensure safe navigation and efficient facility use, as well as the maintenance of maritime security*

Harbour Master's Office (n) (**mar law**) the task of harbormasters' offices is to control navigation in the internal and territorial waters of a country, actions of search and rescue on sea, inspection of navigation safety, inspection of the maritime domain, registration and deletion of vessels as well as organizing a register of vessels. **lučka kapetanija, tal. capitaneria del porto**: *The task of harbormasters' offices is to control navigation in the internal and territorial waters of the Republic of Croatia, actions of search and rescue on sea, inspection of navigation safety, inspection of the maritime domain, registration and deletion of vessels as well as organizing a register of vessels.*

harbour pilot lučki pilot, lučki peljar: *A harbor pilot was transferring from the outbound*

containership to the inbound tanker by launch when the vessels collided at the entrance to the port's approach channel.

harbour tanker (n) (nav arch) lučki tanker

harbour (UK), harbor (US) (n) 1 a luka petroleum harbour (UK), harbor (US) petrolejska / naftna luka; 2 utočište; 3 zaštićeno pristanište

Hard-a-port! (navig) = **hard to port sve lijevo**: By applying full speed, and **helm hard-a-port**, the tanker managed to miss the ship's bow by less than a metre. The pilot also ordered the helm 'hard-a-port'. **wheel Hard-a-port! kormilo sve lijevo** {zapovijed za kormilarenje}

Hard-a-starboard! (navig) **COMPARE Hard-a-port! sve desno**: Twenty five seconds later PV called B and urged her to immediately **put her helm hard-a-starboard**, this was again confirmed by B. The master was shocked to see that the light was now so close that he immediately switched the steering to manual and ordered the second officer to put the helm "hard to starboard". **wheel Hard-a-starboard! kormilo sve desno** {zapovijed za kormilarenje}

hard contact (n) (safety, navig) jak dodir (broda s drugim brodom), udar (broda o brod): Three ship pilots have been injured after their pilot boat made 'hard contact' with an LNG carrier during a routine transfer.

harden (v) očvrsnuti, stvrdnuti

harden up (v) (boating/yachting) okrenuti jedrilicu prema vjetru

hardness (n) (marine eng) **COMPARE strength** tvrdoća **Brinell hardness tvrdoća po Brinellu**

hard over (n) (seamanship) kormilo sve u stranu (pri okretu jedrilice, broda)

hard to port (navig) **sve lijevo**: At 0557 the vessel was swinging quickly to starboard; the pilot again **ordered the helm hard-to-port**, the engine to full ahead and the OOW to steer a heading of 071 degrees. He put the steering controls into manual mode and **turned the helm hard to port**. **wheel hard to port kormilo sve lijevo**: at 2015 the pilot had to order dead slow ahead, **wheel hard to port** in order to maintain the correct heading

hard to starboard (navig) = **Hard-a-port! sve desno**: Two minutes later, the vessel's engine was stopped and the pilot ordered 'dead-slow-ahead' and the **helm hard-to-starboard**: Once the ferry was abeam to starboard, the pilot **put the helm hard-to-starboard** and asked for full ahead on the main engine. **wheel hard to starboard kormilo sve desno**

hard wood (cargo) tvrdo drvo, tvrda drvena građa

harness (n) 1 (safety) radna oprema **safety harness zaštitna radna oprema**: The skipper and bosun **donned safety harnesses**, went over the side, and managed to throw buckets of sea



water through the scuttle.; 2 (boating/yachting) trapez

harvest clams and scallop (v) (fishing) kupiti / hvatati školjke (čančice, lisanke ..) i kapice s morskog dna kočom, kuoit školjke česljanjem morskog dna **Scallops and clams are harvested using dredges.**

hatch /hætʃ/ (n) = **hold** **1** (nav arch) an opening in a ship's deck for passing and handling cargo or stores **grotlo**: He closed the **hatch** immediately and alerted the crew. To get a better view, he went down on the main deck abreast the forward end of **No.2 hatch** and tried to direct operations from there. He then returned to the forward **hatch** and, on opening it, saw flames in the hold. **unobstructed hatches** **ravna grotla, grotla bez zapreka, cargo hatch grotlo za krcanje tereta, access hatch otvor za ulaz u tank / skladište / spremište, palubni otvor**: The AB opened the **access hatch** on the aft working deck to enable the senior engineer to access the bottle room located in the hold below. A rating had been posted at the **access hatch** of the ballast tank; his task was to stand by at the entrance and advise the bosun once the surveyors were out of the tank., **entrance hatch of the hold otvor za ulaz u skladište**: He then got off the crane and ran to the **entrance hatch of cargo hold No. 2.**, **Hatch No. 2 brodsko skladište broj 2, Hatch #1 brodsko skladište broj 1**: The Second Officer was dismantling the side cleats of **hatch #1** for overhauling with the aid of a pipe wrench., **engine room hatch grotlo strojarnice**: The **engine room escape hatch** was locked from the outside., **emergency escape hatch grotlo za izlaz u nuždi, pomoćno grotlo za izlaz**: Despite the flames, the skipper opened the door again and ran across the accommodation area to the **emergency escape hatch** in the opposite corner, where the other two crew members were able to help him climb out., **booby hatch malo grotlo za ulaz osoba u skladište**: Ship's crew should ensure that the locking pins are always properly secured whenever the **booby hatch** is in the open position.



; **2** (nav arch) extended meaning to: ship's hold **brodsko skladište**: **Hatches** served by two sets of cargo gear generally measure 20 by 30 feet or larger. **batten down the hatch**; **3** (nav arch) poklopac grotla, **bokaporta**; **4** (nav arch) otvor grotla **Hatch #1, #2, #3, ...** (n) (nav arch) **brodsko skladište br. 1, 2, 3 ...**: The Second Officer was dismantling the side cleats of **hatch #1** for overhauling with the aid of a pipe wrench. An AB slipped on the port side of the main deck adjacent to **hatch #2** and bruised his left knee slightly. A port crane is now working on **Hatch #3**.

hatch arrangements (n) (nav arch) uređaj / oprema za zatvaranje, otvaranje i osiguranje grotlenog poklopca: Regularly examine upper deck, non-watertight hatch arrangements.

hatch beam (n) (nav arch) a portable beam across the hatch to support hatch covers **greda / nosač grotla, sponja grotla {hatchway beam}**

hatch boards (n) (nav arch) daske grotlenih poklopaca, **tavaloni grotlenih poklopaca**: The fish hold did not have a watertight cover or even a tarpaulin to cover the **hatch**

boards, and there was virtually no paint protection to prevent hull corrosion.

hatch-carling (n) (sailing vessels) uzdužna pražnica grotla

hatch coaming (n) (nav arch) = **coaming** an upright steel wall, in the shape of a shallow box without top or bottom, is put around the entry to the hold, which helps to keep out water. **pražnica grotla, soljer, soljera; ta. battente di boccaporto**: There was a large hole in the fish hold **hatch coaming**, which clearly compromised the watertight integrity. The day after sailing, the crew observed black smoke coming from no. 3 cargo hold, between the **hatch coaming** and the hatch cover. However when we have to do some work on hatch covers at sea as part of the hold cleaning process, we sometimes have to put our hand between the **hatch coaming** and the partly opened hatch cover. However when we have to do some work on hatch covers at sea as part of the hold cleaning process, we sometimes have to put our hand between the **hatch coaming** and the partly opened hatch cover.

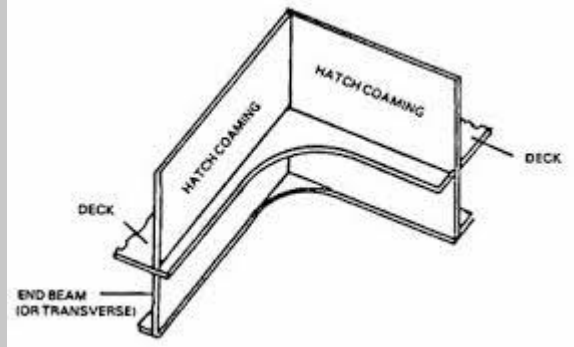

hatchcover (n) (nav arch) grotleni poklopac, poklopac grotla, bokaporta,

bukaporta: However when we have to do some work on **hatch covers** at sea as part of the hold cleaning process, we sometimes have to put our hand between the hatch coaming and the partly opened **hatch cover**.

essel was carrying a cargo of sawn timber and, at the time of the accident, shore stevedores were discharging the timber loaded on top of the forward **hatch cover**. Inspections have also revealed **hatch cover** rubber packing that is missing or damaged. Give the crew a warning when **hatch covers** are removed before berthing. The cargo was not trimmed or compacted in the hold and was noted to be 'steaming' before the **hatch covers** were closed.

automatic hatchcover 1 grotleni poklopaci s automatskim zatvaranjem; 2 poklopac tipa McGregor; 3 McGregor, endfolding



hatchcover sklopivi poklopac grotla

, slide

hatchcover klizni poklopac grotla, **hydraulic hatchcover** hidraulički poklopac grotla, **mechanical hatchcover** poklopac grotla s mehaničkim pogonom,

hatchcover girder nosač grotlenog poklopca, **close / open the hatchcover** zatvoriti / otvoriti grotleni poklopac

The chief officer asked the bosun and deckhand to close the cargo hatch covers., **cargo ship hatchcover** grotleno poklopac teretnjaka

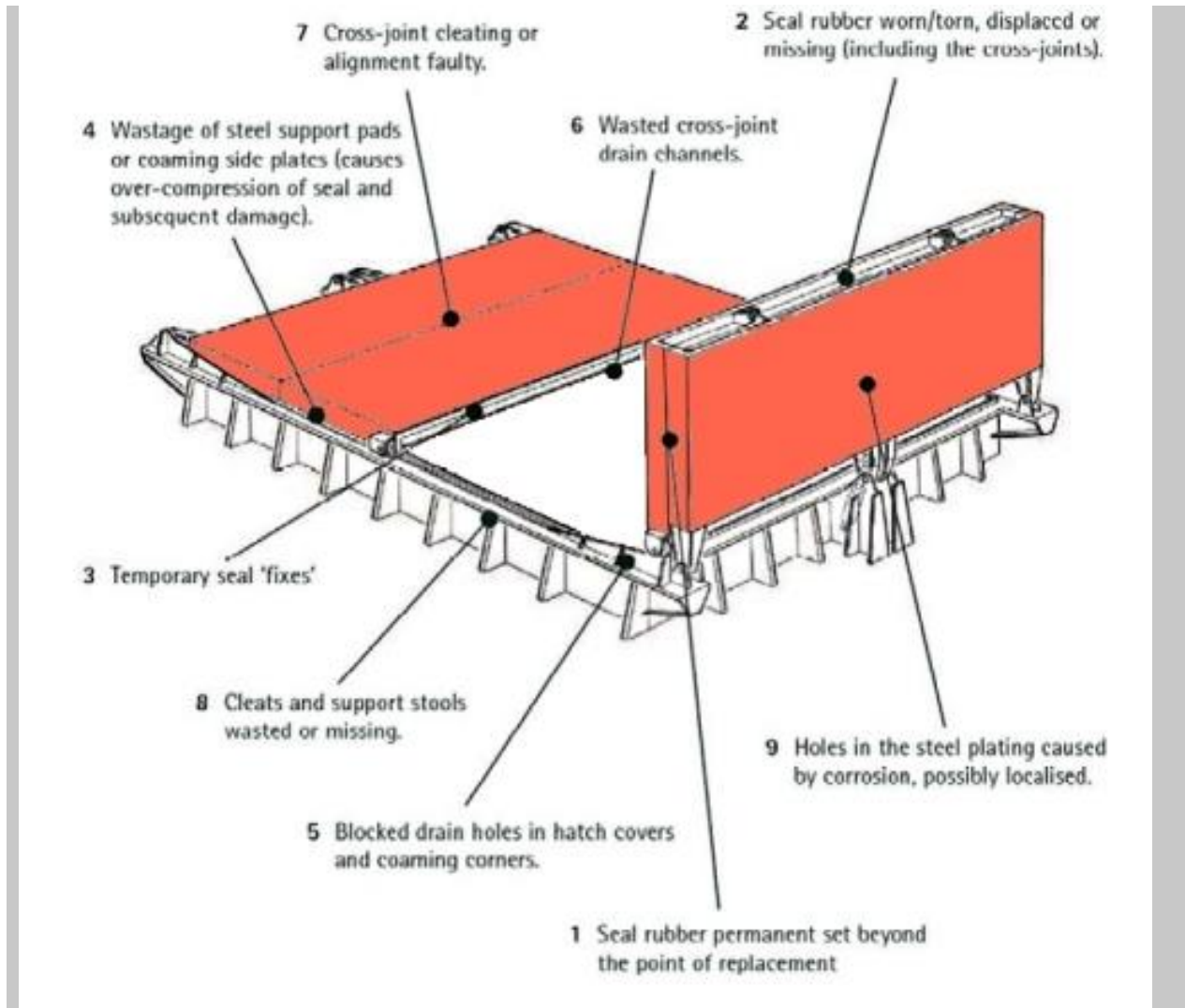

hatch crane (n) (*nav arch*) dizalica pri brodskom skladištu, dizalica kod grotla

palubna dizalica: Operate the *hatch crane* only if there is a person on each side to check whether the hooks are connected properly.

hatch end beam (n) (*nav arch*) poprični nosač palube na kraju otvora grotlašca **završna sponja**

hatch ladder (*nav arch*) stepenice u skladištu (broda)

hatch lid (n) (*nav arch*) poklopac grotla: The hatch coamings and *hatch lids* were severely corroded and wasted away. At the end of the working day the steel fore and aft folding *hatch lids* were closed. All *hatch lid securing arrangements* were painted yellow and a prominent warning stencilled on them to ensure that the *lid* is properly secured when in the open

hatch lifting hook (n) (*nav arch*) kuka za dizanje grotlenog poklopca

Hatch List of Lights sjladišna lista

hatchman (n) (*seamanship*) voditelj grupe u brodskom skladištu, tal. *capostiva*

hatch opening (n) (*nav arch*) otvor grotla: What is the size of the *hatch openings*? At the time of the accident the main deck *hatch opening* was not roped off. At the time of the accident the main deck *hatch opening* was not roped off.

hatch pontoon (n) (nav arch) **grotleni ponton, pontonski poklopac grotla**: The bosun of a self-unloader ship equipped with a deck gantry crane and stackable **hatch pontoons** was instructed to



open cargo hold no. 2

hatchrails (n) (nav arch) **ograda grotla**

hatch trunk (n) (nav arch) **grotlišće**: The J/E leaned over the open **hatchway trunk** to look into the engine room with his right hand resting on the coaming edge and his left hand taking the support of the partially open lid. The weight accumulates in the **hatchway** and the load should be trimmed to the ends and sides to avoid undue strains on the ship's structure. The **hatchway** had a portable lid which was designed to be lifted and stowed clear by means of a portable davit fitted on one side of the coaming.

hatchway (n) **1** (nav arch) an opening in a deck through which cargo or stores may be handled, machinery or boilers installed or removed, and access (by means of a ladder) is obtained to the decks and holds below **grotlo, soljer**. After successfully exiting via the escape **hatchway**, the team leader instructed a rating to operate the external hand-wheel to ensure the free opening of the hatch lid for emergency entry purposes. **hatchway beam nosač grotla**

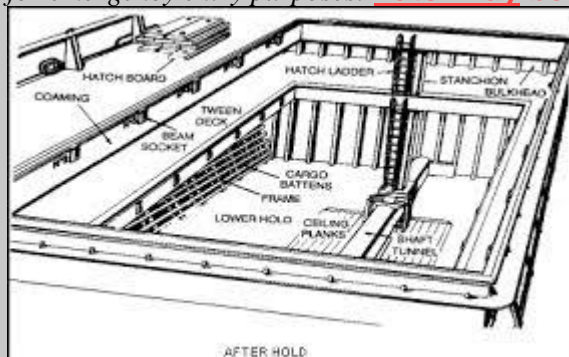

; **2** (boating/yachting) **otvor kabine, bokaporta;**

tal. boccaporto, bukaporta

haul /ho:l/ (v) **prevoziti (cestom, morem)**: a number of specialized ships **haul** ore from South America to Baltimore, Maryland **haul commodities prevoziti robe**

haul /ho:l/ **1** **udaljenost ruta (tereta)**: The operator of a **long-haul container ship** entering an SECA may choose to reduce the feed rate. **on longer /shorter hauls na duljim / kraćim udaljenostima (rutama) long-haul vehicle vozilo na dugim rutama / putovanjima / udaljenostima; 2 dio putovanja broda/brodce**: After the last haul of the trip, the skipper of a 20m trawler set the autopilot to return to port at a speed of about 7 knots.

haul /ho:l/ (v) **1** (seamanship) to pull, to pull on a rope **vući (konop), povlačiti (konop), natezati (konop), tal. alare; cazzare**: The deckhands on the forecastle are **hauling the forward spring**. this case, the evidence suggests that the AB was struck by the flailing messenger rope as it whiplashed around his leg because the rope was **being hauled** by the tug faster than it was being paid out by the AB. After securing the first spring on the twin bitt, the second **spring line** was wound around

the winch drum and **hailed in taut**. The trawl block was **then hauled** and tensioned. **haul the line / rope (in) povući konop, uvući konop**: After securing the first spring on the twin bitt, the second spring line was wound around the winch drum and **hailed in taut**. **povlačiti konop / uže**; **2**

(seamanship) podići (osobu, mornara): After several attempts, a life ring was thrown, and was grabbed by the crewman, allowing the other crew to **haul him** alongside a ladder.; **3 (fishing) podići ribarski alat / mrežu ... haul the net**: He then returned to the main deck to **haul the net**. At about 1300, just as the skipper was about to **haul the nets**, the nets came fast on an obstruction. He was unable to **haul both nets** together on the main winch and so **hailed each net** in turn until both were near the surface. He alerted the crew, asking them to don lifejackets and prepare to **haul the net**. **podići mrežu, haul the fishing gear (fishing) podići ribarski alat / kavez ...**:

After three pots were **hailed on board**, the skipper/owner's body was found entangled in the gear. The skipper instructed the crew to **haul in the fishing gear** and don their lifejackets.

haul /hɔ:l/ (v) **(boating/yachting) skretati smjer u vjetra**: The weight accumulates in the hatchway and the load should be trimmed to the ends and sides to avoid undue strains on the ship's structure. The cargo of scrap iron is dropped in the hatchway and allowed to pile up in pyramidal form.

haul /hɔ:l/ (v) **1 izvlačiti brod na kopno / dok (radi popravka); 2 izvući osobu iz mora**: After about 10 minutes of strenuous effort, a spinnaker halyard was connected to the skipper's tether and he was **hailed clear of the water**.

haul /hɔ:l/ (n) **(boating/yachting) promijeniti smjer (o vjetru)**: the wind **hailed** to the southwest

haul aboard (v) podići na brod / brodicu za spašavanje: He was **hailed aboard the lifeboat**, wrapped in a blanket and brought to our port side where the pilot ladder was rigged ready for the Port Authorities to board.

haulage /'hɔ:lɪdʒ/ (n) **1 (shipping econ) prijevoz (cestom) road haulage vehicle**

cestovno teretno vozilo, carrier haulage the inland transport service, which is performed by the sea-carrier under the terms and conditions of the tariff and of the relevant transport document

kopneni prijevoz u nadležnosti pomorskog prijevoznika, road haulage cestovni prijevoz; 2 (US, shipping econ) inland delivery dostava unutar zemlje

haul alongside (v) (seamanship, fishing) povući do boka broda: A bumper catch of pilchards was **then hailed alongside** and the skipper and the deckhand brailed the fish into large tubs on deck, and then filled the tank in the fish hold.

haul around (v) (boating/yachting) okrenuti (jedrilicu) iz krme u pola krme

Haul away! order to pull **Vuci!, Povlači!**

haul clear (v) (seamanship) podići iznad mora, podići iz mora: After about 10 minutes of strenuous effort, a spinnaker halyard was connected to the skipper's tether and he was **hailed clear of the water**. To avoid this danger, the crew had attached a tripping line to the ring so that once the boat was released, the ring and fall could be **hailed clear** and secured on deck.

haul down (v) (boating/yachting) spustiti (jedro), tal. ammainare

hauler /'hɔ:lə/ (n) **1 (cargo handling) kamion, teški kamion; 2 (shipping econ, US) kamionski prijevoznik, cestovni prijevoznik**

haulier /'hɔ:lɪə/ (n) **1 (shipping econ) kopneni prijevoznik road haulier cestovni prijevoznik; 2 (shipping econ) person or company making the inland delivery of freight or containerised freight otpremnik tereta / kontejnera kopnom**

haul in (v) 1 (seamanship) povlačiti (konop, uže), povlačiti (konop) na brod, rekuperati; tal. recuperare un cavo: After securing the first spring on the twin bitt, the second

spring line was wound around the winch drum and **hailed in taut**. **haul in a line** **povlačiti konop**. The seamen on the forecastle **were hauling in the headline**. The crewmember risked life and limb by moving towards a **line that was being hailed in**. After that, he began to **haul in** the section of the stern line now on deck with the winch., **haul in taught** **povući i zategnuti (uže, konop)**: After securing the first spring on the twin bitt, the second spring line was wound around the winch drum and **hailed in taut**.; **2 (seamanship) podizati sidreni lanac**: He promptly raised the rest of the crew and **hailed in on the anchor chain**; The skipper instructed the crew to **haul in the fishing gear** and don their lifejackets.; **3 (safety) podići (brodicu za spašavanje)**: A line from the aft mooring winch was passed and the lifeboat was **hailed-in** under the davits.; **4 (seamanship) podignuti osobu iz mora na brodicu za spašavanje / palubu / brod**: He was **hailed aboard the lifeboat**, wrapped in a blanket and brought to our port side where the pilot ladder was rigged ready for the Port Authorities to board. Just as **the skipper was hailed on deck**, his lifejacket was pulled from his body and over his head.; **5 (fishing) povlačiti mrežu / ribarski alat / koću / kavez / vršu**: A fishing vessel was on an easterly heading and engaged in hauling a line of pots which was about 1 mile long and lay in a north/south direction off a port on the east coast. A 19 metre twin rig trawler **was hauling in the first trawl** of the trip when the centre warp parted close to the clump. At about 1200, the three crew, one of whom was salaried, **hailed in the catch**, during which it was found that the centre warp had stranded. **The gear was hailed on board** and the cod end emptied on to the deck. After three pots were **hailed on board**, the skipper/owner's body was found entangled in the gear.; **6 (boating/yachting) zategnuti uzdu (škotu, škotinu) tal. mettere in forza la scotta**

haul in (v) (boating/yachting) **zategnuti škotu, kacat(i) škotu**

hauling line; hauling part (n) (seamanship) **živi kraj užeta (na koloturniku/čekrku)**

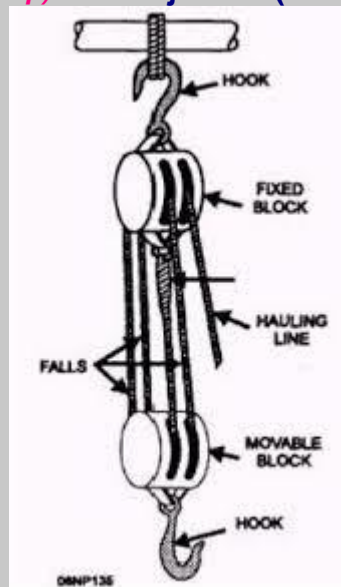

radni kraj užeta (na koloturniku/čekrku)

haul inboard (v) (seamanship) **podići na brod, podići na palubu, povlačiti na brod**:

After a considerable struggle, the tanker's mooring lines were attached as messengers, and the mooring winches used to **haul the bridle pennants inboard**.

haul off (v) (seamanship, boating/yachting) **okrenuti brod u vjetar, okrenuti od (veza ili nekog objekta)**

Haul out! (seamanship) order given to a boat coxswain to take his boat from the ship's side and secure it at the boat boom **Pripremi brodicu za spašavanje za spuštanje!**

haul taught (v) (seamanship) čvrsto povući (uže), tal. *arridare*, tal. *assuccare*

haul the anchor (v) (ship handling, seamanship) podizati sidro, podići sidro: *When the mate went forward to haul the anchor, the bridge team consisted of the master, the third mate and a helmsman.*

haul up (v) (boating/yachting) jedriti u u vjetar, orcat; tal. *orzare*

haven /'heɪvən/ (n) (navig) zaklonište za brodove (sigurno), luka, pristanište: *Skippers and mates of vessels operating within 60 miles of a safe haven are permitted to use the Boatmaster's Licence medical, ML5, which is renewable every five years. Of course, the best way to avoid an accident in restricted visibility is not to get underway, or to seek a safe haven if conditions change while underway.*

hawse /hɔːz/ (n) (nav arch) = **hawse hole** a hole in the bow through which a cable or chain passes **sidreno oko**

hawse hole /hɔːz/ (n) (nav arch) a hole in the ship's bow for stowing the anchor **sidreno oko**, **pramčano oko**

hawse line (n) (seamanship) privezno uže

hawsepipe, hawse-pipe, hawse pipe /'hɔːz,paɪp/ (n) (nav arch) a pipe lead-in for anchor chain through ship's bow; tube leading the anchor chain from the deck on which the windlass is located down and forward through the vessel's bow plating **padna cijev**, **sidreno ždrijelo**, **sidreno oko**, **oko sidra**: *The replacement anchor's relative position in the hawse pipe was not the same as the original, because the shank length and connecting linkages were different. Walk out (to) (of anchors) means to reverse the action of a windlass to lower the anchor until it is clear of the hawse pipe and ready for dropping. As the 4th shackle was passing through the hawse pipe, with the ship making slight sternway, the cable suddenly began to run freely, despite the dog clutch being fully engaged ... They failed to keep the anchors ready outside the hawse pipe. At 21:00 decision was made to gas-cut the cable at hawse pipe.*



hawser /'hɔːzə/ (n) (seamanship) a large rope or a cable used in warping, towing, and mooring

deblji konop, uže (za tegljenje): *Lines of thick diameter are usually referred to as cables and when used for towing they may be called (towing) hawsers. The purpose of the weak link is to reduce the risk of the hawser parting when picking up/casting off the chain, which has an attendant hazard of whiplash. The mooring equipment of the SPM consisted of a chafing chain (76 mm diameter) joined to a*

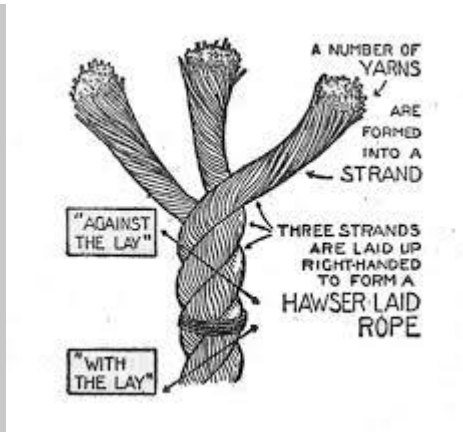

polypropylene **hawser** (80 mm diameter).

hawse-timbers (n) (sailing vessels) očna rebra, rebra pramčanog oka

hazard (n) (safety) događaj koji može štetno utjecati na okoliš, život i zdravlje ljudi te izazvati

oštećenje ili uništenje imovine **opasnost**: Both officers were aware of the **hazard**, and the master asked the chief officer whether they were clear of the reef. There would be an accompanying severe and immediate fire **hazard**. Always remember that fire is **the greatest hazard** aboard ship. **moving hazards** **pokretne opasnosti**, **dangers and hazards along the route** **opasnosti na ruti**, **fire \ opasnost od požara**: Haphazard storage creates **fire hazard**. Apart from malfunction/loss of vital navigation and communication equipment, such water ingress can pose a serious electrocution and **fire hazard**. Leakage from fuel pressure systems is a **serious fire hazard**. **health hazard** **opasnost po zdravlje**: Underestimation of **health hazard** of this cargo is the main reason of the near miss. It should still not contain harmful chemicals or chemical wastes that would cause machinery damage or pose a **health hazard to personnel**. **navigational hazard** **opasnost za plovidbu**: When manoeuvring in close proximity to another vessel or **navigational hazard** the possibility of something going wrong must be carefully considered.

hazardous (adj) (cargo, safety) **opasan (teret, roba)**: The terminal managers in the loading port did not consider the cargo to be **hazardous**, and the wet cargo was loaded in rain without trimming or measuring the cargo temperature. Running main propulsion engines while a vessel is alongside is an extremely **hazardous activity** and must be controlled carefully.

hazardous area (n) (navig, safety) **opasno područje**: Demarcate and point out **hazardous areas** and control measures already taken by vessel.

hazardous cargo (n) (cargo, safety) **opasni teret**: This is the vessel overtaking you on your starboard side, I am carrying **hazardous cargo**, what are your intentions?' The Collision Regulations clearly state obligations for vessels 'restricted in their ability to manoeuvre' and such 200145 A vessel was berthed port side to and loading **hazardous cargo**.

hazardous goods (n) (cargo, safety) **opasna roba, opasan teret**: the mast or superstructure of a vessel IMO Class Group of dangerous or **hazardous goods**, harmful substances or marine pollutants in sea transport as classified in the International Maritime **Dangerous Goods Code** (IMDG Code).

hazardous incident (n) (safety) **opasna nezgoda, opasan slučaj, opasni događaj**: A **hazardous incident** occurred on board a tanker while crew members were engaged in rinsing and mopping up in a slop tank and discharging oily water slops. It also shows passing too close to a fishing vessel when uncertain about her type of operations or manoeuvrability **can lead to a hazardous incident**.

hazardous materials (n) (safety) **opasne tvari, opasni materijali**

hazardous situation (n) (safety) **opasno stanje, opasna situacija**: I practice of having

only one vessel at that particular anchorage, the Port Control allowed two large vessels to anchor there hence **contributing to a hazardous situation**. During manoeuvring, propulsion plant's requirements are below system's capacity and the failure of one generator is unlikely to **present a hazardous situation**.

haze /heɪz/ (n) (meteorol) fine dust or salt particles in the air that reduce visibility **sumaglica**: The pilot boat appeared through the **haze** and the pilot disembarked without any delay and highly rewarded for his great efforts. The vessel approached the alter course position in daylight on a warm, calm day with a **slight haze** and with no significant tide.

HBG; trim lever (n) (stabil) **poluga trima**

HCS; Heading Control System (n) (navig) **sustav nadzora pramčanog kuta**

head /hed/ (n) **1** (navig) the fore end of a ship **pramac broda, prednji dio broda**: The ship started picking up speed but **the head** responded very slowly. Brod je počeo dobivati brzinu, ali je pramac reagirao vrlo sporo. About one minute later the pilot gave the helmsman orders to bring the **vessel's head** towards the north pillar of the bridge, which was not illuminated but was visible. **His** required constant attention throughout the period of loading and discharging, particularly when trimmed **by the head**, to ensure no weight came onto the lifting wires. **AIS** wrongly set up Colregs violation and **AIS** wrongly set up **MARS Report 201018** Own vessel: speed 10 knots, course over ground 242 degrees, **ship's head** 235 degrees. The **ship's head** began to turn to starboard, but it soon became apparent that she was closing the shallows and would not be able to complete the turn. The OOW was alerted to this abnormality when the autopilot alarm activated after the **ship's head had wandered off course**. As the skipper selected neutral, the heel increased under the influence of the strong tide and **the head** continued to turn to port.;

2 (marine eng) **gornji dio, glava**: A simple connection attaches the exhaust manifold to **the head**. **cylinder head glava cilindra**: The combustion chamber is enclosed between the **cylinder**

head and the piston and the most of it contained in the top of the piston.;

3 poklopac head cover

poklopac cilindra; **4** attachment of a sail halyard on the top of the sail luff **gornji rub sošnog /**

čtvrtašnog jedra, tal. punto di drizza; **5** (ports) **glava (gata, doka)** Contact with the **pier**

head The line then passed between the **docking head** and cruciform arrangement wherever space allowed.

head /hed/ (v) (navig) **uputiti se (prema), biti u smjeru prema**: The third officer did not realise that **the vessel was heading towards** shoal ground. The master decided to **head back toward** BXA buoy and requested for assistance of the pilot station. Having asked his two passengers if they were holding on, he commenced a turn to starboard to **head down stream**. **head for the port uputiti se**

prema luci. The trials were completed and it was decided to **head back into port**., **head in a**

direction ploviti u smjeru: On clearing the breakwater, the skipper ordered the helmsman to **head**

in a northerly direction. Once the helicopter arrived they agreed with the pilot that the launch **would**

head in the direction of a prominent headland that was about 5 miles away., **head north / south**

etc. ploviti prema sjeveru / jugu itd., biti okrenut u smjeru sjevera / juga itd.: He

plotted his position at 0850 UTC and manoeuvred his vessel to **head north** with the use of helm and engines, acquiring a speed of about 3 knots in so doing.

head (n) (boating/yachting) a toilet on board of a ship **brodski zahod, brodska kupaonica**

Captain of the head (navy, seamanship) The rating in whom is vested the responsibility for the

cleanliness of the ratings' latrines **glavni od zahoda** {The toilet or latrine of a vessel, which for sailing

ships projected from the bows}

head (n) (mar law) **voditelj, šef službe**: The Chief Steward is **the head** of the Catering

Department. Master instructed all ship staff to carry out risk assessment prior to commencing any task;

The **department head** and the assigned work team must inspect the site of work and identify the hazards

involved; Master instructed all **department heads** to explain assigne

header /'hɛdɚ/ (n) **1 (marine eng) razdjeljivač, cijevna komora, cijevni sakupljač:** *The water wall tubes are connected either to the top and bottom headers or to the bottom header and the steam drum.*; **2 (marine eng) kolektor, sabirnik pipe header cijevni kolektor, sabirna cijev**

header /'hɛdɚ/ (n) (meteorol, boating/yachting) **promjena smjera vjetra prema pramcu**

header tank (n) (boating/yachting) **tank kolektora izlazne vode:** *The system may incorporate a header tank arrangement to supply oil to the bearings whilst the turbocharger comes to rest should the oil supply fail. To make up for any leaks in the system there is a header tank, which automatically makes up any deficiency.*

headfoil (n) (boating/yachting) **šina floka**

head for (v) (navig) **ploviti prema:** *However, the engineers required the tug to be run at full speed in a straight line to make their adjustments, so the master had to head for open water outside the harbour. The ship had then altered course to 2300 T to head for Cherbourg, either for cargo or to disembark the pilot. Since the vessel had only one hold, running fore and aft, the Master reduced speed and altered course to head for the nearest suitable port of refuge. After dredging we head for the western buoy on a course of 020. We met a southbound LPG tanker which appeared to head for the separation zone between the two lanes.*

headhaul /'hɛd,hɔ:l/ (n) (shipping econ) **outgoing voyage of a vessel from port of origin to its ports of destination (<http://www.globalshiplease.com/glossary.cfm>) putovanje broda od polazišne do odredišne luke, isplativija dionica putovanja broda:** *Headhaul usually refers to the stronger or dominant leg of a round-trip voyage attracting the greater volume of cargo relative to the weaker backhaul leg.*

head-in (adv) (navig) **pramcem prema kopnu (uz obalu u luci, riječnu obalu) berthed head-in brod vezan pramcem prema kopnu (uz obalu u luci, riječnu obalu):** *Our handy-size, multi-purpose vessel was berthed head-in, starboard side to and had already singled up with pilot on board.*

heading /'hɛdɪŋ/ (n) **1 (navig) COMPARE course:** *The horizontal direction the vessel's bows at a given moment measured in degrees clockwise from north (SMCP) pramčani kut (u odnosu na pravi sjever), pramčanica:* *Checking his radar, he confirmed that the heading of the unknown vessel had a very small Closest Point of Approach (CPA) with the dive site. About 1 minute later, the ship's heading started to drift to the north, away from the lights of the harbour and into darkness. alter a heading promijeniti pramčani kut:* *By that time, tanker's heading had been altered to 227° and the bulk carrier was 79° abaft tanker's starboard beam at a distance of 1.7nm. he assessed the fishing vessels' aspects from their navigation lights and altered the autopilot heading about 10° to port to pass ahead of them. The Master was called, speed reduced to minimum and heading altered into the sea and swell., follow a heading ploviti u smjeru ...:* *The vessel was following an autopilot-controlled heading of 221° at a speed over the ground (SOG)² of 11.9 knots (kts)., adjust a heading namjestiti pramčani kut, namjestiti pramčanicu, What is your heading? ... My heading is one - two - eight degrees. Koji je Vaš kurs? ... Moj kurs je jedan - dva - osam stupnjeva., on a heading of na pramčanom kutu od ...:* *The vessel passed abeam of the charted rocks at a speed of approximately six knots and on a heading of nearly 227° T. The wind was NW 25 knots and the vessel was on a heading 335degrees., on a reciprocal heading na suprotnoj pramčanici:* *We continued to turn hard a starboard and main engine full ahead until we were steaming away from the other vessel on a reciprocal heading and the other vessel was well clear., original heading početni pramčani kut početna pramčanica:* *But the tanker continued on*

her original heading and a close-quarters situation was quickly developing. , **maintain heading** održavati pramčani kut, držati pramčani kut, **steady heading** stabilan pramčani kut. The skipper found that the autopilot had difficulty in keeping the vessel *on a steady heading*. , **heading display** pokazivač pramčanice: The traffic lanes trend west-northwest to east-southeast, while the **heading display** for this ship indicated it was heading northeast at about 14 knots. , **veer from the heading** skretati s pramčanice: This allowed the trawler to *veer from her heading* until she came to an abrupt stop against a rock. , **change of heading** promjena pramčanice: As the vessel entered a narrow part of the channel, the pilot requested *a slight change of heading* to port. , **adjust the heading** ispraviti pramčanicu: He then *adjusted the ship's heading* to aim toward the centre of the channel and the bright harbour lights ahead. ; 2 (navig) smjer kretanja; 3 naslov (članka, knjige, izvješća) podnaslov, natuknica

Heading Control System (n) (navig) (u područjima gustog prometa) kut pramčanice upravlja se putem autopilota kontrola pramčanice, sustav kontrole pramčanice

heading line (n) (navig) pramčanica

heading line; HL (n) (navig) pramčanica (na radarskom pokazivaču) The *heading line* indicates the ship's heading and it is the solid line which appears at zero degrees on the bearing scale.

heading marker (HM) (n) (navig) oznaka kuta pramčanice / azimuta: The *heading marker* in the North-up position requires constant adjustment to give a correct reading.

head injury (n) (safety) ozljeda glave: In most cases when mooring ropes part they cause *head injury*. The victim was wearing a safety helmet which probably helped prevent a *head injury*.

head into the wind (prep phr) (navig) pramac u vjetar **bring the ship's head into the wind** into the wind okrenuti brod u vjetar, dovesti pramac u vjetar. The port main engine tripped due to the excessive list and, with only one engine, there was not enough power to *bring the ships head into the wind*. , **hold the ship's head into the wind** držati pramac u vjetar: The master requested the assistance of a harbour tug to *hold the ship's head into wind*, while he attempted to manoeuvre the ship back to her original anchor position. , **turn the ship's head into the wind** okrenuti brod u vjetar: Using full rudder and engine power, and transmitting appropriate signals on the air horn and VHF radio, the master just managed to *turn the ship's head into the wind* and execute the 180-degree turn and head out to open sea.

headland (n) (navig) obalna uzvisina, uzvisina rta, promontorij: the radar cannot see through the headland so anything behind the headland will be hidden in the radar's shadow area. An inbound passenger ferry was *rounding a headland* and approaching her final waypoint, at which point the passage plan required her to alter course to port and head towards the harbour approaches. He also chose this position because it was *in the lee of a prominent headland* and it was outside the

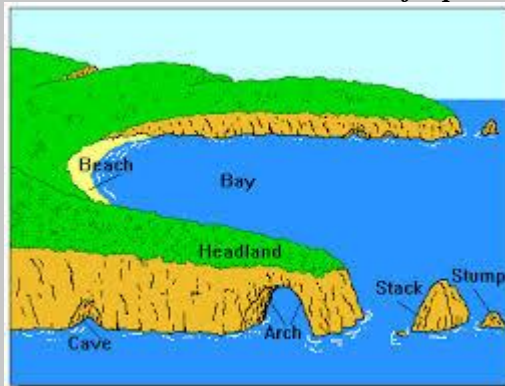

main tidal stream.

head-ledges (n) (nav arch) poprečna pražnica grotla

head light (n) (nav arch) pramčano svjetlo, prednje svjetlo

headline /'hɛd.laɪn/ (n) naslov, natuknica

headline (n) (seamanship) **ANTONYM stern line** pramčano uže, provijera, tal.

cavo di prora; cavo alla lunga: The forward mooring station lowered the **headlines** to the mooring boat but they could not be made secure in good time. This accident occurred when a 15,000 dwt vessel was unberthing; she was singled up to one **head-line** and one back spring on the forecastle. The **head line** and **breast line** began to run out around the bits, and the starboard anchor was let go. Send the **head line(s)** ashore. **let go of the headline** **otпустiti pramčano uže**: .. the master selected "start engine" on the telegraph, and soon afterwards he instructed the forward and after mooring parties to **let go of the head and stern lines**. **Let go the head line.!**, **heave up the headline** **podizati pramčano uže**: Then third mate proceeded to **heave up a head line** and the OS was asked to **heave up the starboard breast line**. **tighten the headline** **zategnuti pramčano uže**, **napeti pramčano uže**: Once the vessel was alongside again, the **head lines were again tightened** and the stern swung further off the

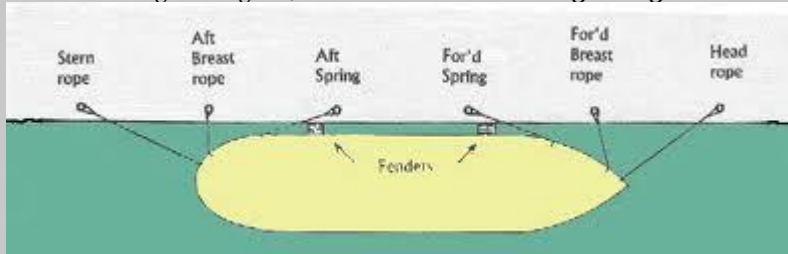

jetty.

head of breakwater (n) (ports) vrh lukobrana, kraj lukobrana (prema moru): It was commended that pilots should use tugboats and advise captains to use their assistance until the vessel is pulled away to the roadstead – behind the **head of the eastern breakwater** to the water region with safe depths (for a given draught of a vessel),

head off (v) 1 (navig) **otpadati**: The ship altered course to starboard and then appeared to **head off** to pass east of the Bank.; 2 (boating/yachting) **skretati od vjetro**

head office (n) 1 (mar law) **sjedište (firme), matična kuća**: The investigation report was forwarded to the **fleet Head Office** in order to instigate legal action against the original equipment manufacturer (OEM) for potential breach of code(s) in the material, design etc. A telex to **head office** reporting the damage caused by a rogue swell was, I suspect, treated with some scepticism.; 2 **uprava, direkcija**: Following a further brief debate between ship and **head office**, the ropes were replaced. The completed log is used to compile a summary sheet or abstract of information which is returned to the **company head office** for record purposes.

head of pump (n) (marine eng) **tlačna visina pumpe, visina stupca pumpe, jačina pumpe**: The appropriate **head of the pump** will prevent any type of suction problem.

head of sail (n) (boating/yachting) **gornji rogalj jedra**

head of the pier (n) (ports) = **pier head** **vrh gata, krajnji dio gata (prema moru)**:

Fortunately, there were no injuries and, although material damage was caused to the **head of the pier**, the vessel sustained only superficial scratches to her paintwork. The ship came to rest on the southerly **pier head**.

head on (prep phr) (navig) **nasuprot drugom brodu, u suprotnom kursu**: , he observed another small vessel about a mile away right ahead and coming **head on** The fishing vessel **collided head-on** with the port quarter of the anchored bulk carrier, before bouncing along her port side. At 0330 a vessel was sighted fine to port, nearly **head on**, masthead lights visible, a few minutes later the Master

departed from bridge. The two vessels **collided** nearly **head-on** at about 6:40 a.m. **sailing head on plovdba u suprotnim kursovima**, **head on course kurs u pramčanici**: *el's starboard side, the overtaking vessel is putting the priority on herself being able to turn to starboard in case of another ship appearing on a head on course.*, **come head on on dolaziti ravno u pramac**: *Simultaneously, he observed another small vessel about a mile away, right ahead and coming head on, and altered more to starboard to 324?*, **head on encounter susret brodova pramac o pramac**: *This situation inevitably leads to head on encounters with westbound traffic and alterations of course by each vessel to port,*, **collide head on sudariti se pramcem o pramac**: *The fishing vessel collided head-on with the port quarter of the anchored bulk carrier, before bouncing along her port side.*

head on collision (n) (navig) sudar pramcem o pramac: *Recently we handled a damaged vessel which had a head on collision with a small unlit island during the night.*

head-on situation (n) (navig) protu-kurs položaj brodova u protukursu, brodovi u (na)suprotnim kursovima: *The ferry's OOW should have foreseen that his intended port alteration of course would result in a head-on situation.*

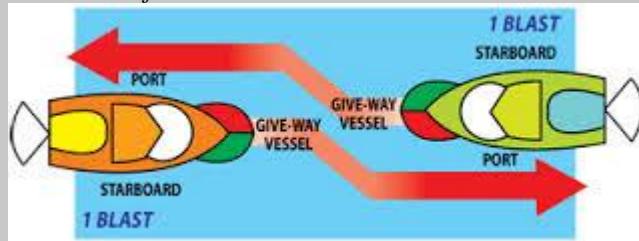

head-on vessel (navig) brod koji ima pravo puta: *Earlier, at about 23:30 hours, I had encountered a head-on vessel and, in accordance with Colregs, I altered our original course from 259 degrees to a new course of 285 degrees in order to pass the other astern.*

head out to sea (v) (navig) isploviti prema otvorenom moru: *On approaching strong winds, masters of ro-ros and similar high-sided vessels must not hesitate to leave port or confined waters and anchorages and head out to open sea. ... the port anchor was quickly heaved up and with a single astern engine movement we were able to safely clear the wharf and head out to sea.*

head rope = headline pramčano uže: *This caused the port head rope to be lost overboard after being pulled through the bollards upon which it had been turned up. She was secured by 2 × 26.5cm (10.5) circumference head ropes and a 19cm (7.5) spring forward; The head ropes were tightened and the engines put astern.*

heads (n) (shipping econ) izdaci, troškovi various heads razni izdaci

heads (n) (boating/yachting) kupaonica (sa zahodom, umivaonikom i tušem u jedrilici/jahti)

head sail (n) (boating/yachting) = foresail any sail flown in front of the most forward mast



prečka, prednje jedro, flok

heads compartment (n) (boating/yachting) brodska kupaonica sa zahodom

head sea (n) (navig) valovi u pramac: *It was daylight with a forecast force 9 headwind and 6m head sea, and the vessel was making good a speed of about 3 knots through the water and 1 knot over the ground. As the vessel encountered force 9 winds with a 6 metre head sea, it was discovered that nylon mooring lines on the aft deck were becoming unsecured. The owner and the remaining friend carried on, struggling through head seas until they were able to seek some shelter by using an inshore route up an estuary.*

headstay (n) (boating/yachting) COMPARE forestay Wire from the bow to the upper part of a sailboat's mast pramčano leto (od vrha jarobola do pramca), **proveni štraj** {leto od pramca do vrha jarbola}

Heads up! (n) (boating/yachting) Pazi glavu! {Upozorenje pri manovri (letanju, kruženju itd.)}

head to (v) (navig) ploviti prema, biti okrenut prema: *With the assistance of three tugboats (towlines on bow and stern and the assisting tugboat) the ship unberthed from the quay and was heading to the exit from the port.*

head-to-tide (prep phr) (shipping econ, boating/yachting) pramcem prema struji

head towards (v) (navig) ploviti prema: *The waypoint displayed as the next destination waypoint in the GPS was also not as he expected; the vessel had been heading towards the wrong waypoint.*

head to wind (prep phr) (navig) pramcem u vjetar, u vjetar, protiv vjetra

head-to-wind method (n) (boating/yachting) postupak (okretanja jedrilice) u vjetar

head up (n) (navig) pramčanica gore (na pokazivaču radara): *In a Ship's Head-up display where the heading marker always points straight up to the 000° on the graduation scale. Change the radar to head up ... miles range scale; head up relative head-up / north-up / course-up; head up true-motion north-up / course-up. A2/3.4 (IMO SMCP) head up orientation of radar display orientacija*

radarske slike pramčanica gore, head up mode The head-up mode is a display in which the line connecting own ship and the top of the display indicates own ship's heading način pokazivanja pramčanica gore: *The radar sets was decentred and working in head-up mode at ranges of between 0.5 and 0.75 nm.*

head up (v) (boating/yachting) ANTONYM bear away skrenuti u vjetar: *The radar sets was decentred and working in head-up mode at ranges of between 0.5 and 0.75 nm.*

head-up motion radar head up: Unstabilized display. Heading is at the top of the screen. radar s pokazivanjem smjera u pramčanici broda

headway (adv) (navig) ANTONYM sternway forward motion enough to steer effectively; ship making way ahead, bow first gibanje broda prema naprijed gather headway početi s

kretati prema naprijed: *The ship was gathering headway.*, **make headway** **kretati se prema naprijed (o brodu)**: *With our ship still making headway, the container vessel's port quarter came into contact with our vessel's bow. We sounded 5 short & rapid blasts on the whistle and put the engines on Stop but were still making headway. Our bow was by now 0.2 miles from the SBM and we were making headway at about 0.5 knots. We sounded warning blasts on the whistle and the tugs also gave warning. The ship immediately started to make headway but the angle with the berth remained too small.*, **vessel making headway** **gibanje broda naprijed**, **kretanje broda naprijed**, **lose headway** **prestati se kretati naprijed (o brodu)**, **zaustaviti se (o brodu)**, **izgubiti abrivu**: *As he did this, he stalled into wind, and lost all headway. As he did this, he stalled into wind, and the boat lost all headway.*, **stop the headway** **zaustaviti kretanje naprijed**: *He stopped the headway abreast of Le Pot a shallow in the south of Le Cochon buoy.*

health regulations (n) (mar law) **zdravstveni propisi**

heart (n) (seamanship) the inside center strand of rope. **srčika**, **jezgro konopa**

heat /hi:t/ (n) (marine eng) **toplina** **waste heat** **1 otpadna toplina**: *An Exhaust Gas Economiser (EGE) was fitted in the funnel uptakes to generate steam from the waste heat contained in the main engine exhaust gases.*; **2 izgubljena toplina**, **generate heat** **proizvoditi toplinu**: *However friction generates heat, which will reduce the viscosity, the thickness of the film and may result in metal to metal contact.*, **transfer heat** **prenositi toplinu**: *Piston rings must resist corrosion, readily transfer heat and have thermal expansion to maintain ring groove clearances.*, **specific heat** **specifična toplina**: *Flame Arrestors: The flame trap is manufactured from brass or aluminium alloy which both have a high specific heat capacity.*, **excessive heat** **prevelika toplina**, **prezagrijanost**: *The engine crankshaft was damaged and the entablature probably distorted due to the excessive heat generated as a result of the overspeed.*, **residual heat** **preostala toplina**, **zaostala toplina**: *After hot work is completed, visit the work site and adjacent areas during the following 2 hours to ensure that residual heat has not caused smouldering or fire.*, **heat detector** **detektor topline**: *Heat detectors are used in places such as the galley and laundry where other types of detectors would give off false alarms.*

heat (v) **grijati**: *Turbochargers also heat the inducted air by compression. A boiler is used to heat feed water in order to produce steam.* **heat up** **zagrijavati se**: *Because they are very small these droplets heat up very quickly and start to burn as the piston passes over TDC.*

heat conductivity (n) (marine eng) **toplinska vodljivost**: *A thin flame plate for the cylinder head promotes good heat conductivity while high stiffness is imparted by a strong deck plate absorbing the vertically acting gas forces. cal arrangement of bore cooling is applied to the upper collar of the cylinder liner, which is made from lamellar cast iron, a material of good heat conductivity and wear resistance.*

heat detector (n) (safety) **detektor topline**

heat energy (n) (marine eng) **toplinska energija**

heat engine (n) (marine eng) **toplinski stroj**

heater /'hi:te/ (n) **1 zagrijač** **direct contact heater** **dodirni zagrijač**, **feed heater** **zagrijač napojne vode**, **surface heater** **površinski zagrijač**; **2 (marine eng) radiator**: *All the steam heaters on the Lara Rickmers class are of the shell and tube type.*

heat exchanger (n) (marine eng) **izmjenjivač topline**: *Lubricating oil system: self-contained forced feed system, with oil flow progressing through gear-type pumps, heat exchanger and filters to the engine lubrication points. The plate-type heat exchanger is made up of a number of pressed plates*

surrounded by seals and held together in a frame . **heat exchanger tube cijev izmjenjivača topline**

heat exhaustion (n) (safety, med) toplotna iscrpljenost

heat fire detector (n) (safety) toplinski javljač požara, toplinski detektor

heat flow (n) (marine eng) strujanje topline: ... the exhaust seat insert incorporates a water-cooled cavity to maximize **heat flow** from the valves.

heating /hi:tiŋ/ (n) (marine eng) grijanje, zagrijavanje: ..., effective use of the centrifugal separators, settling tanks and filters is essential, and the correct fuel viscosity must be maintained by **heating**, adequate injection pressure and correct injection timing. When transporting such cargoes, besides taking care to control the **heating of fuel oil** tanks, the recommendations of the IMSBC Code must be strictly followed to prevent a dangerous situation from developing as well as to avoid **oil heating**

grijanje goriva, space heating grijanje prostorija, water heating zagrijavanje vode

heating coils (n) (marine eng) serpentine (rashladnog uređaja), zagrijač sa

spiralnim cijevima, spiralna cijev za zagrijavanje: We will heat both slop tanks using heating coils. The workload increases when the cargo stops flowing due to freezing, when the level of cargo goes below **heating coils**. The **heating coils** in the tank were also reported to be leaking, causing a gradual increase in sounding; **steam heating coils parni zagrijač s spiralnim cijevima**

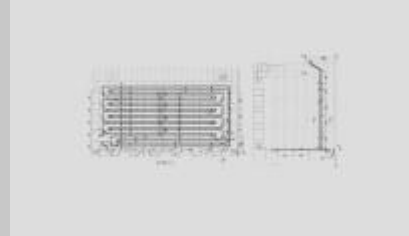

heating of cargo (n) (cargo handling) zagrijavanje tereta, pregrijavanje tereta

heating radiator (n) (marine eng) radijator

heating system (n) (marine eng) sustav grijanja: Heat recovery steam generators located in the exhaust ducts of the gas turbines produce the steam to drive the steam turbine and feed auxiliaries such as evaporators and **heating systems**.

heating & ventilation system (n) (marine eng) sustav grijanja i ventilacije

heat load (n) (marine eng) toplinsko opterećenje: The **heat load** on the cylinder liner has been reduced by lowering the mating surface between cylinder liner and cylinder cover as much as possible.

heat loss (n) (marine eng) gubitak topline, toplinski gubitak: If all else fails, oilskins secured around cuffs, waist and ankles can reduce **heat loss** in immersion situations, and reduce the early onset of hypothermia.

heat-resistant (adj) (marine eng) otporan na toplotu: Pistons are of composite construction, with a **heat-resistant steel** crown and forged aluminium body. Thus the wall can be very hot—requiring **heat-resistant materials**— but it can also absorb too much heat from the air in the initial compression strokes during starting and pre The heat shield was a post-installation modification - originally the turbochargers had been fully clad with **heat-resistant insulation**.

heat-resisting (adj) (marine eng) otporan na toplinu, termootporan: The crown is made of **heat-resisting steel** and is provided with five ring grooves, which are hard-chrome plated on both lands.

heat source (n) (marine eng) izvor topline: Possible **heat sources** causing ignition include heat exchangers, exhaust pipes, turbochargers, electrical contacts, static electricity and faulty wiring.

heat stroke (n) (med, safety) toplotni udar: **Heat stroke** is caused by a failure of the 'thermostat' in the brain: the body becomes dangerously overheated due to a high fever or prolonged exposure to heat.

exposure to heat stroke **izloženost toplini** *Heat stroke is caused by a failure of the 'thermostat' in the brain: the body becomes dangerously overheated due to a high fever or prolonged exposure to heat.*

heat transfer (n) (marine eng) **prijenos topline**: *The plates have various designs of corrugations to aid heat transfer and provide support for the large, flat surface.*

heat-treated (adj) (marine eng) **toplinski obrađen**: *Crankshaft is manufactured from heat-treated alloy steel, with unhardened bearing trunnions and concave fillets.*

heave /hi:v/ (n) (navig, nav arch) **the whole ship alternately lifting and lowering with the vertical movement of the water (tide)** **podizanje i spužtanje broda**

heave (=heave; heaved; heaved / (arch) heave; hove; hove) (v) (nav arch, ship handling) **podizati se (o brodu, trupu broda)**: *Upon berthing, (moored to four+two+two fore and aft, all with rather short leads) we continued to feel the effects of the swell as the vessel continued to roll, heave and surge alongside.*

heave (=heave; heaved; heaved / (arch) heave; hove; hove) (v) (seamanship, boating/yachting) **baciti (tanji konop, pandul na obalu), dobaciti (tanji konop, pandul)**

heave alongside (v) (ship handling) **povlačiti brod konopima uz lučku obalu / vez**: *200206 During berthing operations the back spring had been put out and was being used to heave the vessel alongside into position.*

heave anchor (v) (ship handling, seamanship) **podignuti sidro**: *Gone out of the relative shelter given by Ile de Groix, the master decided to heave anchor and to reposition. As the crew tried to heave anchor once again they noticed that their anchor appeared to be fouled with the ground tackle of the second tanker. When she attempted to heave the anchor and get under way, the hydraulic windlass motor suffered a catastrophic failure and the cable ran out to the bitter end. heave home the anchor*
podići sidru u sidreno oko: *We proceeded to heave home the anchors and get underway.*

Heave and Away! Ho-ruk! (uzvik pri potezanju konopa)

heave around (v) (navig) **to revolve the drum of a capstan, winch or windlass to pull the line, rope or cable** **okretati bubanj vitla (radi potezanja konopa), potezati uže vitlom**

heave away /'hi:v ə'wei/ (v) 1 (seamanship) **to haul away povlačiti (olabavljeno) uže vitlom, Povlačite (konop vitlom)!; 2 (seamanship) to heave around a capstan; pull okretati bubanj vitla (radi povlačenja i napinjanja užeta) {tal.: alare}**

heave down (v) (boating/yachting) **turn a ship on its side (for cleaning); careen nagnuti (brod, brodicu radi čišćenja dna i bokova)**

Heave ho! (seamanship) **a call for extra collective effort; poticajni uzvik ili naredba Jače! (vuci, diži itd.)**

heave in (v) = **haul in** 1 (seamanship) **to haul in povlačiti (konop, lanac), uvlačiti (konop, lanac), vući konop (na brod, bez zatezanja), rikuperat tal. virare**: *As the tug began to heave in the tow wire, the towing winch suffered a burst hydraulic oil line which could not be immediately repaired. Heave in easy! The spring that was being heaved in began paying out rapidly as the drum could not take the weight due to loss of hydraulic power. As the capstan heaved in the wire, the crew manually flaked about 75 metres of it on the deck to achieve the desired length of tow. The ship's crew changed from manual hauling to using a winch to heave in the tow line.; 2 podizati lanac sidra, tal. virare* *As the cable continued to heave in, the bob weight operated the limit switch, but once again the motor failed to stop and the cable continued to be heaved in. ... she let go both anchors but due to her headway, she continued to close with our vessel, while we tested our engine and continued to heave in our anchor cable. To avoid contact with it, the Mooring Master insisted that instead of using a short kick ahead*

on the engine, the chafe chain be released by **heaving in** some slack. Once the engines were running, **I began heaving in our port anchor** but it was slow going at the start, especially as we were dragging at a fast rate backwards towards the beach. When three cables away, she let go both anchors but due to her headway, she continued to close with our vessel, while we tested our engine and continued to **heave in** our anchor cable.

Heave in easy! (seamanship) **Podižite polako! (o sidru)**

heavenly body (n) (navig) **nebesko tijelo**

heave on (v) **1** (seamanship, ship handling) **natezati (uže, konop), zatezati (konop),**

napinjati (konop, lanac), tal. agguantare: To bring the bow alongside, the third mate **heaved on** the starboard breast line and second mate slackened the stern lines. As the winch operator attempted to **heave in on the springs**, the winch repeatedly stalled and rendered. The tanker was warped ahead safely and correctly positioned by **heaving on** the after backspring. The forward mooring party, which initially consisted of an officer and two crewmen, was required to **slack down the headlines** and **heave on the backsprings** to assist the vessel's movement along the quay. The C/O was looking at the men on the forecandle and instructing them to **heave on the headlines**. The vessel was also unable to **heave on her stern lines and bow lines** simultaneously to keep the vessel alongside ... **heave on forward spring**

zategnite pramčani špring; 2 (ship handling, seamanship) **napinjati sidreni lanac,**

zatezati sidreni lanac, It is also likely that, due to heaving on the anchor cable, the

ship had minimal headway. Once fast, the skipper attempted to free the trawl by alternate **heaving on the port and starboard warps** pulling the vessel towards the fastener against the prevailing tidal stream, at times submerging the gunwale. {tal.: **mettere in forza il cavo**}

heave out (v) (seamanship, navig) **popuštati (konop), ispuštati**

heave; (past tense: heaved / hove), (past participle: heaved / hove) 1 to

haul or pull on a line **vući (konop), povući (konop), tal. virare:** The ship's aft mooring deck crew manually **heaved the messenger line** through the transom panama eye. The vessel's crew began to **heave the towline** back on board. He was waiting for assistance from his colleagues to **heave the rope** using the ship's winches on board. **Stop heaving! Prestani vući / povlačiti!; 2 podizati**

(sidro), ta. virare: We will **heave anchor**. **Podizat ćemo sidro.** While preparing to depart anchorage and **heaving the port anchor** it was discovered that the end shackle pin was protruding from its normal position. {pret.tense and past participle: **heaved (modern form); hove (archaic form)**}

Heave right in!; Heave right on! (v) (ship handling, seamanship) order given to heave the anchor up into the hawse **Podigni siro u sidreno oko!**

Heave short! (seamanship) to heave in until the vessel is riding nearly over her anchor **Lanac okomito!**

heave short (v) (seamanship) to heave in until the vessel is riding nearly over her anchor, i.e. at short stay **povlačiti se po sidru (tako da brod dođe okomito na sidro)**

heave taut (v) (seamanship) to haul in until the line has a strain upon it **napinjati konop jako dok ne bude zategnut, povući jako konop (uže), tal. mettere in forza; arridare**

heave the lead /,hi:v ðə 'lɛd/ (v) (navig, seamanship) mjeriti dubinu mora plavčicom

heave the rope on the winch (v) (seamanship, ship handling) **povlačiti konop**

vitlom, zatezati konop vitlom: He was accompanied by the bosun and another able seaman, they were both **heaving the port guy rope** on the warping drum of the winch.

heave tight = heave taut (jako, čvrsto) **napinjati (konop) dok ne bude zategnut:**

The officer was operating the winch. On **heaving the sternline tight**, one of the seamen used a stopper to secure the rope in readiness for it to be turned up on the bits.

heave to (v) 1 (*navig*) (in extremely heavy weather, or while waiting for entering the port) to bring vessel on a course on which she rides easily and hold her there by the use of the ship's engines (holding a position), just just enough to maintain steerageway **zavlačiti brod (u olujnom nevremenu), čekati na moru za ulaz u luku**: *The vessel remained stubbornly beam on to the wind despite all attempts to heave to with the head into the sea and swell. The Master found himself unable to hold the ship's head into the wind and heave-to due to the severity of the weather. As sunset approached he advised the passengers and crew of his intentions to heave-to; he then turned the ship into the wind and sea and reduced speed, predicting that the depression would pass ahead of his intended track. An alternative option would have been to heave to at sea.*; 2 (*boating/yachting*) stop a sailing vessel by lashing the helm in opposition to the sails **zaustaviti se jedrima**

heave up (v) 1 (*ship handling, seamanship*) **podići sidro (u sidreno oko), tal. virare l'ancora, podizati lanac sidra**: *You must heave up anchor. Pilot sttaion to Master: Heave up and proceed to berth! Having embarked a pilot, a vessel had heaved up her anchor and was under way. The vessel heaved up anchor and started proceeding towards a new position closer inshore in an already crowded anchorage. Have your crew on stand by for heaving up anchor when the pilot embarks. Stand by for heaving up%! While heaving up the port anchor in an area with strong current, the anchor appeared to be fouled; We were heaving up the port anchor in a position where the depth of water was 60 metres. The port anchor was quickly heaved up and with a single astern engine movement, we were able to safely clear the wharf and head out to sea. heave up anchor! Podigni sidro!*; 2 (*ship handling, seamanship*) **podizati (lanac sidra)**: *Heave up port cable. ... due to heaving on the anchor cable, the ship had minimal headway.*; 3 (*seamanship, ship handling*) **podizati (labavo, slobodno uže), podignuti (uže)**: *Then third mate proceeded to heave up a head line and the OS was asked to heave up the starboard breast line. Then third mate proceeded to heave up a head line and the OS was asked to heave up the starboard breast line. Within 10-15 seconds of the OS being asked to heave up the starboard breast line a loud sound of parting rope was heard. The aft mooring team on the cargo vessel took up the slack in the messenger lines and attempted to heave up the tow wire by hand. The second officer looked down at the tow wire and gesticulated to the welder to heave up the messenger line. Within 10-15 seconds of the OS being asked to heave up the starboard breast line a loud sound of parting rope was heard. heave up on the line napinjati uže zatezati uže: the mooring party does not seem to have appreciated that it is extremely dangerous to heave up on the spring whilst the vessel is still moving ahead at speed and that merely stopping the engines does not take the way off of the vessel. It is extremely dangerous to heave up on the spring whilst the vessel is still moving ahead at speed and that merely stopping the engines does not take the way off of the vessel.*; 4 (*seamanship, safety*) **podizati (brodicu za spašavanje, splav itd.), podignuti (brodicu, spalv itd.)**: *When I received his signal, I started to heave up the boat from the poop deck winch station while two seamen were guiding the aft part of lifeboat on to the slides.*

heaving (n) 1 (*ship handling, seamanship*) **bacanje, dobacivanje (konopa na obalu); 2 (ship handling, seamanship) potezanje (olabavljenog užeta, lanca); 3 (ship handling, shipping econ) podizanje sidra**: *This had been done prior to heaving anchor.*; 4 (*seamanship*) **potezanje (rampe) povlačenje**: *I was told by the CO and Bosun that the hinged ramp door could not be hove in fully, and that the final heaving and tightening was done with two crew members jointly hauling on the two chain blocks hooked on to the hinged flap.*

heaving (n) (*nav arch, navig, ship handling*) **COMPARE ship's motions** alternate lifting and lowering of the ship with the water **podizanje trupa broda (zbog gibanja mora), poniranje**: *The Pilot stated to the investigating team that the vessel was not rolling or heaving but yawing. As heaving continued, the messenger line slipped off the side of the warping drum, causing the tow*

wire to drop back down towards the tug.

heaving line (n) (seamanship, ship handling) a small line thrown to an approaching vessel, or a dock as a messenger **bacalo, pandul, tal. sagola**: Indeed, the chief mate had previously instructed all deckhands to leave the **heaving lines** attached to the head and stern lines. The next stage was to pass over the stern and head lines using **heaving lines** and secure them onto two of the turntable's bollards. Indeed, the chief mate had previously instructed all deckhands to leave the **heaving lines** attached to the head and stern lines. When our vessel was approximately 15-20 metres from the berth, an aft spring line was sent ashore **by heaving line** and secured.

heaving to; heaving-to (n) **1 (navig, safety) zavlacenje broda (u nevremenu); 2 (navig) zavlacenje broda pri dolasku u luku (ako nema veza odmah pri dolasku); 3 (boating/yachting) zaustavni položaj, zaustavljanje jedrima; 4 zaustavljanje jedrilice**

heavy /'hevi/ (adj) **1 težak**: The push rod and rocker arm is **heavy** and the engine must overcome the inertia of these heavy parts. **The old ropes were heavy and difficult to handle, and had a tendency to get caught under fenders.** **heavy rod teška motka; 2 (meteorol) jak (kiša) heavy rain jaka kiša**: By now, **heavy rain** had reduced the visibility to about 3nm; it had also adversely affected the quality of the picture on the bridge radar displays. **heavy knocking jako lupanje (u motoru)**: **Light knocking** leads to automatic adjustment of the pilot fuel timing and cylinder-specific air-fuel ratio; **heavy knocking** leads to load reduction or a gas trip. **3 (oceanogr) velik, visok heavy seas visoki valovi** A fully-laden bulk carrier lost steerage **in heavy seas** due to flooding of the steering gear compartment by sea water.

heavy cargo (n) (cargo) **teški teret, teški tereti**: When the wave hit, **the heavy cargo probably moved slightly, and the tie bars failed, allowing the deck cargo to move further.**

heavy crane (n) (cargo handling) **dizalica za teške terete**: Using the **heavy crane**, an iron pipe (so-called 'pile') of 85 metres in length weighting 425 tonnes and with a diameter of about 3.6 m.

heavy damage (n) (cargo handling, safety) **jako oštećenje suffer heavy damage pretrpjeti jako oštećenje**. There were no injuries but **the boat suffered quite heavy damage.**, **sustain heavy damage pretrpjeti jako oštećenje**: This resulted in the jib lowering out of control, falling heavily on the open hatch covers and **sustaining heavy damage.**

heavy-duty (adj) **izdržljiv, jak, koji radi u teškim uvjetima heavy-duty test test izdržljivosti**. **Extensive heavy-duty field tests with MTU high-speed engines in fast ferries are said to have demonstrated the ability to reduce engine wear, extend draining intervals and lower fuel consumption.** **heavy-duty work rad u teškim uvjetima**: e, One of the easiest methods to help however, vulnerable to abrasion and are prevent movement of a deck cargo, is to not suitable for really **heavy-duty work.**, **heavy-duty engine izdržljiv stroj, stroj za rad u teškim uvjetima** Heavy-duty high-speed engines, **heavy-duty shoes teške radne cipele, teška radna obuća**: Wearing non skid, **heavy duty shoes** was a must. In winter, with ice and snow on the gangplank it was a sheer balancing act at times. **heavy-duty bearings izdržljivi ležajevi, jaki ležajevi** The crankshaft incorporates hardened large diameter pins and journals forged in one piece and supported by **heavy-duty bearings** for durability.

heavy fuel (n) (marine eng) **teško gorivo, nafta, mazut**

heavy fuel oil (n) (marine eng) **teško gorivo**

heavy fuel oil (HFO) (n) (marine eng) **teško gorivo, teška nafta**

heavy hauler (n) (US, cargo handling) **teški kamion, kamion za teške terete**

heavy lift teški teret, teško kolet: The stricken drilling rig has started its journey aboard a

heavy lift ship more than two months after the rig ran aground in the North Sea.

heavy lift cargo teški teret(i)

heavy lift cargo gear uređaji za rukovanje teškim teretima

heavy lift clause (n) (mar law) prijevoznik ne snosi ni troškove niti rizik za ukrcaj i iskrcaj tereta (koleta) koji prelazi određenu težinu (DP) **klauzula o teškim teretima**

heavy-lift derricks (n) (cargo handling) **samarice za teške terete** Some ships have special



heavy-lift derricks that may serve one or more holds.

heavy lifting beam greda za teške terete Heavy lifting beams are suitable for heavy and long articles such as locomotives, boilers or railway passenger coaches.

heavy lift ship (n) (nav arch) **brod za teške terete**: The *heavy-lift vessel* ... 19 arrived in Los Angeles carrying two new gantry cranes for the West Basin Container Terminal at the Port of Los Angeles. The stricken drilling rig has been loaded onto a semi-submersible **heavy lift ship**.



heavy load teški teret

heavy oil (n) (marine eng) teška nafta, mazut

heavy rain (n) (meteorol) **jaka kiša**: A large inbound vessel was approaching the pilot station **in a gale and heavy rain** and was instructed to prepare combination ladders on both sides. We approached the One Fathom Bank beacons via the recommended southern side of the traffic separation scheme in visibility at times less than 500 metres **in heavy rain**. As mistakes in providing the figure can be made and cargo can be **wetted by heavy rain** whilst stored in the open or during loading, the moisture content of the cargo should be monitored.

heavy sea (n) (meteorol, oceanogr) **uzburkano more, tal. mare agitato**: ... the other ship was a small cargo vessel which was rolling heavily and yawing as she headed into the **heavy sea and swell**. This allows rapid hoisting and lowering of the boat, which is important **in heavy sea/swell conditions**.

heavy seas (n) (navig, oceanogr) **visoki valovi, jako valovito more**: With the ship rolling about 20 degrees **in a heavy beam sea** and swell, crew members had to perch precariously in the crevice between the very hot bellows and the manifold, ... **encounter heavy seas naići na velike valove** The containership **encountered heavy seas** during a passage of the English Channel, causing catastrophic hull failure.

heavy traffic (n) (navig) **gust promet, jak promet**: There is **heavy traffic** in the area of ... After turning the ship around **in heavy traffic** and steaming back about 15 miles, the Master anchored in the chosen spot in depths of about 25 m, paying out five shackles. **In heavy traffic situations**, doubling of the watch should be considered if there is a possibility of the OOW being distracted by other tasks, ...

heavy weather (n) (meteorol) **nevrijeme**: **Heavy weather damage**: Three container vessels have recently **suffered heavy-weather damage** to deck equipment, bow structure, anchor and containers.

heel 1 (n) (seamanship, navig) the term heel is used to describe a ship that has been forcibly inclined by external forces (wind, waves, etc.) **nagib (uslijed vjetra) nagnuće, tal. sbandamento** This includes understanding what impact the vessel's speed, heading, **heel**, and trim will have on the crew as it abandons ship. Despite the skipper's efforts, he was unable to free the dredge or **correct the heel** before downflooding occurred into the engine room via the vents sited under the bulwark. **the ship has a heel brod se nagnuo, angle of heel kut nagiba broda**: Although your vessel may appear to have good initial stability, ensure that downflooding does not occur before 40 degrees of heel so as to maintain an adequate righting moment at **greater angles of heel**. The boat ran aground and her **angle of heel** increased to 30° as a result of heavy wind and waves. ... specific consideration should be given to ensure the viability of passenger muster stations following the effects of **a large angle of heel**. It has been estimated that these intakes would have been immersed at **only 17 degrees of heel**. The boat was brought onto the desired heading and was making about 4 1/2 knots when she grounded violently, and after a few bounces took on a substantial **angle of heel**.; **2 nagib (jedrilice); 3 (boating/yachting) peta (jarbola)**: Before the mainsail could be reefed, the **heel rapidly increased**, and at about 0320 the boat very quickly inverted, trapping the skipper inside the cabin.

heel (v) **COMPARE list 1** (seamanship, navig) **naginjati se (uslijed vjetra, valova)** At very close range the target **began to heel** and she turned to PORT. A large wave hit the vessel on her port side, **causing her to heel about 35° to starboard**, before she came back to an average of about 25°. The vessel immediately yawed and **heeled to starboard**. The ship rolled very heavily several times, **heeling the ship** to more than 30°.; **2 (boating/yachting) naginjati se (jedrilica)**: There was an 8-10 knot north-easterly wind, and the boat was on a port tack and **heeling about 15° to starboard** when the first reef was put in the mainsail just before midnight. By 0245 the wind had increased to 25 knots, gusting 35 knots, and the boat was **heeling 25° to starboard**.

heeling (n) **1 (seamanship, navig, ship handling) nagibanje (broda) heeling angle kut nagibanja**: **Heeling angle** equivalent to a GZ-value equal to 50% of GZ-max; The angle at which the working deck immerses; 15 degrees.; **2 (boating/yachting) inclination caused by the wind's force on the sails of a sailing vessel naginjanje (jedrilice)** This creates initial instability and **results in heeling** to an angle where the ship becomes stable again (lolling).

heeling arm curve (n) (nav arch) **krivulja poluga nagibnoga momenta**

heeling force (n) (boating/yachting) **silu naginjanja**

heeling moment (n) (stabil) **nagibni moment**

heeling moment curve (n) (nav arch) **krivulja nagibnoga momenta**

heel over (v) (navig) **nagnuti se**: The impact caused her to **heel over** violently, and seas poured in over her port quarter.

height /hait/ (n) **visina** **height of the waves** **visina valova**: Concern grew as the **height of the waves** and the pitching and rolling of the vessel increased. A **Significant Wave Height** of 6 metres was predicted, with a maximum wave height of 9., **height of tide** **visina plime**: Taking into account the **height of tide** of 1.4 metres and an estimated squat of 0.9 metre, the vessel would have grounded at a charted depth of 10.13 metres,...

height of observer's eye (n) (navig) **visina očišta**

held covered (adj) (mar ins) **klauzula povrede jamstva, klauzula drži se pokrivenim**

helicopter /'hɛlɪ,kɒptə/ (n) (safety) **helikopter** **winch a person into the helicopter** **podići osobu vitlom u helikopter**: The pilot and the two crew members were then winched into the

helicopter and taken ashore., **rescue helicopter** **helikopter za spašavanje na moru**: The coastguard immediately activated the inshore and all weather lifeboats, **rescue helicopter** and coastal rescue teams to search the area for possible survivors. The captain contacted the coastguard via Digital Selective Calling who alerted the **rescue helicopter** and two lifeboat stations. A **rescue helicopter** carrying a doctor arrived after approximately 45 minutes., **SAR helicopter**

helikopter u sastavu Službe traganja i spašavanja: The man who had collapsed to the deck was winched off the boat by **SAR helicopter** and taken to hospital, and two others that had been transferred ashore at the slipway were also taken to hospital by air ambulance., **helicopter**

evacuation **evakuacija helikopterom** **izvlačenje helikopterom**: The doctor requested **helicopter evacuation** for the injured man, who was subsequently airlifted to hospital for treatment.

helicopter carrier (n) (navy) **nosač helikoptera**

helicopter rescue (n) (safety) **spašavanje helikopterom, evakuacija helikopterom**: This enabled a prompt distress call to be made to the coastguard, which quickly initiated a **helicopter rescue**.

heliograph (n) (safety, navig) **signalno zrcalo za privlačenje pozornosti i slanje poruka pogibelji s pomoću odsjaja Sunčevih zraka sa spasilačke jedinice** **heliograf**

helix (n) (marine eng) **kosi žlijeb, kosi izrez (na plovku pumpe goriva)**: The **helix of the pump plunger** is shaped so as to raise P_{max} throughout the part-load range and thereby reduce part-load brake specific fuel consumption.

hell piece 1 (nav arch) **peta statve; 2 (boating/yachting) petica**

helm 1 (nav arch) **kormilo**: No significant alteration of course was detected from her and rather than waste precious time on the VHF, I ordered our **helm** 20.. Under the master's guidance, **the OOW was at the helm** again for most of the two hour cruise, ... When the master realised that the next port hand mark, a light-float, was now on the starboard bow, **he used both helm and engines** to try and manoeuvre the vessel towards the main channel. The berthing pilot began the manoeuvre to turn the tanker using a combination of engine, **helm** and tug movements. **respond to helm** **reagirati na kormilo**: The rudder stalled and the boat failed to **respond to the helm**, **take the helm** **preuzeti kormilarenje**: The OOW changed to hand-steering and instructed his lookout to **take the helm**., **helm a-weather**

kormilo u vjetar, ta. barra al vento, put the helm amidships **staviti kormilo u sredinu**: About 30 seconds later, the chief officer noted that the ship was approaching the northern breakwater arm at the entrance, and **put the helm amidships** to slow the rate of turn. The bank suction effect on vessel A became progressively more pronounced, requiring increasing starboard helm; **placing the helm amidships** caused the vessel to sheer to port., **apply the starboard/port helm** **staviti**

the helm amidships caused the vessel to sheer to port., **apply the starboard/port helm** **staviti**

kormilo u desno/lijevo: He reacted by **applying full starboard helm.**, **order hard port / starboard helm zapovijediti da se kormilo stavi sve lijevo / desno**: Meanwhile, the bulk carrier's OOW had also been contacted by the TSS services and after a short conversation this OOW **ordered hard port helm.**, **order the helm 20 degrees zapovijediti da se kormilo okrene 20 za stupnjeva**: No significant alteration of course was detected from her and rather than waste precious time on the VHF, I **ordered our helm 20.**, **helm TAKE OVER button dugme za preuzimanje kormila**: The officer pressed the **helm TAKE OVER button** and confirmed; the helmsman then confirmed he had hand steering., **amount of helm kut kormila stupanj zakreta kormila**: The ship started to turn quickly to port and the pilot was not aware of the **amount of helm** the master had applied. The superintendent was told about a minute later, by which time he had ordered slow ahead and had increased the amount of port helm., **order helm amidships izdati zapovijed za kormilo u sredinu, order the helm into manual zapovijediti prebacivanje na ručno kormilarenje**: I ordered the helm into manual and the Third Mate gave the signal indicating that we believed the target to be the giving way vessel., **automatic helm automatsko kormilo**: When the vessel cleared the approaches to the harbour, the skipper set a course on the automatic helm to pass on his port side a small island, which lay about 2 miles to the south-west.; **2 kormilarsko kolo**

helm-a-weather (n) (seamanship) **kormilo u vjetar, tal. barra al vento**

helm control (n) (ship handling) **kontrola nad kormilom, sposobnost kormilarenja**

brodom: When the ship is underway with a stern swell running at the same or slower speed, the rudder becomes ineffective and **helm control** is only restored by giving short kicks ahead. It should be standard practice to make sure that the **helm control** is always in the midships position before switching over to a new **helm control station**.

helmet /'hɛlmit/ (n) (safety) **kaciga safety helmet zaštitna kaciga**: Although he was wearing the safety helmet at the time of the accident, and despite receiving prompt medical assistance, the injuries the OS sustained to his head were fatal.

helm hard to port; helm hard-a-port (navig) **kormilo sve u lijevo**: At 0557 the vessel was swinging quickly to starboard; the pilot again ordered the **helm hard-to-port**, the engine to full ahead and the OOW to steer a heading of 071 degrees. The pilot also ordered the **helm 'hard-a-port'**.

helm hard to starboard; helm hard-a-starboard (navig) **kormilo sve u desno**: Two minutes later, the vessel's engine was stopped and the pilot ordered 'dead-slow-ahead' and the **helm hard-to-starboard**: Twenty five seconds later PV called B and urged her to immediately put her **helm hard-a-starboard**, this was again confirmed by B.

helm indicator (n) (navig) **pokazival otklona kormila**: A few minutes later, the gyro off-course alarm sounded (vessel still on autopilot) and the **helm indicator** showed the rudder to be moving to starboard. The exterior bridge wing **helm indicator illumination** was very poor and could not be



seen from the superintendent's position.

helm input (n) (navig) informacije za kormilarenje, ulazni podaci za držanje

kormila The pilot had previous experience of the vessel and knew that she required constant **helm input** to resist her tendency to yaw.

helm instructions (n) (navig) upute za kormilarenje: The pilot had a clear view from the crane, but he had no need to give any **helm instructions** to the pulling tug and only occasional **helm instructions** to the pushing tug.

helm orders (n) (navig) = **steering orders** zapovijedi za kormilarenje, naredbe za

kormilarenje: Meanwhile, with the **port helm order**, the tanker had turned almost 90deg from her original heading, but could not avoid a glancing contact on her starboard quarter with the crossing vessel. As the vessel was swinging to port, **he reduced the helm order to port 10o** and then engaged in a VHF radio conversation to arrange passing with an outbound vessel, ... **The Quartermaster (QM) was not given a helm order**, or a course to steer, and instead was given broad directions on what he should do. This can only be achieved by the good seamanship practice of habitually checking the rudder angle repeater **after each helm order has been given.** **Midship! Sredina!, tal.**

barra al centro!, Port 5! (10! / 15! / 20!) Pet lijevo! (10 / 15 / 20 lijevo!), Starboard 5! (10! / 15! / 20!) Pet desno! (10 / 15 / 20 desno!) Hard-a-port! Sve lijevo!, tal. tutto a sinistra!, Hard-a-starboard! Sve desno!, ta. Tutto a dritta!, Nothing to port / starboard! Ništa lijevo / desno!, Meet her! Ispitajte! (osjetljivost kormila) Steady! Ravno!, Steady as she goes! Tako ravno!, Ease to five / ten! Smanjite na pet / deset!, Keep the buoy / mark ... to port side / starboard side! Ostavite plutaču / oznaku ... s lijeve / desne strane!, Report if she does not answer the wheel!

Izvijestite ako brod ne sluša kormilo!, **Finished with the wheel!** Svršeno s ručnim kormilarenjem!, **Standard helm orders** standardne naredbe za kormilarenje

helm port (n) (sailing vessels, nav arch) provlaka kormila

helmsman (n) 1 kormilar, **timunjer**; tal. **timoniere**: The International Convention on Standards of Training, Certification and Watchkeeping for Seafarers (STCW) requires that a helmsman be able to understand and respond to helm orders in English The bridge team consisted of the master, officer of the watch (OOW), **helmsman** and a pilot. An **AB helmsman**, and the second officer, who was on the engine controls, accompanied the master on the bridge. The bridge was manned by the master, second officer, **helmsman**, and a pilot who had conduct of the vessel.; 2 **COMPARE crew** :4 kormilar jedrilice

hemp (n) (seamanship) **konoplja**: A prominent risk while carrying certain cargoes is oxygen

depletion due to the inherent form of the cargo, for example, self-heating, oxidation: cargoes such as jute, hemp, flax, sisal, kapok, cotton and other vegetable fibres ... **hemp rope konop od konoplje**

herring (n) (fishing) haringa

herringbone (n) riblja kost

hesitate (v) oklijevati: *If there is any doubt, do not hesitate to call the emergency services to seek advice or to arrange treatment. OOW must use all available equipment and controls and must not hesitate to use the whistle when needed; OOW must not hesitate to call the master;*

hesitation (n) oklijevanje: *... and during the subsequent discussion of the trawler the operator asked the OOW whether he intended "to do a 360..." After some hesitation the OOW confirmed that this was his intent. called on and the officer should have no hesitation to do so.*

hex nut (n) (marine eng) šesterokutna matica

hide (cargo) koža raw hide sirova koža

high (n) = anti-cyclone; anticyclone (meteorol) an area of high pressure, usually accompanied by anticyclonic and outward wind flow **anticiklona**

high, wide and handsome (adj) (boating/yachting) jedriti s povoljnim vjetrom

high cube container (n) (cargo) High-cube containers are similar in structure to standard containers, but taller. In contrast to standard containers, which have a maximum height of 2591 mm (8'6), high-cube containers are 2896 mm, or 9'6, tall. High-cube containers are for the most part 40' long, but are sometimes made as 45' containers. **visoki kontenjer:** *The 48-foot (14.63 m) shipping container is a High Cube container in that it is 9 ft 6 in (2.90 m) tall on the exterior. It is 8 ft 6 in (2.59 m) wide which makes it 6 inches (15 cm) wider than ISO-standard containers. On the stack weights screen or the bay plan, the only clue indicating the presence of a high-cube container may be the letters HC*



(high-cube) instead of perhaps DC (dry container 8'6)

Higher National Certificate; (HNC) (n) (mar law) COMPARE Higher National Diploma (HND) potvrđnica o završenom višem stručnom obrazovanju: *At the conclusion of the initial training the successful trainee will have attained: Deck HNC/HND, Foundation Degree or Honours Degree in Marine Operations OOW/D Certificate of Competency. Higher National Certificate; (HNC) in Marine Operations / Nautical Studies potvrđnica o završenom višem stručnom obrazovanju - nautika, Higher National Certificate; (HNC) Marine Engineering potvrđnica o završenom višem stručnom obrazovanju - brodska elektrotehnika i elektronika, Higher National Certificate; (HNC) in Marine Electrical/Electronic Engineering potvrđnica o završenom višem stručnom obrazovanju - brodska elektrotehnika i elektronika*

Higher National Diploma (HND) (n) (mar law) diploma koja se u V. Britaniji stječe nakon završenog tro- ili dvogodišnjeg studija na akademijama ili višim i visokim (pomorskim) stručnim školama **diploma visokog stručnog obrazovanja** *He continued to sail in the fleet gaining*

a Master Mariners Certificate and **HND in Nautical Science** and served as Master aboard four of the company's vessels, ... At the conclusion of the initial training the successful trainee **will have attained: Deck HNC/HND, Foundation Degree or Honours Degree in Marine Operations OOW/D Certificate of Competency.** **Higher National Diploma (HND) Deck diploma o završenom visokom**

stručnom studiju nautike / navigacije, Higher National Diploma (HND) Engine diploma o završenom visokom stručnom studiju brodstrojarstva: On completion of the course of studies the successful trainee will have attained HNC/HND, Foundation Degree or Honours Degree in Marine Engineering and OOW/E Certificate of Competency - Engine, **Higher National Diploma (HND) Electro-Technical diploma o završenom visokom stručnom studiju brodske elektrotehnike** {A B.Sc Degree is an academic diploma (e.g. 'diplomirani prvostupnik navigacije' - Bachelor of Science - Navigation; Bachelor of Science - Deck)}

high evaporation rate (n) (marine eng) visok stupanj isparivanja

high frequency (HF) (n) (electr, comm) visoke frekvencije

high pressure (n) 1 (marine eng) visok tlak, visok pritisak: The subsequent investigation revealed that the fire had started as a result of a leak on the main gearbox cooler spraying oil at high pressure (18 bar) onto the engine room deckhead and falling onto the starboard engine exhaust manifold.; 2 (meteorol) visoki tlak area of **high pressure područje visokog tlaka zraka anticiklona**

high-pressure (adj) (marine eng) visokotlačni: The high-pressure compressor of the VTR..4P turbocharger was selected for thermodynamic and economic reasons. High-pressure direct injection for the gaseous fuel maintains the diesel process, The high-pressure fuel system was designed and endurance tested at 2000 bar; an actual injection pressure of around 1400 bar ... The auxiliary media for both fuel and gas operation call for a high-pressure gas supply; a fuel oil supply (pilot oil); control of oil supply for activating the gas injection valves and sealing oil supply. It operates on the common rail principle in which timing valves, operated by cams on the camshaft, control the injection of fuel from a high-pressure manifold through spring-loaded injectors to the cylinders. **high-pressure boiler visokotlačni kotao, high-pressure marine watertube boiler brodski visokotlačni vodocijevni kotao, high-pressure rotary feed pump visokotlačna rotaciona napojna pumpa, high-pressure pump visokotlačna pumpa** The pilot fuel system is a common rail (CR) system with one engine-mounted high-pressure pump supplying the pilot fuel to every injection valve at a constant pressure of 900 bar. **high-pressure valve visokotlačni ventil:** A small quantity of gas is injected into the pre-chamber just before TDC by the directly controlled high-pressure pilot gas valve, the gas having been compressed to 230 bar in a small dedicated compressor. **high-pressure fuel visokotlačno gorivo:** The fuel pumps will discharge high-pressure fuel to their respective injectors. **high-pressure pipe visokotlačna cijev:** High-pressure fuel and servo oil delivery pipes, and electronic systems, are also duplicated. **high-pressure system visokotlačni sustav:** The high-pressure system is designed and endurance tested at 2000 bar, and the injection pressure is around 1800 bar.

high quality fish (n) (fishing) bijela riba, oborita riba

high sea (n) (meteorol, oceanogr) sedmi stupanj stanja mora s valovima visine od šest do devet metara **velo more:** SMCP: Smooth/moderate/rough/high sea / slight/moderate/heavy swell from SE ...

high sea chest (n) (marine eng, nav arch) usisni ventil za otvoreno more, usisni koš za otvoreno more: The whole fleet was advised to use high sea chest in ports as this is generally located close to several overboard discharges; e.

high seas (n) 1 (mar law) = **open sea** all parts of the sea that are not included in the exclusive economic zone, in the territorial sea or in the internal waters of a State, or in the archipelagic waters of an archipelagic State. (UNCLOS) **otvoreno more (u međunarodnom pravu mora) Law of the High Seas Zakon o otvorenom moru, high seas routes putovi otvorenim morem**; 2 (oceanogr) **visoki valovi, jako valovito more**

high sea suction (n) (marine eng, nav arch) **usis za plovidbu otvorenim morem, usis mora za hlađenje motora**: *At the time, the high sea suction was in use, and even though it was well under water, the C/E instructed the duty engineer to change over to the low sea suction ... Good practice dictates that high sea suction intakes should be used in shallow waters to reduce the risk of the vessel ingesting mud and weed, ...*

high slack water (n) (oceanogr) **vosok vodostaj**

high speed craft; HSC (n) 1 (nav arch) = **high speed ship / vessel brzi putnički brod**: *... the high-speed craft hit one or more waves with a speed of 33-35 knots. The impact and movement on a small high speed craft is greater at the bow and reduces towards the stern.*



; 2 (nav arch) **brzi brodovi**

high speed engine (n) (marine eng) **brzohodni motor**: *The connecting rod must be strong, yet must not be too heavy because of inertia forces, especially in high speed engines. In case of limited power systems like medium speed engines of high speed engines, clutches and reverse gears.*

high speed ship / vessel (n) (nav arch) **brzi putnički brod, brzi brod**: *A high speed ferry was proceeding in the river approach to a UK port. All radars, including those with automatic tracking systems and ARPA, have difficulty maintaining track on small, high speed vessels. A small high speed vessel was employed to conduct pleasure trips for tourists.*

high tide (n) (oceanogr) = **high water visoki vodostaj, plima, visoka voda**: *The vessel was refloated on the next high tide. The next day the ship was floated off the bank on the high tide using her own engine after removing a lot of the ship's ballast and most of the fresh water. Therefore, it was decided to wait for high tide.*

high water (n) 1 (oceanogr) **ANTONYM low water** Maximum height reached by a rising tide. The height may be solely due to the periodic tidal forces or it may have superimposed upon it the effects of prevailing meteorological conditions. **visoki vodostaj, velika voda**: *As the tide reached high water, the stream next to the bank started to ebb.*; 2 (oceanogr) **ANTONYM low water plima, visoka voda, tal. alta marea**: *High water at Tilbury was predicted for 1156 with a predicted height of 6.2m. PLima u Tilburiju bila je predviđena za 11:56 sati, a njena visina trebala je iznositi 6,2 m The timing of the passage was planned for high water (HW) at the beacons to maximise the available depth of water. {Syn: high tide}*

high wind (n) (boating/yachting) **jak vjetar**: *This type of vessel has been rightly described as a 'ping-pong ball on the water' and under high wind conditions, ro-ros are almost impossible to control or manoeuvre. {vjetar preko 20 čvorova}*

high wind warning (n) (meteorol) **warning** Issued when sustained winds from 40 to 73 mph are expected for at least 1 hour or any wind gusts are expected to reach 58 mph or more (Seasources.net) **upozorenje za jak vjetar**

hijack (v) (mar law) **oteti, kidnapirati**: *an oil tanker with 24 crew was hijacked on Sunday off the*

coast of ...

hijacking (n) (mar law) otmica

hike /haik/ (v) (boating/yachting) sjesti na razmu / kraj palube jedrilice, visiti {radi ravnanja nagnute jedrilice}

hiking straps (n) (boating/yachting) trake za noge {za posadu (posebno flokista) pri ravnanju jedrilice}

Himalaya Clause (n) (mar law) A clause in a bill of lading (supra) extending to specified third parties, such as servants or agents of the carrier (supra) and independent contractors (e.g. stevedores and terminal operators) employed by the carrier, the benefit of the exemptions, limitations, defences and immunities of the carrier under the bill of lading. (Tetley) **odredba (u teretnici) pod nazivom Himalaya o pravima i obvezama trećih strana (podugovarača)**

hinge (n) (marine eng) šarka, britvela, osovinica: *The chief engineer tried to raise the stern ramp, but once it reached an angle of 45 degrees it was evident the hinges of the ramp were damaged. Had a suitable method of Non-Destructive Testing been carried out on the door hinge components, after the cracks were discovered, it might have been possible to determine the depth and extent of the cracks. This resulted in the booby hatch inadvertently moving on its hinge while the person was using the*



hatch; some injuries have resulted.

hinged door 1 (nav arch) vrata s osovinama / šarkama: *The lower frame box is on the front of the engine provided with a large hinged door for each cylinder.*



2 brodska rampa (na ro-ro brodovima): *Then suddenly, the rubber seal disengaged from the fixed ramp section causing the hinged ramp to swing down on to the*



cadet.

hinterland (*shipping econ*) **zaleđe (npr. luke), gravitacijsko područje luke:** *The consignment was destined for a project site **deep in the hinterland**, involving transportation on a single lane road by special trailer for a distance of nearly 900 kilometres from the discharge port.*

hire (*n*) **1 (mar law) zakupnina, najam broda, naval, tal. noleggio; 2** [Fr.: loyer or loyer d'affrètement] [Span.: precio or tarifa] [Ital.: prezzo di noleggio] [Gr: Mietzins] - The consideration (monetary compensation) in bareboat, demise and time charterparties. (Tetley); A sum of money paid to the shipowner by a charterer for the use of a ship. **najmnina (broda) (u ugovorima na vrijeme i ugovorima o zakupu), zakupnina (broda) vessel daily hire dnevna najamnina za brod, off-hire clause klauzula o (privremenom) prestanku najma /čartera, klauzula /odredba) o prestanku plaćanja najamnine, payment of hire plaćanje zakupnine, neplaćanje vozarine (u prijevoznom ugovoru), non-payment of hire neplaćanje zakupnine, neplaćanje vozarine, fixed daily hire fiksna dnevna najamnina broda.** *The voyage time and port time are calculated and multiplied by the fixed daily hire.*

hire (*v*) **1 (mar law, shipping econ) unajmiti, uzeti u najam hire a ship unajmiti / iznajmiti brod.** *A company had hired a class V passenger vessel ., hire a boat / barge unajmiti brodicu / teglenicu:* *At the discharge port, a slop barge was hired and the contaminated ballast from the fuel tanks was duly disposed ashore. A 12 metre long, twin screw charter boat was hired by a team of divers for 2 days of diving., hire to iznajmiti (nekome), hire from unajmiti od; 2 (mar law, shipping econ) iznajmiti, dati u najam; 3 unajmiti (osobu, stručnjaka):* *In some cases special skilled personnel may need to be hired, like electricians and others. However, the terminal staff were concerned about the paint can, which had sunk releasing more paint so a diver was hired to recover it before the ship departed.*

hit (*v*) **1 (navig, safety) udariti u hit the dock udariti u gat.** *The ship hit the dock head., hit the berth udariti u obalu / vez:* *First the stern hit the berth and a few minutes later the bow of the container vessel which was moored ahead was violently hit by our starboard side midship section and, hit the ship udariti u brod.* *In less than 30 seconds she hit the bow of the mother vessel at a speed of about 18 knots. se to pass south of the buoys found herself in a very close quarters situation with the next inbound vessel and I was amazed how she managed to avoid hitting either this vessel or the buoys., hit the reef udariti u greben:* *The group continued to watch for any signs of waves breaking over hidden obstructions when suddenly the RHIB hit a submerged reef and came to an abrupt stop., hit the buoy udariti u plutaču:* *Seconds later, the ship hit the buoy with her starboard quarter., hit*

the quay udariti u lučku obalu: *The vessel **hit the quay**, and then the link span, causing significant damage to both the ferry and the port facilities.*, **hit the waves udariti u valove, naići na jake valove:** *Six passengers and one crewmember were injured when **the vessel hit the waves**.*, **hit the rock udariti o stijenu / hrid:** *He put the vessel astern, but it was too late and they **hit the rocks** on the port side of the channel.*, **hit the button pritisnuti dugme:** *However, he too was unable to take control, so the master hit the **engine emergency stop button**.*, **hit the bridge udariti u most:** *Mooring lines failed and **the vessel drifted and hit a nearby bridge**.*, **hit the water udariti u površinu vode / mora:** *ility of back injuries to persons sitting on tubes is also considerably greater due to the twisted position of the spine and the shock of the boat **hitting the water**. As soon as this button was pressed the FRB descended at high speed **hitting the water** about 18 metres below.*; **2 udariti (osobu, člana posade, dio tijela), pogoditi:** *The end of **the rope hit the winch operator** causing severe injuries, the 3rd officer also just missed being injured by the other rope. **The rope hit the Chief Engineer** who was checking the mooring winch operation. The crew in the vicinity recognised the danger and started to move clear, but the rope parted and **hit two of the crew on the head** as it recoiled. During the securing of one container, the chain broke at **the hook and hit a stevedore on the head**. **The seaman was hit by the mooring line** and was killed almost instantly. As his head came level with the nozzle, it suddenly jerked clear and whipped violently, **hitting him on the face**.*

hitch (n) (seamanship) COMPARE bend: a knot that secures a rope or line to an object, a stanchion, mooring ring, bollard. Hitches are used to bend a rope to or around an object, such as a ring, spar, or stanchion. **uzao, čvor, volta:** *However, before the eye was sufficiently slack to be removed from the bits, the **messenger's hitch** failed and the AB hastily attempted to reattach the messenger to the mooring rope's eye. Poor seamanship: entangled mooring ropes, perhaps caused by passing them through the same fairlead and fitter's **initial hitch on the mooring rope's eye** was unreliable due to lack of expertise;* **bowline hitch petlja, back-wall hitch uzao za kuku, rolling 1 dvostruki vrzni uzao, half hitch poluuzao, timber hitch dvostruki ribarski uzao, clove hitch vrzni uzao, without a hitch (figurative) bez problema:** *The process continued **without a hitch** until the davit arms were fully swung out and the boat began to lower.*

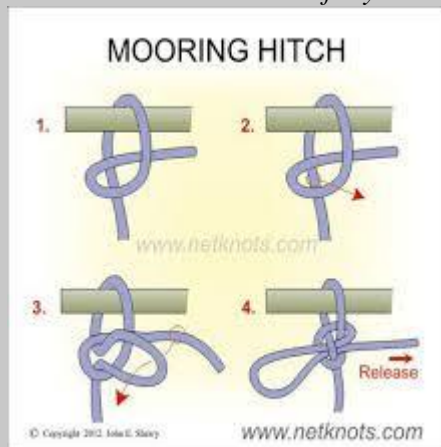

HM off; heading mark off (n) (navig) kontrola za isključivanje oznake pramčanice (na radarskom pokazivaču): *The heading mark may sometimes hide a small echo. To show that echo, press and hold down the HM OFF key to temporarily erase the heading mark. Release the key to display the heading mark.*

HMS; H.M.S.; (Her/His Majesty's Ship) (n) (navy) brod Ratne mornarice Velike Britanije, brod Kraljevske mornarice (GB): *He was the Navigating Officer of HMS*

During his naval career he was a bridge watch keeper and commanded the aircraft carrier HMS-

HNC; Higher National Certificate (*n*) (*mar law*) **SEE academic awards in ship officer programmes (UK) - Marine Engineering** **SEE academic awards in ship officer programmes (UK) - Navigation** A full-time Higher

National Certificate (HNC) takes one year to complete, or two years part-time. Many HNC courses cover the same subjects as an HND, but an HNC is one level below an HND (it's generally equivalent to the first year at university).

(<https://www.whatuni.com/advice/choosing-a-course/what-is-a-hnd-and-a-hnc/2116/>) **potvrđnica o završenom jednogodišnjem ili dvogodišnjem višem stručnom studiju:** *A full-time Higher National Certificate (HNC) takes one year to complete, or two years part-time.*

HND; Higher National Diploma (*n*) (*mar law*) A Higher National Diploma (HND) is a work-related course provided by higher and further education colleges in the UK. A full-time HND takes two years to complete, or three to four years part-time. Generally an HND is the equivalent to two years at university. (<https://www.whatuni.com/advice/choosing-a-course/what-is-a-hnd-and-a-hnc/2116/>) ;

Generally an HND is the equivalent to two years at university **svjedodžba o završenom**

visokom stručnom studiju **HND; Higher National Diploma** **in Nautical Science:** *He gained a Master Mariners Certificate and HND in Nautical Science and served as Master aboard four of the company's vessels.* **svjedodžba o završenom visokoškolskom stručnom studiju**

nautike, **HND Marine Engineering** **svjedodžba o završenom visokom stručnom**

studiju brodskog strojarstva, **Higher National Diploma (HND) in Nautical Science**

Diploma o završenom visokoškolskom stručnom studiju nautike: *The Academy offers a full deck officer cadet programme by a Higher National Diploma (HND) route, leading ultimately to the award of a UK Maritime and Coastguard Agency (MCA) Deck Officer's Certificate of Competency*

(STCW'95 II/I OOW), and the Higher National Diploma (HND) in Nautical Science., **Higher National**

Diploma (HND) in Marine Engineering **svjedodžba o završenom visokoškolskom**

stručnom studiju brodskog strojarstva: *The Academy offers a full engineer officer cadet*

programme by a Higher National Diploma (HND) route, leading ultimately to the award of a UK Maritime and Coastguard Agency (MCA) Engineer Officer's Certificate of Competency (STCW'95 III/I OOW), and

the Higher National Diploma (HND) in Marine Engineering., **Foundation Degree - Marine**

Electro-Technical Officer (METO) **Diploma o završenom visokoškolskom**

stručnom studiju brodskog časnika elektrotehnike: *Warsash Maritime Academy offers a*

full marine electro-technical officer (METO) cadet programme by a foundation degree route, leading ultimately to the award of:

hogging (*n*) (*nav arch*) the distortion of a vessel's hull when her ends drop below their normal

position relative to her midship portion. **pregib (broda):** *Longitudinal Stresses created by Hogging and Sagging can be very severe and can cause a ship to break up*



hogshead (n) (cargo) bačva (pivska)

HO (hold) (n) (shipping econ) brodsko skladište, štiva

hoist (n) **1** (cargo handling) vitlo: The operator *released the hoist* and luffing lever controls and pushed the 'power off' button. **full hoist position**; **2** (cargo handling) uređaj za dizanje tereta (na dizalici): They disconnected the *crane hoist wire*, and stayed in the lifeboat while the crane jib was lowered.; **3** (cargo handling, marine eng) koloturnik, čekrk, **parank**, **paranak**: After the accident, the overhauling stand was properly aligned to be in line with the *chain hoist* and purifiers; **2** Fleet circular issued instructing all vessels to discuss the incident at the next safety meeting. Thread the slings through the lifting eyes and fit them to the hook of *the hoist*. Realising the emergency, other crew members rushed to the site with a *portable lever hoist* (chain block) and managed to relieve the stress and free the trapped men.

hoist (n) (navig) podigač (zastave, oznaka)

hoist (v) (navig) podići, istaknuti (zastavu) tal. *issare*: It is also safer when you need to make fast only one hook and you are ready to *hoist a whole lifeboat up*. Each time the crew tried to *hoist the ladder*, it descended rather than moving up. The tender was then positioned immediately below the vessel's crane, which was used to *hoist the tender* and transfer it to its stowage position on the sun deck.

hoist the flag podići zastavu, istaknuti zastavu

hoist (v) (boating/yachting) podignuti jedro, podići jedro, tal. *issare* **hoist the mainsail** podignuti glavno jedro

hoist (n) (nav arch) dizalo (za peljara) lift **pilot hoist** peljarsko dizalo

hoist (n) (safety) podigač (uže za podizanje osoba na helikopter)

hoist (n) (navig, comm) signalna zastavica

hoist = pilot hoist peljarsko vitlo **pilot hoist** peljarsko vitlo: The pilot then sailed with the ship to test the port *pilot hoist* and reported that this was satisfactory. Case 1 deals with the failure of a *pilot hoist* and happened to a pilot disembarking from a high sided vessel on the UK coast shortly before midnight.

hoist away (v) (seamanship) podizati do sljedeće naredbe

hoist in (v) (seamanship) hoist an object to a required height and swing it in **podići do željene visine i zakrenuti** (brodicu za spašavanje)

hoist out (v) (seamanship) swing out and lower away **zakrenuti i spuštati** (brodicu za spašavanje)

hoist speed (n) (cargo handling) brzina dizanja (uređaja za dizanje tereta na dizalici)

hoist system (n) (cargo handling) uređaj za dizanje (na dizalici)

hold /həʊld/ (n) (nav arch) the space or compartment between the lowermost deck and the bottom of the ship, or top of the inner bottom if one is fitted (SeaSources.net) **brodsko skladište**,

skladište: A typical mid-size ship may have **five or six holds**; three or four forward of the machinery space and superstructure, and one or two aft. There, he plotted the vessel's position on the chart before checking the **hold** and hull for damage. ial report from the Hong Kong SAR Marine Accident Investigation Section While berthed and after discharging cargo, crew were instructed to clean the **hold**.

work a hold ukrcavati / iskravati brodsko skladište, cargo hold brodsko skladište, štiva: Forced ventilation or adequate natural ventilation must be carried out prior to admitting any personnel into **cargo hold** carrying logs. This type of cargo is liable to self-heat, and can therefore reduce the levels of oxygen within the **cargo hold**.

upper gornje skladište, lower hold doljnje skladište: Clean the tween deck(s) before opening **lower hold(s)**. The chief officer instructed that the main deck and **lower hold** were to be washed in accordance with the appropriate work order.

hold space brodski skladišni prostor, prostor skladišta, No. 3 hold brodsko skladište br. 3: It was refused by the consignee, the Calcia company, because a 30 cm layer of water was above the cargo in the **number 3 hold**. The bosun of a self-unloader ship equipped with a deck gantry crane and stackable hatch pontoons was instructed to open **cargo hold no. 3**.

bulkcarrier hold skladište broda za rasutet terete

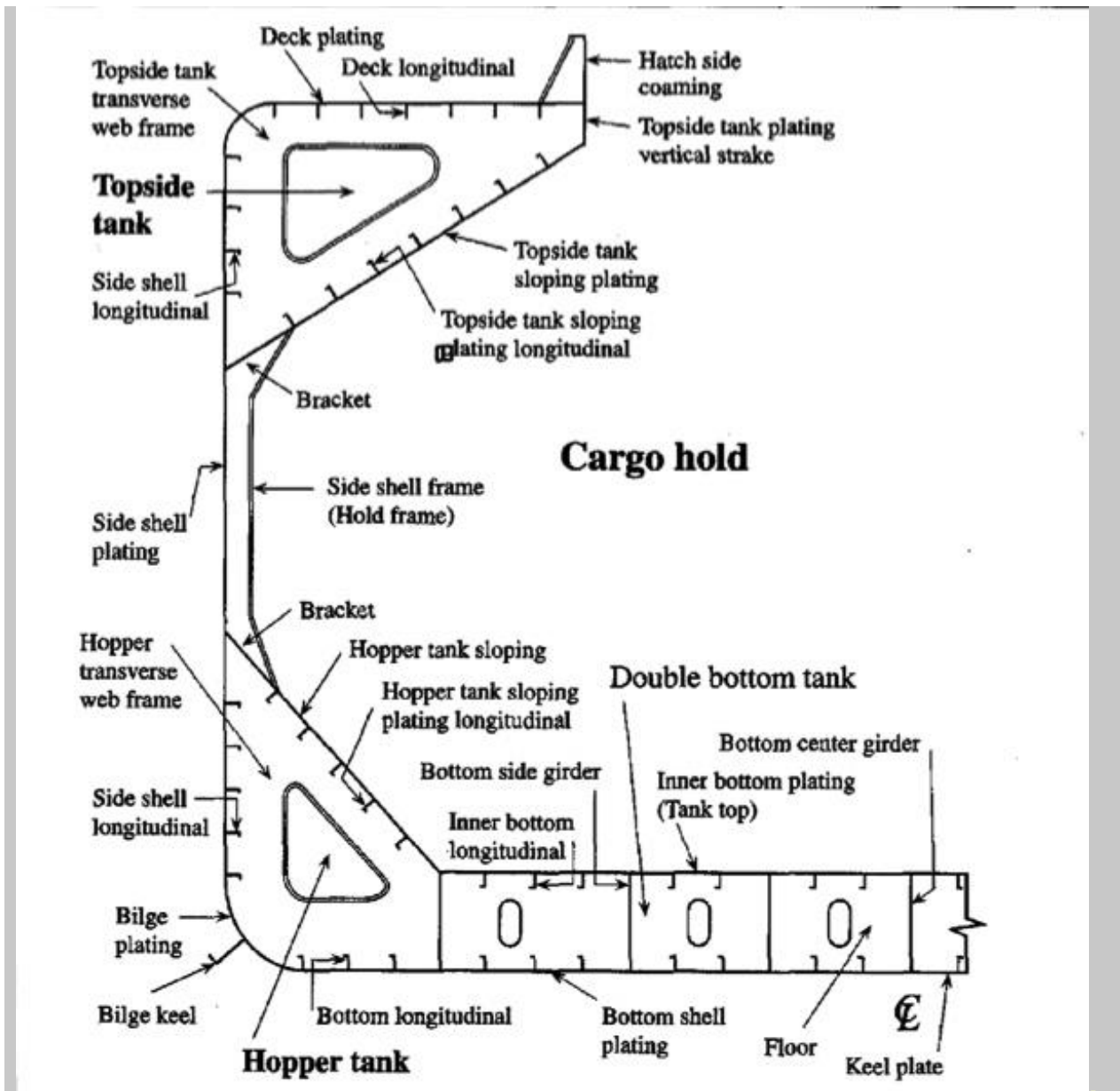

hold bilge system kaljužni sustav skladišta: With the *hold bilge system* already pumping out two holds, a crew member was instructed by the chief officer to enter the third hold to attend to the portable pump.

hold bulkhead pregrada skladišta: In general, was in poor condition with heavy scaling on all surfaces and large wasted holes in the deck beams, especially those adjacent to the former *hold bulkhead*.

hold ladder ljestve broskog skladišta: Because of the poor light in the hold, the seafarer decided to use a light cluster placed close to the top of the *hold ladder* to illuminate the whole space.

hold ventilation ventilacija skladišta, prozračivanje skladišta: All *hold ventilation* was stopped and the engineers isolated electrical power to the forward part of the ship.

hold (v) držati, zgrabiti hold the ship's head in ... držati pramac broda u smjeru ...:

The Master found himself unable to *hold the ship's head into the wind* and heave-to due to the severity of the weather.

hold down the button pritiskati dugme: The group were advised of the need to *hold down the DSC button* for at least 5 seconds, after which the transmission would be acknowledged by a "beep".

hold position držati poziciju broda: We positioned the vessel 3nm east of the NE

bound lane to keep well clear of the traffic and maintained the vessels head into wind and tide to hold position, in other words no longer RAM.

hold a ship (v) (mar law) **zadržati brod**: *A freighter is being held in the port of Duluth amid an ongoing investigation into alleged violations of U.S. environmental law.*

hold beam (n) (sailing vessels, nav arch) **sponja skladišta** **hold beam knee-rider** **okvirno koljeno sponje skladišta**, **hold beam lodging knee** **horizontalno koljeno sponje skladišta**, **hold beam shelve** **dopodsponjak skladišta**, **hold beam clamp** **podspojak skladišta**, **hold beam waterway** **proveza sponje skladišta**, **hold beam spricketting** **nadproveza sponje skladišta**

hold-beam clamp (n) (sailing vessels) **podspojak donje palube**

hold-beam spricketting (n) (sailing vessels) **nadproveza donje palube**

hold-beam waterways (n) (sailing vessels) **proveza donje palube**

hold ceiling (n) **1** (sailing vessels) **nutarnja oplata skladišta**; **2** (nav arch) **podac**, **drveni oblog dvodna**

hold coaming (n) (nav arch) **pražnica skladišta**, **pražnica grotla**: *They were sent to weld a doubler plate to a corroded steel box section on the upper deck, adjacent to the deck coaming of a 5845m³ tween deck hold coaming. Two ABs were sweeping out cargo residue from the trackways between the side-rolling hatch covers and the cargo-hold coaming when the bosun decided to remove the securing pins in anticipation of closing the hatches.*

holder /'həʊldə/ (n) (mar law) **imalac**, **posjednik**, **imalac (isprave, dokumenta, teretnice; stvari)**: *Cargo must only be delivered to the holder of the original B/L or his agent.* **holder of the original B/L** Holder means any Person rightfully in possession of the Bill of Lading or the named Consignee in the event the Bill of Lading is non-negotiable. **imalac (posjednik) originalnog primjerka teretnice**

holder of the bill of lading (n) (mar law) any person rightfully in possession of a particular Bill of Lading or the named Consignee in the event the Bill of Lading is non-negotiable **imatelj teretnice**

hold hatch (n) (nav arch) **grotlo broskog skladišta**: *Crucially, the hold lights were left on throughout loading and after the hold hatches were closed. Beam trawler arrangement had been dredged: 45 bags were in the fish hold and 7 were on the fish hold hatch waiting to be stowed.*

hold hatch cover (n) (nav arch) **poklopac grotla broskog skladišta**, **grotleni poklopac**: *The cargo hold hatch covers and ventilators were then closed.*

holding-down bolts (n) (marine eng) **pričvrtni vijci glave cilindra**, **pritezni vijci glave cilindra**: *Cylinder heads: individual, with six holding-down bolts, housing caged exhaust valves and air inlet valves seated on pressed-in seat inserts; valve operation is by Y lever-type gear.*

holding ground (n) (seamanship) **dno koje drži dobro**, **dno dobro za sidrenje**: *Five shackles of cable were deployed on a holding ground of sand. Furthermore, the anchorage has poor holding ground and ships have tended to drag anchors under these conditions. The anchoring equipment is designed to hold a ship in good holding ground in conditions such as to avoid dragging of the anchor.*

holding power (n) (ship handling) **jačina držanja (sidra, lanca)**: *Tandem anchoring is a recognised technique for improving holding power on a single chain.*

holding tank (n) **1** (nav arch, marine eng) **tank za zadržavanje (ulja, prijava vode itd.)**: *Once the engine had cooled, the contents of the lub-oil drain tank were transferred to a holding tank and the lub-oil drain tank was inspected. ates, the bilge high-level alarms should be placed just above the*

point where, under normal working conditions, the accumulation would be pumped to a **holding tank**, overboard, or through an oily water separation system if required. ; 2 (boating/yachting) spremnik za fekalije

hold inspection (n) (cargo) pregled skladišta

hold ladder (n) (nav arch) ljestve u brodskom skladištu

hold on (n) 1 (seamanship, ship handling) držati (se na užetu), zaustaviti (uže), **agvantat**, zadržati se (na užetu) **Hold on the line!** Uhvati uže! (i prebaci ga na bitvu ili vitlo) **Prihvati konop!**, **Ćapaj cim!**, **Agvanta cim!**, **hold on aft breast line** **Držite se na zadnjem bočnom konopu**; 2 (seamanship, ship handling) držati, uhvatiti **Hold on tight!** (seamanship) **Drži čvrsto!**, **Nategni (konop)!**; 3 (safety) držati se (za nešto):

Life-rings were thrown to him, but he was unable to hold on, and once again he drifted away from the boat. The man then made a grab for the rail but could not hold on, and fell in. {tal.: agguantare}

hold on (v) (comm) biti na vezi, ostati na vezi: **Hold on!** Ostanite na vezi!

hold onto the manrope (v) (safety) držati se za rukohvat, držati se za uže

rukohvata: *the pilot was holding onto the man ropes, while the pilot boat was pitching and the gunwale sliding down along the shipside with the manrope(s) between the gunwale ...*

hold pillar (n) (nav arch) upora skladišta, stup u skladištu

hold platform (n) (nav arch) platforma u brodskom skladištu

hold someone responsible for (v) (shipping econ) držati nekoga odgovornim za,

smatrati nekoga odgovornim za: *We hereby hold you fully responsible for the damage to the subject cargo. Ovime Vas držimo u potpunosti odgovornim za štetu na predmetnom teretu.*

hold space (n) (nav arch) brodski skladišni prostor, prostor broskog skladišta: *For a given trade, hold spaces are usually designed so that the ratio of bale cubic to deadweight is 10 to 15 percent greater than the overall stowage factor of the goods carried to allow for more rapid cargo handling and broken stowage*

hold-stanchion (nav arch, sailing vessels) = orlop beam upora doljnje palube

hold the carrier harmless (v) (shipping econ, mar law) držati / smatrati da

prijevoznik nije kriv: *We agree to hold the above named carrier harmless and indemnified against any and all lawful claims which may be made against the carrier arising out of the same shipment*

hold the stern off the berth (v) (seamanship) COMPARE **hold the stern on the berth** držati krmu dalje od veza, držati krmu na razmaku od veza

hold the stern on the berth (v) (seamanship) držati krmu uz vez / obalu: *In addition to the mooring lines, a tug was being used to hold the vessel's stern on the berth while its bow thrusters were being used forward.*

hole (n) (safety, boating/yachting) rupa (na trupu broda), škulja: *The hole in her hull was first seen when illuminated by a rescue helicopter. Leaning over the side of the boat, they could see a section of shell plating at the waterline, opening and closing the hole as it moved about in the seaway. As a result of the collision, the RIMAC took on water due to a hole in the area of the port side of cargo hold 5; however, this did not compromise her buoyancy. As the pilot boat's coxswain passed the ship's stern to take off the pilot, he reported to the master and pilot that he could see a hole in the ship's port quarter. Some of them fall into the water which could cause us danger and pollute the water by protruding from the ground under the ship and piercing a hole in the bottom plating. The vessels collided, ripping a large hole in the ferry's engine room. block a hole začepiti rupu*

holing (n) 1 (safety, boating/yachting) rupa na brodici / jahti; 2 nastajanje rupe

hollow (adj) (marine eng) šupalj, izdubljen, prazan: The push rods are usually **hollow** in order to obtain the stiffness without unnecessary weight, Camshafts: modular design with one cam element per cylinder; they are **hollow** and form the main lube oil supply to the engine.

Home Address (n) (mar law) kućna adresa

home port (n) (mar law) luka pripadnosti: A scallop dredger returned to her **home port** and landed her catch. The ship had suffered only minor damage and returned to her **home port** for repair the same day. SE 19 Better to be Safe Than Sorry Narrative First incident: On a Tuesday morning, a 28m, wooden-hulled, 60-year old beamer sailed from her **home port** to her fishing grounds. The ship was then able to make a further loaded trip to the **home port** where permanent repairs were carried out in a shipyard.

home port (n) (shipping econ) port from which a cruise ship loads passengers and begins its itinerary, and to which it returns to disembark passengers upon conclusion of voyage **polazna luka kružnog putovanja** {Sometimes referred to as embarkation port and turn around port.}

homing (n) 1 (navig) ugađanje (radiofrekvencija), reguliranje; 2 (navig) plovidba ravno prema radio faru ili radiogoniometru

homing frequency (n) (comm) frekvencija navođenja na cilj

honing (n) (marine eng) vlačno glačanje, fino brušenje, honanje, honovanje:

Careful machining followed by full deep **honing** to remove all damaged hard phase from the liner surface reportedly delivers an ideal running surface for the piston rings, lube oil consumption are fostered by a chrome-ceramic piston ring coating, an anti-polishing ring at the top of the cylinder liner and special **honing of the liner surface**.

hook (n) (cargo) kuka, ganač; tal. **gancio**: The AB secured the lifting hook, and the second officer, who was operating the recovery davit on the vessel, then pushed the winch “start” button to raise the boat. The **hook** had failed due to ductile overloading. **can hook kuka za bačve**: Can or barrel hooks are suitable for hoisting barrels or drums., **crane hook kuka dizalice**: Meanwhile,

the disconnected cargo hoses were still suspended from the **deck crane hook** and were temporarily lashed to the hose saddles at the side railings. Always watch the **crane hook** when it is being moved., **cargo hook kuka za teret**: Ship's staff instructed the stevedores to be more safety conscious and ensure no person or vehicle to come directly under the **cargo hook** at any time., **boat hook kuka brodice za spašavanje**: After two attempts where the heaving line fell short the seafarer, holding a **boat hook**,

placed himself right next to the aft fairlead's stag-horn, looking upwards .., **davit hook kuka sohe**: The limit switch itself was activated by a circular block which was lifted when in contact with the **davit hook**., **lifeboat hook kuka brodice za spašavanje**: Root cause/contributory factors Inadequate understanding and/or improper operation of the **lifeboat hook** on-load release system and resetting procedure; The **forward hook** had not been correctly reset; , **quick-release hook brzootpusna kuka**, **towing hook kuka za tegljenje**: However, while the tug was pulling at full power, the

towline slipped from the **towing hook** and entered the water near the vessel's stern.

hook (n) (fishing) udica **circle hook** okrugla udica



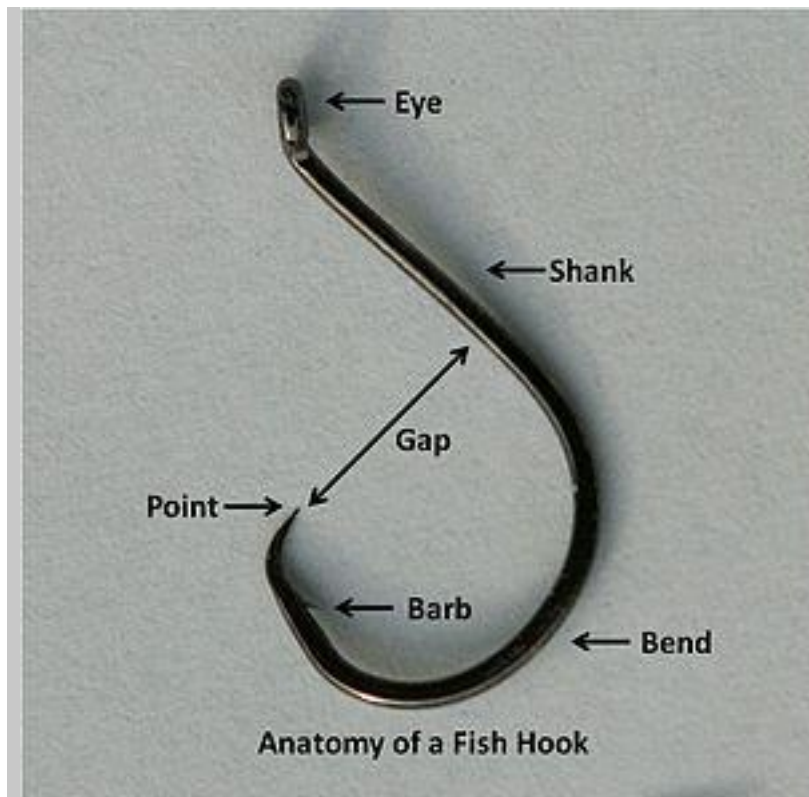

hook point (n) (fishing) vršak udice, oštrica udice

hook pull (n) (navig) snaga na kuki (za tegljenje)

hookup (n) (ports) priključak (za vodu, gorivo itd.) **water hookups** lučki priključak za vodu

hoop stresses (n) (marine eng) a normal stress in the tangential (azimuth) direction **obodna**

naprezanja: Because of the resulting higher pressures in the cylinder from the combustion of the greater mass of fuel, and the larger diameters, the liner must be made thicker at the top to accommodate the higher hoop stresses, and prevent cracking of the material.

hopper 1 (n) (cargo) lijevak, lijevak bunkera (za iskrcaj rasutih tereta): When the grab is also used, the iron ore would be discharged into a **hopper**, feeding by gravity a railway wagon or road vehicle below. 7 Grab bucket of the on-shore crane grabs cargo and drops it into **hopper**.



(dizalice za rsuti teret)

hopper barge (n) (nav arch) klapeta, maona s dnom na otvaranje

hopper tank (n) (nav arch) **donji bočni tank**: On the inclined plates of the **hopper tanks** and in the lower hold and the lower stool of the transverse bulkhead, extensive damage in the shape of groove corrosion was found with depth up

horizontal longitudinal shift of centre of gravity (n) (nav arch) **horizontalni uzdužni pomak sustavnoga težišta broda**

horizontal transverse shift of centre of gravity (n) (nav arch) **horizontalni poprječni pomak sustavnoga težišta broda**

horizontal-tube boiler (n) (marine eng) **kotao s položenim cijevima, kosocijevni kotao**

horn (n) (boating/yachting, comm) **sirena, rog za zvučne signale, klakson**: The yacht has no engine and is **sounding fog horn** as required. He also **sounded his horn** in compliance with Rule 34d.

fog horn **signalna sirena za maglu**: remainder of the crew, and started taking evasive action by switching the steering from autopilot to manual, going hard to port and **sounding the fog horn.**, **blast on the horn** **znak sirenom**: However in this case, the skipper saw no crew members on the deck of the receiving ship and **sounded several blasts on his horn** to attract attention.

, **ship's horn** **brodska sirena**: Master observed a tug and barge approaching from the North on a collision course, **sounded ship's horn** several times to give attention to the Master of the tug, but no reaction. As the fishing vessel closed, the anglers shouted and **sounded the boat's horn**, but this had no effect; they also tried to cut the



anchor rope.



horn cleat (n) (seamanship) **kljuna, kljunasta bitva**

horn timber (n) (sailing vessels) **srednje rebro krmenog okvira**

horse (n) (boating/yachting) a footrope on a square rigged sailing ship that is found at the extreme outer end of the yard **uže za stajanje na križu jedrenjaka**



horse latitudes (n) (meteorol) **COMPARE trade winds** the latitudes on the outer margins of the trades where the prevailing winds are light and variable **promjenjivi vjetrovi, konjske širine**

horse mackerel (n) (fishing) = **Jack mackerel** lat. *Trachurus spp.* **šarun, širun, šnjur**



horsepower; HP; hp (n) (marine eng) **konjska snaga**: The boat was fitted with a **90 HP engine**, and there were two 150N lifejackets and a buoyancy aid carried in a kitbag. The 12 cylinder version weighs in at 2000 metric tons and delivers **90,000 Horse Power** at 100 Revs per minute, with best fuel economy at 53,244 HP at 90 Rpm. The engine weighs in at 2,300 tons and **is capable of delivering 109,000 horsepower**. 4 metre RIB with a **150 horsepower engine**, providing a top speed of about 50 knots (Figure 1). ulated by the naval architect, and, once the chosen engine is coupled to a fixed pitch propeller, the relationship between **engine horsepower**, propeller revolutions and ship speed is set according to the fixed propeller curve. **British horsepower; HP; hp britanska**

konjska snaga, nominal horsepower; HP; hp nazivna konjska snaga, shaft horsepower; HP; hp snaga na osovini: By using the indicator to calculate mean indicated pressure and thus indicated horsepower, and the torsionmeter to calculate **shaft horsepower (shp)** from torque readings and shaft revolutions, ..., **brake horsepower; HP; hp snaga na kočnici** Performance An important parameter for a marine diesel engine is the rating figure, usually stated as **brake horsepower (bhp)** or kilowatts per cylinder at a given revolutions per minute. , **indicated horsepower; HP; hp indicirana snaga**: By using the indicator to calculate mean indicated pressure and thus **indicated horsepower**, and the torsionmeter to calculate shaft horsepower (shp) from torque readings and shaft revolutions,

horseshoe buoy (n) (safety) **kolut za spašavanje** {nalazi se na ogradi brodice radi dobacivanja osobi u moru}

horseshoe life preserver (n) (boating/yachting) **kolut za spašavanje u obliku slova**



U

hose (n) 1 (*cargo handling*) savitljiva cijev (za prekrcaj tekućih tereta, nafte itd.), fleksibilna cijev (za prekrcaj tekućih tereta, nafte itd.) gumena cijev, cijev (gumena, platnena, sintetička), **maniga**: *The discharging pressure was reduced at the request of the terminal, due to a leakage in the shore flexible hose. The hoses are connected to the tanker, which discharges the cargo to the buoy and then to an undersea pipeline that runs ashore, and connects directly to the refineries by other pipelines. Heavy hoses, laying on the floor, are a trip hazard; not to mention they can be easily damaged, tangled, twisted, confusing and dripping residue liquids.* **end of hose kraj savitljive cijevi, cargo hose cijev za iskrcaj/ukrcaj nafte (i drugih tekućih tereta), maniga ukrcajna / iskrcajna cijev za naftu (i druge tekuće terete)**: *The duty officer had not checked that the ABs had blanked the manifold after the cargo hose had been disconnected, which, although not a checklist item, was a company operating procedure.*, **flexible floating hose savitljiva plutajuća cijev (za naftu), shore hose obalna fleksibilna cijev, obalna maniga** *The terminal or cargo interests' representative should be requested to sign a dry tank certificate and only after this has been signed should shore hoses be disconnected.*, **disconnect the hose otpojiti cijev, otpojiti obalnu manigu**: *Shore party reboarded vessel and managed to disconnect cargo hose and lower it to the water.*, **hose-handling crane dizalica za rukovanje ukrcajnim / iskrcajnim cijevima**: *The use of eye protection should be considered when operating hose handling cranes or other hydraulic machinery where flexible hoses and fittings may be exposed to the aggressive elements of the sea.*, **hose connection spoj cijevi**: *One of the hose connections became jammed and a second member climbed out of the tank to assist. The hose connection routine was then started by picking up the hoses from the mother vessel.*, **hose derrick samarica za ukrcajnu / iskrcajnu cijev (za naftu, tekuće terete)**: *Routine maintenance was being carried out on a cargo hose derrick.*, **the hose parted cijev je pukla**: *While the caustic soda was being pumped out, the hose parted from the pressure side of the pump, spattering one crew member with the caustic solution.*, **hose party grupa za rukovanje cijevi za ukrcaj / iskrcaj (nafte, tekućih tereta)**: *After about 20 minutes, as the contents of the cylinders were exhausted, the fire began to die out and the hose parties were finally able to enter the burnt out gas storage room and put out the remaining fires, now confined to the control valves of a few cylind,* **hose rupture puknuće savitljive cijevi**: *Cargo hose rupture caused spill.*, **rubber hose gumena cijev**: *Sparks from the welding fell through this hole on to electrical cables and rubber hose stored in the workshop below the deck.*, **suction hose usisna savitljiva cijev, crpna savitljiva cijev**: *Tank entry for the tank cleaners and the suction hose was through a manhole located in the engine room at an upper level.*



; 2 (marine eng) savitljiva cijev (na motoru / u strojarnici), fleksibilna cijev, gumena / plastična cijev, cijev: With the hose partially disconnected in the engine room, the base oil remaining in the hose flowed out under gravity and splashed over the running engine. burst hose prsnuta cijev: Eye injury due to burst hose, hose fittings oprema cijevi (ventili, obujmice, prirubnice itd.) fitinzi za cijevi: An investigation of the fuel tanks found that the fuel pick-up tubes within both tanks had become detached from the tank top fuel hose fittings., leaking hose cijev koja pušta: The fire continued to be fed by more fuel from the leaking hose. The ship's staff requested the terminal to replace the leaking hose, which took place within next two hours; , hose coupling spojka cijevi: Root cause/contributory factors: Worn and insufficient threads on the water hose coupling., hose failure propuštanje cijevi, zatajivanje cijevi: No abnormal manifold pressures were noted at any time prior to or at the time of the hose failure., flexible hose 1 savitljiva cijev, fleksibilna cijev; 2 savitljiva cijev: The consequence in this case was that diesel fuel oil was supplied to the fire as the auxiliary engine's flexible hose melted., steam hose cijev za paru, parna cijev: A steam hose was inserted into the tank, steam pressure was increased and a cargo pump was started to remove any water collecting in the tank.; 3 (safety) vatrogasna cijev: A CO2 extinguisher was used initially, followed by a fire hose, to quench the fire and cool the surrounding area. hose reel system sustav za namatanje savitljive cijevi: firemain and hose reel system, fire hose vatrogasna cijev: This was followed by a water jet from a charged fire hose and the fire was soon extinguished., hose hydrant hidrant vatrogasnih cijevi: The hoses to hydrant in ... are worn., hose spanner ključ za pritezanje vatrogasne cijevi

hospitalisation (n) (mar law) hospitalizacija, smještanje u bolnicu: As a result of the spill, the second engineer suffered burn injuries, which required hospitalisation. The incident resulted in the hospitalisation of two crew members during the venting of a cargo tank containing high sulphur crude.

hospital ship (n) (nav arch) bolnički brod, brod bolnica: The injured man was landed ashore later in the day to the care of a charity hospital ship, where the medical team were unable to save his little finger.

hot (v) (v) vruć run hot (marine eng) pregrijati se

hot bulb engine (n) (marine eng) motor sa zagrijanom glavom, tal. motore a testa calda

hotel staff (n) (shipping econ) Those persons on board providing services to passengers and who are not regularly assigned to perform shipboard safety and pollution prevention related duties are considered hotel staff and not part of the ship's crew as defined above (Shipping Articles) bijelo osoblje: Accordingly, hotel staff are not required to sign Shipping Articles. U skladu s time bijelo

osoblje ne mora potpisivati ugovor o ukrcaju

hot gases (n) (marine eng) **vrući plinovi**: Explosions caused by overheating of surfaces within the engine crankcase or by leakage of **hot gases** past the piston have always posed a danger. The machine itself is water cooled since it is circulated by **hot exhaust gases**.

hot spots (n) (safety) **vruća mjesta, vruće točke**: Check adjacent compartments and spaces for **hot spots** and secondary fires. No **hot spots** were found and a fire watch covering the hold and adjacent compartments was established.

hot water wash (n) (cargo handling) **ispiranje tankova vrućom vodom**

hot work (n) (marine eng) **radovi s otvorenim plamenom**: The port authority approved the **hot work**, which was conditional upon the contractor complying with the ship's safety management system (SMS). No dedicated fire watch was in place either during the **hot work** or after it was completed.

hot work permit (n) (marine eng) **dozvola za rad s alatima koji proizvode visoku temperaturu**: Completion of an decision to do so, in this case, resulted in approved **hot work permit** to work the fire re-igniting. It is important to note that the master, chief officer and chief engineer had not issued any **hot work permit** for that day - the crewmembers took it upon themselves to use gas cutting equipment without first informing senior management on board.

hounding (n) (sailing vessels) **vanjski dio kosnika**

hound-piece (n) (sailing vessels) **čeljust debla (donjeg dijela jarbola)**

hounds (n) (boating/yachting) prednje leto i pripone nisu uhvaćeni za vrh jarbola već na 7/8 visine ili niže **oputa na sedamosminskom jarbolu**

hourglass (n) (boating/yachting) **zapatljani špinaker (na sredini prednjeg leta / štraja)**

house /haus/ (n) **1 (v) (marine eng)** to stow or secure anything in its proper place **smjestiti, biti kućište nečemu**. They have to **house** the inlet and exhaust valves, the fuel injector, the air start valve, relief valve and indicator cock. The head is mounted on the engine block with hydraulically tensioned studs, and is arranged to **house** two inlet and two exhaust valves, all equipped with rotators; The main frame and casing, together with a motor support bracket, **house** the pumping element assembly.; **2 (boating/yachting)** **spustiti viši dio jarbola (kod jedrenjaka), spremiti**: A top-mast was housed by lowering it and securing it to a lowermast; **3 (seamanship)** **spremiti i učvrstiti (opremu, teret)**

house bill of lading (n) (mar law) **podteretnica koju izdaje špediter kao podteretničku priznanicu u okviru njegove skupne teretnice ili FCL teretnice kućna teretnica, podteretnica**

house flag (n) (mar law) **zastava brodarskoga društva, zastava kompanije**

housing /'haʊzɪŋ/ (n) **1 (marine eng) kućište**: Corrosion in the **valve housing** was effectively minimized by introducing the optimized cooling water system; The **thrust bearing housing** forms a vessel and contains an oil bath providing additional lubrication for the bearing segments. 35 m/s calling for increased diameters of the main and crankpin journals, and reinforcement of the **main bearing housing** and bedplate. **bearing housing kućište ležaja**. Bearing housing contains cooling oil grooves.; **crankhouse housing kućište koljenastog vratila, kućište koljenaste osovine**: The **crankcase housing** has transverse diaphragms between each cylinder to provide water compartments around the cylinder liners.; **engine housing kućište motora**: The crankshaft damper is mounted outside the **engine housing** for optimum cooling and accessibility; bolted covers and replaceable nylon bearings permit rebuilding of the damper on site.; **stern gland housing kućište brtvenice statvene cijevi, pump housing kućište pumpe**. The **pump housing** incorporates the compact RTA-series arrangement.,

valve housing kućište ventila: *The valve housing is made of cast iron and arranged for water cooling, and is provided with a bottom piece of steel with Stellite welded onto the seat. Corrosion in the valve housing was effectively minimized by introducing the optimized cooling water system;* ; 2 (marine eng) **plašt**; 3 (nav arch) **kućište azipoda, kućište azimutnog**

porivnika: *A podded propulsor (or pod) incorporates its electric drive motor in a hydro-dynamically optimized submerged housing which can be fully rotated with the propeller(s) to secure 360° azimuthing and thrusting capability.*

hove in; (=heaved in) (=heave; (arch) hove; hove / heave; heaved;

heaved) (v, adj) (seamanship, archaic) = heave in povučen (uže), uvučen (uže): *This resulted in a poor lead for the messenger, which bunched up around the outer edge of the drum as it hove (=heaved) in. As the trawl wires were hove in, it became apparent that there was an abnormal weight in, or on, the gear. I was told by the CO and Bosun that the hinged ramp door could not be hove in fully, and that the final heaving and tightening was done with two crew members jointly hauling on the two chain blocks hooked on to the hinged floor.*

hovercraft (n) (nav arch) lebdjelica, plovilo na zračnom jastuku: *The hovercraft evacuated the crew from the ice and took them to the port for emergency care control and later back to the vessel. The hovercraft set off at 40 knots.*

hove-to; (=heaved to) (=heave; (arch) hove; hove / heave; heaved;

heaved) (v, adj) 1 (navig) = heave to čekati na moru (za ulaz u luku ili radi

obavljanja popravka): *The vessel then hove to in order to recover the ramp. When the ship was hove-to at slow speed the stabilisers became ineffective and acted only as a bilge keel. The vessel remained hove-to all night. Some flooding of forward spaces was caused by wave damage to ventilation pipes when the vessel was hove to, but she reached port without further problems.*; 2 (navig,

seamanship) zavlačiti (smanjiti brzinu i okrenuti u vjetar u olujnom nevremenu): *The speed was reduced and the vessel hove to wind. Fearing bottom contact due to the increase in draught with each roll, we turned around and slowly steamed out to deeper waters and hove to until conditions improved the next day. The weather deteriorated and the vessel was hove to for a day. Even though we were hove to, the seas were still breaking over the after deck and the crew did a magnificent job in rigging the equipment ...*

hove-to; (=hove to) (=heave; (arch) hove; hove / heave; heaved;

heaved) (adj) (boating/yachting) zaustavljena jedrilica: *No avoiding action was taken by the ship, and the yacht finally hove to, resulting in the ship passing ahead at a range of about 0.8 nm.*

HOW (HandOver Word) (n) (navig) COMPARE TLM (Telemetry) riječ HOW

(predaja signala), Riječ za predaju signala (u GPS navigacijskoj poruci) {The word HOW contains information on time-of-week, alert flag, anti-spoof flag, subframe ID, and parity bits. The other eight words are different for each subframe and contain further supplementary information such as ephemeris, almanac, states of satellites, etc.}

How is the cable growing? (seamanship) Kako se proteže sidreni lanac?

How is the cable leading? (seamanship) Kako radi sidreni lanac?

HSC; Heading Control System sustav automatskog kormilarenja

HSC; High Speed Craft (n) (nav arch) = high speed ship / vessel vrlo brzi

brodovi, brzi brodovi: *I believe that HSC do generally give way to other vessels. On clearing the entrance of the estuary, the master of the HSC retained the con of the vessel and increased speed to about 34 knots.*

hub (n) (nav arch) glavčina (propelera): *She sustained major damage, including the total loss of*



her port controllable pitch **propeller hub** and a section of tail shaft.

hub port (n) (shipping econ) jedna od većih luka u kružnim putovanjima, npr. luka Dubrovnik, **glavna luka**: As well as being a World-class **hub port** for containers and new vehicles, Southampton handles a wide range of other trades including cruise ships.

huer, color, background color (n) (navig) kontrola na radaru za namještanje boje na pokazivaču i pozadine pokazivača

hulk (n) (seamanship) stari brod, istrošen brod

hull /hʌl/ (n) (nav arch) the body of a ship excluding her superstructure, her masts, rigging, and mooring and cargo handling equipment; A hull is a primary structural element ensuring buoyancy as well as total and local durability of a vessel. **trup (broda)**: The fishing vessel sustained damage to its prow and gunwale; the tanker a little paint damage to her hull. **Hull girder strength** and buckling checks are carried out on all critical sections along the entire length of the hull. There were slight personal injuries and the hull was dented. **The hole in her hull** was first seen when illuminated by a rescue helicopter. **The vessel's hull was surveyed** by divers and, apart from loss of paint, was found to be undamaged. Subsequently, she went into the nearest port where she was unloaded and her hull was strengthened with temporary external stiffeners. **The repairs to the hull's steelwork** caused several days of lost time to the vessel. Had there been more traffic in the area the vessel could have been in collision and, once aground, had the sea been rougher the vessel's hull might have breached. **damage to the hull oštećenje trupa broda**: The vessel sustained only superficial damage to her hull coating. No injuries or pollution had occurred, but the vessel had suffered damage to her hull and propellers., **double hull dvotrupac, brod s dva trupa**:

Probable Cause The ship is a double hull tanker., **underwater hull podvodni dio trupa**: As a further precaution, a diving team was organised to survey the vessel's underwater hull and rudder area for damage. At the next port, the vessel underwent a routine underwater hull coating inspection and the divers reported damage to the propeller blades., **inner / outer hull vanjski / nutarnji trup**: The WHRB 6.50 was constructed with an inner and outer hull.

hull and machinery insurance (n) (mar ins, mar law) osiguranje brodova: Hull and machinery insurance is to protect the shipowner's investment in the ship. It is basically a property insurance which covers the ship itself, the machinery and equipment

hull damage (n) (safety) oštećenje trupa, šteta na trupu: The vessel sustained significant hull damage. Only when tank soundings the following day revealed loss of fuel oil from no.2 starboard fuel oil tank, collision with TGI and hull damage was confirmed. **suffer hull damage pretrpjati oštećenje trupa, oštetiti trup**: The icebreaker ... suffered hull damage in Alaska. However, the

container vessel *suffered extensive hull damage*. The ferry *suffered substantial hull damage*, but was able to return alongside without assistance.

hull deflection /'hʌl,dɪ'fleksjən/ (n) (nav arch) **izvijanje trupa, savijanje trupa,**

deformacije trupa: ..., the importance of the so-called sag of the bedplate is emphasized in order to counteract the hog caused by **hull deflections** as a result of the loading down of the ship, and partly by deformations due to the heating up of the engine and certain tanks.

hull insurance (mar law, mar ins) **osiguranje broda, polica osiguranja broda**

hull number (n) (nav arch) **broj novogradnje (u brodogradilištu), broj trupa**

hull plating (n) (nav arch) **oplata:** She sustained minor damage to her **hull plating**. This dented and punctured the **hull plating** below the waterline of the vessel trailing the net. Fortunately there were no injuries, but the vessel suffered extensive penetrations to the **port hull shell plating**.

hull repairs (n) (nav arch) **popravci na trupu:** The vessel was refloated a few hours later on a rising tide, with the assistance of two tugs and was taken out of service for 2 weeks while **hull repairs** were carried out.

hull resistance (n) (seamanship, nav arch) **otpor broda, otpor trupa broda:** Because of the difference between loaded and trials draught, the **hull resistance** may be 25–30 per cent greater for the same speed.

hull side (n) (boating/yachting) **unutrašnja stranica trupa jedrilice**

hull stress (n) (nav arch) **naprezanje trupa:** Research and review the technological aids available which would assist masters to measure **hull stresses** in port and at sea.

hull vibration (n) (nav arch, marine eng) **vibracije trupa:** Since resonance with both the vertical and horizontal **hull vibration** modes is rare, the standard engine is not prepared for the fitting of such compensators. **Hull vibration** can only be excited by a low-speed engine if it is located on or near a node of critical hull vibration, and if the frequency of this vibration mode coincides with the first or second harmonic of the engine excitation.

humidifier /'hju:'mɪdɪ,fæə/ (n) (marine eng) **uređaj za vlaženje zraka**

humidity /'hju:'mɪdɪti/ (n) **1 (marine eng) vlažnost:** Bypass valves on the intercooler are modulated depending on the pressure and **relative humidity of the air** so that condensation formation can be avoided. MAN Diesel has also pursued NOx reduction by increasing the **humidity of the charge air** with water vapour. Although the vessel was operating **in an area with high humidity**, the possibility of more water than usual accumulating in the service tanks was not considered. Increased air temperature, in particular, reduces efficiency and lowers fuel economy; **relative humidity** has a less significant influence, though at high inlet temperatures an increase in humidity will have an adverse effect on sfc. ; **2 (cargo**

handling) vlažnost: Are the temperature / **humidity** recorders in the hold(s) operational? The temperature / **humidity** recorders in the hold(s) will be operational in han an hour. ; **3 (meteorol)**

vlažnost: Heat sickness can frequently occur onboard ships due to the extreme temperature and **high humidity conditions** in which seafarers often work. **relative humidity relativna vlažnost**

hump /hʌmp/ (n) (fishing) Underwater area higher than the surrounding area. **brak**

hurricane (n) (meteorol) a severe tropical cyclone with sustained winds over 64 knots **orkan,**

uragan: Effect of recent **hurricane:** navigational warnings about changes to channel depths and unreliable buoys not taken into consideration in the passage plan; What is the latest tropical storm warning? 4.1 The latest tropical storm warning is as follows: Tropical storm warning at ... UTC.

Hurricane... (name) / tropical cyclone / tornado / willy_willy / typhoon ... (name) with central pressure of ... millibars / hectopascals located in position . (IMO SMCP) **path of the hurricane put orkana:** The cargo ship went missing after sailing into the path of **Hurricane Joaquin** as it sailed from Florida to

Puerto Rico. , **hurricane is gaining strength** orkan dobiva na snazi: Hurricane Mathew at 11am EDT 1500 UTC is once again **gaining strength** with max winds now at 120 knots (about 140 mph). , **hurricane winds** orkanski vjetrovi: It is difficult for me to understand why I could not use the bay for shelter and had to struggle against **huge waves and hurricane winds** in the open seas instead of getting protection from shore line against the storm.

hurricane force (n) (meteorol) orkan, orkanska jačina vjetra

hurricane scale ljestvica orkana 1 minimal damage, 2 moderate damage, 3 extensive damage, 4 extreme damage, 5 catastrophic

husbandry (n) 1 (mar law) COMPARE ship's husband agent services provided to a ship in the port, for requisite repairs, attending to the management, equipment, and other concerns of the ship; A ship's husband is usually authorized to act as the general agent of the owners, in relation to the ship in her home port. opći agencijski poslovi za brod u luci (za popravke, opremu itd.): Our ship **husbandry services** include inspections, repairs, hull cleaning, and propeller polishing. **Good husbandry** is always to be encouraged, and in this case the skipper wasted no time instructing the crew member to thoroughly clean out and wash down the accommodation area.

ship's husbandry opći agencijski poslovi za brod u luci: Corporation provides consulting and commercial diving services for all facets of **ship's husbandry** (the inspection, maintenance, and repair of underwater hull and hull appendages of waterborne ships, submarines, tugboats, and other watercraft). Typical services include: Emergency blank, plug, and cofferdam installation, Rudder removal and installation, Habitat installation Screw removal and installation Underwater inspections including video and still photography Bow thruster removal and installation Stern tube wraps removal and installation Un-fouling of vessels' running gear (<http://seawardmarinecorp.com/services/ships-husbandry/> ; 2

farming (mussels etc.) **uzgoj (školjaka itd.)**, **kultivacija** **husbandry of mussels** **uzgoj dagnja / školjaka**: It operates two 43m vessels and one 20m vessel in the **husbandry and harvesting of mussels**.

hydrant /'haidrənt/ (n) (nav arch) hidrant **hydrant outlet** priključak hidranta: A system of **hydrant outlets**, each with an isolating valve, is located around the ship and hoses with the appropriate snap-in connectors are strategically located ... Moreover, all the **hydrant outlets** are provided with an isolating valve so as to isolate those valves which are not in use. , **fire hydrant** hidrant za gašenje **požara**: While carrying out routine maintenance of a **fire hydrant** in the engine room, a crew member decided to use a wheel key spanner to free up the stiff valve.

hydraulic /'hai'drɒlik/ (adj) (marine eng) hidraulični, hidraulički **hydraulic machinery**

hidraulički strojevi, **hidraulično postrojenje**, **hydraulic system** **hidraulički sustav**: Return lines are not designed to take high pressure in most **hydraulic systems**. Before arrival in extreme cold conditions, **hydraulic systems** should be carefully inspected, system oil confirmed to be at optimum levels, and condition and oil filter elements renewed or cleaned. , **hydraulic pressure** tlak

hidrauličnog ulja: Before arrival in extreme cold conditions, hydraulic systems should be carefully inspected, system oil confirmed to be at optimum levels, and condition and oil filter elements renewed or cleaned. The third engineer raised the alarm and the ETO was eventually freed after the **hydraulic pressure** on the watertight door was released. **hidraulična pumpa**, **hydraulic pump**: The Chief Engineer found a fault with the CPP **hydraulic pump** unit which had caused the pitch control to fail. As a result of the crew being in the engine room, the main engines and generators were kept running, although the controllable pitch propeller hydraulic **pump had** to be restarted to maintain propulsion. ,

hydraulic control **hidrauličko upravljanje**: Steering gears can be arranged with **hydraulic control equipment** known as a 'telemeter', or with electrical control equipment. In principle, this consists of the ME engine hydraulic control oil system and an ELGI valve. , **hydraulic line** **hidraulički vod**

hidraulička cijev: Following a temporary suspension in operations due to a **hydraulic line failure**, the anchor was aweigh at 1039. **hydraulic control platform postolje za upravljanje hidraulikom:** The AB went round to the **starboard hydraulic control platform** and could not find the chief officer. **hydraulic clutch hidraulička izvrstiva spojka, hidrauličko kvačilo:** At engine loads above 50 per cent of the optimized power, the power turbine is connected to the crankshaft via a **hydraulic clutch** and flexible coupling. **hydraulic copupling hidraulička spojka, hydraulic drive system hidraulički pogon:** The fire pump was in operation to provide cooling water for the windlass **hydraulic drive system**. **hydraulic governor hidraulički regulator:** Governor The engine revolution per minute is controlled by a **hydraulic governor**. **hydraulic hose hidraulička savitljiva cijev, hidraulička fleksibilna cijev:** Above the cargo discharge pipe a **hydraulic hose** was found to be leaking from an end fitting. **hydraulic machinery hidraulički strojevi, strojarnica hidrauličkog sustava:** The team, led by the C/E, and comprising of the 3/E, J/E and an OS, entered the **hydraulic machinery room** and started the main pump motor. **hydraulic fluid hidraulična tekućina:** the Chief Engineer instructed the motorman to go to the steering gear flat and mop up a small quantity of accumulated leaked **hydraulic fluid**. **hydraulic motor hidraulički motor:** Subsequent operation of the controls resulted in sudden overloading of the **hydraulic motor** and sheared the drive shaft linkage. **hydraulic pipe hidraulička cijev, He was attempting to dismantle a hydraulic pipe on deck to carry out repairs., hydraulic piston hidraulički klip:** The tightening force is applied by a **hydraulic piston** to which oil is fed via the engine's lubricating/cooling oil system. **hydraulic power snaga hidraulike, jačina hidrauličkog sustava, hidraulička energija, hidraulički pogon:** The crane's **hydraulic power** was drawn from the tug's port main engine, which had to be running for the crane to operate. As the ship' port list increased, **hydraulic power** was lost, resulting in band brakes on the automatic trawl winch system activating.

hydraulic grab (n) (cargo handling) hidraulič grabilica: In executing this task, the upper end of pipe, which was lying alongside, was grasped by the heavy crane by means of a **hydraulic grab** and raised on one side.

hydraulic jack 1 (marine eng) hidraulički pritezni uređaj (za vijke): Again the **hydraulic jack** was pumped to approximately 250 bar pressure, the pin was struck again and the deflected maul landed heavily on the leading seaman's right hand. There are four bolts at each connection point which help for assembly and removal of the connecting rod, and are tightened to their required torque using **hydraulic jack**. Extracting the sheave pin appears to be in order, the risk assessment must consider the possibility of two more hazards when applying tension with the **hydraulic jack**; 1) the rod coming off the the pin due to corroded / wasted threads, and, 2) the threaded rod fracturing, especially if not of approved strength. Therefore, most of the important or big screws are tightened hydraulically on ships such as cylinder head nuts, exhaust valve nuts, for crank pin bearing, cross head bearing, main bearing, tie bolts, etc. (<http://marineengineeringonline.com/an-introduction-to-hydraulic-jacks-on-ships/>)

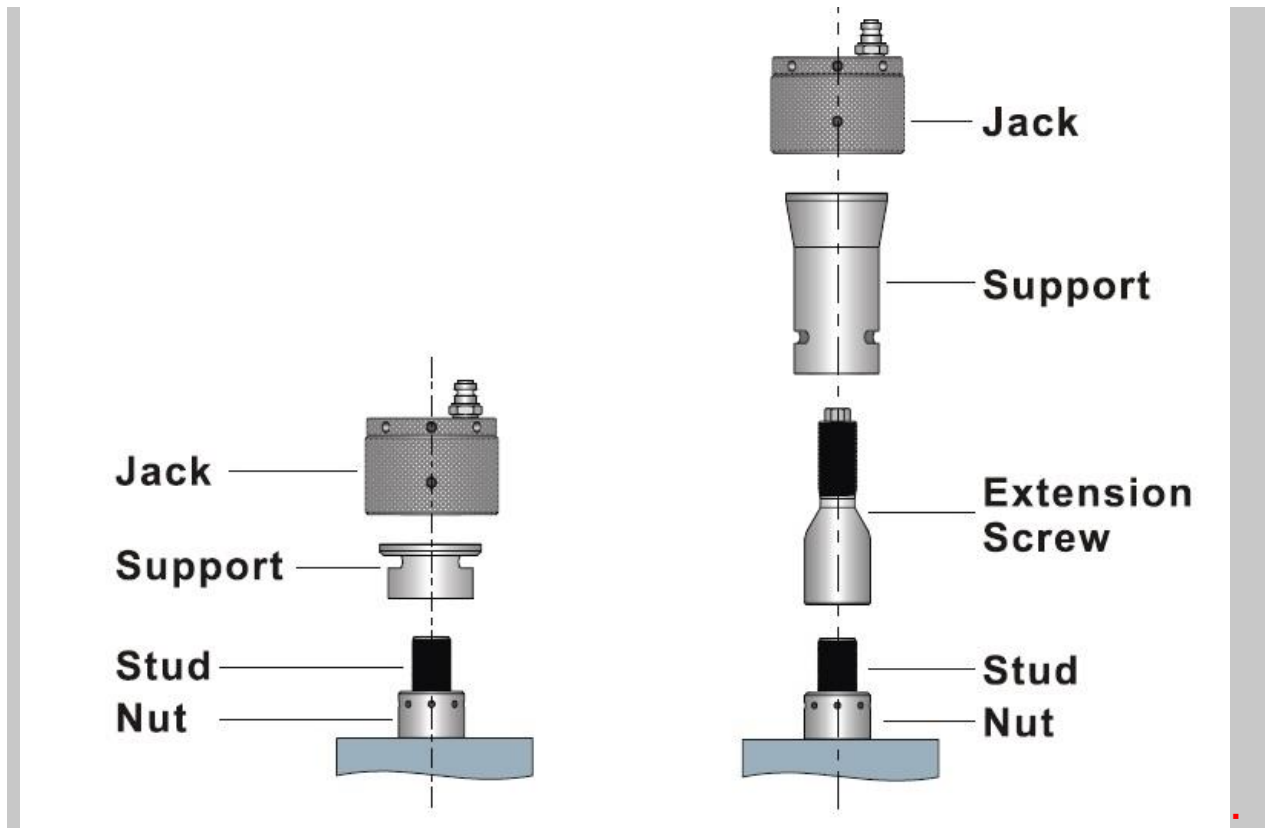

2 (marine eng, seamanship) hidraulička dizalica

hydraulic oil (n) (marine eng) hidraulično ulje: Any leakage of fuel, lubricating and **hydraulic oil** should be disposed of in accordance with Oil Pollution Regulations at the earliest opportunity. During this operation, a flexible hose on the crane came adrift from its coupling and **hydraulic oil** under high pressure sprayed out, some of it entering the bosun's eyes. **hydraulic oil leakage curenje**

hidrauličkog ulja puštanje hidrauličkog ulja: Over the years, the steering rams had suffered from **hydraulic oil leakage**, and the hydraulic oil reservoir and header tank had been regularly topped to cope with the loss of oil.

hydraulic ram (n) (marine eng) hidraulički klip, hidraulička dizalica



hydraulics /hai'drɒliks/ (n) (marine eng) hidraulika: The crew were called, and the engineer went

to the engine room to **start the hydraulics** ready for hauling. The skipper tried the main engine stop button, but this did not work either, so he reduced engine speed and **engaged the hydraulics** to try and stall the engine.

hydrofoil /ˈhaɪdrəˌfɔɪl/ (n) (nav arch) **hidrokrilni brod**. I recently travelled from Sicily to Stromboli and back again using one catamaran and two separate **hydrofoil passenger vessels** for different legs of the



journey.

hydrogen; (H) /ˈhaɪdrɪdʒən/ (n) (chem) **vodik**. Sulphamic acid will liberate hydrogen gas as it attacks scale and steel and the work site must be tested for the presence of **hydrogen** after the cleaning operation. Carbon yields 8080 kcal/kg when completely burned, **hydrogen** 34 000 kcal/kg; oxygen is assumed to be already attached to its proportion of hydrogen: that is, an amount of **hydrogen** equal to one-eighth t As the steam drum door was opened, the air combined with the **hydrogen** to create a mixture that was within the hydrogen's wide explosive limits; Insufficient arrangements were made to ventilate the boiler ... **hydrogen; (H) chloride vodikov klorid**: Freons decompose producing **hydrogen**

chloride, hydrogen fluoride, phosgene, and chlorine., **hydrogen; (H) peroxide vodikov**

peroksid: The chief officer quickly identified the contents of the tank as **hydrogen peroxide**, and consulted the appropriate substance information sheet on the ship's dangerous cargo database.,

hydrogen; (H) sulphide: This unusual property of **hydrogen sulphide** makes it extremely dangerous to rely totally on the sense of smell to warn of the presence of the gas.

hydrostatic calculation /ˌhaɪdrəʊˈstæɪtɪk/ (n) (stabil) **hidrostatski proračun, proračun hidrostatkog stabiliteta** **hydrostatic calculation for a specific trim** **hidrostatski proračun za određeni trim, hydrostatic calculation for one waterline** **hidrostatski proračun za jednu vodenu liniju**

hydrostatic curves /ˌhaɪdrəʊˈstæɪtɪk/ (n) (stabil, nav arch) **dijagramni list broda**

hydrostatic data /ˌhaɪdrəʊˈstæɪtɪk/ (n) (stabil) **hidrostatske informacije broda, hidrostatski podatci broda** **hydrostatic data for even keel and trim** **hidrostatski podaci za brod na ravnoj kobilici i za trim, Hydrostatic data for intact stability** **hidrostatski podatci za stabilnost broda u neoštećenome stanju**

hydrostatic particulars /ˌhaɪdrəʊˈstæɪtɪk/ (n) (stabil) = **hydrostatic data** **hidrostatski podatci**

hydrostatic release unit /ˌhaɪdrəʊˈstæɪtɪk/ (n) 1 (safety, nav arch) **hidrostatski uređaj za otpuštanje, uređaj koji uslijed hidrostatskog tlaka oslobađa splav za spašavanje, EPIRB ili drugo sredstvo kada se pri potonuću brod nađe na**

određenoj dubini: It had not inflated automatically because the painter had not been attached to the weak link of the **hydrostatic release unit (HRU)**. The **hydrostatic release unit (HRU)** is secured to an open hook on the cradle. Four months before the accident, the skipper had purchased a new liferaft for the vessel, fitted it with a **hydrostatic release unit (HRU)** and, thankfully, decided that the crew would

benefit from attending another sea survival course, which they subsequently did.; 2 (safety)

hidrostatska kopča: The vessel was equipped with a liferaft fitted with a hydrostatic release unit.



hydrostatic stability data (n) (stabil) **hidrostatske informacije**

hydrostatic tables /,haɪdrəʊ'stæɪtɪk/ (n) (stabil) **hidrostatske tablice, tablice**

hidrostatskog stabiliteta broda: The data given in the **hydrostatic tables** and in the isocline stability tables (MS- and KN-tables) are presented as a function of the ship's moulded draught amidships *T* for the following trim values: -1.0, 0.0, 1.0, 2.0 and 3.0 metres (positive trim is trim aft).

MEAN KEEL DRAFT FT	TONS PER INCH IMMERSION	TOTAL DISPL. TONS S.W.	TOTAL DISPL. TONS F.W.	MOMENT TO TRIM 1' FT. TONS	TOTAL DEAD-WEIGHT TONS S.W.	KM _T FEET	LCB FEET AFT	LCF FEET AFT	MEAN KEEL DRAFT FT-IN	MEAN KEEL DRAFT METER	HYDRO-STATIC TABLE
17		1300		120	700			8.35		17	TON= 2240 LBS
16	10.5	1200		115	800	18.58	4.5	8.5	16	5	
		1100		110	500	18.66		8.57			
15	10.0	1000		105	400	18.64	4.0	8.5	15	4	
		900		100	300	18.60		8.0			
14	9.5	800		95	200	18.70	3.5	8.0	14	4	
		700		90	100	18.80		7.0			
13	9.0	600		85	100	17.00	3.0	6.0	13	4	
		500		80	0	17.20		5.0			
12	8.5			75		17.40	2.5	4.0	12	4	
				70		17.40		3.0			
11				65					11	LIGHT SHIP= 590 TONS	

hygiene /'haɪdʒi:n/ (n) (med) **higijena**

hygrometer /haɪ'grɒmɪtə/ (n) (navig) **higrometar, instrument za mjerenje vlažnosti**

hygroscopic cargoes (n) (cargo) cargoes which have natural moisture content and are mainly of plant origin **higroskopski tereti, tereti koji sadrže vlagu**

hyperbola /haɪ'pɜ:bəle/ (n) (math) **hiperbola arms of hyperbola grane hiperbole**

hyperbolic navigation /,haɪpə'bɒlɪk/ (n) (navig) **hiperbolička navigacija**

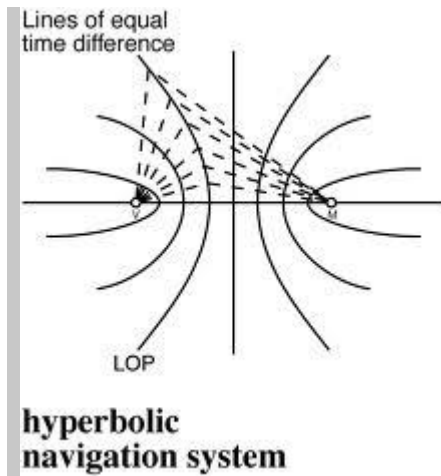

hyperbolic system /ˌhaɪpəˈbɒlɪk/ (n) (navig) sustav hiperboličke navigacije

hyperpyrexia /ˌhaɪpəpaɪˈrɛksɪə/ (n) (med) hipertermija

hypothermia /ˌhaɪpəθɜːmɪə/ (n) (safety) podhlađenje, hipotermija: *In cold conditions, with a water temperature of 6°C and a significant wind-chill factor there was a risk of him starting to develop the symptoms of hypothermia. All four were taken off by the inshore lifeboat, and taken to hospital suffering from mild hypothermia. It also increases susceptibility to hypothermia and reduces the chances of survival in cold water. The 7-man crew were then airlifted to hospital and treated for hypothermia and shock. The helicopter had a task to airlift the casualty to hospital as a further precaution against secondary drowning or hypothermia.*

IALA A /aɪˈæləˈeɪ/ (n) (navig) red colour for the left hand of the ship sustav IALA A **IALA A buoyage system** susatv IALA A {crveno svjetlo na lijevoj strani kanala, dolazeći s mora}

IALA B /aɪˈæləˈbiː/ (n) (navig) red colour for the right hand of the ship sustav IALA B: *The service was aligned to, but did not meet, all of the VTS standards of the International Association of Marine Aids to Navigation and Lighthouse Authorities (IALA). However, the port traffic services did not meet the VTS standards set by the IALA. To ensure clarity and increase the probability of a message being understood, IALA has developed the following message markers: Instruction, Advice, Warning, Information, Question, Answer, Request and Intention. IALA B buoyage system sustav IALA B {crveno svjetlo na desnoj strani kanala, dolazeći s mora}*

IAMSAR; International Aeronautical and Maritime Search and Rescue Manual /ˈaɪəmsɑː/ (n) (safety) Priručnik o traganju i spašavanju: *The questions are normally asked and advice given by the On-scene Co_ordinator (OSC). For further information see IAMSAR Manual, London/Montreal, 1998*

ice (n) (oceanogr, meteorol) led *The hovercraft evacuated the crew from the ice and took them to Laupus for emergency care control and later back to the vessel. The passage plan for another ship, bound for St Petersburg in the depths of winter, made no reference to the certainty of meeting ice and no reference to the obtaining of ice reports despite the fact that, as the master told me, ... Ice in the area is reported to be exceeding 1 meter thick, with ridged ice up to 2.5 meters thick. fast ice obalni led, drift ice putujući led, ice formation stvaranje leda, formiranje leda: Attempts were then made to refit the sampling valve, but the 11 bar pressure of the cargo and the formation of ice on the connection made it impossible.*

ice belt (n) (nav arch) protuledni pojas oplata broda, pojas oplata s pojačanjem protiv leda

ice-bound (adj) (navig) caught in the ice okružen ledom, obuhvaćen ledom, u ledu

ice box (n) (fishing) rashladna kutija

icebreaker (n) (nav arch) ledolamac: *When being assisted by an ice-breaker it is important to maintain a continuous listening watch on the appropriate VHF Channel and to maintain a proper lookout for sound and visual signals. MV ... requires ice_breaker assistance to reach*

ice buoy (n) (navig) plutača za led **lighted ice buoy (LIB)** svjetleća plutača za led, svjetleća oznaka za led

ice class (n) (nav arch) klasa broda za plovidbu u ledenim područjima

ice clause (n) (mar law) klauzula o ledu, klauzula o pravima i dužnostima broдача u slučaju zaleđenosti mora

ice code (n) (oceanogr) vrste leda **0 no ice, 1 slush or young ice, 2 fast ice, 3 drift ice, 4 packed slush or strips of hummocked ice, 5 open lead near shore, 6 heavy fast ice, 8 hummocked ice, 9 ice jamming, 7 heavy drift ice**

ice cover (n) (oceanogr) ledeni pokrov: *A helicopter was dispatched to explore the ice cover of the East Siberian Sea in hopes of finding an escape route for the vessels.*

ice navigation (n) (navig) plovidba u području leda

ice pack (n) (oceanogr) = **pack-ice** plovac: *Navigation is dangerous due to floating ice / pack ice / iceberg(s).*

icepod /'aɪspɒd/ (n) (nav arch) An azimuthing, pulling thruster and designed to 1A Super Ice Class

azimutni porivnik za plovidbu u ledenim uvjetima: *The icebreaking multipurpose support and supply vessel (IMSV): Propulsion: Wärtsilä, 2x ICEPOD FS, 1750BOP-ICE, 1750 kW each*

ice strengthening (n) (nav arch) pojačanje konstrukcije broda za plovidbu u ledenim uvjetima

icing (n) (oceanogr) a serious hazard where cold temperatures (below about -10°C) combined with high wind speed (typically force 8 or above on the Beaufort scale) result in spray blown off the sea freezing immediately on contact with the ship (<http://www.nauticed.org>) **leđenje**: *Icing is expected / not expected in area ...*

IC; integrated circuit (n) (electr) integrirani (strujni) krug

I.C.S. (Institute of Chartered Shipbrokers) (n) (mar law) Udruga brodarskih mešetara, Udruga pomorskih brokera

I.C.S. (International Code of Signals) (n) (comm) Međunarodni signalni kodeks (MSK)

I.C.S. (International Chamber of Shipping) (n) (mar law) Međunarodna brodarska komora, Međunarodna udruga broдача

identification dimensions (n) (nav arch) mjere istovjetnosti broda

identification of stars (n) (navig) identifikacija zvijezda

identity clause (n) (mar law) = **identity of carrier clause** identitetne klauzule

identity of carrier clause (n) (mar law) identitetna klauzula, klauzula o identitetu prijevoznika

idler (n) (marine eng) nepogonski zupčanik

idle stroke (n) (marine eng) prazan hod, jalov takt

idle to full time (prep phr) (marine eng) vrijeme prijelaska iz praznog hoda do pune snage stroja

idle vessel (n) (shipping econ, nav arch) brod izvan pogona, brod na mrtvom vezu:

Reactivating the *Idle Vessel*

idling /'aidliŋ/ (n) (marine eng) rad (motora, uređaja) u praznom hodu

i.e.; Lat 'Id est' /'ai 'i:/ tj., to jest: Fire/explosion includes ships where fire/explosion is the first event reported, or where fire/explosion results from hull/machinery damage, i.e. this category includes fires due to engine damage, but not fires due to collision etc. The volume of displacement, V, is the underwater volume of a ship afloat i.e. the volume below the waterline. {lat. id est}

IF; intermediate frequency (n) (electr) međufrekvencija: The received **IF** signal is an analog signal. **IF; intermediate frequency amplifier** međufrekvencijsko pojačalo

IGC Code (n) (nav arch) pravilnik IGC {International Code for the Construction and Equipment of Ships Carrying Liquefied Gases in Bulk (IGC Code)}

ignite /ig'nait/ (v) (marine eng, safety) zapaliti(se), upaliti se (motor): The compressed air from the bottle is necessary to **ignite the fuel**. The starboard cargo engine (its lever left in the ON position) must have developed high pressure in the cylinder causing the safety valve to crack open and **ignite the flammable gases** in the engine room. If the impact had been more direct, the steel plate could have pierced the tank, and also provided the energy to **ignite the flammable mixture of fuel vapour** and air which would have formed within the truck's empty tanks. The cargo was liable to self-heat and **ignite spontaneously** because it contained fine shavings contaminated with cutting oil, cast iron borings and organic flammable materials. Unfortunately, the junior engineer succeeded in his attempt to **ignite the boiler** and the residual fuel ignited explosively.

ignition /ig'nifən/ (n) (marine eng) paljenje, zapaljenje: Better still, the electrodes should have been bench tested away from all **sources of ignition**. The source of heat for ignition comes from piston blowby, **slow ignition** and afterburning, or excessive exhaust back pressure, which causes a blowback through the scavenge ports. The engine room fire was probably caused by the **ignition of lubricating oil** that sprayed from a fatigue-fractured fitting on one of the main engine's pre-lubrication oil pumps onto the hot surface of the main engine's exhaust manifold. **spontaneous ignition** samozapaljenje, **ignition system** uređaj za paljenje, **ignition timing** tempiranje paljenja, **ignition switch** prekidač paljenja, **ignition control** upravljanje paljenja, **ignition temperature** temperatura paljenja The **ignition temperature** for this type of oil mist can be extremely low, depending on the type of oil being atomized., **ignition delay** zakašnjelo paljenje, **odgođeno paljenje**: High-aromaticity fuels cause increased **ignition delay** in some cases., **ignition pressure** tlak paljenja The air-blast pressure, which was only just slightly above the **ignition pressure** in the cylinder, was produced by a water-cooled compressor driven off the engine connecting rod by means of a rocking lever., **ignition system** sustav paljenja: Once the **ignition system** was reassembled, it was tried again; but still to no avail. It was then decided to test for a spark at the end of the electrodes., **activate ignition** aktivirati paljenje: As the **ignition** was **activated** and the fuel sprayed from the open ended pipe, a fire erupted, ..., **cause ignition** prouzročiti paljenje, **izazvati paljenje**, **dovesti do paljenja**: Possible heat sources **causing ignition** include heat exchangers, exhaust pipes, turbochargers, electrical contacts, static electricity and faulty wiring., **source of ignition** izvor paljenja, **uzrok paljenja**: The **source of ignition** for these explosions can be attributed to one of the following: - A leaking air start valve., **ignition quality** kvalitet paljenja: Damage due to **poor ignition quality** fuel can be prevented by injection control (pre-injection)., **spontaneous** sponrtano zapaljenje, **samozapaljenje**: The lack of an effective guard allowed fuel to spray onto the adjacent turbocharger and/or exhaust piping causing **spontaneous ignition**., **lead to**

ignition dovesti do paljenja / zapaljenja: *The low spontaneous ignition temperature of the liquid fuel leads first to ignition of the diesel fuel and then to ignition of the air-gas mixture.*, **self-ignition samozapaljenje:** *To prevent the risk of self-ignition, the following precautions should be taken as laid out in the Code of Safe Practice for Solid Bulk Cargo 2004. ... and a fine spray of hydraulic oil began falling on the hot surfaces on the top of the exhaust manifold and ignited after attaining self-ignition temperature.*

I.L.O. (International Labour Organization) (n) (mar law) Međunarodna

organizacija rada: *Considering the number of times one's rest is disturbed in order to stuff another wad of paper to hold a rogue drawer shut, I wonder whether this might constitute a violation of ILO 2006 crew accommodation standards.*

IMDG Code (n) (mar law, cargo handling) The International Maritime Dangerous Goods Code, adopted by the IMO. **Međunarodna pravila o prijevozu opasnih stvari morem:** *In 2004 the IMDG Code becomes compulsory but some bits remain recommendatory, such as the requirement for training for all those involved in sending dangerous goods to sea ... It is of great concern that there is still evidence of non-compliance with the IMDG Code. The correct bulk cargo shipping name (BCSN) for the International Maritime Dangerous Goods (IMDG) class 4. However, if such action is not in accordance with the guidance provided in the IMDG Code Emergency Schedules (EmS), the possibility of injury to personnel, harm to the environment, and damage to the vessel is increased considerably ... Meanwhile, the spillage was diluted with a copious amount of water following the procedures laid down in the IMDG Code supplement.*

IMDG Code - IMO Class and divisions (n) (cargo handling, safety) Pravilnik o prijevozu opasnih tereta morem - vrste i razredba opasnih tereta

1 Explosives

1. eksplozivi, 1.1 Substances which have a mass explosion hazard, 1.2 substances and articles which have a projection hazard but not a mass explosion hazard, 1.3 substances and articles which have a fire hazard and either a minor blast hazard or a minor projection hazard or both, but not a mass explosion hazard, 1.4 substances and articles which present no significant hazard, 1.5 very insensitive substances which have a mass explosion hazard, 1.6 extremely insensitive articles which do not have a mass explosion hazard, **2. plinovi pod tlakom**, 2.1 flammable gases, 2.2 non-flammable, non-toxic gases, 2.3 toxic gases, 3 Flammable liquids, 4. Flammable solids; substances liable to spontaneous combustion; substances which, in contact with water, emit flammable gases **4. zapaljive krute tvari**, 4.1 flammable solids, self-reactive substances and desensitized explosives, 4.2 substances liable to spontaneous combustion, 4.3 substances which, in contact with water, emit flammable gases, **5. Oxidizing substances and organic peroxides** **5. Oksidirajuće tvar**, 5.1 oxidizing substances, 5.2 organic peroxides, **6. Toxic and infectious substances** **Otrovne tvari**, 6.1 toxic substances, 6.2 infectious substances, **7. Radioactive material** **7- Radioaktivne tvari**, **8. Radioactive material** **8. Korozivne tvari**, **9. Miscellaneous dangerous substances and articles** **9. Ostale opasne tvari**

immediate /i'mi:diət/ (adj) (safety) **neposredan**, **koji slijedi odmah:** *Have engines ready for immediate manoeuvre. Pripremite odmah strojeve za manovru* **immediate assistance** **neposredna pomoć:** *However, they were unable to provide immediate assistance because of the swell and shallow waters.*, **immediate cause** **neposredan uzrok** *The immediate cause of the*

accident was that the bow doors of the vessel had been left open as it left the harbour, allowing sea water to enter the main vehicle, **immediate danger neposredna opasnost**. A vessel may use an inshore traffic zone when en route to or from a port, offshore installation or structure, pilot station or any other place situated within the inshore traffic zone or to avoid **immediate danger**, **immediate vicinity neposredna blizina**. His attention was then focused on avoiding her in the knowledge that the radar was indicating no vessels **in the immediate vicinity**, **immediate action neposredna radnja**. No **immediate action** was taken even though the ARPA indicated that the vessels were in collision course. The master and I agreed that **immediate action was necessary** to avoid a collision.

immediately /i' mi: diətli/ (adv) **1 odmah, smjesta**: The main engine was **immediately stopped** and the difficult task of replacing the broken bolts commenced. The helmsman should report **immediately** if the vessel does not answer the wheel. **activate immediately smjesta aktivirati, odmah aktivirati**. The chief officer saw and heard a gas leak, and **immediately activated** the emergency shut down (ESD) valves. **2 neposredno, izravno**: The master was **informed immediately about** the accident and a team assembled to recover the casualty and to render medical first aid.

immersion (n) (nav arch) uronuće, uronjenost: This was apparent only when starboard deck edge **immersion** occurred and water was building up on deck.

immersion of propeller (n) (nav arch) uron propelera: Holds aft of the accommodation and machinery spaces improve the trim of the vessel when partially loaded, and provide the ship with sufficient draft aft for stability and **propeller immersion**.

immersion suit (n) (safety) odijelo za spašavanje: The crew **put on** lifejackets and **immersion suits**, and then launched the liferaft. **don the immersion suit obući odijelo za spašavanje**: After the general alarm was sounded, the crew assembled on the bridge and **donned immersion suits** collected from two decks below. The crew quickly mustered and **donned their immersion**



suits as the vessel began to take on a port list.

immigration (n) (mar law) = immigration office pogranična policija, pomorska pogranična policija: Arriving for a canal transit, the vessel had rigged the starboard accommodation ladder to facilitate the transfer of **immigration**, customs personnel, agents, ship chandlers etc and to embark canal pilots.

Immigration Authority (n) (mar law) pogranične vlasti, pogranična policija: The Third Officer assists the Master with the port paper work and in dealing with the **authorities** (Customs, **Immigration**, Port Health).

immigration office (n) (mar law) služba granične policije, granična policija, pogranična policija, pogranična pomorska policija

immigration officer (n) (mar law) službenik granične policije

Immigration Signal (n) (comm, navig) znak pomorske pogranične policije

imminent /'iminənt/ (adj) 1 (safety) neizbježan, neminovan, koji prijeti: 3 Is danger

imminent ? .3.1 No, danger not imminent. .3.2 Yes, danger of heavy listing (to port / starboard) (IMO SMCP 2001)

imminent danger neizbježna opasnost: ... the sudden failure of the main engine auxiliary blowers resulted in **imminent danger** due to the close proximity of rocky shoals. At about the same time, the outbound pilot boat identified the vessel on radar, realised that she was in **imminent danger of grounding**, and called on VHF to warn the master. In radiotelephony, the spoken word for distress is MAYDAY. The distress signal indicates that the station sending the signal is: 1. threatened by grave and **imminent danger** and requires immediate assistance, or ... At about the same time, the outbound pilot boat identified the vessel on radar, realised that she was in **imminent danger of grounding**, and called on VHF to warn the master.

, **imminent collision neizbježan sudar**: - When confronted with an **imminent collision**, lookouts on the bow should clear the area.

, **imminent grounding**

neizbježno nasukavanje: The OOW had been alerted to the **imminent grounding** by vibration of the ship.; 2 (meteorol) koji dolazi unutar 6 sati od vremena objave

immobilisation; immobilization (n) 1 (marine eng, mar law) imobilizacija stroja:

Making the ramp door operable A new set of wedges and small doublers was quickly fabricated in the engine room workshop and **immobilisation** and hot work permits were obtained at the next berth the following day.; 2 (med) imobilizacija (noge, ruke itd.)

immobilise; immobilize (v) (marine eng, mar law) imobilizirati (brodski stroj)

zaustaviti strojeve (u luci): If it is necessary to work on steering gear when the vessel is at sea, the ship should be stopped and suitable steps taken to **immobilise** the rudder by closing the valves on the hydraulic cylinders or by other appropriate and effective means. **the main engine was**

immobilized glavni je stroj bio imobiliziran. Unfortunately immediately after the pilot boarded No. 2 blower motor also burnt out and vessel's **main engine was immobilised**, leading to an emergency situation.

IMO class (n) (nav arch) **IMO klasa**: .1 Briefing on nature of dangerous goods .1 What is the **IMO Class** of these goods? .1.1 The **IMO Class** of these goods is:2 This package contains **IMO Class** ... goods. .3 These goods are flammable / poisonous ... (IMO SMCP 20101)... Before leaving the vessel, the local emergency services advised the vessel that sawdust was not an appropriate absorbent material to deal with **IMO class 5.1** oxidising agents such as hydrogen peroxide due to the risk of self-ignition.

IMO; International Maritime Organization (n) (mar law, safety) **Međunarodna pomorska organizacija**: **IMO** is an agency of the United Nations, charged with developing a regulatory framework that promotes maritime safety and environmental protection. The system is **an IMO adopted system** and consists of traffic separation schemes and rules aimed at enhancing the safety of navigation in the Straits. In 2008 the **IMO** approved further amendments to curb SOx emissions: ... combined with Admiralty Notices to Mariners number 17 which states in paragraph 4 whilst vessels using traffic lanes in schemes adopted by **the IMO** must, in particular, comply with Rule 10 of the International Collision Regs.

IMO; International Maritime Organization (n) (mar law, safety) **Međunarodna pomorska organizacija**: **IMO** is an agency of the United Nations, charged with developing a regulatory framework that promotes maritime safety and environmental protection. The system is **an IMO adopted system** and consists of traffic separation schemes and rules aimed at enhancing the safety of navigation in the Straits. In 2008 the **IMO** approved further amendments to curb SOx emissions: ... combined with Admiralty Notices to Mariners number 17 which states in paragraph 4 whilst vessels using traffic lanes in schemes adopted by **the IMO** must, in particular, comply with Rule 10 of the International Collision Regs.

IMO Number (n) 1 (mar law) **IMO-ov broj (broda), IMO-ov identifikacijski broj broda**: Over 75% fail to update this information. Bad routines or are they just are slack? · Ship's data are missing. Call sign, Vessel type, **IMO number**, Draught, Ship's size. Vessel type and size is something we can use for identification. ... MV ABC confirms and OOW has to reply to the following questions as a matter of surveillance of merchant navy vessels. The flag, **IMO number**, Port of Registry, name of owners,

IMO Number (n) 1 (mar law) **IMO-ov broj (broda), IMO-ov identifikacijski broj broda**: Over 75% fail to update this information. Bad routines or are they just are slack? · Ship's data are missing. Call sign, Vessel type, **IMO number**, Draught, Ship's size. Vessel type and size is something we can use for identification. ... MV ABC confirms and OOW has to reply to the following questions as a matter of surveillance of merchant navy vessels. The flag, **IMO number**, Port of Registry, name of owners,

Over 75% fail to update this information. Bad routines or are they just are slack? · Ship's data are missing. Call sign, Vessel type, **IMO number**, Draught, Ship's size. Vessel type and size is something we can use for identification. ... MV ABC confirms and OOW has to reply to the following questions as a matter of surveillance of merchant navy vessels. The flag, **IMO number**, Port of Registry, name of owners,

agent, cargo type and quantity.; **2 IMO-ov identifikacijski broj luke**

IMO Performance Standards for Navigational Equipment (n) (safety, mar law)
Izvedbeni zahtjevi za navigacijsku opremu IMO-a

IMO SMCP 2001 (n) (comm, safety) **IMO-ovi standardni pomorsko-komunikacijski**

izrazi *The IMO SMCP meets the requirements of the STCW Convention, 1978, as revised, and of the SOLAS Convention, 1974, as revised, regarding verbal communications; The IMO SMCP was adopted by the IMO Assembly in November 2001 as resolution A.918(22).*

IMO STCW Code, 1995 (n) (mar law) **Pravilnik o izobrazbi, izdavanju svjedodžbi i držanju straže pomoraca (1995)**

The IMO STCW Code requires lookouts to be on duty during the hours of darkness. The IMO SMCP meets the requirements of the STCW Convention, 1978, as revised, and of the SOLAS Convention, 1974, as revised, regarding verbal communications; {The Seafarers' Training, Certification and Watchkeeping (STCW) Code (1995)}

IMO STCW Convention, 1978/1995/2010 (n) (mar law) **Međunarodna konvencija IMO-a o standardima izobrazbe, izdavanju svjedodžbi i držanju straže pomoraca (1978/1995/2010)**

The value and benefits of Resource Management training have been recognised by the 2012 amendments to the STCW Convention in Manila. The IMO SMCP meets the requirements of the IMO STCW Convention, 1978, as revised, and of the SOLAS Convention, 1974, as revised, regarding verbal communications {The International Convention on Standards of Training, Certification and Watchkeeping for Seafarers (STCW), 1978}

impact (n) **1 (navig, safety) udar broda**: *The ship almost rebounded with the impact. Brod se uslijed udarca skoro odbio (od stijene). The impact was so hard in fact that three of the five crew members on board the pilot boat suffered injuries The impact was very heavy for the trawler that sunk rapidly. On very large vessels, the bridge team may not feel the impact of green seas or contact with small vessels or objects; ship impact (safety) udar broda: The ship impact caused considerable damage to the fore-end of the vessel, including penetrations below the waterline. It is uncertain whether the skipper on the tanker realized the risk of collision before the impact. , impact damage oštećenje od / zbog udara: The two crewmen were slightly injured and the lifeboat suffered moderate impact damage.; 2*

(navig, safety) sudar: At about 0425, the crew of the fishing vessel were woken by the impact of their vessel with a much larger vessel.; 3 (med, safety) udarac: Because of the heavy impact on his head he was sent ashore to see a doctor. The flame from the explosion burnt his left hand, wrist and arm and the force of the impact knocked him over backwards, which caused a head wound.; 4 utjecaj (na):

Berthing times can be easily re-scheduled, but accidents can have a long-lasting impact on individuals and companies. Moderate capital costs, compactness and minimal impact on fuel consumption are cited as merits. The Master's duty is to inform the nearest coastal and port state authorities of any defect on the vessel that may affect her safety, structural integrity, navigation and impact on the environment. ... ensure that the means used by DUKW operators to achieve the required standard of buoyancy and stability for their vessels does not adversely impact on their safe operation. ... this application can be run at much higher air flow face velocities than traditional filters in other applications before it has an impact on gas turbine performance.

impact drill (n) (marine eng) **vibraciona bušilica, udarna bušilica cordless impact**



drill baterijska udarna bušilica

impact load (n) (marine eng) udarno opterećenje: ..., there have been many cases where the bow or the stern structure of a container ship has been overloaded and could not withstand the **heavy impact load from the waves**.

impact strength (n) (marine eng) čvrstoća na udar

impact wrench (n) (marine eng) udarni ključ **pneumatic impact wrench** pneumatski udarni ključ

impair /im'peə/ (v) (safety) umanjiti, oslabiti: Such damage can **impair the hatch cover's weathertightness** and can render the vessel unseaworthy. Hazards which arise from the installation operating condition but have the potential to **impair the safety of the crew** and the vessel as a whole must already be provided for in the testing and approval procedures of the Ship Safety Division. **or impair the safe navigation of the vessel** umanjiti sigurnu plovidbu broda

impart /im'pa:t/ (v) **1 dati, predati**: When the connecting rod performs its swinging movement relative to the piston, **the pawls impart an intermittent rotating motion to** a toothed rim, from which it is transmitted to the piston by an annular spring. The camshaft-driven actuators **impart hydraulic drive to** the single central exhaust valve working against an air spring. A thin flame plate for the cylinder head promotes good heat conductivity while high stiffness is **imparted by** a strong deck plate absorbing the vertically acting gas forces. Note how the main bearing caps are bolted in the lower part to both sides of the crankcase, **imparting high crankcase stiffness.**; **2 djelovati (na)**: ... check, wherever possible to withstand the **loads imparted** when design, construction, or condition of vehicle the ferry rolled.; **3**

prenijeti: I recommend that crewing / marine departments of companies regularly **impart Colregs training to** bridge watchkeepers and verify their knowledge of the same.; **4 prenosit**

impede (v) (navy, mar law) ometati, ometi: t buoyancy in their vessels, and where buoyancy foam is fitted for this purpose, the quantity installed is measured by volume and the foam does not t buoyancy in their vessels, and where buoyancy foam is fitted for this purpose, the quantity installed is measured by volume and the foam does not **impede the operation or maintenance** of key equipment. Despite their manoeuvrability many tugs seem reluctant to give way to larger vessels, frequently **impede the fairway** and it is often difficult to contact them on the VTS working channel. **impede passage (navig) ometati prolaz**: The master contacted her by VHF radio and agreed a starboard-to-starboard passing, but it soon became apparent that the inbound vessel **would impede the tanker's passage** within the channel. Rule 9d clearly states **no vessel shall impede the passage of** a vessel that can only be safely navigated in a fairway.

impeller /im'pelə/ (n) **1 (marine eng) rotor**: The components surrounding the **turbine impeller** are designed to be able to absorb the kinetic energy of several broken blades. ... the problems of higher **impeller peripheral speed**, elevated **impeller blade temperature** and increased **impeller blade surface load**, and the problem of optimizing the aerodynamic characteristics of the higher speed air

flow in the **impeller**. The **compressor impeller** is of aluminium alloy or the more expensive titanium. The air exits the **impeller** radially and passes through a diffuser, where some of the kinetic energy gets converted to pressure energy. A labyrinth arrangement is also fitted to the back of the **compressor impeller** to restrict the leakage of air to the gas side; **2 (boating/yachting, marine eng) rotor pompe, impeler**. The pumping element is made up of a top cover, a pump shaft, an **impeller**, a bearing bush and a sealing arrangement around the shaft. The hollow bowl spindle features **an impeller which pumps closing water** from a built-in tank to the operating system for sludge discharge.



impending danger (n) (safety) **neposredna opasnost, prijeteca opasnost**: The OOW noted the crossing vessel's name on the AIS and attempted to alert the crossing vessel on the VHF about **the impending danger**, without success. Radar guard zones and echo sounder shallow water alarms can also help to give warnings of **impending danger**.

imperil /im'peril/ (v) (safety) **ugroziti, dovesti u opasnost**

imperilled /im'perild/ (adj) (safety) **ugrožen**

impetus /'impitəs/ (n) **1 poticaj**: The introduction of electronic fuel injection in the heavy truck market to meet stringent emission controls **gave that impetus** and the investment to advance the technology. **gain impetus dobiti zamah / poticaj; 2 zamah, zalet**

implement (v) **sprovesti, primijeniti**: Carefully identify all hazards in the work area and **implement appropriate control measures**; The bridge team failed to notice rapid swing to port and **implement corrective action** in good time; Companies should **implement procedures** in their SMS to guide ships' officers on how and when to conduct these inspections. **Implement effective training** on new release system, supplemented by maker's video programme; The root cause/contributory factor of this accident was the failure to **implement company's procedures** for using power tools; Inadequate procedures / instructions; The company decided to **implement the following steps** immediately: ... However, the Master and deck officers **did not implement the ship manager's policies** for safe navigation and bridge watchkeeping.

implementation (n) (mar law) **provedba, primjena (konvencije, zakona, odredaba**

itd.): The **implementation of GMDSS** requires further revision. ..., ship operators, shipmasters and watchkeeping officers alike should make every possible effort to ensure better understanding and **implementation of the Rules of the Road**. Many, many years since the **implementation of SOLAS requirements**, pilots are still faced with this type of situation. Decision taken to expedite the **implementation of a work safety training programme** in the fleet. However, since the **implementation of the ISM Code**, the behaviour of some port state control inspectors has become more and more impudent. * Company procedures/checklists may degenerate into paper tools without proper understanding and **implementation. implementation of the STCW Convention provedba konvencije STCW**

implied indemnity (n) (mar law, mar ins) **prešutno pravo na naknadu**

import(ed) cargo (n) **1 (shipping econ) uvozni teret**: A general cargo ship arrived with an

import cargo that was stacked high on the hatch covers, exposing a large lateral wind area.; **2 (ports) teret u iskrcaju**

impose (v) (mar law, marine eng) nametnuti: The cylinder conditions in the latest designs of low-speed crosshead engines **impose a higher maximum pressure**, higher mean effective pressure and higher cycle temperature than those of previous generations. Finally, inadvertent over-tightening of gangway (and lifeboat) wire falls during stowage **can impose excessive loads** for long periods on the system. Each and every word on the vessel's port papers is checked to find any flaws, so as to be able to **impose heavy fines** ... Subsequently, during a PSC inspection, the PSC official noted this open valve, which was in contravention of local regulations and **imposed a penalty on the vessel**. Such legal requirements are probably years away from **being imposed**, but there can be little doubt that such a move would be in the interests of good practice. It is admitted that, in spite of the **constraints imposed by the regulations** of the port, ship's personnel failed to carry out a Can-thumping test as per Code of Safe Practice for Solid Bulk Cargoes section .. **impose a ban (on) (mar law) uvesti zabranu**: I brought the matter up in the safety meeting and **have imposed an official ban on** the use of the mobile phones on the navigating bridge while the ship is at sea .., **impose radio silence (comm) narediti radio-šutnju**: The distress traffic controlling station/other stations **may impose radio silence on** any interfering stations by using the term "Seelonce Mayday/Distress", unless the latter have messages about the distress.

improper improper maintenance neispravno održavanje: 200870 Gangway accidents Recently we had two accidents involving shore personnel, due to improper maintenance and rigging of portable gangways., **improper handling neispravno rukovanje**: ... Inadequate procedures / instructions; Inadequate checks of power tool and accessories before use; **Improper handling of materials**; Inadequate personal protective equipment (PPE). Send a letter of protest to all parties concerned (in the first instance to the local harbour master, who is responsible for the ship's safety) against loading dangerous/improper cargo., **improper operation neispravan rad, nepravilan rad**: Many injuries have been directly attributable to **improper operation and maintenance of lifeboat launching and recovery systems**, , **improper combustion nepravilno izgaranje**: At the time of running the scavenge air pressure drops and this causes the **improper combustion**., **neispravan teret 1 (adj) neispravan (teret); 2 neprikladan, nepodesan; 3 neodgovarajući**: This indicated an **improper assessment of priorities**.

improper stowage (n) (cargo handling) neispravo slaganje: **Improper stowage** (e.g. containers stowed six-high) or improper use of cargo handling equipment can cause heavy damage or collapse of container stack due deformation of bottom container. **Improper stowage** could restrict air circulation or lead to shifting/crushing;

improve (v) 1 unaprijediti, usavršiti: Taking responsibility for it is essential to **improve safety**. In the rapidly changing situation the skipper did not consider using the quick release mechanism to drop the derrick blocks which would have helped **improve stability**. Make sure that those on board are aware carriage of flares and a VHF radio will of the internationally recognised method **greatly improve your chances of survival** of signalling distress: raising and — you owe it to yourself and your lowering of the arms outstretched at each passengers Establishment of traffic lanes VTS Vessel Traffic Services: services **designed to improve the safety** and efficiency of vessel traffic and to protect the environment VTS area.; **2 poboljšati, dotjerati**: Composite piston of the low NOx engine is designed for increased combustion pressure and low friction **to improve atomization** at the start and stop of injection, ... **To improve combustion** even further, however, a new slide-type valve was introduced for all large bore engines. Modifications are generally intended **to improve performance** or safety, but can catch you out by introducing other problems. Mooring close to roads or tracks, where this is possible, **will significantly improve** the speed of response.

imprudent (adj) neoprezan, nesmotren: Both the Pilot and myself agreed that it would be

imprudent to take this action until the inbound vessel was clear.

impurity /im'pjʊəriti/ (n) (marine eng) **nečistoća, prljavština**: The normal **abrasive impurities** in fuel are ash and sediment compounds. The **separation of impurities** and water from fuel oil is essential for good combustion.

IMX; (intermodal exchange) (n) (ports, shipping econ) **intermodalni centar** {In an IMX yard, containers can be lifted from truck chassis to rail intermodal cars or vice versa.}

in accordance with (prep phr) **u skladu s**: Maintenance systems should be designed and followed to ensure that watertight doors are maintained in accordance with manufacturers' instructions, and **in accordance with good standard marine engineering practice**. Ten minutes before transit, own ship altered course to 090 **in accordance with the passage plan**, in order to pass between beacons. Earlier, at about 23:30 hours, I had encountered a head-on vessel and, **in accordance with Colregs**, I altered our original course from 259 degrees to a new course of 285 degrees in order to pass the other at a safe distance. Reduction in speed from full speed to the recognised manoeuvring speed is to be as gradual as possible and **in accordance with the manufacturer's instructions**. Two tugs were assisting, one was made fast on the port quarter and the other was standing by forward to assist **in accordance with pilot's orders**. Hence, he lacked an understanding that his was a stand-on vessel in a crossing situation and was therefore expected to maintain course and speed **in accordance with Rule 17(a) (i) of the COLREGs**. The clearance must be set **in accordance with the temperature of the engine**. Check that all non-cargo lifting appliances on board have been identified and recorded **in accordance with national regulations**. **In accordance with the pre-arrival schedule and loading plan**, extra ballast was being pumped out.

inaccuracy (n) **nepreciznost, manja netočnost**: To keep **measurement inaccuracies** to a minimum, standard procedures should be adopted by the ship's crew when measuring cargo and calibrating equipment. Despite the fact that the master had 12-years experience as master mariner, in this case **he demonstrated inaccuracy in visual range finding abilities** and estimation of own ship speed as well as possible unawareness of ship's inertia characteristics. AIS Inaccuracies AIS Inaccuracies MARS Report 200552 There have been some more reported **inaccuracies in AIS data** displayed by vessels. Even so, **inaccuracies in determining** shaft stiffness, damping effects, coupling performance and hull structure response make it advisable in certain borderline cases

inactive (adj) **nedjelotvoran, neaktivan**: ..., the governor reduces fuel injection to zero, which, in turn, causes a pressure increase in the rail system as the individual injectors **become inactive**.

remain inactive ne aktivirati se, mirovati, ostati neaktivan: The method of navigation employed was unconventional, provided little stimulation to the watchkeeper and allowed him to **remain inactive** for prolonged periods of time.

inadequate (adj) **neodgovarajući, neprikladan**: ... a hazardous condition was found but the repair was **grossly inadequate** and did not eliminate the unsafe condition. **Inadequate assessment** of needs and risks; He came to the engine room and observed that all the sea water pumps were showing **inadequate discharge pressure**. The securing of these drums was **evidently inadequate for the intended purpose**: either the lashings used or their securing points were not capable of restraining the oil drums or were poorly adjusted/secured. An accident can be defined as an unexpected hazardous occurrence caused by unsafe practices that arise from **inadequate knowledge**, improper training, and failure to follow proper procedures, and usually resulting in loss of life or injury to personnel, damage to property etc. The events leading to the capsizing were a mix of complacency, poor shipboard procedures and **inadequate leadership**, both afloat and ashore. The root cause of the accident was the failure of the pilot ladder due to **inadequate maintenance and inspection**. The fact that the boats involved in the collision were not carrying radios to communicate their predicament demonstrated the **inadequate planning for the passage**. **Inadequate risk assessment and work planning**, position of high sea suction and changes to draughts not adequately considered. **Inadequate securing** of items, cargo nets not used in conjunction with pallets. Improper motivation arising from complacency, **inadequate supervision**, operating without authority and defective equipment also contributed to the error chain.

inboard (adj) (seamanship, marine eng) **brodski, unutarbrodski, nutarnji**: Turbocharging system: based on non-cooled turbochargers with **inboard plain bearings** lubricated from the engine's lube oil system. Although a gangway watch has traditionally been kept at the **inboard side of the gangway**, this is not always the best position. **inboard engine (marine eng) brodski motor**: The boat did not have an **inboard engine** fitted but, as required by class rules, did have a small outboard which was stored inside the hull near the mast. That yacht then started the **inboard engine** and, leaving his sails to flog, made towards the man in the water.

inboard (adv) **unutra, u brod, na brod, u unutrašnjost broda**: He then started to bring his catch **inboard** and stow the gear. However, they could easily have been removed after the gangway was hoisted **inboard** and before it was finally secured. Together they dragged the skipper **inboard** and began attempts to resuscitate him. The crew of a twin beam scallop dredger **had hauled the beams inboard** and had secured them in position with the safety chains ready to empty the catch of scallops.

inboard of **prema unutra, s nutarnje strane**: Meanwhile, he and another crewman led the messenger line **inboard of the bits** holding the 'firewire', round a standing roller bollard and between another set of bits, to the mooring winch. **s intentions with the rest of the team, the carpenter then passed the messenger line through the aft centreline bits, diagonally across the deck, inboard of the starboard winch, to a pedestal fairlead located forward of the winch.**

inbound (adj) **1 (navig) koji se kreće prema unutra (luci, obali, ušću, plovnom kanalu, tjesnacu itd.)**: Two ships crossed ahead of us **inbound to** Singapore and there were several fishing boats in the vicinity which we were required to avoid. The tanker **was inbound** and was moving very slowly ahead while waiting for the pilot from the container ship to board. **inbound traffic brodovi koji plove prema luci (ušću, ulazu u plovni kanal)**: In the meantime we had managed to get ahead of her and clear of all **inbound traffic** by passing north of the buoys. **inbound lane ulazni plovidbeni smjer, plovidbeni smjer prema luci** The other passenger vessel elected to enter the TSS on the southern limit of the **inbound lane**, and we elected to proceed further north and join the TSS at the northern border of the inbound lane, to leave the outbound coaster a safe pass; **2 (shipping econ) teret u uvozu, teret u iskrcaju**

inbound (adv) (navig) **prema unutra, prema luci (ušću itd.)**: As a number of yachts, including our own, **were transiting inbound** between the navigation marks, we were appalled to be rapidly caught and passed by an MCA rigid inflatable at speeds in excess of 15 knots. The traffic situation was of a lower intensity than normal, with another large passenger vessel, ETA Pilot 07.00, **inbound** and two small coasters **outbound**.

inbound ship (n) (navig) **brod koji se kreće prema luci (ušću, kanalu, tjesnacu), brod koji uplovljava**: The master checked his ARPA and decided that because this indicated the **inbound ship** to be passing clear on his starboard side, it would be safe for him to alter to port and increase speed, and then cross ahead of the **inbound ship** Just after sunset on a calm evening, a large **inbound container ship** was approaching the pilot boarding position about a mile NE of the harbour's breakwater entrance Odmah po zalasku sunca jedne tihe večeri veliki kontejnerski brod na putu u luku približavao se poziciji za ukrcaj peljara oko jedne nautičke milje od ulaska kod lukobrana An **inbound vessel** was a 190 meter box ship with 9.

in bulk (prep phr) **1 (cargo) u rasutom stanju**: Traditionally, scrap metal **has been carried in bulk** and is, therefore, subject to the Bulk Cargo (BC) Code. A bulk carrier loaded a full cargo of **wheat in bulk**. Access hatches need attention too My vessel was en route to Norway to load **cement in bulk** through a chute.; **2 (cargo handling, cargo) u velikim količinama**: Further investigations revealed that the previous vessel at the berth had discharged a cargo of **caustic soda in bulk**, some of which had spilt on the wharf and the fittings thereon. This enabled the local Lloyd's Surveyor to complete the survey and issue a Document of Compliance for Carriage of **Dangerous Goods in Bulk**.

incandescent (adj) (marine eng) užaren: Probably *incandescent pieces of metal* had (fall) into the crankcase and (bring) about the accident. He found an electric light fixture lying on the bunk with the *incandescent bulb* still burning.

in charge of (prep phr) zadužen za, odgovoran za, nadležan za: On the bridge were the Master, Mate, a deck cadet and a helmsman, the Second Engineer was *in charge of the engine room*. On the bridge were the master, pilot, helmsman and the chief mate *in charge of the watch*. Although they might be qualified to be *in charge of a navigational watch*, the less experienced still require careful monitoring and close support, particularly in potentially challenging situations. The officer *in charge of anchoring* must know the number of shackles available on each anchor. An experienced and responsible deck officer shall be *in charge of the forward station* when connecting/disconnecting chafe chain; The person *in charge of the mooring party* does not seem to have appreciated that it is extremely dangerous to heave up on the spring whilst the vessel is still moving ahead. The Chief Engineer, or Chief Engineering Officer, is *in charge of the Engine Department*.

incident (n) (mar law, safety) SEE marine casualty COMPARE accident SEE marine casualty IMO definition: Marine incident means an occurrence or event being caused by, or in connection with, the operations of a ship by which the ship or any person is imperilled, or as a result of which serious damage to the ship or structure or the environment might be caused.

([http://www.imo.org/blast/blastDataHelper.asp?data_id=22633&filename=A849\(20\).pdf](http://www.imo.org/blast/blastDataHelper.asp?data_id=22633&filename=A849(20).pdf)); An incident means any occurrence, other than an accident, that is associated with the operation of a ship and affects or could affect the safety of operation. (

<http://www.maritimenz.govt.nz/commercial/safety/accidents-reporting/definitions.asp>) **izvanredni događaj na moru koji je prouzročio štetne posljedice koje ne ugrožavaju ljudske živote, imovinu i okoliš**

u velikoj mjeri **nezgoda, pomorska nezgoda, slučaj nezgode:** Vessels must advise the Harbourmaster immediately (through the relevant VTS station) if involved in any of the following **incidents:** Collision, sinking, fire, grounding, pollution, damage to ship or structure, foul or lost anchor. There were reportedly 13 crew members on board the vessel **during the incident** and they had tried to de-ballast the vessel to correct the list. The 5,350 TEU vessel was sailing from Qingdao to **when the incident occurred. This incident took place** in the middle of the night, visibility was good, wind ESE force 4. **This incident demonstrates that**, even on a short trip, in a sheltered harbour, things can go wrong. The matter was reported to the vessel's owners who replied that **the incident had been caused by** failure of the guard frame to revert automatically to the operation position ... The following **incident happened** while on a loaded passage from Madras to Singapore. The first **incident involved** a large container vessel, the other a large passenger vessel. **This incident involved a close quarters situation** between a ro-ro ferry crossing a traffic lane, and two vessels – a container ship and a tanker – ... **This incident involved two crew members** tasked with general maintenance of hatch cover hydraulics while the ship was at sea. A hazardous **incident occurred** on board a tanker while crew members were engaged in rinsing and mopping up in a slop tank and discharging oily water slops ... **The incident occurred** at approximately 0400 in good visibility. **incident investigation istraga pomorske nezgode:** This involved safety inspections, cargo survey work, **accident and incident investigation**, port captaincy and usual wide range of work involved with this type of position. In my **incident investigation report**, I will certainly identify improper stowage as the main root cause., **incident report izvješće o pomorskoj nezgodi:** An **incident report** was sent to the office to be shared with the rest of the fleet; , **hazardous incident opasna nezgoda:** A **hazardous incident** occurred on board a tanker while crew members were engaged in rinsing and mopping up in a slop tank ... , **major incident veća nezgoda:** ... the awareness and prompt actions of a crewman, followed up by preplanned emergency procedures, prevented a **major incident.** , **serious incident ozbiljna nezgoda:** In this case, a **serious incident** did not escalate into a crisis. , **cause of the incident uzrok nezgode:** The root cause of the **incident** was due to poor visibility compounded by excessive speed for the prevailing conditions and the

pilot's ineffective use of the radar equipment to monitor the situation., **contribute to the incident** **pridonjeti nezgodi / nesreći**: We also believe that in this case **poor cross cultural communications contributed to the incident** *The Lessons* A number of factors - predominantly relating to bridge manning and management - **contributed to the incident.**, **report the incident** **izvijestiti o nezgodi, podnijeti izvješće o nezgodi**: The skipper of the fishing vessel **reported the incident** to the coastguard. As a result, **the master decided not to report the incident** to the authorities or the ship's management company, and the ship continued on its passage. {In its generic use the term 'incident' refers to any maritime accident (=serious consequences) or incident (=minor accidents). For specific use of the terms 'accident' and 'incident' see 'marine casualty.'}

incinerator /ɪnˈsɪnəˌreɪtə/ (n) (marine eng) **incinerator, spaljivač (otpada)**: Kværner of Norway provided the solid/oil waste **incinerator unit**, which has an approximate burning capacity for solid waste of 50 kg/hr for sludge oil. The local fire alarm for the **incinerator area** was activated and the appropriate fire extinguishing mist system for the **incinerator** was triggered. **incinerator room** **prostorija incineratora**: A little while later, the fourth engineer went up to the **incinerator room** to check the safety parameters of the equipment.

incised wound (n) (med) **posjekotina**



incision /ɪnˈsɪʒən/ (n) (med) **posjekotina**

inclination /ɪnklɪˈneɪʃən/ (n) (marine eng) **nagib, kosina**: The oil distribution grooves have a very small **angle of inclination** to avoid blow-by over the piston rings and small but regular quantities of cylinder oil supplied by an accumulator system. **ship's inclination** **nagib broda**: List is the **inclination** of the vessel to port side or starboard side.

inclining experiment (n) (nav arch) **pokus nagiba, ispitivanje kojim se određuje položaj težišta broda**

inclining test (n) (nav arch, navig) a test performed on a ship to determine its stability, lightship weight and the coordinates of its center of gravity **pokus naginjanja broda**: The **inclining test/experiment**, and its subsequent analysis, indicated that her inherent stability had been poor.

inclinometer /ɪnklɪˈnɒmɪtə/ (n) (navig) **pokazivač nagiba broda**

inclusive of (adj) (mar law) **koji uključuje**

incoming air (n) (marine eng) **dolazni zrak, dolazeći zrak**: An engine driven scavenge blower is fitted and the **incoming air** is blown into the cylinder through the inlet ports when they are uncovered by the piston.

incoming vessel (n) (navig) **brod koji dolazi / ulazi u luku**: It is suggested that ports and **incoming vessels** voluntarily adopt a system whereby essential information is exchanged before arrival, preferably in writing, or at least verbally. Recently, I boarded an **incoming tanker** whose harbour

manoeuvring speeds were abnormally high. We observed that the **incoming vessel**, too, had deployed some small rope fenders and proceeded to berth and conduct cargo operations.

incompetency (n) 1 neosposobljenost; 2 nesposobnost

incompetent 1 (adj) **nestručan**: Competency should be assessed by the peers and not a one sided declaration that they are **incompetent**. Some officers are **incompetent** or have forged certificates,

incompetent handling **nestručno rukovanje**; 2 (mar law) **neovlašten**

in consideration of (prep phr) (shipping econ, mar law) **u zamjenu za, uz nadoknadu za**: The voyage charter, the most common of the three, provides transport for a single voyage, and designated cargo between two ports **in consideration of** an agreed fee.

incorporate /ɪnˈkɔːpəˌreɪt/ (v) 1 **ugraditi, uključiti**: Preparations for sea trial shall **incorporate**: i) passage plans that ensure ample sea room, avoid transiting congested inshore waters, and provide for contingency anchorages; ii)...; 2 **imati u sebi, sadržavati**: Most marine gas turbines **incorporate** a free power turbine, which is free to rotate at whatever speed is dictated by the combination of the power output of the gas turbine change un Larger engine models **incorporate** pumps with variable injection timing for optimizing fuel economy at part load; the start of fuel injection is controlled; 3 **utjeloviti**

incorrect (adj) 1 nesipravan; 2 netočan; 3 pogrešan

INCOTERMS 2000 (n) (shipping econ, mar law) the internationally accepted and employed terms for contracts of sale, were first published by the International Chamber of Commerce (ICC) in 1936; The latest revision, known as Incoterms 2000, came into force on January 1, 2000. **Međunarodna pravila za tumačenje trgovinskih uvjeta, Uvjeti međunarodnih trgovinskih ugovora, trgovinski uvjeti, ponude međunarodnog pomorskog prijevoza**: The terms consist of 13 rules which are fundamental to international trade, defining the most important responsibilities of buyers and sellers in international sales contracts. **Incoterms** are a basic reference for sales contracts, recognised as the international standard by customs authorities and courts everywhere. (<http://www.maerskline.com/en-jm/help/shipping-glossary>)

in-court settlement (n) (mar law) **sudska nagodba**

increase (n) **porast, rast, povećanje**: The long-term effects on the engine are a **significant increase in fuel consumption** and component damage. The **increase in air density** is, however, fractionally offset by the **increase of air temperature** resulting from adiabatic compression in the turboblower, the) Because of an **increase in pressure**, the relief valve opened. **The pressure increase in the drainage pot** was sufficient to fracture the observation glass, leading to its catastrophic failure.

increase (v) 1 **povećati (se), porasti**: I altered course slightly to port to **increase** CPA to about 0.0515 Our vessel was drifting to port so I ordered to increase the speed to slow ahead and **increase helm** to 20 degrees to starboard. The pilot then asked the Master to **increase the pitch** to 20% and requested the helmsman to steer on a heading of 353° gyro (G) to bring the vessel to the south of the channel centreline. Within limits, so far as combustion is concerned, it is possible sometimes to **increase the speed of an engine** if the mean pressure is reduced.; 2 **povisiti (se), pojačati (se)**: The oil level **failed to increase** and the pressure remained at zero. The weather forecast on the day of the accident was for the wind to **increase** and veer during the day to become onshore, leading to deteriorating local sea conditions.

increment (n) 1 **povećanje (troškova), porast**; 2 **utržak**

incur (v) 1 (shipping econ, mar law) **nastati (o troškovima), izazvati**: Repairs delayed the vessel by 2 weeks, spoiling perishable cargo and **incurring further penalties**. As a result of the ship's staff's not observing the maker's maintenance instructions and poor engineering practice, **the company incurred an unplanned expenditure** of nearly US\$ 100,000. **costs / expenses incurred nastali**

troškovi, proizašli troškovi *Substantial costs were incurred by the member in making the cargo fit for on-carriage.*; **2 (marine eng) povećati** : The standard methods for curing heavily contaminated fuels involve the use of biocides, which may be toxic and **incur disposal problems.**; **3 (nav arch, safety) nastati (oštećenje / šteta)** : The chief officer went forward to **determine what damage had been incurred**, and when he arrived back on the bridge made a report to the coastguard.

incurred (adj) (mar law, shipping econ) nastao iz, koji proizlazi iz, izazvan the cost/expenses incurred in delivery troškovi nastali pri isporuci : In addition to the extra expenses incurred, the vessel arrived at the discharging port three days late. , **damage incurred (nav arch, shipping econ) nastalo oštećenje, prouzročena šteta nastali izdaci** : The actual damage incurred was as follows: On the port side 10 half round steel fendering on the sheer strake at deck level was flattened with, fortunately, the speed of fire spread and the **damage incurred** means that the exact causes will probably never be known. , **loss incurred (shipping econ) pretrpljeni gubitak** However, the **monetary losses incurred** through the incident were quite large.

indemnify /in'demnifai/ (v) (mar law) obeštetiti, nadoknaditi štetu

indemnity (n) (mar law, mar ins) obeštećenje, nadoknada štete, naknada štete Letter of indemnity garantno pismo (za nadoknadu štete) : Having failed to get a response, our terminal **served** the vessel's Master, agent, stevedoring company and consignee with an **indemnity letter**, holding them individually and jointly responsible for any loss or damage arising from underestimated weights of the lifts. The master then issued a letter of protest to the terminal and, in return, received a **letter of indemnity** from them, exonerating the ship from all costs and consequences. , **measure of indemnity opseg prava na naknadu**

indemnity clause (n) (mar law) klauzula u prijevoznim ugovorima kojom se određuje visina naknade štete zbog neispunjenja ugovora klauzula o naknadi

indent /in'dent/ (n) (safety, nav arch) udubljenje (nakon sudara) : A little while later the Master inquired from the C/O if he heard the loud bang, and explained that there was a **heavy indent** on the starboard side of the bridge wing deck. **hull indent** a hollowed, notched, or cut place, as on an edge or on a coastline **udubljenje na trupu broda, indent to the shell plating udubljenje na oplati trupa** : The ship sustained a minor deformation of the outer structure of the bridge wing while the other vessel reported several **indents to the shell plating** in the way of the port quarter above the waterline.



indent /in'dent/ (v) (navig, safety, mar law) udubiti, ulupiti : The bow of the other ship crushed a half round steel fendering and **indented the deck** over 3m up to maximum of 20cm depth in way of the forward store between the collision bulkhead and cargo tanks. The ship sustained significant damage to the shell plating along her length; the **hull was heavily indented**, but it was not breeched and there was no pollution. The bow was distorted and **the hull plating was severely indented and holed.**

indentation /,indent'etʃən/ (n) 1 (nav arch, safety) udubljenje (na trupu broda, oplati

itd.): Unfortunately the momentum of the vessel caused both scows to contact, resulting in a crack on the deck of one and an indentation in the bow of the other. The vessel suffered bottom plate **indentation** forward but no hull penetration. Unfortunately the momentum of the vessel caused both scows to contact, resulting in a crack on the deck of one and an indentation in the bow of the other. Damage to own vessel consisted of **indentation of the bulwark plates** and a 800 mm long tear of the shell plating on the starboard bow.; **2 (marine eng) nazubljenost, nazubljenje, zupčast urez, usjek; 3 (oceanogr)**

razvedenost (obale)

indented (adj) 1 (nav arch) udubljen (o oplati broda): The ship sustained significant damage to the shell plating along her length; **the hull was heavily indented**, but it was not breeched and there was no pollution.; **2 (marine eng) nazubljen; 3 (geogr) razveden (obala) indented coastline razvedena obala, tal. frastagliatura della costa**

independent carrier (n) (shipping econ) carrier that is not a member of a shipping conference. **samostalan prijevoznik, prijevoznik izvan brodarske konferencije**

independent contractor (n) (mar law) samostalni poduzetnik

independent piece (n) (sailing vessels) pramčana statva

index (v) 1 (shipping econ) indeksirati; 2 (marine eng) zakretati (do određenog stupnja)

index; (plural: indexes or indices) /'ɪndɛks; pl. 'ɪndɛksi:z (indexes) or 'ɪndɪ,si:z

(indices)/ **(n) 1 (marine eng) pokazatelj, indeks:** ... the heating temperature may vary, depending on the viscosity and **viscosity index** of the fuel. Ignition quality is indicated as cetane number, diesel index and calculated **cetane index**; the higher the value the better the ignition quality of the fuel. **The cetane number or diesel index** will determine injection timing and also influences the combustion noise and production of black smoke.; **2 pomicanje (vrijednosti):** Increase fuel **pump index** by regulating handwheel.

indicated power (n) (marine eng) indicirana snaga: On modern engines the indicated diagram can be continuously taken by employing two transducers, one pressure transducer in the combustion space and other transducer on the shaft. Through the computer we can thus get on line **indicated diagram and power** of all cylinders.] **The indicated power** can only be measured from diagrams where these are feasible, and they are also subject to significant measurement errors. **measure indicated power izmjeriti indiciranu snagu**

indicator /'ɪndɪ,keɪtə/ (n) pokazatelj, pokazivač, indikator: Centrifugal filters fitted for further filtration of the lubricating oil also serve as the **oil condition indicator**. **card indicator**

indikatorski papirić: It does mean that if **indicator cards** are being taken as a check on cylinder performance, several cycles per cylinder should be taken to ensure that a properly representative,

indicator pen pisac indikatora

indicator cock (n) (marine eng) An engine indicator is used to calculate the indicated power of the engine, and this is connected to the indicator cock.. The engine indicator is operated as the engine fires when running normally. The cock is shut before disconnecting the engine indicator. **indikacijski pipac, indikatorski pipac, pipac kalkulatora indicirane snage, pipac pokazivača indicirane snage, pipac:** **The indicator cock** is opened when the engine is being turned over by the turning gear and, when being started for the first time after being shutdown to blow out any water or debris from the cylinder. **The cock** is then shut for normal running. Cylinder heads for 4 stroke engines are of a complex design. They have to house the inlet and exhaust valves, the fuel injector, the air start valve, relief valve and **indicator cock**. The passages for the inlet air and exhaust gas are incorporated, as are the cooling water passages and spaces. The fire was the result of a defective high pressure fuel pump spraying fuel over a hot **indicator cock** on a cylinder head.



indicator diagram (n) (marine eng) **indikatorski dijagram**. The indicator diagram is very important to know the combustion in the cylinder and also to adjust the engine. Indicator diagrams give efficiency of combustion in the cylinder, condition of the running gear, irregularities in fuel pumping and injection and a lot of things. The main engine **indicator cocks** were left open, the turning gear disengaged, the air receiver valves and main air start valve were shut, and the lubricating and cooling water pumps were left running. **The indicator cock** is opened when the engine is being turned over by the turning gear and, when being started for the first time after being shutdown to blow out any water or debris from the cylinder. **The cock** is then shut for normal running. Watch-keeping duties include checking **the cock** is not leaking exhaust gas, if it is a temporary cap can be screwed on, and **the cock** replaced at the first opportunity at next shutdown.

(<http://www.brighthubengineering.com/marine-engines-machinery/53537-main-engine-layout-familiarization-b-and-w-engine-room-layout/>) **irregularities in Indicator diagram nepravilnosti u**

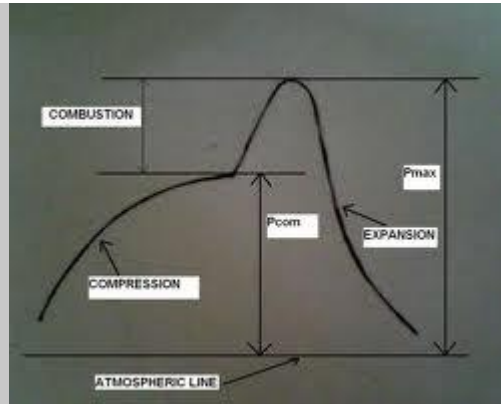

indikatorskom dijagramu

indict /ɪnˈdaɪt/ (v) (mar law) to charge (a person, company) with crime **optužiti**

indictment /ɪnˈdaɪtmənt/ (n) (mar law) **optužnica**: The jury convicted on each of the nine counts in the indictment.

indifferent equilibrium (n) (nav arch) **indiferentna ravnoteža**

indirect drive (n) (marine eng) **posredni pogon, neizravni pogon, pogon s**

reduktorom: The most common form of **indirect drive** of a propeller features one or more medium-speed four-stroke engines connected through clutches and couplings to a reduction gearbox to drive either a fixed pitch or CP propeller. According to the way the main engine is joined to the shafting, they may be classified as direct coupled engines, i.e. coupled directly to the propeller shafting (also called direct drive) and geared engines, i.e. coupled to a reduction gearing (**indirect drive**).

indispensable (adj) **neophodan, prijeko potreban**: For this reason functions that are **indispensable** or needed for safety reasons to protect the machine and/or personnel are denoted with shall while other functions are denoted with should.

indium (n) (chem) **indij**: A thin flash of lead or indium is often added to provide a layer giving protection against corrosion.

indorse /ɪnˈdɔːs/ (v) (mar law) = **endorse** **ovjeriti**

indorsement /ɪnˈdɔːsmənt/ (n) 1 (mar law) = **endorsement** **bilješka na poledini dokumenta, naleđenje; 2 ovjera**

induce /ɪnˈdjuːs/ 1 (marine eng) **inducirati; 2 (electr) povlačiti zrak**: ... while the piston begins to descend on the expansion stroke, the piston movement usually helping to **induce air movement** to assist combustion.

induced air blower (n) (marine eng) **usisni ventilator**

induced draught (n) (marine eng) **umjetni propuh, usisna cirkulacija**

inductance (n) (electr) **indukcija**

induction /ɪnˈdʌkʃən/ (n) 1 (electr) **indukcija**: Synchronous speed: The speed the machine will attain when it is driven by a three-phase squirrel-cage **induction motor** and there is no slip in the motor and the drive system.; 2 (marine eng) **usis, usisavanje, puštanje / uvođenje**: The time period for the **induction** of starting air To improve the **induction** of fuel/air mixture into the crankcase, one-way valves (check valves, reed valves, or rotary valves) may be used in the intake port to allow th The **induction stroke** commences when the inlet valve opens 10° before tdc when air is drawn into the cylinder as the piston moves down.

industrial action (n) (mar law) steps such as a strike or work to rule that workers of a firm may take to enforce their demands or to press addressing of their grievances.

(<http://www.businessdictionary.com/definition/industrial-action.html>) **prestanak rada ili štrajk**

zbor radnih sporova (plaća, uvjeta rada itd.): *A stevedoring company has locked out up to 140 workers at the ports of ... after they took **industrial action** at the weekend. rative The completion date for an extended refit of a Class I passenger vessel, which was new to the company, had been frustratingly **delayed** by **industrial action**.*

industrial dispute (n) (mar law) a disagreement between workers and management over pay, working conditions, hours of work, etc., especially one that includes strikes (= workers refusing to work): (<http://dictionary.cambridge.org/dictionary/english/industrial-dispute>) **radni spor (npr. u luci itd., između sindikata i poslodavaca), prestanak rada zbog radnih sporova** **resolve a industrial dispute** riješiti radni spor (i početi ponovno raditi)

industry /'indəstri/ (n) **1 (shipping econ) grana gospodarstva, grana privrede shipping industry** brodarstvo, brodarsko gospodarstvo, brodarska privreda: *This investigation report is to be circulated among the company vessels and **shipping industry**, **transportation industry (US) transport, transportno gospodarstvo**: The **transportation industry** is the largest industry in the world., **fishing industry** ribarstvo, ribarsko gospodarstvo: *Safety at sea for the **fishing industry** has to be a prime concern, Besides involvement in the UK **fishing industry**, I have also experienced the extremes of artisanal fishing in the Pacific Islands and industrial fisheries of Japan., **marine industry** brodarstvo: He is a Master Mariner and has spent over 33 years in the **marine industry**., **maritime industry** **1** brodarstvo: He began his career in the **maritime industry** as a Deck Officer with in 1964 and came ashore in 1971 having graduated with a BSc in Nautical Science from Southampton University.; **2 pomorsko gospodarstvo, pomorska privreda**: The human element is, quite rightly, a major topic in the maritime industry. Having been involved in the **maritime industry** for more than 63 years, I've seen a dramatic change in the personnel in charge of ports and harbors throughout the world.; **2 industrija (teška, naftna itd.); 3 ljudska djelatnost****

ineffective (adj) **nedjelotvoran, neučinkovit, neefikasan**: *Additionally, Flag State **inspections** of the vessel were **ineffective**. **Ineffective** use of manpower With an **ineffective pump**, water ingress, and a forecast gale, he chose to divert to the nearest port to effect repairs and take shelter. .. pilotage and the port's vessel traffic service were **ineffective** on this occasion. **ineffective lookout** **neefikasno motrenje**: **Ineffective lookout** and failure to take independent action to avoid collision on the part of the crossing vessel.*

inefficient (adj) **1 nedjelotvoran, neefikasan**: *However, **inefficient scavenging** and other losses, reduce the power advantage to about 1.8. The maintenance was considered necessary because the burner unit was emitting excessive black smoke – a sure sign of **inefficient combustion**. **render inefficient** učiniti neefikasnim; **2 bezuspješan***

inert (v) (cargo handling, safety) **inertirati (prazan prostor u tanku)**: *... chemical tankers have nitrogen plants capable of supplying large amounts of N2 but I am not sure if this is sufficient or of high enough quality to **inert all tanks** for all cargoes carried that have a low flash point.*

inert gas; (IG) (n) (cargo handling, safety) **inertni plin**: *Carriage is only permitted under an **inert gas blanket**; The ventilation from an **IG (inert gas) blower** was on but the **IG inlet** was opened on all cargo tanks. During the stoppage, tank pressures rose significantly probably as a result of the unsaturated ullage space containing mainly **inert gas**; During this period, due to very high ambient temperature, No 2P COT pressure relief valve opened, **releasing inert gas (IG)/cargo vapour mixture** to the atmosphere, in breach of the applicable Annex 6 of Marpol. Prior to berthing, the **tank inert gas pressures** had been reduced to 70 mm WG; 4. **The inert gas** is used to blanket the oil cargo during discharging operations.*

inert gas inlet (n) (cargo handling, safety) **ulaz inertnog plina** **close the inert gas inlets** zatvoriti ulaze inertnog plina

inert gas plant (n) (marine eng, safety) **uređaj inertnog plina**: *The inert gas (IG) plant was in operation. so was equipped with a nitrogen gas plant, it was practice to use nitrogen as much as possible for inerting in order to avoid soot generated from the inert gas plant entering the tanks.*

inert gas system; (IGS) (n) (cargo handling, safety) **sustav inertnog plina, sustav za inertiranje atmosfere**: *Line clearance was undertaken for a 45-minute period during which the inert gas system (IGS) was not run.*

inertia /in'ɜ:ʃiə/ (n) **inercija, tromost**: *The first-order inertia force from the lower piston is balanced against the corresponding force from the upper pistons, and a well-balanced engine is obtained. In this case he demonstrated inaccuracy in visual range finding abilities and estimation of own ship speed as well as possible unawareness of ship's inertia characteristics. The inertia forces originating from the unbalanced rotating and reciprocating masses of the engine create unbalanced external moments although the ext The crank also has to absorb the inertia loading due to the conrods and pistons, which easily amounts to several tons on each cylinder. A more robust rod pin end enhances the durability required for the increased piston speeds and higher inertia loads.*

inertial navigation (n) (navig) a navigation aid that uses a computer, motion sensors (accelerometers) and rotation sensors (gyroscopes) to continuously calculate via dead reckoning the position, orientation, and velocity (direction and speed of movement) of a moving object without the need for external references. It is used on vehicles such as ships, aircraft, submarines, guided missiles, and spacecraft. / (Wikip) **inercijalna navigacija**

infectious disease /in'fɛkʃəs di:,zi:z/ (n) (med) = **contagious disease** **infektivna bolest, zarazna bolest**

infested (adj) (safety) **zaražen**

infirmary (n) (med, nav arch) **brodska bolnica**

inflammability (n) (safety) **nezapaljivost**

inflatable boat (n) (boating/yachting, safety) **gumenjak**: *A rigid inflatable boat (RIB) was being employed as a support boat for an event on the water. Fast turns in rigid inflatable boats generate large forces which can throw personnel overboard, despite their best attempts to hold on.*

inflation cord (n) (safety) **konopac za napuhavanje (prsluka za spašavanje)**

information (n) (comm) **obavijest** **obtain information** **dobiti / ishoditi informacije / podatke, scanty information** **oskudni podaci**: *A master's reliance on scanty VHF*

information and another's failure to keep a proper lookout contributed to a collision between a containership and an oil tanker off Jebel Ali earlier this year, AIS information **informacije**

dobivene sustavom AIS: *The lack of AIS information possibly contributed to the tanker master's ignorance of the container ship's identity immediately before the collision., exchange information*

razmijeniti informacije *The master and pilot exchanged information on the vessel's status and briefly discussed the planned departure manoeuvre., wait for further information* **čekati na**

daljnje informacije: *Approximately 30 minutes before arrival at the station he was therefore advised to stop and wait for further information., provision of information* **davanje informacija,**

pružanje informacija: *Provision of information to the surveyor concerning the normal working level of the liquid contained within a tank, and ..., unambiguous information*

nedvosmislene informacije: *When crew critical to an operation are located out of sight of each other, it is vital that unambiguous information is relayed, and that all involved understand their role and responsibilities. {Note that the noun informatio is regularly used in the singular form in English (uncountable noun). The form informations is not acceptable.}*

information exchange (n) **razmjena informacija, razmjena podataka**: *The*

*Master/Pilot information exchange had been carried out in accordance with the Company Safety Management System and the Master had discussed the prevailing weather conditions had already let go and by the time the pilot arrived on the bridge the master had started the departure manoeuvre without any form of **master / pilot information exchange** or notification of his intentions. The **master and pilot shall exchange information regarding** the navigation procedures, local conditions and the ship's characteristics. The ship's stability was determined using the vessel's on board stability computer with **the information provided by the staff captain and the chief engineer.***

information service (n) (navig, safety) služba koja priprema izvješća i upute brodovima u plovodbi u području nadležnosti o događajima i okolnostima zbog kojih bi mogli biti ugroženi ljudski životi, sredstva i morski okoliš **služba izvješćivanja**: Three levels of service can be provided: an **information service (INS)**, a navigational assistance service (NAS) and a traffic organisation service (TOS). The VTS Information Service gave regular traffic broadcasts on the port operations VH radio channel.

infrared (adj) **infracrven**: The coastguard helicopter arrived within 5 minutes and, using the **on board infrared (IR) equipment**, was able to identify to the skipper that the seat of the fire was in the starboard after corner of the engine room.

infrastructure /ˈɪnfɹəˌstrʌktʃə/ (n) (ports) **infrastruktura**: The Port Authority is investing heavily in infrastructure at its container terminals and other facilities and will continue to deliver a high level of service to all carriers. There were no injuries or pollution, but damage was caused to **infrastructure on the quayside** and the vessel's hull in way of empty ballast tanks. This resulted in the vessel making multiple contacts with the jetty's **infrastructure**, resulting in material damage to both the jetty and the vessel before control was regained. **port infrastructure** sea locks, waterways, breakwaters, quay walls, wharves, docks, piers, jetties, and main roads in a port **lučka infrastruktura**: To ensure safety of personnel and **port infrastructure**, we emailed a request to the overseas shipper asking for a document stating the actual weight of each unit as shipped., **shore infrastructure** **obalna infrastruktura**: ears in this area, involving loss of control of large vessels during times of strong tidal flow, resulting in contact damage to vessels and shore infrastructure.

infringe (v) (mar law) **povrijediti, prekršiti** (propise, ugovor)

infringement (n) (mar law) **kršenje** (propisa, ugovora), **prekršaj, povreda** (propisa) Failure to comply with certification requirement may result in a heavy fine, arrest or a penalty due to the **infringement of flag/port state requirements.**

in good order and condition (mar law) **u dobrom izgledu i stanju, klauzula u dobrom izgledu i stanju**

in good working order (safety) **u dobrom stanju za normalan rad**: Check if the inert gas system (IGS) is **fully operational and in good working order**. arrangements (pilot ladder, accommodation ladder, winches, wires, davits, sheaves and all associated equipment) have been thoroughly inspected and **are in good working order**, and comply with IMO recommendations. In addition to authorised service personnel, crew have equal responsibility **for ensuring that lifeboats are in good working order** and are maintained and operated properly.

ingress /ˈɪŋɡrɛs/ (n) (safety) **prodor** **ingress of ballast water into holds** (cargo, mar ins) **prodor balastne vode u brodska skladišta**: the Master discovered that **there was water ingress in No 3(P) ballast deep tank.**, **ingress of water** **prodor vode (u brod)** Ship's tanks and compartments were sounded and monitored for any **ingress of water** or possibility of pollution,

inherent /ɪnˈhɪərənt/ (adj) **sadržan u nečem, inherentan, sam po sebi** This points out the **dangers inherent in false information from ARPA** at low ranges and fast moving vessels in these close quarter situations. The **risks inherent in all lifting operations**, including the launching of watercraft, must be rigorously assessed and safe working practices developed. **inherent vice** **skrivena mana**

inherent vice (n) (nav arch) skrivena mana

inhibit (v) 1 kočiti, ukočiti; 2 spriječiti: The flame deck has drilled coolant channels to inhibit large thermal stresses. To reduce the corrosive action and inhibit the formation of scale deposits in the system it is usual to provide some form of water treatment.

in-irons (n) (boating/yachting) when the bow of a sailboat is headed into the wind and the boat has stalled and is unable to maneuver jedrilica okrenuta sasvim u vjetar, bez kretanja

initial alarm (n) (safety, marine eng) prvi alarm: Main power was restored 15 hours after the initial alarm.

initial course (n) (navig, safety) početni kurs (U SAR-u): After turning my vessel 100 degrees from its initial course he was on my port quarter. It was dark, and shortly after making an initial course alteration to effect his chosen route, the master fell asleep. Assessing my own and the probable intentions of my two targets, I decided to stay on my initial course running over my waypoint.

initial distress message prva poruka za pomoć u pogibli, prva poruka za pomoć koju šalje brod u pogibli

initial operational capability (n) (navig, electr) početak rada (navigacijskog sustava)

initial report (n) (navig, comm) izvješće koje plovni objekt predaje službi VTS pri uplovljavanju u područje njezine nadležnosti početno izvješće: Wherever possible after the initial report, the master may delegate the task of filing reports to additional parties to a responsible agency or person.

initials /iˈniʃəlz/ (n) početna slova, inicijali

initial ship design (n) (nav arch) osnivanje broda

initial stability (n) (stabil) The stability of a ship in the range from 0° to 7°/10° of inclination

početna stabilnost: Although this ballast would have improved initial stability, the effect of the decreased freeboard would have also reduced the vessel's righting lever.

initial transverse metacentre; (M) (n) (stabil) the point of intersection of successive lines of action of buoyancy force (f) when the ship is in the upright condition and subsequently heeled conditions (Rhodes, Ship's Stability, Seamanship, 2003) početni poprečni metacentar

initial transverse stability (n) (stabil) početna poprečna stabilnost

inject /inˈdʒekt/ (v) (marine eng) ubrizgati: The electronically controlled Alpha Lubricator was developed to inject the oil into the cylinder directly on the piston ring pack at the exact time that the effect is optimal. Gas injection is stopped immediately on the first failure to inject the pilot oil by the patented safety valve incorporated in the control oil pump of the engine.

injection /inˈdʒɛkʃən/ (n) **injection valve** 1 ventil za ubrizgavanje: The fuel injection valve is located in the centre of the cylinder head.; 2 fuel injection valve ventil za ubrizgavanje goriva: The fuel injection valve is located in a valve sleeve in the centre of the cylinder head, its opening controlled by the fuel oil pressure and closure effected by the fuel oil pressure. (marine eng)

ubrizgavanje, uštrcavanje injection pump pumpa za ubrizgavanje: The fire was caused by fuel oil spraying from the main engine fuel injection pump where a threaded erosion plug had worked loose and blown out., **injection pump drive** pogon pumpe za ubrizgavanje: The new lower valve and injection pump drive design yielded greater simplicity and eliminated the need for adjustments.,

fuel injection pumpa goriva, fuel injection system sustav za ubrizgavanje goriva: The HP part of the fuel injection system, with the functions of HP generation and accumulation as well as fuel metering, comprises the following:

injection pump (n) (marine eng) pumpa ubrizgavanja goriva: Valve-controlled fuel

injection pumps are located at the height of the cylinder blocks. The cylinder liners are lubricated using separate **injection pumps** which use a different specification of oil.

injection system (n) (marine eng) **uređaj za ubrizgavanje** The nozzle is the interface between the **injection system** and the combustion process: good nozzle performance is essential for good combustion. Two electrically driven pumps installed at the front end of the engine provide hydraulic power for the **injection system**.

injection timing (n) (marine eng) **reguliranje vremena ubrizgavanja, faza ubrizgavanja, tempiranje ubrizgavanja** The cetane number or diesel index will **determine injection timing** and also influences the combustion noise and production of black smoke. **Fuel injection timing** can be freely adjusted independently of the injected quantity, Higher NOx emissions were neutralized by slightly **delayed injection timing**.

injection valve (n) (marine eng) **ventil za ubrizgavanje** Each cylinder is individually served by a fuel injection pump, HP pipe and **injection valve** with uncooled nozzle. The pilot fuel system is a common rail (CR) system with one engine-mounted high-pressure pump supplying the pilot fuel to every **injection valve** at a constant pressure of 900 bar.

injector /in'dʒektə/ (n) (marine eng) **ubrizgač, raspršivač, rasprskač**: The in-line six-cylinder model benefited from an upgraded fuel injection pump and a new **injector** as well as a new charge-air cooling system, which reduces the inlet air temperature by around 10°C ... Further upward movement of the plunger causes the fuel to be raised in pressure and expelled through the delivery valve to the **injector**. **injector nozzle mlaznica ubrizgača** The fuel flows at high velocity through small holes in the **injector nozzle** causing it to divide up into fine spray which penetrates throughout the combustion chamber. **injector needle valve igličasti ventil ubrizgača**: ... the injector has to snap open when the timed HP wave from the pump travelling along the HP pipe has reached the **injector needle valve**. **injector cam brijeg ubrizgača (na bregastom vratilu / osovini) ekscentar za ubrizgač (na bregastom vratilu / osovini)** The camshaft contains the exhaust

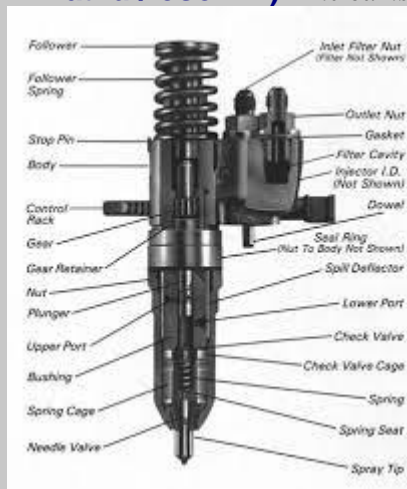

valve cams as well as the unit **injector cams**.

injunction (n) (mar law) an order from a court that prevents someone from doing something **zabrana, mjera, nalog, sudski nalog o zabrani, naredba administrative injunction administrativna zabrana, temporary injunction privremena zabrana (isplovljenja broda)** A **temporary injunction** - arrest of a ship (yacht), which is situated in a marina, shall be effected in a manner that the arrested ship remains berthed within the waters of the port. **grant an injunction izdati zabranu, obtain an injunction against a carrier ishoditi zabranu (od suda) protiv prijevoznika / vozara**

injure (n) **ozlijediti, povrijediti**: Fortunately, **no one was injured**. Na sreću nitko nije bio ozlijeđen. As a result of the sea state during the subsequent manoeuvres, several persons on board the tug **were injured**. The AB reported from the forecandle that **the bosun was seriously injured**. The ship suffered minor damage to her bow but **nobody on board was seriously injured** and there was no pollution.

injured (adj) **ozlijeđen, povrijeđen**: Immediately after berthing, **the injured crew** was sent ashore and the doctor diagnosed a bone fracture, ligament injury and subcutaneous haematoma.

injury (n) (safety) **ozljeda, povreda**: Both vessels suffered major structural damage to their bows, but **there were no injuries** or pollution. - The CE was not wearing gloves, which could have reduced the severity of the injury. No **injuries** or pollution have been reported. **fatal injury smrtonosna ozljeda, fatalna ozljeda**: A **fatal injury** to a crew member on a platform supply ship occurred while the ship was at anchor off the port, **severe injury ozbiljna ozljeda** The failure caused **severe injury** to a stevedore and gave rise to a lengthy off-hire period., **suffer injury ozlijediti se, biti ozlijeđen, doživjeti ozljedu, zadobiti ozljedu**: We are very relieved that our crew are safe and have not suffered any serious injuries., **escape injury izbjeći ozljedu, sustain injury zadobiti ozljedu, pretrpjeti ozljedu, ozlijediti se**: a serious injury sustained when falling overboard on 7 August 2005, **serious injury = serious injury ozbiljna ozljeda**: Fortunately, despite being struck lightly by the pilot boat and scratched by the ship's hull, **the pilot did not sustain any serious injury** and was quickly rescued from the water by the pilot boat's crew. **Wherever there is a serious injury**, a "Mayday" call would be appropriate. **Due to the serious injury**, and under radio medical advice, the vessel deviated to the nearest port, from where the injured crewmember was flown to Singapore

.., **injury due to ozljeda uslijed, ozljeda zbog**: Injury due to parted mooring rope., **injury to (a person) ozljeda (osobe)**: Mooring line failure resulting in serious injury to a deck officer on board the ship ..., **cause injury izazvati ozljedu, prouzročiti ozljedu**: Sudden release of load caused injury Inappropriate use of disc grinder caused injury, **fatal crush injury kobna ozljeda gnječanjem**: As the vessel's bow moved away from the jetty, an AB who was standing inside the bight of the spring line suffered a **fatal crush injury**., **burn injury opeklina**: An crewmember sustained severe burn injury., **scald injury ozljeda prženjem, opeklina, ofuriti se**: The oiler had a large 2nd degree scald injury on his left ankle., **hand / head / leg / eye injury ozljeda ruke / glave / noge / oka**: A ship's crew member sustained a serious hand injury while using an air driven deck scaler during maintenance operations. The spreader and chain block fell on to the bottom plates violently, **inflicting a head injury** on a crew member. Ultra violet light caused **eye injury**. Whilst changing the ultra violet (UV) lamp in the ship's fresh water steriliser unit, a crewmember inadvertently switched on the UV light and stared

ink fish (n) (fishing) **liganj**

inland (adj) **1 kopneni; 2 obalni, na kopnu; 3 u unutrašnjosti; 4 (navig) unutrašnji (plovni putovi) inland port luka unutrašnjih plovnih putova, unutrašnja luka**: The two ships collided in dense fog in the Kiel Canal's **inland port** of Brunsbüttel., **inland sea pilot pilot za unutrašnje plovne putove**: Taking an **Inland Sea pilot** was not necessary but without hesitation I decided to take a pilot for berthing., **inland vessel brod unutrašnjih plovnih putova**: A new mate joined a small **inland passenger vessel** for his first day of work. The hatch crane and hatch arrangement are similar to those in many small ocean going and **inland vessels**.

inland navigation ship (n) (mar law, navig) **brod unutrašnje plovidbe**

inland port (n) (ports) **unutrašnja luka, luka na unutrašnjem plovnom putu**:

Expanding intermodal service in South Carolina through **Inland Port Dillon** will create a competitive

advantage for area businesses by lowering transportation costs and providing greater access to domestic and international markets. <http://www.marinelink.com/news/carolina-planned-inland415305.aspx>

inland waterways (n) (mar law) unutarnji plovidbeni putovi, unutrašnji plovni

putovi It is essential that any information affecting the safe navigation of inland waterways is brought to the attention of all users. The vessel, a typical box/barge type capable of inland waterway transportation, was under the British flag and only a few years old.

inland waterway unit (n) (nav arch, mar law) plovni objekt unutarnje plovidbe, ploveći objekt unutanje plovidbe

inland waterway vessel (n) (nav arch, mar law) brod unutarnje plovidbe

inlet (n) 1 (marine eng) ulaz inlet water ulazna voda, ulaz za vodu; 2 ulazni otvor

(zraka / pare / vode / ulja / goriva itd.); 3 dovod inlet valve dovodni ventil, ulazni

ventil. Closure of the inlet valve is timed so that just the right amount of air is sucked into the cylinders. The inlet valve closes 1° before bdc. The inlet valve is open and a fresh charge of air is being drawn or pushed into the cylinder by the turbocharger. air inlet ventil za ulaz zraka, ventil za

usis zraka, inlet pipe dovodna cijev: The inlet pipe has to be replaced with a new one.

inlet port (n) (marine eng) otvor za usis zraka: Here the inlet ports are machined around the liner about 1/3 of the way up from the bottom. The opening and closing of the exhaust and air inlet ports are shown diagrammatically in the typical timing diagram.

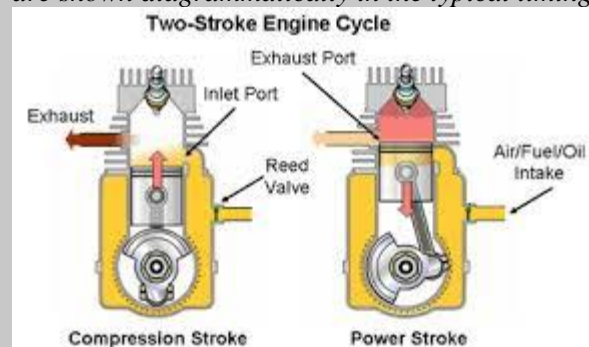

{na cilindru i bloku stroja}

inlet vanes (n) (marine eng) ulazne lopatice

in-line engine (n) (marine eng) redni motor, motor s cilindrima u nizu, L-motor: ... a 320a 320mm mm bore/420bore/420mm mm stroke design which had been offered as stroke design which had been offered as an in-line engine with six, eight and nine cylinders or as V12 and V16 versions with an output of 370 kW/cylinder. As an option for particularly difficult applications, the in-line engine can be specified with control of the turbocharger turbine surface by MaK's Variable Multi-Pulse (VMP) system.

INMARSAT (n) (comm, navig) a British satellite telecommunications company, offering global, mobile services. It provides telephone and data services to users worldwide, via portable or mobile terminals which communicate to ground stations through eleven geostationary telecommunications satellites. **Organizacija INMARSAT:** Maintain the Inmarsat SafetyNET watch and disable the HF DSC watch until it has to be activated as the standby means of shore-ship alerting, should SafetyNET fail ... If the sole means of Distress Alerting in Sea Area A3 were INMARSAT-C, disregarding the use of an EPIRB, the number of False Distress Alerts/Relays would be significantly less. To look at it from another angle: Inmarsat-A, Inmarsat-B and Fleet 77 equipment is all allowed to be installed as part of a ship's GMDSS fit. So, if their Inmarsat-A happens to include a SafetyNET facility, they do not have to programme their 'A' to receive SafetyNET information in addition to their Inmarsat-C.

inner anchorage (n) (navig, ports) nutarnje sidrište, sidrište u zaštićenom dijelu

luke: Our vessel was anchored in a crowded inner anchorage with a current of up to two knots.

inner bottom (n) (nav arch) = **tank top** inner skin or tank top plating; the plating over the double bottom **pokrov dvodna**

inner pilot station (n) (navig, ports) **peljarska postaja u zaštićenom dijelu luke**:

Pilotage is only compulsory from the inner pilot station.

inner port / harbour (n) (ports) **nutarnja luka, zaštićen lučki dio (od valova), luči**

akvatorij zaštićen od otvorenog mora (za ukrcaj peljara): *As the ship approached the inner harbour, speed was reduced to half ahead, giving about 4.3 nm. There were no other vessels moving either in the outer harbour, or the inner harbour, and the navigational light at the entrance to the inner harbour was clear and un-obscured.*

inner-post (n) (sailing vessels) **krmena protustatva**

inner stern post (n) (sailing vessels) **krmena protustatva**

inner surface (n) **nutarnja površina**: *The inner surface of the cylinder liner is usually chrome plated to make it smooth but this smoothness also has its drawback that it does not. Further, the inner surfaces of exhaust gas uptakes and economisers are invariably coated with a highly corrosive and toxic, jelly-like residue and even if skin contact*

innocent passage (mar law) ship or aircraft's right to enter and pass through another's territory so long as it is not prejudicial to the peace, good order or security of the other state. (Duhaimé)

neškodljivi prolaz, slobodan prolaz (tjesnacima, kanalima itd) right of innocent passage **pravo neškodljiva prolaza**

inoculate /iˈnɒkjʊˌleɪt/ (v) (med) **cijepiti (se)**

inoculation /ɪˌnɒkjəˈleɪʃən/ (n) **cijepljenje (radi imunizacije) inoculation certificate** **potvrda o cijepljenju**

inoperative (adj) **pokvaren, koji ne radi / ne funkcionira**: *the vessel was moving astern and had an inoperative bow thruster Fog signal ... (charted name of light / buoy) in position ... inoperative.*

(IMO SMCP) Even if her radar had been inoperative, the bridge watch must have been very much at fault to mistake the lights and to have been in the deep water route. Simple failures render CO2 system inoperative. The ECDIS audible alarm was inoperative. The third accident involved a ro-ro vessel entering the same lock; this vessel was moving astern and had an inoperative bow thruster.

in order to (conj) **s ciljem, kako bi (pri izražavanju namjere)**: *In order to allow a wider clearance, the tanker reduced speed to dead slow. Simultaneously, his aspect was observed to change as he altered course to port and we quickly reversed the helm and steadied up back on 3100 T in order to allow him to pass round our stern. In order to allow a wider clearance, the tanker reduced speed to dead slow.*

in personam (Latin) A type of legal proceedings directed against the defendant personally (e.g. an action for breach of contract, the commission of a tort or delict or the possession of property). Where an action in personam is successful, the judgment may be enforced against all of the defendant's assets, real and personal, moveable and immovable. (Tetley) **pravni postupak u odnosu na osobu**

(tvrtku, trgovačko društvo), in personam (lat.), protiv osobe: *Although admiralty are frequently in personam, against individual or corporate defendants only, the most distinctive feature of admiralty practice is the proceeding in rem, against maritime property.*

inquire, enquire /ɪnˈkwaɪə(r)/ (v) **1 tražiti (informacije) pitati**: *When the two vessels were a little over 4 miles apart, the south-west bound vessel called on VHF channel 16 to inquire into the crossing vessel's intentions. When the two vessels were a little over 4 miles apart, the south-west bound vessel called on VHF channel 16 to inquire into the crossing vessel's intentions.*; **2 (mar law)**

istraživati

inquiry, enquiry /UK ɪnˈkwaɪəri; US ˈɪnkwəri/ (n) **1 (mar law) istraga, The subsequent**

court of inquiry held that the primary cause was the piston of No.: *In our inquiry we found out that SMS procedures were not fully implemented. An inquiry into the incident asked a number of embarrassing questions* **In our inquiry we found our SMS procedures were not fully implemented. court of inquiry, enquiry sud istrage:** *The subsequent court of inquiry held that the primary cause was the piston of No.;* **2 (shipping econ) upit;** **3 traženje informacije make enquiries raspitati se zatražiti informacije**

in rem (Latin) A type of legal proceedings, taken in an admiralty court in a common law jurisdiction, against the ship (and sometimes against cargo and/or freight) (the res) as defendant, in respect of particular types of maritime claims (e.g. to enforce a claim secured by a maritime lien or a statutory right in rem). The taking of an action in rem is generally accompanied by the arrest (supra) of the res, which provides pre-judgment security for the claim and confirms the admiralty court's in rem jurisdiction. (Tetley) **in rem, pravni postupak u odnosu na stvar (npr. brod, teret, vozarinu), protiv stvari:** *Arrest of a vessel is part of the process by which an Admiralty Court gains jurisdiction over the subject matter of a law suit. These lawsuits are known as in rem actions meaning that the action is again a thing rather than a person.*

http://www.maritimelawcenter.com/html/arrest_of_vessel.html

insert (v) 1 umetnuti; 2 uvrstiti

insert (n) (marine eng, electr) umetak, uložak: *The piston consists of a piston crown, piston skirt and cooling insert for oil cooling. An internal insert in the piston crown serves only to direct the cooling water flow and, in particular, to generate water jets, ..*

Inshore Traffic Zone; ITZ (n) (navig, safety) područje između priobalne crte sustava odijeljenoga prometa i obalnoga ruba područje priobalnoga prometa, zona priobalne plovidbe (u shemi odvojene plovidbe): *She had crossed a TSS and Inshore Traffic Zone without anyone having questioned her track until just before she grounded. There were other vessels in the area with the ability to monitor the vessel's AIS signal, none had questioned her track across the TSS and into the Inshore Traffic Zone until she was close to grounding. ... the inshore traffic zone is effectively closed to larger vessels proceeding eastbound from Tanjung Pelepas and Singapore.*

insignia /ɪnˈsɪɡniə/ (n) (mar law) COMPARE naval rank znakovlje, oznake officers' insignia časničko znakovlje



, Captain's

curve kapetanska petlja (dio oznake na rukavu), stripe pruga (oznake na rukavu), štrika

INS; integrated navigation system (n) (navig) integrirani navigacijski sustav, sustav integrirane navigacije: *The purpose of integrated navigation systems (INS) is to enhance the safety of navigation by providing integrated and augmented functions to avoid geographic, traffic and*

environmental hazards.

insofar as (*mar law*) **ukoliko, što se tiče**

inspect /in'spekt/ (v) **1 (safety) pregledati, obaviti inspekcijski pregled (broda),**

pažljivo pregledati: *The undersigned duly authorised by the ... Marine Administration, hereby declares that the above-mentioned vessel has been inspected as indicated below. Inspect cargo as it comes on board. Accordingly, our onboard procedures ensure that my highly reliable and competent crew open, inspect and seal every empty container on the quay before being loaded. On the bridge I informed the*

Master and he inspected the ladder himself. inspect the tanks pregledati tankove, inspect for damages pregledati radi utvrđivanja oštećenja *The boxships is being inspected for any*

damages following a brief grounding incident., inspect the cargo pregledati teret: *Five days into*

the voyage, the first mate intended to inspect the cargo via the access in the forecastle., inspect the pilot ladder arrangement ispitati kako su postavljene peljarske ljestve: *In this case the*

pilot in question boarded the vessel over the stern ramp and did not have the opportunity to inspect the pilot ladder arrangement prior to using it (the same might also be said when the pilot embarks for the first time

from a launch).; 2 nadzirati tour of inspect obilazak (broda / strojarnice) radi nadzora

inspection /in'spektʃən/ (n) **1 pregled, inspekcija make an inspection of pregledati,**

obaviti pregled: *Record in the log book inspections of cargo holds undertaken by the ship's officers or crew during the voyage., perform the inspection obaviti pregled, izvršiti pregled:* *The*

inspection was performed under the authority of ... Maritime Administration, special inspection

izvanredni pregled broda, occasional inspection izvanredni pregled broda, initial

inspection osnovni pregled broda, routine inspection uobičajeni pregled, redoviti

pregled, rutinski pregled: *About 45 minutes later, the Chief Officer also went down to the tunnels to carry out his routine inspection and monitoring of the self-discharging system., conduct an*

inspection provoditi pregled, follow-up inspection naknadni pregled, naknadna

inspekcija, hold inspection inspekcijski pregled skladišta, pregled skladišta: *A*

recent example of the problem was a pre-loading hold inspection and suitability survey on a vessel which was to load fertiliser., inspection hole otvor za pregled, otvor za inspekciju, inspection

revealed that inspekcija je otkrila da .., inspekcija je pokazala da: *An inspection*

revealed that the damage was confined to the bow thruster compartment and in way of the grey water

tank., inspection of the hull inspekcija trupa: *The subsequent diver's inspection of the hull identified that the leading edges of the propeller blades were polished and that there was a mass of large*

size monofilament ... , annual inspection godišnji pregled, godišnja inspekcija *Serious*

injury to crew member during a free-fall lifeboat annual inspection in the port of Marseille on ...; 2

nadzor

inspection report (n) (*mar ins, mar law*) **izvješće o pregledu:** *The introduction of quarterly reviews of risk assessments based on port state control inspection reports, external and internal audits and crew feedback.*

Carrier inspection report vozarovo (prijevoznikovo) izvješće o pregledu

inspector (n) (*safety*) **inspektor, inspektor sigurnosti plovidbe:** *In one, a cargo inspector departed the job-site in the early hours of the morning after a long day loading a bulk-carrier. Even*

classification societies and the class inspector on board during the vessel construction can make mistakes or miss something. On one occasion as a marine inspector, I was driving home at the end of a very long

work day and I fell asleep at the wheel.

in spite of (*conj*) = **despite usprkos:** *In spite of applying more starboard helm, the helmsman*

was unable to stop the head paying off to port even more rapidly. In the Oil Record Book some ships show nil remains of oil on board **in spite of** the massive tank cleaning operations that have taken place.

instability (n) (nav arch, safety) **nestabilnost, promjenjivost** ... longitudinal bulkheads may cause large free surface effects to the extent that the initial metacentric height (GM) becomes negative. **This creates initial instability** and results in heeling to an angle where the ship becomes stable again (lolling). As the group members stood up, the centre of gravity rose and the **boat's instability increased**, eventually causing it to capsize.

install (v) **ugraditi, instalirati, montirati, postaviti**

installation (n) **1 (n) (ports) postrojenje port installations lučka postrojenja, marine installation brodsko postrojenje, shore installation obalno postrojenje, steam turbine installation turbinsko postrojenje, postrojenje parnih turbina; 2 (marine eng) instaliranje, montiranje, postavljanje; 3 instalacija, uređaj; 4 (marine eng) ugradba** Integration of the ancillaries on the engine further eases **shipboard installation** procedures.

in stays (prep phr) (boating/yachting) = **in-irons** jedrilica okrenuta sasvim u vjetar, bez kretanja

Institute Cargo Clauses (n) (mar ins) **Institutske klauzule za teret (za**

kargo-osiguranje) Cargo insurance is usually written in one of two ways, either all risks (**Institute Cargo clause** (A)) or named perils (**Institute Cargo clauses** (B) and (C)). The range of subjects that are covered by the **institute cargo clauses** are as varied as the cargoes that a ship can carry

Institute clauses for builders (n) (mar law) **Institutske klauzule za rizik gradnje**

Institute port risk clauses (n) (mar ins) **Institutske klauzule za lučki rizik**

Institute Time Clauses - Hulls (n) (mar ins) **Institutske klauzule za brod (ua kasko osiguranje)**

Institute War and Strike Clauses (n) **Institutske klauzule za osiguranje rizika od rata i štrajka**

instruct (v) **uputiti, narediti**: The port authorities **instructed** both vessels to proceed to the pilot station

instruction **1 naredba**: When the main engine was running again at about 1900, the Master intended to follow the vessel **operator's instruction** and sail to the port of destination. The container ship's third officer returned to the bridge and, **on instruction from the master**, he rang 'full away' with an engine setting of 80rpm.; **2 (marine eng) upute (za rad, rukovanje, održavanje) uputstvo operating instructions upute za rukovanje** These operating instructions describe routine procedures to follow before and during the start, running and stopping sequences of the separator. Then the fuel oil system will be primed as described in the builders' operating instructions.; **3 (comm) The Message Marker INSTRUCTION** indicates the intention of the sender to inform others about danger.. It must be accepted and carried out by the receiver of the message. **uputa (oznaka poruke u IMO SMCP) INSTRUCTION**. Do not cross the fairway. UPUTA. Ne presjecajte plovidbeni put.

instrument **1 (electr, marine eng) instrument, pokazna naprava**: The C-Command **instrument panels** include a selection of modular monitoring and display options that assist in protecting and enhancing engine operations. Even when driving a generator it is necessary to allow for generator efficiency and **instrument accuracy**. To monitor the traffic on radar, the skipper had to switch between the echo sounder and radar modes on his multifunction **navigational instrument**. **display instrument pokazni instrument, prikazna naprava; 2 (mar law) zakonski**

dokument legal instrument zakonski dokument, zakonska isprava, negotiable instrument **utrživi dokument, negocijabilni instrument** A Bill of Lading is a receipt for the goods shipped, a transferable document of title to the goods thereby enabling the holder to demand the cargo, evidence of the terms of the contract of affreightment but not the actual contract, and a quasi negotiable instrument.

instrumentation (n) (marine eng) **kontrolno-mjerni instrumenti**: However, the clutch appeared to be performing correctly and the chief engineer decided the problem was due to an **instrumentation fault**. The intervention adversely affected the master's ability to maintain a lookout and monitor the **instrumentation on bridge console**. **Bridge wing instrumentation** provides an important tool for checking that helm or engine orders have been correctly executed.

insufficient (adj) **nedovoljan, nedostatan**: When the electrician stopped the first supply fan, there was **insufficient air** available for the main engine turbochargers, causing sudden depressurisation within the engine room. The available headroom is also important in some ships, notably ferries with vehicle decks, and **insufficient headroom** and surrounding free space may make it difficult or impossible for some engines to be installed or overhauled. Noticing the very short time taken to heave up the anchor, it is likely that the other ship had paid out **insufficient chain** under the conditions.

insulate /'insjuleit/ (v) **1 (marine eng, electr) izolirati**: One solution is to **insulate the outside of the liner** so that there was a reduction in the cooling effect. Check that all **exhaust pipes on their vessels are fully insulated** and do not come close to combustible material. The electric cables were **not insulated** properly. ; **2 (cargo handling) izolirati teret**: The cargo should be **insulated** from sources of heat due to vessel operations.

insulated /'insjuleitid/ **1 (electr) izoliran; 2 (marine eng) toplinski izoliran**: The MAIB has concluded that the most likely cause of the fire on board the ship was the **poorly insulated hot exhaust pipe** igniting the plywood structure of the vessel. ; **3 zvučno izoliran sound-insulated zvučno izoliran**

insulation /'insju'leifən/ (n) **1 (electr, marine eng, cargo handling) izolacija**: The **insulation** was observed to be zero **zamijećeno je da je izolacija potpuno istrošena / nestala cable insulation, heat transfer to the other side of bulkheads/decks, and the possible release of gas from nearby gas bottles.** ; **2 (marine eng, cargo handling) izoliranje (od temeperature, mehaničkog dodira itd.)**: The **insulation** and leakage containment cover over the fuel line had not been renewed/refitted. The engine re-started **when the insulation burnt through** on the start electrics, which connected the start circuits.

insulator /'insjuleitə/ (n) (electr) **izolator, loš vodič**

insurable property (n) (mar ins) **osigurljiva imovina**

insurable risk (n) (mar ins) **osigurljiv rizik**

insurance /in'ʃʊərəns ; in'ʃɔ:rəns/ (n) (mar ins, mar law) Insurance is a means of protection against loss, whereby the cost of the loss, which would otherwise fall upon the owners, is taken over by the insurer. **osiguranje**: In general practice the insured does not deal directly with the underwriters, but negotiates through an **insurance**. The **insurance** also covers the crew's hospital bills and costs of sending replacement personnel to the ship if necessary. The Company shall **conclude appropriate insurance to cover themselves fully** against the possible contingencies arising from the Articles of this Agreement.

carry insurance with osigurati se kod, sklopiti osiguranje s, marine insurance pomorsko osiguranje: Insurance brokers, who act as the intermediary between the ship/cargo owner and the underwriters when **marine insurance** is negotiated. , **insurance rates premije**

osiguranja: The shipowner could gain by having his ship in class be obtaining more favourable **insurance rates** and better chartering arrangements. , **insurance of risks osiguranje rizika**

insurance broker (n) (mar ins) Insurance brokers act as the intermediary between the ship/cargo owner and the underwriters when marine insurance is negotiated. **osiguravateljski posrednik, osiguravateljski mešetar, osiguravateljski agent, osiguravateljski broker.** *These recommendations are meant more particularly for: -shipbuilders, -classification societies, -shipowners and the organizations which represent them, -shippers and insurance brokers. The marine insurance broker is the professional intermediary and is the agent for the assured. Hull and machinery cover is often arranged and placed in the insurance market by a professional insurance broker.*

insurance claim (n) (mar ins) **zahtjev za naknadu štete:** *Please make the necessary arrangements for a quick settlement of our insurance claim.*

insurance clause (n) (mar law, mar ins) **klausula o osiguranju**

insurance company (n) (mar ins) = **underwriter = insurer osiguravatelj,**

osiguravajuće društvo: *Would the insurance companies pay out in the event of an accident when the investigation reveals there was no lookout posted?*

insurance of goods (n) (mar ins) = **cargo insurance osiguranje robe, kargo**

osiguranje *Thereafter the buyer incurs all the cargoes including insurance of the goods from departure to the port of destination and pays the freight.*

insurance policy (n) (mar ins) An Insurance Policy is a written contract whereby the insurer (an insurance company), on the basis of an agreed payment termed the premium, undertakes to make good to the insured, any loss or damage to the property specified therein. **polica osiguranja:** *to be done, how it is to be achieved, what equipment is to be used, and the safety precautions to be taken, is a valuable insurance policy; one which usually yields high dividends. The seller is entitled to payment in exchange for the documents –including bill of lading and insurance policy – relative to the shipment.*

marine insurance policy polica pomorskoga osiguranja: *Particular average is normally covered by a marine insurance policy, held with a marine underwriter, which extends to total as well as partial loss.*

insurance premium (n) (mar ins) **premija osiguranja:** *The charterparty may state that the charterer has the privilege of breaching the trading limits by paying an extra insurance premium. Advantages of groupage include less packing: lower insurance premiums; usually quicker transits; less risk of damage and pilferage; and lower rates when compared with such cargo being despatched as an individual shipment. When a shipowner buys a ship, or needs to renew his annual insurance premium, or a cargo owner requires to have his goods insured for the forthcoming voyage, he usually asks his broker to find insurance cover.*

insure (v) (mar ins) **osigurati be insured biti osiguran, osigurati se:** *Goods are as a rule insured against various risks from the moment they leave the suppliers' storehouses until they enter the storehouses of the consignees*

insure against (v) (mar law, mar ins) **osigurati protiv rizika:** *Goods are as a rule insured against various risks from the moment they leave the suppliers' storehouses until they enter the storehouses of the consignees.*

insured /in'ʃʊəd; in'ʃɔ:d/ (n) (mar ins) **osiguranik the insured osiguranik**

insured with (adj) (mar ins) **osiguran kod (osiguravajućeg društva):** *A large container vessel insured with has recently experienced a serious loss of containers.as of 1973 the operators of about 80 percent of the world's ocean tonnage were insured with the British clubs and their Scandinavian and Japanese affiliates Ex.*

insurer /in'ʃʊərə; in'ʃɔ:rə/ **insurers osiguratelj osiguravateljsko društvo:** *After assessing the vessel's watertight integrity and the depth of the water surrounding her; they informed the coastal state authority, owners, insurers and Flag State; (mar ins) osiguratelj, osiguravateljsko*

društvo: Temperature ranges must be strictly adhered to, and in case of unavoidable deviation, **the vessel's P and I insurer** must be immediately notified;

insurer of liability (n) (mar ins, mar law) **osiguratelj odgovornosti**

insure (US); ensure (UK) /in'ʃʊə ; in'ʃɔ:/ (v) **1 (mar ins) osigurati**: Goods are as a rule **insured** against various risks from the moment they leave the suppliers' storehouses until they enter the storehouses of the consignees. The expenses incurred in administering a general average are often quite out of proportion to the amounts involved and because the same underwriters sometimes **insure** both hull and cargo.; **2 (mar law) jamčiti, garantirati; 3 omogućiti**

intact (adj) (cargo) nedirnut, netaknut: The tender was recovered nearby and found to be **intact** and dry. The hull remained **intact** with paint scrape to hull plating in area of grounding. When a hull is designed, stability calculations are performed for the **intact** and damaged states of the vessel

intact stability (n) (nav arch) **stabilnost broda u neoštećenome stanju**: the IBC/BCH Code is amended by Res. MSC.369(93) and the IGC Code is amended by Res. MSC.370(93) requiring tankers to be fitted with an approved stability instrument capable of handling both **intact and damage stability** cases <http://www.amc.gr/amcLoadingSoftware.htm>

intake /'in,teik/ (n) **1 (marine eng) usis**: The engine was shut down, and the fuel, ventilation, **air intake** and exhaust systems were isolated. The crew always kept both low **suction intakes** open because when both ballast pumps were used together, one **intake** could not cope with the demand.; **2 ulaz**: ... only one accommodation door was open to the deck, thus limiting the **intake** of unauthorised personnel to the living quarters.

intake manifold (n) (marine eng) **usisni kolektor**: Air is sucked in either via an intake air silencer, a 90° intake casing or an **intake manifold**; exhaust gas flows into the turbine via either an axial- or radial-flow casing.

intake port (n) (marine eng) **usisni otvor (u košuljici cilindra)**: To improve the induction of fuel/air mixture into the crankcase, one-way valves (check valves, reed valves, or rotary valves) may be used in the **intake port** to allow the fuel air charge to get into the crankcase quickly, but prevent it leaking back out.

integrated bridge system, (ISB) (n) (navig) **sustav integrirane navigacije**: The ship had no paper charts and was fitted with an **integrated bridge system** (IBS) with two interchangeable radar / electronic chart display information system (Ecdis) displays on the bridge with a third, separate unit ... The vessel was equipped with an **integrated bridge system**, including full ECDIS capability, and the OOW was relying heavily on this despite having not been trained in its use.

integrated carrier (n) (shipping econ) Carriers that have both air and ground fleets or other combinations, such as sea, rail and truck (<http://www.maerskline.com/en-jm/help/shipping-glossary>)
intermodalni prijevoznik, prijevoznik u integralnom transportu

intelligence (n) **1 informacije**: In this way they are intended to become an acceptable safety language, using English for the **verbal interchange of intelligence** among individuals of all maritime nations on the many and varied occasions when precise meanings and translations are in doubt, ...; **2 obavještajna služba**

intended course (n) (navig) **namjeravani kurs, željeni kurs**: The weather forecast indicated that the centre of the depression and the **ship's intended course** were converging, so the officers and crew had been ordered to secure the ship for heavy weather. Sometimes, when I go aboard ships, I see the 2nd mate drawing up a plan that shows every buoy and navigation mark in a river, **every intended course and speed change**.

intended manoeuvre (n) (navig) **namjeravana manovra, zadana manovra, željena**

manovra: *The OOW did not check visually or by radar that the **intended manoeuvre** was safe or make a sound signal to indicate he was turning to starboard. Uncertainty might have been avoided if the cargo vessel's Master had effectively communicated his **intended manoeuvre** to the bulk carrier's OOW at a sufficiently early stage.*

intended route (n) (navig) **planirana ruta, namjeravana ruta** *The vessel departed from the **intended route** because the waypoint selected as the destination in the GPS did not follow the sequence of waypoints detailed in the voyage plan. **The intended route had been prepared** using the ship's electronic chart display and information system (ECDIS) and the OOW selected the scale on the ECDIS display*

intended track (n) (navig) The path of intended travel with respect to the earth as drawn on the chart. (Bowditch 2002) **zadana ruta broda, zacrtana ruta, namjeravana ruta, željena ruta:** *This tug's **intended track** should have been marked on the chart, ... eventually, the mate took the con and set a course clear of the coast and back towards the vessel's **intended track**.*

intensity of stress (n) (marine eng) **jakost naprezanja**

intention (n) 1 (navig) **namjera:** *At a distance of 8 cables, own ship called target vessel and stated our **intention to alter course** to starboard in order to avoid an otherwise inevitable collision. ; 2 (comm) **namjera** {one of the message markers in VHF communications (SMCP)}*

interaction between ships during passing or overtaking (n) (navig) **međudjelovanje brodova pri mimoilaženju i pretjecanju**

inter alia /'intə'ɛiliə/ (idiom) (mar law) among other things **između ostalog:** *... formal familiarisation training for all its personnel, which should include, **inter alia**, a thorough knowledge of the Organisation. {Lat.:}*

interchange (n) **izmjena, izmjenjivanje, davanje u zamjenu**

interchange (n) (ports) **mjesto prihvata / otpreme kontejnerkih kamiona na terminalu**

interchangeable (adj) **zamjenjiv, međusobno zamjenjiv**

intercharge (v) **izmjenjivati se, izmjenjivati se međusobno**

INTERCO /'intəkəʊ/ (n) (comm) **Međunarodni signalni kodeks**

interconnect (v) **spojiti međusobno, povezati međusobno**

intercooler (n) (marine eng) **međurashladnik, tal. scambiatore** *Combustion air is supplied by the turbocharger to the individual cylinders via the **intercooler** and the charge air manifold, and ...*

intercooling (n) (marine eng) **međurashladnik:** *Intercooling between the low- and high-pressure turbocharger stages is a key factor because, by allowing an approximation of isothermal compression,*

intercostal (n) (nav arch) **međuelement (između rebrenica, rebara ili sponja), interkostal** {opposite to continuous}

intercostal side keelson (n) (navig) **interkostalna bočna hrptenica dvodna**

interface /'intə'feɪs/ 1 (cargo) **mjesto dodira dvaju sustava transporta; 2 (navig, electr)**

sučelje: *Recently there were repeated reports from the ship complaining of **poor ship-shore interface** at the terminal. The Mother-ship and both of these Guard Ships are equipped with ARPA radars with **GPS interface** giving us the ability to pinpoint the vessels to which we are trying to talk. ; 3 **priključak:** A number of position fixing and communicational aids may be fitted within the main console, or separately such as satcom and satellite back-up radio-station, navtex receiver, RD finder, satnav with gyro and log **interfaces**, Loran-C receiver, Decca navigator, etc.*

interfere /,intə'fiə/ (v) (comm) **ometati**: Anchors on bow rollers often also **interfere with** visibility. ... energy-saving compact fluorescent lights (CFL), sometimes known as radio frequency (RF) lighting devices, **may interfere with** certain communications equipment. It is essential that watchkeepers maintain a proper navigational watch at all times and do not undertake any other duties that **would interfere with** the safe navigation of the vessel. **interfere with distress communications ometati**
komuniciranje u pogibli

interference /,intə'fiərəns/ (n) **smetnja, ometanje**: The echo was weak and occasionally disappeared, giving the impression that **it was interference** or a floating object drifting in the sea. ..., make sure that it is properly fitted with an appropriate HRU, and that it is carried in a position where it can float free **without interference from** obstructions.

interference (n) (electr, navig) **interferencijske smetnje (na radaru)**: be either by a second vessel (e.g. to the Seychelles Islands via Mombassa or Bombay) or by a different form of transport (e.g. to destinations **in the interior of** Canada).

interference rejector (n) (navig, electr) Mutual radar interference may occur in the vicinity of another shipborne radar operating in the same frequency band (9 GHz) **uređaj za uklanjanje međuradarskih smetnja**

interim rate (shipping econ) **interkalarna kamata**

interim report (shipping econ) **međuzvješće, interkalarno izvješće, prijava dolaska broda na vez neposredno po dolasku (tj. bez prethodne najave)**: If the vessel arrives outside working hours and immediate discharge is desired, an **interim report** will be made on board immediately on arrival.

interior /in'tiəriə/ (n) **unutrašnost**: The on-carriage may be either by a second vessel (e.g. to the Seychelles Islands via Mombassa or Bombay) or by a different form of transport (e.g. to destinations **in the interior of** Canada).

intermediary /,intə'mi:diəri/ (n) (n) (mar law, shipping econ) **posrednik**: The marine insurance broker is the professional **intermediary** and is the agent for the assured. More specifically brokers connected with the maritime industry can be categorised as: Insurance brokers, **who act as the intermediary** between the ship/cargo owner and the underwriters when marine insurance is negotiated. The shipper can transfer the goods to the intended buyer, by exchanging the bill of lading for money, usually through **an intermediary** (eg a bank), put the goods on the open market, selling them to whoever offers the most money.

intermediary supervision (n) (nav arch, mar law) **posredni nadzor**

intermediate /,intə'mi:diit/ (adj) **1 prosječan, u sredini, među-**: The AB, however, opened the **intermediate valve** to No 2 centre tank. During the entire discharge operation **at the intermediate port**, the loading computer program was in use with the altered settings to obtain the ship's figures on the quantity discharged.; **2 posredan**

intermediate frame (n) (nav arch) **međurebro**

intermediate fuel oil (IFO) (n) (marine eng) **IFO gorivo, međunafta**: A potential for burning an **intermediate fuel oil grade** such as IF30 was addressed in the development programme, ... Many genset engine builders can now offer designs capable of burning the diesel oil or blended fuel (heavy fuel and distillate fuel mixed in various proportions, usually 70:30) either bunkered as an **intermediate fuel** or blended onboard.

intermediate longitudinal (n) (nav arch) **međuuždužnjak**

intermediate port (n) (shipping econ) **međuluka**: Seafarers are entitled to receive on request, in local currency, from the Master one half of the balance of base wages actually earned and payable **at every intermediate port** where the vessel shall load or discharge cargo before the end of the voyage, but

not more than once in any ten-day period. During the entire discharge operation **at the intermediate port**, the loading computer program was in use with the altered settings to obtain the ship's figures on the quantity discharged.

intermediate pressure boiler (n) (marine eng) srednjotlačni kotao

intermediate pressure compressor (n) (marine eng) srednjotlačni kompresor: An eight-stage variable geometry axial **intermediate pressure (IP) compressor** driven by a single-stage IP turbine feeds air to the HP spool, ...

intermediate shaft (n) (nav arch) međuosovina: The thrust shaft is connected to the crankshaft and the **intermediate shaft** with fitted bolts.

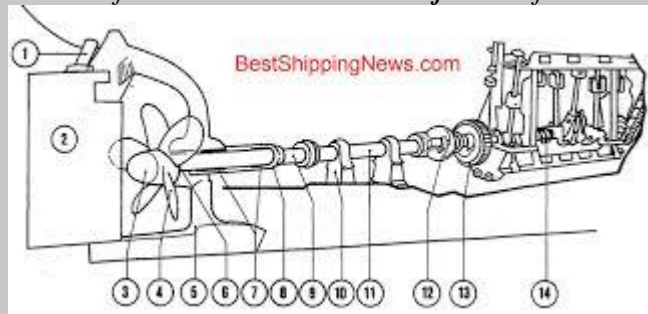

{See No. 11 in the image}

intermittent /,intə'mitənt/ (adj) (comm, marine eng) isprekidan, u razmacima, na prekide
intermittent light ispredidano svjetlo

intermodal marketing company (n) (shipping econ) a company that consolidates container loads or piggyback trailers from several shippers and contracts with railroads for volume space
konsolidacijsko društvo, društvo za konsolidaciju kontejnerskog tereta i vagona za prijevoz kamiona

intermodal transport /,intə'məʊdəl/ (n) (shipping econ) Coordinated transport of freight, especially in connection with relatively long-haul movements, using any combination of freight forwarders, piggy-back, containerisation, air freight, assemblers, rail and road.

(<http://www.maerskline.com/en-jm/help/shipping-glossary>) **intermodalni transport, integralni transport**

intermodal transportation (US) /,intə'məʊdəl/ (n) (shipping econ) Intermodal transportation is the combination of two or more transportation modes used to move freight from origin to destination. **intermodalni transport: Intermodal transportation improves the transfer of freight from intercity movement to local distribution. Intermodal transportation requires cooperation and agreements relating to prices and delivery arrangements among the different carriers.**

internal /in'tɜ:nəl/ = longitudinal uzdužnjak, nutanji nosač ili ojačanje (u konstrukciji broda)

internal combustion engine (n) (marine eng) motor s unutrašnjim izgaranjem:

Explosion-relief valves are used on **internal combustion engines** to protect the crankcase in the event of an explosion of the oil mist, ...

internal waters (n) (mar law) waters on the landward side of the baseline of the territorial sea form part of the internal waters of the State (UNCLOS); morske vode koje obuhvaćaju luke i zaljeve na obali kopna i otoka, dijelove mora između crte niške vode na obali kopna i ravne polazne crte za mjerenje širine teritorijalnoga mora **unutrašnje more**: ... where a casualty or incident occurs **in the internal waters** or territorial sea of another State, the coastal State should notify, with a minimum of delay, the flag State or States of the circumstances ... Foreign vessels have no right of passage within **internal**

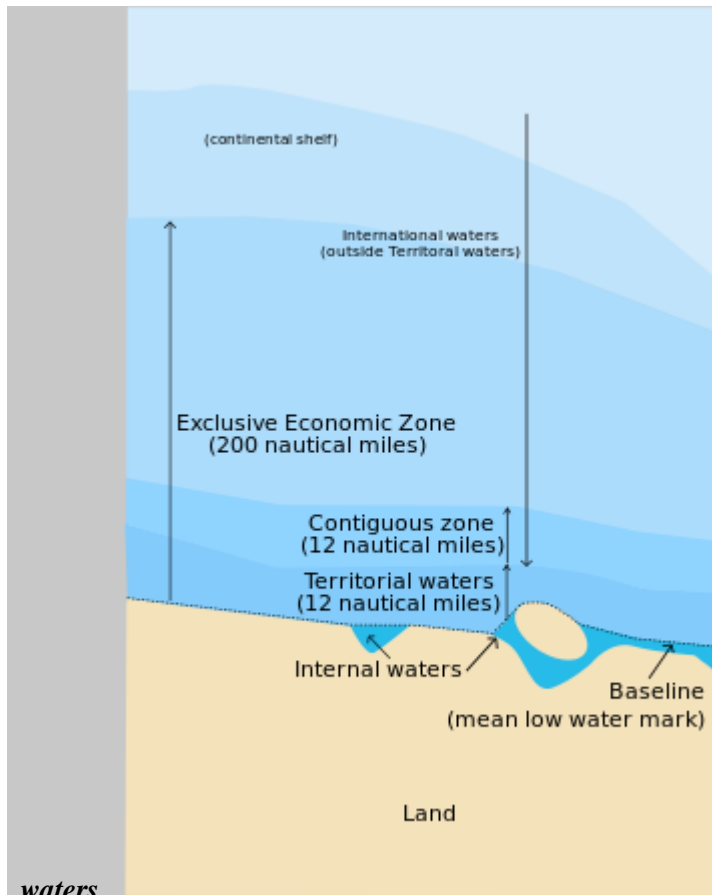

waters.

International Association of Lighthouse authorities; (IALA) (n) (navig)

Međunarodna udruga svjetioničarskih služba The service was aligned to, but did not meet, all of the VTS standards of the *International Association of Marine Aids to Navigation and Lighthouse Authorities (IALA)*. With reference to the provision, declaration of services, the *IALA VTS Manual* includes: An Information Service (INS) is the basic type of service. It should be declared formally and provided as a service by all VTS.

International certificate of vaccination /,intə'neɪʃənəl/ (n) Međunarodna svjedodžba o cijepljenju

International Chamber of Shipping (n) Međunarodno udruženje brodara In accordance with the *International Chamber of Shipping's Bridge Procedures Guide*, effective bridge resource and team management should eliminate the risk that an error on the part of one person could result in a dangerous situation.

International Code for the Construction and Equipment for Ships

Carrying Liquefied Gases in Bulk (IGC) (n) (nav arch, mar law) Međunarodni pravilnik za gradnju i opremu brodova za prijevoz ukapljenih plinova {in bulk = u nepakiranom stanju; bez pakovanja; u velikom količinama}

International Code of Signals (ICS) (n) Međunarodni signalni kodeks {INTERCO}

International Convention on Standards of Training, Certification and Watchkeeping for Seafarers (STCW), 1978 (n) (mar law) Međunarodna konvencija IMO-a o standardima izobrazbe, izdavanju svjedodžbi i držanju straže pomoraca (1978/1995/2010) In the case of collisions and groundings at night or in restricted

visibility, the lookout had been stood down by the officer of the watch, **in contravention of STCW** and, frequently, company standing orders. In fact, it turned out the officer concerned was **in breach of STCW regulations** relating to the hours of rest due to the nature of the trade. Critical operations to be planned properly with additional contingency plans; All key personnel are well rested, **in compliance with STCW regulations**; Always post a designated lookout as a second watchkeeper at night **in accordance with STCW**. **International Convention on Standards of Training, Certification and Watchkeeping for Seafarers (STCW), 1978 Code Pravidnik Konvencije STCW**: The **STCW Code** requires lookouts to be on duty during the hours of darkness.

International Convention on the Safety of Life at Sea (SOLAS) (n) (safety, mar law) Međunarodna konvencija o zaštiti ljudskih života na moru (SOLAS):

Accommodation ladders and portable gangways on ships **must comply with SOLAS regulation II-1/3-9** and the construction, installation, maintenance and testing requirements as detailed in MSC. ... this safety investigation established that the pilot boarding arrangement provided by the ship was not compliant with the relevant **SOLAS requirements** due to its close proximity to the ship.

International Hydrographic Organisation (n) (oceanogr) Međunarodna

hidrografska organizacija: The **International Hydrographic Organization (IHO)** has issued a set of data comprising two fictitious Electronic Navigational Chart (ENC) cells and four sets of tests to check for a number of anomalies ..

international law of the sea (n) (mar law) međunarodno pravo mora: The **Law of the Sea Convention** defines the rights and responsibilities of nations with respect to their use of the world's oceans, establishing guidelines for businesses **The United Nations Convention on the Law of the Sea (UNCLOS)** defined a treaty regarding protection of the marine environment and various maritime boundaries.

International Load Line Convention (n) Međunarodna konvencija o teretnoj liniji

Regarding, for instance, the recent mistrust about the provisions of the **International Load Line Convention of 1966**, if the concern is so severe that these provisions must be changed, those who are now aware of the risk should, as soon as possible.

International Maritime Organization (IMO) (n) Međunarodna pomorska

organizacija (IMO): All the officers and ratings must read and acknowledge **IMO circular MSC1/Circular 1206 'Measures to prevent accident with lifeboats'**. Further, and again in line with ISPS, within mandatory reporting areas, **IMO should encourage** authorities to primarily use passive surveillance techniques (radar), relying on AIS only to the extent necessary for positive identification .. ' In February 2013, Canada and the Republic of Korea submitted a proposed amendment to the ISM Code to the **IMO Sub-Committee on Standards of Training and Watchkeeping**. It is recommended to address their safety management system in respect of maintenance of lifeboats and launching appliances **in line with IMO Resolution A**

International Medical Guide for Ships (n) (med) brodski medicinski priručnik 1

First aid prva pomoć, 2 Shock šok, 3 Pain management postupci u slučaju bolova, 4 Head injuries ozljede glave, 5 Eye injuries and diseases ozljede i bolesti očiju, 6 Bone, joint, and muscle injuries ozljede kostiju, zglobova i mišića, 7 Abdominal and chest injuries ozljede trbušne šupljine i prsa, 8 Wounds rane, 9 Burns, chemical splashes, smoke inhalation, and electrocution opekline, izljevi kemikalija, udisanje dima i elektrokcija, 10 Heat stroke and other heat disorders toplotni udar i druge toplinske smetnje, 11 Poisoning trovanje, 12 Examination of the patient pregled bolesnika, 13 Paralysis, strange behaviour, unconsciousness paraliza, neobično ponašanje, nesvjestica, 14 Chest pain and other disorders of

the heart and circulation bolovi u prsima i druge smetnje u radu srca i cirkulaciji krvvi, **15 Respiratory diseases** bolesti dišnih organa, bolesti respiratornih organa, **16 Gastrointestinal and liver diseases** gastrointezinalne bolesti i bolesti jetra, **17 Kidney and other urinary disorders** bubrežne smetnje i ostale smetnje mokraćnog sustava, **18 Pregnancy and childbirth** trudnoća i porađanje, **19 Sexually transmitted infections** zaraze koje se prenose spolnim odnosima, **20 Skin diseases** bolesti kože, **21 Bone, joint, and muscle disorders** smetnje u kostima, zglobovima i mišićima, **22 Tobacco, alcohol, and drug use** upotreba duhana, alkohola i droga, **23 Infectious diseases** zarazne bolesti, **24 Dental problems** problemi sa zubima, **25 External assistance** pomoć izvana (s kopna ili drugih brodova), **26 Nursing care and medical procedures** njega bolesnika i medicinski postupci, **27 Death at sea** smrt na brodu / moru, **28 Medical care for survivors at sea** medicinska skrb za preživjele / brodolomce / stradalnike na moru, **29 Environmental control and hygiene** ekologija i higijena, **30 Preventing disease and promoting health in seafarers** sprječavanje bolesti i unapređivanje zdravlja pomoraca, **31 Anatomy and physiology** anatomija i fiziologija, **32 International Health Regulations** međunarodni zdravstveni propisi, **33 The ship's medicine chest** brodska apoteka {issued jointly by IMO, ILO and WHO}

International Mobile Satellite Organization (IMSO) (n) (comm, navig) the intergovernmental organization that oversees certain public satellite safety and security communication services provided via the Inmarsat satellites **Međunarodna organizacija za mobilne**

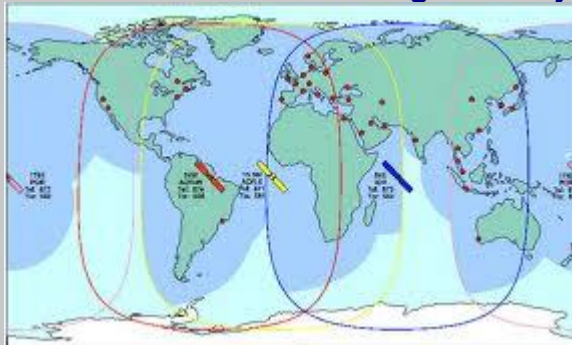

satelitske komunikacije

{Services: 1. Global Maritime Distress Safety System (GMDSS) established by the International Maritime Organization (IMO); 2. Search and rescue co-ordinating communications; 3. Maritime safety information (MSI) broadcasts; 4. Aeronautical mobile satellite (route) service, or AMS(R)S, through compliance with the Standards and Recommended Practices (SARPs) established by the International Civil Aviation Organization (ICAO); 5. General communications}

International Safety Management Code (n) (safety) **Međunarodni kodeks**

upravljanja sigurnošću. *The company's ISM procedures clearly were in place. The chief mate was too busy completing ISM papers, entering details in the Log Book and continuously having to cancel various GMDSS alarms. The ship must have established procedures (as required by the ISM Code) for safely conducting routine operations such as exchanging ballast. Under the ISM Code, it is required to report and record all incidents'*

international sea (n) (mar law) Međunarodno je more otvoreno za upotrebu svim državama, obalnim i neobalnim, a upotrebljavati se smije jedino u miroljubive svrhe. **međunarodno more**

International ship security certificate (n) (mar law, safety) **Međunarodna svjedodžba o sigurnosnoj zaštiti broda**

International Shore Fire Connection (n) (safety) **Univerzalni priključak na obalni protupožarni sustav**

International Standard Organization (ISO) (n) **Međunarodna organizacija za tehničke standarde**, **Međunarodna organizacija za normizaciju**: 35 _ CASE 9

This picture shows the pad and shoe – note the misalignment of the rivet holes. The contractor carrying out the work was certified ISO 9001 compliant, and had issued both a test certificate and inspection test report on the work undertaken. The lifejacket complied with the European Norm (EN) 1095/International Organization for Standardization (ISO) 12401 and 12402 requirements.

International Tonnage Certificate (n) (mar law, nav arch) **Međunarodna svjedodžba o baždarenju**

International Union of Marine Insurance (n) (mar ins) **Međunarodno udruženje za pomorska i prijevozna osiguranja**: *The International Union of Marine Insurance has recently published a report which states that 2010 will join the worst five vessel loss years in the last seventeen years.*

international voyage (n) (mar law) **međunarodno putovanje**: *The aim of the parties to the convention was to establish uniform principles and rules to determine the tonnage of ships engaged on international voyages.*

international waters (n) (mar law) **međunarodne vode**: *Some 13 container ships are waiting in international waters outside the port. Laws between nations governing such things as national versus international waters are considered public international law and are known as the Law of the Seas. Passenger ships operating in international waters are expected to comply with the relevant legislation concerning safety and pollution, that is, solas and marpol.*

international waters (n) (mar law) **međunarodne vode**: *Some 13 container ships are waiting in international waters outside the port. Laws between nations governing such things as national versus international waters are considered public international law and are known as the Law of the Seas. Passenger ships operating in international waters are expected to comply with the relevant legislation concerning safety and pollution, that is, solas and marpol.*

interpose /,intə'pəʊz/ (v) (marine eng) **staviti u**, **staviti između**: *A compression plate or shim is interposed between the foot and the box of the rod large end.*

interpreting (n) **tumačenje**: *Studying and interpreting drawings calls for special skills and experience: a shipowner must entrust this responsibility to suitable persons. Personnel must be given training in correctly interpreting remote gauges and indicators. interpreting the radar display (navig) tumačenje radarskog pokazivača, tumačenje radarske slike, interpreting of the COLREGS tumačenje pravila o izbjegavanju sudara*

interrogate (v) (navig, mar law) **ispitivati**, **ispitati**, **provjeriti**: *He then interrogated an AIS target about 6.5 miles on the starboard bow and altered the vessel's course again, to 122o to increase the CPA with this vessel to about 1.2 miles. Having to interrogate each target and note the ships' names manually posed an especially serious problem in busy areas.*

interrupt /,intə'rʌpt/ (v) (electr, comm, marine eng, navig) **prekidati**, **prekinuti**, **ometati**: *Vessels are not permitted to interrupt loading operations for more than 8 hours for de-ballasting. For shipboard applications, it is critical for a device to interrupt both power conductors. The lookout should never be interrupted (COLREG rule 5 -Lookout). Recordings of the VHF communications showed that channel 69 was very busy with exchanges frequently being interrupted and over-spoken. When a vessel fitted with a CPP is moving ahead and the pitch is set to zero, the flow of water through the propeller and across the rudder is interrupted and steerage will be adversely affected.*

intersection (n) **1 (navig) sjecište**: *From a point about two miles before the intersection of the tracks there is no other shallower water than 30m within a mile of the tanker's track. .7 Your position is distance ... metres / cables from the intersection of radar reference line ... (IMO SMCP) The Coast Pilot advises about the intersection of those two currents and the effect on course that it is likely to have as the bow of a ship enters the south flowing current.; 2 (oceanogr) sjecište (morskih struja) The Coast Pilot advises about the intersection of those two currents and the effect on course that*

it is likely to have as the bow of a ship enters the south flowing current.

interswitching (n) (electr) **prekopčavanje, prekapčanje**

intervention vessel; (IV) (n) (nav arch) **brod za interventne namjene**

intrinsic safety (n) (safety) **samosigurnost**

introduce /,intrə'dju:s/ (v) **1 uvesti**: Identify sources of distraction for bridge watchkeepers, and **introduce measures** to minimise these.; **2 umetnuti**; **3 predstaviti (nekoga)**

introduction /,intrə'dʌkʃən/ **1 uvod**; **2 uvođenje, unošenje**; **3 umetanje**

invaluable /in'veəljʊəbəl/ (adj) **od neprocjenjive vrijednosti, vrlo vrijedan**: Unusual tasks present unusual hazards, and risk assessment is **an invaluable tool** to ensure that any activity is completed as safely as possible. In such situations, **the use of electronic aids, such as ARPA, is invaluable**. The work of the MAIB Inspectors is **invaluable** in ensuring safety at sea is understood and complied with by all. **invaluable information vrlo vrijedna informacija**

invariably /in'veəriəbli/ (adv) **1 nepromjenljivo**; **2 neizbježno**; **3 redovito**: More importantly, it is our seafarers who have the most to gain from studying this review since human conduct is almost **invariably** at the root of maritime incidents. Radars **invariably** require a degree of fine tuning, and two are always better than one.

inventory /'ɪnvəntəri/ (n) **1 inventar, popis roba**: Even though adequate spares for the lifeboat engine and the air motor were available on board, the ship's staff was unaware of its **inventory** and location. All vessels instructed to ensure the timely stocking of spares and **to maintain correct inventory of these and special tools**; ; **2 (shipping econ) vrijednost roba na skladištu (u zalihama)**

inventory carrying costs (n) (shipping econ) financial measurements that calculate all the costs associated with holding goods in storage **troškovi skladištenja robe, troškovi držanja robe u skladištu**: Inventory carrying costs include **inventory-in-storage**, warehousing, obsolescence, deterioration, spoilage and labour costs, as well as insurance and taxes (<http://www.maerskline.com/en-jm/help/shipping-glossary>)

inventory velocity (n) (shipping econ) the speed with which products move from receiving dock to shipping dock **brzina dopreme robe do lučke obale (za ukrcaj na brod)**

inversion /in'veɜ:ʃən/ (n) (boating/yachting) **preokretanje jedrilice (s jarbolom prema dolje) righting from inversion ispravljanje preokrenute jedrilice**

inversion /in'veɜ:ʃən/ (n) (meteorol) inverzija nastaje kada hladni zrak ostane zarobljen ispod sloja toploga zraka, najčeće uvečer ili noću . Zbog toga se zrak u blizini površine zemlje brže hladi nego zrak na većim visinama **inverzija inversion forming stvaranje inverzije, inversion breaking prestanak inverzije**

inverter /in'veɜ:tə/ (n) (electr) pretvarač istosmjerne u izmjeničnu struju **električni inverter**: After rectifying a minor defect with **the starboard inverter**, the engines were started and the vessel shifted over to its loading berth without incident.

investigate (v) (mar law) **istražiti (slučaj), istraživati, ispitivati**: No injury or pollution has been reported and the authorities **are investigating the cause** of the incident. The Coast Guard says it is **investigating the crew, equipment and records** of the 175-meter MV..... for allegations involving violations related to the discharge of oily water. **investigate into the matter istražiti spor / slučaj, investigate the grounding**: The Transportation Safety Board of Canada says it is deploying a team to investigate the grounding. **istražiti nasukanje broda**

investigation /ɪn'vestrɪ'geɪʃən/ (n) (mar law) **istraga**: Investigation into the accident is under way.

*Further investigation showed that the whole auxiliary sea water cooling system was blocked. **outcome of investigation** ishod istrage, **conduct the investigation** provesti istragu, provesti ispitivanje, **complete the investigation**: obaviti istragu **završiti istragu**, **investigation report** izvješće o istrazi. The causes and contributing factors of the ship's mooring line failure are subject to **an ongoing investigation** and will be discussed in a **full investigation report**. {tal.: indagine}*

invite (v) 1 **pozvati, zatražiti**: Also I would like to **invite your valuable comments** for the ships engaged in a particular pattern of voyage, like tankers engaged in lightening trade ...; 2 **(shipping econ) zatražiti ponudu**: *invite* Owner's best offer **invite tenders for zatražiti ponude, raspisati natječaj za**

invoice /'ɪnvoɪs/ (n) **(shipping econ) račun, faktura pro forma invoice** predračun, **consular 1 konzularna faktura, deliver the goods against invoice** isporučiti robu prema fakturi, **make out an invoice** ispostaviti fakturu / račun, **original invoice** izvorni račun, **originalni račun**: The **original invoice** verifies that the amount of the claim does not exceed the terms of sale (value of the goods) at destination, and excludes any prospective profit. , **freight invoice = freight bill** **vozarinska faktura, račun za vozarinu**: Freight bill - Carrier's invoice for freight charges applicable to a shipment. Also called **freight invoice**. , **commercial invoice** **komercijalna faktura, robni račun**: Clean, shipped on board B/L in complete set, together with the **Commercial Invoice** and insurance certificate, both in triplicate, have been handed to the Bank,

involve /ɪn'vɒlv/ **the vessel involved** brod o kojemu je riječ (v) **uključiti, involvirati**: The collision **involved** a containership and a bulk carrier. **be involved in an accident** **sudjelovati u nesreći, vessel involved in a accident** **unesrećeni brod, a ship involved in collision** **brod u sudaru, brod koji je sudjelovao u sudaru**

involve /ɪn'vɒlv/ 1 **obuhvatiti, sadržavati** ... the urgency signal PAN-PAN should be used when an unsafe situation exists that may eventually **involve** a need for assistance, but there is no provision in IMO instruments which requires the originator of the signal to speak the English language. ; 2 **uključiti**: Accidents caused by gangways can be fatal and may often **involve** shore personnel, with attendant legal complications. The key to success is detailed planning, which **should involve** a representative of the shipper, cargo superintendent and surveyor appointed by the carrier. ; 3 **povlačiti za sobom, imati za posljedicu**: After giving this advice he specifically instructed them not to use any other means of heat, which **would involve** open fire on deck, such as a blow lamp.

inward (adv, adj) **ANTONYM outward** **nutarnji, unutarnji, prema unutra**: ... the fitter inserted the holding screws of the panel, which was located just inside the entrance to the cabin **with the door opening inward**. The Master was horrified that **the pilot who conducted the vessel inward** had omitted to relay this crucial information. **inward bound (navig)** **koji se kreće prema unutra (luci, plovnom kanalu itd.)**, **koji plovi prema unutra (luci, plovnom kanalu itd.)**: After her impact with the jetty, the trawler headed seawards, passing very close to other **inward bound vessels**, before the port authorities were able to establish contact and persuade the skipper to return to port.

inward cargo (n) **(shipping econ) teret za iskrcaj s broda**: However, if it is required to commence loading outwards before al the **inward cargo** has been discharged, a special permit must be obtained.

inward clearance (n) **(mar law) dozvola za uplovljenje**: After obtaining **inward clearance**, we unberthed and anchored in the waiting area. When the discharge is completed and all the formalities finished, the master is given a certificate of inward clearance is known as jerque note or **Inward Clearing Bill**. It of lading and sends it to the shipper The forwarding agent will also be employed by the consignee

to collect the delivered goods and arrange the *inward customs clearance and formalities*.

Inward Clearing Bill (n) (mar law) **Potvrda o izvršenom carinskom pregledu (ujedno i dozvola carinskih vlasti za uplovljenje, Dozvola za početak komercijalnih operacija broda u luci**

Inward Clearing Bill (n) **Potvrda o carinskom pregledu i dozvola za uplovljenje (tj. početak trgovačkih operacija)**: *It will be delivered within 14 days of vessel's departure*) List of Outgoing Passengers (if any), signed by Master and countersigned by Emigration Officer, **Inward Clearing Bill** (Jerque Note). Waterguard Officer) when the ship has been searched and no unentered goods are on board; also called **Inward Clearing Bill**.

Inward Entry (n) (mar law) **Opća izjava o dolasku broda, Prijava dolaska broda (u luku)**: *Inward Report: When reporting at the Custom House, inward light dues are paid and GENERAL DECLARATION ON ARRIVAL (or Inward Entry) is completed by the Master or Agent.*

inward passage (n) (navig) **plovidba prema luci / plovnom kanalu**: *Once the towline was secured to the customer vessel, the initial part of the **inward passage** was uneventful, with the tug maintaining a fore/aft position with no weight in the towline. He took no account of a number of buoys found missing **on the inward passage**, the possibility that visual leading marks might be obscured in rain showers, ...*

inward pilot (n) (navig) **peljar za vođenje brodova prema luci**: *Our product tanker was approaching port to pick up the **inward pilot**.*

inward pilotage (n) (navig) **peljarenje prema luci**: *After a short voyage up the coast from her last port the **inward pilotage** lasted from 1230 to 1445.*

Inward Report (n) (shipping econ, mar law) **prijava dolaska broda u luku (carinskim vlastima)**: *The complete **inward report** package includes: Form E1, Ships Stores Declaration; Form IMM200, Crew List; the Form Y14, Crew's Effects Declaration. When practicable, the formal **inward report** may be taken at this time; should the vessel arrive after working hours, the ship's master or agent may present the **inward report** the following day.*

inwards (adv) **prema unutra**: 2), all vessels arriving in or departing from the UK territorial waters **must report inwards**, including vessels arriving and working at offshore installations, and obtain outwards clearance. **clearance / clearing inwards** (mar law) **dopuštenje za uplovljenje broda u luku (od strane carinskih vlasti), dozvola za uplovljenje broda u luku (od strane carinskih vlasti)**: *Here is a list of terms used in **clearing the ship inwards** or outwards. **clear the***

ship inwards (mar law) **dozvoliti uplovljenje brodu (od strane carinskih vlasti),**

Entering inwards (mar law) **Dozvola za uplovljenje broda (od strane carinskih**

vlasti): *Entering inwards: When the ship is berthed, the master must report her arrival at the Custom*

*House. **report the ship inwards** (mar law) **prijaviti brod za uplovljenje u luku (od strane carinskih vlasti)**: **Clearance Inwards**: a document required for **the ship to be cleared inwards or outwards**; it also shows a clear picture of the cargoes loaded for every port .*

inward traffic (n) (navig) **promet brodova prema luci / ulazu u plovni kanal**: *... the route is deep at all points and would not cause navigational difficulties - although he would still have to cross **inward traffic** somewhere between the Channel Islands and Ushant. She had sufficient sea room to safely navigate outside the channel, or alternatively, could have overtaken on the tanker's port side, there being **no inward traffic**.*

inward vessel (n) (navig) **brod u plovidbi prema luci / ulazu u plovni kanal**: *Another **inward vessel** came up astern of me and asked the pilot cutter if he should slot in behind me or continue towards the cutter, he was advised to do the latter ... the pilotage boarding area should be moved, possibly to a position in the centre of the east and west lanes NW of the Kwintebank buoy, so that **inward and***

outward bound vessels can be kept completely separate.

in way of (*prep phr*) (*navig, safety*) **u području (pri opisu štete na trupu broda), na području:** *The hole was punctured above the waterline in way of a ballast tank. in way of of frames 34 and 36 u području rebara br. 34 i 36*

in working order (*prep phr*) (*safety, mar law*) **u radnom stanju, u dobrom stanju:** *ically to verify that progressive flooding cannot occur and that closure devices (such as watertight doors (WTDs) and duct closures) are in place and in working order. The pilot station called the bulk carrier on channel 18 by name and call sign, asked him to change to channel 80 and then asked if the ship's navigation lights were in working order. in good working order u dobrom stanju. All such equipment to be in good working order. eted at the earliest opportunity without fail; In addition to authorised service personnel, crew have equal responsibility for ensuring lifeboats are in good working order and are maintained and operated properly.*

in writing (*n*) (*mar law*) **napismeno, u pisanom obliku:** *The representatives of the terminal should be invited to inspect the tanks and confirm their acceptability in writing prior to the commencement of loading*

iron /'aiən/ (*n*) (*marine eng*) **željezo:** *Regular monitoring detects any sudden increase in a wear element, such as iron or copper, which would indicate that excessive wear was occurring. cast iron kovano željezo. The cylinder block forms the housing to take the cylinder liner and is made of cast iron., close-grained cast iron sivi lijev finozrnate strukture, sitnosrnato ljevano željezo, forged iron kovano željezo, grey cast iron sivi lijev: Such rings of a special alloyed grey cast iron were therefore introduced as standard on new engines., molten iron rastaljeno željezo, pig iron sirovo željezo, sheet iron željezni lim: ... chain slings are indispensable for certain types of packages and useful for most classes of iron goods but the use of such with light cases, sheet iron, coils of copper, piping, sawn logs of valuable timber and other goods liable to buckling, fraying or marking by chain ...*

iron alloy /'aiən,æbi/ (*n*) (*marine eng*) **željezna legura:** *The liner material is a special grey cast iron alloy developed for wear resistance and high strength.*

iron casing /'aiən/ (*n*) (*marine eng*) **željezno kućište, odljevak:** *In the most usual arrangement cylinder liners are enclosed in one cast iron casing forming a cylinder block.*

iron casting (*n*) (*marine eng*) **željezni odljevak:** *The cylinder jacket is a single-piece iron casting, its height determined by the space required for the scavenge air receiver.*

Iron Mike /'aiən/ (*n*) (*navig*) **automatski pilot**

iron ore /'aiən ,ɔ:/ (*n*) (*cargo*) **željezna ruda:** *The major bulk cargoes include raw materials (e.g. iron ore & coal), cereal in general, minor ores and phosphates.*

iron plates /'aiən/ (*n*) (*cargo*) **željezni limovi:** *Many goods have little or no form of packing whatsoever, and are carried loose. These include iron and steel plates, iron rods railway sleepers and steel rails.*

iron rod /'aiən/ (*n*) (*marine eng*) **željezna šipka, željezna motka:** *Many goods have little or no form of packing whatsoever, and are carried loose. These include iron and steel plates, iron rods, railway sleepers and steel rails.*

irregular (*adj*) **1 nepravilan:** *A traditional problem with low load operation is engine fouling due to irregular fuel injection and atomization leading to incomplete combustion.; 2 neispravan irregular cargo neispravan teret: Some tramp ships carry irregular cargoes which do not fit in with the regular liner services.; 3 neredovit: The sensitivity of the heart to the arrhythmogenic action of epinephrine will increase, causing irregular pulse, palpitations, or inadequate circulation.*

irregularity (n) 1 nepravilnost; 2 neispravnost

irreparable /iˈrɛpərəbəl/ (adj) 1 (mar ins) nepopravljiv; 2 nenadoknadiv **irreparable damage** nepopravljiva šteta, nenadoknadiva šteta *Processed steel may suffer irreparable damage if rust is permitted to gain a hold.*

irrevocable letter of credit /iˈrɛvəkəbəl/ (n) (shipping econ) (mar law) neopozivi akreditiv, neopozivi dokumentarni akreditiv: *Irrevocable L/C is the most commonly used method of payment for imports. An irrevocable letter of credit cannot be changed or cancelled unless everyone involved agrees. Irrevocable letters of credit provide more security than revocable ones.*

ISM Code (International Safety Management Code) /ˈaɪ ɛs ˈɛm/ (n) (mar law) (The International Management Code for the Safe Operation of Ships and for Pollution Prevention, which is Annex IX to the Safety of Life at Sea (SOLAS) Convention 1974 as amended) obliges shipowners and ship operators to maintain a high standard of management of their ships and this has increased the extent of classification society duties and reports. (Tetley) **Međunarodni kodeks upravljanja**

sigurnošću, Međunarodni pravilnik o upravljanju sigurnošću (tvrčke, broda itd.):

(1) ensure that the Crew, before joining the Vessel, are given proper familiarisation with their duties in relation to **the ISM Code**; and (2) instruct the Crew to obey all reasonable orders of the Company in connection with the operation of the SMS. 2) When a company, which owns or manages vessels, **complies with the requirements of the ISM Code**, it will be issued with a Document of Compliance. An Interim DOC, valid for no more than twelve months, may be issued to facilitate initial implementation of the **ISM Code** and implementation where a Company is newly established or where new ship types are added to an existing DOC.

isobar /ˈaɪsəʊ, baː/ (n) (meteorol) a line of equal barometric pressure on a weather map **izobara**

isoclinal; icoclinic /ˌaɪsəʊˈklaɪnəl; ˌaɪsəʊˈklɪnɪk/ (adj) (stabil) sloping in the same direction and at the same angle **koji se spušta u istom smjeru, pod istim kutom**

isocline stability /ˌaɪsəʊ, klaɪn/ (n) (stabil) **izoklinska stabilnost**

isolated danger mark /ˈaɪsəleɪtɪd/ (n) (navig) a mark erected on, or moored above or very near, an isolated danger which has navigable water all around it **oznake usamljene opasnosti**: *We normally leave fairway and isolated danger marks to port ...*



isomeric line (n) (meteorol) **izomera**

isophase light (n) (navig) a rhythmic light in which all durations of light and darkness are equal **izofazno svjetlo (jednak period svjetla i tame)**

Description	Characteristic	Chart Abbreviation
Alternating		Alt. R.W.G.
Fixed		F.
Flashing		Fl.
Group flashing		Gp Fl.(2)
Occulting		Occ.
Group occulting		Gp Occ(3)
Quick flashing		Qk.Fl.
Very quick flashing		V.Qk.Fl.
Isophase		Is.
Morse		Mo (letter)

isotherm /'aɪsəʊ, θɜ:m/ (n) (meteorol) izoterma

isothermy /'aɪsəʊ, θɜ:mi/ (n) (meteorol) izotermija

ISPS Code - designated persons and documents (n) (safety) Međunarodni pravilnik o sigurnosnoj zaštiti brodova i lučkih postrojenja (Pravilnik ISPS) - odgovorne osobe i dokumenti **SSO - Ship Security Officer** časnik odgovoran za sigurnosnu zaštitu na brodu, **CSO - Company Security Officer** osoba odgovorna za sigurnosnu zaštitu u brodarskoj kompaniji, **PFSO - Port Facility Security Officer** osoba odgovorna za sigurnosnu zaštitu u luci, **SSP/PFSP - Ship Security Plan / Port Security Plan** plan mjera sigurnosne zaštite na brodu / u lučkom postrojenju, **DOS - Declaration of Security** deklaracija o sigurnosnoj zaštiti, **CSR - Continuous Synopsis Record** trajni zapis o brodu, **SSA/PFSA - Ship Security Assessment / Port Facility Security Assessment** Analiza opasnosti radi utvrđivanja mjera sigurnosne zaštite, **ISSC - International Ship security Certificate** Međunarodna svjedodžba o sigurnosnoj zaštiti, **RSO - Recognized Security Organization** priznata organizacija za sigurnosnu zaštitu

ISPS code; International ship and port facility security code (n) (mar law, safety) Međunarodni pravilnik o sigurnosnoj zaštiti brodova i lučkih postrojenja:

*Additionally, leaving a secured pilot ladder hanging over the side is clearly a **breach of the ISPS Code** and leaving a slack length on deck is very unseamanlike and irresponsible. Moreover, beyond mandatory reporting areas, and **to comply with the ISPS Code**, IMO needs to be of the opinion that masters would normally be expected to isolate AIS.*

issue /'ɪʃu: ; 'ɪsju:/ (n) **1 (mar law) izdavanje (isprave, dokumenta) date of issue and expiry datum izdavanja i istjeka važnosti (isprave, dokumenta); 2 izdanje (dokumenta, časopisa):**

BIMCO have taken steps to address these sort of problems as described in the feature pages 14 and 15 in the December 2004 issue of SEAWAYS.; 3 problem, pitanje: This issue has been discussed with all loading masters at the terminal and correction done for the future. This issue has been raised in accident reports by various investigation agencies in the past. IMOCA works tirelessly to address the issue of safety in the solo sailing environment.

issue /'ɪʃu: ; 'ɪsju:/ (v) (mar law) **izdati (ispravu, dokument) issue a certificate izdati svjedodžbu, izdati potvrdu.**

The discharging operation was postponed as the vessel had to pass Coast Guard inspection in order to issue a Certificate Of Compliance before carrying out any cargo operation. Every two years the Classification Societies issue a Cargo Ship Safety Equipment Certificate on behalf of the Flag State that should include all of the above items., issue a document izdati ispravu, izdati dokument: This enabled the local Lloyd's Surveyor to complete the survey and issue a Document of Compliance for Carriage of Dangerous Goods in Bulk., issue a clean B/L izdati

čistu teretnicu, izdati teretnicu bez primjedaba: If the charter party requires the master to issue clean bills of lading, he must ensure, from the very beginning, that only cargo in apparent good order and condition is allowed to be loaded. **issue instructions izdati upute**: The Traffic Department will shortly issue detailed instructions on the use of mobile phones on board. **issue orders izdati nalog, izdati zapovijed**: ... it is imperative that the construction and operation of these special purpose ships, including the authority of the master to issue orders to the special personnel, be put on a legally clear and consistent footing.

issuing authority (n) (mar law) vlast koja je izdala (dokument): Only the issuing administration may withdraw the smc.

issuing bank (n) (mar law) akreditivna banka, banka koja izdaje akreditiv

ITB; integrated tug and barge unit tug is designed to fit into a notch at the stern of a barge making the whole tug/barge combination a single vessel **tegljač s teglenicom**

item /'aitəm/ (n) 1 stavka (u popisu): This incident involved the vessel's rescue boat, a key item of life-saving equipment which must be ready for deployment at any time (SOLAS Chapter III – Life Saving Appliances - Regulation 20 ...) The Safe Working Load (SWL) of an item of ship's lifting gear is the safe maximum weight that can be lifted with the load suspended directly from the hook in the standard configuration ... **item No. 5 stavka br. 5**: released only after all the designated crew have boarded, been checked off and have secured themselves in their seats (item number 9), or even after item number 4 (Ensure rudder is midships) in the next paragraph titled 'Once crew are in the lifeboat'. ..., the weight of the boat was not adequately transferred to the suspension links on the davit arms, and the harbour pin could not be engaged. **Item no. 4 above** seems to suggest an incorrect length of fall wire(s), possible obstruction to the free movement of davit arm(s) or improper rigging gripes ...; **2 (shipping econ)**

stavka (tereta): Transferring heavy items on top of 'soft' containers, which are liable to collapse, suffer damage and cause the heavy item(s) to be lost.

ITU; International Telecommunication Union (n) (comm) Međunarodna

telekomunikacijska unija: mation on radio from ship to shore Urgency traffic and/or ship to ship / aircraft about a distress / urgency situation as defined in the relevant ITU Radio Regulations.. Signals, and their use in ship's external communications has to be in strict compliance with the relevant radiotelephone procedures as set out in the ITU Radio Regulations. Note: All of the following phrases must come as the culmination (message content) of a radio message exchange between stations covered by the ITU Radio Regulations, and the relevant calling procedures have to be observed.

jack /dʒæk/ (n) (cargo handling, seamanship, marine eng) naprava, sprava, uređaj hydraulic jack hidraulička dizalica, hidraulička naprava (za podizanje, razdvajanje teških komada): There are four bolts at each connection point which help for assembly and removal of the connecting rod, and are tightened to their required torque using hydraulic jack.

jack /dʒæk/ (n) 1 (boating/yachting) a small flag flown at the bow of a ship indicating the ship's nationality zastavica na kosniku; 2 (navy) mornar, pomorac

jack bolts (n) (marine eng) Jack bolts are hydraulically tightened long studs with incorporated hydraulic connection which holds the upper keep of the main bearing intact.

(<http://www.marineinsight.com/main-engine/jack-bolts>) **pritezni svornjaci (temeljnog ležaja), svornjak temeljnog ležaja**: Jack bolts do not pass through the main bearing keep housing but do hold the keep by using hydraulic tension applied and maintained externally.

(<http://www.marineinsight.com/main-engine/jack-bolts>) The main bearings of these engines use holding-down studs instead of the previous hydraulic jack bolts pipe connections are designed to support this type of modular assembly and achieve the shortest possible assembly time i The hydraulic jack bolts on the main bearings were eliminated and replaced by simple holding-down bolts that fix the

bearing cap directly to the bedplate. **tensioning of jack bolts** pitezanje svornjaka temeljnog ležaja

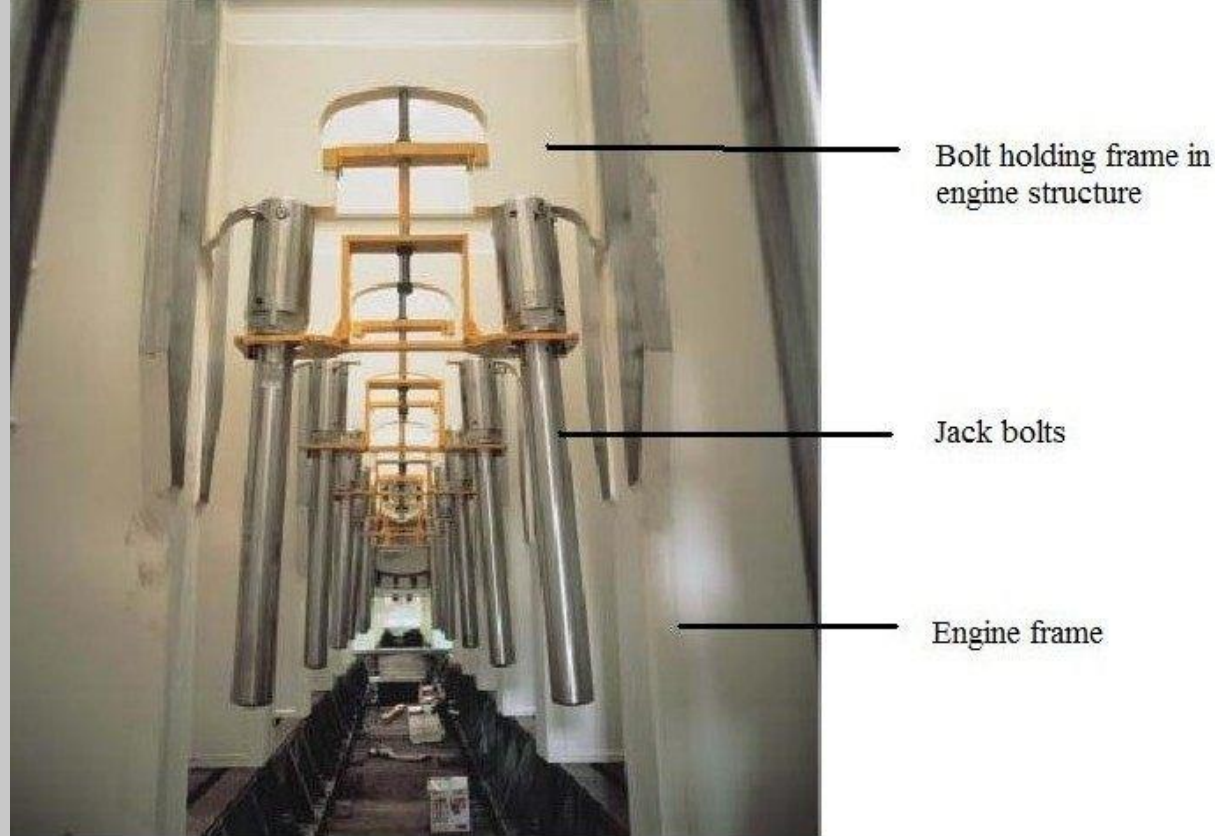

jacket /'dʒækɪt/ (n) 1 (marine eng) = **cylinder jacket** **plašt (cilindra)**: The cast iron cylinder head is fixed to the **water jacket** and to the liner by eight studs screwed into the frame bosses. **cylinder jacket (marine eng) plašt cilindra** The components are clamped together by the **cylinder jacket** and held down by four cylinder head bolts. , **jacket cooling system sustav rashlađivanja košuljica** Both **jacket** and **piston cooling systems** must have alarms fitted to give warning of loss in pressure, high or low tank level or ..., **cooling water jacket vodeni plašt** .. the HT cooling water passes through the HT circulating pump and then through the first stage of the charge-air cooler before entering the **cooling water jacket** and the cylinder head. ; 2 (safety) = **lifejacket** **plutajući prsluk, zaštitni prsluk / jakna**: The owner also had a **buoyancy jacket** and he carried a mobile telephone. An experienced yachtsman was sailing an of clothing and a **waterproof sailing jacket**. The crewman regularly wore a **flotation jacket** on deck, but unfortunately he was not wearing one on this occasion. ; 3 **plašt, omotač**

jackline /'dʒæklaɪn/ (n) (boating/yachting) **sigurnosnu čelično uže za hvatanje (jedriličara)** : During the race, the weather rapidly deteriorated and just before midnight the skipper, who was tethered to a **jackline**, fell overboard while working on the foredeck. **Jacklines** must be tied off



sufficiently to provide complete security

{obložena plastičnim ovojem}

Jack mackerel (n) (fishing) lat. *Trachurus spp* šarun, širun, šnjur

jackstaff /ˈdʒækstɑːf/ (n) (nav arch) flagpole at the bow of a ship; A short vertically erected pole at the bow on which the national flag is hoisted on naval ships while at anchor

(<http://www.marineterms.com>) **nosač kosnika**: *Conventionally, courtesy flags are flown from the jackstaff at the bow.*

jackstays /dʒækˌsteɪz/ (n) 1 (boating/yachting) **SYNONYM jackline** A strong line, usually of flat webbing, or a wire stay running fore and aft along the sides of a boat to which a safety harness can be attached. (<https://www.ypigroup.com/en/yacht-terms/yachting-glossary/>) **sigurnosna**

vrpca / uže za hvatanje (jedriličara u jakom vjetru ili nevremenu); 2 (safety, seamanship) A cable between two ships or from a ship to a fixed point which can be used to support a load during transfer of personnel or materiel along the cable. **uže za prebacivanje tereta / opreme između dva broda**

Jacob's ladder = pilot ladder a ladder of rope with rungs, used over the side **jakovljice, peljarske ljestve, boškaina, tal. biscaglina**: *A pilot plunged into the sea after falling from a Jacob's ladder. While boarding the bulk carrier at the port a ship pilot fell from the vessel's jacob's ladder and was successfully recovered in the early morning darkness. One of our vessels reported that the Jacob's ladder provided by the vessel for embarking the stevedore labourers parted.*

jam /dʒæm/ (n) 1 (navig) **začepljenje (prometa), zastoj prometa traffic jam začepljenje prometa; 2 (marine eng) zapinjanje, zastoj**: *A man put himself in danger by going aft to clear the rope jam.; 3 (marine eng) zaribavanje, zaklinjenje*: *In that report, a crowbar was temporarily inserted into a link to jam it in the bow stopper when the brake could not hold the anchor cable that was under high tension.; 4 (shipping econ) zakrčenost (luke)*

jam (v) (marine eng, seamanship) **ukliniti, začepiti, blokirati, zaustaviti**: *A crowbar was temporarily inserted into a link to jam it in the bow stopper when the brake could not hold the anchor cable that was under high tension. Soon afterwards, the mechanism jammed completely, leaving the yacht with no steering. Post-accident investigation showed that the tripping line had jammed between the cruciform and the jaws of the docking head.*

jam cleat (n) (boating/yachting) **COMPARE clam cleat stoper**

jammed uklinjen, zakrčen, blokiran, začepljen, zaustavljen: *Not allowing shore crew enough time to get a jammed rope off the bollard before starting to heave it in. The first crewman had gone aft to free a creel that had become jammed in the stern opening. The chief engineer became aware of the problem with the tow line and he moved forward to inspect the jammed turns on the winch, gesticulating to the ship's crew to slack back. Examination of the engine, after the incident, revealed that the fuel rack was still jammed in the full "on" position, and only released and returned to the zero position when the governor was removed.*

jammed port (n) (shipping econ) = **congested port zakrčena luka**

jamming cleat (n) (boating/yachting) **naprava s nazubljenim ekscentričnim polugama s oprugama za zaustavljanje konopa žabica**

jam nut (n) (marine eng) **protumatica**

Jason Clause /ˈdʒeɪsən/ (n) (mar ins, mar law) **klausula o nemaru i zajedničkoj havariji**: *General Average and New Jason Clause: General Average shall be adjusted in London unless otherwise agreed in Box 22 according to York-Antwerp Rules 1994 and any subsequent modifications.*

jawl /jɔːl/ (n) (boating/yachting) **a two-masted yacht with the mizzen mast stepped aft of the rudderpost jol, jedrilica slična keču, ali joj je zadnji jarbol smješten iza statve kormila**

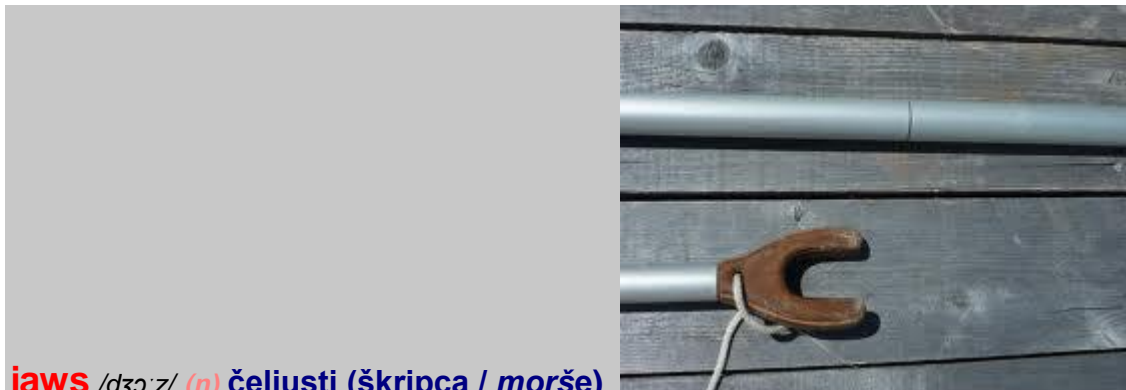

jaws /dʒɔːz/ (n) čeljusti (škripca / morše)

jeer /dʒiə/ (n) (boating/yachting) podigač jedra

jellyfish (n) (fishing) meduza

jerk pump (n) (marine eng) sisaljka s razvodnim klipom (za ubrizgavanje goriva),

Boschova pumpa, Bosch-pumpa: There are two basic systems in use, each of which employs a combination of mechanical and hydraulic operations. The most common system is the **jerk pump** system; the other is the common rail. In the **jerk pump** system the fuel is metered and raised in pressure by a separate fuel pump for each cylinder. The pump is timed to force the fuel through the injector into the cylinder at the appropriate moment. **jerk pump** sysetm sustav visokotlačnih sisaljki za ubrizgavanje goriva, sustav Boschovih pumpa

Jerque Note /dʒɜːk/ (n) (mar law) Potvrda o carinskom pregledu i dozvola za

uplovljenje (tj. početak trgovačkih operacija): It is most convenient to enter the ship outwards as soon as the **Jerque Note** has been issued. The Waterguard Officer checks the landing of all goods destined for the port and when the discharge is completed the ship is searched and the stores checked and compared with the Surplus Store List, and if all is in order the Inward Clearing Bill (or **JERQUE NOTE**) is issued.

jerry can (n) (seamanship, boating/yachting) kanta (za gorivo, vodu): The pump, which was being used as part of the cockle dredging operation, was being topped up with petrol from a **jerry can** while it was running.

jet /dʒɛt/ (n) (marine eng) mlaz, štrcaj: If it is necessary because of insufficient steam for fuel heating, to use Diesel Oil or other lower viscosity fuel a single **pressure jet burner** with the smallest available tip is to be used. Cooling oil is **jet sprayed** into passageways within the piston. The design addresses the demands of **waterjet operation**, notably sudden large load changes if air is drawn into the **jet unit** in severe sea conditions. **water jet (safety) mlaz vode**: This was followed by a **water jet** from a charged fire hose and the fire was soon extinguished., **jet nozzle (safety) mlaznica**: The seaman descended to the top platform, bringing with him a fully pressurized fire hose fitted with a **jet nozzle**.

jetsam /ˈdʒɛtsəm/ (n) (safety) goods or equipment deliberately thrown overboard **izbačeni teret (radi olakšanja broda)**

jettison /ˈdʒɛtɪsən/ (n) to throw overboard, sometimes to lighten the ship in distress **izbacivanje tereta s broda u more (radi olakšanja broda)**: The **point of jettison** was only about 20 metres ahead of the propeller. **jettison of cargo izbacivanje tereta s broda u more**: a heroic **jettison of cargo** to save a listing ship; No **jettison of cargo** shall be made good as general average, unless such cargo is carried in accordance with the recognised custom of the trade. Examples of general average acts are: - **Jettison of cargo**, in order to lighten a vessel., **jettison from underdeck izbacivanje tereta iz broskog skladišta u more, jettison form on deck izbacivanje tereta s palube u more**

jettison /ˈdʒɛtɪsən/ (v) to throw goods / cargo overboard **izbacivati teret u more**: .6 I / MV...will **jettison cargo** to refloat. 6.1 Warning! **Do not jettison IMO-Class cargo.** (IMO SMCP) The list could not be significantly reduced by adding ballast, so the decision was made to **jettison some of the deck cargo**. Crew members were assigned to cut the remaining lashings in an attempt to **jettison the rest of the packages** and reduce the list.

jetty /ˈdʒɛti/ **oil jetty tankerski gat, tankerski vez, T-jetty tankerski vez (u obliku slova T)** 1 a small pier, usually made of timbers for boats, yachts or fishing boats **gat, molo, lučka obala, mul, ribarski molo, tal. molo; pontile; gettata fisherman jetty ribarski gat, ribarski molo, ribarski mul, on the jetty na obali**: The line apparently got caught on an underwater obstruction **on the jetty** and suddenly became taut around his ankles, moving up his body to his waist; he was dragged around the bollard on which the rope was earlier tied,, both the lines were cast off on the forecandle deck and it was confirmed that they were released from the mooring bitt **on the jetty.**, **clear of the jetty odvezan od obale**: The tug would be released once **the vessel was clear of the jetty** and making headway downriver., **towards the jetty prema obali**: As the rate of turn to port increased **towards the jetty**, the pilot ordered the engine astern, the rudder hard to starboard and the bow thrust full to starboard., **away from the jetty od obale / data**: As the vessel's bow moved **away from the jetty**, an AB who was standing inside the bight of the spring line suffered a fatal crush injury.; 2 a big jetty designed for tankers **veliki gat**

jib /dʒɪb/ (n) (boating/yachting) the foremast triangular stay sail at the front of a ship **prečka, prednje jedro, flok; tal. fiocco jib fairelads koloturi uzde floka na palubi, jib lead vodilica škotine**: If the bottom telltale luffs first, then move the **jib lead** aft., **jib sheet uzda prečke, škotina**: Ease the **jib sheet**, moving the lead aft to reduce the power in the sail; use a

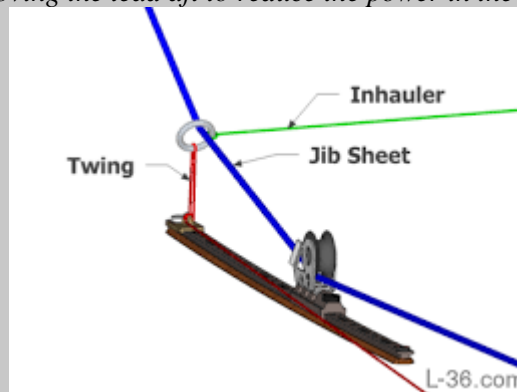

snatchblock to move the jib lead outboard



jib (n) (cargo handling) **krak brodske dizalice**: The seaman lowered the crane **jib**. Seaman A then started to put the rubber pad under the **jib head**, and signaled to B to raise the **crane jib** a little more. **jib**

angle indicator pokazivač nagiba kraka dizalice, **jib head** vrh kraka dizalice: *The jib of the crane resting on the bridge front bulkhead started making a noise due to friction between the jib head and its support.*

jib-boom (n) (boating/yachting) prikosnik

jibe ho! (v) (boating/yachting) zapovijed za kruženje **Pojalabanda! Prepare to jibe ho!!**
Spremni za kruženje! **Spremni za pojalabandu!**

jibe (US); **gybe** (UK); **gibe** /dʒaɪb/ (n) (boating/yachting) = **gybe** kružiti, napraviti pojalabandu

jib fittings (n) (boating/yachting) oprema prečke, oprema floka

jib halyard /dʒɪb,hæljəd/ (n) (boating/yachting) podigač floka, **gindac floka**

jib sheet (n) (boating/yachting) uzda prednjeg leta, škotina, uzde letnog jedra, **škota**



floka, tal. **scotta del fiocco**

jibstay /ˈdʒɪbsteɪ/ (n) (boating/yachting) **COMPARE headstay** malo leto, **štraj floka**, **mali štraj**

jib tack (n) (boating/yachting) = **jib sheet** uzda floka, škotina

jig /dʒɪg/ (n) **1** (fishing) A hook with molded weight attached in lead or steel. Jigs come plain undressed or dressed with hair, marabou, rubber skirts and soft plastics.; varalica sa jednom ili dvije krunice od zavnutih iglica na repnom dijelu kojom se love glavonošci, prvenstveno lignje

(<https://ribolovnajadranu.hr/ribicki-leksikon/>) **skosavica**, **šuštavica**, **plovuća**, **lignjarić**

vertical jig skosavica za lignje, **floating jig** plivajuća skosavica, **suspending jig**

neutralna skosavica, **sinking jig** tonuća skosavica; **2** (fishing) Posebne varalice, raznih dužina i oblika koje svojim kretnjama mame ribu na napad.

(<https://ribolovnajadranu.hr/ribicki-leksikon/>) **varalica**, **jig**

jig /dʒɪg/ (v) (fishing) skosati

jig fishing (n) (fishing) ribolov skosanjem, ribolov sa skosavicama **vertical jig fishing** lignjолов, lov lignja okomitim skosanjem

jig fishing knot (n) (fishing) čvor za kopčanje skosavice

jigging (n) (fishing) skosanje, ribolov skosanjem **vertical jigging** = **vertical jigging** lov lignja okomitim skosanjem, **vertical jigging**, **jigging rig** oprema za skosanje

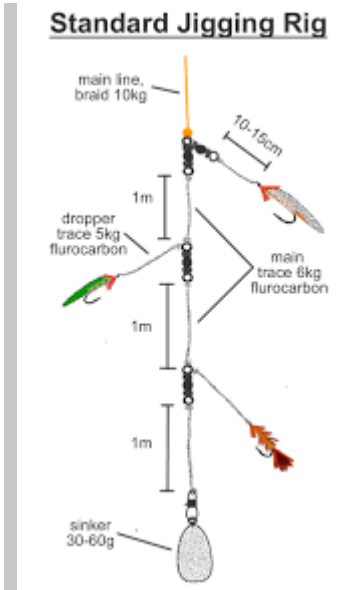

jig head (n) (fishing) COMPARE squid jig glava skosavice

jig hook (n) (fishing) posebna udica koja na vrhu vrata ima olovno otežanje **jig udica**

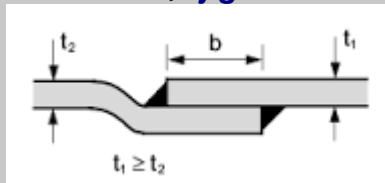

joggled joint /'dʒɔgəld/ (n) (nav arch) džoglovani spoj

john dory (n) (fishing) Lat. Zeus faber kovač, šampjer

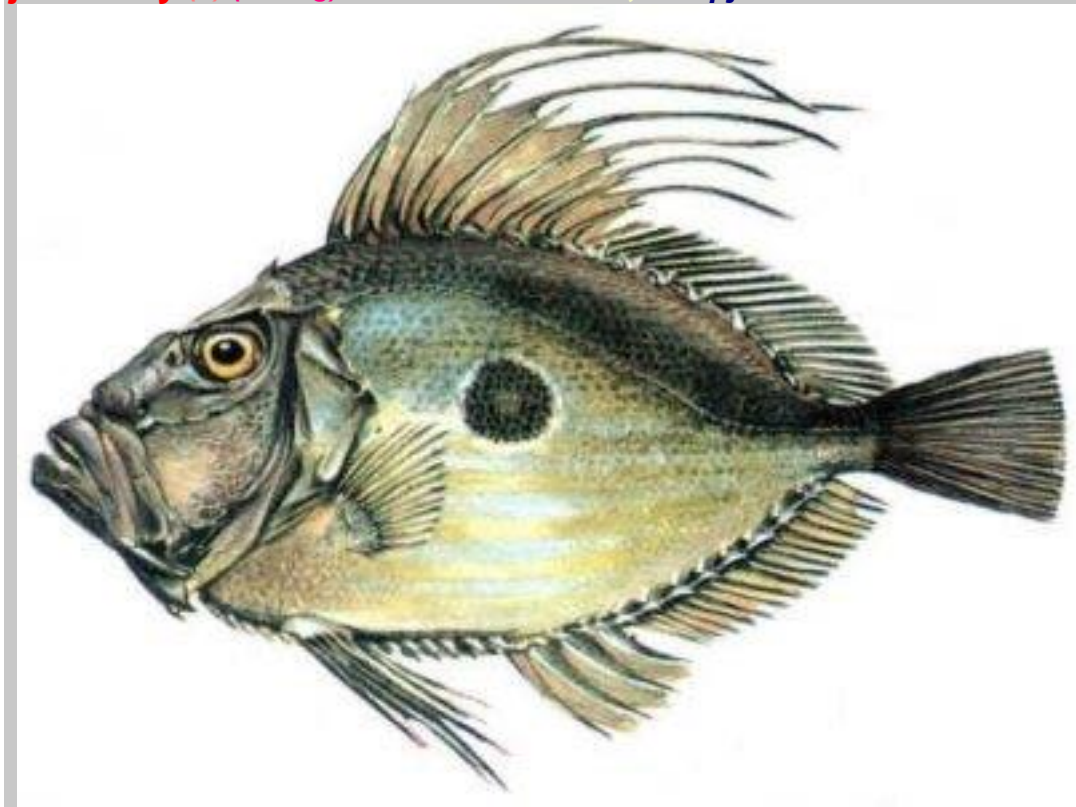

nazivi: riba, sveti petar, šanpjer; lat. ZEUS FABER}

join /dʒɔɪn/ (v) **1 (marine eng) spojiti, povezati:** *The camshafts are of modular construction with single-cylinder sections **joined** by bearing journals.*; **2 sastaviti;** **3 (shipping econ) ukrcati se na brod, zaposliti se na brodu, stupiti u službu:** *In 2004 he **joined** his first ship as an officer godien 2004. prvi put se ukrcao / zaposlio kao časnik This left me only five hours to **join** the ship. Own vessel was heading at 13kts to round the F3 buoy and **join** the SW lane. A new mate **joined** a small inland passenger vessel for his first day of work. He **joined** HM Coastguard in 1994 serving at Belfast, Falmouth etc. He then **joined** the Company as Marine Superintendent in 1996 with special responsibilities for the oil spill compliance programme and contingency planning. I had **joined** the vessel two weeks previous as chief officer.*; **4 pristupiti, pridružiti se, uploviti u, ući u, stupiti u:** *One person went to the wheelhouse to **join** the skipper who, having raised the alarm, was collecting lifejackets from the cabin. The master was alone on the bridge until he was **joined** by the berthing pilot. By nightfall, several vessels **joined** in the SAR operations.*; **5 stupiti u (vojniu službu, firmu)**

joint /dʒɔɪnt/ (n) **1 (marine eng) spoj:** *There is a metallic joint, a copper or soft iron ring, interposed to make a seal. A thick section mild steel ring makes the gas joint between the liner and cylinder head. Studs should be evenly tightened so that a satisfactory joint can be provided. angle joint kosi spoj Transverse diaphragms for each main bearing provide rigid support for the crankshaft, and angled joint faces ensure positive locking of the main bearing caps in the bedplate.*; **step joint stupnjevit spoj stepenasti spoj, lap joint preklopni spoj** *Thanks to the double lap joint, the pressure drop will be almost constant irrespective of the wear on the liner and rings.*; **butt joint ravni spoj, provide a joint spojiti, osigurati spoj make a joint spojiti, napraviti spoj, metallic joint metalni spoj:** *There is a metallic joint, a copper or soft iron ring, interposed to make a seal.*; **failed joint spoj koji propušta, loš spoj:** *It was soon established that the leak originated from a failed joint at a pipeline flange on a fuel pump oil return line (originated).*; **flange joint prirubnički spoj** *He did not take the precaution of staying away from the valve while releasing the flange joint and was right in front of the valve, while dismantling.*; **2 zglob:** 62 MAIB Safety Digest 1/2012 _ CASE 23 CASE 23 Figure 2: Layout of gear throttle cables *As he did so, the steering cable ball joint became disconnected from the outboard engine frame, and the engine turned hard to port. The steering cable had been replaced using an outdated spring-loaded ball joint to connect it to the outboard engine frame.*

joint and several liability (n) (mar law) zajednička i nedjeljiva odgovornost, zajednička i solidarna odgovornost

joint dowel /dʒɔɪnt,dəʊəl/ (n) (sailing vessels) spojni šip

joint liability (n) (mar law) Two or more debtors who are obligated to the same creditor for the same obligation are jointly liable where they may only be compelled to perform the obligation separately and only up to their respective shares of the debt. (Tetley) **zajednička odgovornost**

joint service (n) (shipping econ) zajedničk servis (između dvaju ili više brodara)

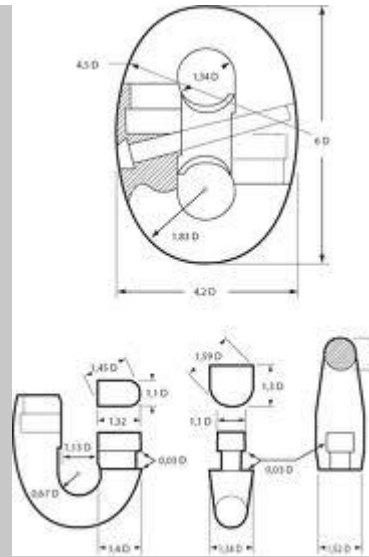

joint shackle spojna karika (lanca)

joint stock company društvo s ograničenom odgovornošću, d.o.o.

joint venture /ˈdʒɔɪnt, ˈventʃə/ (n) (mar law) zajednički pothvat, zajednički poduhvat, zajednička investicija

The new RORO Terminal is a **joint-venture** initiative between the Japan-headquartered shipping company and Saudi Arabia-based Ports Development Company . A large private ship owner purchased its **49.5% stake in the joint venture** last June for approximately \$150 million. These alliances may take the form of pools, **joint ventures**, or space charter agreement. General Average is a partial loss voluntarily and reasonably incurred in time of peril for the safety of the **joint adventure**; which is contributed to by the owners of all property saved,

Jones Act (n) (US, mar law) Jonesov zakon, zakon o priobalnoj plovidbi (kabotaži) u

SAD: A number of U.S. maritime industry stakeholders rallied together in a strong show of support for the **Jones Act**, sending a clear message to opponents that any attempt repeal the 95-year-old law is severely misguided and not in the best interest of the American people.

journal /ˈdʒɜːnəl/ (n) (marine eng) that portion of a shaft or other revolving member which transmits weight directly to and is in immediate contact with the bearing in which it turns **rukavac, oslonac temeljnog ležaja**

The gen-erous diameters of both **crankpin and journal** achieve a large bearing surface while allowing a reduced cylinder spacing ratio. ...the bearings are so con-structed that the bearing pressure **between journal and bearing** is distributed evenly over the entire

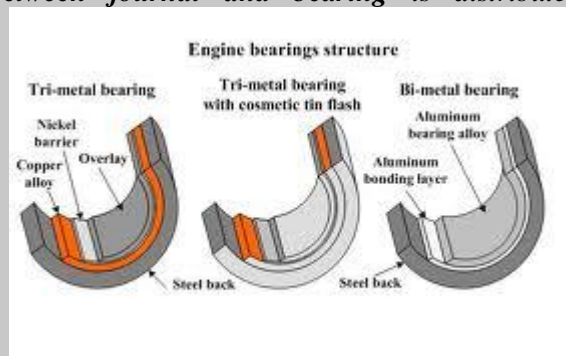

length of the bearing.

joystick control (n) (marine eng, navig) upravljačka ručica (za upravljanje strojem, dizalicom itd.), džojstik

The vessel was in hand-steering, **joystick control**, and the pilot was unhappy with having to continually check the only rudder angle indicator which was sited above his head. The **OOW** then returned to the centreline console and began to adjust the vessel's heading to

port using the **joystick control** on the vessel's track pilot system.

judgement /ˈdʒʌdʒmənt/ (n) **1 (mar law) presuda, sudska odluka**: *In judgement on the case of v. it was stated that if the case was decided on the legal interpretation of the clauses in isolation, the expression the expression days would mean running days and hence include Sundays and*

holidays.; **2 rasuđivanje, prosudba**: *If at any time before the Vessel commences loading, it appears that, in the reasonable judgement of the Master and/or the Owners, performance of the Contract of Carriage, or any part of it, may expose, or is likely to expose, the Vessel, her cargo Annex 1 When surveying, the surveyor is to exercise his professional judgement in determining whether to detain the ship until the deficiencies are corrected or to allow it to sail with certain deficiencies without unreasonable*

judicial decision (n) (mar law) **sudska odluka, sudsko rješenje**: *Common Law: The body of law based on judicial decisions and custom, as distinct from statute law.*

judicial proceedings /dʒuːˈdɪʃəl ,prəˈsiːdɪŋz/ (n) (mar law) **sudski postupak**: *... and, pursuant to Regulation 14(14) of the Merchant Shipping (Accident Reporting and Investigation) Regulations 2012, shall be inadmissible in any judicial proceedings whose purpose, or one of whose purposes is to attribute or apportion liability or blame. (© Crown copyright, 2015 See <http://www.nationalarchives>)*

jumbo boom (n) = **jumbo derrick** (cargo handling) **samarica za teške terete**

jumbo derrick (n) (cargo handling) regularly installed heavy-duty swinging derrick for handling extra heavy lifts **samarica za teške terete**

junction /ˈdʒʌŋkʃən/ (n) (navig) the point where a channel divides when proceeding seaward

mjesto račvanja plovidbenog kanala: *We were crossing the Noord Hinder Junction 1.5 miles north of the Noord Hinder South TSS. Due to the nature of our operations we were required to work in the NE bound lane of the TSS north of the F3 Junction and were restricted in our ability to manoeuvre (RAM).*

junction point /ˈdʒʌŋkʃən/ (n) (navig) **točka promjene kursa (rute)**

junior crew (n) (seamanship) **mlađi mornar**: *A radar was operational and a junior crew member was alone on watch. The pilot was not present to prepare, assist or supervise releasing the tow, deciding to leave the task to the master and more junior crew.*

Junior Engineer /ˈdʒuːnɪə ,ɛndʒɪˈniə/ (n) (marine eng) **mlađi strojar, niži strojar**: *The Junior Engineer was filling in the oily water record book after completing pumping bilges. While trying to find the fault, the junior engineer tried to ignite the boiler.*

Junior Officer (n) (navig) **časnik straže koji ima ovlaštenje za radnu razinu prema STCW 1995; časnik palubne straže na brodovima većim od 500 bt; mlađi časnik straže u stroju koji ima ovlaštenje za radnu razinu prema STCW 1995 mlađi časnik, niži časnik**: *This would have left the vessel at sea and for subsequent port entry under the command of a Junior Officer. Both junior officers claimed that they had the right of way over a crossing vessel when they were following a TSS.*

Junior Seaman (n) (navig, seamanship) **COMPARE ordinary seaman (OS)**

mlađi mornar: *The junior seaman had only been at sea a few days. The senior seaman was probably not at his best after such a long period of duty, and the junior seaman was of limited value as he was very inexperienced.*

junk /dʒʌŋk/ (n) (nav arch, boating/yachting) a sailing vessel common with two or three masts carrying battened lugsails (used in East Asia), **džunka junk rig oputa i snast džunke**

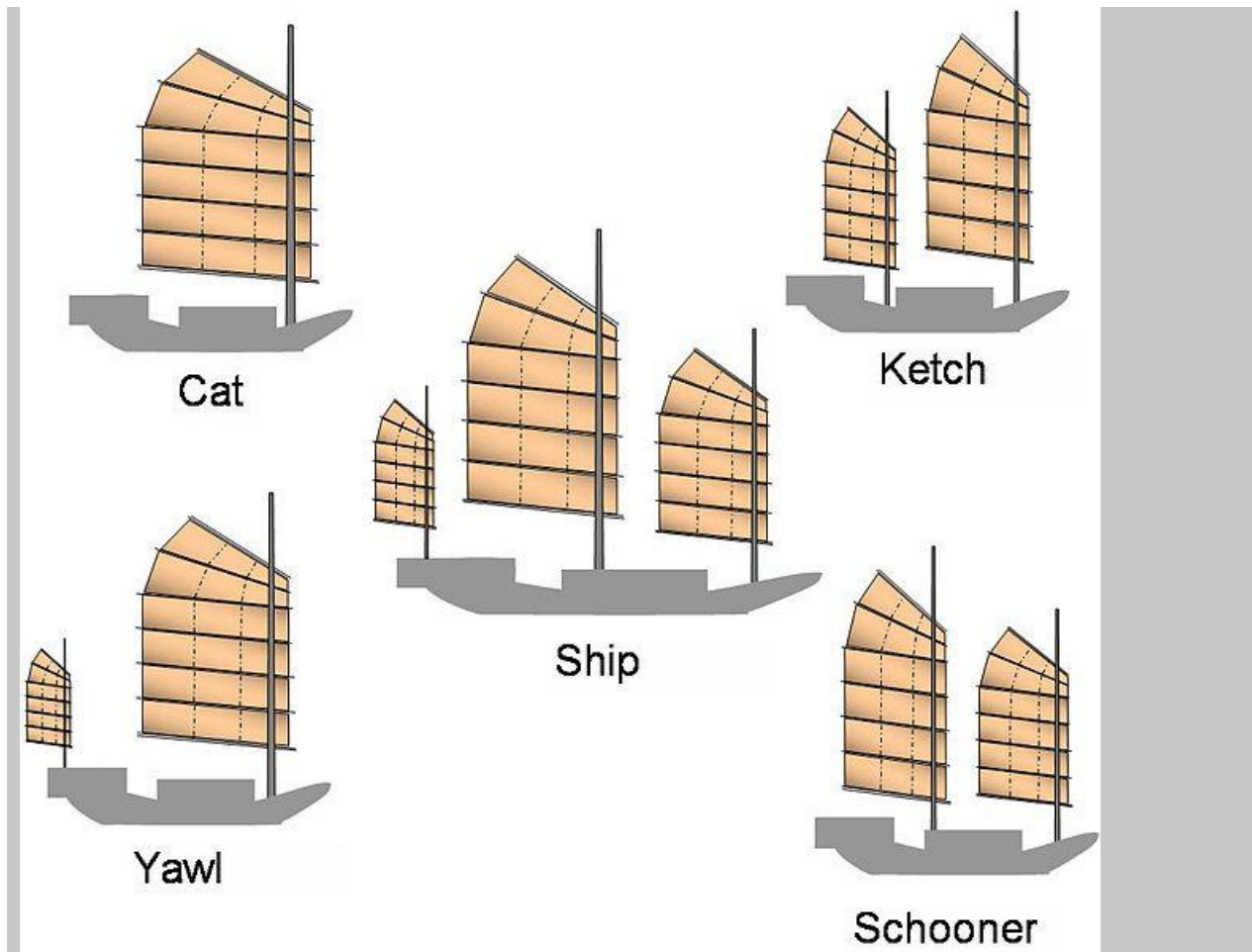

jurisdiction /ˌdʒʊəriˈdɪkʃən/ (n) **1 (mar law)** A term referring to the nature and extent of the legal authority bestowed upon a legislature to enact laws (legislative jurisdiction) or of courts to hear and determine actions and other legal proceedings (judicial jurisdiction), as determined by international conventions or national laws. (Tetley) **pravosuđe:** Admiralty law is distinguished from the Law of the Sea, which is a body of public international law dealing with navigational rights, mineral rights, **jurisdiction over coastal waters** and international law governing relationships between nations. ; **2 (mar law)** court exercises its jurisdiction (i.e. decision-making authority, or competence) over proceedings of certain types (subject-matter jurisdiction, or jurisdiction *ratione materiae*) and over a defined territory (territorial jurisdiction, or jurisdiction *ratione loci*). (Tetley) **pravna nadležnost, sudska nadležnost:** No one is permitted to exercise jurisdiction over the high seas thus you cannot have mandatory reporting ergo there can be no need for AIS, long range or otherwise. Another form of restraint is by this injunction. This forbids the movement of a company's assets from the **jurisdiction of the court** . ; **3 (mar law) nadležnost under jurisdiction pod nadležnošću, u nečijoj nadležnosti:** Some more knots were needed to maintain steerage, navigation marks and lights are in place giving a speed over the ground of at least **in areas under their jurisdiction**, ... marine casualties or incidents where either one or more interested States have a substantial interest in a marine casualty involving **a ship under their jurisdiction**. , **within jurisdiction u nadležnosti:** Harbour authorities play a major role in safe navigation **within their jurisdiction**. , **area of jurisdiction područje nadležnosti:** A port authority should, as an essential element of its formal safety assessment of hazards and risks **in its area of jurisdiction**, develop plans and procedures to control those risks. , **exercise jurisdiction**

over provoditi nadležnost nad, primjenjivati nadležnost: *No one is permitted to exercise jurisdiction over the high seas thus you cannot have mandatory reporting ergo there can be no need for AIS, long range or otherwise.*, **provide jurisdiction biti nadležan za:** *It provides jurisdiction for incidents occurring on board the ship when the ship is on the high seas.* **pružiti nadležnost za jurisdiction clause** (n) (mar law) A clause in a bill of lading, a waybill or a charterparty, providing that any dispute arising under the contract evidenced by that document shall be tried before the competent court of a particular State (Tetley) **klauzula / odredba o sudskoj nadležnosti**

jury anchor /'dʒʊəri/ (n) (safety, nav arch) **olujno sidro, zamjensko sidro, improvizirano sidro**

jury mast /'dʒʊəri/ (n) (seamanship, nav arch) a temporary mast put up by the crew when the spars have been carried away in a storm or in action **olujni jarbol, improvizirani jarbol (nakon obaranja jarbola)**: *Once the boat had lost her mast, it was time to set up a jury rig.*

jury rigging; jury rig (n) (boating/yachting) makeshift rigging; makeshift repairs or temporary contrivances, made with only the tools and materials that happen to be on hand, originally a nautical term. (Wikip.) **priručna snast / oputa, zamjenska snast / oputa, improvizirana snast / oputa, tal. armamento di fortuna, improvizirana oputa i jedrilje (u izvanrednim okolnostima)**

justify /'dʒʌsti, faɪ/ (v) **opravdati:** *Owners and masters must ensure that they do not use this argument to justify bad practice and complacency. Editor's note: The convenience of a direct course and a shorter transit time must not justify the selection of a route that plainly contravenes the Colregs.*

jute /dʒu:t/ (n) (cargo) **juta:** *Bags made of jute, cotton, plastic or paper, are a cheap form of container.*

KB; Height of the Center of Buoyancy (n) (stabil) **visina težišta uzgona:** *Because the center of buoyancy is the geometric center of the underwater body of the ship, the height of the center of buoyancy depends upon the shape of the ship.*

kedge /kɛdʒ/ (v) (seamanship) **povlačiti se po sidru**

kedge anchor (n) **1 (boating/yachting) pomoćno sidro:** *The prudent mariner will also carry a kedge anchor, which can be used as a back-up in an emergency.*; **2 sidro s kladom**

kedge off (v) (boating/yachting) **odsukavati se s pomoću sidra (s pličine)**

kedging-off (n) (seamanship) a method of pulling a boat out of shallow water when it has run aground. **odsukavanje jedrilice / brodice povlačenjem po sidru**

keel /ki:l/ (n) (nav arch) the central structural basis of the hull; a center-line strength member running fore and aft along the bottom of a ship; the base line reference point from which all other reference point measurements are compared **kobilica, kilj, kolumba tal. chiglia** *By the time he was on deck, the depth sounder was showing minimal depth, and almost immediately the keel touched the bottom. A short while later we were passed over a shoal area and less than one foot under the keel was indicated by Echo Sounder at speed of 4.3 knots.* **lay the keel položiti kobilicu** *M/v was a medium size bulk-carrier, the keel was laid 1984, registered in Cyprus and managed by a management company based in Spain. The keel being laid in the Fincantieri yards at Monfalcone.*, **on even keel na ravnoj kobilici:** *Draught on departure Kalundborg Fiord*



was 11.23 m on even keel.

keelboat (n) (boating/yachting) jedrilica s kobilicom

keel date (n) (nav arch) datum postavljanja kobilice broda

keel-haul /'ki:l,hɔ:l/ (v) (seamanship) To tie a rope about a man and, after passing the rope under the ship and bringing it up on deck on the opposite side, haul away, dragging the man down and around the keel of the vessel. As the bottom of the ship was always covered with sharp barnacles, this was a severe punishment used aboard sailing ships long ago. Today, a reprimand. (www.USMM.org)
provlačenje (mornara) ispod kobilice, s jednog boka na drugi {oblik nekadašnje kazne za mornare na jedrenjacima}

keel-knee (n) (sailing vessels) kutni okov krmene statue

keel laying (n) (nav arch) polaganje kobilice: *Keel laying is one of the four specially-celebrated events in the life of a ship; the others are launching, commissioning, and decommissioning.* **keel laying ceremony svečanost polaganja kobilice**

keel plate (n) (nav arch) središnji voj oplate dna plosna kobilica

keel rabbet (n) (sailing vessels) utor kilja

keelson /'kelsən; 'ki:lsən/ (n) (nav arch, sailing vessels) a timber or girder fastened above and parallel to the keel of a ship or boat for additional strength. (FreeDict); a beam attached to the top of the floors to add strength to the keel on a wooden boat **hrptenica rider keelson**

nadhrptenjača, keelson scarphs ključ hrptenice, **sister keelson dohrptenica, side keelson dohrptenica** {tal. paramezzale}

keel strake (n) (nav arch) = **garboard strake** dokobilični voj, dokiljni voj

keep (v) držati **keep cool** držati hladnim, **keep down** 1 smanjiti; 2 ne dati maha, **keep running** držati i radu, držati u pogonu

keep a sharp lookout (v) (seamanship, navig) to be on guard against sudden opposition or danger; place a seaman in a station to watch for danger ahead **pomno motriti** 16 *Keep sharp lookout for lifeboats / liferafts / persons in water / . (IMO SMCP) ... all ships in vicinity are requested to keep a sharp look out, to contact "MV ..." on 6216 khz, to propose assistance and to report to the MRCC.*

keep clear 1 (v) (mar law, navig) **izbjegavati (brod), dati pravo puta** usly the international code flag Alpha, drawing attention to the fact that it was engaged in diving operations and that vessels were to **keep well clear** and pass at slow speed. **keep clear of** **izbjegavati, držati se podalje od**. We replied that, being the stand-on vessel, we were keeping our course and speed and that the bulk carrier, being the overtaking vessel, should **keep clear of us**. Those tempted to blindly charge into

the TSS lanes believing that through traffic must no matter what the circumstances **keep clear of them** would then in fact be violators of Rule 9(d)., **keep clear from (the vessel) zaobići (drugi brod) izbjegli (drugi brod), držati se podalje od (drugog broda)**: I advised other vessels via Ch16 to **keep clear from this vessel**. I advised other vessels via Ch16 to **keep clear from this vessel**.; **2 (navig) ukloniti se drugom brodu, skloniti se s puta (drugom brodu), izbjegli drugi brod**; **3 (boating/yachting) skloniti se s puta (drugoj jedrilici)**

keeping clear (n) (seamanship, navig, boating/yachting) sklanjanje s puta, uklanjanje (jedrilice u regati), davanje prava puta / prolaza: Encountering and **keeping clear of fishing vessels** is a routine occurrence for most bridge watchkeepers. The tanker crossed the TSS as originally planned, took early action to avoid collision in accordance with Rule 16 and exercised the precaution of **keeping clear of the MPC buoy** in accordance with Rule 2(a).

keep out of the way = keep clear = keep clear izbjegavati (drugi brod): As this was alarming, the CV was told that she was an overtaking vessel and that she was required to **keep out of the way**. Rule 13 clearly states that the overtaking vessel **shall keep out of the way** of the vessel being overtaken. In a clear day with no other traffic or land in the way, one would expect, as we were the stand on vessel, that the other vessel would do her duty and **keep out of the way**.

keep running (n) (marine eng) pustiti (stroj itd.) da radi, držati (stroj itd.) u radu: The Chief Engineer kept the two diesel alternators running, despite rising lubricating oil temperatures, to maintain ship mobility.

Keep the buoy / mark on port / starboard side! (navig, seamanship) Ostavite plutaču/oznaku s lijeve / desne strane! {zapovijed za kormilarenje}

keep tight (v) (seamanship) držati konop zategnutim

keep to sea (v) ići u pomorce, postati pomorcem

keg /keg/ (n) 1 (cargo handling) a small barrel used for storing something such as beer or other alcoholic drinks. (Collins Online) bačva, bačvica; **2 (cargo handling) a kind of beer which is kept under pressure in a metal barrel. (Collins Online) pivska metalna bačva**

kellet (n) (seamanship) = anchor sentinel uteg na sidrenom lancu

kenter pin hammer (n) (nav arch) čekić za izbijanje zatika spojne karike sidrenog lanca čekić izbijača spojne karike (sidrenog lanca)

kenter pin punch (n) (nav arch) izbijač spojne karike (sidrenog lanca)

kenter shackle (n) (nav arch) rastavljiva karika za spajanje lanca spojna karika (sidrenog lanca): Spile and other 'locking' pins that hold **Kenter-type joining shackles** together and secure the pin of the 'D' shackles should be sighted at every opportunity. The anchor is badly fouled at the bottom and cannot be freed, the traditional seamanship practice (if time and circumstances permit) is to bring the next



Kenter shackle on deck and open it with **pin** and hammer.

kerosene /'kerəsi:n/ (n) (cargo) **kerozin** *There was an explosion which tore away bulkheads to adjoining tanks and ignited the aviation fuel and kerosene slops that were stored in them. The investigation also revealed that the usual cleaning equipment was not operational, and that the supply of kerosene onboard was exhausted.*

ketch (n) (boating/yachting) jedrilica s dva jarbola; krmeni je jarbol niži od prednjeg **keč**: *I was motor-sailing on a 55 foot ketch steering a course of 2700 T towards Tio Man Island on the east coast of Malaysia at a speed of 6 knots. My first encounter was with a yachtsman motoring along in his 45ft ketch, inshore of the Goodwin Sands, after dark, in a Force 6 and with rain falling in torrents;.*



kevlar (n) (boating/yachting) kevlar {sintetički materijal za jedra}

key 1 (marine eng) klin; 2 tipka (na tipkovnici računala); 3 (electr) tipkalo

key (n) (electr, navig) tipka za uključivanje i isključivanje (radara), dugme za uključivanje i isključivanje: *Press the POWER/BRILL key at the top of the control panel to turn the radar on, and the lamp to its left lights. press the key pritisnuti tipku, pritisnuti dugme, press and hold the key pritisnuti i držite tipku pritisnutom, power key tipka z uključivanje/isključivanje struje / napajanja*

keyed on (adj) (marine eng) klinasto spjen, uklinjen, učvršćen klinom, osiguran

klinom: *Or the camshaft may consist of a steel shaft with separate forged-steel or cast-iron cams keyed on.*

key in (n) (comm) unijeti, utipkati: *key in the ship's name* utipkati ime broda

KG; center of gravity above the keel; KG metres above the keel (n) (stabil) visina sistemnog težišta broda iznad kobilice (dobivena računom centracije),

položaj sistemnog težišta iznad kobilice: *The vertical position of the centre of gravity of a weight on board is expressed in terms of 'metres above the keel' (KG) In practice 'moments about the keel' are taken to determine the final KG of the ship. The centre of gravity (KG) above keel depends on the distribution of cargo in the vessel.*

kick ahead (v) (ship handling, navig, marine eng) dati nekoliko brzih okretaja naprijed,

kratko ubrzati naprijed, kick ahead: *The pilot gave a kick ahead on the engine and the vessel started to turn to port towards another terminal on the other side of the river. The pilot used the CP propeller lever to produce an engine kick ahead, then set the CP propeller lever at full astern but the vessel continued crossing the channel at a 45° angle.*

kick ahead technique (n) (marine eng, seamanship) tehnika / manovra naglog ubrzanja

broda (oko 45% sile poriva) pri otklonu kormila sve u lijevo ili desno **manevar kick ahead**: *Control is best achieved by applying full rudder and utilizing a short but substantial burst of engine power. This is the Kick Ahead technique. The Master gave a kick ahead on the engine to stop the vessel's astern movement..*

kick astern (v) (ship handling, navig, marine eng) dati nekoliko brzih okretaja natrag

kratko usporiti natrag

kicking strap (n) (boating/yachting) **SYNONYM boom vang** a strap or line which exerts downward pressure on the boom near where it joins the mast of a fore-and-aft rigged sailing boat
priteg deblenjaka, vang, tal. caricabasso del boma The kicking strap is used upwind in heavy winds to bend the mast and hereby opening the sail in the bottom part. It also keeps the leech from opening too much when easing the mainsheet in the gusts.

kidnap (v) **SYNONYM abduct oteti**: Five crewmembers were kidnapped from a cargo ship off the coast of, The seafarers were released today morning and are heading home

kilowatt (kW) /'kiləʊ wɒt/ (n) (phys) **kilovat**: The 18-cylinder VP185 model offers a maximum output of 4000 kW at 1950 rev/min, a 3300 kW continuous power rating for fast ferries and patrol craft, and 3000 kW at 1770 rev/min for unrestricted marine duty. L/V42MA design with an output raised to 625 kW/cylinder at 600 rev/min, allowing 6L- to V18-cylinder models to cover a power band up to 11 250 kW. A power range from 1020 kW to 1710 kW at 900/1000 rev/min is covered by six-, eight- and nine-cylinder models. An output band from 2058 kW to 2430 kW at 240 rev/min is covered by the 6EL38 and 6EL40 engines on a mean effective pressure of around 20 bar.

kinetic energy /ki'netik; kai'netik/ (n) the energy of motion of a body, equal to the work it would do if it were brought to rest **kinetička energija**

king post (n) (nav arch) a strong vertical post used to support a derrick boom **teretni stup**



kink /kiŋk/ (n) 1 (seamanship) a twist in a rope or hose **zafrcanost kužeta, zavrnutost užeta, verinanje**. Root causes/contributory factors: 1. The fall wire had a kink in way of the failure location, believed to be a permanent stress point when the gangway is swung out to upper deck level;



; 2 **zapeljani konop** {petlja pri nepravilnom slaganju konopa}
kink /kiŋk/ (v) (seamanship) **zapeljati (o konopu), stvoriti petlju (na užetu / savitljivoj cijevi)**: ... the use of rope slings to lift the jumper hose in the past had probably caused the coiled wire

sleeve to be displaced, causing the hose to kink in places.

kite sail technology (n) (nav arch) **dopunski pogon broda sa jedrom-zmajem**: *Kite sail technology will help to reduce bunker costs and aid in navigation and security surveillance*

klystron; (KLY) /'klɪstrən ; 'klaɪstrən/ (n) (electr) an electron tube for the amplification or generation of microwaves by means of velocity modulation **klistron (radara)**

KML; Height of the Longitudinal Metacenter (n) (ship handling) the distance between the metacenter and the keel measured in feet **visina uzdužnog metacentra**

KM; transverse metacentre (n) (stabil, nav arch) transverse metacentric height above base line; The point of intersection of the vertical through the center of buoyancy of a ship in the position of equilibrium with the vertical through the new center of buoyancy when the ship is slightly heeled **poprečni metacentar KM is the distance from the keel to the metacentre.**

KMT; transverse metacentric height (n) (stabil, nav arch) the transverse metacentric height at zero heel angle **poprečna metacentarska visina**: *KMT is the transverse metacentric height at zero heel angle and is measured from the base line.*

knee (n) (nav arch) **koljeno hold-beam knee-rider (sailing vessels) okvirno koljeno skladišta**

knee of the head (n) (sailing vessels) **kljun**

knee-rider (n) (sailing vessels) **okvirno koljeno**

knight-head (n) (sailing vessels) **pramčano rebro uz statvu**

knob /nɒb/ (n) (marine eng) **okrugla ručica za upravljanje, pomul**

knob /nɒb/ (n) (seamanship) **namotaj na kraju užeta {protiv rastavljanja strukova konopa}**

knocking (n) (marine eng) **lupanje, udaranje**: *The engine was assembled and tested but had to be stopped immediately when loud knocking sounds were heard from the crankcase. The knocking in the cylinders grew too heavy to keep the engine running. heavy knocking jako lupanje, jako udaranje (npr. motora, ventila, ...): Light knocking leads to automatic adjustment of the pilot fuel timing and cylinder-specific air-fuel ratio; heavy knocking leads to load reduction or a gas trip.*

knot /nɒt/ (n) **1 (seamanship) knots are used to form eyes, or to secure a cord or rope around an object, i.e. the line is bent to itself. uzao**: *On inspection, it was found that the rope had parted at the "crane side" of the bowline knot. rope knot uzao za užad, uzao za konope; 2 (navig)*

COMPARE bend COMPARE hitch čvor (mjera za brzinu plovidbe), milja na

sat, nod; tal. nodo: *The vessel arrived in the bay with a 40–45 knot wind blowing from the south-west. With the 21 knot speed of the other vessel, compared to the 6 knots of own vessel, the situation developed very rapidly. The inbound vessel was running with the tide at about 7 knots over the ground, while the outbound vessel was making 5 knots over the ground against the 4 knot tide; 3 (oceanogr)*

čvor (mjera za brzinu vjetrova, morske struje), nod: *The ship was sailing against a 2 knot tidal stream and the starboard propeller was still rotating ahead at 280rpm. Slack water was at 0926 and so the passage was made with a 2 - 4 knot flood stream, which in some sections of the narrow channel was directly abeam. He then held the ship stationary, stemming the 3-4 knot flood tide, with the port's entrance lock on his starboard beam. To collect them, the helmsman manoeuvred his vessel across the 3-4 knot ebb tide back alongside. {A Knot is the generic name for any loop or entanglement of flexible material, created either intentionally or accidentally, by a tucked end or bight. the word also has a very precise meaning : a knot, as distinct from a bend or hitch, secures two ends of the same material, e.g., a bandage, parcel string or shoelace. in addition, a small stuff - thus all angler's knots are by definition merely knots, irrespective of form or function.}*

knowledge /nɒlɪdʒ/ (n) **znanje, poznavanje**: *This is only possible by his vessel, and the pilot a*

detailed verifying that each helm order has been **knowledge of the local environment**. According to this, they should have a complete knowledge of the COLREGS, as well as some **basic knowledge of ship handling**, ARPA limitations and general good seamanship. **have a thorough knowledge of temeljito poznavati**. The ship's staff **must have a thorough knowledge** of the vessel's tanks and piping systems. Ships' officers **should have a thorough knowledge of stability**, particularly the difference between a static list and angle of loll caused by free surface and ... Officers **should gain a thorough knowledge of their vessel's cargo securing manual** to ensure stack weights are not exceeded and securing requirements are complied with at all times.

knuckle /'nʌkəl/ (n) (nav arch) = **chine** crta presjeka dviju ploha brodskoga obrisa; an abrupt change in direction of the plating, frames, keel, deck, or other structure of a vessel **zgib (oplate na trupu broda)**. The numbers of decks and **knuckles** are to be regarded only as identification numbers.



knuckle moulding /'nʌkəl,məʊldɪŋ/ (n) (nav arch) **brid krmenog okvira**

knuckle rail /'nʌkəl/ (n) (nav arch) **brid krmenog okvira**

Kort nozzle (n) (nav arch) **Kortova sapnica (na tegljaču)**: ... we passed the tanker's bow so close that the **starboard Kort Nozzle** around the propeller came into contact momentarily with the tanker's anchor chain.

Kort's nozzle (n) (nav arch) **Kortova sapnica (na tegljaču)**



label /'leɪbəl/ (n) **natpis, etiketa, naljepnica, oznaka**: The watertight door at the aft end of the superstructure **carried the label** "to be kept closed at sea". Check to be sure the cylinder **label** matches the colour code; Look around your vessel; identify a readily accessible place for stowing lifejackets and label it; and, if appropriate, place a 'grab bag' containing other emergency equipment close by.

label /'leɪbəl/ (v) **označiti, obilježiti, upisati / utisnuti naziv**: staviti etiketu / naljepnicu Look around your vessel; identify a readily accessible place for stowing lifejackets **and label it**; and, if appropriate, place a 'grab bag' containing other emergency equipment close by.

label cargo (n) (shipping econ) Cargo, including all commodities, requiring a label according to the provisions of the International Maritime Dangerous Goods Code.

(<http://www.maerskline.com/en-jm/help/shipping-glossary>) **teret s obveznom naljepnicom (prema Međunarodnim pravilima o prijevozu opasnih stvari morem)**

labour, (US) labor /'leɪbəl/ (n) **shore labour, (US) labor** **kopnena radna snaga, lučka**

radna snaga: *On the P&I club surveyor's advice, shore labour was employed to remove the debris from the cargo;* **1 (shipping econ) radna snaga:** *Pneumatic tools reduce the need for manual labour and limit repetitive strain injuries. Other major labour supply countries include Greece, Japan, Norway, Russia and the United Kingdom.* **labour, (US) labor cost cijena / troškovi radne snage, port labour, (US) labor lučka radna snaga lučki radnici;** **2 (navig)** a vessel is labouring when she works heavily in a seaway **probijati se kroz nevrjeme (o brodu) ; 3 mučan posao**

labour through (n) (navig) a vessel is said to labor when she works heavily in a seaway (pounding, panting, hogging and sagging). (www.USMM.org) **probijati se kroz nevrjeme:** *The vessel's movement began to be of grave concern to the skipper as she laboured in the heavy seas, so he ordered the crew to launch the liferaft and to prepare to abandon ship.*

lace-piece /leis/ (n) (nav arch, sailing vessels) **umetci brida**

lacing eye (n) (boating/yachting) očica jedra, očet tal.. occhiello

lacing wire (n) (marine eng) wire that passes through holes in the blades of a turbine and damps the vibration due to friction between the wire and blade. **vezna žica za ublažavanje vibracija (lopatica turbine):** *Lacing wire is used to dampen vibration, which can be a problem. Failure of*



blading due to cracks emanating from lacing wire holes can also be a problem.

lack (n) nedostatak nečega, manjak: *Lack of planning led to a non-compliance with company procedures, industry best practice and statutory requirements.* **lack of nedostatak nečeg, manjak nečeg, pomanjkanje nečeg, lack of communication manjak komunikacije,**

nedovoljna komunikacija: *Lack of communication resulted in misunderstanding of intentions.,*

lack of sea room (navig) nedovoljan prostor (za manevriranje), lack of proper application of the rules of the road slaba primjena pravila o izbjegavanju sudara

ladder /'lædə/ 1 (navig) ljestve: *to judge whether or not a ladder is more than the statutory 9 meters, especially at night, so the pilot only discovers the height after climbing the ladder.* **access ladder**

pristupne ljestve: *An engineer attempted to go down the access ladder between two platforms in the engine room while holding a book and pen in either hand. The upper platform on the access ladder had safety railings only on two sides, with no guard rails or chains on the tank side.; 2 (navig) stepenice,*

skale: *They rushed to the open manhole and saw the Bosun lying motionless on the top platform of the vertical ladder, about 5 metres below the main deck.*

ladder ropes (n) (seamanship) užad peljaskih ljestava: *Pilot fell overboard due to ladder ropes parting Embarkation ladder ropes to be renewed at intervals of not more than three years with renewal date stencilled in its vicinity.*

ladder rung (n) (nav arch) prečka ljestava, gazište ljestava: *The davit cradle ladder rungs were located in very close proximity to the faulty winch brake lever, and as the seaman descended the aft davit cradle, he probably stepped on*

ladders /'lædəz/ (n) (nav arch) = ladder ljestve, stube: *traffic density and routeing prevented a change of heading to provide sufficient lee for rigging the combination ladders;*

laden /'leɪdə/ (adj) nakrcan: *Arriving at a very busy tanker port, and with only three miles to go to the charted pilot station, a laden deep-draught VLCC, displaying the appropriate signals for a vessel*

constrained by her draught (CBD), was crossing a west-bound TSS lane from south to north .. A **partly laden tanker** was shifting from the lightering berth to the main discharge berth, with a harbour pilot on board and with two tugs fast. **fully laden sasvim krcat (brod)**: Own vessel, a 45,000grt container ship on passage from St John, New Brunswick to Livorno, almost **fully laden** and steaming at 19 knots.

laden passage /'leɪdən/ (n) (shipping econ) **ANTONYM ballast passage :1**
plovidba s nakrcanim brodom

laid (adj) **položen**: Several drums **were laid on their sides** and not vertically stowed. He **was carried to the main deck and laid on a mattress** to await an ambulance.

laid down (adj) (mar law) **propisan, zacrtan, utvrđen**: Having made certain that the ship has arrived at the time and place **laid down in the Charter-Party**, the Shippers inspect the ship's holds in order to ascertain whether they are fit to receive the particular cargo the ship General average: The principle of general average is **clearly laid down in Rule A of the York-Antwerp Rules**, reading: "There is a general average act when, and only when, any extraordinary Marine casualty investigator means a person or persons qualified and appointed to investigate a casualty, or incident, under **procedures laid down in national legislation** for the furtherance of marine safety and protection of the marine environment.

laid-off ship /leid/ (n) **brod u raspremi**

laid out (adj) **1 (mar law) SEE laid down naveden, specificiran, zacrtan**: It is worrying that virtually none of the hot work procedures **laid out in the vessel's SMS** or those detailed by the contractor were complied with. The ship's staff carried out the pre-welding checks **as laid out in the Safety Management System (SMS)** and associated risk assessment.; **2 (seamanship, ship handling)**

staviti (uže), postaviti (uže): The master **laid out additional mooring ropes** to restrain the vessel's rolling at berth.

laid rope /leid/ (n) (seamanship) **sukani konop, konop sastavljen od tri struka**

laid teak deck /leid/ (n) (boating/yachting) **paluba od tikovih laminata, paluba pokrivena laminatima od tikovine**

laid-up berth /leid/ (n) (shipping econ) **mrtvi vez**

laid-up ship /leid/ (n) (nav arch, shipping econ) = **lay off ship brod u raspremanju, brod u raspremi, brod na mrtvom vezu, tal.**

ave in disarmo: **TERMINATION DUE TO VESSEL SALE, LAY-UP OR DISCONTINUANCE OF VOYAGE** Where the vessel is sold, **laid up**, or the voyage is discontinued necessitating the termination of employment before the date indicated in the Contract, except only that the Owners may discharge an Employee:(i) upon the total loss of the vessel/unit, or (ii) when **the vessel/unit has been laid up for a continuous period** of at least two months, or (iii) upon the misconduct of the Employee giving rise to a lawful entitlement to dismiss, ... Since the ship just came from being **laid-up for about one year**, the ladders had apparently not been used for some time and ... The boat had been launched that morning **after being laid-up ashore for 6 months**.

lamine /'læmɪ,neɪt/ (n) (boating/yachting) **laminat**: Vessels will be **laid-up** or start trading in accordance with the given freight rates.

land (n) **1 (navig, mar law) ANTONYM board iskrcati se (član posade, putnik, peljar) iskrcati (nekoga)**: I sailed out straight into a typhoon, and after two days, had to deviate to **land a sick engineer**. The intention was to seek a sheltered anchorage, where it would have been possible to **land the passengers** with the vessel's tenders onto an appropriate beach. **land the pilot iskrcati peljara** 3. All vessels subject to compulsory pilotage shall, when entering or leaving the harbour approaches, board or **land their pilot** in the vicinity of Breaksea Light Float (51° 20' N, 3° 19' W);

2 (cargo handling, seamanship) iskrcati (teret, ulja, kaljužu itd.): They also cannot accept the

fact that they have to **land large amounts of slops** to shore facilities as this costs them money. A *Hard Day's Night* Narrative In the early hours of the morning, a Vivier crabber ran aground as she returned to port **to land her catch** after a 6-day trip. Soon after the vessel finished mooring the vessel's crew were occupied with **landing an electric motor**. **land the cargo iskrcati teret ; 3 (safety)**

spustiti se na brod (helikopter) : .16 V: I am ready to receive you. .17 H: MV ... , I am landing. .18 H: MV ... , I am starting operation. (IMO SMCP); **4 (med, safety) pasti na**: Before he could shout a warning, the trolley, weighing over 400kg, twisted off the gantry and fell about 7.5m, **landing on the ship's guardrail**. Luckily, none of the seven people who were standing nearby were injured. Suddenly, he slipped and fell, **landing about 8.5 metres below on top of a container** in the cargo hold .

land (n) (navig) kopno: Inexplicably the pilot failed to execute the 'wheel-over', leaving the vessel heading directly for the **land ahead**. At lunchtime, **the skipper decided to head in to land** and re-store, and elected to take the 6-hour navigation watch back to port. Although other vessels, with AIS receivers, were in the vicinity at the time, no one alerted the vessel until she was **very close to land**. Due to a deep depression producing severe gales, the vessel remained **within the lee of the land** for most of her voyage. The vessel started to drift back **towards the land**. **In this case, the ship's limited engine power gave the master little choice other than to anchor in the shelter of the land**.

land and sea breezes (n) (meteorol) obalno kruženje zraka, obalni povjetarci

land-based (adj) kopneni, obalni: Achieving zero emissions may dictate shutting down all engines and boilers during a port stay, and plug-ging into a **land-based electrical supply system**. Most seafarers of my age will probably agree that the new metric charts are not a patch on the old ones as they contain far less detail of **land based objects**, land contours, etc. The quality and quantity of **land based equipment** (communications, radars, RDF etc.)

land breeze (n) (meteorol) ANTONYM sea breeze a wind that blows from the land towards a body of water **kopnenjak, vjetar s kopna, burin**

land bridge (n) (shipping econ) Containers moving from a foreign country by vessel, and then sent to an inland point in the U.S. or elsewhere by land transportation (rail or truck)

(<http://www.maerskline.com/en-jm/help/shipping-glossary>) **transportni most, kombinacija morskog i kopnenog prijevoza**

land earth station; (LES) (n) (comm) kopnena stanica satelitskih komunikacija

land effect (n) (meteorol) učinak kopna

landfall /'lænd, fɔ:l/ (n) (navig) a ship reaching shore; first sight of land after a voyage **približavanje (broda) kopnu, tal. atterraggio make an early landfall stići (do kopna, luke) ranije od planiranog vremena, ugledati kopno, make a landfall doploviti do kopna / obale, približavati se kopnu / obali, stići do kopna / kopna**: He usually relied heavily on the radar for navigational guidance **when making a landfall**. Somewhere between buoys four and five as they made landfall he fell asleep. , **landfall mark oznaka kopna, oznaka koja pokazuje blizinu kopna**: After BXA **landfall mark**, the ship altered course to 300° at 8.8 knots ...

landing (n) 1 (mar law, shipping econ) iskrcaj (ljudi na) obalu: Means of boarding and **landing of personnel** by boat at sea with this type of vessel is not properly considered during the design stage: - ; **2**

(cargo handling) iskrcaj / spuštanje (roba / tereta na obalu): The Waterguard Officer checks **the landing of all goods** destined for the port and when the discharge is completed the ship is searched and the stores checked and compared with the Surplus Stor In such a case the master may and must deal with the cargo for the benefit of its owner **by landing it**, carrying it on, or transshipping it, as may seem best.

landing area (n) (safety) područje slijetanja (helikoptera na brodu)

landing craft (n) (navy) desantni brod, desantna brodica

landing fees (n) (shipping econ) pristojbe za korištenje zračne luke, aerordomske pristojbe

landing net (n) (fishing) ribolovno pomagalo kojim se prihvaća ulovljena riba

(<https://ribolovnajadrano.hr/riobicki-leksikon>) mreža prihvatnica, mrežica za prihvat ribe, vrećasta mrežica za prihvat ribe, podmetač, sak za ribu, špurtil; šurtil, oprara, janka, sak, lumprara, šica, voliga;

landing place (n) 1 (ports) pristanište; 2 (ports) putnički vez (gat)

landing port (n) (shipping econ, fishing) luka ticanja: An experienced skipper of an 11 metre prawn trawler was well known around the many landing ports he used, ...

landing stage (n) 1 (ports) putničko pristanište (na rijeci, u ušću, kanalu), trajektno pristanište, putnička platforma (na rijeci, u kanalu): After alerting the port authorities, the tug headed upstream to a landing stage where the injured seaman walked ashore and was taken to



hospital.

; 2 (safety) sletišće, letalište: After alerting the port authorities, the tug headed upstream to a landing stage where the injured seaman walked ashore and was taken to hospital.

land-locked state /locked ('lənd,lɒkt/ (n) (mar law) neobalna država, kontinentalna

država: The agent may even be only involved in sales and marketing which would be the case for an agent in, say, Switzerland, Austria, Zimbabwe or any other land-locked state or area.

landlord port (n) (shipping econ, mar law) COMPARE operating port COMPARE port privatization At a landlord port, the port authority builds the wharves, which it then rents or

leases to a terminal operator (usually a stevedoring company).; javna luka čiji se terminali, vezovi, skladišta itd. koja se daju u koncesiju korisnicima (lučka poduzeća, lučki operatori) koncesijska

luka, koncesionarska luka {The operator invests in cargo-handling equipment (forklifts, cranes, etc), hires longshore laborers to operate such lift machinery and negotiates contracts with ocean carriers (steamship services) to handle the unloading and loading of ship cargoes}

landlord-tenant relationship (n) (US, mar law) Landlord-tenant law governs the rental of commercial and residential property. It is composed primarily of state statutory and common law.

(https://www.law.cornell.edu/wex/landlord-tenant_law) odnos između vlasnika (npr. lučke uprave) i zakupca / unajmitelja / koncesionara (terminala, lučke obale): The Port

Authority has had a lengthy landlord-tenant relationship with Maersk at its Barbours Cut container terminal, and the company is now free to call there or at the Port Authority's Bayport container terminal as a common carrier, the port authority said.

land lubber; landlubber (n) (seamanship) a person unfamiliar with being on the sea or anyone inept on board; a non-sailor žabar, kontinentalac, nepomorac

landmark /'lænd,ma:k/ (n) (navig) kopnena oznaka, tal. *punto conspicuo*; *punto di riferimento*, istaknuta oznaka, orijentir. *In confined waters, a good helmsman will always pick a prominent landmark to steer by, not use the compass.*

lane /leɪn/ (n) 1 (navig) plovidbeni smjer (u zoni odvojene plovidbe), staza (u zoni odvojene plovidbe): *A number of vessels were proceeding in both directions within the appropriate lanes.* busy shipping lane plovidbeni smjer s gustim prometom: *The accident occurred as a cargo vessel was proceeding with an unmanned bridge, across busy shipping lanes, before grounding on a mercifully benign stretch of coast. As we approached the Westbound shipping lane close East of the Casquets TSS, we saw three ships about 2nm apart in line abreast of each other approaching about 4nm away.*; 2 a route used by ships or aircraft on regular journeys ruta, redovita ruta

lane (n) (cargo handling, nav arch) parkirna staza (na ro-ro brodu), parkirna traka, kolovoz (za vozila na ro-ro brodu) lane metres of freight duljina parkirnih staza u metrima (za teret vozila na ro-ro brodu). *The new ships will each carry 6,700 lane meters of freight, equivalent to around 450 trailers, and*

lane slipping (n) (navig, electr) proklizavanje pojasa (u sustavu DECCA)

langouste (n) (fishing) Lat. *Palinuridae* jastog

lantern /'læntən/ (n) (seamanship) svjetiljka: *Once the vessel's range was down to 4 miles, I indicated to him that I was unsure of his intentions by five short and rapid flashes on the signal lantern. The combined bow lantern then went out, possibly due to water ingress to the unit. ... a sailing yacht (under 20 metres) was motoring (or motor-sailing) with her steaming light on along with both her masthead combined lantern and ordinary sidelights at the right aspect to produce red-white-red in a vertical line.*

lanyard /'lænjəd/ (boating/yachting) priteg: *Fixing a lanyard to an operating lever and pulling on it from the rope-handling position should strictly be forbidden. The lanyard was pulled back in, and fully unravelled, before a second attempt at a throw was made.* {konopac koji se umeće kroz rupe u drvenom koloturniku radi pritezanja ili popuštanja opute}

lap joint (n) (nav arch) preklopni spoj. *An improved design of S-seal ring (double-lap joint) was developed and tested to achieve a completely tight upper ring.*

lap weld (n) (marine eng) zavareni šav preklopnog spoja, preklopni zavar

larboard /'la:bəd/ (n) (seamanship, navig, archaic) = port the left side of the ship lijeva strana broda {archaic (zastarj.); superseded in 19th cent. owing to confusion with starboard}

large end (n) (marine eng) donja glava ojnice, donji kraj ojnice: *A compression plate or shim is interposed between the foot and the box of the rod large end.* large end bearing ANTONYM bottom end bearing leteći ležaj ojnice ležaj donjnjeg kraja ojnice: *The design of the large end bearing is similar to that of the main bearing. Again, some oil is used to lubricate the large end bearings whilst the remainder leaves via the groove in the centre of this bearing and up the passage in the connecting rod to the small end. bearings.* large end bolts vijci donjnjeg kraja ojnice: *The large end bolts withstand any load since they are strongly made.*

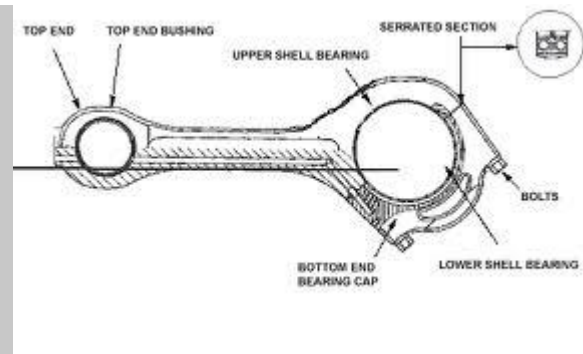

{= big end}

larger draft ship (n) (**shipping econ**) **brod s velikim gazom**: *Larger draft ships that take longer to transit the Canal and typically have longer waiting times,*

large-scaled gurnard (n) (**fishing**) **kokotić hrapavac**

lark's head (n) (**seamanship**) **holanski uzao**

lash /læʃ/ **1** (v) (**cargo handling**) to secure by turns of line, wire, or chain **vezati (teret), ricati,**

ricavati *Lash and secure the goods for sea and report. (IMO SMCP) We sailed with a three degree starboard list and I suggested to the Master that we secure the bow ramp properly and lash the vehicles on deck. The Duty Officer did not warn the stevedore that he had to wait before starting to lash until an overhead container was stowed.; **2** (**seamanship, ship handling**) **pričvrstiti (sidreni lanac),***

bocati *Lash together the eyes of the towing line with manila lashing. It is the custom to lash liferafts to the deck of fishing vessels, using rope or webbing straps.*

lashing /læʃɪŋ/ (n) **1** (**cargo handling**) **vezivanje i učvršćivanje tereta, vezica za teret,**

ric; rice; tal. rizza: *The master immediately removed the lashing and the P/V valve opened fully on the pressure side. The were involved in the lashing and securing of cargoes and consulted the IMO Cargo Securing Manuals (CSM), cargo lashings rice (za teret) on the tanktops, tween decks and hatch covers; On modern container vessels, if the excess weight on hatch covers is not accounted for, the deck cargo lashing configuration as determined by the on-board software may prove to be insufficient.*

insufficient or improper lashing nedovoljno ili nepravilno vezivanje tereta,

tightening of lashing zatezanje vezica za teret, loose lashing labave vezice za teret,

labave rice: *Loose lashings allowing the stacks to tilt and arrest sharply as the slack is taken up.*, **wire**

lashing žičane vezice za teret, žičane rice, lashing equipment oprema za vezivanje

tereta: *Suggested actions include considering temporary reductions in container stack heights, revised weather routing and replacement of suspect lashing equipment.*, **lashing points mjesta**

vezivanja, točke vezivanja: *Review the cargo securing manuals of all company ships carrying freight vehicles to ensure compliance with the numbers of lashing points*

required in the UK Code of Practice., **lashing straps privezne vrpce, privezne trake**

The lashing straps were also of insufficient strength, and tests have shown that the chocks could not have been correctly positioned., **lashing team skupina za vezivanje**

tereta, ruka za ricavanje tereta: *... the port captain said that the lashing team on board were the*

best in the entire port., **chain lashing lančani ric, lanac za vezivanje tereta**: *This caused the tapered pin to fall out and release both the Senhouse slip and the anchor cable chain lashing; It was then found that the port anchor chain lashing had released and the anchor had lowered itself against the*



windlass brake tension, into the water.

; 2

(seamanship) sredstva za osiguranje / pričvršćivanje sidrenog lanca za vrijeme

plovidbe, boce If appropriate, the windlass gear may be engaged after housing and **lashing the anchors**, taking care that only the brake, lashings and the bow stopper are all bearing equal stress; Some time later the weather improved and the Master had the crew check the forecastle for any damage and the **lashing** and anchor stowage. **chain / cable lashings boce (za pričvršćivanje sidrenog lanca)**: As the pin became displaced, the slip released, allowing the **chain lashing** to fall into the hawse

pipe., **lashing rope rice od konopa za vezivanje / učvršćivanje lanca**: Attach a safety loop or **lashing rope** across every temporary connection in the hose and piping system to prevent them from snapping back; i, **lashing arrangements sustav vezivanja / pričvršćivanja (splavi, brodice za spašavanje)**: Owners and skippers of all fishing, merchant and pleasure vessels should urgently review the **lashing arrangements** for liferafts fitted to their vessels, to ensure that any manual

quick release arrangements can be easily operated as intended.; 3 **(seamanship) zapor (za prebacivanje užeta s vitla na bitvu), boca**

lashing and securing equipment (n) (cargo handling) oprema (naprave) za

vezivanje i pričvršćivanje tereta: All person involved in the **lashing and securing of cargoes** have working knowledge of the IMO Cargo Securing Manuals (CSM) ...

lashing bar 1 čelična motka za vezivanje kontejnera a motka za vezivanje tereta,

šipka za vezivanje tereta: On arrival at the vessel's home port an unlashing gang immediately boarded and released the lower **lashing bars** and twist locks that connected the bottom two containers in each stack stowed on deck.

lashing force (n) (cargo handling) COMPARE racking force COMPARE post

load COMPARE lifting force the resultant force in the lashing, causing damage to the

container **sila opreme za učvršćivanje kontejnera**: Exceeding lashing force can be reduced by

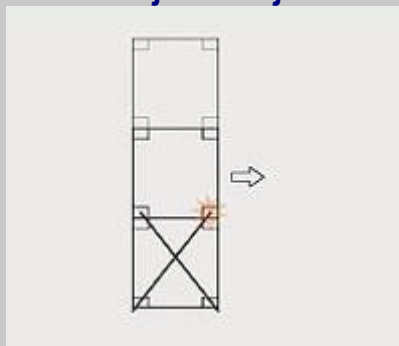

using additional lashing units.

lashing gear (n) (cargo handling) oprema za vezivanje tereta, naprave za

pričvršćivanje tereta, sredstva za pričvršćivanje tereta: Lashing gear for 600-700

containers was found to have been damaged during the incident. **Lashing gear for 600-700 containers** was found to have been damaged during the incident.

lashing inventory (n) (cargo handling, seamanship) popis potrebne opreme i materijala za vezivanje tereta, popis opreme za *ricavanje* tereta

lashing plan (n) (cargo handling) plan vezivanja tereta

lashing ring (n) (cargo handling) kolut za vezivanje tereta *Lashing rings are mounted in the top side rails for securing the cargo.*

lashing rod (n) (cargo handling) = **lashing bar** čelična motka za vezivanje tereta, čelina šipka za vezivanje tereta, pričvrtna šipka: *Two 20 foot containers placed in a 40 foot slot, leaving insufficient space for lashing rods to be fitted to the inward facing ends.*



lashing rope boce (tanja užad za osiguranje priveznih konopa) *Attach a safety loop or lashing rope across every temporary connection in the hose and piping system to prevent them from snapping back;*

lashings /'læʃɪŋz/ oprema za učvršćivanje (tereta), **rice timber lashings** drvena oprema za učvršćivanje, **chain cargo lashings** lančana oprema za učvršćivanje tereta, lanac za vezivanje tereta, lančane *rice* za teret *Assisted by two able seamen, the chief officer managed to secure the anchor cables using chain cargo lashings.*

LASH ship (n) (nav arch) brod za prijevoz teglenica (maona, barža): *A serious injury occurred to a member of crew on board the LASH vessel. {Lighters Aboard Ship}*

last /laːst/ (v) trajati, potrajati *This operation lasted nearly eight minutes, by which time the vessel was very close to the breakwater and nearly parallel with it. The whole incident lasted about one hour.*

latch /lætʃ/ (n) 1 zaporka; 2 (marine eng) zubac: *These must be adjusted optimally to give a smooth and controlled speed of closing, and fail-proof latch activation.;* 3 potiskivač; 4 skakalica

lateen rig /lə'ti:n/ (n) (boating/yachting) latinska snast, latinska oputa

lateen rigging /lə'ti:n/ (n) (boating/yachting) latinska oputa

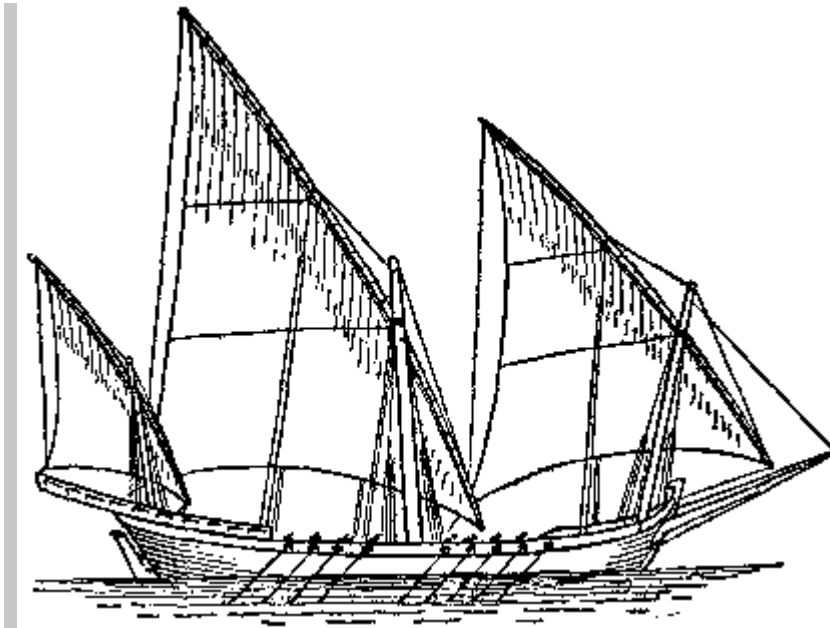

lateen sail /lə'ti:n/ (n) (boating/yachting) a triangular sail set on a long yard mounted at an angle on the mast, and running in a fore-and-aft direction. **latinsko jedro**

latent defect /'leitənt/ (n) (mar law) hidden defect (or the very nature) of a good or property which of itself is the cause of (or contributes to) its deterioration, damage, or wastage. Such characteristics or defects make the item an unacceptable risk to a carrier or insurer. If the characteristic or defect is not visible, and if the carrier or the insurer has not been warned of it, neither of them may be liable for any claim arising solely out of the inherent vice. (Business Dictionary) **skrivena mana** *This could be due to a latent defect, as such an occurrence is unusual under normal usage.*

latent heat /'leitənt/ (n) (marine eng) **skrivena toplina, vezana toplina**

lateral buoy (n) (navig) **bočna oznaka, lateralna oznaka, lateralna plutača**: *After being on watch for almost 3 hours, the chief officer suddenly noticed a lateral buoy close on the vessel's starboard side. The port was entered through a channel marked by pairs of lateral buoys numbered from 1 at the seaward end to 16 near the outer basin. The ship's forward part made contact with a green lateral buoy marking the north side of the channel.*

lateral buoyage system (n) (navig) a system of aids to navigation in which characteristics of buoys and beacons indicate the sides of the channel or route relative to a conventional direction of buoyage (usually upstream) **lateralni sustav označavanja**

lateral marks (n) (navig) sea marks / buoys used to mark the sides of well-defined, navigable channels **bočne oznake, lateralne oznake** *Remember that, when navigating in and around harbours, Lateral Marks are coloured as if you are approaching from the sea. That is, when entering port, you keep the port-hand marks on the port side of your vessel. When proceeding to seaward, you therefore leave them to starboard.* <http://www.otenmaritime.com/iala-system-of-buoyage/lateral-marks> **IALA**

lateral marks **bočne oznake prema IALA-1, IALA B lateral marks oznake kanala prema IALA-i, port-hand mark oznake s lijeve strane, starboard-hand lateral marks**

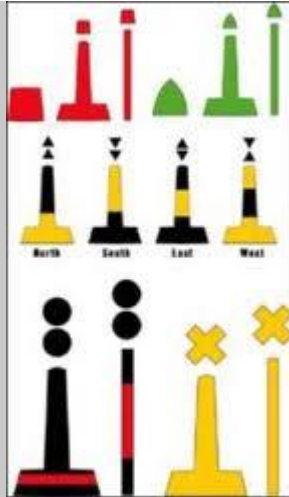

oznake s desne strane

latex /'leɪteks/ (n) (cargo) lateks

lath /la:θ/ (n) (cargo) letva, motka (debljine 1)

lathe /leɪð/ (n) (marine eng) tokarski stroj, drebang; njem. *Drehbank*: Injuries to lathe operators - A crewmember was engaged in **lathe work** in the ship's workshop.

latitude /'læti,tju:d/ (n) (navig) **geografska širina**: He gave a local position, but did not include a **latitude** and longitude. North of **latitude** 55N an increasing swell from the north west was experienced. This was done using **the latitude and longitude** readout of the radar cursor using the co-ordinates of the centre of the anchorage circle from the chart. When the nearer one was little over six miles away, I heard a call from one of them, - no name or call sign, just a **GPS latitude and longitude** to four places of decimals, calling the ship on my starboard bow. Amendment (2) : In addition, the Outer Pulley Lighted Buoy has been moved 25 metres to a new assigned position of **Latitude** 51° 04'.338N., Longitude 04° 12'.920W. 3 Amendment : Following review of the aids to navigation in the approaches to Bideford, ...

angle of latitude kut geografske širine, **measure the latitude** mjerenje geografske širine, **difference of latitude** razlika geografske širine

latter /'læte/ (pron) **COMPARE former drugi (od dva), potonji**: *the latter ship* was involved in another collision **potonji** (drugi) brod imao je još jedan sudar *The inward vessel came up astern of me and asked the pilot cutter if he should slot in behind me or continue towards the cutter, he was advised to do the latter* and it was left to me to contact him and ask him to slot in behind me. Corrosive wear control can be based on **either** feed rate control **or** control of the cylinder oil BN; **the latter approach** calls for two or more lube oil tanks or blending facilities onboard.

lattice /'lætɪs/ (n) (navig, marine eng) mreža, rešetka (na karti): *The results would be the hyperbolic lattice* shown in Figure 1206b. When he interpolates in sight reduction or **lattice tables**, he assumes a linear (constant-rate) change between tabulated values.

launch /b:ntʃ/ (v) 1 (nav arch) **porinuti (brod)**: *The tanker was launched* in Split on 25th July 2009 After *the ship was launched*, the QE2 was fitted out with a steam turbine propulsion system ... **launch**

sideways porinuti bočno: *The MV Ireland (Nb. 435), a dedicated cement carrier, was sideways launched* March 19 at the company's Westerbroak shipyard in northeast Netherlands.; 2 (seamanship)

spustiti u vodu (brodicu za spašavanje, splav): *The crew was able to launch all of the vessel's liferafts successfully in this manner. If the main release device fails to launch the lifeboat, the assigned crew member operates the emergency lifeboat release lever. Hold on to the ropes or to your seat when launching the lifeboat. A safety standby vessel was carrying out a regular drill to launch the Fast Rescue Craft.*; 3 (safety) **lansirati (signalnu raketu)**; 4 (navy) **lansirati (raketu) launch a**

missile lansirati raketu; 5 (safety) započeti (operaciju spašavanja), aktivirati

operaciju spašavanja: *There was a lack of skill in dealing with an emergency situation: the crew took too long to launch a rescue operation.*

launch /lɔːntʃ/ (n) (nav arch) a small power or motor boat **motorna brodica (agenta, lučkih vlasti itd.), peljarska brodica (čamac) pilotina, lanča; tal. lancia tal. scialuppa** A harbor pilot was transferring from the outbound containership to the inbound tanker by launch when the vessels collided at the entrance to the port's approach channel. A **launch** arrived to pick up disembarking crew of 10 persons who were leaving the vessel by pilot ladder (with combination of gangway). A **launch** was to transfer two persons to a vessel at anchor, via the accommodation ladder lowered with its bottom platform near the water level. The vessel was at anchor and a **launch** had been arranged for shore leave. Spares or stores have to be supplied **by launch** at anchorage. **pilot launch peljarska brodica, pilotina lanča:** 201361 Pilot ladder gives way A pilot was about to disembark from a small cargo vessel in benign weather conditions, with a good lee, and the **pilot launch** alongside and under control. The **pilot launch** made two attempts to close in to offer me assistance, but there was too much sea to let him get close in with safety and I asked him to stand off. A pilot was about to disembark from a small cargo vessel in benign weather conditions, with a good lee, and the **pilot launch** alongside and under control. Two pilot vessels available, one has royal blue hull, white superstructure and the other, a **fast pilot launch**, is painted



international orange.

launch /lɔːntʃ/ (n) (nav arch) **porinuće broda sideways launch:** *Launching a ship sideways avoids the need to have a water channel more than half as deep as the ship is long. the sideways launch just puts the ship more or less in a condition it will find itself in a storm, and it ought right itself.* **bočno porinuće broda**

launch a service (v) (shipping econ) otvoriti linijsku službu, otvoriti linijski servis,

otvoriti liniju APL **launched** the Atlantic Gulf Express **Service** – a direct Trans-Atlantic service which connects the key markets of North Europe, US South Atlantic and Gulf of Mexico.

launching (n) 1 (nav arch) the operation of transferring a vessel from the building ways into the water **porinuće, tal. varo.** *The launching of the new ship involves sliding the ship into the water from an inclined slipway.* **side launching bočno porinuće:** *In the side oiled slideway launching system the slideway extends into the water and the ship slides into the water using the slideway. In the second method the slideway doesn't go until the water and the ship along with the frame slides into the water.* **sideway launching bočno porinuće, launching end on (nav arch) porinuće krmom:** *The most popular and widely accepted ship launching method is the end-on launch. In this launch method, the new ship is allowed to slide into the water with its stern entering the water first.* **longitudinal launching uzdužno porinuće, tradicionalno porinuće (na klizajućem navozu / saonicama):** *The longitudinal oiled slideway launching is one of the oldest forms of launching systems.* **ship launching porinuće broda** *Traditionally, ship launching in the water is done using four main types of methods: Gravitational type launching, Floating-out type launching,*

Mechanical Type launching, Airbag launching.

<http://www.marineinsight.com/guidelines/4-types-of-ship-launching-methods/> *Ship naming and*

*launching procedures are arranged to provide a ship hull with her identity., **launching ceremony***

svečanost porinuća broda: *Various guests gathered at the **launching ceremony***



; 2 (safety, nav arch) spuštanje brodice za

spušavanje u more: *... a dangerous occurrence (near miss incident) happened during the annual servicing and inspection of the lifeboat and its **launching gear** in port. **launching gear uređaj za***

spušavanje brodice za spašavanje, **launching appliances sredstva za spuštanje i**

dizanje brodica / splavi za spašavanje, uređaji za spuštanje i dizanje brodica /

splavi za spašavanje: *No one should enter the life boats or carry out any maintenance work on*

*lifeboats and associated **launching appliances** without clear instructions and the presence of a senior*

officer. Recommendations have been made to the vessel.s managers with the scope of reviewing and

updating compliance with procedures established in the IMO guidelines, the ISM Code and SOLAS

*regulations during periodic servicing and maintenance of lifeboats, **launching appliances** and on-load release gear.*

launch the liferaft (v) (safety) spustiti splav za spašavanje (s broda): *The crew put on lifejackets and immersion suits, and then **launched the liferaft**. The vessel was going down rapidly, but the skipper **managed to launch the liferaft** and board it along with one of his crewmen.*

launch the ship (v) (nav arch) porinuti brod: *The ultra-luxury cruise ship was **launched today** at Fincantieri's shipyard in Marghera, Venice. The keel of the first nuclear-powered passenger-cargo ship, the Savannah, was laid on May 22, 1958, and **the ship was launched** in 1960.*

laundry /'b:ndri/ (n) (nav arch) praonica (brodska): *On detecting the fire, the **laundry** was evacuated and door was closed. Fires in commercial **laundry facilities**, hospitals and laundromats have been attributed to the spontaneous ignition of cotton or linen that has been dried and then either stacked*

law /b:/ (n) (mar law) 1 zakon under the law prema zakonu, u skladu sa zakonom:

***Under the law of salvage**, strangers to the maritime venture who succeed in saving maritime property from loss or damage from perils of the sea or other waters are entitled to an award for their efforts and have a maritime lien on the salvaged property therefor. A «Straight» Bill of Lading and the Sea Waybill are*

*consigned to a named consignee, and are therefore nonnegotiable **under the law of most, but not all***

countries** in the case of Straight Bills of Lading., **maritime law = maritime law pomorsko

pravo: ***Maritime law** governs many of the insurance claims relating to ships and cargo, civil matters between shipowners, seamen and passengers, and piracy. ; 2 **pravo question of law pravna***

stvar, stvar prava, spor, public international law međunarodno javno pravo:

*Admiralty law is distinguished from the Law of the Sea, which is a body of **public international law** dealing*

with navigational rights, mineral rights, jurisdiction over coastal waters and international law governing relationships between nations.

Law and Arbitration (*mar law*) **Zakonska nadležnost i arbitraža (za sporove iz ugovora, ili ugovoru o iskorištavanju broda)**

law court (*n*) (*mar law*) **sud**: Place of Arbitration - in most charterparties is affected through London or New York, with organisations like the London Maritime Arbitrators Association (LMAA) or **law courts** like the Commercial Division of the High Court of Justice.

lawful /'lɔ: ful/ (*adj*) **1 zakonit, u skladu sa zakonom**: The seafarers shall conduct themselves in an orderly, faithful, honest and sober manner, and shall at all times be diligent in their respective duties and **obedient to the lawful commands of the Master**, or of any person who shall lawfully succeed him, and their superior officers, in everything relating to the vessel, .. *flading* also provides the name of the ship and its owner, and where and when goods were loaded As a document of title, the bill of lading allows the **lawful possessor of the bill** to be considered the lawful owner of the cargo described on it

Insubordination or any act of **disobedience to lawful orders** of a superior officer. ; **2 pravno /**

zakonski dopustiv: If the charterparty merely describes the cargo to be carried as **lawful merchandise**, the charterers must provide cargo which may be lawfully shipped from the port of loading and lawfully carried to and discharged at the port of destination.

Law of the Sea (*n*) (*mar law*) **pravo mora**: Admiralty law is distinguished from the **Law of the Sea**, which is a body of public international law dealing with navigational rights, mineral rights, jurisdiction **Law of the Sea** **Law of the Sea** is a branch of international law concerned with public order at sea. Laws between nations governing such things as national versus international waters are considered public international law and are known as the **Law of the Seas**. **UN International Tribunal for the Law of the Sea** **Međunarodni sud prava mora Ujedinjenih naroda** If such efforts prove unsuccessful, a country may, subject to some exceptions, refer the dispute for compulsory settlement by the UN International **Tribunal for the Law of the Sea** (located in Hamburg, Ger.), by arbitration, or by the ICJ. <http://en.wikiped>

laws of flotation (*n*) (*stabil*) **zakoni plovnosti Archimedes' principle** when a body is wholly or partially immersed in a liquid, it experiences an upthrust (apparent loss of mass - termed Buoyancy force (Bf), equal to the mass of liquid displaced (Rhodes, Ship's Stability, Seamanship, 2003)

Arhimedov zakon, law of flotation the law of flotation states that every floating body displaces its own mass of the liquid in which it floats **zakon uzgona, draught and freeboard gaz i nadvođe, reserve buoyancy** the volume of the enclosed spaces above the waterline **rezerva plovnosti**

lawsuit (*n*) (*mar law*) **tužba**: Before pursuing a **Jones Act lawsuit**, do everything you need to prepare your case after you recover from your work-related injuries **file the lawsuit podnijeti tužbu**: The bondholders of the owner have made a consensus at a meeting **to file lawsuits** against the company after the company defaulted on bond payments. A claim can be handled by 1) direct negotiations with your employer or insurance adjuster; 2) **filing a law suit**; or 3) legal proceedings before a state or federal agency. You can **file a lawsuit** against the company, even if you get off the ship in another country.

lax /læks/ (*n*) (*fishing*) **losos (norveški)**

lay /ler; leɪd; leɪd/ (=lay; laid; laid) (*v*) **1 (navig) ucrtati (kurs) lay the course (navig) ucrtati kurs**: Since **all courses and bearings laid down** on a chart are true, the bearings taken with the compass must be corrected before being drawn in on the chart, by the application of variation and deviation in the case of a magnetic compass, and of any gyro error in the case of a gyroscopic compass. ;

2 (safety) postaviti lay a mark postaviti pomorsku oznaku, lay a cable položiti kabel;

3 (nav arch) lay the keel položiti kobilicu broda: The **keel** of the first nuclear-powered

passenger-cargo ship, the Savannah, was **laid** in Camden, New Jersey, on May 22, 1958; **4 (seamanship)**

sukati konop / uže; 5 (med) položiti: He then freed the injured engineer and **laid him on the**

deck.; 6 (boating/yachting) to sail in the desired direction without tacking **jedriti u željenom smjeru (bez letanja)**

lay (n) the twist, left or right, of the strands of a rope **suk konopa / užeta right regular lay desni obični suk**: *Regular lay type is used in a wide range of applications. It can be seen as the standard, most frequently used lay type.*, **left regular lay lijevi obični suk, Lang's lay** In a «Lang's» lay rope the wires in the strands and the strands themselves are laid in the same direction **Langov suk** *Langs lay type is especially recommended for multilayer spooling applications, due to its better resistance to the damage occurring at the contact points between each winding on the drum.*, **regular lay** In the regular lay the strands are closed in the direction opposite to the lay of the wires in the



strands **obični suk**:

lay /lei (leid, leid)/ (v) **položiti, spustiti**

lay aside /,lei ə 'said/ 1 (v) (mar law) **odložiti (predmet, spor); 2 (cargo handling) staviti na stranu, odvojiti**: *All packages which are found broken during discharge should be laid aside on board, or if discharging on to the dock, and the damaged cargo locked up (a lock-up should always be provided and carefully recovered, etc.*

lay at anchor (v) (ship handling) **biti na sidru, biti usidren**: *The ship lay at anchor throughout the day while a shore party searched the ship.*

lay-by berth (n) (nav arch) **vez za popravke brodova, remontni vez**: *On arrival at the lay-by berth, a survey identified the need for 23 insert plates. continued her passage, the weather moderated, and she arrived in port for repairs and cargo operations 3 days later. The port authority approved the hot work, which was conditional upon the contractor. While our tanker was moored alongside a lay-by berth for minor repairs, the attending port state control (PSC) officers observed work being carried out in an enclosed space (slop tank) ...*

LAYCAN (layday cancelling date; laydays cancelling) /'leikæn/ (n)

(shipping econ, mar law) (mar law) = **cancelling date / day** A term used in a voyage charterparty, referring to the period of time between the commencement of laytime (being the beginning of the lay days when the charterer must commence loading the cargo), and the cancelling date (being the date after which the charterer may repudiate the charterparty if the ship has not then arrived at the specified port or place of loading). (Tetley) **dan prestanka stojnica, dan kada se**

čarter ugovor (privremeno) prekida: *The NOR (Notice of Readiness) must be given within the 'laycan' period and before laytime can commence. In general chartering parlance, the laydays along with the cancelling is called "laycan". ... 22/23333 ALL DETAILS ABOUT FOR ACCOUNT: FCC*

CARGO/QTY: 50,000 MTS IRON ORE IN BULK 10 PCT MOLOO 1SBP PORT HEDLAND, AUSTRALIA / 1SP LIANYUNGANG, CHINA LAYCAN 0001 HRS 15SEPT/2400 HRS 22SEPT, 2001 (LOCAL TIME).

The **cancelling date** (Box 21, clause 9) defines the other end of this period known as the “laydays” after which the Charterers have the option to cancel the charter party if the ship has still not presented herself for loading.

laydays, lay days /leideiz/ (n) (mar law) = **laytime COMPARE demurrage** In a voyage charterparty, the period of time (the lay days) agreed between the parties during which the shipowner will make and keep the vessel available to the voyage charterer for loading or discharging without payment additional to the freight (Tetley) **stojnice, stalije; tal. stallie** Laydays should be counted from the time stipulated in the C/P. If he takes longer to load or discharge **than the number of laydays allowed**, he must pay demurrage at so much a day. **The laydays commence** within 6 hours on the day the notice of readiness has been delivered. This notice must be given **before the laydays start to count**, and may not be given until the ship is actually ready in all respects.

lay down (v) (mar law) **propisati, utvrđiti, odrediti**: This requirement is laid down in the International Maritime Organization’s “Life-Saving Appliances including LSA Code 2010 Edition”.

lay down in the Charter Party odrediti / utvrđiti / predvidjeti ugovorom o prijevozu, laid down in the COLREGS (mar law, navig) utvrđen u pravilima o izbjegavanju sudara, propisan u pravilima o izbjegavanju sudara, određen u pravilima o izbjegavanju sudara Use the appropriate signals laid down in the ColRegs, and, if necessary, initiate a manoeuvre under Rule 17,

lay down (v) 1 (navig) **odrediti, propisati**: The York-Antwerp rules lay down the conditions which must apply before losses and expenditures come under general average, and how contributions are to be calculated and paid. So in the interest of safety of life and cargo at sea, I would request that the concerned authorities like IMO lay down compulsory rules for shippers to provide required information and certificates, without which the vessel would be unable to sail. ; 2 (nav arch) **položiti (kobilicu)**

lay down the keel

layer /leia/ (n) 1 **sloj**: Often, these washers are either too hard (due to age) or covered by thick layer of paint which makes the rubber washer ineffective. ; 2 **naslaga**: There was a layer of oil on the surface of the bilge water – but then that was not unusual. ; 3 (cargo handling) **red (kontejnera) po visini**: As a container was being loaded on to the 3rd layer by stevedores a twistlock fell from a height of about 8 metres.

laying the keel (n) (nav arch) **polaganje kobilice**: Laying the keel represents the beginning of a ship's construction Much activity, such as design, ordering of material, and initial fabrication, takes place prior to laying of the keel, so in many respects that date is one of convenience

lay off (v) (navig) **ucrtati (kurs) lay off the course ucrtati kurs**: Lay off the required course to make good “AB”

lay off ship (n) (mar law, nav arch) **brod u raspremi**

layout /leiaist/ (n) 1 (nav arch, marine eng) **nacr, opći nacr**: Due to the layout of the wheelhouse, the skipper was unable to see out of the forward windows once he had left the wheel position, ... The vessel’s layout was conventional: a fishing winch amidships, just aft of the forward wheelhouse, and a net drum mounted on a stern gantry. This ineffective use of resources was due to a lack of understanding of the construction and layout of the ship and, consequently, the location of the seat of the fire. The tank layout did not match the tanks on board.

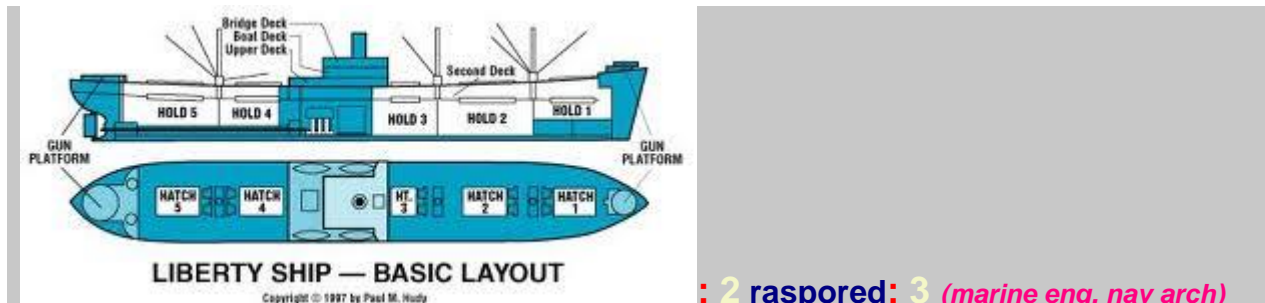

; 2 raspored; 3 (marine eng, nav arch)

situacijski nacrt, situacijski plan, situacioni nacrt: All engineers should be familiar with the engine room pipe **layout** and the crew should be instructed in the correct procedures for each operation. A combination of the cargo vessel's large stern ramp and aft mooring **deck layout** meant that she did not have an aft centreline fairlead; **The layout of the central bridge console** prevented the chief officer from utilising the ECDIS display to support the Master during pilotage. **The general layout of the engine** is conventional with wet cast iron liners and an underslung crankshaft.

lay out (v) 1 (mar law) odrediti, specificirati, utvrditi: This should be clearly **laid out in the vessel's SMS**. To prevent the risk of self-ignition, the following precautions should be taken as **laid out in the Code of Safe Practice for Solid Bulk Cargo 200**.; 2 (safety, seamanship) **postaviti,**

iznijeti: The crew had exercised for a cargo hold fire, and immediately **laid out** the fire hoses for boundary cooling as the master contacted the coastguard. The master **laid out additional mooring ropes** to restrain the vessel's rolling at berth.

lay the course (v) (navig) ucrtati kurs: The third mate **laid a course** on the relevant paper chart.

lay the keel (v) (nav arch) položiti kobilicu: The keel was **laid** on May 15th. The Shipyard **has laid the keel** for the first product tanker. The Shipyard **has laid the keel** for a 84,000 cbm Very Large Gas Carrier.

lay the rope (v) (seamanship) The direction of the twist of the wires in a strand and to the direction that the strands are **laid in the rope**. **sukati konop:** Usually a wire rope consists of a core member, around which **a number of multi wired strands are laid** or helically bent. An assembly of several (usually six) single layer stranded **ropes** (referred to as unit ropes) **laid helically** over a core (usually a seventh single layer stranded rope).

laytime /'leɪtaɪm/ (n) (mar law) **stojnice, vrijeme stojnica:** ... Ice, blockades, congestion, tides, etc., could prevent the ship reaching the agreed destination, and with the above wording in the charterparty, **laytime would count** as soon as the ship reached an alternative destination allowed by the phrase: as near thereto as she may safely get. Strikes in a port can be excluded from laytime calculations, whereas, strikes only affecting the ship in question could be included in the total **laytime**. The NOR (Notice of Readiness) must be given within the 'laycan' period and **before laytime can commence**. **customary laytime uobičajeno vrijeme stojnica**

lay two anchors (v) (boating/yachting, seamanship) postaviti dva sidra

lay up (v) 1 (v) (nav arch) staviti (brod) u raspremu, poslati u raspremu; 2 (shipping econ) to **lay-up a vessel** means to stop using it for a certain period **staviti brod na mrtvi vez:** The owner was pleased with the RIB's performance, but as the weather deteriorated during the latter part of the year, he decided **to lay up the boat** for the winter. The boat had been launched that morning **after being laid-up ashore** for 6 months. The rate of marine growth will be more prominent **if a vessel is laid up for some time**. A high speed ferry was being prepared for a seasonal charter **after a period of winter lay-up**.

lay-up (=lay-up; lay up) (n) 1 (shipping econ) mrtvi vez: The reasons for **lay-up** might be to wait for a better scrap price or to deactivate the vessel due to over-capacities with the intention of

activating it again later. **Prior to lay-up** or issue of a declaration, all machinery should be established to be in normal good condition. **be in lay-up biti na mrtvom vezu (o brodu)**: In February 101 of their offshore vessels were in lay-up., **lay-up period vrijeme broda na mrtvom vezu, hot lay-up topli pogon broda na mrtvom vezu**: The operator must first decide on either a hot lay-up or a cold lay-up. **In a hot lay-up condition** the ship engines and machinery keep running so that the re-commissioning of the vessel can be carried out very quickly, and the vessel's preservation is much easier and cheaper compared to a cold lay-up., **cold lay-up hladni pogon broda na mrtvom vezu**: In a cold lay-up vessels are only supplied with emergency energy for lights, windlass / mooring winches and fire extinguishing – often by portable generators installed on deck. , **place for lay-up mjesto mrtvog veza**: Ideal places for lay-up have good grounds for anchoring or mooring, and almost no current or heavy winds (e.g. should be outside of the typhoon belt). Furthermore it should be legal and authorized by the local port authority.

(<http://www.hellenicshippingnews.com/the-unwanted-ships-how-to-lay-up-a-vessel/>); **2 (mar law, nav arch) raspreda broda be in lay-up biti u raspredmi**

lay up berth (n) 1 (shipping econ) mrtvi vez, vez za duži boravak brodova bez ugovora o plovidbi: Just before 2000, tugs arrived to assist in bringing the vessel back to the lay-up berth.; **2 (nav arch) raspredmi vez**

lay up the engine (n) (boating/yachting) konzervirati motor

lazarette (n) (boating/yachting) krmena sprema, krmena jama: The fire disabled the VHF radio, and flames were coming out of the locker next to the lazarette.

lazyjack /'leizidʒæk/ (n) (boating/yachting) sustav za prikupljanje jedra pri spuštanju na deblenjaku ubirač jedra (po deblenjaku / bumu), lazyjack (čit. lejidžek): The lazyjacks hold the main securely, even in a strong breeze. Make sure there is enough spare line to allow the lazyjacks to be slackened enough to pull them forward and secure them out of the way of the sail. **lazybag tenda ubirača jedra**: But if it's poorly designed or made, a lazybag can flop around annoyingly when you're



under sail, ...

lazaretto; lazaret; lazarette (n) 1 (nav arch, seamanship) a low headroom space below decks used for provisions or spare parts, or miscellaneous storage lazaret; 2 (med) a quarantine building or ship

LB (=lifeboat) (n) (nav arch) brodica za spašavanje, čamac za spašavanje

LBP (= Length between Perpendiculars) = Lpp dužina između okomica

LCB; Longitudinal Center of Boyancy (n) (stabil) the longitudinal position of the centre

of buoyancy **uzdužno težište broda**, **udaljenost sistemnog težišta od sredine broda**: *The longitudinal position of the center of buoyancy is measured in feet from either the forward perpendicular or the midships section.*

LCF (=Longitudinal Center of Flotation) (n) (*stabil*) the longitudinal position of the centre of flotation; LCF is the point at which the ship trims. It is the geometric center of the waterline plane. **udaljenost centra plutanja od sredine broda**: *LCF can be calculated if the exact shape of the waterplane is known or it may be obtained from the curves of form.*

LCG (=longitudinal center of gravity) (n) (*stabil*) **udaljenost sistemnog težišta od sredine broda (od glavnog rebra broda)**: *The longitudinal position of the center of gravity is measured in feet from the midships. {also abbreviated to: XG}*

LCL /'ɛl si: ɛl/ (=Less than container load) (n) (*mar law, shipping econ*)

COMPARE F.C.L. (full container load) Here the carrier takes the goods from two or more shippers, packs them into the container and seals it. (Tetley); Common term for an amount of goods to be shipped and which do not fill an entire container

(<http://www.maerskline.com/en-jm/help/shipping-glossary>); Cargo failing to qualify for freight rates given to a standard shipping container due to insufficient quantity or weight.

(<http://thelawdictionary.org/less-than-container-load-lcl/>) **zbirni kontejner (kontejner s robom**

koja glasi na više različitih primatelja): *Ocean rates for LCL are commonly higher on a per-unit basis than for a full container load. Thus, consolidation of several LCL loads from different places or shippers into a full container can save on costs. {the term refers to a partial container load that is usually consolidated with other goods to fill a container}*

LCT (=less than truckload) (n) (*shipping econ*) cargoes from different sources are usually consolidated into a truck to save costs. **zbirni kamionski teret**

lead /li: d; ɛd; ɛd/ (v) **voditi**: *How is the cable leading? The cable is leading ahead / astern / to port / to starboard / round the bow (IMO SMCP).* **cable leading astern (seamanship)** **sidreni lanac vodi prema krmi, sidreni lanac gleda prema krmi** {lead - led - led}

lead (n) (*seamanship*) dužina užeta za privezivanje od broda do bitve na obali **raspon (užeta za privezivanje)**: *The lead of all mooring lines was relatively short as the vessel was not berthed with her full length alongside the berth.*

lead /ɛd/ (=plumbum (Pb)) (n) (*chem*) **olovo**

leader (n) (*fishing*) A leader is a length of line attached to the end of your main fishing line. It's this separate length to which rigs or lures are tied.; A leader is a section of line that ties directly to the hook or lure, and then to a weight, swivel or the main line.; **završni dio predveza koji spaja udicu s prevezom (rig) i osnovnom strunom (main line)** (<https://ribolovnajadranu.hr/ribicki-leksikon>) **prama,**

upredenica predveza, najlon predveza, pioka; pjok, fila, pic, brk: *There are two main reasons for using leader line. Firstly it can be used to provide increased protection against the sharp edges of teeth, rocks, reef or shell-covered pylons. Second, using specific types of leader can make it difficult for fish to see the line connected to your bait or lure. In order to attach a leader to braided fishing line for drop shooting, it's important to pay attention to the diameter of the braid and leader* **wire leader** **žičana**



prama

fluorcarbon leader fluorkarbonska prama



{predvez je završni dio sistema u ribolovu udičarskim alatima i tehnikama, a prama je završni dio predveza koji spaja udicu spredevom i osnovnom strunom (cf. <https://ribolovnajadrano.hr/ribicki-leksikon/>) }

leading lights (n) (navig) = **leads** A pair of lights or day marks deliberately placed to mark a narrow channel. **svjetla pokrivenog smjera, pokriveni smjer, tal. allineamento**

d'ingresso The ferry passed to the north of the fairway buoy, and about 15 minutes later, was still about 0.5 cable north of the intended track of 236°, indicated by **leading lights**. At this point, the master altered course about 25° to port, to bring the ship further south. As they progressed in the gyro was checked against **leading lights** and found to be out by up to 8°. In this case, a suitable passage should have consisted of setting a course that ensured the vessel was in **the safe sector of the leading light** at least 1 mile from the harbour entrance. While still **looking for the leading lights**, the OOW glanced at the echo sounder and noticed that the water depth was decreasing.

leading marks (n) (navig) **oznake pokrivenog smjera**: It was a very hazy afternoon and **the two leading marks of the main channel** were obscured shortly after passing the front marker. The master initially altered course to port towards a secondary channel, but then had difficulty identifying one of its



leading marks.

leading seaman (n) (seamanship) **SEE boatswain vođa palube, noštromo**: The leading seaman went forward to carry out this task. The necessary scaffolding had been erected earlier under the supervision of the **leading seaman**. To prevent damage to the pin end, the **leading**

seaman held a heavy brass stock between the pin and maul.

lead line /'ledlain/ (n) (seamanship, navig) **olovnica**: *Lead line soundings were made all around the vessel. A lead line sounding over the side on both port and starboard sides revealed that vessel was*



now sitting on the harbour bottom on her starboard side.

lead paint /'ledpeint/ (n) (seamanship) **minij**: *Most lead-based paint in the United Kingdom was banned from sale to the general public in 1992, apart from for specialist use. Lead dust and fumes can be generated from boats with paint containing lead. red lead paint minij (zaštitna boja): White lead is hydrated lead carbonate and red lead is lead tetroxide.*

leads /li:dz/ (n) (navig) **COMPARE leading lights svjetla pokrivenog smjera**: *The Pilot ordered slow ahead and brought the ship onto the leads fixed green Port Entry leads zelena svjetla pokrivenog smjera (za ulaz u luku), red sector of the leads crvena svjetla*

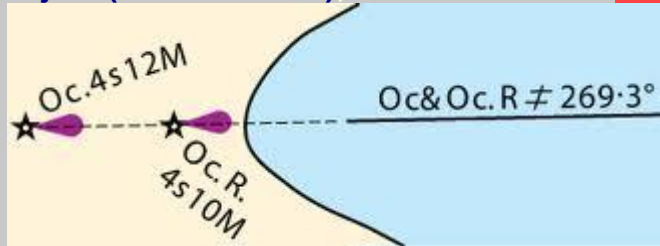

pokrivenog smjera

league /li:g/ (n) (navig, archaic) a unit of length, normally equal to three nautical miles **liga (stara mjera za duljinu = 3,18 naut. milja)**

leak /li:k/ (n) **1 rupa; 2 (safety, marine eng, nav arch) puštanje propuštanje (mora; tekućine), curenje, tal. falla; fessura; via dell'acqua**: *The vessel had a small leak believed to be associated with the planking behind the hull sheathing, which the skipper hadn't been able to fix. The third engineer reported the leak to the bridge and the chief officer immediately reduced the CPP to the dead slow ahead setting. It was soon established that the leak originated from a failed joint at a pipeline flange on a fuel pump oil return line. the ship has developed a leak brod propušta, na brodu je nastala rupa: A ship develops a leak 12 km from the shore., spring a leak propuštati (o brodu), puštati vodu, zrak, plin, tekućinu (o cijevima), dovesti do propuštanja: A research vessel sank early Wednesday while tied up in the harbour after springing a leak., check for a leak provjeriti propuštanje: The ballast tanks were checked for internal leaks., gas leak prpuštanje plina / plinova: The chief officer saw and heard a gas leak, and immediately activated the emergency shut down (ESD) valves., fuel leak curenje goriva pro/puštanje goriva: The starboard main engine was started, then immediately stopped to attend to a fuel leak., hydraulic leak curenje hidrauličkog ulja, prpuštanje hidraulike: Had there been a hydraulic leak, there could potentially have been a fire and/or explosion., a major leak jako pro/puštanje, jako curenje, veća rupa: – a major LPG leak from the gas carrier occurred while alongside the terminal..., oil leak curenje ulja curenje goriva: As the COW line*

was slowly pressurised, a crew member noticed an **oil leak** in the pumphouse where the heater was located. , **cause of the leak** **uzrok puštanja**, **uzrok curenja** Attempts by the ship's staff to determine the cause of leak were of no avail. The cause of the leak was poor engineering practice; , **experience a leak** **doživjeti pro/puštanje**, **doživjeti curenje**, **doći do curenja**: On 17 October, the gas carrier experienced a major leak of liquefied propane, while cargo sampling operations were taking place, alongside the Terminal. , **leak alarm** **alarm zbog curenja / propuštanja** The high-pressure fuel pipe is shielded and fitted with a leak alarm. , **seal the leak** **začepiti propuštanje**, **zatvoriti rupu**, **zabrtviti mjesto curenja**: The sealing compound was then slowly injected into the pipework, enabling the leak to be sealed and capped at 0240 the next morning. Using this method, the leak was sealed 29 hours after it had started. , **detect a leak** **otkriti curenje**, **otkriti rupu**: A leak was detected on the shore flexible cargo hose during pre-discharging pressure test. ; 3 (environ) **ispuštanje (nafte, tekućine) s broda**, **naftna mrlja**: Small leaks account for an overwhelming percentage of oil-related pollution.

leak /li:k/ (v) 1 (safety) **puštati (vodu, more, ulje, naftu)**, **propuštati (vodu, more)**, **ispuštati (ulje)**: Shortly after the start of what was to be a routine task, the Chief informed me that the indicator cock was leaking and that the engine would have to be stopped. The heating coils in the tank were also reported to be leaking, causing a gradual increase in sounding; ; 2 (safety) **ispuštati (ulje, naftu) u more**: Queensland also suffered a spill in 2009 after about 250 metric tons of fuel oil leaked from the ship when its hull was ruptured in rough seas whipped up by a cyclone. Oil was found leaking from under the water surface along the vessel on the port side aft. **leak oil** **ispuštiti ulje/naftu u more**, **ispuštati ulje / naftu u more**: The marine accident destroyed 116,000 square meters (1.2 million square feet) of reef, leaked about 4 tons of oil and spread toxic paint. , **leak fuel** **ispuštati gorivo**: The tugboat pushing an empty petroleum barge has run aground and is leaking fuel.

leakage /'li:kidʒ/ (n) 1 (marine eng, safety) **curenje**: The fire was caused by a hydraulic oil leakage above a main engine where outflowing oil was lit by hot surfaces on the engine. Indications of leaking starting air valves and the cause of their leakage □ The leakage of starting air valves is indicated by the overheating of line between the starting air valve and the starting air manifold, when the engine **leakage groove** kontrolni kanal za kontrolu curenja ili ispuštanja tekućine kontrolni kanal (za kontrolu curenje ili ispuštanja tekućine), **check for any sign of leakage** **provjeriti moguće znak (pro)puštanja**, **fuel leakage** **curenje goriva**, **propuštanje goriva**: Any fuel leakage from pipes, injection valves and pumps is collected in a closed piping system which keeps the hot box and the engine dry and clean. , **gas leakage** **propuštanje plinova**: A control bore is provided in the cylinder cover to enable possible gas leakage to be detected between the two parts of the cover. , **water leakage** **propuštanje vode**, **curenje vode**: If the sump level were to rise this would indicate water leakage into the oil and investigation into the cause must be made. , **oil leakage** **curenje nafte**: stern tube oil leakage has traditionally been considered common operating practice. , **liable to leakage** **sklon curenju / propuštanju**, **podložan curenju / propuštanju**, **subject to leakage** **podložan curenju / propuštanju**, **koji lako pušta**; 2 (environ) **propuštanje (nafte u more, bačve itd)**; 3 (nav arch, safety, environ) **propuštanje (broda)**, **puštanje**: Oil leak from this ship may be the world's worst maritime disaster

leaking 1 (safety, marine eng) **istjecanje tekućine (nafte, goriva) iz cijevi / tanka**: Any leaking or damaged fuel pipe should be reported to the senior engineer immediately. ; 2 (environ,

safety) propuštanje (mora / vode u brod)

leak-off hole (n) (marine eng) kontrolni kanal, odušni otvor: A *leak-off hole* is often provided between the upper and lower rings to ensure that water passing the one or oil passing the other runs to the outside of the engine.

leaky (adj) 1 (cargo handling) šupalj, koji cura / pušta: Search for any packages which may have been tampered with or which are improperly or inadequately protected, broken, *leaky*, damaged, repaired, spilled, torn or stained. **leaky cargo teret koji curi**: No *leaky drums* must be allowed to cross the ship's rail.; 2 (marine eng, nav arch, safety) šupalj, koji cura / pušta: The engine room is at special risk from flashbacks in oilfired boilers, *leaky pipings* carrying oil, overheated bearings and even the accumulation of rubbish (oil rags, dirty oil, tins of oil, etc.) On one of our vessels, cargo damage resulted from ingress of water into no. 3 hold through a *leaky hold-bilge valve* which had gone undetected. **leaky stern tube gland šuplja brtvenica statvene cijevi, šupernica koja propušta**: The bulk carrier developed a *leaky stern tube gland*.

leap year (n) prijestupna godina

lease /li:s/ (n) (shipping econ, mar law) najam, zakup, **leasing on lease** u zakupu u **leasingu**. Our units *on lease* to the shipping company were manufactured in our colour, with our logo and markings, , **long-term lease dogotrajan ugovor o najmu broda**: This is done by taking the ships they require on time charter or another form of **long term lease** known as a bareboat charter, in which event they may be referred to as the disponent owner.

lease (v) (shipping econ, mar law) **ANTONYM hire**: **iznajmiti (brod, brodicu), dati brod u charter, staviti brod pod ugovor o najmu broda**: A charter party is a document of contract by which a shipowner agrees *to lease*, and the charterer agrees *to hire*, a vessel or all the cargo space, or a part of it, on terms and conditions forth in the charter party. When buying or *leasing a liferaft*, it is usually possible to specify additional flares to those supplied as standard.

lease from /li:s/ (v) 1 **unajmiti od**; 2 (shipping econ, mar law) **uzeti u zakup, uzeti u leasing**

lease the ship /li:s/ (v) (shipping econ) **zakupiti brod (u okviru kupoprodajnog ugovora o leasingu)**

lease to /li:s/ (v) 1 **iznajmiti**; 2 (shipping econ, mar law) **dati u zakup, dati u leasing, iznajmiti**. CAI International told investors it currently has 15,000 units *leased to* the shipping company.

leasing /li:sinj/ (n) (mar law) **kupoprodaja zakupom**: The financing will take the form of debt, equity or *leasing*. In this case the company's need for a ship may be of a relatively short duration, and going to the expense and trouble of buying a ship, or *leasing a ship*, and having the complications of hiring and controlling a crew, may not be economically viable.

leather /'leðə/ (n) (cargo) **koža leather belt (marine eng) kožni remen**

leave (=leave; left; left) (v) 1 (navig, shipping econ) **napustiti (luku), isploviti (iz luke) leave the port isploviti, napustiti luku, isploviti iz luke**: As deep draught vessels of differing types can only enter and *leave the port* via the main buoyed channel, ... Otherwise the Carrier shall be relieved of any obligation to load such cargo and *the vessel may leave the port* without further notice and dead freight is to be paid. mv riba **left port of rijeka** morning 13th with complete shipload of 11.00o tons of grain ...' After loading, *the vessel left port* at 2300. , **leave the berth napustiti lučki vez odvezati se od obale**: The vessel's crew began to single up the vessel's mooring lines and the pilot informed Vessel Traffic Services (VTS) that the vessel was preparing *to leave the berth*. *The vessel left the lock stern-first, under tow* by the aft tug. , **leave the leave napustiti plovni kanal, isploviti iz plovnog kanala**: The oncoming outward bound vessel *left the channel* and passed

outside No 4 buoy., **leave the bridge** napustiti zapovjednički most, izaći iz zapovjedničkog mosta: *The pilot then left the bridge, accompanied by the third officer.*; **2 (mar law) iskrcati se (s broda)**: *When I left the ship after 33 months, all the compressor sets and BA's were usable.*; **3 sići s broda leave the vessel sići s broda**: *By the evening, all cargo had been discharged from the after part of the hold and the stevedores left the vessel through an open gate in the starboard side bulwark. The vessel's second officer had left the vessel while the chief officer had been on leave, and he had not been replaced.*

leave (n) 1 dopust; 2 (mar law) dopusnica za izlaz na kopno / u grad

leave the mooring (v) (boating/yachting) napuštanje veza na plutači: *The boat left the mooring late that morning and made its way out to the unrestricted waters of the lake.*

leaving berth (n) (boating/yachting) isplavljanje s bočnog veza

leaving bow first (n) (boating/yachting) manovra isplavljanja odmicanjem pramca od obalne otplovljanje pramcem, napuštanje veza pramcem

leaving stern first (n) (boating/yachting) isplavljanje (s veza) krmom, napuštanje veza odmicanjem krme: *As the ferry left the berth, stern first, the master was at the bridge wing console, manoeuvring her using the combinator controls.*

leaving the berth under power (n) (boating/yachting) isplavljenje motorom, isplavljenje vlastitim pogonom

lee /li:/ (n) (meteorol, navig) zavjetrina: *The pilot boat came on the lee side, because the prevailing 20 knot wind, sea conditions were fairly rough and cold. A deep sea fishing vessel's main engine stopped at a critical moment after she had been sheltering from severe weather for almost 2 days in the lee of an island. Due to a deep depression producing severe gales, the vessel remained within the lee of the land for most of her voyage.* **on the lee u zavjetrini, the lee of the breakwater zavjetrina**

lukobrana, u zavjetrini lukobrana, make a lee pružiti zavjetrinu: *Make a lee on your port side / starboard side. (IMO SMCP) The pilot boat was having difficulty coming alongside in the waves so the pilot, now on deck, requested the Master change course to 180° and then to 160° to make a lee.*

provide a lee pružiti zavjetrinu: *... the pilot boat became aware of the high speed on approach, and called the vessel to slow down and swing to starboard to provide a lee for boarding.*

lee shore obala u zavjetrini: *The master chose to remain at anchor when gale force winds onto a lee shore were forecast.*

leech /li:tʃ/ (n) 1 (boating/yachting) the aft or trailing edge of a fore-and-aft sail; the leeward edge of a spinnaker; a vertical edge of a square sail stražnji rub jedra, stražnji porub jedra, ventana, ventam, tal. balumina: *The sheet exerts a large downwards force on the leech of the sail when the boom is directly above it, much more than the kicker. The kicker controls leech tension and twist when the boom has passed to leeward of the traveller. A series of telltales along the leech of the main should flow evenly. Most boats benefit from a boom vang, which keeps tension on the mainsail's leech.*

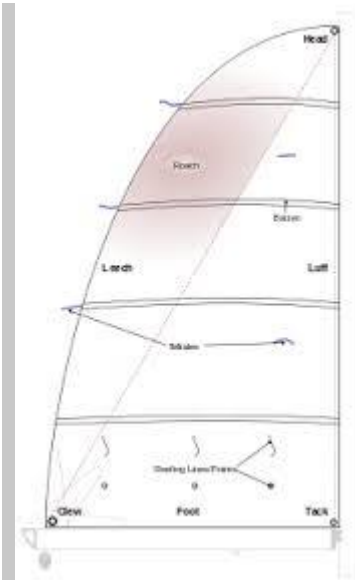

; **2 stražnji rub floka / špinakera**: the trimmer set the jib to her normal setting and observed the **jib leech telltale** flowing 100 percent of the time.

leech cord (n) (boating/yachting) = **leech line ventam**, **konopac stražnjega poruba jedra**, **majolica**: The **leech cord** is really not a sail trim device. Its main purpose is to stop the leech from fluttering BUT it does have some sail trim advantages. The **leech cord** on a mainsail can also be used to fine-tune leech twist.

leech line (n) (boating/yachting) **konopac stražnjega poruba jedra**, **ventam**; **ventan**; **majolica**; **dušica**: Tension on the **leech line** supports the edge of the sail to keep it from fluttering. Most new sails today come with **leech lines** built-in, particularly on larger sailboats.

lee helm (n) (boating/yachting) **ANTONYM weather helm** list kormila više u zavjetrenoj strani; tendency of the boat with poorly trimmed sails to continually turn downwind on its own or if the helm is released **skretanje kormilom od vjetra**, **bježanje od vjetra**, **zavjetreno kormilo**, **otpadanje**, tal. **barra sottovento**: Moving the sails' center of effort forward of the center of lateral resistance tips the scale in the other direction and forces the bow away from the wind, creating **lee helm**. If you experience **lee helm** in light air, shift crew weight to leeward to heel the boat and build weather helm.

Lee-Oh! (interj) (boating/yachting) **uzvik pri zapovjedi za letanje (bordadu)**: Most crew sensibly take the view that **lee-oh** means let go the genoa sheet, which upsets those skippers who shout **lee-oh** at the start of the tack, and like to use the lift from the genoa generated by the rotation of the bow through the wind. The order **Lee-oh** is given when the genoa starts to luff.

leer fish (n) (fishing) **lica**, **lica bilizma** {drugi hrv. nazivi: **bitnica**, **bilizma**, **biliznica**, **lujpa**, **pastirica**, **skočarica**; lat. **LICHIA AMIA**}

lee shore (n) (boating/yachting) the land to the leeward of the vessel (wind blows from the ship to the land) **vjetar s mora**, **obala prema kojoj puše vjetar**: Be alert to navigational dangers and, where possible, keep well clear of a **lee shore**. The master chose to remain at anchor when gale force winds onto a **lee shore** were forecast.

lee side **ANTONYM weather side** = **windward side** (**meteorol**) the side of a ship sheltered from the wind. The side of a ship that is towards the leeward is its lee side **zavjetrina**: We were sailing **on the lee side** of an island. The chief officer asked port control on which side the pilot ladder should be rigged, and was told "**on the best lee side**". **hard-a-lee** means pushing the tiller hard to the **lee side** When the vessel begins drifting (diagonally) leeward, water resistance is generated **on the leeside of the bow**.

leeward /li:wəd, 'lu:əd/ (*adj, adv*) The direction away from the wind **prema zavjetrini, u zavjetrini, koji se nalazi u zavjetrini**. When the vessel begins drifting (diagonally) **leeward**, water resistance is generated on the leeward side of the bow. Vessel's sideways **drift leeward** of the desired course. **on the leeward side u zavjetrini**: The vessel was at 4.30 am **on the leeward side of**

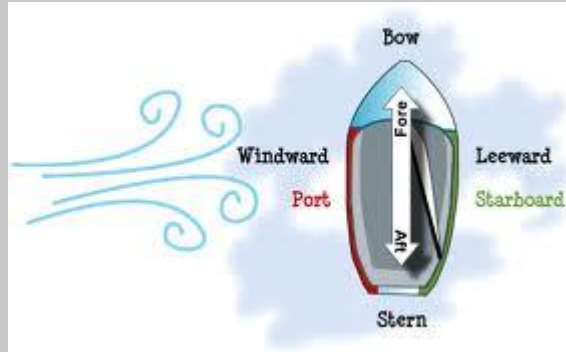

Groix Island to embark the pilot.

leeward /li:wəd, 'lu:əd/ (*n, adv*) (*navig*) **zavjetrina**: The sailing boat was hit by a particularly strong gust of wind which caused it to capsize **to leeward**. It was fortunate that the yacht grounded on a reef with safe water **to leeward**. The analysis conducted after the incident, using the ship's manoeuvring and "rate of turn" data, revealed that the initial "wheel over" position was **too far to leeward**, given the prevailing wind strength and direction. When the wind is pushing the ship's stern away to **leeward**, the stern tends to swing towards the **leeward**

leeward berth (*n*) (*seamanship*) **vez u zavjetrini**

leeward side (*n*) (*navig*) **zavjetrina**

leeway /li:wei/ (*adv, adj*) **1** (*navig*) **COMPARE drift** the amount of drift motion to leeward of an object floating in the water caused by the component of the wind vector that is perpendicular to the object's forward motion; Leeway is the motion of the object induced by wind (10 m reference height) and waves relative to the ambient current (between 0.3 and 1.0 m depth).

(<https://zenodo.org/record/797/files/12152.pdf>) **zanos (u plovidbi, vožnji) zanošenje (u**

odnosu na željeni kurs) A navigator or pilot on a vessel must adjust the ordered course to compensate for **the leeway drift** We are making degrees **leeway** (IMO SMCP). This allowed the westerly wind, blowing across the channel from the left, to have a greater **effect on leeway**. **Correcting the DR position for leeway**, current effects, and steering error result in an estimated position (EP). (Bowditch) **Leeway** and current effects combine to produce the most pronounced natural dynamic effects on a transiting vessel.

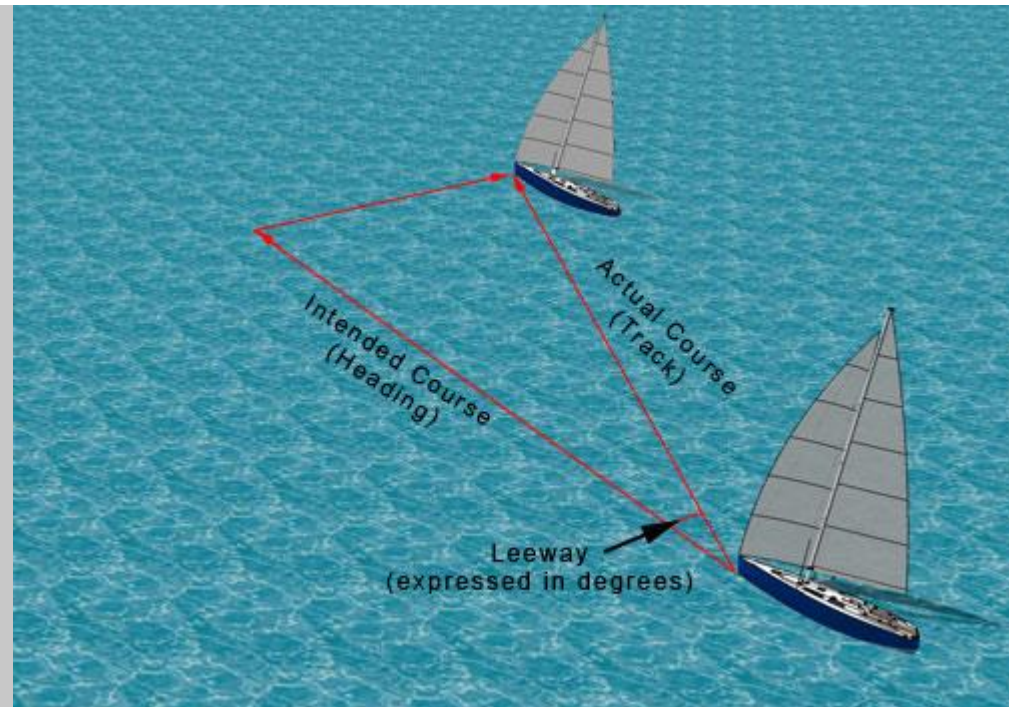

; 2

(boating/yachting) otpadanje (u jedrenju): Coming immediately onto their course of 160°, the combination of **excessive leeway** as the yacht was gathering way, and the onshore swell, quickly placed them in danger. Rough weather will increase **leeway**, because the boat will be carried sideways by breaking waves. Bilge keel yachts (twin keels) **make more leeway** than fin keeled ones in the same conditions. <http://www.sailtrain.co.uk/navigation/leeway.htm>

left-hand (adj) (seamanship, navig) lijevi left-hand side lijeva strana: A straight line joining the date on the left-hand side with the same date of the right-hand side represents a complete circle around the sky, the two ends of the line representing the point 180° from, **left-hand bank lijeva obala rijeke**. Astern thrust was applied, but at the same time the wind caught the bow and the boat gently bumped into the **left-hand bank of the river**., **left-hand lay (seamanship) lijevi suk konopa, uže sukano u lijevo**

left-laid (adj) (seamanship) sukan u lijevo (uže, konop)

leftover cargo (n) (cargo handling) zaostali teret, ostaci tereta

leg (n) 1 (navig) COMPARE waypoint the run or distance made on a single course or heading (before changing it) **dio rute (između dva mijenjanja kursa), stranica, the run or**

sistance made on a single tack (in sailboats): They began **the final leg of their journey** in poor visibility, having had a tiring voyage up-Channel. When the boat rounded the first mark, the crew members' spirits rose as they headed downwind on **the return leg**. The engine rooms had not been re-visited by the time the ferry neared her berth on the **return leg of the crossing** at 0700. Similarly, mark each **track leg's distance** under the course line with a "D" followed by the distance in nautical miles. The computer determines each **track leg's distance** and, given a speed of advance, calculates the times the vessel can expect to pass each waypoint. At 1830, they passed the Needles fairway buoy and settled down for the long **downwind leg** towards Start Point. **leg of the voyage (navig) stranica rute (putovanja) stranica putovanja broda, stranica rute (između dva mijenjanja kursa)**: The initial **leg of the voyage** was uneventful, and the mate later relieved the skipper for his

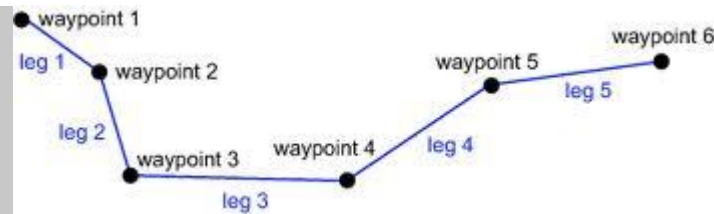

evening meal break.

; 2 (boating/yachting)

a the run or distance made on a single tack (in sailboats) **bordada**, put jedrilice između dva letanja; **b** the side of a racing course between two marks **stranica regatnog polja**

legal owner (n) (mar law) zakonski vlasnik broda

legal proceedings (n) 1 (mar law) pravni postupak, sudski postupak **institute legal proceedings** pokrenuti sudski postupak; 2 sudski progon (EUdict)

legend (n) tumač crteža / slike itd., tekst u potpisu crteža ili slike

leg of voyage = **leg** stranica rute, dio putovanja između dvije promjene kursa / pozicije

leisure /'lɛʒə; US English 'li:zər/ (n) dokolica, odmor **with more leisure** kasnije, bez žurbe

leisure boat (n) (boating/yachting) **SEE pleasure boat** brodica za razonodu : *It was a common feature to meet many leisure boats close to Cherbourg.*

leisure craft (gliseri, jedrilice itd.) (n) (boating/yachting) **SEE pleasure craft** a boat used for personal, family, and sometimes sportsmanlike recreation (motorboats and sailboats)

brodica za razonodu: *Occasionally however, one is hampered from taking the desired action due to large concentrations of leisure craft. For anyone operating a vessel commercially – merchant ship, fishing boat or leisure craft – there is a legal duty to report accidents.*

L-engine (n) (marine eng) redni motor, L-motor, motor s cilindrima u nizu

length (n) **length overall** duljina preko svega **dužina about mid-length of the ship** negdje po sredini dužine broda, **length of ship** duljina broda, **length between perpendiculars** duljina između okomica, **length on waterline** duljina na vodnoj

liniji, **full length** cijela dužina broda: *The lead of all mooring lines was relatively short as the vessel was not berthed with her full length alongside the berth.*

length between perpendiculars (LBP) (n) (nav arch) **COMPARE length**

overall (LOA) the length of a ship measured from the forward side of the stem to the aft side of the stern post at the height of the designed water line. In naval practice, the total length on the designed water line **dužina između okomica**: *Length between perpendiculars (often abbreviated as p/p, p.p., pp, LPP, LBP or Length BPP) is the length of a ship along the waterline from the forward surface of the stem, or main bow perpendicular member, to the after surface of the sternpost, or main stern perpendicular member. (https://en.wikipedia.org/wiki/Length_between_perpendiculars)*

lengthen /'lɛŋθən/ (v) 1 **produžiti, produljiti**: *Checking of friction element: A worn or oily friction element will lengthen the stopping time.*; 2 **istegnuti**

length on waterline (n) (nav arch) duljina na vodnoj liniji

length overall (LOA) (n) (nav arch) the length of a ship measured from the foremost point of the stem to the aftermost part of the stern **dužina (broda) preko svega**:

https://en.wikipedia.org/wiki/Length_between_perpendiculars *Length overall, often abbreviated as (LOA, o/a, o.a. or oa) is the maximum length of a vessel's hull measured parallel to the waterline.*

(<https://www.google.hr/webhp?sourceid=chrome-instant&ion=1&espv=2&ie=UTF-8#q=length+overall>)

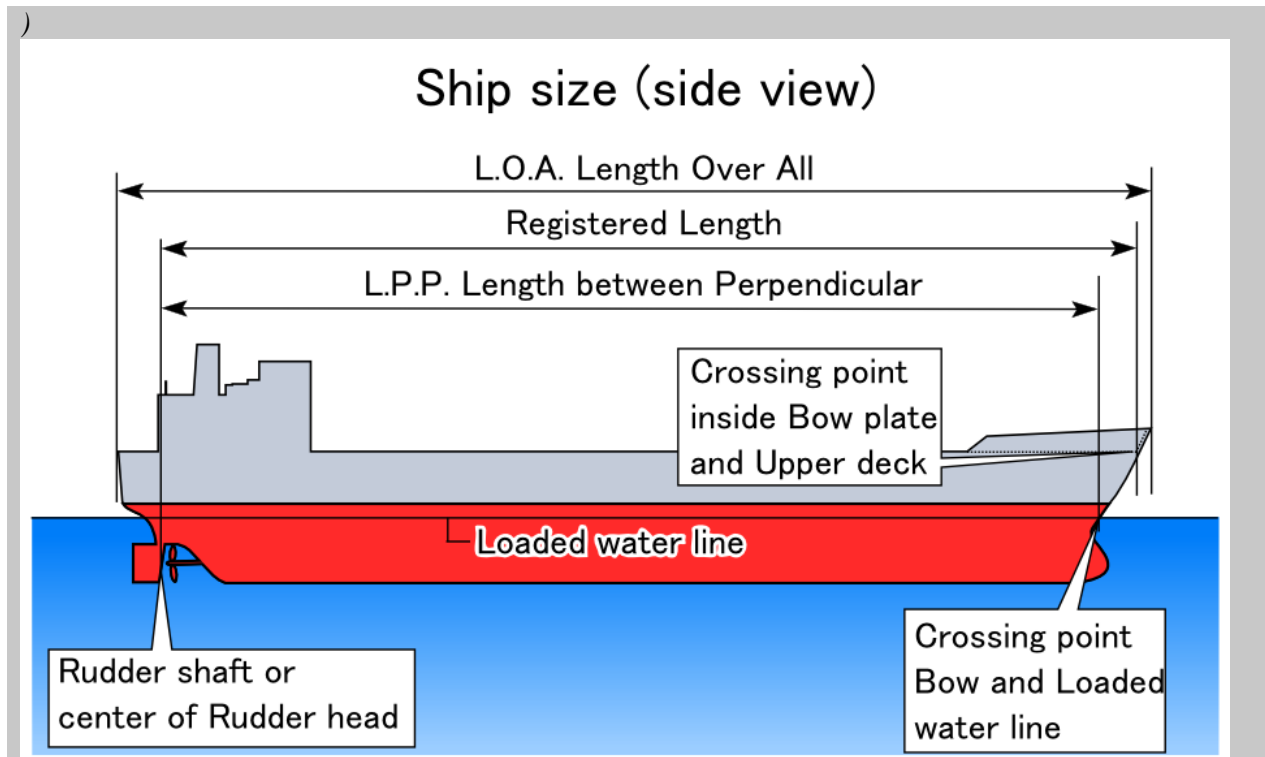

lesson (n) pouka *The most fundamental lesson from this incident is the need to ensure that there is no load on the system prior to conducting any maintenance work. **the lessons learned pouke koje se mogu izvući, pouke koje se mogu naučiti** the lessons learned from the official accident report **Let us learn a lesson from this** and have the crew only in the boat after it has been swung out and then they can use the release gear.*

lessor /'lesə/ (n) (mar law, shipping econ) iznajmitelj *Container lessors were this week also beginning to count the cost of the bankruptcy. **container lessor iznajmitelj kontejnera, trgovačko društvo za iznajmljivanje kontejnera***

Less Than Trailer Load; LTL (n) (shipping econ) prikolica s robom koja glasi na više različitih primatelja, LTL

let go (v) 1 (seamanship, ship handling) oboriti sidro, spustiti sidro, tal. dare fondo

l'ancora *They failed to **let go anchors** in good time. Propustili su pravovremeno oboriti sidra. We have prepared the starboard anchor **for letting go** in case the ship began to drag her port anchor. ... adjust the speed so that the vessel will be dead in the water or have very slight sternway **when the anchor is let go.***

*The mate managed to **let go both anchors** just as the two vessels collided. The master then ordered the vessel's anchor to be **let go** and rotated the pod to astern mode to reduce the vessel's headway. **let go***

port / starboard anchor oborite lijevo sidro *The master ordered the starboard anchor to be **let go**, but this did not slow the vessel's movement. The towed vessel was about 60 metres away when the*

*Master ordered to **let go the port anchor** and put one shackle of chain in the water. **the anchor is let go sidro je spušteno, sidro je oboreno***

*Secondly, the ground speed was not properly ascertained on the bridge when **the anchor was let go**. At 1220 **the starboard anchor was let go to 2 shackles in the water** and at 1223 the Pilot boarded the vessel. ; 2 (seamanship, ship handling)*

otпустити коноп / уže, odbaciti коноп s bitve, molat; tal. mollare *After all lines were **let go**, the ship attempted to clear the berth by putting both the bow thruster and rudder full / hard to port. The bosun was assisted by two other seamen at the aft mooring station who were told to **let go the starboard***

*stern and spring lines and heave them in. **let go everything forward** otpustite svu pramčanu užad, **let go all** Otpustite svu užad, otpustite sve konope, **mola sve!** During this manoeuvre, OSV1 also **let go all ropes**, and as soon as OSV2 was on the port beam, went astern. **let go tug line. Otpusti teglo. Otpusti uže za tegljenje.** ... the pilot began to make preparations to **let go the tugs** and proceed to the designated anchorage. The Pilot instructed the Master to **let go the ship's rope** being used by the forward tug, advising the tug's skipper accordingly. **Tug line is let go. Uže za tegljenje je otpušteno. let go fore and aft** Otpusti sve!, Otpusti svu užad!, **mola sve, let go the tug** otpustiti tegljač, otpustiti remorker: "Let Go the Tug!! Easy! Soon afterwards, the pilot asked the master to **let go the harbour tug**, which had its tow line fast to a bollard on the starboard side, just aft of the forward mooring station. **let go the mooring line** otpustiti priveznu užad, otpustiti užad za privezivanje: He then handed the con to the trainee master, who gave the order to **let go the mooring lines.***

let go of (the line) (v) 1 (ship handling) odbaciti (uže, konop), otpustiti (uže, konop): At about 0347 the master selected "start engine" on the telegraph, and soon afterwards he instructed the forward and after mooring parties to **let go of the head and stern lines.**; 2 (safety, ship handling) osloboditi se (od užeta itd): He managed to **let go of the line** with his right hand but his left hand was badly crushed when it became caught between the tow line and the panama lead.

let go staff (v) (shipping econ, mar law) otpustiti osoblje / zaposlenike: The Company is **letting go of 66 staff** from nine offshore ships and will replace them with contract labour.

let in (v) 1 dovoditi; 2 (safety, nav arch) pustiti unutra: The skipper was unaware that the hull of his vessel was breached above the waterline and **would let in water** in a moderate sea or when heavily loaded.

letter of acceptance of order (n) (mar law) pismo prihvaćanju narudžbe / naloga

letter of acknowledgement (n) (mar law, shipping econ) potvrda o primitku: Letter of Acknowledgement of Order and Its Execution: From: The Sender's Name, Door Number and Street's Name, Area Name, City. **potvrda o primitku i izvršenju naloga / narudžbe**

letter of apology (n) (mar law) pismo isprike: Letter of Apology and Proposal on Over-Shipped-Merchandise From: The Sender's Name, Door Number and Street's Name, Area Name, City.

letter of complaint (n) (mar law) prigovor, reklamacija, pritužba: Letter of Complaint about The Faulty Product

letter of compliance (n) (mar law) pismo o ispunjavanju uvjeta: To assist port states in this requirement ships can request a **letter of compliance** from the surveyor showing date and place of inspection, and that the ship complied with the requirements of the ...

letter of credit (mar law, shipping econ) A written commitment to pay, by a buyer's or importer's bank (called the issuing bank) to the seller's or exporter's bank (called the accepting bank, negotiating bank, or paying bank).; A letter addressed by a banker to a correspondent certifying that a person named therein is entitled to draw on him or his credit up to a certain sum.

(<http://www.maerskline.com/en-jm/help/shipping-glossary>) **akreditiv**: A **letter of credit** guarantees payment of a specified sum in a specified currency, provided the seller meets precisely-defined conditions and submits the prescribed documents within a fixed timeframe. These documents almost always include a clean bill of lading or air waybill, commercial invoice, and certificate of origin. **LETTER OF CREDIT (L/C)**: a letter issued by a bank entitling the bearer to draw funds up to a specified maximum from that bank or its agencies - **open the letter of credit** otvoriti akreditiv: Before the seller arranges to ship the cargo to you, you'll need to demonstrate that you can pay for the shipment. To do this, you'd **open a letter of**

credit from a bank after proving that you have the necessary funds to repay the bank. , **establish a letter of credit** **otvoriti akreditiv**: Where the shipper had sold the goods under a **letter of credit established through a bank**, or when he wishes to obtain payment of his invoice before the consignee obtains the goods, he will pass the full set of original bills to his bank, who will in due course arrange presentation to the consignee against payment. , **confirmed letter of credit** a letter of credit, issued by a foreign bank, whose validity has been confirmed by a domestic bank. **potvrđen akreditiv (od strane uvoznikove banke)** {abbreviated form: L/C}

letter of guarantee (n) (mar law) A written undertaking, or letter of indemnity, usually provided by a bank, promising to hold the carrier harmless, up to a certain sum, for claims that may arise from the delivery of goods to a particular person who is unable to surrender the original bills of lading in return for the goods **garantno pismo (pri dolasku broda), garancija, jamstvo**: *Guarantee letter is issued by the bank to the shipping company as a Bill of Lading: B/L for receiving products before Shipping Document's arrival* **Letters of guarantee**, reasonably worded, are a perfectly legitimate device to protect the carrier from claims if cargo is released without production of the original bill of lading. (http://www.fta.co.uk/policy_and_compliance/sea/long_guide/letters.html) Shippers should try to arrange delivery contracts in such a way that recourse to a **letter of guarantee** does not become necessary.

letter of indemnity /in'dɛmni/ (n) (mar law) A written undertaking by a shipper (infra) to indemnify a carrier for any liability which the carrier may incur for having issued a clean bill of lading when, in fact, the goods received were not as stated on the bill of lading. Such a letter is usually a central document in a fraud, whereby the shipper and carrier knowingly misrepresent to third parties the actual order and condition of the goods at the time of shipment or the bad order of the packing, or whereby they issue duplicate bills of lading to replace lost or stolen originals. Letters of indemnity should not be condoned by courts and are generally held ineffective as against third parties. (Tetley) *isprava kojom se tražitelj obvezuje da će od bodovlasnika, njegove službenike i agente obešteti u odnosu na svaku odgovornost, gubitak, trošak ili oštećenje koji može nastati zbog provedbe njegova naloga.* (D. Pavić) **jamčevno pismo, garantno pismo**: *There is no p&i cover for misdelivery of cargo, so change of destination is usually the subject of a letter of indemnity ... In case of cargo being lost or delayed in transit, the shipping company will allow delivery of the goods to the person claiming to be the consignee, if he gives a letter of indemnity; this is normally countersigned by a bank, and relieves the shipping company of any liability should another person eventually come along with the actual bill of lading. When the owners instruct the master to accept a letter of indemnity (LOI), they will take steps to ensure that the wording of the LOI presented to the master is the same as that which they have proposed. Carriers who meet a shipper request to issue a clean bill of lading in spite of pre-shipment damage or to backdate a bill of lading to meet letter of credit terms sometimes require letters of indemnity.*

letter of inquiry (n) (mar law) **upit, pismo o traženju ponude**: *Reply to The Letter of Inquiry Regarding Freight Rates* Pismo o traženju ponuda o vozarinijama

letter of protest (n) 1 (mar law) = **cargo damage claim** **pismena obavijest** kojom brod (zapovjednik) prebacuje odgovornost za gubitak, štetu ili izdatke prebacuje na drugu osobu **zahtjev za naknadu štete, protestno pismo, reklamacija**: *Please be advised that, from calculations of loading rates, the following difference is noted: Load Rate requested by ship 350 M/T per hour. Load Rate actually received 305 M/T per hour. This letter is to notify you that, on behalf of my vessel's owners and/or charterers, I hold you responsible for the damage/loss/costs sustained as a result of this incident. A letter of protest is a formal declaration whereby a person expresses a personal objection or disapproval of an act. Reasons for issuing a Letter of Protest : Delays/incidents during berthing/un berthing; Delays at loading/discharge terminal (e.g. delays due to waiting for customs or immigration officers), etc. lodge the letter of protest* **podnijeti zahtjev za naknadu štete**: ... and in order to protect the vessel, her owners and/or any other party who may be directly or indirectly concerned, **I lodge this formal letter of protest** and hold the consignor, the shippers and the terminal jointly responsible for any delays, loss,

damage or claims ...; **2 pritužba, prigovor**

Levanter (n) (meteorol, boating/yachting) a strong easterly wind of the Mediterranean, especially in the Strait of Gibraltar, attended by cloudy, foggy, and sometimes rainy weather **istočnjak, istočni vjetar, levant, levanat**

levee /'levi / lɪ'vi:/ (n) (ports) an artificial bank confining a stream channel or limiting adjacent areas subject to flooding. **nasip, diga**: A levee is a critical safety feature for low-lying areas, such as New Orleans. When a levee breaks, surrounding land faces massive destruction

level /'levəl/ (n) (marine eng) **razina**: A wet dock is one in which water can be maintained at various levels by closing a gate when the water is **at the desired level**. As a result, it is likely that the local temperature rose to **a level above** the auto-ignition temperature of the diphosphine gas and that the gas subsequently ignited. **The level of risk** is increased due to many factors. As shown in this case, lives may well depend on **the level of shipboard organisation** and preparedness. **oil level razina ulja, check the oil level provjeriti razinu ulja, level indicator pokazivač razine (tekućine), level reading očitavanje razine, high / low level visoka / niska razina (npr. tekućine u tanku), sea level razina mora**: If the ice is thicker than about 2 meters **above sea level**, it is called an ICE SHELF. However, under exceptional conditions, either severe extra-tropical storms or tropical cyclones can produce changes in sea level that exceed the normal range of tide., **water level razina mora, razina vode**: I observed that the vessel with the bright lights had his nets **at and above water level** and was making about 5 knots. Afterwards he returned to the engine room and found that the **water level** had not reduced but had increased by a further 20cm; it was now well above the floor plates and half way up the main engine.

level-luffing crane (n) (cargo handling) **dizalica s pomičnim krakom (granom)**: The advantages of **Level Luffing cranes** are that they offer high lifting capacities, accurate positioning of the



hook or grab and high duty ratings.

level-luffing gear (n) (cargo handling) **uređaj za dizanje kraka (grane) dizalice**

level luffing speed (n) (cargo handling) **brzina podizanja kraka dizalice**

lever /'li:və (UK), 'levə (US)/ (n) **1 (marine eng) poluga, ručka, ručica, motka**: A lever for one bow thruster which had to be moved to port to move arrow indicator and ship to starboard. He placed the **starboard lever** back to zero pitch and called the Master, who came to the bridge. The linkage was not securely fixed to the throttle and was connected so that **putting the lever in the forward position** put the engine astern, and vice versa. The master immediately changed to auxiliary steering and **put the lever hard to starboard**. **brake lever ručica kočnice, upravljačka poluga kočnice**: The allowable clearance between the stopper pin and **brake lever** is 10 mm., **clutch lever ručica spojke, poluga spojke**: However, the bosun's finger was still positioned between the edge of the **clutch lever** and the stopper plate., **control lever upravljačka poluga, ručica za upravljanje (motorom, uređajem)**: When the vessel was about 100 metres off the jetty, at a speed of 1.2 knots, the **control lever** inexplicably moved on its own to approximately 70 per cent of full power. He set the port **control lever** in the astern position and increased power. The engine continued to race even after the **engine control lever** was brought down to neutral., **compensating lever povratna poluga cranked koljenasta pluga, koljenasto polužje, helm lever ručica kormila**: He quickly changed

over the steering to manual and the pilot pushed the helm lever hard to port., **output lever** poluga za dobavu goriva, **rocker lever** klatna poluga, klackalica, dvokraka poluga, **speed control lever** poluga / ručica regulatora broja okretaja, **starting lever** ručica za upućivanje, **operating lever** upravljačka poluga, upravljačka ručica: Tests showed that the stopping time of the winch was about 3.5 seconds after the operating lever is released., **propeller lever** ručica za upravljanje propelerom, poluga za upravljanje propelerom: The pilot used the CP propeller lever to produce an engine kick ahead, then set the CP propeller lever at full astern but the vessel continued crossing the channel at a 45° angle., **release lever** otpusna poluga, **otpusna ručica**: As the officer removed the pin and operated the release lever, the crew member stepped to one side, which caused the bowsing rope that he was holding to come free from the bitts.

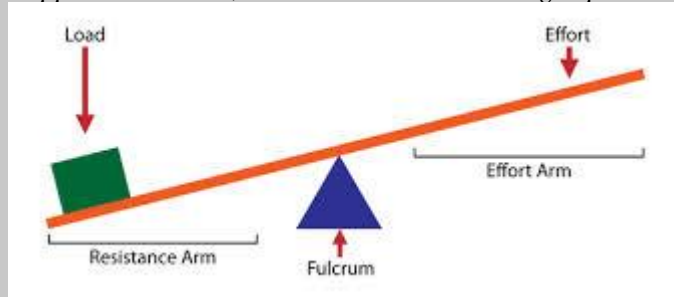

; 2 (navig, seamanship) poluga (u

tegljenju): This manoeuvre only served to cancel the rudder's action, as the larger after tug's force was enhanced due to the very long lever between the ship's pivot point and tug's push point.

levy /'levi/ (n) (shipping econ) an amount of money that must be paid and that is collected by a government or other authority (Webster) **pristojba, porez, namet, naknada**: The shipping industry faces the threat of paying a levy to the European Union on its greenhouse gas emissions ... **The Marine Navigation levy** is a charge against commercial shipping which is used to recover the costs of operating the Commonwealth's marine aids to navigation systems **marine navigation levy** **porez na korištenje plovnih putova**: **The Marine Navigation levy** is a charge against commercial shipping which is used to recover the costs of operating a country's marine aids to navigation systems

lex maritima (n) (mar law) A body of oral rules, customs and usages relating to navigation and maritime commerce, the first elements of which may be traced back to the Rhodian Law (infra) (c. 800 B.C.), and which developed in medieval Western Europe from the ninth to the twelfth centuries as part of a wider, customary mercantile law (the *lex mercatoria* or Law Merchant, infra), administered by merchant judges.(Tetley) **pomorsko pravo (temeljeno na usmenoj predaji)**: This *lex maritima*, part of the *lex mercatoria*, or Law Merchant as it was usually called in England, was the general law applicable in all countries of Western world. Much of this contemporary *lex maritima* is to be found in the maritime arbitral awards rendered by arbitral tribunals around the world by a host of institutional and ad hoc arbitration

lex mercatoria (n) (mar law) **COMPARE lex maritima** A body of oral, customary mercantile law which developed in medieval Europe and was administered quite uniformly across Europe by merchant judges, adjudicating disputes between merchants. The *lex mercatoria* originally included the *lex maritima* (Tetley) **trgovačko pravo (na temeljima srednjevjekovnog prava)**

liabilities (n) (financ) pasiva (u bilanci) **assets and liabilities** aktiva i pasiva

liability /'laie'biliti/ (n) 1 (mar law, shipping econ) **odgovornost, novčana obveza** **admit liability for priznati / preuzeti odgovornost za**: Never admit liability or that your vessel was at fault., **be cleared of any liability**: The classification society, which certified the seaworthiness of the

vessel, **was cleared of any liability** in connections to the disaster. **biti oslobođen nodgovornosti, reject liability odbiti odgovornost**: We reject all liability for the damage/s referred herein and hold you fully responsible for all consequences which may arise from our loading the cargo in a damaged conditio, **be discharged / released from liability biti oslobođen odgovornosti**: The carrier and **the ship shall in any event be discharged from all liability** whatsoever in respect of the goods, unless suit is brought within one(1) year of their delivery or of the date when they should have been delivered ... , **liability for oil pollution odgovornost za onečišćenje mora** OTHER P&I COVERED RISKS: Other risks covered include liability for stowaways, **liability for oil pollution** and other types of pollution and legal liability for wreck removal if the ship sinks and is blocking free navigation for other vessels., **limitation of liability**: ..., failure to comply with this article **will remove the limitation of liability** cover from the shipowner Pollution - the tanker owner **may not avail himself of the limitation of liability** for oil pollution damage if the incident; **2 (mar law) obveza Owner's liability brodarove obveze (npr. iz ugovora o najmu broda / čartera)**

liability (n) **1 (mar law, shipping econ) = shipowner's liability (SOL) = owner's liability (SOL) odgovornost (brodara) the liability of the owner commences at ... and terminates at ... odgovornost brodara počinje ... i završava ...**: in most countries the carrier's liability only commences at the point where the cargo passes through the vessel's permanent manifold connections, **and terminates** when the cargo passes out through the manifold connections at the port of discharge., **noncontractual liability of the shipowner and the ship izvanugovorna odgovornost brodovlasnika i brodara, shipowner's liability (SOL) odgovornost brodara, odgovornost brodovlasnika**: Shipowners are generally entitled to limit their liability in respect of claims arising from damage caused by their ships. The maximum **liability of a shipowner** is usually calculated based on the size of the ship involved in the incident and has no relationship to the amount of damage caused by the incident. There has been a trend in the more recent Conventions to establish systems of determining liability to pay compensation for damage, in addition to providing a **limit on the shipowners liability**. **Liability of the owner of a seagoing ship** in case of damage to cargo or persons due to collision or other accidents is not unlimited. A **typical SOL example** is geographical deviation or departure from the contractually agreed voyage; liability for loss of and/or damage to cargo arising out of such a deviation falls outside the scope of standard P&I., **charterer's liability odgovornost naručitelja prijevoza, odgovornost unajmitelja broda**: General Strike Clause - this clause is needed to explain **the limits of the charterer's liability** with regard to strikes.; **2 (mar law) obveza**

liability for damage to property (n) **(mar law) odgovornost za oštećene stvari**

liability for pollution (n) **(safety, mar ins) odgovornost zbog onečišćenja**

liability insurance (n) **(mar ins) osiguranje odgovornosti**: P&I or Shipowner's liability insurance is a form of marine insurance which protects shipowners, ship-operators and charterers of ships against third party claims for indemnity (third party) ...

liability to damage by ... 1 (mar law, shipping econ) odgovornost prema (brodaru, naručitelju, brodu itd.): Negligence of the other vessel, or default of the Master or the Servants of the Carrier, the Merchant will indemnify the Carrier against all **loss or liability to the other or non carrying vessel** ; **2 (cargo handling) osjetljivost na oštećenja uslijed ... , sklonost oštećenjima uslijed ... , izloženost oštećenju zbog ... , sklonost (kvarenju, hrđanju, mehaničkom oštećivanju itd.)** The principal disadvantage is its **liability to crushing and pilfering**. ... it provides the defenses that are available under the Himalaya Clause, in as much that it applies the **limitation of liability to the servants and agents of the carrier**, enabling such individuals, if

sued personally, to claim the benefits of the Rules ...

liable (adj) (mar law) **odgovoran**: ..., if the latent defect is not discoverable by due diligence, **the carrier is apparently not liable** even if he failed to exercise due diligence in attempting to discover latent defects. When a cargo is lost or damaged, it is not at all easy to determine who has been at fault and **who should be liable**.

liable for /'laɪəbəl/ (adj) (mar law) **odgovoran za, biti dužan da ... , biti obvezan**: If the cargo is discharged in a different condition, or in a lesser quantity, than that entered on the B/L, the shipowners **may be held liable for the damage** or shortfall. Thus **the carrier shall not be liable for any loss or damage** resulting from the reasonable deviation. *operty, occurring on board or in direct connection with the operation of the ship (maritime claims convention 1976) Passengers - the carrier shall be liable for the damage suffered* as a result of the death of or personal injury to passengers. No compensation is payable, and the shipper of the goods **will be liable for all damages and expenses** directly or indirectly arising out of or resulting from the shipment. **The Owners shall be liable for the cost** of maintaining the Employee ashore until repatriation takes place. **The shipowner** retains full possession of their ship and in most cases is **fully liable for the safety of the ship** and its safe operation. **be liable for for the payment of biti obvezan / dužan platiti** *the company is liable for the payment whether or not the ship's articles are endorsed* If the cargo is discharged in a different condition, or in a lesser quantity, than that entered on the B/L, **the shipowners may be held liable for the damage** or shortfall. When a cargo is lost or damaged, it is not at all easy to **determine** who has been at fault and **who should be liable.**, **the shipowner will be held liable for** **brodar će se držati odgovornim za, brodar će se smatrati odgovornim za** : If the cargo is discharged in a different condition, or in lesser quantity than that entered on the B/L, the shipowner may be held liable for the damage or shortage. If the cargo is discharged in a different condition, or in lesser quantity than that entered on the B/L, **the shipowner may be held liable for the damage or shortage**.

liable to /'laɪəbəl/ (adj) **1 koji se lako oštećuje, osjetljiv na; 2 (cargo, cargo handling) = subject to osjetljiv na, sklon (oštećivanju), podložan (oštećivanju), koji se lako (npr. kvari, oštećuje itd.)** : When different lots of bulk grain, or bagged goods are carried, **the contents of which are liable to mix** as a result of torn packages or of sifting, they should be separated. *Cargoes in cartons are liable to crushing. Some commodities are liable to spontaneous heating, which would include: 1. Certain commodities are liable to introduce vermin in the ship, the presence or ravages of which may prove costly.* **liable to tainting koji se lako kalja (prožima) s drugim teretima**: *Butter is liable (susceptible) to tainting with coffee.*, **liable to pilferage podložan krađi (teret)**, **liable to leakage koji lako curi / propušta (teret)**, **liable to deterioration (teret) koji se lako kvari, liable to mechanical damage (teret) osjetljiv na fizičko oštećenje, liable to to damage osjetljiv na oštećivanje (o teretu), podložan oštećivanju (o teretu), koji se lako oštećuje (o teretu)**: *The cargo of steel is liable to damage by rust. Goods liable to damage by rust should not be stowed in the same compartment or container with cargo, packaging or dunnage which is liable to give off moisture.*; **3 (navig, mar law) biti dužan / obvezan**: *The Master and Engineer are liable to keep full and correct logs including scrap logs accessible to the Charterers or their Agents.*

liaise with /li'eɪz/ (v) **povezati se se (nekim)**: *Masters should identify what services and deliveries are to take place at each port of call and liaise with the local agent to ensure the most logical delivery schedules, given the manpower available to the vessel. Liaise closely with the company and P&I club so that decisions are made jointly in the best interests of the safety of the ship and crew ...*

liaison /li'eɪzən/ (n) **veza**: *Pilots are engaged for a variety of reasons depending on circumstances which include pilotage based upon local knowledge, liaison, ship handling and bridge support. in close*

liaison with u uskoj vezi s: At the destination, another agent working *in close liaison with* the agent forwarding the cargo will break bulk the consignment and distribute the goods to the various consignees. **liaison officer** časnik za vezu

liberty (n) sloboda **be at liberty to biti slobodan (da), imati slobodu (za)**

Liberty ship (=pl. Libertys) (n) (nav arch) mass-produced cargo ships built during World

War II to provide the Allies with much needed merchant tonnage **brod tipa Liberty**: *Libertys* carried a crew of about 44 and 12 to 25 Naval Armed Guard About 200 *Libertys* were lost to torpedoes, mines, explosions, etc. during WWII The United States designated this new type of ship the EC2 (E for emergency, C for cargo and 2 for a medium-sized ship between 400 and 450 feet at the waterline.) Consequently, all the EC2 type of emergency cargo ships came to be known as **Liberty ships**.

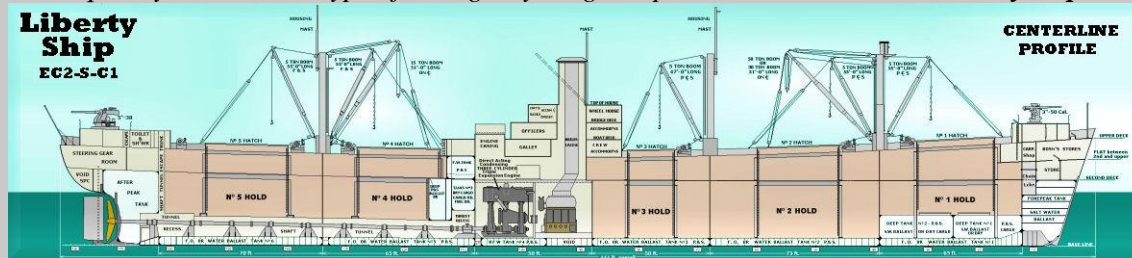

lice /lais/ (n) **uši (štetočine)**: Bales of rags, unless thoroughly fumigated, often harbour lice and other insects which, in turn are carriers of certain diseases.

licence /laisəns/ (= **license**) **1 svjedodžba o ovlaštenju, časničko ovlaštenje**

Master's Licence zapovjednik broda u neograničenoj plovidbi (STCW) **ovlaštenje za zapovjednika duge plovidbe (traditional title in Croatia), zapovjednik broda**

duge plovidbe: A nautical captain may be a civilian with a *master's licence* or a naval commissioned officer of any rank. In most modern navies, the rank of captain is equivalent to the army rank of colonel, and is thus three ranks higher than army captain. (<http://maritime-connector.com/captain-nautical/>),

pilotage licence **ovlaštenje za obavljanje peljarenja**: They hoped that this dismissal and its repercussions would at last convince the authorities to withdraw his *pilotage licence*, and expressed their thanks for my action!; **2 plovidbena dozvola; 3 (mar law) dozvola, odobrenje**: A dredging licence had been granted to the harbour authority. A *licence* or permit card for hazmat training **must be presented** when requested by officials. 4 - 'Crew's Effects'. If you are carrying firearms you should have a **valid licence or permit** authorising their carriage/possession from the appropriate country of origin.

dredging licence **dozvola za jaružanje, dozvola za održavanje dubine plovnog kanala, dozvola za bageriranje**

license /laisəns/ (v) **ovlastiti, dati ovlaštenje, izdati ovlaštenje, izdati časničko ovlaštenje**: It was later found that the service contractor **was not licensed** by the maker;

licensed /laisənst/ (adj) **ovlašten licensed officer** **ovlašteni časnik, licensed average adjuster** **ovlašteni havarijski procjenitelj, ovlašteni procjenitelj pomorskih šteta,**

ovlašteni osigurateljski likvidator štete, licensed navigator **ovlašteni časnik**

palube, ovlašteni časnik navigacije: Many ports require a pilot, a federal or state *licensed navigator* who possesses extensive local knowledge of the harbor, to be on board as the vessel makes its harbor passage. **licensed compass adjuster** **ovlašteni serviser za kalibriranje**

kompasa

licensing (n) (mar law) izdavanje ovlaštenja

lid (n) (nav arch) poklopac tank lid **poklopac tanka**



lie /laɪ/ (=lie; lay; lain) (v intr) **1 (navig)** to make no way (of a ship) **mirovati, stajati (na mjestu, sidru) biti zaustavljen, nalaziti se, biti smješten**: *When the vessel cleared the approaches to the harbour, the skipper set a course on the automatic helm to pass on his port side a small island, which lay about 2 miles to the south-west. The vessel cannot remain on the berth as the terminal operator either wishes to put another ship on the berth, or he just will not allow any ship to lay alongside. ...the Public Prosecutor issued an arrest warrant for the Master who was then detained overnight in a cell whilst his ship lay at anchor.* **lie at anchor (of a ship or boat) biti na sidru, biti usidren, lie alongside (of a ship or boat) biti vezan bočno, biti uz bok; 2 temeljiti se na nečemu, zasnivati se na nečemu; 3 (marine eng) ležati, nalaziti se na**: *if the fault lies in the governor itself* ako se kvar nalazi u samom regulatoru

lien /liːən; li:n/ **1 (n) (mar law)** privilegirano potraživanje u sklopu stvarnih prava na brodu (Grabovac) **pridržaj, zadržavanje (broda), retencija, pravo zapljene imovine, privilegij, zalog lien for freight zalog radi naplate vozarine, lien on the goods / cargo pravo pridržaja robe, pravo zaloga na robu**. *The shipowner has a common law lien on cargo for general average.*, **exercise lien on primijeniti pravo zaloga, have a lien on imati pravo zaloga na, maritime lien pomorski privilegij; 2 pomorski privilegij**
lien clause (n) (mar law) klauzula o retenciji, klauzula o zadržavanju broda
lie to (v) 1 (seamanship, navig) biti vezan na (sidru, plutači); **2 (boating/yachting)** zaustaviti se u vjetru

life /laɪf/ (n) (marine eng) vijek trajanja, rok trajanja **extend the life of the engine produljiti vijek trajanja stroja**

life-belt (n) (safety) pojas za spašavanje

lifeboat (=lifeboat; life-boat; life boat) (n) (nav arch, safety) brodice za

spašavanje, čamac za spašavanje, lajbot, tal. lancia di salvataggio: *Make sure you are properly trained and fully familiar with the correct way to prepare and launch the lifeboat. As the seaman descended the aft davit cradle, he probably stepped on the winch brake lever extension, instead of the ladder rung, and released the lifeboat., compelling personnel to place themselves in a dangerous position on the inclined portion of the davit roller track when securing the lifeboat. Portable pumps were transferred from the lifeboat to the trawler and the flooding was brought under control. At about 2 meters above the embarkation level, the lifeboat's forward hook accidentally opened and the lifeboat dropped. The forward end of the lifeboat fell to the water but it was undamaged and there were no injuries to the crew. The brake then opened and the lifeboat lowered a short distance until the brake again applied itself and the boat swung violently onto two angled plates at the ship's side, ... The starboard lifeboat, with three crew members on board, was unlashd and lowered to the water. Shortly afterwards, the port lifeboat was lowered. Twelve crew ran to the davit and swung off the hand brake to try to stop*

the lifeboat descending. **freefall lifeboat** brodica za spašavanje sa spuštanjem na slobodni pad, brodica za spašavanje koja se spušta vlastitom težinom, **lifeboat capacity** nosivost brodice za spašavanje: While the vessel was at anchor the opportunity was taken to lower the free-fall lifeboat (*capacity 16 persons*) in order to test the engine, water sprays and provide training for the crew., **hoist the lifeboat** podignuti brodicu za spašavanje: Although untested, it was then used to hoist the lifeboat until the limit switch shut off the power., **all-weather lifeboat (ALB)** brodica za spašavanje za sve vremenske uvjete: The skipper made a distress call via VHF radio. In response, the coastguard tasked an **all-weather lifeboat (ALB)**, which went to assist., **lifeboat engine** motor brodice za spašavanje Operate lifeboat engine(s) and report. .5.1 All lifeboat engines are operational. .5.2 No. ... lifeboat engine is not operational (yet). .5.3 No. ... lifeboat engine will be operational in ... minutes. (IMO SMCP), **lifeboat winch** vitlo uređaja za dizanje / spuštanje brodice za spašavanje: Review the condition and specification of other **lifeboat winch motors** to ensure that they would not contribute to further incidents., **lifeboat falls** kolotunici uređaja za spuštanje / dizanje brodice za spašavanje, **koloturnici čekrka (paranka)** za spuštanje / dizanje brodice za spašavanje: Upon renewal of **lifeboat falls**, if time permits, the lifeboat must be lowered to the water level and the remaining length of fall wires on the winch drums must be estimated ... Whilst travelling as a passenger on a cruise ship I noticed that all **the lifeboat falls had been clamped** with only two bulldog grips., **lifeboat equipment** oprema za spuštanje / dizanje brodice za spašavanje, **mehanizam za spuštanje / dizanje brodice za spašavanje**: Therefore ship's crew should take the utmost care to check and ensure **lifeboat equipment remains fit for proper operation** at all times; , **lifeboat stations** 1 **mjesta brodica za spašavanje na brodu** Do not go to the **lifeboat stations** until you are ordered to do so. (IMO SMCP); 2 **VHF postaja brodice za spašavanje**: The captain contacted the coastguard via Digital Selective Calling who alerted the rescue helicopter and two **lifeboat stations**., **lifeboat embarkation** ukrcaj u brodicu za spašavanje: On one of our vessels, the lifeboat embarkation ladder rope **parted during an abandon ship drill conducted in the presence of the US Coast Guard**., **lifeboat hook** kuka uređaja za spuštanje / dizanje brodice za spašavanje Root cause/contributory factors Inadequate understanding and/or improper operation of the **lifeboat hook on-load release system** and resetting procedure; , **lifeboat release gear** uređaj za oslobađanje kuke uređaja za spuštanje / dizanje brodice za spašavanje, **otpusni mehanizam**: ... investigation of the lifeboat release gear test on MV which caused injuries to two people at the nearest ship repair yard. **lifeboat release** oslobađanje brodice za spašavanje (od uređaja za dizanje i spuštanje), **otpuštanje brodice za spašavanje**: During maintenance, the second engineer noted that **the free-fall lifeboat release system hydraulics** appeared to be losing oil and he wanted to personally confirm that all was in order., **lifeboat hoisting and lowering equipment** uređaj za dizanje i spuštanje brodice za spašavanje: Unfortunately there have been a number of accidents, some fatal, resulting from a misunderstanding of the functionality of elements of rescue boat and **lifeboat hoisting and lowering equipment**., **launch the lifeboat** spustiti brodicu za spašavanje u more: The two simulation wires, in place to allow for launch training but so as to prevent an actual launch, failed under the shock load and the **lifeboat launched into the sea**., **enclosed lifeboat** zatvorena brodica za spašavanje: all persons are safely on board a **totally enclosed lifeboat** in the davits and accounted for, ..., **free-fall lifeboat** brodica za spašavanje na slobodan pad, **gravitacijska brodica za spašavanje**: While the vessel was at anchor the opportunity was taken to lower the **free-fall lifeboat** (*capacity 16 persons*) in order to test the engine, water sprays and provide training for the crew.

lower the lifeboat spustiti brodicu za spašavanje: Shortly afterwards, the port lifeboat was lowered. Shortly afterwards, the port lifeboat was lowered. **enter the lifeboat** ući u brodicu za spašavanje: Enter the lifeboat / liferaft only when ordered by an officer / lifeboatman. (IMO SMCP), **hoist the lifeboat** podignuti brodicu za spašavanje (na brod): Although untested, the davit was then used to hoist the lifeboat until the limit switch shut off the power. During a lifeboat drill in port, the crew of a container ship had some problems hoisting the lifeboat using the davit winch motor controls on the boat deck. **suspended lifeboat** viseća brodica za spašavanje, **obješena brodica za spašavanje**, **brodica za spašavanje u zraku (po boku broda)**: The drill was abandoned but as there was a substantial distance between the suspended lifeboat and the nearest ship's deck, it was thought to be too risky to disembark the crew from this position. **board the lifeboat** ukrcati se u brodicu za spašavanje, **ući u brodicu za spašavanje**: During a routine lifeboat drill at anchorage an officer slipped when he was attempting to board a lifeboat which was lowered to the embarkation deck. **lifeboat securing equipment** oprema za prišvrčivanje / osiguravanje brodice za spašavanje, **osigurati brodicu za spašavanje**: They were operating lifeboat securing or release equipment, **recover the lifeboat** podiće brodicu za spašavanje iz mora: The vessel was turned around to recover the lifeboat.



lifeboat davit (n) (nav arch, safety) soha brodice za spašavanje: Substantial damage had been caused to the vessel's port quarter and lifeboat davit. The fourth engineer, along with the bosun, wrongly assumed that the job was officially assigned to them and proceeded to open up the brake unit on the port lifeboat davit.

life-boat deck (n) (nav arch, safety) paluba brodice za spašavanje: The bosun had fallen onto a lifeboat deck some 5 – 6m below the crane operating platform, and had remained conscious.

lifeboat drill (n) (safety) vježba spuštanja brodice za spašavanje: During a lifeboat drill in port, the crew of a container ship had some problems hoisting the lifeboat using the davit winch motor controls on the boat deck. A planned lifeboat drill was carried out on a coastal tanker while she was

alongside in port for engine maintenance.

lifeboat radio (n) (comm, safety) radio-stanica za brodicu za spašavanje

lifeboat station (n) (safety) mjesto brodice za spašavanje: *By the time the seaman arrived at the lifeboat station the bosun had already begun the task. ...the Chairman of the Technical Committee he is responsible for the design, build and maintenance of all weather and inshore lifeboats and lifeboat stations. Follow the lifeboatmen to the lifeboat stations / liferaft stations on the embarkation deck. (IMO SMCP)*

lifebuoy (=lifebuoy; life-buoy; life buoy) (n) 1 (safety) kolut za spašavanje, obruč za spašavanje, tal. *salvagente anulare*: *He threw the life buoy and marker stowed*



alongside the pilot ladder.

; 2 (safety) pojas za spašavanje

lifejacket (=lifejacket; life-jacket; life jacket) (n) (safety) = life-vest prsluk za spašavanje, tal. *giubbotto salvagente* inflatable **lifejacket** prsluk na napuhavanje:

The seaman had been wearing a manually inflatable 150N lifejacket which, for some unknown reason, he did not inflate. Two deckhands, who were wearing inflatable lifejackets and oilskins, went up onto the



aft deck to prepare to launch the buoys.

lifeline (n) 1 (boating/yachting) the lines erected around the edges of decks uže ograde, čelično uže ograde; 2 uže za spašavanje

life preserver (n) (safety) COMPARE personal flotation device; PFD osobno uzgonsko sredstvo {a flottaion vest, coat, belt, cushion}

liferaft (=liferaft; life-raft; life raft) (n) (safety) = raft splav za spašavanje, tal. *zattera di salvataggio* board the **liferaft** popeti se na splav za spašavanje: *According to survivors' statements, six crew boarded a life raft while five others were able to board a lifeboat.*

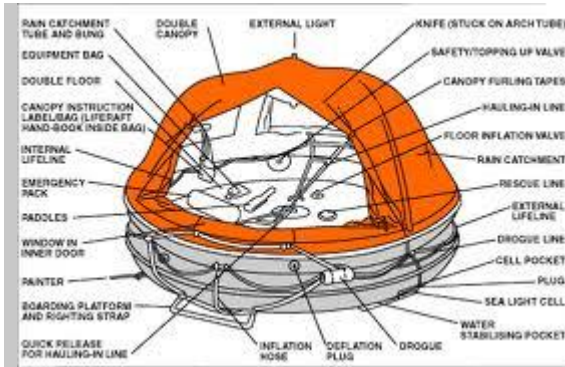

life ring (n) (safety) = **lifebuoy** kolut za spašavanje obruč za spašavanje: A *life ring* has been found from the cargo ship, which went missing on Thursday after sailing through Hurricane Joaquin in the Bahamas.

life-saving apparatus (n) (safety) sredstva (oprema) za spašavanje: The *life-saving apparatus* includes lifeboats, inflatable rubber liferafts, lifebuoys and individual lifejackets.

life saving appliances (n) (safety) oprema za spašavanje: *Life saving appliances* are a crew's last chance at survival if disaster strikes. An officer was undertaking his inspections of the various *life saving appliances* on a relatively new (two years) small coastal vessel. ... the *lifeboat manual* and class certificate, which gives the details of *life saving appliances*/fire fighting appliances, gave the correct diameter.

lifesling (n) (boating/yachting) plutajuće uže za spašavanje



life span of depression (n) (meteorol) trajanje ciklone

life-vest (=life-vest; life vest) (n) (safety) prsluk za spašavanje: For the task, the bosun's mate was wearing the obligatory working *life-vest*, but the bosun was dressed in a coverall and riggers boots. Next, a seaman wearing all appropriate PPE, including an inflatable *life vest* and safety harness with lifeline, descended to the bottom platform of the gangway to monitor the lowering of the pilot ladder. A *life vest* must be made available, and personnel strongly encouraged to wear it during transfers.

don the life-vest staviti na sebe prsluk za spašavanje obući prsluk za spašavanje: After *donning a life-vest*, safety harness, other PPE and taking a portable light, I went aboard alone to investigate the cause of the list.

lifing plant (n) (cargo handling) = **lifting gear** brodski uređaji i alati za teret: Check that all *lifing plants* (dericks, cranes, wires, blocks etc) are in good condition and properly rigged.

lift (v) **podignuti, podići, dizati**: To *lift the boat* from its chocks, the motor controls were operated, but there was no movement of the winch. With the mate keeping a watchful eye on deck, the master

started to lift the 'A' frame into position using separate heaving and luffing winches; heaving in on one set of winches and slacking back on the other. The bosun began to lift the load, with the skipper of the stores barge steadying it as it cleared the deck. lift clear of podignuti s, podignuti izvan dohvata: Despite the efforts of the tug, the stern moved off the quay, requiring the ro-ro ship's stern door to be lifted clear of the linkspan., lift on podignuti na brod, lift off iskrcati (s broda), istovariti (iz vagona, kamiona), lift up podignuti (se). The tanker made contact with the walkway, causing it to lift up and fall into the water.

lifting appliances (n) (cargo handling) sredstva za ukrcaj/iskrcaj tereta, prekrajna sredstva

Examinations of lifting appliances and loose gear should be carried out by persons competent, by virtue of their knowledge and experience, to do so. As a result of serious local degradation of the wire in excess of the limits set by the classification society in their 'Rules for the Certification of Lifting Appliances Onboard Ships'. ... the 'tightening' is achieved simply by a person holding or tapping down the unloaded eye as the weight is taken by the lifting appliance. A lifting appliance generally has no 'redundancy' – so a single failure is enough to cause a major accident.

lifting beam (n) (cargo) greda za (teški) teret: *Lifting beams and spreader bars are designed to lift heavy loads with a crane safely and efficiently. Lifting beams can be provided with fixed or adjustable load centres, adjustable centre of gravity etc. Heavy lifting beams are suitable for heavy and*



long articles such as locomotives, boilers or railway passenger coaches.

lifting boom (n) (cargo handling) samarica

lifting capacity (n) (cargo) nosivost dizalice, moć dizanja: *Four gantry cranes, lifting capacity 3 x 30 tons and 1 x 50 tons, are used for handling ore and coal. The derricks are the ship's cranes, and their lifting capacity can vary from 3 tonnes to 50 tonnes or more.*

lifting equipment (n) (cargo) uređaji za dizanje, brodski uređaji za krcanje tereta:

Lifting equipment should always be in date for survey or test before it is used. Follow the guidance on lifting equipment published by the MCA in Marine Guidance Notes 331 and 332 and in the Code of Safe Working Practices.

lifting force (n) (cargo handling) the resultant vertical lifting force acting on stowed containers, causing damage to the containers sila podizanja: *Exceeding lifting forces can be reduced by use of*

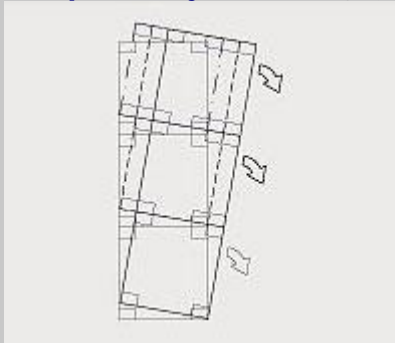

diagonal or vertical lashing units.

lifting frame (n) (cargo) = lifting beam okvirni nosač za dizanje tereta: *Lifting*

frames are used to lift a wide range of commodities including unitised pulp, timber, plywood, aluminium, copper, and lead, as well as non-unitised commodities such as slung timber, tissue reels and big bags of bulk commodities. The Safe Working Load (SWL) of an item of **ship's lifting gear** is the safe maximum weight that can be lifted with the load suspended directly from the hook in the standard configuration or in other specified

lifting gear (n) 1 (cargo handling) uređaj za ukrcaj / iskrcaj tereta na brod / sa broda, lučka vertikalna mehanizacija, sredstva za ukrcaj, obalne dizalice. Attached to the **lifting gear** is a shackle which links the crane or derrick with the form of cargo-handling equipment being used. All the vertical cargo movements are conducted by the **lifting gear** (lift-on/lift-off equipment).; 2

(cargo handling) alati za hvatanje tereta, naprave za hvatanje tereta: The **lifting gear** and sling were duly certified for the load and had not been subjected to any severe loads since new; 4.

lifting height visina dizanja (kraka dizalice): Important measurements are the **minimum lifting height** for lifting tackle, shortest distance between driving motor and wall, free passage for dismantling and assembly, maintenance and operation.

lifting hook (n) (cargo handling) kuka za dizanje tereta: The first problem encountered was that the wire fall from the davit head did not plumb over the **lifting hook**.

lifting machinery (n) (marine eng) postrojenje za dizanje

lifting speed (n) (cargo handling) brzina dizanja

lift on/lift off (=lo-lo ship) (v) (cargo handling) COMPARE roll-on/roll-off

dizanje i spuštanje tereta, vertikalne operacije s teretom: In the current trade today, a portion of the ship is **roll-on/roll-off**; a portion of the ship is **lift-on/lift-off**. (n) **lift on/lift off**

equipment vertikalna mehanizacija: All the vertical cargo movements are conducted by the **lifting gear** (**lift-on/lift-off equipment**), and construction of the container ship TEU container ship cell guide The main characteristic of a container ship is that it depends on shorebased **lift-on/lift-off equipment**, mainly container gantry cranes (also called portainers), to handle its cargo. **uređaji za**

dizanje tereta, **lift on/lift off services (shipping econ)** (n) usluge lučke vertikalne mehanizacije, usluge iskrcaja/iskrcaja tereta (u luci), **lift on/lift off vessel (nav arch)**

COMPARE roll-on/roll-off vessel brod s klasičnim uređajem za teret, brod za vertikalne operacije s teretom: **Lift-on/Lift-off (LoLo)** vessels use a crane to load and unload cargo.

light /laɪt/ (n) 1 (navig) any of a ship's navigation lights **navigacijsko svjetlo**, tal. **fanale**: The skipper then picked up the **quick flashing green light** at the end of the destination's quay. **all-round light** an omnidirectional light; a light which presents the same characteristic over the whole horizon of interest to marine navigation. **svjetlo vodljivo sa svih strana (u 360 stupnjeva)**: The pole

mounted **all-round white light** was broken., **anchor light** sidreno svjetlo: Switch on the **anchor light(s)**. Hoist the anchor ball. Check the anchor position by bearings / by The anchor position is

bearing ... degrees, distance ... kilometres / nautical ... (IMO SMCP), **background light**

pozadinsko svjetlo: Large tows and **background light** also often obscure the tug's stern light and the light for the tow to steer by from an overtaking vessel., **flashing light** bljeskajuće svjetlo: It is

painted in the same colours as the north cardinal mark and is fitted with a quick **flashing light**. After I had called three or four times, she started showing a red **flashing light** (generally used on tankers during cargo

work)., **masthead light** jarbolno svjetlo: Through binoculars, he identified the **masthead light** and the port side light of what he assessed to be a power-driven vessel crossing the traffic lane. She was

exhibiting a **masthead light**, port and starboard sidelights and a stern light., **towing light** svjetlo za

tegljenje: It took a while before I could clearly distinguish the **towing lights**, due to the bright deck

lighting of the tug., **screened light** zaslonjeno svjetlo, **signal light** signalno svjetlo: 200057 Two vessels were seen during one evening exhibiting red over white over red **signal lights** whilst steaming normally along the South West Lane of the TSS off Vlieland and Terschelling. A **signal light** exhibited by day and also, usually with reduced intensity by night., **station light** položajno svjetlo: ... a narrower frequency band can be used, and the signal is less subject to manmade interference or selective fading **single station range light**., **exhibit a light** istaknuti / pokazati svjetlo: A power driven vessel underway, even when not making way through the water, **should exhibit the lights** prescribed in rule 23., **show a light** istaknuti / pokazati svjetlo: These 40-foot diameter buoys **show lights** from heights of about 71 36 feet above the water. 5 knot container vessel, draft of 13.5m, was **showing 3 vertical red lights**., **12 mile range light** svjetlo / svjetionik s dosegom od 12 milja, **display a light** istaknuti svjetlo, **height of light** visina svjetla; 2 (navig) the signal emitted by a lighted aid to navigation **svijetleći signal**

light (=light; lit; lit) (v) (navig) upaliti svjetlo (na jarbolu, plutače itd): The crossing vessel's forward working and deck lights were still lit

light (adj) 1 lagan; 2 prazan, bez tereta (n) **light ship** (shipping econ, stabil) brod bez tereta, prazan brod

light air (n) (meteorol) lahor, tal. bava di vento: The weather conditions were good with **light airs** and excellent visibility.

light airs (n) (boating/yachting) lagani vjetar {vjetar od 10 čvorova i manje}

light alloy (n) lagana slitina, lagana legura

light breeze (n) (meteorol) COMPARE calm, gentle breeze, moderate breeze, fresh breeze, strong breeze, **light air** povjetarac: The weather was fine, with a **light breeze** and rippled sea. In some places the wind becomes a **light breeze** which is unsteady in direction, or stops altogether, while in other places it continues almost undiminished, with changes in direction or calm The sea was calm, there was only a **light breeze** and visibility was very good. {Vjetar jačine 2 na Beaufortovoj ljestvici}

light buoy (=light buoy; lighbuoy) (n) (navig) plutača sa svjetlom: The third mate thought the green light was from an expected isolated danger beacon and he responded to the lookout that the light was a distant 'light buoy'. Large deep-draught vessels are requested to stay at least 1 nautical mile eastward of the **Light Buoy** for pilot boarding because of the strength and proximity of the Gulf Stream current. **red light buoy** plutača sa crvenim svjetlom, **light buoy** marking the



approach channel plutača sa svjetlom koja obilježava plovni kanal

light characteristics (n) (navig) karakteristike pomorskih svjetala: The top marks and **light characteristics** of the beacons indicate that the clear water lies between them ... Consult the chart for the location and **light characteristics** of all navigation aids; consult the light lists to determine their

detailed description.

light dues (n) (mar law) naknade za korištenje plovnih putova, pristojbe za korištenje plovnih putova, naknade za korištenje oznaka na plovnim putovima: *The officer issuing the clearance must also satisfy himself that harbour and light dues have been paid, and that emigration and port health regulations have been carried out. The master or the agent must go to the Custom House and first pay the outward light dues unless these dues have already been fully paid for the current financial year.*

lighten /'laɪtən/ (v) (safety) olakšati brod (iskrcavanjem dijela tereta): *There is a possibility to dredge under the vessel or lighten the LNG carrier by a ship-to-ship transfer of a portion of its bunker fuel or cargo.*

lighter (n) (nav arch) a full-bodied, heavily-built craft, usually not self-propelled, used in bringing merchandise or cargo alongside or in transferring same from a vessel **tegljenica, maona, barža**: *When a shipper's cargo is loaded into lighters from a stranded ship and is taken straight to its destination, the rights and liabilities involved in this are not affected, ...*



lighter (v) (safety) olakšati brod (iskrcavanjem tereta), isprazniti (teret s broda) u tegljenicu **lighter the ship**: *Authorities lightered the ship by removing 500 tonnes of rice from it to allow the stranded ship to refloat.*

lighter- aboard-ship; LASH (n) (nav arch) brod za prijevoz tegljenica: *Containerization, lighter- aboard-ship, and barge- aboard-ship operations have facilitated the shipping of cargoes between oceangoing vessels and those of the inland waterways.*

lighterage 1 (n) (shipping econ) cijena prijevoza tegljenicom; **2** pristojba za upotrebu tegljenice: *The buyer will be responsible for the charges involved in getting the goods off the ship to his warehouse, such as lighterage, dock dues and custom duties.*

lighthouse (n) (navig) a lighted beacon of major importance, usually erected on shore **svjetionik, tal. faro**: *As a vessel proceeds along a coast, the bearing of a fixed point on shore, such as a lighthouse, is measured frequently. INFORMATION: The fairway entrance is: position: bearing 1-3-7 degrees true from North Point Lighthouse, distance: 2 decimal 3 miles REQUEST: Please supply bunkers: quantity: 3 thousand metric tonnes (IMO SMCP) Thank you, Sir. Starboard ladder, and approach the Ambrose Lighthouse from the east. A beacon (S31) stands over a reef about 2.5 n.m. to the NNW of the lighthouse.*

lighting /'laɪtɪŋ/ (n) (nav arch, electr) rasvjeta, sustav rasvjete na brodu: *The retrieval was achieved with considerable difficulty due to inadequate emergency lighting aboard the pilot launch, ... Persons must move with caution in areas that may have obstructions, especially under low lighting conditions; A lack of lighting have been more sensible to let the master on the controls made it difficult for the continue to steer the vessel ... lighting distribution razvod rasvjete*

lighting fishing boat (n) (nav arch, fishing) svjećarica

lightning (n) (meteorol) 1 any form of visible electrical discharges produced by thunderstorms

munja, strijela: A violent squall with thunder and **lightning**, encountered during the rainy season along the west coast of Central America.; **2 sijevanje grom:** A squall with violent thunder, **lightning**, and rain, which blows at night in the Malacca Straits, especially during the southwest monsoon. The circular applied to any severe local storm accompanied by gusty winds, precipitation, thunder, and **lightning**. If the thunder accompanying **lightning** cannot be heard due to its distance, the **lightning** is called **heat lightning**.

lightning rod (n) (nav arch) **šiljak gromobranja, šiljak munjovoda:** A luminous discharge of electricity from pointed objects such as the masts and arms of ships, **lightning rods**, steeples, etc.

light off tests (n) (nav arch) Light-Off occurs as various major components of the ship are completed, energized and tested **ispitivanja rada pojedinih sustava broda:** Light-off events include electronic systems light-off (which may include the ship's Command, Control Communications, Computers, Intelligence, Surveillance and Reconnaissance (C4ISR) equipment), electrical generator light-off, combat systems light-off, and main engine light-off

light range (n) (navig) **svjetlosni domet:** ...the new buoy with an increased **light range** has now been established.

lights navigacijska svjetla: The Master must have local knowledge of the names and characteristics of lights, their ranges and arcs of visibility and what they mark

lights and radio signals (n) (navig) **svjetlosni i radio signali**

light sector (n) (navig) the arc over which a light is visible, described in degrees true, as observed from seaward towards the light **sektor svjetla:** Limits of **light sectors** and arcs of visibility as observed from a vessel are given in the light lists, in clockwise order.

light sequence (n) (navig) **svjetlosni slijed period of light sequence periodi svjetrosnog slijeda**

lightship (n) (nav arch, navig) **brod svjetionik:** The ship then passed very close to a **lightship** before grounding at 2230. An unlighted buoy established in the vicinity of a **lightship** or an important lighted buoy as a reference point in case the lightship or buoy should be dragged off station.

light ship (n) (nav arch) **prazni opremljeni brod (kako je isporučen od brodogradilišta), masa praznoga broda**

light ship mass (n) (nav arch, navig) **masa praznog broda**

light wind sails (n) (boating/yachting) **jedra za lagani vjetar (u regatama)**

lignum vitae /'lignəm 'vaitɪ/ (n) (nav arch) **drvo života, legnosanto**

limber (n) (nav arch) **slivnik podnice, slivnica**

limber boards (n) (nav arch) **podnice slivnika, pokrov sliva**

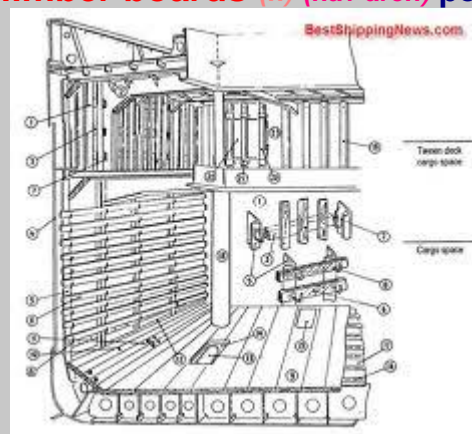

{limber board - see No. 9}

limber hole (n) (nav arch) a hole or slot in a frame or plate for the purpose of preventing water

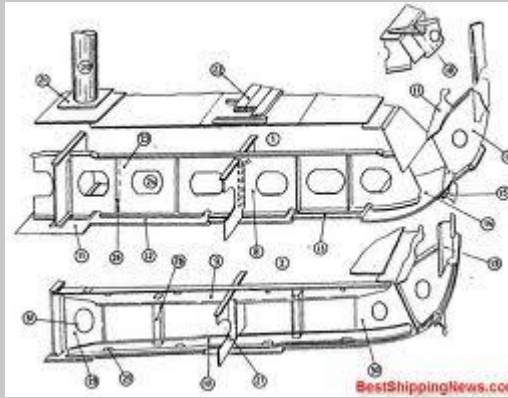

from collecting **sljevnica**, **slivnik**
31}

BestShippingNews.com {limber hole - see No.

limber strakes (n) (sailing vessels) **nutarnja oplata (uz hrptenicu)**

limewash (v) (cargo handling) **prati (brodsko skladište) vapnenom vodom**

limit (n) **granica fatigue limit** (nav arch, marine eng) **granica zamora materijala** If the material is loaded below the **fatigue limit**, which in the example shown is 14×10^3 psi (95×10^3 kN/m²) then it will not fail regardless of the number of stress cycles.

limitation of liability (n) (mar law) **ograničenje odgovornosti** the tanker owner may not avail himself of the **limitation of liability** for oil pollution damage if the incident occurred as a consequence of the actual fault of, or of someone in privity with, the owner failure to comply with this article will remove the **limitation of liability cover** from the shipowner the carrier shall not be entitled to benefit from the **limitation of liability** if it is proved that the damage resulted from an act or omission of the carrier

limitation of shipowners' liability (n) (mar law) The ancient right of shipowners, later extended to charterers, managers, salvors and insurers of ships, to limit their liability for certain maritime claims, either to a sum representing the value of the vessel and pending freight after the casualty, or to a sum determined by the tonnage of the vessel, depending upon the jurisdiction concerned and the applicable or national law. (Tetley) **ograničenje brodarove odgovornosti**

limited company (n) (mar law) **dioničko društvo**

limited liability company (n) (mar law) **dioničko društvo, d.d.**

limit stop (n) (electr) **graničnik**

limit switch (n) (electr) **krajnja sklopka, krajnji prekidač, sigurnosna sklopka** The proximity sensor/**limit switch** fitted to the davit was considered by its manufacturer to be inappropriate for use as a 'final stop' or safety device. The davit arm **limit switch** was found to be working correctly. Although bench tests showed the **limit switch** to be operating normally, it did not cut power when the crane

LIMIT SWITCHES	
Normally Open	Normally Closed
Held Closed	Held Open

block exceeded the set limit.

Line (geogr) **Ekvator, podnevnik** **cross the Line prijeći Ekvator**: *The ceremony of Crossing the Line is an initiation rite that commemorates a sailor's first crossing of the Equator.*

www.nauticapedia.ca/Articles/Crossing_the_Line.php, **Line-crossing ceremony svečanost prijelaska Ekvatora**

line (n) **crta, linija, pravac**: *A rhumb line makes the same angle with all meridians it crosses and appears as a straight line on a Mercator chart.* **in line (with) 1 u jednom pravcu, u ravnoj liniji, na ravnoj liniji**: *Fix by Range and Distance: When the vessel comes in line with a range, plot the bearing to the range and cross this LOP with a distance from another NAVAID. The 2/O on the 8/12 watch had commenced his morning watch on the bridge and, in line with the Master's Standing Orders, had started one engine after the ship had spent a period of time drifting.*; **2 usporedan s**; **3 centriran**

line (n) = **rope, wire 1 (seamanship) uže, konop**; **2 (ship handling, seamanship) = mooring line privezno uže, privezni konop, tal. cavo; cima**: *the line landed on the dock konop je pao na obalu the line parted konop je pukao, uže je puklo as the line runs out dok konop izlazi (iz broda) Tow line hove short. Teglo pritegnuto (na blizu) Heave away! Počinji potezati!, Poteži! Heave easy on the line! Poteži polako!, Napinji polako Heave the line tight! Napni konop jako! All gone and clear! Svi konopi otpušteni i prikupljeni. Let go fore and aft! Otpustite sve konope! Mola sve! Single up! Odbaci sve konope osim jednog! Single up! Surge! Neka konop klizi na bubnju vitla!* **to bend the line zavezati (tanji konop za deblji)**: *Reeving a small diameter messenger of sufficient strength and length through the rigging as the old wire is being unreeved, and subsequently securely bending the messenger line on to a small single-strand eye or the plain end of the new runner wire with a series of timber hitches, may be a safer method.*, **to cast a line baciti konop, dobaciti konop (na obalu) to cast off a line 1 otpustiti konop**: *Awoken by the sound of the engines, one of the deckhands got up and went on deck to cast the lines off. On pilot's advice, all lines were cast off, and the two tugs began pulling the vessel away parallel from the berth.*; **2 odbaciti konop (s bitve), to check the line zaustaviti konop (na kočnici vitla), to get the line across dobaciti (baciti, dodati, prebaciti, predati konop tegljaču itd.), to get line ashore baciti (dobaciti) konop na obalu, to get the line on board povući (prikupiti) konop na brod, to haul (in) the line povući (privući, prikupiti) konop (smanjiti labavost konopa), ručka za upućivanje, prikupiti (povući) konop na brod, rekuperat, to heave on the line zategnuti (napeti) konop, to heave the line 1 potezati (natezati) konop**: *... since the ship's crew was not be able to pull the line on board by hand, the mate went to the bridge door and shouted to them to heave the tow line using one of the ship's mooring winches, so that the buried turn could be pulled free from the winch drum.*; **2 baciti konop ili bacalo na obalu (drugi brod), to let go the line otpustiti konop, odbaciti konop (s bitve), molať**: *During this manoeuvre, OSV1 also let go all ropes, and as soon as OSV2 was on the port beam, went astern. He then handed the con to the trainee master, who gave the order to let go the mooring lines.*, **to make ready the lines pripremiti konope (za privezivanje / odvezivanje)**: *When the vessel reached a position about a mile from the harbour entrance, all three deck crew members were called to make ready the vessel's moorings and fenders.*, **to make fast the line vezati konop, privezati (i učvrstiti) konop, pričvrstiti konop**: *The Master instructed the C/O to slack on that spring too, however, the C/O instructed the AB to make fast the spring on the bitts.*, **to pass the line (down) to dodati (dati, predati) konop nekome (niz brod)**: *A deckhand normally passed the line from the workboat to the dredger.*, **to pick up the line uhvatiti konop, prihvatiti konop, ćapat, to pay out on the line puštati konop (kako se brod odmiče od obale / veza), pratiti konopom (brod koji se odmiče od obale), puštati konop (dok izlazi s palube ili vitla)**: *Using a drum end as a*

winch, and expecting the controller to react quickly enough to stop heaving or **pay out the line**, is highly dangerous. On the tug's bridge, the chief engineer was controlling the towing winch and he started to **pay out the tow rope** as he saw the tanker take up the slack in the messenger line. , **to pull the line on board vući (povući) konop na brod**: When the tug's mate saw that the vessel's mooring team were attempting to manually **pull the tow wire** up, he shouted up to them to stop and use the mooring winch instead. Knowing that the jammed tow line meant that the ship's crew would not be able to **pull the line on board** by hand, the mate went to the bridge door and shouted to them to heave the tow line using one of the ship's mooring winches, ... , **to put some weight / strain on the line malo zategnuti konok (toliko da nije labav)**, **to put the line on / to the winch prebaciti konop preko / na vitlo**, **to put a few turns of line on the winch** namotati konop nekoliko puta oko vitla, **to remove the slack on the line uvući (povući) konop (tako da nije labav)**, **to run the line through** provući / provrsti konop kroz, **to run the line out** izvući / izvlačiti konop (s palube, kroz oko), **to secure the line** pričvrstiti konop, **vezati konop**: ..., the sailor was able to **secure the line** and arrest drifting of the boat, **to send away the line** baciti / dobaciti konop (na obalu), **to slack away the line** popustiti konop, **laškat**: Slack away towing line. The sailor must be able to steer, paint, sew, scrub, polish, scrape, splice, drive a winch, keep a lockout, **slack away a backspring** and do a hundred other jobs. , **to slack off the line** popustiti konop, **to stopper off the line** osigurati (privezni) konop manjim / tanjim užetom, **bocat, bocavat**, **to stow the line** složiti / pospremiti konop, **to turn the line on / to** prebaciti konop preko (bitve, vitla), **to take the line on the bitts / winch** prebaciti konop preko bitve / vitla, **to unbend the line** odvezati konop (tanje uže od priveznog konopa), **odriješiti konop**, **to take up the slack on the line** potegnuti / napeti konop, **to heave away (on) the line** početi potezati, **mooring line** privezno uže, **privezni konop**: The officer on the aft mooring station passed a mooring line ashore, which then parted, and could have injured a crewman. , **breast line** bočno uže: The head line and **breast line** began to run out around the bitts, and the starboard anchor was let go. , **buoy line** uže za privezivanje na plutaču, **head line** pramčano uže, **provijera**: Then third mate proceeded to heave up a **head line** and the OS was asked to heave up the starboard **breast line**. , **heaving line** bacalo, **pandul**: The stern line was quickly secured, but the **head line heaving line** became snagged on an obstruction on the monobuoy's body. The ship's crew **threw a heaving line onto the tug's foredeck** and the tug's chief engineer made it fast to the messenger, which was attached to the tow line. , **stern line** krmeno uže: At about 1620, he walked towards the Panama chock to check the spring line, while an able seaman close by was preparing a **stern line** for the mooring tender. The **stern line** was quickly secured. The ship surged about 5 metres up the jetty, the remaining **stern line** parted and the ship's stern started to leave the quay. , **life line** sigurnosno uže, **uže za spašavanje**: He was holding on to the **life line**, so did not get injured. In an open life boat the **life line** gives support in an emergency right to the moment the boat takes to water. , **messenger line** uže (oko broda, brodice, pramca, krme) za hvatanje drugog užeta ili lanca, **mesinđer**: The carpenter had taken approximately eight to ten turns of the thick **messenger line** around the drum. A **messenger line** is recommended for handling these lines from the tug to the vessel's deck. , **spring line špring**: At that moment, the **spring line** held on the winch drum came under extraordinary load and parted at the Panama chock (Figure 3). , **tow line** teglo, **uže za tegljenje**: The **tow line** became taut and the mate, who was at the bridge controls, stopped the winch as he could no longer pay out the line. A tug approached stern to stern with the containership ready to **make fast a tow line** from her aft tow

winch, as was normal practice., **wire line** čelično uže, čelik-čelo, **sajla**

line³ (v) obložiti

line³ (n) (fishing) povraz, struna, **tunja**, **najlon** (za ribolov) **fluorcarbon line** fluorkarbonski povraz, **monofilament line** povraz od jedne niti, **monofil**

line³ (n) 1 (mar law, shipping econ) **brodarska linija**: Major damage to a **line ship** Involved in collision off China; 2 (mar law, shipping econ) **linijski brodar**: Despite 'early gains', **container lines** are in for another year of losses. **Maersk Line** has recorded a significant profit this year.; 3 (mar law, shipping econ) **brodska linija** (putnička)

line³ (n) 1 = **fishing line** povraz, **tunja**, **struna** a **panula** **fishing lines** **panule**: A **fishing line** has fouled our rudder obstructing the steering of the vessel.

line³ (n) (navy) **formacija ratnih brodova u brazdi**

line³ (n) (electr) **električni vod**, **kabel**

line³ (n) (marine eng) **cjevovod**, **vod** **main feed line** **glavni napojni cjevovod**: The pipe in the **main feed line** had burst., **starting air line** **cijev zraka za upućivanje**, **cjevovod zraka za upućivanje**: The heating generally occurs due to the passage of hot gases from the engine cylinder to the **starting air line**. The heating occurs due to the leakage of hot gases from the engine cylinder into the **starting air line** connected to the starting air rail

line³ (n) (nav arch, cargo handling) **cijev za tekući teret**, **teretni cjevovod**: Investigations may therefore be necessary to prove that the vessel's valves, **lines** and pumps are all in good order.

line³ (n) (nav arch) **brodska cijev**, **cijev brodskih cijevnih instalacija**

line³ (n) (shipping econ, mar law) **brodarsko društvo**, **brodarska kompanija** **the Line** **brodarsko društvo**, **brodarska kompanija**

linear strain /'liniə ,streɪn/ (n) (marine eng, nav arch) **linearna deformacija**

linear stress /'liniə ,stres/ (n) (marine eng, nav arch) **linearno naprezanje**

line boat (n) (nav arch) a large towboat is used to push from 5 to 40 barges in a tow **tegljač s tegljem**, **rječni tegalj**: A **line boat** and a work boat were then used to hold the vessel alongside. They failed to recognise risk of **line boat** got trapped between ship and quay, particularly with onshore wind or tide.

line dressing (n) (fishing) **opremanje povraza**, **tal. montaggio**: The new **line dressing** will further improve flotation, casting and durability also.

line fishing (n) (nav arch) **ribolov parangalom**, **ribolov povlačnim povrazima**: The anchor, which was used to hold bait for rod and **line fishing**, was proving very difficult to heave in. **long**

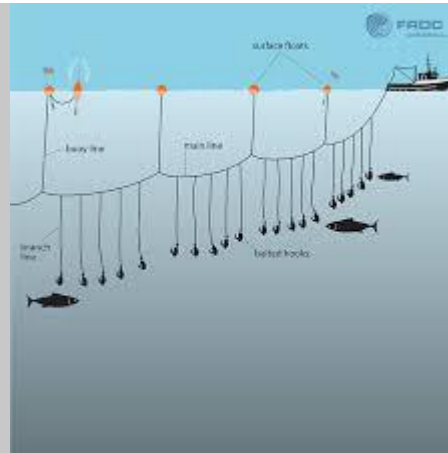

line fishing ribolov parangalom

line handlers (n) (navig) brodoprivezivači: The vast majority of seafarers do not readily appreciate the hazards faced by **line handlers** on the shore during berthing and unberthing operations.

line handling (n) 1 (seamanship) rukovanje konopima: He was more experienced at **line handling** than most of the other crew members.; 2 privezivanje / odvezivanje brodova

line haul (n) (shipping econ) marine portion of a vessel's route covering the greatest distance, usually across an ocean **prekomorski prijevoz**, **prekomorska brodska linija**

line hauler (n) (nav arch) vitlo: ... a large hopper was set into the deck beneath the **line hauler**.

lineman, linesman (US) privezivač: It was his intention to surge the rope while heaving so that just enough slack was given for the **linesman** on the quay to cast off, and the rope could then be retrieved smartly to keep the propellers clear. After signalling to the **linesman** to keep his hands clear, the bosun set the capstan to 'haul' with his left hand and attempted to surge the mooring rope using his other hand.

linen /'linin/ (n) (seamanship) posteljina, rublje

line of bearing (n) (navig) linija azimuta: One of a pair of unlighted structures is used to mark a definite **line of bearing**.

line of buoys (n) (navig) niz plutača, linija plutača: The channel is usually marked by a single or double **line of buoys** and sometimes by ranges.

line of business struka, vrsta posla: What is your **line of business**? Čime se bavite? Kojim poslom se bavite?

line of intersection crta / linija presjecanja

line of no variation (n) (navig) agonička linija, linija točaka bez varijacije

line of position (LOP) (n) (navig) The locus of points along which a ship's position must lie. A minimum of two LOPs are necessary to establish a fix. It is standard practice to use at least three LOPs when obtaining a fix, to guard against the possibility of and, in some cases, remove

ambiguity.(<http://www.sailingissues.com/navcourse4.html>) **stajnica**, **linija položaja**, **linija**

pozicije: The navigator then has enough information to plot the **line of position**. When **advancing a line of position**, consider course changes, speed changes, and set and drift between the two bearing lines. The PCD can cause **line of position errors** about 6 to 8 nautical miles. A long range medium frequency (1850 to 1950 kHz) radionavigation system by which a **hyperbolic line of position** of medium accuracy was

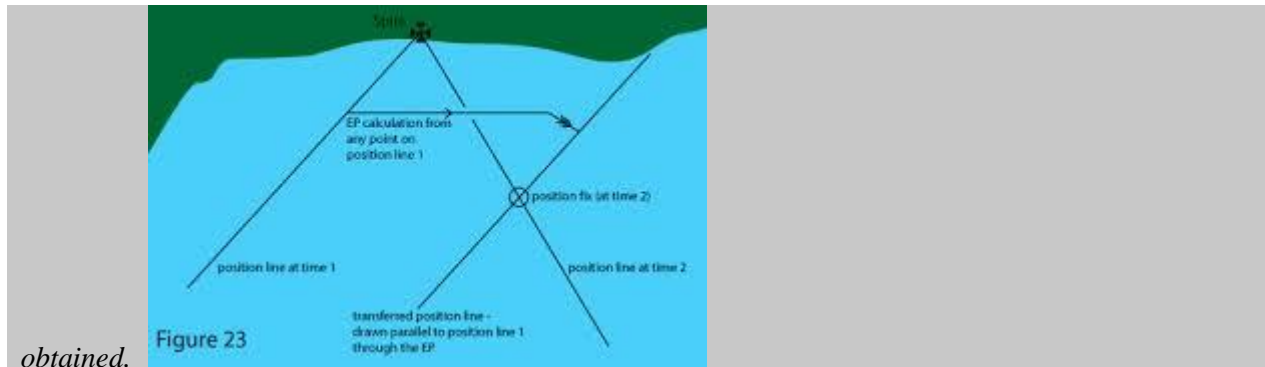

obtained.

line of throw (n) (marine eng) linija kretanja (stapa)

line operator (n) (shipping econ, mar law) linijski brodar, linijsko brodersko poduzeće

line pull (n) (seamanship) vlak, povlak užeta: All blocks are at their strongest when the strain is applied in a straight **line pull**. Bollards were once designed to take **line pull loads** of about 35 tons. Modern container ports usually have bollards with 100-ton **line pull capacities**.

liner /'laine/ (n) = **liner ship** (shipping econ) linijaš, linijski brod, brod linijske

plovidbe, brod redovite plovidbe: I was the bridge watchkeeper on a 9,000 grt **cargo liner**

belonging to a reputable company. Both ships were **container liners** and subject to extreme commercial pressure to maintain schedules and therefore reluctant to reduce speed. **Liners** operate on fixed routes.

cargo liner teretni linijski brod, linijski teretnjak: ... heavy or bulky cargoes are likely to be troublesome or impossible to carry for the ordinary **liner cargo vessel**. Own ship was a 10,000 ton **cargo**

liner on passage in the South Atlantic from the UK to South Africa. , **ocean liner prekoceanski**

linijaš, prekoceanski linijski brod: **Ocean liners** also usually have larger capacities for fuel, victuals, and other stores for consumption on long voyages, compared to dedicated cruise ships.

liner (n) (marine eng) košuljica, radna košuljica: Multi-level cylinder lubrication was adopted

to ensure sufficient lubrication of the **liner**. Gas sealing between **liner** and cylinder head is effected by an iron ring. **cylinder liner košuljica cilindra radna košuljica**: The piston and severely

distorted connecting rod were hanging from the **cylinder liner**. The **cylinder liner** features a high collar and drilled cooling channels. The **cylinder liner** is a one-piece casting and incorporates the

scavenge and exhaust ports in the lower and upper sections, respectiv, **dry liner košuljica**

smještena u cilindru na suho **suha košuljica**: Close contact between **dry liner** and casting is

absolutely necessary; if it is missing, considerable resistance to heat flow results. , **wet liner**

mokra košuljica In **wet liners** the water is in direct contact with outer surface of the liner whereas in

dry liners the water is in indirect contact with outer surface, **compression liner odstojni**

element, podložka, uložka, podložna pločica, liner wear trošenje košuljice: The

common rail on the engine. der liner., reduces carbon deposits on the edge of the piston crown and

reduces cylinder **liner wear**. , **liner wall stijenka košuljice cilindra**: While trying to avoid

corrosive wear by optimizing **liner wall temperatures**, it is necessary to keep as much water as

possible out of the cylinders. , **liner surface površina košuljice cilindra**: A uniform

temperature pattern over the entire **liner surface** is reportedly secured through intensive cooling by a

special water feed in its upper area. , **liner bore provrt košuljice**: The **liner bore** has tiny porous

spots which can retain lubricating oil. The upper part of the **liner bore**, where the top piston ring reaches

the top of its travel, suffers the greatest wear. , **liner cooling hlađenje košuljice cilindra**:

Various possibilities for securing load-dependent **cylinder liner cooling** have therefore been investigated. ,

liner running surface radna površina košuljice cilindra: The insulating tubes are adapted

according to the engine rating to ensure that the temperature of the **liner running surface** is kept above the dew point temperature of water over the full length of the stroke and over a wide load range., **liner lubrication podmazivanje košuljice cilindra**: The five-ring pack includes two compression rings while two spring-loaded scraper rings control lube oil consumption, their position in the upper part of the skirt facilitating easier **piston and liner lubrication.**, **bore-cooled liner hlađenje kroz radijalne kanale u košuljici**: Other refinements included a **bore-cooled cylinder liner** and a bevel-cut connecting rod allowing the crankpin diameter to be enlarged., **liner large bore liner košuljica širokog provrta**

liner (n) (navy) a major warship capable of taking its place in the main (battle) line of fighting ships
glavni brod (ratne formacije)

liner bill of lading (n) (mar law) **linijska teretnica**

liner company (n) (shipping econ) **linijsko trgovačko društvo, linijsko poduzeće**: ... all **liner companies** (which includes all major container and car-carrier companies) have their schedules on the internet.

liner conference (n) (shipping econ, mar law) = **shipping conference = freight conference** **vozarinski sporazumi brodara na istim prometnim ili plovidbenim pravcima linijska konferencija, vozarinska konferencija**

liner operation (n) (shipping econ) **linijska plovidba, linijski srevis**: Therefore, in **liner operation** the regular scheduled service is the basis of this particular type of ships, ...

liner operator (n) (shipping econ, mar law) **linijski brodar**: When accepting the booking of scrap shipments, **liner operators** must demand that the shipper declares the exact nature and contents of scrap in writing.

liner port (n) (shipping econ) **linijska luka**

liner service (n) (shipping econ) **Liner service** consists of regularly scheduled shipping operations on fixed routes **linijska plovidba, linijska služba, linijski servis**: General cargo vessels and multi-purpose vessel often **operate on liner services**. The ship sailed later the next morning, and being **on a liner service**, returned to the same port after six weeks. **On a liner service**, the ship operates to a schedule, it trades on a specific route between advertised load and discharge ports on a regular basis. Competition in **liner service** is regulated generally by agreements, known as conferences, among the shipowners. **In liner service** the service must be marketed, the cargoes documented, arrangements made for loading and discharging these cargo all of which fall under the heading

liner ship (n) (shipping econ) = **liner = cargo liner linijski brod** It would require hundreds of freight aircraft, many miles of rail cars, and fleets of trucks to carry the goods that can fit on one large **liner ship**. About 20 percent of **liner vessels** are ships other than container ships. **Liner ships** also include some car and truck carriers designed specifically to handle passenger vehicles and trucks, ...

liner shipment (n) (shipping econ) **linijska pošiljka**: Ad valorem freight is freight charged as a percentage of the value of a shipment, usually of high-value goods and is not normally used in voyage C/Ps, generally being confined to **liner shipments**.

liner shipping (n) 1 (shipping econ) **linijsko brodarstvo**; 2 (shipping econ) **linijski prijevoz**: **Liner shipping** is the most efficient mode of transport for goods.

liner terms (n) (mar law) **Liner terms** refer to the ordinary responsibility of the shipowner under a charterparty to control and pay for the loading, stowage, trimming and discharge of the cargo of the charterer. **Liner terms** are therefore to be contrasted with terms such as F.I.O., F.I.L.O., F.I.O.S. and F.I.O.S.T., which have the effect of transferring some of those responsibilities from the shipowner to the charterer. (Tetley) **linijski uvjeti**

liner trade (n) (mar law, shipping econ) **ANTONYM** tramp trade **linijska plovdba**:

.... container ships capable of conveying up to 15,000 containers or TEUs (twenty-foot equivalent units) with a speed up to 23 knots have appeared in many **liner cargo trades**. Agreements made for loading and discharging these cargo all of which fall under the heading of **Liner Trades**, which will be carried out either within the liner company or by independent Liner Agents. Container ships are mainly used in the **liner trade**. **In the liner trade** it is usual for the to present his B/L to the Carrier and receive in exchange a Delivery Order..

line runners (n) (mar law) **brodoprivezivači****line runner** (n) (ship handling) **privezivač, brodoprivezivač, lučki privezivač****lines drawing** (n) (nav arch) **nacrt linija**

line service **linijska plovdba, linijski servis**: On January 5, 1818, the full-rigged American ship James Monroe, of the Black Ball Line, sailed from New York City for Liverpool, inaugurating common-carrier **line service** on a dependable schedule.

linesmen (n) (mar law) **privezivači** The forward 64mm backspring was passed down to two **linesmen**. The **linesmen** will use shackles/lashings for securing mooring. The Pilot was immediately informed by the Master, and the **shore linesmen** were requested to return the rope tail with connecting shackle to the ship. Normally the officer will receive orders from bridge, relay them to **linesmen** and run back to tend to lines with the other crew. {sg. linesman}

linesplan; lines plan /'lainzplæn/ (n) (nav arch) **plan broda, nacrt broda u presjeku**

water lines horizontal cross-sections of the hull **vodne linije, vodene linije, ordinates**

evenly-spaced vertical sections in athwart (cross) direction **ordinate broda, buttocks uzdužnice**

broda, diagonals cross-sections of fore-and-aft planes that intersect with the waterlines and verticals

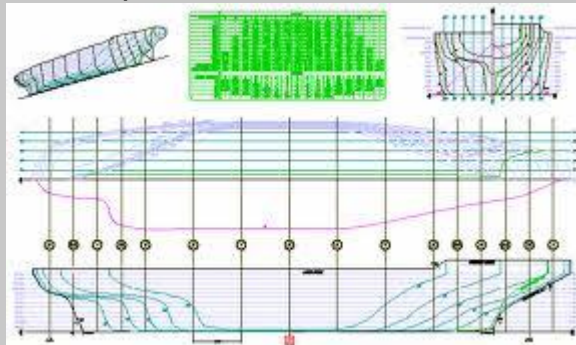

at a certain angle **dijagonale broda**

line squall (n) (meteorol) = **squall line** any non-frontal line or narrow band of active thunderstorms; **line squall** - a squall that occurs along a squall line. **olujna pruga, pruga maha, linija maha, redna oluja, kišna oluja (nastala iz reda tamnih oblaka -**

kumulonimbusa) Line squalls, especially in the tropics, can develop without warning and can turn very violent. About 10 minutes later a violent line squall descended on us with blinding flashes of lightning and deafening peals of thunder. The pilot and the port control were still trying to establish contact with the tug on the radio and with liberal use of the ship's air horn, **a violent line squall descended on us with blinding flashes of lightning and deafening peals of thunder.**



{Usually used to describe solid or broken lines of

strong or severe thunderstorms.}

linestopper (n) (boating/yachting) = clam cleat = cam cleat stoper (užeta)

line storm (n) (meteorol) ekvinokcijska oluja

line-throwing apparatus (n) (nav arch) = line throwing appliance naprava za bacanje konopa uređaj za izbacivanje užeta (za evakuaciju nastradalih s broda):

Lifeboats launched by gravity davits and aircraft ramps or slides have been developed. Other equipment involves rescue boats, lifejackets, lifebuoys, line-throwing apparatus, VHF (portable radio) transponders, and EPIRB transmitters, parachute signals, hand flares, smoke signals, etc. Muster lists, fire drills,



line throwing appliance (n) (safety) naprava za bacanje konopa: *Shortly afterwards, the line-throwing appliance was detonated.*

line-throwing device (n) (seamanship) = line throwing appliance naprava za bacanje konopa

line thunderstorm (n) (meteorol) redna grmljavinska oluja

line traffic (n) 1 (shipping econ) linijska plovidba; 2 (shipping econ) prijevoz robe i putnika linijskim brodovima

line trawler (n) (nav arch) kočar za ribolov s parangalima

line winch (n) (seamanship) vitlo za uže

line with (v) (marine eng) obložiti s nečim: *The main bearings are lined with white metal, and the thrust bearing is incorporated in the aft end of the bedplate. The main bearings consist of steel shells lined with white metal.*

lining /'lainiŋ/ (n) (marine eng) obloga, sloj obloge, podstava: *The brake lining had to be renewed as soon as possible as the brake may not have held.* bearing lining ležajna obloga: *Bearing shells have copper-lead lining and lead-tin plating.*

lining material (n) (marine eng) materijal za podlaganje (strojnih dijelova)

link (n) **1 veza**: To ensure the safe operation of each ship and to provide a **link** between the company and those on board, each company should designate a person ashore having direct access to the highest level of management. ; **2 (nav arch) karika (lanca), oko**

lanca, maja: Good seamanship dictates that the anchor cable should be clearly marked by paint and by turns of seizing wire secured around the relevant **link** adjacent to the joining shackle. **stud-link**

karika s prečkom: This chain is 112 metres in length and a combination of 76 mm and 54 mm **stud link chain** with suitably positioned triangular plates. This includes observing and reporting the condition of all moving parts, confirming the proper condition of cables and fittings, detection of twists in the cables, and cracks in **stud link welds**. , **studless link karika lanca bez prečke**: The shackles require a **studless endlink** at the chain-side, and fit the anchors crown-shackle. Chains consist of chain links which can be

either **stud-links** or **studless links**. , **weak link slaba karika**: The **weak link** had a 'D' shackle at each end, one passing through the eye of the hawser and the other passing through the first link of the chafe chain. The purpose of the **weak link** is to reduce the risk of the hawser parting when picking up/casting off the chain, which has an attendant hazard of whiplash. ; **3 (marine eng) spoj**: The link between the piston and the connecting or piston rod in four-stroke engines is the gudgeon pin, sometimes referred to as the wrist pin. Each individual fuel pump rack is connected to the mechanism by an **adjustable link** so they can be balanced to ensure that each cylinder takes its share of the load. Allen S12 engine in-line cylinder form unit mounted on the engine gearcase connected through a **collapsible link** to the fuel injection pump control shaft.

link (v) **spojiti, povezati**: the North Pacific route **linking** western America with Japan and China Attached to such lifting gear is a shackle which **links** the crane or derrick with the form of cargo-handling equipment being used. **link to spojiti na nešto, spojiti s nečim**: The 2/O had plotted the position of the buoys and channel limits into the basic radar mapping programme, **linked to** the GPS. When changing fuel types, some ships have experienced propulsion losses **linked to** procedural errors or fuel oil incompatibility.

linkage (n) **1 (nav arch) spoj, veza**: Pay particular attention to the **linkage between** the rudder stock **and** the wheel because, as was the case in this accident, disconnecting the two can be the only way the rudder becomes free; **2 (marine eng) spojka**: Subsequent operation of the controls resulted in sudden overloading of the hydraulic motor and sheared the **drive shaft linkage**. ; **3 zglobni spoj; 4 (marine eng) spoj**: This **engine's control linkage** was not fit for purpose. Correct fitting of the **governor linkage** is critical to the control of the engine, and incorrect fitment, on this occasion, is the likely cause of the engine failure.

linkspan (n) **(ports) hidraulična obalna rampa (za ro-ro brodove)**: The bow moved back towards the quay, but the vessel's stern then started to swing rapidly towards a number of small pleasure craft moored alongside a **ro-ro link span** on the north side of the basin. The vessel hit the quay, and then the **link span**, causing significant damage to both the ferry and the port facilities. He then continued manoeuvring astern to ensure the vessel's bow did not damage the berth or **link span**. was in the process of being raised, and had almost reached the fully stowed position when the lifting wire parted and the ramp fell back onto the **link span**. **lift the stern ramp off the linkspan** **podići krmenu rampu s hidraulične obalne rampe**: Despite the efforts of the tug, the stern moved off the quay, requiring the stern door to be lifted clear of the linkspan.



liquefaction /ˌlɪkwɪˈfækʃən/ (n) (cargo handling) ukapljenje, pretvaranje u tekućinu

Cargo trimming is a mandatory requirement for some cargoes, especially where there is a risk of the cargo shifting or where **liquefaction** could take place. It is recommended the cargo in all holds be trimmed in an attempt to minimise the risk of cargo shift. **vulnerable to liquefaction osjetljiv na**

ukapljivanje: Nickel ore, which is listed in the International Maritime Solid Bulk Cargoes Code (IMSBC) as a high-risk 'Group A' cargo, is particularly **vulnerable to liquefaction** and has earned the nickname as the world's most dangerous cargo due its role in several high-profile casualties.

liquefied cargo /ˌlɪkwɪfaɪd/ ukapljeni teret

liquefied natural gas carrier /ˌlɪkwɪfaɪd/ (=LNG carrier) brod za prijevoz



ukapljenih prirodnih plinova

liquefied petroleum gas /ˌlɪkwɪfaɪd/ (=LPG) (n) (marine eng) ukapljeni zemni plin, utekućeni zemni plin

liquefied petroleum / pressurized gas carrier /ˌlɪkwɪfaɪd/ (=LPG carrier) brod za prijevoz ukapljenih petrolejskih plinova



liquidation /ˌlɪkwɪˈdeɪʃən/ (n) (mar law) likvidacija (trgovačkoga društva), ukidanje (trgovačkoga društva) Shares in the shipping company dropped by more than a fifth to a record low, causing fears that the company will slide into **liquidation**

liquid bulk cargo (n) (cargo) tekući voluminozni tereti, tekući masovni teret (nafta, naftni proizvodi), tekući voluminozni tereti. The movement of **liquid bulk cargo**, crude oil and

derivatives, from the tanker is undertaken by means of pipelines connected to the shore-based storage tanks. {tekući tereti koji se prevoze u velikim, voluminuznim količinama, tj. u brodskim tankovima i kopnenim cjevovodima}

liquid cargo (n) (cargo) **tekući teret, tekući tereti (u velikim količinama)**: Liquid cargo is nowadays usually transferred using an articulated arm loading/discharge systems, and groups of arms are often found on a shore refineries ... In many cargo liners, refrigerated accommodation, together with deep tanks for liquid cargo, is provided. **liquid cargo tank tank za tekući teret**: The coating uses no toxic products and can be used to coat all liquid cargo tanks.

liquid fuel (n) (marine eng) **tekuće gorivo**: It appears that the foam would have been incapable of providing the necessary blanket to extinguish a liquid fuel fire. Viscosity will affect jerk-type injector pumps and injector operation since the liquid fuel is the operating medium. The low spontaneous ignition temperature of the liquid fuel leads first to ignition of the diesel fuel and then to ignition of the air-gas mixture.

liquid-in-glass thermometer (n) (marine eng) **stakleni termometar s tekućinom**

liquid separator (n) (marine eng) **odvajač tekućine**

liquefied gas carrier (=LPG carrier) (n) (nav arch) **brod za ukapljene plinove**:

Take forward a proposal to IACS on the development of unified requirements (URs) on sampling arrangements for liquefied gas carriers.

liquefied petroleum gas carrier (=LPG carrier) (n) (nav arch) **brod za ukapljene petrolejske plinove**: Own ship was a 49,000dwt LPG-carrier in ballast. A 10,000 tonne LPG carrier was alongside loading a cargo of ammonia when personnel on an adjacent jetty reported a strong smell of ammonia.

Lisbon Rules 1987 A set of rules on the assessment of damages in ship collisions (supra), prepared by the CMI and adopted at Lisbon in 1987. The Rules do not have the force of law, but are intended rather as guidelines for judges, arbitrators, insurers, average adjusters and others concerned with evaluating collision damages. (Tetley) **Lisabonska pravila 1987 (o procjeni šteta u sudarima)**

list (n) 1 (nav arch, navig) = **heel, COMPARE heel** the deviation of a vessel from the upright position due to bilging, shifting of cargo, or other cause **nagib (uslijed razmještaja ili pomicanja tereta), nagnuće**: Calculate the list caused by a transverse shift of weight and due to the single weight being loaded or discharged. At times, due to the uneven distribution of cargo in the holds, the vessel took a list to one side, and the ballast tank valves were appropriately controlled to keep the ship close to upright. Once hove-to, ballast water was added to reduce the list to about 10°. The master transferred some ballast from the starboard to the port wing tanks to correct the list. **correct the list ispraviti nagib, izravnati brod, develop a list**: The car carrier developed a severe list on Tuesday while underway in the Bay of Biscay on a voyage from Brazil to the port of Le Havre. **nagnuti se, list to port nagnuće u lijevo, nagnutost na lijevu stranu**: MV ... has dangerous list to port. Within two hours the list to port increased to 45° and then 90°. **list to starboard nagnuće u desno, nagnutost na desnu stranu**: MV ... has dangerous list to starboard. ... as the vessel approached the destination pier, she started to develop a list to starboard.; 2 **popis, lista**: The following list contains those items that, as a minimum, the relieving OOD must check prior to assuming the watch. {List is used to describe a ship that is inclined due to the distribution of forces within it.}

list (v) (navig) 1 **COMPARE heel** **nagnuti se (o brodu), nagibati se uslijed pomicanja ili krcanja tereta itd. (o brodu)**: The bulk carrier lists to its port side after taking on water in void spaces after running aground while transiting the Columbia River The vessel listed heavily in rough seas.; 2 **popisati, nabrojati**

listening watch (n) (comm, safety) **straža na radiopostaji** **continuous listening watch** stalna straža na radiopostaji

listening watch (n) (comm) **radijska straža (na VHF radiostanci), radiostraža** **maintain listening watch** držati radiostražu: *All vessels over 20m LOA must maintain a listening watch on channel 12 when in the area.* **continuous listening watch** stalna radijska straža: *A continuous listening watch is maintained on VHF Ch11 and 13, Ch11 being the primary channel for the co-ordination of shipping movements entering and leaving Portsmouth*

listing (n) (navig) **nagibanje, nagib**: *As a result of heavy weather conditions and adverse swell, the cargo in holds No 1 & 2 shifted, resulting in the vessel listing by 14 degrees starboard*

listing (adj) (safety) **nagnut, koji je nagnut**: *A four-man team from SMIT Salvage has successfully boarded the heavily listing car carrier in the Bay of Biscay in an attempt to attach a tow line to the drifting vessel.* 0

list of crew (n) **popis posade**

List of Light and Fog Signals (n) (navig, comm) **popis svjetlosnih signala i signala za maglu**

List of Lighthouses (n) (navig) **popis svjetionika**: *List of lighthouses in England includes lighthouses which are no longer in use as a light but are still standing. It also includes some of the harbour and pier-head lights around the country (Wiki) The lighthouses and lightvessels of Australia are listed in the National Geospatial-Intelligence Agency List of Lights publication.*

List of Lights (n) (navig) The Defense Mapping Agency Hydrographic/Topographic Center publishes the List of Lights, Radio Aids, and Fog Signals (usually referred to as the **List of Lights**, not to be confused with the Coast Guard's Light List). **popis svjetala**: *In addition to Admiralty charts or national charts, each ship must carry a number of publications such as Sailing Directions, updated Notices to Mariners, Tide tables, List of Lights, List of Radio Signals, Nautical Almanac, Pilots, etc. Those situated near the coast and visible from sea are listed in the List of Lights. Verify charted lights against the Light List or the List of Lights to confirm the charted information is correct.*

List of Radio Signals (n) (comm, navig) **popis radio signala Admiralty List of Radio Signals** **Admiralitetski popis radio signala**: *ADMIRALTY List of Radio Signals provides information on all aspects of Maritime Radio Communications, helping bridge crews to manage communications and comply with all reporting regulations throughout a voyage.*

<https://www.admiralty.co.uk/publications/publications-and-reference-guides/admiralty-list-of-radio-signals> {This volume includes: Listing of VHF Radio Direction-Finding Stations; Radar Beacons (Racons and Ramarks); Known operational Automatic Identification System (AIS); Aids to Navigation (AtoN); Radio beacons transmitting DGPS corrections; International Standard and Daylight Saving Times and Dates; International Radio Time Signal Broadcast details
(<https://www.admiralty.co.uk/publications/publications-and-reference-guides/admiralty-list-of-radio-signals>)}

Lists of Lights and Fog Signals (n) (navig, mar law) **popis svjetala i signala za maglu, popis svjetala i pomorskih navigacijskih oznaka Admiralty Lists of Lights and Fog Signals (UK)** ADMIRALTY Lists of Lights and Fog Signals provides coverage of over

70,000 light structures including lighthouses, lightships, lit floating marks, fog signals and other lights of navigational significance. **Popis svih navigacijskih svjetala i signala za maglu Britanskog Admiraliteta i Američke kartografske agencije (DMAHTC)**: *Each volume of List of Lights and Fog Signals offers: 1. Descriptions of the characteristics of lights and fog signals, together with the equivalent foreign language light descriptions, to help bridge crews with identification; 2. Tables to assist in the calculation of geographical and luminous ranges of lights; 3. Details for all lights listed including the international number, location and/or name, geographical position, characteristics and intensity, elevation in metres, range in sea miles and description of structure; 4. Published in 14*

regional volumes (A-P) for simplicity and ease of handling
<https://www.admiralty.co.uk/publications/publications-and-reference-guides/admiralty-list-of-lights-and-fog-signals>, **List of Lights and Fog Signals: (DMAHTC - Defense Mapping Agency Hydrographic/Topographic Center) (US) Popis navigacijskih svjetala, oznaka i signala za maglu Kartografske agencije Ministarstva obrane SAD: DMAHTC List of Lights, Radio Aids, and Fog Signals** The Defense Mapping Agency Hydrographic/Topographic Center publishes the List of Lights, Radio Aids, and Fog Signals (usually referred to as the **List of Lights**, not to be confused with the Coast Guard's Light List). {**Popis svjetala uključuje popis svjetionika, brodova-svjetionika, svjetlećih plutača, signala za maglu i drugih važnih signala.**}

lit (adj) (navig, safety) **upaljen (svjetlo)**: Around midnight, a long line of **weakly lit buoys** came into view, indicating the existence of drift nets. The crossing vessel's forward working and deck lights **were still lit**, such that her port sidelight was not easily seen and the tanker's bridge team was misled to assuming that the crossing vessel was at anchor. **the anchor light was not lit svjetlo nije svjetlilo**

Little Bear (n) (navig) **Mali Medvjed, Mala Kola**: the Phoenicians could plot a course by the recognition of certain stars (the constellation of **the Little Bear** and Polaris or the Pole Star).

live animals (n) (mar law, cargo) **životinje (u prijevozu), žive životinje**: The term goods includes **live animals**, and where the goods are consolidated in a container, pallet or similar article of transport, goods include such article of transport (Art 1). Goods include goods, wares, merchandise, and articles of every kind whatsoever except **live animals** and cargo which by contract is stated as being carried on deck and is so carried (Art I(c)).

live bait (n) (fishing) **živi mamac**: **Live bait** has its downsides. From the initial procurement to care and presentation, natural baits are a hassle, <http://www.berkeley-fishing.com/> What is the best way to rig your **live bait** so your catch won't get away?

live end of rope (n) (boating/yachting) **ANTONYM dead end** kraj užeta kojim se radi i koji je opterećen **živi kraj užeta živi kraj konopa, poteg**. **Live end** can also be called the 'running end', 'live end', or 'tag end'. Make sure the **live end of the rope** is not kinked at the point where it

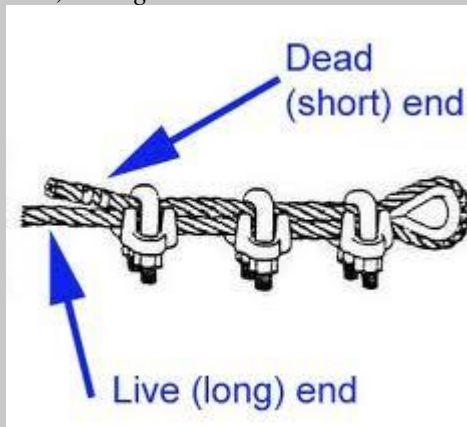

leaves the socket.

livestock /'laiv, stɒk/ (n) (cargo) **stoka (prijevozu)**: A ro-ro passenger vessel carrying **livestock vehicles** encountered heavy weather while on passage. After the vessel is cleared for loading, the chief officer and his team are busy preparing the vessel to receive the **livestock**.

livestock carrier (n) (nav arch) **brod za stoku, brod za prijevoz stoke**

living quarters (n) (nav arch) = **accommodation** :2 **stambene prostorije na**

brodu: No smoke leaks to the external decks and **living quarters** were detected. Due to the risk associated with explosives, it is important that they are stowed 'away from' **living quarters**. MV Becrux is the **largest livestock carrier** in the world with a carrying capacity of almost 60000 goats The **livestock carrier** is designed to carry a variety of animals, such as cattle, sheep, horses, pigs and goats, on a

medium-term charter.

Lloyd's open form (LOF) (n) (mar ins, safety, mar law) **Lloyd'sov standardni obrazac ugovora o spašavanju**: *The most common salvage contract is called a Lloyd's Open Form Salvage Contract*. **sign the Lloyd's open form (LOF)** **potpisati Lloyd'sov standardni obrazac ugovora o spašavanju**: *A Lloyd's open form (LOF) was signed in haste and salvage tugs were called for immediate assistance.*

Lloyd's Standard Form of Salvage Agreement (LOF 2000) (n) (mar law, mar ins, safety) **Lloyd'sov standardni obrazac ugovora o spašavanju**: *Lloyd's Standard Form of Salvage Agreement (Approved and Published by the Council of Lloyd's) PROCEDURAL RULES (pursuant to Clause I of LOF 2000) ...*

LNG carrier **An LNG carrier is a tank ship designed for transporting liquefied natural gas (LNG).**
brod za prijevoz ukapljenih plinova: *An LNG carrier is a tank ship designed for transporting liquefied natural gas (LNG).*

LNG-fuelled (adj) (marine eng, nav arch) **s pogonom na ukapljeni prirodni plin, koji se pokreće ukapljenim prirodnim plinom**: *Recent years have also seen the commissioning of double-ended ropax ferries, a coastal LNG carrier and small roro cargo ships with propulsion by LNG-fuelled Bergen gas engines from Rolls-Royce. DNV GL recently found that 63 LNG-fueled vessels were already operating globally with another 76 LNG-fueled ships being built.* **LNG-fuelled engine** (n) **brodski stroj s pogonom na ukapljeni prirodni plin, LNG-fuelled ship brod s pogonom na ukapljeni prirodni plin**

LNG fuel tank (n) (nav arch) **tank goriva na ukapljeni prirodni plin (LNG)**: *The design incorporates a unique LNG fuel tank positioned in an upright position in the foreship.*

LNG (liquefied natural gas) (n) (cargo) **ukapljeni prirodni plin**

LNG-powered (adj) (nav arch, marine eng) **pogonjen ukapljenim prirodnim plinom, s pogonom na ukapljeni prirodni plin**: *In 2015, NASSCO launched the world's first LNG-powered containership.* **LNG-powered vessel brod s pogonom na ukapljeni prirodni plin**: *Bigger, more capable, cleaner LNG-powered vessels will arrive, ...*

LO, L.O. (=lubricating oil) (n) (marine eng) **ulje za podmazivanje**: *Water cooled casings are necessary for turbochargers with ball and roller bearings with their own integral LO supply (to keep the LO cool). Older engines used a separate LO system for the camshaft because of the possibility of contamination by fuel oil leaking past the fuel pumps.*

LOA (=Length over All) (n) (nav arch) **dužina preko svega**: *All vessels in excess of 20 metres LOA entering the East Solent are required to report to Southampton VTS on VHF Channel 12 when 10 miles from Nab Tower. ... (b) T Jetty; No.1; 4x12 in. FMC loading arms for crude discharge or black product loading. If LOA is more than 200m. berthing only during daytime. (c) LPG Platform; No.1 ; 1x8 in. FMC loading arm for LPG, berthing only during daytime. All vessels over 40m LOA must have an operational radar to navigate in restricted visibility. {= Length over All}*

load /'ləʊd/ (n) **1 (cargo) = cargo teret**: *- Stand clear from moving crane boom and/or block even with no load. The bosun began to drive the trolley outboard ready to pick up the first load. The unusual direction of load on the aft suspension hook damaged the boat's stern, but there were no injuries.*

container load **1 kontejnerski teret; 2 teret u jednom kontejneru; 3 kontejnerska pošiljka, unit load jedinični teret, paletizirani teret; 2 (seamanship, ship handling)**

opterećenje: *Failure to observe basic seamanship practice – never stand directly under load. At a load of about 10 tonnes the sheaves were inspected for any structural change – none was found. Had they done so, they could have ensured that he approached the rope from the opposite direction, causing it to*

move away from him **when it came under load**. At a **load of** about 10 tonnes the sheaves were inspected for any structural change – none was found. Statistical evidence shows that in 53 per cent of all cases of personal injuries arising from mooring incidents, ropes (wire or fibre) have parted **under load** and personnel within 'snap-back zones' have been hit. **safe working load** 1 **sigurnosno opterećenje**; 2 **dozvoljeno opterećenje**: However, the combined weight of the tender and the coxswain put the arrangement close to its **Safe Working Load (SWL)**, **minimum breaking load**; **MBL minimalna sila pucanja (užeta itd.)**, **minimalno opterećenje kidanja (užeta itd.)**: Loads in any one mooring line should not exceed 55% of its Minimum Breaking Load (MBL), **release the load** **osloboditi opterećenje**, **popustiti opterećenje** e or in some other way so that in case of a breakage in towing line or loss of power/bollard pull in one of the vessels, the other vessel may quickly **release the load**, **ready to load** **bulk spreman za krcanje tereta (tekućeg ili rasutog)** Once the tanks reach about –140 °C the tanks **are ready to load bulk**, **load computer računalo za krcanje tereta**: Load computers are placed on vessels to assist officers in cargo operations.; 3 **(marine eng) opterećenje**, **pritisak**: Below 20 per cent load the engines can be run on HFO with a time limit. <tlCorpus><sentence>These blowers cut in and out as a function of scavenge air pressure and usually remain in operation **until the engine reaches 50 per cent load**.</source>New-Pounder</source></tlCorpus> **axial load** **aksijalno opterećenje** **osno opterećenje**: With this sort of arrangement there is **heavy axial loading** on the connecting rod which reaches its peak at the top dead center because the gas pressure and the inertial forces add to increase, **fatigue load** **opterećenje zamora**, **firing load** **opterećenje izgaranja**, **opterećenje ekspanzije**, **thermal load** **toplinsko opterećenje**, **termičko opterećenje** The symmetrical design of the rotating piston achieves **even distributions of thermal load** and wear around the piston., **tensile load** **vlačno opterećenje**, **transverse load** **poprečno opterećenje**, **apply a load** **opterećivati**, **removal of the load** **uklanjanje opterećenja**: the pressure gauge located at the windlass control showed that while a single pump generated about 50 bar, two pumps in tandem raised this to **130 bar under load**, **electrical load** **električno opterećenje** **električni naboj** Two diesel generators were sharing the **electrical load** and the engine speed had been reduced to 60 rpm so that the main engine was ready for any further required reductions of speed., **main engine load** **opterećenje glavnog stroja**: Vessel engineers did not reduce the **main engine load** further as that would have required change over from fuel to diesel oil. Pulsating compressor noise, typically registered at around 30–50 per cent **engine load**, can be an issue due to today's higher power outputs., **take off the load** **rasteretiti**, **skinuti opterećenje**: To begin work, **the engine was taken off load**, declutched from its gearbox and stopped from the machinery control room (MCR)., **bearing load** **opterećenje ležaja**: The special four-bolt design allows for an extra-large bearing which reduces **bearing load**, extends bearing life and improves crankshaft strength and stiffness.

load /'ləʊd/ 1 (v) **(cargo) krcati (teret na brod)**: The vessel berthed at the ore jetty at 0024 on 10 July 2002, to load a cargo of iron ore for Japan In line with this change the vessel was scheduled **to load** 1900 tonnes of animal feed wheat pellets. While discharging a cargo of grain in Egypt we received orders that our vessel should sail to a port in Africa **to load a cargo of Ammonium Nitrate** for Australia. In comparison to containerships, breakbulk ships take much longer **to load and unload**. The plan was for the vessel to berth starboard side alongside in readiness to **load cargo**. The vessel concerned was **loading a full cargo of propylene** in a NW European port. **load aboard ship** **ukrcati / krcati na brod**: On containerships, all loose cargo is packaged into containers and the container itself is **loaded aboard a vessel**, **load cargo** **krcati teret** **ukrcavati teret**: The vessel was alongside in port and **loading cargo** when the accident happened.; 2 **(marine eng) opteretiti**, **opterećivati**

load curve (n) (nav arch) kriviulja opterećenja

loaded leg (shipping econ) = **ballast leg** a subdivision of a ship's voyage during which the ship is carrying cargo **dio putovanja pod teretom, dio putovanja kada brod prevozi teret**. *The cargo piping and ballast piping are also completely separate. This eliminates the discharge of ballast contaminated with oil from the tank's cargo on the previous loaded leg.*

loaded passage (n) (shipping econ) **putovanje pod teretom**: A general cargo ship was on loaded passage in coastal waters, steering a course of 184 degrees (T) and making a speed of about 11.4 knots. Every day, during the **loaded passage**, the Levels (Ullage) and Temperatures (in case of heated cargo) of cargo shall be measured and recorded
<http://shipsbusiness.com/tanker-operation-laden-voyage.html>

loader (n) (cargo) **ukrcavač**: In preparation for loading cargo with a **shore loader**, all the ship's crane jibs were raised and swung clear of the hatchways. What is handling capacity of grain elevator/**ore loader**/... ? (IMO SMCP) The handling capacity of the grain elevator / ore loader / is (IMO SMCP)
side loader **bočni viličar**: Additional equipment: 1/50 t straddle crane, 1/ 35-45 t **side loader** and tugmasters for ro/ro trailers., **front loader** **čeonni viličar**, **ship loader** **brodougčavač (za rasute terete)**

loadicator (=loading indicator) (n) (stabil, cargo handling) **SEE loading**

instrument an approved stability instrument (loading software) capable of handling both intact and damage stability cases (<http://www.amc.gr/amcLoadingSoftware.htm>); uređaj koji registrira

svijanje na pojedinim točkama trupa broda te stabilnost broda; The requirement of loading instrument for bulk carriers is governed by SOLAS chapter XII, regulation 11. Even though there is no statutory requirement for loading computer onboard other ships, classification societies require all tankers of more than 100 meters to have type approved loading instrument. There are three main documents ship should have for it to be actually complying with Loadicator requirements. These are: 1. Class certificate for loadicator, 2. Class approved Loadicator Manual, 3. Class approved loadicator test conditions (<https://www.myseatime.com/blog/detail/compliance-with-loadicator-testing-and-its-records>)

računalni kalulator krcanja tereta i stabiliteta broda, lodikator, loadicator. 1. **Class certificate for loadicator**: This certificate is issued by the class and gives the details of the loadicator software as well as the hardware on which it is installed, including the details of the Make, model and serial number of the computer.

<https://www.myseatime.com/blog/detail/compliance-with-loadicator-testing-and-its-records> 2. **Class approved Loadicator Manual** is the user manual of the loadicator which is from the maker of the loadicator software. 3. **Class approved loadicator test conditions**: These are usually in the form of a booklet specifically titled "test conditions for loadicator" with class stamp. These are usually provided during yard delivery of the vessel or after the loadicator is installed for the first time and approved by the class. The class certificate for **loadicator** is issued by the class and gives the details of the loadicator software as well as the hardware on which it is installed, including the details of the make, model and serial number of the computer.

<https://www.myseatime.com/blog/detail/compliance-with-loadicator-testing-and-its-records> During annual class surveys, **loadicator** need to be tested for its accuracy in presence of a class surveyor.

<http://forums.marineinsight.com/forum/main-forum/1995-loadicator> The ship's loading instrument, e.g. a **loadicator**, is a ship specific onboard equipment and the results of the calculations are only applicable to the ship for which it has been approved. The Chief Officer needs to check all the resultant values (like GM, VCG, LCG, SF, BM) from the **loadicator** and compare it with approved test condition. CAMEL Loading software for Windows is a comprehensive Stress and Stability package, designed for containerships, bulkers, car carriers, tankers etc. The Loadicator is type approved by Det Norske Veritas (DNV) and other Classification Societies. The **loadicator** offers Damage Stability, Ballast Management and Autotrim options. http://www.aeoliki.co.uk/product_loading.htm The test procedure of the **loadicator** includes

choosing a text condition from the approved test conditions, entering the exact same data in the loadicator and comparing the results with the approved test conditions.



{The requirement of loading instrument for bulk carriers is governed by SOLAS chapter XII, regulation 11. Even though there is no statutory requirement for loading computer onboard other ships, classification societies require all tankers of more than 100 meters to have type approved loading instrument. There are three main documents ship should have for it to be actually complying with Loadicator requirements. These are: 1. Class certificate for loadicator, 2. Class approved Loadicator Manual, 3. Class approved loadicator test conditions (<https://www.myseatime.com/blog/detail/compliance-with-loadicator-testing-and-its-records>)}

loadicator manual (n) (cargo handling, stabil) the user manual of the loadicator which is from the maker of the loadicator software

loading /'ləʊdɪŋ/ (n) (cargo handling) krcanje (tereta), ukrcavanje (tereta), ukrcaj

(tereta): A chemical tanker was at anchor where her tanks were to be prepared for **loading** a new cargo of 50% sodium hydroxide solution, also known as caustic soda. The master therefore informed all parties concerned and **stopped the loading** by closing the hatches. Berth No. 3 Northern Jetty was used by the ship for **discharging and loading** chemical products. The accident happened because **deficiencies in the loading and securing** of the deck containers were spotted but not rectified before the ship sailed. It is the duty of the Master to inform the pilot of any special conditions, difficulties, or peculiarities whatsoever pertaining to vessel which might impose hazards in connection with the handling, berthing, unberthing, **loading or discharging** of the vessel. The chief officer is responsible for the safe handling, loading, stowage and carriage, including the custody of the cargo throughout the voyage. **commence loading**

započeti ukrcaj: After **loading commenced**, moorings were regularly tended to by ship's staff.

complete loading završiti ukrcaj: Narrative A fully pressurised gas carrier **had just completed loading** liquefied propane at an oil refinery. **completion of loading završetak**

ukrcaja: The pilot must be given 1 hour's notice before **completion of loading**. After **completion of loading**, a cargo surveyor boarded to take samples of the cargo. **loading/discharge**

ukrcaj/iskrcaj: Any place where a ship can safely lie alongside a quay, pier or dock, at anchor or a buoy, and where she can carry out **loading/discharge operations** or embark and disembark passengers is called a berth (vez, pristan). Prepare the vessel for **loading / discharging**. **cargo loading ukrcaj**

tereta: Cargo **loading** had stopped because the winds were gusting above the terminal's safety limits.

loading arm (n) (cargo) A **marine loading arm**, also known as a **mechanical loading arm**, loading arm, or mla is a device consisting of articulated steel pipes that connect a tankship such as an oil tanker or chemical tanker to a cargo terminal.

obalna dizalica s priključnom cijevi za krcanje nafte **zglobna ruka za krcanje tekućih tereta**, **mehanička ruka za ukrcaj/iskrcaj tekućih tereta**, **ruka za krcanje tekućih tereta**, **loading arm**: The use of loading arms, or articulated

pipe systems, to replace hoses is becoming increasingly popular, especially on bottom loading or unloading

operations. <https://www.loadtec.co.uk/hoses-versus-loading-arms/> *The **loading arm** and **hose** must be flanged oil-tight to the ship's manifold so that oil spills can be avoided. Liquid cargo is nowadays usually transferred using an articulated arm loading/discharge systems, and groups of **loading arms** are often found on a shore refineries or on offshore loading facilities. The **loading arm** will be out of service for some time, resulting in financial consequences for the terminal; Mainly used in the oil and gas industry, **loading arms** and **hoses** are storage tank equipment commonly used to transfer fuel or liquid. Nowadays, a **loading arm** is recommended suitably for tanker loading and unloading, it is seen as the safe, fast and easy way of operation especially in the terminals.*

<https://candnptreoleumequipment.wordpress.com/2015/10/01/loading-arms-versus-hoses/> *All **loading arms** are chiksans with quick connector couplings. **loading arm coupling spojka mehaničke ruke**, **ship's loading arm mehanička ruka za krcanje tekućih tereta**, **brodska dizalica za ukrcaj/iskrcaj nafte**, **terminal / shore loading arm obalna mehanička ruka**, **disconnect the loading arm isključiti spoj mehaničke ruke**: The personnel from the shore have disconnected the loading arms.*



loading berth (n) (ports) **ukrcajni vez**: *The ship moved away from the **loading berth** and started rolling. Two pilots were called to sail the loaded vessel and shift the smaller vessel onto the same **loading berth**.*

loading broker (n) (mar law) **agent-posrednik**, **agent koji posreduje pri ukrcaju tereta**

loading calculator (n) **1 kalkulator krcanja i slaganja tereta u kontejneru**: *The 3D Load Calculator is a tool where you can insert all the pieces you want to load in a container and see the optimal way to load it in a container;* **2 (cargo handling) kalkulator krcanja tereta i stabiliteta broda, lodikator**

loading computer (n) (cargo handling) **računalo za krcanje tereta i stabilitet broda**:

*The ship's **loading computer** was then used to check that the vessel was safe with the pump room flooded. In the **loading computer**, there is an ullage entry program where tank ullage tables, petroleum measurement tables are all interlinked with formulae. Ships were, at this stage, still supplied with **loading computers** that continued to calculate a ship's stability, shear forces, bending and, occasionally, torsion moments. Many of these functions are available only if the tank / draught level gauges and the Ballast Control system is interfaced to the **ShipLoad Loading Computer**. [https://www.km.kongsberg.com/Damage stability calculation by loading computers](https://www.km.kongsberg.com/Damage%20stability%20calculation%20by%20loading%20computers). Do you comply with Resolution MEPC.248(66)? <http://www.sateco.it/loadmaster>*

loading/discharge rates (n) (shipping econ) kapacitet ukrcaja i iskrcaja, brzina

ukrcaja i iskrcaja The loading programme should cover the order in which tanks are to be loaded/discharged, tank/pump/pipe work allocation and loading/discharge rates in order to minimise the stress on the vessel and the risk of cross-contamination of different grades of cargo.

loading hose (n) (cargo handling) COMPARE loading arm savitljiva cijev za

krcanje tekućih tereta, maniga, fleksibilna cijev za krcanje tekućih tereta: Loading arms and hoses are storage tank equipment commonly used to transfer fuel or liquid. Loading hoses are hardwall, flexible, lightweight hose and can be worn in ATEX areas. 2. 2. Used for suction and escape of oil with aromatic content up to 30%.

<https://candnpetroleumequipment.wordpress.com/2015/10/01/loading-arms-versus-hoses/>



loading instrument (=loadicator) (n) (cargo handling, stabil) A loading instrument is an instrument, which is either analogue or digital, by means of which it can be easily and quickly ascertained that, at specified read-out points, the still water bending moments, shear forces, and the still water torsional moments and lateral loads, where applicable, in any load or ballast condition will not exceed the specified permissible values.

(http://www.iaacs.org.uk/document/public/Publications/Resolution_changes/PDF/UR_S1_Rev7_pdf1322.pdf) ; a shipboard calculation tool which assists the ship's cargo officer in: 1. Planning and controlling cargo and ballasting operations; 2. Rapidly calculating SWSF and SWBM for any load condition.; 3. Identifying the imposed structural limits which are not to be exceeded.

(<http://marinegyaan.com/what-is-use-of-loadicator-or-loading-instruments-on-ships/>) ; a shipboard instrument to calculate trims, drafts, etc. **uređaj za izračunavanje i izradu plana krcanja,**

loadicator: The loading instrument may also be used to perform stability checks if it incorporates stability software. The loading instrument is to be checked for accuracy at regular intervals by the ship's Master by applying test loading conditions.

loading manual (n) (cargo handling, stabil) **priručnik za ukrcaj** The ship's approved loading manual provides a description of the operational loading conditions upon which the design of the hull structure has been based. The approved Loading Manual is to be based on the final data of the ship. The Manual is to include the design loading and ballast conditions upon which the approval of the hull scantlings is based.

loading master (n) (cargo handling) the marine transfer operator at the marine terminal who supervises the movement of petroleum products between tanker ships, barges, and the terminal while the vessel is berthed at the dock (https://en.wikipedia.org/wiki/Loading_master) **lučki nadzornik**

krcanja tereta / broda, lučki voditelj krcanja tereta / broda, nadzornik krcanja tereta / broda: Agent and Loading Master do not board before sailing, so no signatures are possible on 19 L or Letter of Protest. If inspectors or loading master are onboard at the time, get them to seal the samples, with

an accurate description of the contents. Normally a **loading master** or the pilot remains on board, once the vessel is moored, to co-ordinate communications between ship and terminal, as well as assessing weather. A short time later, the **loading master** again asked if the vessel was ready to load but still the lines were not cooled to the correct temperature.

loading operation (n) (cargo handling) Throughout the **loading operation**, the dock water density was consistently measured by the Chief Officer to be about 1.013. **opercija ukrcaja**:

Narrative A ro-ro vessel's late arrival in port had put her **loading operation** behind schedule: there was no time to lose. Before commencing **loading operations**, I always ensured that both stevedores and my deck crew understood the proper technique, ...

loading order (n) (mar law, shipping econ) pismeni nalog lučkom operateru za obavljanje rada koji izdaje korisnik lučkih usluga **dispozicija (ukrcaja)**, **nalog (ukrcaja)**

loading plan (n) (cargo handling) **plan krcanja**: There was no dangerous cargo in this area according to the **loading plans**. In accordance with the pre-arrival schedule and **loading plan**, extra ballast was being pumped out.

loading port (n) (cargo) **luka ukrcaja**: The vessel was en route to a **loading port**, when the chief engineer commenced routine maintenance of no. 1 auxiliary engine as per maintenance programme. ... a coastal LPG tanker was north-east bound in the Dover Strait Traffic Separation Scheme **enroute to its loading port** in Scotland. The terminal managers in the **loading port** did not consider the cargo to be hazardous, and the wet cargo was loaded in rain without trimming or measuring the cargo temperature.

loading rate (n) **ANTONYM unloading rate** (shipping econ, ports) **brzina ukrcaja (u tonama, koletima, broju kontejnera)**, **kapacitet ukrcaja**: The hourly **loading rate** was about 10,000 cu m/hr and six cargo tanks were receiving the cargo simultaneously: two tanks per connection. The initial **loading rate** of 120 m³hr⁻¹ was gradually increased to 250 m³hr. The **hourly loading rate** was about 10,000 cu m/hr and six cargo tanks were receiving the cargo simultaneously: two tanks per connection.

loading sequence (n) (cargo handling) **redosljed krcanja**: A few amendments were made to the loading and deballasting plan and a revised **loading sequence** was submitted. However, the master stated that he would only agree to continue loading after re-working the **loading sequence** based on the higher rate of loading now demanded.

loading terminal (n) (ports) **ukrcajni terminal u luci**: ... The SPM tower, located in position Lat. 29_06.90' N, Long. 048_19.30' E, approx. 1.5 n.m. east of the damaged **loading terminal**. The **loading terminal** numbers the tiers from the bottom of the hold upward including the containers on deck. The cargo stowage plan is prepared by the **loading terminal** after the ship has been loaded and is used to facilitate the subsequent loading and discharge of cargo at all ports along the voyage.

loading valve ventil za ukrcaj (tekućih tereta): In order to stagger the topping off process of the cargo tanks, the **cargo tank loading valves** had been adjusted to achieve the desired 'spread'.

load levelling device (n) (cargo handling) **uređaj za izravnavanje tereta**

load lifting magnet (n) (cargo handling) **magnet za dizanje (tereta)**

load line (n) (nav arch) **teretna linija**, **teretna crta**: A hydrostatic instrument installed in the side of a vessel, below the **light load line**, to indicate the depth to which a vessel is submerged. While discharging at an SBM, a VLCC was required by her owners to have the **Load Lines** changed, in order that the Class Surveyor could check and issue the new certificate on completion of discharge. **summer load line** **ljetna teretna linija**, **winter load line** **zimsko teretna linija**, **winter North Atlantic load line** **zimsko teretna linija za sjeverni Atlantski ocean**, **tropical load line** **tripska teretna linija**, **fresh water load line** **teretna linija za slatku vodu**, **tropical fresh water load line** **tripska teretna linija za slatku vodu**

load lines (*n*) (*nav arch, mar law*) Lines painted on the side of a ship, indicating the maximum depth to which the vessel may safely be loaded. See also the International Convention on Load Lines, adopted by IMO on April 5, 1966, which came into force July 21, 1968. (Tetley) **crte teretnih linija, teretne linije**: Each load line indicates the minimum freeboard that applies to the seasonal zone and/or area as stipulated in the *International Convention on Load Lines, 1966*

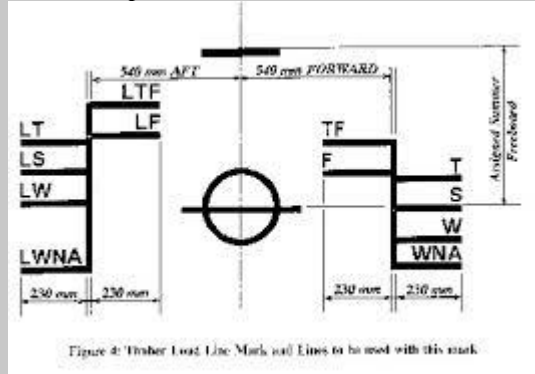

Load Lines Convention (*n*) (*nav arch, mar law*) **Konvencija o teretnim linijama**: Other conventions and amendments were also adopted, such as the *International Convention on Load Lines* (adopted 1966, came into force 1968), a convention on the tonnage measurement of ships (adopted 1969, came into force 1982), ... *The International Convention on Load Lines, 1966* (1966 LL Convention) was adopted by the International Conference on Load Lines on 5 April 1966 and entered into force on 21 July 1968. It has since been amended by means of Assembly resolutions and Protocol of 1988 as amended in 2003 (consolidated edition 2005) **LOADMASTER** - the leading loading computer made for onboard operation while checking longitudinal strength, intact stability and damage stability.

<http://www.ship-technology.com/contractors/computers/kockum-sonics/kockum-sonics1.html>

loadmaster (=load master) (*n*) **1** (*stabil, cargo handling, nav arch*) A load-calculator designed for a vessel approved by a classification bureau for the calculation of the vessels stability **računalo za krcanje tereta i stabilitet broda, kalkulator krcanja tereta i stabiliteta broda, kalkulator krcanja tereta, loadmaster**: **LOADMASTER** - the leading loading computer made for onboard operation while checking longitudinal strength, intact stability and damage stability.

<http://www.ship-technology.com/contractors/computers/kockum-sonics/kockum-sonics1.html>

LOADMASTER calculates damage stability using the Lost Buoyancy Method. By using the **Loadmaster damage generator**, Kockum Sonics can offer support on damage analysis in accordance with MARPOL, IBC or IGC Codes. <http://www.sateco.it/loadmaster> A summary of the calculation results is presented clearly on screen and the program's powerful functionality allows any of the cases to be selected for a detailed study, with the **damage survey report** generated for on- screen presentation as well as hard copy.

Loadmaster Damage Generator kalkulator svijanja (određenih točaka broda)

The screenshot displays the Loadmaster software interface with several key components:

- Ship Picture:** A schematic diagram of the ship's deck layout, showing the Main Deck, Upper Platform, Lower Platform, and Double Bottom.
- Calc. Results:** A summary of calculated parameters for condition 'Cond_D':

Displ	19841.4
DWT	13826.2
dtp	7.847
dm	8.889
dap	9.931
Heel	4.9p
Trim	2.08a
G'Mact0	1.59
SWDens	1.025
Ship	DAMAGE
- Stability Diagrams:** A graph showing the GZ Curve (GZ, m) versus Heel (deg) and Flood-Heel (deg). The curve shows a peak GZ of approximately 1.59 at a heel of 15.9 degrees. The weather criterion is also indicated.
- Cargo Tanks:** A table listing 15 cargo tanks with their respective liquid, product name, weight, gauge system, ullage, volume, and fill status.

Liquid	Product Name	Weight t	Gauge System	Ull/Inn obs. m	Ull/Inn corr. m	Vol. %	Volume m3	Fill
C24	1442.58	Manual_ull	0.793	98.0	1740.36			
C25	1440.79	Manual_ull	0.784	98.0	1738.20			
C26	1440.79	Manual_ull	0.779	98.0	1738.20			
C27	1442.58	Manual_ull	0.784	98.0	1740.36			
C28	1442.58	Manual_ull	0.769	98.0	1740.36			
C29	1440.79	Manual_ull	0.773	98.0	1738.20			
C30	977.99	Manual_ull	0.786	98.0	1179.96			
C31	972.81	Manual_ull	0.781	98.0	1173.62			
C32	209.84	Manual_ull	0.760	98.0	253.15			
- Damage Assessment:** A table detailing damage to various cargo tanks, including the type of damage, fixed volume, maximum volume, permeability factor, volume percentage, inner correction, and full name.

Dmg	Fix. Vol.	Max. Vol. m3	Perm. fact.	Vol. %	Inn. Corr. m	Volume m3	Full Name
C25		1782.82	0.950			1738.20	25 Cargo T.3 PS
TRUNK		1536.70	0.850				Center Trunk
B08		683.25	0.950			0.00	08 WB Wing T. SB
B09		626.91	0.950			0.00	09 WB Wing T. PS
C26		1782.83	0.950			1738.20	26 Cargo T.4 SB
C27		1785.07	0.950			1740.36	27 Cargo T.4 PS
B10		624.37	0.950			0.00	10 WB Wing T. SB
B11	<input checked="" type="checkbox"/>	680.71	0.950			537.17	11 WB Wing T. PS
C28	<input checked="" type="checkbox"/>	1785.07	0.950			1117.81	28 Cargo T.5 SB
C29	<input checked="" type="checkbox"/>	1782.90	0.950			1256.09	29 Cargo T.5 PS
C30		1210.20	0.950			1179.86	30 Cargo T.6 SB
C31		1203.76	0.950			1173.62	31 Cargo T.6 PS
B12		776.86	0.950			0.00	12 WB Wing T. SB
B13		750.36	0.950			0.00	13 WB Wing T. PS

Total: 15578 t in 15 tanks
3 damages, 2911 m3 flooded water

Loadmaster Damage Survey izvješće o točkama svijanja

Damage Results

Statutory Damages

Name	d...	dm	dap	Trim	Heel	G'Mact0	GZmax	GZRange	WFlood	FBmin	FBpos	FOpen
DC09	-1....	3....	7.802	9.13a	0.4s	14.16	3.61	54.0	235	6.19	-3.0	7.16
DC08p	-1....	3....	7.808	9.15a	0.4s	14.29	3.63	53.7	225	6.19	-3.0	7.15
DC02s	-1....	3....	7.718	8.76a	2.4s	12.00	3.21	53.8	580	5.81	-3.0	7.34
DC03s	-0....	3....	7.349	7.39a	3.0s	12.62	3.42	53.3	1675	6.07	-3.0	7.54
DC04s	-0....	3....	7.438	7.84a	2.7s	11.90	3.29	53.5	1174	6.03	-3.0	7.52
DC05s	0....	3....	7.265	7.13a	2.9s	12.40	3.42	53.4	1831	6.17	-3.0	7.63
DC05p	0....	3....	7.289	7.19a	2.2p	12.47	3.52	54.1	1795	6.33	-3.0	7.13
DC04p	-0....	3....	7.467	7.91a	2.0p	11.89	3.39	54.3	1129	6.19	-3.0	6.98
DC03p	-0....	3....	7.366	7.42a	2.2p	12.68	3.53	54.0	1651	6.23	-3.0	7.03
DC02p	-1....	3....	7.743	8.83a	1.6p	11.98	3.31	54.6	536	5.98	-3.0	6.77

Sort by :
 Position
 Name

Apply
Rename
Delete
Print Details

BFP
B1p
B2p
B3p
BTR
CHLKp
CHLKs

2 (cargo handling) = loading master A loadmaster is a position, i.e., the person in charge of loading and unloading the ship. **lučki nadzornik krcanja tereta / broda, lučki voditelj krcanja tereta / broda**

load on ship's construction (n) (nav arch) naprezanje brodske konstrukcije intact ship's load naprezanje brodske konstrukcije u neoštećenome stanju, damaged ship's load naprezanje brodske konstrukcije u oštećenome stanju

load on top (v) (safety) odvojiti ulje od balasne vode: *When the vessel arrived at the Loading Terminal and attempted to load on top, the cargo was not reaching the cargo tanks. The vessel was carrying a cargo of sawn timber and, at the time of the accident, shore stevedores were discharging the timber loaded on top of the forward hatch cover.*

load port (=loadport; loading port) (shipping econ) luka ukrcaja: *As the vessel anchored off the load port, awaiting berth, the cleaning of 3 and 4 holds was in progress. The vessel had loaded a cargo of timber and departed her load port earlier that evening.*

load slinging equipment (n) (cargo handling) hvataljke za teret

loads on a ship (n) (nav arch) sile koje djeluju na brod: *The loads on a ship structure include static loads (weight of structure, sea pressure, tank pressure, etc.), dynamic loads (forces arising from the ship's motions), sloshing loads (forces due to the motion of liquids within tanks), and impact loads (e.g. wave impact loads and bow slamming).*

load-test (n) (marine eng, nav arch) ispitivanje opterećenja, test opterećenja: *During the*

load-test of the rescue boat launching appliance, the three point lifting sling failed. To perform the **load test** we use modern water bags placed in the lifeboat, as well as using other specific water bags to carry out the test directly from the davits.

load water line (n) (nav arch) **teretna vodna linija, teretna vodena linija, vodena linija pod punim teretom, konstruktivna vodena linija**: Sounding pipes extending above the load water-line are fitted in each compartment and ballast tank.

Lo and behold! (interj) (archaic) **Gle čuda!**

lobe /ləʊb/ **1** (marine eng) **režanj, reska**: Each CR fuel pump is driven by a **two-lobe cam**, whose pumping profile can be considerably slower than the conventional jerk pump type that it replaces.; **2** (marine eng) **krilo, krilce rotary lobe pump rotaciona pumpa s krilcima**

lobe /ləʊb/ (n) (navig) **latica (radarskog snopa), lepeza (radarskih valova)**: With radar waves being propagated in the vicinity of the surface of the sea, **the main lobe of the radar beam** is composed of a number of separate lobes, as opposed to the single lobe-shaped pattern of radiation as emitted in free space. **main lobe glavna latica, glavna lepeza, side lobes sekundarne latice bočne lepeze**

lobe pump (n) (marine eng) **pumpa s krilcima, pumpas dva krilasta rotora**

lobe switching (n) (navig) **prespajanje s jedne latice radarskog snopa na drugu**

lobster (n) (fishing) **COMPARE European lobster** lat. *Palinurus elephas*; *Palinurus vulgaris*; **jastog common slimy lobster jastog, common spiny lobster jastog** (drugi hrv. nazivi: **angust, jarulica, jastof, pastov, prug, ragosta**)

locate /ləʊ'keɪt/ (v) **locirati, smjestiti, odrediti mjesto, postaviti, pronaći mjesto**: the leak was **located** in ... mjesto (pro)puštanja bilo je otkriveno na / u ... **Lacking any of this information, locate a channel or safe route delineated on the chart and plot the vessel's track through the channel.**

location /ləʊ'keɪʃən/ (n) **položaj, lokacija, smještaj, mjesto**: From his **location** across the full width of the ship, the deck officer had no view of the quayside, and was relying on and responding to hand signals from an A/B station. The Chief Officer shall prepare a copy of the dangerous cargo stowage plan (**indicating DG class & location**) along with a dangerous cargo list (**indicating Location, Container number, DG class and UN number**), and ... **provide location smjestiti, osigurati mjesto**

lock /lɒk/ (n) **1** (navig) **ustava**: The U.S. Coast Guard reported late Thursday that the vessel remained **in the lock** in Massena, New York, where the water was drained as response crews removed injured passengers. A 286-foot cruise ship hit a wall in the **Eisenhower Lock** in the Saint Lawrence Seaway Thursday night, injuring several passengers. The new world's largest **lock** was opened for business at the Port of Antwerp on Friday. The Kieldrecht **lock** measures 68m wide, 500m long and 17.8m deep **lock gate brana ustave, vrata ustave**: Like the Neopanamax locks in the Panama Canal the Kieldrecht lock in Antwerp uses **rolling gates** to form watertight the lock chambers.



; **2** (n) **brava**

locker (n) (nav arch, cargo handling) parts of the holds for cargoes of special value. They can be locked against pilfering. **loker**, **malo spremište s bravom** **chain locker spremište sidrenog lanca**, **prostor za lance**: *The last length of chain had broken loose from the **chain locker**, and the AB was hit and fatally injured by the bitter end.*

locking pintle (n) (nav arch) **štenac kormila**: *The top or **locking pintle** prevents any vertical movement of the rudder.*

locking screw (n) (marine eng) **pričvrtni vijak**, **zaporni vijak** **locking screw handle kolo pričvrtnog vijka (tlačni gorionik)**

lock nut (n) **1** (nav arch) **matica propelera**; **2** (marine eng) **protumatica**, **tal. controdado**

lock out (n) (mar law, shipping econ) **obustava rada (u luci)**, **masovno isključivanje radnika s posla**: *The **lockout** means no commercial activity for the port until further notice – except for the grain silos, run by the port authority itself.*

<http://www.cbc.ca/news/canada/montreal/port-of-montreal-shut-down-by-lockout-1.877337> *The longshoremen were notified of the association's move late Sunday evening, and were on picket lines early Monday morning in advance of the 8 a.m. **lockout deadline**. The agents also said the **lockout** is costing the port millions of dollars, with containers still waiting to be unloaded.*

<http://www.cbc.ca/news/canada/montreal/port-of-montreal-shut-down-by-lockout-1.877337>

lock up (v) **zatvoriti**, **zaključati**

lock up (n) (nav arch, cargo handling) = **locker** **loker**

lodge a complaint (v) (mar law, shipping econ) **reklamirati**, **podnijeti pritužbu**,

podnijeti reklamaciju: *The crew members **lodged a complaint** with the Police Headquarters at a West African port as the vessel was at an anchorage and a Doctor was not called to see the deceased.*

lodge the Bill of Lading (with) /lɒdʒ/ (v) (mar law) **predati (nekome) teretnicu**: *The note is signed by the wharfinger and returned to the shipper, or his representative, **who then lodges bills of lading with** the shipowner or agent.*

lodge the Note of Sea Protest /lɒdʒ/ (v) (mar law) **podnijeti prijavu pomorske**

nezgode: *Lodge a sea protest at your first available port of call and make sure a log extract, showing relevant entries, is attached.*

lodging knees (n) (sailing vessels) **horizontalna koljena oko grotla**

LOF 2000 (Lloyd's Open Form) = Lloyd's Standard Form of Salvage

Agreement (LOF 2000) A form of salvage contract approved and published by the Council of Lloyd's to replace, as of September 1, 2000, the previous Lloyd's Standard Form Salvage Agreement (LOF 1995). The acronym LOF derives from the former name of the Agreement (Lloyd's Open Form). LOF 2000 provides for salvage services to be rendered on the principle of no cure - no pay (infra), subject, however, to the provisions of the Salvage Convention 1989 (infra) relating to special compensation (infra) and to the SCOPIC Clause (Tetley) **Lloyd'ov standardni obrazac**

ugovora o spašavanju: *Improving the understanding of **LOF** is an area on which both the International Salvage Union and Lloyd's intend to campaign. **Lloyd's Open Form (LOF)** is still the most widely used salvage contract, even after over a century of constant use.*

log /lɒg/ (n) (cargo) **trupac**, **log**: *About 250 tonnes of the **logs** were stowed on deck. A gang of stevedores commenced loading the vessel, skillfully standing atop the floating logs and slinging them in ones or twos, depending on the size of the **logs** and capacity of the ship's cargo gear. The holds were duly filled with **logs** and the vessel berthed at a wharf to load the sawn timber and plywood in the tween decks and the containers on the hatch cover.*

log /lɒk/ (n) (navig) device for measuring the ship's speed and progress **brzinomjer, log tal.**

solcometro: A **log** consisting of a rotator towed through the water by a braided log line attached to a distance-registering device usually secured at the taffrail. The true motion radar requires own ship's speed input, either **log** or manual, in addition to own ship's course input. However, the following observations were made: The radar was stabilised with GPS instead of speed over water from the **log**. The propeller wash was not seen but **the log showed** about 0.5 kts stern way. **speed log brzinomjer, log calibration baždarenje brzinomjera, kalibriranje brzinomjera, common log brzinomjer, patent log patentni log, mehanički brzinomjer na propeller, Walker's Cherub log mehanički brzinomjer, electronic log elektronički brzinomjer, electromagnetic speed log elektromagnetski brzinomjer.** An **electromagnetic log** consists of suitable registering devices and an electromagnetic sensing element, extended below the hull of a vessel, ..., **hydrodynamic speed log hidrodinamički brzinomjer, ultrasonic speed log ultrazvučni brzinomjer, log error grješka brzinomjera, log readings očitavanje vrijednosti brzinomjera, očitavanje brzine** ..., but an increase in power on engine indicators, an increase in current reading from 2.2kts to 3.2kts, and a **Doppler log reading** of 4.5kts were all immediately observed. , **Doppler log ultrazvučni brzinomjer:** It was assumed, wrongly as it turned out, that in shallow water the **Doppler Log** goes automatically into ground tracking mode and gives speed over the ground.

log /lɒg/ (=log book) (n) (mar law, navig) A record book carried aboard a ship in which all significant events relating to the journey are recorded by the ship's officers authorized to make such entries. A ship may have aboard more than one log, including an official log, an engine room log, a radio log, a rough log, etc. The log is at time prima facie evidence in a maritime dispute (Tetley) **dnevnik (brodski, palube itd.):** It cannot be overemphasized that clear and properly annotated echograms and **navigation logs** are especially important in shoal reports. On very large ships, such as VLCCs, some guidance may be available from reliable **doppler logs**, but on many ships a **doppler log** is not available. Like time-delay measuring logs, **Doppler logs** can only track the seabed in relatively shallow waters. **Modern logs** use electronic sensors or spinning devices that induce small electric fields proportional to a vessel's speed. **keep a log voditi dnevnik voditi brodski dnevnik:** As a part of engine room watchkeeping routine, marine engineers are required to **keep a log** of all important machinery parameters such as pressure, temperatures, revolutions etc., **ship's log brodski dnevnik** There, he noticed the **ship's log** indicated the vessel had stopped, so he reduced the pitch on the Controllable Pitch Propeller to zero, and called the master. , **engine room log dnevnik stroja:** Engine room log book is also an important document in case of accident and this gives the clear picture of the engine room working condition and... marine engineers are required to **keep a log** of all important machinery parameters such as pressure, temperatures, revolutions etc. in the **engine room log book.** **engine movement log dnevnik zapovijedi stroju:** It is important that the status of the main engine machinery conforms to the status recorded in the **engine movement log** and machinery state boards to enable everyone involved in an operation to maintain a clear understanding. , **medical log zdravstveni dnevnik, radio log dnevnik radio-službe:** Regarding the (written) **Radio Log:** under GMDSS regulations, vessels are required to log a summary of Distress (Mayday), Urgency (Pan Pan) and Safety (Securité) traffic. He also has to make entry in the **Radio Log** with timings, so he will use a small source of light and lose his night vision for a few minutes every time he uses a light. , **scrap log koncept dnevnika, neslužbena / radna verzija dnevnika, škartafac, make a log ubilježiti u dnevnik:** Make a log of all important events, **deck log dnevnik palube:** At about the same time, he recorded the visibility in the **deck log**, which he assessed to be about 2 miles in light snow. The **deck log** combined with the bearing log should constitute a complete record of the

passage. All events when encountering heavy weather must be carefully and duly entered in the *ship's or deck log book*. **periodic log upis manovre (upisnik naredaba stroju), bridge log dnevnik zapovjedničkog mosta**: Record all events and information in the *bridge log book* correctly. **log entry zapis u dnevniku, bilješka u dnevniku**: In *deck log book* all the entries regarding navigation and charts are mentioned. Whilst not reducing the level of own-vessel business/crew communications, the following should help reduce the number of unnecessary (false) alerts/**log entries** onboard all vessels: **make a false log unijeti krivu zabilješku / zapis**: I have personal knowledge of a similar ballasting error where the Master, in an attempt to hide the mistake from authorities, actually **made false log book entries**. **log readings zapisi u dnevniku, podaci u dnevniku**: He should verify the current operational parameters and the condition of all machinery and see if these correspond to the **log readings**. **electronic log elektronički dnevnik, dnevnik vođen elektroničkim putem**: ... with the increasing use of computers on ships, the daily log books might be totally replaced with **electronic log books**, but currently paper books are in popular use. **official log službeni brodski dnevnik, glavni brodski dnevnik**: The **official log book** is only for the official entries made by only captain and chief engineer about the crew and their behaviour. **position log navigacijski dnevnik, dnevnik pozicija broda**: • Check the **Position Log** and Chart: Check the type and accuracy of the ship's last fix. **fill up the log ispuniti brodski dnevnik, fill in the log ispuniti brodski dnevnik**: The regulations require that a lookout is kept from sunset to sunrise but this is not done in most cases despite **filling in the log books** to that effect.

log /lɒg/ (v) **1 (safety, shipping econ, navig, mar law) unijeti u brodski dnevnik, ubilježiti u dnevnik**: All operations undertaken during loading and discharge should be logged by the ship including details of all valve positions, changes in valve usage, pumping rates, manifold pressures and vessel's draught and trim. ... the Master's license was suspended for one year for failing to reduce speed to investigate, call the RCC, and **log the event**. The quartermaster should **log the change of watch** in the ship's deck log. The helmsman and Second Officer followed the instructions of the Master and Pilot, monitoring and **logging** the vessel's progress, however, the Second Officer was not involved with monitoring radar targets, this function being carried out by the Master and .. dar observations for position fixing, while the bow lookouts reported the sighting of channel buoys as the vessel passed, with a 'bridge-team' member **logging the time, ship's head, and speed** from GPS in the Bell Book. **log the bridge equipment upisati podatke o opremi na mostu u dnevnik, log the time abeam of prominent landmarks and navigation aids ubilježiti vrijeme kada je brod bio subočice istaknutim kopnenim oznakama i plovidbenim oznakama; 2 zabilježiti, registrirati**

log book (=logbook; log) (n) (navig, mar law) brodski dnevnik, tal. giornale di bordo: It is to note that a **log book** is not just for filling records but also to be used as a reference to study previous data of machinery parameters and... * Carefully preserve all samples, records, evidence, communication logs and make detailed **log book entries** of all events. Even temporary memo notes, placards etc on the console, exit door, **log book** may be of great value. **engine log book dnevnik stroja, deck log book dnevnik palube, keep a log book voditi dnevnik**

log carrier (n) (nav arch) brod za trupce, brod za prijevoz trupaca: A general cargo-cum-**log carrier** in ballast was approaching the pilot station to embark the inward pilot.

logger (n) (boating/yachting) jedrenjak s dva jarbola, izvorno s oglavnim jedrima loger

logging (n) bilježenje, unošenje u dnevnik data logging bilježenje podataka

log grab (n) (cargo handling) hvataljka za trupce

logical shore stations (n) (navig) **logičke obalne stanice u sustavu AIS**

logistics /ləˈdʒɪstɪks/ (n) **1 (shipping econ)** The management of freight and information throughout the total supply chain from the original raw material source to the ultimate consumer of the finished product, encompassing factories, assembly and packing plants, warehouses, distribution centres and retail outlets. (<http://www.maerskline.com/en-jm/help/shipping-glossary>) **logisika**

(pomorskog prijevoza): Mr. leads the transportation and **logistics** practice at the company. the company provides marine transportation, offshore support services, port management and **logistics services** ILMI also offers an Associate of Applied Science degree in **Logistics and Operations Management** which focuses on all modes of transportation. ; **2 (marine eng) logistička podrška:** Wärtsilä notes that whichever system of injecting water is applied, consideration must be given to the **logistics** of providing sufficient freshwater onboard.

log reading (n) (navig) **podaci iz brzinomjera, očitavanja s loga:**, but an increase in power on engine indicators, an increase in current reading from 2.2kts to 3.2kts, and a **Doppler log reading** of 4.5kts were all immediately observed. A visual sighting of the clump weight wires showed it to be streamed astern, ...

log vessel (n) (nav arch) **brod za prijevoz trupaca:** On one of our **log vessels**, the stevedores started entering a full cargo hold immediately it was opened for discharge.

loll (n) (stabil) **naginjanje (broda):** Consequently the vessel stopped rolling and remained listed on her starboard side, and this alerted the skipper to the **angle of loll** developing. Ships' officers should have a thorough knowledge of stability, particularly the difference between a static list and **angle of loll** caused by free surface and the appropriate ballasting measures to adopt **angle of loll kut naginjanja:** Soon after leaving the port, the cargo liquefied, forming a free surface and causing a severe

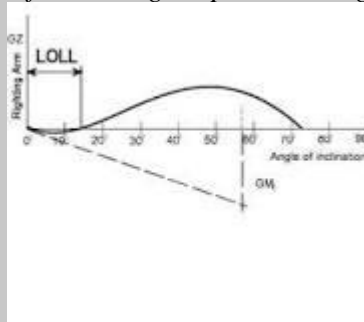

list (angle of loll).

loll (v) (stabil) **nagibati, nagibati se:** The vessel began to list, or possibly **loll**, to one side and the skipper, realising the danger the vessel was in, broadcast a "Mayday" on VHF channel 16. The boat started taking on water over its bow and sides, which then accumulated on the deck and caused the boat to **loll to port**.

lolling (n) (ship handling, nav arch) **promjene kuta nagiba broda:** This change in list, called **lolling** was often 5 degrees or more, which caused havoc with loading arms, hoses, and mooring lines. For a tanker of this size, the stable condition after listing would normally be less than 5 degrees if **lolling** was the only contributory factor.

lo-lo (lift-on/lift-off) system /ləʊləʊ/ **sustav vertikalne manipulacije tereta, ukrcaj i iskrcaj tereta**

lo-lo ship (n) **1 (nav arch) = lift on/lift off = geared ship COMPARE ro-ro ship** ship that uses a crane to load the cargo ; cargo ship with on-board cranes to load and unload cargo, applying vertical loadin and unloading operation **brod s klasičnim dizalicama za teret, brod za vertikalne operacije s teretom, teretni brod ; 2 (nav arch) kontejnerski brod**

long blast (n) (comm, navig) **dugi znak, dugi zvižduk, dugi zvučni signal:** At 0430 the 1st

vessel was heard giving one **long blast** and passed ahead without observation. **sound a long blast dati dugi zvučni signal, dati dugi zvižduk (brodskom sirenom):** He then **sounded one long blast** on the ship's whistle. Unclear as to the cargo vessel's intentions, the Master of the tug **sounded one short and one long blast** on the whistle to alert his crew, then reversed engines to stop and let the cargo vessel cross ahead.

longitude /'lɒndʒi,tju:d; 'lɒŋgi,tju:d/ (n) (geogr) **geografska dužina** **angle of longitude kut geografske dužine, measure the longitude mjeriti geografsku dužinu, difference of longitude razlika geografske dužine**

longitudinal /'lɒndʒi,tju:dinəl; 'lɒŋgi,tju:dinəl/ (adj) **1 (nav arch) SEE structural components** **ukrepi element uzdužno postavljen na limove; a fore and aft strength member of a ship's structure; the fore-and-aft girders in the bottom of a ship** **uzdužnjak deck longitudinal uzdužnjak palube, side longitudinal uzdužnjak boka, bottom longitudinal uzdužnjak dna, inner bottom longitudinal uzdužnjak pokrova dvodna, longitudinal of bilge tank uzdužnjak uzvojnog tanka**

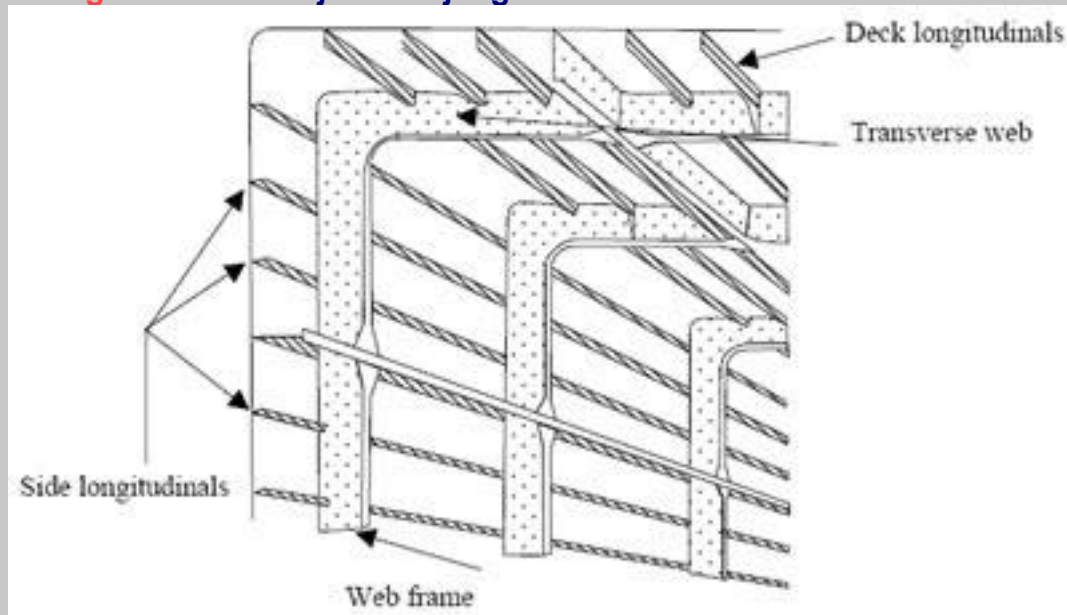

; 2 uzdužni

lim

longitudinal load (n) (nav arch) **naprezanje brodske konstrukcije u uzdužnome smjeru** **uzdužno naprezanje**

longitudinal metacentre; ML (n) (stabil) **uzdužni metacentar:** LM is located where the force of buoyancy's lines of action running through the longitudinal center of buoyancy intersect the vertical line through the center of buoyancy of the untrimmed ship.

longitudinal section /,lɒndʒi'tju:dinəl; ,lɒŋgi'tju:dinəl/ (n) (nav arch) **uzdužni presjek**

longitudinal ship's stability (n) (nav arch) **uzdužna stabilnost broda**

longitudinal stability (n) (nav arch) **COMPARE transverse stability** the measure of a ship's ability to return to its original position after being disturbed by a force that rotates it around a transverse axis **uzdužna stabilnost** **arm of longitudinal stability** **poluga uzdužne stabilnosti** **poluga trima**

longitudinal-transverse load (n) (nav arch) **uzdužnopoprječno naprezanje**

long-line fishing boat (n) (fishing) **brod za ribolov parangalima**

longlining (n) (fishing) **ribolov dugačkim parangalima**: In longlining the lines are commonly between 10-100km long, and have thousands of baited hooks spaced consistently on branching lines (snoods). **pelagic longlining ribolov pučinskim parangalima**



1. the main line 2. baited hooks on branching lines also known as snoods 3. bycatch can be a problem with longlining 4. floats

demersal longlining ribolov pridnenim

parangalima

long passage (n) (navig) **dugotrajna plovidba**

long range identification and tracking (n) (navig, safety) **sustav praćenja i identifikacije brodova**

long sea (n) (oceanogr) **dugi valovi**

longshoreman, (pl.) longshoremen /'bŋ,ʃɔ:mən/ (n) **1 (US, shipping econ) =**

stevedores Dock workers who load and unload ships, or perform administrative tasks associated with the loading or unloading of cargo **lučki radnik**: Longshoremen are employed by a terminal operator who is designed to facilitate the operation of loading and discharging vessels, as well as other terminal activities.; **2 (shipping econ) slagačko društvo, slagatelj** {Longshore gangs are hired by stevedoring firms to work the ships. Longshoremen are also called stevedores.}

lookout /'lʊk,aʊt/ **to keep a sharp lookout motriti pomno**: Vessel should not be complacent and always **keep a sharp lookout** on passing traffic and vessels anchored near own vessel. **Keep sharp lookout for signals / sightings of** the vessel in distress and report every sighting. (IMO SMCP),

maintain a lookout motriti, alert / good / efficient / sharp lookout budno / pomno / djelotvorno / dobro motrenje, post a lookout postaviti motritelja, maintain a proper

lookout pažljivo motriti 1 (n) (navig) motrenje, osmatranje effective lookout

djelotvorno motrenje, ineffective lookout nedjelotvorno motrenje, proper lookout pravilno motrenje: Ensure proper lookout is maintained at all times maintain a proper lookout

pravilno motriti, post a lookout postaviti motritelja, effective lookout efikasno motrenje, efficient lookout učinkovito motrenje, lookout post mjesto motrenja, osmatračnica, lookout duty dužnost motrenja, dužnost motritelja



; **2** The man stationed aloft or in the bows for observing

and reporting objects seen. **motritelj, osmatrač**: *there was no lookout on the bridge the crossing vessel was first seen by the lookout and OOW*; **3 mjesto za motrenje, osmatračnica**

lookout, look-out (v) (navig) motriti, izviđati

lookout duty (n) (mar law) dužnost motrenja, dužnost motritelja: *Two able seamen (ABs) were assigned 4 hours on / 4 hours off lookout duties on the bridge at sea, and 6 hours on / 6 hours off cargo watches in port.* Dva starija mornara (kormilara) postavljena su na dužnost motrenja, 4 sata na mostu u plovidbi odnosno 4 sata izvan motrenja, te 6 sati straže na teretu u luci odnosno 6 sati izvan straže.

look out for (v) paziti na, voditi računa o

look-out; lookout (n) (navig) motritelj

look through (v) pregledati (dokumant)

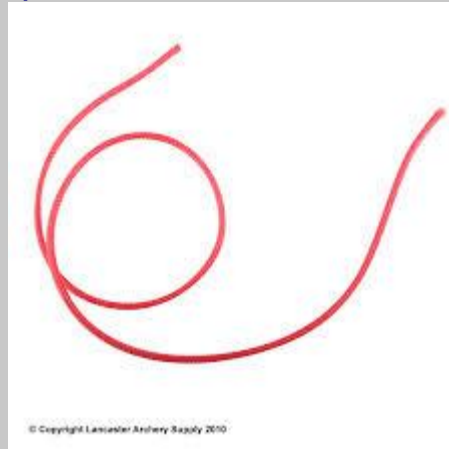

loop /lu:p/ (n) (seamanship) petlja konopa

loop scavenging (n) (marine eng) sustav obrnutog ispiranja motora, vrtložno

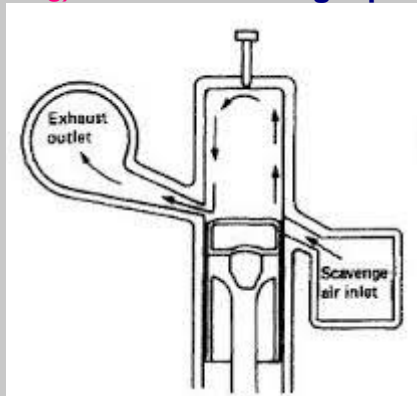

ispiranje, vrtložno ispiranje

loose /lu:s/ (cargo, shipping econ) teret bez pakovanja

loose (adj) (marine eng, seamanship) labav, nepričvršćen, slabo pričvršćen, slabo pritegnut

loose fittings (n) (cargo handling) **ANTONYM fixed fittings** Loose fittings include: - Twistlocks, manual and automatic, - Midlocks and stackers, - Lashings, supports, - RoRo and timber equipment **pomična oprema za pričvršćivanje kontejnera** **loose fittings on decks** **pomična oprema za pričvršćivanje kontejnera na palubi**, **loose fittings in holds** **pomična oprema za pričvršćivanje kontejnera u brodskom skladištu**

loose gear (n) **1** (cargo handling) pribor i alati za sidrenje, privezivanje (vezice, stezaljke, čekići itd.), čekići itd. na palubi), **vrv**; **2 lučki alati**: *There are numerous types of*

tools or loose gear that can be attached to the shipboard or shore-based lifting gear. They include the sling or strop, which is probably the most common form of loose gear.

loose goods nepakirani teret, teret bez pakovanja, teret koji se može upakirati: A mini-caterpillar with push-blade used for the careful distribution of loose goods in cargo holds of bulk carriers.

loosen /'lu:sən/ (v) olabaviti, popustiti, otpustiti, odvrnuti

loosen sail (v) (boating/yachting) odmotavati jedra

loose power (v) (navig, marine eng) ostati bez pogona: A capesize coal carrier lost power in Bosphorus and had to be rescued.

LORAN-C (n) (navig) uređaj LORAN-C shipborne LORAN-C brodski uređaj LORAN-C

LORAN; Long Range Navigation System (n) (navig) Navigacijski sustav dugog dometa za određivanje položaja broda iznosi danju do 650 M, a noću čak i do 1300 M pri jakosti odašiljača od 100kW. Loran-C, navigacijski sustav dugoga dometa LORAN; Long Range Navigation System chain lanac LORANA

lorry /'lɒri/ (n) (cargo) = **truck** kamion, teretno vozilo

lose /lu:z/ (v tr) 1 izgubiti; 2 preterpjeti gubitak

lose overboard (v) (safety) nestati s palube, pasti u more (o teretu): A number of containers were lost overboard when the vessel listed heavily after beaching.

LOS 1982) Law of the Sea (n) (mar law) The United Nations Law of the Sea Convention, adopted at Montego Bay, Jamaica, December 10., 1982 and in force November 16, 1994

Međunarodna konvencija o pravu mora

loss (n) (shipping econ, mar ins) gubitak, šteta, opadanje loss of space gubitak prostora, actual total loss (mar ins) stvarna totalna šteta, bear the loss podnijeti štetu / gubitak, snositi štetu, constructive total loss izvedena totalna šteta, partial loss djelomični gubitak / šteta, recover the loss pokriti gubitak / štetu, nadoknaditi gubitak / štetu, suffer the loss pretrpjeti štetu / gubitak, poslovati s gubitkom: The shipbuilder ... suffered heavier losses for the second quarter of 2016., total loss totalna šteta / gubitak, loss in pressure gubitak tlaka, pad tlaka, loss of life gubitak života, smrtno stradanje: It is also important to remember that there was no loss of seafarers' lives during the incident

loss and damage claim (n) (mar law, mar ins) zahtjev za nadoknadu gubitka ili štete loss and damage claim form obrazac zahtjeva za nadoknadu gubitka ili štete

loss of propulsion (n) (marine eng) nestanak pogona broda, nestanak snage stroja, gubitak propulzije

loss or damage claim (n) (shipping econ, mar law) tražbina za gubitak ili oštećenje (tereta) present the loss or damage claim podnijeti / predložiti tražbinu za gubitak ili oštećenje tereta

Loss Payable Clause (n) (mar ins, mar law) odredba o plaćanju naknade za štetu (u polici osiguranja broda)

lost or not lost (mar law) klauzula o isplati vozarine s ciljem da brodar zadrži pravo na vozarinu makar nije dovezao teret do odredišta (Grabovac) izgubljeno ili nije izgubljeno

lot (n) (cargo, shipping econ) partija tereta, pošiljka tereta, jedinica tereta lots of bulk

grain pošilke žita u rasutom stanju, lot of cargo partija / pošiljka tereta, less than shipload lots više partija/pošiljaka tereta na brodu

loud hailer /'laʊdheɪlə/ (n) (comm) zvučnik velike snage za jednosmjernu vezu s drugim plovnim objektima ili kopnom **zvučnik na dovik, portavoče**

lounge /laʊndʒ/ (n) (nav arch) **salon**

louvre /'lu:və/ (n) (nav arch) a small opening to permit the passage of air for the purpose of ventilation, which may be partially or completely closed by the operation of overlapping shutters **ušće izlaza zraka ventilation louvre ušće izlaza zraka** {US: louvre}

louvred washboard /'lu:vəd/ (n) (boating/yachting) **rešetkasti ventilacijski otvor**

low (n) = **depression 1** (meteorol) An area of low pressure, usually accompanied by cyclonic and inward wind flow **ciklona**; **2** (oceanogr) **niska voda, oseka** {in meteorology a low is sometimes referred to as cyclone}

lower (v tr) **spuštati, spustiti, sniziti, smanjiti lower the cargo spustiti teret, lower the freight sniziti vozarinu, lower the pressure smanjiti tlak, lower the anchor spuštati sidro, majnat sidro, tal. ammainare, lower the cable spuštati sidreni lanac**
A decision to pay out another shackle of cable was taken to try and stop the vessel dragging her anchor. This was done by lowering the cable using the winch brake. When the 10th-shackle mark was sighted coming up on deck, the Chief Officer received orders to pay out another 10 metres of cable. This was done by lowering the cable using the winch brake.

lower bulkhead strake (n) (nav arch) **donji voj pregrade**

lower deck (n) (nav arch) **donja paluba**: *It started when the Chief Officer reported a smell of gas in the lower deck alleyway.*

lower-deck beam (n) (nav arch, sailing vessels) **sponja donje palbe**

lower-deck hook (n) (nav arch, sailing vessels) **zoja donje palube**

lower gudgeon (n) (marine eng) **donja samica**

lower hold (n) (nav arch) **donje skladište**

lower-lift purchase (n) **nateg donje klobučnice**

lower-lifts **donja klobučnica (križa jarbola**

lower line (n) (nav arch) **linija donje palube**

lower mast (boating/yachting, nav arch) **glavni dio jarbola, doljnji dio jarbola, deblo**

lower rigging (n) **donje pripone**

lower strake (n) (nav arch) **donji voj**

lower the anchor (v) (seamanship) **spuštati sidro**

lower the sail (v) (boating/yachting) **spustiti jedro**

low-pressure boiler (n) (marine eng) **niskotlačni kotao**

low-pressure heater (n) (marine eng) **niskotlačni zagrijač**

low-pressure turbine (n) (marine eng) **niskotlačna turbina**

low slack water (n) (oceanogr) **nizak vodostaj**

low tide (n) (oceanogr) **oseka, niska voda, niski vodostaj**

low water (n) **1** (oceanogr) = **low tide** The minimum elevation reached by a falling tide. The low water is due to the periodic tidal forces and the effects of meteorological, hydrologic, and/or

oceanographic conditions. **niski vodostaj, mala voda**; **2** (*oceanogr*) oseka, nisko more, niska voda, tal. *bassa marea* {Syn: low tide}

loxodrome /'lɒksə, drəʊm/ (n) (*navig*) loksodroma

loxodromic /,lɒksə'drəʊmɪk/ **loxodromic curve** loksodromska krivulja

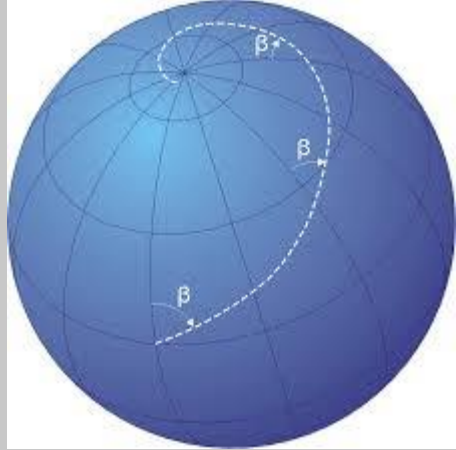

, **loxodromic triangle** loksodromski trokut,

loxodromic course loksodromski kurs loksodromski

Lpp (=Length between perpendiculars) (n) (*nav arch*) dužina između okomica

LRIT; Long Range Identification and Tracking of ships (n) (*navig*) sustav praćenja i identifikacije brodova velikog dometa

lubber (n) (*safety*) a clumsy or unseamlike sailor nespretan pomorac, nepomorac, **žabar**

lubber-hole /'lʌbɨhəʊl/ (n) ulaz u koš (na jarbolu)

lube oil /'lu:boɪl/ (n) (*marine eng*) = **lubricating oil**, **SYNONYM luboil** ulje za podmazivanje

lube oil system (n) (*marine eng*) sustav ulja za podmazivanje

luboil /'lu:boɪl/ (n) (*marine eng*) ulje za podmazivanje

lubricant /'lu:bri:kənt/ (n) (*marine eng, seamanship*) sredstvo za podmazivanje

lubricate /'lu:bri:keɪt/ (v) (*marine eng*) podmazivati

lubricating (n) (*marine eng*) podmazivanje

lubricating oil (n) (*marine eng*) ulje za podmazivanje

lubricating oil system sustav ulja za podmazivanje

lubricating oil system (n) (*marine eng*) sustav ulja za podmazivanja

lubrication /,lu:bri:'keɪʃən/ (n) (*marine eng, seamanship*) podmazivanje

lubrication oil treatment unit (n) (*comm*) uređaj za obradu ulja za podmazivanje

lubricator /'lu:bri:keɪtə/ (n) (*marine eng*) mazalica

luff /lʌf/ (v) **1** (*boating/yachting*) to head a sailing vessel more towards the direction of the wind

prihvaćati (u jedrenju), skretati u vjetar, *orcať, orcavat*; tal. *orzare*; **2** nekontrolirano prihvaćati, bježati u vjetar, bježati u *orcu*; **3** isprazniti jedro

luff /lʌf/ (n) (*boating/yachting*) **COMPARE leech** the forward edge of a sail; leading edge of a sail prednji rub jedra, prednji porub jedra, tal. *inferitura* **luff cord** konopac prednjeg ruba jedra

luffing (n) **1** (*boating/yachting*) prihvaćanje, skretanje u vjetar; **2** when a sailing vessel is

steered far enough to windward that the sail is no longer completely filled with wind **trešnja prednjeg poruba jedra, trešnja jedra, pražnjenje jedra**; **3 (cargo handling) podizanje kraka dizalice**

luffing effect (n) (ship handling) učin skretanja broda u vjetar, efekt bježanja broda u vjetar (zbog smjera vrtnje propelera i kuta zanošenja): *For a given speed the turning effect (yaw movement) or luffing effect is normally greatest when drift angle is close to 45 degrees.*

luffing up (n) (boating/yachting) namjerno skretanje u vjetar **prihvaćanje, orcanje**

luff-line (n) (boating/yachting) konopac prednjeg poruba jedra, utor jedra, **grativ**

luff of jib (n) (boating/yachting) prednji porub jedra

luff of sail (n) (boating/yachting) **COMPARE leech** prednji porub jedra

luff up (v) (boating/yachting) prihvaćati, skretati u vjetar, **orcat, orcavat; tal. orzare**

lug /lʌg/ (n) (nav arch) pločica kojom se međusobno spajaju elementi u prolazima **spojna pločica**

luggage (n) putnički prtljag **pesonal luggage** putnički prtljag

lugless shackle /'lʌgləs/ (n) (seamanship) spojna karika lanca, **patentni škopac,**



škoba

lug sail /lʌgseil/ (n) (boating/yachting) jedro na gornjemu kraju pričvršćeno za drvenu motku postavljenu koso u odnosu na visinu jarbola **oglavno jedro, sošno leto**

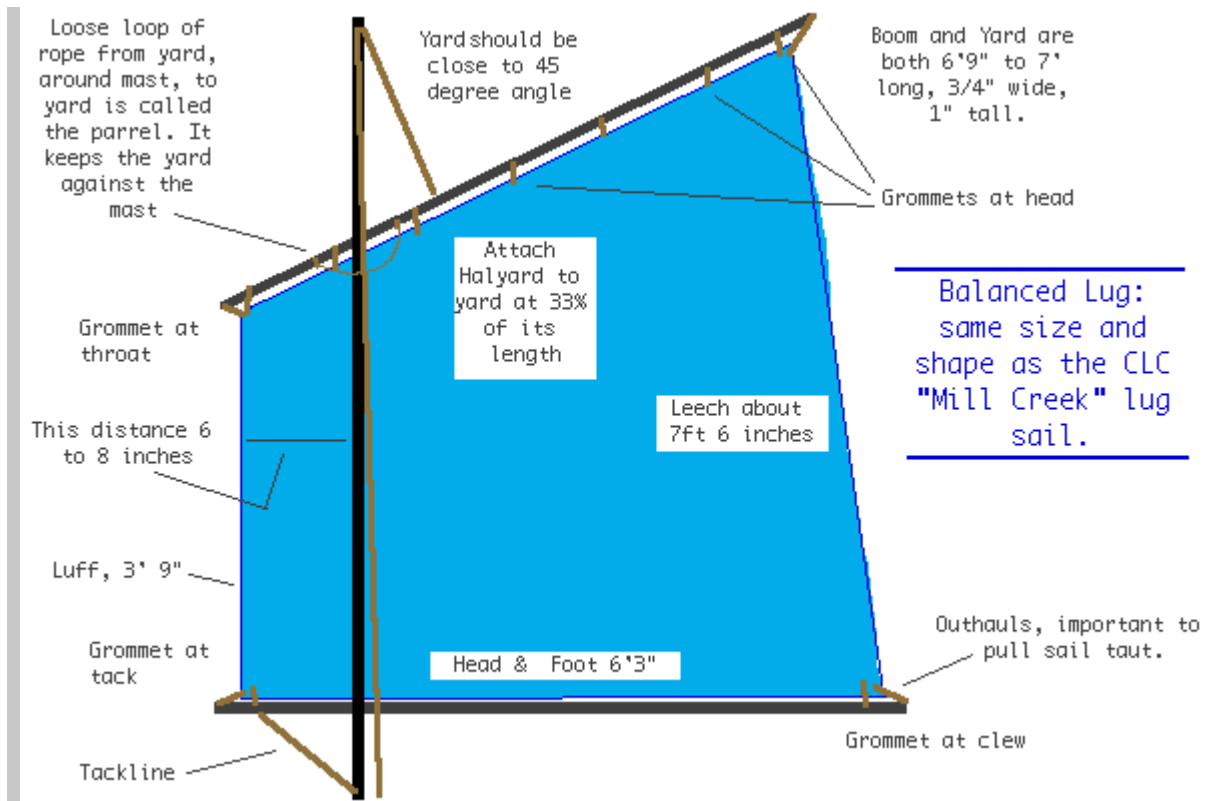

lull /lʌl/ (n) (*meteorol*) tišina, *bonaca*; tal. *bonaccia*

lumber /'lʌmbə(r)/ (US) (n) (*cargo*) drvo, drvena građa

lumber carrier (n) (*nav arch*) = **timber carrier** = **timber carrier** brod za piljenu građu, brod za rezanu građu, brod za drvo

lumber clamp (n) hvataljka ta drvo (rezanu građu)

lumber (US) (n) drvo (teret), rezana građa

lump sum freight /'lʌmpsʌm, freit/ (n) (*shipping econ*) okrugla vozarina, paušalna vozarina, vozarina naprijeko, okrugli iznos vozarine

lurch /lɜ:ʃ/ (n) (*seamanship*) motion of a ship when rolling or pitching suddenly **naglo valjanja ili posrtanje broda**

lure /lʊə/ (n) (*fishing*) any artificial bait used to attract and catch fish; predmet kojim pokušavamo isprovocirati napad ribe **varalica** *Scent Blazer lures are the ultimate in technology for the fishing industry. Not only are they crafted to look extremely realistic but they allow the fisherman to stock the lure with real bait. They work by rushing water through the entry holes in the front of the lure. When the water passes through, the scent of the bait along with minute pieces, attracts a host of species. {Najčešće je riječ o imitacijama ribe napravljenim od balze, silikona, plastike, metala ... no to isto tako mogu biti imitacije crva, kukaca, toplokrvnih životinja ili pak potpuno apstraktne kreacije. (https://ribolovnajadrano.hr/ribicki-leksikon/)}*

lustrous /'lʌstrəs/ (adj) (*marine eng*) sjajan

LWL (n) (*nav arch*) dužina vodene linije {= Length of Waterline}

lying a-hull (n) (*boating/yachting, safety*) plutanje na valovima bez jedara

lying ground (n) 1 a (*navig*) sidrište; 2 mjesto / pozicija sidrenja broda

lying-to method (n) (*boating/yachting*) postupak za kratko zaustavljanje (jedrilice)

machinability /məˈʃiːnəˈbɪlɪti/ (n) (marine eng) sposobnost strojne obrade

machine /məˈʃiːn/ (n) (marine eng) stroj, mašina **testing machine** uređaj / stroj za ispitivanje

machine /məˈʃiːn/ (v) (marine eng) strojno obraditi

machinery /məˈʃiːnəri/ **heavy machinery** (cargo) teški strojevi, **propelling machinery** (marine eng) pogonski strojevi, **steering gear machinery** strojarnica kormilarskog uređaja, **machinery space** strojarnica, **unattended machinery space** automatska strojarnica, strojarnica bez straže u stroju, **unmanned machinery space** strojarnica bez stalne straže u stroju, automatska strojarnica, **auxiliary machinery** pomoćni strojevi, **deck machinery** palubni strojevi, **hydraulic machinery** hidrauličko postrojenje, **refrigerating machinery** rashladni uređaj, **steam machinery** parno postrojenje **1 a (n) (marine eng) = engine room; engine-room; engineroom** strojarnica; **2** all spaces in a ship that primarily contain operating equipment such as main propulsion machinery, auxiliary machinery, pumping systems, heating, ventilation and air conditioning machinery, etc (Ship Terms Glossary.html) **svi strojevi**; **3** strojarnica (mosne dizalice itd.)

machinery room (n) (marine eng) = **engine room; engine-room; engineroom** strojarnica

machinery space (n) (marine eng, nav arch) strojarnica, prostor strojeva: *A ship might reasonably be divided into three distinct areas: the cargo-carrying holds or tanks, the accommodation and the machinery space.* **unattended machinery space** nenadzirana strojarnica, strojarnica bez posade, automatska strojarnica

machinery trials (n) (nav arch) inspections, tests and evaluations specific to the ship's machinery, including its main propulsion system **ispitivanje strojeva, pokusne vožnje strojeva**

machine shop (n) (marine eng) radionica i skladište alata i dijelova za potrebe strojarnice **machine tools** alatni strojevi (za obradu materijala), **power tools** elektroalati, **hand tools** ručni alati, **welding equipment** oprema za zavarivanje, aparat za zavarivanje

machine tool (n) (marine eng) strojni alat

mackerel (n) lat. Scomber spp. **skuša, lokarda** **Spanish mackerel** Lat. Scomber Japonicus



lokarda, **Atlantic mackerel** Lat. *Scomber scombrus*



skuša, škombar,

škombra, **chub mackerel skuša**, **blue mackerel skuša**

MAFI truck (n) (cargo handling, ports) **ro-ro tegljač tipa Mafi**: *MAFI diesel tractors are used for shunting containers and semi-trailers and for loading and unloading of RoRo-ships.*

magic eyeball reflector (n) (navig, electr) **radarski reflektor s magičnim okom**

magic pipe (n) (environ, mar law) a hose used to bypass the shipboard pollution prevention equipment and discharge oily waste water that was in the vessel's bilge holding tank directly into the sea (<http://gcaptain.com/chief-engineer-found-guilty-of-using-magic-pipe/>) **fleksibilna cijev za**

protuzakonito ispuštanje onečišćenih voda u more: *A federal jury in has convicted a chief engineer of environmental crimes relating to the use of a 'magic pipe' aboard the vessel he served on in* <http://gcaptain.com/chief-engineer-found-guilty-of-using-magic-pipe/> *The operator of a car carrier calling at Port of has pleaded guilty and was sentenced to pay \$ million over charges stemming from the use of a so-called magic pipe.* <http://gcaptain.com/tag/magic-pipe/page/3/>

magistrate court /'mædʒɪ, streɪt/ (n) (mar law) **lokalni / općinski sud**

magnesium (Mg) /mæɡ'ni:ziəm/ (n) **magnezij**

magnetic bearing (n) (navig) an absolute bearing using magnetic north **magnetski azimut**

magnetic compass (n) (navig) an instrument employing a magnetized needle which aligns with the Earth's magnetic field and indicates magnetic north

(<http://www.seatalk.info/cgi-bin/nautical-marine-sailing-dictionary>) **magnetski kompas**



magnetic north (n) (navig) the direction towards the North Magnetic Pole **magnetski sjever**

magnetic variation (n) (navig) angular difference between magnetic north and true north, which alters year by year as the magnetic poles move **magnetska varijacija**

magnetron /'mæɡnɪ, trɒn/ (n) (electr, navig) a high power microwave oscillator in which the potential energy of an electron cloud near the cathode is converted into r.f. energy in a series of cavity resonators **magnetron (radara)**: *After the power is turned on and the magnetron has warmed up, "ST-BY" (Stand-by) appears, indicating the radar is ready to transmit radar pulses*

magnify /'mæɡni, faɪ/ (v) **povećati**

magnitude /'mæɡnɪ, tju:d/ (n) (navig) the apparent brightness of a star as measured against a

standard brightness scale (<http://www.seatalk.info/cgi-bin/nautical-marine-sailing-dictionary>)

magnituda

mahogany /məˈhɒɡəni/ (n) (nav arch) mahagoni

maiden call (n) (seamanship) **prvo pristajanje broda u luci**: *The new cruise ship made its maiden call at Hamburg on Tuesday.*

maiden voyage /ˈmeɪdən/ (n) **first voyage for a new ship** **prvo putovanje broda**: *The first ever newbuild liquefied natural gas (LNG) fuelled German seagoing vessel, which is powered by a complete Wärtsilä LNG propulsion solution, had its maiden voyage on December 11.*

main (n) (boating/yachting) = **mainsail** glavno jedro

main aerial system (n) (comm, nav arch) glavni antenski sustav

main arm (n) (cargo handling) **krak dizalice**: *The main arm or derrick boom can be raised when the vessel departs so as to clear the mast and superstructure.*

main bearing (n) (marine eng) glavni ležaj

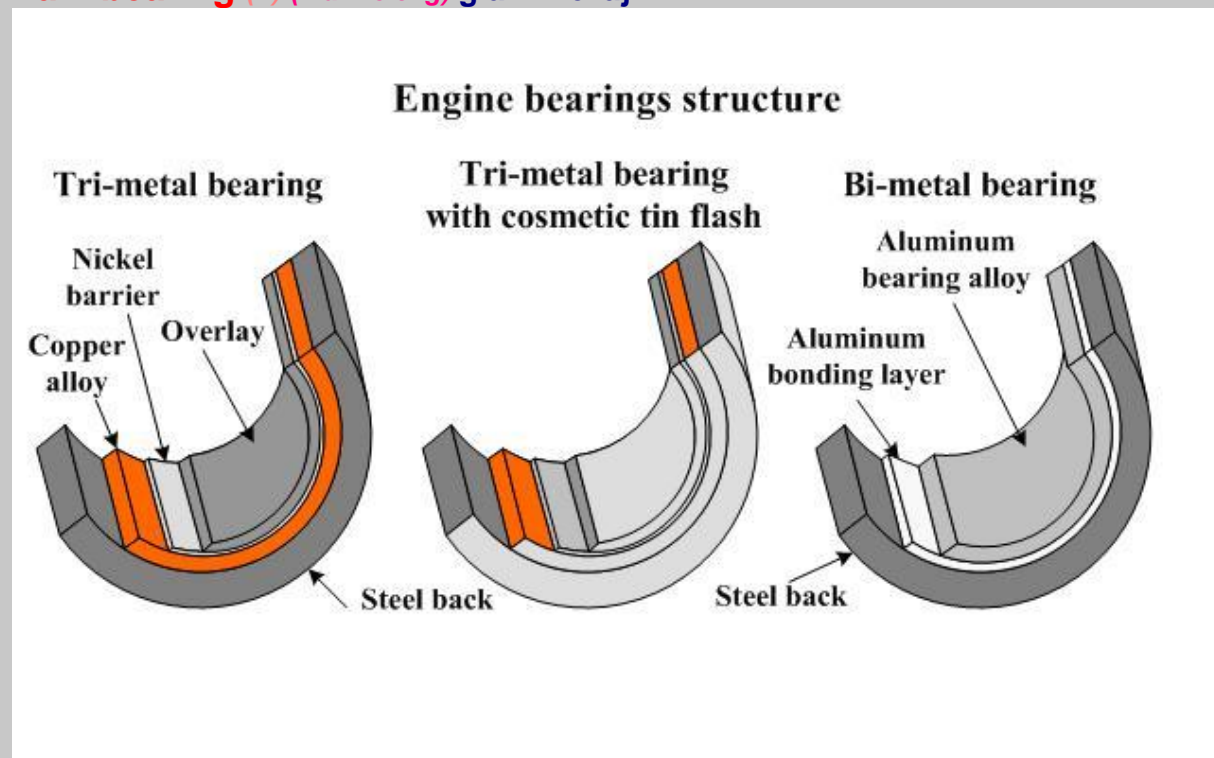

main brace (n) (boating/yachting) one of the braces attached to the mainmast **glavna uzda**

main bridge console

main engine control system

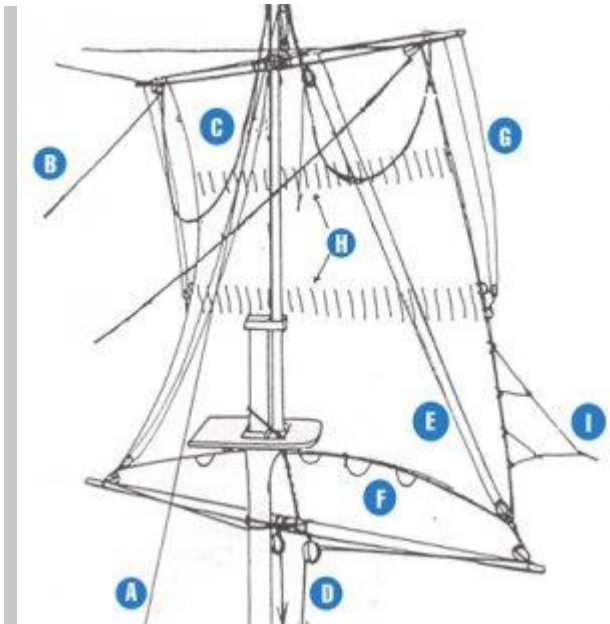

{uzda glavnog križnog jedra u snasti jedrenjaka; main brace is marked by the letter B in the image; Running rigging of a square sail. A: halyard raises yard and sail; B: braces, trim the yard; C: lifts, support yard when lowered; D: sheets, haul clews out to yard below; E: clewlines, haul clews up when stowing; F: buntlines, haul middle of sail up when stowing; G: reef tackles, haul leeches; H: reef points; I: bowlines, pull leech taut when close hauled.}

main bridge console (n) (nav arch, navig) = **console** upravljački pult na zapovjedničkom mostu

main deck (n) (nav arch) the uppermost continuous deck extending from bow to stern; the principal deck of the hull, usually the highest extending from stem to stern and providing strength to the main hull **glavna paluba**: To get a better view, he went down on the **main deck** abreast the forward end

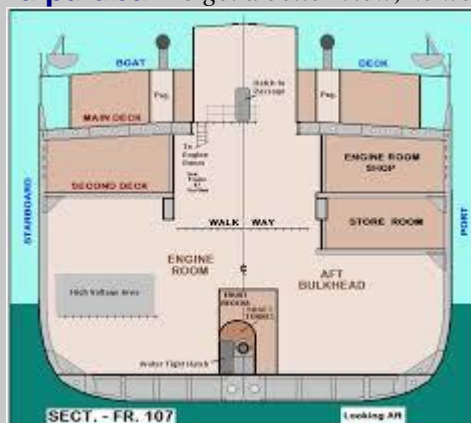

of No. 3 hatch.

main deck line (n) (nav arch) linija glavne palube

main deck stanchion (n) (nav arch) glavna paluba **main deck stanchion beam** sponja glavne palube

main deck stringer bar interkostalna uglovnica proveze glavne palube

main engine (n) (marine eng, nav arch) glavni stroj, glavni motor **start the main engine** uputiti glavni stroj: The master called the crew to mooring stations and requested that the vessel's main engines be started.

main engine control system (n) (marine eng) upravljački sustav glavnog stroja, sustav upravljanja glavnim strojem

main engine systems sustav za brodske strojeve

main halyard (n) (boating/yachting) podigač glavnog jedra

mainland /ˈmeɪnlənd/ (n) (geogr, navig) kopno

main line (n) (fishing) **SEE fishing line** uzica koja je namotana na rolu, a na njega se veže, predvez, na kojemu su prame ili pjoke (<https://ribolovnajadrano.hr/ribicki-leksikon>) **osnovni najlon, povraz, tunja**

mainmast /ˈmeɪnmɑːst/ (n) (nav arch) the tallest mast on a ship **glavni jarbol**

main particulars (n) (nav arch) osnovni podaci o brodu

main piece of rudder (n) (nav arch, sailing vessels) struk kormila

main propulsion machinery (n) (marine eng) glavno pogonsko postrojenje, glavno porivno postrojenje

main rail (n) (sailing vessels) donja razma ograde

main register (n) (mar law) glavna knjiga upisnika brodova

mains /ˈmeɪnz/ (n) (electr) glavni vod, glavni dovod električne energije

mainsail /ˈmeɪn,seɪl; (nautical) ˈmeɪnsəl/ (boating/yachting) glavno jedro, jedro, tal. *randa*



mainsail fittings (n) (boating/yachting) operma glavnog jedra

mainsail parts (n) (boating/yachting) jedro krstaša - dijelovi, glavno jedro (krstaša, jedrilice)

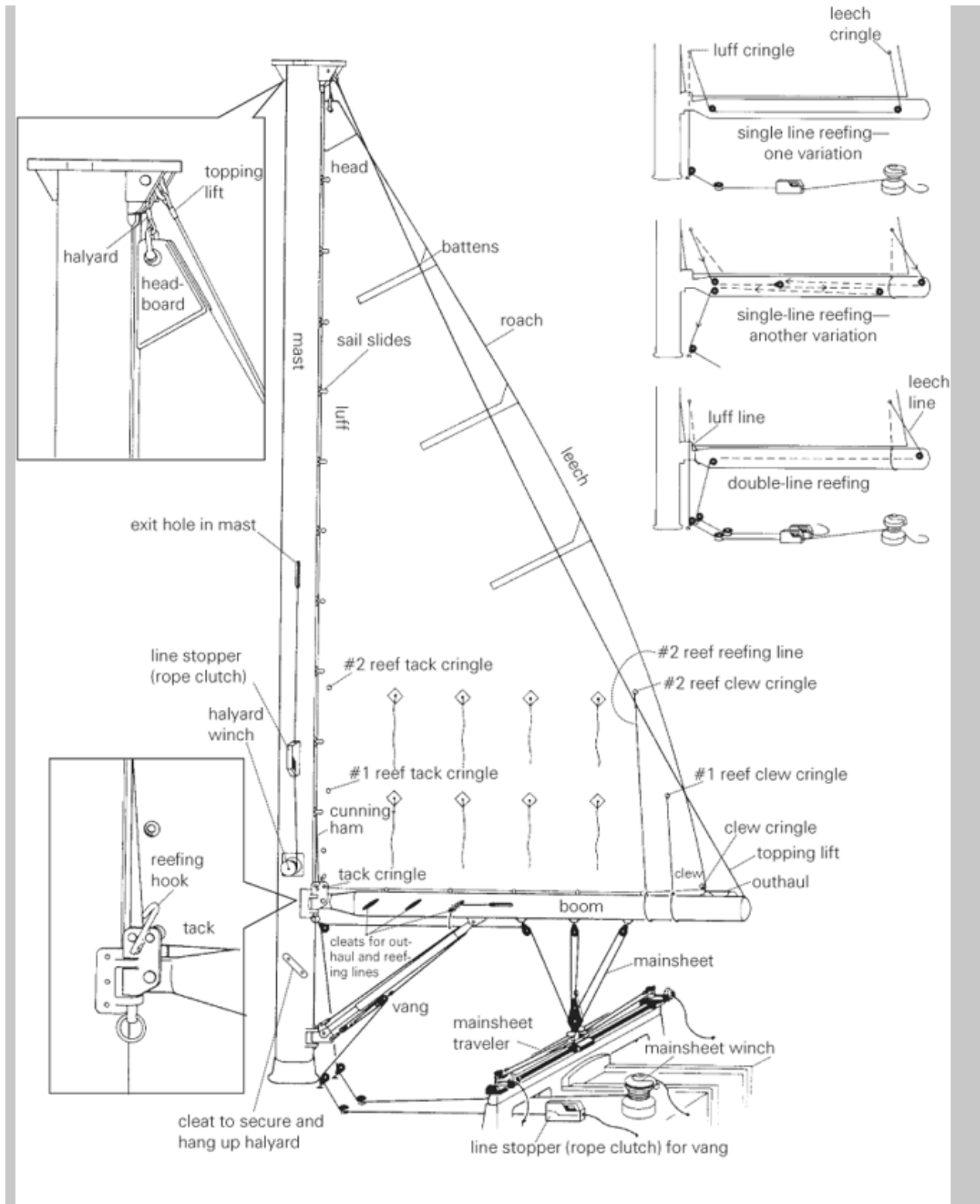

main sheet /ˈmeɪn.ʃiːt/ (n) (boating/yachting) sail control line that allows the most obvious effect on mainsail trim. Primarily used to control the angle of the boom, and thereby the mainsail, this control can also increase or decrease downward tension on the boom while sailing upwind, significantly affecting sail shape (<http://www.nauticed.org/>) **uzda glavnoga jedra škota (jedra) tal. scotta della**

randa

mainsheet tackle (n) (boating/yachting) koloturnici glavne škote

mainsheet traveller (n) (boating/yachting) klizač škote, tal. barra di scotta

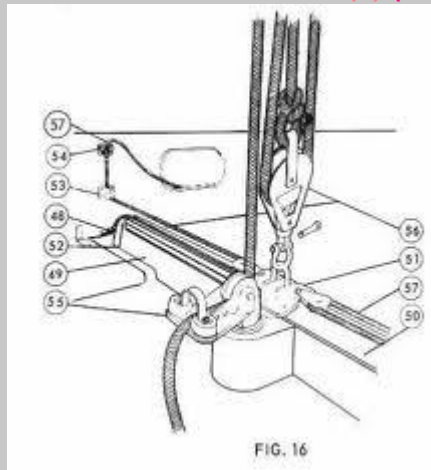

mainsheet traveller rail tračnica klizača uzde, šina klizača škote

main shroud (n) (boating/yachting) pripona glavnog jarbola

main stay (n) (boating/yachting) the stay running from the top of the mainmast to the bottom of the foremast, or from the top of the foremast to the ship's stem leto glavnog jarbola, glavni štraj

main switchboard glavna razvodna ploča, glavna rasklopna ploča

maintain /'meintein/ 1 održavati **maintain the hull** održavati trup; 2 = keep

održavati, držati **maintain the course** držati kurs, **maintain the watch** držati stražu

During the voyage to the next port the master, chief officer and second officer maintained their normal navigation watches. Za vrijeme plovidbe do sljedeće luke prvi i drugi časnik palube držali su svoje normalne plovidbene straže

maintenance /'meintinəns/ (n) održavanje, tal. **manutenzione** proper **maintenance** 1:

Most of the cargo loss or damage resulting cargo claims can be prevented by a proper maintenance of vessels and proper care of cargo.; 2 pravilno održavanje, **undergo maintenance** biti

podvrgnut radovima održavanja, obavljati radove održavanja: *The ro-ro ferry was undergoing maintenance in a shipyard overseas* Ro-ro trajekt je obavljao radove održavanja

main yard (n) (boating/yachting) glavni križ

maize /meiz/ (n) (cargo) kukuruz: *In this case, the maize cargo was fumigated by placing bags of aluminium phosphide fumigant on top of the cargo in each of the vessel's four holds.*

major damage (n) velika / veća šteta

make a lee (n) (navig) pružiti brodu privjetrinu, stati u privjetrinu

make boarding speed (v) (navig) ploviti brzinom za ukrcaj peljara

make fast (v) (seamanship) 1 to tie up a mooring line, ship etc. zavezati, vezati

(konop, uže), privezati (brod, uže), završiti privez, tal. **dare volta headline made fast** pramčani konop vezan i učvršćen, **tug made fast** 1 tegljač privezan; 2 teglo

uhvaćeno, **make fast the line** zavezati konop *Making a tug line fast to a ship presents a*

significant hazard to both ship and tug crews.; 2 **privezati brod:** *The tugs were made fast at 0808, the forward tug with a bollard pull of 30 tonnes and the after tug with a bollard pull of 10 tonnes.* **ship made**

fast and secured brod privezan i vezovi učvršćeni (u izvješću poslanom ptem

radija)

make good 1 (v) (*mar law, mar ins*) nadoknaditi štetu, obeštetiti: *the cost of fuel in the salvage operation shall be made good to the Shipowner* brodaru će se nadoknaditi troškovi za gorivo u operaciji spašavanja; **2 (navig)** preći put / udaljenost **course / distance made good** pređeni kurs / udaljenost, **make good course** ploviti na kursu od ...: *The OOW also identified that the container ship was making good a course over the ground (COG) of 216° at a speed of 12.4kts and was overtaking the tanker.*

make of the engine (n) (*marine eng*) izvedba motora, tip stroja

maker (n) proizvođač, konstruktor (stroja, itd.)

make sail (v) (*boating/yachting*) razviti jedra, povećati jedrilje (jedrenjaka)

make the land (v) (*navig*) stići do kopna, stići do obale

make the landfall (v) (*navig*) stići do kopna, stići do obale

make up (v) **1** sastaviti (napisati, ispuniti) dokument / obrazac / pismo; **2 (v intr)** činiti / sačinjavati (pošiljku); **3** dopunjavati, dolijevati; **4** nadoknaditi, dodavati

make-up feed tank (n) (*marine eng*) tank za dodatnu napojnu vodu, nadolijevni napojni tank

make water (v) (*safety*) to take in water; to leak puštati, krcati more / vodu, prodor mora

make way (v) (*navig*) kretati se (o brodu), tal. *abbrivare*: *The ship was making its way down the river towards the exit under the command of captain at 12 knots.* **make way through the water** kretati se kroz vodu, **make way over the ground 1** kretati se preko dna; **2:** *the term is used to express that the vessel is actually moving through the water, i.e. making way through the water and thus responding to her rudder.*, **make way ahead** kretati se naprijed, **make way astern** kretati se natrag

making way under power (n) (*boating/yachting*) plovidba motorom

malfunction /mæl'fʌŋkʃən/ (*n*) neispravnost, loš rad, loše funkcioniranje, greška

malicious act /mə'liʃəs/ (*n*) (*mar law*) zlonamjerni čin

malicious damage /mə'liʃəs/ (*n*) (*mar law, mar ins*) šteta osiguranomu interesu nanasena isključivo namjernim djelovanjem trećih osoba **zlonamjerna šteta**

Malicious Damage Clause (n) (*mar ins*) klauzula o zlonamjernoj šteti

malleability /,mæliə'biliti/ (*marine eng*) kovnost

malleable /'mæliəbəl/ (*adj*) **1** (*marine eng*) kovan; **2** koji se može kovati

mallet /'mælit/ (*n*) (*marine eng*) veliki bat, *macola*

man (v) **1** to take up a duty position; to post a man on a duty on board ship **postaviti posadu na**

brodu, zaposliti posadu na brodu, (o brodu) imati posadu: *the ship was manned by 16*

crew of various nationalities **man the ship** postaviti brodsku posadu, **man the**

engineroom postaviti posadu stroja, časnici i posada u strojarnici: *The engine room was adequately manned at the time of the incident; 6. Strojarnica je imala odgovarajući broj posade.*, **man**

the bridge postaviti članove posade na mostu, biti na radnom mjestu na mostu,

osoblje na mostu, časnici i posada na mostu: *The Master, 3/O and a helmsman manned the bridge. The bridge was manned, as normal, by the master, the chief officer and a helmsman.*, **man the**

tiller držati rudo kormila: *He was manning the tiller in the gale force wind.*, **man the**

držati kormilo, kormilariti, biti za kormilom; 2 popuniti brod posadom: *The vessel/unit*

shall be competently and adequately manned so as to ensure its safe operation and the maintenance of a sea-watch system.; **3 voditi (brod), upravljati**: the ship must be well manned brodom valja dobro upravljati

manage (v) **1 rukovoditi; 2 upravljati; 3 uspjeti; 4 (shipping econ) koristiti (brod), ekonomski upravljati brodom, poslovno voditi brod**: The ship is owned by Shenzhen Energy Transport, China and managed by Tosco Keymax International Ship Management Company, China. **manage the ship poslovno voditi brod, ekonomski upravljati brodom, iskoristavati brod manage in house poslovno voditi brod unutar vlastite firme**: By managing ships both in house and by using third-party management companies, owners can benchmark their own operations against those of a contractor., **manage by a third party dati brod na poslovno vođenje trećoj stranci**

management (n) **1 upravljanje; 2 (mar law) upravljanje brodovima, poslovno vođenje brodova**: BSM will be responsible for all aspects of management including crewing, technical operations, safety performance, environmental performance, and energy efficiency. **ship management company upravitelj brodova, trgovačko društvo koje se bavi upravljanjem brodova, management a ship upravljati brodom (za vlasnika broda)**: Maersk Line has decided to hand over the management of six vessels to Bernhard Schulte Shipmanagement (BSM)., **in-house management upravljanje brodovima unutar brodarskog društva, vlastito upravljanje brodovima, vlastiti management, third-party management poslovno vođenje broda od strane treće pravne osobe, upravljanje broda od strane treće pravne osobe**

management board (n) (mar law) uprava (dioničkog društva), upravni odbor

management level (n) (mar law) razina odgovornosti za obavljanje dodijeljenih zadataka, dužnosti ili odgovornosti zapovjednika ili upravitelja stroja na pomorskom brodu **upravljačka razina**

Management Office Staff (n) (shipping econ) Poslovno osoblje brodarara na kopnu

management of the ship (n) (mar law, shipping econ) rukovođenje brodom, rukovanje brodom, poslovanje brodom

manager (n) (mar law) upravitelj (broda) **ship manager** upravitelj broda

manage the ship (v) (mar law, shipping econ) poslovno voditi brod **upravljati brodom**: The ship is owned by Ltd, registered in Luxembourg; it is managed by Singapore-based Shipmanagement. But the ship is chartered by Maersk Line and Maersk owns the ship's containers.

managing director **1 izvršni upravitelj, direktor; 2 upravitelj (broda)**

managing owner (mar law) poslovođa broda (PZ 2004)

man-basket (n) (seamanship) mornarska košara, košara za prijenos osoba: The ABs agreed that one would go in the **man-basket** and clear the fastenings from the top of the stack while the other opened the hatch covers to enable the containers in the hold to be discharged. To get onto the top of the container stacks after each tier had been discharged, the ratings were transported from the quay in a **man-basket**, which was lifted by crane.

mandatory /'mændətəri; 'mændətri/ (adj) (mar law) obvezujući, obvezan (prema međunarodnim konvencijama, sporazumima, nacionalnim zakonima itd).:

Consequently most fishermen are required only to undertake a **mandatory basic training** in Survival, Fire Fighting, First Aid and Safety Awareness. He has also completed all **mandatory safety**

*training courses, the last one being the safety awareness course which he had completed in December 2002. **mandatory carriage requirements obvezno imati na brodu, nešto što se mora obvezno nalaziti na brodu, uređaj koji obvezno mora biti na brodu:** The OOW should always be aware that other ships fitted with AIS as a **mandatory carriage requirement** might switch off AIS under certain circumstances by professional judgement of the master. Časnik straže treba uvijek imati na umu da bi drugi brodovi, koji su premljeni uređajem AIS, koji se obvezno mora nalaziti na brodu, mogli isključiti uređaj AIS u određenim okolnostima na temelju stručne prosudbe zapovjednika. **mandatory criteria obvezna mjerila, obvezni kriteriji:** To elaborate **mandatory criteria** for safety of construction and safe operation of river-sea vessels. **mandatory course obvezni tečaj:** They had all attended the **mandatory fire-fighting course** and, importantly, had regularly practised fire drills. **mandatory reporting obvezno izvješćivanje, obvezno javljanje:** ude establishing and operating a system of traffic clearances or VTA system of traffic clearances or VTS sailing plans or both in relation to priority of movements, allocation of space, **mandatory reporting** of movements in the VTS area, routes to be followed, speed limits to be observed or other appropriate measures which **mandatory requirement obvezni zahtjev:** Although the use of an additional bridge lookout during darkness is a **mandatory requirement**, many vessels continue to operate with a lone watchkeeper at night. **mandatory training obvezna izobrazba, obvezna specijalistička izobrazba:** If you are a fishing vessel skipper, have you completed your **mandatory training**? **mandatory training course obvezni tečaj specijalističke izobrazbe, osnovni tečaj izobrazbe:** The advent of improved vessels and the greater availability of **mandatory training courses** mean a better and safer working environment for everyone.*

Mandatory Ship Reporting System (n) (navig, comm) Sustav obveznog javljanja brodova **Mandatory Ship Reporting System** **ADRIREP** Sustav obveznog javljanja brodova za Jadran

maneuver /məˈnuːvəl/ (n) (US) (navig) = **manoeuvre** manovra

maneuver /məˈnuːvəl/ (v) (navig, US) = **manoeuvre** rukovati brodom, manovrirati, manevrirati

maneuvering space (n) (navig) širina prostora za manevriranje

manganese (Mn) /ˈmæŋgəˌniːz/ (n) (chem) mangan **manganese (Mn)** bronz
manganska bronca

manhole /ˈmænˌheʊl/ 1 (nav arch) okrugli ili ovalni otvor na palubama i drugim konstrukcijskim dijelovima broda; an opening into a tank or compartment designed to admit a man **provlaka, otvor (na palubi broda) manhole cover poklopac otvora, portela:** The chief officer also instructed him to renew the gaskets of the **manhole cover**. **deck manhole provlaka palube, palubna provlaka:** ... the water flowed along the upper deck and before the crew could divert the water into another ballast tank via the **deck manhole**, a small amount trickled over the deck edge at the



stern.

; 2 šahta

manifest /'mæni, fɛst/ (n) (mar law) Entire listing of all cargo on board a vessel as required by the relevant local authorities e.g. customs. (<http://www.maerskline.com/en-jm/help/shipping-glossary>)
prijava tereta, manifest manifest of Dangerous Goods Manifest opasnog tereta, manifest of Goods Manifest tereta, Cargo manifest Manifest tereta, prijava tereta, Freight manifest vozarinski manifest, inward / outward cargo manifest ulazni / izlazni manifest, ship manifest brodski manifest, Transit manifest Manifest teret u tranzitu / provozu

manifold /'mæni, fəʊld/ **common manifold 1 sabirnik, kolektor exhaust manifold ispušna razvodna cijev, ispušni kolektor**: *that sprayed from a fatigue-fractured fitting on one of the main engine's pre-lubrication oil pumps onto the hot surface of the main engine's exhaust manifold. In the meantime, the mate went into the port engine room and saw that the large oily rag he had used when dipping the engine sump was on the engine exhaust manifold and was on fire. This had allowed heated fuel and vapour to escape where it was ignited, probably by the engine's hot exhaust manifold.*
air start manifold kolektor uputnog zraka, kolektor zraka za upućivanje stroja: *The sketch shows a relief valve as fitted to the air start manifold of Sulzer RTA 2 stroke engines. 'Tell tales/drains' at each end of the starting air manifold found to have been blanked off with screwed plugs. The air is cooled down to reduce its volume and is then delivered to the engine cylinders via the air manifold or scavenge air receiver.*; **2 (marine eng) distribution manifold sabirna cijev 1 (n) (marine eng) a casting or chest containing several valves razvodni ventil, ventil s više priključaka, manifold, višepriključna cijev**: *Oil cargo is discharged from the ship's tanks, via the cargo piping system to the main ship's manifold usually situated amidships, on either port or starboard side. From there by means of shore-based loading arms oil is transferred to the shore manifold and is then distributed to shore-based storage tanks on the oil terminal. The duty officer had not checked that the ABs had blanked the manifold after the cargo hose had been disconnected.*



; **2 (marine eng) razvodna cijev; 3 razdjelnik manifold**

pressure tlak u razdjelniku

manifold /'mæni, fəʊld/ (adj) **višestruk, mnogostruk**

manifold (n) (nav arch, cargo handling) On a tanker, the interface between the shore pipeline connection and the tanker's pipeline system. Usually measured in inches of diameter **glavni ventil za ukrcaj i iskrcaj nafte (na tankeru ili na terminalu), manifold, flandža (prirubnica na priključnoj cijevi za krcanje nafte)**: *..., due to the oil entering a long vertical downward section in the fuel oil line immediately inboard of the ship's manifold a partial vacuum created near the manifold caused a 'pinch' to form in the hose and the pressure gauge to read below zero. Samples should be taken*

after completion of loading and again prior to commencement of discharge from ship's cargo tanks, and at the **manifold** at the start of loading and discharge. ... some 100 litres of cargo spilled into the **manifold** drip tray and approximately 20 litres overflowed on to the main deck.

Manila rope (n) (*seamanship*) rope made from the fibers of the abaca plant **knop od manile**
manipulation (n) (*cargo handling*) = **handling** rukovanje (teretom)

manned /'mænd/ (adj) (*safety*) **brod s potrebnom posadom**: The vessel shall be competently and adequately manned so as to ensure its safe operation and the maintenance of a sea-watch system

traditionally manned ship **brod s klasičnom posadom**, **adequately manned**: The engine room was adequately manned at the time of the incident. **odgovarajuće popunjen**

posadom, **manned machinery space** **brod s posadom u stroju**, **brod sa stražom u stroju**: om Port Kelang, Malaysia, and joining westbound lane of the Malacca Strait TSS, my 2,824 TEU container vessel proceeded on maneuvering speed and with **manned machinery space** towards One Fathom Bank.

manned engine room (n) (*marine eng*) **brod sa stražom u stroju**, **strojarnica s posadom u stroju**

manning /'mæniŋ/ **1** (n) (*navig, mar law*) **brodska posada**; **2** **sustav popunjavanja brodske posade** **manning of vessels** **popunjavanje brodova posadom**; **3** **vođenje brodova** (imenovanjem i ostavljanjem časnika i članova niže posade), **kadrovsko popunjavanje brodova**

manning system (n) **ship manning system** **sustav postavljanja, raspoređivanja i zapošljavanja posade**, **General Purpose manning system** **Sustav posade opće namjene**, **sustav polivalentne posade**, **conventional** **sustav klasične / tradicionalne posade** (*mar law, seamanship*) **sustav postavljanja, raspoređivanja i zapošljavanja**

manoeuvring (UK), maneuvering (US) /mə'nu:vəriŋ/ **1** **rukovanje brodom**, **manovriranje brodom**: The tanker's engine was ready for **manoeuvring (UK)**, **maneuving (US)**; **2** **rukokreće** (prvi hrvatski naziv, J. Mikoč 1852); **3** **manovra**: The tanker's engine was ready for **maneuving** but the speed was too high to take effective action to avoid collision.

manoeuvrability /mə,nu:vɾə'biliti/ (n) (*navig*) **spособnost manevriranja**: These tugs are known by their captains for their quick acceleration and **manoeuvrability** and can work in any climate, no matter how challenging. **restricted manoeuvrability** **ograničena sposobnost manevriranja**

manoeuvrability /mə,nu:vɾə'biliti/ (n) (*navig*) **manevarska sposobnost**, **upravljivost**

manoeuvre /mə'nu:və/ (v) (*UK, nav arch, seamanship*) = **maneuver**

manovrirati, manevrirati: A fully laden 80,000 tonnes deadweight tanker was manoeuvring to go alongside when a total power loss occurred as a result of the sea water cooling system becoming blocked. The ship was maneuvered on the basis of scanty VHF radio information. **manoeuvre the ship off**

the berth **izvoditi brod sa veza, isploviti s veza**: The master agreed to the pilot's suggestion that he would **manoeuvre the ship off the berth** and turn her, and then that the pilot would take over to negotiate the locks and the river passage., **manoeuvre the ship clear of the berth** **voditi**

brod s veza: The master **manoeuvred the vessel clear of the berth** and then headed on a north westerly course at a speed of 4 knots towards a reef, ..., **manoeuvre the vessel / ship**

manevrirati brodom: When **maneuving a vessel** in a confined waterway where the margin for error is small, a tug is always a good investment.

manoeuvre /mə'nu:və/ (n) (*UK*) **1** (*navig, seamanship*) = **manoeuvre** **manovra**, **tal.**

manovra **conduct the manoeuvre** **voditi manovru, izvesti manovru**: *The pilot had conducted the manoeuvre, under similar tidal conditions, on a number of occasions without incident. Peljar je mnogo puta bez nezgoda izvodio takvu manovru pod istim uvjetima.*; **2 rukokreće (prvi hrvatski naziv, J. Mikoč 1852)**

manoeuvring booklet (*navig*) **manevarski priručnik**

manoeuvring characteristics /məˈnu:vəriŋ/ = **ship handling characteristics**

manevarska obilježja broda **manevarske karakteristike**: *The pilot asked the Master about the vessel's manoeuvring characteristics and was informed that the bow went to starboard when going astern, but was not told that the vessel had a controllable pitch propeller drive (CPP).* **ship's**

manoeuvring characteristics **manevarske karakteristike broda**: *They failed to understand ship's manoeuvring characteristics.*

manoeuvring console (*n*) (*navig, nav arch*) **manevarski pult, upravljački pult za manovru** **wing manoeuvring console** **krilni manevarski pult, upravljački pult za manovru na krilu mosta**: *The master and pilot then moved to the port bridge wing manoeuvring console*

manoeuvring machinery /məˈnu:vəriŋ/ (*n*) (*nav arch*) **rudder, side thrusters, and steering gear uređaji za manevriranje brodom**

manoeuvring mode (*n*) (*navig*) **plovidba u režimu manevriranja, brodski stroj u manevarskom režimu** **on manoeuvring mode** **u manevarskom režimu, u režimu manevriranja**: *The vessel's engine was on harbour manoeuvring mode under bridge control.*

manoeuvring speed /məˈnu:vəriŋ/ (*n*) (*navig*) **brzina manevriranja**

man-of-war (*n*) (*navy*) **a warship from the age of sail** **ratni brod**

manoeuvre (UK), manoeuver (US) /məˈnu:vəl/ (*v*) **rukovati brodom, manevrirati brodom, tal. manovrare vessel restricted in her ability to manoeuvre** **brod ograničene sposobnosti manevriranja**

man overboard (*n*) (*safety*) **an emergency call that alerts the crew that someone aboard has gone overboard and must be rescued** **čovjek u moru, osoba u moru, tal. uomo in mare**

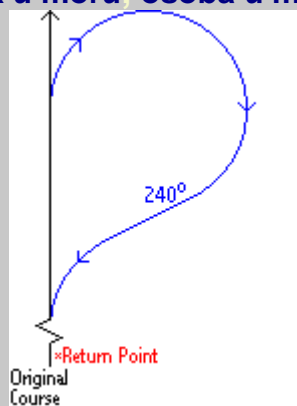

Scharnow turn **Scharnowow zaokret**

Williamson turn

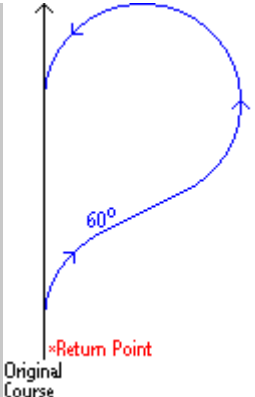

Wiliamsonov zaokret, **Anderson turn** običan zaokret



Andersonov zaokret, **man overboard manoeuvre (UK) / manoeuver (US)** manovra čovjek u moru

man-overboard alarm system (n) (boating/yachting) alarmni sustav za osobu palu u more

man overboard manoeuvre manovra čovjek u moru, manovra traženja čovjeka palog u more, manovra osoba i moru

man-overboard procedure (n) (safety) spašavanje čovjeka u moru

manpower (n) (shipping econ) radna snaga

manrope /'mæn.rəʊp/ (n) (safety) ropes hung and used as a handrail for assistance in ascending and descending (on an accommodation ladder or gangway) rukohvat od konopa, *gvardaman*

man the wheel (v) 1 (navig) biti za kormilom, biti na kormilu, kormilariti; 2 postaviti kormilara

manual /'mænjʊəl/ (n) priručnik

manual control (n) (marine eng) ručno upravljanje

manual labour (n) 1 radna snaga; 2 ručni rad

manual pump (n) (marine eng) ručna pumpa

manual steering (n) (navig) ručno kormilarinje **test manual steering** isprobati ručno kormilarenje

manufacture /,mænjʊ'fæktʃə/ (n) 1 proizvodnja; 2 izradba; 3 tvornički proizvod; 4 proizvod, izrađevina

manufacture and distribution (n) (shipping econ) proizvodnja roba i distribucija (transport)

manufactured /,mænjʊ'fæktʃəd/ (adj) proizveden, izrađen

manufacturer /,mænjʊ'fæktʃərə/ (n) proizvođač **manufacturer's data** podatci **proizvođača**: *The maintenance work on the davit winch had been performed without the aid of the*

winch *manufacturer's data.*

map (n) (geogr) pomorska karta, karta, *mapa*

map data (n) (geogr) podatci na karti

MarAd (US) (Maritime Administration) /'ma:ræd/ **1** Pomorska uprava (u SAD); **2** ministarstvo pomorstva

Marconi rig (n) (boating/yachting) another term for Bermudan rig **bermudska snast / oputa** {The mainsail is triangular, rigged fore-and-aft with the lead edge fixed to the mast}

margin /'ma:dʒin/ **1** (n) rub, **margin**; **2** (cargo) razlika u dužini tereta drva (nastala rezanjem radi formiranja koleta/svežnja)

margin /'ma:dʒin/ (n) (sailing vessels) brid krmelog okvira

margin plate (n) **1** (nav arch) krajnji niz limova opločenja pokrova dvodna uz bok ili uzvoj broda postavljen vodoravno ili koso; the outer boundary of the inner bottom, connecting it to the shell plating

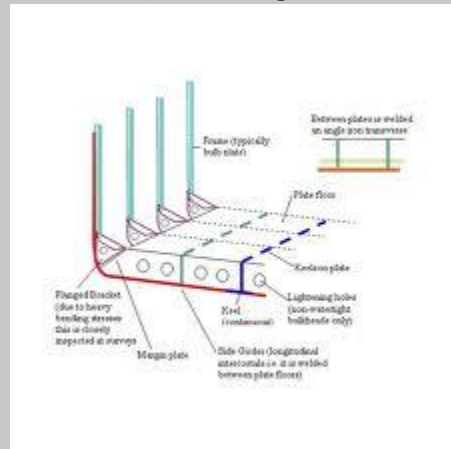

at the bilge **završna ploča** (u konstrukciji broda)

bočnica dvodna margin plate bar spojna uglovnica bočnice dvodna

marina /mə'ri:nə/ (n) (boating/yachting) a docking facility for small ships and yachts **marina**, nautička marina, tal. *marina*; *porto da diporto*

marina berth /mə'ri:nə/ (n) (boating/yachting) vez u marini



marine /mə'ri:n/ (adj) **1** koji se odnosi na brod, brodske strojeve (marine engine), tehničku opremu broda, morska bogatstva (nafta, minerali, riba), zanimanja vezana uz brod i more (marine surveyor, marine superintendent), znanost iskorištavanja mora i morskih bogatstava (marine science, marine biology, marine fisheries policy), morsku floru i faunu (marine life); concerned with the sea; found or fitted on board **brodski**, **morski marine diesel engine** **brodski dizel motor**; **2** **pomorski**; **3** **morski marine industries** djelatnosti koje se bave vađenjem nafte, ruda itd., **marine technology** tehnologija iskorištavanja morskih resursa {pridjev

MARINE % uglavnom se u značenju i uporabi odnosi na brod (BRODSKI) i podmorje (MORSKI), dok se pridjev **MARITIME** (POMORSKI) većinom odnosi na ekonomske i druge djelatnosti i aktivnosti na moru}

marine /mə'ri:n/ (n) mornarica **merchant marine** trgovačka mornarica

marine /mə'ri:n/ (n) (navy) soldiers afloat; a soldier trained to serve at sea **marinac** (US)

marine accident (n) (navig, safety) = **marine casualty** **COMPARE** **marine**

incident pomorska nezgoda: Between 1950 and 1978, the augmentation of the shipping fleet caused an increase in number of **marine accident** and casualty. **marine accident investigation**

istraga pomorske nezgode: ... has been responsible for all facets of **marine accident investigations**, including the collection of evidence and analysis of facts to determine probable cause and the preparation of detailed reports for use by both domestic and international government agencies.

marine accident report izvješće o pomorskoj nezgodi, **marine accident investigator istražitelj pomorske nezgode**, **marine accident brief** kratak prikaz pomorske nezgode, kratke upute o djelovanju u pomorskoj nezgodi

Marine Accident Investigation Branch; (MAIB) (n) (safety) Odjel za

istraživanje pomorskih nezgoda (u velikoj Britaniji): The UK Marine Accident Investigation Branch (MAIB) issued the report of the multi-agency investigation of the collision between the Arctic Ocean and the Maritime Lady, the capsizing of the Maritime Lady, contact with the wreck by the Sunny Blossom, and the subsequent grounding of the Sunny Blossom in the Elbe River on 5 December 2005 <http://www.marinelink.com/maritime/marine-accident-investigation>

marine application (n) brodaska primjena, primjena na brodu

marine barograph (n) (meteorol) brodski barograf

marine barometer (n) (meteorol) brodski barometar

marine bill of lading (n) (mar law) = **bill of lading** pomorska teretnica, teretnica

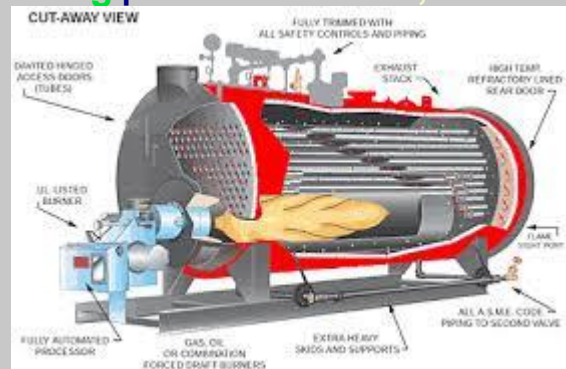

marine boiler (n) (marine eng) brodski kotao

marine cargo surveyor (n) (mar law) brodski inspektor tereta, brodski inspektor za štete na teretu, pomorski inspektor za štete na teretu

marine casualty (n) (nav arch) = **maritime accident** (see: **marine casualty**)

IMO defines two types of undesired events at sea; **MARINE CASUALTY** (largely synonymous to the general concept of 'accident', *nesreća* in Croatian) and **INCIDENT** (*nezgoda* in Croatian, i.e. an undesired event at sea other than 'accident').; **MARINE CASUALTY** (i.e. an 'accident') means an event that has resulted in any of the following: **1** the death of, or serious injury to, a person that is caused by, or in connection with, the operations of a ship or; **2** the loss of a person from a ship that is caused by, or in connection with, the operations of a ship; or **3** the loss, presumed loss or abandonment of a ship; or **4** material damage to a ship; or **5** the stranding or disabling of a ship, or the involvement of a ship in a collision; or **6** material damage being caused by, or in connection with, the operation of a ship; or **7** damage to the environment brought about by the damage of a ship or ships being caused by, or in

connection with, the operations of a ship or ships. (IMO RESOLUTION A.849(20) adopted on 27 November 1997 - CODE FOR THE INVESTIGATION OF MARINE CASUALTIES AND INCIDENTS); POMORSKA NESREĆA: izvanredni događaj na moru koji je prouzročio štetne posljedice kojima su neposredno ugroženi ljudski životi, imovina i okoliš **pomorska nesreća**: *The underlying cause of these marine casualties was that the ship's Master and members of the bridge team became distracted and lost their situational awareness either while maneuvering the ship to rendezvous with the pilot* **marine casualty investigation** istraga pomorske nesreće, **marine casualty reporting** izveščivanje o pomorskoj nesreći, **marine casualty notice obavijest o pomorskoj nesreći**, **notice of marine casualty obavijest o pomorskoj nesreći**, **major marine casualty** teža pomorska nesreća: veća pomorska nesreće, **marine casualty report** izvješće o pomorskoj nesreći, **a vessel involved in a marine casualty** brod koji pretrpio pomorsku nesreću, **brod koji je doživio pomorsku nesreću**: 46CFR §4.05-1(a) *requires the owner, agent, master or person in charge of a vessel involved in a marine casualty to give notice as soon as possible (emphasis added) to the nearest Coast Guard Safety or Marine Inspection Office if the casualty involves either a grounding which creates a hazard to the safety of the vessel, navigation or the environment, or an occurrence materially affecting the vessel's seaworthiness or fitness for service, site of the marine casualty* mjesto pomorske nesreće, **very serious marine casualty** vrlo teška pomorska nesreća **vrlo teška pomorska nezgoda**: *A very serious marine casualty means a marine casualty involving the total loss of the ship or a death or severe damage to the environment.*, **marine casualty reporting form obrazac izvješća o pomorskoj nesreći** **complete the marine casualty reporting form** ispuniti obrazac izvješća o pomorskoj nesreći, **type of marine casualty** vrsta pomorske nesreće: *Type of marine casualty Very serious marine casualty {A marine casualty means an event, or a sequence of events, that has resulted in any of the following which has occurred directly in connection with the operations of a ship: .1 the death of, or serious injury to, a person; .2 the loss of a person from a ship; .3 the loss, presumed loss or abandonment of a ship; .4 material damage to a ship; .5 the stranding or disabling of a ship, or the involvement of a ship in a collision; .6 material damage to marine infrastructure external to a ship, that could seriously endanger the safety of the ship, another ship or an individual; or .7 severe damage to the environment, or the potential for severe damage to the environment, brought about by the damage of a ship or ships. (Source: IMO Resolution MSC.255(84), Code of the International Standards and Recommended Practices for a Safety Investigation into a Marine Casualty or Marine Incident (Casualty Investigation Code), 16 May 2008)}*

marine control systems (n) (marine eng) vessel movement control systems exemplified by dynamically positioned (DP) vessels with electrical propulsion systems **sustav i upravljanja i pozicioniranja broda**

marine diesel (n) (marine eng) = **marine diesel oil (MDO)** brodsko dizel gorivo, **brodska nafta**: *The vessel is fully loaded with grain in its cargo holds, and is carrying 218,380 gallons of high sulfur fuel and 39,380 gallons of marine diesel. Fuel oil combustion generates substantially greater volumes of particles (and soot) than the burning of cleaner fuels, such as marine diesel and marine gas oils.*

marine diesel engine (n) (marine eng) brodski dizel motor, **brodski dizelski motor**
marine diesel oil (MDO) (n) (marine eng) brodska nafta, **brodsko pogonsko gorivo**, **brodsko dizel gorivo**:

marine drone (n) (safety) bespilotno istraživačko plovilo, **daljinski upravljano istraživačko plovilo**, **plutajući dron**

marine engine (n) (marine eng) **brodski stroj**: *Unlike the 4 stroke engine, a two stroke diesel engine does not use the piston to push out the exhaust gas, instead, air enters the cylinder around bottom*

dead centre and sweeps or scavenges the exhaust gas from the cylinder.



marine engineer /mə'ri:n ɛndʒi'niə/ (n) (*marine eng*) = **engineering officer** Marine engineer officers are responsible for the maintenance and operation of a ship's main propulsion machinery and auxiliary plant, including deck machinery, air conditioning plants, refrigeration plants and domestic and electrical services. . **pomorski strojar, brodski strojar, inženjer**

brodstrojarstva: Depending on the type of ship and the operational circumstances, engineer officers will be required to keep watches in the ship's engine room

marine engineering /mə'ri:n ɛndʒi'niəriŋ/ (n) (*marine eng*) **brodsko strojarstvo, brodstrojarstvo, pomorsko strojarstvo** **marine engineering plant** **brodsko postrojenje**

marine environment (n) **morski okoliš**

Marine Environment Protection Committee (n) (*environ*) **Odbor za zaštitu**

morskog okoliša: The International Maritime Organization's (IMO) **Marine Environment Protection Committee (MEPC70)** meeting brought progress by member countries

marine evacuation system (n) (*safety*) **sustav za brzo napuštanje broda**

marine fuel oil (MFO) (n) (*marine eng*) **brodsko gorivo**

marine gas (n) (*marine eng*) **brodsko plinsko ulje, vrlo lako dizelsko gorivo, laka brodska nafta** **marine gas turbine** **brodska plinska turbina, marine gas oil = gas oil** **brodsko plinsko ulje**

marine highways (n) (*shipping econ*) = **short-sea service** **kratka plovidba**

marine incident (n) (*safety*) **COMPARE marine casualty** IMO defines two types of undesired events at sea; **MARINE CASUALTY** (largely synonymous to the general concept of 'accident', *nesreća* in Croatian) and **INCIDENT** (*nezgoda* in Croatian, i.e. an undesired event at sea other than 'accident').; **A MARINE INCIDENT** (IMO DEFINITION) is an occurrence or event being caused by, or in connection with, the operations of a ship by which the ship or any person is imperilled, or as a result of which serious damage to the ship or structure or the environment might be caused. (RESOLUTION A.849(20) adopted on 27 November 1997 - CODE FOR THE INVESTIGATION OF MARINE CASUALTIES AND INCIDENTS); A marine INCIDENT means any occurrence, other than an accident, that is associated with the operation of a ship and affects or could affect the safety of operation. (<http://www.maritimenz.govt.nz/commercial/safety/accidents-reporting/definitions.asp>)

pomorska nezgoda: A **marine incident** means an event, or sequence of events, other than a marine casualty, which has occurred directly in connection with the operations of a ship that endangered, or, if not corrected, would endanger the safety of the ship, its occupants or any other person or the environment. However, a **marine incident** does not include a deliberate act or omission, with the intention to cause harm to the safety of a ship, an individual or the environment. (IMO Resolution MSC.255(84), Code of the

*International Standards and Recommended Practices for a Safety Investigation into a Marine Casualty or Marine Incident (Casualty Investigation Code), 16 May 2008) The information gathered from **marine incident reports** helps to develop safety standards, education programs and on-water compliance programs that benefit all waterways users. **report a marine incident** **prijaviti pomorsku***

nezgodu. Reporting a **marine incident** may also help you if you decide to make insurance claims on any damage. , **marine incident report** **izvješće o pomorskoj nezgodi**, **izvještaj o omorskoj**

nezgodi: Some insurance companies may require a **marine incident report** to validate claims.

marine installation (n) (marine eng, nav arch) 1 **brodska instalacija**; 2 **brodska ugradba**

marine insurance (n) (mar ins) **pomorsko osiguranje** Marine Insurance is the insurance of interests (property and earnings) that may be imperilled in a maritime adventure. In basic terms there are three main types of **marine insurance**: Hull and machinery, Cargo insurance, and P&I insurance..

Marine Insurance Act (n) (mar law) **Zakon o pomorskom osiguranju**

marine life (n) Plants and animals of the sea, from the high-tide mark along the shore to the depths of the ocean. (<http://www.ecologydictionary.org>) **morski životinjski i biljni svijet**

marine loading arm (mla) (n) (cargo handling) = **loading arm** dizalica (s **crijevom**, **manigom**) za krcanje tankera

marine medicine (n) (med) **brodska medicina**

marine meteorological report (n) (meteorol) **brodsko meteorološko izvješće**

marine meteorological service (n) (meteorol) **pomorska meteorološka služba**

marine note of protest (n) (mar law) = **note of sea protest** **prijava pomorske nezgode**

marine occupations (n) (mar law) merchant and cruise ship jobs **pomoračka zanimanja**

marine plant (n) (marine eng) **brodsko postrojenje**

marine projects (n) (ports) **projekti (novih) lučkih infrastrukturnih objekata**

marine propelling engine (n) (marine eng) **brodski porivni stroj**, **glavni brodski porivnik**

marine propulsion (n) (marine eng) **brodski pogon**, **brodski porivni sustav**

mariner (n) 1 a seafarer, sailor, person who makes his living at sea **pomorac**; 2 anyone employed aboard ship **moreplovac**

marine radar (n) (electr, navig) **navigacijski radar**, **brodski radar** **marine radar block**

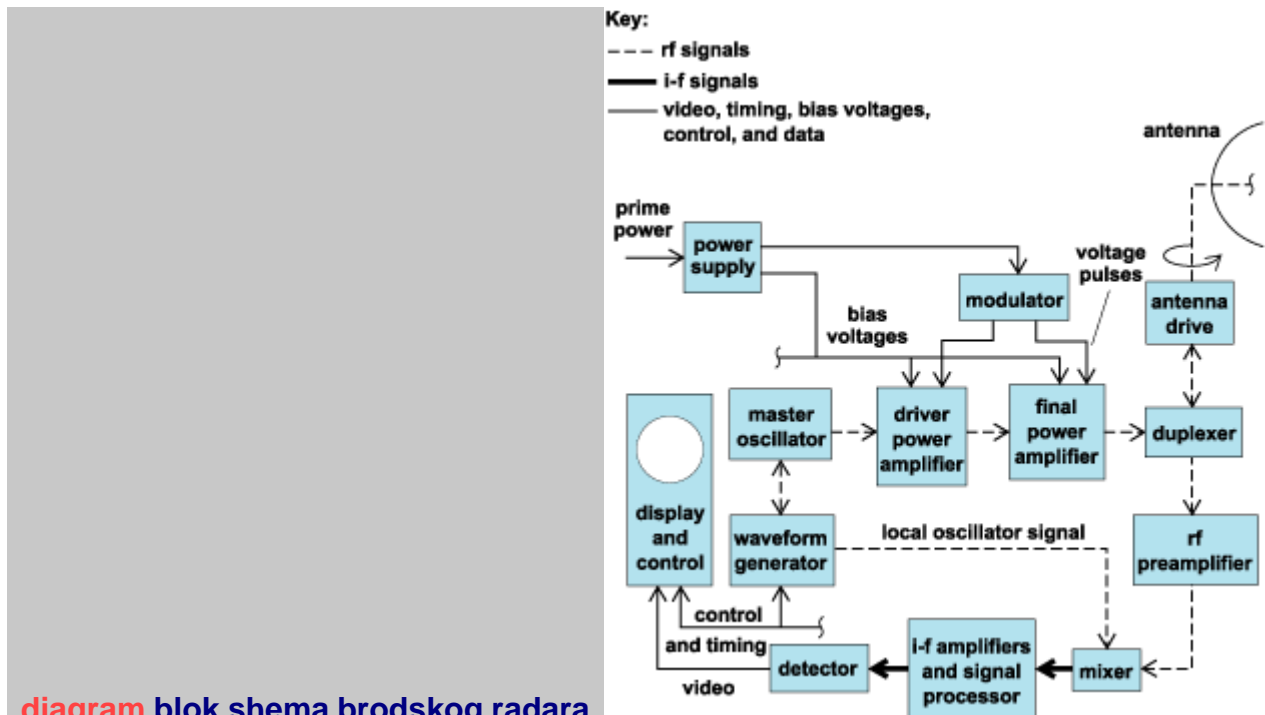

diagram blok shema brodskog radara

marine radar - technical specifications (n) (electr, navig) brodski radar - tehničke osobine radar category 1 kategorija radara; 2 IMO and fishing radar - peak power ≤ 75 kW IMO i ribarski radar - vršna snaga ≤ 75 kW; 3 river radar riječni radar; 4 pleasure rasonoda (radari na brodicama za rasonodu) {Rec. ITU-R M.1313}

marine reinsurance (n) (mar ins) pomorsko reosiguranje

mariner's compass (n) (navig) brodski kompas

marine safety investigation (n) (safety) pomorska sigurnosna istraga

marine snail (n) morski puž, ugrc, nanara, ogrc

marine survey (nav arch) inspekcija broda (opreme itd.), pregled broda (opreme itd.), **Types of marine surveys** 1 vrste inspekcije broda: **Condition & Valuation (C&V) for Purchase & Insurance:** inspekcija stanja broda i procjena broda radi prodaje i osiguranja; 2 **Damage Inspection;** inspekcija oštećenja, pregled oštećenja; 3 **Appraisals;** razne procjene; 4 **Corrosion Inspection** inspekcija stupnja korozije

marine surveyor: (n) 1 (mar law, nav arch, safety) pomorski inspektor: *Marine surveyors perform inspections of vessels of all types including pleasure craft, passenger vessels, tugboats, barges, dredges, oil rigs, ferries, cargo vessels and warships, as well as marine cargo, marine engines and facilities such as canals, drydocks, loading docks and more for the purpose of pre-purchase evaluation, insurance eligibility, insurance claim resolution and regulation compliance.*; 2 (mar law, nav arch) stručna osoba koja prema nalogu broдача, naručitelja, klasifikacijske ustanove, suda, osiguratelja ili drugoga nalogodavca pregledava brod, utvrđuje stanje u kojemu se brod nalazi i o tome podnosi izvješće; A Marine surveyor (including Yacht & Small Craft Surveyor, Hull & Machinery Surveyor and/or Cargo Surveyor) is a person who conducts inspections, surveys or examinations of marine vessels to assess, monitor and report on their condition and the products on them, as well as inspects damage caused to both vessels .. (https://en.wikipedia.org/wiki/Marine_surveyor) **inspektor broda, brodski inspektor.** He came ashore in 2003 and worked as **Marine Surveyor/consultant** with Cargo Analytics

Ltd in **Yacht & Small Craft Surveyor** inspektor jahti i brodica, **Hull & Machinery Surveyor** inspektor brodskog trupa i strojeva, **Cargo Surveyor** inspektor tereta

marine weather station (n) (*meteorol*) pomorska meteorološka postaja

maritime /'mæri, taim/ (*adj*) koji se odnosi na pomorstvo, ekonomiku pomorstva, pomorsko gospodarstvo, prijevoz morem, pomorski transport **pomorski**, **morski** **maritime affairs** pomorstvo, pomorske djelatnosti, **maritime Declaration of Health** Pomorska zdravstvena izjava, **maritime industry** pomorsko gospodarstvo, pomorska privreda, **Bureau of maritime Affairs** ministarstvo pomorstva, ministarstvo trgovačke mornarice, **maritime intelligence** pomorske informacije, **maritime administration** 1 pomorska uprava; 2 ministarstvo pomorstva {za različitu uporabu i odnos prema riječi MARINE vidi natuknicu marine}

maritime accident (see: marine casualty) (n) (*safety*) 1 = **marine casualty** izvanredni događaj na moru koji je prouzročio štetne posljedice kojima su neposredno ugroženi ljudski životi, imovina i okoliš **pomorska nesreća**; 2 pomorska nezgoda

maritime administrative law (n) (*mar law*) pomorsko upravno pravo

Maritime Administration 1 (n) (*mar law*) pomorska uprava; 2 Ministarstvo pomorstva

maritime agency contract (n) (*mar law*) ugovor o pomorskoj agenciji

maritime agency services (n) (*mar law*) pomorski agencijski poslovi

maritime agent (n) (*mar law*) pomorski agent

maritime claims (n) (*mar law*) potraživanja (iz pomorskog pothvata)

maritime code (n) (*mar law*) skup zakona kojima se reguliraju pitanja, odnosi i rješavaju prekršaji u pomorstvu **pomorski zakonik**

maritime communications (n) pomorske komunikacije

maritime craft (n) (*nav arch*) = **sea object** pomorski objekt

maritime declaration of health (n) (*mar law*) pomorska zdravstvena izjava

maritime demesne /di'mein; di'mi:n/ (n) (*mar law*) pomorsko dobro

maritime domain /de'mein/ (n) (*mar law*) pomorsko dobro

maritime education and training; (MET) sustav naobrazbe i izobrazbe

pomoraca, sustav školovanja pomoraca *The maritime education and training must be completed in order to achieve professional seafaring certification and related educational qualifications.*

maritime incident (n) (*shipping econ*) an occurrence or event being caused by, or in connection with, the operations of a ship by which the ship or any person is imperilled, or as a result of which serious damage to the ship or structure or the environment might be caused. (RESOLUTION A.849(20) adopted on 27 November 1997 CODE FOR THE INVESTIGATION OF MARINE CASUALTIES AND INCIDENTS); 'izvanredni događaj na moru koji je prouzročio štetne posljedice koje ne ugrožavaju ljudske živote, imovinu i okoliš u velikoj mjeri; an event, or sequence of events, other than a marine casualty, which has occurred directly in connection with the operations of a ship that endangered, or, if not corrected, would endanger the safety of the ship, its occupants or any other person or the environment. **pomorska nezgoda** {Naziv maritime incident u engleskom jeziku također je i opći naziv za svaku nezgodu na moru, bez obzira pripada li u kategoriju nezgoda ('incident') i nesreća ('casualty', 'maritime accident')}.

maritime industry (n) **1** (*shipping econ*) people working for transportation (ship, rail, truck and towboat/barge) companies, freight forwarders and customs brokers; stevedoring companies; labor unions; chandlers; warehouses; ship building and repair firms; importers/exporters; pilot associations, etc. (<http://www.aapa-ports.org>) **pomorska privreda**; **2 pomorstvo**

maritime law (n) **1** (*mar law*) a complete system of law, both public and private, substantive and procedural, national and international, with its own courts and jurisdiction, which goes back to Rhodian law of 800 B.C. and pre-dates both the civil and common laws. Its more modern origins were civilian in nature, as first seen in the Rôles of Oléron of circa 1190 A.D. Maritime law was subsequently greatly influenced and formed by the English Admiralty Court and then later by the common law itself. (Tetley)

pomorsko pravo: *Maritime law consists of a body of laws, conventions and treaties that governs international private business or other matters involving ships, shipping or crimes* **Maritime law** is a body of both domestic law governing maritime activities, and private international law governing the relationships between private entities that operate vessels on the oceans. **Maritime law** is composed of two main parts - national maritime statutes and international maritime conventions, on the one hand, and the general maritime law (*lex maritima*), on the other; **2** (*mar law*) maritime law in a narrow sense

pomorsko privatno pravo: A distinctive feature of **maritime law** is the privilege accorded to a shipowner and certain other persons (such as charterers in some instances) to limit the amount of their liability, under certain circumstances, in respect of tort and some contract claims.

maritime lien (n) **1** (*mar law*) A secured claim against a ship (and sometimes against cargo or bunkers) in respect of services provided to the vessel or damages done by it. A maritime lien is a substantive right in the property of another, derived from the general maritime law and rooted in the civil law concept of a privilège. It arises without notice, registration or other formalities, at the time the services are rendered or the damages are done. (Tetley) „sredstvo osiguranja stvarnopravne

odgovornosti za određene tražbine koje nastaju iz same plovidbe“ (Čorić 1993) ; privilegiji na brodu primjenjuju se na tražbine (claims) prema vlasniku, zakupcu ili brodaru (owner, charterer or ship operator), a pod posebnim uvjetima i prema poslodavcu i poslovođi broda (ship manager and the employer) za tražbine kao što su plaće, smrt, tjelesne ozljede, spašavanje, lučke naknade, štete počinjene na drugim stvarima itd. (Pomorski zakonik RH); maritime lien ima pravo prvenstva pred

hipotekom/mortgageom **pomorski privilegij** **pravo zadržavanja broda**, **privilegij na brodu**:

Under the law of salvage, strangers to the maritime venture who succeed in saving maritime property from loss or damage from perils of the sea or other waters are entitled to an award for their efforts and have a maritime lien on the salvaged property therefor. Maritime liens can arise not only when the personified ship is charged with a maritime tort such as a negligent collision or personal injury, but also for salvage services, for general average contributions, and for breach of certain maritime contracts.; **2**

pravo retencije, **pravo zadržaja broda**, **pravo zapljene imovine**; **3 pomorsko založno pravo**

maritime lien on cargo (n) (*mar law*) = **cargo lien** **privilegij na stvarima ukrcanima na brodu**

maritime mobile service identity (n) (*comm*) identifikacijska oznaka pošiljatelja ili primatelja digitalnoga selektivnog poziva **digitalni selektivni broj**

maritime navigational risk (n) (*mar ins*) **pomorski plovidbeni rizik**

maritime offence (n) (*mar law*) povreda propisa kojima se uređuju odnosi u morskim i podmorskim prostorima Republike Hrvatske ili nad kojima Republika Hrvatska ima suverena prava, njihovim obalama i lukama, pomorskim objektima hrvatske državne pripadnosti te svim pomorskim objektima koji plove ili se nalaze u morskim i podmorskim prostorima Republike Hrvatske u vezi sa sigurnošću plovidbe i zaštite ljudskih života i okoliša te s prometom na moru **pomorski prekršaj**

maritime peril (n) 1 (mar law, safety) pogibelj na moru; 2 opasnost na moru

maritime power (n) (shipping econ) pomorska sila

maritime property law (n) (mar law) pomorsko imovinsko pravo

Maritime Rescue Coordination Centre (MRCC) Pomorska središnjica za usklađivanje potrage (Hrv.), Pomorski centar za koordinaciju traganja i

spašavanja (opći naziv): *The Captain again asked the owner's permission to call MRCC again. The Marine Rescue Coordination Centre and the Master of Seaport were notified about the accident after the ship had arrived to Seaport.*

maritime risk (n) (mar ins) pomorski rizik

maritime safety sigurnost na moru

Maritime Safety Committee; MSC (n) (safety) Međunarodni odbor za sigurnost (IMO-a)

maritime services (n) (shipping econ) SEE ship management usluge brodovima, poslovođenje brodova

maritime venture, maritime adventure, marine adventure (n) (shipping econ) (mar law) any situation where insurable property is exposed ... (Marine Insurance Act, Canada) pomorski poduhvat, pomorski pothvat, pomorsko putovanje

mark /ma:k/ (n) 1 (navig) a visual aid to navigation, which includes floating marks (buoys) and fixed marks (beacons) oznaka bear a mark imato oznaku na sebi, nositi oznaku, leading mark glavna oznaka, navigation mark = Mk; (Mark) navigacijska oznaka, sea mark morska oznaka, plovidbena oznaka, land mark oznaka na kopnu; 2 (boating/yachting) regatna oznaka

mark /ma:k/ (v) označiti, obilježiti

marker word oznaka (VHF) poruke (prema SMCP), označitelj (VHF) poruke, uvodna riječ (VHF) poruke

mark-room (n) (boating/yachting) prostor dopušten jedrilici za jedrenje prema oznaci prostor oznake

marks, quality, weight, measurement unknown (n) (mar law, shipping econ) oznake, kakvoća, mjera i masa nepoznati

marks and numbers (n) (mar law) the identifying details on or of a package or the actual markings that appear on the packages oznake i brojevi (na pakovanju tereta i u teretnici)

marks unknown (n) (shipping econ, cargo) oznake nepoznate

marks unknwn (n) (mar law) oznake nepoznate (u teretnici)

mark zone (n) (boating/yachting) područje u regatnome polju oko regatne oznake unutar udaljenosti od triju duljina trupa njoj bliže jedrilice zona oznake

marlin /ma:lin/ (n) (fishing) sabljarka

marlin /ma:lin/ (n) (seamanship) konopac iz dva suka

marlinspike /ma:linspaik/ (n) (seamanship) pointed iron implement used in separating the strands of rope in splicing, marling, etc šilo za pletenje konopa, jedrarski trn, kavlja; tal. caviglia



(per impiombare)

MARPOL Konvencija o zaštiti od onečišćavanja mora, Međunarodna konvencija o sprječavanju zagađivanja s brodova

marry (v) (*seamanship*) to temporarily sew the ends of two ropes together for rendering through a block; to prepare rope strands for splicing **uplesti krajeve dva konopa**

marshalling yard 1 (n) (*ports*) a system of tracks within a certain area used for making up trains, storing cars, placing cars to be loaded or unloaded, etc. **ranžirni kolodvor**; 2 (*ports, cargo handling*) a container parking lot, or any open area where containers are stored in a precise order according to the ship loading plan. **kontejnersko slagalište**

mass /mæs/ (n) (*phys*) masa **high mass** velika masa, **low mass** mala masa

mast /ma::st/ (n) (*nav arch*) 1 jarbol; 2 (*boating/yachting*) jarbol jedrilice **unstayed mast** samostojeći jarbol, jarbol s priponama i letom, **stayed mast** pripeti jarbol, **carbon mast** karbonski jarbol

mast aerial (n) (*comm, nav arch*) jarbolna antena

mast and rigging (n) (*boating/yachting*) oputa

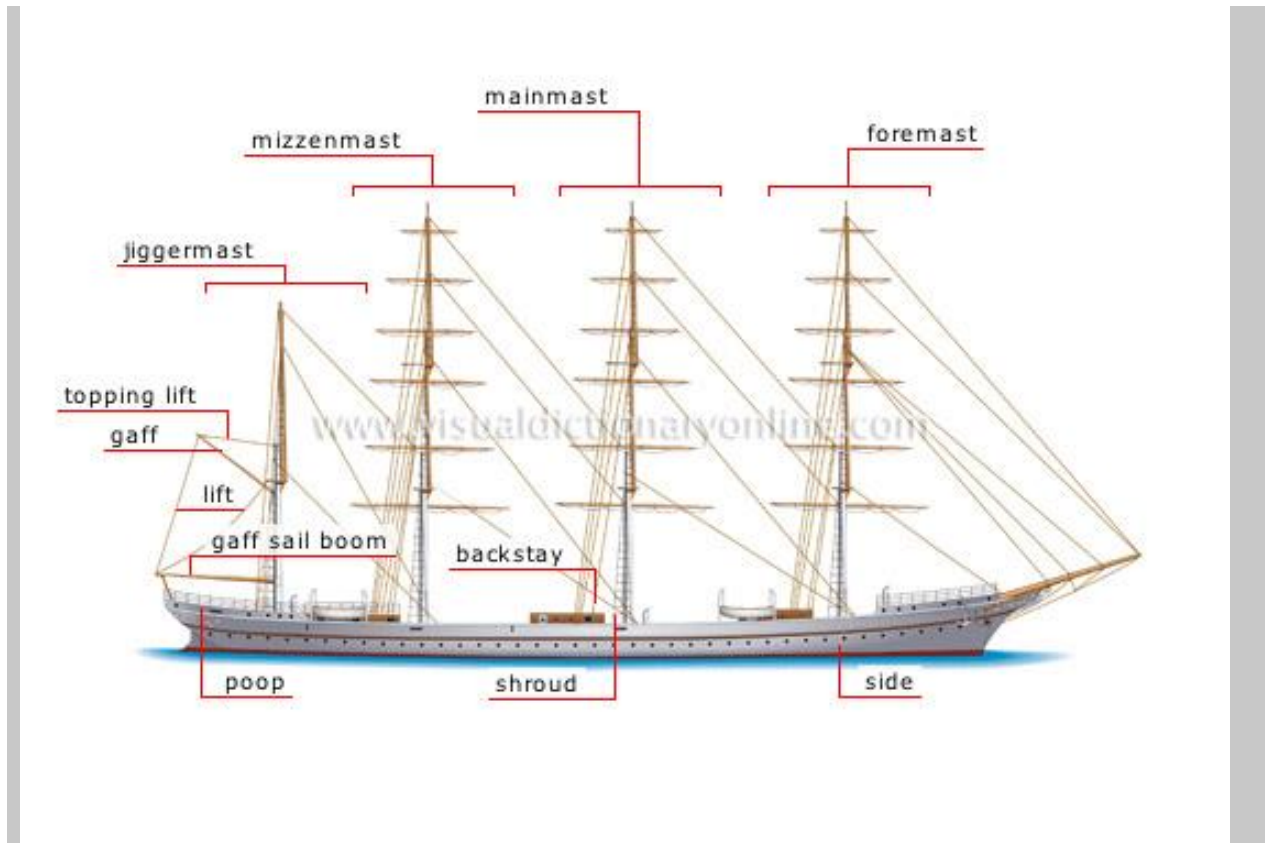

mast-beam (n) (sailing vessels) palubna sponja jarbola

mast bend (n) (boating/yachting) savijenost jarbola

mast chocks (n) = **mast wedging** klinovi jarbola

master (n) the person having command of a ship **zapovjednik (broda)**, *barba*, *master*, *ta. comandante; capitano*

Master Mariner /'ma:ste 'mærinə/ (UK) 1 (n) (mar law) a sailor who has achieved a level of competence and experience to be qualified to act / serve as the Captain of a commercial vessel of any size, of any type, operating anywhere in the world. In the US merchant navy a Master Mariner license comes rated for the maximum gross tonnage of vessel which that license-holder is allowed to operate with the highest being a license for any gross tonnage.; In the British Merchant Navy a Master Mariner who has sailed in command of an oceangoing merchant ship will be titled Captain

kapetan **trgovačkog broda, kapetan duge plovidbe, zapovjednik broda od 3000 bt i više:** *In many countries, the term "Master Mariner" is reserved only for those who hold an unlimited master's certificate.*; 2 **viši pomorski kapetan (s položenim posebnim ispitim za to zvanje u**

UK) {The conventions or acts governing the certificate have evolved alongside the shipping industry and the official name of a Master Mariner's qualification has varied over the years. The UK Maritime & Coastguard Agency, in-line with the amended STCW convention, currently title the certificate Master Unlimited.}

Master-pilot exchange; MPX (n) (navig, comm) **razmjena informacija između**

zapovjednika i peljara: *The Master-pilot exchange (MPX) was conducted prior to departure, including discussion of the passage plan.*

Master-Pilot Exchange (MPX) (n) (navig) **interakcija zapovjednika i peljara** {The explicit purpose of the MPX is to tell the pilot the particulars of the ship: its draft, condition of engines and navigational equipment, and special conditions or characteristics which might affect the pilot's ability to

understand how the ship will handle in close quarters.}

master plan (n) (ports) **razvojni plan port master plan** razvojni plan luke

master's certificate = Master Unlimited Certificate of Competency

svjedodžba o ovlaštenju za zapovjednika, svjedodžba o položenom kapetanskom

ispitu, ovlaštenje za zapovjednika duge plovidbe, zapovjednik duge plovidbe

(traditional name for the Master's Certificate in Croatia.): *He obtained his Master's*

Certificate in 1985 and was promoted to Master in 1988. Stekao je svjedodžbu o ovlaštenju za

zapovjednika u 1985. godini, a 1988. godine bio je unaprijeđen u zapovjednika broda.

Master's disbursements (n) (mar ins) Expenditures made by the master and paid for with his own funds or obtained on his personal credit for the purchase of necessaries for the ship (Tetley)

zapovjednikovi izdaci

master's licence svjedodžba o ovlaštenju za zapovjednika, svjedodžba o

položenom kapetanskom ispitu: *The company's representatives came aboard to investigate the*

incident as directed by the Maritime Administrator the Master's license was suspended for one year for

failing to reduce speed to investigate, call the RCC, and log the event.

master station (n) (comm) **matična postaja, glavna/ nadređena radiostanica**

master's ticket svjedodžba o ovlaštenju za zapovjednika

Master Unlimited (n) (mar law, navig) The UK Maritime & Coastguard Agency, in-line with the amended STCW convention, currently title the certificate Master Unlimited

(<https://www.gov.uk/government/organisations/maritime-and-coastguard-agency#mu>); The term

“unlimited” (often referred to as unrestricted) indicates that there are no limits on size, power or

geographic location on the certificate. It is the highest level of professional qualification amongst

mariners and Deck Officers (Wiki) **zapovjednik broda u neograničenoj plovidbi**: *Skills: A*

Mater Unlimited must have a valid USCG MMC (Merchant Mariner Credential) with Master Unlimited.

Must have VSO (Vessel Security Officers), a valid TWIC (Transportation Worker Identification Credential)

, Passport, and Medical Certificate In the UK, an unrestricted master's certificate is colloquially called

a Master's Ticket or a Master's. It is sometimes still referred to as a “Class 1” or “Master

Foreign-Going” as it was named during the latter part of the 20th century. The conventions or acts

governing the certificate have evolved alongside the shipping industry and the official name of a Master

Mariner's qualification has varied over the years. The UK Maritime & Coastguard Agency, in-line with the

amended STCW convention, currently title the certificate Master Unlimited.

https://en.wikipedia.org/wiki/Master_mariner

Master Unlimited Certificate of Competency (n) (mar law, navig) **Ovlaštenje za zapovjednika broda u neograničenoj plovidbi**

mast fittings okov jarbola

mast foot (n) (boating/yachting) **peta jarbola**

mast gate (n) (boating/yachting) **SYNONYM partners** otvor na palubi za smještaj jarbola (na malim jedrilicama)

mast head (n) **1** the top part of the mast; a small platform partway up the mast, just above the

height of the mast's main yard **vrh jarbola**: *The Tanker in ballast and gas free at anchor is showing*

anchor lights and a flashing red light at the mast head.; **2** **postolje iznad glanog križa (služi za**

motrenje)

masthead fly (n) (boating/yachting) **vjetrokaz (na vrhu jarbola)**

masthead light (n) (nav arch) the white running light carried by a vessel underway on the

foremast or in the forepart of the vessel **jarbolno svjetlo**: *The boat was displaying a masthead light,*

port and starboard sidelights and a stern light. Through binoculars, he **identified the masthead light** and the port side light of what he assessed to be a power-driven vessel crossing the traffic lane. She was **exhibiting a masthead light**, port and starboard sidelights and a stern light. Most of them are unaware of the danger that this puts them in, particularly in busy shipping lanes where it is often impossible **to pick out a masthead light** from the background shore lights.



mast-hole (n) (sailing vessels) otvor za jarbol

mast house (n) (nav arch) jarbolna kućica, kazamat

mast rig snast

mast step (n) (boating/yachting) petica jarbola, škaca; tal. *scassa dell'albero*

mast stepping the process of raising the mast **podizanje jarbola**; *produžavanje jarbola*

mast-top ladder (n) ljestvice koša (na jarbolu)

mast track 1 žljeb u jabolu (za jedro), utor, *puč*; 2 šina uz jarbol (za hvatanje jedra)

mast wedging (n) klinovi jarbola

mate /meɪt/ **second mate's certificate** ovlaštenje / svjedodžba poručnika trgovačke mornarice (n) (mar law) časnik palube, **official second mate** drugi časnik palube, **first mate** prvi časnik palube, **third mate** treći časnik palube

material /mə'tɪəriəl/ (n) (marine eng) materijal **soft material** mekan materijal, plastičan materijal, **ductile material** rastezljiv materijal, **ductible material** provodljivi materijal, **engineering material** tehnički materijal, tehnološki materijal, **flexible material** elastičan materijal, gibljiv materijal

mate's receipt (n) (mar law) časnička potvrda, potvrda o ukrcaju tereta: *A Mate's Receipt should only be signed once it has been verified that the goods are actually loaded on board.* **sign the mate's receipt** potpisati časničku potvrdu, **endorse the mate's receipt** ovjeriti časničku potvrdu: *It is important to carefully note any damage to the cargo and endorse the Mate's Receipt accordingly.*

math /mæθ/ (n) (math) matematika, računanje

matter /'mætə/ (n) tvar, materija **solid matter** krute tvari, **foreign matter** strana tvar, nečistoće

matting /'mætiŋ/ (n) (cargo) hasura, rogožina

maturity date /mə'tjʊəri'ti/ (n) (mar law) dospelost

maximum allowable banding moment (n) (nav arch) maksimalno dopušteni momenti svijanja

maximum allowable shear force (n) (nav arch) maksimalno dopuštene poprečne sile

maximum ebb (n) (oceanogr) najveća oseka, najjača oseka

maximum flood (n) (oceanogr) najveća plima, najviša plima

maximum power (n) (marine eng) maksimalna snaga (brodskog stroja)

maximum section (n) (nav arch) najveće rebro {poprečni presjek na najvećem rebru}

mayday /'meɪ,deɪ/ (n) (navig, safety) the international distress signal given by voice radio on one of the emergency channels **oznaka poruke u pogibli, oznaka poruke za poziv u pomoć, glasovna poruka u pogibli** **mayday call** **poziv za pomoć u pogibli** *The owner broadcast a "Mayday" call and a lifeboat was launched to respond. Unfortunately, valuable rescue time had been lost and 1 hour and 40 minutes elapsed between the "Mayday" call and the crew being rescued by helicopter.*

mayday relay message prenesena poruka s oznakom mayday

MCS; (multiple console support) (n) (navig) glavna kontrolna stanica (u sustavu GPS)

MCT; moment to change trim 1 cm (n) (stabil, nav arch) the longitudinal moment required to change the trim one centimetre. **moment promjene trima za 1 cm**

MDS; Minimum Detectable Signal (n) (navig) najmanji detektibilni signal (na radaru)

mean high-water line /mi:n/ (nav arch, oceanogr) In regard to tide, the average height of high water measured over a period **crta srednje više visoke vode**

mean low-water line (n) (navig, oceanogr) In regard to tide, the average height of low water, measured over a period **crta srednje niske vode**

mean range (n) (oceanogr) srednji raspon plime i oseke

mean sea level (n) (oceanogr) the average height of the sea surface, based upon hourly observation of the tide height on the open coast or in adjacent waters that have free access to the sea **srednji vodostaj, srednja razina mora, obična voda, normalna voda**

mean tide level (n) (oceanogr) srednja razina morskih mijena

mean water level (n) (oceanogr) The average height of the water surface, determined at equal (usually hourly) intervals over a considerable period of time **srednji vodostaj, normalna voda**

measure /'meɪʒə/ (n) mjera

measurement /'meɪʒəmənt/ (n) 1 (nav arch) izmjere (broda), dimenzije (broda) **tonnage measurement** **baždarenje (broda); 2 dimenzije (tereta)**

measurement ton; M/T (n) (shipping econ) **COMPARE weight ton; W/T**

prostorna tona *Measurement tons are usually expressed as cargo measurement of 40 cubic feet (1.12 meters) or cubic meters (35.3 cubic feet.)*

measures unknown (n) (shipping econ, mar law) masa nepoznata (u teretnici)

measure the bearing (v) (navig) izmjeriti azimut, odrediti azimut, izmjeriti kut: *The relative bearing from own ship to targets can be measured by the cursor and by the EBL.* **measure the bearing with an EBL** **izmjeriti azimut do objekta putem elektroničkog smjerala (EBL), measure the bearing to a target nekog objekta, measure the bearing between two targets izmjeriti azimute između dva objekta, measure the bearing by cursor izmjeriti azimut s pomoću kursora (na radaru), measure the bearing by EBL izmjeriti azimut s pomoću elektroničkog smjerala**

measure the range (v) (navig) izmjeriti udaljenost (radarom): *The range from own ship to target can be measured in three ways: by range rings, by cursor, and by VRM. {In modern rasterscan radars range is measured electronically. When the pulse is transmitted a very precise clocklike timebase signal is produced in the switch register, corresponding to the speed of the transmitted pulse. If a returning echo is received at precisely the same time as the timebase signal is produced a switch is turned on and the returning echo displayed.}*

measuring range (n) (navig) mjerenje udaljenosti (putem radara itd.) measuring range by range rings mjerenje udaljenosti s pomoću kružnica na radarskom pokazivaču, by cursor mjerenje udaljenosti s pomoću kursora, by VRM mjerenje udaljenosti s pomoću promjenljivih daljinskih kružnica (na radarskom pokazivaču), precise measuring range točnost mjerenja udaljenosti

mechanic (n) (mar law) An engine room rating responsible for the daily maintenance and repairs of mechanic equipment onboard the ship under the supervision of Chief Mechanic. **mehaničar** **chief mechanic** **stariji mehaničar**, **viši mehaničar**, **marine mechanic** **brodski mehaničar**: *The marine mechanic in our company is to assist in scheduling, coordinating, and performing vessel repair & maintenance. He also coordinates in purchasing of parts and repair services and supplies, schedule routine maintenance requirements for the Company vessels and accurately files records of all maintenance performed using company program*

mechanical /mi'kænikəl/ (adj) **mehanički** mechanical control **mehaničko upravljanje**, **mehaničko reguliranje**, mechanical draught **mehanički propuh**, **umjetna cirkulacija zraka**, mechanical marine propulsion **mehanički pogon broda**, mechanical propulsion **mehanički pogon**, **mehanički poriv**, mechanical property **mehaničko svojstvo**

mechanical advantage (n) (phys) a measure of the force amplification achieved by using a tool, mechanical device or machine system; omjer sila između kraka kolotura i kraka tereta **prijenosni omjer** {odnos sila kraka kolotura i kraka tereta (prema zakonu poluge (law of the levers))}

mechanical damage (n) **mehaničko oštećenje**, **fizičko oštećenje**

mechanism /'mekə.nizəm/ (n) (marine eng) **mehanizam**, **stroj**, **uređaj**, **mehanički uređaj**, **camshaft drive** mechanism **pogonski mehanizam razvodne osovine**, **pogonski uređaj bregastog vratila**, **valve** mechanism **mehanizam za otvaranje ventila**, **polužje za pokretanje ventila**

medevac /'medɪ.væk/ (v) (med) **evakuirati bolesnika helikopterom**: *The Coast Guard medevaced a 64-year-old man from Bayou Rigolettes. Sector New Orleans directed the launch of an MH-65 Dolphin helicopter crew from Coast Guard Air Station New Orleans to recover the man*

medical advice (n) (med) **savjet liječnika**, **medicinski savjeti**

medical assistance (n) (med) **liječnička pomoć**, **medicinska pomoć** **request** medical assistance **zatražiti liječničku pomoć**, **render** medical assistance **pružiti liječničku pomoć**

medical attendance (n) **bolesnička njega**

medical examination (n) (med) **liječnički pregled** **pass** medical examination **proći liječnički pregled**

medical guide **medicinski vodič**, **medicinski priručnik**

medical history (n) (med) **povijest bolesti**

medical log (n) (med) **zdravstveni dnevnik**

medical response team (n) (**safety**) brodski tim za interventnu zdravstvenu pomoć

medicare /'mɛdi,kɛə/ (n) (**safety**) medicinska zaštita i njega, tečaj medicinske zaštite i njege

Mediterranean moor (n) (**seamanship, navig**) the MEDITERRANEAN MOOR consists of making a ship fast stem-on to a berth with the bows held in position by the anchors **četverovez, vezivanje u četverovez s krmom prema obali**. *The port anchor was dropped to help swing the stern around for a perfect mediterranean moor.*

Mediterranean mussel (n) (**fishing**) Lat. *Mytilus galloprovincialis* dagnja

Mediterranean sand smelt (n) (**fishing**) gavun

Mediterranean spearfish (n) (**fishing**) lat. *Tetrapturus belone* iglan

medium (n) **1** sredstvo through the **medium** of posredstvom, s pomoću, putem; **2** medij

medium (adj) srednji

medium frequency (MF) (n) (**comm**) srednje frekvencije

medium-speed diesel engine (n) (**marine eng**) srednjohodni dizel motor: *An optional variable inlet valve closure (VIC) facility—first designed for the Sulzer ZA40S medium-speed engine—controls the closing time of the inlet valves. MAN 51/60DF EnGinE MAN Diesel's 510-mm-bore 51/60DF medium-speed engine.*

Med-Moor (n) (**seamanship**) = **Mediterranean moor** vezivanje u četverovez, četverovez

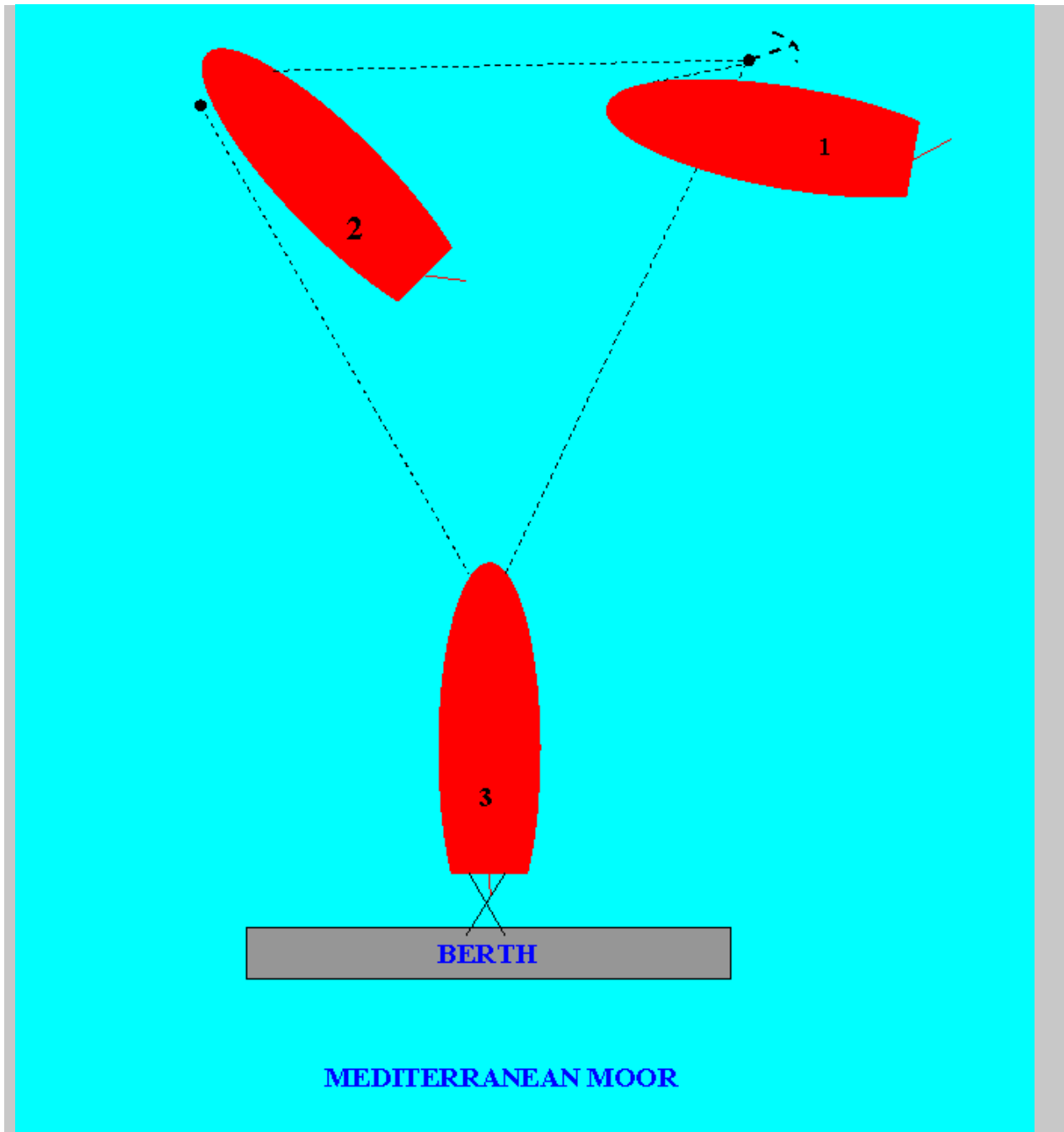

Meet her! (v) (navig, seamanship) order to the helmsman to apply opposite helm to check the swing of a vessel by putting on opposite rudder **Ispitaj!** {Provjeri osjetljivost kormila!}

megayacht (n) (nav arch) yachts that are generally over 100 feet (30.5 meters) LOA, though there is no firm cut-off point on the lower-end of the size range. **megajahta**

melt /mɛlt/ (v) (marine eng) taliti se, rastaliti se, topiti se {melt - melted - melted / molten}

melting point (n) (marine eng) talište, temperatura taljenja

member (n) (nav arch) element konstrukcije strucural member of the hull element
jonstrukcije trupa

memorandum of association /,mɛməˈrændəm/ (n) (mar law) društveni ugovor (o

osnivanju trgovačkog društva)

menu /'mɛnju:/ (n) (*navig*) **izbornik**, **meni** **close the menu** zatvoriti izbornik, **open the 1** otvoriti izbornik

mercantile /'mɜ:kən,tail/ (adj) = **merchant** trgovački **mercantile marine** trgovačka mornarica, **mercantile goods** trgovačka roba

merchandise /'mɜ:tʃən,daiz/ roba, tereti

merchant /'mɜ:tʃənt/ (n) (*mar law*) **1** **trgovac**: *the Phoenician merchants operated their own vessels, transporting goods in the Mediterranean*; **2** Merchant includes the Shipper, Holder, Consignee, Receiver of the Goods, any Person owning or entitled to the possession of the Goods or of the Bill of Lading and anyone acting on behalf of any such Person. **naručitelj prijevoza (u teretnici)**; **3** korisnik prijevoza

merchant /'mɜ:tʃənt/ (adj) (*shipping econ*) = **mercantile** trgovački **merchant marine** trgovačka mornarica, **merchant navy** trgovačka mornarica, **merchant ship** trgovački brod, brod trgovačke mornarice

merchant fleet (n) = **merchant navy** = **merchant marine** trgovačka mornarica

merchant marine (n) trgovačka mornarica

merchant navy (n) trgovačka mornarica

Merchant Shipping Act (*mar law*) **Zakon o trgovačkoj mornarici**

mercurial barometer (n) (*meteorol*) **COMPARE aneroid barometer** živin barometar

merge /mɜ:dʒ/ (v) **1** (*navig*) **spojiti se**: *in areas where traffic merges vessels should navigate with particular caution* u područjima gdje se plovidbeni tokovi spajaju valja ploviti posebno oprezno; **2** (*mar law, shipping econ*) **spojiti** trgovačka društva, **spojiti kompanije**

merger /'mɜ:dʒə/ (n) **1** (*shipping econ, mar law*) **spajanje** (poduzeća, tvrtki itd.), **udruživanje**, **integracija**, **fuzija**; **2** (*mar law, shipping econ*) **pripajanje** (poduzeća, firme, tvrtke); **3** (*mar law, shipping econ*) **preuzimanje**

mesh (n) **1** mreža **fine mesh** mreža sitna oka; **2** sito; **3** (*marine eng*) međusobno zahvatanje zubaca

mess (n) (*seamanship*) an eating place aboard ship **blagovaonica**

message marker (n) (*comm*) **oznaka poruke**

messenger /'mɛsɪndʒə/ a light chain or rope used for hauling in a cable or to feed a heavier line to areas not easily reached.; also called messenger line. **tanje uže (konop ili lanac) za prihvaćanje užadi za privezivanje**, **tanji lanac ili uže za prebcivanje sidrenog lanca (s jednog oka na drugo)**, **mesinđer**, **gija**

messenger line a light line used for hauling over a heavier rope or cable **tanji konop (ili lanac) za prihvaćanje i povlačenje užadi za privezivanje**, **gija**, **mesinđer**: *After reaching the bow of the car carrier, the salvors were able to attach a messenger line from a tug to the car carrier. A heaving line was thrown down from the ship to the single crewman on the aft deck of the tug, and the tug's messenger line was attached. The second officer looked down at the tow wire and gesticulated to the welder to heave up the messenger line. The second officer looked down at the tow wire and gesticulated to the welder to heave up the messenger line.*

messman (n) brodski konobar

messroom (n) officers' messroom časnička blagovaonica (nav arch) a space or compartment where members of the crew eat their meals; a dining room aboard a ship

blagovaonica, mesrum, messer

metacenter (US) /'mɛtə, sɛntə/ (n) (nav arch, stabil) metacentar, točka metacentra

metacentre /'mɛtə, sɛntə/ (n) (stabil, nav arch) the intersection of a vertical line through the centre of buoyancy of a floating body at equilibrium with the formerly vertical line through the centre of gravity of the body when the body is tilted (<http://www.thefreedictionary.com>); točka oko koje se brod okreće u poprečnom smislu **metacentar**: *As the ship is inclined through small angles of heel, the lines of buoyant force intersect at a point called the metacenter.* longitudinal **metacentre** uzdužni

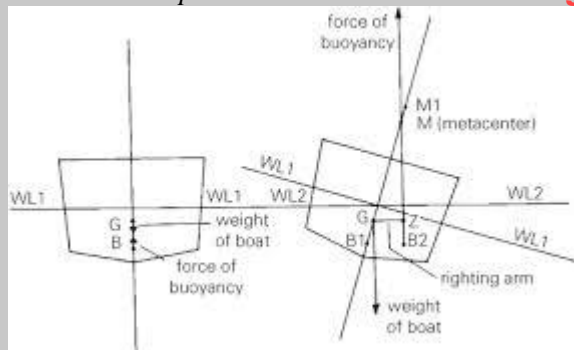

metacentar

{The metacentre remains directly above the centre of buoyancy regardless of the tilt of a ship.}

metacentric height; (GM) /,mɛtə'sɛntrɪk, haɪt/ (n) (nav arch) the vertical distance between the ship's centre of gravity and the initial transverse metacenter **metacentarska visina** initial

metacentric height; (GM) početna metacentarska visina: *Partially filled cargo tanks with no longitudinal bulkheads may cause large free surface effects to the extent that the initial metacentric height (GM) becomes negative.*, transverse **metacentric height; (GM)** poprečna

metacentarska visina, longitudinal **metacentric height; (GM)** uzdužna metacentarska visina

metacentric radius /,mɛtə'sɛntrɪk/ (n) (nav arch) metacentarski polumjer

metal /'mɛtəl/ (n) (marine eng) kovina, metal bearing **metal** ležajni materijal, white **metal** bijela kovina, bijeli metal, ferrous **metal** željezni metal, non-ferrous **metal** obojeni metal

meteorological /,mi:tiərə'ldʒɪkəl/ meteorološki

meteorological instrument /,mi:tiərə'ldʒɪkəl/ (n) (meteorol) meteorološki instrument

meteorological tides (n) (oceanogr) olujna plima i oseka

meteorology /,mi:tiə'rɒlədʒi/ (n) the study of the physics, chemistry, and dynamics of the atmosphere and the direct effects of the atmosphere upon the Earth's surface, the oceans, and life in general (Seasources.net) **meteorologija**

meteorological conditions /,mi:tiərə'ldʒɪkəl/ (n) (navig) vremenski uvjeti,

meteorološki uvjeti observe **meteorological conditions** pratiti vremenske uvjete

methane /'mi:θeɪn/ (n) metan

method of cargo handling (n) (cargo) način rukovanja teretom

method of payment (n) način plaćanja

methods of packing vrste pakiranja / pakovanja / ambalaže

metric tonne (UK); metric ton (US) (*n*) (*stabil, nav arch*) a unit of weight equal to 1,000 kilograms; a non-SI metric unit of mass equal to 1000 kilograms **metrička tona** {1 MT = 2,204.62lbs or 35.314 cft}

MF CW radar; multi-frequency continuous wave radar multifrekvencijski CW radarski prijemnik

mice /maɪs/ (*n*) **miševi** {plural od 'mouse'}

MIC; microwave integrated circuit (*n*) (*electr*) integrirani mikrovalni krug (radara) The MIC consists of a local oscillator and mixer circuits. Incorporating those devices on an IC improves quality, reliability, sensitivity and noise figure (nf).

micrometer /maɪ'krɒmɪtə/ (*n*) (*marine eng*) **mikrometar** **micrometer caliper** mikrometar na vijak

microprocessor /,maɪkrəʊ'prɒsɛsə/ **mikroprocesor**

midbody (*n*) (*nav arch*) **srednji dio trupa broda**

middle ground (*n*) (*navig*) a shoal, a sandbank or rock outcrop in a fairway, which effectively divides the fairway in two parts **plićina u sredini plovidbenoga kanala**

Middle Watch (*n*) **ponoćna straža** {od 00:00 do 04:00 sati}

mid perpendicular (*n*) (*nav arch*) **središnji perpendikular**

midshipman (*n*) (*navy*) a probationary rank held by young naval officers under training **brodski dočasnik**

Midships! (*navig, seamanship*) **Sredina!** {zapovijed za kormilarenje}

midships (*n*) **midships portion** srednji dio broda (*nav arch, seamanship*) **COMPARE zz_gen_cargo_ship_midship_section** sredina broda, srednji dio broda, u sredini broda **helm to midships** kormilo u sredini, Kormilo u sredinu!

midship section (*n*) (*nav arch*) the vertical transverse section located at the midpoint between the forward and after perpendiculars **glavno rebro** {poprečni presjek na glavnom rebru}

midship section plane (*n*) (*nav arch*) **ravnina glavnog rebra**

midships portion srednji dio broda

military submersible (*n*) (*navy*) **vojna ronilica**

milling machine (*n*) (*marine eng*) **glodalica, freza**

mine /maɪn/ **to strike a mine** udariti u minu, naletjeti na minu **mina**

mine clearance (*n*) (*safety*) **razminiranje, čišćenje mina**

minelayer (*n*) (*nav arch*) **minopolagač**

mineral ores (*cargo*) **rude minerala**

minesweeper (*n*) (*nav arch*) **minolovac**

minesweeping (*n*) (*safety*) **čišćenje mina**

minimal /'mɪnɪmə/ (*adj*) of the least possible; minimum or smallest (Collins on-line Dict.); Something that is minimal is very small in quantity or degree. **najmanji, minimalan, posve malen, neznan**

minimize; minimise /'mɪnɪ,maɪz/ (*v*) **smanjiti na minimum, minimizirati, umanjiti**

minimum /'mɪnɪmə/ (*adj*) 1. the least possible amount, degree, or quantity, 2. the least amount recorded, allowed, or reached, eg. temperature, 3. being the least possible, recorded, allowed, etc ⇒

minimum age, 4. (mathematics) a value of a function that is less than any neighbouring value (Collins on-line Dict.) **minimalan, najmanji**

minimum angle of flooding (n) (stabil) minimalni kut natapanja

minimum clearance equipment (n) (navig) mjerač najmanjeg razmaka

Ministry of the Interior (n) (mar law) Ministarstvo unutrašnjih poslova

minnow /'mɪnəʊ/ (n) 1 (fishing) a spinning lure imitating a minnow **varalica tipa minnow, rapala minnow**; 2 (fishing) mala slatkovodna riba koja se koristi kao mamac **minnow**

minor /'maɪnə/ (adj) 1 **ANTONYM major damage manji minor damage ANTONYM major damage manja šteta**; 2 manje važan, nevažan; 3 niži; 4 neznatan

minus /'maɪnəs/ (n) (prep, adj) minus, manje

MIO; Marine Information Overlays (n) (navig) environmental information that is not part of an electronic chart (e.g. tides, currents, ice etc.) **pomorski informacijski slojevi**

misalignment /'mɪsə'leɪnmənt/ (n) izvcentičnost, necentriranost

miscellaneous /,mɪsə'leɪniəs/ **razno, ostalo**

miscellaneous dangerous substances (n) (cargo) ostale opasne tvari {klasa 9 opasnih tereta}

mischievous /'mɪstʃɪf/ (n) (mar law) neprilika, nevolja, nezgoda

misdescribed (adj) (cargo) krivo opisanoteret

mishap /'mɪʃæp/ A mishap means an event that: causes any person to be harmed; or in different circumstances, might have caused any person to be

harmed.(<http://www.maritimenz.govt.nz/commercial/safety/accidents-reporting/definitions.asp>); A

mishap is an unfortunate but not very serious event that happens to someone. (Collins English Dictionary on Line) **nezgoda**

missile boat /'mɪsaɪl/ (n) (navy) raketnjača

missing (n) (safety) nestala osoba, nestali be **missing nestati** A total of six people are missing after two cargo ships sank in two separate incidents.

mist (n) (meteorol) microscopic water droplets suspended in the air which produce a thin grayish veil over the landscape **izmaglica, sumaglica** Mist reduces visibility to a lesser extent than fog.

Mitchell bearing (n) (marine eng) = **tilting pad bearing, thrust block odrivni blok**

mitigate /'mɪtɪ'geɪt/ (v) **ublažiti (štetu)**: The marine salvage authorities mobilized several assets to area to survey, contain and cleanup the fuel oil spill and mitigate any impacts to the environment.

mitigation /,mɪtɪ'geɪʃən/ (n) **ublažavanje mitigation of pollution effects ublažavanja posljedica onečišćenja**

mitigation of damage (n) (mar ins, cargo) **ublažavanje štete**

mix (v) (cargo) **pomiješati (teret)**

mixer (n) (electr) **mješalo (radara)**

mixture /'mɪkstʃə/ (n) (cargo) **mješavina, pomiješani teret, mješoviti teret**

mizzen (n) (boating/yachting) sail set on the aft mast **jedro na zadnjem jarbolu, mezzana**

mizzen mast (n) (boating/yachting) the third mast on a ship; aft mast of a sailing ship or boat **mali krmni jarbol (na keču ili jolu), krmni jarbol, tal. albero di mezzana**

Mk; (Mark) (n) = **mark oznaka**

mla (marine loading arm) (n) (cargo handling) dizalica (s crijevom / manigom za krcanje tankera)

MMSI; (Maritime Mobile Service Identity Number) (n) (comm) Identifikacijski broj pomorske mobilne postaje, jedinstveni devetoznamenasti identifikacijski broj mobilne postaje, identifikacijski broj broda ili postaje u opasnosti

mobile crane /'məʊbaɪl/ (n) (cargo handling) autodizalica



mobile earth station (MES) (n) (comm) zemaljska mobilna postaja {u satelitskoj komunikaciji}

MOB (man-overboard) lifering (n) (safety) pojas za spašavanje s dimnim i svjetlosnim signalom **MOB inflatable life ring** pojas za spašavanje s dimnim i



svjetlosnim signalom

modal /'mɔːdəl/ (adj) modalni

mode /mɔːd/ (n) (navig) način prikaza (radarske slike), oblik radarske slike **relative mode** relativna slika, **true mode** prava slika

model /'mɒdəl/ **model**, ogledni primjerak **IMO model course** ogledni tečaj IMO-a

moderate breeze /'mɒdərɪt/ (n) (meteorol) vjetar jačine četiri bofora i brzine od 20 do 28 kilometara na sat **umjereni vjetar**

moderate sea /ˈmɒdərɪt/ (*meteorol, oceanogr*) četvrti stupanj stanja mora s valovima visine od 1,25 do 2,5 metara **uzburkano more**

modulator (n) (*electr*) the device responsible for monitoring the magnetron **modulator rada magnetrona**

moist (*adj*) vlažan (teret)

moisture /ˈmɔɪstʃə/ (n) vlaga

mold /mɔʊld/ (n) (*marine eng, US*) 1 kalup; 2 odljev

molded breadth /mɔʊldɪd/ (US) teorijska širina broda, baždarska širina broda

mold (US); mould (UK) /mɔʊld/ (n) (*marine eng, nav arch*) kalup, odljev

mole /mɔʊl/ (n) 1 (*ports*) a a pier or breakwater protecting a harbour, usually used as a landing pier **gat, molo, điga, mul**; 2 lukobran, valobran; 3 nasip, lučki zaštitni nasip

mollusk /mɒləsk/ (n) (*fishing*) glavonožac

MOLOO (more or less in owner's option) (*shipping econ*) više ili manje, prema brodarovu izboru (o količini tereta)

molybdenum (Mo) /mɒˈlɪbdɪnəm/ (n) (*chem*) molibden

moment (n) (*stabil*) the tendency of a force to produce a rotation about a pivot point **moment**

moment of stability (n) (*nav arch*) **moment statičke stabilnosti**

moment of statical stability (n) (*stabil*) = **righting moment**; **RM** moment statičke stabilnosti

moment of transverse stability (n) (*nav arch*) **moment poprječne stabilnosti**

moment of initial transverse stability **moment početne poprječne stabilnosti**

moment of transverse statical stability (n) (*stabil*) **moment poprječne statičke stabilnosti**

moment to change trim (MCT) (n) (*stabil*) **moment promjene trima**

monel metal /mɒˈnɛl/ (n) (*marine eng*) **meonel metal (nikalna legura)**

monitor (n) **monitor traffic** **pratiti promet (brodova)** (*navig*) **pratiti**: the 3/O was monitoring the situation from the forward console **monitor the ship** **pratiti brod (na radaru)**: the crossing vessel failed to make reports to the VTS and hence was not being monitored., **monitor the ship's position** **pratiti poziciju broda**: The second officer monitored the ship's position using the cross track error facility on the Global Positioning System (GPS) receiver., **monitor visually**: The OWW was monitoring other vessels in the area visually, by radar and by AIS. **pratiti vizualno**

monitor (n) (*safety*) **protupožarni top**: The Master immediately requested permission from shore to cool the tank deck with sea water from **deck monitors**. The fire was extinguished in several minutes by the master and another crew member using **deck monitors**.

monitoring **praćenje, kontrola**

monkey island (n) (*seamanship, nav arch*) a flying bridge on top of a pilothouse or chart house



krov kormilarnice

monkey line (n) (seamanship) konop sa čvorovima (za penjanje)

monkfish /ˈmɒŋk, fɪʃ/ (n) (fishing) = **frogfish** Lat. *Lophius spp* grdobina, žaba, rošpo

mono (n) (fishing) **COMPARE fishing line** povraz od jedne niti, jendovlaktasti najlon, monofil

monofilament line (n) (fishing) povraz od jedne niti, **monofil**. Fluorocarbon is approximately the same diameter as nylon **monofilament** of the same break strength. The Trilene Fishing Knot is best for use with **monofilament** or **fluorocarbon** and is effective for tying line to snaps, swivels, hooks etc.

monopole antenna (n) (navig) monopolna antena

monsoon /mɒnˈsuːn/ (n) (meteorol) a persistent seasonal wind, often responsible for seasonal precipitation regime **monsun**

moon full moon puni mjesec: *The moon was full, hence the tides were larger than normal.*, **new moon** mlađ, mladi mjesec, **first quarter** prva četvrt, **last quarter** zadnja četvrt mjesec

moor /mɔː(r); muə; US muːr/ (v) **standing moor** sidrenje sa dva sidra, **running moor** sidrenje na jednom sidru, **to moor starboard / port side on / to vezati se / pristati desnim / lijevom bokom na obalu**, **to moor bow / stern on / to (ship handling) vezati se / pristati u četverovez pramcem / krmom na obalu** 1 (ship handling) to dock a ship; to make fast either to a laid mooring or to a quay or by dropping the anchor: *The vessel was securely moored alongside using self-tensioning winches.* Brod je bio sigurno vezan uz obalu koristeći samozatezna privezna vitla **moor alongside** privezati se uz obalu, **pristati uz obalu**, **privezati (brod) tal. ormeggiare; attraccare** *A small gas tanker was moored alongside a terminal berth; all mooring bollards were in use due to bad weather.*, **moor by the head** vezati se u četverovez pramcem na obalu, **moor by the stern** privezati se u četverovez krmom na obalu, **moor to starboard side** pristati desnom stranom uz obalu, **moor to port side** pristati lijevom stranom uz obalu, **moor stern on** privezati se u četverovez srmon na obalu, **moor bow on** privezati se u četverovez pramcem na obalu, **moor to the dolphins** privezati se na privezne stupove, **moor alongside a ship** privezati se bokom na drugi brod, **moor, moor with open hawse** privezati se s dva sidra po pramcu, **moor with two anchors ahead** privezati se s dva sidra po pramcu a (o brodu) **privezati se**: *The vessel was moored port side to the jetty, heading west, by four headlines, two forward breastlines, two forward springs, two aft springs and six sternlines to quick release hooks on the*

mooring dolphins; **2** (navig, ship handling) pristati uz / na obalu / na sidru: Vessels moor either port side or starboard side depending on the prevailing weather conditions and characteristics of the port facilities.; **3** (ship handling) to attach a boat to a mooring buoy or post **vezati se na sidru ili plutači / plutačama**; **4** usidriti se

moor /mɔː(r); mʊə; US mʊr/ (n) (seamanship, ship handling) vez, privez

moor bow to / on (v) (seamanship, ship handling) privezati se pramcem na obalu

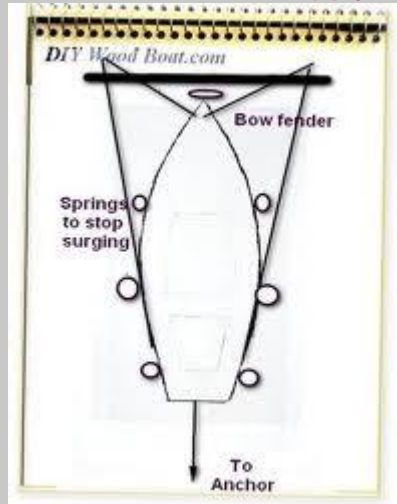

moor by the head (v) (seamanship, ship handling) privezati se pramcem na obalu

moored /mɔːd; mʊəd/ (adj) **1** (seamanship) privezan: Is the ship securely moored? Je li brod sigurno privezan?; **2** (seamanship) usidren: AIS data on Monday showed the vessel moored near Alesund, Norway as of 16:33 GMT.

mooring /ˈmɔːrɪŋ; ˈmʊərɪŋ; US ˈmʊrɪŋ/ **leave the moorings** napustiti vez **isploviti**, **mooring bow on / to** vezivanje / pristajanje u četverovez, pramcem na obalu, **mooring stern on / to** vezivanje / pristajanje u četverovez, krmom na obalu, **mooring port side on / to** vezivanje / pristajanje u lijevim bokom na obalu, **mooring starboard side on / to** vezivanje / pristajanje u desnim bokom na obalu **1** (ship handling, navig) = **docking = tying up** the operation of anchoring a vessel in a harbor, securing her to a mooring buoy, or to a wharf or dock by means of chains or ropes **privezivanje, vezivanje**



; 2 (*ship handling*) = **berthing** pristajanje; 3 (*ship handling*) the operation of anchoring a vessel in a harbor, securing her to a mooring buoy, or to a wharf or dock by means of chains or ropes **sidrenje**; 4 (*ship handling*) **vez na brodu, privezna užad na brodu forward/aft starboard mooring** pramčani/krmeni vez na desnoj strani broda, sva privezna užad na desnoj strani pramca/krme, **aft mooring** krmeni vez, **forward mooring** pramčani vez; 5 (*ship handling*) **vez na plutači**; 6 (*ship handling*) **vez, privez, muring, tal. ormeggio**

mooring (n) (*boating/yachting*) **vez na plutači**

mooring (n) 1 (*boating/yachting*) **sidreni blok, korpomorto**; 2 **sidrena užad u marini, muring**

mooring anchor (n) (*seamanship, ship handling*) **sidro za privezivanje, privezno sidro**

mooring area (n) (*navig, ship handling*) **područje sidrenja**

mooring arrangements (n) (*navig, ship handling*) **organizacija privezivanja, dogovor o privezivanju, upute za privezivanje**

mooring assistance (n) (*navig, ship handling*) **pomoć pri privezivanju**: *appropriate mooring assistance has been arranged*

mooring bitt (n) (*nav arch*) **bitva, privezna bitva**

mooring block (n) (*navig*) **sidreni blok, korpomorto**

mooring boats (n) (*navig, seamanship*) **privezivačka brodica, privezivački čamac**:

The forward mooring station lowered the headlines to the mooring boat but they could not be made secure in good time. Vessels Transiting the Canal must have Mooring Boats hired from Mooring Company and Approved by the Suez Canal Authority.

mooring buoy (n) (*boating/yachting, seamanship*) **privezna plutača, plutača za**

privezivanje, tal. boa d'ormeggio; gavitello: *The pilot boarded and we headed for the mooring buoy on a course of 2700.*

mooring cable (n) (*nav arch, seamanship*) **privezno uže, privezni konop**

mooring cleat (n) (*boating/yachting*) **kljuna, mala bitva**

mooring gear (n) (*seamanship*) **For mooring and anchor gear see SHIPBUILDING PICTURE**

DICTIONARY: <https://forshipbuilding.com/equipment/anchors/> uređaj za privezivanje, privezni uređaj tal. attrezzatura di ormeggio

mooring line

mooring line



{For mooring and anchor gear see: <https://forshipbuilding.com/equipment/anchors/>}

mooring line (*n*) (*seamanship, ship handling*) the chains or ropes used to tie up a ship **privezno uže**, **privezni konop**, **uže / konop za privezivanje**, **cima**, **lancana**, tal. **cavo di ormeggio** **mooring lines arrangement** **privezna užad broda**

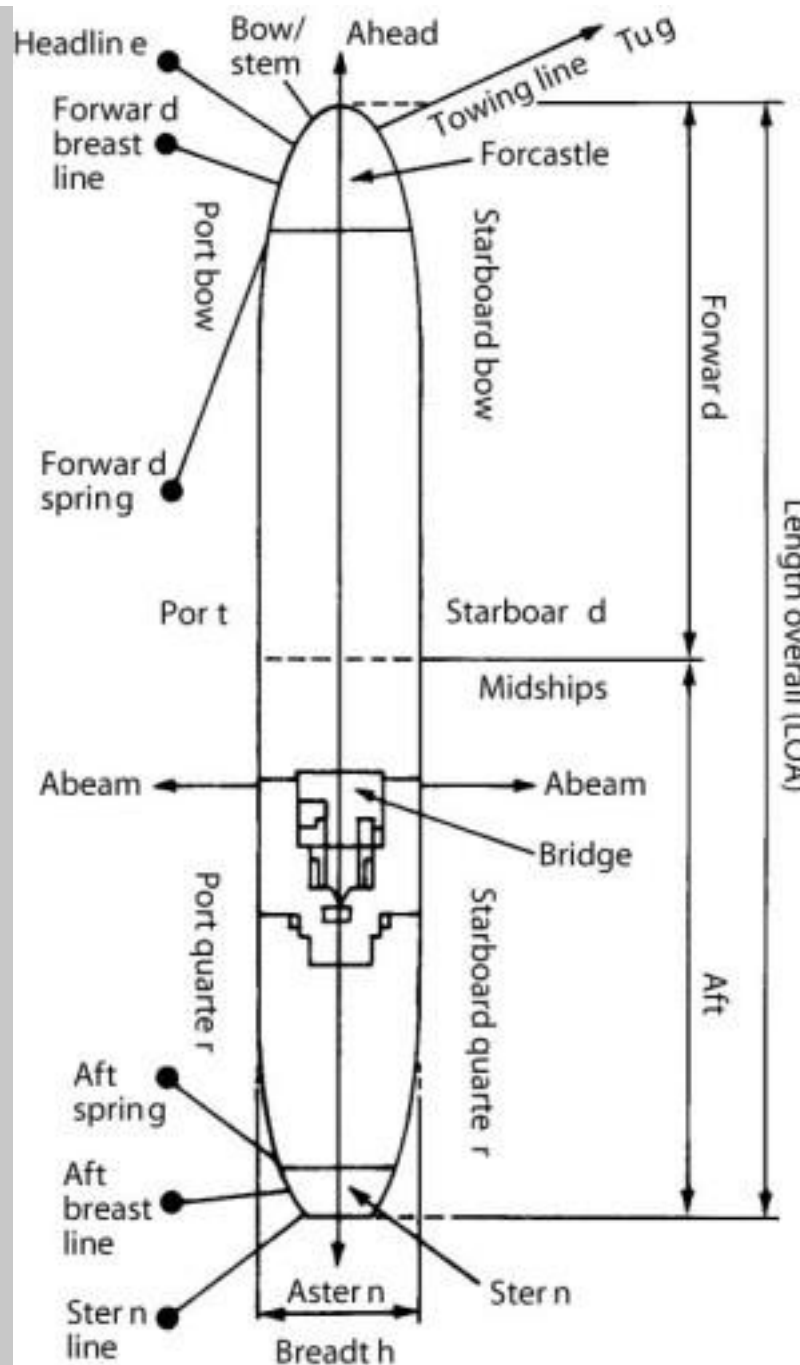

mooring man (n) (seamanship) privezivač, armizator

mooring party (n) (seamanship) privezivači (na obali), armizatori: *The forward mooring party, which initially consisted of an officer and two crewmen, was required to slack down the headlines and heave on the backsprings ...*

mooring pipe (n) (sailing vessels) oko za privezu, privezno oko

mooring post (n) (seamanship) privezni stup

mooring ring (n) (boating/yachting) metalni kolut ugrađen u obalni zid za vezivanje priveznoga užeta **privezni kolut, anel; tal. anello**

mooring rope (n) (nav arch, seamanship, ship handling) privezno uže, privezni konop:

The **mooring ropes** were wound on winch drums with brakes applied rather than being put onto bits.

shore mooring rope: In addition to five shore mooring ropes, four vessel's own mooring ropes were used, and the stern ramp was on the linkspan. In this instance, these consisted of five **shore mooring ropes** in addition to four of the vessel's own ropes, and the stern ramp was on the linkspan **Pored pet priveznih užadi koje je dala luka, korištena su četiri brodska privezna užeta, a krmena rampa je bila oslonjena na hidrauličkoj obalnoj ro-ro rampi.**, **vessel's own mooring rope** privezna užad s kopna, privezna užad koju daje luka, **wind the**



mooring rope on the winch namotati privezno uže na vitlo

moorings /'mɔːrɪŋz; 'mʊərɪŋz; US 'mʊrɪŋz/ **1** (seamanship, ship handling) **COMPARE**

mooring line privezivačka užad, brodski vez (krmeni ili pramčani vez), svi konopi (užad) na pramčanom ili krmenom vezu) **slip the moorings** isploviti, odvezati se, **check the moorings** provjeriti vezove broda, provjeriti priveznu užad,

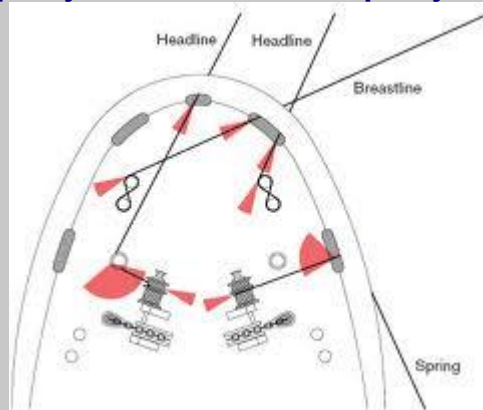

forward mooringss pramčani vez

, **aftmooringss**

krmeni vez, **shore moorings** privezna užad s kopna: Due to the poor weather forecast, all the available shore moorings were used to moor the vessel., **vessel's own moorings** brodska

privezna užad, privezna užad u vlasništvu broda, **shore moorings** privezivačka uža s kopna (u vlasništvu lučke privezivačke tvrtke) Due to the poor weather forecast, all the available shore moorings were used to moor the vessel., **ship's moorings** brodska

privezivačka užad, privezivačka užad koja pripada brodu; **2** sidreni konop (u marini), **muring**, privezna užad koju daje luka

moorings (n) (boating/yachting, seamanship, ship handling) vez na plutači

mooring shock absorber (n) (boating/yachting) čelični amortizer na oprugu oprugu (za priveznu užad)

mooring snubber (n) (boating/yachting) amortizer priveznog užeta **mooring rubber snubber** gumeni amortizer

mooring spring (n) (boating/yachting) gumeni amortizer (za privezne konope)

mooring station (n) (seamanship) privezno mjesto (na brodu), privezna postaja (na brodu):

All radio and talk-back contact was lost with the mooring stations. **forward mooring station**

privezno mjesto na pramcu broda *The forward mooring station was manned by the*

C/O, Bosun, an Ordinary Seaman (OS), a Trainee Seaman (trainee) and a deck cadet. **aft mooring**

station **privezno mjesto na krmi broda**, **call the crew to mooring stations**: *The master*

called the crew to mooring stations and requested that the vessel's main engines be started. **narediti**

posadi da dođe na mjesta za privezne postaje, **pozvati posadu na mjesta za**

manovru {Mooring stations include the forward station (bow, forecastle) and the aft station (stern, poop).}

mooring team (n) (seamanship) privezivačka skupina, privezivačka grupa,

privezivački tim: *The aft deck mooring team closed up as the pilot boarded, 15 minutes before the*

scheduled departure time, and a short time later, the officer-in-charge receive

mooring tower toranj za sidrenje, privezni toranj: *There are two versions of the mooring*

tower. One is where the tanker is moored along side a rigid that comes down from the tower and the other

being when the tanker is moored from the bow. Common for both is that a floating hose is connected to the

turntable at the dower so the tanker will still move according to environmental forces.



mooring warps (n) (boating/yachting) privezna užad, privezni konopi, vezaljke

mooring wharf (n) (ports) vez, pristan

mooring winch (n) (nav arch) pritezno vitlo: *The bosun and a seaman were carrying out*

routine greasing of a mooring winch. The first line, the forward spring from the starboard mooring winch,

was put ashore at 2130. **automatic mooring winch** automatsko pritezno vitlo



mooring wire (n) (seamanship, nav arch) privezno čelično uče, privezno čelik-čelo
moor stern to / on (v) (seamanship) privezati se krmom na obalu

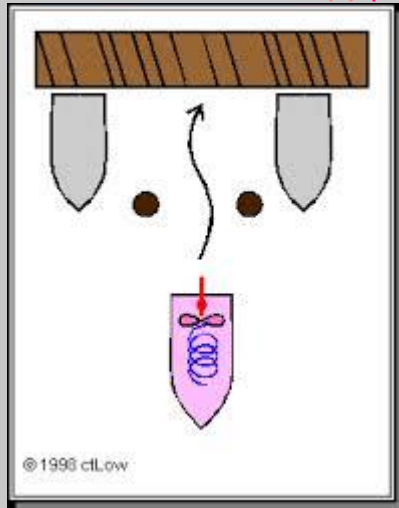

moor to four+two+two fore and aft (v) (ship handling) privezati brod s dva pramčana užeta, dva bočna užeta i dna špringa na pramcu i krmi: *We moored to four+two+two fore and aft, all with rather short leads.*

moray /mɔːˈreɪ; US ˈmɔːreɪ/ (n) (fishing) = **moray eel** murina **Mediterranean moray**



murina

{lat. Muraena}

moray eel (n) (fishing) murina

morning watch (n) jutarnja straža, jutarnja gvardija

Morse code /mɔːs/ Morzeova abeceda

morse lights /mɔːs/ morze svjetla

mortgage /ˈmɔːɡɪdʒ/ **joint mortgage** zajednička hipoteka **1** hipoteka, založnica, založno pravo, **mortgage registered mortgage** hipoteka na brodu upisanom u upisnik brodova; **2** Termin mortgage razlikuje se od termina pomorska hipoteka po tome što „mortgage poznaje i dopušta stupanje vjerovnika u posjed, tj. deposesiju broda u slučaju propusta dužnika, dok hipotekarni vjerovnik može samo tražiti prodaju broda“ (Čorić, 1993). Security on a ship and its appurtenances by the shipowner as security for a loan. It is derived from the English common law chattel mortgage and is similar to the hypothèque maritime of the civil law.(Tetley) **pomorska hipoteka**

mortgage claim (n) (mar law) an agreement under which a person borrows money to buy property, esp a house or a ship, and the lender may take possession of the property if the borrower fails to repay the money; zahtjev hipotekarnoga vjerovnika prema hipotekarnomu dužniku zaštićen

obveznim pravom **hipotekarna tražbina**

mortgagee /,mɔ:gi'dʒi:/ (n) (mar law) **hipotekarni vjerovnik**

mortgage of ships (n) (mar law) a mortgage provides a creditor with security for the repayment of a loan or the performance of some other obligation by the acquisition of a property interest in the ship. It may in fact be used to secure any financial obligation involving the ... operation of a ship.

(www.duhaime.org) **hipoteka na brodu, ugovorno založno pravo (hipoteka na brodu), hipotekarna tražbina**

mortgage on a ship (n) (mar law) **hipoteka na brodu**

mother vessel (n) (shipping econ) Main ocean vessel in a liner service designated to move containers from set origin points to set destination ports/points on a regular basis.

(http://www.maerskline.com/en-jm/help/shipping-glossary) **matični brod**

motion /'mɔʃən/ (n) 1 (phys, marine eng) **gibanje, kretanje** **rotary motion** **kružno gibanje, whirling motion** **vtložno gibanje**; 2 **pomicanje**; 3 (mar law) **prijedlog za tužbu, pokretanje postupka**

motor /'mɔʊtə/ (n) 1 (electr) **elektromotor** **A.C motors** **motori izmjenične struje, D.C. motors** **motori istosmjerne struje**; 2 (marine eng) **pokretač, motor**

motor boat (n) (nav arch) **motorna brodica, motorni čamac**

motor driven pump (n) (electr) **elektromotorna pumpa**

motor generator (n) (electr, navig) **jedinica napajanja (radara)**

motor launch (n) (nav arch) **motorna brodica**

motorman /'mɔʊtəmən/ (n) (n) **motorist**

motorsailer (n) (nav arch) **motorna jedrilica, motorsailer, motorsejler**



motor ship, motorship; (m.s.) /'mɔʊtəʃɪp/ (n) (nav arch) **motorni brod, brod na motorni pogon**

motor vehicles (n) (cargo) **motorna vozila**

motor vessel, (m.v.) (n) (n) (nav arch) = **motor ship, motorship; (m.s.)** **motorni brod, brod na motorni pogon**

moulded beam (UK), molded beam (US) (n) (nav arch) = **moulded breadth** **teorijska širina broda, baždarska širina**

moulded breadth /mɔʊldɪd/ (n) (nav arch, UK) **teorijska širina broda, baždarska širina**

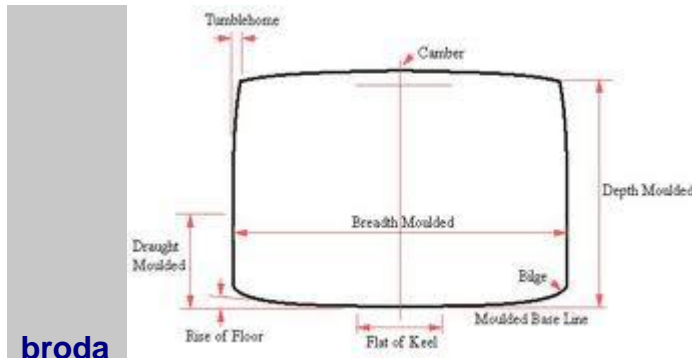

broda

moulded depth (n) (nav arch) baždarna visina trupa broda

moulded depth of ship (n) (nav arch) teorijska visina broda

moulded draught (n) (nav arch) teorijski gaz broda

moulded surface (n) (nav arch) teoretska forma

mould (UK); mold (US) /məʊld/ (n) (marine eng, nav arch) kalup, odljev

mould; (US mold) (n) (marine eng, UK) 1 kalup; 2 odljevak

mouldy /məʊldi/ (adj) pljesniv (teret)

mount /maʊnt/ (v) postaviti, ugraditi: *mount the instrument on shock-absorbing material* {MOUNT ne znači MONTIRATI!. Ekvivalent za montirati je FIT, INSTALL}

mounting (n) 1 (marine eng) postolje; 2 montiranje; 3 (nav arch) postolje na palubi

deck mounting postolje na palubi: *The front bench seat was torn from its deck mountings, plunging two of the children into the water. The incident caused considerable damage, with the Panama fairlead detached from the deck plating, an air vent pipe detached from deck mounting, ...*

mouth (n) (geogr) ušće (rijeke)

movable jaw (n) (marine eng) škrip, morša

move /mu:v/ (v) 1 gibati se; 2 kretati se; 3 micati se: *At the berth we had to move the ship 20 meters astern.*

move ahead (v) (seamanship, comm) pomaknuti brod naprijed (na vezu): *Move ahead 20 metres.*

move astern (v) (seamanship, comm) pomaknuti brod nazad **move astern 10 metres.**

move away from the quay (v) (ship handling, seamanship) udaljivati se od obale /

veza: *With the combined effects of the turning moments created by the rudder and the forward spring, the stern of the ship gradually moves away from the wharf.*

move headway (v) (ship handling) kretati se naprijed

movement /'mu:vmənt/ (n) 1 (phys) gibanje **up-and-down movement** izmjeneično

gibanje, recipročno gibanje; 2 kretanje; 3 micanje; 4 (shipping econ) promet (tereta

u luci): *The Terminal's excellent passenger and freight facilities ensure smooth and efficient movement of passengers and freight through the port and onwards to their ultimate destinations* **annual cargo**

movement godišnji promet tereta

movement of cargo 1 (n) (shipping econ) transport tereta, promet tereta (u luci); 2 (cargo) pomicanje / gibanje tereta

move off the quay (v) (seamanship) odmicati se od obale: *Despite the efforts of the tug, the stern moved off the quay, requiring the stern door to be lifted clear of the linkspan.*

move sternway (v) (ship handling) kretati se natrag / krmom

move the cargo 1 a (v) (*shipping econ*) transportirati teret (npr. putem neke luke);
2 prenositi teret; **3** premjestiti teret

moving parts (n) (*marine eng, boating/yachting*) pokretni dijelovi (motora)

M.Sc; Master of Science (n) (*mar law*) magistar znanosti, magistar inženjer, mag. ing.

M.Sc; Master of Science in Marine Engineering (n) (*mar law, navig*)

COMPARE BSc Degree Marine Engineering magistar znanosti brodstrojarstva i tehnologije pomorskog prometa; akademsko zvanje

M.Sc; Master of Science in Marine Operations Management - Nautical Studies (n) (*mar law, navig*) **COMPARE M.Sc; Master of Science in Marine Operations Management - Nautical Studies** magistar nautičkih znanosti i tehnologije pomorskog prometa; akademsko zvanje

MSDS; (Materials Safety Data Sheet) a document that contains information on the potential hazards (health, fire, reactivity and environmental) and how to work safely with the chemical product. It is an essential starting point for the development of a complete health and safety program. It also contains information on the use, storage, handling and emergency procedures all related to the hazards of the material. **tabelarni podaci o potencijalnim opasnostima kemijskih tvari u prijevozu**

MS; M.S.; M/S; (Motor Ship) (n) (*nav arch*) brod an motorni pogon

MTC; moment to change trim 1 cm (n) (*stabil*) the longitudinal moment required to change the trim one centimetre **moment promjene trima za 1 cm zagažaja**

MTI; Moving Target Identification (n) (*navig*) izdvajanje pokretnih ciljeva (na radaru), otkrivanje pokretnih ciljeva (na radaru)

MTI radar; moving target indication radar (n) (*navig*) radar za izdvajanje pokretnih ciljeva / OBJEKATA

MT1; Moment to Change Trim One Inch (n) (*stabil*) moment promjene trima za jedan inč

mt; M.T. (motor tanker) tanker

MTS (metric tons) metričke tone

mucking /'mʌkiŋ/ (n) (*safety, cargo handling*) collecting all the sludge in bags and leave them inside cargo tanks to be disposed in the next port of call **skupljanje i odlaganje taloga iz tanka**: *After all cargo tanks have been washed, purged and gasfree we will start with mucking operation.* **cargo tanks mucking odlaganje taloga iz tankova za teret, start mucking započeti skupljanje i odlaganje taloga, stop mucking zaustaviti skupljanje i odlaganje taloga**

mud (n) **mulj**: *a great deal of mud was stirred up by the propeller the cooling water side of the condenser was completely filled with mud* **glutinous mud ljepljivi mulj**

mule (n) (*navig*) the ships are guided though the lock chambers by electric locomotives, known as 'mulas' (mules) **električna lokomotiva (u Panamskom kanalu)**: *The mules are used for side-to-side and braking control in the locks, which are narrow relative to modern-day ships.*

multiple echo (n) **višestruka jeka**

mullet (n) (*fishing*) lat. *Liza spp* **cipal, porodica cipala grey mullet cipal**

multiblade rudder (n) (nav arch) višeplošno kormilo

multihull /ˈmʌltiˌhʌl/ (n) (nav arch) višetupac

multimodal carriage /ˌmʌltiˈməʊdəl/ (n) (shipping econ) the transport of goods by two or more carriers using two or more modes of transport or types of carriage (i.e. truck, rail, sea and air).

multimodalni prijevoz

multimodal or combined bill of lading /ˌmʌltiˈməʊdəl/ (n) (mar law) A through bill of lading (infra) which involves at least two different modes of transport - road, rail, air and sea

multimodalna ili kombinirana teretnica, direktna teretnica

multi-modal transport (n) (shipping econ) multimodalni transport

multimodal transport /ˌmʌltiˈməʊdəl/ mješoviti prijevoz, multimodalni transport

multimodal transport operator /ˌmʌltiˈməʊdəl/ (n) (shipping econ) = **combined transport operator** poduzetnik mješovitoga prijevoza

multiple /ˈmʌltipəl/ (adj) višestruk, višekratan, mnogobrojan **multiple echo** (navig) višestruka jeka

multiple-buoy mooring (MBM) /ˈmʌltipəl/ sidrenje / vez na više plutača



multiple-point mooring (MPM) /ˈmʌltipəl/ **COMPARE multiple-buoy mooring (MBM)** sidrenje / vez na više točaka (sidara i/ili plutača)

multiple-time-around echoes (n) (electr, navig) jeka druge vremenske baze (radara)

multiplication /ˌmʌltipliˈkeɪʃən/ (n) (math) **COMPARE addition, subtraction, division** množenje

multiplied by /ˈmʌltiˌplaɪd/ (adj) = **dividers** pomnožen s

multi-purpose port /ˌmʌltiˈpɜːpəs/ (n) (shipping econ) višenamjenska luka

multi-purpose ship /ˌmʌltiˈpɜːpəs/ (n) (nav arch) višenamjenski brod

multipurpose tug /ˌmʌltiˈpɜːpəs/ (n) (nav arch) višenamjenski tegljač

murry (n) murina

mushroom anchor (n) (nav arch, boating/yachting) gljivasto sidro

mushroom ventilator (n) (boating/yachting) a ventilator whose top is shaped like a mushroom and fitted with baffle plates so as to permit the passage of air and prevent the entrance of rain or spray

odušna gljiva, gljivasti ventilacijski otvor na kabini

musky octopus (n) (fishing) Lat. Eledone moschata **muzgavac**



mussel /ˈmʌsəl/ (n) (fishing) = **Mediterranean mussel** dagnja

muster /ˈmʌstə/ to hold a **muster** vršiti prozivku / prozivanje posade (na zbornom mjestu) **1** zbor članova posade (u izvanrednim prilikama, vježbama gašenja požara, napuštanja broda itd.): *The reserve team was the only one to report a full muster.*; **2** proziv, prozivanje, prozivka, glavna prozivka

muster /ˈmʌstə/ (v) **obaviti proziv**: *All passengers were mustered at their their assembly stations. The crew **mustered**, donned lifejackets and deployed a liferaft as a precaution. The crew **mustered on the bridge** and the chief engineer went to the engine control room to investigate. The general alarm was sounded and the crew **were mustered**.*

muster list /ˈmʌstə,lɪst/ (n) **1** (navig, safety) **a raspored za uzbunu**; **2** proziv za uzbunu, prozivanje posade na zbornom mjestu

muster role raspored za uzbunu

muster station /ˈmʌstə,steɪʃən/ (n) (safety) zborna mjesto, mjesto okupljanja (za prozivku)

muzgy octopus (n) (fishing) muzgavac, mrkač {lat. *Eledone moschata*}

MV; (motor vessel) (n) (nav arch) motorni brod

mv; **M.V.** (motor vessel) motorni brod

MY; (motor yacht) (n) (nav arch) motorna jahta

NAABSA (not always afloat but safely aground) (mar law) brod koji nije uvijek u plutajućem stanju, ali leži sigurno na dnu (npr. brod koji se oslanja na dno u lukama s plimnim režimom, čekajući plimu)

nadir /ˈneɪdɪə ; ˈnædɪə/ 1.the point on the celestial sphere directly below an observer and diametrically opposite the zenith **nadir**

naked light (n) **1** (marine eng) open flame, such as match or burning cigarette **otvoreni**

plamen (npr. cigaredte); **2** (safety) nezaštićeno svjetlo

named (n) (shipping econ) imenovan, naznačen (teret)

named bill of lading (n) (mar law) A bill of lading providing for the delivery of the goods to a named person, without also specifying to order or assigns. The named consignee obtains delivery of the goods by surrendering one of the originals of the bill to the carrier or his agent. Although a document of title, the nominate bill of lading is not negotiable. (Tetley) **teretnica na ime**

name of ship (n) (mar law) ime broda

name the ship (v) (nav arch) **krstiti brod, dati brodu ime**: *The first hybrid tug to operate in German waters was officially named during a party held Thursday in the Port of Bremerhaven.*

naming ceremony (n) (nav arch) **svečanost krštenja broda**: *A naming ceremony was held today for Finland's new-generation icebreaker, Polaris, built at Arctech Helsinki Shipyard.*

naphtha /ˈnæfθə; ˈnæpθə/ (n) (cargo, marine eng) a distillation product from petroleum boiling in the approximate range 100–200°C and containing aliphatic hydrocarbons: used as a solvent and in petrol (collinsdictionary); a general term that has been used for over two thousand years to refer to flammable liquid hydrocarbon mixtures (Wikipedia) **nafta (kao derivat), nafta (gorivo)**: *A cruise ship was involved in a collision with a tanker carrying flammable naphtha early Saturday morning in the Dardanelles strait near Gallipoli, Turkey. flammable naphtha zapaljiva nafta {it is used differently in different industries and regions to refer to gross products like crude oil or refined products such as kerosene (Wikipedia)}*

Narcotics List /na:ˈkɒtɪks/ (mar law) popis narkotika, narkotik lista

narrow area (n) (navig) **područje skućenih voda, područje ograničene plovidbe**: *If the master was not familiar with the situations like the actual one, where the fully loaded ship is to navigate in a narrow area with shallow water.*

narrow channel (n) (navig) uski kanal

narrow rope (n) (seamanship) jedrenac

narrows (n) (geogr, navig) the most confined part of a fairway, channel, sound, strait, river **tjesnac, uski kanal, najuži dio plovidbenoga kanala**

national claims to maritime jurisdiction /ˈnæʃənəl/ (mar law) nacionalne/državne pretenzije za nadležnost nad pomorskim područjem

nationality of the ship /ˌnæʃəˈnæliiti/ (n) (mar law) državna pripadnost broda

natural boil off gas; NBOG (n) (marine eng, nav arch) ispareni ukapljeni prirodni plin, vaporizirani ukapljeni prirodni plin: *In the Wärtsilä 5RT-flex50DF two-stroke dual-fuel engine burns the "natural boil off gas" (NBOG) which arises through vaporisation of a small part of an LNG carrier's cargo due to the ambient air and sea temperatures and the motion of the ship.*

natural circulation /ˈnætʃrəl/ (n) (marine eng) = natural draught; natural draft prirodna cirkulacija (zraka)

natural draught; natural draft (n) (marine eng) prirodni propuh, prirodna cirkulacija zraka

nature of cargo (n) **1 a** (cargo) karakteristike tereta, narav tereta; **2** vrsta tereta

nature of the goods (n) (cargo) karakteristike robe

Nautical Almanac /ˈnɔ:tɪkəl, ˈɔ:lmə, næk/ (n) (navig) nautički godišnjak



nautical assessor /'nɔ:tɪkəl/ (n) (mar law) Court-appointed experts (usually on matters of navigation and seamanship) who sit with the judge on the bench during the trial of maritime disputes and give their opinions to the judge, at his request, on matters relating to their field of expertise. (Tetley)
sudski nautički vještak, nautički ekspert-istražitelj

nautical chart: This information was included in the sailing direction abstract which was attached to the passage plan and also marked on **nautical chart** with a caution symbol.

nautical publications /'nɔ:tɪkəl/ (n) (navig) Nautical publications include: List of radio signals, Catalogue of charts and publications, Notices to mariners, Sailing directions, List of light and fog signals, Tide tables **nautičke publikacije**

nautical tables /'nɔ:tɪkəl/ (n) (navig) **nautičke tablice**

nautical tourism /'nɔ:tɪkəl/ (n) (boating/yachting) **nautički turizam**

nautics /'nɔ:tɪks/ (n) (boating/yachting) **nautika**

NAV (n) (navig) **kontrola na radaru za pokazivanje/skrivanje navigacijskih podataka**: The NAV key shows/hides navigation data, including position, range and bearing to waypoint, ship's speed and more.

NAVAIDS /'næveɪds/ **navigacijska pomagala (na brodu)**

naval /'neɪvəl/ (adj) **1 mornarički, koji se odnosi na ratnu mornaricu naval craft ratni brodovi, naval base mornarička baza; 2 pomorski; 3 brodski naval brass brodska mjed**

naval architect /'neɪvəl ,a:ki,tɛkt/ (n) (marine eng) **inženjer brodogradnje**: The naval architect is concerned with the hull, its construction, form, habitability and ability to endure its environment.

naval base (n) (navy) **mornarička baza**: Accidental discharge of carbon dioxide resulted in serious injury to a shore-based engineer at the Naval Base.

naval medicine (n) (med) = **marine medicine** **brodska medicina**

naval movements (n) (navy) **kretanje ratnih brodova**: Ch13 is normally used by the naval tugs and to control naval movements within the naval base

naval officer (n) (navy) **mornarički časnik**



naval rank (n) (navy) **mornarički čin**

naval submersible (n) (navy) vojna ronilica

naval yard (n) (navy) vojno brodogradilište

NAVAREA Warnings /'næv,ɛəriə/ (n) (navig) the world is divided into 16 NAVAREAS. Warnings are issued when there is a need for immediate information regarding new dangers or changes in navigational aids **upozorenja za glavna (svjetska) plovibena područja**



navigability; /,nævigə'biliti/ (n) (safety, navig) plovnost

navigable /'nævigəbəl/ (adj) (navig) plovan, po kojem se može ploviti **navigable waterway** plovibeni kanal

navigableness /plovnost/ (n) (navig) plovnost

navigable waterway (n) (navig) plovní put

navigate /'nævi,geit/ (v) (navig) ploviti

navigate blind (v) (navig): On leaving the charted area the ship was **navigated blind**, at full sea speed as it approached shallow water and an area of course alterations.

navigating /'nævi,geitin/ (adj) (navig) plovibeni, koji se odnosi na plovidbu

navigating bridge (n) (navig) the conning station or command post of a ship **zapovjednički**

most, komandni most, tal. ponte di comando: Details were reported to the **navigating bridge**, and the chief engineer advised that the fixed CO₂ system needed to be used.



navigating cadet (n) (mar law) vježbenik palube, kadet, kado: A navigating cadet is an apprentice officer who provides assistance in various duties on a merchant ship, such as maintenance and minor repair duties. This level is necessary for further career development in deck department.

navigating in fog (n) (navig) plovidba u magli

navigating lights (n) (navig) navigacijska svjetla: It was dark and the skipper was able to see the **south cardinal navigation light** marking the exit on the other side of the wind farm, as well as the rows of red aviation safety lights on the wind turbines. The mast head tricolour **navigation light** was on, and a "rain-catcher" radar reflector was hoisted.

navigating officer (n) (mar law) časnik palube: The navigating officer is responsible for safe

navigation of the ship, and its cargo operations.

navigation /,nævi'geɪʃən/ (n) (*navig*) plovidba, navigacija, moreplovstvo **Board of navigation** (*mar law*) ministarstvo pomorstva, ministarstvo trgovačke mornarice, **navigation in coastal waters** obalna navigacija, plovidba u obalnim vodama, **terestrička navigacija**, **navigation in ocean waters** navigacija na otvorenom moru, **navigation in heavy weather** plovidba u nevremenu, **navigation in restricted visibility** plovidba u smanjenoj vidljivosti, **navigation in ice** plovidba u uvjetima leda, plovidba kroz led, **ocean navigation** ocenaska navigacija, na vigation na otvorenom moru, **polar navigation** polarna navigacija, **electronic navigation** elektronička navigacija, **barhymetric navigation** batimetrijska navigacija, **hyperbolic navigation** hiperbolička navigacija, **inertial navigation** inercijalna navigacija, **satellite navigation** satelitska navigacija, **RDF navigation** navigacija koja koristi linije položaja slušanjem ili smjeranjem radiofarova, **radar navigation** navigacija radarskim smjeranjem, **dead reckoning navigation** zbrojena navigacija, **celestial navigation** nebeska navigacija, astronomska navigacija, **astronomical navigation** astronomska navigacija, **terrestrial navigation** infrequent (see: coastal navigation) **terestrička navigacija**, obalna navigacija, **piloting** obalna navigacija

navigational /,nævi'geɪʃənəl/ (adj) (*navig*) navigacijski, plovidbeni

navigational aids (n) (*navig*) pomorske oznake {lighthouses, seamarks, lights, buoys etc. in the fairway}

navigational assistance service (n) (*navig, safety*) služba koja pomaže brodovima prema zahtjevu ili potrebi u otežanim navigacijskim ili meteorološkim okolnostima **služba navigacijske pomoći**

navigational equipment (n) (*navig*) navigacijski uređaji: *The ship is fitted with navigational equipment consistent with SOLAS requirements. The equipment includes two global positioning system (GPS) units, an automatic radar plotting aid (ARPA) equipped radar with GPS input and a gyro compass with an auto-pilot.*

navigational instruments (n) (*navig*) navigacijski instrumenti **log brzinomjer**, **depth sounder dubinomjer**, **wind instruments vjetromjeri**, **calibrating instruments elektronički instrumenti**, **radar radar**, **GPS GPS-uređaji**, **chart plotter ploter karta**, **GMDSS and DSC GMDSS i DSC**, **AIS AIS**, **navtex navtex**, **weather fax vremenski faks**, **integrated navigation system sustav integrirane navigacije**, **communication**



systems sustavi veza

navigational publications (n) (*navig*) **SYNONYM reference books**

navigacijski priručnici *appropriate charts and navigational publications must be corrected to date*

nautical almanac **navigacijski godišnjak**, **nautički almanah**, **pilot book** **peljarska knjiga**, **peljar**, **tidal atlas** **plimni atlas**, **instruction manuals** **priručnici s uputama**, **lights and radio signals** **svjetlosni i radio signali**

navigation bridge (n) (nav arch) **navigacijski most**

navigation bridge deck (n) (nav arch) **paluba navigacijskog mosta**

navigation hazard (n) (safety) **opasnost za plovidbu**: *The passage plan was not properly checked for navigational hazards using the ECDIS 'check-route' function.*

navigation instruments (n) (boating/yachting, navig) **navigacijski instrumenti**, **ploča s navigacijskim instrumentima**

navigation lights (n) (navig) **navigacijska svjetla** **white light** **bijelo svjetlo**, **all-round white light** **kružno bijelo svjetlo**, **masthead tricolour light** **jarbolno svjetlo**, **separate lights** **odvojena svjetla**, **basic navigation lights** **temeljna svjetla**

navigation light sectors (n) (navig) **sektori navigacijskih svjetala**, **sektori broskog svjetla**

navtex, navigation telex /'næv,tɛks/ (n) (oceanogr, meteorol, comm) **navigacijski teleks**, **navteks** **navtex, navigation telex receiver** **prijemnik navteksa**



navy (n) (navy) **ratna mornarica**

NB (N.B., nb, n.b.) /'nɛute 'bi:ni/ **Napomena!**, **Upamti!** {lat. *Nota bene!*}

neap tide /ni:p/ (n) (oceanogr) **ANTONYM spring tide** a tide of less than average range, caused by the gravitational forces of the moon and the sun opposing each other **mrtva morska**

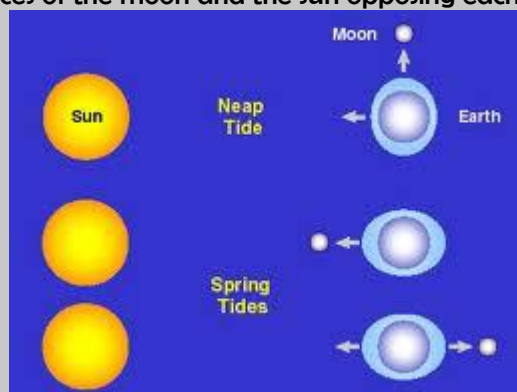

mijena, tal. *acqua morta*

near-coastal voyages (n) (mar law) priobalna putovanja

near gale (n) (meteorol) vjetar jačine sedam bofora i brzine od 50 do 61 kilometara na sat **žestoki vjetar**

near miss (n) (navig, safety) izvanredni događaj na moru koji je mogao prouzročiti štetne posljedice za ljudske živote, imovinu ili okoliš, ali ih nije prouzročio; a sequence of events that could have lead to an unfortunate condition, but the loss was prevented due to a fortune or sudden break in the train of events, thus preventing an accident (<http://www.marineinsight.com>) **izbjegnuta nezgoda**: *Near miss in Port Approach Channel. Near miss is considered as a primary stage and steps are taken to avoid such conditions.* **near miss reporting izvješćivanje o izbjegnutim nezgodama**

needlepoint (n) (fishing) vršak udice

neglect /ni'glect/ (v) (mar law) propustiti, zanemariti

neglect /ni'glect/ (n) (mar law) nemar, propust

negligence /'neglidʒəns/ (n) (mar law) **negligence clause** klauzula o nemarnosti nemar, nepažljivost

negligence clause /ni'glect/ (n) (mar law) klauzula o nemarnosti

negligence general average clause /ni'glect/ (n) (mar ins) = **Jason Clause** klauzula o nemaru u zajedničkoj havariji

negligent /'neglidʒənt/ (adj) neman

negotiable /ni'gəʊfəbəl/ (adj) 1 (mar law) utrživ, koji se može prodati, **negocijabilan negotiable Bill of Lading negocijabilna teretnica**; 2 prenosiv

negotiable bill of lading (n) (mar law) Something that can be negotiated, transferred or assigned from one person to another in return for equivalent value by being delivered either with endorsement (as of an instrument to order) or without endorsement (as of an instrument to bearer) so that the title passes to the transferee who is not prejudiced in his rights by any defect or flaw in the title of prior parties nor by personal defenses available to prior parties among themselves provided in both cases that the transferee is a bona fide holder without notice

(<http://www.maerskline.com/en-jm/help/shipping-glossary>) **negocijabilna teretnica, prenosiva teretnica, utrživa teretnica**

negotiable document of title /ni'gəʊfəbəl/ (n) (mar law) prenosiv vrijednosni papir

negotiable instrument /ni'gəʊfəbəl/ (n) (mar law) prenosivi dokument; kao instrument, teretnica može biti prenosiva, tj. njome se može prenijeti pravo na predaju robe **negocijabilni instrument**

negotiate a bend (v) (navig) ploviti zavojem rijeke, isplanirati manovru plovidbe zavojem rijeke

negotiate a course change (v) (navig) izvesti promjenu kursa (u ograničenim vodama), isplanirati manovru promjene kursa (u ograničenim vodama) *pilotage plan for negotiating a 90° course change between the reefs*

Neptune /'neptju:n/ (n) Neptun, bog mora (starogrčki)

net ribarska mreža **haul the net** potezati mrežu, **seine net** mreža plivarica, **shoot the net** spuštati mrežu, **recover the net** podići mrežu, **tow the net** vući mrežu, **povlačiti mrežu**: *The trawler was towing its nets on a COG of 153° at a speed of 4.8kts*

net profit neto dobit, čista dobit (iz poslovanja)

netting needle (n) (seamanship) igla za mrežu

net tonnage (n) (nav arch) **COMPARE gross tonnage** the net tonnage is produced by a formula which is a function of the moulded volume of all cargo spaces of the ship; the internal cubic capacity of a vessel which remains after the capacities of certain specified spaces have been deducted from the gross tonnage **neto tonaža**

network (n) mreža (npr. putova)

neutral equilibrium (n) (nav arch) = **indifferent equilibrium** indiferentna ravnoteža

nevertheless /ˌneɪvðəˈles/ 1 (conj) usprkos tome, ipak, bez obzira na; 2 ništa manje {= even so, still, however, yet, regardless, nonetheless, notwithstanding,}

newbuild (n) (nav arch) novogradnja

newbuilding (n) (nav arch) = **ship under construction** a new ship under construction or just completed **novogradnja** **newbuilding** No. 457 **Novogradnja broj 457**

new moon (n) (navig) mladi mjesec, mlad

new ship (n) (nav arch) brod koji podliježe primjeni određenih pravila i propisa zbog rokova u kojima se odvijaju faze gradnje **novi brod**

newsprint carrier (n) (nav arch) brod za papir

newsprint ship (n) (nav arch) brod za papir, brod za prijevoz papira

next of kin (n) 1 a (mar law) rođak; 2 srodstvo

nickel (Ni) /ˈnikəl/ (n) (chem) nikalj, nikal, niki

night orders (n) (navig) 1 The means by which the captain informs the officer of the deck of his orders for operating the ship. **zapovijedi za stražu na mostu za sljedeća 24 sata** *Night orders include assigned operating areas, maximum speeds allowed, required positions with respect to PIM or DR, and, regarding submarines, the maximum depth at which the ship can operate. (Bowditch) As the master completed his night orders, the second officer arrived on the bridge to take over as the officer of the watch (OOW).*; 2 **zapovijedi za noćnu stražu na mostu** {The Night Order Book, despite its name, can contain orders for the entire 24 hour period for which the Captain or Commanding Officer issues it.}

nimbostratus /ˌnimbə(ʊ)ˈstrɑːtəs, -ˈstreɪtəs/ (n) (meteorol) nimbostratus, gusti oblak s tamnom osnovom

NIR; non-ionising radiations (n) (med) neionizirajuća zračenja

nitriding /ˈnaɪtraɪdɪŋ/ (n) (marine eng) nitriranje

nitrogen /ˈnaɪtrədʒən/ (n) (chem) dušik *The atmosphere is usually established by flushing the container with nitrogen and CO2 During transport, the atmosphere is regulated by nitrogen flushing or CO2 and ethylene scrubbers.*

nitrogen (N) /ˈnaɪtrədʒən/ (n) dušik

nitrogen oxide; NOx /ˈnaɪtrədʒən məˈnɒksaɪd/ (n) (chem, marine eng) dušični monoksid

NMEA; National Marine Electronics Association NMEA, Američko nacionalno udruženje za brodsku elektroniku **NMEA; National Marine Electronics Association standard 0183** a combined electrical and data specification for communication between marine electronics such as echo sounder, sonars, anemometer, gyrocompass, autopilot, GPS receivers and many other types of instruments. It has been defined by, and is controlled by, the National Marine Electronics Association.; standard NMEA-a koji određuje svojstva komunikacijskog signala, oblik komunikacijskog protokola, vrijeme komuniciranja i oblik poruke **standard NME 0183**

sentence poruka, oblik poruke, **bus** sabirnica, komunikacijska veza, **talker** izvor, odašiljač, **listener** utok, primatelj, **prijamnik**, **carriage return; (CR)** novi odlomak

line feed; (LF) novi red, **talker sentence** rečenica izvora, **proprietary sentence** rečenica proizvođača, **query sentence** rečenica upita {The NMEA 0183 standard uses a simple ASCII, serial communications protocol that defines how data are transmitted in a sentence from one talker to multiple listeners at a time. Through the use of intermediate expanders, a talker can have a unidirectional conversation with a nearly unlimited number of listeners, and using multiplexers, multiple sensors can talk to a single computer port.}

NNSS; (Navy Navigation Satellite System) mornarički satelitski navigacijski sustav, **NNSS**

Noah's Ark /'noʊəz a:k/ (n) kunjka

Noah's Ark shell (n) (fishing) Lat. Arca Noae kunjka

no-cure no-pay (n) (mar ins, mar law) načelo o korisnom rezultatu spašavanja, nema li uspjeha, nema ni nagrade, bez uspjeha nema nagrade {ako spašavanje bude neuspješno, neće biti niti nagrade za spašavanje}

no-go area (n) (navig) nedopušteno područje plovidbe (određeno ili ucrtano od strane navigatora, zbog plićine i drugih opasnosti), isključeno područje plovidbe (određeno ili ucrtano od strane navigatora, zbog plićine i drugih opasnosti):

Hazards and 'no go' areas must be highlighted, enabling watchkeepers to quickly identify unsafe areas. No depth or no go areas, cross track error or waypoint alarms were set on the ECS. Dangers and No Go areas on navigational charts should only be marked with a chart pencil and with great care.

no-go zone (n) 1 (navig) isključena zona plovidbe (određeno ili ucrtano od strane navigatora, zbog plićine i drugih opasnosti), nedopuštena zona plovidbe (određeno ili ucrtano od strane navigatora, zbog plićine i drugih opasnosti), zabranjeno područje plovidbe (određeno od strane navigatora, zbog plićine i drugih opasnosti) *Inexplicably, the pilot had made two no-go zones southeast of the intended course line on his PPU but not the 10.7 m spot much nearer the course line on which they eventually grounded. Always study the chart in detail and outline any no-go areas in the vicinity of your course line.*

; 2 (boating/yachting) a position when a boat attempts to sail either directly into the wind or at an angle toward the wind where its sails cannot generate any lift. This angle is generally around 40 to 45 degree mark but can vary dependant on the characteristics of the boat and its rig. **nedostižno područje, područje u koje se ne može jedriti ravno u smjeru vjetra**

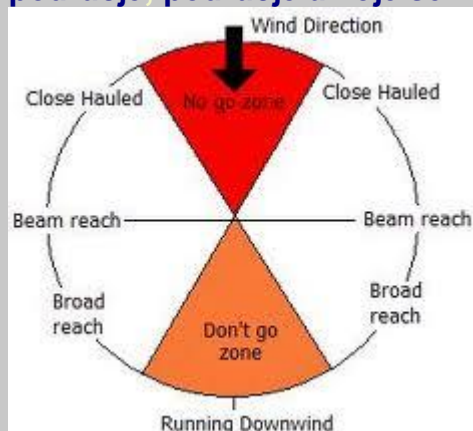

{Najbliže što većina jedrilica može postići jest kut od 45° prema smjeru vjetra.}

noise (n) 1 šum, buka; 2 (navig, electr) radarski šum **noise rejection** uklanjanje radarskog šuma

nominal (adj) nazivni, nominalan

nominal range (n) (navig) najveća udaljenost na kojoj se vidi svjetlo s obzirom na zakrivljenost Zemlje i lom svjetlosti **geografski domet**

nominate bill of lading /'nɒmɪnɪt/ (n) (mar law) = **named bill of lading** = **straight bill of lading** teretnica na ime

non-cellular ships (n) (nav arch) nekontejnerski brodovi

non-commissioned officer dočasnik (vođa palube, stroja), odgovorna osoba bez časničkog ovlaštenja

non-conformity /,nɒnkən'fɔ:mɪti/ (n) (safety) neusklađenost **major non-conformity** veća neusklađenost

noncontractual liability of the shipowner and the ship operator (n) (mar law) izvanugovorna odgovornost brodovlasnika i broдача

non-controllable forces (n) (nav arch) neupravljive sile

non-corrosive (adj) (marine eng) nehrđajući, nekorozičan, koji ne izaziva koroziju

non-delivery (n) (shipping econ, mar law) neisporuka, propuštena isporuka: *Time limit for filing a claim is 9 months from date of delivery, or in the event of non-delivery, 9 months after a reasonable time for delivery has elapsed.*

non-ferrous metal; nonferrous metal /,nɒn'fɛrəs/ (n) **ANTONYM ferrous metal** (marine eng) obojeni metal

non-negotiable bill of lading (n) (mar law) **ANTONYM negotiable bill of lading** A document not made out to order, but being a receipt and evidence of the contract of carriage, but which is not a document of title, e.g. a waybill and, in some jurisdictions (such as the USA), a (straight) consigned bill of lading. (<http://www.maerskline.com/en-jm/help/shipping-glossary>)

neutrživa teretnica, neprenosiva teretnica

non-return valve (n) (marine eng) nepovratni ventil

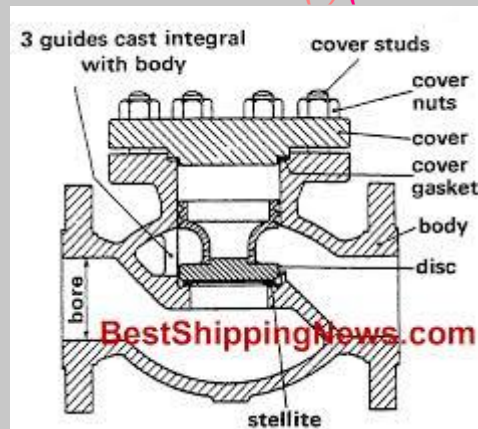

non-reversible (adj) (marine eng) neprekretni, nereverzibilan, s direktnim prijenosom

non-skid (adj) siguran od klizanja, neklizav

nonslip sole (n) (boating/yachting) protuklizni potplat (čizme za jedrenje)

nonstructural tank (n) (nav arch) nestrukturni tank

non-tidal waters (n) (oceanogr) vode bez plime, bezplimne vode

normal baseline (n) (mar law) normalna osnovna crta, ravna osnovna crta: *Except where otherwise provided in this Convention, the normal baseline for measuring the breadth of the*

territorial sea is the low-water line along the coast as marked on large-scale charts officially recognized by the coastal State. (UNCLOS) {cf. UNCLOS}

northbound /'nɔ:θ,baʊnd/ (adj) **ANTONYM southbound** sjeverni, u sjevernom smjeru, prema sjeveru, koji se kreće prema sjeveru **northbound convoy** sjeverni konvoj, konvoj prema sjeveru

north-east trades (n) (meteorol) sjeveroistočni pasati

north-east wind (meteorol) sjeveroistočnjak, bura, grego

northern blue fin tuna (n) tuna, tunj

north-up (n) (navig) Relative motion: Compass-stabilized with reference to north. Bearing scale is fixed. True motion: Ground or sea stabilized with compass and speed inputs. Own ship moves on the display. Landmasses and sea are fixed. **sjever gore (na pokazivaču radara), prikaz kretanja broda stabiliziran prema pravom meridijanu** **north-up orientation of radar display** orijentacija radarske slike sjever gore, **north-up mode** The north-up mode paints target pips at their measured distances and in their true (heading sensor) directions from own ship, north bearing maintained at the top of the screen. **način pokazivanja sjever gore**

north-up motion radar radar s pokazivanjem smjera na sjever, radar s prikazom pravog kretanja broda prema pravom meridijanu

north-west wind (n) (mar law) sjeverozapadnjak, maestral, *majštral*

north wind (n) (meteorol) sjevernjak, tramontana

Norway lobster (n) (fishing) Lat. *Nephrops norvegicus* škamp



no-sail zone (n) (boating/yachting) an area where boats cannot sail directly into the wind; the closest that most sailboats can achieve is an angle of 40-45 degrees either side of the direction of the true wind **nedostižno područje (u jedrenju)**

notary public /'nəʊtəri,pʌblik/ (n) (mar law) javni bilježnik, notar

notch /nɒtʃ/ (n) (marine eng) urez

notched /nɒtʃt/ (adj) (marine eng) nazubljen

note /'neʊt/ (v) **1 primiti na znanje; 2 opaziti, primijetiti; 3 zabilježiti, zapisati** **make a note of** zabilježiti, zapisati, **take notes** bilježiti, praviti bilješke, **note down** zabilježiti, zapisati: *An engine cadet was assigned to note down the readings and the fourth engineer was to operate the main engine turning gear remote control. In case of major problem, don't forget to*

note down the date and time of the event in the log book.

note /'nəʊt/ (n) 1 a bilješka; 2 primjedba; 3 (shipping econ, mar law) obavijest
note of marine protest (n) (mar law) prijava pomorske nezgode, (lt.) *nota di protesta* lodge / note / state / enter / file a note of marine protest prijaviti pomorsku nezgodu

note of protest (n) (mar law) a declaration by the master of circumstances beyond his control which may give, or may have given, rise to loss or damage. **prijava pomorske nezgode**, (lt..) *nota di protesta*: , *fearing damage to the cargo during the bad weather, I state the present sea protest, reserving the right to extend the same at the time and place convenient.* **enter a note of protest** podnijeti prijavu pomorske nezgode. **prijaviti pomorsku nezgodu**, **extend a note of protest** proširiti prijavu pomorske nezgode (protest), **make a note of protest** prijaviti pomorsku nezgodu, **issue a note of protest** podnijeti prijavu pomorske nezgode, **prijaviti protest**: A Note of Protest should be issued by the Master and an acknowledgement obtained from the shippers and/or charterers., **draw up a note of protest** **sastaviti prijavu pomorske nezgode**: a Note of Protest should be drawn up by the Master to be attached to the bill of lading or passed to the shipper and any named consignee or notify party.

note of sea protest (n) (mar law) prijava pomorske nezgode

Nothing to port / starboard! (navig, seamanship) Ništa lijevo / desno! {zapovijed za kormilarenje}

nothing to starboard / port; nothing to right / left (seamanship) order given to the helmsman not to allow the ship to come to right (left) of the course because of some danger lying on that side of the course **ništa u desno / lijevo**

notice /'nəʊtɪs/ (v) 1 a opaziti, primijetiti **advance notice** ranija / prethodna obavijest, obavijest unaprijed, **final notice** zadnja obavijest, zadnja ETA, **preliminary notice** prethodna obavijest / ETA, **serve the notice on the master** predati / uručiti obavijest zapovjedniku

notice /'nəʊtɪs/ (n) (mar law, shipping econ) obavijest **give notice to** obavijestiti nekoga at the appropriate stage of the passage plan notice was give to the engine room

notice /'nəʊtɪs/ (n) (mar law) zapis u koji se bilježe osobni odnosi važni za raspolaganje brodom i imovinom **zabilježba**

notice of abandonment (n) (mar law) obavijest o proglašavanju broda stvarnom totalnom štetom

notice of abandonment (n) (mar ins) obavijest koju osiguranik mora dati osiguratelju ako odluči napustiti osiguranu stvar u korist osiguratelja **obavijest o napuštanju broda**

notice of arrival (n) (shipping econ, mar law) = **ETA Notice** obavijest o dolasku broda u luku

Notice of Readiness, N/R (n) (mar law) Pismo spremnosti, obavijest o spremnosti accept the Notice of Readiness, N/R prihvatiti / usvojiti pismo spremnosti, **tender the Notice of Readiness, N/R** predati pismo spremnosti, **deliver the Notice of Readiness, N/R** predati pismo spremnosti

notice of shipment (n) (mar law, shipping econ) = **shipping note** najava ukrcaja

Notices to Mariners (n) (navig) a radio broadcast or publication designed to provide important marine information **oglasi za pomorce**, **obavijesti za pomorce** **Admiralty Notices to**

Mariners Admiralitetski oglasi za pomorce, **annual Notices to Mariners** godišnji oglasi za pomorce (izdaju se na početku svake godine), **cummulative Notices to Mariners** kumulativni oglasi za pomorce (izdaju se u siječnu i lipnju) {**Local Notice to Mariners**: a written or broadcast document issued by the coast guard to disseminate important information affecting aids to navigation, dredging, marine construction, special marine activities, and bridge construction on the waterways within that district}

notices to shipping (n) (comm, safety) obavijesti za brodove, obavijesti za pomorce

notification /ˌnəʊtifiˈkeɪʃən/ (n) (**mar law**) 1 (**shipping econ**) obavijest: Notifications of the incident have been made to the Port Authority.; 2 naznaka (npr. ETA-e); 3 najava **give notification obavijestiti, najaviti**

notify /ˈnəʊtɪfaɪ/ (v) 1 (**mar law, shipping econ**) obavijestiti: Notify the shipper and charterers that you intend to alter the shipping document to reflect your observations Notify the master if visibility deteriorates At 0952, the pilot notified London Vessel Traffic Services (VTS) of the vessel's readiness to depart and requested a traffic update.; 2 upozoriti; 3 objaviti, oglasiti

Notify address (n) (**mar law**) adresa za obavijest

notify party (n) (**mar law**) person identified in the bill of lading (supra) as the party to be notified by the carrier (supra) when the goods arrive at their destination. **upute za predaju robe, obavijest primatelju pošiljke (u teretnici), osoba koju je prijevoznik dužan obavijestiti o dolasku broda**

not under control (NUC) (brod) nesposoban za manevriranje

notwithstanding /ˌnɒtwɪθˈstændɪŋ/ (conj) 1 bez obzira, makar, premda; 2 (**mar law**) ne kršeći (odredbe konvencije, zakona, ugovora itd.)

nought /nɔ:t/ 1 ništica; 2 nula

noxious /ˈnɒksjəs/ (adj) 1 škodljiv; 2 otrovan

noxious substance /ˈnɒksjəs/ (n) (**cargo**) škodljiva tvar

nozzle /ˈnɒzəl/ (n) (**marine eng**) mlaznica dizel motora, sapnica **air foam nozzle**



mlaznica zraka za stvaranje pjene za gašenje

NS; (nuclear ship) (n) (**nav arch**) brod na nuklearni pogon

NT (net ton) neto tona

nuclear-powered ship (n) (**nav arch**) nuklearni brod

nuclear-powered submarine (n) (**navy**) nuklearna podmornica

nuclear propulsion plant (n) (**marine eng**) nuklearno pogonsko postrojenje,

atomsko pogonsko postrojenje

nuclear ship (n) (nav arch) nuklearni brod

nucleus; pl. nuclei, nucleuses /'nju:kliəs; pl. nju:kli,ai/ jezgra, srž, nukleus

number and kind of packages (n) (mar law) broj i oznake koleta (u teretnici)

nun /nʌn/ (n) (navig) = **can** stožasta plutača s parnim brojem (obično crvena)



nursehound (n) (fishing) morska mačka, mačka mrkulja

nut /nʌt/ (n) (marine eng) **COMPARE bolt** matica (vijka), tal. **dado nut coupling**

spojna matica matica steznog vijka, navojna stezna spojka, bolt, washer and nut

vijak, podloška i matica, bolt with nut vijak s maticom, backing nut protumatica: *On*

investigation, it was found that the backing nut on the pipe compression joint had vibrated loose.

nuts /nʌts/ (n) (cargo) orašići

NVOCC (non-vessel-operating common carrier) (n) (mar law) A common carrier that does not operate the vessel by which the ocean transportation is provided, and is a shipper in its relationship with an ocean common carrier. (Tetley) **linijski brodar koji ne iskorištava brod u prekomorskoj plovidbi**

oak /əʊk/ (n) (cargo) hrastovina

oakum /'əʊkəm/ (n) (seamanship) a substance made from soft vegetable fiber such as hemp and jute impregnated with pine tar **vuna za šuperenje**

oar /ɔ:/ (n) (seamanship) veslo

oath /əʊθ/ (n) (mar law) prisega, zakletva **under oath** pod prisegom

oats /əʊts/ (n) (cargo) zob

object /'ɔbdʒɪkt/ (n) 1 a predmet; 2 objekt; 3 (mar law) predmet osiguranja **insured object** predmet osiguranja

object /əb'dʒɛkt/ (v) 1 primijetiti, imati primjedbu; 2 (mar law) prigovoriti

objection /əb'dʒɛkʃən/ (n) (mar law) primjedba, prigovor

objective /əb'dʒɛktiv/ (n) 1 cilj, svrha **with the objective of** s ciljem; 2 objektiv (fotoaparata)

obligation /,ɔbli'geɪʃən/ (n) 1 obveza; 2 dužnost

obliged /ə'blaɪdʒd/ (adj) koji je obvezan **be obliged** biti obvezan

oblique motion /ə'bli:k/ (n) (seamanship, ship handling) A vessel's motion is said to be oblique when the flow of water along either side of the hull is not symmetrical. (H. Baudu, *Ship Handling*, p. 106) **koso gibanje broda**

obnoxious /əb'nɔkʃəs/ (adj) (cargo) extremely unpleasant **škodljiv (teret), neugodan (teret s neugodnim mirisom)** **obnoxious cargo** **škodljiv teret** *Berth No. 7 is intended for foreign container vessels and vessels carrying flammable, obnoxious and poisonous cargo.*

obscured /əb'skjʊəd/ (adj) **obscured light** zasjenjeno svjetlo, zatamjeno svjetlo

(navig) zasjenjen, koji se ne vidi (zbog zaklonjenosti ili djelovanja drugog objekta)

lighthouse **obscured by city lights** svjetlo svjetonika zasjenjeno svjetlima grada

obscured light /əb'skjʊəd/ (navig) potamnjeno svjetlo

obscure sight /əb'skjʊə,sait/ (v) (seamanship, navig) spriječiti preglednost,

onemogućiti vidokrug: *His line of sight was obscured by the mooring winch.*

observation /ˌɒbzə'veɪʃən/ (n) 1 (navig) a potrenje, promatranje **make an observation** of (the Sun, celestial body) motriti, snimiti (Sunce, nebesko tijelo); 2 smjeranje, snimanje (npr. nebeskih tijela) u navigaciji; 3 praćenje; 4 (mar law) poštivanje (pravila, zakona, konvencije itd.), pridržavanje; 5 (safety) opaska, zapažanje:

However, the following observations were made: ...

observe /əb'zɜ:v/ (v) 1 a motriti; 2 pratiti; 3 (navig) snimati (nebesko tijelo), motriti (nebesko tijelo); 4 snimati položaj broda; 5 (mar law) primijeniti (odredbu, pravilo, zakon), poštivati **observe the COLREGS** poštivati pravila o izbjegavanju sudara, primjenjivati pravila o izbjegavanju sudara, **observe the regulations** poštivati propise; 6 opaziti (u navigaciji), primijetiti: *Once on the new heading, the Master observed a container feeder vessel crossing from the west-bound lane into the separation zone.*

observer /əb'zɜ:və/ (n) 1 (navig) a motritelj, promatrač; 2 smjerač

obstruct /əb'strʌkt/ (v) (navig) zapriječiti, prepriječiti, ometati: *Ensure nothing is obstructing the propellers* **obstruct the propeller** zapriječiti okretanje propelera

obstruction /əb'strʌkʃən/ (n) (navig) prepreka, zapreka, smetnja **obstruction to navigation** prepreka plovidbi, smetnja plovidbi, **come fast upon an obstruction** The vessel has come fast upon an obstruction., Brod je zapeo o zapreku

obstruction /əb'strʌkʃən/ (n) (navig) podvodna zapreka

obtain /əb'teɪn/ (v) 1 a (v tr) dobiti; 2 ishoditi (npr. dozvolu, rezultat itd.) **obtain a permit** ishoditi dozvolu; 3 (v intr) nastati (npr. okolnost); 4 postići **obtain the officer rank** postići časnički rang

obtain the information (v) 1 ishoditi informaciju; 2 dobiti obavijest, dobiti informaciju

obvious /'ɒbvɪəs/ (adj) očit, očigledan, jasan

occasional inspection /ə'keɪʒənəl/ (n) (nav arch) obvezatni pregled kojemu podliježe postojeći brod nakon što pretrpi nesreću ili se utvrde nedostaci koji mogu utjecati na sposobnost broda za plovidbu **izvanredni pregled broda**

occasional survey /ə'keɪʒənəl/ (n) izvanredni pregled (broda)

occluded front /ə'klu:did/ (n) (meteorol) a result of warm and cold fronts meeting, cold front overtaking the warm front **okludirana fronta, okluzivna fronta, zatvorena fronta**

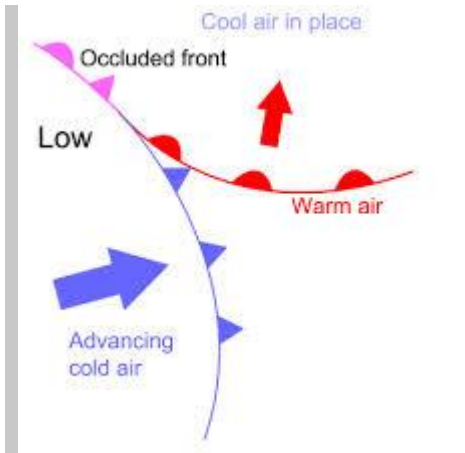

occulting light /ɒˈkʌltɪŋ/ (n) (navig) **COMPARE flashing light, fixed light** a light in which the total duration of light in each period is clearly longer than the total duration of darkness and in which the intervals of darkness (occultations) are all of equal duration **prekidajuće svjetlo, svjetlo na prekide** **group occulting light** Pk (2) **na prekide u grupi, composite group**

Description	Characteristic	Chart Abbreviation
Alternating		Alt. R.W.G.
Fixed		F.
Flashing		Fl.
Group flashing		Gp Fl.(2)
Occulting		Occ.
Group occulting		Gp Occ(3)
Quick flashing		Qk.Fl.
Very quick flashing		V.Qk.Fl.
Isophase		Iso.
Morse		Mo.(letter)

occulting light Pk (2+3) **na prekide u grupi**

occupational safety (n) (safety) sigurnost na radu

occur /əˈkɜː/ (v) **dogoditi se, zbiti se, nastati** *accidents occur frequently* nesreće se često događaju **loss occurred** nastali gubitak, **delay occurred** nastalo kašnjenje, **damage occurred** nastala šteta

occurrence /əˈkʌrəns/ (n) **1** događaj, prilika, zbivanje **serious occurrence** ozbiljan događaj; **2** nastanak (npr. nesreće) **accidental occurrence** nesretan slučaj, nezgoda; **3** slučaj

ocean /ˈəʊʃən/ (=ocean) (n)

ocean bill of lading (n) (mar law) = **bill of lading = marine bill of lading**
pomorska teretnica, teretnica

ocean carrier (n) **1** (US, shipping econ) motorni brod, prekoceanski brod; **2** (US) = **sea carrier; sea-carrier** pomorski prijevoznik

ocean freight forwarder (US) A person who dispatches shipments from the United States via a common carrier, books or otherwise arranges space for those shipments on behalf of shippers and processes the documentation or performs related activities incident to those shipments. (Tetley)

prekomorski otpremnik, prekomorski špediter

oceangoing (adj) (shipping econ) prekoocenaski, prekomorski **oceangoing ship**
prekoceanski brod

ocean-going tug (n) (nav arch) = **deep-sea tug** oceanski tegljač

ocean navigation (n) (navig) = **deep-sea navigation** oceanska navigacija, oceanska plovidba, duga plovidba, prekomorska plovidba {Ocean navigatio first involved dead reckonng, after which it used astronomical navigation. Today the term may involve any form of electronic navigation.}

oceanography /ˌəʊʃəˈnɒɡrəfi/ (n) oceanografija

ocean transportation (n) (shipping econ, mar law, US) pomorski transport, morski transport, pomorski prijevoz {US term for: (international) maritime transport}

octane /ˈɔktɛɪn/ (n) (marine eng) oktan

octane number /ˈɔktɛɪn/ (n) (marine eng) oktanski broj

octopus /ˈɔktəpəs/ (n) (fishing) Lat. Octopus vulgaris hobotnica, mrkač



odd number (n) (math) neparni broj

odour /ˈəʊdə/ (n) (cargo handling) miris, neugodan miris residual odours zaostali mirisi

OD; overdrawn (adj, adv) prekoračen (iznos bankovnog računa), preko odobrenog limita OD; overdrawn € 55 away from the overdraft limit 55 eura preko odobrenog limita, €55 OD 55 eura preko odobrenog limita

off (prep) nedaleko, izvan off the breakwater nedaleko lukobrana (prema pučini)

off air (comm) prijam nemoguć

off centering picture (n) (navig, electr) slika s pomaknutim središtem (na radaru)

off duty izvan službe, koji nije dežuran

offence /əˈfɛns/ (n) (UK) 1 prekršaj; 2 (mar law) teži prekršaj; 3 (mar law) kazneno

djelo: navigating without due care and attention, or navigating in a manner liable to injure or endanger persons, other vessels or structures such as berths or jetties is an offence liable to prosecution **commit an offence** počiniti kazneno djelo {(US) offense}

offense /əˈfɛns/ (US) = offence prekršaj

off hire (mar law) The period in which a ship is not available for service under a time charter and, accordingly, the charterer generally is not required to pay the hire rate. **vrijeme (kada je brod)**

izvan čartera: *Off-hire periods can include days spent on repairs, drydocking and surveys, whether or not scheduled.* **place off hire** staviti brod izvan najma / čartera *The ship had to be placed off-hire for three days for removal and disposal of the damaged cargo and a heavy cargo damage claim had to be settled with the consignee.*, **go off hire** izaći iz najma (o brodu): *Upon arrival at our next port, the ship went off-hire for nearly two days for investigations, renewal of the damaged*

turbocharger and surveys., **putoff hire** staviti brod izvan najma / čartera *However, the vessel*

was put off hire during the time taken for this operation., **off hire time vrijeme izvan najma / čartera**: Further, it may entail replacement of damaged equipment on an emergency basis, which will result in **off-hire time for the vessel** as well as the high cost of sourcing new equipment at short notice.

off-hire (adv) (shipping econ) izvan najma, izvan čartera: However, **the vessel was put off hire** during the time taken for this operation. d severe damage to the big end bearings and required renewal of the crank shaft; repairs that cost in the order of \$1 million and **left the vessel off-hire** for more than 40 days. **The ship had to be placed off-hire** for three days for removal and disposal of the damaged cargo and a heavy cargo damage claim had to be settled with the consignee. **off-hire time vrijeme izvan najma**: Further, it may entail replacement of damaged equipment on an emergency basis, which will result in **off-hire time for the vessel** as well as the high cost of sourcing new equipment at short notice. Now that owners on voyage charters are getting such high rates, there may be some pressure on Masters and Chief Engineers to reduce **off-hire time**.

office (n) office hours radno vrijeme 1 a ured head office uprava, direkcija, sjedište; 2 služba; 3 odjel

officer /ˈɒfɪsə/ (n) 1 (navig) a member of the crew, other than the master, designated as such by national law or regulations or, in the absence of such designation, by collective agreement or custom; (STCW 2010) časnik, oficir, ufićal tal. ufficiale Chief officer prvi časnik palube, čif, 2nd Officer drugi časnik palube, 3rd officer treći časnik palube, engineer officer časnik stroja, strojar, officer of the watch časnik straže, oficir straže, časnik u gvardiji, apprentice officer kadet, vježbenik, chief officer prvi časnik palube, čif, radio officer radijski časnik, radio-officir, Second officer drugi časnik palube, Third officer treći časnik palube, petty officer dočasnici su npr. 'bosun' (vođa palube) i 'donkeyman' (vođa stroja) dočasnik (npr. 'bosun'-vođa palube i 'donkeyman'-vođa stroja), podoficir; 2 službena osoba, dužnosnik; 3 službenik, činovnik

officer cadet training programme (n) (mar law) visokoškolski studij za pomorske časnike: To become an officer in the merchant navy, you must undertake an officer cadet training programme, which involves academy-based education integrated with periods of practical training at sea.

Officer in charge of a navigational watch on ships of 500 gross tonnage or more (IMO STCW A-II/1 (n) (mar law) časnik plovidbene straže na brodovima od 500 BT ili većima (STCW II/1)

officer-of-the-watch (OOW) (n) (mar law) The officer in charge of the watch časnik straže, ovlašteni časnik duties f the officer-of-the-watch (OOW) dužnosti časnika straže

official /əˈfɪʃəl/ (n) dužnosnik, službena osoba, funkcionar, činovnik port officials lučki dužnosnici, lučki rukovoditelji

official log (n) (navig, mar law) = log službeni brodski dnevnik, glavni brodski dnevnik: Official log book must be kept on every ship, unless exempted it is available with engagement and discharge documents from concerned flag st

offing (n) (navig) mjesto udaljeno od obale {kopno u vidokrugu}

offload (v) (cargo handling) iskrcati: Cargo is offloaded at the manifold, usually located amidships.

offset /ˈɒf sɛt/ (v) 1 nadoknaditi, poravnati, izjednačiti; 2 prebacivanje, premještanje; 3 zamijeniti

offset (adj) zamjenski

offset worm hook (n) (fishing) udica s umjetnim crvom, zamjenska udica: *Offset worm hooks - 1/0-2/0 small soft plastics*

offshore /ˌɔːfʃɔː/ (adj, adv) odobalni, na otvorenom moru, dalje od obale, tal. *a/ largo; altura*

offshore bar (n) (oceanogr) pješčani nanos s obale

offshore construction vessel (OCV) (n) (nav arch) brod za odobalne radove: *The OCV Island Venture is designed for operations such as IMR (Inspection, Maintenance and Repair), ROV (Remotely Operated Vehicle) services, well intervention, and drilling. It comes equipped with 140 ton crane with 3,000 meters wire installed, as well as a 400 ton crane that can operate at up to 4,000 meters.*

offshore drilling unit (n) (nav arch) odobalni objekt za bušenje podmorja

offshore forecast (n) (meteorol) = **forecast** a marine weather forecast for the waters between 60 and 250 miles off the coast **prognoza vremena za otvoreno more**

offshore rig (n) naftna platforma na otvorenom moru



offshore wind (n) (meteorol) vjetar s kopna

offshore wind aft of beam (n) (boating/yachting) vjetar s kopna subočice po krmi

offshore wind ahead (n) (boating/yachting) vjetar s mora u pramac

off station (prep phr) (navig) a floating aid to navigation not on its assigned position **izvan pozicije buoy off station** plutuća izvan ucrtane pozicije

off the berth (adv) (navig) blizu veza, nedaleko od veza: *The vessel arrived off the berth at 0817*

off-watch rest (n) (mar law) **COMPARE on-watch duty** radoblje odmora (nakon razdoblja u straži)

offwind (n) (boating/yachting) niz vjetar

oil /ɔil/ **1** ulje **oil bath** uljna kupka, korito ulja, **oil drain hole** otvor za otjecanje ulja, otvor za drenažu ulja, **oil flow rate** brzina protoka ulja, **oil separator** uljni separator, **cooling oil** rashladno ulje, **excess oil** višak ulja, **heavy fuel oil/lubricating oil** ulje za podmazivanje; **2** nafta **crude oil** **1** sirova nafta; **2** = **petroleum**, **heavy fuel oil** teška nafta

oil barrel (BBL) /ˈbæɪrəl/ = 42 gallons of liquid = about 159 liters **barel**

oil boom (n) plutajuća brana, cijev oko broda za sprječavanje onečišćenja (pri ukrcaju/iskrcaju), barijera: *As a precautionary measure, an oil boom was deployed around the damaged tender boat.*

oil-bulk-ore ship (OBO carrier) brod za prijevoz nafte, sipkih tereta i rude: *About 30 minutes before the incident, a large oil bulk ore (OBO) vessel raised her anchor and began to move in preparation for picking up a pilot.*

oil-burner (n) 1 (marine eng) gorionik, plamenik; 2 rasprskič

oil cake (n) (cargo) uljna pogača

oil clearance (n) (safety) čišćenje ulja / nafte

oil company (shipping econ) naftna kompanija

Oil Discharge Monitoring Equipment; (ODME) (n) (cargo handling, safety) ODME is used to monitor all discharges overboard of oil contaminated water from the cargo tank system.

Uređaj za provjeru izbacivanja zauljenih voda

oil drain (n) (nav arch) pražnjenje ulja, ispust za ulje, drenaža ulja **oil drain tap** čep na ispustu za ulje

oiler (n) (marine eng, mar law) A raing who's duties are to lubricate moving components of the engines and their auxiliary equipment and to monitor the condition and oil level in the engines. **mazač**

oil film (n) (marine eng) tanki sloj ulja, *film ulja*

oil filter (n) (marine eng) filter ulja

oil-fuel (n) (marine eng) gorivo, mazut **oil-fuel burner** uljni rasprskič **uljni gorionik**, **oil-fuel pressure pump** tlačna pumpa pogonskog goriva, **oil-fuel transfer pump** pumpa za prebacivanje goriva, *transferica*

oil-fuel tank (n) (nav arch) tank goriva

oil heating (n) (marine eng) grijanje goriva

oil in bulk (n) (cargo) nafta kao masovni teret

oil leak (n) (marine eng) curenje ulja, propuštanje ulja

oil level (n) (marine eng) razina ulja **check the oil level** provjeriti razinu ulja

oil mist (n) (marine eng) naftna maglica, uljna maglica: *the oil mist was being carried right across the machinery space* uljna maglica prodirala je kroz cijelu strojarnicu

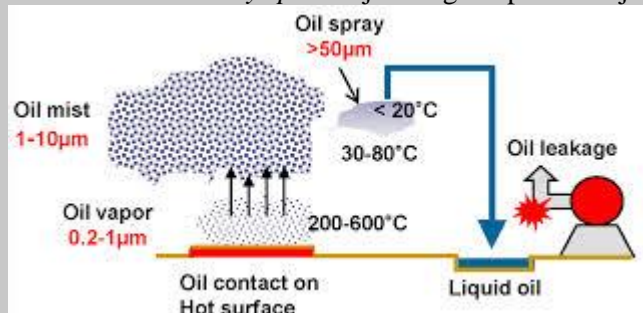

oil pollution onečišćenje uljem, onečišćenje naftom

oil pump (n) 1 (marine eng) pumpa ulja; 2 pumpa nafte

oil record book (n) (marine eng) knjiga o uljima, knjiga evidencije goriva i ulja: *The chief mate of the reefer ship has been sentenced to two months in prison for failing to maintain an accurate oil record book in violation of the Act to Prevent Pollution from Ships (APPS). The discharges were recorded in the ship's oil record book.* **maintain the oil record book** voditi knjigu o uljima

oil-rich fish

oil slick

U.S. Department of Homeland Security
United States Coast Guard

OIL RECORD BOOK FOR SHIPS

CHECK ONE: Vessel is an Auxiliary Power Operation (Part 1 of this Part)
 Vessel is an Equipment Operation (Part 2 of this Part)

Vessel Name:
 Call Sign:
 Home Port:
 MMSI No:

THIS BOOK MUST BE MAINTAINED ABOVE THE DECK FOR AT LEAST THREE YEARS FOLLOWING THE END DATE LISTED ABOVE.

The requirements in this part of the regulations are to be followed by the vessel owner, master, or operator of the vessel, or other person in charge of the vessel, and by the crew members of the vessel, in accordance with the requirements in this part of the regulations. This part of the regulations does not apply to vessels that are not subject to the requirements in this part of the regulations. This part of the regulations does not apply to vessels that are not subject to the requirements in this part of the regulations. This part of the regulations does not apply to vessels that are not subject to the requirements in this part of the regulations.

CG 7000 (REV. 03-01) (SEE INSTRUCTIONS ON REVERSE SIDE)

oil-rich fish plava riba



oil rig (n) = offshore rig naftna platforma

oil rig supplier opksrbljivački brod za naftne platforme

oil seeds (n) (cargo) uljne sjemenke

oil separator (n) (marine eng) separator ulja, odvjajač ulja



oil slick (n) (marine eng, safety) uljna / naftna mrlja



oil spill (n) 1 (safety) izljev ulja/nafte u more, The collision resulted in multiple indentations on our vessel's bow area and a breach in the container vessel's port bunker tank, resulting in an oil spill. The incident created an oil spill. **oil spill response**



akcija sprječavanja izljeva nafte u more
; 2 izljev ulja/nafte zadržan na brodu

oil spray (n) (marine eng) raspršeni mlaz goriva

oil supply (n) (marine eng) dovod goriva

oil tank (n) 1 (marine eng) tank ulja; 2 tank nafte

oil tanker (n) (nav arch) An oil tanker, or a petroleum tanker, is a merchant ship designed for the bulk transport of oil. **tanker za ulje, tanker**. The grounding of the Exxon Valdez was a watershed event, triggering fundamental changes in the way **oil tankers** are managed, operated and maintained.



There are two basic types of **oil tankers**: crude tankers and product tankers.

oil terminal (n) (ports) naftni terminal



oiltight /'ɔɪl, taɪt/ (adj) (marine eng) uljotijesan, uljonepropustan

oil waste reception facility (n) (ports) prihvatno postojenje za uljni otpad

oily /'ɔɪli/ (adj) uljevit, zamrljan uljem, zauljen

oily fish (n) (fishing) plava riba

oily water (n) (safety, nav arch) zauljene vode: Patches of oily water detected near Australia's Great Barrier Reef, a Unesco-protected site, will be investigated further Saturday morning, local authorities said.

oily water separator (n) (marine eng, nav arch) separator zauljenih voda

Old Man (n) the captain of the ship **zapovjednik broda (zast., u brodskom žargonu)**: A little while later the **Old Man** inquired from the C/O if he heard the loud bang, and explained that there was a heavy indent on the starboard side of the bridge wing deck.

old man (n) (nav arch) vreteno / bubanj za namatanje užeta

old salt (n) (seamanship) a veteran sailor **stari mornar, iskusni mornar**

oleiferous seeds /,əʊli'ɪfərəs/ (n) (cargo) uljne sjemenke

olive green cockle (n) (fishing) Lat. Cardium echinatum **bodljikava srčanka**



omission (n) propust, izostavljanje, ispuštanje

omit (v) ispustiti, izostaviti

on behalf of u ime, u korist

on board 1 (adv) **na brodu, u zrakoplovu, u vozilu**: the vessel departed the port with 569 passengers and 422 crewmembers **on board** brod je isplovio iz luke s 569 putnika i 422 člana posade (na brodu) The coastal state should always be informed of any emergency situation **on board**. The highest priority **on board a vessel must** always be the safety of its crew. When the vessels had closed to a

distance of 5 cables, the chief officer **on board** the cargo ship altered course to 027°. **the cargo was loaded on board** teret je ukrcan na brod; **2 (adj) brodski on board training** izobrazba na brodu

on board and ashore (prep phr, adv) **na brodu i na kopnu**: Personnel *on board and ashore* are required to be able to perform all the above activities to a uniformly high standard.

on-carriage (n) (shipping econ) Service of providing inland import transportation to customer's premises from the port of discharge. (<http://www.maerskline.com/en-jm/help/shipping-glossary>) **daljnji prijevoz/transport, kopneni prijevoz do vlasnika tereta**: *On carriage* offers the customer flexibility of door to door transportation. In such cases it would be very complicated and more expensive if the shipper had to arrange **on-carriage** himself by employing an agent at the port of discharge.

on deck stowage (n) (cargo handling, shipping econ) **teret složen na palubi, palubni teret**

on-dock rail (n) (ports) Direct shipside rail service. Includes the ability to load and unload containers/breakbulk directly from rail car to vessel. **kolosijek uz lučku obalu, lučka obala sa željezničkom vezom**

on duty **ANTONYM off duty** **na dužnosti, u službi, u dežurstvu**

one design (n) (boating/yachting) **jedrilice iste klase**

one-design (n) (nav arch, boating/yachting) **monotip, monotipna izvedba**

on even keel (cargo) (brod) **na ravnoj kobilici**

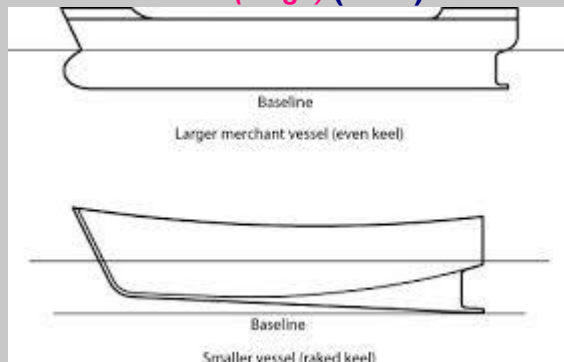

ongoing **u tijeku, u toku**: Investigations are still ongoing for the three recent collisions in the Singapore Strait

on port tack (prep phr) (boating/yachting) **na lijevim uzdama, lijeva škota**

on scene **na mjestu događaja, na mjestu nezgode**: On scene are two tugs contracted by the ship owner, the French emergency tug *Abeille Bourbon*, the French Navy frigate *Primauguet* with a *Lynx* helicopter, and the AHTS *Argonaute*. (<https://gcaptain.com>)

On-Scene Co-ordinator; OSC (n) (navig, safety) **zapovjednik mjesta nezgode, koordinator traganja i spašavanja na mjestu nesreće**

onset /'ɒn, set/ (n) (**safety**) **nastanak, pojava, početak, nastupanje**: The vessel had departed from the terminal prior to the onset of adverse weather Brod je isplovio s terminala prije početka nevremena

onshore wind (n) (meteorol) **vjetar s mora**

on starboard tack (n) (boating/yachting) **na desnim uzdama, desna škota**

on-terminal rail (n) (ports) Rail service and trackage provided by a railroad within a designated terminal area. **terminal sa željezničkom vezom**

on the port / starboard beam (*prep phr*) (*navig*) = **abeam to starboard**

subočice lijevo / desno, lijevo / desno po boku

on the port / starboard bow lijevo / desno po pramcu

on the port / starboard quarter lijevo / desno po krmi

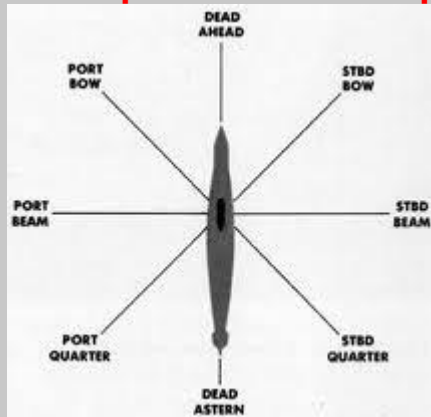

on the port tack (*prep phr*) (*boating/yachting*) a sailboat is on the port tack when the wind is coming over the port (left) side **na lijevim uzdama**

on the starboard tack (*prep phr*) (*boating/yachting*) **na desnim uzdama** a sailboat is on the starboard tack when the wind is coming over the starboard (right) side the vessel on port tack must give way to a vessel on starboard tack

onward carriage (*n*) (*shipping econ*) daljnji prijevoz/transport

on-watch duty (*n*) (*mar law*) razdoblje straže

OOG cargo (*adj*) (*cargo*) izvangabaritni (teret), nestandardni teret (po dimenzijama) {out-of-gauge cargo}

open bill of lading (*n*) (*mar law*) otvorena teretnica, blanko teretnica, *bjanko teretnica*

open chock (*n*) (*nav arch*) **COMPARE chock** zjevača, otvorena zjevača / oko

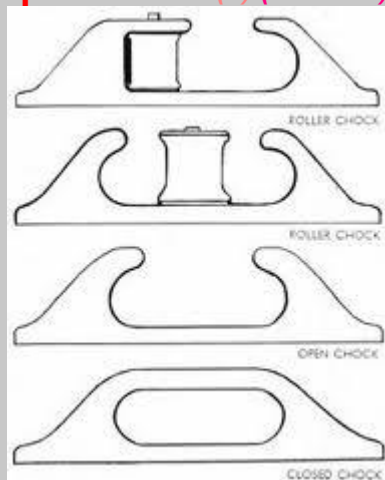

open class (*n*) (*boating/yachting*) **COMPARE one design** otvorena klasa open class race regata za više klasa, regata za svu opremu jedrilica

open cover (*n*) (*mar ins*) opća polica

open cover policy (*n*) (*mar ins*) opća polica, otvoreno pokriće

open end (n) (marine eng) otvoreni kraj, otvorena strana

open flame (n) (safety) otvoreni plamen

open floor (n) (nav arch) otvorena rebrenica

open-hearth furnace (n) Siemens-Martinova peć **open-hearth process**
Siemens-Martinov postupak

opening /'əʊpənɪŋ/ (n) 1 (marine eng) otvor; 2 otvaranje **valve opening** otvaranje ventila

opening port (n) (boating/yachting) palubni otvor s poklopcem (na jedrilici / brodici)



open sea (n) (mar law) otvoreno more

open top container (n) (cargo handling) kontejner otvorena vrha: *Commodities commonly shipped in the open top container include machinery, industrial boilers, tractors, steel pipes,*



steel bars and cables.

operate /'ɒpə'reɪt/ (v) 1 (shipping econ) ploviti (u brodskoj liniji / servisu), biti u

plovidbi/servisu/liniji: *The passenger ferry, owned by Reederei Cassen Eils GmbH, will operate*

*between Cuxhaven and the island of Helgoland. **operate a vessel** poslovno upravljati brodom, **operirati (brodom), operirati brod**. Liners operate on certain well-established routes and on a fixed schedule. Out of the total of 109 vessels employed in 13 joint services 42 ships were operated by CMA CGM and 67 by Maersk., **the vessel operates on a new line** brod plovi na novoj liniji; 2*

upravljati (organizacijom nečega) **operate a terminal** upravljati terminalom, voditi

terminal, ekonomski iskorištavati terminal**: The Shinsundae Container Terminal in the Port of Busan is operated by Pusan East Container Terminal Company Limited., **terminal operated by the

***port company** terminal kojim upravlja lučko poduzeće; 3 (marine eng) pogoniti,*

pokretati fuel pump **operated by a camshaft** pumpa goriva koju pokreće bregasto

vratio; 4 upravljati (uređajem, strojem itd.) **operate a pump** (marine eng) upravljati

***pumpom, rukovati pumpom, **operate satisfactorily** raditi ispravno**: main engine was*

tested and was found to operate satisfactorily.

operate the ship (v) 1 (shipping econ) ekonomski iskorištavati brod, eksploatirati brod, operirati brod: *the oil/chemical tanker XXX was one of 36 vessels owned and operated by the company YYY Ltd.*; 2 pogoniti brod

operate the terminal upravljati terminalom, ekonomski iskorištavati terminal: *Southampton's four-berth container facility is operated by Southampton Container Terminals (SCT).*

operating costs (n) (shipping econ) Operating costs consists of maintenance, insurance, inspections/renewal of certificates and crew wages. These costs are fixed, and incur whether or not the vessel is active.. **operativni troškovi**

operating cycle (n) (marine eng) radni ciklus

operating port (n) (ports, mar law, US) **COMPARE landlord port** At an operational port like Charleston, South Carolina, the port authority builds the wharves, owns the cranes and cargo-handling equipment and hires the labor to move cargo in the sheds and yards. **lučka uprava u statusu lučkog operatora** {A stevedore hires longshore labor to lift cargo between the ship and the dock, where the port's laborers pick it up and bring it to the storage site}

operating voltage (n) (electr) radni napon

operation /ˌɒpəˈreɪʃən/ (n) 1 a rad **safe operation** siguran rad, **under operation** u radu, u pogonu, **boiler operation** rad kotla; 2 (shipping econ) poslovanje, plovidba, servis: *In 1956 Sea-Land commenced operations between New York City and Houston, Texas 1956. godine brodarsko društvo Sea-land započelo je linijski servis između New Yorka i Houstona.* **operation of vessel** upravljanje broda, korištenje broda, poslovanje broda; 3 pogon; 4 hod (stroja); 5 upravljanje (uređajem, strojem), posluživanje (nečega), rukovanje (strojem); 6 operacija, postupak **berthing / unberthing operation** operacija pristajanja / odlaska s veza, pristajanje / odlazak s veza

operational /ˌɒpəˈreɪʃənəl/ (adj) spreman za rad, u radu: *Check if high level alarms are operational and have been tested.*

operational costs (shipping econ) troškovi redovitog pogona broda (osiguranje, gorivo i maziva, tekući popravci i održavanje, dokovanje, posada broda **operativni troškovi**, troškovi pogona broda

operational expenses (n) (shipping econ) pogonski troškovi

operational level (n) (mar law) **COMPARE management level, support level** razina odgovornosti za obavljanje dodijeljenih zadataka, dužnosti ili odgovornosti časnika straže na pomorskom brodu **radna razina**

operator /ˌɒpəˈreɪtə/ (n) 1 a (mar law) brodar, poslovođa: *The tanker's operator conducted an in-house investigation* Tankerski je brodar obavio unutrašnju istragu.; 2 (ports, shipping econ, mar law) **lučko poduzeće**, **lučka kompanija** **port operator** lučko poduzeće, lučko trgovačko društvo, **container terminal operator** port company operating the container terminal under a concession agreement; trgovačko društvo koje upravlja kontejnerskim terminalom na temelju ugovora o koncesiji s lučkom upravom (Port Authority) **operator kontejnerskog terminala**, **koncesionar kontejnerskog terminala**; 3 (marine eng, ports) rukovalac, rukovatelj, operater, upravljač **crane operator** dizaličar, rukovalac dizalice; 4 operator radiostanice

operators' cab (n) (nav arch) kabina dizaličara, dizaličarova kabina



oppm measurer (n) (*shipping econ, cargo handling*) uređaj za mjerenje milijuntih dijelova ulja u tanku {oil part per million measurer}

opposed -piston engine (n) (*marine eng*) motor/stroj s protuhodnim klipovima

optimum /'ɒptɪməm/ (adj) najpovoljniji, optimalan

option /'ɒpʃən/ (n) (*mar law*) izbor at Shipowner's option po izboru brodar, po brodarovoj volji

optional /'ɒpʃənəl/ (adj) po izboru, opcionalan

orbit /'ɔ:bt/ (n) (*navig*) orbita

order /'ɔ:de/ (n) 1 red, redosljed, raspored firing order redosljed paljenja, reverse order obratan redosljed; 2 zapovijed; 3 nalog give orders to 1 narediti, zapovijediti (nekome); 2 izdati naredbu (nekome); 4 (*shipping econ*) naredba place an order naručiti, dati narudžu, poslati narudžbu, receive an order primiti narudžbu; 5 narudžba order book knjiga narudžaba

order /'ɔ:de/ (v) (*navig*) order the helm to dati naredbu kormilaru, dati naredbu za kormilarenje: *At 1001, the pilot ordered the helm to 'port 20°' and, a few seconds later, gave instructions for the tug to be cast off.* narediti, naložiti, dati naredbu, dati nalog order engine full ahead narediti stroju 'svom snagom naprijed': *The pilot ordered the bow thruster full to starboard, but at the prevailing speed this had no effect.* Peljar je naredio 'Pramčani porivnik svom snagom u desno', ali pri tadašnjoj brzini to nije imalo učinka., give orders dati upute, direct an order uputiti nalog, uputiti naredbu

order and conditions of the goods (n) (*mar law*) stanje tereta (jedan od navoda u teretnici)

order bill of lading (n) (*mar law*) A bill of lading providing for delivery of the goods to the order of a specified person, by words such as consigned to XYZ Co. Ltd. or to order or assigns. An order bill is negotiable by endorsement and delivery of the document to the endorsee (Tetley teretnica po narudžbi, teretnica po nalogu)

orderly /'ɔ:deli/ (adv) uredan, učtiv, miran {u opisu radnih karakteristika pomorca}

order printer (n) engine order printer pisač manovre (zapovijedi stroju) (*navig*) pisač manovre

order the engine ahead (v) (*navig, seamanship*) dati naredbu za vožnju naprijed: *On receiving the alert from VTS, the pilot ordered the engine to full ahead, helm hard- a-port and instructed the tug to pull on the vessel's port quarter, intending to manoeuvre the vessel back into the fairway.*

order the engine astern (v) (*navig, seamanship*) dati naredbu za vožnju natrag:

While weighing up the anchor, the master **ordered engines on 'dead slow astern'** but found himself in close quarter situation with a bunker-barge. As the rate of turn to port increased towards the jetty, the pilot **ordered the engine astern**, the rudder hard to starboard and the bow thrust full to starboard.

order the rudder (v) (navig) dati naredbu kormilaru, izdati naredbu za kormilarenje
order the rudder hard to port / starboard dati naredbu kormilaru sve lijevo / sve desno: The Master ordered the rudder hard to port and repeated the Rule 34 (d) sound signal, but the container vessel continued to alter her course to starboard and, on a NW'ly heading, was heading directly for our tanker's bow.

ordinary moor (n) (seamanship) method of mooring with anchors in which the up-stream anchor is dropped first **normalno sidrenje**

ordinary seaman (OS) (n) (seamanship) **COMPARE able-bodied seaman** The beginning grade for members of the deck department. The next step is able bodied seaman.

(www.USMM.org) **mornar**: Ordinary Seaman or OS is an entry-level position in the deck department. An OS performs various general duties within the deck department. His duties include taking care of general needs of the crew and guarding the ship while in port. **{{(obično stariji, iskusniji)}}**

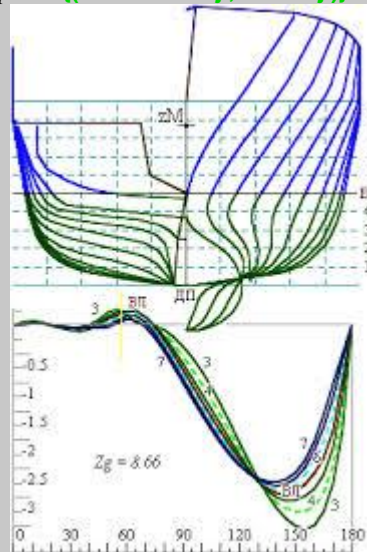

ordinates (n) (nav arch) ordinate broda

ordnance exercise /'ɔ:dnəns/ (n) (navig) vojna vježba gađanja

ore bulk oil carrier; OBO carrier (n) (nav arch) brod za rudaču, rasuti teret i ulje

ore carrier (n) (nav arch) brod za rudaču, brod za prijevoz rudača

Organisation of the Petroleum Exporting Countries (=OPEC) (n) (shipping econ, mar law) Organizacija zemalja izvoznica sirove nafte (OPEC), Organizacija

OPEC: There is more uncertainty over cargo volumes next month after the Organisation of the Petroleum Exporting Countries (OPEC) agreed to reduce production by 1.2 million barrels per day from Jan. 1.

orientation mode (n) (navig) orijentacija načina rada (radara, sustava ECDIS)

orifice plate /'ɔrifis/ (n) (marine eng) ploča s kanalićima (tlačnog gorionika)

O-ring (n) (marine eng) prstenasta brtva, okrugla brtva

orlop beam (n) (sailing vessels) sponja skladišta **{{obsolete (zastarjelo)}}**

orlop deck (n) (nav arch, boating/yachting) najniža paluba ratnog jedrenjaka **{{obsolete (zastarjelo)}}**

orthodromic /,ɔ:θə'drəʊmik/ (adj) (navig) **COMPARE great circle sailing**

ortodromski **orthodromic navigation** ortodromska plovidba, plovidba po ortodromi, **orthodromic course** ortodromski kurs, **orthodromic distance** ortodromska udaljenost

orthodromic curve /ˌɔːθəˈdrɒmɪk/ (**navig**) **ANTONYM loxodromic** the shortest distance between two points on the surface of a sphere, measured along the surface of the sphere (as opposed to a straight line through the sphere's interior) **ortodromska krivulja**



ortodrome /ˌɔːθəˈdrɒm/ (**n**) (**navig**) ortodroma

oscillate /ˈɒsɪˌleɪt/ (**v**) **1 a** oscilirati, gibati se izmjenično; **2** njihati (se); **3** titrati

oscillator time base unit oscilirajuća vremenska baza (radara)

osmosis (**n**) (**marine eng**) osmoza **obrnuta osmosis** povratna osmoza (u desalinizaciji)

Out. (**comm**) Gotovo. Radiotelefonski razgovor završen. **Over and Out.** Gotovo. Radiotelefonski razgovor završen. {In IMO SMCP Phrases (2001) the use of **Out.** is preferred instead of **Over and out.**}

outboard /ˈaʊtˌbɔːd/ (**adj**) (**boating/yachting**) izvanbrodski motor

outboard engine /ˈaʊtˌbɔːd/ (**n**) (**boating/yachting**) izvanbrodski motor, **foribordo**, tal.

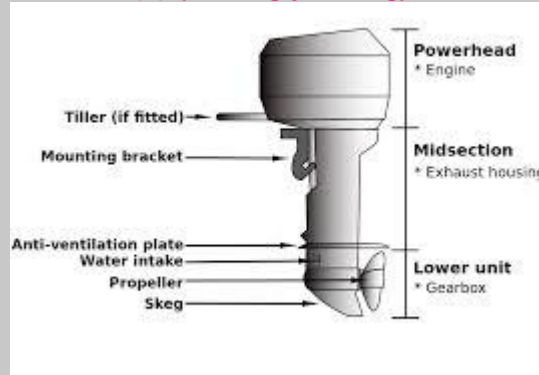

motore fuoribordo

outboard motor /ˈaʊtˌbɔːd/ (**n**) (**boating/yachting, marine eng**) izvanbrodski motor, **fuoribordo**

outbound /ˈaʊtˌbaʊnd/ (**adj**) **ANTONYM inbound** koji izlazi / isplivljava iz luke (ušća, plovnog kanala, tjesnaca itd.): *One coaster was **outbound** in the **outbound** lane and one coaster **outbound** in the **inbound** lane.* **outbound shipment** izvozna pošiljka, pošiljka za ukrcaj na brod, pošiljka u ukrcaju

outbound ship (n) (navig) **ANTONYM inbound ship** brod koji isplovljava (iz luke, ušća, plovnog kanala itd.): *As the pilot was to transfer from an **outbound coastal tanker**, he instructed the container ship to move to the starboard side (west) of the recommended track to avoid the tanker* Budući da je peljar trebao preći na brod s jednog obalnog tankera koji je isplovljavao, peljar je naredo kontejnerskom brodu da se pomakne u desno (zapadno) od preporučenog puta/rute kako bi se izbjegao tanker.

outbreak /'aʊt, breɪk/ (n) **izbijanje** (vatre, požara)

outdated /,aʊt'deɪtɪd/ (adj) **zastarjeli, neažuriran**

outdrive /,aʊt'draɪv/ (n) (boating/yachting, marine eng) = **stern drive** krmeni pogon, krmena osovina

outer port / harbour (n) (ports) **ANTONYM inner port / harbour** vanjska luka, luči akvatorij prema otvorenom moru (za ukrcaj peljara)



outfit /'aʊt, fɪt/ (n) **1 odijelo; 2 (nav arch)** all the parts of a ship that are not structural in nature such as pipes, derricks, masts, rigging, engines, machinery, electrical cable, hotel services, etc. (Ship Terms Glossary.html) **oprema; 3 opremanje**

outfit (v) (nav arch) **opremiti, opremiti s**: *the new tug is outfitted with a fixed-pitch propeller*

outfitting (n) (nav arch) **opremanje**: *IMO regulations focus on the arrangements and outfitting of the vessel as it pertains to safety and environmental performance.* **outfitting wharf opremni vez** {For example, these regulations cover load line (freeboard) requirements, intact and damage stability, firefighting and lifesaving equipment.}

outhaul /'aʊt, ho:l/ (n) **1 (boating/yachting)** konop za pritezanje stražnjeg roglja jedra; **2 (seamanship)** a line used to haul a piece of gear from a ship **uže za prebacivanje stvari s broda**

outlet (n) **1 izlaz; 2 (marine eng)** izlazni (odvodni, odušni) otvor **exhaust gas outlet** izlaz ispušnih plinova, **water outlet** izlaz vode, odvod, **outlet valve** ispušni ventil, izlazni ventil; **3 ispuštanje, istjecanje, otjecanje**

outlet header (n) (marine eng) izlazni kolektor, izlazna sabirna cijev



outline (n) **profil, prikaz**

outlook /'aʊt,lʊk/ (n) (meteorol) izgledi vremena (za 12 sati) further **outlook** izgledi vremena za sljedećih 12 sati, **extended outlook** izgledi vremena za sljedećih nekoliko dana

out of action izvan funkcije, u neradnom stanju: *the port will be out of action for two weeks following last weeks's floods*

out-of-court settlement (n) (mar law) izvansudska nagodba

out of date (n) (adv) zastario

out-of-gauge /'aʊt ev ,geɪdʒ/ izvan gabarita / dimenzija (npr. teret) **out-of-gauge boxes** izvangabaritni kontejneri: *If the pre-plan shows that out of gauge boxes are to be loaded in unacceptable positions, more suitable stowage options should be discussed and agreed with the terminal as soon as possible.*, **out-of-gauge cargoes** izvangabaritni tereti {(US) out-of-gage}

out-of-trim (n) (seamanship) promjena trima broda

output /'aʊt,pʊt/ 1 snaga (na izlazu) **engine output** snaga motora, **reduced power output** smanjena izlazna snaga; 2 korisna snaga; 3 proizvodnja (snage)

outreach /'aʊt,rɪ:tʃ/ (n) **waterside outreach** dohvat na obalnoj / morskoj strani, **landside outreach** dohvat s kopnene strane (cargo handling) dohvat dizalice

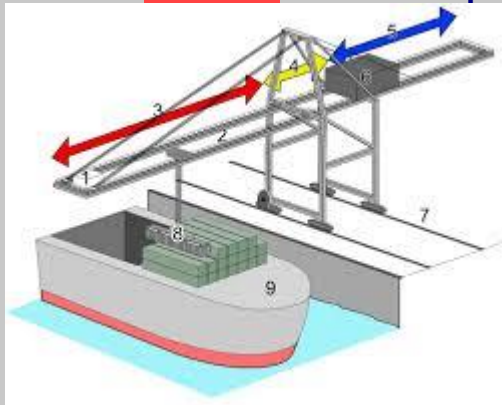

{crane outreach: No. 3}

outrigger /'aʊt,rɪdʒ/ (n) 1 **rasponica koša**; 2 A projecting beam or spar run out from the side of a vessel to help in securing the masts or from a mast to be used in extending a rope or sail **izbačeni**



krak brodice / jedrilice

outsource (v) To hire a third-party provider to assume tasks previously performed in-house. **povjeriti vlastite usluge ili poslove vanjskoj tvrtki**

out-turn /'aʊt,tɜ:n/ (n) (shipping econ) iskrcaj (tereta) **ANTONYM shipment**

outward (adj) **outward bound** a ship leaving the port, heading for the open sea **koji isplavljava** 1 vanjski; 2 (adv) izvan, izvana

outward clearance (n) (mar law) dozvola za isplavljenje

Outward Light Bill (shipping econ) Računa / faktura za korištenje plovni putova (pri odlasku broda iz luke) **Outward Light Bill Receipt** Potvrda o oplaćenju pristojbi za korištenje plovnog puta

outwards /'aʊtwɜːdz/ (adv) prema vani

outweigh /,aʊt'wei/ (v) 1 prevagnuti; 2 pretegnuti

overall /'əʊvəɹ,ɔ:l/ (adj) sveukupni, cjelokupni **length overall** (nav arch) dužina preko svega)

overall rating (n) (marine eng, nav arch) ukupna snaka

overalls (n) (seamanship) = **dungarees** radno odijelo, tuta

overall stability (n) (stabil) a general measure of a ship's ability to resist capsizing in a given condition of loading **ukupna stabilnost broda**

overbear /,əʊvə'beə/ (v) (boating/yachting) uzeti vjetar (jedrilići), ukrasti vjetar

overboard /'əʊvə,bɔ:d/ (adv) 1 preko palube; 2 u more **throw cargo overboard** bacati teret u more, **discharge overboard** iskrcaj u more (npr. tereta nafte ili balasta), **ispuštanje u more**: *The skipper also looked over the side of the boat and observed that both the engine exhaust and bilge discharge overboard were clear of the waterline. Should any overboard discharges occur, they must be documented in an oil record book, a log that is regularly inspected by the U.S. Coast Guard; 3 izvan broda*

overcapacity (n) (shipping econ) prekapacitiranost (npr. broskog prostora): *On Jan. 3, 2017, BIMCO came out with their shipping forecast and it is for lower growth in the coming years, thanks to overcapacity and national subsidies.*

overcarriage (n) (shipping econ) prekrcavanje, suvišno krcanje tereta, krivo ukrcan teret (teret za sljedeći brod ili luku)

overcarry krivo ukrcati teret (za sljedeću luku odnosno u kriv skladište), ukrcati previše tereta

overcast /'əʊvə,kɑ:st/ (adj) (meteorol) sky condition when greater than 9/10 of the sky is covered by clouds **potpuno oblačno, oblačno, nebo prekriveno oblacima, tal. cielo coperto**

overcome (v) prevladati, nadvladati **overcome a problem** prevladati problem, riješiti problem

overcurrent protection (n) (electr) nadstrujna zaštita, zaštita od prekoračenja napona

overdraft limit (n) prekoračenje (računa u banci)

overdrawn (adj) preko dopuštenog ograničenja (o stanju računa na banci), preko limita

overfall (n) (oceanogr) lomovi vala

overflow (n) 1 a izljev; 2 preljevanje, izljevanje

overhand knot (n) čvor protiv otpletanja konopa

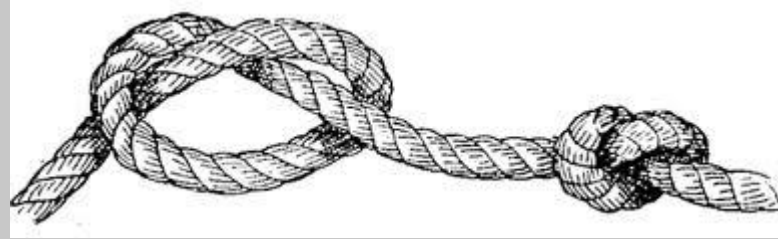

overhang (n) (*nav arch*) dio trupa broda koji nije poduprt vodom; the portion of a vessel's bow or stern which projects beyond a perpendicular at the waterline **prevjes**

overhaul /ˌəʊvəˈhɔːl/ (n) (*marine eng*) 1 temeljit popravak; 2 remont; 3 tehnički pregled, *klasa*; 4 periodični radovi održavanja; 5 pretjecati drugi brod

overhaul /ˌəʊvəˈhɔːl/ (v) 1 to repair or put in proper condition for operation **obaviti remont, popraviti**; 2 tehnički pregledati; 3 temeljito popraviti; 4 periodički servisirati (stroj, pumpu); 5 održavati, preventivno održavati; 6 pregledati, pregledavati

overhaul /ˌəʊvəˈhɔːl/ (n) (*boating/yachting*) rope used to adjust tension in the mainsheet foot nateg po deblenjaku

overhaul (v) (*navig*) pretjecati, stizati (brod ispred)

overhauled (adj) (*marine eng*) servisiran (periodički) **overhauled engine** an engine which has been disassembled, cleaned, inspected, repaired as necessary and tested **remontiran, koji je prošao klasu (o stroju)**: *koji je obavio remont*

overhauling (n) 1 a remont; 2 periodički pregled, *klasa*

overhead The ceiling, or, essentially, the bottom of the deck above **strop palube, svod**

overhead crane (n) (*cargo handling*) viseća mosna dizalica (u skladištu, radionici),



stropna dizalica

overheat (v) 1 a (*marine eng*) **pregrijati (se)**: *the deck steam condenser had overheated and was releasing a lot of steam*; 2 **prejako zagrijavati**

overheating (n) (*cargo, marine eng*) **pregrijavanje, pregrijanost**

overladen /ˌəʊvəˈleɪdən/ (adj) (*shipping econ*) **prekrčan (brod)**

overlanded (adj) 1 (*shipping econ, cargo handling*) cargo volume counts more than originally shipped **višak ukrcanog tereta**; 2 (*shipping econ, cargo handling*) cargo taken beyond original port of discharge **teret prenesen u sljedeću luku, neiskrcan teret**

overlap /ˌəʊvəˈlæp/ (n) (*boating/yachting*) **preklapanje (jedrilica u regati)**

overlapping (n) (*boating/yachting*) 1 **preklapanje (u jedrenju)**

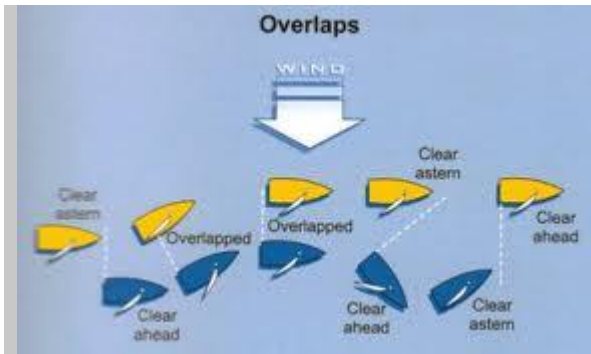

; 2 (marine) preklapanje (osiguranja tereta i

odgovornosti brodara)

overload /ˌəʊvəˈləʊd/ (v) 1 a prenakrcati; 2 preopteretiti

overload /ˌəʊvəˈləʊd/ (n) preopterećenje

overloaded 1 a prenakrcan; 2 preopterećen

override /ˌəʊvəˈraɪd/ (n) 1 (marine eng) prebacivanje, premoštenje emergency

override (safety) prebacivanje u nuždi, premoštenje u nuždi: *It was decided to operate the deck raising/lowering system on emergency override, which used stored hydraulic pressure.*; 2

(marine eng) preskakanje, premoštenje manual override ručno prebacivanje

override /ˌəʊvəˈraɪd/ (n) (marine eng) premosnica, zaobilaženje, prebacivanje

override (v) (marine eng) premostiti, zaobići, prebaciti

overriding (adj) 1 važniji, najvažniji; 2 prioritetan: *in case of an emergency or drill or in other overriding operational conditions* u hitnim slučajevima i vježbama ili u drugim prioritetnim uvjetima

overriding authority and responsibility neograničeno ovlaštenje i

odgovornost (zapovjednika za donošenje odluka glede sigurnosti i zaštite

okoliša): *Nothing in this Safety Management System removes from the Master his overriding authority and responsibility to make decisions, take any steps and issue any orders, whether or not they are in accordance with the contents of this Safety Management System, which he considers are necessary for the preservation of life, prevention of pollution or for the safety of the ship and to request the Company's assistance as may be necessary.*

over-ripen /ˌəʊvəˈraɪpən/ (v) (cargo, shipping econ) sazrijeti prerano (o teretu) : *Bananas may overripen due to failure of the vessel's refrigeration system during the voyage.*

overseas trade prekomorski promet / prijevoz / trgovina

overstow (v) (shipping econ, cargo) složiti preko drugog tereta, složiti previše tereta

oversupply (n) (shipping econ) prekomjerna ponuda, višak ponude nad potražnjom:

The world of container shipping is going through a prolonged period of instability due to oversupply of new ships entering service and decreased demand for transporting goods between major economies

overtake /ˌəʊvəˈteɪk/ (v) 1 (navig) preteći, pretjecati: *The container vessel was overtaking the tanker with a speed advantage of about 5 knots*; 2 sustići, doseći, tal. **raggiungere**

overtaken ship /ˌəʊvəˈteɪkən/ (n) (navig) **ANTONYM** overtaking vessel preticani

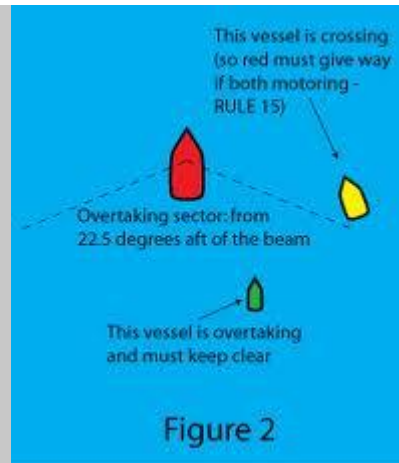

brod, brod kojega drugi brod pretječe

overtaken vessel pretjecani brod

overtaking /ˈəʊvəˈteɪkɪŋ/ (*navig, boating/yachting*) **pretjecanje**: *In a narrow channel overtaking should normally take place on the port side as the vessel being overtaken should be as far as practicable on the starboard side of the cha*

overtaking light (n) (*navig*) = **stern light** krmeno svjetlo (moguće pretjecanje)

overtaking vessel brod koji pretječe

overtime (n) (*shipping econ, mar law*) **prekovremeni rad, plaća za prekovremeni rad**:

*Work performed over and above an eight hour period shall be considered overtime and be compensated for at overtime rates. Vrijeme na radu od preko osam sati smatra se prekovremenim radom i nadoknađuje se kao prekovremeni rad. **overtime rate iznos naknade za prekovremeni rad** Overtime over and above these normal working hours will be paid at the overtime rate stipulated in Appendix A,*

premium overtime rate osnovna naknada za prekovremeni rad

owe /əʊ/ (v) **dugovati (nekome), biti dužan (nekome)**: *The crew from ... and ... and are now owed tens of thousands of dollars. Kompanija sada duguje nekoliko desetaka tisuća dolara posadi iz ... i ...*

owing to (conj) **uslijed, zbog**

owner /ˈəʊnə/ (n) **1 (mar law) vlasnik broda, brodovlasnik, armator shipowner**

brodovlasnik; 2 (shipping econ, mar law) brodar, morski prijevoznik

owner cabin (n) kabina na brodu koju koristi brodovlasnik **brodovlasnikova kabina**

owner insignia (n) (*comm, navig*) oznaka brodovlasnika

owner of the goods (n) (*mar law*) vlasnik robe, vlasnik tereta

Owner/Operator (n) (*mar law*) brodovlasnik/brodar

owner pennant (n) (*comm, navig*) plamenac brodovlasnika

owners /ˈəʊnəz/ (n) (*mar law*) brodovlasnik, vlasnik broda

owner's liability (SOL) (n) (*mar law*) odgovornost koju brodar preuzima za obveze nastale u

*vezi s plovidbom i iskorištavanjem broda **brodarova odgovornost** A typical SOL example is geographical deviation or departure from the contractually agreed voyage; liability for loss of and/or damage to cargo arising out of such a deviation falls outside the scope of standard P&I.*

own ship position (n) (*navig*) položaj broda (u sustavu ECDIS, na radarskoj slici itd.), pozicija broda

own the ship /ˈəʊn/ (v) (*shipping econ, mar law*) biti vlasnik broda, biti

vlasnikom broda *the oil/chemical tanker XXX was one of 36 vessels owned and operated by the company YYY Ltd.*

oxidation (n) (marine eng) oksidacija

oxide /'ɒksaid/ oksid **oxide film** sloj oksida

oxidizing substances and organic peroxides /'ɒksi,daizɪŋ/ (n) (cargo)

oksidirajuće tvari i organski peroksidi {klasa 5 opasnih tvari}

oxygen content recorder (n) (cargo handling, safety) pisač količine kisika

oxygen /'ɒksɪdʒən/ (n) (chem) kisik

oxygen analyzer /'ɒksɪdʒən/ (n) (cargo handling) analizator kisika **fixed and portable**

oxygen analyzer ugrađeni i prijenosni analizatori kisika

oyster (n) (fishing) Lat. *Ostrea edulis* kamenica, oštriga

pack (v) (cargo) nabiti, sabiti, stisnuti, složiti u hrpu

pack (n) (oceanogr) plovac, plutajući led, pomični morski led

package /'pækɪdʒ/ (n) (**shipping econ, cargo**) cargo packaged as a single unit; cargo representing a single unit of cargo in transport **kolet, koleto, pošiljka tereta, jedinica tereta,**

komad tereta fragile package lomljiv kolet, **light package** lagan kolet, **weighty package** teži kolet

packaged goods (n) (**shipping econ**) (cargo) pojedinačni koleti ili odvojene jedinice

tereta u pošiljci **koleti, denčani teret, denčana roba, pakirana roba**

packaging = packing pakovanje (tereta), ambalaža

pack-ice (n) (oceanogr) pomični morski led promjenjiva oblika **plovac**



packing /'pækɪŋ/ (n) (**shipping econ**) pakiranje (tereta), pakovanje **method of packing** vrsta pakovanja

packing /'pækɪŋ/ (**shipping econ**) 1 komad tereta, jedinica tereta, kolet, koleto; 2 pakovanje, ambalaža

packing /'pækɪŋ/ (**marine eng**) 1 (**marine eng**) brtvilo, brtva, brtveni uložak, brtveni materijal **stern gland packing** brtva šupernice, brtva očnice, **stuffing box packing** brtvilo brtvenice, brtva brtvenice, **stern tube packing** brtva statvene cijevi, **propeller shaft packing** brtva propelerske osovine, **rudder packing** brtva osovine kormila, **braided-synthetic packing** brtvena pletenica od sintetičkog vlakna, **trinela** od sintetičkog vlakna, sintetička **trinela**, **pure graphite packing** grafitno brtvilo, **flax plus teflon packing** brtvilo od lana i teflona



; 2 brtvljenje

packing /'pækɪŋ/ **methods of packing** načini pakiranja, vrste ambalaže (*shipping econ*) pakovanje, ambalaža, pakiranje

packing box = stuffing box brtvenica

packing list (n) (*shipping econ*) list of packages for each shipment, showing individual breakdown in weights/measure and quantity popis koleta (tereta), lista pakovanja

paddle /'pædəl/ (n) (*boating/yachting*) lopatica za veslanje

paddle-box (n) (*nav arch*) kućište pogonskog točka

paddle-wheel (n) (*nav arch*) pogonski točak, pogonsko kotač, pogonsko kolo

paddle-wheel arms palci točka, **paddle-wheel floats** lopatice točka, **paddle-wheel rims** vijenac točka, **paddle-wheel shaft** osovina točka

padding (n) (*seamanship*) veslanje lopaticom

pad eye /'pæd.aɪ/ (n) (*cargo handling, nav arch*) a fitting welded to a deck or bulkhead. It has an eye to which lines or tackle are fastened and are used for securing or handling cargo. **ušica (na plaubi) za privezivanje tereta, očet**. *As a result, the deck pad eyes failed and the 80 tonne 'A' frame fell backwards onto the wheelhouse and the main deck.*



PAD; Predicted Area of Danger (n) (*navig*) zone moguće opasnosti (na ARPA radaru)

pagrus (n) (*fishing*) lat. *Pagrus pagrus* porodica *sparidae*, pagar {Other names in Croatian: parag, pagra, pagarić, albun, crvenac, fag, hvag}

paint /peɪnt/ (n) (*seamanship*) boja, *pitura, farba*, tal. *pittura*; *vernice*

paint brush (n) (*seamanship*) kist za bojanje, *pinel wield a paint brush* bojati, *piturat pinelom*

painted comber (n) (*fishing*) *pirka* {lat. *Serranus scriba*}

painter /'peɪntə/ (n) 1 (*safety*) a short piece of rope secured in the bow of a small boat, lifeboat, or liferaft used for making her fast **pramčani konop splavi, pramčani konop brodice za**

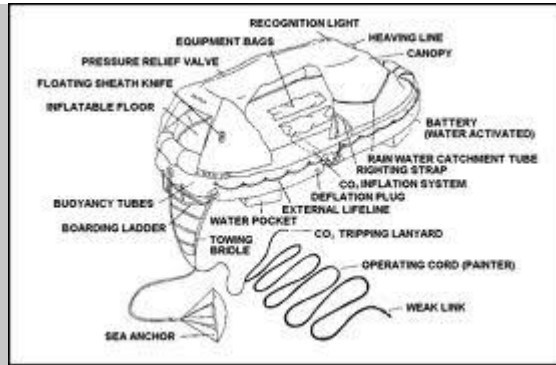

spašavanje, **barbeta**; tal. **barbetta** ; 2
 (boating/yachting) pramčani konop gumenjaka
paint integration (n) (navig) integracija slike (na ARPA radaru)

Pallet Analysis: Best Pallet Version 3.3.0

Prepared By: _____ Company: _____
 Analysis ID: _____ Address: _____
 Date: _____

Pallet Information: Type - Pallet/straw; Weight - 64.5 lbs; HT to Spot
 Pallet Description: 43.0 in L x 90.0 in W, Double Deck, Intermediate, Floor, Reversible
 Pallet Load: 2000 (LBS)

Analysis Summary

Required Payload: 1800 lbs
 Provided Maximum Safe Load: 1517 lbs

Storage and Handling Conditions	Predicted Maximum Safe Load (lbs)	Static Average Deflection (in)	Critical Members
Racked Across Length	1511	0.333	Stringer
Racked Across Width	1290	0.272	Bottom Deckboard
Upright Parallel to Length	3915	0.24	Top Deckboard
Upright High	4055	0.888	Top Deckboard

Disclaimer: The performance estimates of Best Pallet are based on available engineering information compiled in data provided. The quality of workmanship, the input data, and other conditions in which pallets are used may vary widely. Therefore, Inter-Pallet Company, LLC cannot accept responsibility for pallet performance or design in certain circumstances. The performance estimates from Best Pallet should be verified by testing of prototypes prior to implementation.

pallet /'pælit/ (n) (cargo handling) paleta
panama lead /,pæne'ma:; 'pæne,mɑ:./ (n) (nav arch) oko za privez (po sredini pramca ili



krme), središnje oko, **panama**
Panamax /'pæne,mæks/ (n) (nav arch) brod koji može ploviti kroz Panamski kanal **brod tipa Panamax**
pandora (n) (fishing) Lat. *Pagellus erythrinus* **arbut common pandora** **arbut**



{ost. hrv. nazivi: Arbul, Arbor, Jarbut, Ribon,

Ribun, Rumenac, Višćica, Fag;}
panel /'pænel/ ploča, tabla **electrical panel** električna razvodna ploča
panel (n) (nav arch) vodoravni uzdužni presjek **side panel** bočni uzdužni presjek,
bottom panel uzdužni presjek dna, **bridge deck** paluba navigacijskog mosta,

monkey island krov kormilarnice, **boat deck** paluba brodica za spašavanje
panels and sections of a ship (n) (nav arch) vodoravni uzdužni presjeci i
 poprečni presjeci broda

panneling (n) (cargo) oplata (kontejnera)

PAN PAN /,ˈpænˈpæn/ (n, interj) (safety, comm) pozivni signal u žurnosti (npr. za
 medicinsku pomoć): *In urgent medical cases, the radio telephony urgency signal PAN PAN or a*

DSC urgency alert may be used to establish communications **urgency signal PAN PAN signal**

žurnosti za medicinsku pomoć, **PAN PAN call** poziv PAN PAN, **poziv s oznakom**

žurnosti: *The skipper was unable to determine the cause of the flooding so he made a "Pan Pan" call*
by VHF radio, to which the coastguard responded.

panting /ˈpæntɪŋ/ (n) (nav arch) the in and out movement of a ship's plating caused by changes in
 pressure **pulsiranje limova pramca ili krme (zbog udaranja valova)**

panting beam (n) (nav arch) prostorna sponja

pantry /ˈpæntri/ (n) (nav arch) smočnica, sprema, **dispensa**, **pentri**, tal. **cambusa** {tal:
 cambusa}

paper carrier (n) (nav arch) brod za papir, brod za prijevoz papira

paper chart (n) (navig): *The chief officer completed some administrative tasks on the ship's computer*
but did not plot the vessel's position on the paper chart. He relied solely on GPS and did not verify the
course the vessel was following or plot the vessel's position on a paper chart.

parachute flare /ˈpæərəˌfluːt/ (n) (safety) padobranska baklja

parachute smoke signal /ˈpæərəˌfluːt/ padobranski dimni signal

paraffin /ˈpærəfɪn/ (n) (cargo) 1 parafin; 2 (cargo) kerozin, avionsko gorivo

parallax /ˈpæərəˌlæks/ (n) (navig) paralaksa

parallel courses (n) (navig) usporedni kursovi, paralelni kursovi: *the ships came*
alongside each other on almost parallel courses

parallel indexing (n) (navig) ucrtavanje dužine paralelne s pramčanicom

parallel index lines (n) (navig, electr) radarsko smjeralo s urezanim paralelnim
 crtama

parallel midbody (n) (nav arch) paralelni srednjak

parallel moddle body (n) (nav arch) paralelna sredina

parallel rulers (n) (navig) usporedna ravnala

parallel sweep search (n) (navig, safety) traganje po usporednim stazama

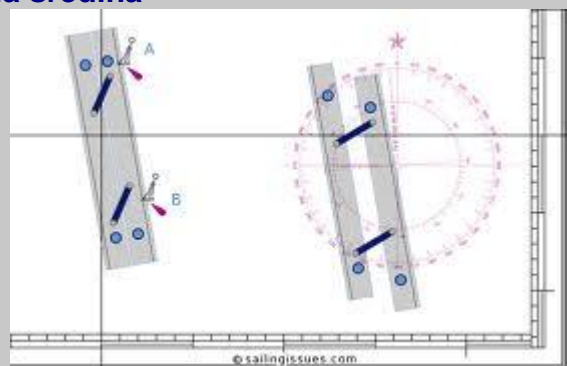

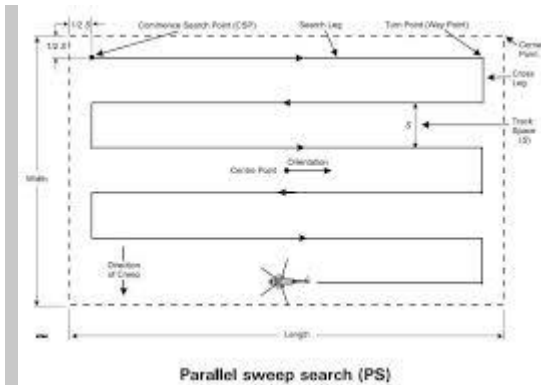

parallel track limiters (n) (navig) COMPARE diverging limiters usporedni graničnici

paramount clause /'pæərə maʊnt/ (n) (mar law) vrhovna klauzula, klauzula u teretnici prema kojoj se teretnica podvrgava pravu i sudskoj nadležnosti mjesta izdanja teretnice

parcel /'pa:səl/ (n) (shipping econ) 1 (shipping econ) departed part of cargo, especially oil, which is all of one nature or is for one consignee or port dio pošiljke, djelomični teret, dio ukupne količine tereta: Fuel oil parcel for Exxon is 5000 tons dio tereta goriva za Exxon iznosi 5000 tona A chemical tanker had discharged parcels of cargo at a port in the Middle East and was outbound through a narrow channel to sea.; 2 kolet, paket, pošiljka, jedinica tereta

parcel tanker (n) (nav arch, shipping econ) a tanker designed to carry an assortment of liquids, as chemicals, or different grades of a liquid, as petroleum, at one time; tanker equipped to carry several types of cargo simultaneously tanker za naftu i derivate, parcel tanker

parking area (n) (cargo handling) prostor za vozila (u ro-ro brodu, trajektu): The cause of the fire has yet to be determined but the coastguard said it might have started in the parking area.

parrel (= 'pærəl) (n) (nav arch, boating/yachting) a movable loop, used to fasten the yard to its respective mast obruč križa

parrel cleat /'pærəl/ (n) obruč križa spojeni hajmicom

part 1 a dio, element fixed part fiksni element, nepomični dio, spare parts rezervni dijelovi, stationary part nepomični dio; 2 komad; 3 strana

part (seamanship) break puknuti (o užetu): The first two attempts failed because the tow line parted on each occasion. The rope was found to have parted at a point about 14 metres from the eye. the line parted uže je puklo, parted line puknuto uže

partial awning deck /'ɔ:nɪŋ/ (n) (nav arch) manevarska paluba

partial awning deck vessel (n) (nav arch) brod s djelomičnom manevarskom palubom

partial bulkhead (n) (nav arch) djelomična pregrada

partial floor djelomična rebrenica

particle /'pa:tɪkəl/ (n) (marine eng) čestica fine particles 1 sitne čestice; 2: the oil broke into fine particles

particular average /pə'tɪkjʊlə/ (n) (mar law) A marine insurance term meaning a partial and not total loss suffered by an insured. (Particular means percentage and average means loss.) (Tetley)

posebna havarija, partikularna havarija

particulars /pəˈtɪkjʊləz/ (n) podaci o nečem **contain particulars about** sadržati podatke o, **main particulars** (nav arch) osnovni podaci o brodu

partition bulkhead /paːˈtɪʃən/ (n) (nav arch) odvojna pregrada, razdjelna pregrada

Partlow chart (n) (cargo handling) A chart that indicates the temperature reading in a reefer container. (<http://www.maerskline.com/en-jm/help/shipping-glossary>) **dijagram temperatura u kontejneru**

partners (n) **1** (boating/yachting) otvor na palubi za prolaz jarbola (na krstašu); **2** otvor na plaubi za jarbol (na malim jedrilicama)

partnership (n) **1** (mar law) partnerstvo, partnersko društvo **general partnership** javno trgovačko društvo, **limited partnership** komanditno društvo; **2** ortakluk

party (n) (safety) grupa, tim, ekipa, **ruka**: the Master ordered for a party consisting of the C/O, C/E and a seaman to internally inspect the damage **mooring party** privezivačka grupa, **privezivačka ruka**

pass (v) **1** prolaziti, ploviti pokraj, proći: he fell asleep while the vessel was passing the peninsula of ... **pass clear ahead** proći slobodno po pramcu: The OOW initially assessed that there was sufficient room for his vessel to pass clear ahead of the red vessel.; **2** preći

pass (n) (mar law) dozvola **shore pass** dozvola za izlazak (s broda) u grad, **issue a shore pass** izdati dozvolu za izlazak s broda u grad/luku

passage /ˈpæsidʒ/ (n) (shipping econ) **passage plan** **1** plan plovidbe; **2** plan putovanja **1** a putovanje **contract of passage** ugovor o putničkom prijevozu; **2** brodsko putovanje, putovanje broda: The root cause of the accident was the deviation from planned track during the critical final stage of the passage the vessel continued on its short passage towards the discharge port **coastwise passage** putovanje uz obalu, **lay out the passage** ucrtati putovanje: Coastwise passages of a few hundred miles or less can be laid out directly on charts, either electronic or paper., **trans-oceanic voyage** prekomorsko putovanje, **prekooceansko putovanje**: For trans-oceanic voyages, construct the track using a navigational computer, a great circle (gnomonic) chart, or the sailings., **passage time** trajanje putovanja broda; **3** plovidba; **4** vijaj, vijad; **5** traversada, putovanje, prijelaz (mora, oceana); **6** prijelaz, prolaz {passage obično označava dio čitavog putovanja broda (voyage), npr. između dviju luka na putovanju}

passage /ˈpæsidʒ/ (n) **1** (marine eng) kanal, otvor, prolaz, hodnik **annular passage** prstenasti prolaz, **drilled passage** zavojni otvor, zavojni kanal, **oil passage** otvor za podmazivanje, **water cooling passage** kanal za hlađenje vodom; **2** (oceanogr) kanal, prolaz {tal. corridoio}

passage management (n) (safety, navig) provedba slijeda odluka donesenih tijekom plovidbe kojima se na siguran način ostvaruje cilj putovanja **upravljanje brodom**, **upravljanje putovanjem broda**

passage of front (n) (meteorol) prolazak fronte

passage plan (n) (navig) a comprehensive, step by step description of how the voyage is to proceed from berth to berth, including undocking, departure, enroute, approach and mooring at the destination.; Passage planning or voyage planning is a procedure to develop a complete description of vessel's voyage from start to finish. The plan includes leaving the dock and harbor area, the enroute portion of a voyage, approaching the destination, and mooring. (MO RESOLUTION A.893(21) **plan**

plovidbe, plan putovanja: positions were plotted as specified in the *passage plan*. The P&I club director added that having a proper *passage plan*, from berth to berth, with the latest available navigational warnings and corrections, is important. **prepare passage plan pripremiti plan**

plovidbe the passage plan has been prepared, **keep to the passage plan držati se plana**

plovidbe, primjenjivati plan plovidbe: At approximately 2300, the ship's master finished his night orders and advised the second officer to keep to the passage plan and to call him if in any doubt.

passage planning (n) (navig) **planiranje putovanja:** Such conditions are commonly experienced within the area, were predictable and could have been avoided by effective *passage planning*.

passageway (n) (nav arch) prolaz, hodnik: Ensure that the crew move safely on upper deck passageways.

pass ahead (v) (navig) proći po pramcu: The OOW assumed that the cargo ship would pass about 2 cables ahead of his vessel.

passenger /'pæsɪndʒə(r)/ (n) putnik

passenger accommodation (n) (nav arch) smještaj putnika

passenger-cargo ship (n) (nav arch) putničko-teretni brod

passenger deck (n) (nav arch) paluba putnika

passenger liner (n) (nav arch) putnički brod, putnički linijaš

passenger list (n) (mar law) popis putnika, lista putnika: Will you show me the Port Sanitary Statements from the previous ports and your fumigation certificate, one copy of the Crew List, a *Passenger List* and also the Cargo Manifest.

Passenger List of Lights Popis putnika

passenger operations (n) (shipping econ) prijevoz putnika

passenger pilot (n) (navig) peljar zvan dužnosti na brodu

passenger service providers (n) (shipping econ) Passenger service providers move people from place to place and are usually hired by individuals. **putnički prijevoznici, transportna poduzeća za prijevoz putnika**

passenger ship (n) (nav arch) putnički brod



passenger ship certificate (n) (mar law) svjedodžba o sigurnosti putničkog broda

passenger traffic (n) (shipping econ) putnički promet, promet putnika

pass close down (n) (navig) proći vrlo blizu: The buoy was seen to be *passing very close down* the starboard side when it disappeared from view. Soon afterwards, the nearest of the fishing vessels (Boat B) *passed very close down* the starboard side.

pass the line (v) (seamanship) predati konop (nekome), spustiti konop (privezivaču),

tegljaču: When berthing, mooring lines **are passed** to the dockside one by one, with a spring, headline and also, if required a breast line. **pass the line ashore** poslati konop na obalu (privezivačkim čamcem)

pass the line through (v) (seamanship) provući konop(uže): Pass the other end of the wire through the panama lead, through the anchor crown D shackle (as a bight) and back through the Panama lead on to the warping drum of the windlass

paste /peɪst/ 1 (seamanship) pasta; 2 (seamanship) ljepilo, kola

PA System (n) (comm) = **Public Address System** brodski razglas

patch /pætʃ/ (n) (boating/yachting) zakrpa

patch /pætʃ/ (v) (boating/yachting) krpiti **patch the sail** zakrpati jedro

patch of oil (n) (safety) uljna mrlja na moru, zauljena površina mora: Patches of oil water detected near Australia's Great Barrier Reef, a Unesco-protected site, will be investigated further Saturday morning, local authorities said.

patent anchor /'pæ.tənt/ (n) (nav arch) = **Hall's anchor** a stockless anchor **patentno sidro**

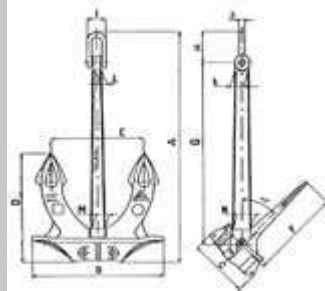

patent log /'pæ.tənt/ (n) (navig) brzinomjer (mehanički vanbrodski): The **patent log**, or speed log, is to be ready for use, the depth finder on, the heaving lines to be at hand, the fenders to be ready,



and the mooring ropes are to be sent on shore.

path /paːθ/ (n) 1 (marine eng) put lubricating oil **path** put mazivog ulja; 2 staza

patient (n) bolesnik, pacijent refer the **patient** to a specialist uputiti pacijenta liječniku specijalisti

Patient Health Status (med) stanje bolesnikova zdravlja **Patient Health Status Form** obrazac za opis stanja bolesnikova zdravlja

patrol /peː'treʊl/ (n) (safety) ophoditi, patrolirati **patrol the strait waters** patrolirati vodama tjesnaca

patrol /peː'treʊl/ (n) (mar law, navy) ophodnja, patrola **step up patrols** uspostaviti ophodnju, patrolirati

patrol boat /peː'treʊl/ (n) (navy) brodica za ophodnju, patrolni brod



{tal. guardiacoste, battello di sorveglianza, vedetta}

patrol ship /pəˈtrɔʊl/ (n) (nav arch) stražarski brod, ophodni brod, patrolni brod

pattern /ˈpætən/ (n) obrazac, uzorak, model

pattern maker (n) (nav arch) modelar, izrađivač modela, izrađivač kalupa

paulin /ˈpɑːlɪn/ (n) (seamanship) COMPARE tarpaulin short form for tarpaulin cerada

pavement /ˈpeɪvmənt/ (n) (ports) tlo, pločnik (na lučkoj obali)

pawl /pɔːl/ (n) (marine eng) zubac, zaustavljač, klin za zaustavljanje

pay /peɪ/ (n) (shipping econ) plaća, nagrada **base pay** osnovica plaće, **seniority pay** naknadna za radni staž, **rate of pay** iznos plaće, plaća u iznosu od, **deduction from the pay** odbitak plaće

paying (n) (seamanship) slackening away on a rope or chain popuštanje konopa

payload /ˈpeɪ.ləʊd/ (n) (cargo, shipping econ) = **cargo deadweight** korisna nosivost, **komercijalna / iskoristiva nosivost** Most of APL's 40' containers have a payload capacity of 28,760 kg with a gross weight of 32,500 kg. **actual payload** razlika između ukupne težine (kontejnera) i tare, **maximum payload** maksimalna korisna nosivost (npr. kontejnera), maksimalna neto težina tereta u kontejneru

payment /ˈpeɪmənt/ (n) (shipping econ) plaćanje **against payment** na temelju izvršenog plaćanja po izvršenom plaćanju, **effect payment** platiti, izvršiti plaćanje, **obtain payment** ishoditi plaćanje, naplatiti, **secure payment** jamčiti plaćanje, osigurati plaćanje, **refuse payment** odbiti plaćanje

payment against documents (n) (mar law) plaćanje uz predočenje dokumenata

payment of freight (n) (shipping econ, mar law) plaćanje vozarine **on payment of freight** nakon plaćanja vozarine

pay off (v intr) (seamanship, navig) otpadati, zanositi se: The pilot then ordered the helm to 'port 20°' and, 12 seconds later, with the bow unexpectedly paying off to starboard, ordered it to 'hard-a-port'.

pay out (v) **pay out the breast line** (seamanship) otpuštati bočno uže (seamanship) To slack out a line made fast on board and let it out slowly **otpuštati uže / lanac**, **otpuštati uže dok se brod odmiče od veza**, **popuštati** The cable was **paid out** to about 7 shackles in the water. As the wind continued to increase, the stern lines began to **pay out** as the winch brakes began to render. {tal. filare un cavo}

payroll /ˈpeɪ.rəʊl/ (n) (shipping econ) plaća, platna lista **payroll calculation**

obračun plaća (pomoraca), **downsize payrolls** sniziti plaće: Several ... shipbuilders are

downsizing their payrolls amid slow economic growth and slacking shipbuilding industry.

PCT (per cent) posto, postotak

peacock wrasse /ræs/ **lumbarak** {drugi hrv. nazivi: božjak, lambraka, lenac, lenica, smokvica, solnjača, tucavica, plazulja, smokvača, zelenka; lat. **CRENILABRUS TINCA**}

peak /pi:k/ (n) **1** (nav arch) pik, tal. **gavone forepeak** pramčani pik, tal. **gavone di prora** krmeni pik, **gavone doi poppa**; **2** (boating/yachting) **COMPARE** gaff pik, vrh sošnjaka {tal. **gavone**}

peak halyard (n) (boating/yachting) podigač pika (na latinskom jedru)



peak tank (n) (nav arch) tank pika, pretežni tank, pramčani tank **forepeak tank**; **FPT**

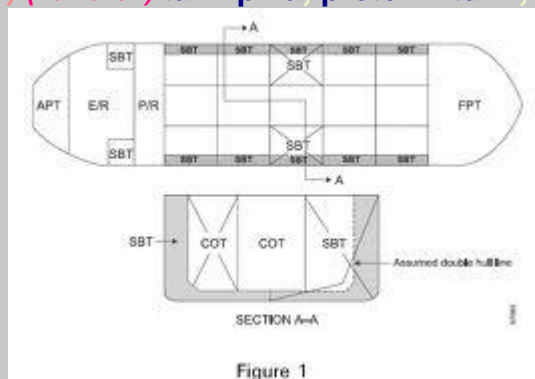

tank forpika

pebbles /ˈpeɪbəl/ (n) (geogr) valutice, šljunčana plaža

peculiar /piˈkju:liə/ (adj) osebujan, čudan, neobičan, poseban

pecuniary /piˈkju:niəri/ (adj) (**mar law**) novčan, u novcu

pedestal /ˈpedɪstəl/ (n) (**marine eng, seamanship**) postolja (svjetla), kormilarsko postolja

peep vane /ˈpi:p,veɪn/ (n) **1** (**marine eng**) a smjerni kanalić



; 2 rupica za smjeranje

pelagic fish /pɛˈlædʒɪk/ plava riba, pučinska riba, pelagička riba

pelagic gear /pɛˈlædʒɪk/ (n) lebdeća oprema za ribolov

pelamid (n) palamida

pelican hook (n) (boating/yachting) kuka u obliku pelikanova kljuna sa zaklopcem na oprugu za hvatanje i brzo otpuštanje konopa deblenjaka spinakera ili očica jedara. **pelikan-kuka**

pellets /ˈpɛlɪts/ (n) (cargo) pelete (željezna ruda u zrnatom stanju)

pelorus /piˈlɔːrəs/ (n) (navig) compass or compass repeater, with sighting vanes or a sighting telescope attached, but it has no directive properties. **pelorus**



{tal. grafometro}

pelorus stand /piˈlɔːrəs/ (n) (navig) stup za pelorus, pelorus stup

penalty /ˈpenəlti/ (n) (mar law) kazna, sankcija: Failure to comply with certification requirement may result in a heavy fine, arrest or a penalty. **introduction of penalty for infringement**
uvođenje sankcija za povredu (pravila)

penalty clause (n) (mar law) klauzula o ograničenju naknade ili odgovornosti u slučaju raskida ili neizvršenja ugovora

pendant; pennant /ˈpenənt/ (n) 1 (boating/yachting) a short length of wire or rope, with a thimble splice into the ends, placed on each side of the main and foremasts (or secured to a spar), and having a block, hook or other fitting at the lower end for hooking on the main and fore tackles. **kratak kraj čekrka pripone (za spajanje pripone na jarbol, palubu ili križeve), kraj podigača (jedra, leta itd.):** A pendant, for sending the topsail-yard up and down, is fitted with a running-eye round the quarter of the topsail-yard, the other end has an eye spliced in it. The mast tackle pendants were wormed, parcelled and served over their whole length. Each was doubled, and the bight was seized to create an eye which fitted over the masthead. (Marquart: Eighteenth Century Rigs &

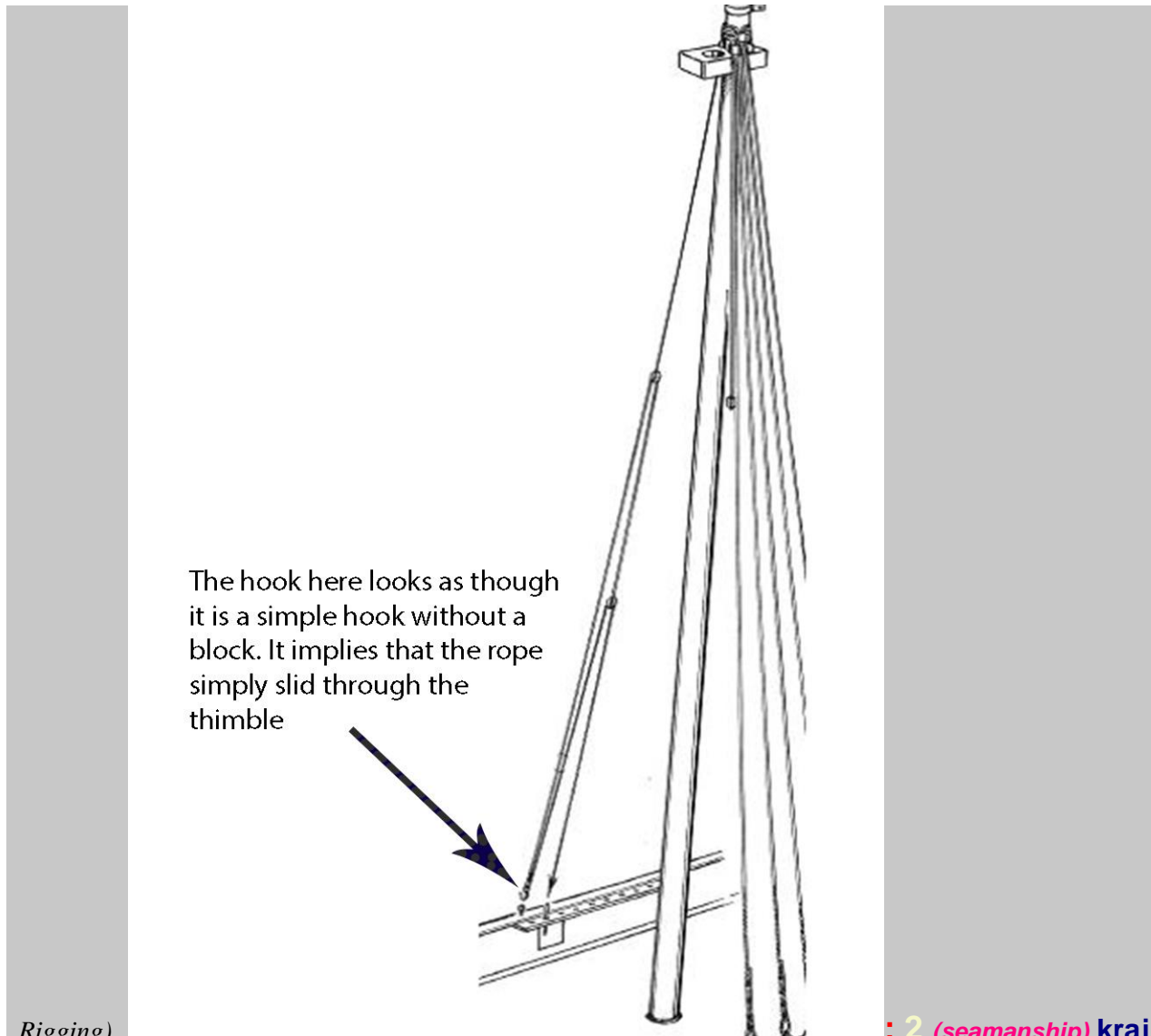

Rigging)

; 2 (seamanship) kraj užeta (s omčom ili kukom) za spajanje na sidreni lanac, kraj mesenđera. These were used to connect the eyes of the messenger and towing pennant on the starboard side. A short length of gantline was already attached to the port pennant and this was used to connect to the messenger on this side.

pending /ˈpendɪŋ/ 1 (mar law) while waiting for or anticipating do, dok, za vrijeme dok, u očekivanju, očekujući **pending completion of the security** do ispunjenja garancije, **pending claim** tražbina u tijeku: ICC regulations prohibit withholding payment of freight bills because of a pending claim; 2 u očekivanju, dok: **pending approval** dok se ne dobije odobrenje

penetrate /ˈpeniːtreɪt/ (v) probiti, prodrijeti, doprijeti do

penetration /ˌpenɪˈtreɪʃən/ (n) (nav arch) probijanje, prodor (vode, mora) hull

penetration probijanje trupa: It is possible that a longline granite or steel weight (the corner of which matched the hole's shape) caused the hull penetration as the monofilament line was wound around the shaft. Also, ensure there are as few hull penetrations as possible to minimise the risk of flooding problems.

penetrometer (n) (cargo) mjerac temperature tereta

pennant /ˈpenənt/ (n) (comm) signalna zastavica izdužena trokutasttoga oblika **plamenac**
numeral pennant brojčani plamenac, brojčana oznak

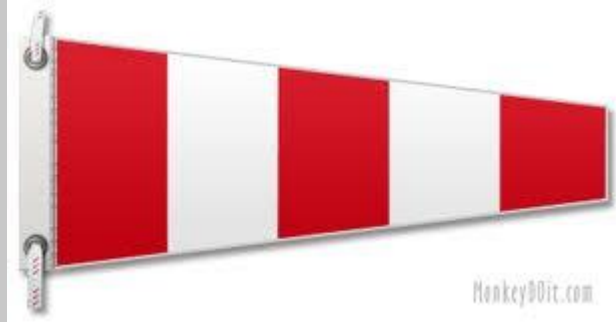

{tal. pennello, guidone}

pen shell (n) periska

per cent /pəˈsɛnt/ (adv) posto

percentage /pəˈsɛntɪdʒ/ (n) postotak

percentage allowance (n) (cargo handling) tolerancija za količinu tereta u

postocima: It is generally acknowledged that ship owners should have the benefit of a percentage allowance, since the measurement of bulk liquids is not an exact science, and unavoidable loss will often occur during a voyage.

per diem /ˈpɜːˈdaɪɛm; ˈpɜːˈdiːɛm/ (adv) (mar law) on a daily basis **na dan, dnevno**

perform /pəˈfɔːməns/ (v) izvršiti, obaviti, izvesti **perform an analysis** izvršiti analizu, analizirati, **perform the actions required** izvršiti potrebne ranje, postupiti u skladu

performance /pəˈfɔːməns/ (n) izvedba, rad, radne karakteristike, performanse **good performance** dobre radne karakteristike (motora itd.), **performance data**: It is automatically loaded with engine performance data from the control system through a standard interface but manually fed with maintenance and inspection data.

performance monitor (n) (navig, electr) monitor za upozorenje o stanju rada

radara: A performance monitor informs the radar operator whether the radar is operating at full efficiency or not. {It should be used when the set is first turned on and at frequent intervals there after when no targets are present on the screen.}

performance standards (n) (navig) izvedbeni standardi (radara)

performing carrier (n) (n) (mar law) = actual carrier stvarni prijevoznik

perigee /ˈpɛrɪˌdʒiː/ (n) (oceanogr) the point in its orbit around the earth when the moon or an artificial satellite is nearest the earth **perigeja**

perigeean tides /ˌpɛrɪˈdʒiːənˌtaɪdz/ (n) (oceanogr) **COMPARE apogeean tides** tides of increased range or tidal currents of increased speed occurring monthly as the result of the Moon being in perigee or nearest the Earth **perigejske mijene, perigejska perioda**

peril /ˈpɛrɪl/ (n) (safety) opasnost, pogibao, pogibelj, rizik **perils of the sea** pomorski rizici, morske opasnost

Perils of the Sea (n) (mar ins) pogibelji mora

per intaken measure (n) (mar law, shipping econ) prema preuzetoj mjeri/količini tereta

periodical survey of the ship (n) periodični pregled broda

perishable goods /ˈpɛrɪʃəbəl/ (n) (cargo) pokvarljivi teret / roba, lako pokvarljiva

roba: Bananas are a sort of perishable cargo and should arrive in a fresh, green unripe condition.

permanent address stalna adresa, adresa prebivališta permanent address for communication adresa za kontaktiranje

permanent deformation (n) (marine eng) trajna deformacija, trajno izobličenje

permanent repairs (n) (nav arch) popravak broda radi obnove klase (nakon

nezgode): With company's and class approval, the vessel continued on its short passage towards the discharge port, where, after unloading, she entered drydock to effect permanent repairs. Once all the investigations were completed, the condition of class required permanent repairs to be conducted on the return voyage and permission was obtained for the ship to resume her passage to the discharge port.

permeability factor (n) (safety) koeficijent naplavljivosti

permission (n) (mar law) dozvola grant permission dati dozvolu, obtain permission dobiti dozvolu, ishoditi dozvolu, without prior permission bez prethodne dozvole, give permission dati dozvolu: At 0956, the mooring lines were singled up and London VTS gave the pilot permission to leave the berth.

permission for entry (n) (mar law) dozvola za uplovljenje, dozvola za ulazak u luku

permit /'pɜːmit/ (n) (mar law) dozvola, dopuštenje permit of Vessel Departure Dozvola odlaska broda, Dozvola za isplavljenje broda, the necessary permits neophodne dozvole, procure a permit ishoditi dozvolu, secure permit from the authorities dobiti dozvolu od službenih organa

permit /pə'mit/ (v) 1 dozvoliti, dopustiti; 2 omogućiti

permitted vertical moments (n) (stabil) dopušteni vertikalni momenti (u Knjizi trima i stabilnosti)

perpendicular /,pɜːpən'dikjʊlə/ (n) (nav arch) okomica after perpendicular krmena okomica, fore perpendicular pramčana okomica, length between perpendiculars dužina između okomica, forward perpendicular pramčana okomica

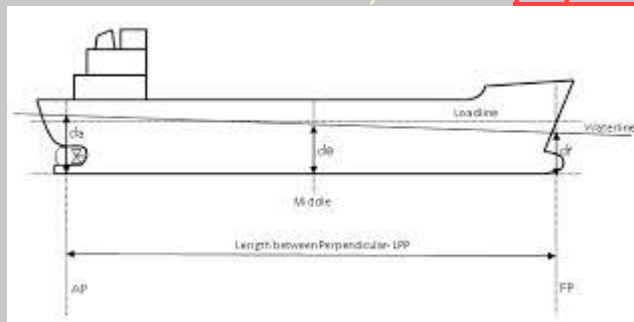

perpendicular to (adj) (navig, ship handling) okomi u odnosu na, okomit na: *the vessel's position was almost perpendicular to the berth*

personal act /'pɜːsənəl/ (n) (mar ins) štete nastale zbog osobne radnje

personal buoyancy (n) (boating/yachting) osobna uzgonska sredstva

personal floating device; PFD (n) (safety) osobna uzgonska oprema, naprave za

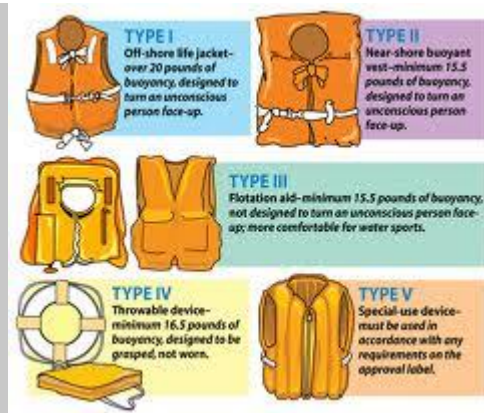

plutanje, osobna oprema za plutanje

personal flotation device; PFD (n) (boating/yachting) **osobna uzgonska oprema**:
Fortunately, the pilot was uninjured and managed to remain afloat with the aid of his personal flotation device (life vest). {npr. prsluk za spašavanje}

personal gas monitor (n) (safety) **osobni uređaj za otkrivanje plina**

personal locator beacon; PLB An emergency radio locator beacon with a two-way speech facility carried by crew members, either on their person or in their survival equipment, and capable of providing homing signals to assist search and rescue operations. **osobni radio lokator u traganju**

i spašavanju *The EPIRB was activated along with the personal locator beacon. The owner also provided an EPIRB and one of the crew had a personal locator beacon.*

personal safety **osobna sigurnost**

personal survival (safety) **osobno preživljavanje** **personal survival course** tečaj **osobnog preživljavanja**, **personal survival technique** tehnike preživljavanja

personal watercraft (PWC) (n) (nav arch) small vessels or conveyances that float on the water and are powered by engines, commonly propelled by jet drives to achieve fairly high speeds, usually in excess of 20 knots. PWC have no interior and are ridden by sitting on top of and astride them as one rides a motorcycle (http://www.westlawn.edu/student_center/definitions.asp) **vodeni skuter**, **morski skuter**, **skuter**, **jet ski**

person in the water (PIW) osoba u moru (u operaciji traganja i spašavanja), **čovjek u moru**

person in water; PIW (n) (safety) **COMPARE man overboard** osoba u moru:
Employers should explore best practices, and develop, implement and comply with PIW procedures

person in water recovery **vađenje osobe iz mora**

personnel /ˌpɜː(r)səˈneɪ/ (n) **1** **osoblje** **ship's personnel** posada broda, **watchkeeping**

personnel **osoblje** **straže**, **skilled personnel** stručno osoblje, **deck personnel** osoblje palube: *Deck personnel were using tugger wires with an endless chain sling connected through the anchor D-shackle to move the anchor ...*; **2** **brodska posada** **all personnel onboard** **sva**

posada na brodu

person overboard (n) (safety) osoba u moru, **čovjek u moru**

pertaining to (conj) (mar law) koji se odnosi na

per working hatch (n) (mar law) ovisno o kapacitetu grobla

petrol /ˈpetrəl/ (n) (marine eng, UK) = **gas** = **gasoline**; **gasolene** **benzin** **petrol station** (UK) **pumpna stanica**

petrol engine (n) (UK) (marine eng) **benzinski motor**

petroleum /peˈtrɔʊliəm/ (n) (cargo) = **crude oil** mineral oil that is found under the ground or the sea and is used to produce petrol/gas, paraffin, diesel oil, etc. **sirova nafta liquefied petroleum gas (LPG) ukapljeni naftni plin**

petrol filter (n) (marine eng) **filtrar benzina**

petrol tank (n) (nav arch) **benzinski tank, tank za benzin**

petty officer /ˈpeti,ɔfɪsə/ (n) **1 (mar law) dočasnik; 2 mlađi časnik (u trg. mornarici) {tal. sottufficiale}**

PFR; period repetition frequency (n) (navig, electr) **perioda ponavljanja impulsa (radara)**

phase detector (n) (navig) **fazni detektor**

phase detector cancellation (n) (navig, electr) **sklop za brisanje s faznim detektorom**

phase shift keying; (PSK) (n) (electr, navig) **pomak faze (u sustavu GPS)**

phasing out (n) (mar law) **isključenje iz plovidbe {isključenje broda iz plovidbe iz plovidbe uslijed zastrajelosti ili neudovoljavanja propisima}**

phenomenal sea (n) (oceanogr) **iznimno teško more**

phosphate /ˈfɒsfəɪt/ (n) (cargo) **fosfat**

phosphor bronze /ˈfɒsfə,brɒnz/ (n) (marine eng) **fosforna bronca**

phosphor (P) /ˈfɒsfə/ (n) (chem) **fosfor**

phyiscal distribution All logistics activities from the production line to the final user, including traffic, packaging, materials handling, warehousing, order entry, customer service, inventory control etc. (<http://www.maerskline.com/en-jm/help/shipping-glossary>) **logistička podrška, logistička podrška od proizvodnje do distribucije robe kupcu**

physical damage (n) **1 (mar ins) fizička šteta, stvarna šteta; 2 mehanička šteta**

physical property (n) **fizikalno svojstvo, fizikalna osobina**

physical shore stations (n) (navig) **obalne stanice u sustavu AIS**

pickerel; pickarel /ˈpɪkərel/ (n) **gira, gera, gira oblica, lužina, menula, manula, lt.**



menola

alamy stock photo

mrlijanka; lat. SPICARA SMARIS}

{drugi hrv. nazivi: čikavica, gera, menula, obljak, manula,

pick up (v) **1 a (seamanship) uhvatiti (konop, uže); 2 podići oznaku, pokupiti**

oznaku; 3 izvaditi (brodolomca) iz mora: *All crewmembers abandoned ship into two lifeboats and were picked up by helicopters* **pick up the survivors** **izvaditi brodolomca iz mora**

pick up a buoy (v) (boating/yachting) **uhvatiti plutaču (čakljom)**

pick up speed (v) (navig) **dobivati brzinu, poprimati brzinu, vraćati brzinu,**

ubrzavati se: *The ship started picking up speed but the head responded very slowly.* Brod je polako počeo dobivati brzinu, ali je pramac reagirao vrlo sporo.

pick up the mooring (v) (boating/yachting) **hvtanje plutače (radi privezivanja)**

P&I Clubs, Protection and Indemnity Clubs (n) (mar law) **P&I klubovi, klubovi osiguranja**

P&I correspondent (n) (mar law, mar ins) **agent P&I kluba, P&I korespondent**

piece (n) **1 komad; 2 dio, element** **distance** **piece** **distancioni element, expansion** **piece** **ekspanzioni spoj, ekspanzioni element**

piece work agreement (n) (mar law) **ugovor o djelu**

pier /pie/ **SYNONYMS** **jetty, dock** **1** a construction work extending into the harbour with sufficient depth of water alongside to accommodate vessels, also used as a promenade or landing place for passengers; a port structure, usually built on piles, extending out into the water and providing a means for vessels to moor alongside **gat, lučki gat, tal. molo**



; 2 molo, mul; 3 dok; 4 pir

pierage /'piəri:dʒ/ (n) (mar law) **pravo na korištenje lučke obale, naknada za korištenje lučke obale**

pier head (n) (ports) the outboard end of a pier **glava gata:** *Contact with the pier head* *The ship came to rest on the southerly pier head. Thus, the ship was heading direct towards the pier-head north of the outer entrance to the harbour.*

piggyback hatchcover /'pigi,bæk/ (n) (seamanship) **vrst pokrivala za grotlo**

piggyback; pickaback /'pigi,bæk/ (n) (shipping econ) a rail transport mode where a loaded truck trailer is shipped on a rail flatcar. ; The transportation of highway trailers or demountable trailer bodies on specially equipped rail flat cars. (<http://www.maerskline.com/en-jm/help/shipping-glossary>)

prijevoz kamiona željeznicom, huckepack transport, piggyback transport

piggy back (pick-me-aback) /'pigi,bæk/ (n) (cargo) **prijevoz kamiona i prikolica željeznicom {njem.: Huckepack}**

pig iron (n) (marine eng) **sirovo željezo, giza bars of pig iron** **ingoti sirovog željeza, remelt pig iron** **pretaliti sirovo željezo**

pigs (of metal) (n) (cargo) **odljevci**

piked dogfish (n) (fishing) = **spur dog** Lat. *Squalus acanthias* **pas kostelj**



pilchard (n) (fishing) Lat. *Sardina pilchardus* **srdela** **European pilchard** **srdela**



pile /pail/ (v) (cargo) **slagati (drvo)**

pile /pail/ (n) **1 a (cargo) hrpa; 2 (ports)** a pointed spar driven into the bottom and projecting above the water **stup (lučke obale itd.), nosač; 3** a long heavy timber driven into the seabed or riverbed to serve as a support for an aid to navigation **stup (plutače)**

pile berth /pail/ (n) (boating/yachting) **vez na priveznom stupu**



pile moorings /pail/ (n) (boating/yachting) **vez na priveznom stupu**

pilferage /'pilfəridʒ/ (n) (mar law) cargo stolen from the ship, container, warehouse or terminal **krađa (tereta ili dijela tereta)** **guard against pilferage** čuvati se of krađe, zaštititi se od krađe, **prevent pilferage** spriječiti krađu {tal. furto}

pilgrim's scallop (n) **jakopska kapica, kapešanta**

pillar /'pilə(r)/ (n) **1 (nav arch)** a vertical member or column giving support to a deck; stanchion **upora, stup (u brodskom skladištu)** **hold pillar = hold-stanchion** **upora donje palube; 2 (navig)** stožasti stup (pomorske oznake), **stožac**

pillar buoy (n) (navig) plutača na stožastom stupu, stožasta plutača

pillar coffering (n) (meteorol) izolacija upore

pillar-girder (n) (nav arch) uzdužna podveza palube

pillar-shaped mark (n) 1 (navig) stožasta oznaka, oznaka u obliku široka stupa; 2 stup, potporanj

pilot /'pailət/ (n) (navig) peljar, pilot, tal. *pilota* **pilot off** peljar / pilot iskrcan, peljar / **pilot sišao s broda**, **pilot on** peljar / pilot ukrcan, peljar / pilot na brodu, **deep-sea**

pilot peljar za otvoreno more: *The master onboard the ro-ro passenger ferry received a VHF radio call from a deep sea pilot onboard the tanker, telling him that his ship was passing too close.*, **docking pilot** peljar za privezivanje brodova, **harbour pilot**

lučki peljar, **sea pilot** peljar za vođenje broda do / od oznake plovnooga kanala,

pilot's accident nesreća peljara: *The pilot's accident occurred while boarding the ship*

pilotage /'pailətɪdʒ/ (n) 1 **harbour pilotage** lučko peljarenje, peljarenje unutar luke,

coastal pilotage dužobalno peljarenje, **ocean pilotage** peljarenje na otvorenom

moru, **vessel pilotage to pilotage** brod koji podliježe peljarenju, brod koji mora

imati peljara, **suspend pilotage**: *NSW Ports Authority suspended pilotage for Port Botany and*

Sydney Harbour due to heavy swell and gale force winds. a (navig) peljarenje, **pilotaža**: *Harbour*

pilotage is compulsory for vessels over 500 GT **compulsory pilotage** obvezno peljarenje: *The*

requirements for compulsory pilotage in the Port of London are contained in the PLA's Pilotage

Directions.; 2 **Pilotage** involves navigating in restricted waters with frequent determination of position relative to geographic and hydrographic features. It is used when the ship is within sight of land.

(Bowditch 2001) **obalna navigacija**

pilotage area (n) (navig) područje obveznog peljarenja: *Before the ship left the pilotage area, a low level alarm for the main engine lub-oil drain tank sounded.*

Pilotage Directions (n) (navig) upute o peljarenju: *for the purpose of the Pilotage Act 1987 and in pursuance of its powers under Section 7 of the said Act, hereby make the following Directions which come into force on 1 October 2003 and which supersede all previous Pilotage Directions.*

pilotage exemption certificate (n) (mar law, ports) svjedodžba o izuzeću od

obveznog peljarenja: *The master held a pilotage exemption certificate for the port and was very familiar with the channel, which he had navigated regularly for over 4 years.*

pilotage slip isprava za obračun peljarenja **peljarska potvrda**

pilotage technique (n) (navig) peljarska tehnika

pilotage waters (n) (mar law) obalne vode, područje obalne navigacije: *In pilotage waters, it may be appropriate to have available a forecast of the times, of alteration of course, speed and sets expected.*

pilot boarding area (n) (navig) područje ukrcanja peljara: *Navigation within the port encompassed the approach channel, the short-term anchorage and the pilot boarding area. Poor planning considerations caused the delay in weighing anchor, which in turn required a high speed approach to the pilot boarding area.*

pilot boarding station (n) (navig) peljarska postaja, mjesto ukrcanja peljara

pilot boat peljarska brodica, **pilotina**: *The vessel was making way at near nine knots in order to match the speed of the pilot boat and was sounding the prescribed fog signal. A pilot boat came alongside to pick up the pilot. a deckhand on board the pilot boat suffered serious injuries whilst the pilot boat was*



pulling away from alongside the container ship.
 imbarcazione del pilota}

{tal.

pilot boat on duty (n) (navig) peljarski brod u službi (zvučni signal)

pilot book (n) (navig) peljar, portolan {tal. portolano}

pilot card (n) (navig, mar law) obrazac s općim podacima o brodu, njegovu pogonu i manevarskim karakteristikama (za potrebe peljara) peljarski listić, peljarski obrazac, peljarska karta:
The pilot was given the vessel's pilot card, which detailed its manoeuvring characteristics. The master and pilot then discussed the departure plan. complete the pilot card ispuniti peljarski listić

hand over the pilot card predati peljarski listić
 {tal. cartellino del pilota}

pilot change over (n) (navig) zamjena peljara, smjena peljara

pilot charges 1 cijena peljarenja, tarife za peljarenje; 2 troškovi peljarenja

pilot hoist (n) (nav arch) The pilot hoist shall be designed to operate as a moving ladder to lift and lower one person on the side of the ship, or as a platform to lift and lower one or more persons on the side of the ship. It shall be of such design and construction as to ensure that the pilot can be embarked and disembarked in a safe manner, including a safe access from the hoist to the deck and vice versa. Such access shall be gained directly by a platform securely guarded by handrails. peljarsko vitlo, peljarsko dizalo, peljarski lift, dizalo za peljara: A pilot boarding hoist is raised by a power winch. The mechanical pilot hoist should be designed to operate as a moving ladder, or as a platform, to lift and lower one person on the side of the ship. Case 1 deals with the failure of a pilot hoist and happened to a pilot disembarking from a high sided vessel on the UK coast shortly before midnight. A mechanical pilot hoist should be so located that it is within the parallel body length of the ship and, as far as is practicable, within the mid-ship half length of the ship The starboard pilot hoist was used to lower the pilot to the waterline and it operated faultlessly

piloting /'pailətɪŋ/ (n) 1 (navig) the act of guiding a ship (in and out of the port) through near shore hazards by a pilot a peljarenje, pilotaža; 2 (navig) determining ship's position and directing her course by means of bearings to landmarks or by buoys and soundings when in sight of land (by eyesight or radar) obalna navigacija, terestrička navijacija

pilot ladder (n) (nav arch) peljarske ljestve, jakovljice, jakubice, boškaina; tal.

biscaglina *The pilot ladder had been rigged such that it was nearly 2 metres too long. The situation was made worse because the seaman, who was also the lookout, was also tasked to rig the pilot ladder alone. During my climb on the pilot ladder from the pilot launch up the ship's side I noticed that one side of*



the ladder lengthened under my weight.

{tal. biscaglina, scaletta per pilota}

pilot landing area (n) (navig) **ANTONYM pilot boarding area** područje iskrcaja peljara

pilot launch (n) (navig) peljarska brodica, *pilotina*, lanča

Pilots /'pailəts/ peljar (knjiga)

pilot services (n) (navig) peljarske usluge **order pilot services** naručiti peljarske usluge

Pilot Signal (n) (comm, navig) znak za peljara, peljarski znak

pilot slip (n) (mar law, navig) = **pilot card** peljarski listić, peljarski obrazac

pilot tender (n) (nav arch) peljarska brodica *pilotina* *The pilot tender was salvaged and set into operation again after extensive repairs.*

pilot transfer (n) (navig) prebacivanje peljara (sa ili na brod), ukrcaj / iskrcaj peljara

pilot wire (n) (navig) čelično uže za peljara

pin (n) 1 a (marine eng) osovina, osnak **loose pin** slobodna osovina, vijal škopca / gambeta, **fully floating pin** osovina s plivajućim ležajem, **wrist pin** osovina klipa, svornjak stapa, **gudgeon pin** osovina klipa, svornjak stapa, *bolcen*; 2 klin, zatik **fitting pin** postavni zatik

pinch /'pintʃ/ (v) (boating/yachting) jedriti previše u vjetar (izgubiti vjetar)

pinch bar (cargo) = **crow bar** podigač, ćuskija, štangulin

pinchers /'pintʃəz/ (n) (cargo) = **pinch bar** podigač, ćuskija (turc.)

pine /pain/ (n) 1 a (cargo) bor; 2 borovina

pinion /'pinjən/ (= 'pinjən) (n) 1 a (marine eng) pogonska osovina; 2 zupčanik, pogonski zupčanik; 3 manji zupčanik u paru {tal. pignone}



pinion gear (n) (marine eng) satelitski zupčanik
{tal. ingranaggio satellite}

pink dentex (n) (fishing) zubatac {drugi hrv. nazivi: pagar, zubatac barjaktar, zubatac krunaš, zubatac okrunjeni, muški pagar; lat. DENTEX DENTEX}

pintle /'pintl/ (n) (nav arch) the pins or bolts which hinge the rudder to the gudgeons on the stern post
štenac kormila, osnac kormila **rudder pintle** štenac kormila, **pintle holder** nosač

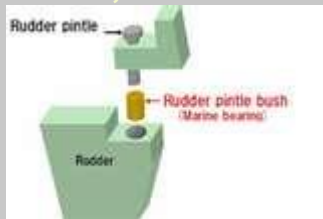

štenca

{tal. agugliotto}

pintle score (n) (nav arch, sailing vessels) izrezak za osnac kormila

pintle strap (n) (nav arch, sailing vessels) vilice osnaca kormila

pip /pip/ (n) (navig) odraz (na radarskom ekranu), bljesak, bijela mrlja (na radaru): The target pips are painted at their measured distance and in their directions relative to own ship's heading

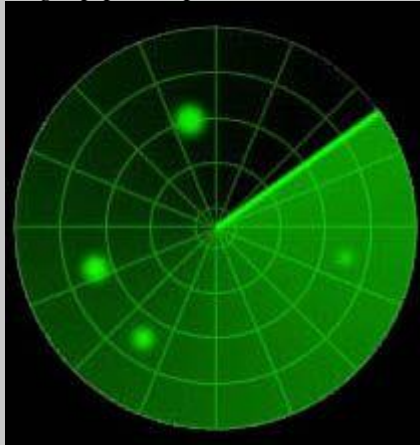

pipe /paip/ (n) (marine eng) cijev, tal. **tubo** articulated oil supply **pipe** zglobna cijev za dovod ulja, **branch pipe** cijevni ogranak, **conducting pipe** dovodna cijev, prijelazna cijev, **delivery pipe** dovodna cijev, **head pipe** glavni vod, **header pipe** sabirna cijev, **large bore pipe** cijev široka promjera široka cijev, **leak oil pipe** cijev za propuštanje ulja, **outlet pipe** izlazna cijev, ispusna cijev, **relief pipe** ispusna cijev, **supply 1** dovodna cijev {tal. tubo}

pipe (n) (seamanship) zviždaljka **bo'sn's pipe** noštomova zviždaljka {zviždaljka (metalna frula) kojom je vođa palube za izdavao zapovijedi}

pipe laying vessel (n) (nav arch) polagač cjevovoda
pipe lifting frames (cargo) okvirni nosači za rukovanje cijevima
pipeline /'paɪpləɪn/ (n) 1 (marine eng) cjevovod; 2 (cargo) naftovod
piper guarnard (n) (fishing) kokot, lastavica {drugi hrv. nazivi: anzuleta, gudin, kapun, lastavica, lučerna, prasica; lat. TRIGLA LYRA}
piper gurnard /'paɪpə,gɜ:nəd/ (n) kokot, lastavica
pipework /'paɪpwɜ:k/ (n) (marine eng) cijevi, sustav cijevi
piping /'paɪpɪŋ/ (n) 1 (marine eng) cijevi high pressure steel **piping** visokotlačni čelični cjevovod; 2 cjevovod: *The piping was blocked with a mixture of fine sand and mud of a clayish texture.* cargo **piping** cjevovod tereta: *There are also considerable quantities of cargo piping both above and below decks.*, **piping system** sustav cjevovoda
piracy /'paɪrəsi/ (n) (mar law, safety) piratstvo, piraterija: *Piracy in the surrounding waterways and seas is on the rise again after a brief lull.*
piston /'pɪstən/ (n) (marine eng) klip (visina veća od promjera), stap (visina manja od promjera); klip parnog stroja **piston crown** glava klipa, čelo klipa, **piston ring** klipni prsten, prsten klipa, **piston skirt** plašt klipa, klizni dio klipa, **piston taper** konusni završetak klipa, stanjeni dio klipa, **hydraulic piston** hidraulički klip, servoklip, **power piston** servoklip, **stuck piston** uklješteni klip, zaribani klip, **trunk piston** klip s produženim plaštem (kod motora bez križne glave), **action of the piston** djelovanje klipa, rad klipa, **piston stroke** hod klipa, hod stapa, stapaj, takt stapa,

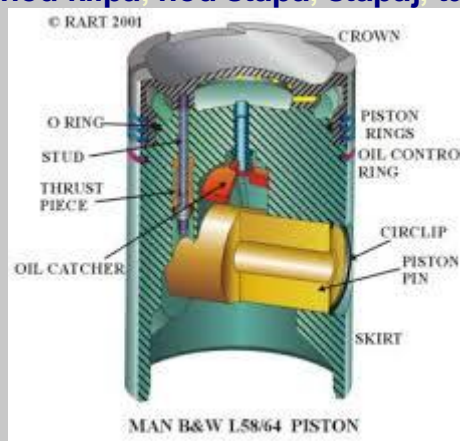

piston connection spoj klipa, spoj stapa
piston engine (n) (marine eng) klipni stroj, stapni stroj
piston head (n) (marine eng) glava klipa: *Temperature measurements on the jet-cooled piston head indicated similar levels to those of the original piston, and even lower in some areas. A cast iron ring is fitted around each piston head to form a bearing surface.*
piston pin (n) (marine eng) = **gudgeon pin** osovina klipa, **bolcen**
piston pump (n) (marine eng) stapna pumpa
piston ring (n) (marine eng) klipni prsten, stapni prsten **butt type piston ring** klipni prsten s ravnim krajevima, **scarfed type piston ring** klipni prsten s kosim krajevima, **lap type piston ring** klipni prsten s preklopnim krajevima



piston rod (n) (marine eng) stapajica, klipnjača

piston skirt (n) (marine eng) košuljica klipa

piston stroke (n) (marine eng) stapni takt

pitch (v) (navig, marine eng, ship handling) voziti prekretnim porivnikom **pitch ahead**

voziti naprijed (koriteći prekretni propeler), zavoziti naprijed: *The OOW moved the starboard azipod control lever to pitch ahead but the ship remained stationary.*, **pitch astern** voziti natrag (koristeći prekretni propeler), voziti krmom, zavoziti krmom

pitch (n) (navig, marine eng) vožnja (prekretnim porivnikom ili azipodom) **ahead pitch**

vožnja naprijed: *Within a few minutes the engineer telephoned the bridge and informed the OOW that ahead pitch was available on the starboard azipod.*, **astern pitch** vožnja natrag, vožnja

krmom: *The chief officer then applied full bow thrust to port and, on the master's suggestion, applied astern pitch to the port propeller. His first reaction was to refloat the ship, so he put some astern pitch on the CPP.*, **zero pitch** prazan hod, **pitch effect** efekt koraka propelera, efekt prekretnog propelera ili azipoda

pitch (n) (seamanship) vertical rise and fall of a vessel's bow and stern caused by a head sea or a following sea **posrtanje**

pitch (v) (seamanship) **posrtati**: *The boat's bow pitched down and the man, realising that he was in danger of falling onto the boat, decided to fall backwards onto the pontoon.*

pitch (n) (nav arch) the distance a propeller will advance during one revolution **korak propelera**, tal. *passo d'elica* **pitch effect** efekt koraka propelera

pitch ahead (n) (navig, marine eng) vožnja naprijed (prekretnim porivnikom ili azipodom)

pitch astern (n) (navig, marine eng) vožnja natrag (prekretnim porivnikom ili azipodom), vožnja krmom (prekretnim porivnikom ili azipodom)

pitch effect (n) (ship handling) efekt koraka propelera

pitching /ˈpɪtʃɪŋ/ (n) (navig) **COMPARE ship's motions** a vessel's motion, rotating about the beam axis, so the bow pitches up and down **posrtanje**, tal. *beccheggio*

pitchpoling (n) (boating/yachting) prevrtanje krmom preko pramca

pitting /ˈpɪtɪŋ/ (n) 1 the localized corrosion of iron and steel in spots, usually caused by irregularities in surface finish, and resulting in small indentations or pits (SeaSources.net) **točkasta korozija**,

brazdasto korodiranje, **jamasto korodiranje**, **piting**; 2 a (marine eng) ljuštenje (rđe), **piting**; 3 točke / rupice nastale zbog korozije

pivot /ˈpɪvət/ (v) (marine eng) okretati se oko oslonca, gibati se u zglobu

pivot /ˈpɪvət/ (= 'pivət) (n) 1 a (marine eng) os; 2 stožer; 3 hvatište; 4 zatik; 5 okretište **pivot point** okretna točka {tal. perno di rotazione}

pivot point /ˈpɪvət/ (n) (ship handling, navig) točka oko koje se brod okreće tijekom zakretanja; pivot point sits at the tangent of the turning circle and the axis of the ship and thus reflects the turning speed. (H. Baudu, p. 248) **točka okretišta broda**: *The closer the pivot point is to the centre of the ship, the smaller the turning radius becomes.* H. Baudu (2014), p. 248 *When turning while the ship makes headway the pivot point may be located approximately in the ship's forward quarter.* H. Baudu (2014), p. 254 *In practice, if the ship is stopped, the pivot point merges with the centre of gravity at the middle of the ship.* **pivoting point** točka okretišta broda

pixel; (picture cell) (n) (electr, navig) točka radarskog zaslona, ćelija (radarskog zaslona) **piksel**

place (n) mjesto in **place of** umjesto, put measures into **place** uvesti mjere, uspostaviti mjere

place (v) smjestiti, postaviti

place of business (n) (mar law) sjedište (tvrtke)

place of issue mjesto izdavanja (isprave, dokumenta)

place of refuge (n) (safety) mjesto zakloništa

place on (v) (marine eng) postaviti, montirati

plague /pleɪɡ/ (n) (med) kuga

plaintiff /ˈpleɪntɪf/ **COMPARE** **defendant** tužitelj, podnositelj tužbenog zahtjeva {u novije vrijeme češće: claimant}

plan (n) plan **Cargo plan** plan tereta, plan krcanja, **outline plan** okvirni plan, skica

plane /pleɪn/ (v) (boating/yachting) glisirati (jedrilicom)

planing /ˈpleɪnɪŋ/ (n) (boating/yachting) a boat moving over the top of the water rather than through the water; exceeding theoretical hull speed by skimming the water **glisiranje (jedrilice)**, **planiranje**

plank /plæŋk/ 1 (n) (cargo, seamanship) deblja daska, planka, tavalon, podnica; 2 (nav arch) trenica (drvenog broda), **madir garboar** **planks** dokobilične trenice / planke

planking (n) 1 (nav arch) broad planks used to cover a wooden vessel's sides; also covering the deck beams **vojevi drvene oplata**, **madiri (ribarske brodice itd.)**; 2 **drvena oplata hull**

planking **drvena oplata trupa**: *The engineer noticed an apparent ingress through hull planking in way of the starboard fuel tanks.* Strojarski časnik opazio je očigledan prodor vode kroz vojeve oplata trupa u području desnih tankova goriva, **bottom planking** **drvena oplata dna**, **deck planking**

drvena oplata palube, **side planking** **drvena bočna oplata**, **topside planking** **oplata mrtvog boka**, **outside planking** **vanjska drvena oplata** {tal.: tavole del fasciame}

planksheer (n) (sailing vessels) vanjska sržnica

plan position indicator; (PPI) (navig) The plan position indicator (PPI), or display console, is the heart of the tactical display system. The PPI console allows its operator to view the inputs from the ship's sensors (radar/sonar/IFF) and tactical symbology, to operate in the desired program mode, and to communicate by voice with other consoles, ship's spaces, or remote ships and aircraft. **pokazivač (na radaru)**, **radarska slika**

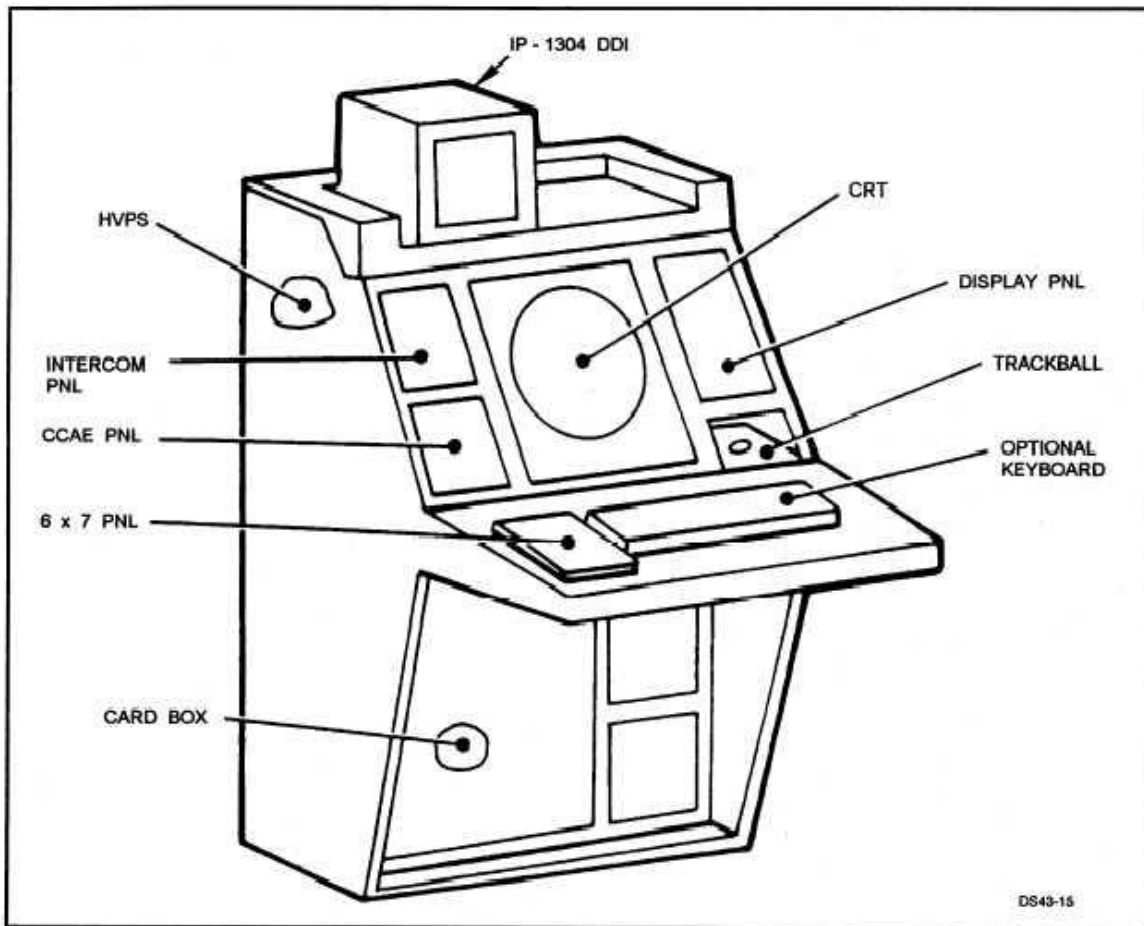

plant /pla::nt/ (n) 1 (marine eng) postrojenje, sustav uređaja: the plant was run up and tested uređaj / postrojenje je puđšteno u rad i isprobano **air conditioning plant** uređaj za

klimatizaciju, klima-uređaj, **refrigerating plant** rashladni uređaj, **main propulsion plant** glavno porivno postrojenje, glavni pogonski stroj, **water distillery plant** uređaj za destilaciju slatke vode, **electrical plant** brodska elektrana, električno postrojenje, **steam driven plant** parno porivno postrojenje; 2 tvornica, pogon

plaster dressing (n) (med) gipsani zavoj

plate (n) 1 (marine eng) ploča **compression plate** kompresiona ploča, **rotating plate** okretna ploča, okretni tanjur; 2 lim, tal. *lamiera* **steel plate** čelični lim, **tin plate** bijeli lim {tal. *lamiera*}

plate floor (n) (nav arch) olakšana rebrenica, puna rebrenica

plate keel (n) (nav arch) plosna kobilica

plate rudder jednoplošno kormilo

platform (n) (marine eng) podište, platforma, podij **rasied platform** utdignuto podište

platform supply vessels; PSV (n) (nav arch) brod za opskrbu platforma: *PSVs are built for serving the daily transportation needs.*

plating /'pleitiŋ/ (n) 1 (nav arch) = **shell plating** oplata, opločenje, tal. *fasciame deck* **plating** oplata palube, **shell plating** oplata broda, oplata trupa, **side plating** bočna

oplata, **bottom plating** vojevi oplata dna; 2 limovi

play (n) 1 (marine eng) zračnost; 2 zazor

pleasure boat (n) (nav arch) brodica za razonodu

pleasure craft /'pleʒə,kra:ft/ (n) 1 (nav arch) in a marine context, are all boats used for recreational not commercial purposes. Though the word craft applies to all sizes of vessels, by convention pleasure craft are boats, and most commonly are small to moderate sized boats, under approximately 80 feet (24.3 meters) LOA. Though the term craft applies to all vessels operating in a fluid medium, the term pleasure craft is only used when applied to boats.

(http://www.westlawn.edu/student_center/definitions.asp) **brodica za razonodu**: A 6m, white-hulled, low freeboard **pleasure craft** was at anchor and engaged in sea angling. Soon after, the crew were able to re-embark, the tow was slipped and the **pleasure craft** made her own way downriver.

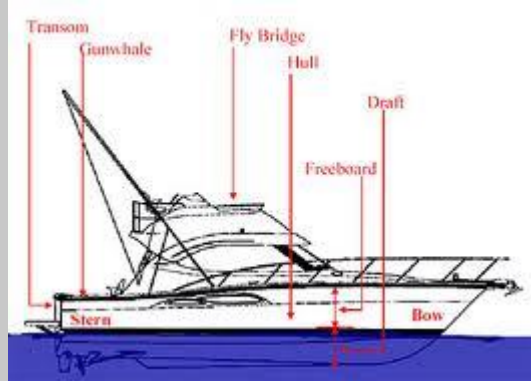

; 2 gliser

pledge /pledʒ/ (n) (mar law) zalog, zaloga

pliers /'plaiəz/ (n) (marine eng) kliješta, tal. pinze {tal. pinze}

Plimsoll line /'plimsəl/ (n) (nav arch) A mark painted on the side of merchant vessels showing the various draught levels to which the ship may be loaded, usually including tropical fresh water, fresh water, tropical sea water, summer sea water, winter sea water and (for vessels under 100 meters in length) winter North Atlantic Ocean water. **Plimsollova linija**

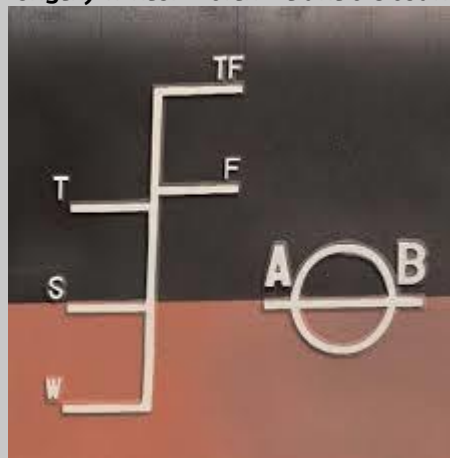

Plimsoll mark /'plimsəl/ (n) (nav arch) oznaka na boku broda koja označava najveći dopušteni gazi; a mark painted on the sides of vessel designating the depth to which the vessel may, under the maritime laws, be loaded in different bodies of water during various seasons of the year

(SeaSources.net) **Pimsolova oznaka**, **oznaka nadvođa**: A Plimsoll mark is Identified by a circle on the vessel's side with a vertical line through and a number of small horizontal lines showing the max depth for summer and winter. **Summer Mark-S** ljetna oznaka, **Tropical-T** Nadvođe za

putovanje tropskim vodama, **Fresh-F** oznaka nadvođa u slatkoj vodi, **Tropical Fresh - TF** oznaka nadvođa u tropskim predjelima u slatkoj vodi {tal. segno di bordo libero}

plot (v) (navig) ucrtati (u kartu), plotirati, tal. *fare il punto*: *At anchor, plot the vessel's position on the largest scale chart available. Soon afterwards, the second officer plotted the vessel's position on the chart and initiated a planned alteration of course from 110o to 118o using the autopilot. plot the ship's position 1 ucrtati poziciju broda; 2: positions were plotted at frequent intervals, plot the course crtati kurs, povlačiti kurs, plot the movement of all ships relative to own position ucrtavanje (na radaru) kretanja svih brodova u odnosu na poziciju vlastitog broda. Press the key to start plotting., plot a fix on the chart ucrtati dobivenu poziciju na karti: *On his return, he plotted a fix on the chart at 1930 using a radar range and bearing of a nearby fairway buoy.**

plotter (n) 1 (navig) navigacijsko ravnalo; 2 patentni dvokut, **plotter plotting** (n) (navig) ucrtavanje (u nautičku kartu), plotiranje, plotovanje radar **plotting** radarsko plotiranje, crtanje manevarskog dijagrama {tal. carteggio}

plotting aid (n) (navig) pomagalo za ucrtavanje, pogalo za plotiranje

plotting chart (n) (navig) karta za ucrtavanje, karta za plotiranje

plotting diagram (n) (navig) dijagram plotiranja (na radaru)

plotting equipment (n) (navig) oprema za crtanje **chart table** navigacijski stol,

parallel rulers usporedna ravnala, **plotters** navigacijsko ravnalo, **dividers**

navigacijski šestar, **pencils** olovke, **compass** šestar

plotting sheet (n) (navig) bijela karta

plotting table (n) (navig) stol za ucrtavanje, stol za plotiranje

plotting a position (n) (navig) ucrtavanje pozicije, ucrtavanje položaja: *At one point, the OOW plotted a position on the chart using a range and bearing.*

plough anchor /plau/ (n) (boating/yachting) plužno sidro, sidro plug {US: plow anchor}

plug /plʌg/ (n) 1 (electr) utikač, tal. presa; 2 (marine eng, nav arch) čep

plumb /plʌm/ (v) to **plumb** the hatch / ship's hold (o dizalici) pokriti grotlo / širinu broskog skladišta priključiti / spojiti (cijev)

plumbing /ˈplʌmɪŋ/ (n) (electr) vodovodne instalacije

plumbow /ˈplʌmbau/ (n) (nav arch) okomiti pramac broda, okomita statva

plummet /ˈplʌmt/ (v) (shipping econ) **SYNONYM** **plunge** padati (o vozarinama):

Container freight rates plummet. Kontejnerske vozarine jako padaju.



plunge /plʌndʒ/ (v) (**shipping econ**) padati (o vozarinama)

plunger /'plʌndʒə/ (n) 1 (**marine eng**) plovak (npr. pumpe goriva), **plunder**. *The plunger has a helix machined into it which also forms a vertical groove and an annular groove at the base of the helix.*; 2 mali klip

ply /plai/ (v) (**navig**) brazditi, ploviti (**idiom**) **ply the oceans** 1 ploviti / brazditi oceanima; 2: *The old Cape of Good Hope route was shortened by the Suez Canal has returned to use for giant oil tankers plying between the Persian Gulf and Europe and America.*

plywood /'plai, wʊd/ (n) (**nav arch**) šperploča **marine plywood** vodootporna šperploča **PMT (per metric ton)** po metričkoj toni

pocket 1 džep; 2 (**marine eng**) jastuk, vrećica **air pocket** zračni jastuk, zračni džep **pod** 1 mahuna, čahura (plodova mahunastih biljaka; graha, graška); 2 (**nav arch, marine eng**) = **azipod** azipodni porivnik, azipod, usmjerivi porivnik,

porivnik-kormilo: *The vessel will also feature a complete ABB Integrated Automation System and three Azipod propulsion units. Three minutes after grounding an engineering alarm sounded and the OOW placed both azipod control levers to zero. Accordingly, the OOW moved the starboard azipod control lever to pitch ahead but the ship remained stationary. Within a few minutes the engineer telephoned the bridge and informed the OOW that ahead pitch was available on the starboard azipod.* **electrical pod električni usmjerivi porivnik, električno porivnik-kormilo, električni azipod**. *The Rolls-Royce electrical pod, type Mermaid, propulsion system offers flexibility in machinery and vessel arrangement, and gives improved efficiency and excellent manoeuvrability.*

point /pɔɪnt/ (n) 1 (**marine eng**) točka, mjesto **boiling point** (**marine eng**) vrelište, točka vrenja, **melting point** talište, temperatura paljenja, **yield point** točka popuštanja (materijala), granica tečenja; 2 stupanj (termometra, barometra)

point (n) 1 (**navig**) one of the 32 divisions of the compass card zraka kompasa; 2 vjetar (iz podjele kompasa na ruže kompasa), smjer **two points on the starboard bow** dva vjetra po pramcu s desne strane (tj. oko 23 stupnja), dva prsta desno po pramcu {point/traka = 11,25 stupnjeva; od ukupno 32 zrake}

point (v) 1 (**boating/yachting**) = **luff** bježati u vjetar, nekontrolirani prihvaćati; 2 to head close to the wind jedriti oštro u vjetar

pointed comber (n) (**fishing**) Lat. Serranus scriba pirka



pointer /'pɔɪntə/ (n) pokazivač, kazaljka, indikator

pointing (n) (**boating/yachting**) = **close reaching** jedrenje uz vjetar

point of interception (n) (**navig**) sjecište, točka presjecanja

point of sail (n) (boating/yachting) smjer kretanja jedrilice u odnosu na vjetar **smjer jedrenja**

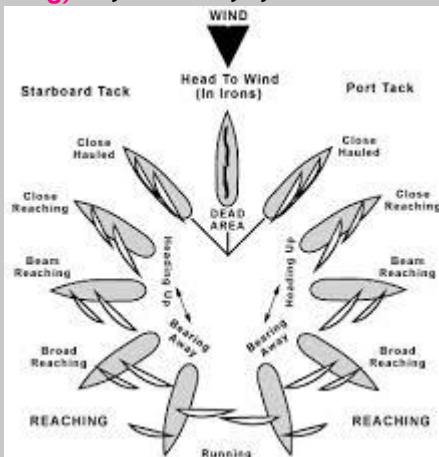

(u odnosu na smjer vjetra)

polar easterlies /'pəʊlə/ (n) (meteorol) polarni istočni vjetrovi

polar expedition ship (n) (nav arch, shipping econ) brod za polarna kružna

putovanja: Europe's newest mega-cruise ship builder MV Werften says it has signed of Letter of Intent to build two **Polar-class luxury expedition vessels** for Crystal Cruises.

polar front /'pəʊlə/ (n) (meteorol) the semi : permanent, semi : continuous front that encircles the northern hemisphere separating air masses of tropical encircles the northern hemisphere separating air masses of tropical **polarna fronta**

pole /'pəʊl/ (n) 1 a stup; 2 kolac, motka, štap

pole /'pəʊl/ izdanak (jarbola) **skysail pole** izdanak jarbola

pole and line fishing (n) (fishing) Pole and line fishing is a traditional method by which predatory fishes are captured one-by-one on hook and line. **ribolov bacanjem ješke (brumanjem) i štapom**

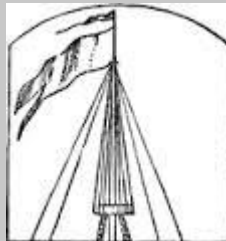

pole mast (n) (nav arch) nastavak jarbola

Pole Star /'pəʊl/ (navig) Sjevernjača

police boat /pə'li:s,bəʊt/ (n) (nav arch) policijski brod

policy /'pɒlisi/ (n) (mar ins) policia osiguranja **unvalued policy** nevalutirana policia, **floating policy** otpisna policia

poling out /'pəʊlɪŋ/ (n) (boating/yachting) zatezanje jedra (kako bi se ubrzalo kretanje niz vjetar)

polling (n) (navig) traženje podataka o odabranom brodu (u sustavu AIS)

polluter /pə'lu:tə/ (n) (safety) onečišćivač, zagađivač

pollution /pə'lu:ʃən/ **onečišćenje** **zagađenje** **polucija:** A major oil pollution occurred as a result of the grounding Usljed nasukanja došlo je do većeg onečišćenja mora. A Coast Guard overflight Monday confirmed **no pollution**. **pollution risk** 1 **opasnost od onečišćenja:** there was no pollution risk; 2: No damage was sustained and no oil pollution occurred as a result of the grounding

pollution damage (n) (safety) šteta zbog onečišćenja

pollution from ships (n) (safety) onečišćenje s brodova

pollution of the marine environment (n) (mar law, safety) onečišćenje morskog okoliša

ponder /ˈpɒndə/ (v) duboko razmišljati, zadupsti se, ponderirati

pontoon /pɒnˈtuːn/ (n) (nav arch) ponton

pontoon hatch cover (n) (nav arch) pontonski grotleni poklopac, pontonsko



grotlo

pool /pu:l/ (n) lokva

pool chit (n) (shipping econ) nalog ukrcaja

poop /pu:p/ (n) 1 (nav arch) the structure or raised deck at the after end of a vessel krmica, kasar



; 2 krmeno nadgrađe

poop deck /pu:p/ (n) (nav arch) a partial deck at the stern above the main deck krmica, kasar,

paluba krme: All synthetic moorings aft parted due to blazing fire on **poop deck**. It was standard practice on board a small UK tanker to rig a gangway from the **poop deck**. The deck officer in charge of the **poop deck** was engaged in making fast one of the tugs with its line.



{derived from the Latin puppio for the sacred deck where the

pupi or doll images of the deities were kept (www.USMM.org); tal. cassero poppiero}

pooping /'pu:piŋ/ (n) (**seamanship**) propinjanje krme

poor cod (n) (**fishing**) pišmolj, pišmoljić

popper (n) (**fishing**) a fishing lure in a variety of sizes and colours. The body is hollow, which keeps it on the waters surface. As the user jerks the rod the lure pops along the surface; župlja varalica koja poskakuje na površini mora i stvara mjehuriće te stvara zvuk pop, pop **popper** {površinska varalice posebnog oblika glave, gdje je alkica za vezanje unutar konkavne udubine, koja svojim bučkanjem prilikom povlačenja stvara zvuk, pop, pop po kojem su varlica i dobile ime. (<https://ribolovnajadrano.hr/ribicki-leksikon/>)}

porgy /'pɔ:gi/ (n) (**fishing**) pagar {=pogy}

porpoise /'pɔ:pəs/ (n) pliskavica {vrsta dupina}

port /pɔ:t/ **1 = seaport** the harbour and the adjacent town or city suitable for loading goods and embarking men **a (n) luka loading port** luka ukrcaja, **discharging port** luka iskrcaja, **enter the port** ući u luku, uploviti u luku, **leave the port** napustiti luku isplivati iz luke, **wait off the port** čekati izvan luke (o brodu), **principal port** glavna luka, **international port** međunarodna luka, luka za međunarodni promet, **inner port** unutrašnja luka, **tidal port** plimna luka, **river port** riječna luka, **riverine port** riječna luka, **convenient port** povoljna luka, **safe port** sigurna luka, **free port** slobodna luka, **leisure port** sportska luka, **outer port** vanjska luka, **multi-purpose port** višenamjenska luka, **congested port** zakrčena luka, **jammed port** zakrčena luka, **transit port** tranzitna luka, provozna luka, **sheltered port** zaštićena luka, **protected port** zaštićena luka, **intermediate port** usputna luka, međuluka, **naval port** ratna luka, **closed port** zatvorena luka, **discharge port** luka iskrcaja, iskrcajna luka, **export port** luka ukrcaja, izvozna luka, **import port** luka iskrcaja, uvozna luka; **2 (marine eng)** kanal i otvor u košuljici cilindra motora, za ispuh i propuhivanje **otvor**, kanal **exhaust port** ispušni kanal, **scavenge port** ispirni kanal; **3 (boating/yachting)** otvor na palubi / kabini jedrilice; **4 (sailing vessels)** odvodni otvor na ogradi

port /pɔ:t/ (**adj, adv**) the term 'port' refers to the left side of a vessel, perceived by a person on board the ship, facing towards the bow **lijevi, lijevo** {Port is derived from the practice of sailors mooring ships on the left side at ports in order to prevent the steering oar from being crushed}

port (n) (**navig, seamanship**) lijeva strana broda

Port, steer one eight two! (**navig, seamanship**) Kormilo lijevo, kurs: jedan osam dva! {zapovijed za kormilarenje}

portable /'pɔ:təbəl/ (**adj**) prenosiv, prijenosni, pomičan, pokretan, lako nosiv **portable radiotelephone** prijenosni radiotelefon, **portable VHF** prijenosni VHF-uređaj

portable extinguisher (n) (**safety**) prijenosni vatrogasni aparat



portable megaphone doglasnik, megafon

portable pilot unit; PPI (n) (navig) The portable pilot unit ensures real time information is available on the Pilot's laptop to assist in onboard decision making.

(<http://www.mastermariners2015.com.au/>) **peljarovo prijenosno navigacijsko računalo:**

Having set up his portable pilot unit (PPU) using a raster chart, the pilot was able to monitor the vessel's speed over ground and time of arrival at the anchorage.

portable pump (n) (marine eng, safety) prijenosna pumpa, prenosiva pumpa

portable radio (n) (comm) prijenosna radiostanica, radiostanica u brodici / splavi za spašavanje check **portable radios** provjeriti prijenosne radiostanice

portable radio station prijenosna radio stanica

portable radio station for survival craft (comm) prijenosna radiopostaja sredstava za spašavanje

port accommodation (n) (ports) lučki kapaciteti (za prihvat brodova i rukovanje teretom)

port administration (n) 1 a (mar law) lučke vlasti; 2 lučka uprava

port agent (n) (mar law) lučki agent

portainer (port container crane) /pɔ:'teinə/ (n) (cargo handling) obalna kontejnerska



dizaica, **portainer**

portal container crane portalna dizalica

portal crane /'pɔ:təl/ (n) (cargo handling, ports) portalna dizalica

portal mast /'pɔ:təl/ (n) (cargo handling) portalni jarbol (za teret)

port anchor (n) (nav arch) lijevo sidro

Port Authority /'pɔ:t ,ɔ:'θɔ:riti/ (n) (mar law) Port Authority (lučka uprava) zajednički je termin za

poduzeće (trgovačko društvo) koje zastupa zakonske, ekonomske i razvojne interese države u luci (npr. potiče međusobnu konkurenciju lučkih poduzeća), ali ovisno o pravno-ekonomskom sustavu neke države, može obavljati i komercijalne poslove pružanja usluga brodu i teretu u luci. Tendencija u Europskoj uniji jest da se funkcije države odvoje od komercijalnih. Poduzeća koja obavljaju lučke operacije (ukrcaj, iskrcaj, slaganje tereta itd.), u engleskom port company ili port operators, registrirana su u nas kao dionička trgovačka društva (d. d.). Tako se poduzeće „Luka Rijeka d. d.“ na službenim web-stranicama (<http://www.lukarijeka.hr>) navodi na engleskom kao Luka Rijeka j.s.c. (joint-stock company). a governing body in a port, i.e. State, Municipal, public, or private body, which is largely responsible for the tasks of construction, administration and sometimes the operation of port facilities and, in certain circumstances, for security (EU Commission) **lučka uprava, tal. *autorità portuale*** *The Port Authority of New York and New Jersey, which owns the terminals and leases them to port operators, issued a statement urging members of the International Longshoremen's Association to "return to work immediately and resolve their differences after they return."* (<https://gcaptain.com>) *The American Association of Port Authorities says close to \$155 Billion will be invested by 2020 to expand U.S. ports to handled bigger vessels.* (Costas Paris WSJ Logistics Report (Jan 2, 2017)) **Port of Rijeka Authority** **Lučka uprava Rijeka, Port of London Authority (PLA) Lučka uprava London:** *the Port of London Authority were established for the purpose of administering, preserving and improving the port of London*



port basin (n) (ports) **lučki bazen**

port bil of lading (n) (mar law, shipping econ) **lučka teretnica**

port bow (n) (nav arch, navig) **ANTONYM starboard bow** **lijeva strana pramca, tal. *mascone prora sinistra* on the port bow s lijeve strane pramca po lijevoj strani**

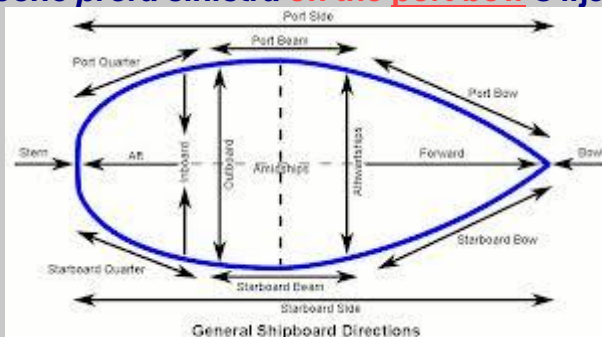

pramca

port captain 1 (shipping econ) **the marine / nautical superintendent of a shipping company in the port predstavnik brodara u luci, port keptin:** *As an employee of the shipowner, cruise liner or ship manager in a port, the port captain ensures that the vessels are crewed, operated and maintained in accordance with the regulatory requirements, company standards, and customer's expectations. I am a port captain and among other jobs, I oversee the discharge of a large number of project cargo consignments. The charterer's port captain stationed himself ashore after the initial visit at the first*

loading port.; **2 (shipping econ)** a ship manager's officer responsible in a port for supervising the vessel Masters and overseeing project safety, training and regulatory compliance programs **predstavnik poslovođe broda (ship managera) u luci** *The essential functions of the port captain are: Recruit, hire, train, mentor, manage and discipline personnel in the projects marine department., Ensure vessel(s) is operated within all pertinent laws, regulations and guidelines mandated by federal, state or local agencies as well as Company policies and Best Practices. Know and utilize the Company SMS (Safety Management System). Ensure that vessel do as well. Periodically inspect vessel for environmental, safety and health deficiencies. Bring deficiencies to the attention of the Vessel Master and Monitor corrective actions until complete., Maintain a cordial working relationship with various agency representatives, Help manage the departmental budget ensuring that spending is prudent and focused., Ensure that the safety of passengers and crew is maximized through vigorous administration and enforcement of safety guidelines and policies., Function as Company Security Officer (CSO)., Manage deck department maintenance at the highest levels., etc.* (<https://hmsgm-openhire.silkroad.com>); **3 (navy, UK)** In the Royal Navy, the captain of the port is the officer, usually with the rank of captain, responsible for the day-to-day running of a Naval Dockyard under the authority of the admiral-superintendent. (Wiki) **mornarički lučki kapetan**; **4 (mar law)** to some extent the role of captain of the port is analogous to that of a harbourmaster (Wiki) - rarely in use **lučki kapetan**; **5 (mar law, US) COMPARE captain of the port** Captain of the Port (COTP) means "the officer of the Coast Guard, under the command of a District Commander, so designated by the Commandant for the purpose of giving immediate direction to Coast Guard law enforcement activities within an assigned area. (<http://definitions.uslegal.com/c/captain-of-the-port/>) **lučki kapetan** {Note that, except in US, the term 'port captain' is only rarely equivalent to the term 'harbourmaster'}

port charges (n) (shipping econ) **troškovi broda u luci**

port clearance (n) (mar law) **dozvola za uplovljenje (ulaz) u luku**

port company (n) (mar law, shipping econ, ports) **lučko poduzeće, tal. ente porto; compagnia portuale**

port control (n) (navig) **lučka kontrola, lučka postaja** **call the port control**: At 2319, the master called the port control and confirmed the requirements for the pilot ladder., **alert the port control** **alarmirati lučku postaju**

port custom (n) (mar law) (shipping econ) **lučke uzance, lučki običaji**

port dues (n) (mar law) a charge levied by the port to all ships entering the port till the time it leaves the port, generally calculated on the gross registered tonnage of the ship as per the tonnage certificate issued for that ship **lučke naknade, lučke pristojbe, lučke takse**: *Vessels engaged in foreign trade that enter any port, whether private or government, shall be charged the following PORT DUES on each call based on GRT*

port economics (n) (shipping econ) **ekonomika luka**

port engine (n) (nav arch) **lijevi stroj**

port engineer (n) (ports) **tehnički direktor luke, tehnički stručnjak u luci**

port entry guide (n) (ports) **vodič o lukama, priručnik o lučkim propisima**

port estate (n) (ports) **zemljište u vlasništvu lučke uprave lučko zemljište**

port facilities (n) (ports) **lučki kapaciteti, lučka postrojenja, lučki uređaji**

port facility security officer; PFSO (n) (safety) **osoba odgovorna za sigurnosnu zaštitu luke**

port fees (n) (shipping econ, mar law) = **port dues** **lučke pristojbe**

port flap (n) (sailing vessels) poklopac otvora na ogradi

port functions (n) (mar law, shipping econ) **COMPARE Port Authority** Within the port system, one or more organizations fill the following roles: 1. Landlord for private entities offering a variety of services.; 2. Regulator of economic activity and operations ; Regulator of marine safety, security, and environmental control (usually the responsibility of the harbourmaster office or coastguard); 3. Planning for future operations and capital investments.; 4. Operator of nautical services and facilities.;5. Marketer and promoter of port services and economic development; 6. Cargo handler and storer (mostly private companies or operators); 7. Provider of ancillary activities **funkcije luke, namjena luke**

port hand mark (n) (navig) a buoy or beacon which is left to the port hand when proceeding in the conventional direction of buoyage (i.e. upstream) **oznaka s lijeve strane (broda), plutača s lijeve strane (broda)**

port health authority (n) (shipping econ) lučke zdravstvene vlasti

port helm (n) (navig) kormilo u lijevo **apply port helm okrenuti kormilo u lijevo**: *The helmsman responded by applying port helm until the pointer indicated 10° to starboard.*, **use port helm staviti kormilo u lijevo**: *Once the vessel was clear of the buoy, port helm was used to manoeuvre the vessel back towards the eastern side of the channel.*

porthole /'pɔ:t,həʊl/ (n) (nav arch) **COMPARE deadlight** a small aperture in the side of a vessel to admit light and air, usually fitted with a watertight glass or metal cover, or both; A porthole on a ship may also be called a **sidescuttle** or **side scuttle** (side hole), as officially termed in the SOLAS Convention. **brodsko okno (na otvaranje), fineštrin, tal. oblo**

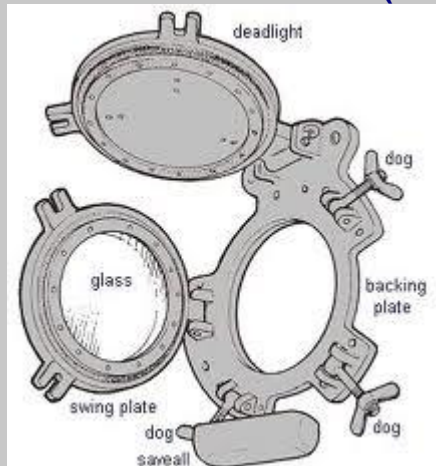

{okno na boku ili strani broda; portlight = okno koje se može otvoriti; deadlight - okno koje se ne može otvoriti}

porthole container (n) (cargo) hlađeni kontejner s otvorima za dovod i odvod zraka

port industry (n) 1 (shipping econ) lučko gospodarstvo, lučka privreda; 2 lučka industrija

port infrastructure (ports) sea locks, waterways, breakwaters, quay walls, wharves, docks, piers, jetties, and main roads in a port **lučka infrastruktura (obale, lukobrani, zaštita)**

port installations (n) (ports) lučka postrojenja, lučki uređaji

portion (n) dio

port labour (n) (shipping econ) lučka radna snaga, lučki radnici

port-lid (n) (sailing vessels) poklopac otvora na ogradi

portlight (n) (nav arch) **COMPARE porthole** an opening in a ship's side, provided with a



glazed lid or cover **brodsko okno (bez otvaranja)**
se može otvarati, za ulaz zraka i svjetla}

{okno koje

port medical officer (n) (shipping econ) **lučki zdravstveni službenik**

port of call (n) (shipping econ) **luka ticanja / pristajanja**: What was your last **port of call**? when possible, inform the other vessel of the name of the ship, port of registry and the next **port of call**.

port of departure (n) (shipping econ) **luka polaska broda (u linjskoj službi)**: The anchor was then weighed and the vessel returned to her original **port of departure**, where she berthed without further mishap.

port of despatch (n) (shipping econ) port from which the goods are shipped **luka otpreme tereta, luka ukrcanja tereta**

port of destination (n) (ports) **luka odredišta**

port of discharge (n) (shipping econ, mar law) **luka iskrcaja**: What should be done if serious damage to cargo is suspected before opening the hatches in the **port of discharge**? ... the terms of this Bill of Lading shall continue to apply until the Goods are delivered by the Carrier to the Merchant at the amended **Port of Discharge** or Place of Delivery, whichever is applicable, unless the Carrier specifically agrees in writing to the contrary.

port official (n) (shipping econ, mar law) **lučki dužnosnik, lučki službenik, nadležna osoba u luci**

port of loading (n) (shipping econ) **luka ukrcanja, ukrcajna luka**: The goods were transported on terms set out in the charter-party which specifies the precise nature and volume of cargo, the **port(s) of loading and discharge** and the laytime and demurrage.

port of origin (n) (shipping econ) **luka porijekla**

port of refuge (n) (safety) **luka zakloništa, luka skloništa**

port of registry (n) **1 (mar law) luka upisa, upisna luka, luka registracije; 2 luka pripadnosti**

port of rotation (n) (shipping econ) **luka rotacije, luka promjene linijske rute**

port of sailing (n) (shipping econ) **luka polaska**

port of shipment (n) (shipping econ) **luka otpreme, luka ukrcanja, otpremna luka**

port operations (n) **1 (shipping econ) lučke operacije (obično ukrcanja/iskrcanja tereta); 2 (cargo) lučke manipulacije**

port operator (n) (shipping econ) trgovačko društvo (najčešće privatno) koje pruža usluge teretu ili brodu u luci; stevedoring firms, cargo handling companies, and terminal operators **lučko**

trgovačko društvo, lučko poduzeće, lučka kompanija, tal. operatore portuale: *Port operators typically pursue conventional microeconomic objectives, such as profit maximization, growth, and additional market share.*

port privatization (n) (mar law, ports) privatizacija luka: *The country's ports have suffered a series of strikes in the past 18 months, principally in protest of the government's port privatisation* **service port 1** a port owned by the government and managed by the port authority that controls the port operations (port labour directly employed by the port authority) **javna luka kojom upravlja i u kojoj lučke operacije obavlja lučka uprava; 2 državna luka, tool port** a type of service port where all assets are owned by the government and operated by the port authority **državna luka s privatnim sлагаčkim i skladišnim operatorima, landlord port** a port owned by the government and managed by the port authority BUT the port authority gives up its control over port operations by leasing the port infrastructure to private operators **koncesijska luka s privatnim operatorima lučke infrastrukture, private port** a port with privately owned and its operations are under the control of private owners and private operators to whom the port operations are leased **privatna luka, luka s privatnom infrastrukturom i suprastrukturom**

port quarter /'kwɔ:tə/ (navig) COMPARE port bow the part of a vessel's side towards the stern on the port side, usually aft of the aftermost mast **lijevi kvartir**

port reception facilities (n) (ports, safety) prihvatna oprema u luci za otpadne tvari

port regulations (n) 1 a (mar law) pravilnik o redu u luci; 2 lučki propisi

port state requirements (n) (mar law) propisi države luke u kojoj se brod nalazi

Failure to comply with certification requirement may result in a heavy fine, arrest or a penalty and loss of insurance due to the infringement of flag/port state requirements.

port security plan (n) (safety) plan sigurnosne zaštite luke

port services (n) (shipping econ) lučke usluge

port side (n) (seamanship) The left side of a vessel when looking forward lijeva strana (broda)

port side to lijevim bokom uz obalu berthed port side to brod vezan lijevim

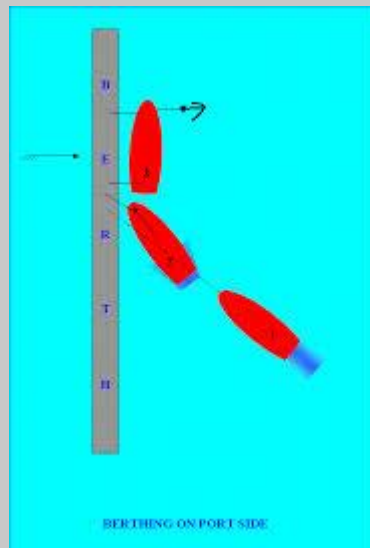

bokom uz obalu

ports or ports as ordered (n) (mar law, shipping econ) luka ili luke kako je naređeno

port state control the procedure whereby governments examine a percentage of ships, which visit their shores, in order to ensure that those ships meet international safety and environmental

standards. Such examination is often conducted by classification societies under contract with the state concerned. Other states, however, have government inspection agencies which inspect visiting ships. Many states take note of the number of detentions by them of ships already inspected and classed by each classification society. (Tetley) **inspekcijski nadzor stranih brodova**, **kontrola/nadzor od strane države luke u kojoj se brod nalazi**

Port State Control Report of Inspection (n) (safety) **Izvešće o obavljenom pregledu (broda) od strane države luke (u kojoj se brod nalazi/o)**

port structures (n) (ports) lučke obale, gatovi i lukobrani **lučki objekti**, **lučki infrastrukturni objekti**

port tack (n) 1 (boating/yachting) **ANTONYM starboard tack** sailing with the main

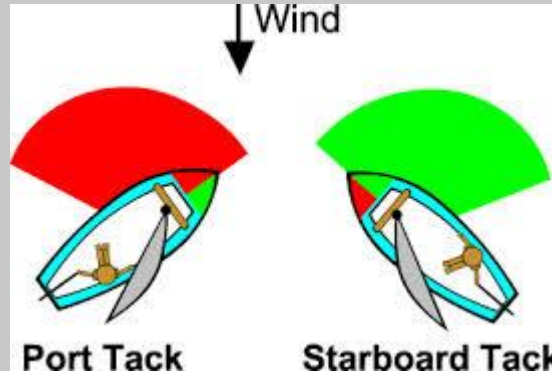

boom on starboard side **lijeva uzda**, **lijeve uzde**
jedrenje na lijevom uzdama {tal. mure a sinistra}

port tariff (n) (shipping econ) **lučke tarife** **port tariff rates** **lučki tarifni stavovi** {Port tariff includes charges on VESSELS (port dues, dockage at berth and anchorage, berthage per GT, DWT or displacement), on CARGOES (wharfage per MT, revenue ton etc., cargo handling rates per ton or MT, storage, etc.)}

Port ten! (n) (navig, seamanship) **Dest lijevo!** {zapovijed za kormilarenje}

port to port bill of lading (n) (mar law) = **marine bill of lading** **pomorska teretnica**, **teretnica**

port user (n) (shipping econ) **korisnik luke**

Port Waste Management (n) (ports) **upravljanje prihvatom broskog otpada u luci**

port watch (n) (navig) **navigacijska straža** dok je brod u luci na sidrištu itd. **navigacijska straža u luci**

port workers (n) (shipping econ) **lučki radnici**, **dokeri**

position /pə'zɪʃən/ 1 a **položaj** **hold in position** (marine eng) **održati u pložaju**: *the shells are in position and shape* **blazinice su propisno ugrađene**; 2 (navig) **pozicija (broda)** **establish / fix the ship's position** **odrediti / utvrditi poziciju broda**, **check position** **provjeriti poziciju broda**: *Frequently check the vessel's position using visual bearings, ranges or transits*, **last known position** **zadnja poznata pozicija**; 3 (seamanship) **držati brod u poziciji**: *The tugs then held the ship in position off the berth while the engineers were trying to clear the blocked cooling system.*

position /pə'zɪʃən/ 1 a **smjestiti**, **postaviti**; 2 **pozicionirati**

Position, Navigation and Timing (n) (navig) **pozicioniranje**, **navigacija** i **proračun vremena**

position circle (n) (navig) kružnica pozicije

position fixing (n) (navig) određivanje pozicije broda

position fixing aids (n) (navig) uređaji za određivanje pozicije broda

position line (n) (navig) stajnica, linija pozicije **transferred position line**

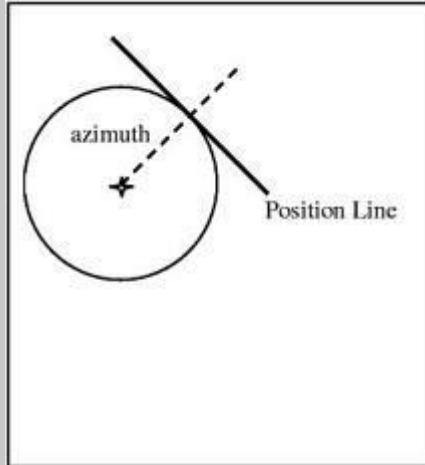

pomaknuta stajnica, prenesena stajnica

position report (n) (navig, comm) izvješće koje zapovjednik broda predaje službi VTS kako bi je obavijestio o položaju broda unutar područja njezine nadležnosti **izvješće o poziciji broda**

positive displacement pump volumetrijska pumpa, volumenska pumpa: *To maintain a constant flow through the separators, individual positive displacement-type pumps operating at constant capacity should be installed.*

positive pressure (n) (marine eng) nadtlak

possession /pəˈzɛʃən/ (n) (mar law) posjedovanje **possession of narcotics and/or contraband cargo, guilty of possession** kriv za posjedovanje (droge, oružja itd.), **take possession of uzeti u posjed, preuzeti**: *When carriers move freight, they are legally taking possession of the goods and are under obligation to deliver them for a reasonable price.*

possessory lien /pəˈzɛsəriˈliːən/ (n) (mar law) zadržavanje broda radi namirenja u korist brodopopravljača i spasavatelja; prestaje gubitkom posjeda; po redu prvenstva za namirenje dolazi iza maritime lien a ispred statutory lien; the right of a bailee to retain property in his possession belonging to another until certain claims of the bailee in possession are satisfied. The common carrier thus had a possessory lien for freight (supra), which was strictly possessory and was lost when the cargo was delivered unconditionally (Tetley) **pravo retencije, pravo zadržanja broda, retencija broda, zakonsko pravo retencije i ručnog zaloga**

possible search area; PSA (n) (seamanship, navig) moguće područje traganja

post /pəʊst/ (n) 1 a stup (svjetla); 2 radno mjesto (na brodu); 3 radno mjesto, namještenje, služba **post applied for** radno mjesto za koje se netko natječe, **vacant post** slobodno (radno) mjesto, **qualify for a post** osposobiti se za službu

post /pəʊst/ 1 **izvjesiti**: *Watch schedules shall be posted where they are easily accessible on board the vessel Raspored straže mora biti izvješten na lako dostupnom mjestu na brodu Protect your owners' interests by posting a gangway watch. keep me posted* Obavještavajte me stalno; 2 **postaviti post a lookout** postaviti motritelja

post load (n) (cargo handling) The resultant pressure force in the container corner post, causing damage to the container **opšterećenje na stup kontejnera, rezultanta sile pritiska na**

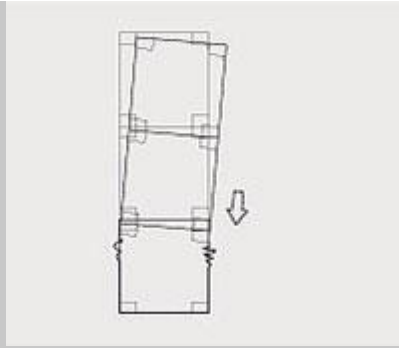

kutni stup kontejnera

post-panamax ship (n) (nav arch) a ship too large to transit the Panama Canal, e.g. container ships capable of carrying up to 8,500 TEUs and more **brod tipa post-panamax**:

Post-Shakedown Availability (n) (nav arch) shipyard's availability following delivery and is used to correct deficiencies found during the shakedown period, or to accomplish other authorized improvements to the ship **obveza brodogradilišta za otklanjanje nedostataka nakon primopredaje broda**

pot (n) (fishing) **vrša, kavez**: The GRP boat, which was fitted with a vivier tank, had sailed that morning to haul and re-bait pots. **haul a line of pots vući vrše / kaveze u nizu**: A fishing vessel was on an easterly heading and engaged in hauling a line of pots which was about 1 mile long and lay in a north/south direction off a port on the east coast.

potable water system (n) (seamanship, safety) **sustav pitke vode**

pots and traps (n) (fishing) **vrše**: In pot and trap fishing mud crabs, blue swimmer crabs and rock lobster are species commonly targeted with these methods.

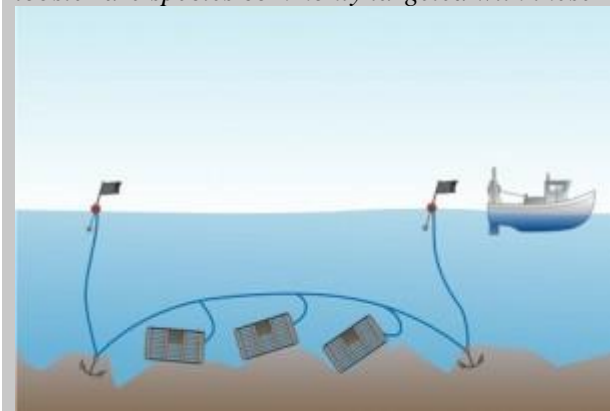

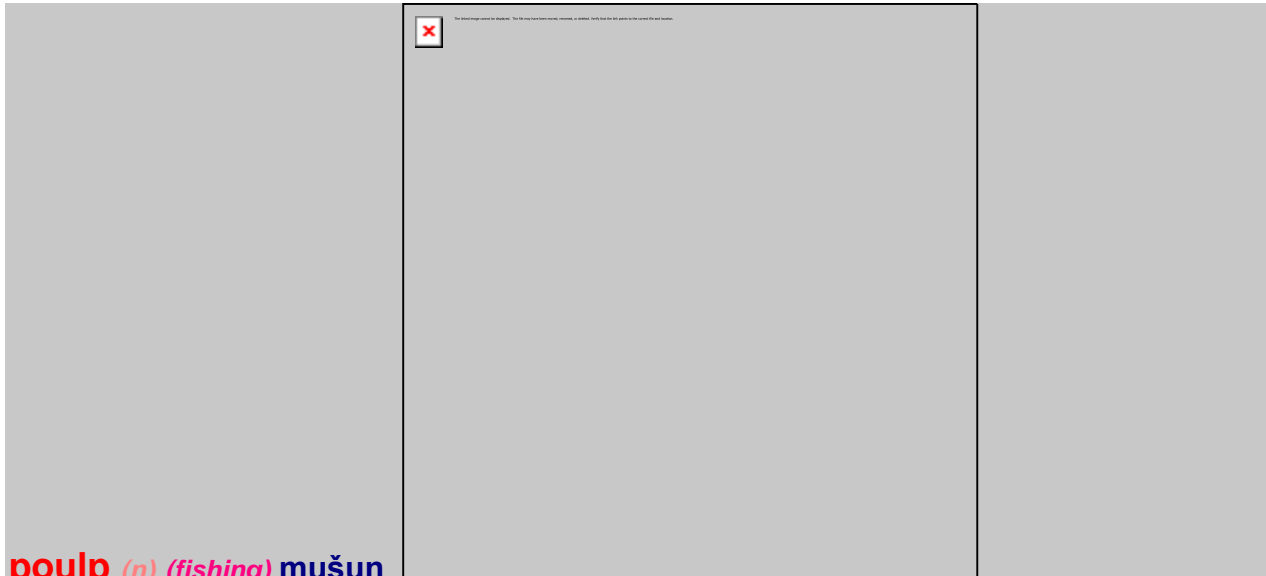

poulp (n) (fishing) mušun

pounding /'paʊndɪŋ/ (n) (seamanship, nav arch) lupanje / udaranje valova o pramac

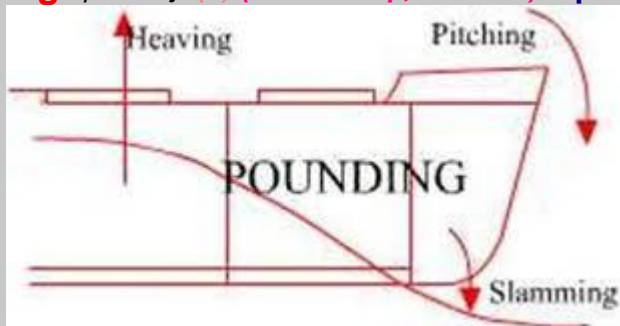

broda

Poutassou (n) molet, ugotica

powder /'paʊdər/ (n) prah **powder fire extinguisher** (safety) vatrogasni aparat na prah

powdery /'paʊdəri/ (adj) (cargo) prašnjav **powdery goods** prašnja roba roba u obliku praha

power /'paʊə/ (n) 1 (marine eng) snaga **develop power** razviri snagu, **lose power**

izgubiti snagu: A capesize bulk carrier blocked ship traffic in the Elbe River in Germany on Tuesday after **losing power** while inbound to the port of Hamburg.

<http://gcaptain.com/capesize-bulk-carrier-breaks-elbe-river-ais/>; 2 energija **power plant**

električna centrala, energana, **produce power** proizvoditi energiju, stvarati snagu;

3 (mar law) moć, punomoć, ovlaštenje **confer the power to** nekoga ovlastiti, dati

nekome ovlaštenje; 4 pogon broda **sail under own power** ploviti vlastitim pogonom

power /'paʊə/ (math) the value of a number or quantity raised to some exponent (Collins on-line

Dict.) **potencija, eksponent**: 5 to the power of 4 pet na četvrtu 5 raised to the power of 4 5 na četvrtu

power /'paʊə/ (v) (marine eng) pokretati, pogoniti, tjerati

powerboat (n) (boating/yachting) gliser

power cable (n) 1 (electr) energetski kabel The vessel's anchor fouled with a power cable.

Sidro se zapetljalo za energetski kabel u moru. **submarine power cable** podvodni kabel; 2

(electr) električni kabel, dovodni kabel

powercaster *(n) (fishing)* rola za bacanje

power distribution *(n) (marine eng)* razvod (električne) snage

power-driven vessel *(n) (navig, nav arch)* any vessel propelled by machinery (COLREGS)

brod na motorni pogon, motorni brod: *A power driven vessel making way through the water shall sound at intervals of not more than 2 minutes one prolonged blast.*

power gear 1 pogonski zupčanik; 2 prijenosni mehanizam; 3 pogonski uređaj; 4 strojevi **auxiliary power gear** pogonski strojevi

power loss *(n)* 1 *(electr)* nestanak električne energije **total power loss** potpun gubitak snage: *a total power loss occurred as a result of the sea water cooling system becoming blocked;* 2 *(marine eng)* gubitak snage:

power of attorney *(n) (mar law)* punomoć: *If the Master cannot present the B/L in time for for the vessel to sail, the Master issues a letter, or power of attorney, to the carrier's agents authorising the agent to sign the Bills of Lading on his behalf.*

power plant *(n)* 1 *(marine eng)* pogonsko postrojenje; 2 pogonski uređaji

power plant *(n)* 1 *(marine eng)* elektrana; 2 brodska elektrana; 3 pogonsko postrojenje

power-propelled *(n, adj) (marine eng, electr)* na električni pogon, s električnim pogonom

power stroke *(n) (marine eng)* radni takt, ekspanzijski takt, radni hod

power supply *(n) (electr)* uređaj za napajanje

power tools a tool powered by electricity električni alati, elektroalati

power unit *(n)* 1 *(marine eng)* pogonsko postrojenje; 2 *(electr, navig)* napajanje (radara), jedinica za napajanje

PPC; Potential Points of Collision *(n) (navig)* moguće točke sudara (na ARA radaru)

PPI control panels *(n) (navig)* upravljački pult radara

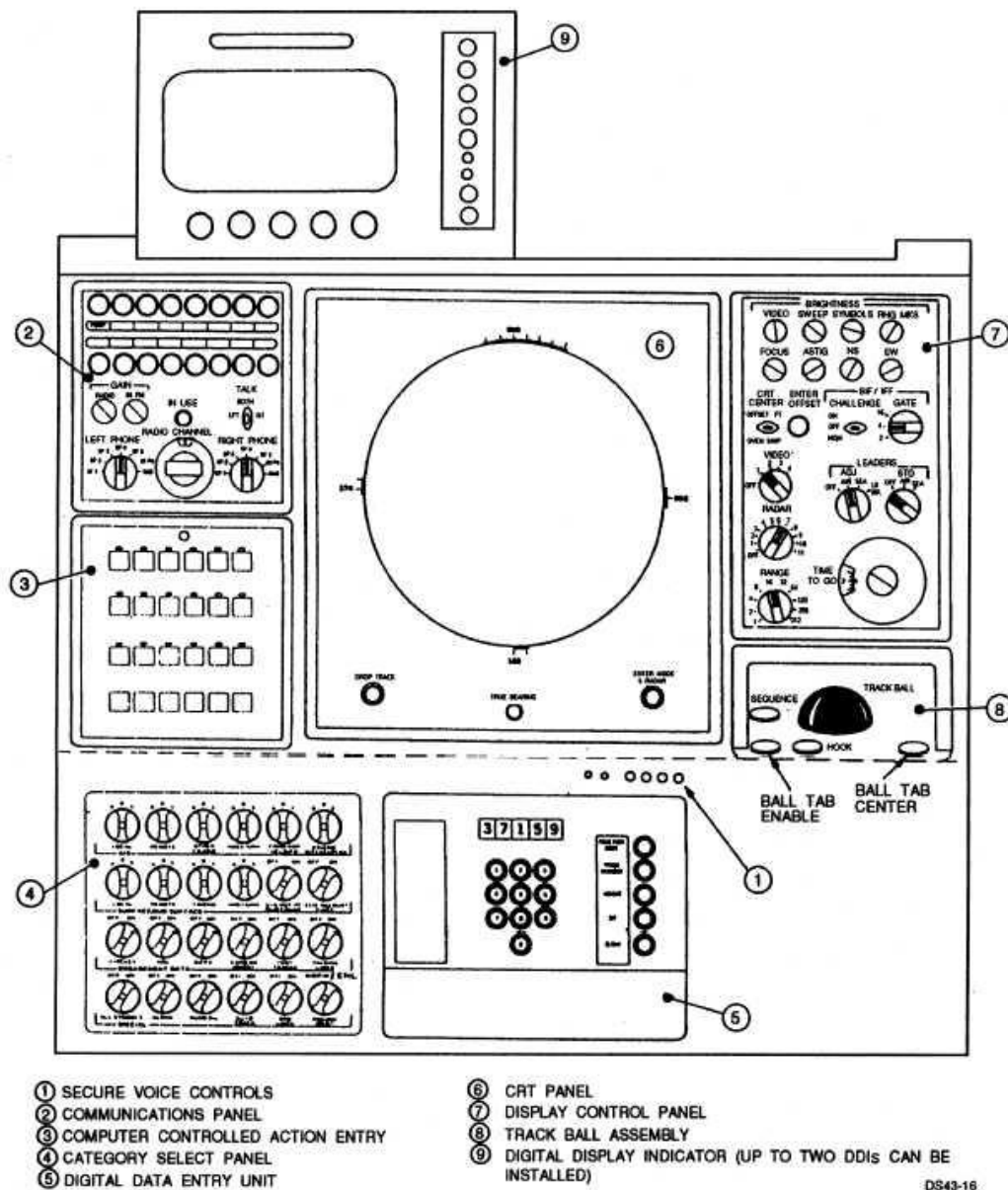

PPI; (plane position indicator) (n) radarski prikaz, prikaz radarske panorame u ravnini: Radar targets are displayed on what is called a Plan Position Indicator, or PPI. This display is essentially a polar diagram, with the transmitting ships' position at the center.

ppm; (parts per million) (n) (cargo) npr. sadržaj H₂S (hydrogen 2 sulphide) u tekućem ili plinovitom teretu milijunti dio, dijelova na milijun, mg/l

practices /'præktisiz/ (n) (shipping econ) običaji **good practices** ustaljeni običaji (dobrog poslovanja)

pram bow /præm/ (n) (boating/yachting) tupi pramac (na manjim brodicama)

pratique /'præti:k; præ'ti:k/ (mar law) = **free pratique** a permit by the port health authorities (usually issue via Customs) for an incoming vessel, being clear of contagious disease, to enter the port.

dozvola lučkih zdravstvenih vlasti za uplovljenje broda, slobodan promet
 certificate of **pratique** dozvola lučkih zdravstvenih vlasti za uplovljenje broda, **free pratique** dozvola lučkih zdravstvenih vlasti za uplovljenje broda

prawn /prɔ:n/ (n) (fishing) kozica, račić

preamplifier (n) (electr, navig) predpojačalo (radara)

pre-arrival (adj, adv) (navig, safety) prije dolaska **pre-arrival checklist** popis provjera

prije dolaska broda u luku: The second officer had completed most of the **pre-arrival checklist** before leaving the bridge to prepare for mooring stations. Next time you fill in a confined space entry permit, tick the boxes in the Next time you fill in a confined space entry permit, tick the boxes in the **pre-arrival/departure checklist**, or carry out a risk assessment, think about who you are doing that for – it should be you and your family., or carry out a risk assessment, think about who you are doing that

for., **pre-arrival checks provjere prije dolaska**: A large container ship was nearing her pilot station when the master decided to carry out the standard **pre-arrival checks** in accordance with the ship's Safety Management System (SMS) procedures., **pre-arrival conference dogovor s**

posadom o dolasku broda: Prior to loading the cargo, the chief officer conducted the required **pre-arrival conference**, but he did not have the cargo Material Safety Data Sheet (MSDS) at the time, so the safety briefing did not properly cover the cargo. A pre-arrival conference was held in preparation for the the berthing operation., **pre-arrival requirements propisi o dolasku broda, zahtjevi na dolazak broda**

The master adhered to the **pre-arrival requirements** as detailed in the ship's SMS.

pre-arrival meeting (n) (navig) radni dogovor prije uplovljenja: A proper pre-arrival, pre-departure meeting should be held to discuss the passage plan and a meeting should be held prior transiting or entering a busy shipping lane

Pre-arrival Notification (n) (mar law) najava dolaska broda u luku, prethodna

obavijest o dolasku broda u luku: Not less than 24 hours before the intended entry, the owner, his local agent or master of the vessel must apply in writing for permission for entry - Pre-arrival Notification providing the required information.

pre-carriage (n) (shipping econ) Service of providing inland export transportation from our

customer's premises to the port of loading. **dovoz od pošiljatelja do broda**: Pre-carriage is a service applicable when the carrier provides inland transportation from the desired inland location, based on the request of the customer. (<http://www.maerskline.com/en-jm/help/shipping-glossary>)

precaution /pri'kɔ:fən/ (n) (safety) mjera opreza **take precautions** poduzeti mjere

opreza: Take every precaution to prevent pollution of the environment by the ship

precautionary area /pri'kɔ:fənəri/ (navig, safety) područje povećanoga opreza,

područje plovidbe gdje valja biti posebno oprezan, područje posebne opreznosti: the precautionary area was marked on the chart

precautions /pri'kɔ:fənz/ mjere opreza

precipitation rate (n) (navig) količina padalina

preclude /pri'klu:d/ (v) (mar law) spriječiti **preclude from** spriječiti da (od)

Pre-Commissioning (PRECOM) (US) period preuzimanja broda od strane

posade prije primopredaje: Crews are designated to take charge of the ship following delivery. The PRECOM crew's task is to prepare the vessel and its mission systems for full operational capability in Coast Guard service.

pre-cooling (n) (marine eng) predhlađenje

predator fish /'predətə,fɪʃ/ (n) (fishing) riba grabežljivica, grabežljivac

predetermined (*adj*) predodređen

preferred channel (*n*) (*navig*) glavni kanal **preferred channel to port / starboard** glavni kanal je lijevo / desno, **preferred channel buoy** plutača koja označava glavni kanal, **preferred channel mark** a lateral mark indicating a channel junction or bifurcation, or a wreck, or other obstruction which, after consulting a chart, may be passed on either side **oznaka**

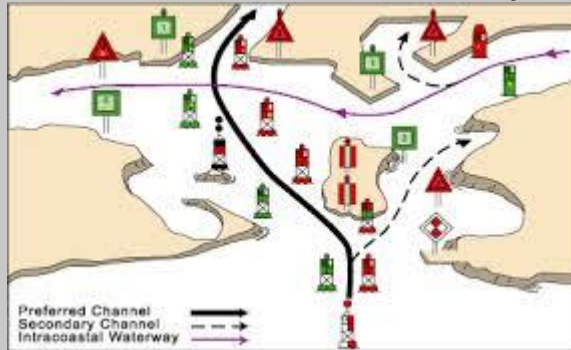

glavnog kanala
{puta}

{glavni kanal pri račvanju plovnog

preheat (*v*) predgrijati

preheater (*n*) (*marine eng*) predgrijač

prejoining briefing (*n*) kratke upute prilikom ukrcanja časnika i posade na brod

prejudice /'predʒʊdis/ (*n*) (*mar law*) 1 a predrasuda; 2 šteta **without prejudice to** (the provision of ...) 1 bez štete za, ne kršeći, ne šteteći; 2 bez kršenja / povrede odredaba (ugovora, pravilnika, konvencije)

prejudice /'predʒʊdis/ (*v*) 1 a predminijevati; 2 unaprijed odrediti

preliminary (*adj*) početni, prethodan **preliminary notice** prethodna obavijest

preliminary note (*n*) (*mar law*) upis kojim se upisivanje, prijenos, ograničenje ili prestanak prava postiže uz uvjet naknadnoga opravdanja **predbilježba**

premises /'premisiz/ (*mar law, shipping econ*) 1 prostorije, prostor, teren, zgrade i pripadajuće zemljište (neke tvrtke) **enter the premises** ući u prostorije / prostore; 2 skladište **importer's premises** uvoznikovo skladište, **producer's premises** proizvođačevo skladište, **buyer's premises** kupčevo skladište, **seller's premises** prodavateljevo skladište

premium (*n*) (*mar law, shipping econ*) premija (osiguranja)

prepaid freight (*n*) (*shipping econ, mar law*) vozarina s plaća unaprijed

preparation priprema, priprava, pripravljanje **preparation for starting** (*marine eng*) priprema (motora(za upućivanje, priprema (motora) za pogon

preparation for sea (*n*) (*navig*) priprema za isplavljanje, priprema za isplavljenje

prepayable (*adj*) (*shipping econ*) plativ unaprijed

pre sea training izobrazba prije ukrcanja

present /'priːznt/ (*v*) predstaviti, predočiti (dokument), predati (dokument), izručiti (dokument), pokazati **present the Bill of Lading** (*mar law*) predati teretnicu, **present the document for inspection** predočiti ispravu radi pregleda

present (*v*) (*fishing*) prezentirati udicu / mamac / skosavicu, pokazivati mamac ribi

Fisherman then **present** bare or baited hooks, or artificial lures, to the target fish which are hauled on board the vessel one at a time. **present a jig** **prezentirati skosavicu**, **present the bait** **prezentirati mamac**

present (v) (ship handling, navig) choosing the side of the ship to present (expose) to the wind **okrenuti stranu broda prema**, **izložiti stranu broda prema** **present beam onto the wind** **okrenuti se bočno prema vjetru**: How should the ship **present** itself at the berth so that starboard anchor can be lowered at a precise spot? The easiest way is to present the beam on to the wind, with a very slight headway to arrive at the mooring point. Baudu (2014), p. 257

presentation /,prɛzən'teɪʃən/ (n) **1 a predstavlanje**; **2 (mar law) predočenje (dokumenta)**, **predavanje (dokumenta)**; **3 (navig) oblici radarskog prikaza**, vrsta radarskog prikaza, vrsta prikaza radarske slike, jedinica radarskog prikaza **unstabilized presentation** nestabiliziran prikaz, **stabilized presentation** stabilizirana slika, **HEAD UP presentation** pramčanica prema gore (nestabilizirana slika), **HEAD UP, NORTH UP presentation** sjever prema gore (stabilizirana slika), **NORTH UP, COURSE UP presentation** kurs prema gore (stabilizirana slika), **COURSE UP**

presentation (n) (fishing) A term encompassing all elements in catching fish. Lure types and color, water depth, structure, retrieve or trolling technique which makes a successful presentation. **mamljenje ribe ribolovnim priborom**, **prezentacija ribolovnog pribora (glavnog najlona, prama, predveza, udica)**, **prezentacija**: Fluorocarbon fishing leaders originated in Japan, where the Japanese are extremely detailed about the presentation of their bait.

presentation mode (n) (navig) **modus radarskog prikaza**, **oblik radarskog prikaza**: This radar has the following presentation modes: relative motion and true motion.

presentation of navigation-related information (n) (navig) **prikazivanje navigacijskih informacija**

preservation /,prɛzə'veɪʃən/ (n) (cargo) **1 čuvanje, očuvanje**; **2 konzervacija**; **3 (mar law) očuvanje (u međunar. pravu mora)**

preserve /pri'zɜ:v/ (v) **1 zaštititi, očuvati** **preserve from (mar law)** **zaštititi (imovinu) od**; **2 (mar law) očuvati (u međunar. pravu mora)**

preserve (n) **zaštićeno područje marine** **preserve** **zaštićeno more**, **zaštićeno morsko područje**, **morski nacionalni park**: A luxury cruise ship has suffered damaged after running aground in a marine preserve off Panama's Pacific coast.

pre-sling (n) (cargo) **staviti teret u pasce**, **imbragivanje**

pre-slinging (n) (cargo) **opasivanje tereta pascima**, **stavljanje tereta u pasce**, **imbragivanje%**

pre-slung /pri:'slʌŋ/ (adj) (cargo) **teret složen u pasce**, **teret složen u brage** **pre-slung cargo** **teret u pascima**, **teret u bragama**



press (v) (marine eng) tlačiti, pritiskati, pritisnuti **press against** pritiskati, tlačiti prema, **press with increasing force** pritiskati sve većom silom, tlačiti sve jače, **press the key** pritisnuti dugme, pritisnuti tipku: *Press the [POWER/BRILL] key to turn on the power.*

pressing (n) (marine eng) prešanje

pressure /'prɛʃə/ (n) (marine eng) tlak, pritisak **cylinder pressure** tlak u cilindru, **compression pressure** tlak kompresije, **excess pressure** tlak preko dozvoljene granice, **firing pressure** tlak izgaranje, **gas pressure** tlak plinova, **loss in pressure** gubitak tlaka, pad tlaka, **raise in pressure** povisiti tlak, **high pressure** visoki tlak, **low pressure** niski tlak, **under pressure** pod tlakom, pod pritiskom, **steam pressure** tlak pare

pressure gage /'prɛʃə geɪdʒ/ (n) (marine eng) manometar, tlakomjer

pressure gauge /'prɛʃə geɪdʒ/ (n) (marine eng) manometar, tlakomjer **bellow pressure gauge** manometar s valovitom komorom, **Bourdon pressure gauge** manometar s Bourdonovom cijevi, **pressure gauge diaphragm** manometar s membranom

pressure jet burner (n) (marine eng) tlačni rasprskič: *gorionik*

pressure pump (n) (marine eng, boating/yachting) tlačna pumpa

pressure switch (n) (marine eng) presostat

pressure vacuum breaker (n) (marine eng) vakumsko-prekotlačni ventil



pressure/vacuum system; (P/V System)

PRF; (pulse repetition frequency)

pressure/vacuum system; (P/V System) (n) (cargo handling, nav arch)
vakuumski/prekotlačni sustav

pressure vessel (n) (marine eng) posuda pod tlakom, tlačni rezervoar

pressurized air (n) (marine eng) stlačeni zrak

pre-strapping (n) (cargo handling) opasivanje tereta čeličnim / plastičnim



trakama

prevailing wind (n) (meteorol) prevladavajući vjetar, pretežni vjetar (vjetar koji je stalan u određeno doba godine)

prevent (v) spriječiti **prevent from** spriječiti od, odvratiti od

preventer (n) 1 (cargo handling, nav arch) uzda (samarice)

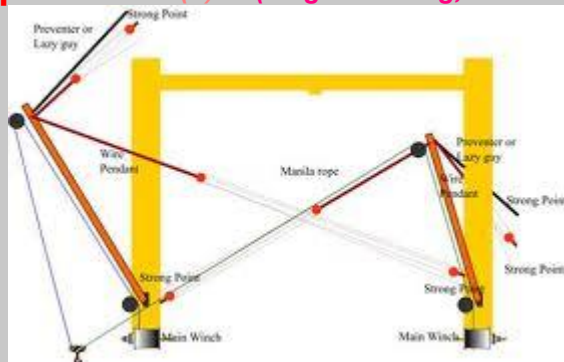

; 2 (sailing vessels) pripona **preventer**

chain-plates protusprežnjaci pripone; 3 (boating/yachting) a sail control line originating at some point on the boom leading to a fixed point on the boat's deck or rail, used to prevent or moderate the effects of an accidental jibe **uže protiv prebacivanja buma**, **uže protiv pojalabande jibe** **preventer** uže protiv prebacivanja buma, **gybe preventer** uže protiv prebacivanja buma

preventer-bolt (n) (sailing vessels) **COMPARE chain-bolt** svornjak protusprežnjaka puta

preventers (n) (cargo handling) brkovi samarice, **sinjaleti**

preventive officer /pri'ventiv/ (n) (mar law) carinski sanitarni službenik

PRF; (pulse repetition frequency) (n) (electr) frekvencije ponavljanja impulsa: A typical pulse repetition frequency is 500 pulses per second for long pulse and 3000 pulses per second for short pulse.

prima facie /'praɪə 'feɪfi/ (n) (*mar law*) (at first sight) a rule whereby a particular fact constitutes evidence of a state of affairs, unless contradicted by other stronger, admissible evidence (Tetley) **na prvi pogled**

prima facie case /'praɪə 'feɪfi 'keɪs/ at first sight; as it seems at first **pravni predmet na prvi pogled (npr. zahtjev za tražbinu)**: *When the claimant has made out a prima facie case, the burden of proof is then shifted to the carrier who must then prove to the contrary to establish his defence.*

prima facie evidence (n) (*mar law*) dokaz (iz teretnice) po principu oborive pravne pretpostavke **dokaz prima facie (na prvi pogled, po izgledu)**

primary winding /'praɪməri/ (n) (*electr*) primarna uzvojnica, primarna zavojnica

prime /'praɪm/ (v) (*marine eng*) nalijevati, puniti (npr. pumpu prije pokretanja), napuniti uljem (da ne bi došlo do trenja), odzračiti (pumpu) **prime the fuel oil system** napuniti cjevovod gorivom da se istisne zrak, odzračiti sustav goriva ručnom ili dodatnom (buster) pumpom

prime mover (n) A machine that transforms energy from/to thermal, electrical or pressure to/from mechanical form, typically a diesel engine or turbine **osnovni pogon, primarni pogon, glavni pokretački stroj**: *regardless of the rotational speed of the prime mover, the propeller shaft must rotate at about 80 to 100 rev/min.*

primer /'praɪmə/ (n) (*seamanship*) podloga (za boju), **prajmer**

prime wood (n) (*cargo*) npr. mahagoni, hrastovina, tikovina **kvalitetno drvo**

priming /'praɪmɪŋ/ (n) **1** to fill (a pump) with its working fluid before starting, in order to improve the sealing of the pump elements and to expel air from it before starting **ispiranje cjevovoda prije uporabe**; **2** (*marine eng*) odnošenje kapljica vode s parom na izlazu iz bublna **kipljenje kotla, burno vrijeme**

priming coat (n) (*safety*) zaštitna boja, podloga za boju

principal /'prɪnsɪpəl/ (n) (*mar law*) nalogodavac, naručitelj (usluge, prijevoza itd.)

principal /'prɪnsɪpəl/ (*adj*) glavni, najvažniji **principal place of business (shipping econ)** sjedište (tvrtke)

print (n) (*marine eng*) a mark or indentation made by pressing something onto a surface **otisak, druk, print**

priority /praɪ'ɔrɪti/ (n) (*comm*) prvenstvo, prioritet, pravo prvenstva **select the priority** izabrati prioritet

prior to /'praɪə ,tu:/ (*prep*) (*mar law*) **ANTONYM upon prije nego**: *watchkeeping personnel shall not consume alcohol within four (4) hours prior to serving as a member of a watch.* osoblje straže ne smije uzimati alkohol četiri sata prije nego što stupi na dužnost člana straže **upon completion of loading and immediately prior to discharge** nakon završetka krcanja i neposredno prije iskrcaja

private carriage (n) (*mar law*) Carriage of particular goods of one shipper under a special contract, usually by charterparty, as opposed to the common carriage (*supra*) of goods of the public in general, on advertised, liner routes, usually under bills of lading or waybills. **slobodna plovidba, tramperska plovidba, tramperska služba**

private carrier privatnik prijevoznik, slobodni prijevoznik, prijevoznik u tramp službi

private domain (n) (*mar law*) A French civil law term referring to all property of the French State

which is capable of being owned, including vessels. Such property is unseizable, may be used only for its stated purpose, may never be exchanged or leased for another person's use and must be sold when it can no longer be used for the stipulated service or use. (Tetley) **privatno dobro**

privateer /ˌpraɪvəˈtiə/ (n) (mar law) **gusar**

privately run terminal (n) (shipping econ) **privatni terminal, terminal kojim upravlja (i koji iskorištava) privatno trgovačko društvo**

private maritime law (n) (mar law) **pomorsko javno pravo**

private port (n) (mar law, ports) **COMPARE port privatization** **privatna luka, luka s privatnom infrastrukturom i suprastrukturom**

private sector (n) (shipping econ) **privatni sektor, privatna gospodarska djelatnost:**

Most of the Port's considerable trade in animal feedstuffs is discharged here where there is large – scale private sector investment in specialist warehousing. **private sector investment** **investicije**

privatnog sektora, investicije u privatnom sektoru

privileged vessel (n) (mar law) = **stand-on vessel ANTONYM burdened vessel** **brod koji ima pravo puta**

prize /praɪz/ (n) (mar law) **ship or property captured at sea in war; contrabans seized and confiscated** **zapljenjeni brod, zapljena**

PR knot (n) (fishing) **he PR Knot is an extremely strong connection designed to join braided superline with a monofilament or flouorocarbon line** **uzao za vezivanje najlona od mono i sukanih / pletenih vlakana, PR uzao**

probability of containment (navig, safety) **vrijednost kojom se iskazuje vjerojatnost prisutnosti ljudi u opasnosti u određenome području traganja** **vjerojatnost sadržavanja**

probability of success; (POS) (n) (safety) **uspješnost traganja (u sustvu SAR)**

problem (n) **problem** **face the problem** **suočiti se s problemom, pose a problem** **predstavljati problem, postaviti (se) kao problem**

procedure /prəˈsiːdʒə/ (n) **1 postupak, postupanje, procedura survival procedure** **postupak za preživljavanje** **postupanje za održavanje na životu, SMS procedures** **procedure upravljanja sustavom sigurnosti** *it was established that all SMS procedures had been properly followed,* **rules of procedure** **pravila postupka; 2 redosljed postupaka / zahvata; 3 tehnološki proces**

procedure for a vessel entering the port (n) (mar law) **postupak ulaska broda u luku**

proceed /prəˈsiːd/ **Heave up and proceed! (seamanship, navig)** **Podignite sidro i isplovite!, proceed to the port / berth** **krenuti / uputiti se prema luci / vezu: The Pilot boarded at 0730 and the ship proceeded inwards., proceed along the fairway** **ploviti plovnim kanalom, proceed alongside** **uploviti i pristati (na vez, uz obalu), proceed at full / great / low speed** **ploviti punom / velikom / malom brzinom, kretati se punom / velikom / malom brzinom, proceed to sea** **isploviti, uputiti se prema otvorenom moru (v) (navig, seamanship)** **prosljediti, (o brodu) isploviti, krenuti, uputiti se, nastaviti (plovību): The Pilot boarded at 0730 and the ship proceeded inwards. Peljar se ukrcao u 0730 i brod se uputio prema luci.**

proceedings /prəˈsiːdɪŋz/ (n) **arbitral proceedings** **arbitražni postupak, legal**

proceedings pravni postupak, **initiate legal proceedings** povesti pravni postupak
1 a (mar law) službeni postupak; **2** rasprava
proceeds /prəˈsiːdɪz/ (n) (mar law) utržak, utržak (od prodaje broda, tereta itd)
process /ˈprəʊsɛs/ (n) (marine eng) proces, tehnološki slijed **basic oxygen process**
 bazni proces s kisikom
process /ˈprəʊsɛs/ (v) procesuirati, obrađivati
processing (n) (cargo) obrada (npr. robe u luci)
produce /prəˈdjuːs/ (v) **1** proizvesti, napraviti, stvoriti; **2 (mar law)** predočiti
 (dokument) **produce the Bill of Lading** predočiti teretnicu
produce /ˈprɒdjuːs/ (n) (cargo) proizvodi **dairy produce** mlječni proizvodi
produce the original Bill of Lading (v) (shipping econ) predočiti originalnu
 teretnicu, uručiti originalnu teretnicu
product carrier (n) (nav arch) = **product tanker** tanker za prerađevine, brod za
 prijevoz naftnih derivata
production **1** proizvodnja; **2 (mar law)** predočenje (terenice)
products of combustion (n) (marine eng) produkti izgaranja
product tanker (n) (nav arch) = **product carrier** Oil products tankers are non-specialised
 tankers below 60,000 dwt, as well as coated tankers above this size. These ships carry a spectrum of
 cargoes, ranging from relatively unsophisticated dirty products such as fuel oil through to clean products
 such as naphtha.; Product tankers, generally much smaller, are designed to move refined products from
 refineries to points near consuming markets. **tanker za prerađevine, tanker za prijevoz**
naftnih derivata, tanker za prijevoz naftnih proizvoda, product tanker: *Product tanker is
 designed for the carriage of refined products derived from crude oil (gasoline, Diesel oil, jet fuel) from
 the refineries.*



proficiency /prəˈfɪʃənsi/ (n) 1 stručnost; 2 stručna sprema, kvalifikacija **Certificate of proficiency** svjedodžba o stručnoj spremi, svjedodžba o kvalifikaciji; 3 vještina; 4 znanje **proficiency test** test znanja; 5 poznavanje; 6 iskustvo

proficiency certificate (n) svjedodžba stručnosti

profile /ˈprəʊfaɪl/ (n) 1 a presjek; 2 obris, oblik; 3 (nav arch) profil **round profile** okrugli profil, **square profile** pravokutni profil

profile /ˈprəʊfaɪl/ (n) (nav arch) lateralni plan

profit **dobit, profit**. *The VLGC carrier owner has reported a small profit for 2Q16 and the company says that demand in the Far East is likely to remain firm both in the short and long term.*

profitable (adj) rentabilan, isplativ, koji donosi dobit (profit)

progress (n) 1 napredak; 2 tijek **in progress** u tijeku; 3 plovidba broda, kretanje broda **monitor the vessel's progress** pratiti kretanje broda: *The vessel's progress through the Firth was being closely monitored.*

prohibit (v) zabraniti

prohibited anchorage (n) (navig, safety) zabranjeno sidrište

prohibited area (n) (navig) područje zabranjene plovidbe

prohibited fishery limits (n) (navig, safety) područje zabranjenog ribolova

project /ˈprɒdʒekt/ (n) projekt

project /prəˈdʒekt/ (v) viriti prema van, izbavivati se

project cargo (n) (cargo) The materials and equipment to assemble a special project overseas, such as a factory or highway. **teret za velike investicijske propjekte**

projected route (n) (navig) zacrtana ruta plovidbe

projection /prəˈdʒɛkʃən/ (n) (**cargo**) izbočina u brodskom skladištu, koja može oštetiti teret) izdanak, izduženje, izbočina, izbojak

projection /prəˈdʒɛkʃən/ (n) (**navig**) projekcija **gnomonic projection** gnomonička projekcija, **Mercator projection** Merkatorova projekcija

projection plane (n) (**nav arch**) ravnina **front view projection plane** nacrtna ravnina, **top view projection plane** tlocrtna ravnina

projector /prəˈdʒɛktə/ (n) (**navig**) **SEE searchlight** reflektor: *LPG & LNG tankers should be equipped with own projectors conform to the Suez Canal Authority's rule of Navigation, and that said projector should be gaslight.*

prolong /prəˈlɒŋ/ (v) **produljiti (vremenski)**, produžiti

prolonged /prəˈlɒŋd/ (adj) **produžen**, dugotrajniji

promenade deck (n) (**nav arch**) promenadna paluba, šetna paluba

prominent object (n) (**navig**) markantni objekt

promote /prəˈmeɪt/ (v) **1 unaprijediti, poboljšati** **be promotee to the rank of officer** biti unaprijeđen u rang časnika; **2 pospješiti**; **3 pomagati**

promotion /prəˈməʊʃən/ (n) **1 a unapređenje (u viši range, na novu dužnost)**; **2 reklamiranje (proizvoda, usluge)**

prompt (adj) **hitar, brz, bez oklijevanja**

promulgate /ˈprɒməˌleɪt/ (n) (**mar law**) **proglasiti, donijeti na snagu**: *4. Orders for the provision of pilotage services to any vessel are to be made in such manner as may from time to time be directed by the Trustees and promulgated by an appropriate Notice to Mariners*

prongs (n) (**cargo**) **vile, vilice (viličara)**

proof (n) (**mar law**) **dokaz burden of proof** teret dokaza

propagation /ˌprɒpəˈgeɪʃən/ the act or process of moving through, causing to move through, or transmitting, esp in the form of a wave **širenje (radarskih, elektromagnetskih itd.) valova**, **propagacija (radarskih itd.) valova** **propagation speed** brzina širenja (radarskih) valova, **pulse propagation** širenje impulsa: *Air ducts created by atmospheric conditions can affect radio pulse propagation and thus radar range.*

propagation delay (n) (**navig**) **propagacijsko kašnjenje (u sustavu GPS) time shift** vremenski pomak, pomak korisničkog sata od GPS vremena, **PRN (pseudo range noise)** signal za određivanje udaljenosti, PRN

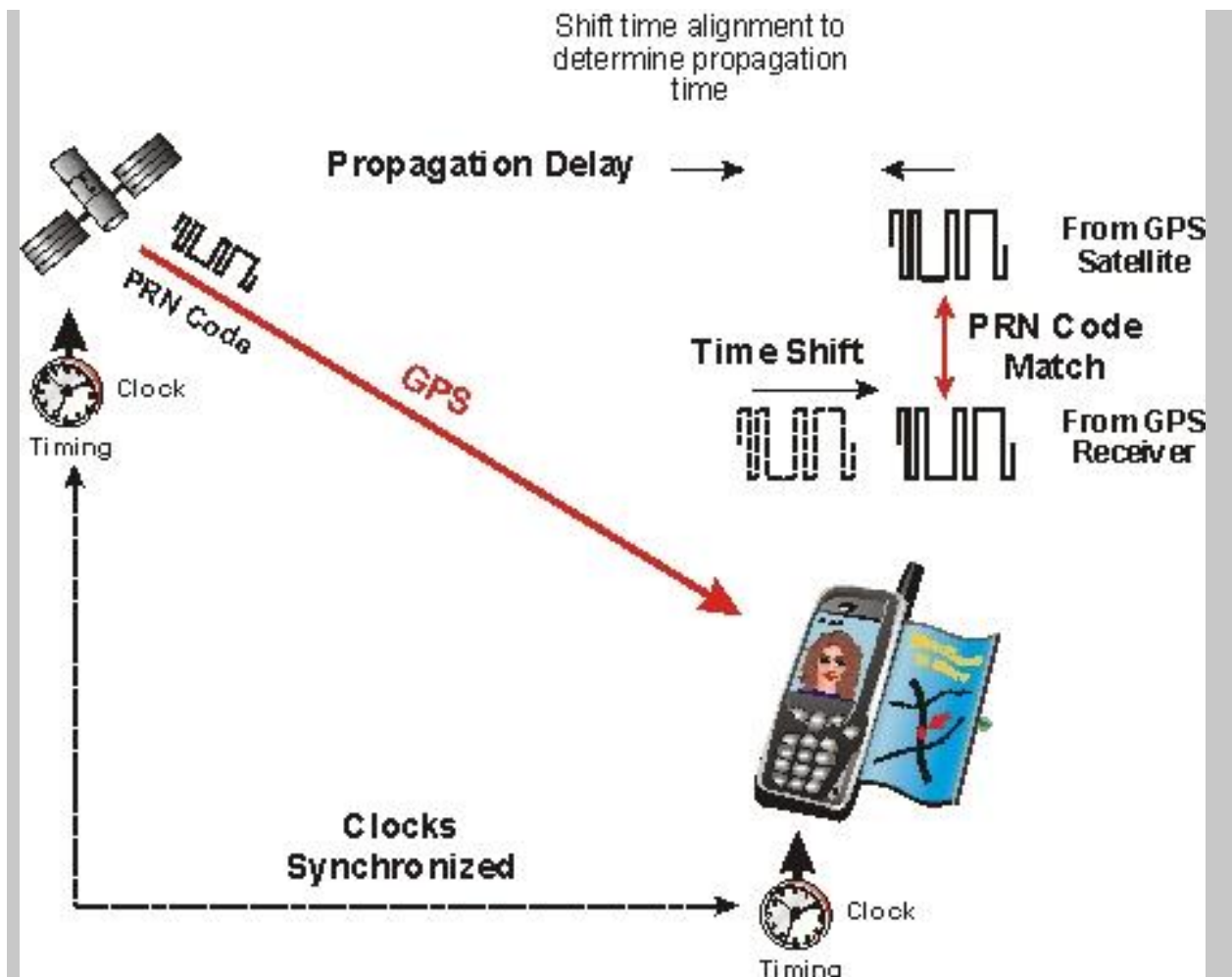

propane /'prəʊpeɪn/ (n) (chem) **propan**

propel /prə'peɪl/ (v) (marine eng) **pogoniti, pokretati, tjerati**

propeller thrust (n) (nav arch) the effort delivered by a propeller in pushing a vessel ahead
potisak propelera, odziv propelera

propelled /prə'peɪld/ (adj) (marine eng) **pogonjen, tjeran** **mechanically propelled** na mehanički pogon

propeller /prə'peɪlə/ **brodski vijak, propeler, tal. elica** **controllable pitch propeller** prekretni propeler, vijak sprekretnim krilima, **fixed propeller** fiksni propeler, vijak s fiksnim krilima, **variable pitch propeller** prekretni propeler, **obstruct the propeller** zapriječiti propeler, predstavljati zapreku propeleru, **turn the propeller** pokrenuti propeler, **left-hand propeller** lijevokretni propeler: *Do you have a right-hand or left-hand propeller?* (IMO SMCP), **right-hand propeller** desnokretni propeler

propeller blade (n) (nav arch) **krilo propelera, lopatica propelera, pata**: *The buoy's superstructure was damaged and its mooring chain was severed by the ferry's propeller blade.*

propeller pitch (n) (nav arch) **korak propelera, uspon lopatice**

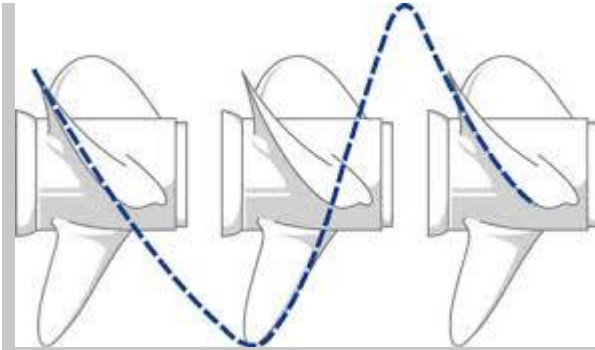

propeller post (n) (nav arch) statva brodskoga vijka, statva propelera

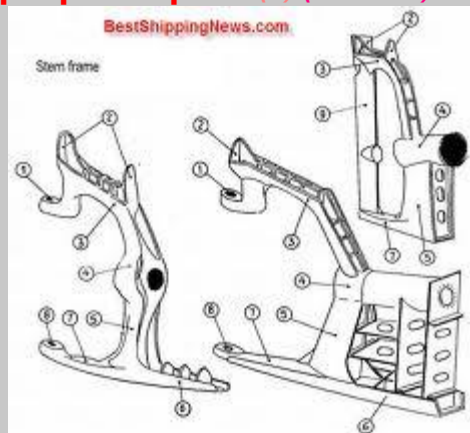

propeller shaft (n) (marine eng, nav arch) propelerska osovina, tal. *albero d'elica*

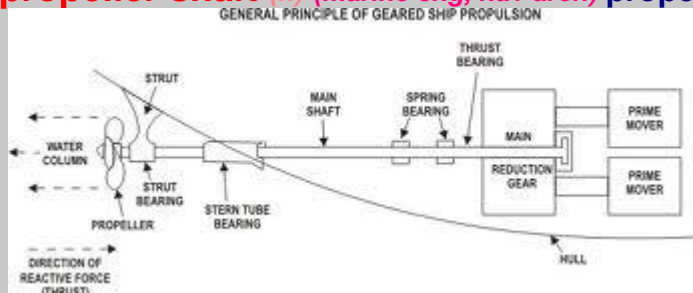

propeller shaft bearing (n) (boating/yachting, nav arch) ležaj propelerske osovine

propeller slip (n) (marine eng, navig) klizanje propelera, proklizavanje popelera

propeller walk; prop walk (n) 1 = **prop walk** smjer okretanja propelera; 2 (n) (navig) tendency for a propeller to push the stern sideways. In theory a right hand propeller in reverse will walk the stern to port **zanošenje krme u stranu** (zbog vrtnje propelera)

proper course (n) (navig, boating/yachting) kurs pravi jedrilice

properly (adv) ispravno, pravilno, propisno, valjano, prikladno: *The cargo must be stowed properly.* Tert valja složiti pravilno.

properly and carefully (adv) (mar law) uredno i brižljivo prevoziti, čuvati, brinuti se (za teret)

property /'prɒpəti/ (n) **salved property** spašenja imovina, **fixed property** nekretnine, **movable property** pokretna imovina 1 svojstvo, osobina, karakteristika **property of the cargo** karakteristika tereta, **special properties of cargo** posebna svojstva tereta; 2 (mar law) imovina

property on board (n) (*mar law*) objekti spašavanja koji obuhvaćaju teret na brodu, brodsku opremu, pripatke i zalihe, vozarinu i prevozninu, putničku prtljagu i osobne stvari posade **stvari s broda**

PROP IMM (%) (n) (*stabil, nav arch*) uronjenost propelera u %

proprietary rights /prə'praɪtəri/ (n) (*mar law*) stvarna prava na brodu

propulsion /prə'pʌlʃən/ (n) **mechanical propulsion** mehanički pogon, **diesel**

propulsion dizelski pogon (*marine eng, navig*) pogon, propulzija **propulsion plant** pogonsko postrojenje, pogonski uređaj, **propulsion unit** pogonsko postrojenje, pogonska jedinica, **marine propulsion** brodski pogon, **steam propulsion** parni pogon, **electric propulsion** električni pogon, električna propulzija, **diesel-electric propulsion** dizel-električni pogon

propulsion machinery (n) (*marine eng, nav arch*) **pogonski strojevi**: *The propulsion machinery is comprised of the two engines, two gearboxes and two controllable pitch propellers,*

propulsion power (n) (*marine eng*) the total maximum continuous rated output power, in kilowatts, of all the ship's main propulsion machinery which appears on the ship's certificate of registry or other official document (STCW 2010) **porivna snaga**

propulsion system (n) (*marine eng*) **porivni sustav**

propulsive /prə'pʌlsɪv/ (adj) (*marine eng*) **pogonski, propulzivan**

propulsive power (n) (*marine eng, nav arch*) **porivna snaga, pogonska snaga**:

Propulsive power is provided by a Sulzer 6RTA62, single acting, direct reversing, two-stroke diesel engine.

prop walk (n) (*ship handling*) **Prop walk** determines the side to which the ship moves. **smjer okretanja propelera**

prop wash (n) (*nav arch, ship handling*) **vodeni mlaz propelera**: *The thrust was so much that the prop wash acted as a small tsunami swamping boats and overturning piers at the marina.*

prop work ahead (n) (*boating/yachting*) **izboj naprijed**

prop work astern (n) (*boating/yachting*) **izboj unatrag**

prosecute /prə'si:kju:t/ (v) **1 tužiti, voditi optužbu**: *The U.S. Department of Justice says 2016 was record year for prosecuting shipping companies and crew for illegal discharges from ocean-going vessels in U.S. waters. gCaptain <info=gcaptain.com@mail83.atl51.rsgsv.net> The master of the MV ... was prosecuted under section 58 of the Merchant Shipping Act 1995 following an investigation by the Maritime & Coastguard Agency.; **2 (shipping econ) vršiti, izvršiti prosecute the voyage izvršiti putovanje, obaviti putovanje***

prospect /'prɒspɛkt/ **izgled prospects** **1 izgledi; 2: What are the prospects? Kakvi su izgledi?**

protect /prə'tekt/ (v) **protect against zaštititi od 1 zaštititi protect from zaštititi od; 2 braniti**

protection (n) **zaštita give protection zaštititi pružiti zaštitu**

Protection and Indemnity Insurance; P & I Insurance /,pi:ən'dai ɪn'fɔ:rəns/ (n) (*mar law*) Protection and Indemnity Insurance is mutual insurance which covers shipowners' liability to third parties for damage to their ship or cargo, as well as statutory liabilities such as pollution and wreck removal, but does not cover direct losses to the shipowner's own ship or cargo - Tetley; Insurance obtained through a mutual association formed by shipowners to provide liability indemnification protection from various liabilities to which they are exposed in the course of their business, and which spreads the liability costs of each member by requiring contribution by all members in the event of a loss. (<http://www.globalshiplease.com/glossary.cfm>) **klupsko osiguranje, osiguranje putem P&I**

klubova, osiguraje bordara od odgovornosti, P&I osiguranje
protection storage unit; (PSU) (n) (navig) = VDR; Voyage Data Recorder
 jedinica za pohranjivanje podataka (VDR-a)

protective clothing (n) (safety, cargo handling) zaštitna odjeća

protest 1 prigovor; 2 protest; 3 žalba, prijava **note of marine protest** prijava pomorske nezgode *nota di fortuna*, pomorski protest



protractor /prəˈtræktə/ (n) (navig) kutomjer

prove (v) 1 dokazati; 2 pokazati se **prove profitable** pokazati se isplativim; 3 potvrditi; 4 ispitati, isprobati

provide /prəˈvaɪd/ (v) 1 pružiti, dati **provide information** pružiti/ dati informacije; 2 osigurati; 3 (mar law) odrediti, utvrditi **as provided in clause 5 of the contract** kao što je određeno odredbom 5 ugovora; 4 (marine eng) montirati, postaviti, umetnuti **be provided with** opremiti (s), ugraditi, montirati, opskrbiti, snabdjeti; 5 nabaviti, pribaviti; 6 pobrinuti se za

provide a service (v) (shipping econ) pružiti uslugu, pružati uslugu: *The transportation industry provides transportation services*

provided (adj) (mar law) određen (ugovorom, propisom, konvencijom), zacrtan, predviđen

provided that (conj) (mar law) pod uvjetom da, ako, ukoliko

provide for (v) predvidjeti, urediti da, osigurati da

provide the berth (v) (shipping econ) osigurati brodu vez, pribaviti brodu vez, rezervirati brodu vez

provide the crew (v) (shipping econ) osigurati brodu posadu, nabaviti posadu broda, zaposliti posadu broda

providing that (conj) pod uvjetom da, ako

provision /prəˈvɪʒən/ (n) 1 a (mar law) odredba, klauzula **make provision** predvidjeti nešto (u ugovoru, konvenciji); 2 uvjet **under the provision that** pod uvjetom da, **make provision for** 1 predvidjeti, urediti, dogovoriti, osigurati; 2 pobrinuti se (za); 3 nabava, nabavka, pribavljanje

Provision and Display of Manoeuvring Information on Board Ships (n) (navig) Pribavljanje i prikaz informacija na brodu o manevarskim svojstvima broda

provisions /prəˈvɪʒənz/ (n) 1 a (shipping econ) brodske namirnice, zalihe hrane, provijant, *provišta*; tal. *provviste*; *provvigioni*; 2 odredbe (ugovora itd.), klauzule

provision store (n) (nav arch) spremište hrane, rashladni spremnik hrane

proW /praʊ/ (n) (seamanship) the part of the bow above the water **pramac**, *prova* {obsolete (zastarjelo); pjesnička uporaba}

proximity /prɒkˈsɪmɪti/ (n) **blizina**: *the proximity of the tanker was recognized only seconds before the collision. in close proximity to / of u blizini*: *Manoeuvring in close proximity to dangers requires a master's undivided attention. The master was aware of the close proximity of the tanker, but*
The Lessons 1.

PRR; passive radar reflector (n) (navig) pasivni radarski reflektor

pseudo random noise (n) (navig) pseudo-slučajno generirani nizovi jedinica (u sustavu GPS)

pseudorange (n) (navig) pseudoudaljenost (u sustavu GPS)

PSV; (platform supply vessel) (n) (nav arch) brod za opskrbu / snabdijevanje platformi

psychrometer /sɪˈkrɒmɪtə/ (n) (meteorol) a hygrometer consisting of wet-bulb and dry-bulb thermometers, the difference in the two thermometer readings being used to determine atmospheric humidity. **psihrometar**

public address announcement (n) (comm, safety) objava putem brodskog

razglasa *The master sounded the fire alarm and made a public address announcement ordering all hands to their emergency muster stations.*

Public Address System (n) (safety) **brodski razglas**: *the master announced over the Public Address System that a fire had been discovered and the passengers and crew to report to their lifeboat embarkation area*

public address system (PA system) (n) (comm) brodski razglas, razglasni uređaj

public domain /deˈmeɪn/ (n) (mar law) **Domaine public** - (public domain) - A French civil law term referring to all property of the French State which is incapable of ownership by virtue of its nature or the purpose for which the property is destined. Such property is unseizable, inalienable and imprescriptible (Tetley) **javno dobro**

public sector (n) (shipping econ) **ANTONYM private sector** javni sektor, državni sektor

public ship (n) (mar law) javni brod

puff = gust nalet vjetra, reful

pull (v) (seamanship) **vući (o tegljaču)**: *the forward tug was pulling ahead* tegljač po pramcu vukao je brod prema naprijed **pull the vessel vući (tegliti) brod**, **pull the vessel off the berth vući brod od veza**: *The pilot then ordered the tug to pull the vessel's stern off the berth*

pull (n) 1 vlak, sila vlaka, sila vučenja **pull force** vlačna sila (tegljača), sila vučenja, bollard **pull** vlačna sila na kuki (tegljača); 2 potezanje, povlačenje

pull along (v) (seamanship) vući dalje, tegliti skroz

pull apart (v) razdvojiti, rastaviti, raskinuti

pull clear (n) (navig) izvući (nasukani brod), odsukati brod: *The ship was pulled clear after less than one hour and towed to the anchorage*

pulley /ˈpʊli/ (n) (cargo handling) kolotur, užnica, tal. **puleggia** **pulley guide** kolutna



vodilica

{tal. puleggia}

pull off (v) (seamanship) **izvući**: *The larger tug was transferred aft to pull the ship off.*

pull of wind (n) (marine eng) **zapuh, nalet vjetra, reful**

pull out (v) **izvući, istrgnuti**

pull over (v) **zaustaviti (auto)**

pull the line on board (v) (seamanship) **povući konop na brod**

pull the sail in (v) (boating/yachting) **ANTONYM ease the sail out** **zategnuti jedro (škotom), povući jedro**

pulp /pʌlp/ (n) (cargo) **pulpa, celuloza**

pulpit /'pʌlpit/ (n) (boating/yachting) **prednja ograda, pramčana ograda** {na jedrilici ili gliseru}

pulse elongation (n) (navig) **modulacija jačine odraza / jeke (radarskog signala)**

pulse generator amplifier / symbol generator; PA/SG (n) (navig) **generator elektromagnetskih impulsa (u predajniku radara)**

pulse length (n) (navig, electr) **duljina impulsa (radara) long pulse length dugački impuls**: *Use a longer pulse when your objective is long range detection, a shorter pulse when resolution is important,*

medium pulse length srednji impuls, short pulse length kratki impuls, set the 1 postaviti duljinu impulsa, appropriate 1 odgovarajuća duljina impulsa,

pravcilna duljina impulsa, choose the pulse length odabrati duljinu impulsa,

preset pulse length predodrediti duljinu impulsa, postaviti duljinu impulsa ranije

pulse repetition rate (PRR) /pʌls/ (n) (navig) **impulsna frekvencija**

pulse stretching (n) (navig) = **pulse elongation** **modulacija jačine radarskog odraza / jeke**

pulse turbocharger (n) (marine eng) **turbopuhalo pulzirajućeg sustava**

pump /pʌmp/ (v) (marine eng) **1 crpiti, sisati, tlačiti, pumpati; 2 nalijevati, pretakati sisaljkom**

pump /pʌmp/ (n) (marine eng, cargo handling) **oil-fuel pressure pump** **lačna sisaljka za gorivo crpka, sisaljka, pumpa submersible pump uronjiva pumpa, auxiliary pump pomoćna pumpa, axial flow pump aksijalno protočna pumpa, booster pump dodatna pumpa, buster-sisaljka, centrifugal pump centrifugalna pumpa, circulating pump cirkulaciona pumpa, protočna pumpa, extraction pump pumpa kondenzata, feed pump napojna pumpa, fresh water pump pumpa slatke vode, fuel pump pumpa goriva, pumpa za dovod goriva, fuel pump rack zupčasta letva pumpe za dovod goriva, gear pump zupčasta pumpa, hydraulic pump**

hidraulična pumpa, **jerk pump** visokotlačna pumpa s razvodnim klipom (za ubrizgavanje goriva), **Boschova pumpa** *Bosch-pumpa*, **luboil pump** pumpa ulja za podmazivanje, **lubricating oil supply pump** dobavna pumpa ulja za podmazivanje, pumpa za dobavu ulja, **positive displacement type pump** pumpa potisnog tipa, **priming pump** pumpa za punjenje (cjevovoda), pumpa za pripremanje prije rada, pumpa za predpodmazivanje, pumpa za uhodavanje, **seawater pump** pumpa morske vode, **separately driven pump** pumpa sa samostalnim pogonom, **service pump** pumpa za opsluživanje, **supply pump** dobavna pumpa, pumpa za dobavljanje, **transfer pump** prijenosna pumpa, pumpa za pretakanje, **pump driven from the engine** pumpa privješena na pogonski stroj, **pump suction line** usisni vod pumpe, **pump action** tlačenje, **reciprocating pump** stapna sisaljka, stapna pumpa, **bilge pump** kaljužna sisaljka, kaljužna pumpa, **double-acting pump** dvoradna pumpa, pumpa koja radi u oba smjera, **single-acting pump** jednoradna pumpa, jednosmjerna pumpa, **reciprocating pump** stapna pumpa, recipročna pumpa, **displacement pump** istisninska pumpa **positive pump** volumetrijska pumpa, volumenska pumpa istisninska pumpa, volumetrijska pumpa, **duplex double acting pump** dvojna dvoradna pumpa, **simplex single acting pump** jednoradna pumpa tipa simplex

pump drive (n) (*marine eng*) **pogon pumpe**: *The engine is reversed by a simple and reliable mechanism, which incorporates an angularly displaceable roller in the fuel pump drive of each cylinder.*

pumping equipment (n) (*marine eng*) **1 pumpna stanica; 2 pumpni uređaj**

crpni uređaj: *Pumping equipment is provided in the tanker storage plant or refinery ashore, but not on the quayside.*

pumping rate (n) (*cargo handling*) **kapacitet pumpe, kapacitet pumpanja**

(tlačenja/crpjenja): *All operations undertaken during loading and discharge should be logged by the ship including details of all valve positions, changes in valve usage, pumping rates, manifold pressures and vessel's draught and trim.*

pumpman (n) **rukovatelj pumpe, poslužitelj sisaljke, pumpman**

pumproom (n) (*nav arch, cargo handling*) **pumpna stanica, pumprum, tal. locale delle pompe**

pump well (n) (*nav arch*) **pumpni zdenac**

punch /pʌntʃ/ (v) **označiti (točku bušenja), punktirati**

punched /pʌntʃt/ (adj) **bušen, ukucana dlijetom (oznaka)**

puncture /'pʌŋktʃə/ (n) (*navig*) **rupa (pri sudaru, dodiru), proboj**

puncture /'pʌŋktʃə/ (v) **probiti**: *A 60 cm by 20 cm hole was punctured above the waterline in way of a ballast tank*

purchase /'pɜ:tʃɪs/ (v) (*mar law*) **kupiti, nabaviti** **purchase department** **nabavna služba**

purchase /'pɜ:tʃɪs/ (n) (*nav arch, cargo handling*) **a tackle; blocks and falls; any mechanical advantage which increases the power applied** **čekrk, paranak**

purchase /'pɜ:tʃɪs/ (v) (*cargo handling*) **podići čekrkom**

purchase order (n) (*shipping econ, mar law*) **Common grouping of orders for goods/services.**

(<http://www.maerskline.com/en-jm/help/shipping-glossary>) **narudžba usluge, nalog za kupnju, skupljanje narudžaba za usluge**: *Most customers group their orders in a particular way to facilitate distribution at the other end.*

purchase price (n) (**shipping econ**) kupovna cijena

purchaser /'pɜːtʃɪsə/ (n) (**mar law**) = **buyer** kupac

purchaser /'pɜːtʃɪsə/

purchaser /'pɜːtʃɪsə/ (n) **brodski ekonom**

purge /pɜːdʒ/ (v) **ispirati, čistiti**

purging (n) (**cargo handling**) **čišćenje tanka ispiranjem**

purifier /'pjʊəri,faɪə/ (n) (**marine eng**) **pročistač, prečistač**

purify /'pjʊəri,faɪ/ (v) **čistiti**

purser /'pɜːsə/ (n) (**mar law**) **brodski ekonom, brodski administrator, brodski komesar**

purse seine (n) (**fishing**) In purse seine fishing the vessel surrounds the school with netting before bringing the bottom together into a purse-like enclosure. **mreža plivarica**: *Purse seine fishing is a technique targeting pelagic (surface/open ocean) schooling fish such as tuna and mackerel.*

purse seiner (n) (**nav arch, fishing**) **plivaričar, kočar s mrežom plivaricom**

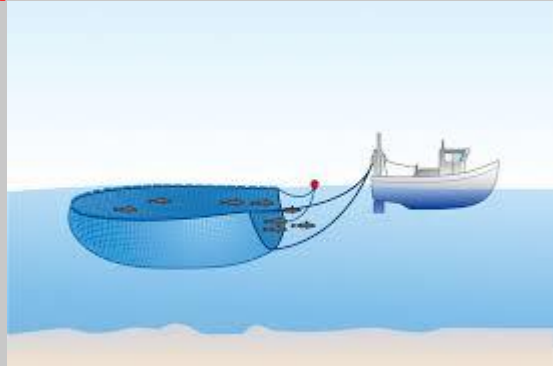

pursuant to (the terms of the contract) /pə'sjuːənt/ (**conj**) (**mar law**) **u skladu s (uvjetima ugovora), sukladno, prema, što slijedi iz**

push (v) (**seamanship**) **ANTONYM pull** **gurati (o tegljaču), potiskivati, goniti**: *Two tugs, secured to the vessel, were pushing square at idling revolutions the aft tug's stem was pushing on the cargo vessel's stern with the aft towline tight.* **krmeni tegljač gurao je svojim pramcem krmu broda, pri čemu je krmeno tegleno uže bilo napeto. push ahead gurati prema pramcu / naprijed, gurati krmu, gurati po krmu, push astern gurati prema krmu / nazad, push apart odvojiti, rastaviti, push on the stern**



pushboat (n) (**nav arch**) **potiskivač**

push button (n) (**electr**) **pritisno dugme (za uključivanje/isključivanje), dugme-preklopka**

pusher (**nav arch**) **potiskivač**

pusher boat (n) (nav arch) potiskivač, gurač

pushing (n) (seamanship) guranje (broda tegljačem)

pushing off (n) (boating/yachting) odguravanje (brodice od obale)

push mode (n) (navig) režim guranja, stav guranja **remain in the push mode** ostati u režimu guranja, nastaviti gurati. *The pilot twice asked the aft tug to tow right astern, but the tug remained in push mode.*

pushpit (n) (boating/yachting) krmena ograda

push point (n) (navig, seamanship) točka guranja (tegljača o brod): *There was a very long lever between the ship's pivot point and tug's push point.* Poluga između točke okretanja broda i točke guranja tegljača bila je preduga.

push rod (n) (marine eng) podizač ventila, podizna motka (usisnog i ispušnog ventila)

push tug (n) (nav arch) = **pusher boat** gurač, potiskivač



put (v) staviti **put into a port** skrenuti u luku (spasa, zakloništa, popravka), **put off** (the ship's arrival) odgoditi (dolazak broda), zavući, otkazati, **put out of commission** (shipping econ) staviti (brod) izvan plovidbe / servisa

put ashore (v) iskrcati se (o pomorcu), iskrcati (pomorca)

put in gear (v) (seamanship) uključiti (spojku sidrenog vitla), pokrenuti

put on slow ahead staviti (stroj) u vožnju polagano naprijed: *The engine was put on dead slow ahead at 0853 but at 0857 the alternators cut out, all power was lost and the engine stopped.*

put out ugasiti **put out the fire** pogasiti vatru, ugasiti požar. *The fire was completely put out at 03:28 h local time on 4 August. Our focus now is to put the fire out and get access to the vessel to assess damage to the vessel and cargo*

put the windlas in gear (v) (seamanship) uključiti spojku sidrenog vitla, uključiti sidreno vitlo, pokrenuti sidreno vitlo, uglobiti lanac / verigu (sidra), *ngranat*; tal. *ingranare il salpancora*

put the wind on the starboard (port) bow (quarter) (v) (meteorol, navig) okrenuti brod desnom (lijevom) stranom pramca (krme) prema vjetru (u tropskoj oluji): *in the path of a tropical revolving storm, put the wind on the port quarter and alter course to starboard as the wind veers*

put to sea (v) (navig) to leave port isploviti

put to (three) shackles (n) (seamanship, navig) pustiti (tri) uze lanca u more

put weight on (n) (seamanship) zategnuti uže, napeti (uže): *the tug master put weight onto the towline zapovjednik tegljača napeo je uže za tegljenje*

PW WD (per weather working day) (shipping econ) po svakom radnom danu,

ako to dopuštaju vremenske prilike

pyrometer /pai'romitə/ (n) (*marine eng*) naprava za određivanje vrlo visokih temperatura
 pirometar

pyrotechnics /,paɪrəʊ'tekniks/ (n) (*safety*) flares, rockets, powder, etc., used for giving signals or for illumination, more generally used as distress signals **pirotehnika**

PZX triangle /,pi: zed 'eks 'traɪ,æŋgəl/ (n) (*navig*) **astronomski trokut**, **navigacijski trokut**

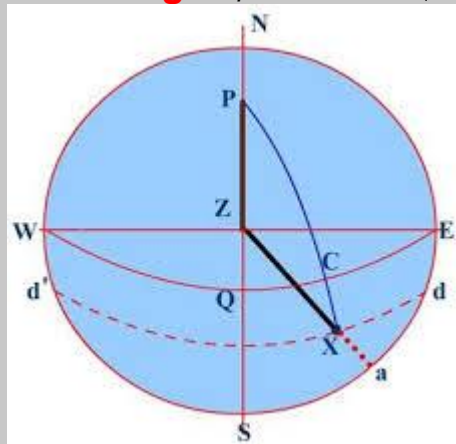

QTY (quantity) količina (tereta)

quadrant /'kwɒdrənt/ (n) (*navig*) a reflecting hand navigational instrument constructed on the same principle as the sextant but measuring angles up to 90 degrees only **kvadrant** (= octant; obsolete)

quadrirème /'kwɒdrɪ,ri:m/ (n) (*nav arch, boating/yachting*) a galley with four banks of oars
 kvadrirema

qualification 1 kvalifikacija; 2 izmjena, modifikacija **without qualification** (*mar law*) bez primjedaba; 3 ograničenje (u zakonu, konvenciji); 4 svjedodžba,

ovlaštenje: *The ship's crew held qualifications for their positions in accordance with international requirements.*

quality control (n) The systematic planning, measuring and control of a combination of people, materials, metrology and machines, with the objective of producing a product that satisfies the quality and profitability of the enterprise. (<http://www.maerskline.com/en-jm/help/shipping-glossary>)

kontrola kakvoće, kontrola kvalitete

quality unknown (n) (*mar law, shipping econ*) kakvoća nepoznata (u teretnici)

quarantine /'kwɒrən,ti:n/ (n) (*safety*) restricted or prohibited intercourse due to contagious disease **karantena** **quarantine inspection** **karantenski pregled**: *There is only one designated quarantine area for all vessels subject for quarantine inspection.*

quarantine disease /'kwɒrən,ti:n/ (n) (*med*) karantenska bolest

quarter /'kwɔ:tə/ (n) 1 četvrtina **one quarter** jedna četvrtina, **three quarters** tri četvrtine;

2 (*nav arch, navy*) the part of a vessel's side towards the stern, usually aft of the aftermost mast **kvartir**, **bočna strana krme** **port quarter** lijevi kvartir, tal. *giardinetto di sinistra*, **starboard quarter** desni kvartir, tal. *giardinetto di dritta*; 3 the general direction along the water in the quadrant between the beam of a vessel and its stern **smjer bočno po krmi** **on the port / starboard quarter** po lijevom / desnom kvartiru (also portions of the vessel's sides about midway between the stem and midlength and between midlength and the stern)

quarter /'kwɔ:tə/ (n) (*nav arch*) kvartir, bočni dio krme

quarterdeck /'kwɔ:tədek/ (n) (*nav arch*) the aftermost deck of a warship **krmena plauba**,



krmica

{traditionally used for the deck on a naval vessel for official or ceremonial use}

{traditionally used for the deck on a naval vessel for official or ceremonial use}

quarterings /'kwɔ:təriŋz/ (n) (*cargo*) teret drva četvrtastog profila **čtvrtače, gredice četvrtastog profila**

quartering sea (n) (*navig*) sea on the quarter (coming from a side of the stern). **valovi u kvartir, malovi u bok krme**

quarterman /'kwɔ:təmən/ (n) **kormilar**

quartermaster (QM) (n) (*seamanship*) **kormilar**: As the ferry began its crossing at 21 knots, visibility was 4-5nm and a **quartermaster (QM)** was on the bridge. The bridge team consisted of the master, second officer, third officer, **quartermaster** and a lookout. The mooring watch was set, the **quartermaster positioned at the gangway** and an OOW on the bridge. On the bridge were the master, who was on the port wing and had the con, the OOW and a **quartermaster**.

quarters /'kwɔ:təz/ (n) (*nav arch*) living compartments on board a ship; living or sleeping rooms

nastambe (posade): Seafarers shall keep their respective quarters clean and in order. Pomorci su dužni držati svoje nastambe čistim i urednim **living quarters stambene prostorije** {it includes staterooms, dining salons, mess rooms, lounging places, passages connected with the foregoing, etc (SeaShore.net)}

quarter timbers /'kwɔ:tə/ (n) (*sailing vessels*) **krmeno krilno rebro**

quarter wave (n) (*boating/yachting*) **valovi u kvartir, valovi u bok krme, valovi koso po krmi**

quartier-irons (n) **nutarnji prsten krilnog debljaka (na križu jarbola)**

quay /ki:/ (n) (*ports*) = **wharf** a wharf, typically one built parallel to the shoreline; a loading and discharging place, usually, paralleling the shore. Usual construction consists of a masonry wall in the water, with fill between the wall and the natural shore (Seasources.net) **lučka obala, tal. banchina**



quay apron /'ki: 'eiprən/ (n) (*ports*) The area between the quay wall (made of solid masonry) and

the nearby warehouse or storage facility; površina između ruba obale i lučkog skladišta **operativna površina lučke obale**

quay crane /ki:/ **obalna dizalica**

quayside crane /ki:said/ (n) (cargo handling) **obalna dizalica**

quick lights (n) (navig) lights exhibiting very rapid regular alternations of light and darkness, normally 60 flashes per minute **kratka svjetla** {formerly called 'flashing lights'}

quick release device (n) (seamanship) **naprava za brzo otpuštanje (lanca, konopa)**

quick release hook (n) (seamanship) (nav arch) **kuka za brzo otpuštanje (lanca, konopa, brodice za spašavanje) brzootpusna kuka, samotpusna kuka**: *the ship was moored to quick release hooks on the mooring dolphins At this point, the hook released the tensioned breastline. The boat then started to lower and almost immediately stopped, at which point the quick release hook opened and the boat fell just under a metre into the water.* **quick release mooring**



hook **kuka za brzo otpuštanje**

quick release towing hook (n) (seamanship, nav arch) **samoopusna kuka za tegljenje brzootpusna kuka za tegljenje**

quick releasing device (n) (nav arch) **naprava za brzo otpuštanje lanca**

quick response: QR (n) (shipping econ) A consumer-driven system of replenishment in which high-quality products and accurate information flow through a paperless (EDI) system between all distribution points from the manufacturing line to the retail checkout counter.

(<http://www.maerskline.com/en-jm/help/shipping-glossary>) **brza organizacija prijevoza putem sustava EDI**

quitclaim (n) (mar law) A legal instrument used to release one person's right, title or interest to another without providing a guarantee or warranty of title.

(<http://www.maerskline.com/en-jm/help/shipping-glossary>) **prepuštanje vlasničkih prava drugome bez jamstva**

quitting the ship (n) (mar law) **napuštanje broda**

quoin; coign; coigne /kwɔɪn ; kɔɪn/ (n) (cargo) **drveni klin za pričvršćivanje bačava**

quotation (n) (shipping econ) **1 ponuda (s cijenom); 2 uvjet prodaje, iz INCOTERMS-a kotacija**

rabate /ri:beit/ (shipping econ) **rabat, popust**

race /reis/ (n) (boating/yachting) **1 regata, regatno natjecanje notice of race**

obavijest o regati, raspis regate; 2 jedno natjecanje jedrilicama tijekom jedriličarske regate plov the second race of the sailing regatta drugi plov regate

racing (n) (boating/yachting) **jedriličarsko natjecanje, regatno natjecanje**

racing boat (n) (boating/yachting) regatna jedrilica

racing mark (n) (boating/yachting) oznaka na regatnom polju: *The helmsman then tried to gybe to head for the first racing mark, but could not as the boat was moving too slowly.*

racing rules; racing Rules of Sailing (n) (boating/yachting) regatna pravila {pravila koja je donijela IYRU (International Yacht Racing Union)}

racing sails (n) (boating/yachting) COMPARE working sails regatna jedra, mnatjecateljska jedra

racing yachtsman (n) (boating/yachting) sportski jedriličar

rack (n) 1 (marine eng) zupčasta letva (pumpe za gorivo); 2 (nav arch) zupčanica; 3 (cargo handling) skladišna polica

rack and pinion (n) (marine eng) zupčasta letva i pogonski zupčanik

rack container (n) (cargo handling) kontejner bez strana, kontejnerska platforma



racking force (n) (cargo handling) a result of the static and dynamic forces within the container parallel to the ship's deck, causing damage to the container **sile izvijanja kontejnera u smjeru paralelnom s palubom broda**: *Exceeding racking forces can be reduced by use of diagonal lashing units. In the pitching condition the racking force is acting in the container side*

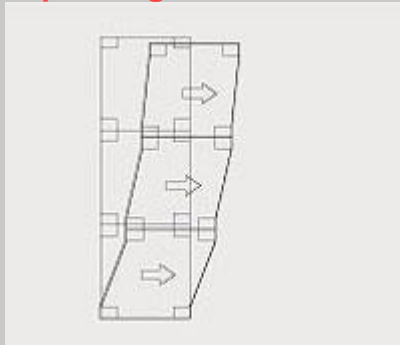

frames.

racon; (RAdar beaCON) /'reikɒn/ (n) (navig) a radar beacon which produces a coded response or radar paint, when triggered by a radar signal; A racon is a radar transponder commonly used to mark maritime navigational hazards and other navigation features. **radarski far odgovarač, radarski far tip racon, rakon, radarski svjetionik**: *The signal transmitted by the RACON appears intermittently on the display as a Morse character, a dashed or dotted line radiating out from the beacon. In the U.S., RACONs are used to mark lighthouses and buoys, inconspicuous coastlines, navigable spans under bridges, offshore structures such as oil platforms, or environmentally sensitive areas such as coral reefs. Racons are particularly useful for showing up objects which otherwise may be difficult to identify.* **interrogation subsystem uređaj za odašiljanje signala, transponder subsystem uređaj za odziv, sensitivity time control automatska kontrola pojačanja prijammika, automatic overload control sustav za automatsku kontrolu preopterećenja, slow sweep racon; (RAdar beaCON) racon sa sporim pretraživanjem, fast sweep racon; (RAdar beaCON) racon s brzim pretraživanjem, frequency agile racon; (RAdar beaCON) racon s podesivom frekvencijom off-set**

racon s pomakom vremena, **integrated time off-set racon; (RAdar beaCON)**
 upravljivi racon s pomakom vremena



{short for: radar beacon}

radar /'reɪdɑː(r)/ (n) **10cm, S-Band, 3 GHz radar** radar valne dužine 10 cm, S-pojasnog područja (2900-3100) (navig) an electronic system designed to transmit radio signals and receive reflected images of those signals from a target in order to determine the bearing and distance to the target (Seasources.net) **radar operational radar** radar u radu, **radar koji je uključen, radar out of operation** 1 radar u kvaru; 2 radar koji je isključen, **3cm, X-Band, 9 GHz radar** radar valne dužine 3 cm, X-pojasnog područja (9320-10000 MHz), 9GHz, **radar target** cilj radarskog motrenja {akronim za: RAdio Direction And Ranging}

radar antenna (n) (navig) radarska antena

radar bands (n) (navig, electr) There are two main frequency bands in commercial Radar: X-Band (9,000 MHz band; wavelength 3cm) and S-Band (3,000 MHz band; wavelength 10 cm). **radarski pojasevi radar bands frequencies** frekvencije radarskih pojaseva

radar bandwidth (n) (electr) širina radarskog pojasa *radar bandwidth is normally matched to the radar pulselength and is usually switched with the range scale and the associated pulselength*

radar beacon; racon (n) (navig) = **racon; (RAdar beaCON)** radarski far odgovarač, radarski odgovarač

radar beam (n) (navig) radarski snop, radarska zraka, glavna radarska latica **horizontal radar beam** horizontalni snop, **vertical radar beam** vertikalni snop

radar beam deflection system otklonski sustav radara

radar bearing (n) (navig) radarski azimut **measure radar bearing** izmjeriti radarski azimut, **odrediti radarski azimut, determine radar bearing:** *Bearing to a target is determined by the direction from which a reflected echo returns.*

radar blip (n) (navig) radarski signal, signal na radarskom ekranu























radar controls (n) (navig) kontrole na radaru, upravljačke naprave na radaru, kontrole radara **SCANNER ON-OFF** prekidač za uključivanje i isključivanje antene, **START-STOP** glavni prekidač za uključivanje i isključivanje motor-generatora ili statičkog konvertera, **TRANSMIT** prekidač za prebacivanje načina rada na odašiljanje, **STAND BY-RUN** spreman za rad (o radaru), spreman za odašiljanje, priprema za rad, preklopka priprema/rad, **STAND BY-TRANSMIT; ST BY/TX** spreman za odašiljanje, spreman za rad, priprema za rad, **PRESS TO VIEW** pritisni za pregled (uključuje radar na nekoliko minuta), **BRILLIANCE CONTROL** kontrola osvijetljenosti (radarske slike), kontrola osvijetljenja, **DAYLIGHT CONTROL** kontrola za pojačano osvijetljenje (za rad danju bez zaštitne maske, na ARPA radarima), **GAIN** dugme za pojačanje radarskog prijavnika i kontrasta slike,

dugme za pojačanje osjetljivosti / kontrasta, **FOCUS CONTROL** kontrola za fokusiranje, **LOG / LIN CONTROL** kontrola za prebacivanje između logaritamskog i linearnog obilježja prijamnika, **SHIFT (CENTERING)** kontrola za pomicanje / centriranje (geometrijskog i elektroničkog središta) **HORIZONTAL / VERTICAL SHIFT** vodoravno / okomito pomicanje, **PICTURE CONTROL** kontrola stabiliziranja slike, **TURN PICTURE CONTROL** kontrola zakretanja slike, **AUTOTRIM PICTURE ALIGNMENT** automatsko centriranje slike, **HEADING LINE ALIGNMENT SWITCH; HL ALIGNMENT SWITCH** prekidač za centriranje pramčanice, prekidač za dovođenje pramčanice u okomit položaj **HEADING MARKER OFF SWITCH** prekidač za privremeno brisanje pramčanice (radi provjere prisutnosti nekog objekta/cilja ispod pramčanice), **CLUTTER CONTROL** kontrola za smanjivanje smetnja, **ANTI CLUTTER CONTROL** kontrola za smanjivanje smetnja, **RAIN SWITCH** preklopka za smanjivanje smetnja od kiše, **ANTI RAIN CLUTTER; A/C RAIN (FTC)** kontrola/preklopka za smanjivanje smetnja od kiše, **LONG / SHORT SWITCH** prekidač za mijenjanje dužine emisionog impulsa, **RANGE SWITCH** prekidač za namještanje dometa radara, **RANGE SELECTOR SWITCH** prekidač za namještanje dometa radara, birač dometa radara, **SCALE INDICATOR** pokazivač dometa radara, **CALL RINGS** prekidač za uključivanje prstenova za mjerenje udaljenosti, **RANGE SELECTOR SWITCH** prekidač za uključivanje prstenova za mjerenje udaljenosti, birač prstenova za mjerenje udaljenosti, **FIXED RANGE RINGS** stalni prstenovi a područja djelovanja radara, **RANGE MARKER** daljinar, prekidač za mjerenje udaljenosti, **VARIABLE RANGE MARKER; VRM** promjenljiva daljinska kružnica (na radarskom pokazivaču), **TUNING CONTROL** kontrola prilagođavanja frekvencije kistrone emisijskoj frekvenciji magnetrona, namještanje frekvencije, kontrola za namještanje prijamnika, **EXPANDED CENTRE SWITCH** prekidač za određivanje vrijednosti napona vremenske baze, **DIMM** regulator osvjetljenja skale i mehaničkog smjerala, prigušivač osvjetljenja, **ELECTRONIC BEARING LINE; EBL** elektroničko smjeralo, **ELECTRONIC BEARING SWITCH; EBM** prekidač za uključivanje elektroničkog smjerala, prekidač za uključivanje elektroničkog kursora, **RX MONITOR** kontrola rada prijamnika, **TX MONITOR** kontrola rada predajnika, **SPEED SWITCH** prekidač za ručno unošenje brzine broda, **TIDE CORRECTION** kontrola za unošenje brzine i smjera morske struje, **PRESENTATION SWITCH** preklopka za izbor vrste rada (TRUE MOTION, RELATIVE MOTION - HEAD UP, RELATIVE MOTION - NORTH UP), **RESET** prekidač za prebacivanje u početni položaj (prije automatskog prenošenja), prekidač za resetiranje, **TRACKER BALL** kugla za upravljanje, **TRACKBALL / CURSOR PAD** kugla za upravljanje (kursorom), **POWER** uključivanje/isključivanje radara, napajanje radara, **ECONOMY** način rada radara sa štednjom energije, **A/C SEA (STC)** kontrola radara za otklanjanje smetnja od valova i mora, **RINGS** kontrola za prikaz i skrivanje kružnica udaljenosti, **OFFSET EBL** kontrola za premještanje elektroničkog smjerala na druge objekte, **PLOT** kontrola za ucrtavanje kretanja svih

radar controls - International Symbols for Radar Controls radar controls - International Symbols for Radar Controls

brodova/objekata u odnosu na vlastiti položaj, **INDEX LINES** kontrola / crta za držanje stalne udaljenosti između vlastitog broda i obalne linije (kopna) ili drugih brodova, **INTERFERENCE REJECTION** kontrola uređaja za uklanjanje međuradarskih smetnja, **GUARD ALARM** alarm zone oko broda, **HM OFF (heading mark OFF)** kontrola za uklanjanje prikaza pramčanice, **ECHO STRETCH** kontrola na radaru za izdužavanje manjih odraza / jeka, **NAV** kontrola na radaru za pokazivanje/skrivanje navigacijskih podataka, kontrola NAV

radar controls - International Symbols for Radar Controls *(n) (navig)*
grafičke oznake kontrole radara, međunarodni znakovi za upravljanje radarom

International Symbols for Radar Controls			
 anti-clutter rain minimum	 anti-clutter rain maximum	 anti-clutter sea minimum	 anti-clutter sea maximum
 scale illumination	 display brilliance	 range rings brilliance	 Variable range marker
 bearing marker	 transmitted power monitor	 transmit receive monitor	 off
 radar on	 radar stand-by	 aerial rotating	 north-up presentation
 ship's head up presentation	 heading marker alignment	 range selector	 short pulse
 long pulse	 tuning	 gain	

radar coverage (n) (comm, navig) **radarska pokrivenost**: QHM Harbour Control maintains radar coverage of the Eastern Solent including the Portsmouth Harbour Approach Channel.

radar detection (n) (navig) **radarsko otkrivanje**, **radarska detekcija**

radar display (n) (navig) **radarski pokazivač**, **pokazivač radara**, **radarski zaslon**,

radarski ekran, **jedinica prikaza**: The third officer monitored the starboard radar display, which he switched between the 3nm and 6nm range scales. **LCD radar display** (liquid crystal display)

LCD radarski pokazivač, **daylight bright CRT radar display** (cathode ray tube)

katodna cijev za upotrebu pri dnevnom svjetlu, **monitor the radar display closely**

pratiti radarski pokazivač pomno, **adjust the radar display** namjesrtiti radarski pokazivač: *The master ordered the helmsman to steer 319° and adjusted the port radar display to*

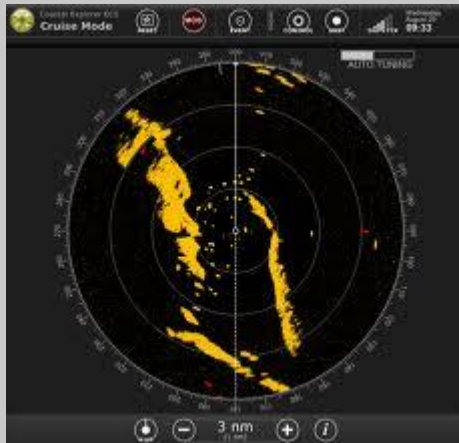

'north-up'.

radar display error

radar display stabilisation (n) (navig) stabilizacija radarske slike

radar duct (n) (electr, navig) valovod, radarski kanal, kanal radara

radar echo (n) (navig) Screen of a cathode-ray tube with an intensity-modulated and persistent radial display, which rotates in synchronism with a highly directional antenna **radarski odraz**,

radarska jeka, **jeka na radarskom zaslonu**, **signal u prijemu** (PPI is the most common type of radar display. The radar antenna is usually represented in the center of the display, so the distance from it and height above ground can be drawn as concentric circles. As the radar antenna rotates, a radial trace on the PPI sweeps in unison with it about the center point.)

radar equation /'reɪdɑː(r) ɪ,kweɪʒ(ə)n/ (n) (navig, electr) **jednadžba radara**

radarflare (n) (navig, safety) **signalna raketa s radarskim signalom**

radar gain (n) (navig) **osjetljivost radara**

radar horizon (n) (navig) **radarski horizont** *Due to refraction radar can see about 6% further*

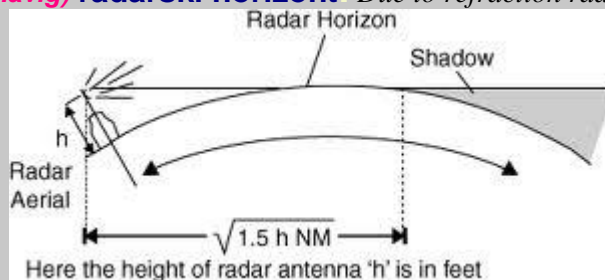

than we can see visually.

radar interference (n) (navig) **međuradarska smetnja (dvaju bliskih brodova)**,

radarska interferencija: *Mutual radar interference may occur in the vicinity of another shipborne radar operating in the same frequency band (9 GHz).*

radar logbook (n) (navig) **dnevnik radara**: *On the technical side, information recorded in the logbook includes: maintenance and repairs carried out, spares on board and their part numbers, technical and performance details and information concerning arcs of shadow and blind sectors. On the operational side, information recorded in the logbook includes: details of detection ranges for various types of targets and information concerning detection ranges of conspicuous objects.*

radar marker (RAdarMARKeR) /'reɪmɑːk/ (n) (navig) **radarska oznaka**

radar mast (n) (navig) **radarski jarbol**

radar navigation (n) (navig) Radar navigation uses radar to determine the distance from or bearing of objects whose position is known. This process is separate from radar's use as a collision avoidance system. [Bowditch 2001] **radarska navigacija**: Radar navigation is similar to traditional navigation in that you have to identify landmarks, measure their position relative to your own and use those measurements to establish a position on the chart. Radar fixing is often quicker than taking bearings with a magnetic compass and is a more professional technique than simply transferring a latitude and longitude from the GPS. 0 {Used primarily when the ship is within radar range of land.}

radar noise (n) (navig) radarske smetnje, radarski šum

radar plotting (n) (navig) radarskom plotiranje, radarsko ucrtavanje: If a risk of collision is developing a radar plot should be started or the target captured by the Automatic Radar Plotting Aid (ARPA). **inaccurate radar plotting** netočno radarsko plotiranje

radar position fixing (n) (navig) određivanje pozicije putem radara

radar presentation (n) (navig) radarski prikaz, radarska prezentacija

radar pulse (n) (electr, navig) radarski impuls: When radar pulses are transmitted the radar receiver is automatically tuned.

radar radar (n) (navig) podožna slika na radarskom ekranu

radar (Radio Detecting and Ranging) radar

radar (radio detecting and ranging) radar

radar range (n) (navig) domet radara, radarska udaljenost: The higher the scanner or target is above the surface, the longer the radar detection range. **measure the radar range to a target** izmjeriti udaljenost do nekog objekta radarom **measure the radar range**: The range to a target may be measured three ways: with the fixed range rings, with the cursor (if set to measure range and bearing), and with the VRM. , **radar range rings** kružnice udaljenosti, **high / low radar range** najveći / najmanji domet radara, **determine radar range** odrediti udaljenost objekta radarom. Radar determines the range to a target by measuring the amount of time required for a reflected echo to return to the scanner.

radar reach (n) (navig) radarsko pretraživanje, traženje radarom

radar receiver (RX) (n) (navig) radarski prijamnik, radarski prijemnik, prijamnik radara

radar receiver - technical specifications radarski prijamnik - tehničke osobine **Intermediate frequency (IF) (MHz)** međufrekvencija, **Short pulse** kratki impuls, **Medium/Long pulse** srednji/dugi impuls, **Noise figure (dB)** šum prijamnika (dB)

radar reflector (n) (navig) radar reflectors are fitted to vessels or navigational buoys or other charted features to improve their reflective properties so as to make them visible to searching radar.

radarski reflektor: The most common type of radar reflector is the octahedral reflector (8 corner

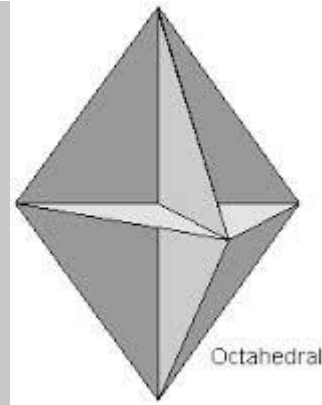

reflectors). **passive radar reflector** pasivni radarski reflektor

active radar reflector aktivni radarski reflektor: *There are two types of active radar reflectors or radar transponders which are used to assist the navigator to identify charted objects: racons and ramarks.*

radar repeater (n) (navig) radarski ponavljač

radar resolution (n) (navig, electr) radar's ability to distinctly display two radar targets which are close to each other **radarska razlučivost**, **rezolucija radara**, **radarska rezolucija**

radar scanner (n) (navig) **radarska antena**: *The scanner transmits the radio pulses and receives their reflected echoes. Most scanners rotate at a constant speed of 24 rpm. Many modern scanners rotate at variable speeds dependent upon the range in use in order to optimize radar detection.*

radar scanners - technical specifications (n) (navig, electr) **radarske antene - tehničke osobine** **beamwidth (to -3 dB) (degrees)** : **horizontal / vertical širina snopa u stupnjevima na 3dB**: **vodoravno / okomito**, **Sidelobe attenuation (dB)** **slabljenje bočnih latica**, **Gain (dB)** **osjetljivost**, **dobitak/jačina**, **Rotation rate (rpm)** **borej okretaja (o/min)**

radarscope (n) (navig) **područje obuhvaćeno radarskim ekranom**

radar service (n) (navig) **radarska služba**: *By using four radar scanner's, the port's radar service extends from the East Lepe buoy, Western Solent to No Mans Land Fort in the Eastern Solent.*

radar shadow (n) (navig) **radarska sjena**

radar simulation simuliranje pomaka navigacijske situacije u vremenu (Sušanj 2006) **radarska simulacija**, **simulacija (na ARPA radaru)**

radar simulator (n) (navig) **radarski simulator (na ARPA-i)**: *The simulator emulates a variety of the functionalities found in modern marine radar and provides control over traffic density, waterways, sea state and weather conditions.*

radar station (n) (navig) **radarska postaja / stanica**

radar surveillance (n) (navig) **radarski nadzor**

radar sweep (n) (navig, electr) **svijetla crta (na radaskom zaslonu)**, **svijetla zraka**
stolen radar sweep **preskočeni otklon svijetle crte**

radar system (n) (navig) **radarski uređaj**

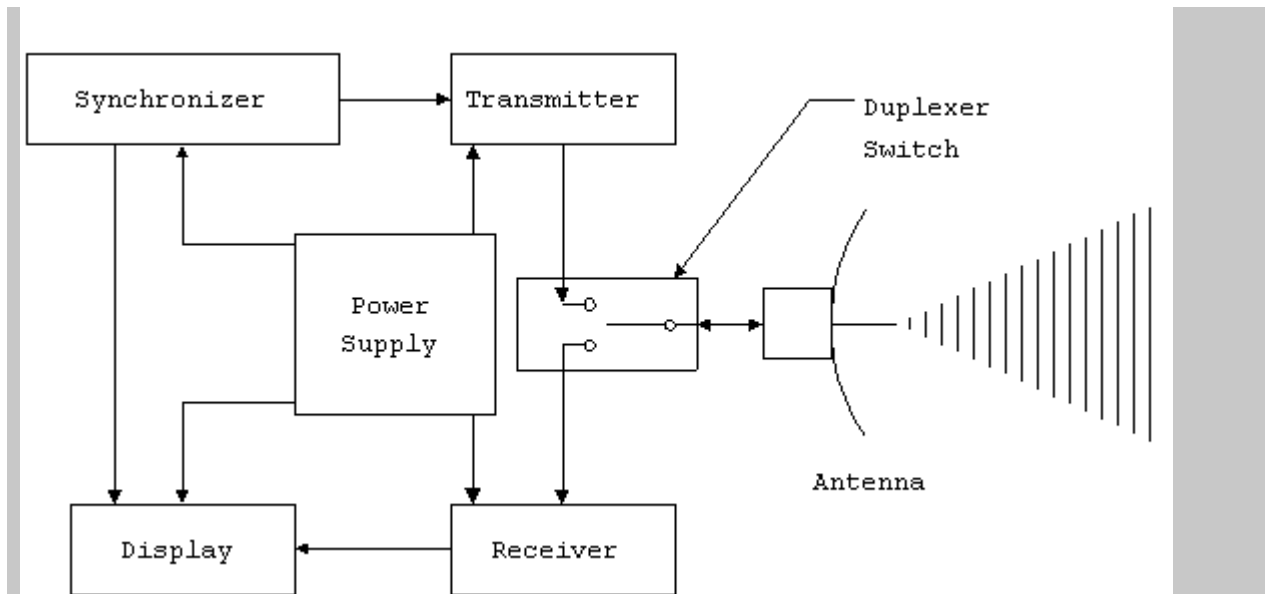

radar target (n) (navig) **radarski cilj** The OOW also noticed a number of radar targets following the south-west traffic lane of the TSS.

radar target enhancer (n) (navig, electr) **pojačalo radarskog signala**

radar transmitter - technical specifications (n) (navig, electr) **radarski**

predajnik, **radarski odašiljač** **Peak power (kW)** vršna snaga (kW), **Frequency (MHz)** frekvencija (MHz), **Pulse length** duljina impulsa, **Pulse repetition rate (Hz)** frekvencija ponavljanja impulsa (Hz)

radar transmitter (TX) (n) (navig) **predajnik radara** **radarski predajnik**

radar transponder (n) (navig) **radarski transponder**: A racon is a radar transponder commonly used to mark maritime navigational hazards and other navigation features.

radial beam (n) (nav arch) = **cant beam** **radijalna sponja**

radial frame (n) (nav arch) = **cant frame** **radijalno rebro**

radial frame **radijalo rebro**

radio /'reidiəʊ/ (v) (comm) **obavijestiti radijom**, **obavijestiti putem radija**

radioactive material (n) (cargo) **radioaktivne tvari** {klasa 7 opasnih tvari}

radiobeacon /'reidiəʊ,bi:kən/ (n) (navig) **electronic apparatus which transmit a radio signal for use in providing a mariner a line of position** **radiofar**, tal. **radiofaro**

radio cabin (n) (nav arch, comm) **radiokabina**, **kabina s radiouređajem**

radio communication (n) (comm) **radiokomunikacija**

radio console (n) (comm) **radiopult**, **radio-konzola**

radio coverage **područje pokriveno dometom radiopostaje / radiostanice**

radio department (n) (mar law) **služba veze**

radio direction finder (RDF) (n) (navig) **radiogoniometar**

radio forecast (n) (meteorol) **radijska vremenska prognoza**

radio frequencies **radijske frekvencije** **band 4 very low**, **band 5 low**, **band 6 medium**, **band 7 high**, **band 8 very high**, **band 9 ultra high**, **band 10 super high**, **band 11 extra high**

radio frequency head (n) (*electr, navig*) frekvencijska glava (radara)

radiofrequency; (r.f.; rf; RF) (n) (*electr*) radiofrekvencija

radiolocator radiolokato

radio log (n) (*comm*) radijski dnevnik

radio medical advice (n) (*med*) radioliječnički savjet

radio navigation (n) (*navig*) Radio navigation uses radio waves to determine position by either radio direction finding systems or hyperbolic systems, such as Decca, Omega and LORAN-C. Replaced recently by GPS. **radionavigacija**

radio navigational warnings (n) (*navig*) NAVAREA Warnings; Coastal Warnings; Local Warnings **radijska upozoravanja za plovidbu**

radio-officer a person holding an appropriate certificate issued or recognized by the Administration under the provisions of the Radio Regulations (STCW 2010) **radio-časnik, radio-oficir, časnik**

radiotelekomunikacija, radiotelegrafist, markoni, tal. marconista

radio operator (n) (*comm*) dežurni radiočasnik, časnik koji koristi radiostanicu, radiotelegrafist

radio receiver (n) (*comm*) radijski prijamnik

radio-room (n) (*nav arch*) radiokabina

radiotelegraphy (W/T) radiotelegrafija

radiotelephone (n) (*comm, navig*) radiotelefon

radiotelephone installation (n) (*comm*) radiotelefonski uređaj

radiotelephony (R/T) (n) (*comm, navig*) radiotelefonija

radio transmitter (n) (*comm*) radijski predajnik

raft /ra:ft/ (n) (*nav arch*) splav, tal. *zattera*

rafting bočno privezivanje dvaju brodova (na sidrištu ili vezu)

rafting alongside (n) (*boating/yachting*) grupni bočni vez

rafting on a buoy (n) (*boating/yachting*) grupni vez na plutači

rag (n) (*cargo*) krpa

rail (n) (*nav arch*) brodska ograda **ship's rail** brodska ograda

rail car (n) (*cargo handling*) = **wagon** vagon

rail connection (n) (*ports*) željeznička veza

rail flatcar (n) (*cargo handling*) vagon za kontejnere, Truck trailers are loaded with goods, driven to a rail yard, and transferred to a rail flatcar.

railhead /ˈreɪl, hɛd/ (n) (*ports*) location for loading and unloading containers at railroad terminal
mjesto za ukrcaj i iskrcaj kontejnera na željezničkom terminalu

railroad car (n) (*cargo handling, US*) vagon, željeznički vagon

railway bar (n) (*cargo*) željezničke šine

railway-ties (n) (*US*) (*cargo*) željeznički pragovi

rail yard (n) (*shipping econ*) teretni kolodvor



rainbow wrasse /ræs/ (n) (fishing) Lat. Coris julis **knez**

hr. nazivi: zastava, dundica, dunnela, frajljica, marijeta, šegavka, vladika, dugnača, kinez, kralj, zlatac, žotra; lat. CORIS JULIS} {drugi

rain clutter (n) (navig) smetnje (na radarskoj slici) zbog kiše **suppress the rain clutter** smanjiti smetnje zbog kiše, **ukloniti smetnje zbog kiše** *Rain clutter can be*

suppressed by adjusting the A/C RAIN and GAIN controls., **rain clutter adjustment** namještanje

zaštite od smetnja zbog kiše, **rain clutter control** kontrola za

uklanjanje/smanjivanje smetnja od kiše i padalina {clutter caused by rain, snow, hail - kiša, snijeg, tuča}

rainstorm (n) (meteorol) kišna oluja, oluja s kišom

raise /reiz/ (v) 1 a podići; 2 povisiti, povećati

raise (n) povišenje, povećanje, porast **raise in temperature** povećanje temperature

raise the anchor (v) (boating/yachting) **ANTONYM lower the anchor** podizati sidro

raising of sunken objects /'reiziŋ/ (n) (mar ins) vađenje plovnih objekata, zrakoplova, njihovih dijelova i tereta te svih drugih stvari koje su potonule u obalnome moru ili unutrašnjim vodama određene države **vađenje potopljenih stvari**

rake /reik/ (n) (nav arch) the fore and aft inclination from the vertical of a mast, smokestack, stempost, etc. **kosina pramca, nagib pramca**

rake /reik/ (n) (boating/yachting) nagib jarbola (prema natrag ili naprijed)

rake (v) (boating/yachting) nagnuti jarbol (prema natrag ili naprijed)

raked /reikt/ (adj) kos, nagnut

rake of mast /reik/ (n) (boating/yachting) nagib jarbola

ram /ræm/ 1 (n) (marine eng) klip, klip hidrauličke pumpe **hydraulic ram** hidraulički klip; 2 hidraulička dizalica

ramark; (RADAR MARKER) /'reima:k/ (n) (navig) (navig) the RAMARK is a Radar beacon which transmits pulses continuously or to special time schedules, rather than on receipt of a vessel's radar pulse. They **radarska oznaka tipa ramark, radarski far tipa ramark, obični radarski far**

ram horns (n) (boating/yachting) kuke na deblenjaku (za hvatanje očice prednjeg roglja pri kraćenju jedra)

ramp /ræmp/ (n) (nav arch) rampa, ukrcajna kosina **bow ramp** pramčana rampa, **stern ramp** krmena rampa, **slewing zakretna rampa, side ramp** bočna rampa, **hoistable ramp** podizna rampa, rampa na podizanje, **ramp door** vrata rampe: *ramp, uneven*

tightening of the chain blocks could impose high torsional loads on the hinges and in turn, compromise the effective sealing of the ramp door against the hull., **stern quarter ramp** bočna krmena vrata,

vrata na kvartiru: 200850 Ramp door near miss During her maiden voyage, the CO of a new ro-ro ship was preparing to set the **stern quarter ramp door** for cargo operations., **hoist the ramp**

podignuti rampu: *ving the winch control lever to 'full hoist', the winch responded by gradually slowing down in its rotation, stopped briefly and then slowly began to hoist the ramp inwards.*



range (n) 1 (navig) doimet dohvat, doseg out of range izvan dometa, at a close range na malom dometu, na maloj udaljenosti: *Consequently, when suddenly faced with another vessel at close range, many ships would be unable to avoid a collision by just stopping.*

measure radar range izmjeriti doimet radara, select thge range of the radar

odabрати doimet radara *For coastal navigation you might select a range of 6 or 12 miles so that appropriate coastal features will be displayed, for collision avoidance a range of 12 miles or 24 miles may be appropriate, for pilotage into a confined anchorage a range of 1/2 a mile may be needed.*

range accuracy preciznost udaljenosti izmjerene radarom: *While radar range accuracy is high radar bearing accuracy is low when compared with visual observations.*

be at a range of ... biti na udaljenosti od ...: *From the target's AIS data shown on the port radar display, the OOW saw that the vessel was at a range of 3.9nm and had a CPA of 0.1nm.*; **2 raspon, opseg range of output raspon dobave (goriva); 3 (electr, navig) $D = 1/2 \times cT$; (c = Speed of Radio Pulse (3 x 10⁸ m/sec); T = Time between transmission of radio pulse and reception of reflected echo; D = Distance**

udaljenost objekta (izmjerena radarom) determine range odrediti udaljenost izmjeriti udaljenost nekog objekta, range scale udaljenost na radarskom pokazivaču, kružnica udaljenosti na radarskom pokazivaču

range discrimination (n) (navig) razlikovanje objekata / ciljeva na istoj ili bliskoj daljenosti (na radaru), odvajanje objekata / ciljeva na istoj ili bliskoj udaljenosti (na radaru)

rangefinder (n) (navig) daljinomjer, instrument za određivanje udaljenosti untrasonic rangefinder ultrazvučni daljinomjer

range lights (n) (navig) = leading lights A pair of lights or day marks deliberately placed to mark a narrow channel. **pokriveni smjer, svjetla pokrivenog smjera**

range of movement (n) (cargo handling) dužina kretanja dizalice duž obale

range resolution (n) (navig) COMPARE bearing resolution **razdvajanje ciljeva (na radaru) prema udaljenosti**

range ring (n) (navig) COMPARE Variable Range Marker; (VRM) kružnica udaljenosti (na radarskom zaslonu), kalibracijski prsten: *The range selected automatically determines the range ring interval, the number of range rings and pulse repetition rate.*

fixed range ring fiksna kružnica udaljenosti, **nepromjenjiva kružnica, variable range ring** promjenjiva kružnica udaljenosti

range scale (n) (navig) ljestvica udaljenosti (na radarskom ekranu) choose the

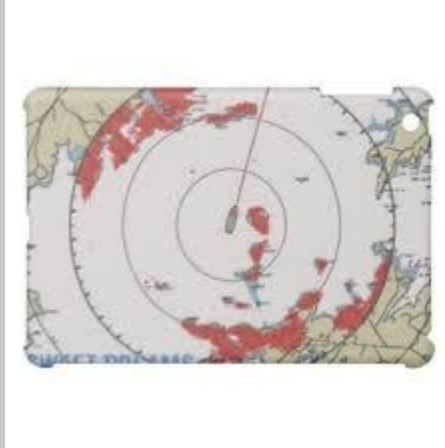

range scale odabrati kružnicu udaljenosti

range strobe daljinar (na radaru), naprava za radarsko snimanje udaljenosti

rank /ræŋk/ 1 čin **naval rank** COMPARE **naval rank** mornarički čin; 2 rang (na brodu), časnički rang

ransom /ˈrænsəm/ (n) (mar law) otkupnina (za oteti brod, posadu itd.): *the pirates raked in an estimated ... million dollars in ransoms last year* Pirati su prošle godine stekli oko ... milijuna dolara na ime otkupnina **pay a ransom** platiti otkupninu

rap (n) (fishing) varalica, varalica **rapala**, rapala

rapala (n) (fishing) varalica, varalica **rapala**, rapala, **wobler**, teturavac {eponim za varalicu finske proizvodnje Rapala (<http://www.podvodni.hr/ribolov/udicarenje/s-obale/1293-varalica-vobler-ili-opce-prihvacena-rapala>); na mnogim dijelovima Jadrana Rapalom nazivaju sve varalice sa stabilizatorom bez obzira pod kojim se nazivom prodaju (<https://ribolovnajadrano.hr/ribicki-leksikon/>)}

rapid bell ringing (n) (navig) brzo zvonjenje

raster chart /ˈræstə/ (n) (navig) skenirana elektronička verzija papirnate pomorske karte; A raster chart (RNC) is a direct copy or scan of an existing paper chart **rasterska karta**



rasterscan display (n) (navig) radarski pokazivač s rasterom: *On a raster scan display the brilliance control regulates the brightness of the picture, making it bright enough for daylight viewing or dim enough so as not to impair the operators night vision.*

ratchet /ˈrætfɪt/ (n) (marine eng) zupčasti kotačić s rasprom, ozubljena ustavljača

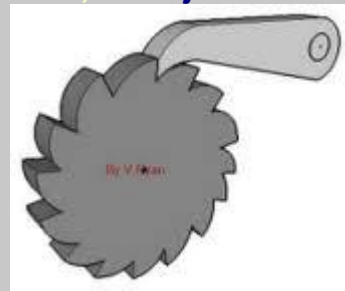

ratchet ring spanner zupčasti ključ, zaustavni ključ

ratchet block (n) (boating/yachting) kolotura sa zupčastim zaporom

ratcheting mechanism (n) (marine eng) zaporna naprava, zaustavni mehanizam {užnica se okreće samo u jednom smjeru}

ratchet ring spanner (n) (marine eng) zupčasti prstenasti ključ, zupčasti okrugli ključ, zaustavni okrugli ljuč **reversible ratchet ring spanner** reverzibilni prstenasti ključ

rate 1 iznos; 2 kapacitet, učin, brzina **discharge rate** (cargo handling) kapacitet iskrcaja, brzina iskrcaja (npr. tona na sat), iskrcajni učin, **rate of fuel supply** (marine eng) omjer dobave goriva, **rate of wearing** stopa trošenja, **flow rate** brzina protoka, **maximum loading and unloading rates** maksimalni kapaciteti ukrcanja i iskrcaja tereta (npr. u tonama na sat); 3 (shipping econ, mar law) vozarinski stav; 4 (shipping econ, mar law) iznos najamnine broda

rate (n) (shipping econ, mar law) vozarinski stav, vozarina **rate changes** promjene vozarine, **set the rate** odrediti vozarinu

rate agreement (n) (shipping econ, mar law) Group of carriers who discuss rates and common problems with options to file independent tariffs.

(<http://www.maerskline.com/en-jm/help/shipping-glossary>) **vozarinski sporazum među brodarima**

rated power (n) (marine eng) indicirana snaga

rate of discharge (n) (cargo handling) kapacite iskrcaja, brzina iskrcaja

rate of loading (n) (cargo handling) kapacitet ukrcanja, brzina iskrcaja

rate of pay (n) (mar law) iznosi plaće (pomorca), platni razredi

rate of turn (n) 1 broj stupnjeva promjene smjera; 2 (navig) brzina okretanja (kod žiroskopskog kompasa) **rate of turn indicator** pokazivač brzine okretanja

rate of turn; (ROT) (n) (navig) brzina zagreta broda

rat guard (n) (nav arch) a dish or circular piece of metal made in two parts and fitted closely on hawsers and lines to prevent rats boarding or leaving a ship while at a dock or wharf **mišobran**,



paratopi

ratify (v) (mar law) **ratificirati ratify the convention** 1 **ratificirati konvenciju** The IMO's International Convention for the Control and Management of Ships' Ballast Water and Sediments (BWMC) **has been ratified** and will enter into force in 12 months' time; 2: The International Convention for the Safety of Life at Sea, which governs ship construction, **was ratified** by most maritime nations in 1936, and updated in 1948, and again in 1960 and 1974.

rating /'reitɪŋ/ (n) (mar law) a member of the ship's crew other than the master or an officer **mornar**, član posade, tal. **bassa forza; marinaio**

rating /'reitɪŋ/ (n) (marine eng) snaga stroja **maximum continous rating** maksimalna

kontinuirana snaga **exceed the maximum operating rating** prekoračiti maksimalnu radnu snagu

rating forming part of a watch (n) (navig, safety, mar law) član posade koji čini dio straže

ratio /ˈreɪʃi.əʊ/ (n) (marine eng) omjer **compression ratio** omjer kompresije

ration /ˈræʃən/ (n) (safety) racionirani obrok

raw materials /rɔː/ (n) (cargo) sirovine

raw picture (n) (navig) **sirova slika** (na radaru), računalno neobrađena slika

raw water filter (n) (boating/yachting, marine eng) = **seawater filter** filter vode za hlađenje motora



ray (n) (fishing) Lat. Rajidae **raža, kamenica**
{lat. batoidea}

rayed Mediterranean limpet (n) (fishing) priljepak, prilipak

RCDS mode; Raster Chart Display System mode rasterski način rada

RCS; radar cross section (n) (navig) radarska površina

RCU; Relative Course Up Picture (n) (navig) relativna slika s korsom prema gore, slika RCU

RDS; residual dynamic stability (n) (stabil) preostala dinamička stabilnost

Re. /ri:/ (n) = **reference** veza (u dopisivanju)

reach (v) 1 stići, prispjeti, doseći, dospjeti (do), doći (do) **reach full speed** postići punu brzinu, razviti punu brzinu, **reach the port** stići u luku, doći do luke; 2

(boating/yachting) **COMPARE point of sail** sail from about 60° to about 160° off the wind jedriti s vjetrom u bok ili pola krme, jedriti *mezonave*

reach² (n) (geogr) ravni dio toka rijeke **upper reach** gornji tok, **lower reach** doljnji tok

reaching (boating/yachting) jedrenje s vjetrom u bok ili pola krme, jedrenje s bočnim vjetrom **broad reaching** jedrenje s vjetrom u pola krme, jedrenje široko u vjetar, **beam reaching** jedrenje s bočnim vjetrom {Reaching consists of close reaching (about 60° to 80°), beam reaching (about 90°) and broad reaching (about 120° to 160°) (<http://www.nauticed.org/>)}

reaching (n) (boating/yachting) otpadanje kontroliranim zakretanjem pramca više niz vjetar od postojećega kursa **namjerno otpadanje, pojanje, pojada**

read (v) 1 očitati (vrijednost); 2 (comm) čuti **How do you read?** Kako me čujete?

readiness /ˈrɛdɪnis/ (n) (safety) spremnost: *the main engine was in a state of readiness for manoeuvring*

reading /ˈriːdɪŋ/ očitavanje (vrijednosti, mjerila itd.), očitana vrijednost **log readings** očitavanja u dnevniku

readings /ˈriːdɪŋz/ (n) **take temperature readings** očitati temperature (marine eng) očitavanje, očitane vrijednosti, rezultat očitavanja **take the readings of** očitati, očitavati

ready (v) 1 spreman, pripravan **make ready**, pripremiti

Ready about. (n) (boating/yachting) Spremni za okret!, Spremni za letanje!, Tal. **Pronti a virare!** {upozorenje posadi prije okretanja jedrilice}

realise (v) (navig) shvatiti: *At this point, the OOW realised that the vessel was aground.*

real property rights (n) (mar law) = **proprietary rights** stvarna prava na brodu

real rights (n) (mar law) stvarna prava

real wind (n) (boating/yachting) smjer i jačina vjetera na određenome mjestu i u određeno vrijeme stvarni vjetar

reanimation (n) (med) reanimacija

rear /riə/ (adj, n) **rear end** stražnji / krmeni dio broda **stražnji dio (broda)**

rear admiral /riə/ kontra-admiral

reason razlog **give reasons for** obrazložiti, objasniti, **by reason of** zbog, uslijed, **the reason why** razlog zašto

reasonably (adv) (mar law) razborito

rebate /ˈriːbeɪt/ (n) (shipping econ) popust, rabat **contract rebate** ugovorni rabat

rebound (n) (shipping econ) skok (vozarine, najamnine): *Short-lived rebounds of rates will bring occasional relief to the market.*

rebuttal /riˈbʌtəl/ (n) (shipping econ, mar law) an act of refuting or disproving sth, esp by offering a contrary contention or argument **odbijanje (tražbine), neprihvatanje tražbine**: *If the claim is declined, and the claimant feels it should have been paid, the claimant should present his rebuttal in letter form to the examiner who declined it.*

recall (n) (boating/yachting) opoziv (regate), tal. **richiamo**

receipt /riˈsiːt/ (n) 1 (shipping econ) primitak (tereta), prijam, prijem; 2 (shipping econ, mar law) potvrda primitka, časnička potvrda **clean receipt** čista potvrda o primitku tereta, **draw up a receipt** sastaviti potvrdu o primitku tereta, sastaviti časničku potvrdu, **issue a receipt** izdati časničku potvrdu, izdati potvrdu o primitku tereta,

sign the **receipt** potpisati časničku potvrdu, potpisati potvrdu o primitku tereta; 3 potvrda, priznanica

Received. (comm) Razumio., Primio. {In line with IMO SMCP (2001), Received, Affirmative or Understood is to be used instead of Roger}

received bill of lading (n) (mar law, shipping econ) Can be issued on the carrier's actual receipt or taking custody of goods, if requested goods are not yet necessarily loaded on board a vessel or other conveyance. (<http://www.maerskline.com/en-jm/help/shipping-glossary>) teretnica primljeno na ukrcaj

received (for shipment) bill of lading (n) (mar law) = **received bill of lading**
A bill of lading issued when goods have been received for shipment by a carrier or his agent but have not yet been loaded aboard the ship. (Tetley) teretnica primljeno na ukrcaj

receiver (n) (marine eng) spremnik, sabirna komora, sabirnik tekućine, spremnik zraka za ispiranje, spremnik zraka za upućivanje, boca zraka za upućivanje **charge air receiver** sabirna komora zraka za ispiranje

receiver (n) (electr) (comm) prijammnik, prijemnik

receiver (n) (mar law, shipping econ) = **consignee** primatelj tereta

receiver (n) (electr, navig) radarski prijammnik

Receiver of Wreck (n) (safety) Službenik za prijavu pomorskih nezgoda / nesreća / brodoloma

receiver sensitivity (n) (navig, electr) osjetljivost prijammnika (radara)

receiving point (n) (navig) točka prihvata (u VTS-u)

receptacle /rɪˈsɛptəkəl/ (n) 1 (marine eng) spremnik, kutija: All battery containers /receptacles should be checked for tightness of fixtures and overall integrity.; 2 (electr) utičnica **AC receptacle** utičnica za iznjeničnu struju, **DC receptacle** utočnica za istosmjernu struju

reception (n) 1 prihvaćanje (otpada, ulja, ...); 2 preuzimanje

recessed /riːsɛst/ (adj) (marine eng) udubljen, produbljen

reciprocal course (n) (nav arch) nasuprotni kurs: Container vessel 'A' was on a reciprocal course in the lane on our port side. He set his heading on a reciprocal course to the tug at near full speed in the expectation that the tug would take avoiding action to prevent a head on situation as defined by the Collision Regulations.

reciprocating engine /riˈsɪprəˌkeɪtɪŋ/ (n) (marine eng) stapni stroj

recirculate (v) (marine eng) recirkulirati, kolati u zatvorenom krugu

recklessly (adv) bezobzirno

recklessly and with knowledge (mar law) bezobzirno i sa sviješću / znanjem

reckoning /ˈrɛkənɪŋ/ (n) (navig) računanje, procjena (pozicije) **dead reckoning** zbrojena navigacija

reclaim /riːˈkleɪm/ (v) (ports) nasipati, nasipavati: The Western docks were reclaimed from the sea and developed in the 1920s.

reclaiming nasipavanje (mora, obale)

reclamation /ˌrɛkleɪˈmeɪʃən/ (n) (ports) nasipavanje (mora) **land reclamation** nasipavanje obale

recommend (v) preporučiti

recommendation (n) preporuka

recompression chamber (n) (boating/yachting, fishing) a hyperbaric treatment chamber used to treat divers suffering from certain diving disorders such as decompression sickness

barokomora

recondition (v) obnoviti, ponovno osposobiti, ponovno dovesti u ispravno stanje (uređaj, ambalažu tereta)

reconditioning (n) (cargo) obnova (pakovanja tereta)

reconnaissance aircraft (n) (safety) izviđački avion

reconstruct (v) ponovno izgraditi, ponovno sastaviti

recooper /ri'ku:pe/ (v) (cargo) popraviti (bačvu, ambalažu sanduka itd.)

record¹ /'rɛkɔ:d/ (n) 1 a (mar law, shipping econ) zapis **keep a record of** 1 voditi

evidenciju o, voditi zabilježbe o; 2: *In the case of damage to a cargo on board, it is vital that all the facts are recorded and documented,* **make a record** zabilježiti, unijeti zapis; 2 podatak, zabilješka

record² /ri'kɔ:d/ (v) 1 a bilježiti, zabilježiti, zapisati, Record in the log book

inspections of cargo holds undertaken by the ship's officers or crew during the

voyage.; 2 snimati: *Weather, VHF communications, Radar and CCTV, are recorded and can be archived for later use in investigations.*

record book (n) 1 registar, upisna knjiga, upisnik; 2 (marine eng) dnevnik (ulja itd.)

oil **record book** dnevnik ulja

recorder /ri'kɔ:də/ (n) snimač, snimalica

records /'rɛkɔ:d/ (n) 1 podaci **bunker sounding records** podaci o mjerenju kaljuža a

evidencija **maintain proper records of** voditi ispravnu evidenciju

recount /ri'kaunt/ (n) (cargo) ponovno brojanje (tereta)

recover (v) 1 izvući (potonuli brod / stvari) iz mora **recover the sunken ship** izvući

brod s dna, podići brod s dna, **recover the buoy** izvući plutaču s dna; 2 (marine eng,

cargo) obnoviti, vratiti u prethodno stanje, regenerirati; 3 **ANTONYM let go**

podignuti sidro: *The port anchor was recovered and, at 1104, the vessel docked at the berth at the*

Container Terminal lijevo je sidro bilo podignuto i u 11:04 brod je pristao uz vez na kontejnerskom

terminalu; 4 (fishing) **podići mrežu, podići ribarski alat**: *The skipper was operating the vessel*

single-handedly and was attempting to recover his dredge gear on board when the accident happened.; 5

spasiti (brodolomce): *The skipper was recovered from the sea.;* 6, **izvući osobu**

helikopterom s broda: *Sector New Orleans directed the launch of an MH-65 Dolphin helicopter*

crew from Coast Guard Air Station New Orleans to recover the man

recover² (v) 1 obnoviti; 2 (shipping econ) naplatiti **recover the monies** 1 naplatiti; 2

ishodovati plaćanje; 3 utjerati naplatu

recover³ (v) (cargo handling, shipping econ) pronaći (nestali teret, kontejner), ući u trag

(teretu, kontejneru): *Based on our experience, we believe that most of our containers will be recovered soon.*

recovery (n) (boating/yachting) 1 spašavanje (čovjeka/osobe iz mora),

izvlačenje osobe iz mora, podizanje osobe iz mora **recovery manoeuvre** manovra

spašavanja osobe u moru; 2 (mar ins) vađenje potopljenih stvari (brodova itd.)

recovery (n) (boating/yachting) izvlačenje jedrilice iz mora (na prikolicu)

recovery (n) (cargo handling, shipping econ) pronalaženje (nestalog tereta,

kontejnera): *Our units on lease to the shipping company were manufactured in our colour, with our logo and markings, which should assist with recovery and re-leasing efforts.*

recovery (n) (med, safety) oporavak: *The deckhand was taken to hospital, where he made a full recovery and was discharged the following day.*

recreational boat (n) (nav arch) brodica za razonodu

rectify /ˈrɛktɪˌfaɪ/ (v) ispraviti, popraviti: *identify and rectify the fault in the scavenge system* pronaći i otkloniti defekt / neispravnost / kvar u sustavu za ispiranje

recycle /riːˈsaɪkəl/ (v) 1 reciklirati; 2 (nav arch) poslati brod u rezalište: *The old aircraft carrier will be recycled after 32 years of service.*

recycling yard (n) (nav arch) rezalište brodova ship recycling yard rezalište brodova

re-delivery (n) (mar law) vraćanje broda (iz čartera), predaja broda vlasniku (iznajmitelju) po istjeku ugovora o najmu (čartera)

red lead /ˈred led/ (n) (seamanship) minij

red mullet (n) (fishing) trlja blatarica, trilja striped red mullet trlja, trilja {lat. *Mullus barbatus*}

red pandora (n) (fishing) COMPARE common pandora arbun (sjevernoafrički Atlantik)

red porgy (n) (fishing) Lat. *Pagrus pagrus* pagar, It. *pagro*



red scorpionfish (n) = scorpion fish škrpina

red sea bream (n) (fishing) COMPARE blackspot sea bream rumenac okan

red snapper (n) (fishing) atlanski arbun Northern red snapper atlanski arbun {lat. *Lutjanidae*}

reduce (v) smanjiti, sniziti, reducirati reduce speed smanjiti brzinu

reduced navigation zbrojena navigacija

reduction gear (n) (marine eng) an arrangement of shafts and gears used so that the number of



revolutions of the output shaft is less than of the input shaft **reduktor**

reduction gearbox (n) (marine eng) **redukcioni zupčani prijenosnik, reduktor**

redwood /'red,wʊd/ (n) (cargo) **sekvoja**

reef /ri:f/ (n) (navig, mar law) rock or coral, possibly only revealed at low tide, shallow enough that the vessel will at least touch if not go aground **greben, hrid, tal. scogliera**: *The tug ran aground just after 2 a.m. Tuesday on a reef at the entrance to Sea Forth Channel.*

reef /ri:f/ (v) (boating/yachting) to reduce the area of a sail by making fast the reef points **kratiti jedro, skratiti jedro, tal. terzarolare reefing the dinghy skraćivanje jedara na**

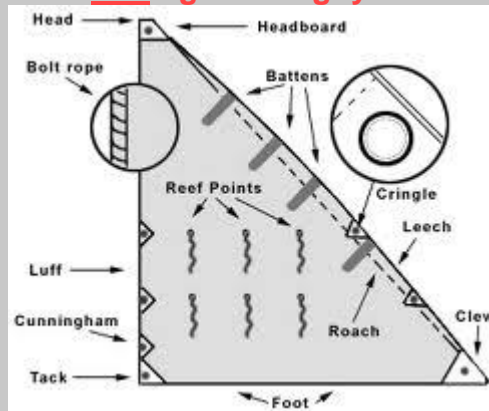

jedrilici, reef sail kratiti jedro

reef (n) (boating/yachting) horizontal part of a sail which can be folded in order to reduce the sail surface **krat (jedra), trcarol; tal. terzarolo first reef prvi krat, second reef drugi krat**

reef /ri:f/ (n) (mar law) **greben (u međunar. pravu mora)**: *In the case of islands situated on atolls or of islands having fringing reefs, the baseline for measuring the breadth of the territorial sea is the seaward low-water line of the reef, as shown by the appropriate symbol on charts officially recognized by the coastal State. (UNCLOS)*

reef band (n) (US) **ruka krata jedra, tal. mano di terzarola**

reefed sail (n) (boating/yachting) **skraćeno jedro**

reefer /ri:fe/ (n) **1 (nav arch) = reefer ship = refrigerated cargo ship**

brod-hladnjača; 2 (cargo) Reefers are refrigerated shipping containers typically used to transport cargo requiring temperature-controlled conditions such as vegetables, fruit, fish, protein or other commodities

(<http://www.maerskline.com/en-us/shipping-services/about-reefer-cargo/about-reefer-cargo/overview>)

hlađeni kontejner reefer container hlađeni kontejner, kontejner-hladnjača: *The unique design of Maersk Line's reefer containers ensure maximized payload, reduced CO2 emissions, optimal product temperature and reduced energy consumption*

reefer cargoes (n) (cargo) **hlađeni tereti**

reefer container (n) (cargo) a container that is used to transport perishable cargo and has its own, self-powered system to keep it cool **hlađeni kontejner**

reefer plugs (n) (cargo handling, nav arch) utičnice / priključci za hlađene kontejnere, frigo-priključci

reefer point priključak / utičnica za hlađene kontejnere: *The terminal is equipped with a bank of reefer/heater points.*

reefer ship brod-hladnjača

reef hook (n) (boating/yachting) kuka na deblenjaku za hvatanje krata jedra

reefing /ri:fiŋ/ (n) (boating/yachting) skraćivanje jedara **mainsail slab reefing** skraćivanje zatezanjem pritega deblenjaka istražnjeg ruba jedra, **roller reefing** skraćivanje namatanjem (prečke oko prednjeg leta), skraćivanje rolanjem, **in-mast roller reefing** skraćivanje glavnog jedra umatanjem jedra u jarbol, skraćivanje rolanjem u jarbol

reefing hook (n) (boating/yachting) kuka za kraćenje jedra {na vratnom okovu buma i jarbola}

reef knot /ri:f/ (n) (seamanship) muški uzao

reef points /ri:f/ (n) (boating/yachting) vezice krata jedra

reef's tack (n) (boating/yachting) prednji rogalj krata jedra

reel /ri:l/ (n) (cargo) svitak, kotur, rola, kalem **cable reel** (cargo) svitak kabela, **kabelska rola**: *Cable reel deck cargo broke loose.* Otkinuo se teret kablovske role na palubi.



reel (n) (fishing) A mechanical device for holding and spooling fishing line. Reels have a line spool, brake to slow running fish, handle to retrieve line and foot for clamping to a rod. **rola ribarskog štapa spinning reel** rola za namatanje najlona, **jigging reel** rola za skosanje, **fishing reel** rola ribarskog štapa {Reel styles include CASTING (revolving spool), SPINNING (line coiling off stationary spool); SPINCAST, (like spinning but with a nose cone), and FLY (storing thick fly line/backing and to fight big fish).}

reel (v) (seamanship) namatati (konop), namotavati, tal. *avvolgere*

reeled paper (cargo) papir u svicima / rolama

reeve (v) (seamanship) to pass the end of a rope through any lead such as a sheave or fair **provući** (uže kroz otvor, užnicu kolotura itd.) {past tense: *rove*}

Ref. = reference veza, predmet dopisa, poziv na (dopis, mail, teleks, faks itd.)

Ref. your letter dated May 11th veza Vaš dopis of 11. svibnja, poziv na Vaš dopis of 11. svibnja, u vezi s Vašim dopisom od 11. svibnja ...

reference /ˈrɛfərəns/ (n) 1 odnos, obzir **with reference to** u odnosu na, u vezi s, s

obzirom na; **2** veza (u dopisivanju), predmet (pisma, e-maila, faksa) **Your reference** Veza - vaš dopis od, with **reference to your letter dated ...** u vezi s Vašim dopisom od ..., Veza: Vaš dopis od ...

reference books /ˈrɛfərəns/ (n) (navig) navigacijski priručnici, navigacijske knjige

reference line /ˈrɛfərəns/ (n) (navig) linija odvajanja (na radarskom ekranu koja odvaja brodove u dolasku i odlasku)

reference rate (n) (shipping econ) = **flat rate** referentna vozarina, standardna vozarina (za obračun drugih vozarina u Worldscale-u)

reference source /ˈrɛfərəns/ referentni izvor, referentna točka, polazna točka (za uspoređivanje, računanje)

refit /ri:'fit/ (v) (marine eng) onboviti, popraviti

reflection /rɪ'flekʃən/ (n) (electr, navig) **COMPARE scattering** odbijanje (energije, elektromagnetskih valova)

refloat /,ri:'fleʊt/ (v) (safety) odsukati (se), odsukati brod, tal. **disincagliare**: *The vessel was refloated on the next rising tide using her own power. The passenger cruise ship Saint Laurent has been safely refloated and removed from the Eisenhower Lock chamber in the Saint Lawrence Seaway following Thursday's allision with a bumper The container ship was refloated in the early morning on Sunday and moved to deeper waters so as to be inspected for damages. A tug was promptly called and with the rising tide the vessel was quickly re-floated and properly berthed.*

refraction /rɪ'frækʃən/ (n) **1** (electr) **COMPARE reflection** Refraction occurs because both light and radar waves are subject to downward bending as they pass through the atmosphere, the amount of bending being greater for longer wavelengths. **lom elektromagnetskog vala**,

refrakcija: *Radar waves are longer than light waves, so bending due to refraction will be greater, resulting in the radar horizon lying beyond the visible horizon.*

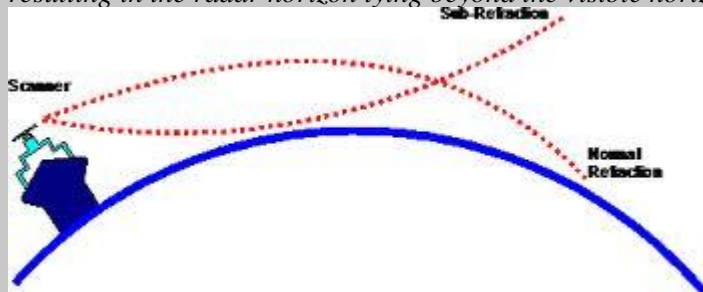

; **2** (meteorol) the bending of light as it passes through areas of different density, such as from air through ice crystals **refrakcija**

refrigerant /ri'frɪdʒərənt/ (n) (marine eng) rashladno sredstvo (tekućina ili plin)

refrigerated accommodation /ri'frɪdʒə,reit/ rashladni prostor (na brodu, u luci), rashladna skladišta (u luci), frižideri

refrigerated cargoes /ri'frɪdʒə,reit/ (n) (cargo) = **reefer cargoes** hladeni tereti:

Written instructions should always be obtained from the shipper prior to loading refrigerated cargo.

refrigerated cargo ship /ri'frɪdʒə,reit/ (n) (nav arch) brod za rashlađeni teret

refrigerated container (n) (cargo) = **reefer** hladeni kontejner: *Refrigerated containers are used for goods which need to be transported at a constant temperature above or below freezing point. These goods are divided into chilled goods and frozen goods, depending on the specified transport temperature.*

refrigerated hold /ri'frɪdʒə,reit/ (n) (nav arch) rashladno skladište, ledenica,

hladionica**refrigerated ship** /riˈfrɪdʒəˌreɪt/ **brod-hladnjača****refrigerating chambers** /riˈfrɪdʒəˌreɪtɪŋ/ (n) (nav arch) **ledenice, hladionice****refrigerating compressor** /riˈfrɪdʒəˌreɪtɪŋ/ **kompresor rashladnog uređaja****refrigerating machinery** (n) (marine eng) **rashladni uređaj****refrigerating plant** /riˈfrɪdʒəˌreɪtɪŋ/ (n) (marine eng) **rashladni uređaj****refrigeration** /riˈfrɪdʒəˈreɪʃən/ (n) (marine eng) **hlađenje, rashladni sustav, sustav hlađenja** **refrigeration plant** rashladni uređaj**refrigeration system** (n) (marine eng, electr) **rashladni sustav****refuelling; refueling (US)** /ˌriːˈfjuːəlɪŋ/ (n) (marine eng) **krcanje goriva, punjenje taknkova goriva****refuge** /ˈrɛfjuːdʒ/ (n) (safety) **zaklonište** **port of refuge** luka zakloništa, luka pribježišta**Regional ENC Coordinating Centre** (n) (navig) **regionalni centar za koordinaciju elektroničkih navigacijskih karata****Regional Marine Pollution Emergency Response Centre (REMPEC)** (n) (safety) **Regionalni centar za žurne intervencije u slučaju onečišćenja mora****register a ship** (v) (mar law) **upisati brod u upisnik brodova, registrirati brod** *The ship was registered in Croatia.***register book** (n) (mar law) **upisnik brodova** **main register book** glani upisnik brodova **insert of the main register book** uložak glavne knjige upisnika brodova**registered mortgage** (n) (mar law) **hipoteka upisana u upisnik brodova, mortgage upisan u upisnik brodova****registered ship mortgage** (n) (mar law) **mortgage na brodu, hipoteka na brodu****register of ships** (n) (nav arch) **javna knjiga u koju se upisuju pomorski brodovi pod uvjetima koje je propisala pojedina država** **upisnik brodova, registar brodova****register of yachts** (n) (mar law) **očevidnik brodica****register ton** (n) (nav arch) **COMPARE net tonnage, gross tonnage** A unit of interior capacity of ships. **registarska tona** {1 Register Ton = 100 cubic feet or 2,832 cubic metres.; today the term is obsolete and the terms 'gross ton' and 'net ton' are used instead}**regular inspection** (n) (nav arch) **redoviti pregled (broda)****regular survey** (n) **redovan pregled (broda)****regulation** 1 **propis**; 2 **pravilnik** **Port regulations** **Pravilnik o redu u luci**; 3 **pravilo (konvencije IMO STCW)****Regulations for Preventing Collisions at Sea (COLREG, COLREGS)****Pravila o izbjegavanju sudara na moru****regulator** (n) (marine eng) **regulator, uređaj za prilagođivanje, uređaj za regulaciju****re-ignition** (n) (safety) **ponovno zapaljenje** *To prevent re-ignition, the space containing the seat of fire should be effectively sealed. Dry powder and CO2 extinguishers were used, but these were unable to remove sufficient heat to prevent re-ignition of the burning material; most probably the rubber air bellows that force the clutch shoes into contact with their mating frictions surfaces.***reinforcement** /ˌriːɪnˈfɔːsmənt/ (n) (nav arch) **pojačanje, ojačanje (konstrukcije)****reinsurance contract** (n) (mar ins) **ugovor o reosiguranju****relating to** (conj) **u vezi s, koji se odnosi na**

relationship srodstvo, rodna veza

relative bearing (n) (navig) a bearing to an object in relation to the bow of the ship **pramčani kut**. *Relative bearings can be represented by two methods: Red 0° to 180° or Green 0° to 180° depending whether they are to Port or Starboard of the heading marker. Echoes to Port would be read as Red 0° to 180° and echoes to Starboard would be read as Green 0° to 180°. Circular configuration 000° to 360°. Measured from ship's head (000°) in a clockwise direction. An echo bearing 30° to Starboard would be read as 030° Rel. and an echo 30° to Port would be read as 330° Rel.*

relative course (n) (navig) relativni kurs

relative motion (n) (navig) prikaz relativnoga kretanja broda, relativno kretanje

(broda), relativno kretanje (na pokazivaču radara): *The navigator, primarily to avoid collision, must accurately and quickly solve the problem of the relative movement of other vessels underway and relate that movement to the chart. This*

relative motion unstabilised display

relative motion unstabilised display

relative motion unstabilised display

relative motion unstabilised display

relative motion unstabilised display

relative motion radar (n) (navig) radar s relativnim pokazivanjem, radar s

relative motion radar

relative motion radar

relative motion radar

relative motion radar

relative motion radar

relative motion radar

relative motion radar

relative motion radar

relative motion radar

relative motion radar

relative motion radar

relative motion radar

relative motion radar

relative motion radar

relative motion radar

relative motion radar

relative motion radar

relative motion radar

relative motion radar

relative motion radar

relative motion radar

relative motion radar

relative motion radar

relative motion radar

relative motion radar

relative motion radar

relative motion radar

pomoraca; 3 ispuštanje u more (nafte, onečišćenja itd.): *The collision resulted in the release of approximately 88,200 gallons of methyl tert-butyl ether (MTBE) from the tanker.*

released date (n) (shipping econ) objavljeni dan (isplovljenja / polaska broda)

release the hook (v) (boating/yachting, safety, seamanship) otpustiti kuku

release the lifeboat (v) (safety) osloboditi brodicu za spašavanje, otkopčati

brodicu za spašavanje: *The accident seriously injured one of the ship's engineers, who was inside the lifeboat when it was released.*

release the sheet (n) (boating/yachting) otpustiti škotu / škotinu / uzdu

release the tug (v) (navig) otpustiti tegljač, otpustiti remorker: *It was the pilot's usual practice to release the assisting tug as soon as he had established that the vessel had sufficient steerage. Peljar je običavao otpustiti tegljač čim bi ustanovio da brod ima dovoljnu brzinu za kormilarenje.*

releasing hook (n) (seamanship, nav arch) kuka na (automatsko) otvaranje, kuka na samootvaranje

reliability /,rilaɪə'biliti/ (n) 1 pouzdanost; 2 (navig) pouzdanost (navigacijskog sustava)

reliable (adj) pouzdan

relief /ri'li:f/ (n) 1 a olakšanje; 2 smjena (straže)

relief crew (n) (shipping econ) zamjenska posada

relief valve (n) (marine eng) odušni ventil, ispusni ventil, sigurnosni ventil: *The crankcase door explosion relief valve is fitted so that if there is an internal explosion, the relief valve*

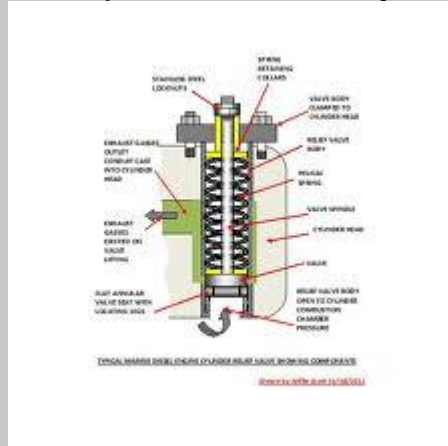

operates and the pressure inside is relieved.

relieve (v) 1 (mar law) osloboditi relieve of obligation osloboditi od obveze; 2 smijeniti (stražu): *The Chief Officer relieved the Master for the 0000-0600 watch* **relieve the watch** smijeniti stražu / gvardiju; **3 (marine eng) osloboditi (tlaka), rasteretiti, popustiti**

relieving officer (n) (navy) časnik koji preuzima / smjenjuje stražu

relieving the watch (n) (navig) smjena straže

re-load (v) (cargo) ponovno ukrcati teret (npr. nakon havarije)

rely on (v) pouzdati se u, osloniti se na

remainder (n) ostatak, preostali dio, preostala količina

remark (n) (mar law) opaska, primjedba remark in the B/L opaske u teretnici

remedy /'remidi/ (n) lijek legal remedy (mar law) pravni lijek

reminder (n) (mar law, shipping econ) opomena

remote control (n) 1 (marine eng) daljinsko upravljanje; 2 daljinski upravljač, daljinska kontrola

remotely controlled (adj) (marine eng, cargo handling) daljinski upravljani **remotely controlled crane**: The container terminal features eight remotely controlled cab-less cranes that unload containers from vessels and places them directly onto automated, battery-powered Lift Automatic Guided Vehicles (Lift AGVs), which can move up to two containers at a time from the quay to the container yard using an onboard navigation system. **daljinski upravljana dizalica**

remotely operated vehicle; ROV (n) (safety) daljinski upravljano plovilo: The new remotely operated vehicle (ROV) is returning to shore after nearly a month of rigorous testing in the open ocean

removable (adj) skidljiv, odstranjiv, zamjenjiv

removal /riˈmu:vəl/ (n) (marine eng) skidanje, odstranjivanje, izvlačenje, uklanjanje

remove (v) skinuti, ukloniti, rasprijeti **remove the valve** (marine eng) skinuti ventil

remuneration /riˈmjʊ:nəˈreɪʃən/ (n) (mar law) naknada (štete, troškova itd.)

render /ˈrɛndə/ (v) 1 (v tr) pružiti, dati **render assistance** pružiti pomoć; 2 učiniti

render responsible učiniti (nekoga) odgovornim; 3 popustiti (o užetu, konopu, lancu): some lines rendered under the force of the wind neki su konopi popustili pod silom vjetra A mooring system should always be adjusted so that the winch or brake will render before the line parts. Sustav privezivanja treba namjestiti tako da vitlo ili kočnica popusti prije negoli uže pukne. Anchor cable rendered in severe gale.

render /ˈrɛndə/ (v intr) 1 (seamanship) popuštati: the anchor chain began to render sidreni je lanac počeo popuštati; 2 popuštati (o vitlu, kočnici), popustiti: As the wind continued to increase, the stern lines, with the exception of the spring, began to pay out as the winch brakes began to render. OCIMF guidelines recommend brakes are set to 60% MBL, so for a rope of 104 mt the brake should have been set to render at a load of 62. **begin to render početi popuštati** As the wind continued to increase, the stern lines began to pay out as the winch brakes began to render.

rendez-vous /ˈrɒndiˌvuː/ (n) (safety) dogovor susreta (broda i plovila u pomoći

brodu): The underlying cause of these marine casualties was that the ship's Master and members of the bridge team became distracted and lost their situational awareness either while maneuvering the ship to rendezvous with the pilot.

renew (v) obnoviti, renovirati

repair /riˈpeɪ/ (n) **shiprepairers** remontno brodogradilište, in poor state of **repair** loše održavan, (brod, uređaj) u lošem stanju, **undergo repair** podvrgnuti se popravku, ići na popravak: Both vessels underwent repairs in port and proceeded on their respective voyages.

popravak repair workshop radionica tza popravke, **ship repair** brodoremont, **permanent repair** 1 popravak (štete na brodu) u brodogradilištu, popravak broda radi obnove klase (nakon nezgode); 2 veći remont, **temporary repair** brzi popravak, manji popravak, manji remont, popravak na licu mjesta, **repair works** popravci, radovi na popravku, **effect repairs** obaviti popravak, **popraviti, beyond repair** šteta koja se više ne može popraviti

repair /riˈpeɪ/ (v) popraviti, obnoviti

repair berth (n) (ports) vez za popravke, remontni vez: Crew safety drills continued apace throughout the duration the vessel remained alongside the **repair berth**, and as part of her abandon ship

training it was planned to lower both starboard side lifeboats to the water.

repairer 1 a mehaničar, majstor; 2 serviser

repairers (n) = **shiprepairers** remontno brodogradilište

repair invoice (n) (*shipping econ*) račun za popravak, račun za popravne radove

repair kit (n) (*boating/yachting, safety*) komplet za popravke

repair ship (n) (*nav arch*) brod radionica

repatriation /,ri:pætri'eifən/ (n) (*mar law*) vraćanje (pomoraca) u domovinu (npr. nakon pomorske nezgode), **repatriacija**: *any seafarer shall be entitled to repatriation at no expense to him to the port at which he was engaged* svaki pomorac ima pravo na besplatan povratak u domovinu do luke u kojoj se ukrcao na brod

repeater /ri'pi:tə/ (n) (*navig*) ponavljač, tal. *ripetitore*

replace (v) (*marine eng*) zamijeniti, ugraditi novi dio, nadomjestiti

replenishment /ri'plenɪfmənt/ (n) opskrba (materijalom, rezervnim dijelovima)

reply and evaluation unit; (REU) (n) (*navig*) **COMPARE VDR; Voyage Data Recorder** jedinica za reprodukciju i procjenu podataka (VDR-a)

report (n) 1 a izvješće, izvještaj, prikaz **arrival report** izvještaj o dolasku broda, izvještaj o uplovljenju, **cargo outturn report** izvještaj o iskrčanom teretu (prilikom prijave štete itd.), **departure report** izvještaj o polasku broda u+ z luke, izvještaj o isplavljenju, **injury report** izvještaj o ozljedama, **make out a report** sastaviti izvještaj, **make up a report** sastaviti izvještaj, **passage report** izvještaj o putovanju (broda), **port activity report** izvještaj o radovima u luci, **radio report** radio izvještaj, izvještaj o radio stanicama i komunikacijama, **survey report** izvještaj o pregledu, **issue a report** napraviti izvještaj, **make a report** izvijestiti, napraviti izvještaj, poslati izvještaj: *the vessel apparently failed to make reports to the VTS and hence was not being monitored. The lookout reported the lights of a vessel ahead to the chief officer.*, **compile a report** sastaviti izvješće; 2 prijava **report seat** prijavnica, šalter za prijavu dolaska broda

report (v) 1 prijaviti, javiti **report in** prijaviti dolazak broda u luku / na vez: *All vessels in excess of 20 metres LOA entering the East Solent are required to report to Southampton VTS on VHF Channel 12 when 10 miles from Nab Tower.*; 2 izvijestiti: *The tanker immediately reported the collision to the VTS* **report on** izvijestiti o (nečemu); 3 dojaviti (požar)

report (v) (*navig*) prijaviti položaj broda, javiti položaj broda: *Vessels over 40m LOA or over 50 gt and tugs engaged in towing, must report to the relevant VTS when passing Waypoints as indicated on approved charts.*

reported (adj) **disabled ship reported in position ...** onesposobljen brod prijavljen na poziciji ... (*navig, comm*) prijavljeno, izvješteno

Report if she does not answer the wheel! (*navig, seamanship*) Izvijestite ako bod ne sluša kormilo! {zapovijed za kormilarenje}

reporting prijava broda službi praćenja i upravljanja plovidbom prijava broda, javljanje broda **reporting point** točka javljanja broda

reporting country (n) (*safety*) država u kojoj je napisano / sastavljeno izvješće

reporting day (n) (*shipping econ*) dan predaje (pisma spremnosti)

reporting officer (n) (*mar law*) prijavni službenik u luci

reporting point (n) (navig) mjesto izvještavanja, točka izvještavanja

reporting scheme (n) (navig, comm) shema javljanja brodova, shema izvješćivanja brodova **comply with the reporting scheme** pridržavati se shem javljanja brodova, ispunjavati zahtjeve sheme javljanja brodova

report procedures (n) (mar law) postupak prijave dolaska / odlaska broda

represent /ˌrɛpriˈzɛnt/ (v) 1 predstaviti, prikazati; 2 zastupati, predstavljati

representative /ˌrɛpriˈzɛntətɪv/ (n) (mar law) predstavnik, zastupnik **owner's representative** predstavnik broдача

reprimand /ˌrɛpriˈmaːnd/ (v) (mar law) ukoriti, opomenuti, prigovoriti

repudiate /riˈpjʊːdiːt/ (v) (mar law) otkloniti, odbaciti **repudiate responsibility** otkloniti / odbaciti odgovornost

request (comm) zahtjev

require /riˈkwaɪə/ (v) 1 a zahtijevati, tražiti; 2 iziskivati; 3 trebati

requirement /riˈkwaɪəmənt/ (n) 1 **meet the requirements** udovoljiti zahtjevima, **comply with the requirements** ispunjavati zahtjeve, pridržavati se zahtjeva: *On arrival at the outer limits, vessels are required to report on Ch 69 that they comply with the navigational safety requirements of Port of London Authority General Directions* a zahtjev; 2 potreba; 3 uvjet; 4 nužda

requisition /ˌrɛkwɪˈzɪʃən/ (v) rekvirirati, oduzeti (brod, teret, ...)

Re. (= Reference) (n) veza (u poslovnom dopisivanju, faksovima, e-mailu), predmet

rescue /ˈrɛskjuː/ (n) (safety) spašavanje, tal. *salvataggio*

rescue (v) (safety) spasiti, spašavati: *The crew was rescued from the sinking containership The U.S. Coast Guard rescued 113 people overnight from a grounded charter vessel near Woods Hole, Massachusetts. The two crewmembers were rescued by a nearby pilot boat without serious injury*

rescue aircraft (n) (safety) spasavalački zrakoplov, zrakoplov za spašavanje

rescue basket (n) (safety) košara za spašavanje

rescue boat (n) (safety) = **rescue vessel** pomorska spasilačka brodice, brodice za traganje i spašavanje (obalne straže, lučkih vlasti itd.): *After the collision, the crew on RIG launched the rescue boat, but were not able to locate the skipper.*

Rescue Coordination Centre (RCC) Središnjica za usklađivanje potrage,



Centar za koordinaciju traganja i spašavanja

rescue coordination service služba za traganje i spašavanje

rescue helicopter (n) (safety) spasavalački helikopter, helikopter za spašavanje: *All 22 crew members were evacuated by Spanish search and rescue helicopters.*

rescue ladder (n) (safety) spasavalačke ljestve

rescue net (n) (safety) mreža za spašavanje

rescue operation (n) (safety) operacija spašavanja ljudi na moru

rescue seat (n) (safety) spasavalačka stolica, sjedalo za spašavanje

rescue sling (n) (safety) pasac za spašavanje, braga za spašavanje

rescue sub-centre; (RSC) (n) (safety) spasilački podcentar

rescue submersible (n) (navy) spasilačka ronilica

rescue team (n) (seamanship) spasavalački tim, spasavalačka grupa

rescue unit; (RU) (n) (safety) spasilačka jedinica

rescue vessel (n) (safety) pomorski spasilački brod

research vessel; (RV) (n) (nav arch) istraživački brod: *RV arrived in the port after*



completing extensive sea and fishing trials and its delivery voyage.

reservation /ˌrɛzəˈveɪʃən/ (n) (mar law) imati rezerve o nečemu, ograditi se od nečega, pokazati sumnju u nešto **make a reservation regarding** izraziti sumnju o nečemu, **ograditi se od nečega**: *Often in these circumstances the shipper will make reservations regarding his loading figure* Često u tim okolnostima krcatelj može imati rezerve u vezi s brojkama o ukrcaju.

reset /riːˈsɛt/ (v) ponovno ugoditi, nanovo regulirati, staviti u početni / nulti položaj, **resetirati**, ponovno podesiti

re-shipment /ˈriː.ʃɪpmənt/ (n) (shipping econ) ponovna otprema / ukrcaj tereta (nakon havarije)

residence /ˈrɛzɪdəns/ (n) 1 sjedište; 2 prebivalište, boravak

resident in /ˈrɛzɪdənt/ (adj) sa sjedištem u, s prebivalištem u

residue /ˈrɛzɪdjuː/ (n) 1 ostatak **fuel residue** ostatak goriva, **cargo residues** ostaci tereta: *The bosun and the crew were asked to get ready to go down into the tank to shovel out the residue cargo, the tank dome being opened at that time.*, **unpumpable residue** ostatak tereta koji se ne može ispumpati; 2 talog

resistance (n) otpor, otpornost **resistance to corrosion** otpornost na koroziju, **frictional resistance** otpor trenja

resistant (adj) otporan **resistant to** otporan na, **corrosion resistant** otporan na koroziju, **fatigue resistant** otporan na zamor (materijala), **temperature resistant** otporan na toplinu

resolution (n) 1 (electr, navig) razlučivost (radarskog zaslona), rezolucija; 2 (navig) razdvajanje ciljeva (na radaru), razlučivanje ciljeva (na radaru)

resonance cavity (n) (electr) rezonancijska kutija (radara)

resort /riːzɔːt/ (n) rješenje, izlaz: *this method should be the last resort* ta bi metoda trebala biti samo krajnje rješenje

resort to law or arbitration (v) (mar law) pribjegavati sudu ili arbitraži, naći rješenje / izlaz u sudu ili arbitraži: *The protagonists now resort to law or arbitration for settlement of their disagreement, secure in the knowledge that whatever the outcome, the money will be available.*

respective (adj) dotičan, koji se tiče

respond (v) 1 **odgovoriti**; 2 (**safety**) **reagirati**: *No pollution or injuries have been reported, according to the General Directorate of Coastal Safety. A total of six vessels were sent to respond to the tanker, the organization reported.* **respond to** 1 **reagirati na**; 2 **biti osjetljiv na**, **respond to an emergency reagirati na opasnost**: *Coast Guard examiners determined that key safety procedures were inadequate and the crew did not have the necessary equipment to safely respond to an onboard emergency*

respond to helm (n) (**navig**) **reagirati na kormilo (o brodu)**

response (v) 1 **odgovor**; 2 **reakcija**

response plan (n) (**safety**) **plan intervencije** {npr. u slučaju onečišćenja}

rest (v) **rest against oslanjati se na**, **ležati na ležati**, **sjesti**, **mirovati**, **počivati**, **odmarati se**

rest (n) 1 **mirovanje** **period of rest** 1 **period mirovanja**, **period izvan rada / pogona**; 2: *a rating forming part of a watch shall be provided a minimum of ten (10) hours of rest in every 24-hour period*, **come to rest zaustaviti se**, **doći u stanje mirovanja**; 2 **odmor (posade)**: *Work and rest period records indicated that the ship's staff was adequately rested.*

restart (v) **ponovno uputiti**, **iznova staviti u pogon**, **ponovno pokrenuti**

restore (v) (**cargo**) **vratiti (teret / pakovanje) u prethodno stanje** **restore into position vratiti (teret / dio) na mjesto**

re-stow (v) 1 (**cargo handling**) **preslagivati**; 2 **ponovno slagati**

rest period (n) (**mar law**) **vrijeme trajanja odmora**

restrain /ri'strein/ (v) **obuzdati**, **ograničiti**

restricted area (n) (**navig**) **područje ograničene plovidbe**, **ograničeno područje**

restricted visibility (n) (**navig**) **any condition in which visibility is restricted by fog, mist, falling snow, heavy rainstorms, sandstorms and any other similar causes (COLREGS)** **smanjena vidljivost navigation in restricted visibility plovidba u uvjetima ograničene vidljivosti**

resume /ri'zju:m/ (v) (**safety, navig**) **nastaviti plovidbu / putovanje / traganje i**

spašavanje, **ponovo započeti**: *The Saint Lawrence Seaway Development Corporation reports that navigation on the St. Lawrence Seaway resumed at 4 p.m. Saturday* **resume the passage / voyage nastaviti putovanje**

resume; résumé /'rezjʊ, meɪ/ (n) (**US**) (**mar law**) = **cv**; **CV**; (**curriculum vitae**)

životopis, biografija: *Resumes should reflect education, experience, salary requirements, minimum requirements specifically related to the attached job description and should be submitted by 4:00 p.m. by March 24, 2016.*

resuscitation /,risʌsi'teɪʃ(ə)n/ (n) (**safety**) **reanimacija**, **oživljavanje**: *The chief officer was evacuated immediately and provided with resuscitation treatment. Following the casualty's recovery to his vessel's deck he was given first-aid by way of chest compressions and mouth to mouth resuscitation.*

retain /ri:'teɪn/ (v) **zadržati**, **sačuvati**

retiming (n) (**marine eng**) **ponovno reguliranje paljenja**

retreat signal /ri'tri:t/ (n) (**safety, navig**) **signal opoziva (u operaciji SAR)**

retrieve crew /ri'tri:v/ (v) (**boating/yachting**) **izvući člana posade u jedrilicu / brodicu**

retrofit (n) (**nav arch**) **dogradnja**, **prilagodba dogradnjom** **undergo retrofits dograditi**, **obaviti dogradnju**: *Ships must first undergo inconvenient retrofits to transit through the new locks of*

the Panama Canal

return (n) povratak, vraćanje **return water** (*marine eng*) povratna voda, količina povratne vode, **inspect the visible returns for flow** provjeravati protok na vidljivim točkama

return (n) (*shipping econ, financ*) zarada, profit: *Australian agribusiness company Elders is quitting the livestock trades citing poor returns on shipping animals to Asia.* <http://splash247.com/>

return cargo (n) 1 (*shipping econ*) povratni teret; 2 (*shipping econ*) teret koji se vraća u polaznu luku

return line (n) (*marine eng*) povratna cijev, povratni vod, povratni cjevovod **fuel pump return line** povratna cijev iz pumpe goriva

return tubes (n) (*marine eng*) povratne cijevi

reveal /ri'v:ɪ/ (v) otkriti, pokazati, iznijeti na vidjelo

revenue /'rɛvi:nju:/ (n) (*shipping econ*) svi prihodi (iz poslovanja) **revenue from business** prihodi iz poslovanja

reversal /ri'vɜ:səl/ (n) 1 (*marine eng*) promjena smjera (u hodu klipa) a preokretanje **make reversal of** preokrenuti, izvršiti preokret

reverse /ri'vɜ:s/ (v) 1 (*marine eng*) preokrenuti, preokretati (stroj); 2 voziti u suprotnom smjeru, promijeniti smjer okretanja, staviti u suprotan smjer

reverse (n) (*ship handling, seamanship*) vožnja krmom, obrnuti smjer **run in reverse** voziti krmom, voziti natrag, **ship movement in reverse** kretnje broda u suprotnom mjeru, vožnja broda krmom, **vessel making way in reverse** gibanje broda u natrag, kretanje broda krmom

reversed frame /ri'vɜ:st/ (n) (*sailing vessels*) proturebro

reverse gear (n) (*marine eng*) uređaj za preokretanje

reversible /ri'vɜ:səbəl/ (adj) (*marine eng*) preokretan **directly reversible** direktno preokretan, **reversible gearbox** preokretni prijenosnik, preokretnik

reversing /ri'vɜ:sɪŋ/ (n) (*marine eng*) (*marine eng*) preokret (stroja), preokretanje **direct reversing** direktni preokret, **reversing gear** preokretni uređaj, preokretni prijenosnik, preokretnik, **reversing engine** preokretni stroj, reverzibilni stroj: *For direct reversing main engines >230 mm bore flame arresters or bursting discs are required for each cylinder fitted between the cylinder start air valve and the manifold.*

revert /ri'vɜ:t/ (v) (*shipping econ, comm*) javiti se ponovno **reverting our ETA in six hours** Javit ćemo naš ETA ponovno za šest sati

revised regulation /ri'vaɪzd/ (n) (*mar law*) izmijenjeni propis, izmijenjeno pravilo

rev/min; RPM (n) (*marine eng*) okretajai u minuti {=revolutions per minute}

revocation /,rɛvə'keɪʃən/ (n) (*mar law*) opoziv

revoke /ri'veʊk/ (v) (*mar law*) 1 a staviti izvan snage; 2 opozvati

revolution /,rɛvə'lʊ:ʃən/ (n) (*marine eng*) okretaj (propelera, okretanje **complete revolution** puni okretaj, **revolution counter** brojač okretaja

revolve /ri'vɒlv/ (v) (*marine eng*) okretati (se), rotirati, gibati se kružno

revolving storm (n) (*meteorol*) vrtložna aluja

revs /'rɪm laɪn/ (n) (*marine eng*) skraćeno od 'revolutions' okretaji, obrtaji

r.f. energy; (radio frequency energy) energija radiofrekvencije

RHIB; Rigid Hull Inflatable Boat (n) (nav arch) gumenjak s tvrdim dnom

rhumb line /ˈrʌm laɪn/ (n) (nav arch) loksodroma

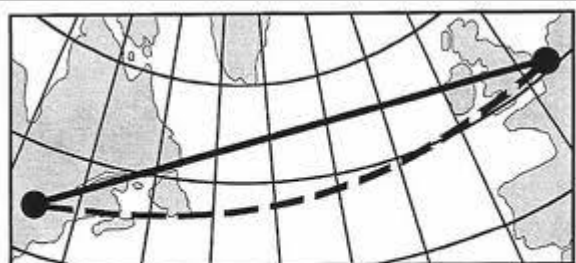

— Great Circle 3150 NM
- - - Rhumb line 3290 NM

RHU; Relative Head Up Picture (n) (navig) relativna slika s pramčanicom prema gore, pramčanica prema gore

rhythmic light (n) (navig) a light showing intermittently with a regular periodicity ritmičko svjetlo

RIB; rigid inflatable boat (n) (safety) = rigid inflatable; rigid inflatable boat;

(RIB) gumenjak s tvrdim V dnom (tipa Avon, Zodiac itd.): A rigid inflatable boat (RIB) was being employed as a support boat for an event on the water. The nine passengers boarded the RIB, each having been fitted with manually inflating lifejackets with a crotch strap. A passenger ferry spotted the empty RIB and the helicopter located the helmsman 300m from his boat. This boat was a rigid-hulled inflatable boat (RIB) with a 225hp outboard engine. **dive RIB; rigid inflatable boat**

ronilački gumenjak s V dnom, RIB; rigid inflatable boat container prazan

kontejner: Our onboard procedures ensure that my highly reliable and competent crew open, inspect and seal every empty container on the quay before being loaded., **RIB; rigid inflatable boat** : The

Bosun asked an AB to lower an empty drum into the hold for the waste. prazna bačva, **RIB; rigid inflatable boat hold prazno brodsko skladište:** A fall into a near empty hold would be fatal.

ride /ˈraɪd/ (v) 1 a jahati; 2 sjediti (na konju, u vozilu); 3 voziti (automobil, motocikl, bicikl); 4 voziti se (u autobusu, automobilu); 5 (navig, seamanship) to lie at anchor; to float in a buoyant manner while being towed or lying at anchor biti na sidru **ride at anchor biti**

usidren, biti na sidru, ležati na sidru; 6 (marine eng) ležati, sjediti, nalaziti se u, podupirati se o **ride in** ležati u, nalaziti se u; 7 (navig) to safely weather a storm whether at anchor or underway **ploviti sigurno kroz oluju; držati se sigurno na sidru u nevremenu**

rider clauses /ˈraɪd/ (n) (mar law) nove odredbe (u brodarskom ugovoru), dopuna ugovora novim odredbama

rider keelson (n) (sailing vessels) gornja hrtpenica

ridge /ˈrɪdʒ/ (n) (meteorol) **ANTONYM** trough an elongated area of high pressure in the atmosphere greben anticiklone **consolidated ridge** ustaljen greben anticiklone

riding light (n) (navig) = anchor light sidreno svjetlo, svjetlo usidrenog broda

riding squad (n) (safety) grupa za hitne intervencije (popravke, servisiranja itd.)

riding turn /ˈraɪdɪŋ/ (n) (boating/yachting) zapleteni voj užeta

rig (v) 1 (seamanship) postaviti rig the pilot ladder on the starboard side 3 feet above the water Postavite jakovljice na desni bok, tri stope iznad mora; 2 fit out for sailing

rig (v) 1 (seamanship) postaviti rig the pilot ladder on the starboard side 3 feet above the water Postavite jakovljice na desni bok, tri stope iznad mora; 2 fit out for sailing

rig (v) 1 (seamanship) postaviti rig the pilot ladder on the starboard side 3 feet above the water Postavite jakovljice na desni bok, tri stope iznad mora; 2 fit out for sailing

rig (v) 1 (seamanship) postaviti rig the pilot ladder on the starboard side 3 feet above the water Postavite jakovljice na desni bok, tri stope iznad mora; 2 fit out for sailing

rig (v) 1 (seamanship) postaviti rig the pilot ladder on the starboard side 3 feet above the water Postavite jakovljice na desni bok, tri stope iznad mora; 2 fit out for sailing

opremiti (jedrilicu, jedrenjak) za plovidbu, pripremiti, tal. *attrezzare*; *allestire*; *armare*

rig (n) (boating/yachting) 1 mast, boom and spars, sails, and lines; opći naziv za sve jarbole, oputu, deblenjake, križeve, užad jarbola i deblenjaka **snast**, tal. *attrezzatura* the **rig** **snast**.

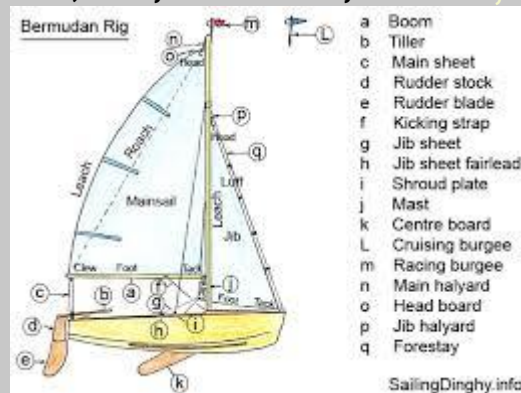

jarbolje i jedrilje

; 2 oprema jedrilice

rig (n) 1 (fishing) an arrangement of items used for fishing. It can be assembled of one or more lines, hooks, sinkers, bobbers, swivels, lures, beads, and other fishing tackle; završni dio sistema u ribolovu udičarskim alatima i tehnikama ((<https://ribolovnajadrano.hr/ribicki-leksikon>) **predvez**, **prevez**, **privez**, **završnjak** the *KD rig* is best used with a curved hook pattern The *Carolina rig* is a popular and effective way to rig for bass. It is a successful method of soft plastic bait presentation in all depths of water. **fluorcarbon rig** **kuorkarbonski predvez**, **Texas rig** sistem za lov silikoncima kod lova spin štapovima ((<https://ribolovnajadrano.hr/ribicki-leksikon/>) **ribolovni sustav Texas rig**, **Carolina rig** način slaganja sistema kod ribolova silikoncima ((<https://ribolovnajadrano.hr/ribicki-leksikon/>) **ribolovni sustav Carolina rig**

Carolina Rig

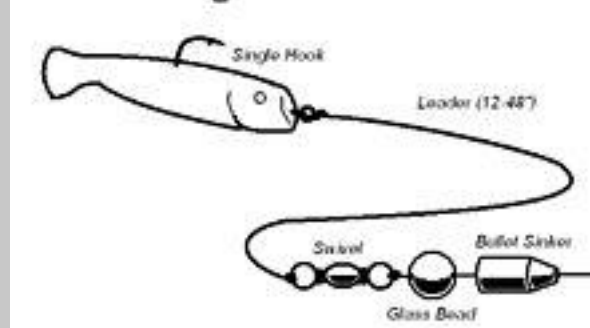

; 2 (fishing) = fishing tackle **SYNONYM**

fishing rig **SYNONYM** **fishing gear** **SYNONYM** **fishing tackle** Gear used in fishing. Member terms: Bob, Bobber, Bobfloat, Cork, Fishhook, Fishing Line, Fishing Pole, Fishing Rod, Gaff, Harpoon, Landing Net, Reel, Fishgig, Fizgig, Gig, Lance, Spear, Spinner **ribolovni pribor**, **dovršen ribolovni alat**, **arma**, **gotov sistem (ribolovnog alata)** {Some rigs are designed to float near the surface of the water, others are designed to sink to the bottom. Some rigs are designed for trolling. Many rigs are designed especially for catching a single species of fish.}

rig (v) (fishing) **napraviti predvez (povraza)** How to rig the Carolina rig? Determine the leader length, the general rule is 18 inches of leader per 10 feet of water. Tie your hook on to the leader. On the other end tie on your swivel using a Palomar knot. Slip on the sinker on your main line. Then slip on a glass bead. This adds sound that attracts bass and acts as an insulator protecting the knot from the banging of the weight. (www.fishinfo.com)

rig a wire (v) (*seamanship*) postaviti čelično uže

rigged opremljen, pripremljen

rigging /*riˈɡɪŋ*/ **standing rigging** stalna / fiksna oputa, nepomična oputa, **running**

rigging pokretna oputa, pomična oputa ¹ wires, ropes, chains, tackle and other hardware used to support and control masts, sails and spars/yards of a (sailing) ship; zajednički naziv za oputu i jedrilje **oputa**, tal. *attrezzatura velica*

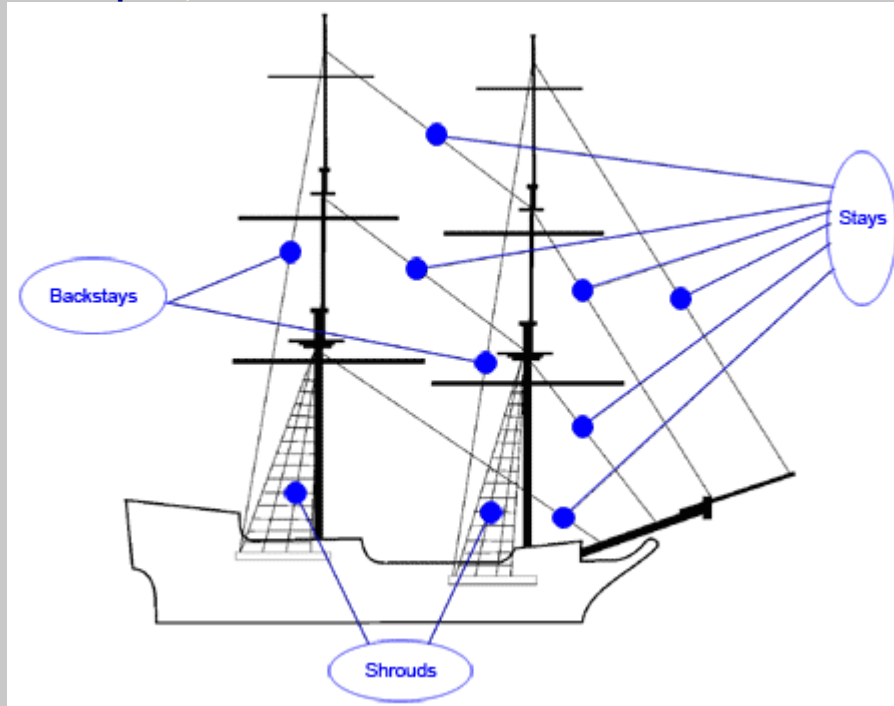

; 2 oputa jarbola; 3

oprema jedrilice; 4 oputa samarice, oputa derića

rigging screw (n) (*cargo handling, nav arch*) = **bottom = turnbuckle** steznica pripone

rigging the boat (n) (*boating/yachting*) priprema jedrilice, opremanje jedrilice

right¹ (n) (*mar law*) pravo **affect the right** ugroziti pravo, nepovoljno utjecati na pravo, **exercise one's right** ostvariti nečije pravo, **reserve the right** pridržati pravo

right² (v) (*seamanship*) ispraviti brod, ispraviti brod

right-hand lay (n) (*seamanship*) lijevi suk konopa, lijevo sukanje konopa

righting arm; GZ (n) (*stabil*) = **righting lever; GZ** poluga uspravljanja **righting arm; GZ curve** krivulja poluge uspravljanja

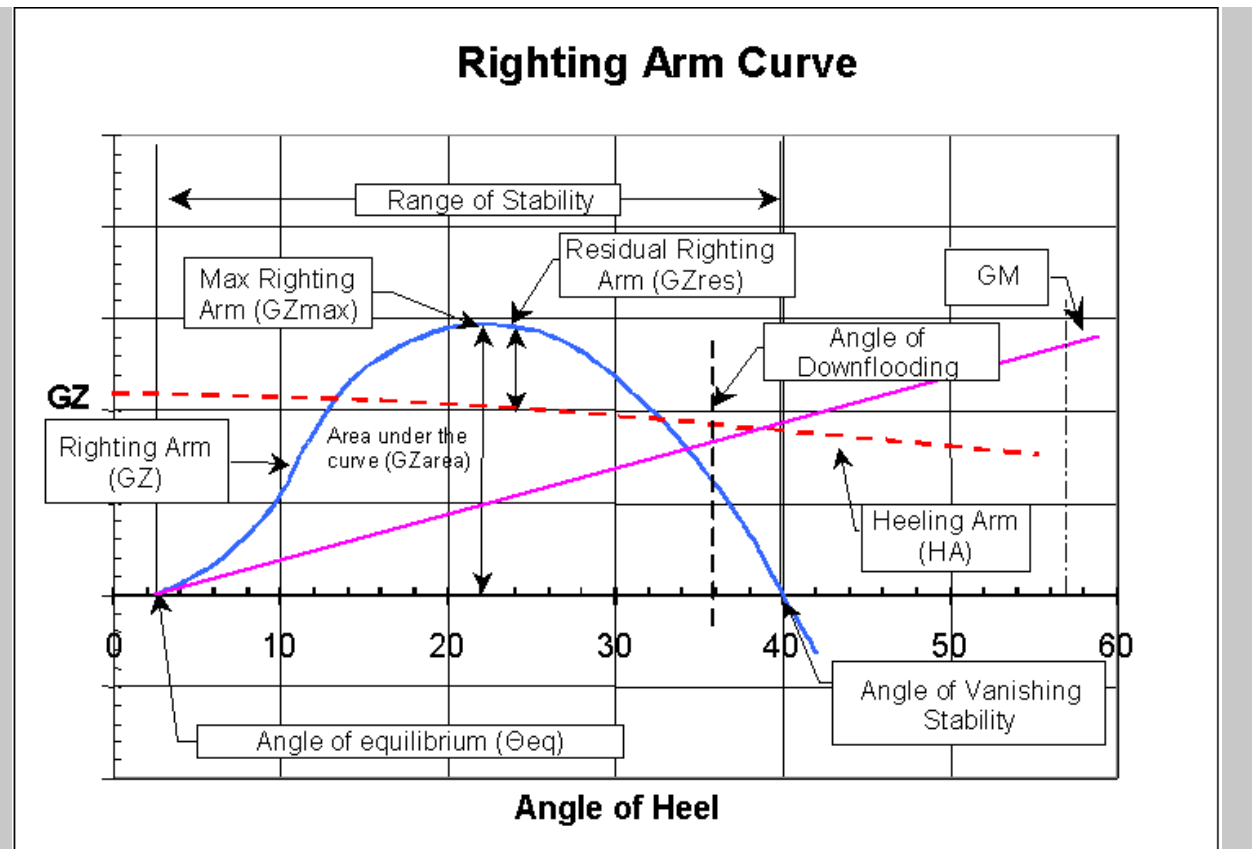

righting lever; GZ (*n*) (*stabil*) the horizontal distance, measured in metres, between the centre of gravity (G) and the vertical line of action of the buoyancy force (Bf) acting through the centre of buoyancy (B) when the ship is heeled (Rhodes, Ship's Stability, Seamanship 2003) **poluga**

uspravljanja broda: Any changes in weight will inevitably impact on a vessel's righting lever and her freeboard, both of which are crucial to safety. ... stability calculations, based on the reported asymmetrical distribution of ballast, show that the cargo loading conditions have a negative righting lever arm (GZ) from 0 degrees to 17.3 degrees but a satisfactory GZ above that angle. **The righting levers (Z)** for specified angles of heel are represented on a Curve of Statical Stability, commonly known as GZ Curve

righting moment; RM (*n*) (*stabil*) **moment statičke stabilnosti:** The Righting Moment is the best measure of a ship's overall stability. It describes the ship's true tendency to resist inclination and return to equilibrium. The Righting Moment is equal to the ship's Righting Arm multiplied by the ship's displacement.

righting the boat (*n*) (*boating/yachting*) **ispravljanje preokrenute jedrilice**

right-laid (*adv*) (*seamanship*) **ANTONYM left-laid** line or wire in which the strands spiral along in a clockwise direction as one looks along the line line or wire in which the strands spiral along in an anticlockwise direction as one looks along the line **sukan u desno (uže, konop)**

right of detention (*n*) (*mar law*) **pravo pridržaja tereta**

right of flag (*n*) (*mar law*) **pravo na vijanje, državna pripadnost**

right of hot pursuit /pəˈsju:t/ (*n*) (*mar law*) **pravo progona (u međunar. pravu mora)**

right of innocent passage (*n*) (*mar law*) navigation through the territorial sea for the purpose (a) traversing that sea without entering internal waters or calling at a roadstead or port facility outside internal waters; or (b) proceeding to or from internal waters or a call at such roadstead or port facility. (UNCLOS) **pravo neškodljiva prolaska:** Subject to this Convention, ships of all States,

whether coastal or land-locked, enjoy the right of innocent passage through the territorial sea. (UNCLOS)

right of ownership (n) (*mar law*) pravo vlasništva (na brodu)

right of way (n) to have the right of way imati pravo puta (*navig, boating/yachting*)

pravo puta, pravo prolaza, tal. *diritto di rotta*

right-of-way vessel brod koji ima pravo puta

rigid inflatable; rigid inflatable boat; (RIB) (n) (*safety, nav arch*) gumenjak s

tvrdim V dnom, gumenjak tipa Avon / Zodiac

rig move (*navig, comm*) pomicanje platforme

rig the pilot ladder (v) (*seamanship*) postaviti jakovljice / peljarske ljestve: *rig the pilot ladder on the port side three feet above the water*

rim (n) (*nav arch*) obod, rub

ring (n) (*marine eng*) prsten **compression ring** kompresijski prsten, brtveni prsten,

joint ring spojni prsten, **oil ring** uljni prsten, **oil scraper ring** uljni strugač,

oil-control ring uljni prsten, **nozzle ring** prsten sapnice, prsten mlaznice, **piston**

ring stapni prsten, klipni prsten, **scraper ring** prsten za otiranje ulja, stručni

prsten, **sealing ring** brtveni prsten, **seat ring**, prstenasto sjedište, prstenasto

sedlo, **top piston ring** gornji prsten stapa, gornji prsten klipa, **ring belt** pojas

prsten, prsteni pojas, **ring face** obod prstena

ringlike (adj) prstenast, u obliku prstena

ring spanner (n) (*marine eng*) okrugli ključ, višekutni ključ, okasti ključ

rinse /rins/ (n) (*cargo handling*) ispiranje **final rinse** 1 zadnje ispširanje (brodskog skladišta); 2 a **final rinse with fresh water** zadnje ispiranje slatkom vodom

rinse /rins/ (v) ispirati

ripen /'raipən/ (v) (*cargo*) dozrijevati

ripening (n) (*cargo*) dozrijevanje (voća): *If premature ripening takes place during the voyage, progressive ripening by emission of high amounts of ethylene can hardly be avoided.*

rippled sea (n) (*meteorol, oceanogr*) prvi stupanj stanja mora s valovima visine od 0 do 0,1 metar naborano more

rise (n) to give rise to dovesti do nečega, izazvati nešto, prouzročiti rast, uspon

rise (v) 1 dići, dizati, dizati se; 2 rasti

riser chain (n) (*boating/yachting*) sidreni lanac plutače

risingwood (n) (*sailing vessels*) unutarnji dio kilja

risk (n) 1 opasnost risk of collision opasnost od sudara, **underestimate the risk**

podcijeniti opasnost / rizik; 2 (*mar ins*) rizik **at seller's risk** na teret prodavatelja,

cover the risk pokriti rizik, obuhvatiti rizik

risk assessment (n) (*safety*) procjena opasnosti, prosudba opasnosti: *Risk assessment in respect of navigation in coastal congested waters must be reviewed No risk assessment or consideration of potential consequences was undertaken* **inadequate risk assessment**

nedovoljna prosudba opasnosti

risk of collision opasnost od sudara, rizik od sudara

river pilot (n) (*mar law*) peljar za vođenje broda s od peljarske stanice do luke i obratno **rječni**

peljar, rječni pilot: *A Mississippi River Pilot is responsible for guiding ships along the Mississippi River, including across the bar from the Gulf of Mexico, through the shifting sandbars and passages at the mouth, and upriver to New Orleans and Baton Rouge.*

riverside /'rive,said/ (*adv*) **riječni, uz rijeku**

rivet /'rivit/ (*n*) **zakovica** joined by **rivets** spojen zakovicama, **flush head rivet** zakovica s ravnom glavom, **snap head rivet** zakovica poluokrugle glave, **pan head rivet** zakovica trapezne glave, **double countersunk rivet** zakovica s obostranim udubljenjem

riveted joint /'rivitid/ (*n*) (*nav arch*) **zakovičasti spoj** **chain riveted joint** lančano zakivanje, **zigzag riveted joint** unakrsno zakivanje, **cik-cak zakivanje**

RM; righting moment (*n*) (*stabil*) the ratio of the weight and buoyancy of an inclined ship **moment statičke stabilnosti broda:** *The size of the righting moment at any displacement and angle of inclination is a measure of the ship's ability to return to an upright position.*

RNC; Raster Navigational Chart (*n*) (*navig*) a digital scan of a paper chart **rasterska navigacijska karta, rasterska karta** **SRNC; Sytem Raster Navigational Chart** sustavna rasterska navigacijska karta

RNLI (=The Royal National Lifeboat Institution (RNLI)) (*n*) (*safety*) the largest charity that saves lives at sea around the coasts of the UK, Ireland, the Channel Islands and the Isle **Britanska udruga za spašavanje na moru**

RNLI lifeboat (*n*) (*safety*) **brodica za spašavanje Britanske udruge za spašavanje na moru:** *The general cargo vessel was undamaged, and stood by the fishing vessel until an RNLI lifeboat arrived and escorted her to her home port. An RNLI lifeboat was dispatched to escort the trawler, and upon its arrival replaced the fire brigade's pump with a lifeboat salvage pump.*

RNU; Relative NORTH UP Picture (*n*) (*navig*) **COMPARE RCU; Relative Course Up Picture** relativna north up slika

roach /rəʊtʃ/ (*n*) (*boating/yachting*) **stražnja rubna zakrivljenost jedra**

road 1 **cesta;** **2** a partly sheltered anchorage in which ships may ride at anchor **sidrište, sidrište uz plovni kanal na prilazu luci, rada in the roads 1** na prilazu luci, **na prilaznom sidrištu; 2** na sidru

road haulage /'hɔ:liŋ/ **cestovni prijevoz / transport**

road haulage vehicle **cestovno teretno vozilo**

roadstead /'rəʊd,sted/ (*n*) **1** (*navig*) a partly sheltered anchorage, usually on the side a port fairway **prilazno sidrište, privremeno sidrište na prilazu luci, tal. rada safe roadstead sigurno prilazno sidrište; 2** (*mar law*) Roadsteads which are normally used for the loading, unloading and anchoring of ships, and which would otherwise be situated wholly or partly outside the outer limit of the territorial sea, are included in the territorial sea. (UNCLOS) **sidrište (u međunar. pravu mora)**

roaring /'rɔ:riŋ/ (*n*) (*meteorol*) **zonalni zapadni vjetrovi, hučne četrdesete paralele**

roaring forties (*n*) (*oceanogr, meteorol*) geographical belt located approximately in 40 degrees south latitude in which are encountered the prevailing or stormy westerlies **pojas olujnih zapadnih vjerova (u području južnih četrdesetih paralela)**

ROB /,a:rəʊ'bi:/ (*n*) **1** (*cargo handling*) quantity of (oil) cargo remaining on board **preostala količina tereta na brodu; 2:** *A dry tank certificate confirming that all pumpable cargo has been*

discharged and any quantity remaining on board (ROB) is unpumpable, will normally be conclusive evidence, particularly if signed by a representative of the consignees.

robbery (n) (mar law) **pljačka** **armed robbery** **oružana pljačka**

robust /rəʊˈbʌst; ˈrɒʊbʌst/ (adj) **masovan, čvrst, robustan**

rock (n) (geogr) **greben**

rock awash (n) (oceanogr) **greben**

rocker (n) (marine eng) **njihalo, pregibna poluga** **rocker arm** **klackalica, optirač ventila, dvokraka poluga, balanser, rocker gear** **polužje klackalice, sistem poluga balansera**: Oil is also supplied to lubricate the **rocker gear** operating the inlet and exhaust valves, and to the camshaft and camshaft drive. Because there are two of each valve mounted in the cylinder head, the **rocker gear** must operate both valves simultaneously.

rocker arm (n) (marine eng) **klackalca, klatna poluga (ventila), pregibna ručica**



rocket /ˈrɒkɪt/ (n) (safety) **signalna raketa**

rocket flare (n) (safety) **signalna raketa**

rocket parachute (n) (safety) **signalna raketa s padobranom** **rocket parachute flare** **signalna raketa s padobranom**

rock ledge (n) (oceanogr) **stijene**

rod (n) (marine eng) **motka, šipka** **adjusting rod** **razvodna motka, motka isključivanja, connecting rod** **ojnica, connecting rod large end** **donji kraj ojnice, donja glava ojnice, piston rod** **stapajica, klipnjača, push rod** **podizna motka, spojna motka, steel rod** (cargo, marine eng) **čelična motka, čelična šipka, tie rod** **kotveni vijak, kotvena šipka**

rode /rəʊd/ (n) 1 (navig, seamanship) = **anchor rode** **lanac između sidra na dnu i broskog sidrenog oka** **sidreni lanac i konop, čitava dužina lanca (i konopa) između broda i sidra**: The vessel is attached to the anchor by the rode, which is made of chain, cable, rope, or a combination of these. The ratio of the length of rode to the water depth is known as the scope.

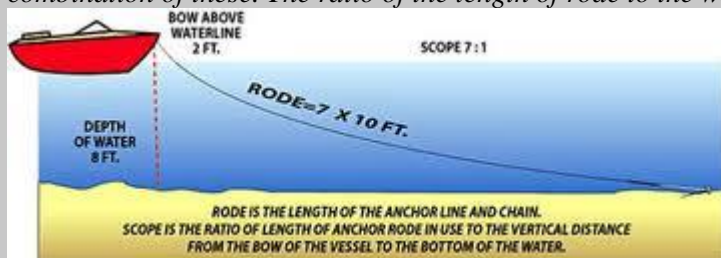

; 2 **sidreni lanac i konop zajedno**

Roger. (comm) SEE Received. Primljeno., Razumio. Roger on that. Razumio.,

Prihvaćam. {IMO SMCP phrases (2001) prefer to use Received, Understood or Affirmative or Positive instead of Roger. (see https://en.wikipedia.org/wiki/Procedure_word)}

rogue /rəʊg/ (adj) (navig) koji krši pravila **rogue vessel** brod koji krši pravila (o izbjegavanju sudara): VTS was informed about the rogue container vessel as soon as it was evident that she was crossing the separation zone.

roll /rɔːl/ (n) (navig) motion of the ship from side to side, alternately raising and lowering each side of the deck **ljuljanje broda, valjanje broda** **period of roll** vrijeme ljuljanja s jednog na drugi bok

roll (v) ljuljati se (o brodu), valjati se (o brodu)

roll call (n) (safety) proziv (posade na zbornom mjestu): *Performing roll call:* .1 At your assembly station one of the officers / crew will perform a roll call. .2 The officer / crew will say This is a roll call, and will call out the passengers individually by their names. .3 When your name is called

roller /ˈrəʊlə/ (n) (marine eng) kotačić, valjak **roller tappet** valjak podizača, **roller bearing** valjkasti ležaj



roller bearing (n) (marine eng) valjkasti ležaj

roller chock (US) a chock fitted with one or more rollers to reduce friction on mooring lines
zjevača s valjcima, oko za privez s valjcima

roller fairlead (n) (nav arch) zjevača s valjcima, oko za privez s valjcima

roller furler drum (n) (boating/yachting) bubanj sustava za namatanje (genove),
bubanj sustava za namatanja prednjeg ili glavnog jedra

roller furling (n) (boating/yachting) mehanički sustav namatanja prednjeg ili glavnog

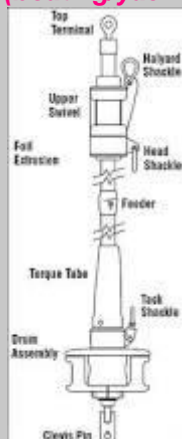

jedra, rol-sistem

roller-furling drum (n) (boating/yachting) bubanj za namatanje prednjeg jedra

roller reefing (n) (boating/yachting) mehanički sustav kraćenja prednjeg ili glavnog jedra rolanjem

roller tappet (n) (marine eng) valjak podizača ventila (nad brijegom razvodne

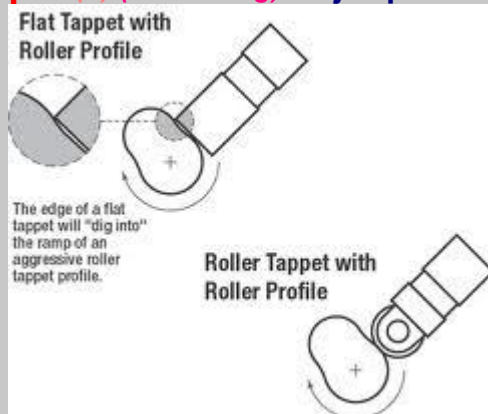

osovine)

roller transporter (n) (cargo handling) transporter (tračni)

rolling /ˈrɒlɪŋ/ 1 (navig) COMPARE ship's motions rotacijsko gibanje broda oko uzdužne osi valjanje broda, ljuljanje broda; 2 (marine eng) valjanje (limova)

rolling cleat (n) = parrel cleat obruči križa spojeni hajmicom

roll-on/roll-off (v) (cargo handling) ukrcaj/tereta na brod i s broda na kotačima, ro-ro (n) roll-on/roll-off services (cargo handling, shipping econ) usluge ukrcaja/iskrcaja na kotačima, ro-ro usluge

roll-on/roll-off vessel (=ro-ro ship) (n) (nav arch) = ro-ro ship vessels tused to carry



wheeled cargo brod za prijevoz teretnih vozila, ro-ro brod

roll tack /rɒl/ (n) (boating/yachting) letanje naglim nagnjanjem

Romeo. (comm) SEE Received. Razumio., Primio. {Romeo is used instead of Received or Roger in Australian Maritime English.}

room (n) soba, dvorana, prostorija, mjesto control room (marine eng) upravljačka kabina, public room (nav arch) društvena prostorija (na brodu), salon, air cooler room (marine eng) prostorija rashladnog zraka, engine room (marine eng, nav arch) strojarnica {(abbr) Rm}

room (n) (ship handling, navig) prostor (za manevriranje): The berthing plan was discussed between the pilot and the Master but the pilot had not mentioned the restricted room due to the other berthed tanker.

root (n) korjen, temelj, podnožje

root /ru:t/ (n) (math) is a value such that . korijen: The second root is often called the square root, while the third root the cubic root. third root of 8 is 2 treći korijen iz 8 jednako je 2, the n-th root of a number n-ti korijen iz nekog broja, square root of drugi korijen iz

root mean square; (RMS) (n) (math) srednja kvadratna vrijednost, RMS distance
root mean square; (RMS); (DRMS) udaljenost RMS

rope /rəʊp/ (n) (seamanship) uže, konop

rope clip (n) (seamanship) boca užeta, vezica za osiguranje konopa

rope clutch (n) (boating/yachting) štoper (podigača jedra, floka, pritega buma itd.)

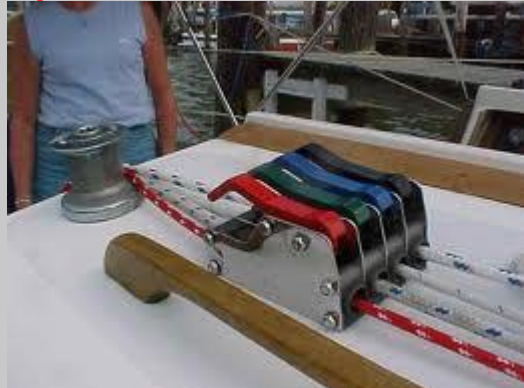

rope drum (n) (nav arch) bubanj vitla (za namatanje užeta), vreteno vitla (za namatanje konopa)

rope fairlead (n) (nav arch) zjevača

rope lashes = lashings konopi i čelik čela za pričvršćivanje sidrenog lanca ili deblje priovezne užadi boce

rope loop (n) (seamanship) omča, radanča

rope off (v) (safety) označiti (opasno) područje

rope-runners privezivači, armizatori; armizadori

rope-running rigging (n) (boating/yachting) oprema za rukovanje užadi (na jedrilici)

rope sling pasac od konopa, braga

rope work (n) (boating/yachting) rukovanje konopima, rad s konopima

ro-ro cargo ferry (n) (nav arch) ro-ro teretni brod: *A ro-ro cargo ferry was on river passage with a pilot embarked.*

ro-ro freight (n) (cargo) ro-ro teret, teret za prijevoz ro-ro brodovima **ro-ro freight vessel** ro-ro brod, brod za prijevoz vozila

ro-ro passenger ferry (n) (nav arch) teretno-putnički trajekt: *The largest ro-ro passenger ferry is MS Color Magic. It weighs 75,100 GT (Gross Ton). It entered the service in September 2007 for Color Line. It was built in Finland by Aker Finnyards. The ferry is 223.70 m long, 35 m wide and can carry 550 cars as well as 1270 lane meters of cargo.*

<http://www.marineinsight.com/types-of-ships/what-are-ro-ro-ships/>

ro-ro ship /rəʊ rəʊ/ = **roll-on/roll-off vessel** ro-ro brod, brod za prijevoz

cestovnih vozila: *The vehicles in the ro-ro ship are loaded and unloaded by means of built-in ramps. For the shipper, the advantage of using a ro-ro ship is speed. Since cars and lorries can drive straight on to the ship at one port and then drive off at the other port within a few minutes of the ship docking, it saves a lot of time of the shipper. The ro-ro ship is different from lo-lo (lift on-lift off) ship that uses a crane to load the cargo.*

ro-ro terminal (n) (ports) ro-ro terminal, terminal za vozila: *Scheduled to start full operation by the third quarter of 2016, the new ro-ro terminal will become NYK's first automotive logistics base in the Middle East.*

roster /'rɒstə/ (n) (navig) raspored straže, raspored *gvardije*

rotary feed pump (n) (marine eng) rotaciona napojna pumpa

rotary motion rotaciono gibanje

rotary movement (n) (marine eng) = **rotary motion** rotaciono gibanje, rotacijsko gibanje

rotary pump (n) (marine eng) rotaciona pumpa

rotate /rəʊ'teɪt/ (v) okretati, okretati se, rotirati, vrtjeti se

rotation /rəʊ'teɪʃən/ (n) (shipping econ) mjesto okretanja; luka na kraju putovanja i početka povratne rute **rotacija port of rotation** luka okretanja (na putovanju linijskog broda)

rotational movement of ship (n) (nav arch) rotacijski pomaci broda

rotation of ports of call (n) (shipping econ) rotacija servisa, redoslijed luka ticanja

rotator (n) (marine eng) rotator **Rotocap valve rotator** rotator ventila tipa Rotocap

rotor /'rəʊtə/ (n) (marine eng) rotor

rotor sail (n) (nav arch) rotating mast with sail as an additional propulsion for ships; a spinning cylinder that uses the Magnus effect to harness wind power to propel a ship **okretno jedro**,

rotirajuće jedro: *The technology is already in commercial use on board the Bore's M/V Estraden, a 9,700 DWT Ro-Ro carrier, which has achieved a 6.1% reduction in fuel consumption through use of the rotor sails.* <http://gcaptain.com/lng-fueled-viking-grace-to-get-rotor-sails/>



rotter chock patentno oko

rough /rʌf/ grub, hrapav, neravan

rough out /'rʌf aʊt/ (v) pročistiti **rough out a note** pročistiti bilješku

rough sea (n) (oceanogr) peti stupanj stanja mora s valovima visine od 2,5 do 4 metra **grubo more**, nemirno more, valovito more, uzburkano more, tal. *mare mosso*

routhtree rail (n) (sailing vessels) donja razma ograde

rough weather (n) (meteorol) nevrijeme

rough-weather passage (n) (boating/yachting, navig) plovidba nemirnim morem

rough-weather sailing (n) (boating/yachting) plovidba po lošem vremenu

round (v) (navig, boating/yachting) oploviti, ploviti oko plutače, okrenuti oko plutače: *the vessel had rounded a right-handed bend in the river* brod je oplovio desni zavoj na rijeci *From the radar and visually it looked like all the 3 vessels were heading towards a meeting point at F3 buoy where it was intended to round the buoy and head SW-ward.*

round (n) (seamanship, safety) obilazak (broda radi kontrole): *On my deck rounds after the bunkering operation had begun on a recent seagoing tour, I was alarmed by the apparent wear and a*

'vacuum pinch' on the fuel oil hose. **requent rounds** **česti obilasci**: *Make frequent rounds of the ship.*

round (n) (safety) **ophodnja, obilazak, patrola**: *Documentary evidence required by P&I club claims handlers includes records of cargo securing and lashing rounds and checks, etc. The officer of the watch should make rounds to inspect the ship at appropriate intervals.*

roundabout (n) (navig) točka ili kružno područje koje se upotrebljava u područjima plovidbe u kojima se susreće više sustava odijeljenoga prometa **kružni tok**

round off 1 a (v) **zaokružiti**; 2 **oploviti**

round the clock (prep phr) **dan i noć, 24 sata na dan, neprekidno**

round turn (n) (seamanship) **voj konopa, namotaj konopa (oko bitve)**

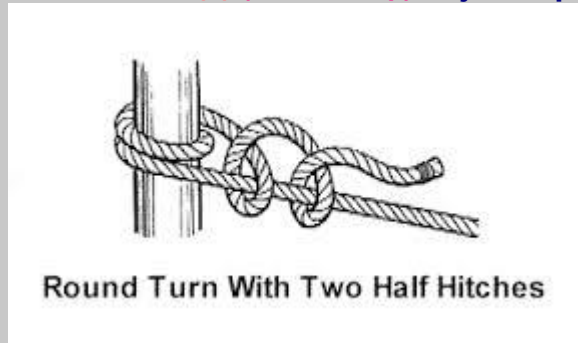

round turn and two half-hitches (n) (seamanship) **dvostruki poluuzao s vojem**

round up (v) (boating/yachting) **prazniti jedro (skretanjem u vjetar), isprazniti jedro**

route /ru:t/ (n) 1 **put, smjer, ruta** **escape route** **izlaz za nuždu**; 2 (navig) **ruta**

(putovanja), **pravac recommended route** **recommended**; 3 (shipping econ) **brodska linija**

routeing /ru:tiŋ/ (n) **weather routeing** **meteorološko usmjeravanje plovidbe (navig) usmjeravanje (plovidbe)**

routeing scheme (n) (navig) **shema odvojene plovidbe, shema usmjerene plovidbe** **follow the traffic routeing scheme** **sljediti shemu odvojene plovidbe**

route monitoring (n) (navig) **nadziranje plovidbenog putovanja**

routine (n) (navig) **rutina, rutinski poslovi** **OOW's routine** **rutinski poslovi i dužnosti**

časnika straže: *Situational awareness techniques are a part of the OOW's routine during this voyage.*

routine communication (n) (comm) **komunikacije koje nisu vezane uz sigurnost broda već uz poslovanje broda i drugo** **rutinske komunikacije**

row /rəʊ/ (n) 1 (cargo handling) **poprečni vodoravni redovi, red tereta, fila**



; 2 (*cargo handling*) the rows of containers on a ship are numbered with even numbers from the center leftward and odd numbers from the center rightward **poprečni red kontejnera (na brodu)**, red kontejnera koji ide poširini broda (od sredine prema bokovima)

row /rəʊ/ (v) veslati

row boat (n) (*nav arch*) brodica na vesla, čamac na vesla

rowing (n) (*seamanship*) veslanje

rowlock; rowlocks /'rɒlək, 'rɪlək/ (n) (*boating/yachting*) rašlje, vilica za veslo, škeram u

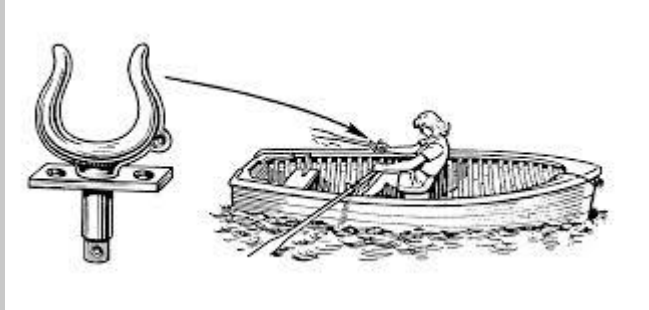

obliku vilice

royal-backstay (n) vršna zapona

royal-mast (n) COMPARE full rigged sailing vessel vršni nastavak jarbola

Royal Navy (n) (*navy*) Kraljevska ratna mornarica, Ratna mornarice Ujedinjenog Kraljevstva

royal-pole (n) vrh jarbola

rpm (revolutions per minute) (n) (*marine eng*) broj okretaja u minuti

R/T (radiotelephony) (n) (*comm*) radiotelefonija

rubber (n) guma **heat resisting rubber** termootporna guma

rubber packing (n) (*nav arch*) gumena brtva **renew the rubber packing** zamijeniti gumenu brtvu (na brodskim grotlima)

rubber ring (n) (*marine eng*) gumeni prsten, gumena brtva

rubber seal (n) (*marine eng*) gumena brtva

rubbing strake (n) (*boating/yachting*) dvostruka razma {za zaštitu od oštećenja boka trenjem}

rubbish (n) otpaci, smeće

rub off (v) 1 (*marine eng*) istrti, izbrusiti; 2 brisati

rudder /'rʌdə/ (n) (*nav arch*) kormilo, *timun*, tal. *timone*; **barra active rudder** aktivno kormilo, **balanced rudder** balansno kormilo, **quarter rudder** bočno kormilo, **single**

plated rudder jednoplošno kormilo, **single pintle rudder** kormilo sa štencem, **semi-balanced rudder** polubalansno kormilo, **semi-spade** poluviseće kormilo, **bow rudder** pramčano kormilo, **spade rudder** viseće kormilo, **unbalanced rudder**

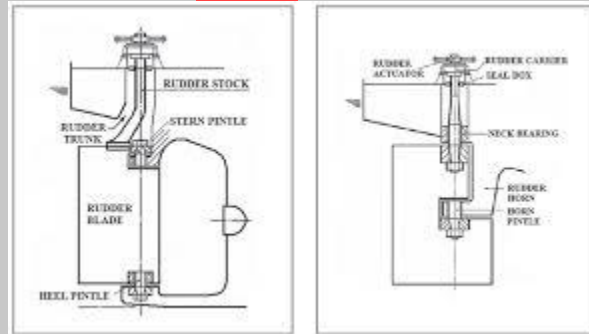

nebalansno kormilo

rudder angle indicator (n) (navig) pokazivač otklona kormila

rudder axle (n) (nav arch) osovina kormila

rudder bearing (n) (boating/yachting, nav arch) ležaj kormila

rudder carrier (n) (nav arch) nosač kormila

rudder (deflection) indicator pokazivač otklona (kormila)

rudder frame (n) (marine eng) rebro kormila

rudder hole otvor za kormilo, tal. losca

rudder horn (n) (nav arch) rog kormila

rudder horn gudgeon (n) (nav arch) samica roga kormila

rudder pintle (n) 1 (nav arch) kratka osovina oko koje se okreće list kormila; the pin on which certain types of rudder swing **štenac kormila**; 2 (nav arch, sailing vessels) osnac kormila

rudder post (n) (nav arch) a part of a rudder by which it is pivoted to the sternpost **statva**

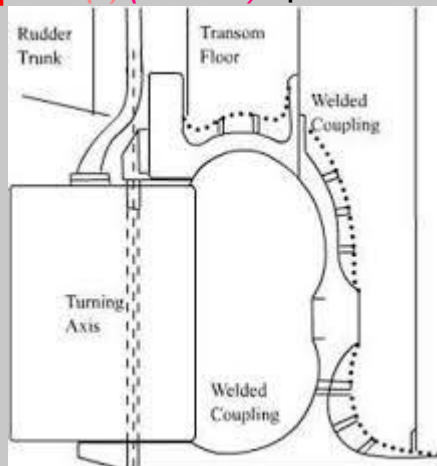

kormila

rudderpropeller (n) (nav arch) propeler s okomitom osovinom; Rudder Propeller can be rotated endlessly to port or starboard and offer pivot capability and vertical adjustment - truly optimum combination of propulsion and steering. **Schottel-propeler**, **rudderpropeller**



{used on tugboats, boatbridge, split hopper barge and ferries}

rudder stock (n) (nav arch) a vertical shaft having a rudder attached to its lower end and having a yoke, quadrant, or tiller fitted to its upper portion by which it may be turned **osovina kormila** (SeaSources.net), tal. *asta del timone*

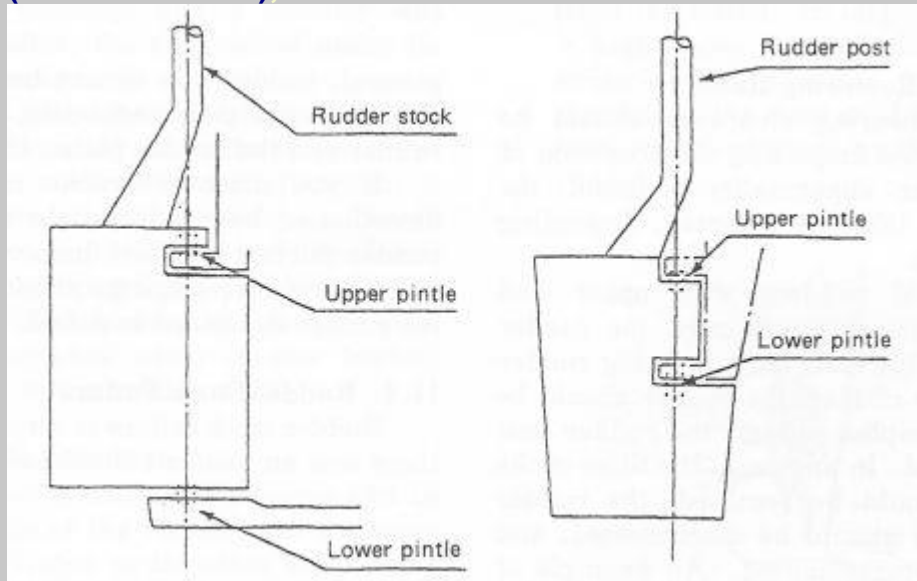

rudder tiller (n) (nav arch) rudo kormila

rudder trunk (n) (nav arch) provlaka kormila

rule /ru:l/ (n) **Steering and Signalling rules** Pravila za kormilarenje i plovību pravilo **rule of the road** pravila o izbjegavanju sudara, **comply with a rule** pridržavati se pravila, **observe a rule** poštivati pravila, **fixed rule** utvrđeno pravilo

ruler (n) (navig) ravnalo

rules (n) (mar law) = Collision Regulations; (COLREGS) = rules of the road = COLREGS pravila o izbjegavanju sudara **Steering and Sailing rules** pravila za plovību i krmilarenje: *teering and Sailing Rules are the most important rules under COLREGS. They have been designed to keep vessels apart when they approach each other.*

non-conformance with the rules nepridržavanje pravila, **followe the rules** slijediti pravila,

primijenjivati pravila: *It is most important to avoid or minimize the damaging effects of a collision, as opposed to blindly following the rules to the letter.*

the rules apply in pravila se primjenjuju u *The rules apply in any visibility (e.g. in sight or in restricted visibility).*

complying with the rules **pridržavanje pravila**: *poštivanje pravila A traffic separation scheme does not relieve any vessel from complying with other rules.*

prescribed in the rules propisano pravilom, **zacrtno**

pravilom, propisano u pravilu, observe the rules poštivati pravila, **lay down the**

rules zacrtati pravilo, **propisati pravilo, compliance with the rules** poštivanje

pravila, **pridržavanje pravila, non-compliance with the rules** nepoštivanje pravila,

nepridržavanje pravila, comply with the rules pridržavati se pravila: *poštivati pravila,*

violate the rules prekršiti pravila, **kršiti pravila, ozbiljno kršiti pravila, break the**

rules kršiti pravila, **violation of the rules** kršenje pravila, **teško kršenje pravila,**

teška povreda pravila, breach of the rules kršenje pravila, **nepridržavanje pravila,**

breach the rules kršiti pravila

rules and regulations pravila i propisi, **pravila**: *The rules and regulations applied for the design and construction of oil tankers are primarily developed by the IMO and the classification societies.*

rules of the road pravila o izbjegavanju sudara (COLREGS)

ruling (n) (mar law) odluka (suda), **rješenje (suda)**: *Tuesday's ruling found the master of the ship guilty of recklessness resulting in catastrophic environmental damage.* **court ruling** **sudska odluka, odluka suda**

run (v) 1 (boating/yachting) to sail freely and easily, especially with the wind aft **jedriti s vjetrom** u krmu, **niz vjetar**; 2 **jedrenje s vjetrom u krmu**

run (n) (shipping econ) vožnja, plovība, putovanje **the run across** prijelaza preko, **plovība preko**

run rad (motora)

run (marine eng) 1 staviti u pogon; 2 biti u pogonu; 3 upravljati (strojem); 4 voditi (uređaj, stroj)

run aground (v) (navig) **nasukati se**: *The vessel ran aground on Lymington Banks at about 1632, at a speed of about 11 A general cargo ship carrying fertilizer ran hard aground in Dardanelles strait. A cargo vessel ran aground Friday afternoon on Gros Cap Reef in Whitefish Bay in Lake Superior.*

run ashore (v) **nasukati se**

run astern (v) (navig, seamanship, ship handling) **voziti natrag, voziti krmom**: *The anchors were set for a SW wind and were tested with the engine running astern while transits were observed.*

run down (v) (navig) **sudariti se**

run free (v) (boating/yachting) **ANTONYM close-hauled sailing** jedriti niz vjetar

rung /rʌŋ/ (n) 1 (nav arch) **palac, škeram**; 2 (seamanship) **prečka (na ljestvama)**



run in (n) (marine eng) razraditi, uhodati

run into danger (v) (navig) izložiti se opasnosti

run mode (n) (navig) **COMPARE stand by mode** radni način rada (radara)

runner /ˈrʌŋə/ (n) **1** (cargo handling) = **cargo runner** a purchase in which a single block is free to move or run in the bight of the line **podigač tereta, uže za dizanje tereta (na samarici, dizalici), živi kraj užeta za podizanje tereta;** **2** (boating/yachting) pomično stražnje leto, pomična zaputka, pomični krmeni štraj

running (n) (boating/yachting) jedrenje s vjetrom u krmu, tal. *vento in poppa*

running (n) **1** (marine eng) hod (motora) **running in** uhodavanje; **2** rad **running away of the engine** prekoračenje brzine motora, **running hours** radni sati, sati pogon, **set running** staviti u pogon, pokrenuti, **troublefree running** nesmetan rad (motora), **failsafe running** besprijekoran rad (motora, uređaja); **3** vožnja **running ahead** vožnja naprijed, **running astern** vožnja krmom, vožnja natrag; **4** okretaj; **5** upravljanje (strojem)

running aground (n) (navig) nasukavanje

running astern (n) (ship handling) vožnja krmom *Running astern with main engine and bow thruster, the wind and the flooding tide were slightly on the vessel's port side.*

running backstay (n) (boating/yachting) pomično stražnje leto, pomična zaputka, *patarac*

running block (n) (seamanship) **ANTONYM standing block COMPARE block** pomičnik kolotur (u čekrku, kolotirniku)

running components (n) (marine eng) radni mehanizam

running days (n) (mar law, shipping econ) tekući dani

running down clause (n) (mar ins) klauzula o sudaru

running fix (n) (navig) **SYNONYM transferred position lines** a navigational position determined by the intersection of two or more lines of position taken at different times and then advanced to a common time **pozicija dvostrukim smjeranjem istog objekta u razmaku vremena, pozicija snimanjem azimuta iz iste točke u razmaku vremena, opažanja u vremenskom razmaku, pozicija broda u razmaku vremena**

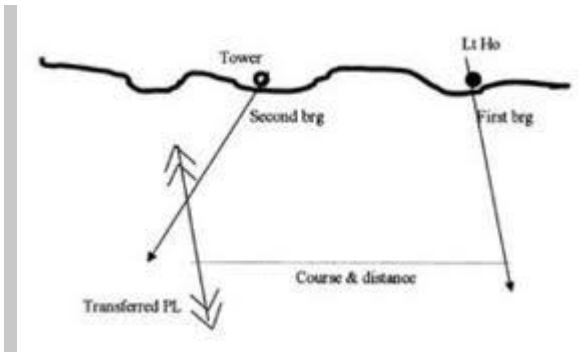

{A line of position obtained at an earlier time may be advanced to the time of the later LOP. These two LOPs should not be parallel to each other; remember that the optimal angular spread is 90°. The position obtained is termed a running fix because the ship has “run” a certain distance during the time interval between the two LOPs (<http://www.sailingissues.com/navcourse4.html>)}

running gear (n) (marine eng) stapni mehanizam

running lights (n) (navig) = **steaming lights** all the lights (masthead, side and stern lights) required by law to be shown by a vessel underway navigacijska svjetla broda u plovidbi

running moor (n) (navig) sidrenje na jednom sidru

running rigging 1 (nav arch) **ANTONYM standing rigging** the rigging of a sailing vessel that is used for raising, lowering and controlling the sails - as opposed to the standing rigging, which supports the mast and other spars. pokretna oputa (samarice, jarbola) vrv (zastarj.) tal. *attrezzatura corrente*; 2 pomična zaputka, pomični štraj, *patarac*

running rigging (boating/yachting) ropes used to control the sails pomična zaputka,



pomična oputa

run out (v) 1 (seamanship) izvlačiti (lanac), puštati (lanac), ispuštati (lanac): *The cable run out was brought under control by using the brake. ... the port windlass jumped out of gear, and the port cable ran out to 11 shackles in the water before it could be controlled. The chain started to run out very quickly and the Third Officer was ordered to put on the brake.*; 2 (med) iscrpsti se, ponestati (snage)

run the engine (v) 1 (boating/yachting) pustiti motor da radi; 2 pokrenuti motor

run the line from ... to ... (v) (seamanship) provući užu od ... do ...

rupture /ˈrʌptʃə/ (n) (nav arch) puknuće, napuklina: *A rupture in the forward bulkhead of center cargo tank No. 1 allowed oil from that tank to enter the forepeak tank.* Napuklina u prednjoj pregradi srednjeg tanka tereta br. 1 omogućilo je da nafta iz toga tanka uđe u tank pramčanog pika.

rust /ˈrʌst/ (v) **hrđati, rđati**

rust /ˈrʌst/ (n) **rđa, hrđa, rđanje, ruzina** *The wire was almost two years old and was without indications of **rust** or defects along almost all of its length. **rust flake** mrlja rđe: Water could be seen seeping into the ship, apparently from under a large **rust flake** at the ship's side., **rust scale** ljuska rđe, **kora rđe** However, a surveyor from the Federal Grain Inspection Service rejected some of the holds due to the presence of **rust scale** and loose paint.*

rust /ˈrʌst/ **rđa, ruzina chip rust** tući ruzinu, **piketat ruzinu**

rust preventer (n) (marine eng) zaštita od rđanja, antikoroziv

rustproof (n) nerđajući

rusty (adj) rđav, zardao

RV; (research vessel) (n) (nav arch) istraživački brod



RX monitoring; (RX MON) (n) (electr) provjera stanja prijavnika

sacrifice /ˈsækrɪˌfaɪs/ (n) (mar ins) žrtvovanje

sacrifice (v) (mar ins) žrtvovati: *sacrifice* a part of the property or earnings in order to save the maritime venture **žrtvovati dio imovine ili zarade kako bi se spasio pomorski poduhvat**

sacrificial anode (n) (boating/yachting, nav arch) zaštitna anoda (na propeleru, kobilici, kormiku itd.)

sacrificial anode material protektor (kod katodne zaštite), žrtveni anodni materijal

saddle /ˈsædl/ (n) (marine eng) sedlo, sjedište, nosač **transverse saddle** poprečni nosač

saddled bream (n) (fishing) Lat. Oblada melanura **ušata**, Ital. **occhiata**



safe (adj) 1 **siguran, bezopasan** far **safer** znatno sigurniji; 2 **dopušten**

safe berth; (SB) (n) (mar law, mar ins) klauzula u ugovoru u prijevozu o sigurnome mjestu ukrcavanja ili iskrcavanja tereta u luci koju određuje naručitelj **siguran vez (u brodarskim ugovorima)**

safeguard (n) (safety) zaštita, mjera zaštite as a safeguard against kao mjera zaštite za, amend safeguards dopuniti mjere zaštite

safeguard (v) zaštititi safeguard against zaštititi od, osigurati od

safely (adv) (safety, shipping econ) sigurno, na siguran način: *Make sure that cargo is carefully and safely loaded, stowed, separated, carried and discharged.*

safe port; (SP) (n) (mar law) luka u koju brod može pristati bez opasnosti fizičke ili političke naravi **sigurna luka (u brodarskim ugovorima)**

safe refuge (n) (meteorol) utočište (pred olujom)

safe speed (n) (navig, safety) sigurna brzina **maintain safe speed 1 držati**

sigurnu brzinu a: *instruction was give to the master to maintain safe speed at all times*, **proceed at safe speed ploviti sigurnom brzinom**

safe track (n) (safety, navig) siguran smjer plovidbe

safety (n) freedom from undue threat of harm to life, property and environment (Ship Terms

Glossary.html) **sigurnost:** *The safety of our people, at sea and on shore, is paramount to us*

safety at sea sigurnost na moru

safety at sea sigurnost na moru

safety at work zaštita na radu

safety belt (n) (safety) sigurnosni pojas

safety boots (n) (safety) zaštitne cipele

safety certificate svjedodžba o sigurnosti

safety check list (n) (safety) sigurnosna kontrolna lista **ship/shore safety check list**

safety code pravilnik o zaštiti

safety contour (n) (navig) sigurnosni obris, sigurnosna kontura (dna mora na karti ECDIS) **set the safety contour postaviti visinu sigurnosnog obrisa dna mora na**

karti ECDIS: *The safety contour of 10 meters was set on ECDIS, which was inappropriate, considering the sailing draught of 10.63 metres. A safety contour setting of 10 metres was inappropriate for the voyage as the sailing draft of 10.63 metres meant that the vessel would have grounded at a chartered depth of 10.13*

metres, before crossing the safety contour, **set of safety contour postavljeni sigurnosni**

obris, postavljena vrijednost sigurnosnog obrisa

safety equipment sigurnosna oprema

safety glasses (n) (seamanship) zaštitne naočale

safety harness (n) (boating/yachting) osobna sigurnosna oprema, sigurnosni pojas



safety helmet (n) (safety) zaštitna kaciga

safety hook (n) (safety) sigurnosna kuka

safety line (n) (safety) sigurnosno uže (za ulaz u zatvorene prostore)

safety management certificate (n) (safety) potvrda upravljanja sigurnošću

safety management procedures (n) (safety, navig) postupci u sustavu

upravljanja sigurnošću na brodu: *The SMS bridge procedures provided by the managers were comprehensive and included extensive guidance on the conduct of navigation using ECDIS.*

safety management system; (SMS) (n) (safety) sustav upravljanja sigurnošću (plovidbe, broda, kompanije)

safety meeting (safety) sastanak o sigurnosti (plovidbe): *A safety meeting was held on board in the presence of company management personnel soon after the incident*

safety message (n) (comm, navig, safety) poruka sigurnosti

safety officer (n) (safety, mar law) an officer responsible for a range of tasks related to safety and security of the ship, crew and cargo **časnik sigurnosti na brodu**

Safety of Life at Sea (SOLAS) Convention 1974 (n) (mar law) Convention for the Safety of Life at Sea, amended 1974, in force May 25, 1980, as amended. Adopted by the IMO
Konvencija o zaštiti ljudskih života na moru

safety regulations propisi o zaštiti

safety rules pravila o sigurnosti

safety stop (n) (safety) sigurnosno zaustavljanje, sigurnosno isključivanje

safety valve (n) (marine eng) sigurnosni ventil

safe water buoy (n) (navig) oznaka / plutača sigurne vode, oznaka / plutača



sigurne plovidbe

safe water mark (n) (navig) oznaka sigurne vode, oznaka sigurne plovidbe

Safe Working Load (SWL) (n) (safety, cargo handling) The Safe Working Load (SWL) of an item of ship's lifting gear is the safe maximum weight that can be lifted with the load suspended directly from the hook in the standard **dopušteno radno opterećenje, sigurno radno opterećenje**:

Lifting gear is to be marked with Safe Working Loads, and will prohibit the use of lifting gear for hoisting personnel. What is the safe working load of the slings? The vessel's forward and aft mooring fittings had an indicated safe working load (SWL) of 45 MT and those of the main deck 24 MT.

sag (v) (nav arch) **progibati se (o trupu broda)** The double bottom was unaffected, but the deck plating crumpled around amidships when **the hull sagged** on the uneven surface.

sagging /'sæɡɪŋ/ (n) (nav arch, cargo handling) **ANTONYM hogging** the deformation or yielding caused when the middle portion of a structure or ship settles or sinks below its designed or

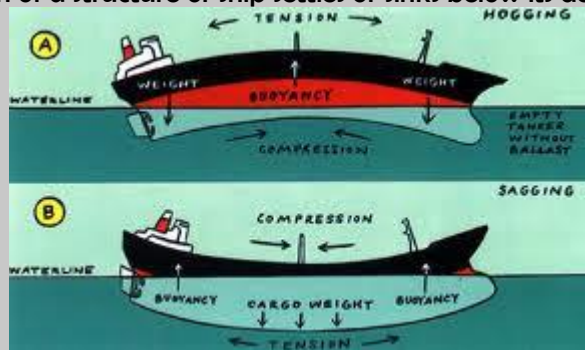

accustomed position **progib (broda)**

said to be (mar law) opaska u teretnici kojom zapovjednik izjavljuje da neki podatak nije unio na temelju svoga vlastitoga opažanja već prema iskazu krcatelja **navodno (u teretnici)**

sail (v) 1 a jedriti; 2 (navig) ploviti; 3 isploviti: *Having completed loading a cargo of toluene and styrene a pilot was ordered, and the vessel sailed at 1515.*

sail (n) (boating/yachting) **jedro sail bag** vreća za jedro, **sail cloth** tkanina za jedro, 1 **area** površina jedara, **sail cut** kraj jedra, **sail locker** spremište jedara, **sail maker** jedrar, **sail needle** jedrarska igla, **sail number** broj na jedru, **sail plan** plan kroja jedra, **sail surface** površina jedra

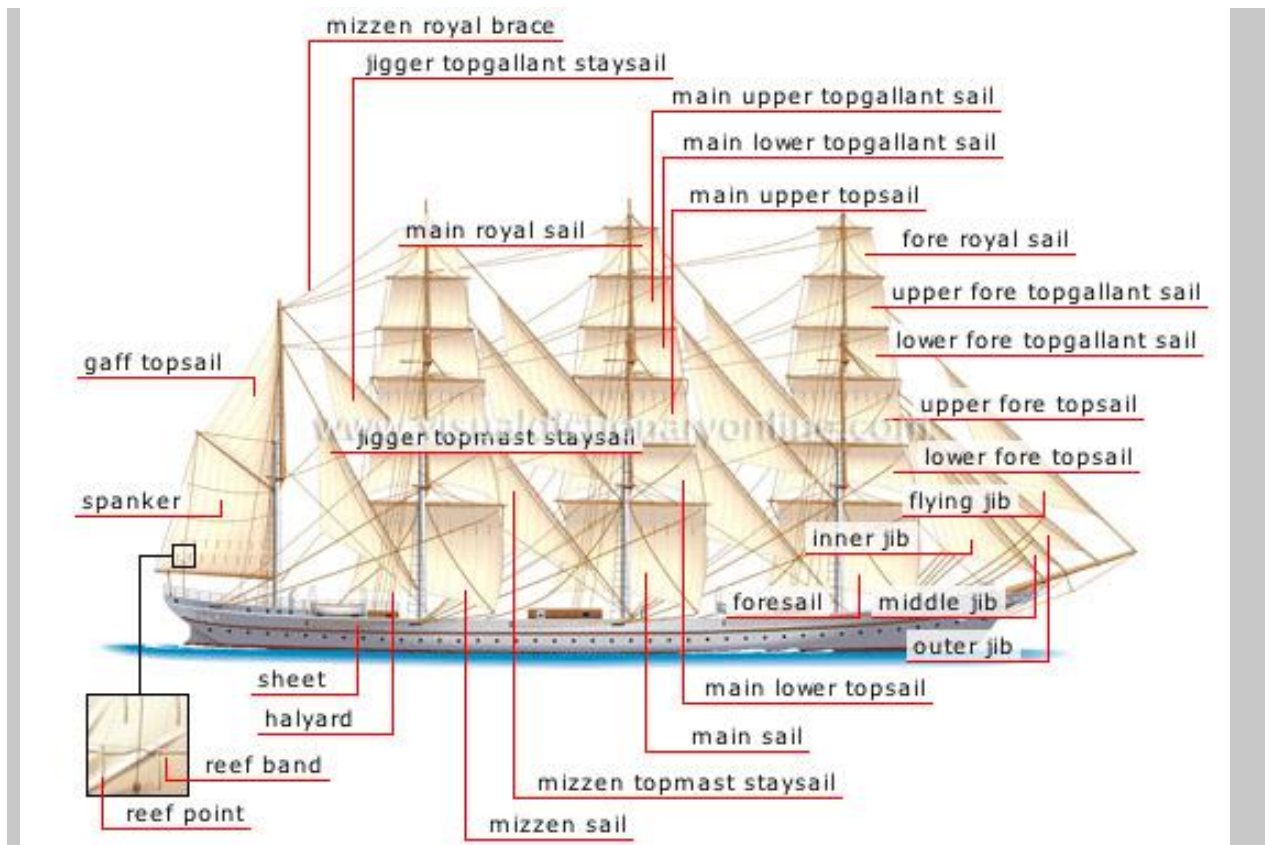

sail away (n) (*nav arch*) the date of the ship's final departure from the construction yard for its homeport or commissioning site (<http://www.uscg.mil/acquisition/programs/glossary.asp>) **dan isplavljanje broda iz brodogradilišta**

sail balance (n) (*boating/yachting*) uravnotežena jedra

sailboard (n) (*boating/yachting*) daska za jedrenje

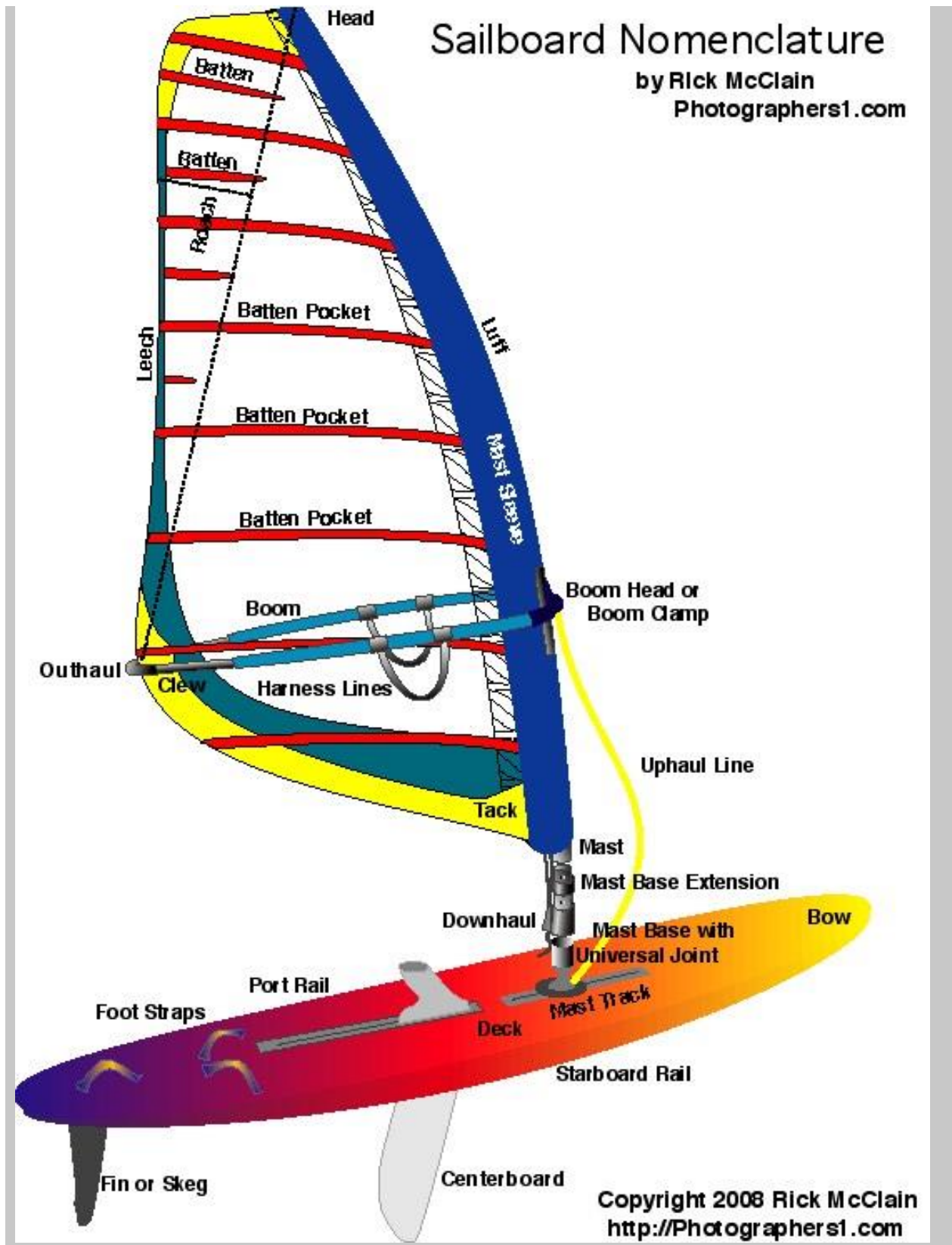

Copyright 2008 Rick McClain
<http://Photographers1.com>

sailboat /ˈseɪlˌboʊt/ (n) (US) 1 (nav arch, boating/yachting) = sailing boat jedrilica

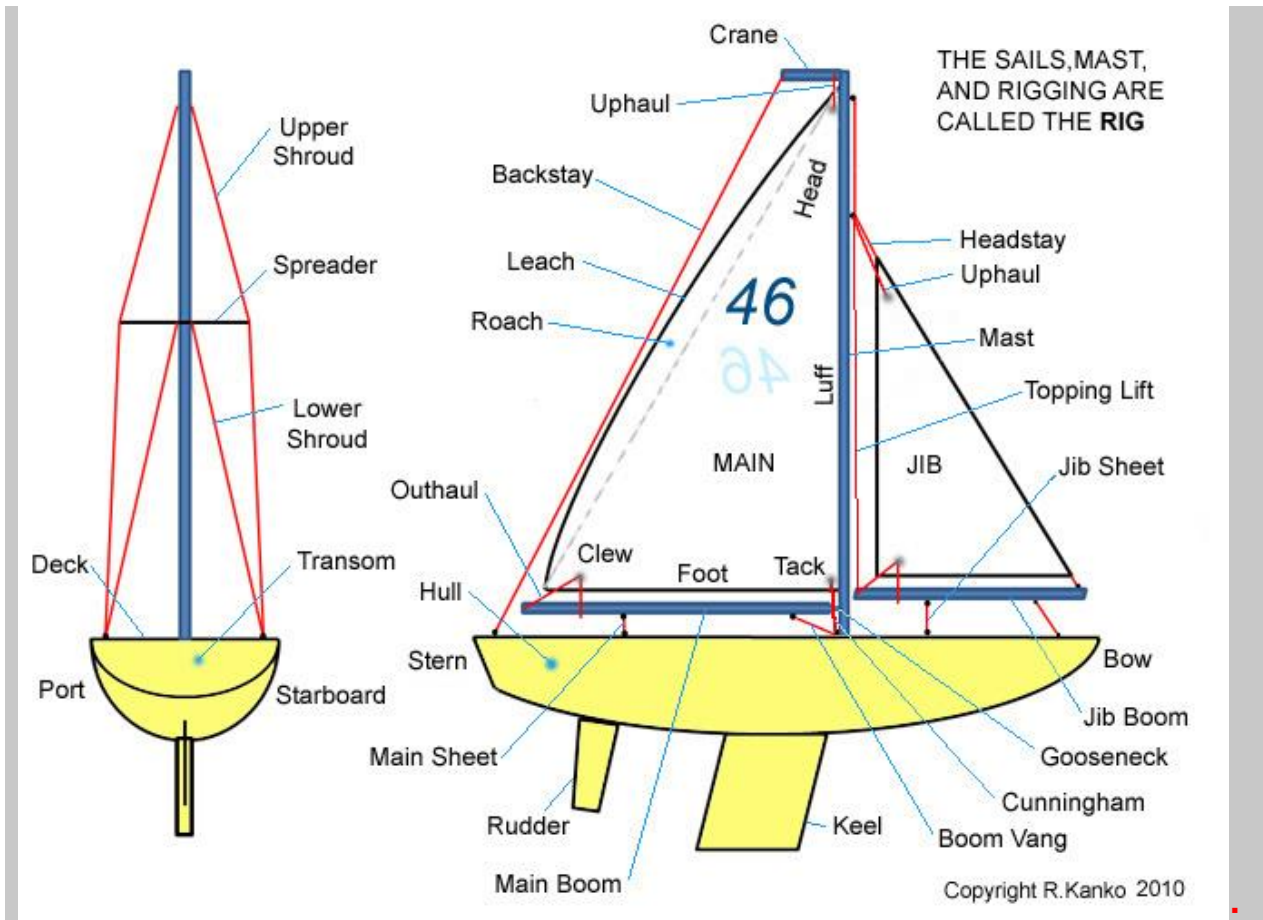

2 krstaš (za razonodu, obiteljski itd.)

sail downwind (v) (boating/yachting) jedriti od vjetra

sail drive; S-drive (n) (nav arch) a transmission system for a boat whose inboard engine has a horizontal output shaft **S-pogon** (jedrilice)

sail hook (n) (boating/yachting) jedrarska kuka

sailing (n) **1** (shipping econ) isplovljenje, polazak broda (iz luke, u linjskoj plovidbi):

Competitive high frequency sailings have led to increased containerised throughput Is the ship safely moored/anchored, gangway in place, and ready for sailing? Je li brod sigurno privezan/usidren, siz

postavljen i spreman za isplovljenje?; 2 (boating/yachting) jedrenje; **3** (boating/yachting) plovidba jedrilicom / krstašem

sailing boat (n) (UK) **1** (boating/yachting) jedrilca; **2** (nav arch) jedrenjak

sailing card (n) (shipping econ) popis linijskih polazaka (iz neke luke u jednom danu, tjednu, mjesecu)

sailing date datum / dan polaska broda datum isplovljenja

Sailing Directions (n) (navig) provides essential information for the port, port facilities and coastal navigation. Each book covers the navigation and regulations for the area covered **upute za**

plovidbu, rute tal. portolano Sailing Directions abstract sažetak uputa za plovidbu

sailing draught (n) (navig) gaz pri isplovljenju

sailing instructions (n) (navig) upute za plovidbu, nalog za plovidbu

sailing knife (n) (boating/yachting) jedriličarski nož

sailing list = **sailing schedule** plovibneni red, red polazaka linijskih brodova, sailing lista

sailing regatta (n) (boating/yachting) jedriličarska regata

sailing schedule plovibneni red, red plovidbe, red vožnje, vozni red

sailing ship (n) (nav arch) jedrenjak

sailing ship rigging (n) (boating/yachting) oputa jedrenjaka

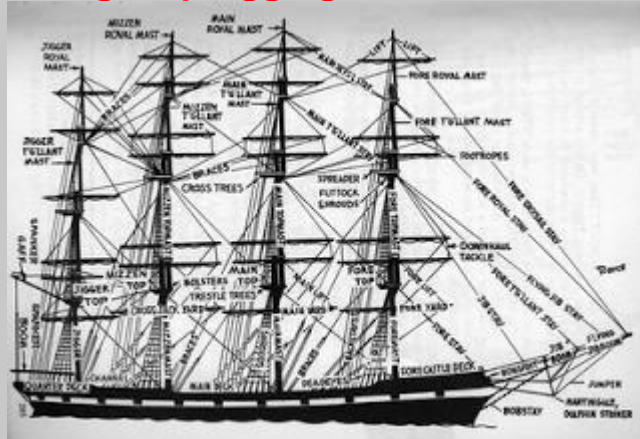

sailing vessel 1 a ny vessel under sail provided that propelling machinery, if fitted, is not being used (COLREGS) jedrenjak brod na jedra; 2 jedrilica

sailing yacht (n) (boating/yachting) sportska jedrilica

sailmaker's awl (n) (boating/yachting) jedrarsko šilo

sailmaker's needle (n) (seamanship) jedrarsko šilo, mornarsko šilo

sailmaker's palm (n) (seamanship) jedrarski dlan

sail match (n) (boating/yachting) = **sailing regatta** jedriličarska regata

sailor (n) mornar

sailor bag (n) (seamanship) mornarska vreća

sailor chest (n) (seamanship) mornarska škrinja

sailor knife (n) (seamanship) mornarski nož

sail panel (n) (boating/yachting) vodoravni, okomiti ili kosi redovi platna koji čine jedro **krojka** (jedra ili špinakera)

sail setting (n) (boating/yachting) namještanje jedara

sail ties vezice za jedro oko buma

sail trimming (n) (boating/yachting) trimanje jedara

sail upwind (v) (boating/yachting) jedriti prema vjetru

sail window (n) (boating/yachting) prozor u jedru, prozirni prozor u jedru

sail yacht (n) (boating/yachting) jedrilica za samostalna obiteljska, komercijalna ili sportska kružna putovanja duž obale i na otvorenome moru **krstaš**

Saint Nicholas /,seɪnt ˈnɪkələs/ (n) 4th-century ad bishop of Myra, in Asia Minor; patron saint of children, sailors, merchants, and pawnbrokers. Feast day: Dec 6 **Sveti Nikola**

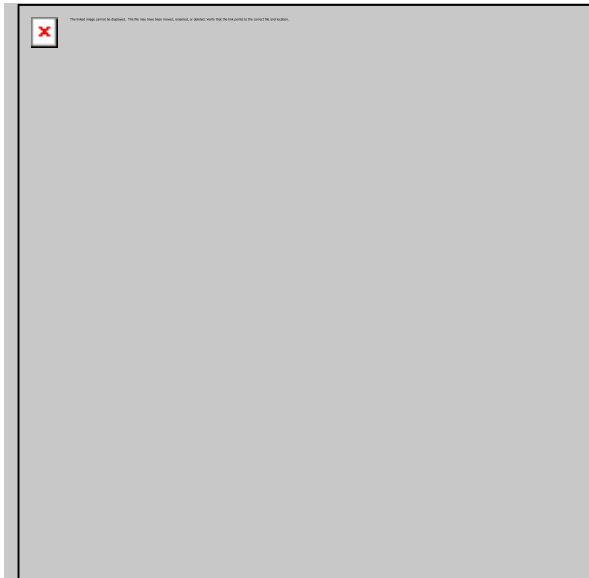

sale (n) prodaja contract of sale ugovor o prodaji, terms of sale kupoprodajni uvjeti, uvjeti prodaje

salema (n) (fishing) Lat. Sarpa salpa **salpa**



sale of ship (n) 1 a (mar law) prodaja broda; 2 prodaja zaplijenjenog ploda

saling list = **sailing card** sailing lista

salinity /sə'liniti/ (n) slanost, slanoća, salinitet

salinometre /sæli'nɒmitə/ (n) salinometar

sally the ship (n) (seamanship, boating/yachting) odsukavati brodicu (naginjanjem s jedne na drugu stranu)

salmon /'sæməŋ/ (n) (fishing) losos

salmon-trout (n) (fishing) pastrva

saloon /sə'lu:n/ (n) (boating/yachting) salon

saltie (seamanship) Great Lakes term for a vessel that sails the oceans **morski brod** ('sɔ:lti)

salt sediment (n) posolica

salute /sə'lu:t/ (n) (navy) vojnički pozdrav, **salva**

salvage /'sælvɪdʒ/ (n) **1 (mar ins)** The salvor has a claim of salvage reward if he has successfully and voluntarily salvaged maritime property in danger. The civil law term is assistance permitting the salvor to be rewarded whether the salvage was successful or not **spašavanje: spašavalačko društvo**
salvage agreement ugovor o spašavanju, **salvage claim** zahtjev za naknadu štete, **odštetni zahtjev**, **salvage operations** operacije spašavanja, **salvage remuneration** naknada za spašavanje, **salvage reward** nagrada za spašavanje, **salvage award** nagrada za spašavanje, **subject-matter of salvage** objekt spašavanja; **2 (safety)** spasilačko društvo, spašavateljsko društvo, spasilac, spašavatelj, spašavateljska kompanija: *Ship owner has hired SMIT Salvage to rescue the vessel.*

salvage award (n) (mar ins) nagrada za spašavanje

salvage company spasilačko društvo, spasilac, spašavatelj **hire a salvage company:** *The ship owner has hired SMIT Salvage Company to rescue the vessel.*

salvage contract (n) (mar ins, mar law) ugovor o spašavanju

salvage craft (n) (nav arch) spasilački brod

salvage crew (n) (safety) spasavalačka grupa: *A US freighter that ran aground in Lake Superior is still stuck Tuesday as salvage crews continue on plans to refloat the vessel*

salvage retention (n) (shipping econ, mar law) držanje primljene oštećene robe: *Salvage must be retained until the claim is resolved, or until the claimant is given disposition by the carrier.*

salvage reward (n) (mar ins) nagrada za spašavanje

salvage services (n) (n) (safety, mar law) usluge spašavanja

salvage tug preoceanski tegljač (za gašenje i spašavanje)

salvage vessel (n) (nav arch) spasilački brod

salve (v) (mar ins) spasiti

salved value spašena vrijednost

salvor /'sælvə/ (n) (mar law, mar ins) = **salvage company** pravna osoba koja samoinicijativno ili na poziv pristupa otklanjanju opasnosti koja prijete ljudima ili imovini na moru **spašavatelj, spasilac, spašavateljsko društvo:** *Salvors boarded the ship on 4 April. The Coast Guard said Friday that salvors will need to unload about 6,000 tons of cargo from the vessel before it can be refloated.*

salvor's expenses (n) (mar law, mar ins) troškovi spašavatelja

salvage award (n) (mar law, mar ins) nagrada za spašavanje

sample /sa:mpəl/ **uzorak (npr. tereta):** *All samples should be sealed, labelled and stored for possible future reference.*

sample can kantica za uzorke

samson post (n) **1 (boating/yachting)** a strong vertical post used to support a ship's windlass and



the heel of a ship's bowsprit **privezni stup (na pramcu)** ; 2

(cargo handling) = king post teretni stup, stup samarice: *The derricks are supported by masts or samson posts.*

sand pijesak coarse grained sand **krupnozrnati pijesak**: *The strainers were blocked with coarse grain sand and shells*

sandbar (n) (oceanogr) = **bar** = offshore bar **pješčani nanos (u ušću rijeke)**



sand paper (n) (marine eng) brusni papir, **karta žmarilja**

sand smelt (n) (fishing) gavun **big scale sand smelt** gavun oligi, oligi {lat. *Atherina presbyter*}

sanitary sewage systems (n) (marine eng) sanitarni odvodni sustavi, sanitarna kanalizacija

Sanitary Statement (n) (mar law) izjava zdravstvenih organa

SAR co-ordinator; SC /,sa:kəʊ'ɔ:di,nertə/ (n) (safety) koordinator traganja i spašavanja, SAR koordinator

sardine /sa:'di:n/ (n) (fishing) lat. *Sardina pilchardus* **srdela**, **sardina Atlantic sardine** srdela, sardina

SAR Mission co-ordinator (n) (safety) koordinator u centru za usklađivanje traganja i spašavanja

SAR (Search and Rescue) (n) (safety) potraga i spašavanje, traganje i spašavanje **International Convention on Maritime Search and Rescue** **Međunarodna konvencija o pomorskom traganju i spašavanju**

SART; Search and Rescue Transponder (n) (navig, safety) A SART is a portable battery powered radar transponder which operates on "x-band or 3 cm radar". **transponder za traganje i spašavanje**: *In the GMDSS (Global Maritime Distress and Safety System), certain classes*

of vessel must carry a SART. **detuning of SART; Search and Rescue Transponder**



resetiranje SART-a (kad je SART vrlo blizu broda)

{In an emergency situation when the SART detects the incoming radar pulse from a searching aircraft or ship it responds by transmitting a distinctive signal which shows up on the radar screen of the searching vessel as a series of 12 blips extending approximately 8 nautical miles outward from the SART's position along its line of bearing.}

satellite communication (SATCOM) /ˈsæteˌlaɪt/ **satelitska komunikacija**

satellite communications (SATCOM) 1 **satelitske komunikacije**; 2 **uređaj satelitskih komunikacija, satelitski uređaj**

satellite navigation (SATNAV) Satellite navigation uses artificial earth satellite systems, such as GPS, to determine position (Bowditch 2001) **satelitski navigator, uređaj satelitske navigacije**

satellite navigation system (n) (navig) **satelitska navigacija**

satellite navigator (SATNAV) **satelitski navigator**

satnav receiver /ˈsætnæv/ **satelitski prijamnik**

SATNAV; (satellite navigation system) (n) 1 (navig) **satelitski navigacijski**

sustav, sustav SATNAV configuration of SATNAV; (satellite navigation system)

konfiguracija sustava SATNAV, coarse acquisition code - C/A (u sustavu GPS)

modulacija C/A, precision code (P/C) modulacija P/C, precise positioning service

služba preciznog pozicioniranja, anti-spoof (A/S) uređaj protiv prijevare, selective

availability (S/A) mogućnost selekcije; 2 (navig) satelitski navigator

saturated passage (n) (marine eng) **zasićeni prolaz, kanal zasićene pare**

saturation /ˌsætʃəˈreɪʃən/ (n) (marine eng) **zasićenje**

save (v) **spasiti**

sawn timber /sɔːn/ (n) (cargo) = **sawn wood** **rezana (drvena) građa**

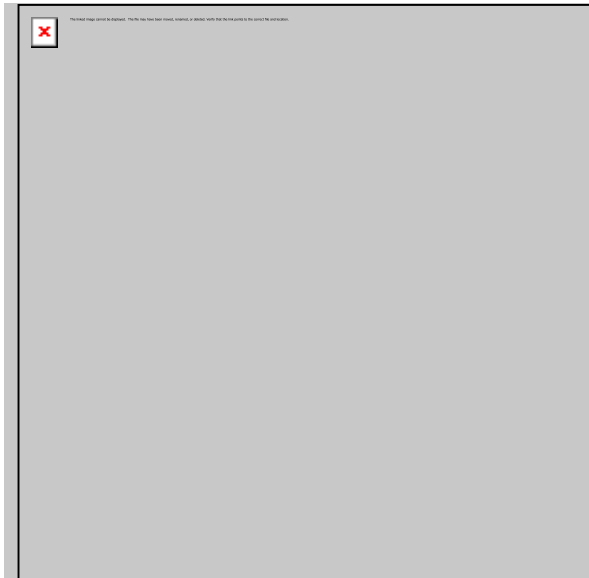

sawn wood /sɔ:n/ (n) (cargo) rezana (drvena) građa

sawtooth current (n) (electr) pilasta struja

S-band radar; 10 cm radar (n) (navig) COMPARE X-band radar; 3 cm radar

radar S-pojasnog područja, radar pojasnog područja S, S radar,

desetcentimetarski radar: A common marine radar wavelength is 10 cm (actually 9.2 to 10 cm) with a frequency of 3000 to 3246 megahertz. This is known as S-band radar. {S-band radars are suited to long range landfall navigation and early detection of targets for collision avoidance, due to their superior range and the cohesive quality of their pulses.}

SBP (safe berth, port) (shipping econ) siguran vez, luka

scaffolding /'skæfəldɪŋ/ (n) (nav arch) temporary wooden or metal structures for supporting workmen, tools, etc. skela (kod gradnje broda)

scale /skeil/ 1 **scale on the ECDIS display** kružnica udaljenosti na pokazivaču

ECDIS-a, udaljenost na pokazivaču ECDIS-a: The OOW selected the scale on the ECDIS

display that closely aligned with the 12 nm range scale set on the adjacent radar display., **scale of ENC**

mjerilo na na elektroničkoj navigacijskoj karti: The scale of ENC in use was unsuitable for the area. a mjerilo (na pomorskoj karti), omjer **small-scale chart** karta malog mjerila,

large-scale chart karta velikog mjerila; 2 ljestvica, skala; 3 vaga

scale (n) (marine eng) kamenac, kotlovac **scale formation** stvaranje kamenca, **scale**

deposit talog kamenca, naslaga kamenca, **cause scale** izazvati stvaranje kamenca

scallop /'skɒləp; 'skæləp/ (=great Mediterranean scallop) (n) (fishing) Lat. *Pecten*

jacobaeus jakopska kapica, kapešanta, lepeza, čančula, jakovljeva kapica, klapun,



kapica

scalop /'skæləp/ (n) (nav arch) otvor za prolaz zavara, tekućine i plinova kroz strukturni element **izrez, skalop**

scampi /'skæmpi/ (n) škamp

scanner /'skæne/ (n) 1 (navig) **radarska antena**: Check that the scanner is free to rotate so as not to foul rigging and that no crew members are working in the vicinity of the scanner. **slotted**



waveguide scanner antena s prorezima antenski sustav ; 2 (nav arch)

scanning (n) (navig, electr) okretanje radarske antene, pretraživanje radarom, radarsko snimanje, **skeniranje**

scanning pretraživanje **radar scanning** radarsko pretraživanje

scantling draught /'skæntliŋ/ (n) (nav arch) konstrukcijski gaz

scantling freeboard /'skæntliŋ/ (n) (nav arch) nadvođe čvrstoće

scantling length (n) (nav arch) konstrukcijska dužina broda

scantlings /'skæntliŋz/ (n) (cargo) 1 (nav arch) the collective dimensions of the various parts, particularly the framing and structural supports. Often used in the plural. ; details and dimension of

structural members of the vessel, the dimensions of a ship's structural members **konstrukcijske dimenzije broda, konstrukcijske dimenzije dijelova broda**; 2 četvrtače, grede

scarph /ska:f/ (n) (nav arch) preklopni spoj okvira

scatter /'skæte/ (navig) raspršivanje **back scatter** reflektivno raspršivanje svjetla (na radaru, ekranu)

scattered cloud (n) (meteorol) raspršeni oblaci

scatterer /'skæteə/ (n) (electr, navig) reflektor

scattering (n) (*electr, navig*) rasipanje (energije, radarskog snopa)

scattering diagram (n) (*math*) rasuti dijagram

scavenge /'skævɪndʒ/ (n) (*marine eng*) ispiranje (c cilindra), propuhavanje, odstranjivanje plinova u dizel motoru **insufficient scavenge pressure** nedovoljan tlak ispiranja, **uniflow scavenge** istosmjerno ispiranje, **scavenge oil filter** filter

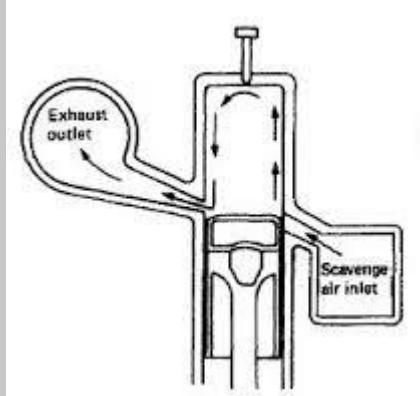

ispirnog ulja

scavenge fire (n) (*marine eng*) požar u ispirnom prostoru: Carbonized lube oil, unburned fuel oil and carbon from the residual products of the combustion spaces are accumulated in the scavenge spaces with the running of the engine. Under certain faulty running condition of the engine, these may ignite causing a fire in the enclosed scavenge space, known as scavenge fire.

scavenging (n) (*marine eng*) Scavenging is the process of removing exhaust gases from the cylinder after combustion and replenishing the cylinder with fresh air. **ispiranje (cilindra), propuhavanje, odstranjivanje plinova u dizel motoru**: Satisfactory Scavenging Depends on efficient evacuation of exhaust gases. **scavenging air** zrak za ispiranje, **zrak za propuhavanje, cross scavenging** poprečni sustav ispiranja, **loop scavenging** obrnuti sustav ispiranja, **okretno ispiranje, vrtložno ispiranje, uniflow scavenging** istosmjerni sustav ispiranja, **uzdužno ispiranje, scavenging port** ispirni kanal, **scavenging pump** ispirna pumpa, **scavenging system** ispirni sustav, **sustav ispiranja**

scene /si:n/ (n) (*safety*) mjesto nezgode **on scene** na mjestu događaja: Two tug boats remain on scene with the damaged vessel to help maintain its position. na mjestu nezgode

schedule /UK 'fedju:l, US 'skedʒu:l/ (n) 1 red vožnje **sailing schedule** red vožnje, red polazaka linijskih brodova iz luke; 2 popis, tabela; 3 program, plan

scheduled service /'fedju:ld/ redovita linija, redovita linijska plovidba

schematic /ski:'mætik/ (n) **schematic of vessel** shema broda (za plan tereta) (*cargo*) shematski prikaz, shema

scheme /ski:m/ (n) 1 shema **ship reporting scheme** (*navig, comm*) shema izvješćivanja (o poziciji broda itd.), **mandatory scheme** međunarodnim propisima obvezna zona izvješćivanja **obvezna zona javljanja / izvješćivanja; 2 zona traffic separation scheme** (*navig*) zona odvojene plovidbe; 3 plan; 4 program

scholarship (n) (*shipping econ*) stipendija **maritime scholarship** stipendije za pomoračka zanimanja: The Singapore government, in collaboration with maritime businesses and local seafarer unions, on 13 August awarded SGD2.6 million (USD1.8 million) in maritime scholarships for students taking up maritime studies. **award scholarship** dodijeliti stipendiju, **receive**

scholarship primiti stipendiju

school (n) (fishing) jato (riba)

schooner /'sku:nə/ (n) (boating/yachting) a sailing vessel with two more masts with the tallest mast



stepped aft **škuner, škuna**

schooner-brig (n) (nav arch) škuner s dvama jarbolima koji se od brika razlikuje rasporedom jedrilja **brik-škuner**

school of fish (n) (fishing) jato riba: Schools of fish are located and enticed into a feeding frenzy by maintaining a constant supply of live or dead baitfish to the water in a process known as 'chumming'.

scientific research ship (n) (nav arch) znanstvenoistraživački brod

scissor platform /'sizə/ (n) (cargo handling) dizalo u obliku škara za podizanje i premještanje tereta s palube na palubu u ro-ro brodovima **škare za dizanje tereta scissor-supported platforms** dizalo na škarama

scoop aboard /'sku:p/ (=sku:p) (v) (boating/yachting) popeti se na jedrilcu (ispravljenju nakon prevrtanja)

scoop bailer /'sku:p ,beilə/ (n) (boating/yachting) ispolac

scope /skəʊp/ (n) 1 a opseg doseg; 2 područje (rada)

scope of chain (n) 1 (navig, seamanship) the ratio between the length of rode deployed and the distance the boat is from the seabed (the height from the seabed to the bow-roller or hawse-pipe, not just depth).; the ratio between length of chain paid out and water depth **raspon lanca**

(primjerena dubini sidrenja), **dužina lanca u moru, dužina sidrenog lanca u**

odnosu na dubinu mora: Poor bridge team management, error chain not identified; Inadequate clearance from submarine cable; Inadequate **scope of chain/cable** under prevailing conditions; Ineffective anchor watch. ... a **scope of chain cable** between 6 and 10, the scope being the ratio between length of

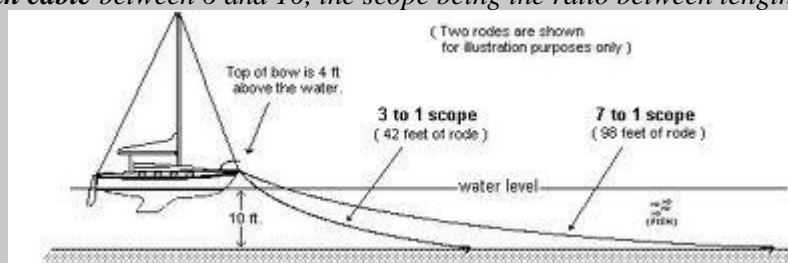

chain paid out and water depth.

the length of anchor rope or cable paid out and the area over which it may range **raspon sidrenog lanca dužina sidrenog lanca u moru** (ubičajena je dužina lanca koja odgovara umnošku: dubina mora puta 5)

SCOPIC Clause (n) (mar law) The Special Compensation P. & I. Club Clause (SCOPIC Clause)

refers to the agreement, which first became effective August 1, 1999, between members of the International Salvage Union (I.S.U.), the International Group of P. & I. Clubs, and certain property underwriters, providing a mechanism for remunerating salvors on the basis of a fixed tariff of daily rates for tugs, equipment and personnel used, rather than by arbitration on the basis provided by arts. 13 and 14 of the Salvage Convention 1989 (Tetley) **odredba SCOPIC**

scorpion fish (=sea scorpion; largescaled scorpionfish) (n) (fishing) Lat.

Scorpaena scrofa **škarpina, škrpina** red **scorpion fish** **škarpina**, small red **scorpion fish** **škarpinica**, black **scorpion fish** **škarpoč, škrpoč**



{lat. Scorpaena

scrofa}

Scotch bollard bitva u oplati broda (za teljenje na kratko)

Scotch derrick *igla* (obalna samarica za teške terete)

Scots law (n) (*mar law*) The uncodified civil law of Scotland, which has been strongly influenced by English common law and United Kingdom statutes. (Tetley) **škotsko pravo**

SCOW /skaʊ/ (n) (*nav arch*) manja barka s ravnim dnom **batana**

scrap¹ (v) (*nav arch*) baciti (brod) u staro željezo, otpisati

scrap² (n) (*nav arch*) staro željezo: *A ten-year boxship has been sent for scrap recently.*

scrape (v) (*safety*) **grebati, ogrebati, strugati, ostrugati**: *She was tracking well clear of us until, at a mere 8 cables range, she decided to take the deep-draught channel, turned to port and scraped down our port side less than 2 cables off. by trawl gear, the fishing vessel responded slowly and, despite the evasive action, the cargo ship collided with her starboard gantry and scraped down her starboard side.*

scrape off /skreɪp/ (v) (*marine eng*) **ostrugati, otirati, piketati**

scraper /'skreɪpə/ (n) (*boating/yachting*) **strugača**

scrap metal /skræp/ (n) (*cargo*) **staro željezo**

scrapping The disposal of old or damaged vessel tonnage by way of sale as scrap metal. ; demollition

or recycling of ships **prodaja broda u staro željezo, bacanje u staro željezo, predaja broda u rezalište**: *Since the ship was beyond repair the company sold the ship for scrapping*
scraps (n) (shipping econ) materijal nastao nakon rezanja broda **staro željezo iron scraps**
staro željezo

scrapyard (n) (shipping econ) rezalište brodova

scratch (v) 1 (marine eng) grepsti, ogrepsti; 2 iscrtati, urezati crte

screen /skri:n/ (n) (electr, navig) zaslona, ekran, katodna cijev

screened /skri:nd/ (adj) (marine eng) zaštićen

screening (n) 1 (marine eng) odjeljivanje, izdvajanje, sortiranje; 2 (marine eng) a spray seal; a strip/layer of wood, plaster, or metal placed on a surface to act as a guide to the thickness of the cement or plaster coat to be applied **žaititni omotač cijevi**: *It was also observed that the joint and the fuel pump inlet pipe bosses were not covered with approved splash prevention screening, as required under Solas. For many years now my company has fitted simple screening around vulnerable areas so as to dump any spray or leak into the bilge, rather than onto a hot surface.*

screen tube /skri:n/ (n) (marine eng) cijev zaslona, ekranska cijev

screw /skru:/ (n) 1 (marine eng) vijak, vida; tal. vite **adjusting screw** vijak za regulaciju, set **screw** pritezni vijak; 2 (nav arch) brodski vijak, propeler

screw die (n) (marine eng) nareznica, mašći

screw pump (n) (marine eng) vijčana pumpa, pužna pumpa

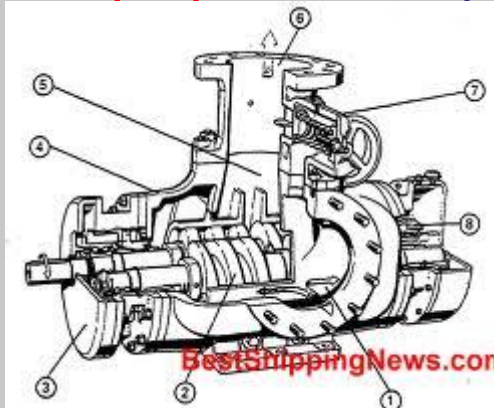

screw transporter pužni prijenosnik, puž

scrub brush (n) (seamanship) gruba četka (za pranje paliube itd.)

scrutinise /'skru:tinaiz/ (v) pomno pregledati

sculling /'skʌliŋ/ (n) 1 (seamanship) veslanje s krme; 2 pomigavanje, tal. voga a bratto

scupper /'skʌpə/ (n) (nav arch) openings in the side of a ship to carry off water from the waterways or from the drains **odljev (s palube), izljevnica, izljev, manikela**: *Scuppers are located in the gutters or waterways, on open decks, and in corners of enclosed decks, and connect to pipes, usually leading overboard* **scupper plug** čep odljeva **remove scuppers** skinuti čepove odljeva, **plug the scuppers** začepiti odljeve, **scupper pipe** odljevna cijev na palubi



{tal. ombrinale}

scurvy; scurvey /'skɜːvi/ (n) (med) skorbut

scuttle /'skʌtəl/ (v) (safety) to sink a vessel deliberately by boring holes in her bottom or by opening sea valves; the act of deliberately sinking a vessel **naplaviti brod bušenjem ili otvaranjem**

kingston ventila (namjerno, radi gašenja požara): *The wrecked Bulk Carrier will be scuttled off Mexico*

scuttle /'skʌtəl/ (n) (nav arch) a small opening, or lid thereof, in a ship's deck or hull **okno, otvor s poklopcem (na palubi ili trupu)**: *A porthole on a ship may also be called a sidescuttle or side*



scuttle (side hole), as officially termed in the SOLAS Convention. 0

SDME; Speed and Distance Measuring Equipment (n) (navig) uređaj za mjerenje brzine i pređenog puta

S.D.R. (special drawing rights) (n) (mar law) Special Drawing Rights are an international value used to provide a regular comparative evaluation by the International Monetary Fund of the currency of member nations. Value of a national currency will rise in S.D.R.s as the value of the national currency rises on the world market. S.D.R.s therefore are a fair evaluation of the comparison of national currencies one with another and as such useful as a valuation for limitation in an international convention. (Tetley) **specijalna prava vučenja**

SDR (special drawing rights) (n) (mar law, shipping econ) posebna prava vučenja

sea (n) big **seas** veliki valovi, calm **seas** bonaca, tiho more, **choppy seas** nemirno more, **uzburkano more**, slight **seas** malo valovito more, **smooth seas** more bez valova mirno more, **heavy seas** veliki / visoki valovi, **in heavy seas** na velikim valovima, **rough sea** jako valovito more, **cross sea** križano more / valovi, **confused sea** križano more, **at sea** na moru, **on the open sea** na ovorenom moru, **in / on the**

high sea na otvorenom moru, u međunarodnim vodama, **to go to the sea** uputiti se na more / u plovidbu, postati pomorac, **to go to sea** ukrcati se na brod (kao pomorac), **enough sea room** dovoljno prostora za manevriranje **1 more**; **2** a large wave val, valovi

Sea Acceptance Test (SAT) (n) (navy, navig) svjedodžba o ispitivanju u pokusnoj vožnji: *Raytheon Anschütz, a leading integrator of naval integrated bridge systems, has successfully completed the Sea Acceptance Test (SAT) for the Synapsis Tactical Command System (SYNTACS) aboard a series of new Interceptors and Patrol Boats*

sea anchor (n) (navig, safety) = **drogue** a drag or drogue (a conical shaped canvas bag) thrown over to keep a vessel to the wind and sea **strujno sidro, zavláčno sidro, tal. ancora galleggiante**

sea-bass /'si:bæs/ (=seabass; sea-bass; sea bass) (n) (fishing) luben, brancin, It. *spigola*; **branzino** European seabass luben, brancin



{drugi hrv. nazivi: agač, brancin, dut,

levrek, smudut, vuk, lubin, morski grgeč ; lat. *DICENTRARCHUS LABRAX* ; tal. *spigola*}

seabed (n) (geogr) morsko dno, tal. *fondale* types of 1 vrste dna

seabee ship /'si:bi:/ (n) (nav arch) brod za prijevoz teglenica tipa Seabee, Seabee-brod

seaboard **1** land bordering on the sea; the seashore obala; **2** primorje, priobalje a tourist centre on the US eastern **seaboard** turističko središte u istočnom američkom primorju

seaboats (n) (seamanship) mornarske čizme

seaborne (adj) morski, koji ide morem, koji se kreće morem

seaborne transport (n) (shipping econ) pomorski prijevoz

sea bream (=seabream; sea-bream; sea bream) (n) **1** (fishing) = **gilt-head**

bream English name for marine sparid fishes. The Sparidae family is also known as **porgies**. These fish have certain distinctive features that make them easily identifiable. First, their bodies are relatively flat. The line from the dorsal area to the front of the fish descends very rapidly giving the face a flattened appearance, especially when viewed in profile. Their color varies widely from species to species, mainly depending on water type and environment. In brackish waters, for example, the fish tend to be darker, with shades of blacks and grays to help them blend in with the environment. Some fish, in other areas, even have a bright red appearance, showing how diverse members of the family can be.

(<http://www.wisegeek.org/what-is-sea-bream.htm>) **ribe iz porodice Sparidae (orade itd.),**

podlanica, komarča, orada, lovrata, It. orata; cagnina: *Sea bream are a variety of fish*

species that are very popular for eating, especially in Europe. ; **2** **ribe iz porodice Sparus aurata (arbuni itd.)** {lat. *pagellus centrodontus*}

sea breeze (n) (meteorol) a wind that blows from a sea or ocean towards a land mass **smorac, vjetar s mora, maestral**

sea carrier; sea-carrier (n) (mar law, shipping econ) morski prijevoznik, pomorski prijevoznik, brodar

seacat (n) (fishing) morska mačka

sea chart (n) (navig) pomorska karta

sea chest (n) 1 (nav arch) a rectangular recess in the hull of a ship. The sea chest provides an intake reservoir from which piping systems draw raw water. **usisni tank morske vode, usisni koš**: A structural sea chest is fitted with strainers or gratings, and sometimes has a lip that forces water into the

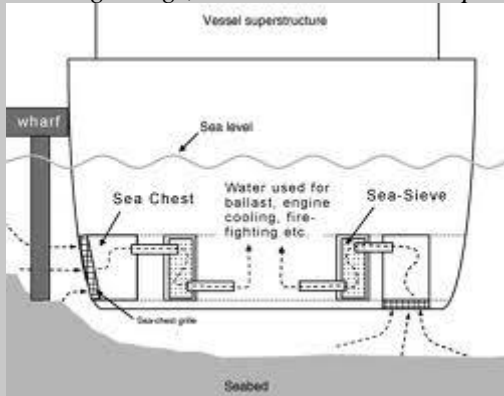

sea chest when the ship is underway.

sailor's trunk **mornarska škrinja**

sea clutter (n) (navig, electr) Echoes from waves cover the central part of the display with random signals known as sea clutter **smetnje zbog morskih valova (na radarskoj slici) suppress the sea clutter smanjiti smetnje zbog valova, ukloniti smetnje zbog valova**: When sea clutter masks the picture, it can be suppressed by the A/C SEA controls and by a combination of A/C RAIN and GAIN controls. **sea clutter suppression level razina smanjenja smetnja zbog valova, sea clutter control kontrola za uklanjanje / ublažavanje smetnja od mora i valova**: At sea the sea clutter control (STC) must be continually monitored and adjusted. 0

seacock /si:kɒk/ (n) (boating/yachting) usisni ventil mora, ventil mora, **kingston, tal. presa a mare**

sea cock (n) (nav arch) ventil za sprječavanje prodora ili za ispuštanje morske vode na plovnome objektu; a sea valve secured to the plating of the vessel below the waterline for use in flooding tanks, magazines, etc., to supply water to pumps, and for similar purposes (SeaSources.net) **ventil morske**



vode, ventil mora, tal. presa a mare

sea crow (n) (fishing) = corb grb

sea devil (n) (fishing) = frogfish grdobina

sea eel (n) ugor

seafarer /'si: fæərə/ **able-bodied seafarer** (AB) kormilar, stariji mornar, junior

seafarer mlađi mornar, **ordinary** 1 mornar 1 pomorac; 2 moreplovac

Seafarer's Book Number (n) (mar law) broj pomorske knjižice

Seafarers' Day (n) (seamanship) = **Day of the Seafarer** Međunarodni dan pomoraca

Seafarer's Identification and Record Book (n) (mar law) pomorska knjižica

sea fog (n) (meteorol) morska magla

seagoing (adj) (shipping econ) prekomorski **seagoing ship** prekomorski brod, brod duge plovidbe

sea-going boat (n) (nav arch, mar law) pomorska brodica, morska brodica

sea-going navigation (n) (shipping econ) pomorska plovidba

seagoing service (n) (mar law) service on board a ship relevant to the issue or revalidation of a certificate or other qualification (STCW 2010) plovidbena služba, plovidbena praksa

sea-going ship (n) 1 (nav arch) pomorski plovni objekt dulji od 12 metara i brutotonaže veće od 15 tona pomorski brod, morski brod; 2 (mar law) brod u međunarodnoj plovidbi

sea-going unit (n) (nav arch, mar law) pomorski ploveći objekt

sea ice (n) (meteorol, oceanogr) morski led

seal /si:l/ (n) 1 a (marine eng) brtva, brtvilo, tal. *guarnizione*; 2 (cargo) pečat, plomba

seal /si:l/ (v) 1 a brtviti, zabrtviti, začepiti: *The sea valves and their seals should be checked in the presence of cargo/terminal representatives prior to loading and checked and sealed again after departure.* **seal off** brtviti, nepropusno zatvoriti, **seal a leak off** začepiti rupu, **zaustaviti curenje, zaustaviti propuštanje (broda)**: *Upon completion of the debunkering, mechanical and chemical methods are both said to have been used to seal off leaks.*; 2 **zapečatiti**: *once loaded, all in-terminal and air cargo containers, trailers and railcars should be sealed.*

sea lane (n) (mar law) plovni put (u pravu mora)

sealing (n) (marine eng) brtvljenje **gast-tight sealing** plinotijesna brtva, plinonepropusna brtva, **form a sealing** brtviti, **make a sealing** brtviti

seam /si:m/ (n) 1 (sailing vessels) a fore-and-aft joint of a shell plating, deck and tank top plating spoj trenica **longitudinal seams** sljubnice trenica, spojevi *madira, kimenat*;



kimenti, puč, butt seams štikovi trenica; 2
(marine eng, nav arch) spoj, šav (zavarivanja)

seaman /'si:mən/ (n) = **seafarer** 1 pomorac, tal. *marinaio*; 2 mornar **able-bodied seaman** kormilar, **ordinary seaman** obični mornar, mladi mornar {pl. *seamen*}

seaman's book (n) (mar law) pomorska knjižica, *matrikula*

seamanship /'si:mənʃɪp/ (n) the art of operating a ship or boat **pomorske vještine** **observe good seamanship** raditi / djelovati ka dobar i stručan pomorac, raditi u skladu s dobrom pomorskom praksom, **practice good seamanship** primjenjivati praksu dobrog pomorca, **practice of good seamanship** The practice of good seamanship should be the goal of everybody on board., ponašanje u skladu s dobrom pomorskom praksom {In the broadest sense, seamanship involves a knowledge of a variety of topics and development of specialized skills including: navigation and international maritime law; weather, meteorology and forecasting; watchstanding; ship-handling and small boat handling; operation of deck equipment, anchors and cables; ropework and line handling; communications; sailing; engines; execution of evolutions such as towing; cargo handling equipment, dangerous cargoes and cargo storage; dealing with emergencies; survival at sea and search and rescue; fire fighting}

Seaman's Passport /'si:mənz/ (n) pomorska knjižica, *matrikula*

sea map pomorska karta

sea mark, seamark (navig) pomorska oznaka, morska oznaka, plovidbena oznaka **sea marks** pomorske oznake

seamless pipe /'si:mlɪs/ (n) (marine eng) bešavna cijev {=*seamless tube*}

seamount (n) (fishing) = **hump** brak

sea object (n) (nav arch) plovni objekt, plutajući objekt i nepomični odobalni objekt **pomorski objekt**

sea pilot (n) (navig) pilot (za vođenje broda u luku), riječni pilot, pilot u plovnom kanalu (US). *On his embarkation, the Sea Pilot refused to complete the pilotage information card, particularly the part related to under keel clearance while on passage in the channel.*

seaplane (n) hidroavion

seaport morska luka, luka

Sea Protest (n) (mar law) Prijava pomorske nezgode, dokaznica pomorske nezgode **Note of Sea Protest** Prijava pomorske nezgode, **note / enter / state / make / file / lodge the Sea Protest** podnijeti prijavu pomorske nezgode: *Lodge a sea protest at your first available port of call.*

seaprotest /'si:,prəʊtɛst/ (n) (mar law) = **note of protest** prijava pomorske nezgode, nota di fortuna **enter / make / note / state / file / lodge a seaprotest** podnijeti prijavu

pomorske nezgode prijaviti pomorsku nezgodu prijaviti protest: *Lodge a sea protest at your next port of call and make sure a log extract showing relevant entries is attached. As this is considered as an act of hostility and violation of the international law upon the high seas, I herewith lodge this protest and repudiate the responsibility for the possible consequences which may arise therefrom.*, **support the seaprotest** **potkrijepiti prijavu pomorske nezgode** {*valkja razlikovati 'seaprotest' (=prijava pomorske nezgode) od letter of protest (=reklamacija, prigovor, zahtjev za naknadu štete)*}

search (n) (safety) **traganje, potraga** *Multiple USCG units & partner agencies rescued 5 people from capsized vessel after a search covering 613 square nm*

Search and Rescue (SAR) /'sɜ:tʃənd,rɛskju:/ (n) (navig, safety) **potraga i spašavanje, traganje i spašavanje**

Search and Rescue (SAR) Convention 1979 (n) (mar law) adopted by the IMO

(supra) on April 27, 1979, which came into force June 22, 1985, as subsequently amended by a revised technical annex on May 18, 1998, which came into force January 1, 2006, and a group of amendments relating to persons in distress at sea, adopted on May 20, 2004, which came into force on July 1, 2006.

(Tetley) **Konvencija o traganju i spašavanju 1979, Konvencija o potrazi i spašavanju 1979**

search and rescue transponder; (SART) (n) (navig) **radarski transponder, transponder SART**

search area (n) (navig, safety) **područje traganja:** *Fortunately, they were found as the search area expanded, were winched from the sea and transferred to hospital, where they were treated for mild hypothermia.*

searching (n) (safety) **potraga, traganje:** *After days of searching, it was determined that the ship sank with the loss of all 33 crew members.*

searchlight /'sɜ:tʃ,laɪt/ (n) (navig) **reflektor:** *LPG & LNG tankers should be equipped with own searchlights conform to the Suez Canal Authority's rule of Navigation, and that said searchlight should be gaslight.* **searchlight beam snop reflektorskog svjetla, stern searchlight kremni**

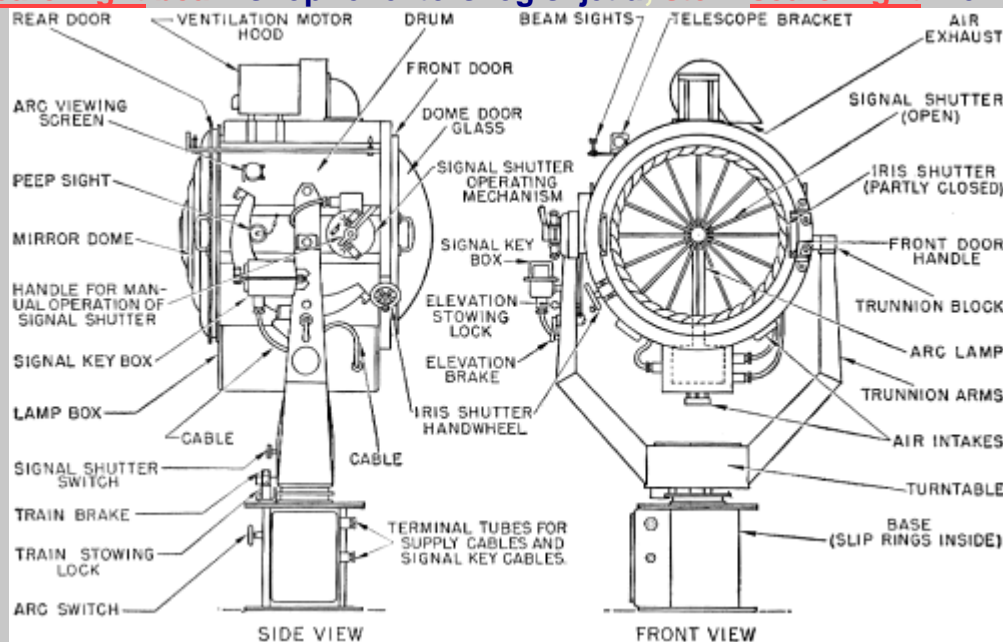

reflektor

Search Mission Co-ordinator (SMC) /'sɜ:tʃ/ (n) (safety) **koordinator u centru za koordinaciju traganja i spašavanja**

search pattern /'sɜ:tʃ/ (n) (safety, navig) manovra traganja i spašavanja, obrazac traganja i spašavanja **expanded square search** prošireni četverokut

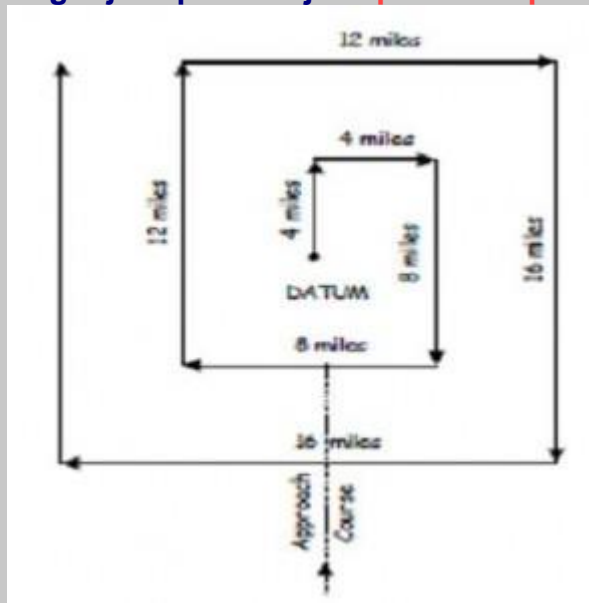

sector search sektorsko traganje

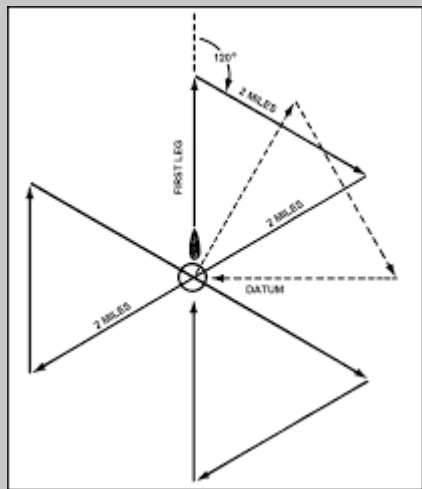

parallel search pattern (single and multiple units)

traganje po usporednim stazama (uključen edan ili više brodova)

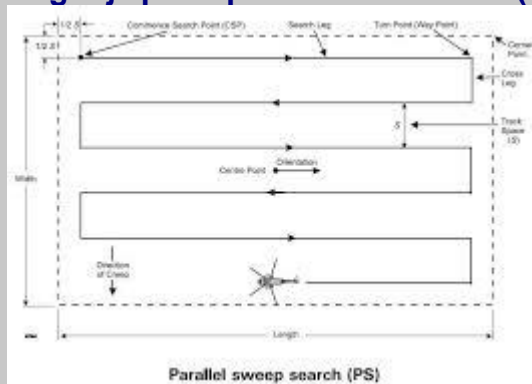

CO-ORDINATED CREEPING LINE SEARCH 1

Ship and 1 Aircraft)

search speed brzina traganja

search the ship (v) (safety) pretražiti brod

search the target (v) (navig) **COMPARE acquire the target** tražiti cilj / objekt (na radaru), pretraživati cilj / objekt

sea room (n) (navig) prostor, mjesto, slobodan prostor za manevriranje: *the OOW did not consider the lack of sea room*

seas (n) (oceanogr, navig) **valovi**: *When a ship is sailing in following or quartering seas its motions can become exaggerated and can result in capsizing.* **following seas** valovi u krmu, **head seas** valovi u pramac, **quartering seas** valovi u krmeni bok, valovi u kvartir

sea service (n) (mar law) plovidbena služba, staž **period of sea service** trajanje plovidbene službe

seasick (adj) imati morskú bolest: *He is seasick*

seasickness /'si:sɪk'nɪs/ (n) (safety) morska molest **anti-seasickness medication** tablete protiv morske bolesti

seaside /'si:saɪd/ (n) **to go to the seaside** ići na more (npr. na izlet) **1** (geogr) primorje, primorski kraj, obalno područje; **2** obala, more

sea smoke (n) (meteorol) morski dim

seasonal correction (n) (nav arch) sezonska korekcija

seasonal periods /'si:zənəl/ razdoblja godišnjih doba

seasonal products /'si:zənəl/ (n) (cargo) sezonski proizvodi (žitarice, voće, drvo)

sea spray (n) (meteorol) morski dim

sea stabilization (n) (navig) **COMPARE ground stabilization** stabilizacija radarske slike kroz vodu

sea-stabilized display (n) (navig) **COMPARE ground-stabilized display** stabilizirana slika kroz vodu, radarska slika stabilizirana u odnosu na more

sea stabilized picture (n) (navig) **COMPARE ground stabilized picture** radarska slika stabilizirana u odnosu na more

sea state (meteorol, oceanogr) stanje mora

seat /si:t/ (n) (marine eng) sjedište, sedlo **valve seat** sjedište ventila

seating /'si:tiŋ/ (n) (marine eng) sjedište, postolje

sea toilet (n) (boating/yachting) brodski zahod

sea trials (n) (nav arch) a series of rigorous, underway tests to determine that the ship's hull, mechanical & electrical and other systems function as required **pokusna vožnja, probna vožnja**: *After successful sea trials MS entered service this month sailing between China and South America. ALP Striker achieved an impressive and most satisfactory bollard pull results of 309.6 tonnes during her sea trials.* **complete the sea trials** obnoviti pokusnu vožnju

sea valve (n) (safety, nav arch) **kingston ventil**, ventil za naplavlivanje (brodskog skladišta, broda): *The sea valves and their seals should be checked prior to loading and checked and sealed again after departure.* Kingstone i njihove brtve valja provjeriti prije krcanja pa ih potom provjeriti

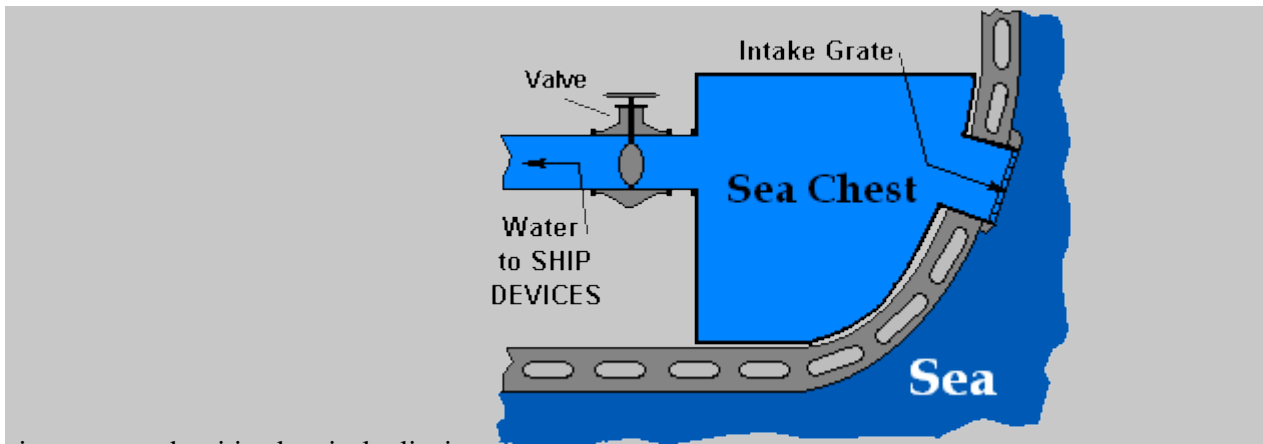

i ponovno zabrtviti nakon isplovljenja.

seaward /'si:wəd/ (adv, adj) prema moru, na morskoj strani, morski

sea-watch system (n) (navig) sustav straže na brodu

sea water cooling suction (n) (marine eng) usis morske vode za hlađenje **high sea water cooling suction** gornji usis morske vode za hlađenje (za plovidbu u plitkoj

vodi): during the final approach to the anchorage the engineers changed over from the low to the high sea water cooling suction, **low sea water cooling suction** doljnji usis morske vode za

hlađenje (za plovidbu na otvorenom moru)

sea water cooling system (n) (marine eng) sustav hlađenja morskom vodom: the whole auxiliary sea water cooling system was blocked with coarse grain sand and shells

seawater filter (n) (boating/yachting, marine eng) filter morske vode za hlađenje motora

seaway /'siwei/ (n) 1 the sea as a route for travel; an ocean traffic lane a (navig) pomorski put, morski prolaz, morski plovni put; 2 a waterway giving access to an inland port, navigable by ocean-going ships plovidbeni put proceed through the **seaway** ploviti plovidbenim kanalom; 3 otvoreno more

seaway bill (n) (mar law) = **waybill** Sea Waybills are not documents of title, so that the holder does not necessarily have ownership of the goods. Sea Waybills are increasingly used instead of Bills of Lading: they are simpler, which helps, e.g., when only short sea crossings are involved, or for regular shipments to established customers whose creditworthiness is not in doubt. Seaway bill takes the same form as B/L but is a non-negotiable receipt and not a document of title. Frequently used in the container trade.; a type of bill of lading used for port-to-port or combined transport carriage

(<http://www.maerskline.com/en-jm/help/shipping-glossary> **pomorski teretni list**: A waybill is identical to a negotiable bill of lading except that it is not a document of title. There are no originals issued for this type of document. {The seaway bill is a non-negotiable document which can only be made out to a named consignee. Therefore no surrender of the document by the consignee is required.}

sea-working unit (n) (mar law, navig) pomorski tehnički plovni objekt, pomorski tehnički ploveći objekt

seaworthiness /'si:wɜ:ðinis/ (n) (safety, nav arch, mar law) A basic theme in maritime law, referring to the obligation of shipowners and carriers to provide a vessel and crew fit to confront the perils of the sea. In the carriage of goods by sea, under art. 3(1) of the Hague and Hague/Visby Rules, the carrier must exercise due diligence before and at the beginning of the voyage (a) to make the ship seaworthy; (b) to properly man, equip and supply the ship; and (c) to make the holds, refrigerating and cool chambers, and all other parts of the ship in which goods are carried, fit and safe for their reception,

carriage and preservation. **spodobnost broda za plovidbu, osposobljenost za plovidbu**
seaworthy /'si: wɜ:ði/ (adj) (mar law, safety) certified for, and capable of, safely sailing at sea **brod sposoban za plovidbu**
seaworthy packing (n) (mar law) ambalaža za prijevoz morem
second assistant engineer (US) (n) (mar law, US) drugi časnik stroja, **drugi (od makine), sekondo** {=third engineer (UK)}
second class certificate (n) (marine eng, mar law) svjedodžba druge klase {po sustavu prije STCW 95}
second cook (n) (mar law) Second Cook supervises the food preparation and quality control. **drugi kuhar, drugi brodski kuhar**
second engineer (n) **1** (marine eng, mar law) drugi časnik stroja (na hrvatskim brodovima), **drugi od makine**; **2** prvi časnik stroja (na brodovima UK) {=prvi časnik stroja (na brodovima UK); = first assistant engineer (na brodovima US)}
Second Engineer; (2nd Engineer) (n) (mar law, seamanship) drugi časnik stroja, drugi oficir stroja, **drugi od makine**
second hand ship (n) (shipping econ) rabljeni brod
Second Mate; 2nd Mate drugi časnik palube, **sekondo, drugi (od koverte / kuverte)**. *The Second Mate was assigned the 0000-0400 and 1200-1600 watches. Drugi časnik postavljen je u stražu / gvardiju od 0000-0400 i 1200-1600 sati. The Second Officer of a merchant ship is responsible for the navigation of the ship working from the bridge. He/she is also responsible for maintaining navigational equipment on the bridge.* **Second Mate; 2nd Mate certificate svjedodžba o ovlaštenju za drugog časnika palube** *After obtaining his Second Mate's Certificate in 1961, he spent the next several years sailing with various companies to gain experience on different types of ships.*
second mate's certificate svjedodžba o položenom poručničkom ispitu, ovlaštenje poručnika trgovačke mornarice (prema STCW 1978)
Second Officer; 2nd Officer (n) (mar law, navig) = **Second Mate; 2nd Mate**
drugi časnik palube: *The OOW was the second officer and he was accompanied on the bridge by an able seaman (AB) lookout.* **sekondo**
section 1 a (nav arch, marine eng) presjek, profil **angle section** L-profil, uglovnica, kutni profil, **channel section** U-profil, **flat section** plosnati profil, **halfround section** poluokrugli profil, **hollow round section** šuplji okrugli profil, **I-section** I-profil, **round section** okrugli profil, **cross-section** porečni presjek; **2** sekcija; **3** (mar law) poglavlje (zakona, ugovora), članak
sector light /'sektə/ (n) (navig) sektor koji označuje sigurno ili opasno područje za plovidbu **sektor svjetla**
sector search (n) (navig, safety) traganje po sektorima
secure /si'kjʊə/ (v) **1** (cargo) pričvrstiti teret, osigurati teret; **2** (shipping econ) priskrbiti (novčana sredstva), dobiti; **3** (ship handling) privezati (uže i učvrstiti ga), privezati
se: *The vessel was well secured to the berth.* **secure at the bollards** privezati na bitve, vezati na bitve: *Since the headlines were not secured at the designated bollards, the headlines were sent for securing at the designated bollards for the springs, but still to no effect.*
secure /si'kjʊə/ (v) (seamanship) **privezati brod:** *The vessel was secured port side to the jetty,*

heading west. There were "light airs" at the time, and the vessel was well secured to the berth.

secured /si'kjʊəd/ (adj) pričvršćen (teret)

secure the line (n) (seamanship) učvrstiti uže

secure the sail (v) (boating/yachting) vezati spuštenu jedro

securing /si'kjʊəriŋ/ (n) (cargo handling) vezivanje tereta, pričvršćivanje tereta

securing cargo vezivanje tereta, pričvršćivanje tereta (u skladištu, na palubi)

securing equipment (n) (cargo handling) oprema za pričvršćivanje (kontejnera)

portable securing equipment prijenosna oprema za pričvršćivanje (kontejnera),

fixed securing equipment trajna oprema za pričvršćivanje (kontejnera)

securing link prsten osigurača (za sidreni lanac)

securite call /,seikju:ri'tei/ **poziv s oznakom SECUTITE (sigurnost)**: *The support boat had made a Securité call on channel 16 giving our course as 235 and speed as 5. The fishing vessel's operator, who had heard the ferry's securité call, saw the ferry and instinctively turned to starboard, towards the south side of the fairway.*

securities /si'kjʊəritiz/ (n) (shipping econ) vrijednosnice, dionice, obveznice, teretnice i drugi vrijednosni papiri

security /si'kjʊəriti/ (n) **1 (safety) zaštita; 2** prema Pravilniku ISPS: sustav preventivnih mjera za zaštitu brodova i luka od prijetnje namjernim nezakonitim i štetnim činom **sigurnosna zaštita; 3**

(shipping econ) **jamstvo, garancija**: *If an underwriters' guarantee is required as the form of additional security, those consignees should immediately inform the insurers who will then make the necessary arrangements.*; **4 (shipping econ) osiguranje plaćanja, instrument plaćanja**

security department (n) (safety, mar law) department(s) related to safety, security and medical needs onboard a ship offers a wide range of job opportunities for applicants. **služba**

sigurnosne zaštite na brodu, služba sigurnosne zaštite u brodarskom društvu

security guard (n) (safety) zaštitarska straža

security level (n) (safety, navig) stupanj opasnosti kojim se određuje mogućnost neželjenoga događaja koji ugrožava sigurnost broda ili lučkoga područja **stupanj sigurnosne zaštite**

security level; SL stupanj sigurnosne zaštite

security officer (n) (safety, mar law) Security Officer is responsible for the security of the ship, crew and cargo in the ocean as well as at the port. **časnik sigurnosne zaštite na brodu**

security on a ship (n) (mar ins) prisilne mjere poduzete radi naplate tražbina **osiguranje na brodu, izvršenje na brodu**

security personnel (n) (safety) personnel responsible for the security of the ship, crew and cargo **osoblje sigurnosne zaštite na brodu**

see that (v) **pobrinuti se da ...**: *The shipper shall see that the cargo is discharged according to Clause 4 of the Charter Party* Krcatelj se mora pobrinuti da se teret iskrca prema odredbi 4 Ugovora o najmu/zakupu

segment (n) segment, isječak **stop segment** granični segment

Segments of GPS system (n) (navig) segmenti sustava GPS **space segment**

satelit(i), ground segment zemaljski segment, kontrolni segment, **user's segment**

korisnički segment, monitoring stations kontrolne stanice, kontrolne postaje

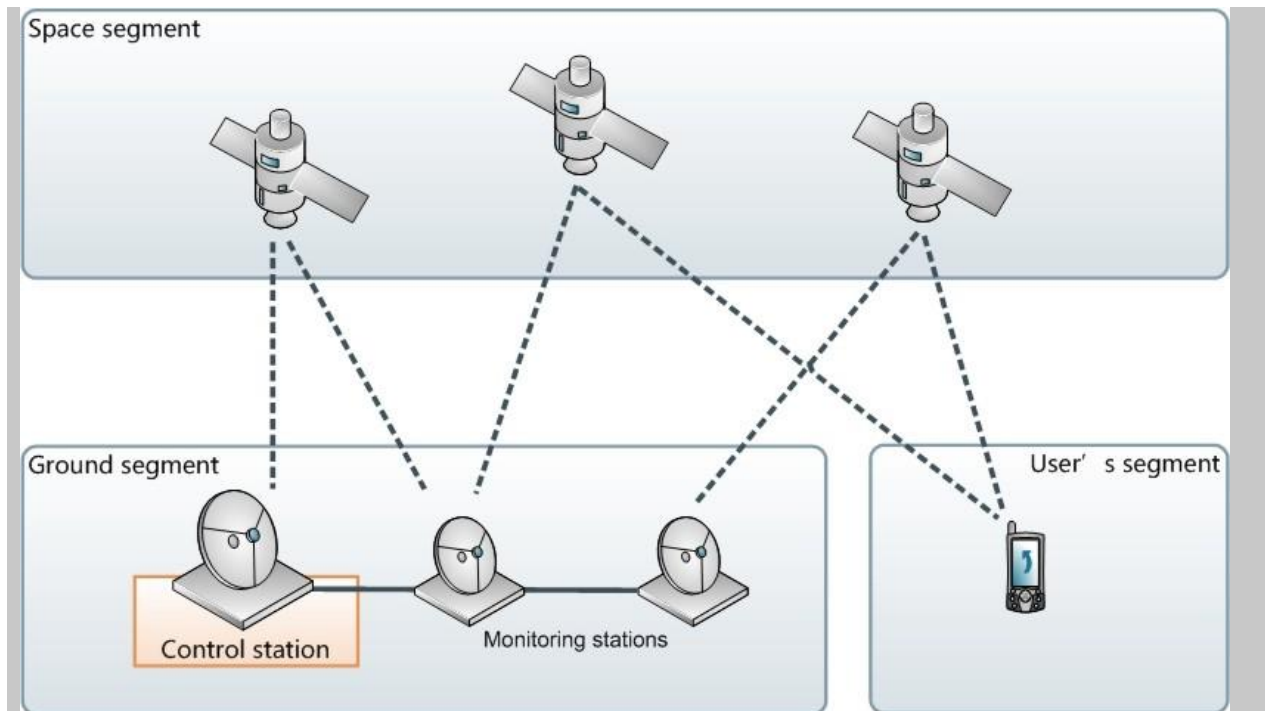

segregated ballast tank (n) (nav arch) odvojeni balastni tank **segregated ballast tank ship** tanker s odvojenim balastnim tankovima

segregation /ˌsɛɡrɪˈɡeɪʃən/ (n) (cargo) odvajanje tereta, separacija tereta **cargo segregation**

seiche; seiches /seɪf; seɪʃɪz/ (n) (geogr) a standing wave in an enclosed or partially enclosed body of water. **seš, stojni val, štiga**

seine net /ˈseɪn/ (n) (fishing) A large fishing net made to hang vertically in the water by weights at

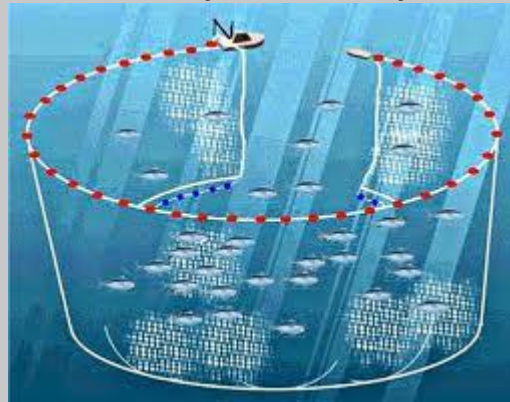

the lower edge and floats at the top. **mreža plivarica**
{tal. senna; rete a borsa}

seiner /ˈseɪnə/ (n) (nav arch) plivaričar, ribarski brod za lov mrežom plivaricom, tal. *peschereccio per la pesca con senna; paranza*



seize /si:z/ (v) **1 (mar law)** to take or capture something using official power and force **uhitati,**

zapljeniti, prisvojiti: *The company's representative said it was illegal from a UN point of view to seize a commercial vessel while in international waters or while making innocent passage through a country's territorial waters.* **seize the ship (mar law) zapljeniti brod, zauzeti brod:** *The irregularities of the ship's travel prompted Panamanian officials to seize the ship.*; **2 (marine eng)**

blokirati se, začepiti se: *the blower bearings seized ležajevi puhala se se zablokirali*

seizing /'si:ziŋ/ **vezivanje dva dijela konopa zajedno**

seizure /'si:ʒə/ (n) **(mar law)** the act or an instance of seizing or the state of being seized **zapljena**

(broda, tereta), prisvojba: *A federal judge on Friday extended the temporary order giving protection to line's vessels **to prevent their seizure** in at least four ports*

<http://www.joc.com/maritime-news/container-lines/> **seizure of the ship:** *We have not received any written or formal confirmation that the seizure of the ship and the cargo case are connected.* **zapljena broda**

selective call (n) **digital selective call (DSC) digitalni selektivni poziv (comm)**
selektivni poziv

self-acting (adj) **automatski**

self-bailing cockpit (boating/yachting) **samoispraznjajući kokpit, samo prazneći kokpit**

self-combustion (n) **(marine eng) samoizgaranje**

self-contained (adj) **samostalan, samprilagodljiv, samoposlužni, koji ne treba pomoćnih mehanizama**

self-draining (n) **(marine eng, nav arch) samopražnjenje**

self-draining (adj) **samoprazneći, koji se sam prazni self-draining cockpit samoprazneći kokpit**

self-ignition (n) **(marine eng) samopaljenje**

self-induction (n) **(electr) samoindukcija**

self-loading (adj) **samopuneći, koji se sam puni / krca, samokrcajući, automatski**

self-lubricating (adj) **(marine eng) samopodmazujući**

self-priming (adj) **(marine eng) samoispirni, samoispirajući**

self-propelled (adj) **(nav arch) na vlastiti pogon, na automatski pogon**

self-propulsion (n) **(marine eng) samopropulzija, automatski pogon**

self-rightening (adj) **samoispravljaajući, samoizravnajući, koji sam izravna / ispravi self-rightening boat samoispravljajuća brodica / jedrilica**

self-righting (n) (boating/yachting) samoizravnujući, samoispravljajući
self-starting motor (n) (marine eng) samostartajući motor, samopokretajući motor, motor na automatsko pokretanje
self synchronizing system (n) (electr) samosinkronizirajući sustav radara, električna osovina
self tacker jedrilica sa samoletajućim flokom
self tacking jib (n) (boating/yachting) samoletajući flok, prednje jedro sa šinom (ispred jarobola) za automatsko letanje
self-tensioning winch (n) (nav arch, seamanship) samozatezno vitlo, vitlo na samozatezanje
self-trimming vessel (n) (nav arch, cargo handling) samotrimajući brod
seller (n) (shipping econ) **ANTONYM buyer** prodavalac, prodavatelj
semaphore /ˈseməˌfoː/ (n) (navig) any visual signaling system with flags, lights, or mechanically moving arms; the flags represent various letters of the alphabet ručna signalizacija, signalizacija zastavicama, signalne zastavice, tal. semaforo a braccia



semi-balanced rudder (n) (nav arch) polubalansno kormilo
semi-controllable forces (n) (navig) sile koje utječu na gibanje broda koje uz odgovarajuća ograničenja može djelomično nadzirati osoba koja upravlja brodom djelomično upravljive sile
semidiurnal /ˌsemɪdaɪˈzːnəl/ (n) (oceanogr) poludnevni **semidiurnal tide** poludnevne mijene, dvije plime i dvije oseke dnevno, **semidiurnal current** poludnevna struja
semi-portal crane poluportalna dizalica
semi refrigerated liquefied gas cargoes (cargo) polurashlađeni ukapljeni plinovi
SENC; System Electronic Navigational Chart (n) (navig) sustavna elektronička navigacijska karta
send ashore (v) (seamanship) dodati konop / uže na obalu, poslati konop / uže na obalu privezivačkom brodicom: *After closing with the berth, the aft backspring was sent asore. When our vessel was approximately 15-20 metres from the berth, an aft spring line was sent ashore by heaving line and secured.*
send away the line (v) (seamanship) dodati uže {dobaciti, dodati, poslati uže s broda na obalu i obratno s pomoću privezivačke brodice ili tegljača}
send out the line (n) (seamanship) baciti konop (s broda na obalu, drugi brod)
Senhouse slip hook (n) (safety, seamanship, nav arch) samootpusna kuka tipa **Senhouse**: *The Senhouse slip holding the anchor chain lashing was fitted with a tapered pin.* liferaft
Senhouse slip hook samootpusna kuka splavi za spašavanje



senior crew member (n) (*seamanship*) stariji član posade, iskusan član posade, stariji mornar: *Senior crew members should guide those with less experience in operational safety.*

Senior Officer (n) (*mar law*) zapovjednik i prvi časnik palube; upravitelj stroja i drugi časnik stroja stariji časnik, viši časnik

sensitive (adj) osjetljiv **sensitive areas** (*navig*) osjetljiva područja (plovidbe), **sensitive cargoes** (*cargo*) osjetljivi tereti, **cargoes sensitive to rusting** tereti osjetljivi na rđanje

sensitive sea area (n) (*safety*) osjetljivo morsko područje **particularly sensitive sea area** posebno osjetljivo morsko područje

sensor (n) **sensor output** izlaz senzora osjetilo, senzor, osjetnik, tal. *rivelatore*

sensor interface unit; (SIU) (n) (*navig*) **COMPARE VDR; Voyage Data Recorder** jedinica senzorskog sučelja (VDR-a)

sentence (n) (*mar law*) presuda

sentence (v) (*mar law*) **osuditi**: *The master of MV was sentenced to pay £2,000, plus thousands more in costs, after pleading guilty.*

sentinel (n) (*seamanship*) uteg na sidrenom lancu / konopu

separate /ˈsepəˌreɪt/ (v) odvojiti, odijeliti, rastaviti

separate /ˈsepɹɪt/ (adj) odvojen, razvdvojen

separation /ˌsepəˈreɪʃən/ (n) (*cargo*) odvajanje, separacija (tereta)

separation (n) (*navig*) **razmak brodova (pri plovidbi kanalom)**: *All vessels should maintain a half-mile separation from specified vessels.*

separation (n) (*cargo*) **odvajanje (tereta), separacija**: *Damage can be reduced by immediate separation of wet cargo (e.g. wet fertiliser) from the rest of the cargo.*

separation line (n) (*navig*) linija odvajanja (plovidbenih putova)

separation zone (n) (*navig*) područje odvajanja, zona odvajanja (plovidbenih putova)

separator /ˈsepəˌreɪtə/ (n) (*marine eng*) separator, odvajač **oil water separator; OWS**

separator vode iz nafte ili ulja, oily water separator; OWS OWS is used to treat the oil-water mixture from bilge spaces, oil tanks or any compartment in the ship which has accumulated water, before discharging it to the sea. **separator zauljenih voda**: *Almost all OWS use gravity*

system for the separation of water from oil.

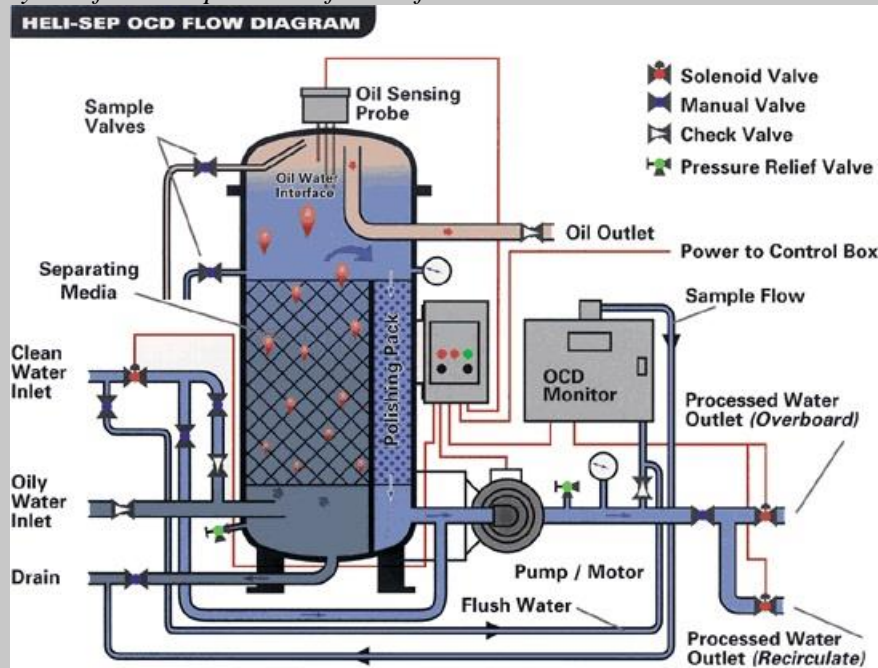

sequence /'si:kwens/ (n) redosljed **correct sequence** pravilan redosljed, **loading sequence** (cargo handling) redosljed krcanja tereta, **unloading sequence** redosljed iskrcaja tereta

sequence of events (n) 1 slijed događaja / zbivanja; 2 (marine eng) redosljed faza rada (motora)

sequential lobing (n) (navig) = **lobe switching** prespajanje s jedne laticе radarskog snopa na drugu

sequential readings /si'kwɛnfəl/ (n) sekvencijalna očitavanja, očitane vrijednosti u nizu

sequential switching (n) (navig) = **lobe switching** prespajanje s jedne laticе radarskog snopa na drugu

series /'siəri:z/ (n) niz, slijed, red, serija

serious injury (n) (med) an injury which is sustained by a person in a casualty resulting in incapacitation for more than 72 hours commencing within seven days from the date of injury. (RESOLUTION A.849(20) adopted on 27 November 1997 - CODE FOR THE INVESTIGATION OF MARINE CASUALTIES AND INCIDENTS) **ozbiljna ozljeda**

serious marine incident (n) (mar law) The term serious marine incident includes the following events involving a vessel in commercial service: (a) Any marine casualty or accident as defined in §4.03-1 which is required by §4.05-1 to be reported to the Coast Guard and which results in any of the following: (1) One or more deaths; (2) An injury to a crewmember, passenger, or other person which requires professional medical treatment beyond first aid, and, in the case of a person employed on board a vessel in commercial service, which renders the individual unfit to perform routine vessel duties; (3) Damage to property, as defined in §4.05-1(a)(7) of this part, in excess of \$100,000; (4) Actual or constructive total loss of any vessel subject to inspection under 46 U.S.C. 3301; (5) Actual or constructive total loss of any self-propelled vessel, not subject to inspection under 46 U.S.C. 3301, of 100 gross tons or more. (b) A discharge of oil of 10,000 gallons or more into the navigable waters of the United States, as defined in 33 U.S.C. 1321, whether or not resulting from a marine casualty. (c) A discharge of a reportable quantity of a hazardous substance into the navigable waters of the United States, or a release of a

reportable quantity of a hazardous substance into the environment of the United States, whether or not resulting from a marine casualty. (USCG eCFR) **teža pomorska nezgoda**

servant /'sɜ:vənt/ **1 službenik (vozara) owner's servant** brodarov agent, brodarov službenik; **2 podugovorna stranka, subkontrahent**

serve /sɜ:v/ (v) **1 (mar law) služiti na brodu (o pomorcu) , ploviti, biti ukrcan (radi službe na brodu), biti zaposlen na brodu** *all Employees serving in any offshore vesse The pilot was employed by the PLA and had served 21 years as a river pilot. Peljar je bio zaposlen u Lučkoj upravi Londona (Port of London Authority, PLA) i plovio je na 21 godinu kao peljar. He served at sea from Cadet to Chief Officer with ... Liners before coming ashore to a container consortium ...*; **2 posluživati**: *The hatches on this ship are served by two sets of cargo gear generally measure 20 by 30 feet or larger*

service (n) **liner service** **1 linijska plovdba, linijski servis, linijska služba; 2 liner service** linijska plovdba, linijska služba, linijski servis, **tramp service** slobodna plovdba, tramperska plovdba **1 (marine eng) služba, pogon out of service** izvan službe, izvan pogona, koji ne radi, **service life** vijek trajanja, rok trajanja, **be in service** biti u pogonu; **2 (shipping econ)** redovita linijska plovdba plovdba, linija, služba, servis, redovita pruga **resume service** nastaviti plovidbu, ponovno započeti plovidbu, **roll-on/roll-off service** ro-ro linija, **lift-on/lift-off service** linijski servis za generalni i kontejnerski teret, **deepsea service** prekomorska linija, prekooceanska linija, prekomorska linijska plovdba: *Cork is the only Irish port providing a deepsea ro-ro service to Scandinavia, and the Mediterranean, and West Africa.*, **shortsea service** servis kratke linijske plovidbe, kratka linijska plovdba, **door-to-door service** direktni prijevoz od skladišta pošiljatelja do skladišta primatelja robe **služba vrata-vrata, direktni prijevoz (od skladišta pošiljatelja do skladišta primatelja robe), feeder service** služba razvoza, **razvoz** *feeder services allow Irish exporters to service deepsea markets speedily and efficiently*, **enter into service** stupiti u službu, **pustiti brod u plovidbu** *The MV entered into service for the Norwegian shipping company in April.*, **open a service** otvoriti liniju, **uvesti linijski servis**: *Maersk Line will open a new service from Asia to the U.S.*, **launch a service** otvoriti (linijski) servis, **otvoriti liniju**: *APL Launches Atlantic Gulf Express Service.* ; **3 linija, brodarska linija; 4 plovidbena služba, služba na brodu, plovidba (pomorca) time od service** vrijeme plovidbene službe, trajanje plovidbene službe; **5 tehničko održavanje i posluživanje, servis**

service capacity (n) (navig) kapacitet sustava

service port (n) (mar law, ports) **COMPARE port privatization** državna luka, javna luka kolom upravlja i u kojoj lučke operacije obavlja lučka uprava

service providers (n) **1 (shipping econ)** The many companies and government agencies that provide transportation to the public and to businesses are known as service providers **pružatelj (transportnih) usluga; 2 transportna poduzeća**

service speed (n) (nav arch) brzina u službi, brzina u plovidbi, plovidbena brzina: *The ships will operate at service speed of 21 knots.*

servicing (n) **1 (marine eng) servisiranje, tehnička pomoć; 2 (shipping econ) servisna usluga**

servomotor /'sɜ:vəʊ,məʊtə/ (n) (electr, marine eng) servomotor

set (adj) 1 utvrđen, propisan, ustaljen set list of readings utvrđeni popis podataka; 2 udubljen

set (v) namjestiti, ugoditi, regulirati, postaviti, prilagoditi, podesiti set at an angle podesiti u kut, postaviti pod kutom, set down 1 spustiti; 2 spustiti se, set up izazvati, nastati, stvarati se

set (v) (oceanogr) imati smjer (o morskoj struji, plimnoj struji), teći u smjeru ...: *There was a tidal stream of 0.1 knot setting to the south-west. The ship was now on a south easterly heading, and as she continued to be set to the north by the wind and the swell.* **unusual tidal sets** neuobičajeni smjerovi morske struje

set (n) (marine eng) aparat, postrojenje, agregat

set (n) (math) skup, niz set of conditions niz uvjeta, set theory teorija skupova

set (n) (oceanogr) the direction toward which the resultant of the forces of wind and current is acting **smjer morske struje**: *Beware of unusual tidal sets.*

set (n) 1 (boating/yachting) jedro podignuto i napunjeno vjetrom; 2 (boating/yachting) all the sails of a boat **sva jedra, svo jedrilje, tal. gioco di vele**

set and drift (n) 1 (geogr) smjer i jačina morske struje; 2 (navig) zanos i otpadanje zbog struje

set course (v) (navig) postaviti kurs broda, staviti brod u kurs

set flying (n) (boating/yachting) odviti i razviti špinaker

set forth (v) (mar law) utvrditi (u ugovoru, pravilniku, zakonu, propisu)

set in (v) (navig, safety) udubiti se (npr. oplata pri sudaru), biti udubljen, pretrpjati **udubljenje**: *Our ship's outer hull was evenly set in from the tank top to the upper deck by up to about 18 inches*

set of current smjer struje

set of sails (n) (boating/yachting) = **suit of sails** jedrilje

set of tide (n) 1 (oceanogr) smjer struje; 2 smjer plimne struje

set of valves (n) (marine eng) garnitura ventila, komplet ventila

set out (v) set out terms and conditions (mar law) = **lay down** utvrditi uvjete (ugovora), odrediti uvjete (ugovora), propisati uvjete (ugovora): *This agreement sets out the minimum standard terms and conditions applicable to all Employees serving in any offshore vessel/unit* *All watchkeeping personnel shall observe the principles and guidance set out in the STCW 1005 as amended* osoblje straže dužno je poštivati načela i upute određene konvencijom STCW 1995 i njenim izmjenama i dopunama

set point (n) (cargo handling) Specific temperature that a refrigerated container has been set to keep. Ideally, the set point and the actual temperature should be identical throughout the voyage. (<http://www.maerskline.com/en-jm/help/shipping-glossary>) **namještena temperatura**

set sail (v) 1 (boating/yachting, navig) isploviti, uputiti se na more set sail for isploviti za (neku luku), uputiti se za (neku luku), započeti putovanje: *The oil tanker was ordered to set sail for Singapore. The container vessel COSCO Shipping Panama set sail from the Greek Port of Piraeus today on its way to Panama.*; 2 podignuti jedra, namjestiti jedra {tal. salpare}

set sail (v) 1 isploviti, započeti putovanje; 2 (boating/yachting) napuniti jedra

set taut (v) **SYNONYM** **take out all the slack** zategnuti (uže) **Set the breast line taut!** Zategni božno uže!

set the engine to (v) **postaviti stroj u (neki od položaja za rad)**: *the engine was set to 'dead slow ahead' and, at 1000, to 'slow ahead'*. **set the engine to full astern** **postaviti stroj u položaj svom snagom nazad**

set the sails (v) (*boating/yachting*) **podići i namjestiti jedra, tal.** *inferire le vele*

setting (n) **postavljanje, ugađanje, namještanje, podešavanje** **the setting of the spring** (*marine eng*) **namještenost opruge, regulacija opruge**

setting (n) (*oceanogr*) **smjer morske struje**

setting of current (n) (*oceanogr*) **smjer morske struje**

setting of tide (n) **1 (oceanogr) smjer plimne struje; 2 smjer morske struje**

settle (v) **1 (marine eng) taložiti se, slijegati se; 2 (marine eng, navig) ustaliti se,**

stabilizirati se: *The engine, running full power ahead, was brought to 80 rev/min astern in 32 s and had settled down steadily at full astern revolutions in 50 s. The ship settled down to a quiet, if somewhat rough passage.*

settlement (n) **rješenje (problema) financial settlement** **financijsko / bankarsko izvršenje**

settling tank (n) (*nav arch, marine eng*) **taložni tank**: *The centrifugal pumps discharge bilge water directly overboard, while the piston unit discharges into a settling tank. To ensure fuel feed to the main engine, the separated heavy fuel oil (HFO) is first pumped into the settling tank (buffer tank).*



set up (v) **1 regulirati, podesiti, ugoditi, namjestiti; 2 urediti; 3 osnovati**

sever /sɛvə/ (v) **1 odvojiti; 2 raskinuti**

severance /sɛvərəns/ **1 odvajanje; 2 raskid (radnog ugovora itd.) severance pay** **compensation that an employer provides to an employee who has been laid off, whose job has been eliminated, who through mutual agreement has decided to leave the company, or who has parted ways with the company for other reasons** **naknada za sporazumni raskid radnog odnosa, severance costs** **the costs which are legally required to be paid to the crew as a result of the early termination of any contracts for service on the vessel (BIMCO) naknada za prijevremeni završetak radnog odnosa / ugovora pomorca** {Typically, severance pay amounts to a week or two of pay for every year that the employee was with the company. Executives may receive a month's pay for each year of service and senior executives generally receive severance pay as outlined in the employment contract. <http://www.investopedia.com/terms/s/severancepay.asp>}

severe sea conditions /si'viə/ (n) (*meteorol*) **vrlo teški uvjeti na moru (visoki valovi itd.)**

sewage plant /'su:ɪdʒ/ (n) (*nav arch*) **uređaj za obradu otpadnih / fekalnih voda**

sewage treatment plant /'su:ɪdʒ/ (n) (*nav arch*) **uređaj za obradu otpadnih / fekalnih**

voda: *Sewage on board ships needs to be treated before it is discharged to the sea. Sewage treatment plant is used to treat the sewage and make it less harmful for the sea.*

sewing kit /'səʊɪŋ/ (n) (*boating/yachting*) **komplet za šivanje (jedara)**

sextant /'sɛkstənt/ (n) (*navig*) **optical navigational instrument for measuring vertical and horizontal angles at sea** **sekstant error of the sextant** **grješka sekstanta**



shackle /'ʃækəl/ (n) **1 (nav arch, seamanship) uza lanca**: The vessel was anchored using seven shackles of chain in position, which gave a swing circle as indicated ... **shackle of cable uza lanca**: A VLCC fully loaded with crude oil was laying at anchor **with 10 shackles of cable out**. ; **2 uza (lanca = 25 m) nod**: The port anchor was about two shackles in the water. She informed that she has lost her port anchor with **6 shackles of cable** and was unable to start her engines.

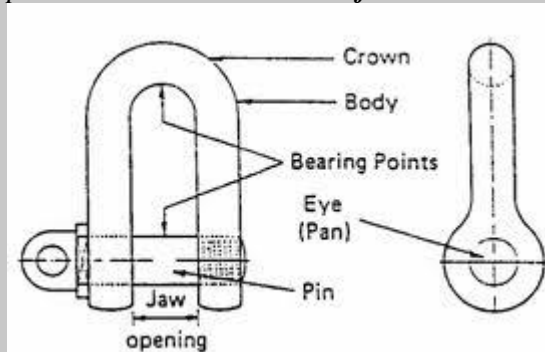

; **3 (nav arch, cargo handling)** A U-shaped piece of iron or steel with eyes in the end closed by a shackle pin **škopac, gambet, tal. grappino snap shackle škopac s oprugom, omega shackle omega škopac, shackle pin osovina škopca, peran, anchor shackle sidreni škopac, joining shackle spojni škopac (sidrenog lanca), lančana škoba, lugless shackle škopac na otvaranje (za spajanje dijelova lanca) patentna škoba / škopac, Kenter shackle patentna škoba / škopac**

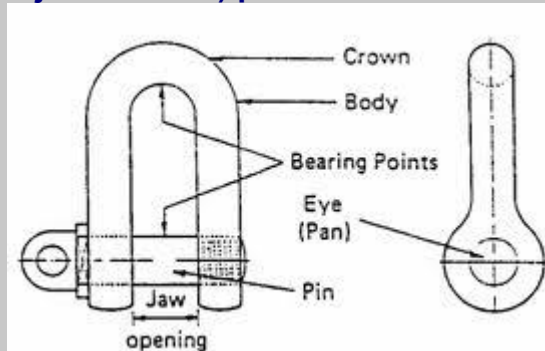

shackle /'ʃækəl/ (v) (seamanship) pričvrstiti škopcem
shackle bonding cords (n) (seamanship) povezice za škopac
shade deck (n) (nav arch) osojna paluba
shade deck vessel (n) (nav arch) brod s osojnom palubom

shade fish (n) hama, krb

shadows (n) (navig) radarske sjene

shaft (n) 1 (marine eng) a rotating or oscillating round, straight bar for transmitting motion and torque, usually supported on bearings and carrying gears, wheels, or the like, as a propeller shaft on a ship, or a drive shaft of an engine **vratilo**, **osovina**, tal. **albero** **multi-throw shaft** **osovina s više koljena**, **turbine shaft** **turbinska osovina**, **vratilo turbine**, **terminal shaft** **izlazna osovina**; 2 **vratilo**, **pogonsla osovina** **output shaft** **izlazna osovina**, **intermediate shaft** **međuosovina**; 3 **vreteno** {A SHAFT is a general term for a mechanical component used for transmitting torque. It may be belt driven, may be used for connecting different parts of a drive train, and many other applications.}

shaft alley (n) (nav arch) a watertight passage, housing the propeller shafting from the engine room to the bulkhead at which the stern tube commences **osovinski tunel**

shaft assembly (n) (nav arch) **osovinski sklop**, **osovinski vod**

shaft bearing (n) (marine eng) **osivinski ležaj**, **ležaj vratila**, **ležaj osovine**

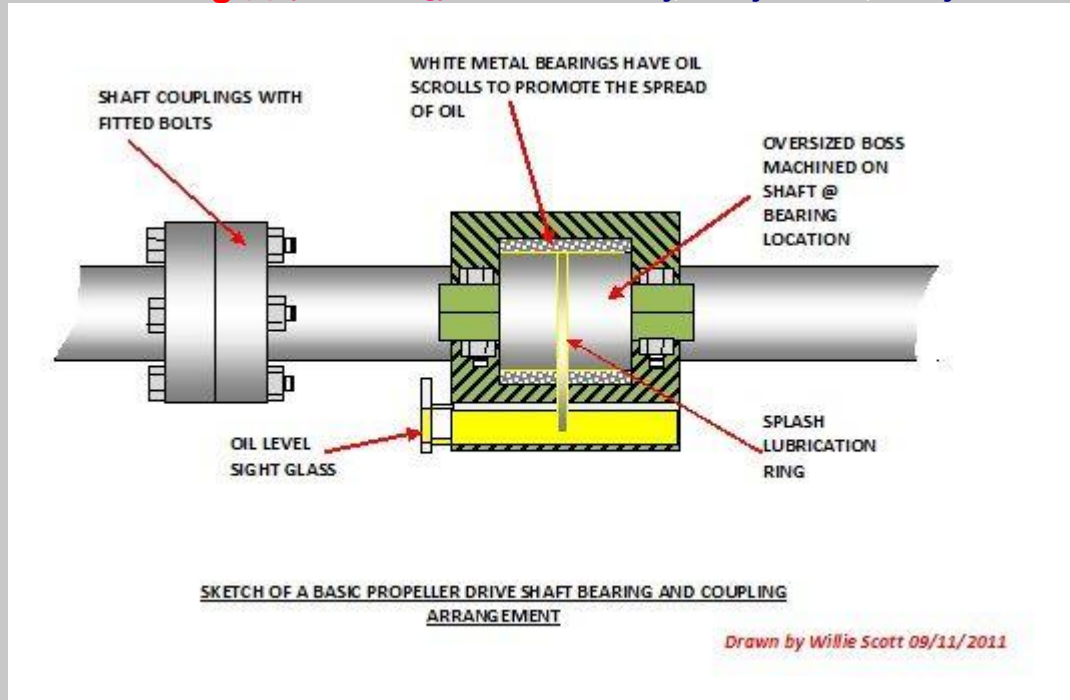

shaft boss (n) (nav arch) **nogavica**

shaft bracket (n) (nav arch) **strukturni nosač osovine propelera**

shaft coupling (n) (nav arch, marine eng) The means of joining together two sections of a shaft, usually by means of bolts through flanges on the ends of the sections of the shafts **osovinska spojka**



spojka osovine

shaft generator (marine eng) **osovinski generator**

shafting (n) (nav arch, marine eng) = **shaft assembly** osovinski vod **parallel shafting** paralelne osovine, **skew shafting** križna vratila, ukrštene osovine, **mimosmjerne osovine**, **propeller shafting** osovinski vod propelera

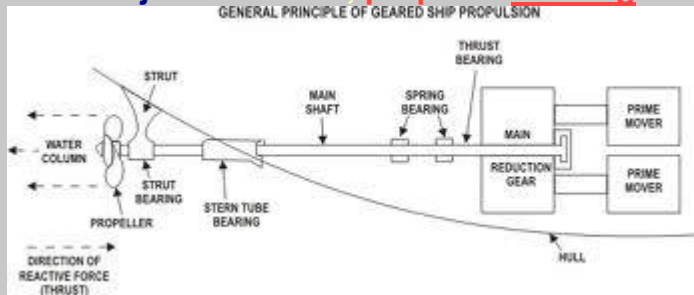

shaft tunnel (n) (nav arch) tunel osovinskog voda, tunel osovine



shake (v) (boating/yachting) lepršati (o jedrima), tresti se, tal. fileggiare

shake out (v) (boating/yachting) otpustiti kratove jedra, odkratiti jedro, raskratiti jedro, razviti cijelo jedro

shallow (adj, n) plitak **shallow waters** plićina

shallow water (n) plitka voda, plitko more, tal. *basso fondo*. Realising the vessel was approaching shallow water, the bridge team ordered the port anchor dropped.

shallow water effect (n) (navig) utjecaj plitke vode

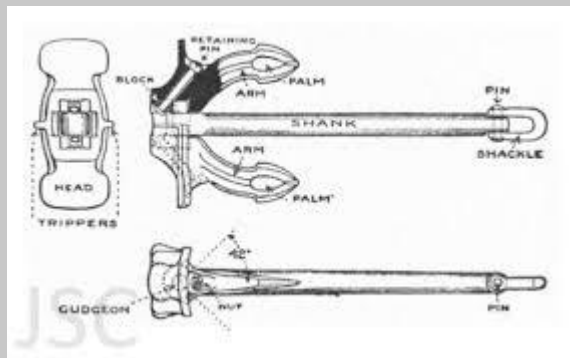

shank /ʃæŋk/ (n) 1 (seamanship) struk sidra
(nav arch) struk ojnice

shape (n) (navig) znak, oznaka na brodu i na moru (kugle, romboidi itd.), oblik **diamond shape** dvostruki stožac, romboid. A vessel or object being towed, other than those mentioned in paragraph (g) of this Rule, shall exhibit, when the length of the tow exceeds 200 meters, a diamond shape where it can best be seen., **display a shape** istaknuti oznaku na brodu, **exhibit a shape** istaknuti znak / oblik (npr. kuglu, dvostruki stožac itd.), nositi

znakove: (d) A vessel engaged in dredging or underwater operations, when restricted in her ability to maneuver, shall exhibit the lights and shapes prescribed in subparagraphs (b)(i),(ii) and (iii) of this Rule
 Brod koji je zauzet jaružanjem ili podvodnim radovima, kad je ograničene mogućnosti manevriranja, mora

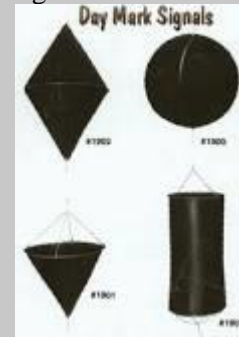

nositi svjetla i znakove propisane u stavku 2. točke a), b) i c) ovoga članka

shape (v) **oblikovati, dati oblik, poprimiti oblik**

share (n) **1 (shipping econ, mar law) dionica:** Shares of the shipping company fell by the daily limit of 30% today, as trading resumed after the shipping line filed for court receivership last Wednesday
 Money raised from the sale of new shares goes to the company itself, which it can use for development.; **2 karat**

shareholder (n) (mar law, shipping econ) **dioničar:** Revenue from the sale of existing shares goes to the existing shareholder. **majority shareholder većinski dioničar (u vlasništvu broda):** French shipping group CMA CGM has upped its stake in Singapore-listed rival NOL to 78% after NOL's majority shareholder unloaded its shares as planned. XXX Capital Management has become the top shareholder in the line

shark (n) (fishing) **morski pas**

sharpnose sevengill shark (n) **pas volonja**

sharp-snouted seabream (n) **pic**

sharp-snouted sparus (n) **pic**

sharpnout seabream (=sheepshead bream) (n) (fishing) Lat. *Diplodus puntazzo*;



Lat. *Diplodus puntazzo* **pic**

shear /ʃiə/ (v) (marine eng) **odrezati, odlomiti, rasjeći**

shear force /ʃiə/ **1 (nav arch)** to cause (a part, member, shaft, etc) to deform or fracture or (of a part, etc) to deform or fracture as a result of excess torsion or transverse load (Collins ED) **smik,**

smicanje: The loading instrument provides a means to readily calculate the still water shear forces and bending moments, in any load or ballast condition, and assess these values against the design limits.; **2**

(*stabil*) **poprečna sila** **allowable shear force** dopuštena poprečna sila
shear force curve (*n*) (*nav arch*) krivulja poprečnih sila
shearing /'ʃiəriŋ/ (*n*) (*marine eng*) odrez, naprezanje na odrez
shearing forces (*n*) **1** (*nav arch*) vertikalne sile na određenim točkama ili mjestima broda **sile prekida**; **2** naprezanje unutarnjeg materijala sa tendencijom lomaili uzdužnog prekidanja **sile prekida**
shear legs; **shears** (*n*) **1** (*cargo handling*) support used in a hoisting rig consisting of two spars

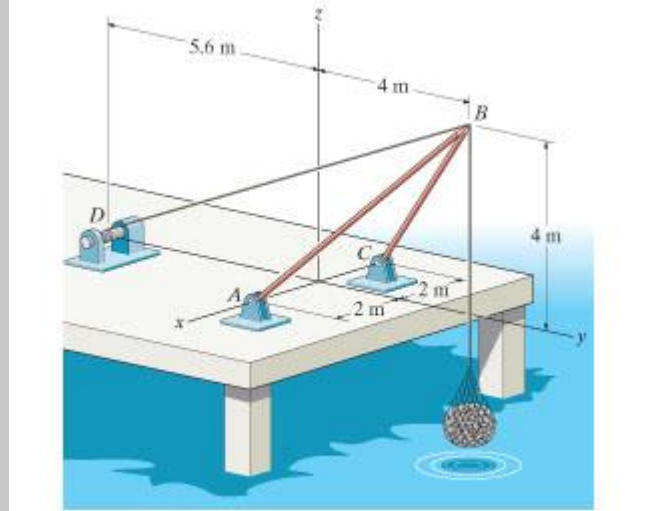

lashed together at the head **križno postolje**

2 (*boating/yachting*) **kavalet**, križ, škare

sheathing /'ʃi:ðin/ wood planking fitted over a steel deck, to the planking fitted over the underwater portion of a steel hull **podnice**, **pajoli**, **obloga dna skladišta**

sheave /'ʃi:v/ (*n*) **1** (*seamanship*) the wheel of the block over which the fall of the block is rove



užnica kolotura

; **2** kolotur

shed (*n*) **1** (*ports*) nadstrešnica, skladište-nadstrešnica **transit shed** obalno skladište za privremeno / prolazno skladištenje roba); **2** prizemno skladište, skladište hangarskog tipa, hangar

sheep shank (*n*) (*seamanship*) skraćenica (konopa)

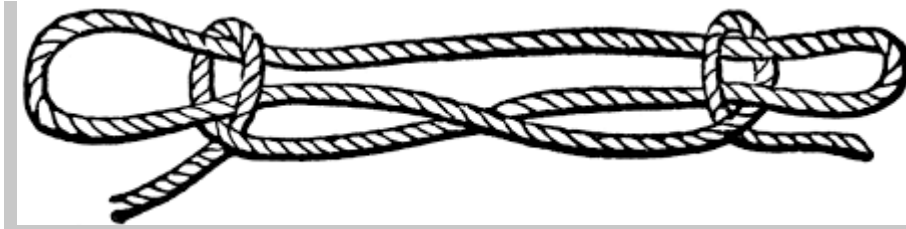

sheer /ʃiə(r)/ (n) (**nav arch**) 1 a (**nav arch**) uzdužna zakrivljenost palube po boku; the upward curve of a vessel's longitudinal lines as viewed from the side **skok palube, uzvoj palube, zakrivljenost palube**; 2 (**nav arch**) uzvoj pramca, **brandun**; 3 (**navig**) naglo skretanje broda: *while being towed back to the anchorage, the tanker took a sheer to port and went aground.*

correct the sheer ispraviti brod, zaustaviti skretanje; 4 the angle a ship takes to her cable when at anchor **kut smjera sidrenog lanca u odnosu na brod**

sheer /ʃiə(r)/ (n) (**seamanship, navig**) skretanje (naglo), promjena kursa (nagla): *Whilst being towed back to the anchorage, the tanker took a sheer to port and went aground*

sheer /ʃiə(r)/ (v) (**navig**) naglo skrenuti

sheer draught plan /ʃiə(r)/ (n) (**nav arch**) nacrt linija broda

sheer off (v) (**navig**) odvojiti se (od drugih brodova promjenom kursa)

sheer plan /ʃiə(r)/ (n) (**nav arch**) a side elevation of the ship's form **uzdužni presjek broda**

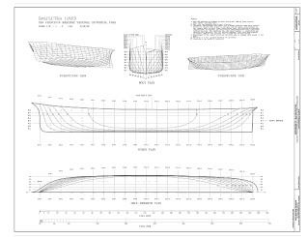

sheer-poles /ʃiə(r)/ (n) **raspinjač**

sheer strake /ʃiə(r)/ (n) (**nav arch**) the uppermost strake of plating of the ship's side plating

završni voj, uzvojni voj, pojasni voj: *The actual damage incurred was as follows: On the port side 10 half round steel fendering on the sheer strake at deck level was flattened with, fortunately, only minor indentation to hull plating and bending of 5 beam knees. Access over the side was through an opening in the bulwark set inboard 400/500 mm from the sheer strake.* **upper-deck sheer strake**

pojasni voj gornje palube, main-deck sheer strake **pojasni voj glavne plaube**

sheet /ʃi:t/ (n) 1 (**boating/yachting**) = **main sheet** uzda, škota **main sheet** uzda

glavnog jedra, škota glavnog jedra, škota, **jib sheet** uzda prečke, škota prečke,

škota prednjeg jedra, škotina; 2 (**nav arch**) lim **steel sheet** čelični lim

sheet bend (n) (**seamanship**) zastavnu uzao, škotni uzao, tal. **nodo di scotta** **sheet**

bend knot zastavni uzao, **single sheet bend** jednostruki zastavni uzao



, **double sheet bend** dvostruki zastavni uzao



sheet fairlead (n) (boating/yachting) zjevača škote {tal.: passascotta}

sheet in (v) (boating/yachting) (boating/yachting) **ANTONYM** sheet out zatezati škotu, tal. cazzare la scotta

sheet iron (n) (marine eng) željezni lim

sheet leads (n) (boating/yachting) usmjerivači škotina, vodilice škotina s koloturama

sheet out (v) (boating/yachting) popuštati škotu

shelf life (n) (shipping econ) vijek trajanja robe u skladištu

shell (n) 1 a (nav arch) oplata (broda), vanjska oplata **shell plating** oplata broda; 2 (marine eng) blazinica, šalica (ležaja), zdjelica **bottom shell** donja blazinica, **lower shell** donja blazinica, **main bearing shell** blazinica temeljnog ležaja, **top shell** gornja blazinica, **upper shell** gornja blazinica; 3 (safety) granata; 4 plašt **boiler shell** plašt kotla

shellback /'ʃɛl,bæk/ (n) morski vuk {an experienced or old sailor; a sailor who has crossed the equator}

shell plating (n) (nav arch) the plating forming the outer skin of a vessel oplata, opločenje trupa

shelter /'ʃɛltə/ (n) (navig) zaštita, zaklonište (brodu) **seek shelter** potražiti zaklonište, tražiti zaklonište: , during NNE gales (in winter) a vessel could be forced to leave anchorage and seek shelter under the lee of the nearby island Krk.

shelter deck /'ʃɛltə/ (nav arch) a deck fitted from stem to stern on a relatively light superstructure **zaštitna paluba**: A few minutes later, the smell grew stronger and the skipper called the mate from the shelter deck to investigate.

shelter deck vessel /'ʃɛltə/ (n) (nav arch) brod sa zaštitnom palubom **open shelter deck vessel** brod s otvorenom zaštitnom palubom, **closed shelter deck vessel** brod sa zatvorenom zaštitnom palubom

sheltered area (n) (oceanogr, meteorol) zaštićeno područje (od mora i vjetrova): They launched in a relatively **sheltered area**, but had intended to move out to a more exposed position on the coast to fish.

shelving /'ʃɛlvɪŋ/ (n) (boating/yachting) police

SHEX /ʃɛks/ (mar law) Sunday as and holidays excluded

shift (n) (shipping econ) smjena, straža, **gardija** **ordinary working shift** redovna radna smjena, smjena u redovnom radnom vremenu

shift (v) 1 (cargo, seamanship, cargo handling) **pomicati (se)** As a result of heavy weather conditions and adverse swell, the cargo in holds No 1 & 2 shifted, resulting in the vessel listing by 14

degrees starboard.; **2 (navig, seamanship) prebaciti se, premjestiti se:** *The vessel had to shift to another berth across the river to complete loading operations.*

shifting (n) 1 (cargo) pomicanje tereta: *Grounds for Vessel Shifting within Berth and to Anchorage* **Razlozi za pomicanje / premještanje broda na vezu i na sidrište** **shifting**

cargo pomicanje tereta; 2 pomicanje broda (duž veza)

shifting boards (n) (cargo) boards used to stop grain from shifting **pregrada za žito, žitna pregrada, razdjelne daske, razdjelna pregrada** **grain shifting boards** **žitna pregrada**

shim /'ʃɪm/ (n) (marine eng) podložna pločica, podložak za reguliranje zračnosti **compression shim** podloška za reguliranje kompresije

SHINC /ʃɪnk/ (mar law) Sundays and holidays included

shingle /'ʃɪŋɡəl/ (n) (geogr) šljunak **shifting shingle of the seabed** pomični šljunak morskog dna

shingles /'ʃɪŋɡəlz/ (n) (cargo) krovne drvene pločice, šindra

ship (n) COMPARE boat any vessel or conveyance that floats on or operates on the water and is equal to or larger than 197 feet (60 meters) length overall (LOA). A ship may be used for pleasure, commercial, or residential purposes. **brod arrived ship (shipping econ) brod u luci iskrcaja (prema ugovoru o prijevozu), mother ship** matični brod, **brod-matica, deep-sea ship** brod duge plovidbe, **prekooceanski brod, seagoing ship** prekomorski brod, **short sea ship** brod kratke plovidbe

ship agent (n) (mar law) brodski agent

ship bell (n) (navig) Measure of time onboard ship. One bell sounds for each half hour. One bell means 12:30, two bells mean 1:00, three bells mean 1:30, and so on until 4:00 (eight bells). At 4:30 the cycle begins again with one bell. **brodsko vrijeme, jedinica mjere za brodsko vrijeme**

shipboard /'ʃɪp,bɔ:d/ (adj) brodski, koji se nalazi na brodu **shipboard crane** brodska dizalica, **palubna dizalica, shipboard automation** brodska automatizacija, **shipboard service** 1 brodska služba; 2 brodska uporaba, brodska primjena

shipboard crane (n) (nav arch) brodska dizalica

shipborne /'ʃɪp,bɔ:n/ (adj, adv) 1 (seamanship) carried or designed to be transported by ship **brodski, na brodu; 2 (shipping econ) COMPARE airborne** koji se prevozi brodom

shipbreakers (n) (nav arch) raspremno brodogradilište, rezalište brodova

ship breaking industry (n) (nav arch) industrija raspreme brodova, industrija rezanja brodova {rezanje brodova za staro željezo}

shipbreaking yard (n) (nav arch) raspremno brodogradilište, rezalište

shipbroker (n) (mar law) an agent for the ship owner when buying, selling and chartering ships; a ship broker may also obtain cargo and may arrange for its loading or discharge. A person/company who on behalf of shipowner/shipper negotiates a deal for the transportation of cargo at an agreed price. (<http://www.clarksons.com/glossary/>) **agent posrednik, pomorski broker, brodski mešetar, posrednik:** *Shipbrokers also act on behalf of shipping companies in negotiating the purchasing and selling of ships, both second-hand tonnage and newbuilding contracts.*

shipbroking a financial service, which forms part of the global shipping industry. Shipbrokers are specialist intermediaries/negotiators (i.e. brokers) between shipowners and charterers who use ships to transport cargo, or between buyers and sellers of ships.(Wiki) **posredništvo za brodove** {=chartering, sale and purchase of ships}

shipbuilder (n) (nav arch, mar law) **brodograditelj, brodogradilište** shipbuilders
brodogradilište, brodogradilišna firma

shipbuilding (n) (nav arch) shipbuilding deals with design, construction, operations and maintenance of marine vessels **brodogradnja, gradnja broda**: *The discipline of shipbuilding monitors all stages of the life of a marine vessel right from the initial designing to advanced design, actual construction, testing, operations, and maintenance as well as launching, at-sea testing, sea trials and dry-docking of the vessels.*

shipbuilding contract (n) (nav arch) **ugovor o gradnji broda**

shipbuilding terms (n) **brodograđevno nazivlje**

shipchandler (n) (shipping econ) = **chandler** **brodoopskrjljivač, šipčandler, šipšandler**

ship classification (n) (nav arch) **klasifikacija brodova**

ship contract (n) (nav arch, mar law) **ugovor o gradnji broda**: *This ship contract is very important for Finnish shipyard.*

ship design and construction (n) **1** (nav arch) For Ship Design and Construction see: SHIPBUILDING PICTURE DICTIONARY - <http://forshipbuilding.com/ship-structure/> **projektiranje i**

gradnja broda: *ABS will review the design, survey the construction and class the ships for operation on delivery in the course of 2016.*; **2** **ship design and construction**

ship discharge (n) (ports) **brodski ispust, preuzimanje kaljužnih voda s broda u luci**

ship disposal (n) (nav arch) **odlaganje broda u rezalište**: *Ship Disposal involves a number of challenging issues, especially things related to the environmental and safety issues. There are various environmentally friendly methods and options available for a ship disposal. Green Ship Recycling or Ship Breaking is considered as the best option for disposing of a retiring vessel in a safe and environmentally friendly way.*

ship documents (n) **brodske isprave**

ship earth station (SES) (n) (comm) **brodska zemaljska postaja / stanica (u satelitskoj komunikaciji)**

ship form (n) (nav arch) **ploha koja opisuje brodski trup brodska forma**

ship handler (n) **1** (ship handling, navig) **osoba koja rukuje brodom, osoba koja**

manevrira brodom: *Internal Factors/forces under the control of the Ship handler are Engine power, speed, effect and type of the propeller, rudder movement and type, thrusters, anchors and mooring lines, tugs. External Factors/forces that the ship handler must take into account are: tide, Sudden change in wind velocity and direction (gust), set and drift, proximity of other ships, depth of harbours or waterways;* **2**

(ship handling) **voditelj operacije rukovanja brodom (zapovjednik, časnik palubne straže ili osoba na terminalu), voditelj manevriranja brodom**

ship handling (n) (navig, seamanship) = **manoeuvring (UK), maneuvering (US)**

the art of proper control of a ship while underway, especially in harbours, around docks and piers; **ship handler's control of ship's motion, understanding and competence in responding to physical forces acting upon the ship and motions of the ship, ship's hydrodynamics and aerodynamics in all weather, tide and current and wave conditions** **rukovanje brodom, manevriranje**: *(As per IMO STCW 2010) ship handling includes: 1. Manoeuvring the ship when approaching pilot stations to embark or disembark the pilot, taking account of weather, tide, distance to travel and stopping distance, 2. navigating a river, estuary and confined waters, allowing for the effects of current, winds and shallow water on the actions of*

the helm, 3. turning the ship at a constant rate, 4. manoeuvring in shallow waters, allowing for the reduction in under-keel clearance caused by squat, roll and pitch, 5. handling the interactions between ship and river banks (bank effects), 6. berthing/docking and unberthing/undocking under all wind, tide and current conditions, with or without a tug, 7. handling interactions between ship and tugs, 8. being able to use ship's propulsion systems and manoeuvring systems, 9. choosing a mooring; to moor using one or two anchors; to assess the various factors that determine the length of anchor chain to drop, 10. to be able to notice an anchor dragging, and know how to release a fouled anchor, 11. to be able to enter a dry dock, when damaged or undamaged, 12. to be able to sail and manoeuvre in bad weather, including coming to the assistance of a ship or aircraft, to be able to carry out emergency towing operations; 13. to be able to manoeuvre with care in order to launch lifeboats and to release survival gear in bad weather, 14. to be able to winch survivors on board from rescue craft or liferafts, 15. to be able to assess the manoeuvring characteristics of the main types of ship (stopping distances, turning circle at different speeds and draft, 16. to be able to sail at reduced speed to avoid damage being caused by other ships by bow wave or wake, 17. to be able to take necessary precautions when sailing in ice, or when ice is accumulating on board, 18. to be able to sail close to or within traffic separation zones, and in zones covered by the VTS. The most basic thing to be understood in ship handling is to know and anticipate how a ship behaves under all circumstances and what orders should be given in order to make the ship behave and move exactly the way you want her to.

ship handling characteristics (n) (navig, seamanship) manevarske karakteristike broda

ship in international navigation (n) (mar law) brod u međunarodnoj plovidbi

shipload /'ʃipləʊd/ (n) **complete shipload** sav brodski teret - jedinstvena pošiljka (pod jednom teretnicom) (shipping econ) a full load for a ship sav brodski teret (kao jedna pošiljka)



shiploader (n) (cargo handling) brodounkravač

ship loading software (n) (cargo handling, ship handling) softver za izračun

stabiliteta broda pri krcanju tereta na brod. amcLoad is a convenient, high performance ship loading software (in worldwide distribution) developed for cargo ships carrying liquid or dry cargo i.e. Oil Tankers, Chemical Tankers, LPG Tankers, Bulk Carriers, Cement Carriers, General Cargo Ships, etc.

ship management (n) 1 (shipping econ, mar law) 'the rendering of services under contract related to the systematic organisation of economic resources and transactions required for the sustenance of a ship as a revenue-earning entity' (Panayides, P. M., 2001); The provision of ship operating services relating to crewing, technical and safety management (including maintenance and repair) and the compliance with all government, flag state, class certification and international rules and regulations. **poslovno vođenje broda, upravljanje brodom** **ship management contract** ugovor o upravljanju brodom; 2 (mar law, shipping econ) ekonomsko upravljanje brodovima **ship management company** upravitelj brodova trgovačko

društvo (poduzeće) koje se bavi upravljanjem brodova; 3 brodski management (ekonomsko iskorištavanje brodova)

ship management information (n) (mar law) podaci o korisniku broda

ship manager (n) (mar law, shipping econ) fizička ili pravna osoba koja upravlja poslovanjem, tehničkim održavanjem broda i popunjavanjem broda posadom (Pomorski zakonik 2004)

poslovođa broda, upravitelj broda

Ship Master's Medical Report (n) (med) zapovjednikovo zdravstveno izvješće

Ship Master's Medical Report Form obrazac zapovjednikova zdravstvenog izvješća

shipment (n) 1 (shipping econ) = **consignment, package** A quantity of goods or cargo that are shipped together.; Cargo transported under the terms of a single bill of lading or air waybill, irrespective of the quantity or number of containers, packages, or pieces.

(<http://www.businessdictionary.com/definition/shipment.html>) **pošiljka**: *Much of Cork's traffic in trade vehicles is handled at the Tivoli Ro-Ro terminal where regular shipments are discharged from British and mainland European ports.* **accept the shipment** prihvatiti pošiljku, **deliver the**

shipment predati pošiljku, **take delivery of the shipment** preuzeti pošiljku; 2

(shipping econ, mar law) The act or an instance of shipping goods **otprema, špedicija**; 3

(shipping econ, ship handling) **ukrcaj (robe, tereta)**; 4 (cargo handling) **partija tereta**

ship mortgage (n) (mar law) Security on a ship and its appurtenances by the shipowner as security for a loan. It is derived from the English common law chattel mortgage and is similar to the hypothèque maritime of the civil law. Ship mortgages in common law jurisdictions may be either legal or equitable mortgages (Tetley); „pravo prema kojem je vjerovnik ovlašten namiriti svoju tražbinu iz prodajne cijene broda ostvarene sudskom prodajom ili izvansudskom prodajom ili uzimanjem broda u posjed i iskorištavanjem broda.“ (Pomorski zakonik RH) **pomorska hipoteka, hipoteka na brodu, brodska hipoteka**

ship naming (n) (US, nav arch) ceremony is held at the shipyard when a new ship is ready to sail out after undergoing the required sea trials **imenovanje broda**: *Ship Naming traditionally occurs before the ship is christened, while construction is in progress. Once the construction of a ship is completed, the ship owner is notified of the completion and a particular date is fixed for its naming ceremony. Ship naming ceremony is held at the shipyard when a new ship is ready to sail out after undergoing the required sea trials.*

ship naming and launching (n) (nav arch) **krštenje i porinučje broda**: *Ship naming and launching procedures are arranged to provide a ship hull with her identity.*

ship observation (n) (navig, safety) **brodsko motrenje**

ship operating expenses (n) (nav arch, shipping econ) The costs of operating a ship, primarily consisting of crew wages and associated costs, insurance premiums, ship management fees, lubricants and spare parts, and repair and maintenance costs. Ship operating expenses exclude fuel cost, port expenses, agents' fees, canal dues and extra war risk insurance, as well as commissions, which are included in voyage expenses. (<http://www.globalshiplease.com/glossary.cfm>) **operativni troškovi broda**

ship operator 1 (n) (mar law, shipping econ) = **carrier** fizička ili pravna osoba koja je kao posjednik broda nositelj plovidbenoga pothvata; osoba koja je nositelj brodarske djelatnosti u najširem smislu (DP); A firm that charters vessels for its service requirements, which are handled by their own offices or appointed agents at ports of call. Vessel operators also handle the operation of vessels on

behalf of owners. **brodar**; **2 brodarsko poduzeće**; **3 poslovođa (broda)**

shipowner /'ʃip.əʊnə/ (n) (mar law) vlasnik broda, brodovlasnik

shipowner's bill of lading (n) (mar law) teretnica koju izdaje brodovlasnik (u svojstvu ugovornog prijevoznika)

shipowner; ship owner (n) **1** (mar law, shipping econ) brodovlasnik, brodarsko poduzeće, brodarska tvrtka; **2** brodar

shipowner's liability (SOL) SOL or Shipowners' Liability to Cargo is a common term used to describe the insurance arranged to cover a member's liabilities arising from a breach of contract of carriage, where such a breach deprives the carrier of the right to rely on defences or rights of limitation which would otherwise have been available to him. **odgovornost bodara, odgovornost**

vlasnika broda A typical SOL example is geographical deviation or departure from the contractually agreed voyage; liability for loss of and/or damage to cargo arising out of such a deviation falls outside the scope of standard P&I. **shipowner's liability (SOL) insurance osiguranje brodarove odgovornosti**

shipped bill of lading (n) (mar law) teretnica ukrcano na brod **shipped on board bill of lading teretnica ukrcano na brod**

shipped in apparent good order and condition (n) (mar law) ukrcano u prividno dobrom izgledu i stanju (kaluzula u teretnici)

shipped on board bill of lading (n) (mar law) = **shipped bill of lading** A bill of lading (supra) issued when goods have been loaded aboard the ship. (Tetley) **teretnica ukrcano na brod**

shipper /ʃipə(r)/ (n) **1 a** (shipping econ) The party who contracts with a carrier for the carriage of goods. (Tetley); any person by whom or in whose name or on whose behalf a contract of carriage of goods by sea has been concluded with a carrier, or any person by whom or in whose name or on whose behalf the goods are actually delivered to the carrier in relation to the contract of carriage by sea.

(Hamburg Rules); osoba koja na temelju ugovora o prijevozu predaje stvari prijevozniku radi prijevoza

(PZ) **krcatelj** The Shipper is a legal entity or person named on the bill of lading or waybill as shipper and/or who (or in whose name or on whose behalf) a contract of carriage has been concluded with a carrier. **at shipper's risk na odgovornost / rizik krcatelja; 2 otpremnik, pošiljatelj**

{shipper nije brodar već krcatelj ili otpremnik. Riječ brodar jednaka je riječi ship operator ili shipowner}

shipper packed (n) (shipping econ) contents of containers as loaded (stuffed), stowed (packed/braced), weighed and/or counted by or for the shipper

(<http://www.maerskline.com/en-jm/help/shipping-glossary>) **pošiljka pakovana od strane krcatelja**

shipper's note (mar law, shipping econ) = **shipping note** najava ukrcaja, dispozicija ukrcaja

shipping /'ʃipɪŋ/ (n) **1** (shipping econ, mar law) pomorski prijevoz, pomorski transport, morski transport: the process of transporting an item by sea **shipping consignment**

pomorska pošiljka / teret, pošiljka robe morem, **shipping documents** robni

dokumenti, otpremni dokumenti, **shipping marks** transportne oznake, **shipping**

note prijava ukrcaja, **shipping procedure** proces pomorskog prijevoza,

organizacija pomorskog prijevoza prijevoz robe (morem), **shipping space** brodski

prostor, brodski teretni prostor, **shipping technology** tehnologija pomorskog

prijevoza / transporta; 2 (*shipping econ, mar law*) brodarstvo, brodarsko gospodarstvo **shipping company** brodarsko poduzeće, brodarsko trgovačko društvo, brodar, **shipping industry** brodarstvo; 3 (*shipping econ*) ukrcaj tereta, otprema tereta; 4 plovidba **tramp shipping** (*shipping econ*) slobodna plovidba, **liner shipping** linijska plovidba; 5 (*navig*) brodovlje, brodovi, svi brodovi (u luci, na sidrištu itd.), flota

Shipping Act (*n*) (*shipping econ*) Zakon o pomorskom prijevozu (US), pomorski zakon

shipping agent (*n*) (*mar law*) pomorski agent, brodarski agent, brodarov agent

shipping agents (*n*) 1 (*mar law, shipping econ*) pomorska agencija; 2 brodarska agencija {Jobs and duties of shipping agents: bunkers, crew changes, luboil and water supply, off port limits services, ship chandlery, spares and provisions, sullage/sewage, P&I, warehouse storage, etc.}

shipping area (*n*) (*navig*) plovidbeno područje, područje pomorskog prometa: *a few minutes of refamiliarisation of the rigging, and practising of key manoeuvres is time well spent before venturing into a busy shipping area.*

shipping articles (*n*) (*mar law*) = **ship's articles** ugovor o ukrcanju, radni ugovor (pomorca) **sign the shipping articles** potpisati radni ugovor, potpisati ugovor o ukrcanju

shipping certificate (*n*) (*mar law, shipping econ*) potvrda (nalik teretnici) koja se izdaje primateljima tereta u okviru grupne (skupne) teretnice **otpremička potvrda**, **otpremička priznanica**, **špediterska potvrda**

shipping channel (*n*) (*navig*) plovidbeni kanal, plovni kanal, plovidbeni put, plovni put **deepwater shipping channel** plovidbeni kanal za brodove velikog gaza, plovidbeni kanal za preoocenaske brodove: *This dangerous deepwater shipping channel leads to the Milford Haven waterway and Port of Milford Haven, the UK's largest energy port and the biggest port in Wales.*

shipping company (*n*) 1 (*mar law, shipping econ*) brodarsko društvo, brodarsko poduzeće, brodarska kompanija; 2 (*shipping econ*) a company that operates frequent scheduled or liner services, with predetermined port calls, using a number of owned or chartered vessels to transport cargoes by containers; also known as a liner company or a ship operator. **linijski brodarsko društvo**, **linijski brodar**

shipping conference (*n*) (*shipping econ*) brodarska konferencija

shipping container (*n*) (*cargo, cargo handling, US*) = **container = freight**

container a standard sized container that is resealable and lockable that is used with standard equipment for handling freight. 2 standard sizes in 20 foot and 40 foot

(<http://thelawdictionary.org/shipping-container/>) **kontejner**

shipping documents (*n*) (*mar law, shipping econ*) documents in international transport of goods such as: certificates of origin, condition and suitability of goods for export, Particulars of specifications, weight and/or measurement, Invoices in respect of the full interest insured, bills of lading, charterparties, letter of indemnity, delivery orders, dock warrants etc.; Air waybill, bill of lading, or truck bill of lading, commercial invoice, certificate of origin, insurance certificate, packing list, or other documents required to clear customs and take delivery of the goods. **prijevozne isprave**, **robni dokumenti**, **prijevozni dokumenti**

shipping forecast (*n*) (*meteorol*) prognoza vremena za brodove, prognoza

vremena za pomorce

shipping industry (n) **1 a** (*shipping econ*) the industry devoted to moving goods or passengers by water **brodarstvo, brodarsko gospodarstvo**; **2 pomorsko gospodarstvo, pomorska privreda**

shipping law pomorsko pravo: ..., this section will look at the liens found in shipping operations, and examples will be mainly from *shipping law*.

shipping line (n) (*mar law, shipping econ*) **1 brodarska linija, brodska linija, brodski servis**: Modern shipment, between freight forwarder and *shipping line*, is contracted by means of a Combined Transport Document.; **2 linijsko brodarsko društvo**: Many of the larger exporting companies maintain an inhouse shipping and distribution department which negotiates contracts of affreightment or carriage of goods for the company with the *shipping line* that trades to the area of the world where the company's goods are destined.; **3 brodarsko linijsko poduzeće**; **4 linijski brodar**: Liner Waybill: Document, issued by a *shipping line* to a shipper, which serves as a receipt for the goods and evidence of the contract of carriage.

shipping market (n) (*shipping econ*) **pomorsko tržište, tržište broskog prostora**

shipping movements (n) (*navig*) **kretanje brodova (luci, području VTS-a)**. The VTS operations and information service covers the Solent and Southampton Water and involves the monitoring and co-ordination of shipping movements.

shipping note (n) (*mar law, shipping econ*) . **najava ukrcaja, obavijest o ukrcaju** {A notice sent to a local or foreign buyer advising that shipment has gone forward and containing details of packing, routing, etc. A copy of the invoice is often enclosed and, if desired, a copy of the bill of lading}

shipping order (n) (*mar law, shipping econ*) = **shipper's note** Equivalent of booking and contract of carriage evidencing the agreement to transport goods.

(<http://www.maerskline.com/en-jm/help/shipping-glossary>) **nalog ukrcaja, dispozicija ukrcaja**

shipping procedure (n) (*shipping econ, mar law*) **pomorski prijevoz, proces**

prijevoza morem: The *shipping procedure* starts when cargo liner, operating on schedule voyages, at her terminal port, and the owners or agents have estimated the date when she will be ready to start loading for the next port.

shipping routes (n) (*shipping econ*) **morski transportni pravci, morski transportni putovi**

shipping space (n) (*shipping econ*) **brodski prostor (za teret) book shipping space zaključiti brodski prostor, rezervirati brodski prostor, bukirati brodski prostor**

shipping tonnage (ports) (n) total volume of ships handled expressed in dwt or GT **promet brodova u luci (u dwt ili BT)**

ship prices (n) (*nav arch, shipping econ*) **cijene brodova**: *Ship prices include: New build prices, second hand prices and scrap prices* Cijene brodova uključuju: cijene novogradnji, cijene rabljenih brodova, cijene brodova za raspremu/rezalište

ship propulsion (n) (*marine eng*) **pogon broda, poriv broda**

ship reconstruction (n) (*nav arch*) **preinaka na brodu**

shiprepairer /'ʃɪp,rɪ'peɪə/ (n) **remontni brodograditelj, remontno brodogradilište**

shiprepairers /'ʃɪp,rɪ'peɪə/ (n) **remontno brodogradilište**

ship repairs (n) **poslovi popravka brodova**

ship repair yard (n) **remontno brodogradilište**: After the collision the ship was towed to a ship repair yard for repairs.

ship reporting points (n) (navig) točke javljanja broda

ship reporting scheme (n) (comm) shema izvješćivanja (o poziciji broda itd.), zona javljanja brodova (na putu u luku) **enter the ship reporting scheme** ući u zonu javljanja brodova, **leave the ship reporting scheme** izaći iz zone javljanja brodova

ship rescue (n) (safety) spašavanje s broda

ship routing (n) (navig) usmjeravanje plovidbe

ship routing scheme (n) (navig) shema usmjeravanja plovidbe

ship's agent/s (n) (mar law) brodski agent, lučki agent, lučka agencija, lučki agent

ship's alarm system (n) (safety, comm) brodski sustav uzbune

ship's appurtenances (n) (mar law) stvar koja prema namjeni trajno služi uporabi na brodu i kada je od njega privremeno odvojena **pripadnosti broda**

ship's articles (n) (mar law) = **shipping articles** radni ugovor (pomorca), ugovor o ukrcanju (pomorca)

ship's books (n) (mar law) brodske knjige

ship's bottom (n) (nav arch) brodsko dno {tal.: **carena**}

ship's capacity plan (n) (nav arch) brodski kapacitetni plan, kapacitetni plan broda

ship's capsize moment (n) (nav arch) moment prevrtanja

ship's clock (n) (nav arch) brodski sat

ship's company (n) (seamanship) brodska posada

ship's complement (n) (mar law) = **ship's crew** brodska posada

ship's crane (n) (nav arch) brodska dizalica

ship's crew (n) **brodska posada**: *The **ship's crew** accepted the stowage factors as stated in the list. To avoid further delays, the **ship's crew** completed the work tightening up all the bolts. A **ship's crew member** sustained a serious hand injury while using an air driven deck scaler during maintenance operations.*

ship's delivery order (n) (mar law) any document which is neither a bill of lading nor a sea waybill but contains an undertaking which: a) is given under or for the purposes of a contract for the carriage by sea of the goods to which the document relates, or of goods which include those goods; and b) is an undertaking by the carrier to a person identified in the document to deliver the goods to which the document relates to that person. (Tetley) **nalog za iskladištenje (iz broda), izručnica, bez zapreke, delivery order**

ship's documents (n) (nav arch, mar law) brodski papiri, brodski dokumenti

ship seas (v) (navig) krcati more {prelamanje valova preko pramca palube}

ship section (n) **1** (nav arch) presjek broda **moulded dimensions of the ship section** **baždarne dimenzije sekcije broda**

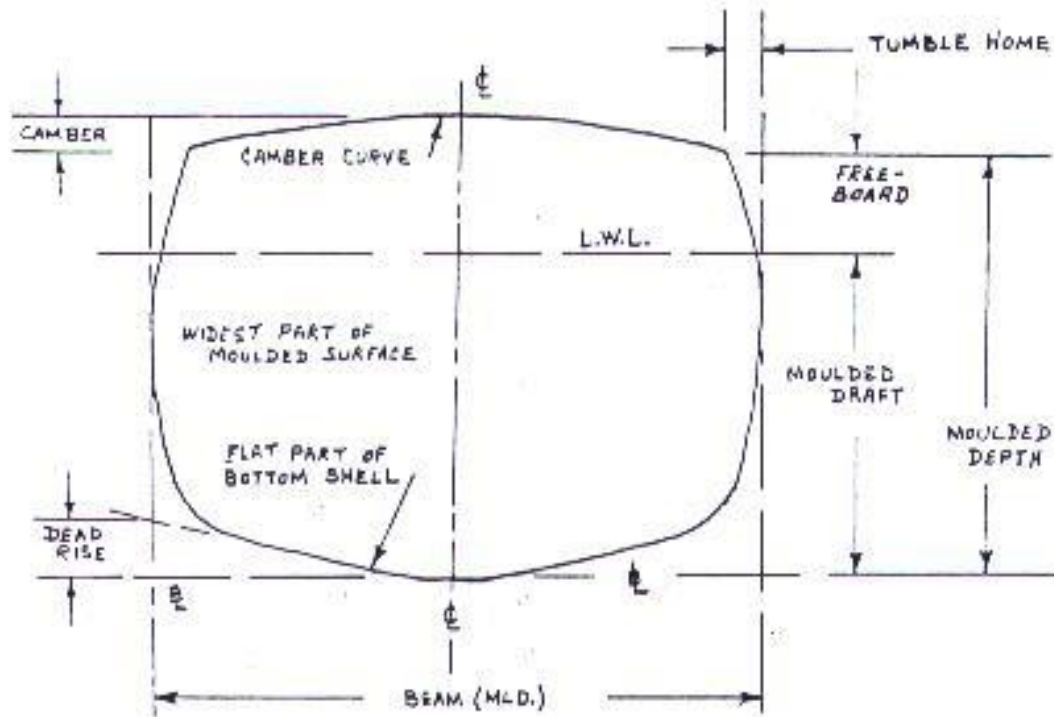

FIG. 3 - Moulded Dimensions at Midship Section

forecastle pramčani kaštel, forepeak ship section sekcija pramčanog pika, engine room section sekcija strojarnice, bow ship section pramčana sekcija, stern ship section krmena sekcija, rudder ship section sekcija kormilarskog uređaja; 2 (nav arch) sekcija broda

ship security officer časnik odgovoran za sigurnosnu zaštitu broda

ship security plan (n) (safety) plan sigurnosne zaštite broda

ships entering Croatian ports (n) (mar law) brodovi koji uplovljavaju u hrvatske luke

ship's figures (n) (shipping econ) ANTONYM shore figures brojke (o teretu) zabilježene na brodu (od strane brodske posade)

ship's friction resistance (n) (navig) otpor trenja broda

ship's gang (n) (mar law) ANTONYM shore gang grupa lučkih radnika koja obavlja ukrcaj/iskrcaj tereta s broda ili jednog brodskog skladišta brodska ruka

ship's gear (n) (nav arch) brodski uređaj za teret, brodski teretni uređaj

ship's generating unit brodska centrala

shipshape (adj) (seamanship, mar law) a nautical term used to signify that the whole vessel, or the portion under discussion, is neat in appearance and in good order (SeaSources.net) brod u potpunosti spreman za isplavljenje (uređen i počišćen)

ship's head (n) (navig) pramac broda, prednji kraj broda: *The ship's head began to turn to starboard, but it soon became apparent that she was closing the shallows and would not be able to complete the turn. The master requested the assistance of a harbour tug to hold the ship's head into wind, while he attempted to manoeuvre the ship back to her original anchor position. He then adjusted the*

vessel's head with the use of the stern azimuths.

ship's hospital (n) (nav arch) **brodska bolnica**: They then removed the casualty to the *ship's hospital* where further first aid treatment was provided. He was moved to the *ship's hospital* for closer examination and administration of first aid.

ship's husband (n) (mar law, shipping econ) An agent appointed by the owner of a ship, and invested with authority to make the requisite repairs, and attend to the management, equipment, and other concerns of the ship he is usually authorized to act as the general agent of the owners, in relation to the ship in her home port. An agent who is responsible for providing maintenance and supplies for a ship in port. **generalni agent broda u luci**

ship's immunity (n) (mar law) **imunitet broda**

ship's ISM audit (n) (safety) **prosudba upravljanja sigurnošću**

ships leaving Croatian ports (n) (mar law) **brodovi koji napuštaju hrvatske luke**

ship's load calculation in open sea condition (n) (nav arch) **proračun napreznja broda na valovima**

ship's load calculation in still water (n) (nav arch, cargo handling) **proračun napreznja broda u mirnoj vodi**

ship's log (n) (mar law) = **log brodski dnevnik**: In case of heavy weather, keep a copy of any meteorological reports, or warnings, and properly record the conditions in the *ship's log*. ... the coxswain was not monitoring the pilot boat's position as he had become distracted by completing an entry in the *ship's log*.

ship's lookout (n) (navig, safety) **brodsko motrenje, motritelj**

ship's machinery (n) **1 (nav arch, marine eng) brodska strojna postrojenja; 2 brodska strojarnica**

ship's manifest (n) (mar law) osnovna isprava za carinski nadzor broda **brodsi manifest**

ship's manifold (n) **brodski razvodnik tereta (na tankerima)**: It is also useful whenever possible to obtain samples of cargo immediately prior to loading, including samples from a point as near to the ship's manifold as possible.

ships meteorological station (n) (nav arch, meteorol) **brodska meteorološka postaja**

ship's motions (n) (nav arch) **gibanja broda surging zastajanje i ubrzavanje, proklizavanje, rolling valjanje, pitching posrtanje, swaying zanošenje, yawing**

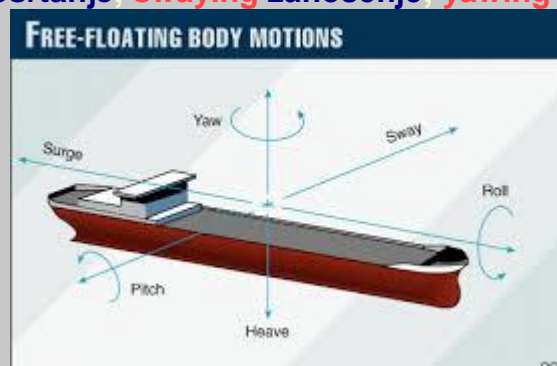

zaošijavanje, heaving dizanje i spuštanje

ship's name (n) (mar law) **ime broda**

ship's notes (n) (mar law) zapisi u koje se unose podaci o važnijim događajima i obavljenim radnjama na brodu **brodski zapisi**

ship's operations officer (n) (seamanship, US) **časnik palube**: *The Ships Operations Officer - Chief Mate shall organize and track daily shipboard M&R programs with Master & C/E. Assist with the training of Cadets in maintenance and operational deck skills. Required to go on summer cruise of up to 120 days per year. He will be responsible for maintaining security, safety and drill schedule aboard the vessel.*

ship-source pollution (n) (safety) **onečišćenje s brodova**

ship's papers (n) (mar law) **brodske isprave, brodske isprave i knjige**

ship's particulars (n) (nav arch) **podaci o brodu, osnovni podaci o brodu**

ship's pharmacy (n) (nav arch) **brodska ljekarna, brodska apoteka**

ship's position (n) (navig) **pozicija broda, položaj broda, tal. punto nave**

ship's records (n) (mar law) **brodske knjige**

ship's sponsor (n) (nav arch) **kuma broda (pri krštenju broda)**

ship's stability (nav arch) **stabilnost broda, stabilitet broda**

Ship's Store Declaration (n) (shipping econ) **Popis namirnica, potrošnog i pogonskog materijala**

ship's strength (n) (nav arch) **čvrstoća broda**

ship's systems (n) (nav arch) **brodski sustavi**

ship's thrust force (n) (seamanship, navig) **sila poriva broda**

ship's turning force (n) (navig, seamanship) **sila zakretanja broda**

ship's turning moment (navig, seamanship) **moment sile koji nastoji zakrenuti brod, a tvori ga sila zakretanja broda koja djeluje na određenoj poluzi zakretanja **zakretni moment broda****

ship's vertical axis (nav arch) **vertikalna os broda**

ship's voyage (n) (shipping econ) **pomorsko putovanje**

ship's weight curve (n) (nav arch) **krivulja težina**

shiptainer /'ʃip,teinə/ (n) (cargo handling) **brodska kontejnerska dizalica**

ship tonnage (n) (stabil) **mjere broda, glavne mjere broda**

ship-to-ship transfer; (STS transfer) A ship-to-ship (STS) transfer operation is the transfer of cargo between seagoing ships positioned alongside each other, either while stationary or underway. Cargoes typically transferred via STS methods include crude oil, LNG,LPG, and petroleum products. **prekrcaj s broda na brod (u plovidbi)** {These operations are carried out in accordance with guidelines set out by the OCIMF and the International Chamber Of Shipping (ICS), with the strictest adherence to safety regulations.}

ship to shore collision (n) (navig, mar law) **udar (broda o kopno ili obalna/kopnena postrojenja)**

ship traffic (n) (navig) **kretanje brodova**

ship type IMO Code (n) (mar law) **IMO-ov kod za vrstu broda**

ship under construction (n) (nav arch, mar law) **brod u gradnji**



ship unloader (n) (cargo handling) brodoiskrcavač

ship water (v) (safety) krcati (valove, more)

ship weather report (meteorol) brodsko meteorološko izvješće

shipwreck /'ʃɪp, rɛk/ (n) 1 a (navig) podrtina, olupina



; 2 (mar law) brodolom, tal. naufragio: A prison sentence for the captain's role in the deadly cruiser liner **shipwreck** was upheld on Tuesday by the appeals court. **survive a shipwreck** preživjeti brodolom; 3 brod koji je pretrpio brodolom

shipwright /'ʃɪp, raɪt/ (n) (mar law) brodograditelj (manji), malo brodogradilište

shipyard (n) brodogradilište, škver, tal. cantiere (navale)

shoal /ʃəʊl/ (n) uncharted **shoal** neucrtana plićina (oceanogr) a patch of shallow water

plićina: As a result, the 3/O, who was monitoring the situation from the forward console, did not realise that the vessel was heading towards shoal ground. The 46,000 DWT motor vessel remains hard aground on a shoal about 15 nautical miles from Varberg, Sweden in the Kattegat. **rocky shoals** stjenovite

plićine, **charted shoal** ucrtana plićina

shoaling (n) 1 (navig, boating/yachting) smanjivanje dubine mora; 2 (ports)

nakupljanje mulja i pijeska (u plovodbenom kanalu)

shock (n) 1 (marine eng) udar, udarac; 2 (safety) šok

shock-absorbing (adj) (marine eng) koji uklanja ili smanjuje udarce

shop (n) (nav arch) A building where work is performed in a protected area **radionica** (u brodogradilištu), radionička zgrada

shore /ʃɔː/ (n) 1 (geogr) dio obale koji se proteže od crte srednjih viših visokih voda mora i obuhvaća pojas kopna koji je ograničen crtom do koje dopiru najveći valovi tijekom nevremena; (law) the tract of coastland lying between the ordinary marks of high and low water; the land along the edge of a sea,

lake, or wide river; land, as opposed to water (esp in the phrase on shore) **morska obala** (prirodna), **kopno shore launch** brodica za prijevoz plopsade / putnika (do i s brodova na sidrištu), **shore installations** obalna postrojenja, obalna mehanizacija (za teret), **shore-based** kopneni; 2 (nav arch) bočni potporanj (za držanje brodice u gradnji uspravnom)

shore-based (adj) obalni, kopneni, koji se nalazi na kopnu

shore-based crane (n) (cargo handling) obalna dizalica

shore-based lifting gear obalne dizalice

shore connection (n) (electr, nav arch) = **cold ironing** kopneni električni

priključak, obalni priključak (na električnu struju), priključak s kopna (struje,

teretnih uređaja itd.): *Cold ironing – providing ships with shoreside power so vessels can turn off their engines while hotelling in port – is one of the key elements of the clean air action plan (CAAP) recently adopted by the two ports.*

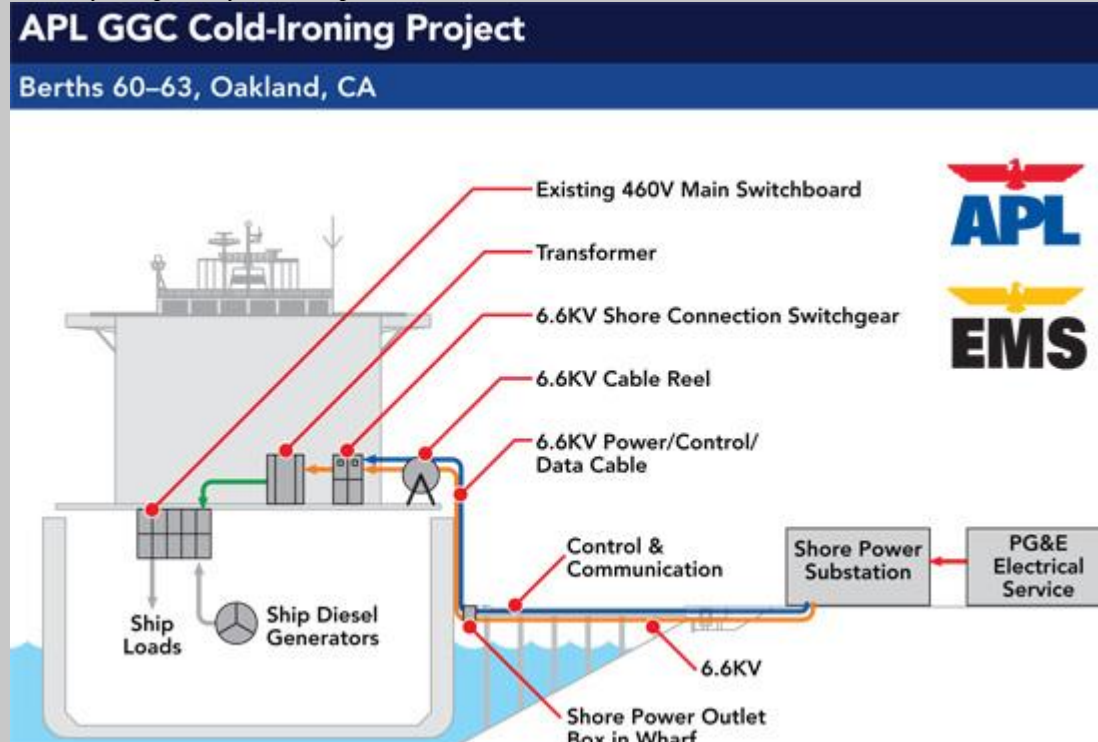

shore crane (n) (cargo handling) obalna dizalica

shore emergency services (n) (safety) služba pomoći s kopna u slučaju opasnosti

shore figures (n) (shipping econ) brojke (o teretu) zabilježene na obali (od strane predstavnika u luci):

A calculation of the loaded quantity should be made, based upon the vessel's ullage and temperature figures, and the result compared with the shore figure to ensure that any difference falls within the vessel's experience factor.

shore fishing (n) (fishing) ribolov s obale, ribolov s kopna

shore gang (n) (cargo handling) a group of port workers consisting of a gang foreman, a hatchwayman, winchman, stevedores **obalna ruka**

shore installations (n) (ports) kopnene instalacije, kopnena postrojenja

shore leave (n) (mar law) dozvola (članu posade) za ulaz u grad

shoreline (n) (oceanogr) obalna crta, obala

shore operator (n) (mar law) ovlaštenik koncesije u luci, lučki koncesionar, lučki operater, lučko poduzeće

shore pass (n) (mar law) dozvola (članu posade) za ulaz u grad: *Shore passes are given by Immigration Police.*

shorepower (n) (electr) = cold ironing obalni priključak (na električnu struju)

shore spinning (n) (fishing) varaličarenje s obale

shore terminal (n) (ports) obalni terminal, terminal na kopnu

shortage (n) (shipping econ) manjak (tereta pri isporuci): *In many countries, courts will accept that the carrier is not liable for shortages of up to 0.5% of the quantity laden. **shortage claim** 1 tražbina zbog manjka tereta; 2: Much of the documentation and evidence required for shortage claims is also necessary to contest contamination claims.*

shortage claim (n) (mar ins, mar law) zahtjev na nadoknadu štete zbog manjka tereta

short circuit /'ʃɔ:t ,sɜ:kɪt/ (n) (electr) kratki spoj

short coastal navigation (n) (shipping econ) mala obalna plovdba

short coastal service area (n) mala obalna plovdba

shortcomings (n) (safety, navig) nedostatci **serious shortcomings** ozbiljni

nedostatci *The serious shortcomings with the navigation on board the vessel had not been identified during the vessel's recent audits and inspections. Both **shortcomings** were subject to Flag State approved exemptions from safety regulations.*

short delivery (n) (shipping econ, mar law) manjkava isporuka, nepotpuna isporuka, manjak tereta

shortfall /'ʃɔ:t ,fɔ:l/ (n) (mar law, shipping econ) manjak (tereta)

short form bill of lading (n) (mar law) skraćeni oblik teretnice

short-handed sailing (n) (boating/yachting) jedrenje / plovdba sa smanjenim brojem posade

short landed Cargo volume count (at delivery destination) less than originally shipped.

(<http://www.maerskline.com/en-jm/help/shipping-glossary>) manjak tereta (po obujmu, broju koleta) pri iskrcaju **short landed cargo** manjak tereta pri iskrcaju

short-sea service (n) 1 (shipping econ) = short sea trade kratka plovdba; 2 velika obalna plovdba

short sea shipping (n) (shipping econ) kratka plovdba

short sea trade 1 kratka plovdba; 2 velika obalna plovdba

short shipped cargo (n) (shipping econ, mar law) cargo missing when loading the shipment on the vessel; i.e. less than shown in the bill of lading **short shipped cargo**

short splice (n) (seamanship) upleteni spoj dva užeta

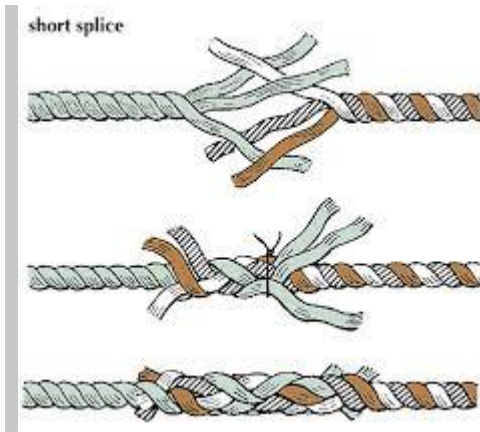

shot (n) (US, seamanship) = **shackle** :1 a short length of chain, usually 15 fathoms (90 feet) **uza sidrenog lanca** {a method of measuring chain length}

shoulder /ˈʃəʊldə/ (n) 1 a (marine eng) rame, izbočina; 2 (nav arch, navig) mjesto na oplati desne ili lijeve strane pramca broda predviđeno za guranje ili vučenja od strane tegljača **strana pramca**

The smaller tug was made fast on the port shoulder to assist in maintaining the course. **port shoulder** lijeva strana pramca, **starboard shoulder** desna strana pramca

shove off (v) (seamanship) to push a boat away from alongside **odgurnuti brodicu (bočno)** od obale ilio drugog broda

showers /ˈʃəʊəz/ (n) (meteorol) pljuskovi, tal. *rovescio*

shower sump pump (n) (boating/yachting) crpka vode iz kupaonice

SHP; shaft horse power (n) (nav arch) snaga na osovini

shrimp (n) Lat. *Parapenaeus longirostris* račić, kozica

shrimps (n) (fishing) račići

shrink (v) stegnuti se, skupiti se, suziti se **shrink on to** navući na toplo (cijev itd.) navući u zgrijanom stanju

shroud /ʃraʊd/ (boating/yachting) standing rigging running from a mast to the sides of a ships **pripona, sartija**; tal. *sartia* **lower shroud** donja pripona, **topmast shroud** križna

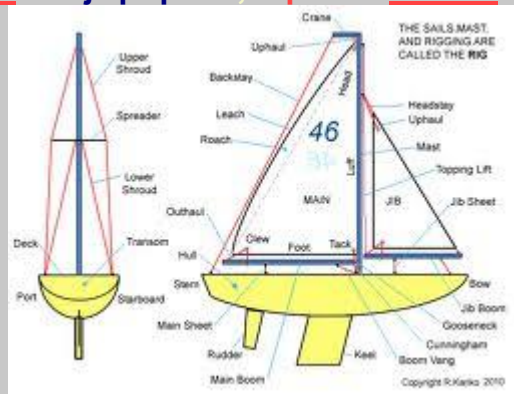

pripona, upper shroud gornja pripona

shroud whip (n) (boating/yachting) uže za napinjanje pripona

shudder (n) (navig) podrhtavanje (trupa broda), **trešnja**: *A very short while later a shudder was felt and the vessel's speed decreased.*

shunting yard /ˈʃʌntɪŋ/ (n) (ports) ranžirni kolodvor

shutdown /ˈʃʌt,daʊn/ (n) **1 a** (marine eng) isključenje pogona, prekid pogona, obustavljanje rada **shutdown procedure** postupak isključenja pogona; **2** (marine eng) mirovanje **prolonged shutdown** dugotrajno mirovanje; **3** zatvaranje (luke, terminala, linije, usluge), prestanak rada (luke, terminala, linije, usluge)

shut down (v) **1** ugasiti (motor, radar itd.): *When the door of the cabinet containing the CO2 release mechanism was opened, a power black-out occurred and the engine shut down.*; **2** (marine eng) **zatvoriti**: *The steam supply to the deck machinery was shut down*; **3** (shipping econ) **prestati poslovati, zatvoriti (liniju, servis, terminal)**: *APM Terminals notified the Texas Workforce Commission on June 12 that it would shut down its Barbours Cut terminal in La Porte, Texas on July 24, about a month sooner than expected. Wild weather and heavy seas shut down Australia's Port Botany terminal today.*

shutdown procedure (n) (safety, cargo handling) postupak za prekid rada **emergency shutdown procedure** postupak za prekid rada u slučaju opasnosti

shut off (v) **1 a** isključiti, zatvoriti; **2** (marine eng) prekinuti dovod (nečaga) **shut off valve** ventil za zaustavljanje (dovoda)

shut-off valve (n) (electr) ventil za isključivanje motora, ventil za isključivanje dovoda goriva

shutting down the engine (n) (marine eng, shipping econ) gašenje stroja, gašenje motora: *Shutting down the engine for longer periods*

shuttle tanker (n) (shipping econ, nav arch) moderate sized tanker designed for the regular short-haul transport of oil between FPSO (=Floating production, storage and offloading vessel) vessels or single point mooring buoys and coastal refinery terminals

(<http://www.scribd.com/doc/10232629/Glossary-of-Naval-Architecture-Terminologies-Definitions#scribd>); A shuttle tanker is a ship designed for oil transport from an off-shore oil field as an alternative to constructing oil pipelines. It is equipped with off-loading equipment compatible with the oil field in question. **tanker za prijevoz tereta nafte sa naftnih platformi, tanker za kraće plovidbe (od naftnih platforma do odredišta)**: *Tankers on the North Sea run (often called shuttle tankers) have been specially designed to load at the bow from a single point mooring at sea. A shuttle tanker is a ship designed for oil transport from an off-shore oil field as an alternative to constructing oil pipelines. Shuttle tankers are largely conventional tankers which are equipped to station themselves on an offshore loading buoy far at sea and to load their cargo of crude oil directly from the oilfield, where it has been kept in a reservoir with perhaps the sulphur removed.*



sick (adj) bolestan

sick bay (n) (safety, nav arch) = **ship's hospital** the compartment on board reserved for medical purposes **brodska bolnica**

sick cases (n) (med) slučaji oboljenja / bolesti / oboljelih na brodu

Sick List (n) (med) Popis oboljelih

sickness (n) (med) bolest, oboljenje

sick pay (n) 1 (med, mar law) bolovanje; 2 (mar law) naknada za bolovanje

sick room (n) (safety) brodska bolnica

side (n) (seamanship) strana (broda), tal. **banda port / starboard side** lijeva / desna strana broda

side coils (n) (nav arch) bočne serpentine

side deck (n) (boating/yachting) bočni dio palube

side elevation (n) bočna vertikalna projekcija, bočni pogled, bokocrt, elevacija

side flat line (n) (nav arch) granica ravnog boka

sidelight (n) (navig) bočno navigacijsko svjetlo **port sidelight** lijevo navigacijsko

svjetlo: *the ship's port sidelight was not easily seen*, **starboard sidelight** desno navigacijsko svjetlo, **fixed sidelight** stalno okno, **sidelight with movable deadlight plug** okno sa skidljivim čepom, okno sa skidljivim poklopcem

sidelight frame okvid okna

sidelights (n) (navig) the red and green running lights, carried on the port and starboard sides respectively, of vessels under-way **bočna svjetla**

side light; side lights (n) (nav arch) = **porthole** brodsko okno, bočno okno

side loader (n) (cargo handling) **bočni viličar**: *The container side loader quickly and safely stacks 20ft and 40ft fully loaded, hazardous and fragile containers on top of each other.*



<http://www.steelbro.com/products/sidelifters/productivity.html>

side lobe echoes (n) (navig) **lažna bočna jeka (na radaru)**: *Side lobe echoes can be reduced through careful reduction of sensitivity or proper adjustment of the A/C SEA control.*

sidescuttle (n) (nav arch) **SEE porthole** A porthole on a ship may also be called a **sidescuttle** or **side scuttle** (side hole), as officially termed in the SOLAS Convention. **bočno okno (s poklopcem i bez)**: *Side scuttles and windows together with their glasses, deadlights shall be of approved design and substantial construction in accordance with, or equivalent to, recognised national or international standards.*

side shell (n) (nav arch) oplata boka

side strake (n) (nav arch) voj boka

side stringer (n) (nav arch) proveza boka

side tank (n) (navig) bočni tank

side trawler (n) (nav arch) bočni kočar

sideways force (n) (boating/yachting) sila zanošenja

side web (n) (nav arch) okvir boka

sifting (adj) (cargo) rešetkast, koji djeluje kao sito, koji se rasipa

sight /sait/ (n) 1 (navig) an accurately timed measurement of the altitude of a celestial body

snimak, smjeranje (nebeskih tijela) **Sun sight** snimak Sunca (sekstantom), **Moon sight** snimak Mjeseca, **star sight** snimak zvijezde, **to take sights of the Sun / Moon / planets / stars** snimiti pložaj Sunca, Mjeseca, planeta, zvijezda; 2 vidokrug **to be in sight of land** vidjeti kopno, biti na domak kopna, kopno u vidokrugu, **vessels insight of each other** (navig) visual perception of an object brodovi u međusobnom vidokrugu (kada vide jedan drugoga, bilo okom ili radarom); 3 vizualno opažanje

sight /sait/ (v) 1 a (navig) snimati (nebeska tijela), smjerati; 2 (cargo) vizualno pregledati (teret) **fo sighting** na uvid; 3 opaziti, ugledati: *At this time, the OOW sighted an unidentified vessel emerge from a cluster of anchored ships*

sight /sait/ (v) (navig, safety) opaziti (u traganju i spašavanju), uočiti: *The OOW failed to sight the red lightbuoy marking the southern limit of the approach channel into the basin.* Časnik u straži nije opazio plutaču sa crvenim svjetlom koja obilježava prilazni kanal prema lučkom bazenu.

sighted /saitid/ (adj) (safety, comm) opažen, uočen **sighted one liferaft in position ...** Opažena jedna splav za spašavanje na poziciji

sight glass (n) (marine eng) kontrolno staklo, kontrolni prozorčić

sighting (n) (safety, comm) opažaj, opaženi brod, uočeni brod **Report sightings!** Izvijestite o svojim opažanjima!

sighting of oil (n) (safety) opažena zauljena površina mora, primijećeno ulje/nafta na moru: *The sighting of oil near the reef is of environmental concern because the world heritage site is the largest ecosystem of its kind, hosting over 1,500 species of fish, 400 of coral and 4,000 mollusks.*

sign /sain/ (v) (mar law) potpisati (se) **sign the Bill of Lading** potpisati teretnicu

sign /sain/ (n) znak

signal /signəl/ (n) 1 znak; 2 (navig, safety) signal distress **signal** signal pogibelji, signal pogibli, **fog signal** signal za maglu, **gun signal** signal iz vatrenog oružja, signal pucnjem, **light 1** svjetlosni signal, **manoeuvrig signal** signal za manovru, **smoke signal** dimni signal, **sound signal** zvučni signal, **warning signal** signal upozorenja, **whistle signal** signal zviždaljkom / sirenom

signal buoy (n) (navig) signalna plutača

signal flag (n) (comm) signalna zastavica **maritime signal flags**

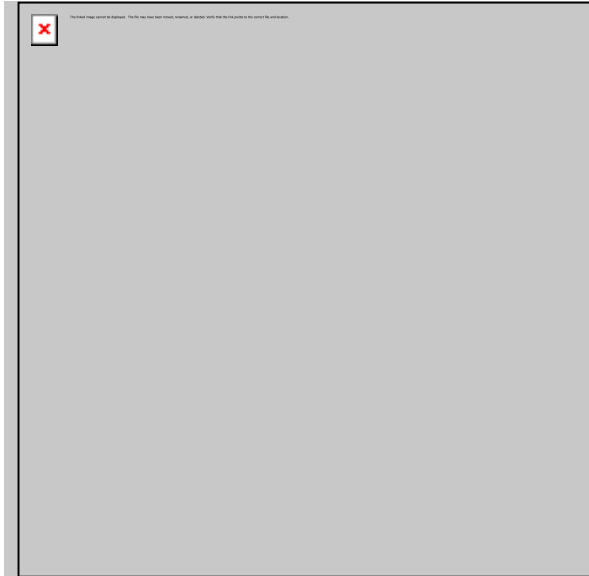

pomorske signalne zastavice

signal hoists (n) (comm, navig) signalne zastavice

signal lights (n) (navig) signalna svjetla

signalling (n) (comm, navig) signalizacija

signal pistol (n) (comm, nav arch) signalni pištolj

signal station (n) (comm, navig) signalna stanica

signature (n) (mar law) potpis signature of Master potpis zapovjednika, signature of Seafarer potpis pomorca

signing-on and signing-off (n) (mar law) ukrcaj / iskrcaj pomoraca, sklapanje pomoračkih ugovora

sign off /sain/ (v) (shipping econ) iskrcati se s broda (završiti ili prekinuti zaposlenje na brodu), potpisati ugovor o iskrcanju (pomorca), završiti ugovor o ukrcanju, iskrcati se, raskinuti ugovor

sign on /sain/ (v) (shipping econ) ukrcati se na brod (započeti ugovor o zaposlenju na brodu), uposliti se na brodu, potpisati ugovor o ukrcanju (pomorca), tal.

imbarcare (un marittimo) sign on the Agreement potpisati (radni) ugovor

sign-on sign-off agreement (n) (mar law) = **articles of agreement** **SEE shipping articles** ugovor o ukrcanju (pomorca), radni ugovor (pomorca)

silence šutnja **radio silence** 1 radiošutnja; 2 **impose silence** nametnuti radiošutnju, narediti radiošutnju

silencer /'sailənsə/ (n) (marine eng) prigušivač

silicon; (Si) /'silikən/ (n) (chem) silicij, kremen

silo /'sailəʊ/ (n) (ports, cargo handling) = **elevator** silos

silt (n) mulj, talog

simple turn (n) (seamanship) **COMPARE round turn** poluvoj konopa

simultaneously (adv) istovremeno, istodobno, simultano

since (prep) 1 **od, otkada**: *the navigation in the channel has been discontinued since last March* plovidba kanalom je obustavljena od prošlog ožujka; 2 (conj) **budući da, jer**: *the launching has*

been postponed since the hull painting hadn't been finished on time porinué broda je odgođeno budući da radovi na bojanju trupa nisu bili završeni na vrijeme

single (adj) pojedinačan, jednostruk, jednovremen **single storage capacity** (**shipping econ**) kapacitet jednovremenog uskladištenja, **single user berth** vez koji koristi samo jedan brodar

single-acting (adj) (**marine eng**) jednoradni (stroj) **single-acting engine** jednoradni motor

single arm anchor (n) (**nav arch**) jednokrako sidro

single bend (n) (**seamanship**) zastavni uzao

single-buoy mooring (SBM) (n) (**navig**) **SEE single-point mooring (SPM)** sidrenje na jednom sidru, vez na jednom sidru



single-drum boiler (n) (**marine eng**) kotao s jednim bubnjem, kotao s jednostrukom komorom

singled up /'sɪŋɡəl,ʌp/ (adj) (**navig, seamanship**) brod koji je ujednostručio užad za privezivanje (pri manovri odvezivanja), brod koji je (pri manovri odvezivanja) ostao na jednom užetu na pramcu i krmi, **singled up**: The ship is singled up to one headline, one spring forward and one breast line aft.

single-flow boiler kotao s jednostrukom dimnom komorom

single-handed sailing (n) (**boating/yachting**) jedrenje u jednosjedima

single-handed yacht (n) (**boating/yachting**) jedrilica jednosjed, jednosjed

single lace hitch (n) (**seamanship**) čipkarski uzao

single-point mooring (SPM) (n) (**navig**) the single point mooring buoy consists of a buoy that is permanently moored to the seabed by means of multiple mooring lines **sidrenje (privez) na jednu točku (sidro ili plutaču)**: shuttle tankers have been specially designed to load at the bow from a single point mooring at sea. Single Point Mooring (SPM), also known as mono-mooring or bow mooring, means the tanker is moored at the bow, using one or two hawsers to a buoy or tower. This had little effect, and the ship drifted beam on to the wind, eventually striking the **SPM buoy** aft of amidships. (The two main types of SPM are Catenary Anchor Leg Mooring (CALM) and Single Anchor Leg Mooring (SALM). CALM the most common, where a large buoy held in place by more anchor cables that extend in catenaries to anchor points some distance from the buoy. The SALM system is similar, except that the SALM is anchored by a single anchor leg. (<http://www.marimatech.com/products/offshore>))

single propeller (n) (**nav arch**) jedan propeler

single sideband radio (SSB) (n) **single sideband radio (SSB)** transmitter uskopojasni predajnik (**comm**) uskopojasni radio, SSB

Single up! (v) (navig, seamanship) (Zapovijed koja se izdaje na početku manovre odvezivanja); an order to take in the extra parts of doubled up mooring lines, so that only a single part of each line remains on the dock **Ujednostručiti, Ostanite na jednom konopu! (na vezu koji zapovijedi pilot ili zapovjednik), Single up! (izg. singl ap), smanjite broj privezne užadi na minimum (naredba peljara ili zapovjednika pri odvezivanju broda):** *Some time before the Pilot comes aboard the ship, the Master or the Officer of the Watch (OOW) has to tell the officers in charge of the Fore and After (Mooring) Station to single up. Under their control the ratings then cast off all but the essential mooring ropes (lines) so that the vessel is singled up aft and singled up forward.* **Single up to a headline and one spring. Ujednostručiti na jedan pramčano uže i špring.**

single-user berth (n) (mar law, ports) privatni vez, brodarov vez, unajmljeni vez

single voyage charter (n) (mar law) brodarski ugovor za jedno putovanje

singling up ujednostručenje užadi za privezivanje

sink (v) **1:** *A cargo ship sank and one person died after colliding with freighter near the Bosphorus Strait's Black Sea entrance.* **a (v intr) potonuti, tal. andare a picco:** *As the vessel's freeboard reduced, the Master realised that the vessel was sinking and ordered the crew to prepare to launch the liferafts* *The vessel sank late in the evening on 18 March 2015.* ; **2 (v tr) potopiti (drugi brod), tal. affondare sink a ship potopiti brod**

sink a ship (v) (navy) potopiti brod

sinker (n) (fishing) Any type of weight used for fishing rigs, made from lead or steel. **uteg (za povraz, udice, predvez itd.), olovo:** *A pyramid sinker made of lead is nowadays widely regarded as too toxic a material.* **bullet sinker uteg u obliku metka, egg sinker weight jajasto**



olovo

sink outlet (n) (boating/yachting, marine eng) ispust sudopera, odvod sudopera

sirocco; scirocco /si'roko/ (n) (meteorol) široko, šilok, južni vjetar {hot southerly wind blowing from the north coasts of Africa across the Mediterranean; southerly wind in the Adriatic}

sisal (n) (seamanship) sisal, konop od sisala

sistership (n) **1 a (nav arch) brod blizanac (iste konstrukcije); 2 (shipping econ) brod iste kompanije**

situated (adj) smješten, položen

situational awareness (n) (safety) poznavanje stanja, poznavanje situacije,

svjesnost o stanju: *This affected their situational awareness and they failed to sight the red lightbuoy marking the southern limit of the approach channel into the basin. The OOW monitored the vessel's position solely against the intended track. Consequently, his situational awareness was poor.* **lose**

situational awareness izgubiti kontrolu nad poznavanjem stanja

situation report izvješće o stanju (u plovidbi, u području plovidbe)

six degrees of freedom (n) **COMPARE ship's motions** šest vrsta gibanja

broda

size (n) veličina, obujam **ship's size** veličina broda

size/weight ratio (n) (*marine eng*) omjer veličine i težine

skalop (n) (*nav arch*) otvor za prolaz zavara, tekućine i plinova kroz strukturni element **izrez**

skeg (n) (*nav arch*) a reinforcing brace between the after end of a keel and the rudderpost **peta**

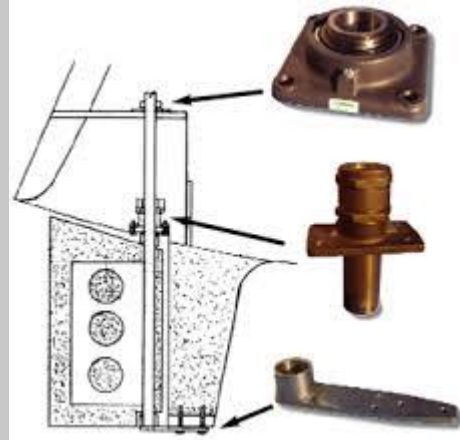

kormila, produžena **peta** kobilice i kormila, **skeg**

skeg of keel (n) (*sailing vessels*) **peta** krmene statve

sketch skica, nacrt, shematski crtež

skew /skju:/ (adj) kos, nakriv

skid; skids (n) (*nav arch*) staza sohe **inclined skid; skids** kosa staza za spuštanje brodice ili splavi za spašavanje

skiff (n) (*seamanship, nav arch*) a small sea-going boat for rowing or sailing; motorised boats of small size and construction used for various purposes requiring fast speed **skif, brza brodica**

skill (n) vještina

skim (n) (*boating/yachting*) = **plane** glisirati

skimmer /'skime/ (n) (*boating/yachting*) gliser

skimming boat (n) (*boating/yachting*) = **speedboat; speed-boat, skimmer**
gliser

skipper /'skipə/ 1 (*seamanship*) a person who has command of a boat or sea-craft or tug, more or less equivalent to captain in charge aboard ship **zapovjednik brodice / manjeg broda** (npr. tegljača, peljarske brodice, ribarskog broda), **skiper, kapetan** ribarice, ta. **padrone marittimo** **tug skipper** zapovjednik tegljača; 2 (*boating/yachting*) kormilar (jedrilice), tal. **commandante di yacht**

skylight /'skai.lait/ (n) (*nav arch*) (in old time ships) an erection built on a deck, having glass lights in its top and fitted over an opening in the deck for the purpose of admitting light and air to a compartment below **vidnik engine skylight** **vidnik strojarnice**



{tal. osteriggio}

skysail mast (n) nadvršni nastavak

slab reefing (n) (boating/yachting) vezivanje ostatka jedra nakon kraćenja

slack (adj) **ANTONYM taut** the opposite of taut; loose labav (konop, lanac), popušten (konop) **cable is slack** konop je labav

Slack away! (v) (seamanship) start slacking; make loose **Popusti konop!** **Slack away head / stern / breast line.** **Popusti pramčano / krmeno / bočno uže.**

slacken /'slækən/ (n, v) **1** popustiti (uže) **a** (seamanship) olabaviti se (konop, vitlo): *The second mate relayed the order to slacken the breastlines to the bosun.*; **2** usporiti **slacken speed** usporiti brzinu broda

slackness /'slæknis/ (n) **1** popustljivost; **2** propust

slack; slacken (v) (seamanship) **ANTONYM tauten** to allow a rope or chain to run out, or feed it out **olabaviti (konop), popustiti (konop)**: *The pilot instructed the master to slack all headlines and sternlines.* **slack; slacken away** **popustiti (konop)**

slack water (n) **high slack water** visoki vodostaj, **low slack water** niski vodostaj (oceanogr) **period mirovanja** morskih mijena, **vodostaj**, tal. **stanca**: *The best time to berth or leave is at slack water. The vessel's arrival at its berth was planned to coincide with the period of slack water. After casting off the berth just after slack water, the vessel's stern-first exit was assisted by two large tugs. The plan therefore required a reduced speed to ensure they reached the straits at slack water. Slack water was at 0926 and so the passage was made with a 2 - 4 knot flood stream, which in some sections of the narrow channel was directly abeam.*

slats /slæts/ (n) (cargo) letve

slave station (n) (navig) **COMPARE master station** pomoćna postaja, pomoćna stanica

sleepers /'sli:pə/ (n) (cargo, UK) željeznički pragovi

sleeping cabin (n) (boating/yachting) kabina za spavanje

sleet /sli:t/ (n) (meteorol) rain drops that freeze into ice pellets before reaching the ground
susnježica

sleeve /sli:v/ (n) (marine eng) a casing, usually of brass, fitted over line or other shafting for protection against wear or corrosion, or as a bearing surface **tuljak, košuljica, kolčak, cijevasti element**

slew (v) (seamanship) okretati se (oko osi)



slewing crane /slu:ɪŋ/ okretna dizalica

slewing speed /slu:ɪŋ/ brzina (horizontalnog) okretanja dizalice

slick (n) oil **slick** uljna / naftna mrlja (*safety*) mrlja

slide sklizni kanal (daska) za napuštanje broda

slide (v) klizati, pomicati klizanjem **slide the camshaft axially** uzdužno pomicati bregastu osovinu klizanjem

slider (n) (*boating/yachting*) klizač (za hvatanje jedra uz jarbol)

sliding doors (n) (*nav arch*) klizna vrata

sliding hatch beam pomična sponja

slight malen, neznatan, lagan, površan, slab **visibility slight to moderate** vidljivost slaba do umjerena

slightly (adv) slabo, lagano, malo, neznatno

slight sea (n) (*oceanogr*) treći stupanj stanja mora s valovima visine od 0,5 do 1,25 metara valovito more

sling (n) (*cargo*) a piece of line whose ends are spliced together, passed around an article to be hoisted

pasac, braga, tal. braca; braga **chain sling** lančani pasac, lančana braga: *Chain slings, however, are used for heavy slender cargoes, such as timber or steel rails.*, **make up into**

slings složiti teret u pasce / brage, **net sling** mrežasti pasac, mrežasta braga, **rope**

sling pasac od konopa, **webbing sling** platneni / tkani pasac

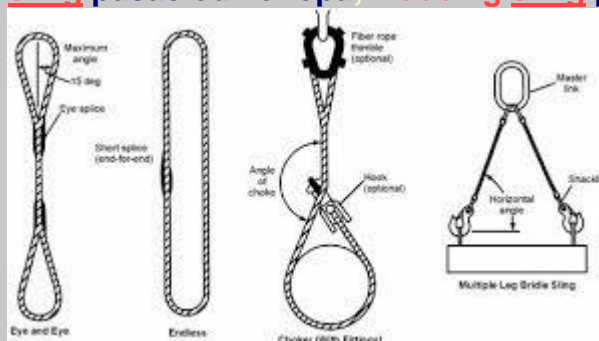

slinging opasivanje tereta, stavljanje tereta u pasce, imbragivanje

sling of lower yard (n) vješalo donjeg križa

sling (slung, slung) (v) (*cargo*) opasati teret pascem ili bragom, staviti u pasac / bragu, imbragati; tal. imbracare

slip (n) 1 (*ports*) obalna rampa (za trajekte); 2 (*ports*) obala između dva gata; 3 (*nav*

arch) kosi navoz

slip (v) (seamanship) When at anchor, disconnecting the cable or letting the end of the cable run out **ispustiti lanac (da isklizne) u more** **slip the cable / chain** pustiti da lanac isklizne u more: *The cable was subsequently slipped and the vessel was taken out of service due to the damage to the windlass and the loss of her anchor.*

slip (n) (mar ins) **ceduljica / bilješka s podacima o riziku**

slip 1 (nav arch) **klizanje propelera**; 2 the difference between the pitch of a propeller and the advance of the ship through the water corresponding to one revolution **hod propelera u jednom okretaju**

slip gear (n) (nav arch) **uređaj za ispuštanje (lanca, užeta)**

slip hook (n) (nav arch, ports) **samootpusna kuka, slipna kuka**

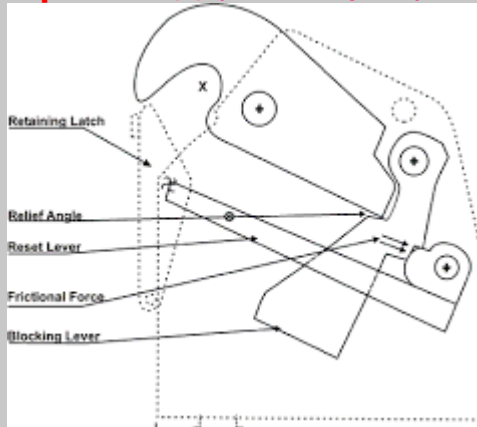

slip line (n) (seamanship) **udvojak, duplin**

slipper (n) (marine eng) **klizni element, klizač**

slip rope (seamanship) **vezice za pričvršćivanje konopa, boce od konopa**

slipway; slipways /'slip,wei/ (n) (nav arch) 1 an inclined launching berth where the ship is built **navoz (u brodogradilištu), tal. scalo (d'immersione)**: *The ship launching slipway, a structure consisting of a sloping way down to the water from the shipyard, is an essential aspect of the ship launching procedure and has been extensively used for launching newly made or repaired ships.*

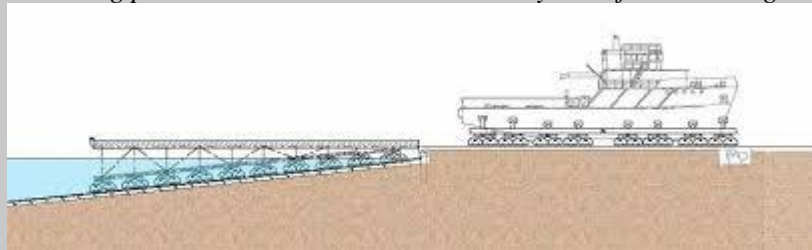

; 2 (boating/yachting) **rampa za**

spuštanje i izvlačenje brodica, skalada, fuzaljka, tal. scalo (d'allaggio)

slip wire (n) (seamanship) **čelikčelo za pričvršćivanje užadi, žičane boce**

sloop /slu:p/ a single-masted boat with only one headsail set at any one time; **krstaš s jednim visokim jarbolom i trokutastim jedrima od kojih glavno jedro može biti pričvršćeno za sošnjak slup**



slop /slɒp/ (n) (cargo handling) talog discharge the remaining slops to the barge **iskrcaj** preostalog taloga iz tanka u teglenicu

slop chest /slɒp/ (n) (shipping econ) = **bonded store** a ship's store of merchandise, such as clothing, tobacco, etc., maintained aboard merchant ships for sale to the crew **sidil**, **zapečaćeno skladište (na brodu)**, **zapečaćeno spremište**

slope (n) (geogr) kosina, padina

slop tank (nav arch) a tank specifically designated for the collection of tank draining, tank washings and other oily mixtures **taložni tank**: *The ship should compile and retain a report on the condition of the vessel's tanks prior to loading, including a record of the ullages in slop tanks. Before tank washing operations begin, the volume of space available in the slop tank must be determined and a rough estimate made of the washing time necessary to fill that volume.*

sloshing (n) (seamanship) **prelijevanje vod s jedne strane tanka (broda) u**

drugu: *For this vessel sloshing will only be a problem when water ballast is filled into hold no. 3 while at sea.*

sloshing loads (n) (nav arch) **sile zapljuskivanja**: *Sloshing loads may be induced on the ship's internal structure through the movement of the fluids in tanks/holds whilst slamming of the bottom shell structure forward may occur due to emergence of the fore end of the ship from the sea in heavy weather.*

slot /slɒt/ (n) **1 a** (cargo) prostor na kontejnerskom brodu potreban da bi se ukrcao jedan standardni ISO kontejner od 20 stopa (Karmelić 2010); the space in a ship occupied by one TEU container. Also Slot Position, Cell Position (Drinković); jedinični prostor za slaganje kontejnera na brodu **skladišno**

mjesto kontejnera u brodu, **slot**: *Container ships are equipped with specially designed holds with cells or slots to facilitate speedy container handling using shore-based lifting gear.*; **2** (marine eng)

prorez, **utor** **axial slot** **uzdužni prorez**, **uzdužni utor**, **uzdužni presjek**

slot (n) (cargo handling, nav arch) urez u palubi za hvatanje vezova za teret **urez u palubi**

slot charter (n) (mar law, shipping econ) chartering by a carrier of slots/spaces on other carrier's vessels **ugovor o najmu/zakupu jednog ili više mjesta za kontejner na kontejnerskom brodu**

slot cost calculation (shipping econ) **izračun troška slota**

slot position (n) (shipping econ, cargo handling) = **slot** = **cell position slot**

slot weld **azola**

Slow ahead! (seamanship, navig) **Lagano naprijed!** *Initially the engine was on slow ahead but at 0802 was reduced to dead slow ahead*

Slow astern! (*seamanship, navig*) **Lagano krmom!** {naredba za upravljanje strojem}

slow down (*v*) (*navig*) **usporiti, smanjiti brzinu:** *If you are on the overtaken vessel's port side, you have no choice but to slow down or alter to port if required to do so by another vessel. When about 20 minutes from the first set of beacons, own vessel started to slow down, ...*

Slow speed ahead / astern! (*navig, comm*) **Polako naprijed / natrag!**

slow-speed diesel engine (*n*) (*marine eng*) **sporohodni dizel motor**

slow steaming (*n*) (*shipping econ*) a process of deliberately reducing the speed of cargo ships to cut down fuel consumption and carbon emissions **plovidba smanjenom brzinom (radi ekonomičnosti), usporena plovidba:** *Slow steaming involves reducing the speed of the cargo ship from usual 20-24 knots to around 15 knots. The term slow steaming is used as a notion for vessels sailing below their design speed.*

sludge /slʌdʒ/ (*n*) (*marine eng*) **kal, fekalije, mulj, talog, blato, zauljeni talog:** *Kværner of Norway provided the solid/oil waste incinerator unit, which has an approximate burning capacity for solid waste of 50 kg/hr for sludge oil. The evidence presented to the jury showed that the vessel discharged around ten metric tons of sludge into the ocean.* **sludge oil, zauljeni kal, sludge**

tanker, tanker za prijevoz mulja i otpadaka kanalizacije, tanker za otpadnu vodu, sludge tank, tank otpadnih voda

sluice /slu:s/ (*n*) (*nav arch*) **odvodni kanal**

small craft (*n*) **1** (*navy*) **brodice;** **2** in a marine context, is any vessel or conveyance that floats on or operates on the water and is under 197 feet (60 meters) length overall (LOA). A small craft may be used for pleasure, commercial, or residential purposes. Small craft is synonymous with boat in marine use. Though the term craft applies to all vessels operating in a fluid medium, the term small craft is only used when applied to boats. (http://www.westlawn.edu/student_center/definitions.asp) **manji brodovi**

small end (*n*) (*marine eng*) **ANTONYM large end = top end, gornji kraj ojnice**

small spider crab (*n*) (*fishing*) **bradavičasti račnjak, mala rakovica** {*lat. Maja crispata* - <http://obrt-kornati-nautilus.hr>}

small-spotted catshark (*n*) (*fishing*) **morska mačka, bljedica**

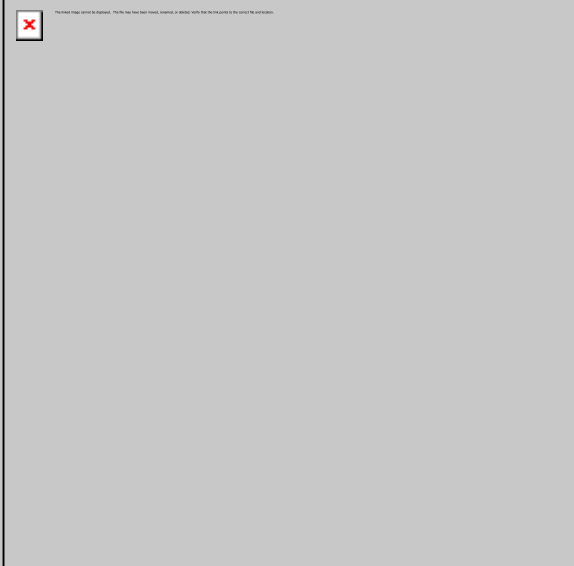

navig) IMO-ovi standardni pomorsko-komunikacijski izrazi, IMO-ov standardni pomorsko-komunikacijski rječnik

SMDG User Group for Shipping Lines and Container Terminals. **skupina korisnika brodarskih linija i kontejnerskih terminala:** *SMDG develops and promotes UN/EDIFACT EDI messages for the maritime industry and is an official Pan European User Group recognised by the UN/EDIFACT Board.*

smear /smɪə/ cover with oil, grease, etc **podmazati, zaštititi kontakte od korozije:** *A regular maintenance program consists of periodically checking mounting bolts and brackets, keeping wiring connections clean, tight and external wiring connections smeared with a thin coating of petroleum jelly.*

SMNV; IMO Standard Marine Navigational Vocabulary, 1979 (n) (comm, safety, navig) **COMPARE SMCP; IMO Standard Marine Communication**

Phrases IMO-ov standardni navigacijski pomorski rječnik {SMNV was replaced in 2001 by IMO Standard Marine Communication Phrases and is not in official use any more}

smoke buoy (n) (navig) dimna plutača

smoke density (n) (marine eng) gustoća dima

smoke detector detektor dima

smoke detector system (n) (safety) cijevni vatrodjavni javljač

smoke fire detector (n) (safety) dimni javljač požara

smoke helmet (n) (safety) protudimna kaciga

smoke signal (n) (navig, safety) dimni signal

smoke stack (n) (nav arch) dimnjak

smooth (adj) **1** a gladak, ravan, brušen; **2** ravnomjeran, neisprekidan, bez vibracija

smoother izgladivač (

smoothness /'smu:ðnis/ (n) (marine eng) miran rad (motora)

smooth sea (n) (oceanogr) drugi stupanj stanja mora s valovima visine od 0,1 do 0,5 metara valićasto more

smooth Venus clam (n) rumenka

smother /'smʌðə/ (v) (safety) prigušiti (vatru, požar), spriječiti pristup zraka, pogasiti (vatru, požar)

SMS audit (n) (safety) revizija u sustavu SMS-a

SMS Code (n) (safety) The ISM Code establishes safety-management objectives and requires a safety management system (SMS) to be established by the Company (see ISM Company) **Pravilnik o upravljanju sigurnosti**

SMS Company the shipowner or any person, such as the manager or bareboat charterer, who has assumed responsibility for operating the ship. **brodarsko društvo (u Pravilniku o upravljanju sigurnosti)**

SMS; Safety Management System (n) (safety) a formal risk management framework to improve safety in the maritime industry **sustav upravljanja sigurnošću (plovidbe, broda, kompanije)** **DPA - Designated Person Ashore** zadužena osoba brodarskog društva (kompanije), **DOC - Document of Compliance (issued to the Company)** potvrda o usklađenosti (koja se izdaje kompaniji), **SMC - Safety Management Certificate (issued to the ship)** Potvrda o upravljanju sigurnošću (koja se izdaje brodu)

smuggling /ˈsmʌŋɡəlɪŋ/ (n) (mar law) krijumčarenje, **kontrabanda**

snap (n) (fishing) A small device similar to a dog leash snap, tied to the line and used for attachment and quick release of hooks, rigs and lures. **kopča (za udicu)**

snap back (v) (seamanship) **naglo se vratiti (konop kada pukne), naglo odskočiti (privezno uže pri pucanju), odbiti se od, letjeti / šibati uokolo (o puknutom konopu), šibati okolo (puknuti konop)** *The first headline parted, snapped back and struck the seaman on the head.* **snap back zone** **opasna zona (na kaštelu, plaubi, krmici) zbog letenja puknutog užeta**

snap shackle (n) (boating/yachting) **kopča za prednje jedro, karabin, tal.**



moschettone

snatch block (n) (nav arch) a single sheaved block with a hinged strap that can be opened and the bight of a rope inserted, making it unnecessary to reeve the end of the rope through the block

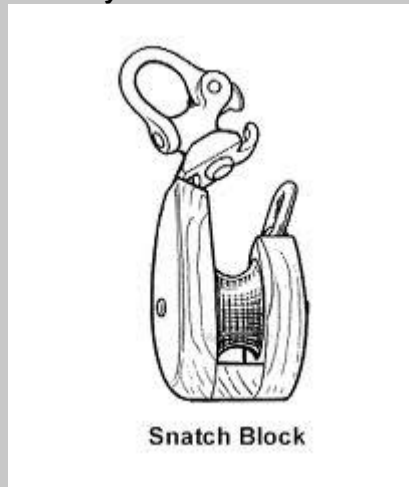

Snatch Block

(Seasources.net) **otvoren koloturnik**

Snellius–Pothenot problem (n) (navig) determining the position of an unknown accessible point P by its bearings from three inaccessible known points A, B, and C. **Pothenotov problem, određivanje pozicije broda mjerenjem dvaju horizontalnih kutova istodobno**

snipe /snaɪp/ (n) (boating/yachting) **šljuka**

snotter /ˈsnoʊtər/ (n) (cargo handling) **pasac (s dvije omče na krajevima)** *Snotters or canvas slings are suitable for bagged cargo.*

snow pellets (n) (meteorol) precipitation of white, opaque grains of ice **snježne pelete**

SNR; Signal to Noise Ratio (n) (navig) **odnos korisnog i smetajućeg signala (kod radara)**

SNR;;signal to noise ratio (n) (electr, navig) **odnos signal/šum**

snub /snʌb/ (n) (boating/yachting) amortizer za privezni konop {gumeni ili od čelične opruge}

snub (v) 1 (boating/yachting) namotati uže na bitvi (jedan namotaj), staviti jednu voltu užeta preko bitve; 2 (seamanship) check a line, wire, or chain quickly naglo zaustaviti (uže na vitlu)

snubbing (n) (seamanship) zaustavljanje (broda) po sidrenom lancu

soaked /səʊkt/ (adj) (cargo) natopljen (vodom, morem), napijen (vodom, tekućinom), namočen

soar /sɔ:/ (v) (shipping econ) **ANTONYM plummet** jako rasti (o vozarinama): VLCC rates are soaring on growing West Africa, Middle East cargoes.

social responsibility društvena odgovornost, odgovornost u grupi

socket (n) (electr) utičnica

socket wrench (n) (marine eng) usadni ključ, nasadni ključ



© School Division, Houghton Mifflin Company

soft wood (n) (cargo) meko drvo, mekana građa

SOG (speed over ground) (n) (navig) brzina preko dna: The vessel was proceeding against the ebb current at between 8 kts speed over ground and 9.5 to 10 kts speed through water A quick check of the GPS gave an astern SOG (speed over ground) of around one knot, so the chain was running out at rate of one shackle per minute.

solar panel (n) (electr) solarna ploča

solar power (n) (electr) sunačeva energija, solarna energija

SOLAS (International Convention for the safety of Life at Sea) (n) (mar law) Međunarodna konvencija o zaštiti ljudskih života na moru

solder /ˈsɒldə/ (n) 1 (marine eng, electr) lem; 2 lemilica

soldering /ˈsəʊldəriŋ/ (n) (marine eng) lemljenje

sole /səʊl/ (n) (fishing) list common sole list {drugi hrv. nazivi: plac, platusa, sval, švoj, švoja, tabinjaš, zalistak; lat. SOLEA VULGARIS QUENS}

sole fish /səʊl/ (=black sole; Dover sole) (n) (fishing) Lat. Solea solea list, švoj, lt.



sogliola

sole piece /'səʊl/ (n) 1 (nav arch) a peta statve; 2 petica

solid (n) 1 a i tvrdo tijelo; 2 kruta tvar

solid (adj) 1 a krut, čvrst; 2 cjelovit, iz jednog komada **solid forged** iskovan od jednog dijela

solid bulk cargoes (n) (cargo) kruti rasuti tereti {ugljen i sl.}

solid fuel (n) (marine eng) kruto gorivo

solid waste (n) (marine eng) kruti otpad (iz brodske kanalizacije)

solvent /'sɒlvənt/ (n) (marine eng) otapalo, rastvarač: An important function of the cleaning agent is to be a good **solvent** for the gypsum in the sludge. It should also act as a **dispersant** and **emulsifier**

sonar; (**SOund Navigation And Ranging**) (n) (navig) a sound-based device used to detect and range underwater targets and obstacles **ultrazvučni navigacijski uređaj, sonar** {ASDIC}

soot /su:t/ (n) (marine eng) čađa, gar

SOTDMA; (**Self Organizing Time Division Multiple Access**) (n) (navig) samoorganizirajući vremenski podijeljen višetruki pristup (u sustavu AIS)

sound (adj) in **sound condition** u dobrom stanju, u **zdravom stanju** (cargo) ispravan, **zdrav** (teret)

sound (v) 1 dati zvučni signal **sound** a **fire alarm** dati zvučni alarm za požar,

zazvoniti na uzbunu: a fire alarm **sounded** on the fire control panel in the bridge požarni alarm zazvonio je na kontrolnoj ploči za požar na mostu *when the lub oil low pressure alarm sounded they decided to stop the engine* kad se oglasio alarm za preniski tlak ulja odlučili su zaustaviti stroj, **the alarm**

sounded uključio se alarm, sound a blast: A power driven vessel underway but stopped and making no way through the water shall **sound** at intervals of no more than 2 minutes two prolonged blasts in succession with an interval of about 2 seconds between them. **dati znak broskom sirenom**; 2

to measure the depth of the water **mjeriti dubinu mora**

sound (n) 1 (geogr) ocean or sea channel between two bodies of land; a body of water between the mainland and a large coastal island **prolaz (između kopna i otoka), tjesnac**; 2 (geogr) a large sea or ocean inlet larger than a bay, deeper than a bight, and wider than a fjord; or a narrow sea (wiki) **uvala, tal. braccio di mare**

sound (v) (seamanship) **izmjeriti dubinu (mora, tanka), tal. scandagliare**: All the ship's tanks / compartments were **sounded** and monitored for any ingress of water or possibility of pollution

sounding /'saʊndɪŋ/ (n) **1 (cargo)** mjerenje količine tekućine u tanku, merenje tanka: *Soundings of the fore peak indicated no ingress of water.* **take the bilge soundings** izmjeriti kaljuže; **2 (navig)** mjerenje dubine mora, snimanje dubine mora **sounding interval** interval snimanja dubine

sounding machine mehanički dubinomjer

sounding pipe (n) (nav arch, cargo handling) a vertical pipe in an oil or water tank, used to guide a sounding device when measuring the depth of liquid in the tank **cijev za sondiranje**,

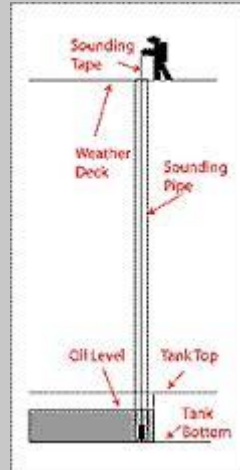

sonda za mjerenje kaljuže, mjerna cijev

sound-insulated (adj) (marine eng) zvučno izoliran

soundpowered telephone (n) (comm) bezbaterijski telefon

sound signal (n) (navig, comm) a device which transmits sound, intended to provide information to mariners during periods of restricted visibility and foul weather **zvučni signal** **sound the**

sound signal: *At the same time the appropriate sound signal under Rule 34 (d) was sounded on the whistle (air horn) to convey doubt as to other vessel's intentions and illegal manoeuvre.* **dati zvučni**

signal, make a sound signal **dati zvučni signal**: *No sound signal was made and the second officer did not look over the starboard quarter to make sure that there were no vessels in close proximity.*

sound signals zvučni signali

southbound /'saʊθ,baʊnd/ (adj) (navig) južni, u smjeru juga, koji se kreće prema jugu **southbound convoy** konvoj u smjeru juga **južni konvoj**

southeasterly /,saʊ'i:stəli/ (n) (meteorol) jugoistočnjak, jugo

south-east trades (n) (meteorol) jugoistočni pasati

south-east wind (n) (meteorol) jugoistočni vjetar, jugoistočnjak, jugo

southerly /'sʌðəli/ južni vjetar

space /speɪs/ (n) **1 a (marine eng)** prostor: **wasted space** (shipping econ) izgubljeni /

neskorišteni brodski prostor, **annular water space** prstensti vodeni prostor,

rashladni prostor u obliku prstena, **bunker space** prostor za bunker (gorivo),

combustion space izgarni prostor, izgarna komora, prostor za sagorijevanje,

confined space ograđeni prostor, omeđeni prostor, suženi prostor, zatvoreni

prostor, **cooling space** rashladni prostor, **machinery 1** prostor strojeva,

strojarnica, **steering gear space** prostor kormilarskog stroja, **water space** vodeni

prostor; **2** razmak, udaljenost

space heating (n) (marine eng) grijanje prostora, grijanje prostorije

space vehicle; (SV) (n) (navig) satelit (u sustavu GPS)

span /spæn/ 1 a klobučnica (samarice); 2 razmak između nogara dizalice

span /spæn/ (n) (nav arch) zastavno leto {tal.: straglio a paranchi}

Spanish burton (n) (cargo handling) any of several tackles employing a runner in addition to the

6–55. Determine the force P needed to support the 20-kg mass using the *Spanish Burton* rig. Also, what are the reactions at the supporting hooks A , B , and C ?

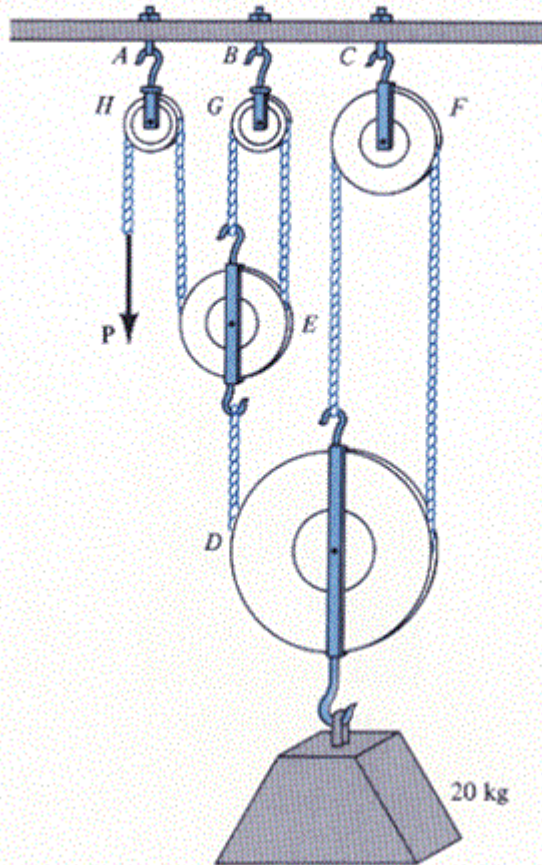

Probs. 6–55 / 6–56

fall španjolski čekrk

Spanish mackerel (n) 1 a plavica; 2 lokarda

spanker /spæŋkə/ (n) (boating/yachting) 1 On a square rigged ship, the spanker is a gaff rigged fore-and-aft sail set from and aft of the aftmost mast. **stražnje sošno jedro (na jedrenjaku); 2 (boating/yachting) spenker (na regatnoj jedrilici)**



spanner /'spæne/ (n) (UK) 1 (marine eng) ključ za vijke ratchet combination spanner zaustavni okrugli ključ, zaustavni okasti ključ, ring spanner okrugli ključ, okasti ključ, adjustable spanner namjestivi ključ, podesivi ključ, francuz



; 2 ključ za spajanje vatrogasnih cijevi
spanner wrench /'spæne/ (n) (marine eng) COMPARE spanner COMPARE

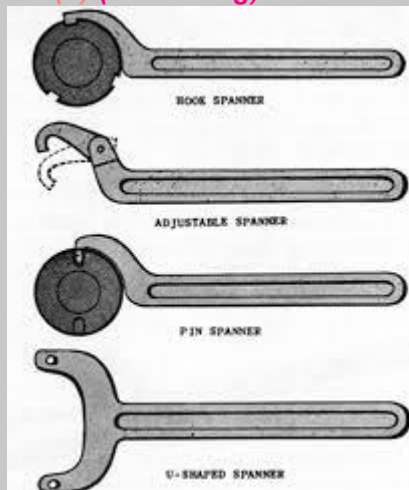

wrench ključ za vijke

span tackle (n) (cargo handling) podigač kraka samarice

spar /spa:/ (n) 1 (boating/yachting, nav arch) general term for mast, boom, pole, yard etc. jarboli, deblenjaci, križevi itd., tal. alberatura; 2 (nav arch) križ (jarbola)

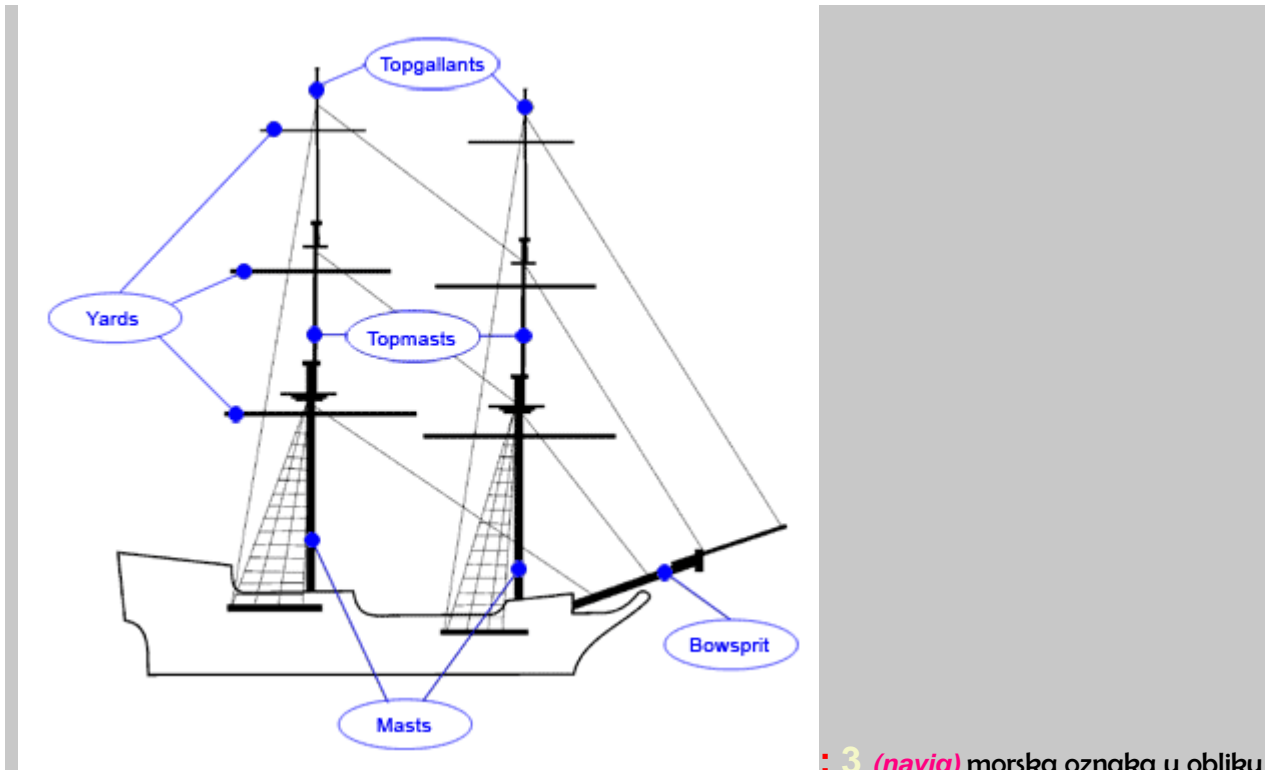

; 3 (navig) morska oznaka u obliku

štapa ili motke **motka, štap** {spar je opći i zajednički naziv za sve jarbole i motke (drvene, aluminijske, grafitne itd.) koje drže jedra, flokove, špinakere}



spar buoy (n) (navig) plutača na stupu

spar ceiling (n) 1 (nav arch) podnice, **pajoli, obloga dna skladišta**: *Before commencing to load scrap iron, the lower strakes of spar ceiling should be well protected from damage by covering with dunnage boards.*; 2 bokoštitnice (u brodskom skladištu); 3 = **cargo battens** letve skladišta



spare anchor (n) (nav arch) pričuvno / rezervno sidro

spare part (n) (marine eng) **SYNONYM spares** pričuvni dio, rezervni dio

spares /spɛə/ (n) (*marine eng*) pričuvni / rezervni dijelovi, rezervni dijelovi **essential spares** osnovni pričuvni dijelovi

spark /spa:k/ (n) (*electr*) iskra, varnica **spark-ignition system** sustav paljenja iskrom

spark plug (n) (*marine eng*) svjećica za paljenje smjese u benzinskom motoru **svjećica**, tal. **candela**

spar sail (n) (*boating/yachting*) križno jedro

spar-shaped mark rešetkasta oznaka

spawning /'spɔ:nɪŋ/ (n) **1** (*fishing*) Reproductive activity of fish; the act of releasing eggs into the water by female fish for fertilization by male fish **mriještenje**; **2** (*fishing*) **mrijestilište**

SPB (safe berth, port) (*shipping econ*) siguran vez i luka

speaker (n) (*comm*) zvučnik

speaking tube doglasna cijev, **potravoče**

speargun /'spiəgʌn/ (n) (*fishing*) podvodna puška

special cargo (n) (*cargo*) poseban teret, **specijalni teret**: *Special cargoes include Out of Gauge cargo, In Gauge and Break Bulk cargo*

special compensation (n) (*mar law, mar ins*) posebna naknada (za spašavanje)

special craft (n) (*nav arch*) specijalni brod

special drawing rights (SDR) (n) (*mar law, shipping econ*) posebna prava vučenja

special inspection (*nav arch*) = **occasional inspection** izvanredni pregled broda

special marks (n) **COMPARE lateral marks, cardinal marks, isolated danger mark, safe water mark** (*navig*) posebne oznake

special rate (n) (*shipping econ*) freight rate established for a specified commodity for a specific period of time **posebna vozaina, specijalna tarifa**

special survey (n) specijalni pregled (broda)

specifications (n) (*marine eng*) opis, specifikacija **technical specifications** tehnički opis

specify (v) (*mar law*) = **stipulate** odrediti (ugovorom, propisom)

specimen (n) **1** uzorak; **2** epruveta

spectral efficiency (n) (*navig*) iskoristivost spektra

speed (n) = **powerboat** brzina **great speed** velika brzina, **high speed** velika brzina, **increased speed** povećana brzina, **low speed** mala brzina, **reduced speed** smanjena brzina, **safe speed** sigurna brzina, **at high / low speed** velikom / malom brzinom, **speed control** (*marine eng*) upravljanje brzinom, upravljač brzine, kontrola brzine, **speed droop** variranje brzine, opadanje brzine, **speed range** **1** broj okretaja; **2** raspon snage, **speed sensing** mjerenje brzine, praćenje brzine, **speed setting** namještanje brzine, **firing speed** brzina potrebna za paljenje, **rated speed** nazivna brzina, **running speed** radna brzina, eksploatacijska brzina, brzina okretaja (motora), **economic speed** ekonomična brzina, **measure speed** mjeriti brzinu. *Today, sea navigators measure their ship's speed using modern GPS (Global Positioning System) driven device.*

speed and distance (n) (navig) brzina i udaljenost speed and distance run
 pređena brzina i udaljenost, speed and distance covered pređena brzina i
 udaljenost

speedboat; speed-boat (n) (boating/yachting) gliser



speed control (n) 1 (marine eng, nav arch) upravljač brzine: upravljačka ručica za brzinu; 2
 upravljanje brzinom, kontrola brzine

speed log (n) (navig) brzinomjer: Other modern navigating aids on board are various types of
 radars, RDF, *speed logs*, depth finders, chronometers, compasses and electronic charts. The Nautical
 Institute survey showed that only 35 per cent of VLCCs are fitted with bottom lock doppler *speed logs*.
 Other equipment is to be tested and made ready for going to sea: the engine-room telegraph, the *speed log*,
 the ship's whistle, the steering gear and the winches, for instance.



speed made good (n) (navig) stvarna brzina putovanja

speed of advance (SOA) (n) 1 (meteorol) brzina napredovanja (oluje, ...); 2 brzina plovidbe, brzina kretanja broda: *After adjusting the track as necessary to pass well clear of any hazard, choose a speed of advance (SOA) that ensures the ship will arrive on time at its destination or at any required point.*

speed over ground (SOG) (navig) = speed made good brzina preko dna

speed range (n) (marine eng) raspon brzine

speed through the water (STW) (n) (navig) brzina kroz vodu

speed trials (n) (nav arch) = trial trip pokusna vožnja

steel plates and profiles (n) (nav arch) čelični limovi i profili

sphere (n) kugla, sfera

sphere buoy (n) (navig) okrugla plutača, plutača u obliku kugle

spherical trigonometry (n) (navig) sferna trigonometrija

spider crab (n) (fishing) Lat. *Maja squinado* rakovica

spider hoop (n) klinarica jarbola

spill (n) (safety, cargo) izljev (nafte, ulja), curenje: *An accidental spill occurred during routine fuel transfer operations.*

spillage (n) (safety, cargo) izljev (nafte, ulja), onečišćenje, prosipanje, curenje
spillage during loading/discharging curenje (prosipanje) tereta za vrijeme ukrcanja/iskrcanja

spill control gear (n) (safety) oprema za kontrolu izljeva

spilled (adj) (cargo, environ) iscuren, koji je iscurio, prosut oil / fuel spilled iscurena

nafta / gorivo: *There still have been no signs of oil or fuel spilled since the ship ran aground Monday*

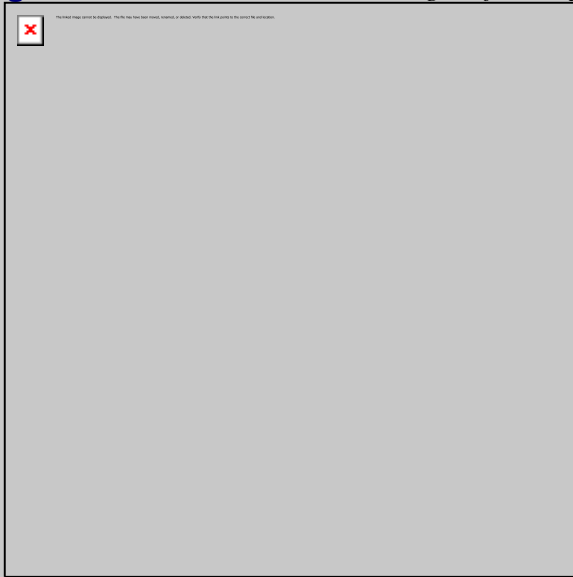

morning.

spin (n) (fishing) **spin** {varaličarska tehnika u kojoj se varalica (za razliku od panule koja se vuče za plovilom) izbacuje sa obale ili s plovila, te se kretnjama štapa i namotavanjem strune na rolu pokušava isprovocirati napad ribe. (<https://ribolovnajadranu.hr/ribicki-leksikon/>)}

spinacker boom (n) (boating/yachting) **deblenjak spinakera, tangun špinakera**

spindle /'spindel/ (n) (marine eng) A spindle is a narrow shaft that is used for rotating parts that rotate around the spindle itself **vreteno actuator spindle motka / vreteno servoklipa, control spindle upravljačko vreteno, razvodna motka**

spinnaker (n) **asymetric spinnaker** **asimetrični špinaker (boating/yachting) špinaker, spinaker spinnaker pole tangun špinakera, hoist the spinnaker podići špinaker, lower the spinnaker spustiti špinaker, ripped spinnaker rasparan špinaker**

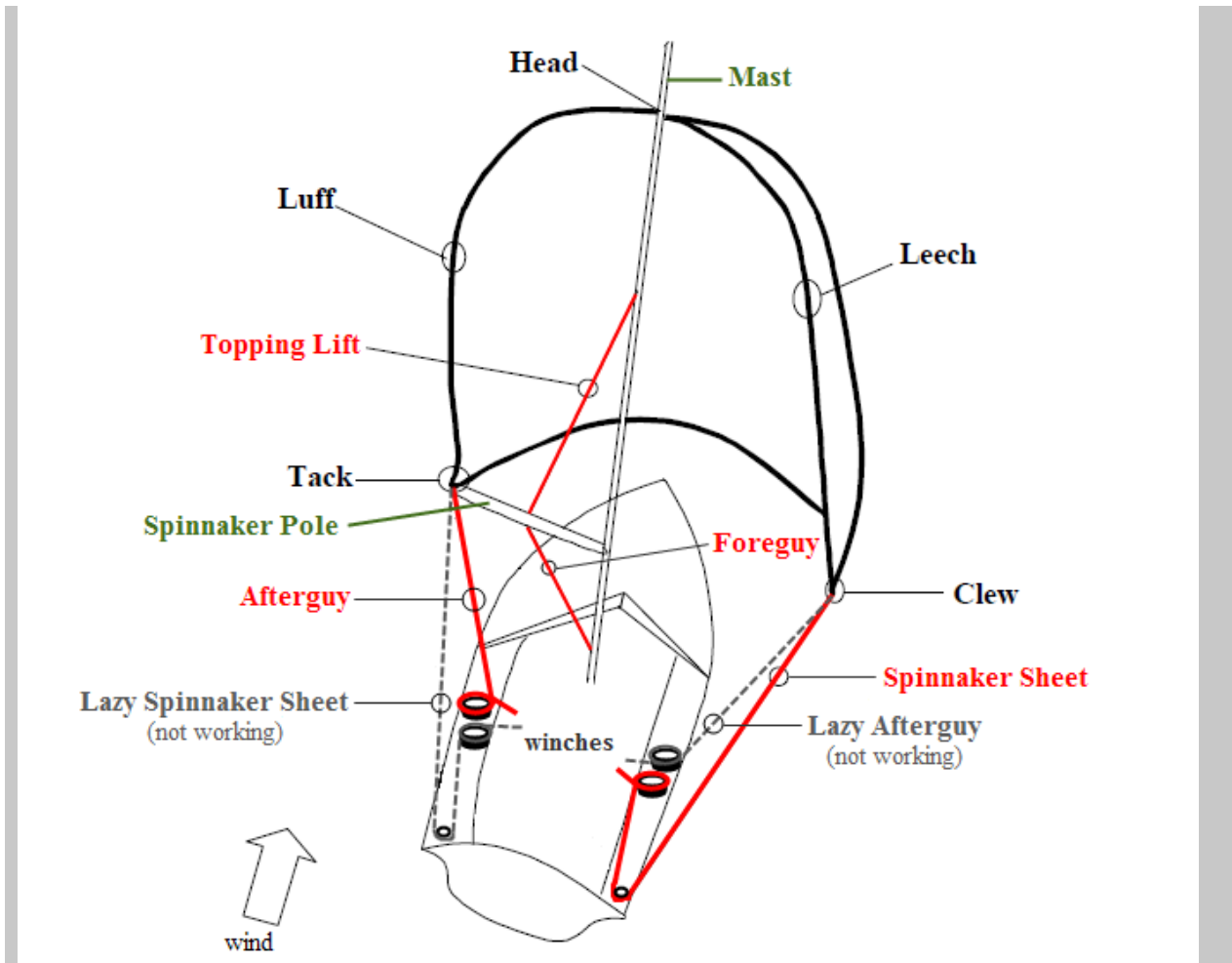

spinnaker chute (n) (boating/yachting) jama za špinaker, cijev za šinaker pack the spinnaker in the spinnaker chute slagati špinaker u cijev

spinnaker guy (n) (boating/yachting) privjetrinska uzda spinakera

spinnaker pole (n) (boating/yachting) deblenjak špinakera, tangun; tal. *tangone*

spinnaker pouch (n) (boating/yachting) džep za špinaker, vreća za špinaker

spinnaker sheet (n) (boating/yachting) uzda pričvršćena za zavjetrinski rogalj spinakera zavjeterinska uzda špinakera

spinning (n) (fishing) varaličarenje shore spinning varaličarenje s obale

spinning lure (n) (fishing) teturavac, varalica teturavac

spinning reel (n) (fishing) rola (za dizanje najlonske niti na ribarskom štapu)

two-speed spinning reel dvobrzinska rola

spiny cockle (n) (fishing) čančica

spiny dogfish (n) (fishing) kostelj

spiny lobster (n) (fishing) jastog

spirits (n) žestoka pića

spit (n) (geogr) rat, prirodni šljunčani nasip {cf. 'Zlatni rat' u Bolu na Braču; engl. Golden Horn}

splash about (v) 1 (marine eng) zapljuskivati; 2 poprskati

splice /splais/ (v) (*safety*) plesti (konop, uže) **short splice** kratka upletka

splice /splais/ (n) (*seamanship*) upletka, *pjumbadura*; tal. *impiombatura* **eye-splice** upletka s okom, **horse-shoe splice** potkovasta upletka, **cut-splice** dvopletka

splicing (n) (*seamanship*) pletenje konopa, pletenje užadi, *pjumbavanje*

split (n) izrez, iscijep, rascijep

split (v) raskoliti, razdvojiti, odcijepiti

split (adj) razdvojen, razrezan, raskoljen **split pin** (*marine eng*) rascijepka, **split big end** koso podijeljen doljnji kraj (ojnice)

spoilage /'spɔɪlɪdʒ/ (n) (*cargo handling*) kvarenje tereta

spoiler /'spɔɪlə/ (n) (*boating/yachting*) produžetak ili spuštenu dio krme jedrilice koji služi za silaženje



u more **spojler**

spoil ground (n) (*navig*) muljevito dno, nevidljivo dno: *Note the approximate position of this spoil ground as lat 22° 23.24N, long 114 °42.21E.*

spoke /spəʊk/ (n) (*nav arch*) a radial projection from the rim of a wheel, as in a ship's wheel **ručica kormilarskog kola**, **paok kormilarskog kola** **king-spoke** The upper spoke of a steering wheel when the rudder is amidships, usually marked in some fashion (top spoke of neutral steering wheel). **gornja ručica kormilarskog kola**

sponson /'spɒnsən/ (n) (*nav arch*) galerija

spontaneous combustion /spɒn'teɪniəs kəm'blɪstʃən/ (n) (*cargo, marine eng*) samozapaljenje

spool (n) (*fishing*) kalem (ribarskog najlona), špula (ribarskog najlona)

spot (n) 1 mjesto; 2 točka, mrlja, pjega

spot commission (n) (*shipping econ, mar law*) broker commission negotiated and invoiced within the same business year **provizija za posredovanje u sklapanju ugovora o kratkoročnom (jednogodišnjem) najmu brodova**, trenutna provizija, promptna provizija

spot freight rate The spot freight rate is the freight rate a vessel receives on a USD per tonne of cargo basis (<https://brage.bibsys.no>) **trenutna vozarina**, **promptna vozarina** *For tankers, spot freight rates are reported in Worldscale.*

spot market (n) 1 (*shipping econ*) **ANTONYM futures market** The market for the immediate chartering of a vessel, usually for single voyages.; Short term contracts for voyage, trip or short term time charters, normally no longer than three months in duration. (<http://www.clarksons.com/glossary/>) **tržište kratkoročnih ugovora o najmu brodova**, **ugovori o kratkoročnom najmu brodova**, **tržište ugovora o neposrednom, trenutnom najmu brodova**, **spot tržište**: *The tanker operator forecasts the tanker spot market*

to improve from the current levels, but to remain well below the levels seen at the start of the year. ; 2
(financ) The spot is a market for financial instruments such as commodities and securities which are traded immediately or on the spot. In spot markets, spot trades are made with spot prices.

(<http://www.investopedia.com/terms/s/spotmarket.asp?>); The spot market is also referred to as the “physical market” or the “cash market” because of the instant and immediate pace and movement of orders made as orders are made at current market prices. Market prices are unlike forward prices, which cover prices at a later date. **tržište robama i vrijednosnicama po tekućim cijenama i uvjetima na licu mjesta, gotovinsko tržište**: Unlike the *futures market*, orders made in the *spot market* are settled instantly. *Spot markets* can be organized markets or exchanges or over-the-counter (OTC) markets. In some cases, crude oil, for example, futures market goods are sold at *spot prices*. However, the physical delivery of the goods happens on a later date. The *spot market* is also referred to as the “*physical market*” or the “*cash market*” because of the instant and immediate pace and movement of orders made as orders are made at current market prices.

spot prices (n) 1 (shipping econ) tekuće cijene na tržištu tereta i vozarina), trenutne cijene, promptne cijene; 2 The current price of a financial instrument is called the spot price. It is the price which a particular instrument can be sold or bought during a particular time and specified place. **tekuće cijene na tržištu roba (tereta) i vrijednosnica, cijene na licu mjesta, trenutne cijene**: In some cases, crude oil, for example, goods are sold at *spot prices*. However, the physical delivery of the goods happens on a later date.

spot rates (n) (shipping econ, mar law) vozarinski stavovi za kratkoročni najam brodova, najamnina za kratkoročni najam broda, vozarine ugovorene na licu mjesta po tekućim cijenama i uvjetima, trenutni vozarinski stavovi, promptni vozarinski stavovi: To maximize profit (minimize costs), ship owners must adjust speed in response to bunker prices and *spot rates*.

spot trade (n) 1 (shipping econ) a spot trade is the purchase of financial instruments done on the spot or immediately (<http://www.investopedia.com/terms>) **burza financijskih instrumenata (vrijednosnica, teretnica itd.); 2 (financ, shipping econ) trgovanje financijskim instrumentima (vrijednosnicama, tereticama, ...)**

sprains, strains, dislocations, fractures (n) (safety) uganuća, istegnuća, iščašenja, lomovi

sprat /spræt/ (n) papalina, saraga

sprats /spræts/ (n) (fishing) a genus of small oily fish of the family Clupeidae **sleđice, papalina** {lat. *Sprattus sprattus*; *Sprattus phaeolicus* /*balearicus*}

spray /sprei/ (n) (marine eng) raspršeni mlaz, sprej divide up into spray raspršiti, fine spray sitna prašina, spray nozzle mlaznica raspršivača, spray deflector raspršivač, adjustable spray nozzle podesiva mlaznica, automatic spray sysetm (safety) automatski sustav gašenja požara raspršivanjem

spray hood /'sprei,hu:d/ (n) (boating/yachting) vjetrobrian (na kabini), zaštitna cerada (nad ulazom u kabinu jedrilice/krstaša), *sprayhood*



spraying (n) (seamanship) špricanje (mora)

spray out (v) raspršiti

spread (v) 1 širiti se, razviti (se); 2 proširiti se (o vatri, požaru) *The fire spread from the engine room to deck 15 via the exhaust stack, forcing crews to fight the fire in two places.*

spread (n) razmak

spreader /'sprɛdə/ (n) 1 (cargo handling) hvataljka (dizalice) za kontejner, **spreader container spreader** hvataljka kontejnera, kontejnerski spreder, **telescopic spreader** teleskopski spreder, spreder na izvlačenje po dužini



; 2 (boating/yachting) = **crosstree** križ na

jarbolu, tal. *crocetta*; 3 gazište (peljarskih ljestvava) **elongated spreader** produženo gazište peljarskih ljestava

spring (n) 1 (marine eng) opruga, %tal. *molla* **calibrated spring** graduirana opruga, **helical spring** spiralna opruga; 2 (seamanship) špring (konop, uže) **amidships spring** središnji špring, **stopping spring** zaustavni špring, **forward spring** pramčani špring, **aft spring** krmeni špring

spring-loaded (adj) nabijen oprugom, opterećen oprugom, napregnut oprugom

spring tide (n) (oceanogr) near the time of full moon and new moon, gravitational forces of the moon and the sun act together, producing tides that are higher and lower than average

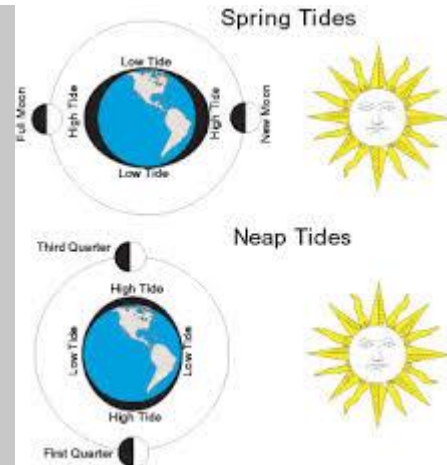

(Seasources.net) živa morska mijena, tal. *acqua viva*

sprinkler /'sprɪŋklə/ (n) **sprinkler system** sprinkler sustav, sustav gašenja prskanjem vode, **sprinkler head** prskalica: A deflector plate on the *sprinkler head* causes water to spray out over a larger area., **sprinkler system** uređaj sprinklera, šprinkler-uređaj (safety) sprinkler

sprinkler system (n) (nav arch, safety) sustav gašenja požara prskanjem, sprinkler sustav gašenja požara

sprocket /'sprɒkɪt/ (n) (marine eng) zubac, klin **sprocket-wheel** a wheel on whose periphery are teeth designed to engage with the links of a pitch or sprocket chain through which motion is transmitted to a second sprocket **lančanik zupčanik za lančani prijenos**



spur dog (=piked dogfish) (n) (fishing) pas

spur gear /'spɜː/ (n) (marine eng) čelnik, čelni zupčanik, zupčanik s ravnim zupcima: The camshafts are driven by a train of hardened and ground steel *spur gears* from the crankshaft split gear.



Academy Artworks

spurling gate (n) (nav arch) zvon lančanika

spurling pipe (n) (nav arch) cijev lančanika

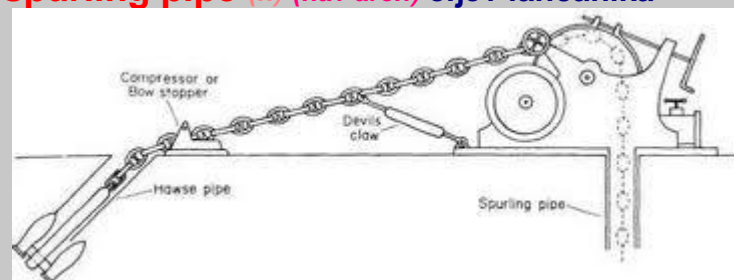

squall /skwɔ:l/ (n) **1 (meteorol)** a strong wind characterized by a sudden onset in which the wind speed increases at least 16 knots and is sustained at 22 knots or more for at least one minute (Seasources.net) **olujni nalet, nalet jakog vjetra s kišom, nevera, crna bura, tal.groppo;**

colpo di vento; raffica. After the squall cleared, in about 10 minutes, we were horrified to see that our ship was lying at right angles to the wharf with our stem only a few metres from the vessel at the next berth astern **heavy weather squall jaki nalet vjetra popraćen kišom, olujna nevera; 2**

oluja, olujni vjetar

squall line /'skwɔ:l/ (n) (meteorol) = **line squall** olujna pruga, pruga maha, linija maha, redna oluja

squally weather /'skwɔ:li/ (n) (meteorol) olujno nevrijeme, oluja

square /skwɛə/ (n) kvadrat

square /skwɛə/ (adj) četvrtast

square-body frame (n) (sailing vessels) središnje rebro

squared /skwɛəd/ (adj) (math) na kvadrat, na dugu potenciju

square knot (n) (seamanship) = reef knot muški uzao



square off /skwɛə/ (v) (cargo) odrezati (kraj daske), izravnati rub (daske)
square-rigged sail (n) (boating/yachting) križno jedro

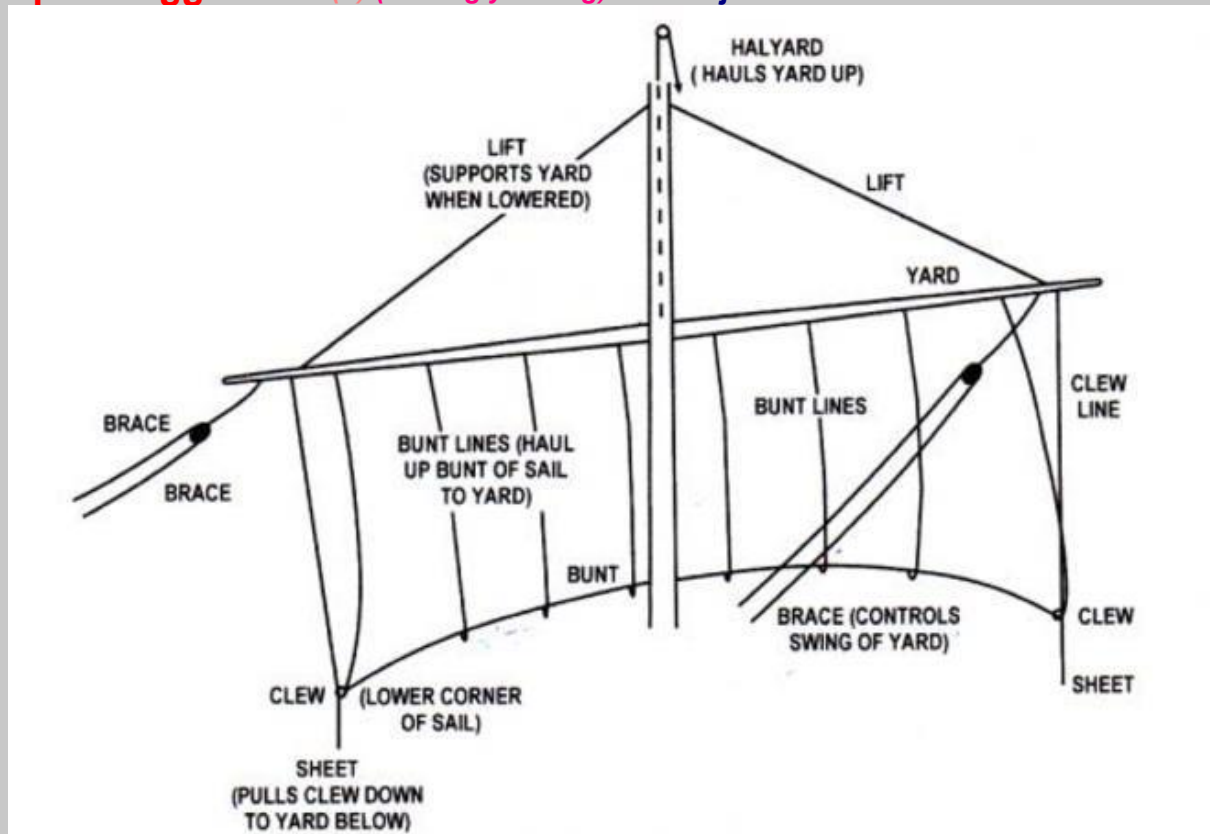

square-rigged ship (n) (sailing vessels, boating/yachting) COMPARE fore-and-aft
 rigged ship brod s križnim jedrima

square root (n) (math) drugi korijen, kvadratni korijen

square sail (n) (boating/yachting) četvrtasto jedro, tal. *vela quadra*



squat /skwɒt/ (n) (navig) uron broda koji nastaje usljed djelovanja smanjenog tlaka ispod trupa, a posebno je izražen u plitkoj vodi; the phenomenon by which a vessel moving quickly through shallow water creates an area of lowered pressure under its keel that reduces the ship's buoyancy, particularly at the bow **zagažaj broda**, **uron krme**. OOW must be aware of underkeel clearance and effects of squat. Časnik straže mora znati dubinu ispod kobilice i uron. **effect of squat učin urona broda, djelovanje urona broda** During the transit, as per the passage plan, speed was to be reduced to below 12 knots to minimise the **effect of squat on** under keel clearance.

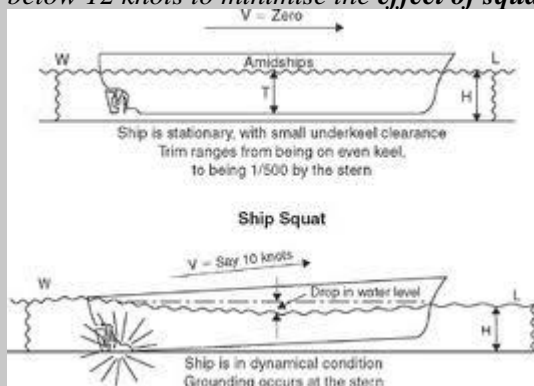

{The reduced buoyancy causes the ship to squat lower in the water than would ordinarily be expected}

sqelch control knob (SQL) /'skwɛltʃ/ (n) (comm) kodačić (na VHF uređaju) za isključivanje buke/smetnje na kanalu

squid /skwid/ (=European squid) (n) = **ink fish** 1 Lat. Loligo vulgaris **liganj**, **lignja**, europska **lignja**, kalamar **common squid** **liganj**, **lignja**



; 2 totan



{drugi hrv. nazivi: kalamar, ligan, oliganj, uligna; lat: LOLIGO

VULGARIS}

squid jig (n) (fishing) skosavica (za lignje)**SRM; (safety related messages)** (n) (navig, comm) sigurnosno povezane poruke, poruke povezane sa sigurnošću**SS; S.S.; (steamship)** (n) 1 (nav arch) parobrod, parni brod, brod na parni pogon; 2 (US) svaki brod na mehanički pogon**stabilisation;** (n) (navig) stabilizacija (radarske slike) **sea stabilisation;** stabilizacija radarske slike kroz vodu, **ground stabilisation;** stabilizacija radarske slike preko dna**stability** /stə'bilɪt/ (n) 1 (stabil) the tendency which a vessel has to return to the upright position after the removal of an external force which inclined her away from that position **stabilnost (broda)****dynamic stability** dinamička stabilnost, **positive stability** pozitivan stabilitet(jerilica se može sama izravhati), **negative stability** negativna stabilnost, **neutral****stability** neutralna stabilnost, **static stability** statička stabilnost, statički stabilitet;

2 stabilitet (broda)

stability book (n) (nav arch, safety) knjiga stabiliteta**stability calculation** (n) (nav arch, stabil) proračun stabilnosti, račun centracije, izračun stabiliteta **ship's stability calculation** izračun broskog stabiliteta**stability curve** (n) (nav arch, navig) krivulja stabiliteta **stability curve diagram** krivulja poluga stabiliteta, Reedov dijagram

stability for great angle of heel (n) (nav arch) stabilnost pri većim kutovima nagiba

stability information (n) (navig) informacija o stabilitetu post stability information izvjesiti informaciju o stabilitetu

stability in the damaged condition (n) (stabil) = **damage stability** stabilnost broda u oštećenom stanju

stability table (n) (stabil) tablica stabilnosti, tablica centracije

stability triangle /'traɪ,æŋgəl/ (n) (stabil) trokut stabilneta

stabilization (n) (navig) stabilizacija radarske slike

stabilized display (n) (navy) radarski prikaz stabiliziran kompasom: *Stabilized display is a type of presentation also known as north up display.* **north-up stabilized display** radarski prikaz s oznakom azimuta prema sjeveru: *With a North-up or Course-up stabilised display, where the radar is interfaced with a gyro compass the heading marker will always point to the true course being steered.* **course-up stabilized display** radarski prikaz stabiliziran s kursom

stabilizer; stabiliser /'steɪbɪ,laɪzə/ (n) (nav arch) stabilizator (na putničkom brodu)

stabilize; stabilise /'steɪbɪ,laɪz/ (v) (navig) stabilizirati stabilize; stabilise the radar stabilizirati radar. *The radar was stabilised with GPS instead of speed over water from the log*

stabilizing compass (n) (navig) stabilizacija kompasom

stable equilibrium (n) (nav arch) stabilna ravnoteža

stack /stæk/ (v) (cargo) slagati (kontejnere)

stack /stæk/ (n) 1 (cargo) red složenog tereta (npr. složenih kontejnera) **container stack** two or more containers, one placed above the other, forming a vertical column **red složenih kontejnera**; 2 (ports) An identifiable amount of containers stowed in a orderly way in one specified place on an (ocean) terminal, container freight station, container yard or depot. **slagalište kontejnera** površina na terminalu za slaganje kontejnera

stack /stæk/ (n) (nav arch) brodski dimnjak, *ciminjera*

stacking /'stækiŋ/ (n) (cargo) slaganje (kontejnera) stacking area slagalište kontejnera skladišni prostor za kontejnere

stacking area (= 'stækiŋ) (n) (ports) skladišni prostor (za kontejnere)



stacking cone /'stækiŋ/ (n) (cargo handling) prijenosni kutni element za spajanje dva kontejnera po visini **prijenosni kutni element (za spajanje dva kontejnera po visini)**

stacking crane /'stækiŋ/ skladišna kontejnerska dizalica

stadimeter (n) (navig) a navigation instrument for measuring the distance to object whose height is known **stadimetar**

staff /sta:f/ (n) 1 **osoblje, personal shipboard staff** brodsko osoblje, engine room **staff** osoblje strojarnice; 2 **posada**

staff (n) (nav arch) a light pole to carry an ensign or jack, or a topmark on a buoy **zastavni stup, jarbolet za zastavu na pramcu**

staff cuts (n) (shipping econ, mar law) **smanjenje radne snage, otpuštanje zaposlenika**: *The shipowner has made plenty of staff cuts already this year.*

stage /steidʒ/ (n) 1 **faza, etapa, dio (provedbe plana) first stage** prva faza; 2 (seamanship) a floor or platform of planks supporting workmen during the construction or the cleaning and painting of a vessel, located either inside or outside the vessel **platforma (za bojanje i održavanje broda s bočne strane)**

stage hitch (n) (seamanship) **vez za sjedalo (za radove na boku broda)**

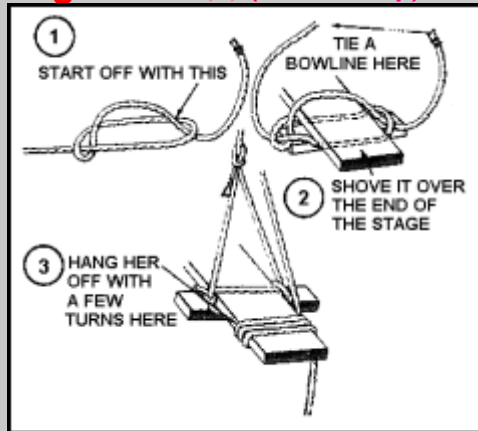

stained /steind/ (adj) (cargo) **zamrljan (o vrećama tereta), zauljen, zamašćen stained bag** zamašćena vreća

stainless steel /'steɪnlɪs/ (n) (marine eng) **nerđajući čelik**

stake /steɪk/ (n) (cargo, safety) **kolac, štap**

stakeholders /'steɪk, həʊldəz/ (n) Any person, group or organisation with an interest in, or who may be affected by, the activities of another organisation.; svi zainteresirani sudionici obuhvaćeni u u nekom poslu, projektu, pothvatu **zainteresirani u nekom poslu, projektu, pothvatu, bitni čimbenici glavni dioniočari**

stale /steɪl/ (adj) (cargo) **pljesniv, ustajao**

stanchion /'sta:nʃən/ (n) 1 (cargo) **upora za drvo, okomiti drveni stupovi za slaganje tereta drva**: *Vertical timber side members, or stanchions, are used to secure the cargo either side.*

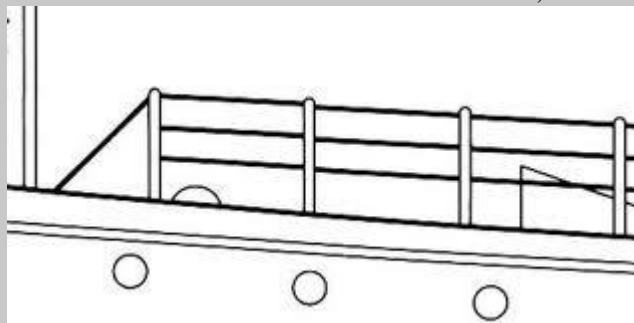

; 2 (nav arch) = **pillar** upora (u skladištu ili trupu broda) **upper-deck stanchion** upora gornje palube, **main-deck stanchion**

upora glavne palube, **lower-deck stanchion** upora donje palube, **hold stanchion** upora skladišta; **3** (*boating/yachting, nav arch*) vertical structural supports of bulwarks and safety railings **stupić ograde**; **4** (*nav arch*) vertical post near a deck's edge that supports life-lines **upora linice broda, tal. candeliere**

stand (*n*) (*marine eng*) stol, plit **control stand** upravljački pult

standard (*n*) Petrograd **standard** (*UK*) jedinica ta mjeru drva u prijevozu (*cargo handling, shipping econ*) jedinica za mjeru u prijevozu drva **standard**

standard chain length (*n*) (*seamanship*) dio sidrenoga lanca koji čine jedna spojna karika i ostale karike **lančana uza**

standard display (*n*) (*navig*) standardni prikaz podataka (u sustavu ECDIS)

standard knee (*n*) (*sailing vessels*) vertikalno koljeno

standard of competence (*n*) (*mar law*) razina stručnoga znanja i sposobnosti koju pomorac treba postići za pravilno obavljanje djelatnosti na brodu u skladu s međunarodno dogovorenim mjerilima **standard osposobljenosti**

Standards of Training, Certification and Watchkeeping for Seafarers (STCW) Convention 1978 (*n*) (*mar law*) Konvencija o standardima za obrazovanje, izdavanje ovlaštenja i držanje straže pomoraca

standby /'stændbaɪ/ (*n*) **1** (*navig*) rad (radara itd.) u pripremi; **2** u pripravnosti (osoba, član posade): *A qualified helmsman should be on standby to take the wheel immediately* **have a helmsman on standby** **1** staviti kormilara u pripravnost; **2** imati kormilara u pripravnosti

stand by (*v*) **ring stand by** narediti pozor u stroju (telegrafom) **1** (*comm, safety*) to be prepared to execute an order or a manœuvre **biti spreman / pripravan** **put the engines on stand by** staviti strojeve u stanje pripravnosti **dati naredbu Pozor u stroju**; **2** čekati na poziv na radiopostaji **stand by on!** to be on radio watch waiting for a call or instructions **Čekajte!, Ostanite na kanalu!**; **3** to remain in the vicinity, prepared to render assistance **biti u blizini, stajati pokraj** (broda u opasnosti radi pružanja pomoći), **biti spreman** (za pružanje pomoći)

stand-by (*adj*) rezervni, pomoćni **stand-by generator** pomoćni generator, rezervni generator

stand-by! (*v*) **1** (*marine eng, comm*) Pozor (u stroju)!; **2** (*comm*) Pozor! (ostanite na liniji / na vezi)

Stand by engine(s)! (*navig, marine eng*) Pozor u stroju! **Stand by engine(s)!**s Pozor u strojevima!, **EngineStand by engine(s)!**ing by. Stroj u pripravnosti. {naredba za upravljanje strojem}

Stand by for let go. (*navig, comm*) Spremni za odvezivanje., Spremni za manevar isplovljenja. **Standing by for let go.** Spremni smo za odvezivanje

stand by mode (*n*) (*navig*) pripravn način rada (radara)

stand clear of (*navig*) (*v*) stajati podalje od, držati se podalje od

standing block (*n*) (*seamanship*) nepomični kolotur (u čekrku, koloturniku)



standing moor /'stændɪŋ/ (n) **1** (seamanship) sidrenje s dva sidra (ili plutače); **2** stalni / stabilni vez

standing orders /'stændɪŋ/ (n) (navig) In the standing orders the Captain sets required fix intervals, intervals for fathometer navigation and collision avoidance requirements. **trajne zapovjedi (zapovjednika / brodara straži)**: *The master had not issued any written standing orders. Similarly, masters should make this requirement clear in their standing orders: "If in doubt, call me out! He gave the following reasons for this: 1 There was a Standing Order to call the Master for any alteration of course of more than two degrees. Master's standing orders zapovjednikove trajne zapovjedi, bridge standing orders stalne zapovijedi mostu.* I wonder if some ships have **Bridge Standing Orders**, why OOWs are so reluctant to call Masters and why action is left so late. **call the master (in case of doubt) nazvati zapovjednika (u slučaju dvojbe), pozvati zapovjednika** {While Night Orders are in effect only for the 24 hours after they are written, Standing Orders are continuously in force.}

standing part of rope /'stændɪŋ/ (n) (seamanship) mrtvi kraj konopa

standing rigging /'stændɪŋ/ (n) **1** (nav arch) all the wires and ropes that support the mast and boom; oputa kojom se učvršćuje samarica **nepokretna oputa (samarice, jarbola), nepomična oputa;** **2** (boating/yachting) oputa kojom se učvršćuje jarbolje; rigging that is permanently secured and that is not hauled upon, as shrouds, stays, etc **nepomična oputa, tal.**

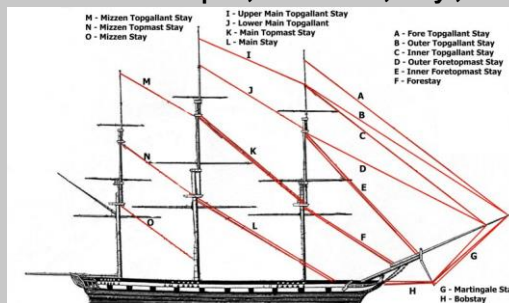

attrezzatura dormiente

stand off (v) (navig) odmaknuti se (od obale, drugog broda)

stand on /'stænd,ɒn/ (= 'stænd,ɒn) (v) **ANTONYM** give way držati kurs i brzinu (brod koji ima pravo puta)

stand-on vessel (n) (navig, mar law) = **right-of-way vessel** brod s pravom puta, brod koji ima pravo puta

standpoint stajalište, stanovište, gledište

staple knee /'stæpl/ (n) (sailing vessels) okvirno koljeno

starboard /'sta:bəd; 'sta:bɔ:d/ (adj) **ANTONYM** port² towards the right-hand side of a vessel facing forward, the term 'starboard' refers to the right side of a vessel, perceived by a person on board,

facing towards the bow **desni, tal. *dritta* starboard side desna strana, starboard engine desni stroj** **on the starboard side na desnoj strani, s desne strane** {The word starboard comes from Old English *steorbord*, literally meaning the side on which the ship is steered. Before ships had rudders on their centrelines, they were steered by use of a specialized steering oar, which was held by an oarsman located in the stern of the ship and, due to the prevalence of right-handed sailors, on the right-hand side of it (http://en.wikipedia.org/wiki/Port_and_starboard)}

starboard /'sta:ˌbɒd ; 'sta:ˌbɔ:d/ (n) (seamanship) **ANTONYM port** the right-hand side of the ship when looking from aft forward **desna strana broda, desni bok broda**

Starboard, steer one eight two! (navig, seamanship) Kormilo desno, kurs: jedan osam dva! {zapovijed za kormilarenje}

starboard anchor (n) (nav arch) desno sidro

starboard bow (n) (nav arch, navig) **COMPARE port bow** desna strana pramca, desni pramac, tal. *mascone prora dritta on the starboard bow* desno po pramcu, **two points on the starboard bow** dva vjetra (prsta, =oko 23 stupnja) po pramcu s desne strane, **see a ship on the starboard bow** ugledati brod subočice po pramcu
At 0011, the OOW saw a vessel 20° off the starboard bow.

starboard engine (n) (nav arch) desni stroj

starboard hand mark (n) (navy) **ANTONYM port hand mark** oznaka s desne strane (broda), oznaka koju valja ostaviti s desne strane broda

starboard helm (n) (navig) kormilo u desno: *Once the vessel was clear of the buoy, starboard helm was used to manoeuvre the vessel back towards the western side of the channel.*

starboard quarter (n) (navig) desni kvartir

starboard side to (adv) (navig) desnim bokom uz obalu **berthed starboard side to** brod vezan desnim bokom uz obalu

starboard tack (n) **1** (boating/yachting) sailing with the main boom on port side **desna uzda, desne uzde; 2 jedrenje na desnim uzdama**

Starboard ten! (navig, seamanship) Deset desno! {zapovijed za kormilarenje}

starboard turn (n) (navig) okret u desno **sharp starboard turn** nagli okret u desno

stargazer (n) (fishing) Lat. URANOSCOPIUS SCABER **bežmek, ćać, ćaća, batoglav, pušać**



start (n) uputiti, staviti u pogon, pokrenuti, startati **start from cold (marine eng)** staviti u pogon iz hladnog stroja, **start the lubricating oil pumps** uključiti pumpe ulja za podmazivanje

starter (n) (marine eng) potretač, starter, tal. *avviatore* **starter air** uputni ventil

starter grip (n) (marine eng, boating/yachting) ručica za pokretanje izvanbrodskoga

benzinskog motora

start from cold (v) (marine eng) staviti u pogon iz hladnog stanja

starting (n) (marine eng) upućivanje, stavljanje u pogon, pokretanje, startanje

starting air system sustav za upućivanje zrakom sustav upućivanja zrakom

starting air distributor (n) (marine eng) razvodnik zraka za upućivanje stroja: *The starting valve is opened by control air from the starting air distributor and closed by a spring.*

starting air system (n) (marine eng) sustav zraka za upućivanje

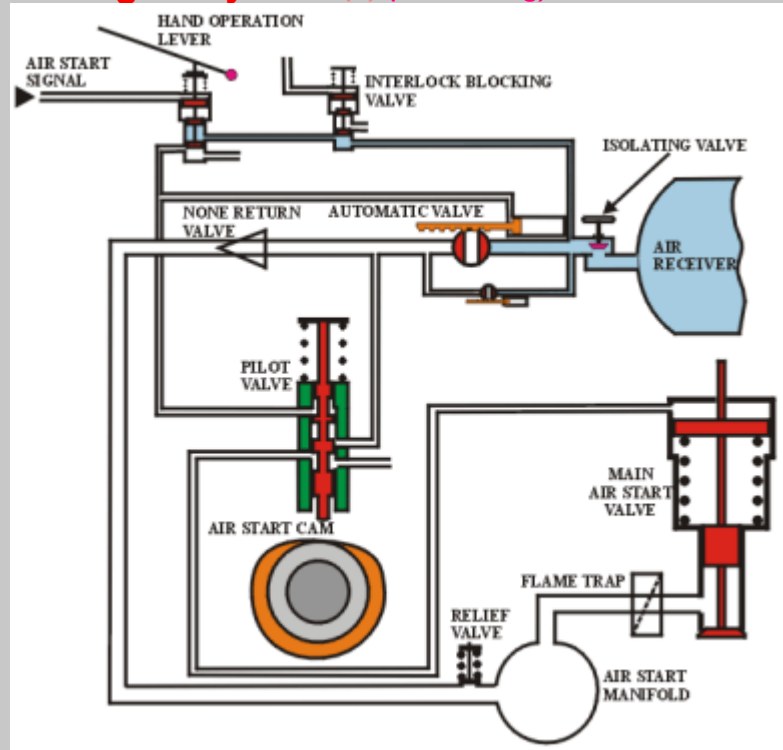

starting crank (n) (marine eng) ručica za upućivanje motora, kurbla

starting problems (n) (marine eng) nevolje s paljenjem, nevolje s upućivanjem stroja

starting to luff (n) (boating/yachting) početak prihvaćanja

start-up/shut-down procedures (n) (cargo handling) postupci za početak i

završetak krcanja tereta (npr. nafte): *An efficient system of communication should be established between the vessel and the terminal and the start-up/shut-down procedures for cargo operations agreed.*

state (v) 1 navesti; 2 razjasniti; 3 prikazati, razložiti; 4 ustanoviti; 5 odrediti

statement /'steitmənt/ (n) 1 (mar law) izjava, iskaz; 2 tvrdnja; 3 navod

statement of compliance (n) (mar law, ports) izjava o sukladnosti

statement of facts (n) take the statement of facts from the Master uzeti izjavu od zapovjednika 1 (mar law, shipping econ) a vremenska tablica; 2 (mar law) vremenska tablica, činjenično stanje, izjava o činjeničnom stanju; 3 (mar law) utvrđivanje činjeničnog stanja

state of sea (n) (oceanogr) = **sea state** stanje mora 0 calm (glassy) (0 m) 1 mirno; 2 glatko; 3 uralno, 1 calm (rippled) (0-0.1) naborano, 2 smooth (0.1-0.5) malo

valovito, valićasto, 3 slight (0.5-1.25) umjereno valovito, 4 moderate (1.25-2.5) valovito, 5 rough (2.5-4) jače valovito, 6 very rough (4-6) jako valovito, 7 high (6-9) teško more, 8 very high (10-14) vrlo teško more, 9 confused (higher than 14 m) izuzetno teško more {cf. Douglas: Sea State Scale}

statical load (n) (nav arch) statičko naprezanje

statical stability (n) (nav arch) statička stabilnost **moment of statical stability** moment statičke stabilnosti

statical stability arm curve (nav arch) krivulja poluga statičke stabilnosti

statical stability curve; GZ curve (n) (stabil, nav arch) a graphical representation of the ship's transverse statical stability **krivulja statičke stabilnosti**

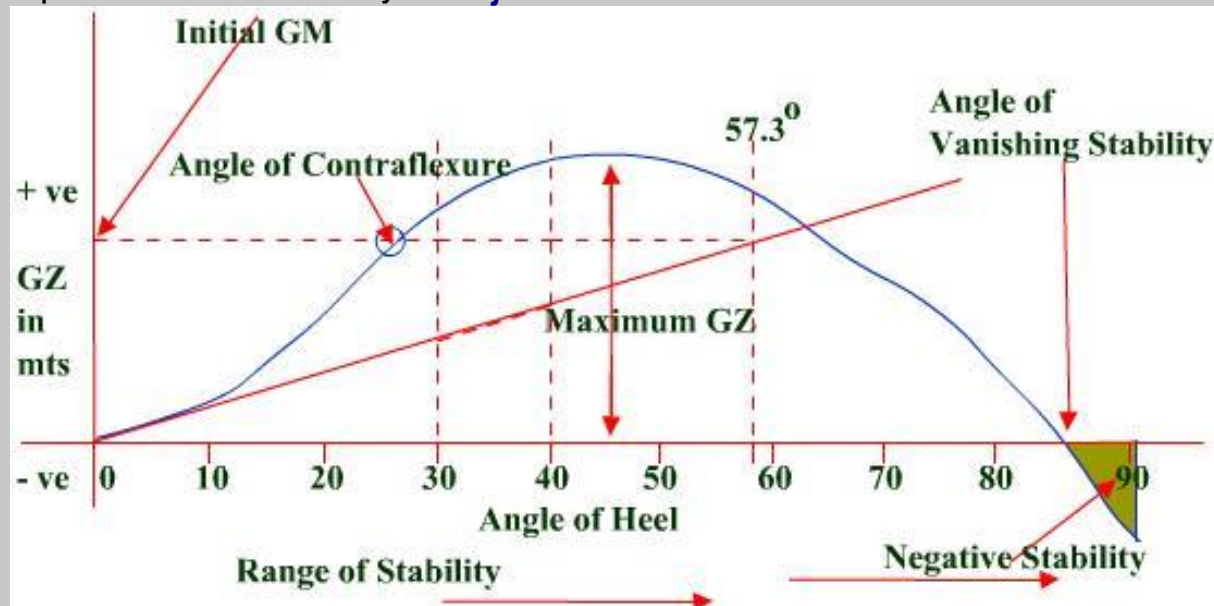

statical stability moment curve (n) (nav arch) krivulja momenata statičke stabilnosti

static converter (n) (electr, navig) = **motor generator** jedinica napajanja (radara)

station 1 (comm) postaja, stanica; **2** (nav arch) motrilište

station (n) (nav arch) presjek brodskoga obrisa ravninom okomitom na uzdužnu simetralnu ravninu i ravninu projektne vodne linije **teorijsko rebro**

stationary (adj) nepomičan, nepokretan, fiksna, stacionaran **remain stationary** biti stacionaran, **stationary component** stacionarni dio

statute /'stætju:t/ (n) (mar law) an enactment of a legislative body (e.g. parliament) expressed in a formal document **objavljeni zakon (koji je donio parlament)**, **važeći zakon**, **zakon na snazi**

statute of limitations /'stætju:t/ (n) (mar law) a legislative enactment prescribing the period of time within which proceedings must be instituted to enforce a right or bring an action at law **zastara** **fall under statute of limitations** zastarjeti

statutory /'stætju:təri/ (adj) (mar law) zakonski, prema zakonu **statutory duty** zakonska obveza / dužnost **statutory requirements** zakonski propisi / uvjeti

statutory certificates /'stætju:təri/ (n) (mar law) isprave propisane međunarodnim ugovornim

dokumentima ili nacionalnim propisima **statutarne isprave, zakonske svjedodžbe, propisane svjedodžbe**

statutory lien /'stætjʊtəri/ (n) (mar law) privilegiji koje priznaje zakon, ali se ostvaruju samo nakon utuživanja potraživanja; primijenjuje se radi namirenja potraživanja brodoopskrbljivača, šteta na teretu i tjelesnih šteta; imaju prednost pred hipotekom/mortgage na brodu (Grabovac) **zakonski privilegij na brod**

statutory publications /'stætjʊtəri/ (n) (mar law, navig) publications such as: International Code of Signals, operating and maintenance manuals for nav aids, navigation tables, nautical almanac, notices to mariners, shipping guidance and information notices, sailing directions, lights list, tide tables, tidal stream atlases, admiralty list of radio signals **zakonom propisane publikacije (koje svaki brod mora imati)**

statutory regulations /'stætjʊtəri/ (n) (mar law) **zakonski propisi, satutarni propisi:** *Standards of accommodation are high, and are controlled by various IMO and ILO statutory regulations.* **IMO and ILO statutory regulations obvezujući propisi IMO-a i ILO-a**

statutory requirements (n) (mar law, safety) **zakonski zahtjevi**

statutory stipulations /'stætjʊtəri/ (n) (mar law) **zakonske odredbe**

stave /steiv/ (n) (cargo) **duga, dužica, prečka (za bačve, sanduke)**

stay /stei/ (n) **1 (boating/yachting) leto, štraj; tal. strallo; straglio check stay check**

stay, lower stay donje leto, jibstay leto floka (do gornjeg križa ili 7/8 jarbola),

headstay prednje leto (od vrha jarbola do pramca), prednji štraj proveni štraj; **2 (nav arch) prečka karike lanca {tal. straglio}**

stay /stei/ (n) (shipping econ) **boravak port stay vrijeme boravka broda u luci**

stay (n) (mar law) court order to temporarily suspend the execution of a court judgment or other

court order (Wiki) **odgoda izvršenja, odgoda izvršenja (sudske odluke):** *The*

Gibraltar-based single-hull tanker Wilmington has been given a stay of execution and will be able to

continue its role as a storage vessel for fuel oil until the courts have reviewed the EU-legislation on

single-hull tankers **stay of execution odgoda izvršenja, stay order Court order that suspends**

a judicial proceeding (or a judgment resulting from it) in part or in full. **nalog za odgodu izvršenja**

(sudske odluke): *The Line was granted stay orders to protect its ships from seizure in the ports of ...*

earlier this month, and is applying for stay orders elsewhere.

staysail (n) (boating/yachting) smal jib tacked between mast and headstay **mali flok, letno jedro, tal. trinchetta**

STBY/TX key (n) (navig, electr) **tipka za pripremu i odašiljanje (radarskih impulsa),**

tipka STBY/TX: *The STBY/TX key toggles between stand-by and transmit status {standby / transmission key}*

STC; Sensitivity Time Constant = A/C rain (FTC) promjenjivo vremenski ovisno pojačanje (na radarskom prijammniku)

STCW Convention (n) (mar law) = **IMO STCW Convention, 1978/1995/2010**

The International Convention on Standards of Training, Certification and Watchkeeping for Seafarers

(STCW), 1978/1995/2010 **Međunarodna konvencija IMO-a o standardima izobrazbe,**

izdavanju svjedodžbi i držanju straže pomoraca (1978/1995/2010)

steadily /'stedili/ (adv) **stalno, postupno**

Steady! /'stedi/ (navig, seamanship) an order to hold a vessel on the course she is heading **Ravno!** {zapovijed za kormilarenje}

steady /ˈstɛdi/ (adj) **1 (navig, seamanship)** to keep the helm so as to stop the swing of the ship to port or starboard **stalan, ustaljen steady course ustaljen kurs, on a steady course na pravom kursu, na stabilnom kursu, na sigurnom kursu**: *Once the vessel was on a steady course to the anchorage, the Master used the vessel's paper chart to plot a direct course line from the assigned anchorage back to the vessel's position*; **2 (figurative) to be on a steady course biti uspješan u nečemu (figurative use)**: *With more than 120 years in the marine insurance business, we are now on a steady course. We have a long history to rely on and can step in to the future with confidence.*

steady /ˈstɛdi/ (v) **ustaliti, stabilizirati, uravniti steady the course ustaliti kurs**: *The Master steadied the vessel on a heading to return her to the planned track.*

Steady as she goes! (navig, seamanship) **Tako ravno!** {zapovijed za kormilarenje}

steadying sail (n) (boating/yachting) a sail hoisted to steady the ship against rolling, rather than for propulsion **ravnajuće jedro**

steady wind /ˈstɛdi/ (n) (meteorol) **stalni vjetar**

stealth /stɛlθ/ (adj) (navy) moving with extreme care and quietness, esp so as to avoid detection **neprimjetljiv, nevidljiv stealth destroyer nevidljivi razarač**

steam /sti:m/ (n) **1 (marine eng) para bled steam ispuštena para, para oduzeta iz niskotlačne turbine, exhaust steam ispušna para, turbine gland steam para koja istječe iz brtvenice turbine, admit steam pustiti paru u, dovesti paru u, generate steam proizvoditi paru, heat by steam zagrijavati parom, produce steam proizvoditi paru, raise steam dignuti tlak pare, supply steam dobiti paru, dovesti paru**; **2 vodena para steam coil parni zagrijač sa spiralnim cijevima**

steam /sti:m/ (v) (seamanship) **ploviti**: *The vessel was steaming at 14 knots, and the master had instructed the chief officer to remain at least 3 cables from the island.*

steam bending (n) (marine eng) **savijanje pod parom**

steam bent frame (n) (nav arch) **drveno rebro savijeno parom**

steam chest valve (n) (marine eng) **razvodnik pare**

steam drum (n) (marine eng) **parni bubanj, parna komora**

steamer /ˈsti:mə(r)/ (n) (marine eng) **parnjak, parobrod, brod na parni pogon**

steam generating plant (n) (marine eng) **uređaj za proizvodnju pare**

steam generator (n) (marine eng) **generator pare**

steam heating coil (n) (marine eng) **parni zagrijač sa spiralnim cijevima**

steaming (n) (navig, shipping econ) **plovidba, plovljenje**

steaming lights (n) (boating/yachting) **1 (navig) navigacijska svjetla combined stern / masthead light kombinirano svjetlo, single steaming light jedno jarbolno svjetlo, two steaming lights dva jarbolna svjetla**; **2 svjetla motornih brodova**

steam plant (n) (marine eng) **parno postrojenje**

steam-powered (adj) (marine eng) **na parni pogon**

steam pressure (n) (marine eng) **tlak pare**

steam propulsion (n) (marine eng) **parni pogon**

steam reciprocating engine (n) (marine eng) **parni stapni stroj**

steamship 1 a (n) parobrod **steamship company** parobrodarsko društvo, brodarsko društvo, brodar; 2 (US) Today, ships that transport cargo overseas are powered by diesel fuel instead of steam **motorni brod**; 3 (US) brod (općenito)

steamship agent (n) (prep phr) (US, mar law, shipping econ) The local representative who acts as a liaison among ship owners, local port authorities, terminals and supply/service companies. An agent handles all details for getting the ship into port; having it unloaded and loaded; inspected and out to sea quickly. An agent arranges for pilots; tug services; stevedores; inspections, etc., as well as, seeing that a ship is supplied with food, water, mail, medical services, etc. A steamship agency does not own the ship. **pomorski agent, brodski agent**

steamship company 1 (shipping econ, mar law) parobrodarsko društvo; 2 (US, mar law, shipping econ) a business company that owns ships that operate in international trade **brodarsko društvo**

steamship line (n) (US, mar law, shipping econ) A steamship (ocean carrier) service running on a particular international route. Examples: NSCSA (National Shipping Company of Saudi Arabia), American President Lines (APL), Maersk Sealand, Evergreen, etc. **brodarska linija, linija, brodski servis**

steam turbine /sti:m 't3:bin ; sti:m 't3:bain/ (n) (marine eng) **parna turbina**

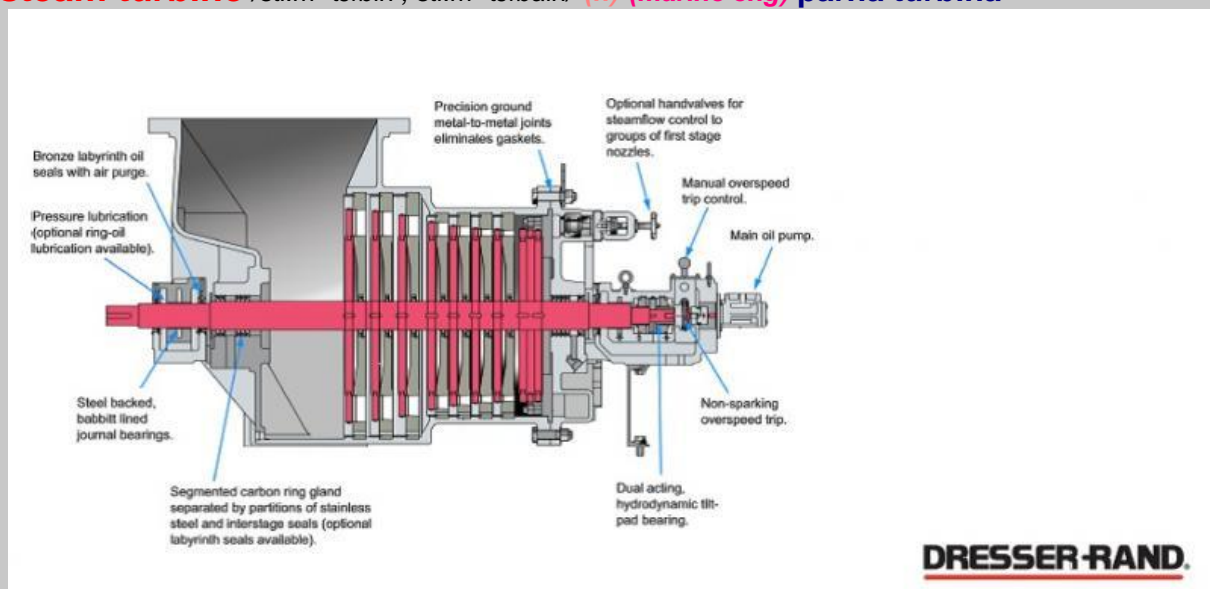

steel /sti:l/ (n) **čelik alloy steel** legirani čelik, **carbon steel** ugljični čelik, **corrosion-resistant steel** čelik otporan na koroziju, **fine-grained steel** čelik sitnozrnate strukture, **stainless steel** nerđajući čelik

steel plate (n) (cargo, nav arch) čelični lim

steel rope = wire čelično uže, čelik-čelo, **kavodifero**

steel sling čelični pasac

steep sea (n) (meteorol) olujno more

steer /stiə/ (v) (navig) kormilariti, držati smjer, tal. **timonare steer the course** 1 držati kurs kormilariti u smjeru; 2: A general cargo ship was on loaded passage in coastal waters, steering a course of 184 degree true and making a speed of about 11.4 knots.

steerage /'stiəri:dʒ/ (n) (navig) **brzina za kormilarenje**: the vessel had sufficient steerage broj je imao brzinu dovoljnu za kormilarenje

steerageway /'stiəriðʒ,wei/ (n) (navig) the slowest speed at which a vessel is capable of steering
 sposobnost kormilarenja, mogućnost kormilarenja, sposobnost manevriranja,
 minimalna brzina za kormilarenje at minimum steerageway pri minimalnoj
 sposobnosti kormilarenja: *The intended track now involved a very sharp starboard turn of almost
 130° at minimum steerage way, keeping close to the breakwater head.*, **lose steerageway**: *When a
 vessel no longer answers her rudder, she is said to have lost her steerageway*

steer around ploviti oko, upravljati brodom tako da brod plovi oko (plutače,
 lukobrana, drugog broda, nekog objekta): *Immediately on reaching the bridge, the pilot
 ordered half ahead and hard-astarboard, with the intention of steering the ship around the breakwater
 head.*

steering /'stiəriŋ/ (n) 1 (navig) kormilarenje automatic steering automatsko
 kormilarenje, manual steering ručno kormilarenje, hand steering ručno
 kormilarenje, emergency steering kormilarenje u nuždi, sustav kormilarenja u
 nuždi; 2 sposobnost kormilarenja

steering /'stiəriŋ/ (n) (navig) sposobnost kormilarenja, sposobnost broda za
 kormilarenje loss of steering gubitak sposobnosti za kormilarenje

steering cable (n) (nav arch) lanac kormilarskog uređaja: *The steering cable had been
 replaced using an outdated spring-loaded ball joint to connect it to the outboard engine frame.*

steering column upravljački stup (kormila)

steering control stand (n) (nav arch) kormilarski stalak

steering engine kormilarski stroj

steering equipment kormilarski uređaj

steering failure (n) (safety) zakazivanje kormilarskog uređaja, otkazivanje

kormilarskog uređaja: *the vessel had suffered a steering failure* brodu je otkazao kormilarski uređaj

steering gear (n) (nav arch) a gear consisting of the steering wheels, leads, steering engine, and
 fittings by which the rudder is turned **kormilarski uređaj**: *Her main engine was kept at full ahead,
 but was stopped when the chief engineer reported to the master that the steering gear was badly
 damaged. test the steering gear* isprobati rad kormilarskog uređaja: *0421 Steering gear
 tested, started heaving port anchor.*, **main steering gear** glavni kormilarski uređaj, **auxiliary**

steering gear pomoćni kormilarski uređaj, **remote steering gear controls** daljinski
 upravljači kormilarskog uređaja, **steering gear linkage** polužje kormilarskog
 uređaja, **steering gear test** test kormilarskog uređaja, isprobavanje kormilarskog
 uređaja, **steering gear unit pump** pumpni agregat kormilarskog uređaja



steering light svjetlo za kormilarenje

steering machinery strojnica kormilarskog uređaja

steering orders = helm orders zapovijedi za kormilarenje, naredbe za kormilarenje, tal. *ordini al timoniere* **1** Midships!, **3** Starboard five!, **2** Starboard!, **4** Port fifteen!, **5** Hard-a-starboard!, **6** Hard-a-port!, **7** Meet her!, **8** Steady!, **9** Steady as she goes!, **10** Starboard ten!, **11** Ease to five!

steering stand (n) (navig) kormilarsko postolje, mjesto za kormilarenje

steering wheel (n) (nav arch) a ship's wheel or boat's wheel is used to change course; together with



the rest of the steering mechanism it forms part of the helm **kormilarsko kolo**

stellar catfish morska mačka mrkulja {lat. *Scyliorhinus stellaris*}

St. Elmo's Fire (n) (meteorol) a luminous, and often audible, electric discharge that is intermediate in nature between a spark discharge and a point discharge (Seasources.net) **vatra**

svetog Elma {It is seen also, during stormy weather, emanating from the yards and masts of ships at sea.}

stem /stɛm/ (n) **1** (nav arch) the extension of keel at the forward of a ship; the bow frame forming the apex of the intersection of the forward sides of a ship **pramčana statva**, **ašta** **stem rabbet**

(sailing vessels) **utor pramčane statve**; **2** (seamanship, figurative) **pramac / prednji dio**

broda: *If there is a tide or current running, the vessel's stem should be turned into it. {tal. dritto di prora}*

stem (v) (navig) **ploviti prema**, **ploviti protiv stem the tide** **ploviti protiv struje**

stem band (n) (nav arch) središnji lim opločenja pramčane statve od kobilice do vrha pramca **žlijeb pramčane statve**, **kopo**

stem-piece (n) (sailing vessels) **umetak za statvu**, **umetak za protustatvu**

stemson /stɛmsən/ (n) (nav arch, sailing vessels) **pramčano koljeno**

stem the current (v) (seamanship) **ploviti protiv struje**, **okrenuti se protiv struje**

stem the tide (v) (navig) to head the vessel's bow directly into the current or waves; overcome

adverse circumstance **ploviti pramcem protiv struje**, **biti okrenut pramcem prema struji**

The Pilot continued proceedings for berthing, directing the tugs to turn the ship around through 180 degrees, to stem the tide.

step the mast (n) (v) **postaviti jarbol**, **staviti jarbol u ležište**

stere /stiə/ (n) (cargo) a unit used to measure volumes of stacked timber equal to one cubic metre (35.315 cubic feet) **jedinica za mjeru u prijevozu drva** (Franc., Italija)

stere /stiə/ (n) (cargo handling) **stere**, tradicionalna metrička jedinica u prijevozu drva **za orijev**, otprilike jednaka jednom kubnom metru ili 35.314 kubnih stopa

stern /stɜːn/ (n) (nav arch) the after end of a vessel **krma**, tal. *poppa* {tal. *poppa*}

stern breast line (n) (seamanship) **bočno krmeno uže**

stern door (n) (nav arch) **krmena vrata** (na ro-ro brodu)



stern drive (n) (marine eng) krmeni pogon, krmena osovina

stern frame (n) (nav arch) strength member including the rudder post used in the construction of single krmena statva, okvir krmene statve {tal. ordinata di poppa; it includes rudder post, propeller post, and aperture for the propeller in single-screw vessels}

stern gland (n) (marine eng, boating/yachting) brtvenica statvene cijevi, šupernica, očnica, brtvenica, tal. premistoppa During this relatively short run, the owner decided to again check the stern gland. The dredger was eventually salvaged and, after much investigation, water was found to be leaking through the hull plating near to the stern gland in the engine room. There was a mass of large size monofilament longline around the propeller and the stern gland housing.

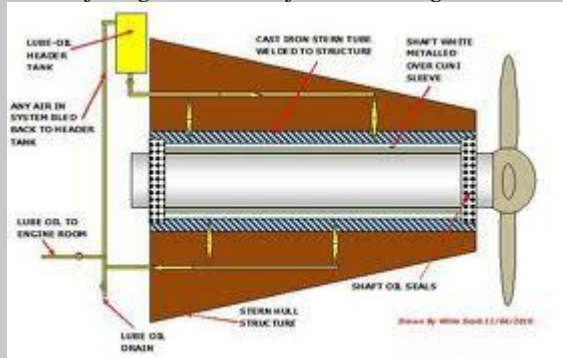

{tal. anello pressatrecce di poppa}

stern-in, wind ahead berth (n) (boating/yachting) pramac van, vjetar s pramca

stern into tide (n) (boating/yachting, seamanship) struja straga, struja u krmu

stern light (n) (navig) = overtaking light krmeno svjetlo: Our vessel was overtaking a large bulk carrier in ballast. His stern light seemed very dim, it later turned out to be a cabin light. She was exhibiting a masthead light, port and starboard sidelights and a stern light.

stern line (n) (seamanship) krmeno uže, tal. cavo di ormeggio di poppa; cavo alla lunga di poppa

sternpost /'stɜːn,pəʊst/ (n) (nav arch) the main vertical post in the stern frame upon which the rudder is hung krmena statva sternpost rabbet (sailing vessels) utor krmene statve, foot of the sternpost peta krmene statve: The recovery was successful and the vessel managed to get alongside the quay under her own power, where initial repairs to the foot of the stem post were carried out. {dritto di poppa}

stern power (n) (navig) snaga za vožnju krmom, snaga za vožnju natrag: the vessel did not have very good stern power brod nije imao dovoljno snage za punu vožnju krmom

stern quarters (n) 1 (seamanship) krmeni kvartiri; 2 krmene nastambe

stern ramp (n) (nav arch) krmena rampa (na trajektu, ro-ro brodu)

sternson (n) (sailing vessels) krmeno koljeno

stern thruster (n) (nav arch) krmeni bočni propeler

stern timbers (n) (sailing vessels) rebra krmenog okvira

stern trim (n) (cargo handling, nav arch) uronuće po krmu, trim po krmu

stern tube (n) (nav arch) the tube under the hull to bear the tailshaft for propulsion statvena cijev, cijev za osovinu brodskog vijka **stern tube bearing** ležaj statvene cijevi, **stern tube replacement** zamjena statvene cijevi

stern tube sealing arrangement (n) (nav arch) brtvljenje statvene cijevi

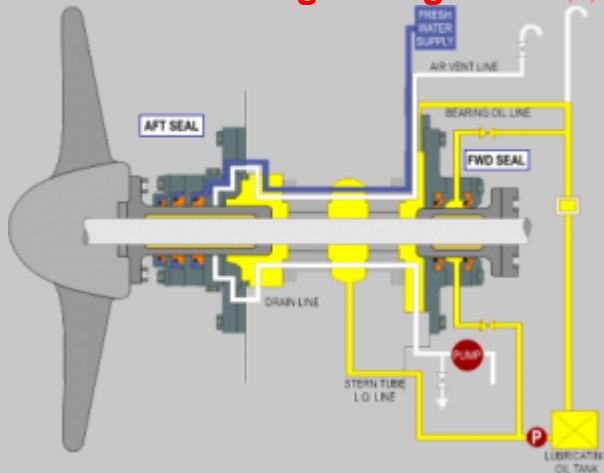

sternway (adv) (navig) **ANTONYM headway** ship making way in reverse, stern first gibanje broda prema natrag, kretanje broda natrag, kretanje krmom, krmom, **abriva po krmu**

stevedore (n) (shipping econ) = **port operator = longshoreman, (pl.)**

longshoremen Terminal operator who is designated to facilitate the operation of loading and discharging vessels and various terminal activities.

(<http://www.maerskline.com/en-jm/help/shipping-glossary>) **slagatelj, slagač, slagateljsko društvo, štivador, lučko poduzeće**

stevedores /'sti:vi,də:z/ **1** Labor management companies that provide equipment and hire workers to transfer cargo between ships and docks. Stevedore companies may also serve as terminal operators. The laborers hired by the stevedoring firms are called stevedores or longshoremen.

slagatelj, lučki slagači, štivador; 2 slagateljsko društvo

stevedoring company /'sti:vi,də:riŋ/ (n) (shipping econ) **slagateljsko društvo, slagatelj, lučki slagači, štivador**

steward /'stjuəd/ (n) (shipping econ) brodski konobar, **kamarijer** **Chief steward** glavni konobar

steward call system pozini uređaj konobara

sticker (n) (cargo handling) komadić drveta koji u pakiranju služi kako bi odvojio raspiljene daske jednu od druge i tako omogućio prozračivanje tereta **sticker**

stiff (adj) (nav arch) = **tender** **krut (brod)**

stiffened panel (n) (nav arch) **ukrepljeno opločenje**

stiffener /'stifəne/ (n) (nav arch) a steel element added for strengthening plating, in the form of a secondary structural **ukrepa, ojačanje**: *After the accident the ship went into the nearest port where*

her hull was strengthened with temporary external stiffeners **bulkhead stiffener** ukrepa pregrade, **longitudinal stiffener on longitudinal bulkhead** uzdužna ukrepa uzdužne pregrade {An angle bar, T-bar, channel, etc., used to stiffen plating of a bulkhead, etc}

stiffness (n) (marine eng, nav arch) **krutost, ukrućenje**

stiffness (n) (nav arch) the tendency of a vessel to remain in the upright position, or a measure of the rapidity with which she returns to that position after having been inclined from it by an external force **sposobnost uspravljanja (broda), uspravnost (broda)**

stiff ship (n) (stabil, nav arch) a ship with a very large GM (metacentric height) caused by KG (height of the ship's center of gravity the above keel) being too small. **kruti brod**

stipulate /'stɪpjʊ, leɪt/ (v) (mar law) = **lay down** = **set out** **odrediti, utvrditi, propisati**

stipulated /'stɪpjʊ, leɪtɪd/ (adj) (mar law) **određen (u ugovoru, propisu, konvenciji), predviđen, zacrtan**

stirrups /'stɪrəps/ (n) **stremen nogostupa (na križu jarbola)**



stock /stɒk/ (n) (nav arch) **struk kormila**

stock /stɒk/ (n) (shipping econ) **zalihe large stocks** velike zalihe

stock /stɒk/ (n) (boating/yachting) **klada (admiralitetskog) sidra**

stock (n) (nav arch) a general term applied to the keel blocks, bilge blocks, and timbers upon which a vessel is constructed **klada**

stock bearing **ležaj struka kormila**

stockless anchor (n) (nav arch) **patentno sidro, sidro bez klade**

stockpile /'stɒk, paɪl/ (n) (ports) **skladište za rasuti i sipki teret** *To maximise the unloading*



process loose cargoes are often loaded from a stockpile or stockyard into a hopper

stocks (n) (nav arch) a general term applied to the keel blocks, bilge blocks, and timbers upon which a vessel is constructed (SeaSources.net) **klade**

stockyard /'stɒk, jɑːd/ (n) (ports) **1 lučko skladište; 2 skladište za sipki i rasuti teret**

stokehold /'stəʊk, həʊld/ (n) (nav arch) **ložište, kotlovnica**

stoker /'stəʊkə/ (n) (marine eng) **ložrač, fogašta; tal. fuochista**

stonefruit (n) (cargo) **koštunjičavo voće** *Apples, pears, kiwis, grapes and stonefruit (peaches, cherries etc.) are traditionally the main products that dominate this segment of reefer transportation.*

Stop engine! (navig, marine eng) **Zaustavite stroj! Stop port / starboard engine!**

Zaustavite lijevi / desni stroj! {naredba za upravljanje strojem}

Stop heaving! (v) (seamanship) Ne povlačite više!, Zaustavite povlačenje! (užeta),
Zaustavite podizanje! (sidra)

stoppage /'stɒpɪdʒ/ (n) zastoј, prekid, obustava

stopped (adj) (navig, seamanship) zaustavljen vessel **stopped** zaustavljen brod

stopper 1 (seamanship, nav arch) štoper (sidrenog lanca): *Evidently they had not applied*

stoppers on the chain prior to abandoning the tanker. **chain stopper** štoper lanca; **2**

(boating/yachting, seamanship) naprava s jednom ili dvjema nazubljenima ekscentričnim polutkama za zaustavljanje pomične užadi jedrilja ili pomične opute jarbola **štoper (na jedrilici)**, **stopper line stopper** rope to secure another rope **stopper užadi (podigača, škotina)**, lt. *bozza; bozze*



; **3** (fishing) Gumena ili silikonska perlica ili tubica koja se

navuče na najlon i služi kao graničnik kod slaganja sistema ribolovnog alata.

(<https://ribolovnajadrano.hr/ribicki-leksikon/>) **stopper**

stopper knot (n) **1** (seamanship) čvor protiv raspletanja užeta



; **2** (seamanship) čvor protiv izlaska užeta iz

užnice (bucela)

stopping distance (n) (navig) zaustavni put (broda) *Although the engine was then set to 'full astern', the vessel's stopping distance of 4 cables exceeded the available space ahead and she consequently made contact with the quay.* Iako je stroj stavljen u položaj svom snagom natrag, zaustavni put broda od 4 kabela bio je duži od raspoloživog prostora po pramcu pa je brod zbog toga udario u obalu.

stop the line (v) (seamanship) zaustaviti uže na vitlu, zadržati uže na vitlu,
aguantare **stop the line the line!** Zaustavi uže / konop!, tal. *Aguanta!; Tieni fermo!*

stop-water (n) (nav arch, sailing vessels) brtvica kilja

storage /'stɔːrɪdʒ/ (n) **1 a** (cargo) skladištenje, uskladištenje; **2** (ports) skladište

back-up storage pozadinsko skladište, **covered storage** natkriveno skladište,

zatvoreni skladišni prostor, **open storage** otvoreno skladište, otvoreni skladišni prostor, **single storage capacity** jednovremeno uskladištenje, jednovremeni

skladišni kapacitet, **cold storage** skladište-hladnjača, rashladno skladište; **3 skladištenje tereta radi povoljne prodaje** (npr. nafte), držanje zaliha na skladištu: *Oil producers may be struggling as a result of low prices but the oil storage business has never been in better shape.* **oil storage facilities** skladišni kapaciteti za naftu, **storage tank** tank za skladištenje (sirove) nafte

storage /'stɔ:ri:dʒ/ (n) (boating/yachting) odlaganje (opreme, odjeće itd.)

storage /'stɔ:ri:dʒ/ (n) (ports) skladišna, naknada za skladištenje **free storage period** ležarina, razdoblje bez naplate skladišnine, vrijeme oslobođeno od plaćanja skladišnine

storage accommodation /'stɔ:ri:dʒ/ (n) (ports) skladišni kapaciteti

storage area (n) **1** (cargo handling) skladišni prostor; **2** (nav arch) spremište: *He and his assistant went to the acetylene storage area, but were confronted by a ferocious fire on the port polypropylene mooring rope and from the acetylene bottles.*

storage battery (n) (electr) akumulator

storage charge (n) (shipping econ, mar law) Charge for goods held in storage facilities (warehouses) under a fixed agreement for periods of time, and which is not included in other arrangement. (<http://www.maerskline.com/en-jm/help/shipping-glossary>) **skladišna**

storage facilities (n) (ports) skladišni kapaciteti

storage locker (n) (boating/yachting) ostava, spremište pod klupom kokpita

storage tank (n) **1** (ports) tank za teret; **2** (marine eng, nav arch) spremnik, rezervoar

store /stɔ:/ (n) sprema, brodska sprema **List of stores** Popis zaliha, **check the stores** provjeriti zalihe (hrane, vode ...), **Bosun's store** sprema vode palube **{(abbr) STR}**

store /stɔ:/ (v) **1** (cargo) uskladištiti, spremi: *Oil companies booked tankers are expected to store as many as 9 million barrels of crude in northwest Europe amid signs that space in on-land depots is filling up. There are 14 to 16 Aframax-class tankers now storing crude in the region, J;* **2** pohraniti; **3** memorirati; **4** sakupljati

storehouse /'stɔ:ˌhaʊs/ (n) (ports) spremište, skladište **supplier's storehouse** dobavljačevo skladište

storekeeper /'stɔ:ˌki:pə/ (n) (shipping econ) brodski skladištar

store list (n) popis zaliha hrane

Store List of Lights Popis zaliha

storeroom /'stɔ:ˌru:m/ (n) **1** (nav arch) spremište; **2** (nav arch) smočnica, **dispensa**, **ta. cambusa**

stores /stɔ:z/ (n) **1** a (shipping econ) skladišta; **2** brodske zalihe, zalihe **stores and spares** brodske zalihe i rezervni dijelovi: *Our vessel anchored at 0730 to await delivery of stores and spares. Delivery of stores and spares have to be arranged and cleared through customs.*; **3** zalihe hrane

stores and provisions (n) (seamanship) zalihe i hrana za brod, zalihe i provijant

stores file (n) (seamanship) knjiga / mapa zaliha

storing (n) skladištenje, spremanje robe

storm (n) (meteorol) wind of at least force 10 Bf. (48 knots) **jaka oluja**, **orkanski vjetar** **centre of the storm** središte oluje, **centar oluje**: *The center of the storm, which drenched parts of*

northeast Florida, Georgia and South Carolina earlier this week, was not threatening land as it moved east-southeast about 270 miles (435 km) southwest of Cape Hatteras, North Carolina, , **to weather the storm** prebroditi oluju, proći kroz oluju

storm jib (n) (boating/yachting) olujna prečka, olujni flok, tal. *tormentina*

storm sail (n) (boating/yachting) olujno jedro

storm sails (n) (boating/yachting) **ANTONYM light wind sails** olujna jedra: *Storm sails are heavy, bulky and impractical for a skipper to take from yacht to yacht.*

storm signal (n) (safety) znak upozorenja za oliju

storm surge (n) (oceanogr) **COMPARE storm tide** a rise in water level on oceans and lakes caused by high winds pushing the water' surface and piling water deeper and deeper as the storm moves forward. If combined with high tide may have destructive effect both as it moves ashore and when retreating after the storm passes **olujna plima**

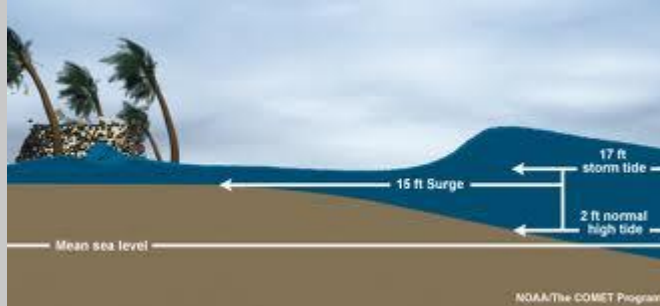

{olujnu plimu slijedi olujna oseka: opasna je za okoliš i brodove (u riječnim ušćima) kad se more naglo povlači}

storm tide (n) (oceanogr) olujna plima

storm track (n) (meteorol) putanja oluje

storm valves and pipes (n) (nav arch, safety) ventili na plaubi i cijevi koji se zatvaraju u slučaju nevremena

stow /stəʊ/ (v) 1 (cargo) slagati (teret), složiti; 2 (boating/yachting) složiti jedro (oko buma)

stow /stəʊ/ (n) složeni teret, red (složenog) tereta **logs in under deck stow** trupci složeni ispod palube

stowage /stəʊɪdʒ/ (cargo) slaganje (tereta) **improper stowage** neispravno slaganje tereta

stowage factor /stəʊɪdʒ/ (n) (shipping econ, cargo handling) (cargo handling) the space occupied by a unit weight of cargo under normal conditions. It allows the calculation of the space the cargo will occupy in the hold, given the weight of the cargo (Swadi) **faktor slaganja**: *Prior to loading bulk cargo, the shipper should declare characteristics & density of the cargo, stowage factor, angle of repose, amounts and special properties.*

stowage plan /stəʊɪdʒ/ (n) (cargo handling) plan slaganja tereta, plan krcanja tereta **stowage plan of the hold** plan slaganja u brodskom skladištu, **stowage plan of the tween deck** plan slaganja u međupalublju

stowaway /stəʊe,wei/ (n) (mar law) a person illegally aboard and in hiding **slijepi putnik, ta. clandestino**

stowed /stəʊd/ (adj) (cargo handling) **složen**: *Make sure that cargo is carefully and safely loaded, stowed, separated, carried and discharged.* **cargo stowed** složeni teret

stow sails (v) (boating/yachting) slagati jedra (nakon jedrenja)

stow the sail (v) (boating/yachting) složiti jedro

St.Pierre (n) kovač

starboard quarter (n) (navig) COMPARE starboard bow desni kvartir

straddle carrier /'strædəl/ (n) (cargo handling) Container terminal equipment, which is motorized and runs on rubber tires. kontejnerski prijenosnik



{It can straddle a single row of containers and is primarily used to move containers around the terminal, but also to transport containers to and from the transtainer and load/unload containers from truck chassis.}

straight /streit/ (adv) ravno, izravno, direktno

straight /streit/ (adj) ravan, izravan, direktan, nesvinut a straight line pravac, ravna crta

straight bill of lading /streit/ (n) (mar law) A straight bill states that the goods are consigned or destined to a specified person. It is marked nonnegotiable or not negotiable on its face. It may be transferred by its holder by delivery, accompanied with an agreement (express or implied) to transfer the title to the bill or to the goods it represents (Tetley) teretnica na ime

straight course /streit/ (n) (boating/yachting) ravan kurs keep a straight course držati ravan kurs

straighten /'streitən/ (v) izravnati

straight line (n) 1 pravac; 2 ravna linija

strain¹ /strein/ (n) (phys) the change in dimension of a body under load expressed as the ratio of the total deflection or change in dimension to the original unloaded dimension. It may be a ratio of lengths, areas, or volumes - Collins On-line izobličenje, deformacija linear strain linearna deformacija, value of strain veličina deformacije

strain² /strein/ 1 (v) naprezati se (materijal); 2 deformirati se, izobličiti se

strainer /'streinə/ (n) (marine eng) pročistač, filter, cjedilo, tal. *succhiarella*: The strainers were blocked with coarse grain sand and shells. fine mesh strainer pročistač guste mreže, pročistač s finim sitom, discharge strainer tlačni pročistač, suction strainer usisni pročistač

strait /streit/ (n) (geogr) tjesnac a narrow strait uski tjesnac

strake /streik/ (n) (nav arch) vodoravni niz čeličnih limova na brodskoj oplati; continuous planking or plating fitted out to and from stem to stern of a vessel's side voj tal. *fasciame*; *corso di lamiera* strake A, B, C ... voj S, B, C itd., bilge strake kaljužni voj, sheer strake završni voj, garboard strake dokiljni voj, dokobilični voj, bottom strake voj dna, side strake voj boka, deck strake voj palube, bulkhead strake voj pregrade, inside strake nutarnji voj, outside strake vanjski voj {The strakes of shell plating are usually lettered, starting with A at the

bottom row or garboard strake.}

strand /strænd/ (n) (seamanship) an element of a rope, consisting, in a fiber rope, of a number of rope yarns twisted together and, in a wire rope, of a primary assemblage of wires **struk užeta**: *The parted rope was an 8-strand polypropylene rope, 72 mm in diameter.* **three-stranded rope**

trostručni konop, **konop sastavljen od tri struka**, **strand fraying** **rasukavanje struka konopa**

strand (v) (safety, navig) **nasukati se**: *was stranded at 10 The ship 29' 45N, 107 50' 37E at 02:00 h local time on 5 July.*

stranded ship /'strændid/ (n) **1 (safety) nasukan brod**; **2 (shipping econ) brodovi koji su izgubili posao (zbog stečaja ili slično)**: *Stranded cargo ship finally begins unloading in U.S More than half of the companies vessels, 86 as of Wednesday, are still stranded as port authorities and services block the ships from docking for fear they won't be paid.* <http://fortune.com/>

stranding /'strændiŋ/ (n) (safety) **nasukanje cause stranding prouzrokovati nasukanje, prevent stranding spriječiti nasukanje**

strap /stræp/ (n) **1 (cargo) traka (čelična ili plastična)**; **2 a short line or wire having an eye in either end kratki pasac, kratka braga**

strapping (cargo) **obvezivanje koleta / pakovanja (plastičnim ili metalnim trakam)**

stray /streɪ/ (v) **stray off the track skrenuti s rute**: *Realising that the ship had strayed well off the desired safe track and heading, he then ordered the two tugs (700 BHP forward and 1800 BHP aft), to push with maximum power (navig) zastraniti, kretati se pogrešnim putom*

streaked gurnard /stri:kt 'gɜ:nəd/ (n) Lat. *Lepidotrigla Cavillone* **kokot lastavica, kokot**



glavaš, kopunić

stream /stri:m/ (n) **SYNONYM current the Golf Stream Golfska struja (oceanogr) morska struja**

stream /stri:m/ (n) (marine eng) **strujanje exhaust stream ispušno strujanje**

stream anchor (n) (nav arch) an anchor weighing from about one-fourth to one-third the weight of the main bow anchors and used when mooring in a narrow channel or harbor to prevent the vessel's stern from swinging with the current or the tide **strujno sidro**

streaked weeverfish (=greater weever) (n) **1 (fishing) Lat. *Trachinus draco* pauk mrkulj pauk, ranj**; **2 Lat. *Trachinus radiatus* pauk bijelac**



{Trachinus radiatus}

strength /strɛŋθ/ **1** čvrstoća (materijala) **tensile strength** vlačna čvrstoća, **increase strength** povećati čvrstoću; **2** čvrstina (broda); **3** jačina

strength deck (n) **1** (nav arch) the uppermost continuous deck contributing to the hull girder longitudinal strength **paluba čvrstoće**; **2** (nav arch) = **main deck** glavna paluba

stress /stres/ (n) **1** (phys) force or a system of forces producing deformation; a. An applied force or system of forces that tends to strain or deform a body. **naprezanje, napregnuto stanje**: *As with any cargo ship it is important to load the cargo so that stresses in the ship remain at a minimum or at least evenly distributed.* **bending stress** naprezanje zbog savijanja, **fluctuating stress** izmjenično naprezanje, **tensile stress** vlačno naprezanje, **naprezanje zbog vlaka, compressive stress** kompresivno naprezanje, **naprezanje, shear stress** smično naprezanje, **ultimate stress** maksimalno vlačno naprezanje: *granica naprezanja na vlak*, **unit stress** jedinično naprezanje, **working stress** radno naprezanje, **measure the stress** izmjeriti naprezanje, **value of stress** veličina naprezanja; **2** udar, udarac; **3** pritisak

stress imposed (n) (nav arch) **naprezanje izazvano ...**: *In harbour, where the ship is in sheltered water and is subjected to reduced dynamic loads, the hull is permitted to carry a higher level of stress imposed by the static loads, so a certain amount of difference in the loading of each hold is allowable.*

stress od weather (n) djelovanje nevremena

stress-strain curve (n) (marine eng) krivulja naprezanja i deformacije

stress-strain diagram (n) (marine eng) dijagram naprezanja i deformacije

stress-strain line (n) (marine eng) linija naprezanja i deformacije

stretch /stretʃ/ (n) (marine eng) rastezanje, vlačna sila **stretch of the stud** rastezanje vijka, vlak vijka

stretch /stretʃ/ (v) (boating/yachting) **1** razvući, rasporstrijeti; **2** razapeti jedro

stretching screw (n) (cargo handling) = **turnbuckle** stezaljka, škartoc

strike /straik/ (v) **udariti**: *When the squalls struck, some lines rendered; others parted.* Kad je olujni vjetar zahvatio brod, neki su prijevezni konopi popustili, a drugi su puknuli. **strike a dock** udariti u

luku obalu The Transportation Safety Board is sending two investigators to the port after large container ship strikes dock in Vancouver, **strike an object** **udariti u neku lučku građevinu**, **strike a bridge**: The general cargo ship MV was transiting the Ems River when it struck the bridge near the town of Weener at about 6:40 p.m. local time after the bridge failed to raise for the vessel. The vessel **struck a bridge** on Main-Donau-Kanal. **udariti u most**, **strike a buoy** **udariti u plutaču**
strike (n) (mar law) **štrajk**: Shipping Services is advising of a further 24 hour **general strike** in on December 3 which is expected to affect vessel movements at many country's ports and terminals. **Strike** has brought all ships to a halt. **Strike** causes delays at ports. Štrajk izaziva kašnjenja u lukama.

strike clause /strɪkf/ (n) (mar law) **klauzula o štrajku**, **klauzula o pravima i dužnostima brođara u slučaju štrajka**

stringer /ˈstriŋə/ (n) **SEE structural components** a fore-and-aft girder running along the side of a ship and also to the outboard strake of plating on any deck **proveza** **stringer plate** **lim proveze**, **bulkhead** **stringer** **proveza pregrade**, **side** **stringer** **bočna proveza**, **proveza boka**, **deck** **stringer** **palubna proveza**, **deck** **stringer plate** **palubna proveza**

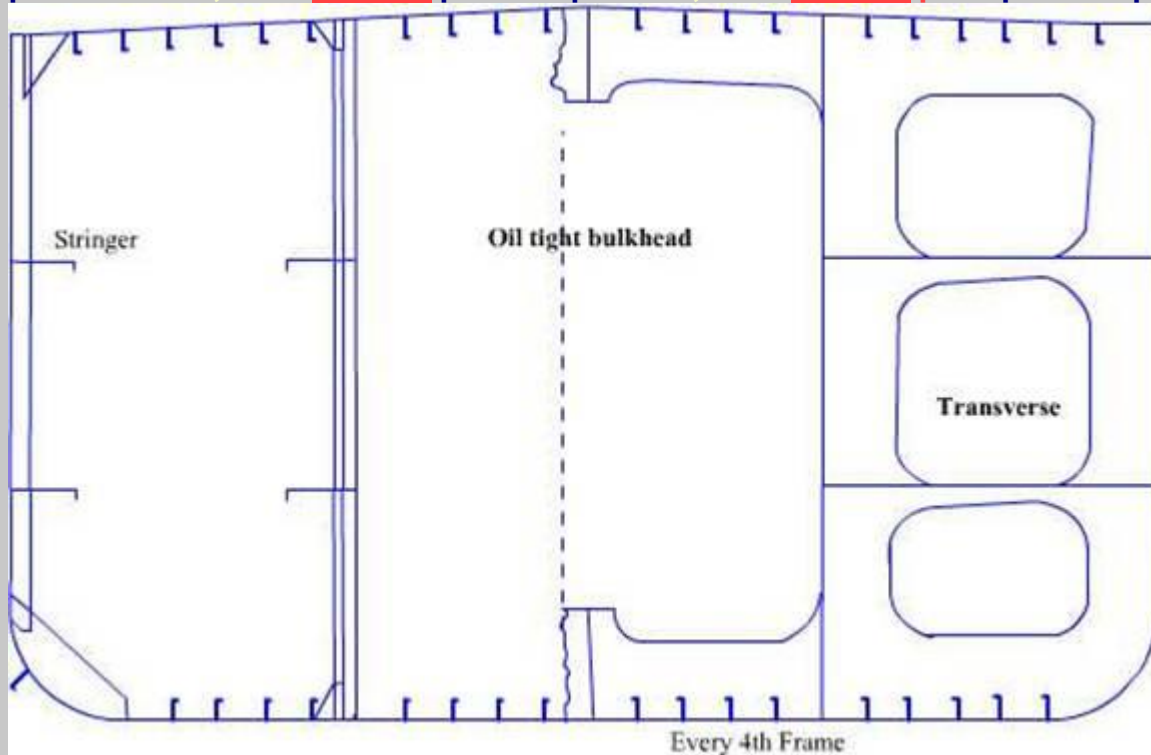

stringer plate /ˈstriŋə/ (n) (nav arch) **palubna proveza**

strip (n) **vrpca**, **traka** **bimetallic** **strip** **bimetalna traka**

strip (v) **strip the tank** **očistiti (tank)**, **odstraniti nečistoće u tanku**

stripe /straip/ 1 (navig) **pruga (pomorske oznake / plutače / svjetionika)**; 2 **pruga (na zastavi)**; 3 (seamanship) **pruga na časničkoj odori**, **štrika**

striped red mullet (n) 1 (fishing) Lat. *Mullus surmuletus* **trlja od kamena**, **trilja**, **trlja**



; 2 Lat. Mullus

barbatus **trlja blatarica****striped seabream** (n) (fishing) Lat. *Lithognathus mormyrus* **ovčica****stripping** /stripin/ (n) 1 (cargo) **posušivanje (tanka)** special purpose areas for container stuffing and stripping shed have been set up.; 2 (cargo handling) **ANTONYM stuffing** The process of

removing cargo from a container.; a service offered to the customer in which the carrier performs stripping (cargo unloading) or stuffing (cargo loading) of the customer's container at the port area.

pražnjenje kontejnera**stripping pump** (n) (cargo handling) **pumpa za čišćenje cjevovoda****stripping system** (n) (nav arch) before changing cargoes or gas-freeing it is most important to remove all cargo liquid from tanks, piping, reliquefaction plant and any other part of the cargo system.**sustav čišćenja starog tereta (iz taknova, cjevovoda, pumpa itd.)** There are two kinds of stripping procedures applying for this vessel. Cargo tanks 6P&S, 5P&S, 4P&S which are located aft of the manifold and cargo tanks 3P&S, 2P&S, SLOP which are at fore of the manifold. Stripping is done by using compressed air or nitrogen when substances can not face to contact the air ie oxygen.**stroke** /strəuk/ (n) (marine eng) **stapaj, hod (klipa), takt stroke / bore ratio omjer stapaj / provrt cilindra, bottom of the stroke donji krajnji položaj klipa, on its down stroke**

klip (stap) u hodu prema dolje, **working stroke** radni takt, **power stroke** radni takt, **compression stroke** kompresijski takt, takt stlačivanja, **exhaust stroke** ispušni takt, **expansion stroke** ekspanzijski takt, takt ekspanzije, **firing stroke** takt paljenja, **idle stroke** jalovi takt, **induction stroke** usisni takt, **power stroke** radni takt, **return stroke** povratni stapaj, **suction stroke** usisni takt, **top of stroke** gornji položaj klipa, gornji položaj stapaja, **working stroke** radni takt

stroke /strɒk/ (n) (seamanship) zaveslaj

strongbacks; strong back (n) (nav arch) zaštitni tegljački luk

strong beam (n) (nav arch) pojačana sponja, pojačana palubna sponja

strong breeze (n) (boating/yachting) (meteorol) jak vjetar

strong gale (n) (meteorol) (meteorol) olujan vjetar

strop (n) (cargo handling) pasac (s dvije omče na krajevima), braga

structural components (n) (nav arch) elementi konstrukcije broda: *Ship's structural components undergo several types of deformation.*

Chapter 6: Ship Structural Components

Longitudinal Strength Members

- Keel
- Longitudinal
- Stringers
- Deck Girders
- Plating

Transverse Strength Members

- Frame
- Floor
- Deck Beams
- Plating

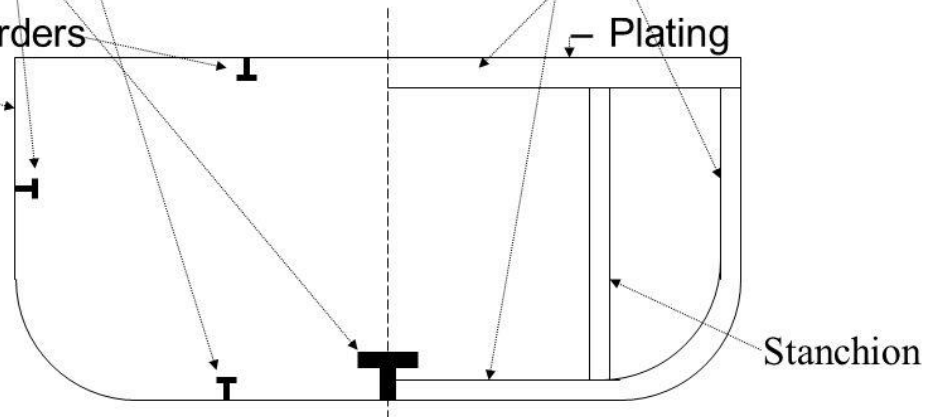

{cf. <http://slideplayer.com/slide/3816017/>}

structural features /'strʌktʃərəl/ (n) (nav arch, marine eng) konstrukcijska obilježja, konstrukcijske osobine

structural item /'strʌktʃərəl/ (n) (marine eng, nav arch) strukturni element

structural member /'strʌktʃərəl/ (n) (nav arch) konstrukcijski dio broda

structural tank /'strʌktʃərəl/ (n) (nav arch) strukturni tank

structure /ˈstrʌktʃə/ (n) **1** konstrukcija **supporting structure** nosiva konstrukcija; **2** struktura

strut /strʌt/ **1** (nav arch) prostorna sponja; **2 = panting beam**

strut /strʌt/ **1** (nav arch) podupora; **2** (nav arch) nosač izvan trupa na podvodnome dijelu broda; brace supporting the propeller shaft; = shaft bracket **skrok**

STS; Ship-to-Ship Transfer (n) (navig, cargo handling) the transfer of ship's cargo, which can be oil or gas cargo, between two merchant tanker vessels positioned alongside each other **operacija prekrcaja s broda na brod**

stud /stʌd/ (n) (marine eng) holding down bolt **usadni vijak, pržunjer, tal. prigioniero**; Maintenance is facilitated by hydraulic tightening devices for the cylinder head **holding-down studs**, the main bearing studs and the connecting rod big end studs. **fixing stud** **pričvrсни vijak, tensioning stud** **pritezni vijak, vijak za pritezanje**



stud /stʌd/ (n) (navig, seamanship) **prečka karike lanca**; Chains consist of chain links which can be either stud-links or studless links. **stud link** **karika lanca s prečkom**



studless chain /ˈstʌdlis/ (n) (nav arch) **sidreni lanac s karikama bez prečke**

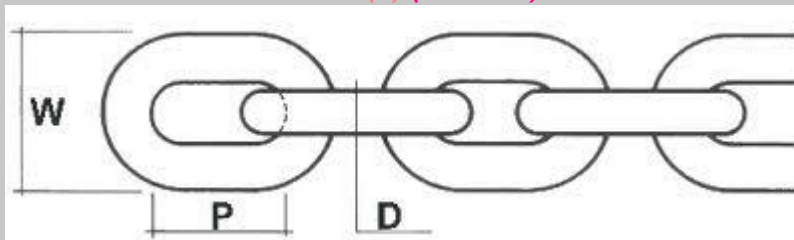

studless chain link /ˈstʌdlis/ **karika bez prečke**

Stuelcken derrick (n) (cargo handling) **samarica za teške terete (proizvođač**



Stuelcken)

stuff /stʌf/ (v) (cargo) puniti (teret u kontejner) **bagged stuff** uvrećeni teret teret u vrećama, vrećarija

stuffing /'stʌfɪŋ/ (n) (cargo) **ANTONYM stripping** The process of packing a container with loose cargo prior to inland or ocean shipment. **punjenje (kontejnera)**: special purpose areas for reefer containers and dangerous cargo containers and a container stuffing and stripping shed have been set up.

stuffing and stripping /'stʌfɪŋ/ (n) (cargo handling) punjenje i pražnjenje kontejnera

stuffing box /'stʌfɪŋ/ (n) **1** (marine eng) an assembly which is used to house a gland seal. It is used to prevent leakage of fluid, such as water or steam, between sliding or turning parts **brtvenica stuffing box bulkhead pregrada brtvenice, stuffing box packing brtva brtvenice**

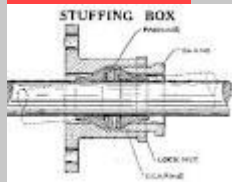

2 (nav arch, boating/yachting) When used within a nautical setting, a stuffing box is wrapped around the shaft of a boat's propeller. **šupernica (propelerske osovine)**

sturgeon /'stɜːdʒən/ (n) (fishing) jesetra

S-twist (n) (seamanship) **ANTONYM Z-twist** sukanje konopa u lijevo

STW (speed through the water) (n) (navig) brzina kroz vodu

stylus (n) pisač, pisaljka indikatora

sub-charter (n) (mar law) potprijevozni ugovor, podugovor, podbrodarski ugovor, podčarter

Sub-Committee on Safety of Navigation, Communication and Search and Rescue (n) (safety, mar law) Pododbor za sigurnost plovidbe, komunikacije te tražanje i spašavanje IMO-a

subcontract (n) (mar law) podugovor

sub-contractor; subcontractor /,sʌbkən'trækte/ **1** (mar law) Sub-Contractor includes owners, charterers, and operators of vessels (other than the Carrier), stevedores, longshoremen, lighterers, terminal and groupage operators, road and rail transport operators, warehousemen, customs inspection stations, port authorities, pilots and any independent contractors employed by the Carrier

performing the Carriage and any direct and indirect sub-contractors, servants and agents thereof whether in direct contractual privity or not. (TeamLines) **podugovorni poduzetnik**; **2 (shipping econ) dobavljač**; **3 izvođač (radova, ugovorenog posla)**

subdivision freeboard /ˈsʌbdiˌviʒən/ (n) (nav arch) pregradno nadvođe

subjected to /səbˈdʒektɪd ˌtuː/ (adj) (mar law, marine eng) podvrnut

subject to /ˈsʌbdʒɪkt tuː/ (adj) = **liable to** **subject to to damage by rust** **podložan rđanju**, koji lako rđa, osjetljiv na oštećenje rđanjem, sklon rđanju, **be subject to** **1 biti podvrnut, biti podležan, podlijegati, biti izvrnut**; **2: All rights and obligations of the parties to these Articles shall be subject to the Laws and Regulations of the Republic of ...** Sva prava i obveze stranaka u ovom radnom ugovoru podliježu zakonima i propisima Republike ... **podložan nečemu (o teretu)**, osjetljiv na nešto, sklon nečemu (npr. rđanju), koji se lako (npr. oštećuje, kvari itd)

subject to (v) podvrnuti, podvrći, izvrnuti, izložiti

submarine (n) (navy) podmornica **attack submarine** napadačka podmornica, **tactical submarine** taktička podmornica

submarine (adj) podmorski

submarine cables and pipelines (n) (navig) podvodni kablovi i cjevovodi

Submerged Turret Loading (STL) system (n) (cargo handling) Sustav krcanja sirove nafte putem uronjenog prekrcajng tornja: *The basis of the Submerged Turret Loading system is the buoy moored to the seabed. The buoy is pulled into and secured in a mating cone in the bottom of the vessel and thus connecting the mooring system. Internal in the buoy is the turret to the mooring and riser systems. The outer buoy hull can rotate freely with the vessel around the turret by means of internal turret bearings. Oil is transferred through an in-line swivel via the loading manifold to the piping system of the vessel. Disconnected, the buoy will float in an equilibrium position ready for new connection.*

submersible /səbˈmɜːsəbəl/ (n) (nav arch) ronilica

submission /səbˈmɪʃən/ (n) podnesak, podnošenje (molbe, zahtjeva itd.)

submit /səbˈmɪt/ (v) (mar law) **1 a podnijeti, dostaviti**; **2 predati (dokument)** **submit a claim** podnijeti odštetni zahtjev, uložiti reklamaciju, **submit a document** **1 predati ispravu, predati dokument** *Within 24 hours of the ship's arrival, its owner, local agent or master should submit the documents to the Port Formalities Office (PFO).*; **2: The following documents are submitted in support of this claim: ...**

sub-refraction (n) (electr, navig) podrefrakcija

subsidy (n) (shipping econ, financ) subvencija, državna potpora: *Government support for any industry including shipping – which is feeling the heat of global competition might seem like a good thing. But direct subsidies from governments in fact have a negative impact on the global shipping industry as they affect free trade.*

subsistence /səbˈsɪstəns/ (n) naknada za troškove (dnevnic, bolovanja itd.) **daily subsistence allowance** naknada za dnevnice

substandard vessel (n) (mar law) podstandardni brod

substantial /səbˈstænfəl/ **1 a čvrst, jak**; **2 znatan, izrazit** **substantial damage** znatna šteta, velika šteta

substitute flag /ˈsʌbstɪˌtjuːt/ (n) (comm) ponavljač, zastavica ponavljač

substitution clause /ˌsʌbstɪˈtjuːʃən/ (n) (mar law) supstitucijske klauzule (u brodarskim ugovorima)

subtract /səbˈtrækt/ (v) **oduzeti**

subtraction /səbˈtrækʃən/ (n) (math) **oduzimanje**

suction /ˈsʌkʃən/ (n) (marine eng) **usis, sisanje, usisavanje** suction stroke **usisni takt, sea water suction** **1 usis morske vode; 2 low / high sea water suction** **usis morske vode na otvorenom moru / u plitkim vodama, suction strainer** **usisni pročistač, suction pipe** **usisna cijev, suction valve** **usisni ventil**

suction and discharge mode (n) (marine eng) **režim crpljenja i tlačanja**

(tekućine): *The centrifugal type sea water, fresh water, ballast and bilge pumps, all driven by electric motors. These are capable of operating in regular conditions in both suction and discharge mode without overloading.*

suction stroke (n) (marine eng) **usisni takt, faza usisa**

suction ventilator (n) (nav arch) **usisni ventilator, zračni ejektor**

sue /sjuː; US suː/ (v) (mar ins) **tužiti**: *The consignee is not the original party to that contract of carriage. However, upon receiving the bill of lading from the shipper, he will also acquire the right to sue the carrier by reason of the transfer of the bill of lading to himself. The Merchant Marine Act of 1920, which is commonly referred to as the Jones Act, is a federal law that allows seamen to sue their employers for on-the-job injuries caused by negligence on the part of vessel owners, companies, shipmasters, or fellow crew members* **sue (somebody) for damage** **tužiti (nekoga) zbog štete**

sue and labour clause (n) (mar law) **klausula o dužnosti umanjavanja štete ako je osiguranik poduzeo mjere za umanjavanje štete**

Suez Canal Required Documents (n) (navig) **Isprave za prolaz Sueskim kanalom**

Suezmax (n) (nav arch) **brod koji može ploviti Sueskim kanalom** **brod tipa Suezmax**

suffer damage (v) (navig) **pretrpjeti oštećenje** **biti oštećen**: *Both vessels suffered major structural damage to their bows, but there were no injuries or pollution.*

suitable (adj) **prikladan, pogodan, podesan** suitable for **pogodan za**

suit of sails /su:t; sju:t/ (n) **1 (boating/yachting) jedrilje, komplet jedara, sve jedrilje podignuto i razvijeno; 2 sve jedrilje podignuto i razvijeno**

sullage (n) **COMPARE sewage plant** **filth or waste, esp sewage** **brodske otpadne vode, fekalije, kanalizacijski otpad**

sulphur emission from vessels (n) (safety, marine eng) **ispuštanje sumpora iz**

brodova: *The United Nations' shipping agency set global regulations on Thursday to limit the amount of sulphur emissions from vessels and said they would come into force from 2020*

sulphur; (S); sulfur (US) /ˈsʌlfə/ **sumpor**

sultriness /ˈsʌltrɪnis/ (n) (meteorol) **sparina**

sumbarine /ˈsʌbməˌriːn; ˌsʌbməˈriːn/ (adj) **podmorski, podvodni** sumbarine cable **podmorski kabel**

summer fresh water line **teretna linija za slatku vodu (ljetna)**

summer tank (n) (nav arch) **ljetni tank**

sump /sʌmp/ (n) **1 (marine eng) uljno korito, dno kartera, slivnik, dno kartera** sump



tank **slivni tank**, **engine sump** **uljno krito**

2 (*boating/yachting*) **santina**

sunburn /'sʌn,bɜ:n/ (*n*) (*safety*) **sunčanica**

sundry /'sʌndri/ (*pron*) **razno**, **ostalo**

sunken (*adj*) (*safety*) **potonuli (brod)**: A giant crane was used to lift a **sunken** tugboat from the bottom of the Hudson River.

sunpowered telephone **bezbaterijski telefon**

sunrise /'sʌn,raɪz/ (*n*) **izlazak sunca**

sunset /'sʌn,sɛt/ (*n*) **zalazak sunca**

sunstroke /'sʌn,strʊk/ (*n*) (*med*) **sunčanica**

supercargo (*n*) (*mar law*) **nadzornik tereta**, **inspektor tereta**, **soprakariko**

supercharging /'su:pə,tʃɑ:ʒɪŋ/ (*n*) (*marine eng*) **prednabijanje**

superheat /,su:pə'hi:t/ (*v*) (*marine eng*) **pregrijavati**

superheater /,su:pə'hi:tə/ **pregrijač (pare)**

superintendent **nadzornik**, **kontrolor**, **šoprakariko**, **tal. sovraccarico**: At that time I was Assistant Dock Superintendent, later transferring to 'Special Projects' within the Company.

superior /su:'piəriə/ (*adj*) **nadređeni**, **pretpostavljeni**, **viši** **o činu**

super-refraction (*n*) (*electr, navig*) **nadrefrakcija**, **superrefrakcija**: The radar beam is refracted more than normal causing considerably increased target detection ranges, typically up to 25%.

supersede /,su:pə'si:d/ (*v*) **istisnuti**, **zamijeniti**

superseding clause (*n*) (*mar law*) A clause in a bill of lading (providing that the bill of lading itself supersedes all agreements or freight engagements for the shipment of the goods, and also that all the terms of the bill of lading, whether written, typed, stamped or printed, are binding on the shipper, consignee, owner of the goods and holder of the bill, as if the bill were signed by them, any local customs or privileges to the contrary notwithstanding (Tetley) **viša odredba (ugovora itd)**, **klauzula višeg reda**, **jača klauzula**

super-slow steaming (*n*) (*shipping econ, navig*) sailing involving two-stroke engines (on container vessels) which are able to run continuously at low loads ensuring a more flexible and energy-efficient vessel operation., thus reducing consumption to more than 50 per cent and significantly reducing the pollution of the environment **superekonomična plovidba**: Maersk Line won award for super slow steaming initiative.

superstructure /'su:pə,straʃtʃə/ (*n*) (*nav arch*) a structure built above the uppermost complete deck; a pilot house, bridge, galley house, etc; according to International Convention on Load Lines (1966): detached enclosed structure on the freeboard deck and extending transversely to within 4% of the breadth from the vessel's sides **nadgrađe**

superstructure decks /'su:pə, strʌktʃə/ **palube nadgrađa**

supertanker /'su:pə, tæŋkə/ (n) (**nav arch**) **supretanker**: So-called supertankers, which exceed 100,000 dwt, are employed to transport crude petroleum from the oil fields to refineries.

supervise /'su:pə, vaiz/ **1 a nadzirati, nadgledati; 2 recenzirati**

supervision /,su:pə'viʒən/ (n) **1 a nadzor, nadziranje, nadgledanje; 2 tehnički nadzor**

supervision during the ship construction (n) **nadzor nad gradnjom broda**

supervisory board /su:pə'vaizəri/ (**mar law**) **nadzorni odbor (dioničkog društva)**

superyacht (n) (**nav arch**) yachts that are generally over 150 feet (45.7 meters) LOA, though there is no firm cut-off point on the lower-end of the size range. Many super yachts are ships, not boats or small-craft **superjahta**

supper pipe **odljevena cijev**

supplant /sə'plɑ:nt/ (v) **potisnuti**

supplant /sə'plɑ:nt/ (v) **istisnuti, izgurati**

supplement /sʌplimənt/ (n) **dodatak, dopuna**

supplier /sə'plaiə/ (n) **1 (shipping econ) dobavljač supplier's storehouse dobavljačevo skladište; 2 (mar law) osoba koja će u naručiteljevo ime isporučiti teret koji treba ukrcati i prevesti isporučitelj robe; 3 opsrbljivač**

supplies (n) (**seamanship**) = **stores** brodske zalihe (materijala), zalihe hrane

supply /sə'plai/ (n) **1 a dovod, dobavljanje, dobava supply of fresh air dovod**

svježeg zraka, supply system sustav dovoda / dotoka, dobavni sustav, metered

fuel supply dozirana dobava goriva, power supply snabdijevanje (električnom)

energijom, dovod električne energije, fuel-oil supply dovod goriva; 2

snabdijevanje, opskrba; 3 dostava; 4 dotok

supply /sə'plai/ (v) **dobavljati, snabdijevati, opskrbljivati, podržavati**

supply and demand (n) (**shipping econ**) **ponuda i potražnja**: Freight rates fluctuate according to supply and demand: When cargoes are fewer than ships, rates are low.

supply boat (n) (**nav arch**) **opskrbna brodica**

supply ship (n) (**nav arch**) **opskrni brod, brod za opskrbu**

support /sə'pɔ:t/ **1 a (marine eng) nosač, stup, potpora, uporanj; 2 (navig) nosač / stup svjetlosne oznake; 3 podrška; 4 postolje**

support /sə'pɔ:t/ (v) **nositi, podnijeti, podupirati, podržavati**

support level /sə'pɔ:t/ (n) (**mar law**) **razina odgovornosti za obavljanje dodijeljenih zadataka, dužnosti ili odgovornosti na pomorskom brodu pod vodstvom osobe na radnoj ili upravljačkoj razini pomoćna razina**

surcharges /'sɜ: tʃɑ: dʒ/ (n) (**shipping econ**) **additional charges above ocean freight dodatni troškovi (iznad iznosa vozarine) mandatory surcharges obvezni dodatni troškovi (iznad osnovnih)**: A mandatory surcharge constitutes a part of the rate which is not covered by the basic ocean freight. (<http://www.maerskline.com/en-us/shipping-services/rates-and-pricing>), **Bunker**

Adjustment Factor– SBF a charge to account for the fluctuations in bunker costs (oil used by the vessels) that changes on quarterly basis **dodatni troškovi uslije fluktuacije cijena broskog goriva, Terminal Handling Charges –THC** The Terminal Handling Charges are based on the

cost of handling the container in the terminals, including loading and discharging containers to/from the vessel. **dodatni troškovi rukovanja teretom na terminalu, Documentation Charges** the charges for providing the necessary transport documents at the origin and destination, based on your shipping instructions **troškovi za izradu transportne dokumentacije**

sure /ʃʊː; ʃʊə/ (adj) **siguran, pouzdan** **make sure** provjeriti, uvjeriti se, osigurati se

surf /sɜːf/ (v) **1 (boating/yachting)** to ride on or along a wave on a surfboard **surfati na dasci**; **2 (navig)** planirati (na valovima), klizati (na valovima)

surf /sɜːf/ (n) **1 (oceanogr) = breaker** the waves breaking upon a shore or reef **lomni valovi (na grebenu ili obali)**; **2 (oceanogr)** pjena lomnih valova

surface (n) površina, ploha **bearing surface** ležajna površina, **glazed surface** ostakljena površina, **inclined surface** kosa površina, **inner surface** unutarnja površina, **outer surface** vanjska površina, vanjska ploha, **sloping 1** kosa površina, nagnuta ploha, **running surface** radna površina, klizna ploha, **wearing surface** površina izložena trošenju, **surface heater** površinski zagrijač, **bearing surface** ležajna površina

surface effect ship; (SES) (n) (nav arch) dvotrupac koji dio istisnine poništava tlakom zračnoga jastuka među trupovima **ses**

surface permeability factor (n) (nav arch, safety) površinski koeficijent naplavljenosti

surface ship (n) (navy) površinski brod

surfboarding jahanje na valovima, surfanje daskom

surf casting obalni ribolov sa plitko položenih pjeskovitih obala **surf** {natjecateljska disciplina u kojoj se nakon odbacivanja štap polaže u posebni nosač, te se tek nakon što se primijeti da se riba zakačila uzima u ruke i pristupa izvlačenju lovine (<https://ribolovnajadranu.hr/ribicki-leksikon/>)}

surfing (n) (boating/yachting) jahanje na valovima, surfanje

surge /sɜːdʒ/ (n) **1 COMPARE ship's motions** a vessel's transient motion in a fore and aft direction **zalijetanje i zastajanje broda, ubrzavanje i usporavanje broda (u odnosu na valove), proklizavanje**; **2 (seamanship)** sudden strain on a towing hawser caused by the pitching, sheering, or yawing of the tow and/ or the towing vessel **naglo zatezanje i popuštanje užeta za tegljenje**

surge /sɜːdʒ/ (v) (seamanship) to slack off a line by allowing it to slip around the object **puštati užu da klizi oko bubnja na vitlu to which it is secured**

surge (n) (oceanogr) the swell of the sea **dizanje mora (od valova prema obali) storm surge** naglo dizanje mora u oluji

surgeon /ˈsɜːdʒən/ (n) **1 a brodski liječnik**; **2 kirurg**

surge the cable /ˈsɜːdʒ/ (v) (seamanship) **popustiti lanac, popušati lanac**

surging **1 (navig) COMPARE ship's motions** in surging the sea's motion accelerates and decelerates the ship **zastajanje**; **2 (navig)** ubrzanje (broda na valu), proklizavanje

surmullet /sɜːˈmʌlt/ (n) (fishing) trilja, trnlja kamenjarka {lat. *Mullus surmuletus*}

surplus /ˈsɜːplʌs/ (n) **1 a višak, suvišak**; **2 preostatak**; **3 pretičak**

surround (v) **1 okružiti, opkoliti**; **2 opasati**

survey /ˈsɜːveɪ/ **1 (nav arch, marine eng)** pregled (broda, opreme itd.), inspekcija

(broda, opreme itd.), kontrola: *If possible, the Master should attend the survey of damaged cargo himself, or have his Chief Officer attend.* **call a survey** zatražiti pregled, **joint survey** zajednički pregled, **submit a ship to survey** podvrgnuti brod pregledu, **arrange for a survey** dogovoriti pregled, **organizirati pregled**, **intermediate survey** The inspection of a ship by a classification society surveyor that takes place 24 to 36 months after each Special Survey. **međupregled**, **periodični pregled**, **periodična inspekcija broda (dvo- ili trogodišnja)**, **annual survey** godišnji pregled, **continuous survey** postupni pregled, **special survey** The inspection of a ship by a classification society surveyor that takes place every five years, as part of the recertification of the ship by a classification society. (<http://www.globalshiplease.com/glossary.cfm>) **izvanredni pregled**, **klasifikacijski pregled**, **periodical survey** periodični pregled, **hatch survey** pregled broskog skladišta, **underwater survey** podvodni pregled broda, **pregled dna broda**: *The ship was refloated within an hour and proceeded to the port where an underwater survey was conducted.*; **2 (cargo) kontrola robe**, **kontrola tereta**

survey /sɜː'veɪ/ (v) **1** pregledati, pregledavati: *Ensure any damage is surveyed and recorded.* **survey the damage** pregledati štetu, obaviti pregled štete; **2** kontrolirati

survey and control book (n) (nav arch) knjiga pregleda i nadzora

surveyor (n) **1** (safety) inspektor, nadzornik, kontrolor **marine surveyor** person who inspects a ship hull or its cargo for damage or quality **brodski inspektor**, **marine cargo surveyor** brodski inspektor za štete na teretu; **2** kontrolor (robe, tereta), kontrolna kuća **cargo surveyor** inspektor tereta, inspektor za štete na teretu; **3** fizička ili pravna osoba koja zaprima prijave o nastalim štetama na teretu te utvrđuje njihovu prirodu i opseg **havarijski procjenitelj**

survey report (n) (nav arch) izvješće o inspekciji (broda, opreme)

surveys of the ship (n) pregledi broda

survey vessel (n) (nav arch) istraživački brod

survival /sə'veɪvəl/ **preživljavanje**

survival craft /sə'veɪvəl/ (n) (safety) plovila za spašavanje

survival suit /sə'veɪvəl/ (n) (safety) odijelo za preživljavanje: **donn the survival suit** obući odijelo za preživljavanje, **staviti odijelo za preživljavanje**, **imati na sebi odijelo za preživljavanje**: *The seafarers donned their survival suits and got into a liferaft.* Pomorci su imali na sebi odijela za preživljavanje i popeli se na splav za spašavanje. *The three donned their survival suits and got into a liferaft, then onto a daughter craft from an emergency response and rescue vessel (ERRV) that was now on scene*

survivor /sə'veɪvəl/ (n) (safety) preživjeli, brodolomac, pomorac koji je pretrpio brodolom

susceptibility /sə,septə'bɪlɪti/ (cargo) osjetljivost, sklonost (oštećenju) **susceptibility to chilling** osjetljivost na hladnoću

susceptible to /sə,septə'bəl/ (adj) **SYNONYM liable to** **SYNONYM subject to** osjetljiv na (o teretu) **susceptible to rusting** osjetljiv na rđanje, koji lako rđa

suspect /sə'spɛkt/ (v) **sumnjati (na)** **suspect damage to cargo** **1** sumnjati na štetu na teretu; **2** predvidjeti štetu na teretu

suspect (adj) **sumnjiv**

suspicious /səˈspɪʃəs/ (adj) **sumnjiv**

sustain /səˈsteɪn/ (v) (mar ins) **pretrpjeti, podnositi sustain damage 1 pretrpjeti štetu;**

2: *the tug sustained significant damage above the waterline* tegljač je pretrpio znatnu štetu iznad vodene linije *No damage was sustained and no oil pollution occurred as a result of the grounding.* Brod nije pretrpio nikakvu štetu niti je došlo do onečišćenja mora uslijed nasukanja, **sustain engine failure pretrpjeti otkaz glavnog stroja, doći do otkazivanja glavnog stroja, otkazati (o stroju).** *The ship sustained engine failure, causing the vessel to drift into rocks.* Brodu je otkazao glavni stroj pa je brod otplutao do grebena.

SV; (sailing vessel) (n) (nav arch) jedrenjak

swamp /swɒmp/ (v) (seamanship) **napuniti brodicu vodom / morem (bez potapanja)**

swan-neck ventilator (n) (nav arch) kukasti ventilator

sway /swei/ (v) (seamanship) **a rhythmic vessel's motion from side to side zanošenje broda (bočno), pomicati se bočno**

swaying /ˈsweɪŋ/ (n) (navig) (nav arch) **COMPARE ship's motions** in swaying the sea's motion accelerates and decelerates the ship from side to side **bočno gibanje broda**

sweat /swet/ (n) (cargo) **znojiti se (o teretu)**

sweat /swet/ (n) (cargo) **znojenje, kondenzacija ship's sweat kondenzacija na dijelovima konstrukcije broda, cargo sweat kondenzacija na teretu, znojenje tereta**

sweat clause /swet/ (n) (mar ins, mar law) **klauzula o znojenju tereta (kondenzaciji)**

sweating /ˈswɛtɪŋ/ (n) (cargo) **vlaženje tereta zbog kondenzacije znojenje (tereta), kondenzacija (tereta)**

sweep (n) (electr, navig) svjetla točka (na radarskom zaslonu)

sweep down /swi:p/ (v) (cargo handling) **počistiti (skladište od zaostataka tereta)**

sweepings /ˈswi:pɪŋz/ (n) (shipping econ) **pometačina (ostaci tereta iz broskog skladišta)**

swell /swel/ (n) **1 (oceanogr) a valovi mrtvog mora; 2 (oceanogr) mrtvo more, bibavica, štiga, tal. onda lunga; ondata; mare moto ondosu heavy swell jako mrtvo more**

swept volume /ˈswɛpt/ (n) (marine eng) **stapajni volumen**

SWG; (slotted wave guide) (n) (electr, navig) valovod (radara) s prorezima

swing /swɪŋ/ (v) **1 (ship handling) progressive change of heading caused by an angle on the rudder, or by a ship circling around her anchor skrenuti (pramac ili krma broda ili tegljača, npr. pod djelovanjem sile tegljenja), skretati, okretati (se)** *the tug master put weight onto the towline which resulted in the tug's bow immediately swinging to starboard and making contact with the lock wall* zapovjednik tegljača napeo je užu za tegljenje, što je odmah izazvalo skretanje tegljačevog pramca udesno i dodir s oblnim zidom ustave *The vessel's rate of turn now accelerated to starboard and the vessel was swinging rapidly towards the right-hand bank of the river.* Brzina okretanja broda udesno se povećavala i brod je brzo skretao prema riječnoj obali na desnoj strani. *However, the vessel's head was still swinging rapidly to starboard.* **swing to starboard / port skretati u desno / lijevo** *The vessel was now swinging to starboard even though the bow thruster was full to port.* ; **2 (ship handling) okrenuti (brod), zaokrenuti (brod); 3 (marine eng) gibati se oko osi, njihati se**

swing (n) (seamanship, navig) zakretanje (broda), okretanje: *The master used the engines and thrusters in an attempt to arrest the swing but, despite the efforts of the crew, the forward winch brakes*

also began to render. Zapovjednik je upotrebio strojeve i pramčane porivnike kako bi zaustavio zakretanje broda, ali usprkos pokušajima posade kočnica na pramčanom vitlu je počerla popuštati. **commence the swing** započeti zakretanje / okretanje (broda)

swing away (v) (seamanship) odmicati se od (obale) skretanjem, skrenuti od obale (o pramcu) : *The ship's bow began to swing away from the berth.*

swing in (v) 1 (boating/yachting) vratiti se u jedrilicu (iz položaja trapeziranja); 2 (seamanship) zakrenuti prema unutra **swing in the lifeboat** zakrenuti podignutu brodicu za spašavanje prema ležištu na palubi

swinging (n) 1 (navig) okretanje broda, zaokretanje broda: *The manoeuvre required swinging the vessel 180 degrees and then backing astern to berth port-side to.*; 2 (cargo handling) njihanje (tereta), ljuljanje (tereta)

swinging area (n) (cargo handling) područje okretanja broda, krug okretanja broda: *The Master had briefed the officers on the intended manoeuvre to ensure the vessel was turned as tightly as possible owing to the relatively confined swinging area.*

swing out (v) 1 (boating/yachting) izbaciti se van (na trapezu); 2 (seamanship) zakrenuti (brodicu za spašavanje) izvan boka broda (radi spuštanja)

swing out the lifeboat (v) (seamanship) izvući brodicu za spašavanje izvan boka broda (radi spuštanja)

swirl plate /'swɜ:ɪ/ (n) (marine eng) ploča za raspršivanje

switch¹ (n) (electr) sklopka, prekidač, preklopka, tal. *interruttore*

switch² (v) 1 a prebaciti; 2 uključiti **switch on** uključiti, **switch off** isključiti

switchboard /'swɪtʃ,bɔ:d/ razvodna ploča, rasklopna ploča, tal. *quadro elettrico*;

quadro di distribuzione main **switchboard** glavna razvodna ploča: *The main elements of a marine distribution system are the main and emergency switchboards, power panel boards, motor*



controllers, lighting and small power panel boards.

emergency switchboard pomoćna razvodna ploča, razvodna ploča za izvanredna stanja

switchbox /'swɪtʃ,bɒks/ (n) (electr) razvodna kutija

switch off (v) (electr) isključiti

switch on (v) (electr) uključiti **switch on the radar set** isključiti radar (iz napona):

Before switching off the radar set turn the brilliance and gain, to the minimum and turn off the anti-clutter controls. This will extend the life of the display and allow the next operator to set up the radar using standard procedure in the minimum time.

swivel /'swɪvəl/ (n) 1 (nav arch, boating/yachting) sastavni dio lanca koji omogućuje njegovo okretanje; a special link constructed in two parts which revolve on each other, used to prevent fouling due to turns or twists in chain, etc. vrtulj, vrtuljak, vrtulja, vrtilica, **đogulin**



; 2 (fishing) dio sitnog ribolovnog pribora koji spaja dva

najlona te služi da se najlon ne uvrće (<https://ribolovnajadranu.hr/ribicki-leksikon>) **vertjelica**, **vrtilo**, **zogulin**, **đogulin**, **cogulin**

swivel (n) (fishing) A rigging component with many uses. Swivels acts as a line stop and rigging connectors for bottom rigs also connects the fishing line to a leader to prevent line twist; dio sitnog ribolovnog pribora koji se gotovo uvijek koristi u svim ribolovnim tehnikama; Metalne je konstrukcije i ima funkciju spajanja dvaju najlona te služi da se najlon ne uvrće. **vertjelica**, **vrtilica**, **đogulin**,



zogulin, **žogulin**

SWL (safe working load) certified load limit applied to lifting appliances and gear **sigurno radno opterećenje**, **dopušteno radno opterećenje** **shackle with SWL (safe working load) of 6 tonnes** **škopac sa sigurnim radnim opterećenjem od 6 tona**

swordfish /'sɔ:d.fɪʃ/ (n) (fishing) **iglon**, **sabljarka** {**drugi hrv. nazivi: armenjak, jaglun, kljunara, mač, sabljan, špada; lat. XIPHIAS GLADIUS**}

sycamore /'sɪkə.mɔ:/ (n) 1 a (cargo) **egipatska smokva**; 2 **američka platana**

synchronous motor /'sɪŋkrənəs/ (n) (marine eng) **sinkroni motor**

synopsis /si'nɒpsɪs/ **general synopsis** **stanje vremena**, **situacija**, **synopsis of surface weather** **stanje vremena (na površini mora)** 1 opis; 2 (meteorol) **stanje vremena**, **vremenska situacija**, tal. **situazione**

synopsis /si'nɒpsɪs/ (n) **sažeti opis**, **sažeti prikaz**

synopsis of surface weather /si'nɒpsɪs/ (n) (meteorol) **prikaz stanja vremena (na oceanima, morima)**

synoptic chart /si'nɒptɪk/ (n) (meteorol) **sinoptička karta**

synoptic situation /si'nɒptɪk/ (n) (meteorol) **sinoptičko stanje**

synthetic rope /sɪn'tetɪk/ (n) (seamanship) **sintetičko uže**

synthetic fuel /sin'θetik/ (n) (marine eng) sintetičko gorivo, umjetno gorivo
system sustav, sistem **cooling system** sustav hlađenja, rashladni sustav, **cooling water system** sustav rashladne vode, **common rail system** jednolinijski sustav (pumpa), **fuel-supply system** sustav za dobavu goriva, **jerk pump system** pojedinačni sustav pumpa, **piston cooling system** sustav rashlađivanja klipa, **water-cooling system** vodorashladni sustav, sustav rashlađivanja vodom, **close-feed system** zatvoreni napojni sustav, **heating system** sustav grijanja, **spark ignition system** sustav paljenja iskrom, **watch-keeping system** sustav držanja straže, sustav **gvardije**

system capacity (n) (navig, electr) mogućnosti navigacijskog sustava
System Electronic Navigation Chart; (SENC) (n) (ports) systemska elektronička navigacijska karta (SENC)

table of offsets (n) (nav arch) tablica očitavanja

tacit acceptance /'tæsɪt/ (n) (mar law) prihvaćanje šutnjom

tack /tæk/ (v) (boating/yachting) = **come about** letati, okretati, okrenuti u vjetar, promijeniti smjer jedrilice (stranu jedrilice u odnosu na smjer vjetra), tal. **bordeggiare**

tack /tæk/ (n) 1 (boating/yachting) attachment on the lower part of the luff of a sail **prednji doljnji rogalj (jedra ili prečke), oglavni rogalj, privjetreni rogalj, tal. punto di mura**

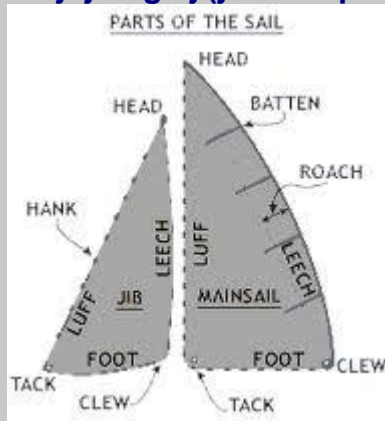

; 2 **uzda, škota, tal. mura on port / starboard tack na lijevom / desnim uzdama**: *Boats on a port tack shall keep clear of boats on starboard tack (Rule 10).*, **on opposite tacks na suprotnim uzdama, on the same tacks na istim uzdama**; 3 one leg of a zigzag course steered in beating to windward; jedna strana okreta pri jedrenju oštro u vjetar **bordada, jedna strana letanja**; 4 okret u vjetar; 5 promjena strane jedrenja, prebacivanje smjera jedrenja; 6 rogalj špinakera za hvatanje tanguna
tack /tæk/ (n) (boating/yachting) oglavni rogalj, doljnji prednji kut jedra
tack (n) (boating/yachting) uzda najnižeg križnog jedra (na jedrenjaku)
tack (n) (boating/yachting) okret, letanje, ta. **bordata**
tacking /'tækiŋ/ (n) (boating/yachting) **COMPARE gybing** one of the two most important manœuvres in sailing by turning the boat through the wind using the rudder, sails, and crew weight; okretanje jedrilice s jedne strane na drugu u smjeru vjetra **letanje, okretanje jedrilice u smjeru vjetra, zbordžavanje roll tacking letanje s njihanjem, tacking**

with a trapeze letanje s trapezom

tackle /ˈtækəl; (often nautical) ˈteikəl/ (n) **under ship's tackle** pod čekrkom, na obali ispod broda, **ground tackle** sidro 1 (cargo handling) = **block and tackle** any mechanical system for lifting or pulling, esp an arrangement of ropes and pulleys designed to lift heavy weights (Collins) koloturnik, čekrk, **parank**; tal. **paranco**, **palan span tackle** klobučnica, **podigač samarice**, čekrk kraka samarice, **paranak** kraka samarice

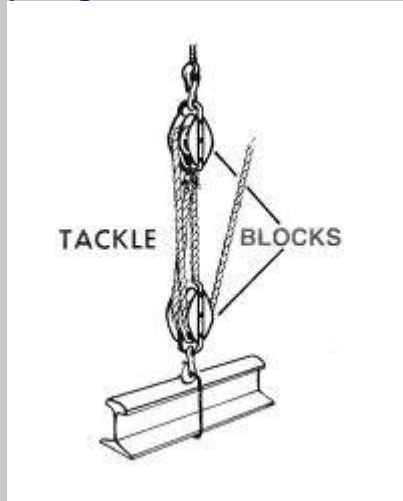

; 2 sidreni lanac i konop (tal.: paranco)

tackle /ˈtækəl; (often nautical) ˈteikəl/ (v) **tackle the fire** uhvatiti se u kpštac s vatrom, gasiti požar prihvatiti se čega, nositi se s nečim, latiti se

tackle-to-tackle (n) (mar law, shipping econ) preuzimanje teret ispod brodskog teretnog vitla, prijevoz od ispod čekrka (u ukrcaju) do ispod čekrka (u iskrcaju)

t-aft; the moulded draught measured on APO (frame zero) **baždarni gaz** izmjeren na krmenoj okomici (perpendikularu)

tag (v) (navig) imenovati, staviti oznaku s nazivom, označiti s nazivom **tag the track** označiti putanju. *The VTSO manually acquired the ship's radar target as the vessel left the short-term anchorage prior to the collision, but he did not 'tag' the track with the vessel's name.*

tail end shaft (n) (nav arch) **propelerska osovina**

tail of line (n) (seamanship) slobodan kraj konopa

tailshaft (n) (nav arch) = **propeller shaft** the aft section of the shaft which receives the propeller **osovina propelera, propelerska osovina**

taint /teint/ (n) **liable / susceptible / subject to taint** osjetljiv na kaljanje (teret) (cargo handling) **kaljanje, prožimanje**. *Some cargoes are liable to damage from taint. These should not be stowed next to strong smelling cargoes.*

taint /teint/ (v) (cargo handling) assume the characteristics of another cargo stowed in the same hold **kaljati se (o teretu), prožimati se (svojevima drugog tereta)**

tainting /ˈteintɪŋ/ (n) 1 (cargo handling) a kaljanje (npr. mirisom, bojom drugog tereta), prožimanje; 2 mrlja, pjega

take take the bearings snimiti azimut, **take the soundings** mjeriti / sondirati

kaljuže, take the sights of snimiti azimut / položaj (zvijezda, nebeskih tijela) uzeti

take action (n) (navig) **poduzeti (radnju, mjeru)**: *The OOW took action by altering the course*

to starboard in order to keep out of the way of the stand on vessel.

take a turn (v) (seamanship) to pass a turn around a belaying pin or cleat **prebaciti (uže)**
preko bitve, tal. date volta

take delivery of (v) **1** (nav arch) **preuzeti take delivery of the ship preuzeti brod**
(prilikom primopredaje); 2 (shipping econ, mar law) **ANTONYM deliver the goods**
preuzeti teret / robu, primiti teret / robu take delivery of the cargo / goods /
consignment / shipment preuzeti teret / robu / pošiljku: *The Merchant shall take delivery*
of the Goods upon discharge. Naručitelj je dužan preuzeti robu po njenom iskrcaju s broda. The Merchant
or his Assign shall take delivery of the goods and continue to receive the goods as fast as the vessel can
deliver and-but only if required by the Carrier - also outside ordinary work

take in (v) (boating/yachting) to lower and furl the sails **ubрати jedro, spustiti i ubрати jedro**

take in water (v) (safety, seamanship) **krcati vodu / more (o oštećenom brodu):** *The*
fore peak of the cargo ship was damaged, causing it to take in water.

take legal action (v) (mar law) a judicial proceeding brought by one party against another
tužiti, podnijeti tužbu, pokrenuti sudski postupak

take off (safety) **uzlet (helikoptera)**

take off pilot (v) (navig) **iskrcati peljara:** *The pilot was taken off the 257-meter shuttle tanker off*
St. Ann's Head in 35 knot winds and wave heights of 4-5 meters.

take on (v) (cargo) **poprimiti (boju, miris)**

take out all the slack (v) (seamanship) set taut **zategnuti (uže)**

takeover (n) (mar law, shipping econ) **preuzimanje tvrtke / kompanije**

take over (v) **1** (shipping econ) **preuzeti (teret, trošak, ...); 2** (mar law) **preuzeti stražu,**
smijeniti stražu: *Before taking over a navigational watch the officer should read and sign the standing*
orders take over the watch preuzeti stražu, smijeniti stražu, preuzeti gvardiju: *When*
taking over the watch, the OOW did not check the ship's intended track relative to any dangers to
navigation that would be encountered on his watch.; 3 (shipping econ) **preuzeti tvrtku /**
kompaniju; 4 (shipping econ) **preuzeti položaj / funkciju :** *Ms. will take over as chief*
executive officer, succeeding Mr.

take place (v) **dogoditi se, zbiti se, odviti se, odigrati se**

take the bearing (v) (navig) **izmjeriti azimut, snimiti azimut**

take the ground (n) (mar law, safety) **dodirivanje dna**

take the wind out of his sails (v) (boating/yachting) **ukrasti vjetar (drugo jadrilici /**
jedrenjaku), jedriti uz vjetar (u privjetrini drugom brodu) i uzeti mu vjetar

take up the slack on the line (v tr) (seamanship) **potegnuti olabavljeni konop**

take water in (v) (seamanship) **krcati vodu, propuštati vodu / more:** *the vessel reportedly*
took water in its engine room at about 10.00 en route from to

talkback system (n) (comm) **interkomunikacijski sustav**

talkie-walkie (n) (comm) = **walkie-talkie; walky-talky** ručni radiotelefon,
toki-voki {more frequently: walkie-talkie}

tall ship (n) (boating/yachting) **jedrenjak, veći brodovi na jedra** {npr.: škuneri, brigantini,
brigovi i barkovi}

tally /ˈtæli/ (v) (cargo, shipping econ) **brojati (teret):** *Tally the cargo!*

tally /ˈtæli/ (n) (cargo) **brojanje tereta**

tally (v) (boating/yachting) zatezati uzde floka (škotine)

tally book /ˈtæli/ (n) (cargo) brojačka knjižica

tally clerk /ˈtæli/ (n) (shipping econ, mar law) osoba koja uspoređuje ukrcan teret s opisom tereta na teretnici **brojač (tereta)**

tallying /ˈtæliŋ/ (n) (shipping econ) **brojanje tereta** *The tallying of cargo during loading and discharge is a useful means to avoid or limit shortfalls. The tallying of cargo during loading and discharge is a useful means to avoid or limit shortfalls.*

tallyman /ˈtælimən/ (n) (mar law, shipping econ) **brojač (tereta u luci)**

tally sheet (n) (cargo, mar law) **brojački listić**

tampered (adj) (cargo handling) **neovlašteno otvoren (kolet, pošiljka), neovlašteno**

diran (kolet, pošiljka), pomiješan bez dopuštenja *Masters must be fully aware of all items stored in the ship's bonded locker and make sure that none of the items placed under seal is tampered with. Therefore careful watch should be maintained, when loading, for any packages which may have been tampered with, or broken.*

tamper with /ˈtæmpə/ (v) **dirati (teret ili pošiljku neovlašteno), nezakonito otvoriti (pošiljku)** *Our package was tampered with! Netko je nezakonito otvarao našu pošiljku!*

tangled (adj) (seamanship) = **fouled** **zapleten**

tank /tæŋk/ (n) **lower tank donji tank, upper tank gornji tank, wing tank bočni tank**

(nav arch, marine eng) a compartment for liquids or gases **tank, cisterna, rezervoar, čatrnja,**

tal. cassa; serbatoio; cisterna; tanica; tanca collecting tank sabirač, sabirnik,

kolektor, double bottom tank tank dvodna, expansion tank ekspanzioni tank,

header tank kolektor, sabirnik, heavy oil tank tank teškog goriva, inspection tank

kontrolni tank, lubricating oil tank tank ulja za podmazivanje, make-up tank

kompenzacijski tank, nadolijevni tank, service tank pogonski tank, potrošni tank,

dnevni tank, sump tank slivni tank, supply tank dobavni tank, dobavni rezervoar,

fresh water tank tank slatke / svježe vode, after peak tank zatežni tank, tank

krmenog pika, bilge water collecting tank sabirni tank kaljužnih voda, heavy fuel

oil deep tank duboki tank za tešku naftu, fore peak tank pretežni tank, tank

pramčanog pika, daily tank dnevni tank, de-aerator tank tank otplinjača, drain tank

odljevni tank drenažni tank, duplicate tank dvostruki tank, feed tank napojni tank,

fuel oil tank tank za gorivo, oil tank tank za naftu, service tank za dnevnu

upotrebu, dnevni tank, settling tank dnevni tank, storage tank spremnik {{abbr} Tk}

tank blowing **propuhavanje tanka**

tank bulkhead (n) (nav arch) **pregrada tanka**

tank ceiling (n) (nav arch) **vrh dvodna, pokrov dvodna, gornja stijenka dvodna** *It had originally been built with two holds covered by means of wooden hatchboards and tarpaulins, side bilges and a wooden tank top ceiling. However, to facilitate the carriage of bulk cargoes the tank top ceiling had been floored over with steel plates welded together.*

tank cleaning (n) (cargo handling, seamanship) **čišćenje tankova**

tank cleaning system (n) (nav arch) **sustav čišćenja tankova** *Each cargo tank is fitted with two tank cleaning hatches for tank portable tank cleaning machines. Tank cleaning hatches is also used for ventilation gas freeing fans. Tank cleaning pump is centrifugal, electric driven capacity 40 m³/h, 10 bar.*

tank container (n) (cargo) **kontejner za tekuće terete, tank-kontejner**: Tank containers are generally designed for an operating pressure of up to 3 bar (above atmospheric).

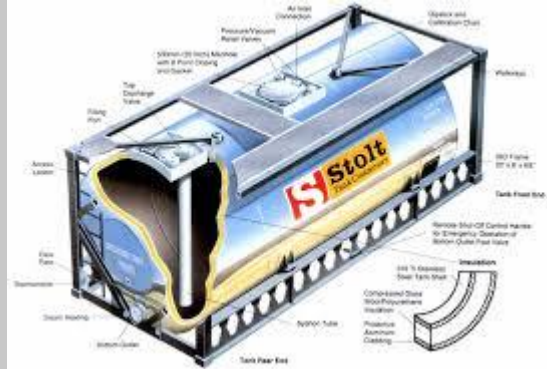

tanker /ˈtæŋkə/ (n) (nav arch) **tanker oil tanker** tanker za prijevoz nafte, **tanker za prijevoz zemnog ulja, sludge tanker** tankr za prijevoz otpadnih voda, **shuttle tanker** tanker za prijevoz sirove nafte sa naftnih platforma

tanker design and construction (n) (nav arch) projektiranje i gradnja tankera:

Most of IMO's regulations pertaining to tanker design and construction are contained in the International Convention for the Safety of Life at Sea (SOLAS) and the International Convention for the Prevention of Pollution from Ships (MARPOL 73/78 and subsequent amendments).

tankerman (n) (seamanship) person responsible for of the day-to-day operations of a small oil tanker or LNG tank barge etc. **tankerski mornar**: The *tankerman* is responsible for the safe and efficient transfer of liquefied natural gas products between barges, ships, and facilities including completion and accountability of barge logs, bills of lading and gauge reports.

tanker operation /ˈtæŋkə/ (n) (shipping econ) linjski servis

tank gauge /ˈtæŋk ˌɡeɪdʒ/ (n) (nav arch, cargo handling) pokazivač razine tekućine u tanku

tank level (n) (marine eng) razina u tanku

tank suction (n) (marine eng) usis tanka

tank-test (n) (nav arch) pokus u bazenu, ispitivanje modela broda u bazenu

tank-test (v) ispitivati u bazenu, obavljati pokuse u bazenu

tank top /ˈtæŋk,tɒp/ (n) **SYNONYM inner bottom 1** (nav arch) the plating laid on the bottom floors of a ship, which forms the top side of the tank sections or double bottom (SeaSources.net)

pokrov dvodna: However, to facilitate the carriage of bulk cargoes the *tank top ceiling* had been floored over with steel plates welded together.; **2** (nav arch, marine eng) vrh tanka

tank venting system (n) (nav arch, safety) sustav odzračivanja tankova

tank vent pipe (n) (boating/yachting, marine eng) odzračna cijev tanka

tap /tæp/ (n) (boating/yachting, marine eng) slavina

taper /ˈteɪpə/ (v) **1** (marine eng) a stanjiti se (prema jednom kraju, npr. klipa), stanjivati se; **2** ukositi, zašiljiti (se)

tapered /ˈteɪpəd/ (adj) zašiljen, koničan

tapering (n) (marine eng) suženje, stanjivanje **tapering to a thinner section** smanjen na tanji presjek obrađen na tanji presjek

taper of shaft /ˈteɪpə/ (nav arch) kosina propellerske osovine

tappet /ˈtæpɪt/ (n) (*marine eng*) a mechanical part that reciprocates to receive or transmit intermittent motion, esp the part of an internal-combustion engine that transmits motion from the camshaft to the push rods or valves **valjak (podizača ventila) roller tappet valjak podizača ventila**

tare weight /ˈtɛə weɪt/ (n) (*shipping econ*) Weight of an empty container. Gross weight = net weight + tare weight. (<http://www.maerskline.com/en-jm/help/shipping-glossary>) **tara, težina praznog kontejnera**

target /ˈtɑːɡɪt/ (n) **1 cilj; 2 (navig) objekt radarskog motrenja (npr. brod), objekt radarskog snimanja, cilj radarskog motrenja** *The second officer saw a target on the tanker's starboard quarter at a range of 1.9nm.* **acquired target označeni objekt (na radarskom ekranu) prihvaćen cilj radarskog motrenja, tracked target označeni objekt (na zaslonu) prikazani objekt (na zaslonu), target lost cilj izgubljen, objekt radarskog motrenja izgubljen, activated AIS target aktivan AIS objekt, dangerous AIS target opasan AIS objekt, selected AIS target odabran AIS objekt, sleeping AIS target AIS objekt u mirovanju, lost AIS target izgubljen AIS objekt, acquire the target uhvatiti objekt, odrediti poziciju objekta (na radarskom pokazivaču) prihvatiti radarski objekt**

target alarm (n) (*navig*) The target alarm serves to alert the navigator to targets (ships, landmasses, etc.) entering a set area, with audio and visual alarms. **alarm za unesene objekte, alarm cilja set the target alarm namjestiti alarm za neki objekt, silence the target alarm namjestiti alarm na tiho, deactivate the 1 isključiti alarm za objekte**

target swap (n) (*navig*) zamjena cikja / objekta (radarskog motrenja)

target tracking (n) (*navig*) traženje i pronalaženje cilja / broda / objekta

tariff /ˈtærɪf/ (*shipping econ*) the charges, rates and rules of a transportation company as listed in published industry tables. List of published rates, rules and regulations applicable to the transportation of goods in specified trade lanes or between two areas.

(<http://www.maerskline.com/en-jm/help/shipping-glossary>) **cijene usluga, tarifa port tariff lučke tarife, cijene lučkih usluga, effective tariff važeće tarife**

tarp /tɑːp/ (n) (*cargo*) cerada, nepropusni prekrivač

tarpaulin /tɑːˈpɔːlɪn/ (n) (*cargo handling*) heavy canvas used as a covering **cerada tarpaulin sheet pokrov od cerade** *If the cargo needs to be protected from rain, tarpaulin sheets can be provided to cover the top of the container*

taut /tɔːt/ (adj) (*seamanship*) (*seamanship*) **ANTONYM slack; slacken zategnut (konop, lanac), napet** *When the operator reported that the line was taut, the supervisor asked the pilot to have it slackened.* **cable is taut konop je napet, konop je zategnut**

tauten /tɔːtən/ (v) **napinjati (konop), zatezati** *The spring is therefore first tautened by hauling on the head line to prevent the stress caused by a jolt.*

T-bar (n) (*nav arch*) a rolled or extruded structural shape having a cross section shaped like the letter T **T-profil**

TBCR (Time of bow closest range) (n) (*navig*) **vremensko razdoblje do minimalne udaljenosti mimoilaženja po pramcu**

TCPA (time of closest point of approach) (n) (*navig*) **vremensko razdoblje**

najbliže točke mimoilaženja **TCPA (time of closest point of approach) limit**
vremenska granica točke mimoilaženja

TDMA; (Time Division Multiple Access) (n) (navig) vremenski podijeljen
višestruki pristup (u sustavu AIS)

teak /ti:k/ (n) 1 tik; 2 (cargo) tikovina

tear¹ /tɛə/ (n) 1 (marine eng, cargo handling) deranje; 2 (nav arch) pukotina, napuklina,
puknuće: Damage to own vessel consisted of indentation of the bulwark plates and a 800 mm long tear
of the shell plating on the starboard bow.

tear² /tɛə/ (v) kidati parati

tear³ /tɛə/ (v) habati se

tear up /tɛə/ (v) rastaviti, skidati, demontirati

technical data (n) (marine eng, nav arch) specifikacija, tehnički podaci

technical specifications (n) (marine eng) tehnički opis, tehnički podaci, tehničke
osobine

technical supervision (n) tehnički pregled, tehnički nadzor

technical waterborne craft (n) (nav arch) tehnički plovni objekt

technique /tɛk'ni:k/ tehnika, metode, postupci **navigation techniques** (navig)
tehnikе plovidbe, metode navigacije, practise celestial navigation **techniques**
primjenjivati tehnikе nebeske navigacije

tee bar; T-bar /ti: ba:/ (n) (nav arch) profil u obliku slova T, t-profil

teel strapping (n) (cargo handling) čelične trake

telegraph /'tɛli,græf; 'tɛli,gra:f/ (n) (marine eng) an apparatus either mechanical or electrical used
for transmitting orders to various parts of a ship. **telegraf**, uređaj za prijenos zapovijedi **bridge**
telegraph brodski telegraf (na mostu), davač zapovijedi stroju, **engine-room**
telegraph strojarski telegraf, **emergency telegraph** pomoćni telegraf, telegraf u
nuždi

telemedicine (n) (med) telemedicina, zdravstvena skrb na daljinu: *Telemedicine in the
maritime sector - FutureCare enlisted the minds and might of Yale with data and information*

telemeter /ti'lemitə/ (n) (navig) telemetar, daljinomjer

telemotor A device for operating the control valves of the steering engine from the pilothouse, either
by fluid pressure or by electricity. (Ship Terms Glossary.html) **letemotor**

teleprinter /'tɛli,printə/ (n) (comm) teleprinter

telescopic /,tɛli'skɒpik/ (adj) teleskopski, izvlačiv, na izvlačenje

telex over radio radiotelex

tell-tale /'tɛl teil/ (n) 1 (boating/yachting) a piece of cloth or yarn tied to the stay or sail to act as wind
direction indicator; vrpčasti pokazivač namještenosti jedra u odnosu na smjer vjetra, postavljen na
priponama ili u jedru ili prednjem jedru **pokazivač vjetra**, vunice, **muštravent**, **moštravenat**

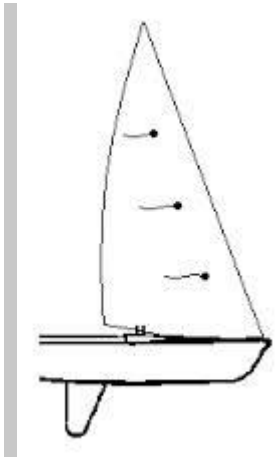

; 2 (*marine eng*) an indicator of the status or malfunction of a system within a motor vehicle **pokazivač neispravnosti**

temperature (*n*) temperatura **constant operating temperature** stalna radna temperatura, **exhaust temperature** temperatura ispušnih plinova, **rate of temperature rise** raspon povišenja temperature, **temperature regulator** termoregulacioni ventil, termostat, **working temperature** radna temperatura, **temperature drop** pad temperature, **smanjenje temperature**, **temperature increase / decrease** porast / pad temperature, **temperature reading** očitavanje temperature, **raise the temperature** podići temperaturu, **povisiti temperaturu**, **reduce the temperature** sniziti temperaturu, **smanjiti temperaturu**

temperature drop (*n*) (*marine eng*) pad temperature

temperature log (*n*) (*cargo handling*) dnevnik temperatura

temperature-resistant (*adj*) (*marine eng*) otporanna temperaturu

tempered /'tɛmpəd/ (*adj*) (*marine eng*) grijan, kaljen, otvrdnut **grijanjem**: ... nitrated for high wear resistance and anti-corrosion properties; crankshafts are forged in one piece from wear-resistant, quenched and **tempered** alloy steel.

template /'tɛmpleit; 'tɛmplit/ (*n*) 1 model; 2 obrazac

temporarily extinguished light /'tɛmpərə'reli/ (*navig*) privremeno pogašeno svjetlo

temporary /'tɛmpərəri/ (*adj*) privremen, provizoran **temporary notice** privremena obavijest

temporary measures (*n*) (*mar law*) Privremene mjere uključuju zadržavanje broda (detention, arrest), zapljenu broda (seizure), prodaju zaplijenjenoga broda (sale of ships) itd. **privremene mjere (zadržavanja broda radi naplate tražbina)**

temporary repair **popravak na licu mjesta**: *The crew carried out a temporary repair, and the vessel was re-floated at 2120.* Posada broda je obavila manji popravak na licu mjesta pa je brod odsukan u 2120 sati.

temporary shipowner (*n*) (*mar law*) brodar

tend (*v*) 1 biti sklon, imati tendenciju: ... westbound vessels in the Singapore Strait often **tend to** treat it as a restricted fairway with some justification and believe that they are, under Rule 9

(*d*), privileged.; 2 (*seamanship*) paziti, pomoći, opsluživati **tend the ship** (*safety, navig*) opsluživati brod, **paziti na brod**: *An experienced yachtsman remained behind to tend the El Pirata.*

tender /'tɛndə/ (v) (**shipping econ**) predati, dovesti do **tender the goods to the ship's tackle** dovesti robu ispod brodskog čekrka (=dizalice, samarice), **tender the Notice of Readiness** predati pismo spremnosti, **get in the tender** ući u pomoćni gumenjak / brodicu, **get out of the tender** izaći iz gumenjaka / brodice, **invite tenders** zatražoto ponude, raspisati natječaj

tender /'tɛndə/ (n) **1** a small boat used from shore to the main boat or 'mother boat' **pomoćna brodica, pomoćni gumenjak (uz jahtu, gliser), pomoćni čamac, tender, bajbot**. ... an able seaman close by was preparing a stern line for the **mooring tender**. ... three fishermen were using a borrowed **tender** to get ashore from their vessel, which was moored on a mid stream pontoon. **tow the tender** vući pomoćni gumenjak, **tender boat 1** pomoćna brodica; **2 bajbot**



; **2 (shipping econ) ponuda (na natječaju), tender:**

The Environment and the safety requirements related to the aforementioned recommendations to the call for tender documents.

tender /'tɛndə/ (adj) (**navig**) **ANTONYM stiff** gegav (brod), nedovoljno stabilan brod **tender ship** gegav brod

tender boat (n) (**navig**) **pomoćna brodica, radna brodica**: *As a precautionary measure, an oil boom was deployed around the damaged tender boat. A second ship's tender boat was used to tow the damaged tender boat ashore.*

tender clause /'tɛndə/ (n) (**shipping econ, mar law**) **klauzula ponude, klauzula veta, nadzora i ponude**

tender ship (n) a ship with very small GM (metacentric height) caused by KG (height of the ship's center of gravity the above the keel) being too large **gegav brod**

tend the buoy (v) (**seamanship**) održavati plutaču

tend to /'tɛnd tu:/ (v) **težiti ka, nastojati, biti sklon nečemu**: *it tends to influence* nastoji utjecati **tend to dry off** težiti posušivanju

tennon; tenon /'tɛnən/ (n) (**boating/yachting**) šip **tennon; tenon heel** petica jarbola

tensile /'tɛnsail/ (adj) (**marine eng**) **vlačni, koji se odnosi na vlak** **tensile force** **vlačna sila, sila vlaka, tensile strength** the measure of a material's ability to withstand a tensile, or pulling stress without rupture, usually measured in pounds or tons per square inch of cross section.

vlačna čvrstoća, tensile stress **vlačno naprezanje, naprezanje uslijed vlaka, tensile test** test na vlak, ispitivanje rastezanaj

tension /'tɛnʃən/ (v) **stezati, stegnuti**

tension /'tɛnʃən/ (n) **1 (phys)** a force that tends to produce an elongation of a body or structure. The act of stretching or the state or degree of being stretched **napetost, vlak, naprezaje na vlak; 2**

(electr) električni napon, napon: *However, by the time the operator reached the dolphin, there was considerable tension in the line.* **high tension visoki napon, extra high tension (EHT) vrlo visoki napon;** **3 zategnutost užeta / konopa, napetost užeta / konopa:** *The intensity of the tension on the mooring lines is controlled by operating mooring winches or turning the mooring lines around a bitt so that they counter the thrust of a propeller.*

tensioner /ˈtɛnʃənə/ (n) (cargo handling) **stezaljka, tirant, škartoc:** tensioner

tension winch (n) (seamanship) **samopritezno vitlo**

term (n) **1 a naziv, termin;** **2 rok;** **3 stavka, klauzula;** **4 stručni naziv, termin**

terminal /ˈtɜːmɪnəl/ (n) **1 (ports)** Terminals are centralized meeting points where service providers can manage the flow of transportation vehicles, serve customers, and efficiently load and unload freight and passengers. **terminal port terminal lučki terminal, oil terminal naftni terminal;** **2**

(electr) stezaljka, priključak, klema: *It was also observed that the cable terminals within the socket were loose and there was poor contact within the multiple outlets of the adaptor.*; **3 (seamanship) završetak užeta**

Terminal Handling Service - Destination; (DHC) (n) (shipping econ) This service covers the cost of the handling of a container at the destination port or terminal.

(<http://www.maerskline.com/en-jm/help/shipping-glossary>) **tarifa uključuje rukovanje kontejnera u luci ili terminalu odredišta**

Terminal Handling Service - Origin; (OHC) (n) (shipping econ) This service covers the cost of handling a container at the origin port or terminal. **tarifa uključuje rukovanje kontejnera u luci otpreme**

terminal operation /ˈtɜːmɪnəl/ (n) (shipping econ) **poslovno upravljanje terminalom:** *Terminal operation is organized to provide such necessary services as customer ticketing, package handling, and parking and docking for automobiles, trucks, aircraft, or ships.*

terminal operator /ˈtɜːmɪnəl/ (n) (shipping econ) the company that operates cargo handling activities on a wharf **poduzetnik poslova kontejnerskog terminala, operator**

kontejnerskog terminala, lučko poduzeće koje upravlja kontejnerskim terminalom, terminal-operator {A terminal operator oversees unloading cargo from ship to dock, checking the quantity of cargoes versus the ship's manifest (list of goods), transferring of the cargo into the shed, checking documents authorizing a trucker to pick up cargo, overseeing the loading/unloading of railroad cars, etc.}

terminal port /ˈtɜːmɪnəl/ (n) (shipping econ) **zadnja luka (na putovanju broda), kraljnja luka the ship at her terminal port brod u zadnjoj luci svoga putovanja**

terminal staff /ˈtɜːmɪnəl/ (n) (ports) **osoblje terminala, zaposleni na (lučkom) terminalu**

terminate /ˈtɜːmɪˌneɪt/ (v) (mar law) **završiti (ugovor), ispuniti, okončati:** *the period of employment is terminated by reason of completion of the voyage rok zaposlenja završio je završetkom putovanja*

termination (n) (mar law) **završetak (ugovora), istjek roka trajanja (ugovora):** *The Fee and Expenses shall continue to be payable for a further period of the number of months stated in Box 19 as from the effective date of termination.*

terms and conditions (n) (mar law) Terms and Conditions means all terms, rights, defences, provisions, conditions, exceptions, limitations and liberties of the Bill of Lading. **opći uvjeti poslovanja, opći uvjeti poslovanja prijevoznika, ugovorni uvjeti**

terms of agreement (n) (mar law) stavke ugovora

terms of sale; TOS (n) (mar law) = **INCOTERMS 2000** trgovinski uvjeti, **INCOTERMS**

terms of shipment (n) (shipping econ, mar law) trgovinski uvjeti

terrestrial navigation /tə'restriəl/ (n) (navig) = **coastal navigation** method of determining the position of the ship by using terrestrial landmarks such as light house, buoys, islands, and other fixed objects. **terestrička navigacija**

territorial sea (n) (mar law) **COMPARE continental shelf** An area over which the sovereignty of a coastal State extends, beyond its land territory and internal waters and, in the case of an archipelagic State, its archipelagic waters, to an adjacent belt of sea, described as the territorial sea.

teritorijalno more: Every State has the right to establish the breadth of its territorial sea up to a limit not exceeding 12 nautical miles, measured from baselines determined in accordance with this Convention. (UNCLOS) **breadth of the territorial sea** 1 **širina teritorijalnog mora**; 2: Every State has the right to establish the breadth of its territorial sea up to a limit not exceeding 12 nautical miles, measured from baselines determined in accordance with this Convention., **outer limit of the territorial sea**

vanjska granica teritorijalnoga mora: The outer limit of the territorial sea is the line every point of which is at a distance from the nearest point of the baseline equal to the breadth of the territorial sea.

territorial waters (n) (mar law) **COMPARE continental shelf** veliki vodeni prostori koji su u cijelosti okruženi kopnom **unutrašnje more**

terylene /'tɛrɪ.li:n/ (n) (boating/yachting) terilen, dakron

test (n) ispitivanje, pokus, test

test (v) ispitati, isprobati **test the navigation equipment** (navig) ispitati navigacijsku opremu, **test the main engine** isprobati glavni stroj

test-bed (n) (marine eng) ispitni stol (motora), probni stol

testing (n) ispitivanje, testiranje **mechanical testing** mehaničko ispitivanje, **testing machine** stroj za spitivanje, uređaj za ispitivanje

test run (n) (marine eng) probni rad (motora)

test run (v) (navig) isprobati stroj (npr. kratko zaveziti krmom prije ili za vrijeme uplovljenja), **isporbati vožnju krmom:** at 1942 the engine was test run on slow astern for approximately one minute

TEU (twenty-foot-equivalent unit) /'ti: i: 'ju:./ kontejnerska jedinica svedena na 20 stopa, služi za iskazivanje kapaciteta broda; A standard of measurement used in container transport based on the dimensions of a container 20 ft long x 8 ft wide (6050 x 2440 x 2590 mm) **kontejner dužine 20 stopa, kontejnerska jedinica od 20 stopa, jedinica TEU, TEU-jedinica**

texture /'tɛkstʃə/ (n) 1 (marine eng) a sastav; 2 tkivo

t-fwd (n) (stabil, nav arch) the moulded draught measured on FP **baždarni gaz izmjeren na pramčanoj okomici (perpendikularu)**

thaw /θɔ:/ (v) (oceanogr) topiti se, otapati se (led)

thermal conductivity (n) (marine eng) toplinska vodljivost

thermal energy (n) = **heat energy** toplinska energija

thermal protective aid (n) (safety) termozaštitno odijelo

thermal runaway (n) (electr, boating/yachting) pad unutarnjeg otpora (akumulatora, uslijed zagrijavanja), **kaskadni efekt**

thermals (n) (boating/yachting) termo odjeća

thermocouple (n) (marine eng) termoelement, termospoj, termopar

thermodynamics /ˌθɜːməʊdaɪˈnæmiks/ termodinamika, nauka o toplini

thermometer /θɜːˈmɒmɪtə/ (n) termometar, toplomjer **bimetalic strip** thermometer

bimetalni termometar, **liquid in glass** thermometer stakleni termometar s tekućinom

thick (adj) debeo

thickness (n) debljina

thick weather (n) (meteorol) gusta magla

thimble /ˈθɪmbəl/ (n) (seamanship) omča, očica, radanča; tal. redancia; radancia rope



thimble omča konopa

thin (adj) tanak **make thin** stanjiti, **render thinner** razrijediti, smanjiti viskozitet

thinner (n) razrjeđivač

third assistant engineer (n) (US) (marine eng, mar law) treći časnik stroja, *treći od makine* (=fourth engineer (UK))

third engineer (n) (marine eng, mar law) drugi časnik stroja (u hrvatskom sustavu), *treći od makine* (=third assistant engineer (US))

Third Engineer; 3rd Engineer (n) (mar law, safety) treći časnik stroja, treći oficir stroja, *treći od makine*

third mate (n) (navig, mar law) **SYNONYM third officer** treći časnik palube {customarily the third mate is the ship's safety officer, responsible for the ship's firefighting equipment, lifeboats, and other emergency systems}

Third Mate; 3rd Mate treći časnik palube, *treći (od koverte / kuverte)* **terco**: *The Third Officer of a merchant ship is responsible for the safety of the ship and the crew. He/she undertakes the responsibilities for maintenance of lifeboats and fire-fighting and signal equipment.*

third officer (n) = **third mate** (navig, mar law) treći časnik palube

third party liability (mar ins, mar law) odgovornost za štete nanesene trećim osobama

thole-pin; tholepin /ˈθəʊl,pɪn/ (n) (nav arch) palac za veslo, škeram



Thornback ray (n) raža

thorough /'θʌrə/ (adj) 1 a skroz; 2 temeljit; 3 potpun, cjelovit a **thorough investigation** cjelovito istraživanje, a **thorough survey** potpun pregled, kompletan pregled

thoroughly /'θʌrəli/ (adv) u potpunosti, u cijelosti, potpuno, kompletno

though /ðəʊ/ (conj) premda, iako, makar, ma da

thread /θreɪd/ (n) 1 (boating/yachting) konac **waxed thread** navoštene konac; 2 (marine eng) navoj **male thread** muški navoj, **female thread** ženski navoj

threading machine (n) (marine eng) stroj za narezivanje, nareznica

threat /θret/ (n) (safety) prijetnja **threat to navigation** prijetnja sigurnosti plovidbe

threaten /'θretən/ (v) (safety) prijetiti, ugrožavati

three-island vessel brod s trodijelnim nadgrađem (kaštel, most, krmica)

three-point-fix (n) (navig) pozicija s pomoću tri točke

three pole cable (n) (electr) kabel s tri žile

three pole switch (n) (electr) trolni prekidač

three sixty (n) (navig) okret za 360 stupnjeva **Are you going to do a three sixty?**

three-strand rope (n) (seamanship) konop sukan od tri struka, sukani konop, sukano uže

threshold /'θreʃəʊld; 'θreʃ, həʊld/ (n) (electr, navig) razina prihvaćanja signala

throttle /'θrɒtəl/ (n) (marine eng) gas, papučica gasa, tal. acceleratore

through bill of lading (n) (mar law) A bill of lading (supra) providing for the carriage of goods by water, from their point of origin to their final destination, either by successive ocean carriers or by more than one mode of transportation (Tetley); teretnica koja pokriva prijevoz u kojemu sudjeluje više prijevoznika **izravna teretnica**, **direktna teretnica**, **multimodalna ili kombinirana teretnica**, **teretnika koja pokriva prijevoz od vrata prodavaoca do vrata kupca**

through-hull fitting (n) (boating/yachting) ventil za odvod / dovod na trupu

throughout /'θruː.pʊt/ (prep) skoz, skroz-naskroz, preko svega

throughput /'θruː.pʊt/ (n) (shipping econ) promet (luke): *Shanghai become the world's largest container port by throughput.* **unitised throughput** promet jediničnog tereta

through rate /'θruː./ (n) (shipping econ) a freight rate applicable from point of origin to destination **direktna vozarina**, **direktan vozarinski stav**: *A through rate may be either a joint rate or a combination of two or more rates.*

through traffic /'θruː./ (n) (shipping econ) direktan promet

through transport /'θruː./ (n) (shipping econ) izravni prijevoz, direktni transport

throw (n) (marine eng) par koljena osovine s osnacem ručka

throw overboard (v) = **jettison** bacati (teret) u more, baciti preko palube u more

thrust /θrʌst/ (n) 1 (marine eng) potisak, pritisak, guranje **piston thrust** potisak klipa, potisak stapa, **side thrust** bočna sila; 2 (seamanship) poriv **thrust astern** poriv prema natrag, **thrust forward** poriv prema naprijed

thrust bearing /'θrʌst/ (n) (marine eng) odzivni ležaj

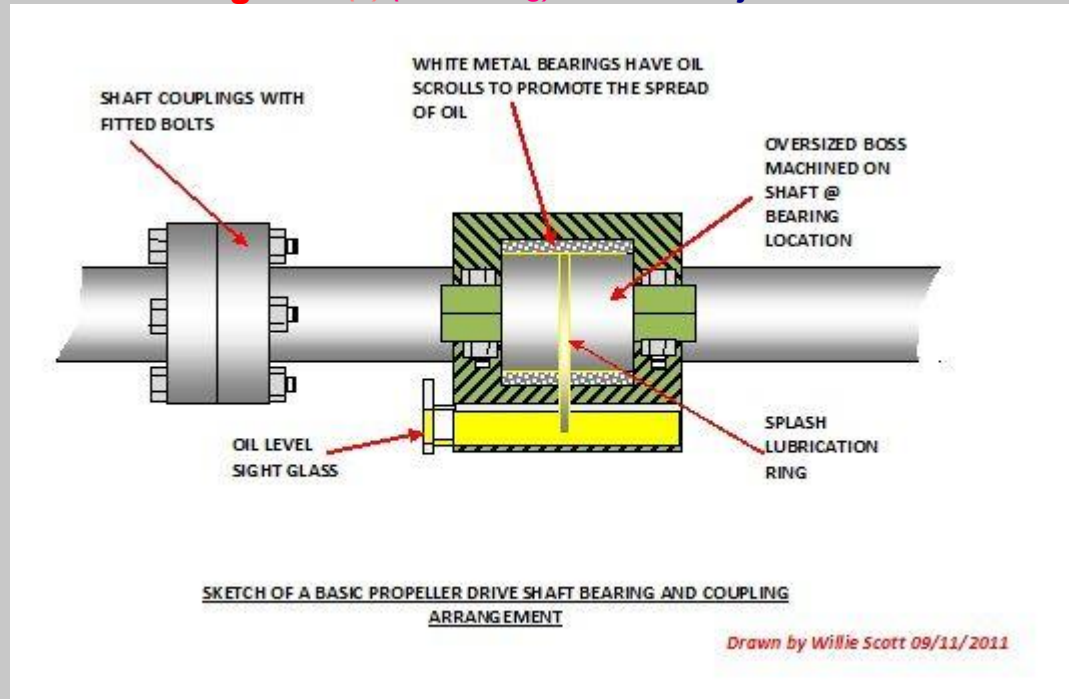

thrust block /'θrʌst/ (n) (marine eng) odzivni blok **main engine thrust block** odzivni blok glavnog stroja {ostali nazivi: **tilting pad bearing**; **Mitchell bearing**}

thruster /'θrʌstə/ (n) (marine eng) porivnik, **traster**, **thruster**. *The Captain fired up the thrusters to back the ship off the docks.* **bow** pramčani porivnik (za manevriranje), **stern thruster** porivnik na krmi (za manevriranje)

thunder /'θʌnde/ (meteorol) grom, grmljavina

thunderbolt /'θʌnde, bœʌlt/ (n) (meteorol) munja

thunder clouds (n) (meteorol) olujni oblaci

thunderstorm /'θʌnde, stɔ:m/ (n) (meteorol) a storm with lightning and thunder, produced by a cumulonimbus cloud, usually producing gusty winds, heavy rain and sometimes hail **grmljavinska oluja**, **grmljavinsko nevrijeme**, **oluja**, **nevera** (na Jadranskom moru), tal. **temporale thunderstorm** **high** grmljavinska anticiklona, **light thunderstorm** **neverin**, **severe thunderstorm** **jaka** grmljavinska oluja

thursh wrasse (n) (fishing) Lat. *Symphodus tinca* lumbrak



thwart /θwɔ:t/ (n) (**boating/yachting, nav arch**) klupica, poprečna klupica (na jedrilici, brodici za spašavanje)

thwartships /θwɔ:tʃɪps/ (adv) (**seamanship**) = **athwartships** at right angles to the fore and aft line (across the ship) **poprijeko** (boda, brodice)

ticket **Master's ticket** svjedodžba o položenom kapetanskom ispitu, tiket svjedodžba o položenom ispitu za ovlaštenje

ticket (n) (**shipping econ**) putna karta (na putničkom brodu, trajektu)

tick off (v) označiti kvačicom (npr. na popisu pitanja, radnji itd.) štrihirati

tidal arrow (n) (**oceanogr**) plimna strjelica

tidal atlass (n) (**navig**) plimni atlas

tidal berth (n) (**oceanogr**) plimni vez, vez s plimnim režimom

tidal conditions (n) (**oceanogr**) plimni uvjeti

tidal current (n) (**oceanogr**) plimna struja, tal. *corrente di marea*

tidal curve (n) (**oceanogr**) plimna krivulja

tidal drift (n) (**oceanogr**) brzina plimne struje

tidal energy platform (n) (**nav arch**) brod-platforma za proizvodnju električne

energije korištenjem plime i oseke: *The tidal energy platform was designed by Damen to be transported and installed all over in the world to provide clean energy in remote areas and small islands, replacing diesel generators.*

tidal port plimna luka, luka s plimnim režimom

tidal race (n) (**oceanogr**) brzac (struje)

tidal range (**oceanogr**) raspon plime, plimni režim, razlika / raspon između plime i oseke: *Max tidal range in the port of Rijeka is 1.2 m.*

tidal rip (n) (oceanogr) sraz struja, spoj struja

tidal set (n) (navy) smjer plimne struje

tidal stream (n) (oceanogr) = **tidal current** plimna struja: *The tidal stream around Tilburyness is complex due to the fluvial flow of the river. Plimna struja oko Tilburynessa je složena uslijed riječnog toka Tidal stream: 290° at 6kts The tidal stream was flowing north to south.*

tidal waters (n) (oceanogr) plimne vode, vode s plimom

tidal wave (n) (oceanogr) plimni val

tide /taɪd/ (n) (oceanogr) ebb **tide** oseka, flood **tide** plima, high **tide** plima, visoka voda, low **tide** oseka, niska voda, neap **tide** mrtva morska mijena, spring **tide** živa morska mijena, to stem the **tide** ploviti protiv plimne struje, ploviti protiv struje 1 the vertical rise and fall of the ocean level caused by the gravitational force between the earth and the moon (and to a lesser extent, between the earth and the sun (Seasources.net) a morska mijena, tal. *marea*; 2 plima i oseka the **tide rises and falls** plima raste i pada, the **tide drops** plima opada, height of **tide** visina plime: *We had to wait for sufficient height of tide to transit these channels, slack **tide** stanje mirovanja mijena, mirovanje mijena, semidiurnal **tide** poludnevne mijene, diurnal **tide** jednodnevne mijene, rising **tide** plima u rastu, more u porastu: A tug was promptly called and with the **rising tide** the vessel was quickly re-floated and properly berthed.; 3 plima; 4 **SYNONYM tidal current** plimna struja set of **tide** smjer plimne struje, drift of **tide** jačina plimne struje, brzina plimne struje, setting of **tide** smjer plimne struje; 5 struja {tal.: *marea*}*

tide rips (n) (oceanogr) sraz struje

tides (n) (oceanogr) 1 morske mijene; 2 struje variable **tides** promjenljive struje

Tide Tables (n) (navig) Tablice morskih mijena, tal. *Annuario delle maree* Admiralty **Tide Tables** Admiralitetske tablice morskih mijena

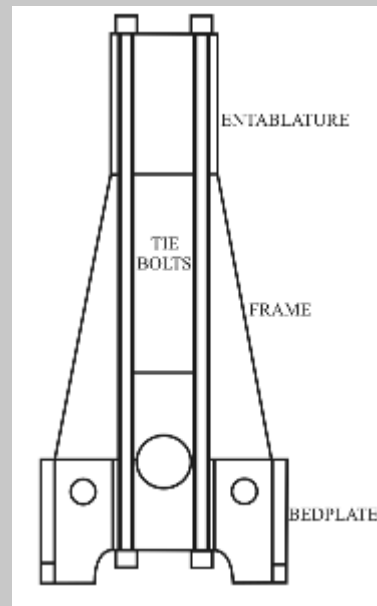

tie-bolt /ˈtaɪ,bəʊlt/ (n) (comm) kotveni vijak, kotvena šipka

tier /tiə/ (n) (cargo) tiers are the vertically positioned containers on board a vessel red kontejnera (na brodu) po visini: bottom **tiers** redovi kontejnera na dnu broda / skladišta, subsequent **tiers** redovi (kontejnera) koji se slažu jedan iznad drugoga, Number of

Tiers on Deck for Container Carriers broj vertikalnih redova kontejnera na palubi

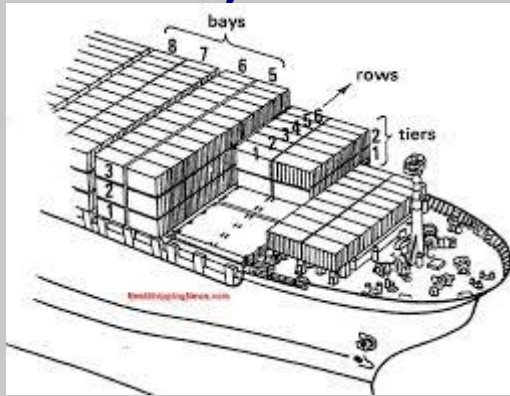

za kontejnerske brodove

{The container tiers are numbered with even numbers, starting from the bottom. The conventional way is start with 02 in the hold and then count up with 04, 06 etc. In the case of deck cargoes, it is conventional to start numbering with 80 or 82.}

tie-rod /'taɪrɒd/ (n) (marine eng) kotveni vijak, kotvena šipka

tie up /'taɪ,ʌp/ (=tied up; tying up) (v) (US) 1 (seamanship) = moor¹ privezati

brodicu, privezati barku, privezati brod *The fishing boat entered into a small inlet on the Normandy coast, tying up at the wooden jetty. Ribarica je ušla u malu uvalu na normandijskoj obali privezavši se uz drveni gat. How to tie up a boat? Kako privezati brodicu? A wharf is a place place at which ships tie up to unload and load cargo. The longshoremen and ship staff are tying up the Grand Princess in Ocho Rios. Privezivači i brodska posada privezuje brod za kružna putovanja Grand Princess u luci Ocho Rios.; 2 (seamanship) vezati brodsko uže*

tight /taɪt/ (adj, adv) 1 nepropusan **air-tight** zrakonepropusan, hermetičan, **gas-tight** plinonepropusan, plinotijesan, **water-tight** vodonepropusan, vodotijesan, **oil-tight** uljonepropusan; 2 napet (konop): *the headline is tight* pramčano uže je napeto / zategnuto; 3 tijesan; 4 čvrst; 5 zategnut (vijak)

tighten /'taɪtən/ (v) **tighten up** stegnuti, zategnuti, spojiti zategnuti, stegnuti, pritezati

tiller /'tɪlə/ (n) (boating/yachting) an arm attached to the rudder head for operating the rudder **rudo kormila**, **argola**, **orgutlo**, tal. **barra del timone** **rudder tiller** rudo kormila, **tiller**



extension produžetak ruda kormila

tilt (v) (cargo) **naginjati se**, **nagnuti se**: *Loose lashings allowing the stacks to tilt and arrest sharply as the slack is taken up.*

tilt (n) nagib (zvrka)

tilt (n) (navig) stožasta rotacija radarske antene (uslijed valjanja i posrtanja broda)

tilting (n) 1 (cargo handling) nagib, kosina, kosi položaj; 2 (navig, electr) brzina nagiba (zvrka)

tilting pad bearing (n) (marine eng) = **thrust block** odrivni blok

timber /'timbe/ = **lumber** (cargo) drvo, rezana građa: Cargo vessels often carry timber, usually sawn construction material such as deals, battens, planks and boards. **green timber** svježe (prerano posječeno) drvo, drvo podložno pljesnivošću, **newly sawn timber** svježe rezano / sječeno drvo, **timber deck cargo** drveni palubni teret

timber carrier (n) (nav arch) brod za drvo, brod za prijevoz drva



timber deck cargo (n) (cargo) palubni teret drva

timber load line teretne linije za teret drva

timber load line marks

timber load line marks oznake teretnih linija za teret drva

time (n) vrijeme **in ample time** uz dovoljno vremena, **in good time** pravodobno, **sawn time** rezana (drvena) građa, **delivery time** vrijeme isporuke, rok isporuke, **in course of time** tijekom vremena

time (v) vremenski regulirati, tempirati

timebase /'taim,beis/ (n) (electr, navig) vremenska baza (radara), sustav vremenske baze (radara)

timebase trace (n) (navig) neprekinuta svijetla crta (na radarskom zaslonu)

time charter (n) (mar law) A time charterer (TC) is an arrangement where the charterer is given operational control for the cargo-holding vessel, while leaving management in control of the ship owner.

(<https://brage.bibsys.no>) **brodarski ugovor na vrijeme za cijeli brod**, **ugovor na vrijeme**:

A general cargo vessel operating under a time charter agreement was scheduled to load a combined cargo of containers and cement bags under deck and, unusually for the ship, containers on deck. Under **TC (time charter) contracts**, vessels are hired for a specific period at a pre-decided daily rate. **trip time charter**

The trip time charter is for one voyage, or a very short period of time **ugovor o najmu broda za jedno ili vrlo kratko putovanje**. **Trip charter rates** are therefore also spot rates, but in contrast to the voyage charter the payment is made on a \$/day basis, hence reducing risk for the ship owner

in the occurrence of delay outside of port (<https://brage.bibsys.no>), **enter into a time charter contract**

contract sklopiti ugovor o najmu broda na vrijeme: Shipping announced **has entered into a time charter contract** with, for one of its Capesize dry bulk vessels, the m/v

time charterparty (mar law) A time charterparty is a contract whereby the lessor (the shipowner or demise charterer) places a fully equipped and manned ship at the disposal of the lessee (the time charterer) for a period of time for a consideration called hire payable at specified intervals during the term of the charter (Tetley) **brodarski ugovor na vrijeme (EUDict)**, **ugovor o najmu broda na vrijeme**, **ugovor o iskorištavanju broda na vrijeme**

time charter rate; TC rate (n) (shipping econ, mar law) the daily rate the ship owner receives for operating a vessel under a time charter agreement, and is denoted in USD/day (https://brage.bibsys.no **dnevna najamnina broda u ugovoru na vrijeme**: *Rising TC rates give a brighter outlook for the dry bulk industry and vice versa. TC rates for dry bulk vessels have fallen considerably over the last few months. Panamax and Ultramax one-year TC rates have fallen by 38% and 39%, respectively, to \$5,000 and \$5,200 per day.*

time freight (n) (shipping econ) vozarina po jedinici vremena

time lost in waiting for berth to count as loading or discharging time (n) (mar law) vrijeme izgubljeno zbog čekanja na privez računa se kao vrijeme ukrcaja

time policy (n) (mar ins) policica na vrijeme

time sheet (n) (mar law) dokument u obliku tablice koji se sastavlja radi bilježenja i obračunavanja stojnica i prekostojnica i uštede u vremenu **vremenska tablica**

time slot (n) (navig) vremenski interval

time to bow cross range; (TBCR) (n) (navig) **COMPARE bow cross range: (BCR)** vremensko razdoblje do dolaska na točku najmanje удаčjenosti mimoilaženja brodova po pramcu (u minutama)

time to closest point of approach (TCPA) (n) (navig) **COMPARE closest point of approach; (CPA)** vrijeme do najbliže točke susreta, vremenski interval do dolaska na najmanju udaljenost mimoilaženja (u minutama)

time zone (n) (oceanogr) vremenska zona

timing /'taimɪŋ/ (n) **1** (marine eng) vremensko reguliranje, vremensko usklađivanje, tempiranje, sinkroniziranje **scavenge and exhaust port timing** vrijeme otvaranja i zatvaranja ispirnih i ispušnih kanala; **2** reguliranje trenutka paljenja, otvaranja i zatvaranja ventila **timing gear drive** pogonski uređaj za reguliranje, zaupčasti prijenos regulacijskog uređaja

timing belt (n) (marine eng) razvodni remen

tin (n) limenka

tin; (Sn) /tin/ a metallic element, occurring in cassiterite, that has several allotropes; the ordinary malleable silvery-white metal slowly changes below 13.2°C to a grey powder. It is used extensively in alloys, esp bronze and pewter, and as a noncorroding coating for steel. Symbol: Sn **kositar, kalaj tin; (Sn)-based alloy slitina na bazi kositra**

tip /tip/ (n) **1** (marine eng) **vršak burner tip** vršak gorionika, vršak plamenika; **2** (geogr) vrh rta, krajnja točka rta: *tip of Cape Cod*

tipping effect (n) (cargo handling) efekt rušenja (na vrhu reda tereta)

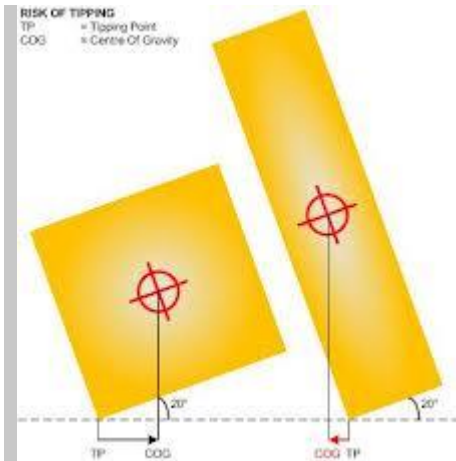

tipping moment moment rušenja (složenog reda kontejnera): *The lashing bridge allows the anchoring points for each stack to be moved higher up the stack, which allows the lashings to be more effective in reducing the tipping moments acting on a stack when a vessel is rolling heavily.*

titanium; (Ti) /tai'teiniəm/ (n) (chem) titan

title /'taitəl/ (n) (mar law) 1 naslov document of **title** isprava o pravu vlasništva nad teretom; 2 pravo vlasništva (nad robom, teretom) **title to the goods** pravo na robu

TK; (n) (stabil, nav arch) draught amidships measured from the lower side of the keel plate at Lpp2 gaz na glavnom rebru mjereno od donje strane kobilice

TKM; Height of Transverse Metacentre on Bow Base Line (n) (stabil) udaljenost metacentra od kobilice

T-knot (n) (fishing) čvor za kopčanje skosavice, čvor (za spajanje skosavice) s kopčom na T

TLM (Telemetry) (n) (navig) riječ TLM (u GPS navigacijskoj koruci), telemetrijska

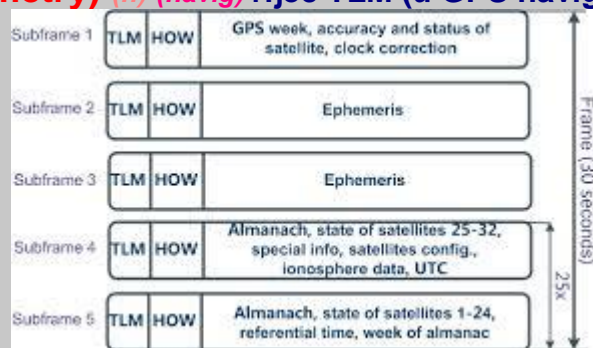

informacija

information on telemetry and parity bits.

(The TLM word carries preamble,

T; moulded draught amidships (n) (stabil, nav arch) the moulded draught amidships, i.e. measured from the upper side of the keel plate at Lpp/2. **baždarni gaz na glavnom rebru**

TM; transverse metacentre (n) (nav arch) poprječni metacentar **initial TM;** transverse metacentre početni poprječni metacentar

TM; True Motion Picture (n) (navig) prava slika, *TM slika*

to-and-fro amo-tamo **to-and-fro motion** gibanje amo tamo

toestrap /'təʊ, strəp/ (n) (boating/yachting) traka za noge (za držanje pri nagnutoj jedrilici)

toestraps /strəps/ (n) (boating/yachting) trake za oslanjanje stopala pri nagnjanju jedrilice ili

užešnju flokista ili kormilara o trapez **vrpce za noge**

TOFC (trailer on flat car) (n) (cargo) prikolice na vlaku (vidi piggyback, huckepack)

toll (n) (shipping econ) naknada za prolaz kanalom: *The ACP sets tolls for containerhips based on vessel size and TEUs. The toll was paid by the Mitsui O.S.K. Lines-operated containerhip for a northbound transit of the canal.*

topot blenny (n) (fishing) slingurica, babica mrkulja {lat. *Parablennius gattorugine*}

ton /tʌn/ (n) (nav arch) is a unit of measure - used principally as a unit of mass, and as a unit of volume

tona short ton (US) kratka tona (2000 lbs), **long ton (UK)** (UK) duga tona (2240 lbs),

metric ton equal to 1000 kilograms, or approximately 2204 pounds **metrička tona (1000 kg / 2204 lbs)** {The word ton is derived from the tun, the term applied to a barrel of the largest size}

to name bill of lading (n) (mar law) = **named bill of lading** teretnica (koja glasi) na ime

tonnage /ˈtʌnɪdʒ/ (n) **1 a** (nav arch) **tonaža broda**, tal. **stazza gross tonnage (GT)** the actual carrying capacity of the ship's hull below the upper deck, in cubic feet, divided by 100. **bruto tonaža**, tal. **stazza lorda**, **gross register tonnage (GRT)** The volumetric cargo capacity of the ship according to its certificate of registry. **bruto registarska tona**, **net tonnage** gross tonnage less the number of cubic feet reserved for crew's quarters, ships stores, bunkers, engine room space, etc. **neto tonaža**, tal. **stazza netta**, **deadweight cargo capacity** In a voyage charterparty, the vessel's deadweight tonnage, from which bunkers, fresh water and constant (e.g. galley supplies, paint, lubricating, oil, etc.) are deducted, to determine the ship's actual cargo carrying capacity. **kapacitet nosivosti**, **deadweight tonnage** the actual cargo carrying capacity of the ship, when she is fully loaded with cargo so that the hull is immersed in water up to her Plimsoll marks **nosivost**, **displacement tonnage** a term usually used in warships to measure the weight of the water displaced by the ship when she is fully loaded with all her crew, bunkers, stores and equipment and armament on board. **istisnina**, **register tonnage** the gross tonnage and/or the net tonnage, as entered on a ship's certificate of registry. A register ton is 100 cu. ft. **registarska tonaža**; **2 zapremninska tonaža**, **baždarna tonaža**; **3 brodovlje**, **brodovi**

Tonnage Dues Slip /ˈtʌnɪdʒ/ (n) (shipping econ) Isprava o obračunu pristojba na temelju tonaže

tonnage mark /ˈtʌnɪdʒ/ (n) (nav arch) baždarska oznaka

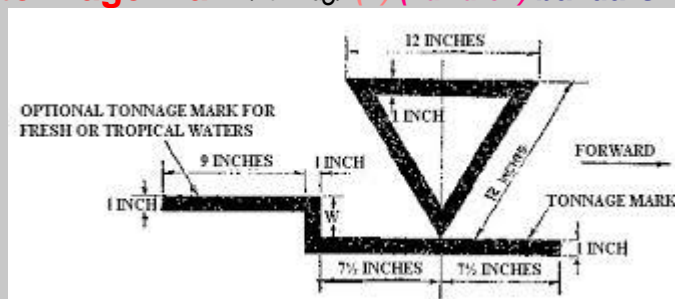

tonnage measurement /ˈtʌnɪdʒ/ (n) (mar law) način određivanja zapremnine broskog prostora (kao mjerilo za naplatu pristojbi i drugih naknada broda prema luci, državi luke itd.) **baždarenje broda**

tonnage measurement certificate /ˈtʌnɪdʒ/ baždarska svjedodžba

tonnage measurement certificates /ˈtʌnɪdʒ/ baždarske isprave

tonnage measurement deck /ˈtɒnɪdʒ/ **paluba baždarenja**

tonnage opening /ˈtɒnɪdʒ/ (n) (nav arch) **tonažni otvor**

tonne /tʌn/ (n) (cargo) a unit of mass equal to 1000 kg or 2204.6 pounds **tona**, **metrička tona** {The metric ton is officially called tonne by ISO}

tonne-miles; tm (n) (shipping econ) A unit of freight transportation equivalent to a ton of freight moved one mile. **tona milja**, **tona-milja**, **jedinica prijevoza tereta: jedna tona tereta**

prevezenog u duljini od jedne milje: *This ship will start trading when freight rates rise slightly above \$155 per million tonne-miles (mtm). At \$155 per mtm, the ship will sail at the lowest possible speed of 11 knots to save fuel, offering a transportation of 10,1 billion tonne-miles (btm) a year.* **MTM - million ton miles** **milijun tona milja** {ton-mile in the USA: 1 ton-mile * (0.907185 t / short ton) * (1.609344 km / mile) = 1.460 tkm[]}

tool /tu:l/ (n) **power tool** **alatni stroj**, **mehanički alat** **1** (marine eng) **alat**, **oruđe** **store tools** **spremiti alat**; **2** (marine eng) **sredstvo**

toolbox (n) (marine eng) **kutija za alat**

tool cabinet (n) (marine eng) **kolica za radionice**

tool port (n) (mar law, ports) **COMPARE port privatization** **državna luka s privatnim sлагаčkim i skadišnim operatorima**

to order bill of lading (n) (mar law) = **order bill of lading** **teretnica po naredbi / nalogu**

to order of shipper (prep phr) (mar law, shipping econ) The shipper, by way of endorsement and passing of the document, allows a transfer of the rights to take delivery of the goods in the document e.g. a bill of lading. **po krcateljevom nalogu**, **po nalogu krcatelja**

tooth (n) (marine eng) **zub**, **zubac** (zupčanika)

toothed gear /tu:θt/ (n) (marine eng) **zupčanik**

top (n) **koš** (na jarbolu, samarici), **tal. coffa** {tal.: coffa}

top dead centre; (TDC) (n) (marine eng) **ANTONYM bottom dead centre;**

BDC; BTD **gornja mrtva točka (hoda klipa motora)**: *When setting the engine to TDC on the compression stroke for cylinder #1, you must realize that the crankshaft rotates twice for every single rotation of the camshaft. onal jerk pump fuel injection system: diesel fuel is injected at high pressure into the combustion chamber just before the top dead centre (TDC).*

reach top dead centre; (TDC) **doseći gornju mrtvu točju** {tal.: punto morto superiore}

top end (n) **1** (marine eng) **gornji krajnji položaj**; **2** (marine eng) **ANTONYM large end** **gornji kraj ojnice**, **manji kraj ojnice**

toper (n) **pas butor**

tope shark (n) **pas butor**

topgallant-bulwark planking /ˌtɒpˈgælənt; (nautical) təˈgælənt/ (=təˈgælənt , 'bulwək ,plæŋkɪŋ) (n) (sailing vessels) **oplata među razmama**



topgallant mast /te'gælənt/ (n) **gornji nastavak (jarbola)**

topgallant rail /te'gælənt/ (n) (sailing vessels) **gornja razma, razma**

top mark, topmark (n) (navig) one or more relatively small objects of characteristic shape and color placed on an aid to identify its purpose **vršni znak (pomorske oznake), oznaka na**

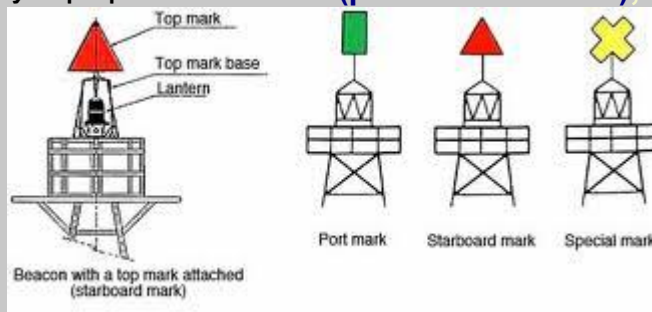

vrhu, tal. maraglio (boa)

topmast /'tɒp,mɑːst/; (nautical) 'tɒpməst/ (n) **kosni nastavak topmast trestle tree križac**

kosnog nastavka, topmast head izdanak kosnog nastavka, vrh kosnog nastavka,

topmast cap glavina kosnog nastavka, topmast rigging pripone nastavka jarbola,

topmast cross-tree gornji križac, topmast backstay zapone kosnog nastavka

topmast stay (n) (nav arch) **prednje leto, leto kosnika**

topmast-studding-sail booms (n) **debljak košnog krilnog jedra**

top of ballast tank pokrov dvodna

top of inner bottom (n) (nav arch) **pokrov dvodna**

~ to port / starboard /'ɔːltə/ (v tr) (navig) **promijeniti kurs ~ to port / starboard**

promijeniti kurs u lijevo / desno: *Immediately after crossing, she inexplicably began to alter*

course hard to starboard and turn back towards our vessel. The tanker's master assumed that the container ship would alter to port on leaving the buoyed channel and pass astern.

topping lift /'tɒpiŋ/ (n) **1 (cargo handling) = span** line, wire, or tackle used to hoist, lower, and support the head of a cargo boom or the outboard end of a sailing boom or boat boom **klobučnica**

samarice, španjola *The derrick topping lift double purchase was disconnected from the derrick*

head and attached to the derrick boom near the heel with a wire strop, with the intent **topping lift**

tackle koloturnik klobučnice; 2 (boating/yachting) podigač deblenjaka, gindac buma;

3 (boating/yachting) ANTONYM downhaul podigač deblenjaka spinakera, podigač

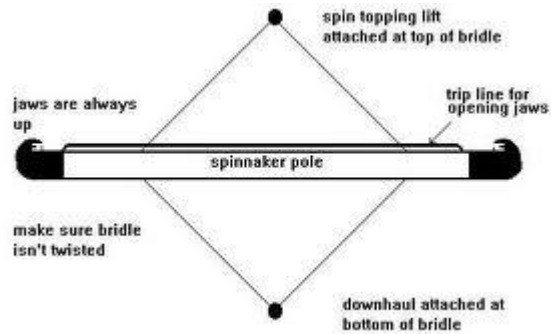

tanguna špinakera, gondolijera

podigač križa (na jedrenjaku), tal. amantiglio

topping winch /ˈtɒpɪŋ/ vitlo klobučnice

topping wire /ˈtɒpɪŋ/ (n) (cargo handling) čelično uže nosač kraka dizalice

topsail /ˈtɒpˌseɪl; (naut) ˈtɒpsəl/ (n) (boating/yachting) vršnjača

topsail-tye /ˈtɒpsəlˌtaɪ/ (n) podržac košnog križa

topside planking /ˈtɒpsaɪd/ (n) (sailing vessels) oplata mrtvog boka

topsides (n) (boating/yachting) dio trupa iznad vodne linije

top swivel (n) (boating/yachting) vrtilica na vrhu prednjeg leta (radi sprječavanja podigača zajedno s jedrom), dogulin

top tier (n) (cargo handling) najviši red (kontejnera)

top timber (n) (sailing vessels) izdanak rebra, gornji dio rebra

top up (n) (marine eng) dopuniti, doliti **top up the fuel tank** dopuniti tank (do vrha)

torch /tɔːtʃ/ (n) 1 (safety) svjetiljka, baterijska svjetiljka **torch light** ručna svjetiljka; 2 (marine eng) plamenik **cutting torch** plamenik aparata zarezanje



turn /tɔːn/ (adj) (cargo) poderan (vreća)

tornado /tɔːˈneɪdəs/ (n) (meteorol) a violent rotating column of air, in contact with the ground, pendant from a cumulonimbus cloud **tornado**

toroidal /tɔːˈrɔɪdəl/ (adj) (marine eng) prstenast, toroidan

torpedo boat /tɔːˈpiːdəʊˌbəʊt/ (n) (navy) torpednjak, torpedni čamac

torque /tɔːk/ (n) (marine eng) any force or system of forces that causes or tends to cause rotation; the ability of a shaft to cause rotation (Collins On-Line) **zakretni moment, torzija load torque moment opterećenja, opterećenje zakreta, smooth torque jednoličan zakretni**

moment, ravnomjeran zakretni moment

torque monitoring system (n) (marine eng) kvantificirano praćenje radnih

karakteristika stroja *The new torque monitoring system, called Torductor Marine, is aimed at optimizing engine and fuel efficiency in the maritime sector. {Torductor Marine provides ship-owners with a clear and quantifiable insight into the performance of the vessels engine, such as propulsion power, Specific Fuel Oil Consumption (SFOC), total number of shaft revolutions and the total amount of energy developed during a voyage. }*

torque wrench /'tɔːrɛntʃ/ (n) (marine eng) momentni ključ, kilo-ključ, dinamometar

precision torque wrench precizni momentni ključ: *torque wrench with quick lock rotary mushroom ratchet head precizni momentni ključ s brzim zaključavanjem obrtne reverzibilne zavrtnje glave*



torsion /'tɔːʃən/ (n) (marine eng) the twisting of a part by application of equal and opposite torques at either end **torzija, zakretanje, uvijanje, sukanje torsion moment zakretni moment**

tort a civil wrong arising from an act or failure to act, independently of any contract, for which an action for personal injury or property damages may be brought; Tort laws involve civil suits, which are actions brought to protect an individual's private rights. There are two major categories of torts typically seen in education-related cases: intentional and negligence. (www.thefreedictionary.com/Civil+tort);

zaštita prava pojedinca od drugih pojedinaca; odgovornost pojedinca; tort, in common law, civil law, and the vast majority of legal systems that derive from them, any instance of harmful behaviour, such as physical attack on one's person, interference with one's possessions, or the use and enjoyment of one's land, economic interests (under certain conditions), honour, reputation, and privacy. The term derives from Latin *tortum*, meaning "something twisted, wrung, or crooked." The concept encompasses only those civil wrongs independent of contracts. ; civil wrong arising from an act or failure to act,

independently of any contract, for which an action for personal injury or property damages may be brought (<https://www.collinsdictionary.com/dictionary/english/tort>) **krivica (u građanskom pravu), delikt, odgovornost maritime tort krivica u pomorskom pravu, delikt u pomorskom pravu:** *Maritime liens can arise not only when the personified ship is charged with a maritime tort such as a negligent collision or personal injury, but also for salvage services, for general average contributions, and for breach of certain maritime contracts.*

tort law /tɔːt/ (n) (mar law) zaštita privatnih prava pojedinaca

torts /tɔːts/ (n) (mar ins) izvanugovorna odgovornost

total loss (n) (mar law) an actual total loss of the vessel or such damage to the vessel that the cost of saving and repairing her would exceed her market value at the time of the collision. (Lisbon Rules 1987,

potpuni gubitak broda, totalna šteta constructive total loss potpuni gubitak pri kojemu je brod toliko uništen da njegov popravak nije isplativ **izvedeni potpuni gubitak, izvedena**

totalna šteta, actual total loss stvarni potpuni gubitak, stvarna totalna šteta

to the same extent as the insurer (n) (mar ins, mar law) u staj mjeri koliko i

osiguravatelj

touch (n) 1 dodir, doticaj, kontakt; 2 nekoliko okretaja propelera (pri manevriranju)

touch (v) dodirnuti, taknuti **touch the bottom** dodirnuti dno (npr. brod na vezu), nasukati se

touch and go (v) (mar law, safety) dodirnuti dno i nastaviti putovanje (o brodu)

touch screen (n) 1 (nav arch) radarski pokazivač (ekran) na dodir prsta; 2 zaslon na dodir, ekran na dodir

tough /tʌf/ (adj) žilav, otporan, čvrst

tough material (n) (marine eng) žilavi materijal

toughness /ˈtʌfnɪs/ žilavost

tour /tʊə/ (n) 1 a obilazak **make a tour** obići; 2 smjena

tourist boat /ˈtʊərɪst/ (n) (nav arch) turistički brod

tourist craft /ˈtʊərɪst/ (n) (nav arch) turistički brod

TOVALOP (n) (mar law) Tanker Owners' Voluntary Agreement concerning Liability for Oil Pollution.

An agreement subscribed by most of the world's tanker operators whereby the Owners agree to reimburse Governments for oil pollution clean-up costs. Each member insures his potential liability under the agreement. (Tetley) **TOVALOP**, Sporazum kojim se tankerski brod obvezuje nadoknaditi štete državama nastale zbog onečišćavanja mora uljem

tow /təʊ/ (v) (seamanship) **tegliti**: *The pilot twice asked the aft tug to tow right astern, but the tug remained in push mode.* Peljar je dvaput tražio zapovjednika krmenog tegljača da tegli ravno u krmu, ali je tegljač i dalje ostao u stanju guranja. *The vessel was refloated later Monday night and had to be towed to an nearby anchorage.* **tow alongside** **tegliti po boku**, **tow the vessel** **tegliti brod**: *the bulk carrier is currently awaiting for the tug to arrive on scene* **to tow the vessel** **to Port Arthur.**

tow /təʊ/ (n) 1 (navig) **tegalj (tegljač/i + tegljeni brod)** **take in tow** **odtegliti uzeti u tegalj**, **under tow** **u teglju**: *The ship that ran aground in bad weather has been successfully refloated and stabilized and is now under tow to a safe harbor,* ; 2 **tegljenje**

towage /ˈtəʊɪdʒ/ (n) (navig, mar law) a contract whereby one ship moves another. Towage, as opposed to salvage, is a service contract, which does not involve a marine peril, and the consideration is an hourly or daily rate or a lump sum, rather than a salvage reward based on the peril, the work accomplished and the value of the object salvaged. (Tetley) **tegljenje**, **remorkaža**

towage contract /ˈtəʊɪdʒ/ (n) (mar law) ugovor o tegljenju

towboat /ˈtəʊ, bəʊt/ **tegljač**, **remorker**

tow bridge (nav arch) stremen za tegljenje (na tegljaču)

tower /ˈtaʊə/ 1 (cargo) **prekrcajni most (dizalica)**; 2 (navig) **toranj (svjetla, oznake)**

To whom it my concern (n) (mar law) potvrda

tow hook kuka za tegljenje

tow hook (nav arch) kuka za tegljenje

towing /ˈtəʊɪŋ/ (n) (seamanship) **tegljenje** **towing operations** 1 **tegljenje**, **operacije**

tegljenja; 2: *The towing operation has been approved by French officials and commenced on Friday afternoon,*

towing bollard (n) (nav arch) tegljačka bitva

towing bridle (boating/yachting) uzde za tegljenje

towing hawser uže za tegljenje, teglo

towing hook (n) (nav arch, seamanship) = **tow hook** kuka za tegljenje: *survey of the salvaged tug (Figure 2) found that many of the watertight doors and hatches were open and it was not*



possible to release the towing hook.

towing light (n) (navig) svjetlo za tegljenje

towing line (n) (seamanship) teglo, uže za tegljenje **attach the towing line** privezati uže za tegljenje

towing vessel (n) (nav arch) tegljač

towing winch (n) (nav arch) vitlo za tegljenje

towline /'təʊ.laɪn/ (n) (seamanship) = **towing line** uže za tegljenje, teglo **attach the**

towline: *A four-man team from SMIT Salvage has successfully boarded the heavily listing car carrier in an attempt to attach a tow line to the drifting vessel.* **privezati uže za tegljenje, establish a towline** uspostaviti tegalj (vezivanjem teženog užeta na brod): *Crews have started preparing for the car-carrier's possible grounding if a tow line cannot be established in the next 24 hours.*

tow-rail (n) (nav arch) luk za tegljenje

tow rope (n) (seamanship) = **towing line** uže za tegljenje

tow safe guard rail zaštitni tegljački luk

toxic and infectious substances /'tɒksɪk ənd ɪn,fɛkʃəs/ (n) (cargo) otrovne i infektivne tvari {klasa 6 opasnih tvari}

TPC; tones per centimetre immersion (n) (stabil) the line of the ship's hydrostatic data that allows a means of calculating the change in draught when loading and discharging cargo **tone po centimetru urona broda, tone po centimetru zagažaja** *TPC is the immersion weight, i.e. the weight which when added or subtracted will change the draught by one centimetre*

tracer (n) (shipping econ) = **cargo tracer** A request on a transportation line to trace a shipment for the purpose of expediting its movement or establishing delivery.

(<http://www.maerskline.com/en-jm/help/shipping-glossary>) **potražnica za teretom**

track /træk/ (n) 1 (navig) the path a vessel or aircraft plots over the surface of the Earth; The track or course over ground, is the actual path followed by the vessel from A to B.; The intended or desired horizontal direction of travel with respect to the earth. The track as expressed in degrees of the compass may be different from the course due to such factors as making allowance for current or sea or steering to resume the track. (Bowditch 2002); smjer kretanja broda **trajektorij, trajektorija, put (kretanja broda) putanja (broda), trag kretanja broda (na karti, ECDIS karti itd.), ruta, kurs broda preko dna, tal. percorso; traiettoria planned track** planirana ruta:

The ship altered course to follow her planned track into the TSS, **wrong track** pogrešna ruta, **right track** ispravna ruta, **intended track** zadana ruta, zacrtana ruta, namjeravana ruta, ucertana ruta (na karti, elektroničkoj karit itd.) određena ruta At this point she was approximately 0.5 mile north of her intended track., **construct a track** izraditi rutu, **adjust a track** ispraviti rutu, podesiti rutu, **computer-generated track** računalna ruta, **resume the track** vratiti se na zadanu rutu, **charted track** ucertani put, ucertana



putanja broda ; 2 (navig) ruta, ucertana ruta
 putovanja, trajektorij: the pilot instructed the container ship to move to the starboard side of the recommended track to avoid the tanker and maintain minimum speed **recommended track**
 preporučena ruta, **deviate from the planned track** skrenuti s planirane rute, **plot the track** ucertati rutu, **lay the track** ucertati rutu broda: If the scale of the chart permits, lay the track out to the starboard side of the channel to allow for any vessel traffic proceeding in the opposite direction., **track indicator** pokazivač rute; 3 (navig) put između dvije pozicije, trajektorij **determine the ship's track** odrediti stvaran put kretanja broda, **odrediti put kretanja broda preko dna**: If the ship is equipped with an ECDIS, it is reasonable for the navigator to simply monitor the progress of the ship along the chosen track, visually ensuring that the ship is proceeding as desired, checking the compass, sounder and other indicators only occasionally.
 (Bowditch 2002), **departure track** ruta broda pri isplavljenju, **approach track** ruta broda prilikom prilaza (luci, oznaci) {A mark or succession of marks left by something that has passed. A path, route, or course indicated by such marks. Some ambiguity exists in the fact that the path a navigator intends to follow, after evaluating and counteracting possible effects of wind and current, is also called a track}
track /træk/ (v) (navig) To follow the movements of an object such as by radar or an optical system. pratiti (put kretanja broda na radaru)



track (n) (boating/yachting) šina jarbola (za hvatanje jedra)

trackball (n) (navig, electr) kuglica za upravljanje kursorom (radara), kugla za upravljanje, kugla za ucrtavanje: roll the trackball to choose a menu or sub menu roll the trackball upward or downward to adjust the tuning **roll the trackball** pomicati kuglicu



{Trackball chooses menu items and options; shifts cursor.}

Track Control System (in high traffic density) The system that keeps the vessel on a predetermined track, using an input from satellite navigation system **uređaj za upravljanje rutom broda, uređaj za kontrolu rute / putanje broda**

track indicator (n) (navig) pokazivač rute, pokazivač putanje broda

tracking /'trækiŋ/ (n) (navy) In the operation of automated radar plotting aids, the process of observing the sequential changes in the position of a target to establish its motion. **praćenje i pronalaženje (objekta / cilja), praćenje (objekta radarom itd.) automatic tracking system** susatv automatskog praćenja i pronalaženja objekata *All radars, including those with automatic tracking systems and ARPA, have difficulty maintaining track on small, high speed vessels.*

tracking ball (n) (navig) kugla za ucrtavanje (na radaru) *This radar is operated with the controls of the display unit (and the remote controller), which includes 18 keys that are labeled with their functions, three knob controls and a trackball.*

tracking of vessels (n) (navig) radarsko praćenje kretanja broda **continuous**

tracking of vessels stalno radarsko praćenje kretanja brodova: . Continuous tracking of the vessel movement will be maintained by the Vessel Traffic Centre (VTC) which will also pass relevant navigational information affecting the projected route to the vessel.

tracking subsystem (n) (navig) sustav za praćenje ARPA radara

track-line (n) (navig) = intended track zadana ruta

tractor /'trækte/ traktor, cestovni tegljač

trade /treid/ (n) 1 a (shipping econ) = service trgovina international trade

međunarodna trgovina, Ministry of trade (UK) Ministarstvo trgovine; 2 promet

seaborne trade pomorski promet, pomorska trgovina; 3 plovidba, servis

international trade međunarodna plovidba; 4 linija, ruta

trades /treidz/ (n) (meteorol) SYNONYM trade winds pasati

trade terms 1 trgovinski uvjeti, trgovinske odredbe; 2 međunarodni trgovinski uvjeti, oblici i uvjeti kupoprodaje, uvjeti međunarodnog prijevoza stvari

trade winds (n) (meteorol) steady winds blowing toward the equator, N.E. in the northern and SE.

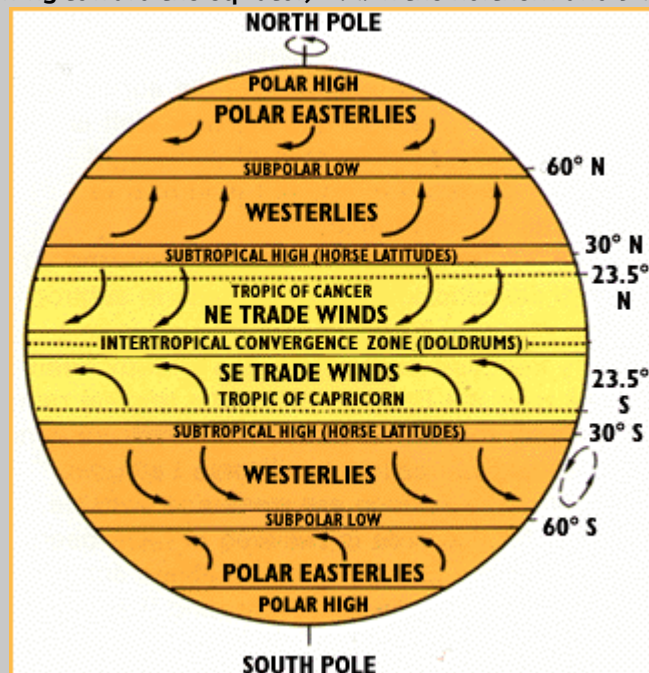

in the southern hemisphere pasati, tal. alisei

traditionally manned engineer room (n) (marine eng, mar law) strojarnica s klasičnom posadom

traditional manning system (n) (mar law) klasični sustav sastava posade

traffic /'træfik/ (n) 1 (ports, shipping econ) promet (roba, tereta u luci) handle the traffic promet (roba): The Port's lift-on lift-off container traffic, door – to – door and feeder, is handled at the Tivoli Container Terminal from where at least ten sailings per week are operated to European ports. a

promet roba; 2 promet (gradski, cestovni); 3 (navig) plovidba traffic lane kanal /

staza odvojene plovidbe, traffic separation scheme zona odvojene plovidbe, inshore traffic zone zona priobalne plovidbe, seaborne traffic pomorski promet,

through traffic direktan promet / transport / plovidba, traffic zone zona plovidbe,

zona prometa, područje prometa brodova, traffic conditions uvjeti prometa, uvjeti

u plovodbenom kanalu *Traffic Conditions* were moderate to heavy.

traffic clearance (n) (navig) slobodan prolaz (u sustavu VTS-a), odobrenje slobodnog prolaza

traffic density (n) (navig) gustoća prometa: 3 *The traffic organisation service concerns the operational management of traffic and the forward planning of vessel movements to prevent congestion and dangerous situations, and is particularly relevant in times of high traffic density or when the movement of special transports may effect the flow* **encounter traffic density** naići na gust promet

traffic flow (n) 1 (navig, shipping econ) prometni tok; 2 (navig) plovodbeni tok **general direction of traffic flow** glavni smjer plovodbe: *A vessel using a traffic separation scheme shall normally join or leave a traffic lane at the termination of the lane, but when joining or leaving from either side shall do so at as small an angle to the general direction of traffic flow as practicable.*

traffic information (n) (navig) prometne informacije, informacije o prometu, obavijesti o predavanju

traffic lane (n) (navig) **COMPARE Traffic Separation Scheme; (TSS)** an area within defined limits on which one-way traffic is established **plovodbena staza (u shemi odvojene plovodbe), plovodbeni smjer, smjer plovodbenog kanala**: *A vessel shall so far as practicable avoid crossing traffic lanes, but if obliged to do so shall cross on a heading as nearly as practicable at right angles to the general direction of traffic flow. The general cargo vessel was on passage in the south-west traffic lane of the Dover Strait traffic separation scheme (TSS).* **cross the traffic lane** presijecati plovodbenu stazu, presijecati plovodbeni smjer

traffic management (n) (navig, safety) provedba odluka kojima se omogućuje sigurna plovodba svim brodovima u određenome području **upravljanje plovodbom**

traffic organisation service (n) (navig) služba organizacije prometa / plovodbe: *The traffic organisation service concerns the operational management of traffic and the forward planning of vessel movements to prevent congestion and dangerous situations, and is particularly relevant in times of high traffic density.*

traffic report (n) 1 (navig) izvješće o stanju prometa brodova (u plovnom kanalu, luci); 2 (ports) izvješće o prometu tereta (u luci)

traffic restrictions (n) (navig) ograničenja prometa

traffic routing scheme sustav usmjeravanja plovodbe **follow traffic routing scheme** držati se pravila sustava usmjeravanja plovodbe

traffic separation line (n) (navig) linija odvojene plovodbe, crta odvojene plovodbe

Traffic Separation Scheme; (TSS) (n) (navig) a shipping corridor marked by buoys which separate incoming from outgoing vessels **shema odvojene plovodbe, sustav odijeljenoga prometa, sustav usmjerene i odijeljene plovodbe, shema odvojenog prometa, područja s razdvojenim prometom, razdvojeni promet**: *A vessel using a traffic separation scheme shall proceed in the appropriate traffic lane in the general direction of traffic flow for that lane.*



traffic speed (n) (navig) brzina prometnoga tijeka, brzina prometa (u plovidbenom kanalu)

trailer /'treile/ (n) (cargo handling) **COMPARE MAFI truck** prikolica, ro-ro prikolica
MAFI trailer ro-ro prikolica, ro-ro prikolica tipa MAFI, mafi prikolica



trailer (n) (boating/yachting) prikolica (za brodicu, jedrilicu), *treler*

trailer-on-flatcar (TOFC) (n) (cargo handling) A container placed on a chassis that is in turn placed on a railroad car.; Service in which a container is loaded on a rail car with chassis, bogies or wheels. (<http://www.maerskline.com/en-jm/help/shipping-glossary>) **vagon za kamionske prikolice, kamionska prikolica na vagonu**

trailing warps (n) (boating/yachting, safety) tegljenje konopa (radi usporavanja u nevremenu)

trainee engineer (n) (mar law) = **engineering cadet** vježbenik stroja, asistent

stroja: Reporting to the second engineer, a trainee engineer assists senior engineers in carrying out daily maintenance and repair works within the engine room. No prior experience is required for this position but a diploma from a maritime school is a must.

train ferry (n) (nav arch) trajekt za prijevoz vlakova

training (n) 1 izobrazba; 2 obuka; 3 uvježbavanje; 4 školovanje

training scheme 1 program izobrazbe; 2 program školovanja

training ship (n) (nav arch) = **training vessel** školski brod

training vessel (n) (nav arch) školski brod

tramp /træmp/ (n) (shipping econ) = **tramp ship** Tramps, known also as general-service ships, maintain neither regular routes nor regular service. **brod slobodne plovidbe, tramper,**

brod-lutalica: Whenever a *dry-cargo tramp* or a tanker calls at a port its interests will be entrusted to a company in that port those who specialise in Port Agency.

trampoline /'træmpəlin; 'træmpə,li:n/ (n) (boating/yachting) elastična mreža (između dva trupa) na katamaranu

tramp service (n) (shipping econ) slobodna plovidba, tramperska plovidba,

tramperski servis

tramp ship (n) (*shipping econ*) As opposed to freight liners, tramp ships trade on the spot market with no fixed schedule or itinerary/ports-of-call(s). **brod slobodne plovidbe, tramper, brod-lutalica**

tramp shipping (n) **1** (*shipping econ*) trampersko brodarstvo, slobodno brodarstvo, brodarstvo u slobodnoj plovidbi; **2** slobodna plovidba

tramp trade (n) (*shipping econ*) slobodna plovidba, tramperska plovidba

trank /træŋk/ (n) (*boating/yachting*) silaz

transatlantic crossing /,trænzət'leəntik/ (n) (*navig*) prijelaz preko Atlantika

transceiver /træn'si:və/ (n) (*comm*) primopredajnik **switch on the transceiver** isključiti primopredajnik, **switch the transceiver back off** ponovno uključiti primopredajnik, **switch on the transceiver** uključiti primopredajnik

transceiver unit (n) (*electr, navig*) odašiljačko-prijamna jedinica (radara)

transcript (n) (*navig*) ispis (izgovorenoga teksta), prijepis (izgovorenoga teksta) **transcript of the VHF conversation** ispis razgovora putem VHF radija

transfer /trænsfə/ (n) **1 a** (*shipping econ*) prijenos (roba); **2** prekrcaj (osoba), prebacivanje (peljara s broda ili na brod); **3** prijenos (energije) **heat transfer** prijenos topline; **4** prijenos robnih dokumenata: *The consignee will also acquire the right to sue the carrier by reason of the transfer of the bill of lading to himself.*

transfer /trænsfə/ (n) (*navig*) udaljenost okomita na početni kurs od trenutka otklona kormila do trenutka kada je brod postigao neki novi, unaprijed zadni kurs **bočni pomak, bočni pomak broda**

transfer of a ship's registration (n) (*mar law*) prijenos upisa broda

transfer pipe system (n) (*nav arch*) cjevovod za pretakanje **transfer pipe system for oil-fuel** (*marine eng*) cjevovod za pretakanje goriva

transfer pump (n) (*marine eng*) sisaljka za prebacivanje

transferred position lines (n) (*navig*) premještene pozicijske linije

transshipment (n) (*shipping econ*) **1** (*cargo*) The unloading of cargo at a port or point where it is then reloaded, sometimes into another mode of transportation, for transfer to a final destination. **prekrcaj, prekrcaj tereta (s jednog broda na drugi ili na teglenicu); 2 teret u provozu, teret u tranzitu**

transshipment cargo (n) (*cargo*) teret u prekrcaju, teret za prekrcaj (s broda na brod)

transshipment clause (n) (*mar law, shipping econ*) klauzula o prekrcaju

transit /'trænsit; 'trænsit/ (n) **1 a** transport, prijevoz; **2** prijenos; **3** (*shipping econ*) tranzitni promet, tranzit, provoz; **4** (*navig*) putovanje (broda) **in transit** za vrijeme transporta / prijevoza, **night transit** noćno putovanje, putovanje noću: *a potentially dangerous incident occurred during the night transit, transit the channel* plovidba kanalom, prolaz broda kanalom, prolaz (kanalom ili plovidbenim putom): *The Neopanamax vessel will make the inaugural transit of the Expanded Panama Canal on Sunday, June 26, after a 14-day journey. The video was filmed on board the MV COSCO Shipping Panama during the inaugural transit of the expanded Panama Canal, June 26, 2016.*; **5** (*navig*) prolaz duž nečega (kanalom, rijekom,

ušćem) *Vessels with a draught of 6.0 metres or less should use the Barrow Deep or Princes Channel, waiting for sufficient height of tide to transit these channels.*; **6 prolaz (kanalom) transit speed**

brzina prolaska (npr. kroz kanal); 7 prijelaz (preko mora, oceana)

transit^v (v) 1 prevoziti, prelaziti (udaljenost, rutu, kanal); 2 ploviti (kanalom, duž rijeke itd.): *an efficient lookout and safe speed must be maintained while transiting precautionary areas*

The vessel was aground while transiting the channel in-bound to the port. transit the lock prolaziti

kroz ustavu, transit the waters prolaziti vodama, ploviti vodama, transit a strait

ploviti tjesnacem, prolaziti tjesnacem: *Our VLCC was on a loaded voyage and was transiting a busy strait by night, drawing 19.9 metres even keel.*

transitⁿ (n) (navig, boating/yachting) objekt u preklapanju, objekti koji se preklapaju closed transit zatvoreni objekt, in transit objekti se preklapaju, open transit otvoreni objekt, choose transits odabrati objekte za odabiranje položaja / preklapanja

transit area (n) (navig) područje plovidbe: *A few hours into the passage, the vessel approached a restricted transit area*

transit port (n) 1 (US, mar law) ANTONYM captive cargo port međunarodna luka, prekomorska luka; 2 (shipping econ) When the majority of cargoes moving through a port aren't coming from or destined for the local market transitna luka

transit shed *The shed on a wharf is designed to protect cargoes from weather damage and is used only for short-term storage. obalno skladište, skladište uz obalu*



transit speed brzina prolaza

transit time (n) (shipping econ) vrijeme prolaska broda kanalom in-transit time vrijeme prlovidbe broda kanalom: *Despite all these measures, the in-transit time (currently averaging 12.23 hours), the number of vessels awaiting transit, and the waiting time for many of these vessels, have not been reduced to acceptable levels.*

translation (n) pomak, premještanje, premještaj

translator shift of ship (n) (navig) gibanja broda u smjeru koordinatnih osi translacijski pomaci broda

transloading (n) (shipping econ) = transhipment prekrcaj (tereta, kontejnera) s broda na brod

transmission /trænz'miʃən/ (n) prijenos, transmisija, odašiljanje, emitirati

commence and cease transmissions započeti i prestati emitirati, transmission on VHF emitiranje na VHF-u

transmission shaft (n) (nav arch) prijenosna osovina, međuosovina

transmit /trænz'mit/ (v) (comm) odaslati, prenijeti, transmitirati, emitirati

transmit switch (n) (comm) prekidač za odašiljanje poruke (na VHF uređaju)

transmitter /trænz'mfə/ (n) (comm, electr) predajnik, odašiljač **transmitter unit** (navig) odašiljačka jedinica (radara)

transmitter/receiver unit; t/r = **transceiver** primopredajnik, radarski

predajnik i odašiljač: *The transmitter/receiver unit, or t/r, is generally housed in the gearbox of the scanner unit.*

transom /trænsəm/ (n) (nav arch) a more or less flat surface across the stern of a vessel **zrcalo**



transom edge (n) (nav arch) rub zrcala

transom flap (n) (boating/yachting) zasun na zrcalu

transom flaps (n) (boating/yachting) klapne na zrcalu kreme (za pražnjenje vode)

transom knee (n) (nav arch) koljeno na zrcalu (brodice)

transom plate (n) (nav arch) transom ploča, krmena poprečnica

transponder; (TRANSMitter - resPONDER) (n) (navig) transponder

transport /'træns,pɔ:t/ (n) = **transportation** prijevoz, transport

transport /træns'pɔ:t/ (v) prevoziti

transportation /,træns'pɔ:teɪn/ (n) (US) = **transport** movement of people and goods from one location to another **transport**, prijevoz (roba, putnika) **means of transportation**

transportno sredstvo, **ocean transportation** pomorski transport

transportation department (US) (n) (mar law) ministarstvo transporta

transportation improvement (US) (n) (shipping econ) unapređivanje transporta

transportation industry (n) (shipping econ) transport (grana gospodarstva)

transportation vehicle (US) (shipping econ) prijevozno sredstvo, transportno sredstvo

transport beneficiary (n) (shipping econ, mar law) osoba koja ima određena prava prema ugovoru o prijevozu stvari **korisnik prijevoza**

transport operator (n) (mar law) opći prijevoznik koji radi s vlastitim ili unajmljenim/zakupljenim prijevoznim sredstvima (EU, za razliku od carrier = pomorski prijevoznik)

prijevoznik, **opći prijevoznik**

transtainer /,trænstəɪnə/ (n) (cargo handling) A type of crane used in the handling of containers, which is motorized, mounted on rubber tires or rail wheels and can straddle at least four railway tracks,

some up to six, with a lifting capacity of 35 tons for loading and unloading containers to and from railway cards. **skladišna kontejnerska dizalica**: *Transtainers or stacking cranes, straddle carriers, van carriers, front and side loading fork-lift trucks are used for moving and stacking containers within the terminal up to five-high, i.e. five containers one above the other.*

transversal stability calculation proračun centracije T

transverse /trænz'vɜ:s/ (adj) at right angles to the ship's fore-and-aft center line **poprijek**, **popriječan**

transverse (n) (navig) **SEE deck beam** sponja, poprečna greda

transverse axis /trænz'vɜ:s/ (n) (nav arch) **poprječna os** **ship's transverse axis** **poprječna os broda**

transverse bulkhead (n) (nav arch) **poprječna pregrada**

transverse effect (n) (seamanship) učin izboja **transverse effect of the propeller** **bočni izboj propelera**

transverse frame (n) (nav arch) **popriječno rebro**

transverse load (n) (nav arch) **poprječno naprezanje**

transverse movement (n) (ship handling) **poprečno kretanje broda**, **bočno gibanje broda**

transverse propulsion unit (n) (nav arch, marine eng) **poprečni propellerski uređaj na pramcu ili krmu**, koji služi za manevriranje brodom **poprečni propeler**

transverse section (n) (nav arch) **poprečni presjek**

transverse shift of stern (n) (navig, seamanship) **izboj krme**

transverse stability (n) (nav arch, stabil) the measure of a ship's ability to return to an upright position after being disturbed by a force that rotates it around a longitudinal axis **poprječna**

stabilnost **initial transverse stability** **početna poprječna stabilnost**, **arm of transverse stability** **poluga poprječne stabilnosti**, **poluga uspravljanja**

transverse statical stability (n) (stabil) the ability of a ship to return to the upright position when it has been forcibly heeled by an external force and is momentarily at rest when floating in still water (Rhodes, Ship' Stability, Seamanship, 2003) **poprječna statička stabilnost**

transverse thrust (n) (seamanship, navig) **izboj** **sila izboja**, **bočni odziv propelera**

trapeze /trə'pi:z/ (n) (boating/yachting) **trapez** **standard trapeze** **harness** **standardna**



oprema trapeza

trapezing techniques (n) (boating/yachting) **tehnike trapeziranja**, **tehnike na trapezu**

trapped radar wave (n) (navig) uhvaćeni val (u radarskom kanalu)

travel /'trævl/ (n) 1 a (shipping econ) putovanje travel expenses putni troškovi, prijevozni troškovi; 2 (marine eng) put, hod piston travel hod klipa, put klipa, gibanje klipa

travel /'trævl/ putovati, ploviti. Many shorter routes, including coastal routes, are heavily traveled.

traveller /'trævələ/ (n) (boating/yachting) klizač uzde mainshet traveller klizač uzde glavnog jedra, klizač škote, karel, tal. *carrello della scotta*

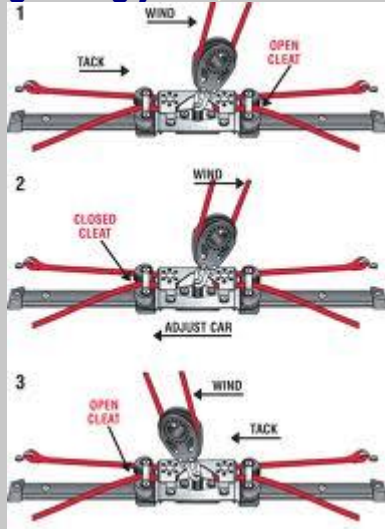

{US: traveler}

travelling crane (n) (cargo handling) pokretna obalna dizalica (na šinama)

traverse /'trævɜ:s; trə'vɜ:s/ (v) (shipping econ) prelaziti, prijeći

trawl /trɔ:l/ (n) (nav arch, fishing) kočica, povlačna mreža trawl block koloturnik kočice, koloturnik za povlačenje mreže: *The trawl block was then hauled and tensioned.*, trawl gear oprema za kočarenje, kočarski alat *The starboard derrick, with the trawl gear suspended from it, probably then swung inboard and the trawler rapidly capsized to port.*

trawl /trɔ:l/ (v) (navig) kočariti, povlačiti kočicu: *The lights were those of a fishing vessel, which was trawling in a northerly direction.*

trawl door (n) (nav arch) vrata kočice, vrata za kočicu (na kočarici): *A deckhand placed a hook into one of the trawl door inner chain links.*

trawler /'trɔ:lə/ (n) (nav arch) kočarica, kočar, tal. *peschereccio a strascio* pair trawler kočar u paru, shrimp trawler kočar za rakove, stern trawler krmeni kočar

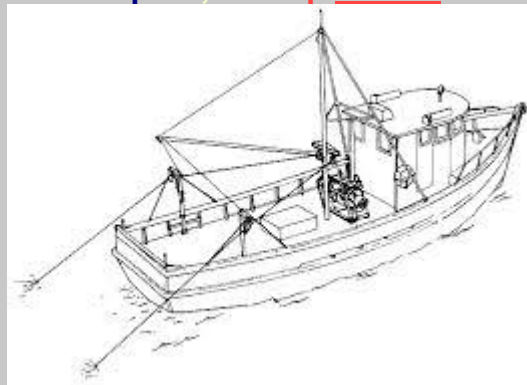

{tal.: peschereccio a strascico}

trawling /ˈtrɔːlɪŋ/ (n) (fishing) koćarenje, ribolov koćama **pelagic trawling** pučinsko koćarenje: Pelagic (surface/open ocean) trawling involves the towing of large nets behind one or more fishing vessels. , **demersal trawling** pridнено koćarenje, koćarenje po morskom dnu: The main feature in all demersal trawling techniques is that the hauled net maintains contact with the seafloor as the vessel is underway. This is achieved by weighting the bottom edge of the net entrance, whilst floating the top edge with the use of buoys, **vessel engaged in trawling** brod koji koćari, **koćar koji vuče mrežu / koću, brod u koćarenju**: COLREGS require that a vessel engaged in trawling, in addition to the lights prescribed for its length, should display two all-round lights in a vertical line. The upper light is green and the lower light is white.

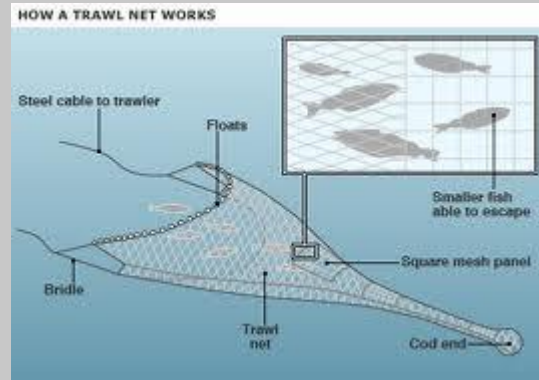

trawl net (n) (fishing) mreža potegača, koća
{tal.: rete a strascico}

trawl winch (n) (nav arch, fishing) vitlo za vuču mreža

treat /tri:t/ (n) 1 (marine eng) obraditi, obrađivati, tretirati; 2 pripremiti

treatment (n) 1 obrada, tretman, priprema **heat treatment** toplinska obrada, **chemical treatment** kemijska obrada; 2 (safety) liječenje **medical treatment** liječnička obrada, liječenje

treaty /tri:ti/ (n) (mar law) pakt, sporazum

trend /trɛnd/ (n) 1 kretanje, tendencija; 2 tok, smjer

trend of anchor (n) (nav arch) vrat kraka sidra

trestle /trɛsəl/ (n) 1 (ports) a braced structural tower-like framework of timber, metal, or reinforced concrete that is used to support a bridge or ropeway **potpornik, potporni toranj (ceste)**: The north trestle connects the unloading platform to the shore and includes a roadway and the oil pipelines.; 2 **cesta na potpornicima / stupovima**

trial /ˈtraɪəl/ **pokus, ispitivanje, testiranje** **sped trials** probna vožnja (broda), **test-bed trial** ispitivanje (motora) na probnom stolu, **pokus na ispitnom stolu**

trial /ˈtraɪəl/ (n) 1 (mar law) suđenje; 2 rasprava, sudski proces

trial manoeuvre (n) (navig) pokusna manovra (na ARPA radaru): The OOW also used the ARPA's trial manoeuvre facility to determine the effect of the intended alteration on the CPA's of the other vessels in the area.

trial speed (n) (nav arch) brzina na pokusnoj plovidbi

trial trip (n) (nav arch) **COMPARE speed trials** pokusna vožnja

triangle /ˈtraɪ.æŋɡəl/ **trokut**

triangle file (n) (marine eng) trokutasta turpija

triangular trihedral corner reflector (n) (navig, electr) **COMPARE dihedral**

corner reflector trostrani radarski reflektor s istostraničnim trokutima

tribunal /traɪˈbjuːnəl; triˈbjuːnəl/ (n) (mar law) sud

tributary /ˈtribjʊtəri; ˈtribjʊtri/ (n) (geogr) pritoka (rijeke)

trick (n) (boating/yachting) a period of time spent at the wheel vrijeme straže za kormilom (na jedrenjacima)

trident /ˈtrɪdənt,spɪə/ (n) (fishing) osti, trozub **trident** spear osti

trigger unit (n) (electr, navig) okidni sklop (radara)

tri-lens radar reflector (n) (navig) radarski reflektor s tri (Lineburgove) leće

trim /trim/ (v) 1 (stabil, nav arch, cargo handling) izravnavanje gaza broda (na pramcu i krmi)

ravnornim slaganjem tereta po dužini broda; the arithmetic sum of the drafts forward and aft

above and below the mean water-line(SeaSources.net) **trim**, tal. **assetto**: TRIM is positive when aft is larger than fwd, i.e. the ship has an aft trim. **aft trim** krmeni trim, **forward trim** pramčani

trim, **moment to change trim** jedinični moment trima, **trim by the stern** trim po krmi

(zatežan brod): A small trim by the stern is desirable as most ships are expected to sail better in a

seaway in this condition., **trim by the head** trim po pramcu: Excessive trim by the head should be

avoided because the rudder will be immersed less making the ship difficult to steer.; 2 (boating/yachting)

trimanje jedara, **namještanje jedara**, **ugađanje jedara**

Trim and Stability Book (n) (stabil) knjiga trima i stabiliteta



trimaran (n) (nav arch) trotrupac, trimaran

trim by head (n) (cargo handling) pretega

trim by stern (n) (nav arch, cargo handling) zatega

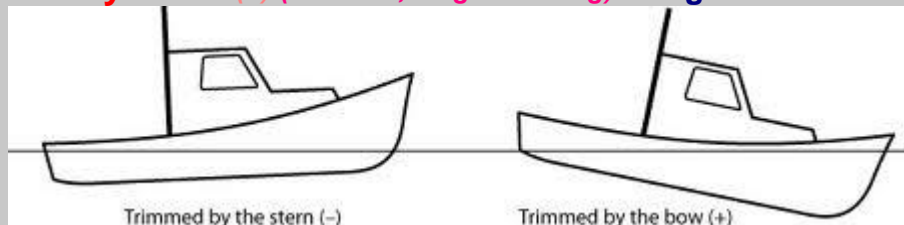

trim calculation (n) (stabil) proračun trima, centracija trima

trim calculations (n) (stabil) proračun trima

trim forward (n) (cargo handling) pretega

trim indicator pokazivač trima

trimmed by the bow /trimd/ on even keel (brod) na ravnoj kobilici (cargo) brod

trimovan / triman po pramcu, pretežan brod

trimmed by the stern (cargo) zatežan bord, brod trimovan / triman po krmi

trimming /'trimɪŋ/ (n) (cargo handling, safety) izravnavanje gaza broda (na pramcu i krmi) ravnomjernim slaganjem tereta po dužini broda **trimanje broda** **trimanje tereta**, **uravnotežavanje tereta na brodu**: *Cargo trimming is a mandatory requirement for some cargoes, especially where there is a risk of the cargo shifting or where liquefaction could take place. It is recommended the cargo in all holds be trimmed in an attempt to minimise the risk of cargo shift.*

trimming hatch (n) (nav arch) **otvor za sipke terete**

trimming lever (n) (stabil, cargo handling) **poluga trima**

trimming moment (n) (nav arch, stabil) a moment exerted by a weight anywhere in the ship acting about the center of flotation **moment trima**, **moment trimovanja**: *A trimming moment causes the ship to trim or tip, around the center of flotation.*

trimming of sail (n) (boating/yachting) **ugađanje jedra**, **podešavanje jedra**, **trimanje jedra**

trim the sail (v) (boating/yachting) **namjestiti jedro**

Trinity House /'trɪnɪti/ (n) (shipping econ) **Uprava za održavanje plovidbenih putova u Vel. Britaniji**

trip /trɪp/ (n) (marine eng, safety) **izbacivanje iz rada / pogona**, **naprava za iskopčavanje iz pogona** (u slučaju pregrijavanja, manjka ulja, itd.) **zaštita low-lube-oil-pressure trip** **zaštita od preniskog tlaka ulja**, **overspeed trip** **izbacivanje u slučaju prevelike brzine**, **zaštita od nadnormalne brzine**, **trip test** **test iskapčanja**

Triple-E containerships (n) (nav arch) **Three E: energy efficiency (energetska efikasnost), economy of scale (ekonomika velikih brojeva), environment (zaštita okoliša)** **kontejnerski brod tipa tri-e**: *Maersk Line has indicated that the central considerations of the original Triple-E's – energy efficiency, economy of scale and the environment – will remain unchanged. {Triple E: economy of scale and the environment}*

tripod /'traɪpɒd/ (adj) **tripod**, **na tri noge**

tripod mast /'traɪpɒd/ (n) (nav arch) **tripodni jarbol**, **tronogi jarbol**

trip out (v) (electr, marine eng) **izbaciti (osigurač)**

trip out (v) (marine eng, electr) **ispasti iz rada**, **iskopčati se**: *At 1811 the port generator tripped out on high fresh water temperature, closely followed by the starboard generator tripping out, also on high fresh water temperature.*

tripping bracket (n) (nav arch) a plate added to the free edge of structural members for reinforcement **koljeno struka**

tripping line (n) (seamanship, boating/yachting) **lagan konop vezan za glavu (krunu) sidra i plovak za označavanje pozicije sidra** **orepina**, **konopac za otpetljavanje sidra**

trireme /'traɪri:m/ (n) (boating/yachting, nav arch) **trirema**

troller /'trɒlə/ (n) (nav arch) **brod za ribolov panulama**



trolley /ˈtrɒli/ (n) (marine eng) **kolica universal telescopic multi purpose trolley**
teleskopska namjestiva kolica, teleskopska podesiva kolica

trolling (n) **1 (fishing)** A fishing method where fishing lines are pulled behind a boat to attract and catch fish.; panula, odnosno oblik ili tehnika ribolova u kojoj se povlačenjem mamca, umjetnog ili prirodnog, pokušava isprovocirati napad ribe koju lovimo

(<https://ribolovnajadrano.hr/ribicki-leksikon/>) **panulanje, ribolov panulom; 2 (fishing)**
panula, traina

tropical cyclone (meteorol) **tropski ciklon**

tropical depression (n) (meteorol) tropical mass of thunderstorms with a cyclonic wind circulation and winds near the surface between 23 mph and 39 mph (Seasources.net) **tropska ciklona**

tropical disturbance (n) (meteorol) an organized mass of thunderstorms in the tropics than lasts for more than 24 hours, has a slight cyclonic circulation, and winds less than 23 mph (Seasources.net) **tropski poremećaj**

tropical freeboard (n) (nav arch) **tropsko nadvođe**

tropical fresh water freeboard (n) (nav arch) **tropsko nadvođe za slatku vodu**

tropical fresh water timber freeboard (n) (nav arch) **tropsko nadvođe za teret drva za slatku vodu**

tropical storm (n) (meteorol) an organized low pressure system in the tropics with wind speeds between 38 and 74 mph (34 to 63 knots) **tropska oluja achieve tropical storm status**

dostići status / status tropske oluje: *Julia Achieves Tropical Storm Status Again.*,

designation as a tropical storm status tropske oluje: *Julia regained its designation as a tropical storm as it milled off the southeast coast of the United States on Friday, the National Hurricane Center said in an advisory.*

trot /trɒt/ **niz priveznih plutača**

trouble (n) **1 a neprilika, nezgoda; 2 poteškoća, problem, smetnje u radu engine**
trouble poteškoće sa strojem, kvar u stroju; **3 kvar**

troubleshooting (n) (marine eng, safety) **otklanjanje kvarova, otklanjenje neispravnosti** *uklanjanje problema*

trough /trɒf/ **1 (meteorol)** an elongated area of relatively low atmospheric pressure surface or aloft

dolina (ciklone / zračne fronte); 2 (oceanogr) ANTONYM crest the valley between two

waves **dolina vala:** *The ship pitched into the following trough and then a second, larger wave was*

shipped on board. Without warning, the pilot launch's bow dipped into the trough of a wave and a large

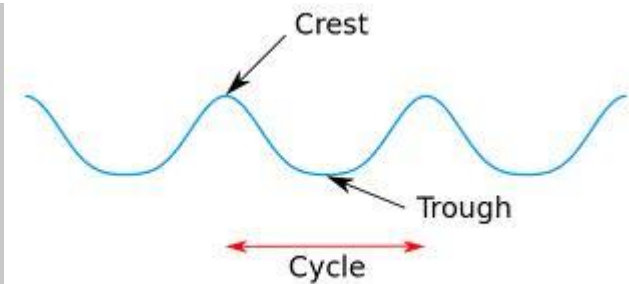

amount of water was shipped over forward.

trout /traʊt/ (n) (fishing) pastrva

truck /trʌk/ (n) 1 (cargo handling) kamion; 2 teretni vagon

truck /trʌk/ (n) (sailing vessels, nav arch) jabučnica, jabuka jarbola

trucking industry (n) (shipping econ) djelatnost kamionskog prijevoza

truck trailer (n) (cargo handling) kamionska prikolica

true bearing (n) (navig) pravi azimut, azimut pravi, tal. *rilevamento vero*

true course (n) (navig) pravi kurs, kurs pravi, tal. *rotta vera*

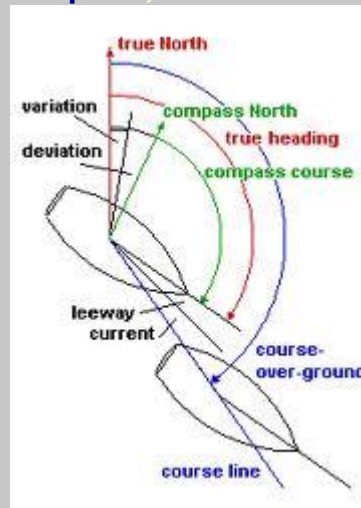

true heading (n) (navig) pravi kurs

true motion (n) (navig) COMPARE relative motion prikaz pravoga kretanja broda, pravo kretanje (broda)

true motion mode (n) (navig) Own ship and other moving objects move in accordance with their true courses and speed. In ground stabilized TM, all fixed targets, such as landmasses, appear as stationary echoes. način pokazivanja s pravim kretanjem boda

true motion radar (n) (navig) radar s pokazivanjem pravog kretanja broda, radar sa stvarnim pokazivanjem

true north (n) (navig) pravi sjever, sjever pravi

true picture (n) (navig) prava slika (ciljeva na radarskom pokazivaču)

true range (n) (navig) COMPARE pseudorange prava udaljenost (u sustavu GPS)

true scale (n) (navig) stvarno mjerilo true scale outline prikaz u stvarnom mjerilu

true wind (n) (boating/yachting) the wind which we feel when we are stationary pravi vjetar

trunk (n) (boating/yachting) kućište pomične kobilice jedrilice

trunk deck vessel /'trʌŋk/ (n) (nav arch) škrinjasti brod

trunk piston (n) (marine eng) klip s produženim plaštem, klip dizelskog stroja bez križne glave

trunk piston engine (n) (marine eng) motor bez križne glave, motor s klipom

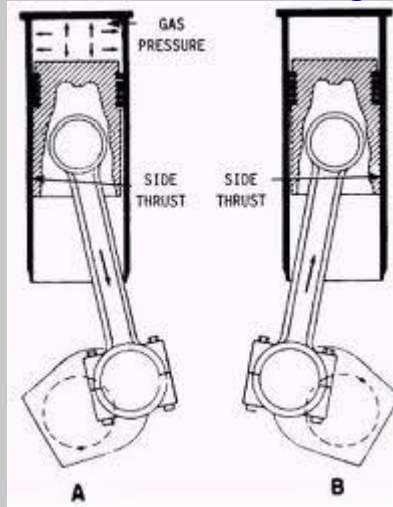

produžena plašta, klipni motor

truss /trʌs/ (n) hajmica (jarbola)

truss hoop /'trʌs/ (n) obroč hajmice

try out the engines (v) (marine eng) isprobati strojeve (prije manovre itd.)

trysail /'traɪ, seɪl; (nautical) 'traɪsəl/ (n) (boating/yachting) olujno jedro

TSC; Track Control System (n) (navig) sustav automatskog praćenja rute

T-shaped (adj) u obliku slova T, T-oblika

TSM; Volumetric Transverse Shifting Moment (of grain) (n) (stabil) moment volumetrijskog pomaka (za žito)

TSS (traffic separation scheme) (n) (navig) = **Traffic Separation Scheme;**

(TSS) A method of regulating the flow of vessel traffic moving in different directions. The term is defined by the International Maritime Organization (IMO) in its Resolution A/284 of November 20, 1973, as a scheme which separates traffic proceeding in opposite or nearly opposite directions, by the use of a separation zone or line, traffic lanes, or by other means. Today, traffic separation schemes are often part of Vessel Traffic Services (V.T.S.), in ports or restricted coastal areas **zona odvojene plovidbe busy**

TSS (traffic separation scheme) zona odvojene plovidbe s gustim prometom:

Shortly after entering a busy traffic separation scheme (TSS), the master of a large container vessel arrived on the bridge to assist the bridge team during the vessel's transi

TS; (training ship) (n) (nav arch) školski brod

tube /tju:b/ (n) (marine eng) cijev **Bourdon tube** Bourdonova cijev, **closely packed tube**

cijevi složene jedna do druge, **snop gusto sabijenih cijevi**, **guide tube** provodna

cijev, **dovodna cijev**, **U-tube** U-manometar, **Venturi-tube** venturijeva cijev, **bank of**

tubes 1 snop cijevi, red cijevi; 2 bakrena cijev, **fire tubes** plamene cijevi,

generating tube cijevi, **heat exchanger tubes** cijevi izmjenjivača topline, **small**

diameter tube cijev malog promjera, **wall of the tube** stijenka cijevi, **water tube**

cijevi za vodu, **tube inclination** nagib cijevi, **tube plate** cijevploča, cijevna stijena

tug /tʌg/ (n) (nav arch) = **tugboat, tug-boat, tug boat** tegljač, remorker; tal.

tugboat, tug-boat, tug boat

tumble home; tumblehome

rimorchiatore Use of tugs is compulsory for berthing and unberthing- The number of tugs allocated is decided by the Harbour Authority according to gross tonnage The new **tug** is designed for towing very large floating objects while also offering services such as anchor handling, positioning and mooring.

salvage tug spasavalački tegljač, anchor handling tug teglač za manovru sidrenja

The DP II Anchor Handling Salvage Tug was delivered on 12 September to ALP Maritime Services. ,

harbour tug lučki tegljač, seagoing tug tegljač za otvoreno more, oceangoing tug tegljač za otvoreno more, river tug riječni tegljač, tug's crew posada tegljača:

Prompt action by the **tug's crew** prevented this fire from spreading throughout the engine room.,

powerful tug jaki tegljač, snažni tegljač The Damen ASD Tug 2810 is proven in the industry.

More than 170 of these compact, powerful tugs are working in ports worldwide.

tugboat, tug-boat, tug boat /ˈtʌɡˌbəʊt/ (n) (nav arch) **tegljač, remorker**



tugmaster /ˈtʌɡmɑːstə/ (n) (cargo handling) **tegljač prikolica (na kontejnerskom terminalu)**

tug-master /ˈtʌɡ,mɑːstə/ (n) **tegljač za ro-ro prikolicе**



tug's hook (n) (nav arch, ship handling) **kuka tegljača**: As soon as the tow line was secured to the **tug's hook**, the tug's skipper manoeuvred ahead because there was a danger of the tow line fouling



the tug's propellers.

tumble home; tumblehome (n) (nav arch) **ANTONYM flare** the decreasing of a vessel's beam above the waterline as it approaches the rail **uvučeni bok**

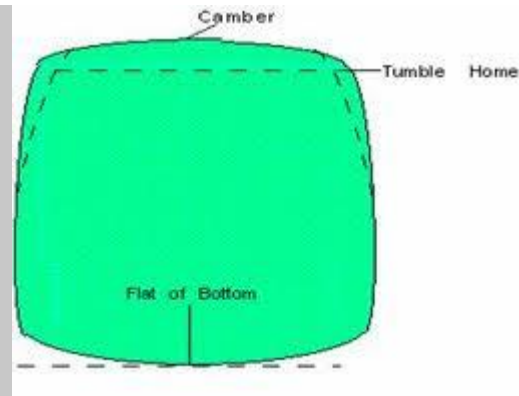

tuna /tju:nə/ (n) (fishing) Lat.: Thunnus thynnus - (tribe) Thunnini **tuna**, **tunj**

tuna clipper (fishing, nav arch) **tunolovac** udičar

tuna fish (n) (fishing) lat. *Thunnus thynnus* **tuna**, **tunj**

tuna seiner /tju:nə, seinə/ (n) (fishing, nav arch) plivaričar za lov tune **tunolovac**



tune (n) ugađati, namještati, regulirati, podešavati **tune the frequency** (comm)

ugađati frekvenciju, **tune the transceiver** ugađati primopredajnik, **tune the radar**

ugađati radar: Most modern raster scan radars will automatically tune the radar for optimum performance. However, many operators still prefer to tune the set manually to get that little bit of extra performance from the radar.

tune the radar set (n) (navig) **ugoditi radar**: To tune the radar set choose a distant weak target, as the effect of tuning will be more obvious. Then adjust the tuning knob for the clearest and brightest picture. If you are at sea, with no targets visible, adjust the set for maximum sea clutter.

tungsten; (W) /tʌŋstən/ (n) (chem) **volfram**, **tungsten**

tuning /tju:nɪŋ/ **1 a** ugađanje (radara itd.), fina regulacija, fino namještanje, fino

podešavanje: The radar receiver can be tuned automatically or manually, and the default tuning method is automatic; **2 regulacija**; **3 štelanje**; **4** adjusting the standing rigging, the sails and the hull to balance the boat for optimum performance **ugađanje jedara**

tuning control (n) (navig) **kontrola za ugađanje radara (na frekvenciju odašiljača)**:

The tuning control can be compared to the tuning control of an ordinary radio, in that it tunes the receiver to the frequency of the transmitter.

tunnel /ˈtʌnəl/ (n) (nav arch, marine eng) = shaft tunnel osovinski tunel tunnel access prostor za pristup osovinskom tunelu, shaft tunnel osovinski tunel

tunnel recess (n) (nav arch) prostor odrivnog ležaja

tunny /ˈtʌni/ (n) tuna, tunj

turbine /ˈtɜːbin; ˈtɜːbaɪn/ (n) (marine eng) turbina gas turbine plinska turbina,

low-pressure turbine niskotlačna turbina, steam turbine parna turbina, turbine blade lopatica turbine, turbine casing kućište turbine, turbine gland steam para koja istječe iz brtvenice turbine

turbine blading (n) (marine eng) turbinske lopatice, lopatičje turbine

turbine propulsion turbinski pogon ship's turbine propulsion

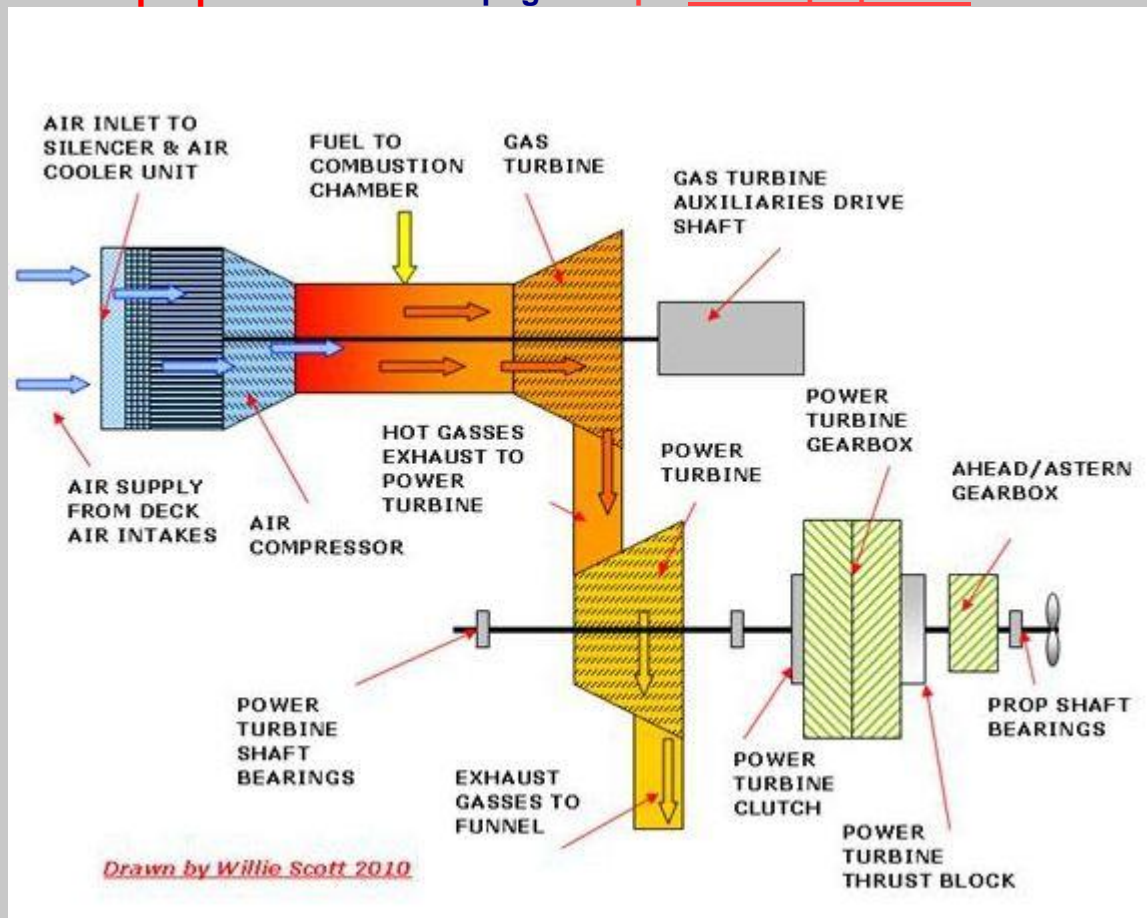

turbo blower /ˈtɜːbəʊ/ (n) (marine eng) turbo puhalo

turbo-blower /ˈtɜːbəʊ,bləʊə/ (n) (marine eng) trubopuhalo: During a short sea passage on a twin-engined ship, a motorman was cleaning around the **turbo-blower** of one of the main engines.

turbocharge /ˈtɜːbəʊ,tʃɑːdʒ/ (n) (marine eng) turbonabijanje

turbo-charged engine /ˈtɜːbəʊ/ (n) (marine eng) motor s turbonabijanjem

turbocharger /ˈtɜːbəʊ,tʃɑːdʒə/ (n) (marine eng) turbopuhalo

turbocharging

turbogenerator

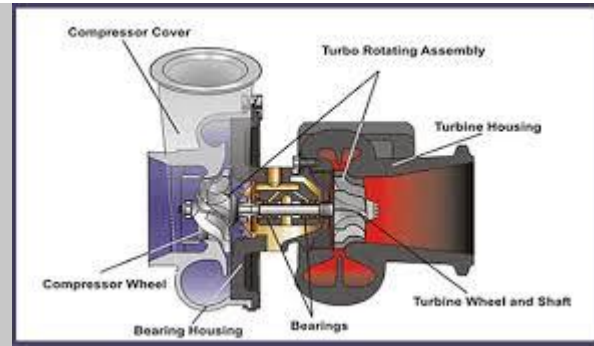

turbocharging /tɜːbəʊˌtʃɑːdʒɪŋ/ (n) (marine eng) turbonabijanje

turbocompressor (n) (marine eng) turbokompresor

turboelectric drive /tɜːbəʊɪˈlektɹɪk/ (n) (marine eng) turboelektrični pogon

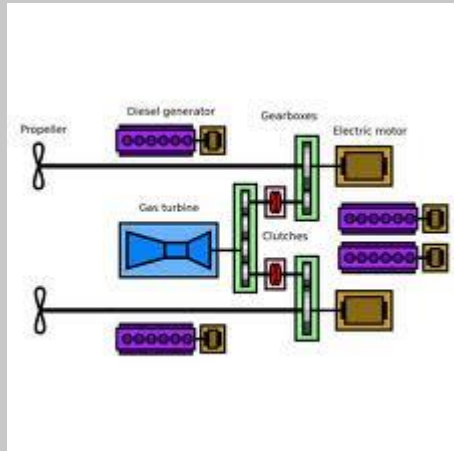

turbogenerator /tɜːbəʊˈdʒɛnəˌreɪtə/ (n) (marine eng) turbogenerator

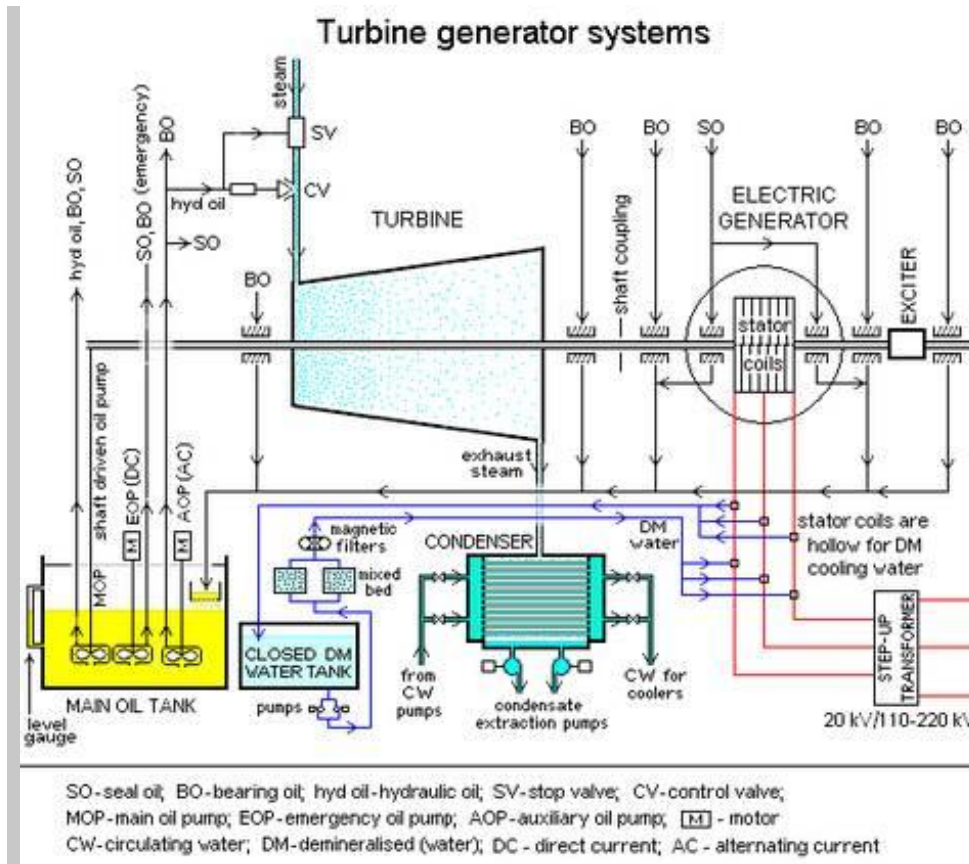

turbot /'ts:bət/ (n) (fishing) romb, rumbac, rumbač, plat {lat. *Scophthalmus maximus*}

turbulence /'ts:bjələns/ (n) (meteorol) disrupted flow in the atmosphere that produces gusts and eddies **turbulencija**

turn (v) **okrenuti, okretati**: *Meanwhile, the tanker had turned almost 90deg from her original heading The ship started to turn quickly to starboard. **turn the line on the winch namotati / prebaciti uže oko vitla, turn the ship onto a heading okrenuti brod na pramčanicu od ... stupnjeva, okrenuti brod u ... smjer** Accordingly, at approximately 0013 the OOW turned the vessel onto a north-westerly heading. **turn towards skretati prema, okrenuti prema** At the same time, the second officer noticed that his ship was turning towards the bulk carrier.*

turn (n) **1 okret, namotaj (užeta), volta, tal. volta libera put a few turns on on the winch namotati / prebaciti konop nekoliko puta oko (bubnja) vitla**

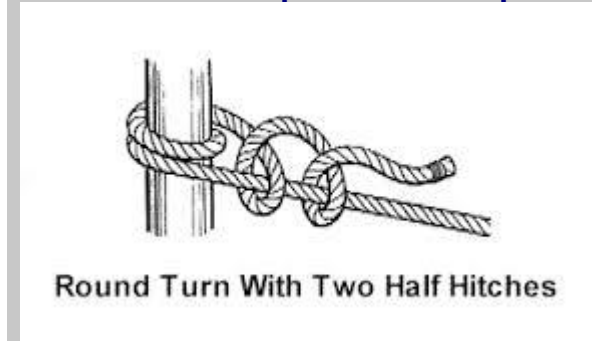

turn, catch a **turn** with a spring **prebaciti špring oko vitla, in turn** naizmjenice; **2 smjena take one's turn** smjenjivati se, preuzeti

smjenu; 3 (seamanship) voj konopa, namotaj konopa; 4 (navig) okret broda (u rijeci)

*The vessel was approaching a starboard turn in the river, with a flood current astern, when the pilot ordered the helm to starboard 15°. **starboard turn okret broda u desno, port turn okret broda u lijevo, rate of turn brzina okretanja:** Within 30 seconds the vessel's rate of turn was 25°/min to starboard., **round the turn doći na pola okreta:** Soon afterward, as the vessel was rounding the turn, the pilot ordered the engine stopped.*

turn (marine eng) tokariti

turn-around promet (tereta u luci)

turnaround time (n) (shipping econ) vrijeme obrtaja broda, vrijeme iskrcaja/ukrcaja

tereta s/iz boda u luci: *For private terminals, turnaround or transfer time is directly related to how much profit is made.*

turn away from the wind (n) (boating/yachting) skrenuti od vjetra

turnbuckle /'tɜ:n,bʌkəl/ (n) (nav arch, cargo handling) = bottlescrew navojna stezaljka za vezivanje i pričvršćivanje tereta **stezaljka, škartoc tirant, tal. arridatoio; tornichetto**

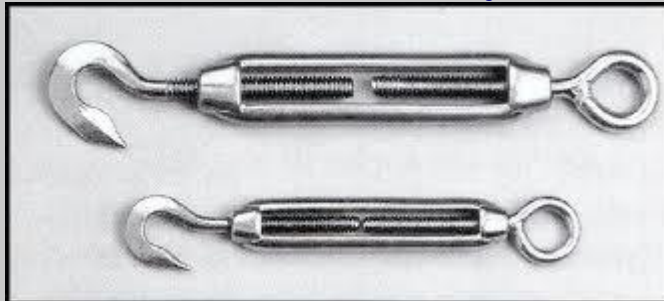

turned (adj) (marine eng) istokaren, otokaren

turned off (adj) isključen

turning (n) (ship handling) okretanje broda

turning ability (n) (ship handling, navig) sposobnost okretanja (broda)

turning basin (n) (navig) širina prostora za okretanje plovila

turning circle (n) (navig, ship handling) krug okretanja broda

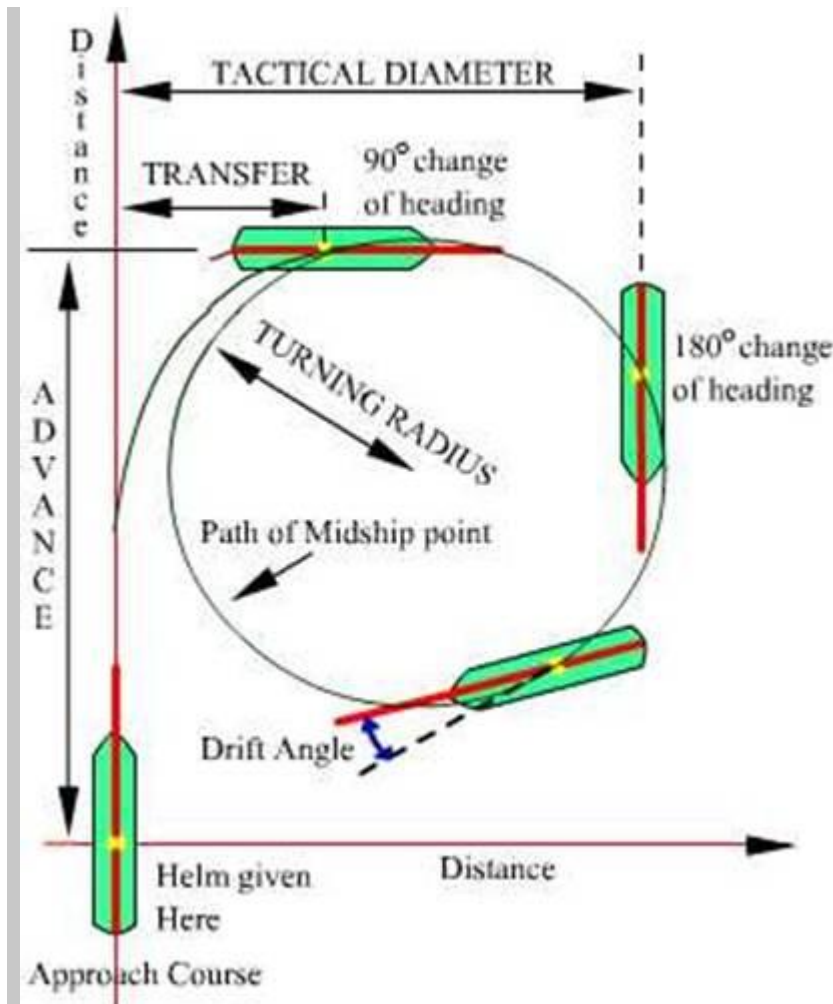

turning effect (n) (navig, ship handling) okretni učin (kormila)

turning forces (n) (boating/yachting) sile skretanja

turning gear (n) (marine eng) The turning gear on a turbine installation is a reversible electric motor driving a gearwheel which meshes into the high-pressure turbine primary pinion. **uređaj za**

okretanje stroja, okretaljka: makineta An engine flywheel housing of multi-functional design supports starters and **turning gear**, and conveys fluids between the different modules. So, dis-engage the **turning gear** before starting. The indicator cocks are opened, the **turning gear engaged** and the engine turned through several complete revolutions. The engine's **turning gear** was engaged, and the engine was then allowed to cool before the lub-oil pump was stopped and the cooling water system drained.

turning in a narrow channel (n) (boating/yachting, seamanship, ship handling)

okretanje u uskom kanalu

turning lever (n) (nav arch, navig) poluga zakretanja broda

turning moment (ship handling) zakretni moment **ship's turning moment** moment sile koji nastoji zakrenuti brod, a tvori ga sila zakretanja broda koja djeluje na određenoj poluzi zakretanja **zakretni moment broda**

turning point (n) (navig) točka okreta

turn-key project /'tɜ:n,ki:/ (n) (shipping econ) projekt ključ u ruke

turn off isključiti

turn on (v) uključiti

turn over (v) (boating/yachting) prevrnuti se

turnround (n) (navig) okretanje broda za 180 stupnjeva **make a turnround** okrenuti brod za 180 stupnjeva

turn-round (n) **1** (shipping econ, ports) promet (tereta u luci), obrtaj (tereta), ukrcaj i iskrcaj broda; **2** vrijeme boravka broda u luci

turn the boat (v) (boating/yachting) okrenuti jedrilicu, promijeniti smjer

turn the engine over by hand (v) (marine eng, boating/yachting) okrenuti motor ručno nekoliko puta (zimi)

turn the ship around (v) (navig) okrenuti brod: *The Pilot directed the tugs to turn the ship around through 180 degrees, to stem the tide*

turn towards the wind (v) (boating/yachting) skrenuti prema vjetru

turpentine /'tɜ:pən,tain/ (n) terpentin

turpentine oil /'tɜ:pən,tain/ (n) (seamanship) terpentin

turret /'tʌrɪt/ (n) (cargo handling) toranj (za krcanje/iskrcaj nafte): *The basis of the Submerged*



Turret Loading system is the buoy moored to the seabed.

turret deck vessel /'tʌrɪt/ (n) (nav arch) brod s tornjem

turtle (v) (boating/yachting) preokrenuti jedrilicu (s jarbolom prem dnu mora) **turn turtle** prevrnuti se

tween deck, tweendeck, 'tween deck /'twi:ndɛk/ (nav arch) the deck or decks between the ceiling and main deck **međupaluba, tal. interponte** *One or more 'tween decks may be fitted to facilitate flexibility in cargo loading and unloading, cargo segregation, and to improve stability.*

tween-deck ceiling (n) (sailing vessels) unutarnja oplata međupalublja

tweendecks /'twi:ndɛks/ (nav arch) the deck or decks space between the ceiling and main deck

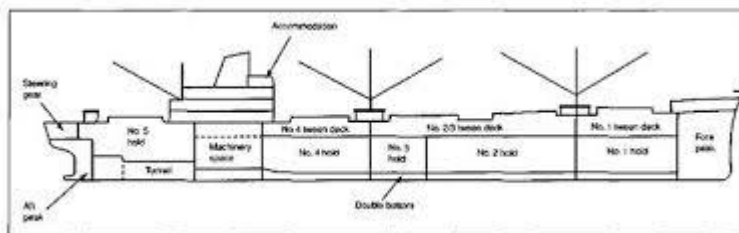

međupalublje, koridur

Twenty-foot Equivalent Unit (TEU) (*cargo*) kontejner dužine 20 stopa (standardna veličina kontejnera)

twilight /'twai,lait/ (*n*) **sumrak, suton nautical twilight** sunrise or sunset when the centre of the sun is 6 to 12 degrees below the horizon, so that the general outlines are recognizable, and all the stars and nebulae visible, to permit to take celestial sights with the sextant **nautički suton / sumrak**

twin crane /twin/ **dvostruka dizalica, tandemska dizalica**

twin engine boat (*n*) (*nav arch*) **brodica s dva motora**

twin hull ship (*n*) (*nav arch*) **dvotrupac**



twin propellers (*n*) (*nav arch*) **dva propelera**

twin screw boat **brodica s dva vijka, brodica s dva propelera**

twist /twist/ (*n*) (*boating/yachting*) **zakrivljenost jedra po stražnjem porubu**

twist kutna razlika između vrha i dna jedra u odnosu na vjetar **nagnutost jedra prema vjetru**

twist (*v*) **sukati, uvijati, svijati**

twist lock /'twistlɒk/ (*n*) (*cargo handling*) **zakretna brava (za pričvršćivanje uglova**

kontejnera), twistlok: *If manual twist locks are used, screening checks should be carried out*

whenever possible in order to ensure that rogue devices are not present. **fully automatic twist lock**

automatska stezna brava, semi-automatic twist lock poluautomatska zakretna

brava: *An AB and an OS were releasing and removing the semi-automatic twistlocks used to secure*



the containers.

two-banded bream (*n*) (*fishing*) Lat. *Diplodus vulgaris fratar*



two half hitches (n) (seamanship) dvostruki poluuzao



two mixer cancellation (n) (navig, electr) COMPARE phase detector
cancellation sklop za brisanje s dva mješaća

two round turns (seamanship) dvovoj

two-stroke cycle (n) (marine eng) tvotaktni radni proces

two-stroke engine (n) (marine eng) dvotaktni motor

two-way route (n) (navig) dvosmjerni plovidbeni pravac

TWS radar; track-while-scan radar (n) (navig) COMPARE continuous
tracking radar radar za povremeno praćenje više ciljeva

TX - RX (n) (electr) odašiljanje i primanje impulsa **TX - RX time difference**
vremenska razlika između odašiljanja i primanja impulsa, **TX - RX cell** TR - RX
ćelija {TR = transmission; RX = reception}

TX/RX switching (n) (electr, navig) prebacivanje s predajnika na prijamnik: A TX/RX
switching device enables the Radar to transmit the radio pulse and receive its reflected echo through one
scanner.

tye (n) (boating/yachting) čelični podigač jedra, čelični gindac, tal. amanta

tying up /,taɪnɪŋ'ʌp/ (n) (seamanship) = mooring privezivanje (broda, brodice)
vezivanje (broda, brodice)

typhoon /tai'fu:n/ (n) (meteorol) a hurricane that forms in the Western Pacific Ocean **tajfun**

UCAE (unforeseen circumstances always accepted) (shipping econ)

nepredvidljive okolnosti uvijek se prihvaćaju

UKC (under-keel clearance) razmak od dna broda (kobilice) do morskog dna **dubina ispod kobilice** **gross UKC (under-keel clearance)** bruto dubina ispod kobilice

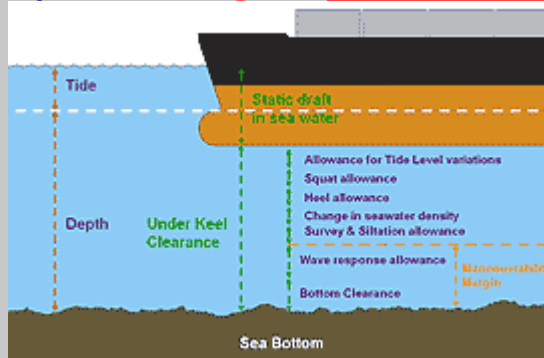

ullage /'ʌlɪdʒ/ (n) (shipping econ) visina praznog prostora, kalo, prazni prostor tanka (između vrha razine tekućine/tereta i vrha tanka) **record of the ullages** zapis kala

bilješke o kalu, iznosi kala *The ship should compile and retain a report on the condition of the vessel's tanks prior to loading, including a record of the ullages in slop tanks.*, **ullage report 1**

izvješće o kalu; **2 prepare ullage report** pripremiti izvješće o kalu, **prepare ullage**

report pripremiti izvješće o kalu, **ullage tape** vrpca za mjerenje kala, **ullage**

measurement mjerenje kala, **ullage readings** izmjere kala, očitane vrijednosti kala

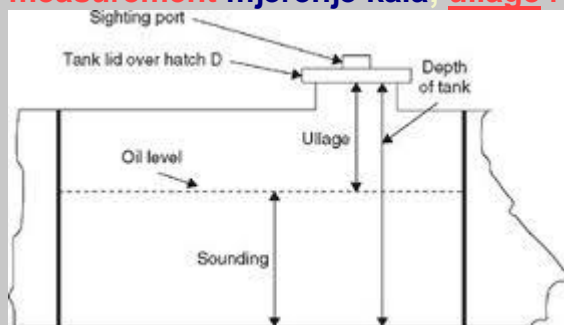

ullage tapes /'ʌlɪdʒ/ (n) (cargo handling) vrpce/trake za mjerenje praznog prostora u

tanku: *Under the Bosun's control they stow away various equipments such as dip stick, ullage tapes, sample cans and thermometers.*

ultimate tensile stress; (UTS) /'ʌltimit/ (n) (marine eng) krajnje vlačno naprezanje, granica naprezanja na vlak

ultra-large containerships; (ULCV) (n) (nav arch) superkontejnerski brod: a

Japanese shipyard has received an order for four ULCVs carrying more than 18,000 TEU units from a multinational owner,

Ultra large crude carrier (ULLCC) /'ʌltrə/ (n) (nav arch) Ultra Large Crude Carrier (ULCC)

is an ocean-going crude oil tanker of 300,000 to 550,000 dwt. **ultra veliki tanker**

ultra-violet /'ʌltrə,vaiəlit/ (adj) ultravioletan

umbrella treaty (n) (mar law) okvirni ugovor

UMS (unattended machinery space) strojarnica bez stalne straže u stroju, nadzor i

upravljanje sa zapovjedničkog mosta **automatska strojarnica** **UMS (unattended machinery**

space) watch automatska straža, straža na brodu s automatskom strojarnicom
unattended /ˌʌnəˈtɛndɪd/ (adj) **unattended machinery space (UMS)** strojarnica bez posade u stroju, automatska strojarnica bez ljudskog nadzora, bez posade: *the bridge should not be left unattended at any time*

unattended engine-room (marine eng) strojarnica bez časnika straže u stroju, automatska strojarnica (upravljana s mosta)

unattended machinery space; (UMS) strojarnica bez časnika straže u stroju, automatska strojarnica (upravljana s mosta)

unauthorised people (n) (mar law, safety) neovlaštene osobe

unbend /ˌʌnˈbɛnd/ (v) to untie (a line, rope, ship) odvezati

unberth /ˌʌnˈbɜːθ/ (v) (seamanship) odvezati se: *After completing the loading of 129,959 tonnes of iron ore at 0109 on 11 July, the ship immediately started unberthing on a falling tide.*

unberthing /ˌʌnˈbɜːθɪŋ/ (n) 1 (seamanship) isplavljenje s veza, manovra isplavljenja s veza **unberthing manoeuvre** manovra isplavljenja s veza manovra napuštanja veza, **unberthing operation** operacija isplavljenja s veza, operacija napuštanja veza; 2 (seamanship, navig) odvezivanje, manovra odvezivanja

unberthing manoeuvre /ˌʌnˈbɜːθɪŋ/ (n) (navig, seamanship) manovra odvezivanja, manovra isplavljenja

unberthing orders (n) (seamanship) zapovijedi za odvezivanje, naredbe za odvezivanje **Stand by engine(s)**. Pripremite glavni(e) stroj(eve)., **Pozor u stroju.**, **Are you ready to get underway?** Jeste li spremni za isplavljenje/plovidbu?, **Yes, we are ready (to get underway).** **No, we are not ready (yet) (to get underway).** **We will be ready to get underway in ... minutes.** Da, spremni smo za isplavljenje/plovidbu. Ne, nismo spremni (još) za isplavljenje/plovidbu. Bit ćemo spremni za isplavljenje/plovidbu za... minuta., **Stand by for letting go.** Pripremite se za otpuštanje konopa., **Single up the ... lines and ... springs fore and aft.** Ostavite po jedan ... konop i po jedan pramčani i krmni špring., **Slack away / hold on / heave on the ... line.** Popuštajte/zadržite/pritežite ... konop., **Let go the ... line.** Otpustite ... konop (s bitve)., **Let go the towing line(s).** Otpustite užu za tegljenje (teglo)., **Stand by bow anchor(s).** Pripremite pramčano(a) sidro(a)., **Finished with manoeuvring stations.** Odvezivanje završeno.

uncertainty phase (n) (safety, navig) stupanj opasnosti koji određuje centar za koordinaciju traganja i spašavanja ako postoji sumnja u sigurnost plovnoa objekta i osoba na njemu **stupanj neizvjesnosti**

UNCITRAL (n) (mar law) The United Nations Commission on International Trade Law was established by a United Nations General Assembly Resolution in 1966. The aim of UNCITRAL is to harmonize and unify international trade law. (Tetley) **UNCITRAL**, **Povjerenstvo UN-a za međunarodno trgovinsko pravo**

unclaused bill of lading /ˌʌnˈkluːzɪd/ = **clean bill of lading** čista teretnica

unclean bill of lading /ˌʌnˈkliːn/ (n) (mar law, shipping econ) nečista teretnica

uncleat (v) (boating/yachting) **ANTONYM cleat**: izbaciti konop sa stopera, izvući konop iz stopera

UNCLOS (United Nations Convention on the Law of the Sea) (mar law)

Međunarodna konvencija UN o pravu mora **continental shelf** epikontinentalni pojas, **exclusive economic zone** isključivi gospodarski pojas, **contiguous zone** vanjski pojas, **territorial sea** teritorijalno more, **internal waters** unutrašnje vode, **baseline** polazna crta **normal / straight baseline** normalna / ravna polazna crta, **reef** greben, **roadstead** sidrište, **right of innocent passage** pravo neškodljiva prolaska, **sea lane** plovni put, **high seas** otvoreno more, **high seas routes** putovi otvorenim morem, **conservation** očuvanje (živih bogatstava), **right of hot pursuit** pravo progona, **preservation** očuvanje, **the Authority** vlast, **dumping** potapanje, **international waters** međunarodne vode

unconsciousness (n) (safety) nesvjestica

uncover /ʌn'kʌvə/ (v) otkriti, otvoriti

undeclared /,ʌndi'kleəd/ (adj) (shipping econ) neprijavljen

undeclared cargo /,ʌndi'kleəd/ (n) (mar law, shipping econ) neprijavljeni teret

underestimate (v) (safety) podcijeniti: *The master had underestimated the environmental conditions*

under-keel clearance; UKC (n) (navig) dubina pod kobilicom, dubina ispod

kobilice: *The OOW also knew about squat, but he assumed that an under keel clearance (UKC) of 0.7 metres would be enough to pass the shallowest part without a problem..* **gross under keel**

clearance bruto dubina ispod kobilice, **net under-keel clearance; UKC** neto dubina ispod kobilice, **under-keel-clearance**: *During the transit, as per the passage plan, speed was to be reduced to below 12 knots to minimise the effect of squat on under keel clearance.*

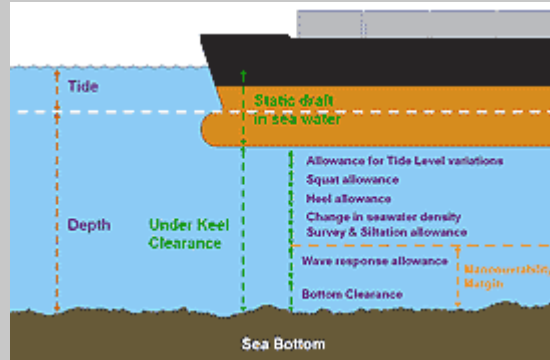

undermanned ship /,ʌndə'mænd/ (adj) (seamanship) brod s nedostatnom posadom

under sail (prep phr) (boating/yachting) plovdba jedrima

under ship's tackle (n) (shipping econ) ispod vitla broda, ispod čekrka broda, ispod brodske dizalice **delivery under ship's tackle** predaja (tereta) ispod čekrka broda

underside (n) donji dio, donja strana, donji kraj, dno

undersigned /,ʌndə'saɪnd/ (n) (mar law) niže potpisani: *We, the undersigned, have checked the items on the checklist*

undertake (v) 1 obavljati; 2 poduzeti; 3 (mar law) obvezati se: *The carrier undertakes to deliver the goods against surrender of the document and the consignee undertakes to take over the goods from the carrier. Prijevoznik se obvezuje predati robu uz predočenje robnih dokumenata, a primatelj se*

obvezuje istu preuzeti od prijevoznika.

under tow (n) (navig) brod u teglju

underwater fishing /ˈʌndəˈwɔ:tə/ (n) (fishing) podvodni ribolov

underwater operations /ˈʌndəˈwɔ:tə/ (n) podvodni radovi

underwater repair /ˈʌndəˈwɔ:tə/ (n) (nav arch) podvodni popravci

underwater rock /ˈʌndəˈwɔ:tə/ (n) (oceanogr) podvodna stijena **charted underwater rock** 1 ucrtana podvodna stijena; 2: *The master rang emergency full astern but the ship grounded on a charted underwater rock.*, **uncharted underwater rock** neucrtana podvodna stijena

underway /ˈʌndəˈwei/ **vessel underway** brod u plovidbi, brod koji je isplovio iz luke: *Are you ready to get underway? Yes, ready to get underway.* (adv) (navig) said of a vessel when she is not at anchor, nor made fast to the shore, or aground (COLREGS) (brod) u plovidbi, brod koji plovi {tal.: in navigazione; alla via}

underway /ˈʌndəˈwei/ (adv) (navig, seamanship) u plovidbi, brod u kretanju **while underway** u plovidbi, dok brod plovi

under way but not making way /ˈʌndəˈwei/ (n) (boating/yachting) spreman za plovidbu (zvučni signal)

underwriter /ˈʌndəˈraɪtə/ (n) (mar ins) osiguratelj **underwriters** osiguratelj

undock /ʌnˈdɒk/ (v) (navig, seamanship) odvezati se, napustiti vez, otići s veza

undocking /ʌnˈdɒkɪŋ/ (n) 1 (seamanship) odlazak s veza, manovra isplavljenja s veza; 2 (seamanship) odvezivanje

unendorsed bill of lading /ˌʌnɪnˈdɒsəd/ (n) (mar law) teretnica bez opaske

unentered (adj) (shipping econ) neprijavljen **unentered goods** neprijavljena roba

uneven /ʌnˈi:vən/ (adj) neravan

unfamiliar (adj) nepoznat **unfamiliar area** (navig) nepoznato područje: *When navigating in an unfamiliar area, restricted visibility, or in darkness, this is usually best achieved by the use of latitude and longitude or reference to a local feature.*

unhook (v) 1 (cargo handling) otpustiti s kuke, izvaditi kuku (s tereta); 2 otpustiti s udice

unidentified underwater object /ˌʌnɑɪˈdeɪntɪˌfaɪd/ neidentificirani podmorski objekt

unidirectional engine /juːnɪdɪˈrɛkʃənəl; juːnɪdɑɪˈrɛkʃənəl/ (n) (marine eng) istosmjerni motor, neprekretni stroj

uniflow scavenge /ˈjuːniˌfləʊ/ (n) (marine eng) istosmjerno ispiranje, uzdužno ispiranje

uniform /ˈjuːniˌfɔ:m/ (adj) jednak, jednolik, ujednačen po veličini (o teretu), jednoličan, jednoobrazan

Uniform Customs and Practice for Documentary Credits (1993) (n) (mar law) Jedinstvena pravila i običaji za dokumentarne akreditive, 1993

uniform lateral buoyage system (n) (navig) jedinstveni lateralni sustav označavanja (na moru)

union purchase /ˈjuːnjənˌpɜːtʃɪs/ (n) (cargo handling) zajednički rad dviju samarica (na istom grotlu), povezani podigači dviju samarica, španjola, dvostruki koloturnik,

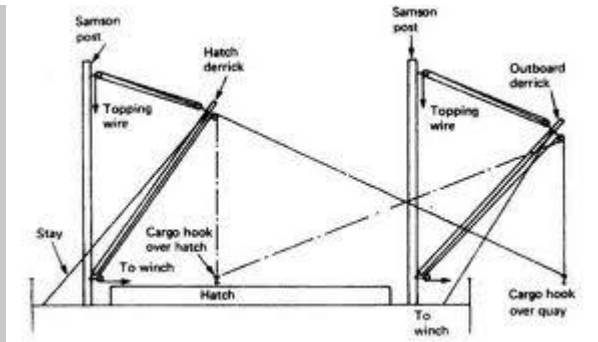

smarice spojene za zajednički rad

unit /'ju:nit/ **1** a jedinica; **2** uređaj, mehanizam, postrojenje, jedinica **control unit** **1** upravljački uređaj; **2** kontrolni uređaj **feed-water unit** napojni uređaj, **power unit** pogonski agregat, jedinica snage, **main propulsion unit** glavno pogonsko postrojenje, **propulsion unit** pogonsko postrojenje, pogonski uređaj, pogonska jedinica, **steam generating unit** uređaj za proizvodnju pare; **3** postrojenje; **4** cjelina **as a complete unit** kao zasebna cjelina, kao poseban sklop; **5** element; **6** mjerna jedinica, jedinica mjerenja

unit cargo (*cargo*) jedinični teret (na paletama), paletizirani teret

uniterrupted (*adj*) neprekidan, neprestan

uniterrupted power supply; (UPS) (*n*) (*cargo handling, electr*) stalna opskrba električnom energijom ((*npr. napajanje električnom strujom hlađenih kontejnera na brodu*))

unitised /'ju:nitaizd/ paletiziran (teret), jediničan (teret)

unitised cargo (*n*) (*shipping econ*) jedinični teret (na paletama itd.): *Unitised cargoes (commodities) include paper, pulp, plywood, hardboard, lumber, aluminium, lead, steel pipes and many more.*

unitising slaganje u jedinični teret. *The process of unitising consists of strapping together individual bales or bundles into a unit.*

unit load (*n*) (*shipping econ*) jedinični teret (na paletama itd.)

unit stress (*n*) (*marine eng*) jedinično naprezanje

universal joint (*n*) (*boating/yachting*) univerzalni zglob, univerzalna osovinica (omogućuje postavljanje u svim smjerovima)

Universal Time Co-ordinated (UTC) (*n*) **1** (*navig*) koordinirano univerzalno vrijeme; **2** (*boating/yachting*) zglob jarbola (daske za jedrenje)

unlay /ʌn'lei/ (*v*) (*seamanship*) untwist and separate the strands of a rope otplesti (konop, uže)

unless (*conj*) ako ne, ukoliko ne, osim ako

unlikely /ʌn'laikli/ (*adj*) nevjerojatan, koji se ne očekuje **in the unlikely event** u teško vjerojatnom slučaju

unlikely /ʌn'laikli/ (*adv*) nevjerojatno

unlimited navigation (*n*) (*mar law*) neograničena plovidba

unlimited trade (*n*) (*mar law, shipping econ*) = **unlimited navigation** neograničena plovidba

unlit /,ʌn'lit/ **unlit buoy** pogašeno svjetlo, pogašena plutača (*adj*) neosvjetljen, pogašen, ugašen, bez svjetla, ugašena (plutača), plutača bez svjetla: *the buoy in the*

fairway was *unlit*

unload /ʌnˈləʊd/ (v) (cargo handling) **ANTONYM load** iskrcati

unloader /ʌnˈləʊdɚ/ (n) (cargo handling) brodoiskrcavač (na terminalu za rasute terete), mosna dizalica za iskrcaj rasutog tereta **ship unloader** brodoiskrcavač

unloading /ʌnˈləʊdɪŋ/ **1 SYNONYM discharge** iskrcaj broda: *Unloading was carried out during the day, suspended overnight, resumed at 0900 the following morning and completed by midday.* Iskrcaj je obavljen za vrijeme dana, prekinut po noći, ponovno započeo u 0900 sljedećeg dana i završen do podna. ; **2 iskrcaj tereta**

unloading arm (n) (ports) **COMPARE loading arm** iskrcajni kran, **maniga**: *The unloading platform supports the unloading arms, pumps and the operator's shed.*



unloading platform (n) (ports) iskrcajna platforma (za naftu): *The unloading platform is the larger rectangle in the middle that is inside the fender line so the ship won't actually touch it.*

unloading rate (n) (ports) kapacitet iskrcaja: brzina iskrcaja (u tonama, koletima, broju kontejnera) A 57.000 t capacity silos for grain and soya storage with 5.000 t/day unloading rates.

UN/LOCODE; United nations Codes for Ports and other Locations (n) (navig, mar law) šifrirani popis luka i odredišta UN/LOCODE

unmanned engine room /ʌnˈmænd/ (n) (marine eng) = **unmanned machinery space (UMS)** automatska strojarnica, strojarnica bez osoblja prisutnog u stroju: *The engine room is arranged with a control and monitoring system, that meets LR class requirements for a periodically unmanned engine room.* **periodically unmanned engine room** strojarnica **povremeno bez osoblja prisutnog u stroju**: engineer officers in charge of a watch in a manned engine-room or designated duty engineer in a **periodically unmanned engine-room (UMS)** (A-III/1) Chief Engineer Officers and Second Engineer officers on-ships-with 3,000kw propulsion power or more.

unmanned machinery space (UMS) /ʌnˈmænd/ (n) (marine eng) automatska strojarnica (upravljana s mosta), strojarnica bez stalne straže u stroju

unmanned vessel (n) (nav arch) brod bez posade, brod upravlján s kopna,

autonomni brod: *Rolls-Royce offers a vision in which a small crew of 7 to 14 people monitor and control the operation of a fleet of unmanned vessels across the world using interactive smart screens, voice recognition systems, holograms and surveillance drones to monitor what is happening both on board and around the ship. (http://gcaptain.com)*

unmoor /ʌnˈmʊə ; ʌnˈmɔː/ (v) (seamanship) **ANTONYM moor** the act of letting go a mooring buoy, letting go mooring lines, or if a ship is moored with anchors, reconnecting each anchor to its own chain and heaving in the anchors (Seasources.net) **odvezati se, napustiti vez**

unmooring /ʌnˈmɔːrɪŋ/ (n) (seamanship) odvezivanje, manovra odvezivanja broda

unmooring manoeuvre manovra odvezivanja

unobstructed deck /ˌʌnəb'strʌktɪd/ (n) (nav arch) kontinuirana paluba, paluba bez zapreka

unpacked (adj) (shipping econ) nepakovan (teret), neupakiran, bez pakovanja
unpacked bulk goods nepakovani rasuti teret, nepakovani masovni teret

unreefed sail /ˌʌn'ri:ft/ (n) (boating/yachting) neskraćeno jedro

unreeve 1 izvući užu iz kolotura; **2** odmotati (kabel)

unreliable /ˌʌnrɪ'laɪəbəl/ (adj) nepouzdan

unrig /ˌʌn'riɡ/ (v) raspremi (jarbol, samaricu)

unripe /ˌʌn'raɪp/ (adj) (cargo) nezreo, nesazrio

unscrew /ˌʌn'skruː/ (v) odviti, odvidati

unseaworthy /ˌʌn'si:wə:θi/ (adj) (nav arch) nesposoban za plovidbu

unship /ʌn'ʃɪp/ (v) **1** the act of detaching or unrigging any piece of apparatus from its operating position raspremi; **2** (boating/yachting) oboriti jarbol, skinuti jarbol i oputu

unsound /ʌn'saʊnd/ (adj) (cargo) neispravan (koletu, teret), nezdrav (koletu)

unstable equilibrium (n) (nav arch) labilna ravnoteža

unstable ship (n) (stabil) nestabilan brod: *A ship may become unstable if the centre of gravity (G) is allowed to rise too high.*

unwind /ʌn'waɪnd/ (v) (marine eng, cargo handling, seamanship) odmotati, odviti, odvrnuti

up and down (prep phr) (seamanship) okomit (sidor, sidreni lanac) {tal.: a picco}

up-and-down motion (n) (marine eng) gibanje gore-dolje, hod gore-dolje

up-and-down movement (n) (marine eng) = **up-and-down motion** gibanje gore-dolje, kretanje gore-dolje

upbound (adj) (navig) a vessel traveling upstream koji plovi uzvodno

update /ʌp'deɪt/ (v) ažurirati, osvježiti **update AIS voyage details** osvježiti podatke u sustavu AIS

updated /ʌp'deɪtɪd/ (adj) **ANTONYM outdated** osvježen, ažuriran **updated list** najsvježiji popis, ažuriran popis

updating (n) (navig) ažuriranje, vremensko obnavljanje **chart 1** ažuriranje navigacijskih karata

uphaul /ʌp'hɔ:l/ (n) (boating/yachting) = **topping lift** :**3** podigač tanguna špinakera

upkeep /ʌp'ki:p/ (n) (seamanship, marine eng) = **maintenance** održavanje

upon (prep) **ANTONYM prior to** nakon, nakon nečega, nakon što

upper deck (n) (nav arch) gornja paluba: *In particular, access to the upper deck tiers is a problem, even with the approved fire-fighting equipment required by SOLAS.* **upper deck plating**

oplata gornje palube, **upper deck beam** sponja gornje palube

upper-deck beam (n) (nav arch, sailing vessels) sponja palube

upper-deck hock (n) (nav arch, sailing vessels) zoja gornje palube

upper deck line (n) (nav arch) linija gornje palube

upper deck sheer strake (n) (nav arch) pojasni voj gornje palube

upper-deck stringer bar uglovnica proveze gornje palube

upper drum (n) (marine eng) gornji bubanj, gornja komora (kotla)

upper end (n) (marine eng) gornji kraj, gornji dio

uppermost /ˈʌpə, məʊst/ (adj) najviši

upper strake (n) (nav arch) gornji voj

upright (adj) uspravan in **upright position** u uspravnom položaju

upstream /ˈʌpˈstri:m/ (adv) **ANTONYM downstream** uzvodno, uz rijeku

uptake (n) (marine eng) a metal conduit connecting the boiler combustion space with the base of the smokestack **dimovod**

up-to-date; up to date /ʌp tə deɪt/ (adj) osvježen (o podacima), osuvremenjen, ažuriran

upturned (n) (boating/yachting) prevrnut (jedrilica, brodica): *The youngest member of the crew swam to the upturned hull and managed to climb on to it. The following morning, a passing ship saw the upturned hull and the survivor, and raised the alarm.*

upwind /ˈʌpˈwɪnd/ (prep) (boating/yachting) uz vjetar

upwind (n) (boating/yachting) svi kursovi u vjetar

urgency /ˈɜːdʒənsi/ (comm) žurnost, hitnoća (drugi stupanj prioriteta u pomorskim komunikacijama), usmena poruka s oznakom Pan Pan

urgency alert (n) (comm) signal uzbune u žurnosti **transmit urgency alert** poslati signal o žurnosti, emitirati signal o žurnosti *A DSC urgency alert may be transmitted only with the authority of the master of skipper, or the person responsible for the safety of the vessel*

urgency message /ˈɜːdʒənsi/ (n) (comm, navig, safety) poruka žurnosti

urgency traffic /ˈɜːdʒənsi/ (n) (comm) radio promet u žurnosti

USCG; (US Coastguard) (n) (mar law) 1 Američka obalna straža; 2 (nav arch) inicijali brodova Američke obalne straže

use (n) uporaba, upotreba, primjena in **use** u upotrebi, **make use of** 1 upotrijebiti, koristiti; 2 primijeniti

use (v) 1 koristiti, uporabiti; 2 primijeniti

user menu overview (n) (navig) pregled korisnikova izbornika na radaru

U.S.F.; (United States Frigate) (n) (navy) fregata Mornarice SAD-a

U-shaped (adj) u obliku slova U

USS; (United States Ship) (n) (navig) brod Ratne mornarice SAD-a, brod Američke ratne mornarice

usufruct /ˈjuːsju, frʌkt/ (n) 1 (mar law) plodouživanje; 2 (mar law) The legal right of using and enjoying the profits of something belonging to another party.
(<http://www.maerskline.com/en-jm/help/shipping-glossary>) iskorištavanje (tuđega)

utilities /juːˈtɪlɪtɪz/ (n) **public utilities** 1 businesses that provide the public with necessities, such as water, electricity, natural gas, and telephone and telegraph communication **komunalne ustanove, komunalije**; 2 **komunalne usluge, komunalnije**, useful features, or something useful to the home such as power, electricity, gas, water, cable and telephone, telecommunications, internet connection, water, wastewater, etc. **komunalne usluge, komunalije**

utilization /juːˈtɪlaɪˈzeɪʃən/ (n) 1 upotreba, korištenje; 2 iskorištavanje

utmost /ˈʌt, məʊst/ (adj) krajnji, najviši, maksimalan

vacation days /və'keɪfən/ (n) (shipping econ) dani dopusta

vaccination /,væksɪ'neɪfən/ (n) (med) cijepljenje, vakcinacija

vaccination certificate /,væksɪ'neɪfən/ svjedodžba o cijepljenju

vaccine /'væksɪ:n/ (n) cjepivo, vakcina

vacuum /'vækjuəm/ (n) vakuum **vacuum pump line** vakuumski crpni cjevovod, vakuumska pumpna linija

vacuum clamps /'vækjuəm/ (n) (cargo handling) vakuumska kliješta: *Vacuum clamps were primarily designed to lift newsprint, but are now also used with other types of reeled paper.*

valid until koji vrijedi / važi i do (o ispravi)

valuables /'væljʊəbəlz/ (n) dragocjenosti

value /'væljʊ:/ (n) 1 a vrijednost; 2 količina; 3 iznos

valued policy (n) (mar ins, mar law) policia u kojoj je označena ugovorena vrijednost osiguranoga interesa **valutirana policia**

valueless /'væljʊlɪs/ (adj) bezvrijedan

valve /vælv/ (n) (marine eng) ventil, pipac, tal. *valvola* **valve head** glava ventila, pladanj ventila, **valve lifter** podizač ventila, **valveoperating gear** 1 ventilno polužje, ventilski uređaj; 2 mehanizam ventila, mehanizam za otvaranje ventila, **valve rocker gear** ventilno polužje, ventilski uređaj, mehanizam ventila, **valve seat** sjedište ventila, ležište ventila, sedlo ventila, sjedalo ventila, **valve stem** vreteno ventila, struk ventila, osovina ventila, loza, **air master valve** glavni ventil zraka, master ventil, manevarski ventil, **automatic valve** automatski ventil, **control slide valve** razvodni ventil, razvodnik, **delivery valve** dovodni ventil, dobavni ventil, tlačni ventil, **exhaust valve** ispušni ventil, **fuel injection valve** ventil goriva, **fuel spray valve** ventil za raspršivanje goriva, **inlet valve** usisni ventil, ulazni ventil, **indicator valve** indikatorski pipac, pipac za indiciranje, **isolating non-return valve** izdvojeni nepovratni ventil, **interlock valve** ventil uređaja za blokiranje, **main stop valve** glavni zaporni ventil, **master valve** glavni ventil, master ventil, **needle valve** igličasti ventil, **non-return valve** nepovratni ventil, **n.r. valve** (non-return valve) nepovratni ventil, **one-piece valve** jednodjelni ventil, **pilot air control valve** ventil za upravljanje sekundarnog zraka, **pilot valve** razvodni ventil, upravljački ventil, pilot ventil, **piston valve** klipni ventil, razvodni ventil, razvodnik, **pump delivery valve** dobavni ventil pumpe, **pressure regulating valve** regulacioni ventil tlaka, prekotlačni ventil, pretlačni ventil, **quick speed valve** brzozaporni ventil, **relief valve** odušni ventil, otpusni ventil, sigurnosni ventil, **remote operating non-return valve** nepovratni ventil s daljinskim upravljanjem, **safety valve** sigurnosni ventil, **starting air valve** ventil uputnog zraka, ventil zraka za upućivanje, **starting valve** uputni ventil, **thermostatic valve** termoregulacioni ventil, termostatski ventil, **air inlet valve** ventil za ulaz zraka, **cylinder head valve** ventil na glavi cilindra, **distribution box valve** razvodna ventilna stanica, **inlet valve** usisni ventil **valve operating mechanism** (n) (marine eng) mehanizam otvaranja ventila,

polužje za pokretanje ventila, ventilno polužje

valve overlap (n) (marine eng) preklapanje ventila

van /væn/ (n) 1 (cargo) a covered motor vehicle for transporting goods, etc, by road **kombi**, **manje**

teretno vozilo: *Special rapid tensioners are available for lashing automobiles and vans.*; 2

karavan, **natkriveno vozilo**

vanadium; (V) /və'neidiəm/ (n) (chem) **vanadij**

van carrier /'væn,kærie/ (n) (cargo handling) **kontejnerski prienosnik (na gumenim**

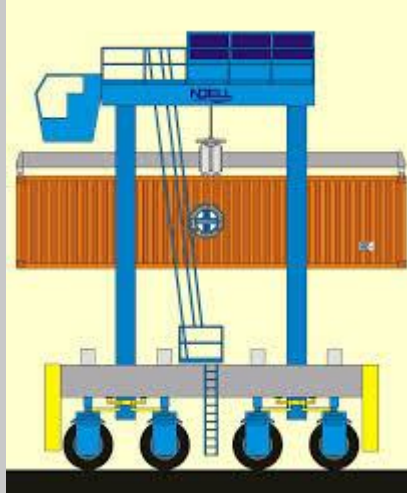

kotačima), **jahač**

vane /vein/ (boating/yachting) **vjetrulja (zastavica na vrhu jarbola)**, **moštravent**,



muštravent

vane /vein/ (n) (marine eng) **krilce (turbine)**, **lopatica** **radial vane** **radijalne lopatice**, **radijalna krila**, **rotating vane** **rotirajuće krilce**, **okretno krilce**, **krilce rotora**, **inlet**

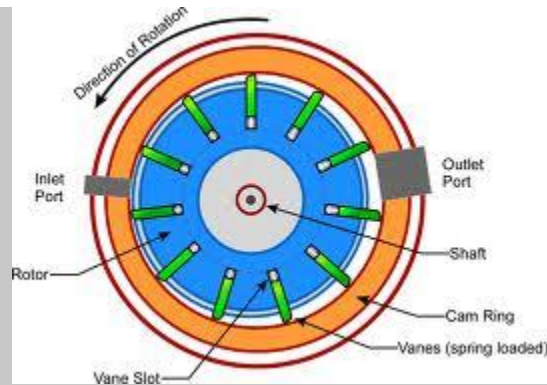

vane ulazne lopatice

vang /væŋ/ (n) (boating/yachting) priteg deblenjaka (buma), **vang**, tal. ritenuta del boma boom **vang** priteg deblenjaka, **spinnaker pole vang** priteg deblenjaka

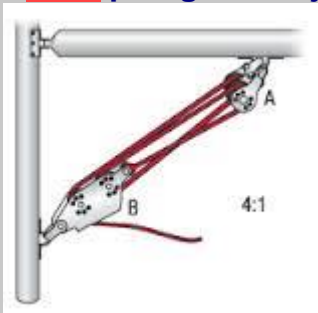

spinakera

vanishing angle (n) (nav arch, navig) maximum angle degree of heel after which the vessel becomes unable to return to her upright position **kritični kut nagiba (broda)**

vapor /'veɪpə/ (n) (US) 1 (marine eng) = **vapour** para; 2 raspršena tekućina

vapour /'veɪpə/ (n) 1 (marine eng, UK) para; 2 raspršena tekućina

vapour return line (n) (marine eng) povratni cjevovod pare

variable /'vɛəriəbəl/ (adj) promjenljiv (vjetar, ...)

variable pitch propeller (n) (nav arch) prekretni propeler, propeler s promjenjivim

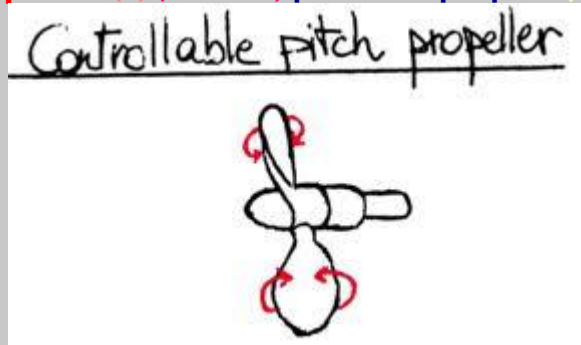

korakom prepelera

Variable Range Marker; (VRM) (n) (navig) promjenjiva kružnica udaljenosti (na radarskom zaslonu), promjenjiva daljinska kružnica, promjenjivi označivač udaljenosti, promjenjiva kružnica za mjerenje udaljenosti **check the accuracy of Variable Range Marker; (VRM)** provjeriti preciznost promjenjivog označivača



udaljenosti

variation /ˌveəriˈeɪʃən/ (n) **1** magnetic compass error caused by the difference between the magnetic pole and the geographic pole and certain local conditions **magnetic variation** **magnetska varijacija** **a** (navig) **varijacija**; **2** (marine eng) **variranje, odstupanje, varijacija, promjena**

variegated scallop (n) **kapica mala**

variety (n) **raznolikost, mnogostrukost**

varnish (n) (boating/yachting) **lak, tal. smalto**

vary (v) **1 odstupati, varirati; 2 mijenjati se**

vast (v) (seamanship) **COMPARE Avast!; avast** stati, zaustaviti, prestati

vauxhall (n) (nav arch) **linica, puna ograda broda**

V-belt /ˈviːbɛlt/ (n) (marine eng) **konusni remen**

VCG; vertical centre of gravity (n) (stabil, nav arch) = **KG; center of gravity above the keel; KG metres above the keel** the height above the baseline of the centre of gravity **visina sistemnog težišta broda iznad kobilice, vertikalno težište**



V-drive /ˈviːdraɪv/ (n) (nav arch, marine eng) **V-pogon**

VDR recording /ˈviːdiː, a:t/ **snimak crne kutije, snimak VDR-a** the VDR recording shows that the vessel was already turning to starboard before the 'port 20°' order was given. Snima VDR-a pokazuje da je brod skretao u desno prije nego što je kormilaru dana naredba lijevo 20.

VDR; Voyage Data Recorder /ˌviːdiːˈaː/ (n) (navig) **VDRs**, required for ships over 3,000 gross tons under international law, are the equivalent of 'black boxes' on aircraft, recording crucial data such as radar images, position, speed and bring audio, among other data. (gCaptain <info@gcaptain.com>) **uređaj za zapis plovidbenog putovanja, snimalica podataka o putovanju, crna**

kutija uređaj VDR *The National Transportation Safety Board has completed its documentation of the wreck of the cargo ship ... and the associated debris field, but the vessel's voyage data recorder (VDR) has not been located. Audio recordings are likely to have been deleted deliberately from the voyage data recorder (VDR)* **simplified VDR system pojednostavljeni uređaj za zapis**

plovidbenog putovanja, pojednostavljeni uređaj VDR

VDU (visual display unit) /'vi: di: ,ju:/ (n) ekran

vector chart /'vɛktə/ (n) (*navig*) slojevita pomorska karta s više razina pa se može mijenjati nominalno mjerilo. Vektorski podaci (koordinate točaka i njihove veze) formirane su tako da tvore geometrijske figure u obliku I+točaka, linija i područja (Kos, Zorović, Vranić) **vektorska karta**

Vee-engine /'vi:,ɛndʒɪn/ (n) (*marine eng*) **V-stroj, V-motor, motor s cilindrim smještenim**

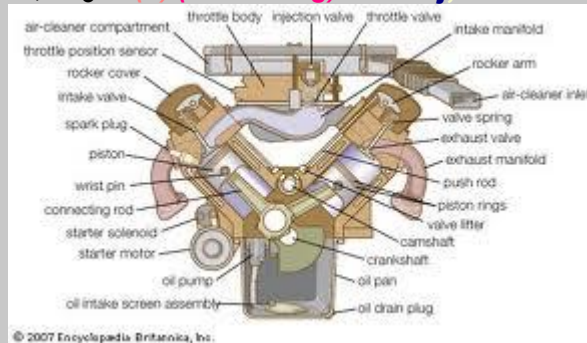

u V-položaju

veer /viə/ **1** (*meteorol*) mijenjati smjer (u smjeru kazaljke na satu, na sjevernoj

polutki) (o vjetru), skretati (o vjetru): *SW wind veering to NE jugozapadni vjetar u skretanju na sjeverozapadni Four days into the voyage, while transiting a TSS, a gale warning was received warning of southerly veering westerly force 8 to 10 winds imminent.* **2** (*seamanship*) allow a

line, wire, or chain to run out by its own weight **ispuštati konop ili lanac:** *They were veering the cable by slacking the brake on a disconnected windlass.* **to veer out the cable ispuštati sidreni lanac (kontrolirano), to veer in the cable uvlačiti lanac (sidra), povlačiti lanac (sidra) podizati lanac (sidra) virat, veer the line izvlačiti užu / konop;** **3** skrenuti u smjeru kazaljke na satu (o brodu) : *with the bow entering the lee of the breakwater and the stern still exposed to the full force of the wind, the vessel veered to starboard;* **4** (*boating/yachting*) **skretati jedrilicu od vjetra**

veer and haul the line (v) (*seamanship*) izvlačiti i povlačiti užu na prekide

veering /'viəriŋ/ (*adj*) **veering wind** vjetar koji skreće u smjeru kazaljke na satu (sjev. polutka) (*meteorol*) vjetar koji skreće u smjeru kazaljke na satu (sjev. polutka), satno skretanje vjetra

veering wind (n) (*meteorol*) wind which changes in a clockwise direction with time at a given location (e.g., from southerly to westerly), or which change direction in a clockwise sense with height (e.g., southeasterly at the surface turning to southwesterly aloft) (Seasources.net) **vjetar u skretanju u smjeru kazaljke na satu (npr. sa sjevera na sjeveroistok)**

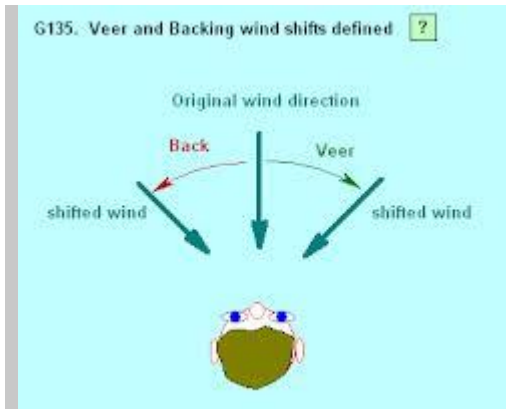

veer out (v) (*seamanship*) ispuštati sidreni lanac

vehicle /'vi:ikəl/ **1 vozilo road vehicle** cestovno vozilo, **vehicle carrier** brod za prijevoz vozila; **2 (marine eng)** prijenosnik, medij **act as a vehicle** djelovati kao prijenosnik / medij; **3 vozila (vrsta tereta)** *All types of vehicle, from automobiles to road-building machinery, can be transported by container ship.*

vehicle deck /'vi:ikəl/ (*n*) (*nav arch*) paluba za vozila

vehicle ferry /'vi:ikəl/ brod / trajekt za prijevoz vozila



velocity /vi'lsiti/ (*n*) brzina

velocity made good (VMG) (*n*) (*boating/yachting*) stvarna brzina

vendor /'vɛndə:/ (*n*) (*mar law, shipping econ*) prodavalac, prodavatelj

venereal disease /vi'nɪəriəl/ (*n*) (*med*) spolna bolest

vent /'vɛnt/ (*n*) (*nav arch, marine eng*) odušna cijev, odušnik **deck vent** palubni odušnik
Shortly after, water could be heard entering the double-bottomed tanks through the deck vents.

ventilating cowl /'venti,leitiŋ/ (*nav arch*) a hood shaped top or end of a natural ventilation trunk that may berotated to cause wind to blow air into or out of the trunk **zračnik**, **šijun**



ventilating fan /ˈventi.leitiŋ/ (n) (nav arch) ventilator

ventilation /ˌventiˈleɪʃən/ (n) (cargo) (marine eng) ventilacija, prozračivanje, prozračenost **insufficient ventilation** nedovoljna ventilacija, **natural ventilation** prirodna ventilacija, **forced ventilation** prisilna ventilacija

ventilation chute (n) (nav arch) zračnik

ventilation system /ˌventiˈleɪʃən/ **closed @** zatvoreni ventilacijski sustav
ventilacijski sustav

venting /ˈventɪŋ/ (n) **1** (marine eng) **a** odzračivanje, otplinjavanje, odsušivanje; **2** (cargo handling) prozračivanje: Emissions produced by venting during loading and transit are in the range of 0.1 to 0.3 percent, depending on tanker design and cargo characteristics.

verify /ˈveriˌfaɪ/ (v) provjeriti, verificirati, ovjeriti

vermin /ˈvɜːmɪn/ (n) (cargo handling) nametnici, štetočine, gamad, crvi

vernal equinox /ˈvɜːnəl ˈɛkwɪˌnɒks/ (n) (navig) proljetni ekvinocij

vernier caliper /ˈvɜːniə ˈkæɪlɪpə/ (n) (marine eng) an extremely precise measuring instrument; the reading error is 1/20 mm = 0.05 mm **pomična mjerka**, **obični šubler**

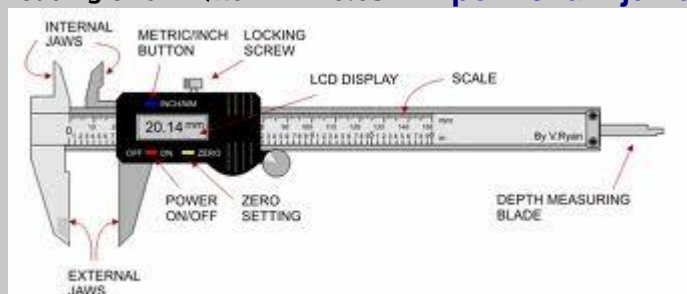

versatile /ˈvɜːsəˌtaɪl/ (adj) **praktičan** **extremely versatile** izuzetno praktičan

vertex /ˈvɜːtɪks/ (n) **1** vrh, vršak; **2** (navig) vrh / vršak pomorske oznake

vertical (adj) **okomit**, **vertikalan**

vertical jigging (n) (boating/yachting) U Vertical jiggingu postoje dvije osnovne tehnike izvođenja: short i long jerk. Kao što sama riječ govori, short jerk označava kratko trzanje štapom i namotavanje role, dok long jerk nešto duži trzaj sa štapom prilikom kojeg varalica klizi kroz more i u povratku jig svojom akcijom privlači ribu na udarac.

(<http://www.podvodni.hr/ribolov/udicarenje/jigging/1036-uvod-u-vertical-jigging>) **lovi ligana**

okomitim skosanjem, **tehnika ribolova trzanjem**, **skosanjem s pomoću ribarskog**

štapa, vertical jigging, jiganje {Osnovni pribor za Vertical Jigging sačinjava: štap, rola, upredenica, fluorokarbonski predvez (nije nužno), zjogulin te sami jig. Štap za ovu tehniku mora biti upravo namijenjen tome i napravljen tako da izdrži sve napore s obzirom da je oprema izložena velikom savijanju prilikom prezentacije varalice tj. jiga. Obično se koriste štapovi koji su deklarirani za rad sa varalicama od 100-300 gr s kojima je moguće pokriti sve dubine lova na kojima ste mislili koristiti ovu tehniku. (<http://www.podvodni.hr/ribolov/udicarenje/jigging/1036-uvod-u-vertical-jigging>)}

vertical moment; Vm (n) (stabil) vertikalni moment

vertical tube boiler (n) (marine eng) strmocijevni kotao, kotao s strmim cijevima

Very High Frequency (VHF) brlo visoka vrekvencija (30-300 MHz)

very high sea (n) (meteorol, oceanogr) osmi stupanj stanja mora s valovima visine od devet do četrnaest metara **teško more, more jačine 8**



Very Large Crude Carrier (=VLCC) (n) (nav arch) = **VLCC** supertanker, vrlo veliki tanker (preko 250 000 dwt)

very large gas carrier; VLGC a large gas carrier with a carrying capacity of more than 60,000 cbm **vrlo veliki brod za prijevoz plinova**

very quick lights (VQ) (navig) vrlo brza svjetla **very quick lights (VQ) lights**

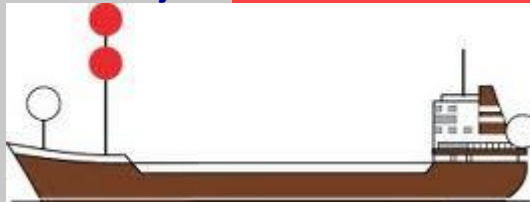

svjetla koja ističe nasukani brod

very rough sea (n) (meteorol, oceanogr) šesti stupanj stanja mora s valovima visine od četiri do šest metara **olujno more, more jačine 8**

vessel (n) = **ship** 1 very description of water craft, including non-displacement craft, WIG craft and seaplanes, used or capable of being used as a means of transportation on water (COLREGS) **brod**
vessel engaged in fishing brod koji ribari, vessel constrained by her draught brod koji je ograničen u manevriranju zbog svojeg gaza, **general cargo vessel** brod za generalni teret, **inward / outward vessel** brod koji uplovljava / isplovljava, **seagoing vessel** 1 morski brod; 2 prekomorski brod, **foreign-going vessel** brod u međunarodnoj plovidbi, **merchant vessel** trgovački brod; 2 sud, posuda, zatvorena tlačna posuda **pressure vessel** tlačna posuda, tlačni rezervoar, posuda pod tlakom, **close pressure vessel** zatvorena posuda pod tlakom, zatvorena tlačna posuda {generički naziv za plovilo}

vessel aground (navig, safety) nasukani brod, brod se nasukao

vessel alongside

vessel not under command (NUC)



vessel alongside (n) (navig, seamanship) brod uz obalu, brod vezan bočno uz obalu



vessel capital cost (n) (shipping econ) kapitalna vrijednost broda

vessel constrained by her draught (n) (mar law) brod ograničen svojim gazom

A vessel constrained by her draught may, in addition to the lights prescribed for power-driven vessels in Rule 23, exhibit where they can best be seen three all-round red lights in a vertical line, or a cylinder.

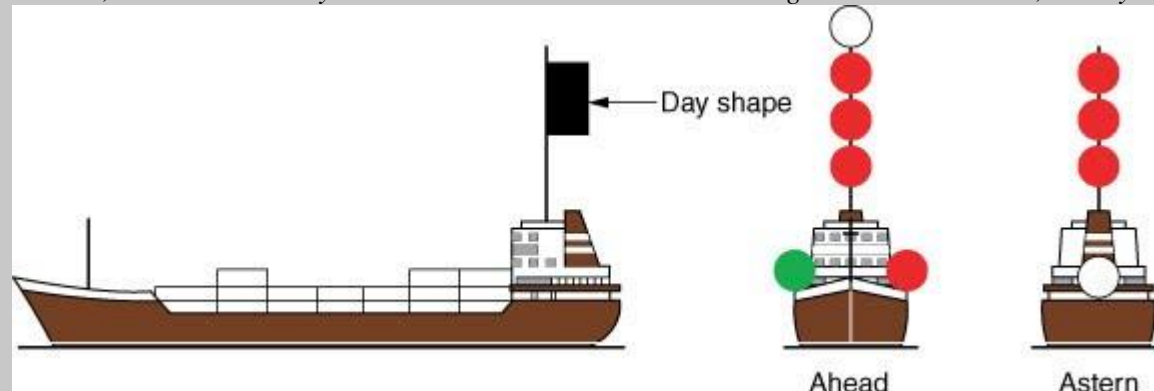

vessel engaged in fishing (n) (mar law) any vessel fishing with nets, lines, trawls or other fishing apparatus which restrict manoeuvrability, but does not include a vessel fishing with trolling lines or other fishing apparatus which do not restrict manoeuvrability (COLREGS) brod koji riba

vessel finder (n) (navig) uređaj satelitske navigacije za traženje i praćenje kretanja brodova. **Vessel Finder**: An AIS recreation of the incident from *Vessel Finder* is provided below

vessel movements (n) (ports) promet brodova u luci: the Port of Southampton is one of the largest and most diverse ports in Europe, handling 55,000 commercial vessel movements and 34 million tonnes of cargo each year.

vessel not under command (NUC) (n) (mar law) vessel which through some exceptional

circumstance is unable to manoeuvre as required by these Rules and is therefore unable to keep out of the way of another vessel (COLREGS) **brod koji ne može manevrirati, brod nesposoban za manevriranje**

Vessel Operational Agreement (n) (shipping econ) Sporazum o brodskoj operativi **daily Vessel Operational Agreement**

vessel operative cost (n) (shipping econ) operativni troškovi broda

vessel restricted in her ability to manoeuvre (RAM) (n) (mar law) a vessel which from the nature of her work is restricted in her ability to manoeuvre as required by these Rules and is therefore unable to keep out of the way of another vessel (COLREGS) **brod ograničene**

moćnosti manevriranja, brod ograničene sposobnosti manevriranja: *The term "vessels restricted in their ability to manoeuvre" shall include but not be limited to: (i) a vessel engaged in laying, servicing or picking up a navigation mark, submarine cable or pipeline; (ii) a vessel engaged in dredging, surveying or underwater operations; (iii) a vessel engaged in replenishment or transferring persons, provisions or cargo while underway; (iv) a vessel engaged in the launching or recovery of aircraft; (v) a vessel engaged in mine clearance operations; (vi) a vessel engaged in a towing operation such as severely restricts the towing vessel and her tow in their ability to deviate from their course.*

vessel routing system (n) (navig, safety) sustav mjera i postupaka za poboljšanje sigurnosti plovidbe u područjima velike gustoće prometa **sustav usmjerene plovidbe**

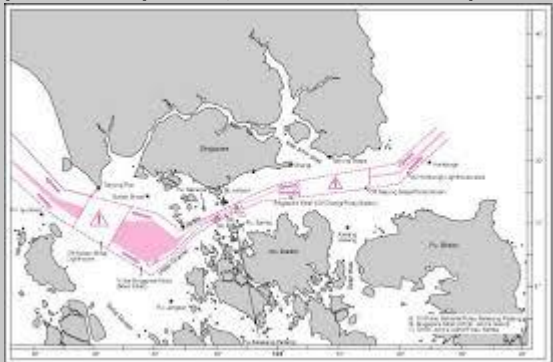

vessel sharing agreement (n) (mar law, shipping econ) A term agreement between two or more carriers in which a number of container positions (slots) equal in space are reserved on particular vessels for each of the participants. (<http://www.maerskline.com/en-jm/help/shipping-glossary>)

sporazum o raspodjeli brodskog prostora

vessel's status (n) (navig) current function or condition of the ship at sea, e.g. vessel restricted in her ability to manoeuvre, vessel not under command, vessel fishing, towing etc. **stanje broda,**

služba broda, funkcija broda: *The second officer did not acquire the vessel on the ARPA or use the AIS data to determine the vessel's name or status.*

vessel subject to compulsory pilotage (n) (mar law, navig) **brod koji podliježe obveznom peljarenju, brod koji obvezno mora imati peljara**

Vessel Traffic Monitoring Information System (VTMIS) (n) (navig) **Služba za nadzor i upravljanje pomorskim prometom**

vessel traffic planning (navig, safety) planiranje plovidbe, planiranje prometa u plovidbenom području

Vessel Traffic Service Area (n) (navig, safety) **Područje službe nadzora pomorske**

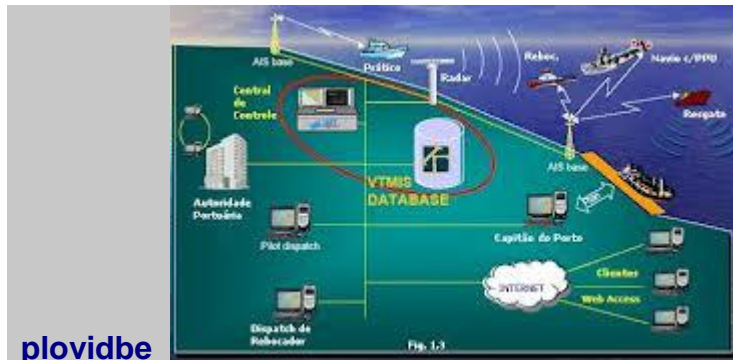

plovidbe

vessel traffic service; (VTS) (n) (navig, safety) služba nadzora pomorske plovidbe, služba nadzora plovidbe, kontrola i vođenje plovidbe (u kanalima, lukama itd.) služba VTS

vessel underway; vessel under way; (n) (mar law) brod koji plovi, brod u plovidbi

vessel/unit (n) (mar law) (u ugovorima o ukrcanju pomorca) brod ili plutajući objekt

vessel valuation (n) (shipping econ) (nav arch) tehnička i ekonomska prosudba gradnje novoga ili kupovanja rabljenoga broda **prosudba broda, tehničko i ekonomsko vrjednovanje broda**

vetting /ˈvɛtɪŋ/ (n) (shipping econ) to check the contents, quality, etc. of something carefully

odabir napovoljnijeg rješenja, vetting, osnivanje broda ship vetting (shipping econ)

Ship vetting is an in-depth assessment of a ship's quality and suitability for a task. It is the best way to match available vessels to the operational requirements of the voyage and the need to properly manage risk. **odabir najpovoljnijeg broda (za određen ugovor o zakupu ili ekonomskom iskorištavanju brodova)**

Ship vetting is the process through which a prospective charterer or buyer of a particular piece of tonnage will evaluate the subject vessel to assess its past performance, safety records, performance results, regulatory compliance and many other items.

VGM; (verified gross mass) (n) (mar law, shipping econ) **ovjerena broto masa**

(kontejnera): *The IMO's three-month so-called "light touch" enforcement of the SOLAS revision that all packed containers must have a certified VGM (verified gross mass) before loading on board a ship comes to an end.*

VHF radiotelephone /ˈviː eɪtʃ ,eɪ/ **UKV radiotelefon, VHF radio:** *I made a brief call on VHF*



and the OOW of the other ship promised to keep well clear.

via /ˈvaɪə/ (prep) **putem, preko, via** **via port of Rijeka 1** **putem luke Rijeka, preko luke Rijeka, kroz luku Rijeka; 2:** *the Mediterranean-Asian route via the Suez Canal*

vibration /vai'breifən/ (n) (**phys, marine eng**) vibracija, vibriranje, titranje: *The severe vibrations lasted several seconds.* **engine vibrations** 1 vibriranje motora, vibriranje stroja; 2 vibracije u stroju, **torsional vibrations** torzijska vibracija, **create vibration** izazvati vibracije, stvoriti vibracije

vice /vais/ (n) 1 (**mar law, nav arch**) mana, nedostatak **inherent vice** skrivena mana; 2 (**marine eng**) škrip, **morša bench vice** škrip na radioničkom stolu



Victory ship COMPARE Liberty ship an emergency fast cargo vessels to replace the slower Liberty ships in World War II **teretni brod tipa Victory (za prijevoz u konvojima u II. svjetskom ratu)**: *On April 28, 1943, the new ships were given the name **Victory** and designated the VC2 type (V for **Victory type**, C for cargo, and 2 for a medium sized ship between 400 and 450 feet long at the waterline). **The Victorries** could carry 10,850 deadweight tons (the weight of cargo a ship can carry) or 4,555 net tons (the amount of space available for cargo and passengers), a larger load than the Liberties could manage. Victory ships typically carried a crew of 62 civilian merchant sailors and 28 naval personnel to operate defensive guns and communications equipment. **The Victory ships** were different from the Liberty ships primarily in propulsion, the steam engine of the Liberty giving way to the more modern, faster steam turbine. **The Victory ships** had engines producing between 5,500 to 8,500 horsepower. Their cruising speed was 15-17 knots (approximately 18.5 miles per hour).*



victualling /'vitəliŋ/ (n) (**shipping econ, boating/yachting**) opskrba broda / brodice namirnicama, **panatika**; tal. **panatica**

Victualling Bill /'vitəliŋ/ (n) (**shipping econ**) račun / potvrda o kupljenim namirnicama (u carinskom skladištu)

victuals store /'vitəlz/ spremište namirnica, **gambuža** {tal.: **cambusa**}

view (n) pogled **in view of** u vezi s, s obzirom na, s ciljem da, **with a view to** u svrhu, s ciljem da

vigilance /'vidʒiləns/ (n) (**safety**) budnost, oprez

violate /'vaiəleɪt/ (v) (**mar law**), **prekršiti**: *Three shipping companies and a number of their employees were convicted of **violating** the Act to Prevent Pollution from Ships, obstruction of justice, and false*

statements.

violation /ˌvaɪələʃən/ (n) (*navig*) **kršenje**: The root cause/contributory factor of the accident was **violation** of COLREGS Rules 5 (Lookout), 8 (Action to avoid collision), 10 (Traffic separation schemes), 17 (Action by stand on-vessel) and 18 (Responsibilities between vessels) by rogue container vessel

violation of COLREGS

violent /ˈvaɪələnt/ (adj) **žestok (vjetar), jak, snažan**: The ship capsized in extraordinarily **violent sea conditions** caused by gale force winds and a strong, opposing tidal stream.

violently /ˈvaɪələntli/ (adv) **žestoko, jako, snažno**

violent storm (n) (*meteorol*) **jaki orkanski vjetar, teška oluja**

viscosity /ˌvɪsˈkɒsɪti/ (n) (*marine eng*) **viskoznost, viskozitet, žilavost, ljepljivost** **reduce**

viscosity **smanjiti viskoznost, viscosity regulator regulator viskoznosti, mjerač viskoziteta**

viscous /ˈvɪskəs/ (adj) **viskoznan, ljepljiv, žilav** **render oil less viscous smanjiti viskoznost goriva**

visibility (*meteorol*) **vidljivost**: Daylight **Visibility**: moderate in rain showers **arc of visibility**

kut vidljivosti, bad visibility loša vidljivost, excellent visibility izvrsna vidljivost,

good visibility visibility more than 5 nautical miles **dobra vidljivost, moderate visibility**

visibility between 2 and 5 nautical miles **umjerena vidljivost, poor visibility 1 visibility between**

1000 m and 2 nautical miles; 2 **loša vidljivost, restricted visibility 1 visibility less than 0.5**

nautical mile **ograničena vidljivost; 2 smanjena vidljivost, reduced visibility**

smanjena vidljivost, the visibility deteriorated vidljivost se pogoršala, visibility

improves vidljivost se poboljšava

visibility report (n) (*meteorol*) **izvješće o vidljivosti**

visibility scale (n) (*meteorol*) **ljestvica vidljivosti, stupnjevi vidljivosti 1 dense fog**

gusta magla, 2 thick fog jaka magla, 3 fog magla, 4 moderate fog umjerena magla,

5 poor visibility slaba vidljivost, 6 moderate visibility umjerena vidljivost, 7 good

visibility dobra vidljivost, 8 very good visibility vrlo dobra vidljivost, 9 exceptional

visibility izuzetna vidljivost

visible (adj) **vidljiv, koji se vidi**

visual display unit (VDU) **pokazivač, ekran, *displej***

visual signal (n) (*comm, navig*) **vizualni signal, vidljivi signal**

vituals /ˈvɪtəlz/ (n) **namirnice, *provišta***

VLCC (=Very Large Crude Carrier) (n) (*nav arch*) **Very Large Crude Carrier (VLCC) is an ocean-going crude oil tanker of 200,000 to 299,999 dwt. **supertanker, vrlo veliki tanker****

(preko 250 000 dwt) VLCC rates dnevna najamnina za supertankere *MidEast VLCC*

*rates jump by almost \$13,000 a day; Basra cargos could increase **daily rates** by \$9,000. Freight rates on*

Asian routes for very large crude carriers (VLCCs) are set to climb higher next week as unloading delays and weather-related port congestion in China tighten vessel supply on strong chartering activity, brokers

*said on Thursday. (<http://www.marinelink.com/maritime/tanker-charter-rates>), **freight rates for***

VLCC **vozarinski stavovi za supertankere *Freight rates on Asian routes for very large crude***

carriers (VLCCs) are set to climb higher next week as unloading delays and weather-related port

congestion in China tighten vessel supply on strong chartering activity, brokers said on Thursday.

*(<http://www.marinelink.com/maritime/tanker-charter-rates>) Ship owners will try to push **VLCC rates close***

to 100 on the *Worldscale* measure, **daily rates for VLCCs** dnevna najamnina za supertankere, **VLCC surge** vozarine VLLC brodova naglo rastu: *VLCC rates from the Middle East to Japan surged to W88.5 from around W79 a week earlier, equivalent to daily earnings of \$65,858,*



voice hailer doglas, megafon, portavoče

void (n) (*nav arch*) an enclosed empty space in the ship prazan prostor, praznina

void spaces (n) (*cargo handling*) prazni prostori (u brodskom skladištu)

Voith-Schneider propeller (n) (*nav arch*) propeler tipa Voith-Schneider



Voith-Schneider propulsion (n) (*nav arch*) The Voith Schneider Propeller (VSP) combines propulsion and steering in one unit **pogon tipa Voith-Schneider** {pogon i propeler u istoj jedinici}

volatile organic compounds (VOCs) /'vɒlə, taɪl/ (n) (*cargo handling*) hlapljivi

organski sastojci: *Volatile organic compounds (VOCs) are emitted when loading and have to be removed, this being done with equipment on deck. It is estimated that 4 to 7 million of tons of cargo is lost due to VOC emission yearly*

volatility /vɒlə, tɪlɪtɪ/ (n) (*chem*) hlapljivost

voltage /'veʊltɪdʒ/ (n) (*electr*) napon, električni napon **lethal voltage** napon opasan po život {u značenju 'električni napon' naziv VOLTAGE ima prednost pred nazivom TENSION}

volume /'vɒlju:m/ (n) 1 a **volumen** **cylinder volume** volumen cilindra, **swept volume** stapajni volumen; 2 obim; 3 količina (tereta)

volume control (VOL) (n) (*comm*) upravljačka ručica/kotačić za jačinu zvuka (na VHF uređaju)

volume of cargo (n) (*shipping econ*) količina tereta

volume rate (n) (*mar law*) Rate applicable in connection with a specified volume (weight) of

freight. **vozarina na temelju količine (težine) tereta**

voluntary /'vɒləntəri/ (adj) **1 (mar law) namjeran voluntary risk namjeran rizik (radi spašavanja pomorskog pothvata), voluntary sacrifice namjerno žrtvovanje (tereta); 2 dobrovoljan**

volute /'vɒlju:t/ (n) (marine eng) puž, spirala

vortex /'vɔ:tɛks/ (n) (marine eng) vrtlog **vortex chamber** vrtložna komora

voyage /'vɔɪdʒ/ (n) (shipping econ, navig) putovanje (broda), vijaj **complete the voyage** završiti putovanje, **interrupt the voyage** prekinuti putovanje, **resume the voyage** nastaviti putovanje (nakon nesreće, havarije)

voyage charterparty (n) (mar law) A voyage charterparty is a contract whereby the lessor (the shipowner or demise or time charterer) places all or part of the carrying capacity of a ship at the disposal of the lessee (the voyage charterer) for the transport of goods agreed upon, on one or more voyages, for a consideration called freight, based on the quantity of cargo carried and is payable as provided for in the charterparty (Tetley) **brodarski ugovor za putovanje, zakup broda za jednu plovidbu (EUdict), ugovor o najmu broda za putovanje, ugovor na putovanje**. *As the voyage charter covers only one voyage, it is known as a "spot contract". For VLCCs, the voyage charter contract is the most common arrangement today.*

voyage costs (n) (shipping econ) **COMPARE operating costs** cost that incur for a particular voyage. Fuel costs, canal dues, pilotage and port charges are the main costs related to a specific voyage. (<https://brage.bibsys.no>) **troškovi putovanja broda**

voyage data recorder; (VDR) (n) (navig) A protective capsule (recoverable in the event of a casualty) used to provide a record of key operational events throughout a 12 hour period. Events recorded include: radar, voice, DGPS, engine orders, weather information. In the event of an incident involving the ship, these data may be used to analyse events. (A. Ferguson) **crna kutija, snimalica podataka o putovanju, uređaj za bilježenje podataka o pomorskom putovanju**



voyage estimate (shipping econ) proračun putovanja broda

voyage expenses (n) (shipping econ, nav arch) Expenses incurred for a ship's traveling from a loading port to a discharging port, such as bunkers cost, port expenses, agent's fees, canal dues, extra war risk insurance and commissions. **troškovi putovanja broda**

voyage monitoring (n) (navig) nadziranje provedbe putovanja

voyage planning (n) (navig, shipping econ) planiranje putovanja, planiranje plovidbe
 {The term *Voyage planning* includes both navigational and shipping aspects of the voyage, whereas the term

passage planning is narrower in meaning and refers to navigational aspect of the voyage}}

voyage policy (n) (mar ins) **polica na putovanje**

voyage recording (n) (navig) **snimanje putovanja**

VRM (Variable Range Marker) /vi: a:r ,εm/ (n) (navig) = **Variable Range Marker;**

(VRM) the variable range marker (VRM) is used primarily to determine the ranges to target pips on the PPI **promjenljiva daljinska kružnica (na radarskom pokazivaču)**, **pomična kružnica udaljenosti**, **promjenljiva kružnica za mjerenje udaljenosti**, **kalibracijski prsten**. *The accuracy of the VRM can be checked by placing the variable ring exactly over several of the fixed rings in turn, and noting any discrepancy in the readings indicated.* **VRM (Variable Range Marker) unit 1** **mjerna jedinica promjenjive daljinske kružnice;** **2** **choose the VRM unit** **izabrati mjernu jedinicu promjenjive kružnice udaljenosti**, **move the VRM (Variable Range Marker)** **pomjeranje promjenjive daljinske kružnice**: *Whether you use a traditional controls or a trackball, the method of use is the same. The range of a target is measured by moving the VRM strobe or cursor until it just touches but does not cut the closest edge of the target.*

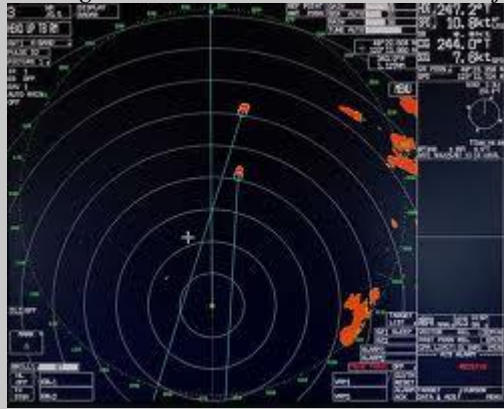

VTMS; (Vessel Traffic Management System) (n) (navig, safety) a marine traffic monitoring system established by harbour or port authorities, similar to air traffic control for aircraft. Typical VTS systems use radar, closed-circuit television (CCTV), VHF radiotelephony and automatic identification system to keep track of vessel movements and provide navigational safety in a limited geographical area. **Služba nadzora i upravljanja plovidbom u luci** {**VTMS key functions are:** **Providing an operator with early traffic warnings (audible and visible); Providing an operator with early collision warnings (audible and visible); Providing vessel data; Distributing data to remote location; Playback and logging; Remote control and monitoring of equipment**}

VTS area /vi: ti: ,εs/ (navig, safety) **područje VTS-a**: *When a VTS authority organises and manages traffic within its VTS area as part of its function, then it would normally also declare the provision of a Traffic Organisation Service (TOS). As a minimum, a vessel navigating within a VTS area should contact the operator, alerting them of their presence.*

VTS order (n) (navig) **zapovijed od službe VTS-a** **comply with the VTS order** **izvršiti naredbu VTS-a** **poslušati naredbu VTS-a**: *Both vessels complied with VTS orders and anchored in a designated area for investigations by port authorities;*

VTS (vessel traffic service) /vi: ti: ,εs/ (n) (navig, safety) Systems facilitating safe and efficient vessel traffic movement to or from ports, or within restricted sea areas adjacent to the coasts of states, under which ship traffic is subject to the supply or exchange of information, or the giving of advice or instructions, by coastal stations. On November 27, 1997, the International Maritime Organization (IMO) adopted Resolution A.857(20), entitled Guidelines for Vessel Traffic Services. That Resolution defines a V.T.S. as a service implemented by a Competent Authority, designed to improve the safety and efficiency of vessel traffic and to protect the environment. The service should have the capability to

interact with the traffic and to respond to traffic situations developing in the V.T.S. area. **služba nadzora plovidbe, služba VTS, VTS, služba kontrole i vođenja plovidbe, sustav nadzora plovidbe**

wage /weɪdʒ/ (n) **1 (shipping econ) zarada, plaća:** *The wages of each Employee shall be calculated in accordance with this Agreement and the attached minimum wage (Appendix A) Zarade svakog pomorca obračunavaju se u skladu s ovim ugovorom i priloženom tablicom o minimalnoj plaći* **Account of Seamen wages obračun plaća pomoraca, net wages neto zarada, čista zarada, neto plaća; 2 nadnica**

wages and maintenance (n) (mar law) **plaće i troškovi uzdržavanja (u brodarskim ugovorima)**

waggon /ˈwæɡən/ (n) (cargo handling) **vagon**

wagon /ˈwæɡən/ (n) (cargo handling) **vagon**

waist (n) (seamanship) **portion of the deck between the forecastle and quarterdeck of a sailing vessel dio trupa između pramca i krme (jedrenjaka)**

waiting time (n) (shipping econ) **vrijeme čekanja na vez (koje se ne računa u vrijeme stojnica)**

wait time (n) (shipping econ) **vrijeme čekanja (na uplovljenje, iskrcaj broda itd.)** *The wait time to pass through the Panama Canal has shortened to four days, down from more than 10 days last month, the authority that runs the waterway said on Thursday.* **normal wait time normalno vrijeme čekanja:** *The authority confirmed it had received several complains from users. A normal wait time (waiting period) to pass through the Panama Canal is 24-36 hours*

waive /weɪv/ (v) (mar ins, mar law) **to set aside or relinquish ⇒ to waive one's right to something; - to refrain from enforcing (a claim) or applying (a law, penalty, etc)** **odustati od nečega (odštetnog zahtjeva, tražbine, tužbe) waive inspection 1 odustati od pregleda (robe); 2:** *The carrier will send a representative to perform the inspection or will waive inspection. If the carrier does not respond within 5 working days, the consignee may make the inspection himself.* **waive on the right of claim odusatati od prava na prigovor**

waiver /ˈweɪvər/ (n) **1 (mar ins, mar law) odustajanje od (odštetnog) zahtjeva; 2 (mar law) Document used to allow cargo carriage by different flag vessels other than original destination country vessels. prepuštanje prijevoza drugom brodu**

wake /weɪk/ (n) (navig) **vessel's track through the water brazda (broda), šija the vessel's wake 1 brazda broda; 2:** *The vessel's wake immediately caught the tug's skeg* **Brazda broda odmah**

je zahvatila petu kormila na tegljaču



wale /weɪl/ (n) (sailing vessels) **the side planking on a wood ship lying between the bottom and the top-side planking voj gaza, pojas gaza**

walk back /wɔ:k, 'bæk/ (v) (**seamanship**) 1 **prekrenuti smjer okretanja sidrenog vitla, filare l'ancora**; 2 **vratiti / uvući sidro**: *Walk back the anchor clear of the hawse pipe* Vratite/uvucite sidro tako da visi iz sidrenog oka (padne cijevi) **walk back anchor** **povući sidri prema natrag**

walkie-talkie; walky-talky /,wɔ:ki 'tɔ:ki/ **SEE talkie-walkie** ručni radiotelefon, **voki-toki, toki-voki**

walk out (v) (**seamanship**) **ANTONYM walk back** payout anchor cable under power **izvući sidro (iz sidrenog oka, prije obaranja), pinelat, tal. appennellare l'ancora**: *At this point, control of the anchor windlass was transferred to the bridge and the cable was walked out. All vessels should walk out the anchor when anchoring in deep water.* **anchor izvući sidro (iz sidrenog oka)**

walkway /'wɔ:k,wei/ (n) (**nav arch**) **nogostup**

wall (n) 1 (**marine eng**) **stijenska, stijena cylindrical wall** valkasta stijena, **dividing wall** razvodna stijena, **thin wall** tanka stijenska; 2 (**nav arch**) **pregrada**

walrus /'wɔ:lɹəs/ (n) **morž**

war clause (n) (**mar law**) **klauzula o pravima i dužnostima broдача u slučaju rata**

ward room /'wɔ:d,ru:m/ (n) (**nav arch**) **časnički salon**



ware (n) **roba**

warehouse /'weə,haʊs/ (n) (**ports**) **ANTONYM transit shed** A place in which goods or merchandise is stored. Warehouses operated by private firms house goods for longer periods **skladište bonded warehouse** carinsko skladište, **consignment warehouse** konsignacijsko skladište, **dock warehouse** obalno skladište, **lučko skladište**, **public warehouse** javno skladište

warehouse to warehouse (n) (**shipping econ**) **od skladišta do skladišta**

warfing (n) (**shipping econ**) an owner or manager of a wharf **lučko poduzeće, lučki operator export warfing** luka ukrcaja

warm up (v) **zagrijati**

warm up the engine (n) (**boating/yachting**) **zagrijati motor**

warn (v) **upozoriti**

warning (n) **fog warning** upozorenje za maglu, **storm warning** upozorenje za oluju, upozorenje o oluji (**comm, safety**) upozorenje **gale warning (meteorol)** upozorenje za jak vjetar, **give warning of 1** upozoriti na; 2 **najaviti opasnost o**, **monitor Navarea warning** pratiti upozorenja za pojedina plovidbena područja, **warning sign** znak upozorenja, **warning light** upozoravajuće svjetlo, **issue a warning** izdati

upozorenje, objaviti upozorenje: *The Bureau of Meteorology (BOM) has issued a marine wind warning for the Sydney, Hunter and Illawarra coasts until midnight tomorrow-*

warp /wɔ:p/ (v) **1** to move (a vessel) by hauling on a rope fixed to a stationary object ashore or (of a vessel) to be moved thus **pomicati brod uz obalu (pomoću priteznog vitla)**; **2 pritezati (uže):** *Both mooring parties were warping the vessel astern*; **3 (boating/yachting) povlačenje krme usidrenog broda u stranu (s pomoću manjeg sidra)**; **4** move one end of a vessel broadside by heaving on a line secured on the dock **potezati brod prema obali (vitlom)**

warp /wɔ:p/ (n) (seamanship) **pritezno vitlo** {tal.: salpancore; gomena}

warp (n) (boating/yachting) **uzdužne niti jedarskog platna**

warping /'wɔ:piŋ/ (n) (seamanship) **zatezanje (užeta), natezanje (užeta)**

warping capstan /'wɔ:piŋ/ (n) (seamanship) **pritezno vreteno**

warping drum /'wɔ:piŋ/ (n) **1 (seamanship) bubanj za namatanje i zatezanje konopa (na sidrenom vitlu)**; **2 (nav arch, seamanship) pritezno vitlo**

warping end /'wɔ:piŋ/ (n) = **winch drum** **glava vitla, bubanj vitla (za pritezanje priveznog konopa)**

warping head /'wɔ:piŋ/ (n) (seamanship) **bubanj za uže (na sidrenom vitlu), barbotin**



warping line /'wɔ:piŋ/ (n) (seamanship) **priteno uže, pritezni konop**

warping winch /'wɔ:piŋ/ (n) (seamanship) **pritezno vitlo:** *When mooring alongside we used the warping winch on the main deck aft to sed to warp in the stern*

warps /'wɔ:ps/ (n) (seamanship, boating/yachting) **privezna užad, vezaljke**

warranty /'wɔ:rənti/ (n) (mar law) **1 a** čvrsta ugovorna obveza osiguranika u pomorskom osiguranju da nešto učini ili propusti **jamstvo, garancija**; **2 ovlaštenje, punomoć**; **3 opravdanje**

war ship (n) (navy) **ratni bod**

warty Venus (n) (fishing) **prnjavica**

wash /wɔʃ/ (n) **1 (navig)** porast razine mora zbog pramčanog vala uslijed prevelike brzine broda u kanalu **pramčani val (koji stvara brod pri kretanju), podizanje razine mora:** *damage caused by wash or draw off due to excessive speed*; **2 brazda**

wash bulkhead (n) (nav arch) **propusna pregrada s otvorima koja dijeli unutarnji prostor tanka:** *A partial bulkhead fitted along the centreline in a tank, usually found in deep tanks and peak tanks to withstand the flow of liquid caused by the ship's motion* **pljuskača**

washer /'wɔʃə/ (n) (marine eng) **COMPARE bolt** **podloška, šajbica spring washer**



elastična podloška

{tal.: rondella}

wash-plate (n) (nav arch) parcijalna pregrada, djelomična pregrada

wastage /weɪstɪdʒ/ (n) (cargo handling) loss by use, decay, evaporation or leakage **gubitak tereta** (uslijed trošenja, hlapljenja ili curenja)

waste /weɪst/ (n) **1 a** (safety) otpad, **škart waste water** otpadne vode, **ship's waste** brodski otpad, **generate waste** stvarati otpad: *passenger ships generate some 1,000 tonnes of waste per day*, **solid waste** kruti otpad, **toxic waste** toksični otpad, **waste disposal** predaja i prihvata otpada (u luci); **2** smeće

waste disposal vessel (n) (nav arch) brod za otpatke, brod za prijevoz otpada

waste gas /weɪst/ (n) (marine eng) otpadni plin

watch /wɒtʃ/ (n) **1 a i** (navig) straža, **gvardija** **change over the watch** zamijeniti / smjeniti stražu, **keep the watch** držati stražu, **biti u gvardiji**, **maintain a safe and continuous watch** držati sigurnu i neprekidnu stražu, **stand the watch** držati stražu, **post a watch** postaviti stražu: *Protect your owners' interests by posting a gangway watch.*, **take over the watch** preuzeti stražu, **relieve the watch** smijeniti stražu, **keep a watch on** imati na oku, **motriti**, **paziti**, **on watch** u straži: *all crew members on watch or on call should be fit for duty*, **hand over the watch** predati stražu **predati gvardiju**; **2** **pozornost**, **pažnja**, **vođenje računa o**: *A close watch should be maintained on weather conditions in order that cargo operations can be shut down in good time*; **3** **vrijeme straže**, **vrijeme**

Fwd Port	Middle	Morning	Fore-noon	After-noon	First Dog	Last Dog	First
	Midnight to 0400	4am to 8am	8am to 12.30pm	12.30pm to 4 pm	4pm to 6pm	6pm to 8pm	8 pm to Midnight
Day 1							
Day 2							
Day 3							
Day 4							
Day 5							
Day 6							
Day 7							
Day 8							
Day 9							
Day 10							

trajanja **gvardije**

watch /wɒtʃ/ (n, v) **1** čuvati, **paziti na watch the cargo** čuvati teret; **2** (navig) **paziti** **pozorno**, **pomno motriti**

watch duties (n) (seamanship) dužnosti držanja straže, dužnosti držanja **gvardije**

watch handover (n) (navig) preuzimanje straže, smjena straže: *In preparation for the watch handover, the second officer checked the settings on the port 'X-band' radar display.*

watchkeeper /wɒtʃ,ki:pə/ **osoba u straži**, **osoba koja drži stražu**: *At 0400 on 13 June 2013,*

the chief officer took over the duties of the bridge watchkeeper U 0400 dana 13. lipnja 2013. prvi časnik palube preuzeo je stražu.

watchkeeping /ˈwɒtʃ, ki:piŋ/ (n) (navig) **straža, obavljanje straže**: *Whilst watchkeeping at sea, the officer of the navigational watch shall be assisted by at least one posted lookout* **solo**

watchkeeping **straža s jednim časnikom**: *At no time, especially during periods of darkness, shall solo watchkeeping be undertaken*

watchkeeping officer /ˈwɒtʃ, ki:piŋ/ = **officer-of-the-watch (OOW)** časnik straže

watchkeeping personnel /ˈwɒtʃ, ki:piŋ/ (n) (navig, safety) **osoblje straže**

watchkeeping receiver /ˈwɒtʃ, ki:piŋ/ **alarmni prijamnik**

watchkeeping regime /ˈwɒtʃ, ki:piŋ/ (navy) **način obavljanja straže a six hour on / six hour off** **watchkeeping regime**

watch-keeping system /ˈwɒtʃ, ki:piŋ/ (n) (navig) **sustav držanja straže** **traditional watch-keeping system** **klasični sustav držanja straže**

watchman /ˈwɒtʃmən/ (n) (safety) **stražar**: *Employment of shore watchmen is advisable*

gangway watchman **stražar kod broskog siza, stražar kod brodske skale, deck watchman** **stražar na palubi**

watchman: (n) (navig) **radarski stražar, upozorenje o istjeku namještenog vremena**

straže na radaru: *The Watchman feature transmits for one minute at the elapse of the chosen time interval to help you keep regular watch of the radar picture for safety or other purposes.*

watch officer (n) (mar law) **časnik straže, tal. ufficiale di quarto**

watch receiver (n) (navig, safety) **dežurni prijamnik, trajno uključeni prijamnik**

watchstander /ˈwɒtʃ, stændə/ (n) (navig) **časnik ili član posade u straži**

watchstanding /ˈwɒtʃ, stændiŋ/ (n) (seamanship) **držanje straže, držanje gvardije**

watch system (n) (mar law) **sustav držanja straže** **traditional watch system** **tradicionalan sustav držanja straže**

water (n) **1 a (marine eng) voda** **cooling water** **rashladna voda, fresh water** **slatka voda, raw water** **sekundarna rashladna voda, recirculated cooling water** **rashladna voda koja kruži u zavorenom krugu, salt water** **morska voda, slana voda, sea water** **morska voda, more, water cooled** **hlađen vodom, water cooling** **hlađenje vodom, water make-up** **dodavanje vode, water space** **vodeni prostor, rashladni prostor, water treatment** **obrada vode, obradba vode, pripremanje vode, feed water** **napojna voda; 2 (oceanogr) more** **ship water** **krcati more u nevremenu (u brod, kaljuže, skladište, na plaubu), depth of the water at the berth** **dubina mora uz vez**

water area (n) (mar law, ports) **akvatorij**

water ballast (n) (nav arch) **vodeni balast** **No4 DB TK S&B water ballast** **desni i lijevi tank** **dvodna br. 4** **{{abbr} WB; tal: zavorra}**

waterborne /ˈwɔ:tə, bɔ:n/ (adj) **1 pomorski, na vodi / moru, po vodi / moru** **waterborne craft** **plovilo, waterborne paint** **brodska boja; 2 koji se prevozi morem; 3 koji pluta, koji plovi**

waterborne craft (n) (nav arch) **plovidbeni objekt, plovilo**

water bucket (n) (seamanship) **sud za vodu, kanta za vodu, sić**

water bus (n) (nav arch) **hidrobus**

water circulating pump (n) (marine eng) vodoprotlačna sisaljka, vodocirkulaciona voda

water-cooled /'wɔ:tə,kʊ:ld/ (adj) (marine eng) hlađen vodom, na vodeno hlađenje

water cooling /'wɔ:təku:liŋ/ (n) (marine eng) hlađenje vodom **water cooling passage** prolaz / janal vode za hlađenje

water cooling suction /'wɔ:təku:liŋ/ (n) (marine eng) sisanje vode za hlađenje: *During the final approach to the anchorage the engineers changed over from the low to the high sea water cooling suction.*

water cooling system /'wɔ:təku:liŋ/ (n) (marine eng) sustav rashladne vode, sustav voda za hlađenje: *The whole auxiliary sea water cooling system was blocked, comprising the pump strainers, the main air compressor cooler, the deck steam condenser, the lubricating oil and air coolers of the two diesel generators and the turbo alternator.*

water drain (n) (nav arch) odvod vode, škarik

water drum (n) (marine eng) vodeni bubanj

waterfront /'wɔ:tə,frʌnt/ (n) the area of a town or city alongside a body of water, such as a harbour or dockyard, Waterfront may refer to the dockland district of a community. **primorje, područje uz more, obalno područje, lučko područje, gradski priobalni pojas, priobalje:**

Australian waterfront productivity has deteriorated in the second half of 199 lučki promet Australije opao je u drugoj polovici 1999. godine **Belfast waterfront** obalno / lučko područje Belfasta, **Canadian waterfront** Kanadsko primorje, Kanadsko priobalje



water gauge (n) (marine eng) mjerac razine vode

Waterguard Officer (n) (shipping econ) carinski službenik zadužen za izdavanje dozvole za obavljanje lučkih operacija

water heating (n) (marine eng) zagrijavanje vode

water line (n) (nav arch) presjek teoretske forme vodoravnom linijom na zadanoj visini iznad

osnovice; A term used to describe a line drawn parallel to the molded base line and at a certain height above it **vodna linija, vodena linija:** *Inspections have revealed significant damage to the ship's hull below the water line as a result of its grounding* {tal.: libnea di galleggiamento / ummersione; It represents a plane parallel to the surface of the water when the vessel is floating on an even keel, i.e., without trim. In the body plan and the sheer plan it is a straight line, but in the plan view of the lines it shows the contour of the hull line at the given distance above the base line.}

water line plan (n) (nav arch) nacrt vodenih linija i vertikala, horizontalni plan

waterline plan (n) (nav arch) = **half-breadth plan** nacrt vodnih linija broda

water plane (n) (nav arch) ravnina vodne linije, ploha vodene linije, ravan vodene linije

water plug (n) (nav arch) priključak za vodu

waterproof /'wɔ:tə,pru:f/ (adj) vodonepropustan, vodotijesan, nepromočiv
waterproof canvas nepromočivo platno, nepromočiva cerada

waterproofs /'wɔ:tə,pru:fs/ (n) (boating/yachting) nepropusna odijela

waters /'wɔ:təz/ (n) (navig) more, vode in Croatian waters u hrvatskim vodama

water separator (marine eng) separator vode

waterspout /'wɔ:təspaut/ (meteorol) 1 a rapidly rotating column of air extending from a cumulonimbus cloud with a circulation that reaches the surface of the water a morska pijavica



; 2 prolom oblaka

water spray system (n) (cargo handling) vodena zavjesa: *Is the water spray system ready for use? Je li vodena zavjesna spremna za upotrebu?*

water supply (n) (nav arch, marine eng) dovod vode, opskrba vodom

watertight /'wɔ:tə,tait/ (adj) vodotijesan, vodootporan

watertight bulkhead /'wɔ:tə,tait/ (n) (nav arch) vodonepropusna pregrada

watertight door (n) (nav arch) vodonepropusna vrata: *There may be watertight doors in the bulkheads on the 'tween decks levels.* watertight door frame okvir nepropusnih vrata



watertight lug /'wɔ:tə,tait/ (n) (nav arch) nepropusna pločica

water track (n) (navig) kurs brazde

water tube /'wɔ:tə,tju:b/ (n) (marine eng) vodena cijev, cijev (kotla) za protok vode

watertube boiler /'wɔ:tə,tju:b/ (n) (marine eng) vodocijevni kotao diagram of watertube boiler shema vodocijevnog kotla, highr-pressure marine watertube

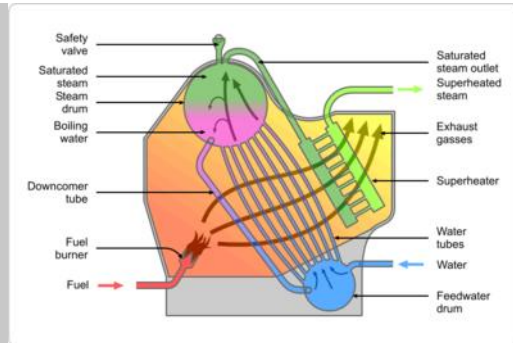

boiler visokotlačni brodski vodocijevni kotao

watertube wall /'wɔ:tə,tju:b/ (n) (marine eng) vodocijevni ekran (kod kotla) rear

watertube wall stražni vodocijevni ekran, **side watertube wall** bočni vodocijevni ekran

waterway /'wɔ:tə,wei/ (navig) a navigable body of water **plovni put**, **plovni kanal**: *The Columbia River waterway remains open to all traffic, but the Captain of the Port may need to limit deep-draft commercial traffic upriver ...* **confined waterway** uski plovidbeni kanal, **suženi plovidbeni kanal**: *When manoeuvring a vessel in a confined waterway where the margin for error is small, a tug is always a good investment. {tal: via d'acqua navigabile}*

waterway /'wɔ:tə,wei/ (n) (sailing vessels) proveza

wave (n) 1 (oceanogr) val **wave height** visina vala *About 11 hours later, a maximum wave height of 15.6 metres was recorded. ... the World Meteorological Organization has established a new world record significant wave height of a massive 19 meters measured by a buoy in the North Atlantic.*; 2 (marine eng) nalet, **prodor wave of exhaust gas fumes** (marine eng) oblak dima ispušnih plinova

waveguide (n) (electr, navig) valovod (radara)

wavelength /'weiv,leŋθ/ (n) (comm, oceanogr) valna duljina, duljina vala

wax /wæks/ (n) vosak

way (n) get under **way** isploviti, zaploviti, otploviti, **under way** u plovidbi, u vožnji, **vessel under way** brod koji nije nasukan, usidren ili privezan **brod u plovidbi**, **brod u vožnji put**, **prolaz in way of frame No. ... and ... u/na području rebra br. ... i ... (pri opisu oštećenja na brodu)**, **take all the way off** zaustaviti kretanje broda, **under way** (brod) u plovidbi, **by way of** putem, posredstvom, preko

waybill /'wei,bil/ (n) 1 (mar law, shipping econ) A waybill is a non-negotiable receipt issued after receipt of the goods by the carrier. It is clearly marked non-negotiable. It is usually employed in the container trade for normal shipments with consent of the shipper who does not insist on being issued a negotiable bill of lading. It is not a document of title, so that delivery of the goods shipped is made, not by presentation of a document, but by the consignee nominated on the waybill identifying himself. Only one original waybill is usually issued to the shipper. Although it is not a document of title, it is a contract of carriage (Tetley); prijevozna isprava kojom prijevoznik potvrđuje da je robu primio na prijevoz (Grabovac); neprenosiva prijevozna isprava koja se izdaje nakon što pomorski prijevoznik preuzme robu; The document used to identify the shipper and consignee, present the routing, describe the goods, present the applicable rate, show the weight of the shipment, and make other useful information notations. **teretni list**, **pomorski vozni list**, **pomorski teretni list** **Sea Waybill** **pomorski teretni list**, **liner waybill** linijski tovarni list, **tovarni list**: *The liner waybill is also referred to as a sea waybill or an ocean waybill or simply waybill.*; 2 **tovarni list** (npr. željeznički) (The

document used to identify the shipper and consignee, present the routing, describe the goods, present the applicable rate, show the weight of the shipment, and make other useful information notations.}

waypoint /ˈweɪ.pɔɪnt/ (n) (**navig**) 1 međutočka, točka promjene kursa (na putovanju; obično se unosi u GPS ili na kartu za plotiranje), točka okreta **distance to WP005** udaljenost do međutočke 005, **approach the waypoint** približavati se međutočki: *A few minutes later, the vessel was approaching a planned waypoint requiring an alteration of 24° to starboard to 314°.*, **waypoint marker** oznaka međutočke na radaru: *The waypoint marker shows the location of the destination waypoint set on a navigation plotter.*, **reach the waypoint** doći do međutočke, **doploviti do međutočke**: *At about 2100 hrs, after reaching her waypoint, the vessel altered course to 070°T and was proceeding along the designated east-bound deep water route.*, **arrive at a waypoint** stići do međutočke, **doći na međutočku**: *At 2345, the vessel arrived at a navigational waypoint indicating a planned course alteration.* a međutočka; 2 točka promjene kursa / rute; 3 točka javljanja pozicije, točka izvještavanja pozicije broda; 4 točka snimanja / javljanja / dobivanja pozicije broda (u hiperboličkoj navigaciji); 5 izvještajna točka, referentna točka

ways (n) (**nav arch**) = **slipway**; **slipways** navoz

wear /weə/ (n) trošenje, habanje **wear and tear** (**marine eng, shipping econ**) trošenje i habanje, **ordinary wear and tear** uključeno redovito trošenje i habanje

wear /weə/ (v) 1 trošiti se, habati se; 2 nositi, oblačiti **wear the goggles** nositi zaštitne naočale

wear and tear (n) (**safety**) habanje i trošenje

wear-in (n) 1 a (**marine eng**) trošenje; 2 habanje

wear out (v) potrošiti se, ishabati se

wear-out (v) 1 a (**marine eng**) trošiti, istrošiti; 2 ishabati, ishabati

wear-out (n) 1 a (**marine eng**) trošenje; 2 habanje **maximum wear-out** najveće trošenje, najveće habanje, **resist wear-out** oduprijeti se trošenju, pružiti otpor habanju, **suffer wear-out** biti izvrgnut trošenju, biti oštećen habanjem

wear-resistant (adj) otporan na trošenje, otporan na habanje

weather /ˈweðə/ (**meteorol**) vrijeme (atmosfersko) **bad weather** loše vrijeme, nevrijeme, **boisterous weather** jako nevrijeme, **fair weather** lijepo vrijeme, **heavy weather** nevrijeme, **to encounter / enter bad weather** naići na nevrijeme, ući u nevrijeme, **adverse weather** loše vremenske prilike, nepovoljne vremenske prilike, **in severest weather condition** u najoštrijim vremenskim uvjetima, **rough weather** nevrijeme, loše vrijeme, **stand the weather** držati se / oduprijeti se nevremenu, **through stress of weather** zbog djelovanja / utjecaja nevremena, **thick weather** gusta magla, **unstable weather** nestabilno vrijeme, **severe weather** nevrijeme

weather (v) 1 (**navig**) prebroditi, izdržati nevrijeme; 2 proći u privjetrini drugog broda

weatherboard /ˈweðə.bo:d/ (n) (**navig**) privjetrina, strana privjetrine

weather deck (n) (**nav arch**) the uppermost continuous exposed deck - usually either the main deck or, in larger vessels, the upper deck **izložena paluba**

weatherfax (n) (**meteorol**) vremenski faks

weather forecast vremeska prognoza, tal. *bollettino meteorologico*: WEATHER FORECAST FOR THE ADRIATIC FOR THE FIRST 12 HOURS VREMENSKA PROGNOZA ZA JADRAN ZA PRVIH 12 SATI

weather helm (n) (boating/yachting) list kormila više u privjetrenoj strani; tendency of boat to head into the wind when the helm is released skretanje kormilom u vjetar, privjetreno kormilo, bježanje u vjetar (kad se ispusti rudo/kolo kormila), skretanje u vjetar, tal. *barra sopravento*

weather map (n) (meteorol) zemljopisna karta određenoga područja s ucrtanom mrežom meteoroloških stanica na kojoj su dogovorenim znacima prikazane vremenske prilike tijekom

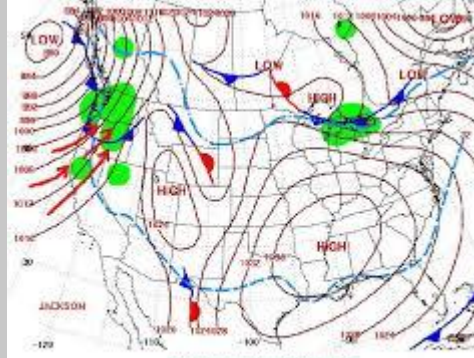

sinoptičkoga motrenja vremenska karta

The warm, rainy air, drawn in red arrows, moves in a counterclockwise direction around the LOW, northward up and over the top of the cold air lying in the Williams Valley.

weather outlook further **weather outlook** daljnji izgledi vremena (za sljedećih 12 sati) izgledi vremena (za 12 sati)

weather permitting (prep phr) (mar law) ako vrijeme dopušta

weather permitting working days (n) (shipping econ, mar law) pogodni radni dani

weather report vremesko izvješće, izvještaj o vremenu

weather route (n) (meteorol) klimatološka navigacijska ruta

weather running days (n) (mar law, shipping econ) tekući dani ako vrijeme dopušta

weather shore (n) (boating/yachting) **ANTONYM** lee shore obala s koje puše vjetar

weather side (n) = **windward side** 1 (navig, meteorol) windward side privjetrina; 2 strana broda izložena vjetru, strana privjetrine

weather system (n) (meteorol) vremenski sustav {ciklone i anticiklone na nekom području}

weather warning (n) (meteorol) vremensko upozorenje, upozorenje o nevremenu

weather wizard (n) (meteorol, navig) izvješće o vremenskim prilikama

weather working days (n) (mar law) tekući dani ako vrijeme dopušta, radni dani ako vrijeme dopušta

web /wɛb/ (nav arch) the vertical portion of a beam; the athwartship portion of a frame; the portion of a girder between the flanges **struk nosača**, **okvir**, **okvirni nosač** **side web** **okvir boka**, **bottom web** **okvir dna**, **deck web** **okvir palube**, **longitudinal bulkhead web** **okvir uzdužne pregrade**, **web** **frame** **okvirno rebro**

web frame /wɛb/ (n) (nav arch) a built-up frame to provide extra strength consisting of a web plate with flanges on its edges, placed several frame spaces apart, with the smaller, regular frames in

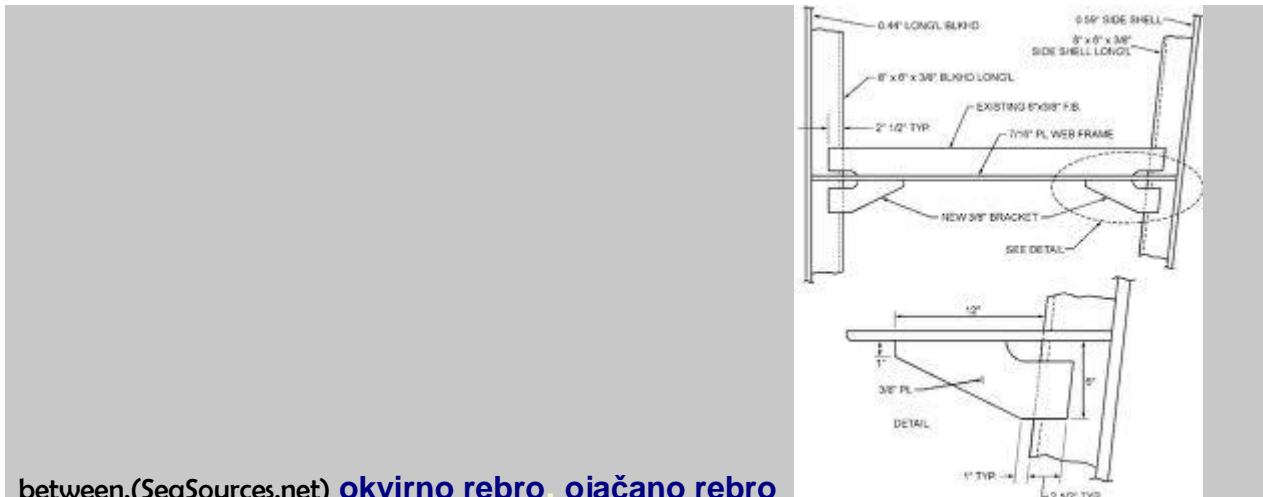

between.(SeaSources.net) **okvirno rebro, ojačano rebro**

wedge /wɛdʒ/ (n) (marine eng, seamanship) wood or metal pieces shaped in the form of a sharp V, used for driving up or for separating work **klin, kunj**

weed /wi:d/ (n) (oceanogr) morska trava, morske alge

weigh /ˈweɪə/ (v) (shipping econ) podići sidro tako da brod može zaploviti; heave up an anchor in preparation for sailing; raising the anchor of the vessel from the sea floor and pulling it up to the side of the vessel after the engines have been brought up to operating power.; lift anchor off the bottom

podići sidro, dizati sidro: While the anchor was being weighed the cable rendered against the

windlass dok smo podizali sidro konop na vitlu je popustio the decision was taken to weigh anchor bilo je odlučeno da se podigne sidro **weigh anchor! Podigni sidro!**

weighed /weɪd/ (adj) **podignuto (sidro) anchor weighed sidro podignuto (s dna)**

weighing anchor /ˈweɪɪŋ/ (n) (boating/yachting, seamanship) dizanje sidra

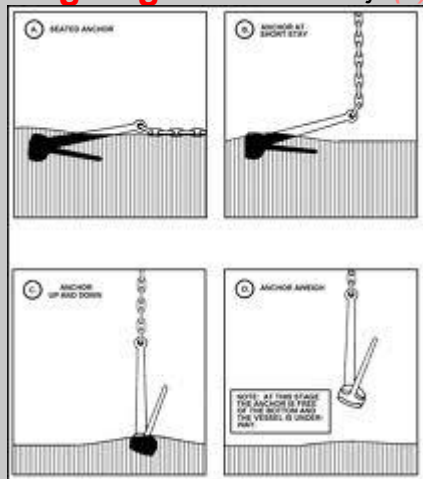

weight /weɪt/ (n) **1 težina, uteg gross weight bruto težina, light weight mala težina, take the weight on the line preuzimati težinu napinjanje konopa, napinjati konop:**

The master instructed the C/O to start taking the weight on the head line.; **2 (seamanship)**

opterećenje (užeta, konopa): The lines were bearing too much weight, which the master instructed to be cast off. Konopi su bili suviše opterećeni pa je zapovjednik naredio da se otpuste. **put the weight on the line opteretiti uže (konop)**

weight: (n) **1 (fishing) olovo (na dnu povraza), uteg (na dnu povraza); 2 (fishing)**

peškafondo

weight, quantity, number of packages unknown (n) (mar law) težina, količina tereta i broj koleta nepoznati (primjedba u teretnici)

weight force; Wf (n) (stabil) the force acting vertically downwards **silu teže**

weight or measurement in owner's option (n) (shipping econ, mar law) težina ili obujam po izboru broдача

weight; t (n) (stabil) = **weight; w** težina (t)

weight ton; W/T (n) (shipping econ) **težinska tona**: Weight tons can be expressed in short tons of 2000 pounds, long tons of 2240 pounds or metric tons of 1000 kilos (2204.62 pounds)

weight unknown (n) (mar law) težina tereta nepoznata (primjedba u teretnici)

weight; w (n) (stabil) **teret shift the weight pomjerena težina**: *Whenever a weight already on board is shifted, G will move parallel to and in the same direction as the shift of the centre of gravity of the wight*

weld /'weld/ (n) (marine eng) var, zavareni dio

weld /'weld/ (v) zavariti, zavarivati

weldable /'weldəbəl/ (adj) zavariv, koji se može zavariti

welded /'weldid/ (adj) (marine eng) zavaren **welded plating** (nav arch) zavareni lim, zavarena oplata

welding /'weldiŋ/ (n) (marine eng) zavarivanje **arc welding** lučno zavarivanje

well /'wel/ (n) **1** (nav arch) The space in the bottom of the ship to which bilge water drains so that it maybe pumped overboard. Also the space between partial superstructures (Ship Terms Glossary.html)

zdenac deck well palubni zdenac, **deep well pump** sisaljka dubokog zdenca: *The chief officer then circulated the cargo, using the deep well pump, to ensure a good representative sample was obtained.*; **2** (nav arch) **sliv tekućeg goriva** {tal.: **pozzo**}

westbound /'west.baʊnd/ (adj, adv) koji se kreće prema zapadu: *a laden product tanker was westbound*

westerlies (n) (meteorol) zapadni vjetrovi

westerly wind (meteorol) zapadni vjetar, zapadnjak: *Although there was a flood tide and the westerly wind was blowing at 15 knots, a tug was not considered necessary.*

wet /wet/ (adj) mokar **wet paint** svježa boja

wet /wet/ (v) pomoćiti, smoćiti

wet-bulb thermometer (n) (marine eng) uronjivi termometar

wet damage (n) (cargo, mar ins) šteta nastala vlagom ili moćenjem tereta

wetdock refit (n) (seamanship) održavanje u moru

wether forecast (n) (meteorol) vremenska prognoza **the latest wether forecast** najnovija vremenska prognoza

wet market (n) (shipping econ, mar law) generic term for the tanker market **tankersko tržište**

wet submersible (navy) ronilica u kojoj je posada u ronilačkim odijelima i izložena tlaku okolne tekućine **mokra podmornica**

whale /weil/ (n) kit

whale boat (n) (nav arch) kitolovac

whale catcher (n) (nav arch) kitolovac

whaler /'weɪlə/ (n) (nav arch) kitolovac, brod kitolovac

whaling (n) (fishing) lov na kitove, kitolovstvo

wharf /wɔːf/ **SYNONYM quay** 1 (ports) the oldest term in English referring to port structures. It denotes any structure of timber, masonry, cement, or other material built along or at an angle to the navigable waterway, with sufficient depth of water to accommodate vessels and receive and discharge cargo or passengers **lučka obala, pristan, vez, tal. banchina; calata; pontile**: *The wharf typically has front and rear loading docks (aprons), a transit shed, open (unshedded) storage areas, truck bays, and rail tracks.*; 2 a structure built for boats to stop at, at the edge of the land or leading from the land out into the water (MacMillan) **gat, molo**; 3 (US) same as a pier (in US use) **gat, dok** {pl.: wharves; wharfs; tal: banchina; the term 'quay' is more usually used in UK (implying a structure with solid foundations), whereas the term 'wharf' is more widely used in US}

wharfage /'wɔːfɪdʒ/ (n) 1 (ports) **lučke obale (sve operativne obale zajedno); 2**

(shipping econ, mar law) = **cargo dues** naknade za korištenje vezova naplative na temelju tereta koji brod prevozi; A charge assessed by a pier or wharf owner for handling incoming or outgoing cargo. **naknada za korištenje lučkih obala i lučke mehanizacije**: *All non-containerized foreign cargoes coming in (imported), going out (exported) or transshipped through a government-owned wharf shall be charged WHARFAGE for the use of port facilities on the basis of the total metric or revenue tonnage whichever is applicable, rounded off to the nearest ton. All containerized foreign cargoes (FCL) shall charged WHARFAGE per box The wharfage fee is then charged back to the customer in order to provide transparency and to share the costs.* **wharfage fee naknada za korištenje lučkih obala**

wharfinger /'wɔːfɪndʒə/ (n) 1 (mar law) predstavnik broдача / brođovlasnika u luci, predstavnik broдача na vezu u luci (u vlasništvu broдача); 2 (shipping econ) brođar koji upravlja vezom (terminalom) u luci; 3 (shipping econ) = **dock master** upravitelj lučkog veza / terminala, menadžer veza / terminala **upravitelj veza**

What is your heading? (navig, seamanship) Koji je vaš kurs? My heading is ... degrees. Moj kurs je ... stupnjeva. {zapovijed za kormilarenje}

wheat /wi:t/ (n) (cargo) pšenica

wheel /wi:l/ (n) 1 (marine eng) kotač, zupčanik **chain wheel** lančanik, **sprocket wheel** zupčanik za lančani prijenos, lančanik, **toothed wheel** zupčanik, **turbine wheel** kolo turbine, rotor turbine, disk s lopaticama, **worm wheel** pužno kolo; 2 (nav arch) **kormilarsko kolo, kormilo**: *The Master instructed the helmsman to switch to manual steering and ordered the wheel to hard-a-port.* **take the wheel** preuzeti kormilarenje, **steering wheel** kormilarsko kolo

wheeled (adj) **wheeled cargo** ro-ro teret, teret na kotačima 1 na kotačima, opremljen s kotačima; 2 pokretan

wheelhouse /'wi:l.haus/ (n) (nav arch) location on a ship where the steering wheel is located, often interchanged with pilothouse and bridge **kormilarnica**



{tal.: timoneria}

wheelhouse poster (n) (navig) poster u kormilarnici

wheelhouse top /'wi:l,haus/ (n) (nav arch) krov kormilarnice

wheel orders (n) (navig) naredbe za kormilarenje

wheel over point; WOP (n) 1 (navig, nav arch) točka započinjanja otklona kormila;
2 proračunate točke okretanja broda

wheelsman /'wi:lzmen/ (n) (mar law) kormilar

whereas /wɛər'æz/ (conj) dok, dočim, naprotiv, dok nasuprot tome ...

whereby /wɛə'baɪ/ (conj) (mar law) čime

wherever (pron, adv) gdje god, kamo god

whether in berth or not (mar law, shipping econ) bez obzira je li brod na vezu ili nije

while /waɪl/ (conj) dok, za vrijeme dok

whilst /waɪlst/ = **while** pretežno u pravnim tekstovima dok, za vrijeme dok

whip /wɪp/ (n) 1 (seamanship) a method of preventing the ends of a line from unlaying or fraying by turns of small stuff, stout twine or seizing wire with the ends tucked **podvezica (konopa)**

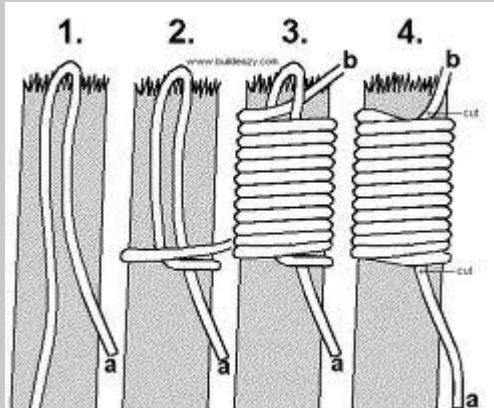

; 2 kruna (konopa) **single whip** poteg kolotura,
double whip dvostruki koloturni nateg

whip /wɪp/ (v) (seamanship) zavitlati, kovitlati, osloboditi se naglo i udariti (o užetu) :
The line whipped back towards the ship, striking the seaman who had been looking over the bulwark.

whip antenna (n) (nav arch, comm) štapna antena, štap-antena



whip lifting rope (n) (nav arch, cargo handling) čelično uže za dizanje tereta

whipping podvezivanje konopa (da se ne bi raspleo)

whipping (n) (seamanship) obvezivanje traja konopa (radi sprječavanja otpletanja)

whip wire (n) (seamanship) dvostruki konop (za izvlačenje s kuke, koloture itd.),

duplin, povratni privezni konop

whirl /wɜ:l/ (n) vrtlog

whirling motion /'wɜ:lɪŋ/ (n) (marine eng) vrtložno gibanje

whirlwind /'wɜ:l,wɪnd/ (n) (meteorol) vrtložni vjetar

whisker pole /'wɪskə/ (n) (boating/yachting) deblenjak prečke, **tangun floka**, **tangun**



(postavljen na floku)

whistle /wɪsl/ (n) (comm) brodska zviždaljka, brodska sirena

white bream (n) (fishing) Lat. Diplodus sargus sargus **šarag**, **sarag**



white cap (n) (oceanogr) valovi s pjenicom na vrhu

whitecup (n) (oceanogr) pjena vala

white fish bijela riba

white horses (n) (oceanogr) waves in wind strong enough to produce foam or spray on the wave tops valovi s pjenom na vrhovima, bjeličasti valovi, tal. *maroso (onda)* **white horses and caps** foam or spray on wave tops caused by stronger winds (usually above Force 4) **ovčice, valovi s pjenom na vrhovima**

white lead /'waɪt,lɛd/ (n) (seamanship) bijeli olovni minij

white seabream (n) 1 Lat. *Diplodus annularis* špar, Ital. *sparo*, kolorep, baraj, češljic, šparac, bili špar, šparma, špijun, frankul, šparmić, barić, haluz, prstenac, kolorepi



šarag (other Croatian names)

(fishing) Lat. *Diplodus sargus* šarag, šarg

whiting (n) (fishing) Lat. *Merlangius merlangus* pišmolj, ugotica



WHO (World Health Organization) (n) Svjetska zdravstvena organizacija

wide berth (n) (*navig*) keep at a considerable distance **zaobilazak u širokom luku** wide berth requested **mole se brodovi da plove u širokom luku oko ...**, **keep a wide berth** **ploviti u širokom luku oko**

widen /'waɪdɪn/ (v) proširiti

width /'wɪðθ/ (n) (*nav arch*) **COMPARE beam** širina broda

wield /wi:l/ (v) rukovati, magati

Wilco. (*comm*) I understand and will comply. **Primio.** Učinit ću kako je naređeno.

wildcat /'waɪld,kæt/ (n) (*US, seamanship*) = **cable lifter = gipsy; gipse** a sprocket wheel on the windlass for taking links of the chain cable **podigač sidra (u sidrenom vitlu)**, **barbotin**

wilful; willful /'wɪlfʊl/ (*adj*) namjieran wilful; willful **misconduct (mar law)** namjerni neposluh, baraterija

willy-nilly /'wɪli'wɪli/ (*meteorol*) orkan, ciklon, tropska oluja {pješčana oluja u Australiji;}

winch (n) (*nav arch, seamanship*) a hoisting or pulling machine fitted with a horizontal single or double drum **vitlo, motovilo, vinč, manat, tal. verricello** **self-tensioning winch**

samozatezno vitlo, service a winch održavati vitlo, **dismantle a winch** rastaviti vitlo, **cargo winch** teretno vitlo, **steam winch** parno vitlo, **warping winch** pritezno vitlo, **hydraulic winch** hidraulično vitlo, **operate the winch** rukovati vitlom, **upravljati vitlom**: The carpenter asked the second officer to **operate the winch**, and told the welder and the two ratings to help him push the messenger back onto the rotating drum.

, **winch brake kočnica vitla**: Despite the attempts by the AB to **secure the winch brake**, the anchor chain continued to run out. **winch handle / lever ručica kočnice vitla**: The brake remote control is a wire connected

between the boat operator and the **winch brake handle**. , **winch barrel bubanj vitla**: The tow line had become jammed under other turns on the **winch barrel**. , **winch control upravljač vitla**

uređaj za upravljanje vitlom: He operated the hydraulic **winch control** at minimum speed to gently open and lower the ramp door. A second able seaman was at the **winch controls**. , **winch control lever**

upravljačka ručica / poluga vitla: esponding to the shouts overheard on the portable VHF radios the master, who was busy with arrival formalities, ordered the CO on the VHF to move the **winch control lever** to 'full hoist' position, while he rushed towards the after deck. , **winch drive pogon vitla**:

Before ramp door operations, with the ramp secured and the **winch drive** out of gear if possible, the movement of winch actuators must be confirmed to be in synchronisation with the remote control lever. ,

winch clutch spojka vitla, kvačilo vitla: to pay out the port trawl wire but the main engine stopped, resulting in the loss of hydraulic power and a consequent inability to disengage the winch clutch. , **electric winch električno vitlo**: The primary cause of this accident was the failure of the winch interlock microswitch, which should have prevented the **electric winch** from operating when the

manual handle was inserted.vitlo. **hydraulic winch hidrauličko vitlo**: While Brian cleared off the

stern deck I started to get the gear aboard with the **hydraulic winch**, which was turning in order to use the warping drum, ..., **lifeboat winch vitlo brodice za spašavanje**: Review the condition and specification of other **lifeboat winch motors** to ensure that they would not contribute to further incidents., **Stop winch! Zaustavi vitlo!**: Calling out to my mate Brian, "Stop winch"! Acting quickly he stopped it by the emergency lever. Unfortunately I had been pulled right around the drum, underneath it and thrown out on to t, **towing winch vitlo za tegljenje**: A harbour tug was tasked to assist in the berthing operations of a 75,000gt bulk carrier and to pass her tow line from her forward **towing winch** through a panama lead at the ship's starboard shoulder., **trawl winch vitlo kočarice vitlo za povlačenje kočice**: Heavy equipment was installed including: a main engine capable of providing 265kW (but de-rated to 228kW); a **trawl winch** with a core pull of 5., **electrical winch**: Moreover, the **electrical winch** had no emergency stop arrangement. **električno vitlo**



{tal.: verricello}

winch aboard (v) (seamanship) podići vitlom na brod: The casualty was winched aboard a rescue helicopter and taken to hospital.

winch brake (n) (seamanship) kočnica vitla: With each boat fully loaded, its **winch brake** was released and then re-applied on a couple of occasions as the lifeboat was lowered to the water.

winch controller upravljač vitlom: He then stood to one side to see along the starboard deck and instructed the **winch controller** to start heaving.

winch driver (n) (seamanship) rukovatelj vitla: Each winch position is equipped with a safety cage for the **winch driver**.

winch drum (n) (seamanship, marine eng) bubanj vitla: On the forward mooring deck a 28mm HMPE rope on a captive **winch drum** was employed as a breast line; a 56mm polyester mix rope on a



captive winch was also used as a breast line;

winch gear (n) (cargo handling) pogonski uređaj vitla, pogon vitla: The O/S was holding the hose of the grease gun with his right hand while resting his left hand on the groove where the **winch gear** is engaged.

winch handle (n) (boating/yachting) ručica vitla: The gangway was lowered manually by means

of the **winch handle** and rigged for access.

winch head (n) (nav arch, seamanship) **glava vitla, bubanj vitla**: ..., he slipped on the recovered dredging gear lying on the deck and, as he fell, his left hand became caught in the rope between the **winch head** and the lower framework.

winch in (v) (boating/yachting) **potegnuti uže vitlom**

winchman (n) (seamanship) **rukovatelj vitla**

winch motor (n) (cargo handling) **motor vitla**: The controls of the electrical **winch motor** were unreliable. The **winch motor** was rated with a nominal pull of 50kN.

winch operator (n) (seamanship) **rukovatelj vitla**: A **winch operator** must stand only on the designated area for a safe and effective operating position;

wind /wind/ (n) (meteorol) **vjetar**: Wind: westerly, 40kts, gusting 56kts **prevailing winds**

pretežiti vjetrovi, heavy wind jak vjetar, an area of high winds područje jakih

vjetrova, shifting wind promjenjivi vjetar, vjetar promjenjiva smjera, coastal wind

vjetar s mora, obalni vjetar

wind /waind; waund; waund/ (=pret. wound; pp. wound) (v) (marine eng, seamanship)

namotati, namotavati, tal. avvolgere The drum, which has cable wound on it, is usually smooth with flanged ends. Bubanj vitla, oko kojega je namotano čelično uže, obično je gladak i ima prirubnice na krajevima

The mooring ropes were wound on winch drums with brakes applied rather **wind the rope on the winch namotati / namotavati konop / uže na vitlo**: After securing the first spring on the twin bitt, the second **spring line** was wound around the winch drum and **hailed in taut**.

windage (n) 1 (boating/yachting) **zanošenje zbog dijelova jedrilice i posade izložene**

vjetru; 2 (boating/yachting) izdržljivost broda na vjetru windage area površina broda

izložena vjetru: The vessel was light draught and had a large **windage area**, and was yawing substantially.

wind ahead (n) (boating/yachting) **vjeter sprijeda, vjetar u pramac**

wind and tide opposed (n) (boating/yachting) **vjetar i struja iz suprotnih smjerova, pristajanje s vjetrom i strujom iz suprotnih smjerova**

wind and tide together (n) (boating/yachting) **vjetar i struja zajedno, pristajanje s vjetrom i strujom u istom smjeru**

wind astern (n) (boating/yachting) **vjetar straga**

windbound (adj) (navig, boating/yachting) **nošen vjetrom windbound ship brod koji je zadržan vjetrom**

wind chill factor (n) **hladnoća pojačana vjetrom**

wind deviation (n) (meteorol) **otklon vjetra**

wind direction (n) (meteorol) **smjer vjetra**

wind drift (n) (ship handling, navig, seamanship) **zanošenje broda vjetrom**

windfall (n) (meteorol) **obrušavanje vjetra (s planina uz more)**

wind force (n) (meteorol) **jačina vjetra**

wind generator (n) (boating/yachting) **vjetrogenerator**

wind indicator (n) (boating/yachting) **vjetrokaz**

winding /waindiŋ/ (n) 1 (electr) **zavojnica, navojnica motor windings 1 zavojnice**

motora; 2: Bow thruster motor windings and wiring were damaged by sea water, secondary

winding sekundarna zavojnica, primary winding primarna zavojnica



; 2 uzvojnica; 3 (*seamanship*) namotaji (konopa,

lanca); 4 namatanje

windjammer /'wind,dʒæmə/ (n) (*nav arch*) a large iron- or steel-hulled square-rigged sailing ship of the late 19th and early 20th centuries with three, four, or five masts , built mainly between the 1870s and



1900 to carry cargo on long voyages (Wikip.) jedrenjak

windlass /'windləs/ (n) (*nav arch*) a special type of winch used to raise and lower the anchors and to handle the forward mooring lines. sidreno vitlo, vitlo sidra, *mulinel*, tal. *salpancora*; *argano* put the windlass in gear uključiti spojku sidrenog vitla, *ingranat*, put the windlass out of gear isključiti spojku sidrenog vitla, *dežgranat*



{tal.: *salpancore*; *ingranare il salpancore*}

windlass barrel (n) (*nav arch*) bubanj sidrenog vitla, tal. *tamburo del mulinello*

windline (n) (*oceanogr*) tragovi vala nošeni vjetrom, obrisi valova (uslijed vjetra)

wind on the beam (n) (*navig, boating/yachting*) bočni vjetar, vjetar u bok

wind on the quarter (n) (*navig, boating/yachting*) vjetar u kvartir

window /'windrəʊd/ (n) (*nav arch*) brodski prozor

window wiper (n) (*navig*) brisač stakla

wind right aft (n) (navig, boating/yachting) vjetar ravno u krmu

windrode /ˈwɪnd.rəʊd/ (adj) (boating/yachting, navy) caused to ride or drive by the wind in opposition to the course of the tide; -- said of a vessel lying at anchor, with wind and tide opposed to each other **okrenut u vjetar, a protiv smjera struje (o brodu na sidru)**



wind rose (n) (navig) ruža vjetrova, vjetrulja

wind rotation (n) (meteorol) skretanje vjetra

wind run (n) (meteorol) put vjetra

windscreen (n) (nav arch) vjetrobran, tal. *parabrezza* **windscreen wiper** brisač vjetrobrana, brisač vjetrobranskog stakla {tal.: *parabrezza*}

wind's eye (n) (meteorol) pravi smjer vjetra

wind shear (n) (meteorol) variation in wind speed and/or direction over a short distance
smicanje vjetra **low-level wind shear** prizemno smicanje vjetra

windshield (n) (nav arch) vjetrobran **bridge wing windshield** vjetrobran na krilu mosta, *paravenat*

wind shift (n) (boating/yachting) promjena vjetra, promjena smjera vjetra

wind speed and direction indicator pokazivač smjera i brzine vjetra

windsurfing /ˈwɪnd.sɜːfɪŋ/ (n) (boating/yachting) jedrenje na dasci, *surfanje*

wind the ship /waɪnd/ (v) (seamanship) okrenuti brod (na vezu, u doku, lučkom bazenu)

wind vane (n) (boating/yachting) an instrument that determines the direction from which a wind is blowing **senzor smjera vjetra**, tal. *banderuola*

windward /ˈwɪndwəd/ (adv, adj) (navig) = **weather side** = **upwind** prema vjetru, u privjetrini, na strani vjetra, u smjeru vjetra, %šoravento **windward course** kurs u vjetar

windward berth /ˈwɪndwəd/ (n) (boating/yachting) privjetreni vez

windward helm (n) (boating/yachting) = **weather helm** proivjetreno kormilo

windward side /ˈwɪndwəd/ **privjetrina**

wing (n) (nav arch) an open-air extension of the bridge to port or starboard, intended for issuing orders and communication while docking, mooring etc. **krilo navigacijskog mosta** **take someone) under one's wing** uzeti nekoga pod svoje okrilje / pasku

wing and wing (n) (boating/yachting) sailing downwind with jib on one side and mainsail on opposite side **jedrenje u leptiru**, **leptir** {jedrenje u krmu s jedrima u obliku leptira, jedno na jednoj a

flok na suprotnoj strani jedrilice}

wing control upravljački uređaj na krilu mosta, daljinska kontrola na krilima mosta

wing double bottoms (n) (nav arch) bočna dvodna

wing nut (n) (marine eng) krilasta matica, matica s krilcima

wing tank lower wing tank donji bočni tank, **upper wing tank** gornji bočni tank, **overhead wing tank** gornji bočni tank, viseći bočni tank the tank adjacent to the double bottom tanks. These tanks are located at the side on both port and stbd side. They are used for

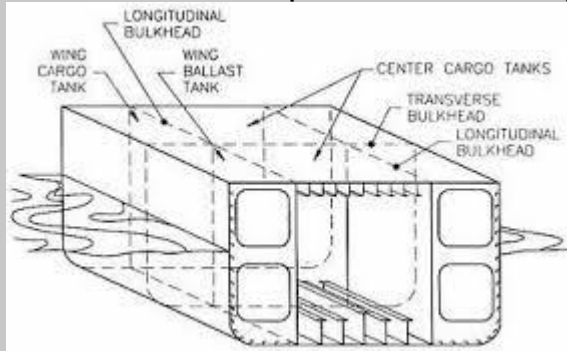

ballasting purposes. **bočni tank**

wing transom (n) (sailing vessels) završna prečanica krme

winterize the engine /'wɪntəˌraɪz/ (n) (marine eng, boating/yachting) pripremiti motor za zimu

wiper (n) = **cleaner** a rating responsible for general duties within the engine department such as cleaning of engine room and various tools and equipment. **čistač (u službi stroja)**

wire /'waɪə/ čelično uže, čelik-čelo **worn and damaged wires** istrošena i oštećena čelična užad {tal.: filo meccanico, cavo}

wire (n) (navy) antena podmornice **poke the wire** izroniti na antensku dubinu: *Let's poke the wire.* - *Poke the wire, aye, Sir.*

wireless /'waɪələs/ (n) (comm) radio

wireless /'waɪələs/ (v) (comm) obavijestiti putem radija

wireless operator /'waɪələs/ (n) (comm) radiotelegrafist, radiooperater {tal.: marconista}

wireless telegraphy; W/T /'waɪələs/ radiotelegrafija

wire line (n) (seamanship) čelik čelo, čelično uže

wire rod (cargo) željezna šipka

wire rope (n) (seamanship) čelično uže, **sajla**, **kavodifero semi-solid wire rope** polukruto čelično uže

wire-running rigging (n) (boating/yachting) oprema za rukovanje čeličnom užadi

wire sling (n) (cargo handling) čelični pasac, čelična braga



{tal.: braga di acciaio}

wiring /'waɪərɪŋ/ (n) (electr) električni vodovi, kablovi

wiring diagram (n) (electr) električna shema, shema spajanja

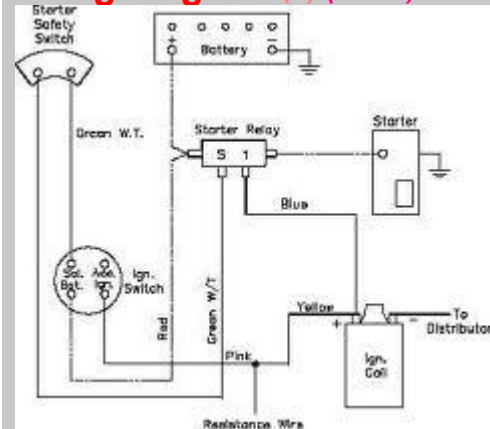

withdraw /wið'drɔ:/ (v) 1 a izvući, izvlačiti; 2 izvaditi; 3 naplatiti (ček), podići (novac)

withdraw a cheque naplatiti ček; 4 podići (novac) withdraw €100 podići 100 eura

withdrawal /wið'drɔ:əl/ (n) 1 a izvlačenje; 2 vađenje; 3 povlačenje; 4 vučenje (novca, mjenica)

within (prep) u, unutar (neko vremena), za neko vrijeme, u okviru

withold; withhold /wið'həʊld/ (v) zadržati, čekati (s isplatom): *ICC regulations prohibit withholding payment of freight bills because of a pending claim.*

withstand /wið'stænd/ (v) 1 a oduprijeti se, odoljeti; 2 izdržati (nevrijeme, štetu), podnijeti

witness /'wɪtnɪs/ (n) (mar law) svjedok

wobbler; wabblers /'wɒblə/ (n) (fishing) a type of fishing lure varalica tipa **wobbler**, **vobler** wobbler; wabblers fishing ribolov voblerima, spoon wobbler; wabblers



žličasta varalica

wording /'wɜ:diŋ/ (n) (mar law) tekst, riječi the original wording (mar law) izvorni tekst *the original wording of Article 4 reads ... izvorni tekst članka 4 glasi ...*

work (v) 1 raditi work on a six hour on / six hours off watchkeeping regime (navig) raditi po sistemu 6 sati straže 6 sati odmora; 2 jako opteretiti, turirati work the machinery (marine eng) preopteretiti strojeve

work (n) rad hard work 1 naporan rad; 2 težak rad, mechanical work mehanički rad, useful work koristan rad

workboat (n) (nav arch) radna brodica, brodica za izvođenje radova i popravaka: *The Sea Machines V2 is a heavy-duty autonomus workboat built for offshore and nearshore operations.*
unmanned autonomous workboat samostalna radna brodica bez pomorske posade

worker (n) radnik day worker dnevničar

working /'wɜ:kɪŋ/ (n) 1 rad; 2 djelovanje; 3 funkcioniranje; 4 pogon (stroja), hod (stroja)

working channel (n) (comm) radni kanal: *The port's working channel, VHF channel 69, was very busy and the ship's master did not hear the full exchange between port control and the tug.*

working cycle (n) = operating cycle (marine eng) radni ciklus

working days (n) (mar law) radni dani

working end (n) (seamanship) radni dio užeta / konoipa, slobodni dio konopa

working end of rope (n) (seamanship) = live end of rope živi kraj konopa

working frequency (n) (comm, navig) radna frekvencija: *The station maintains a listening watch on VHF channels 12, 14 and 16. VHF CH12 is the principal working frequency for communication with VTS, as well as inter-ship communications throughout the area.*

working knowledge (n) praktično znanje, radno znanje, stvarno znanje, praktično poznavanje

working lights (n) (navig) radna svjetla (na plaubi)

working load (n) (marine eng, cargo handling) radno opterećenje

working/operation procedures (n) (safety) planovi i kontrolne liste za brodske operacije

working part (n) (marine eng) radni dio, radni element

working permit (n) (safety) radna dozvola

working pressure (n) (marine eng) radni tlak, radni pritiska

Working Procedure Agreement (n) (shipping econ) Sporazum o radnim procedurama

working sails (n) (boating/yachting) radna jedra, uobičajeni komplet jedara

working stress (n) (marine eng) radno naprezanje

working stroke (n) (marine eng) = power stroke radni takt, radni stapaj

working temeperature (n) (marine eng) radna temperatura optimum working temeperature optimalna radna temperatura, reach working temeperature postići radnu temperaturu

works (n) (ports) radovi, građevinski radovi general works javni radovi, javni građevinski radovi

workship /'wɜ:k,ʃɪp/ (n) (nav arch) = repair ship brod radionica

workshop /'wɜ:k,ʃɒp/ (n) (marine eng, seamanship) radionica

workshop training (n) (marine eng) radionička praksa

worktable /'wɜ:k, teɪbəl/ (n) radni stol

World Geodetic System; (WGS) (n) (navig) Svjetski geodetski sustav

Worldscale; WS (n) (shipping econ, mar law) An international index of freight for tankers.

Worldscale is a schedule of freight rates for a standard ship in US dollars per tonne of oil for an array of oil routes. The rates listed in the table are designated as Worldscale Flat or WS100 and are revised annually. (<http://www.clarksons.com/glossary/>) Worldscale is a nominal worldwide tanker scale used to

establish payment of freight services; Nominal freight scale applying to the carriage of oil and oil products in bulk by sea. An international freight index for tankers that provides a method of calculating the freight applicable to transporting oil by reference to a Standard Vessel on a round trip voyage from one or several load ports to one or several discharge ports. (www.worldscale.co.uk)

međunarodni indeks tankerskih vozarina, međunarodna tablica tankerskih vozarina

Worldscale: The flat rate point 100 is effectively the breakeven point in accordance with the basis of calculation for the **Worldscale** Standard vessel but not for any other size. **Worldscale** includes expenses associated with ports, transit fees, port and voyage time and vessel bunker costs assessed in relation to the **Worldscale** Standard Vessel basis of calculation in order to produce a comparative nominal freight scale reported in dollars per tonne. **Worldscale** is used to calculate freight rates for oil tankers and product carriers. It is a tanker chartering tool, its principle is to provide the ship-owner with the same net return per day irrespective of voyage performed for the **Worldscale** Standard Vessel at WS100. **Worldscale;**

WS rates vozarinski stavovi izračunani prema tablici Worldscale: **Worldscale Rates** are based upon a 75,000 tonne total capacity vessel performing a round voyage and expressed in dollars per tonne of cargo. Any new **Worldscale rate** request will require mileage calculations, any voyage costs and port cost information. Rate calculations may involve several different route options to determine the cheapest.

World-wide Navigational Warning Service (WWNWS) (n) (navig) Globalna služba upozorenja za plovidbu

world-wide navigational warning system; (WWNWS) (n) (navig, comm)

svjetski sustav izvještavanja brodova, sustav koordiniranoga izvješćivanja i upozoravanja brodova u plovidbi, sustav WWNWS

Worldwide Radio Navigation System; WWRNS (n) (navig) Globalni radio-navigacijski sustav

worm¹ /wɜ:m/ (n) 1 (marine eng) puž **worm gear** pužni prijenos, pužni pogon; 2 pužni vijak, vijak s bekonačnim navojem

worm² (n) (fishing) crv

worm, serve, and parcel (v) (seamanship) zaštititi užad od oštećenja (omatanjem nitima konopa, krpom)

wormwheel /'wɜ:m,wi:l/ (n) (marine eng) The toothed wheel of a worm gear **nazubljeno kolo**



(pužnog supčanika)

worn /wɔ:n/ (adj) (marine eng) **istrošen** (past participle of: wear (wore, worn))

WPT (waypoint) (n) (navig) = **waypoint** međutočka

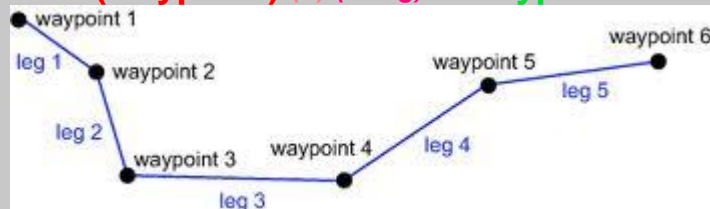

WP (weather permitting) (shipping econ) pod uvjetom da to dopuštaju vremenske prilike



wrap /ræp/ (n) (seamanship) **namotaj, volta**

wrapstop (n) (boating/yachting) plastični obruč ili kapa na završetku najviše cijevi za namatanje genove kojim se sprječava vrtnja i pucanje leta **protuvrtuljak**

wreck /rɛk/ (n) **1 a** (navig, safety) **podrtina, tal. relitto**. *Over the weekend approximately 150 cubic meters of oil was pumped from the wreck of the stranded bulkcarrier to a tank barge brought in from Panama. wreck swept to showing hull odvučena na prikazanu dubinu, wreck showing hull podrtina koj strši izvode, wreck considered dangerous podrtina, vjerojatno opasna, wreck not considered dangerous podrtina koja nije opasna, dangerous wreck opasna podrtina: Dangerous wreck in position 15 degrees 34 minutes North*



061 degrees 29 minutes West.

; 2 brodolom; 3

vađenje potonulih stvari stvari potonule u more

wreckage /ˈrɛkɪdʒ/ (n) 1 a (safety, mar ins) brodolom: The National Transportation Safety Board has released the first photos and video of the wreckage of the sunken El Faro.; 2 uništenje broda; 3 (mar ins) = raising of sunken objects vađenje potonulih stvari, stvari potonule u more

wreck buoy /ˈrɛk/ (n) (safety, navig) oznaka podrtine, putača koja označava podrtinu



wreckfish (n) lat. *Polyprion americanus* kirnja glavulja Atlantic **wreckfish** kirnja glavulja

wreck removal /ˈrɛk/ (n) (mar law) The operation of clearing navigable waters of sunken vessels or other submerged objects which threaten the safety of navigation. Wreck removal claims are frequently secured by special legislative rights of detention, sale and/or forfeiture, under national law. (Tetley)
uklanjanje potonulih brodova i drugih stvari (u plovidbenom kanalu itd.)

Wreck Removal Convention /ˈrɛk/ (n) (mar law) Međunarodna konvencija o
uklanjanju podrtina

wrench /rɛntʃ/ (n) (US) (marine eng) ključ za pritezanje i otpuštanje vijaka, vrst alata za stezanje i otpuštanje matice vijka; a hand tool used to exert a twisting strain, such as setting up bolts, nuts, etc
ključ za vijke torque **wrench** moment ključ, dinamometar



, **impact wrench** udarni ključ **pneumatic**

wrench pneumatski udarni ključ, **hexagonal key wrench** šesterokutni ključ, **socket wrench** usadni ključ, nasadni ključ, **pipe wrench** *rolcange* (njem. *Rohrzange*) ključ za cijevi

writ /rit/ (n) (*mar law*) pravna isprava, službena isprava, sudski nalog za izvršenje

writing (n) pisanje **in writing** (*mar law*) 1 pismeno, napisano, pisanim putem; 2: *Put your observations or remarks in writing.*

writ in personam (n) (*mar law*) In common law jurisdictions, the writ whereby an action was traditionally instituted against a person, including a corporation, rather than against a thing **pravni postupak protiv osobe** (brodara itd.)

writ in rem (n) (*mar law*) In common law jurisdictions, the writ whereby an action was traditionally instituted against a thing. **postupak protiv stvari** (npr. broda itd.), **sudski postupak protiv stvari** (npr. broda itd.)

wrongdoing 1 a prijestup; 2 zlodjelo

wrought iron /rɔ:t/ (n) (*marine eng*) kovano željezo

W/T (wireless telegraphy) (n) (*comm*) radiotelegrafija

X-band radar; **3 cm radar** (n) (*navig*) radar X-pojasnog područja, radar

frekvencijskog područja X, **X radar**, **trocentimetarski radar**: *the commonest commercial marine radar is 3 cm (actually 3.1 to 3.2 cm). This corresponds to a frequency of 9300 to 9500 megahertz (millions of cycles per second) and is known as X-band radar. {X-band radars are particularly suited to coastal navigation and pilotage due to their high picture definition and quality.}*

xB; **centre of buoyancy from aft perpendicular** (n) (*stabil*) **COMPARE yB**; centre of buoyancy from aft perpendicular **centar uzgona iznad krmene okomice**

xF; **centre of flotation from aft perpendicular** (n) (*stabil*) udaljenost centra plovnosti od krmene okomice

xF; **longitudinal centre of flotation** uzdužni centar plovnosti

Xg; **centre of gravity from aft perpendicular** (n) (*stabil*) udaljenost sistemnog težišta od krmene okomice

XG; **longitudinal centre of gravity** (n) (*stabil*) udaljenost sistemnog težišta od sredine broda

X2 Zoom (n) (*navig*) kontrola na radaru za bolju informaciju o željenom objektu / cilju {cf *FURUNO Operator's Guide to Marine Radar*}

yacht /jɔ:t/ (n) 1 jedrilica **single-handed yacht** jednosjed, **sailing yacht** a recreational sailing boat **jahta-jedrilica**, **power yacht** motorna jahta



; 2 plovni objekt duljine veće od dvanaest metara namijenjen za dulji boravak na moru i koji je pored posade ovlašten prevoziti ne više od dvanaest



putnika (Pom. zakonik RH) **jahta**; 3 A yacht is any moderately large vessel or conveyance that floats on the water which is used for pleasure, not for commercial purposes (http://www.westlawn.edu/student_center/definitions.asp); a medium-sized sailing boat equipped for leisure, cruising or racing **jahta** {tal.: natante di diporto; Yachts are differentiated from working ships mainly by their leisure purpose, and are basically fancy houseboats. However, since the level of luxury on larger yachts has seen an increasing trend, the use of the word yacht to mean any sailing vessel has been diminishing and is more and more limited to racing yachts or cruising yachts. Yacht lengths generally start at 32-35 feet (10-11 m) and go up to hundreds of feet. A mega yacht generally refers to any yacht (sail or power) above 100 ft (34 m) and a super yacht generally refers to any yacht over 200 ft (70 m). This size is small in relation to typical cruise liners and oil tankers. (SeaSources.net)}

yacht club /jɔ:t/ (n) (boating/yachting) jedričarski klub

yachting /'jɒtɪŋ/ (n) (boating/yachting) nautika, jahting tal. navigazione da diporto

yacht racing /jɔ:t/ (n) (boating/yachting) sportsko jedrenje

yachtsman /'jɒtsmən/ (n) (boating/yachting) jedriličar

yachtswoman /'jɒtswʊmən/ (n) (boating/yachting) jedriličarka

yard /jɑ:d/ (n) 1 (nav arch) a shipyard **brodogradilište**: During the night shift, shipyard workers brought on 450V electrical supplies and distribution boxes from the yard to provide power to the ship Za vrijeme noćne smjene brodogradilišni radnici donijeli su priključne kablove za 450 volta i priključne ormariće za opskrbu broda električnom energijom; 2 (nav arch) **remontno brodogradilište, remontni vez**

yard /jɑ:d/ (n) the horizontal spar from which a square sail is suspended **križ (jarbola) signal yard križ za uastave, yard-pennant klobučnica zastave, lamp yard križ za svjetlo, lower yard donji križ, topsail yard kosni križ, topgallant yard gornji križ, sway the yard**



podići križ sošnoga jedra, **royal yard** vršni križ

yard-arm irons /ja:d,a:m, 'aienz/ (n) vanjski prsten krilnog deblaka (na križu jarbola)

yard number /ja:d/ (n) (nav arch) each shipyard typically numbers the ships that it has built in consecutive order **novogradnja broj ...**

yard-pennant /ja:d/ (n) klobučnica križa

yarn /ja:n/ (n) (seamanship) **COMPARE strand** nit konopa, nit struka konopa, tal. **filo synthetic monofilament yarn** povraz od jedne sintetičke niti, monofil

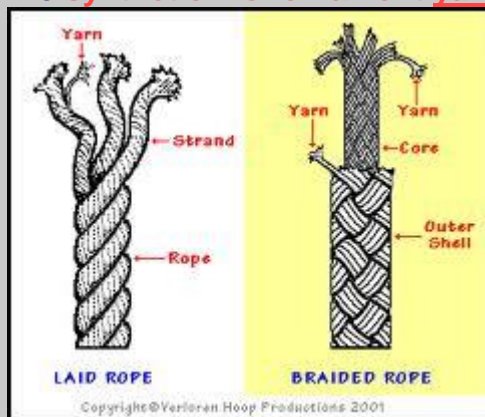

yaw /jɔ:/ (v) (navig, boating/yachting) **COMPARE ship's motions** a vessel's motion rotating about the vertical axis, so the bow rotates from side to side; to veer suddenly and unintentionally off the course (Seasources.net) **zaošijavati**, tal. **sbandare**

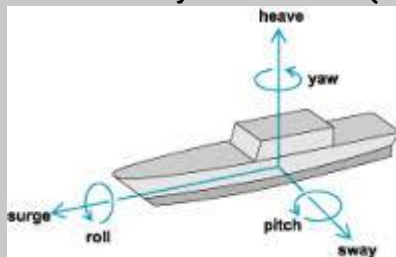

yaw error (n) (navig) grješka određivanja radarskog azimuta zbog zaošijavanja

broda: A 3° yaw at the wrong moment will produce a 3° error in the radar bearing.

yawing /'jɔ:ɪŋ/ (n) (navig) **1 COMPARE ship's motions** a vessel's motion rotating about the vertical axis, so the bow 'yaws' from side to side **zaošijavanje**; **2 (boating/yachting) bježanje u vjetar, bježanje u orcu, štraorcivanje** {tal.: **straorzata**}



yawl /jɔ:l/ (n) (nav arch) jol, jola

{vrsta zastarjele jedrilice}

yB; (n) (stabil) udaljenost točke B od krmene kobilice

year built (n) (nav arch) godina izgradnje broda

year of build (n) (nav arch) godina gradnje (broda) *Year of build: 1984*

year of build, yr. of build (n) (mar law) godina granje broda

Yellow Book (n) (med) žuta knjižica (svjedodžba o cijepljenju)

yellow fever (n) (med) žuta groznica

yellowtail /'jɛləʊ.teil/ (n) gof, orhan

yellow tail /'jɛləʊ.teil/ (n) (fishing) gof {drugi hrv. nazivi: bilizmuša, felun, orhan, orva, plančavac, šarbun, kulfar, alfun; lat.SERIOLA DUMERILI}

yew /ju:/ (n) (cargo) tisa, tisovina

yG; (n) (stabil) = **XG;** longitudinal centre of gravity udaljenost sistemnog težišta (G) od krmene kobilice

yoke /jəʊk/ (n) (nav arch) a frame or bar having its center portion bored and keyed or otherwise



constructed for attachment to the rudder stock **jaram (kormila)**

York-Antwerp Rules /'jɔ:k ,æntwɜ:p/ (n) (mar law) The rules under which a general average sacrifice is determined and by which the payments to the party who sacrificed are calculated. The most recent Rules are the York/Antwerp Rules 1994, amended in Sydney, Australia in 1994 at a meeting of the CMI. The Rules are not imposed by a national or international statute, but by agreement of the parties, in the charterparty or the bill of lading (Tetley); ugovorne odredbe u predmetu zajedničkih havarija
York-Antwerpenska pravila

zare (n) (fishing) zara, varalica tipa **zare** silent **zare** tiha zara

Z-drive /'zɛd,draiv; (US) 'zi:,draiv/ (n) (nav arch, marine eng) a type of marine propulsion unit, i.e. an azimuth thruster in which the pod can rotate 360 degrees allowing for rapid changes in thrust direction and thus vessel direction. This eliminates the need for a conventional rudder. (wikipedia) **Z-pogon**



{The Z-drive is so named because of the appearance (in cross section) of the mechanical driveshaft or transmission configuration used to connect the mechanically-supplied driving energy to the Z-Drive azimuth thruster device. (<http://en.wikipedia.org/wiki/>)}

zenith /UK 'zɛniθ ; US 'zi:niθ/ (n) (navig) zenit

zenith distance /UK 'zɛniθ ; US 'zi:niθ/ (n) (navig) zenitna udaljenost

zephyr winds /'zɛfə/ (n) (meteorol) a gentle breeze **lahor** {a gentle breeze. The west wind}

zinc /zɪŋk/ (n) (chem) cink

zinc anode /'zɪŋk,ænəʊd/ (boating/yachting, nav arch) cink-anoda, anoda od cinka



zinc plate /zɪŋk/ (n) (nav arch) anodna ploča od cinka, cink-ploča, protugalvanska ploča

zodiac /'zəʊdi,æk/ (n) (navig) the position of the sun throughout a year as it appears to move through successive star groups or constellations **zodijak**

zodiac /'zəʊdi,æk/ (n) (nav arch) a brand of very popular inflatable and rigid inflatable boats (RIBs) used by SCUBA divers because of their stability and ease of boarding from the water and as tenders by much of the boating community **gumenjak tipa zodiak**

zone /zəʊn/ (n) (ports) geografski pojas **port industrial zone** lučka industrijska zona, **free zone** slobodna (carinska) zona

Z-twist (n) (seamanship) twisted rope with a right-hand lay, the most common twist in rope; opposite of S-twist **sukanje konopa u desno**

zulu time (n) (navig) the difference between local time and Greenwich Meridian Time or Greenwich Mean Time (GMT) **univerzalno koordinirano vrijeme (UTC)**, razlika između lokalnog i univerzalnog koordiniranog vremena {Zulu time is sometimes denoted by the letter Z, a reference to the equivalent nautical time zone (GMT), which has been denoted by a Z since about 1950.}

zz_chem_tanker (n) (nav arch) tanker za prijevoz kemikalija

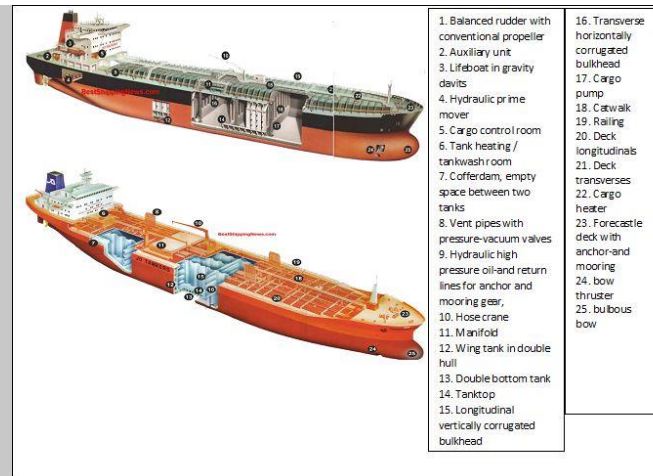

zz_gen_cargo_ship_midship_section (n) (nav arch) brod za generalni teret - presjek sredine broda

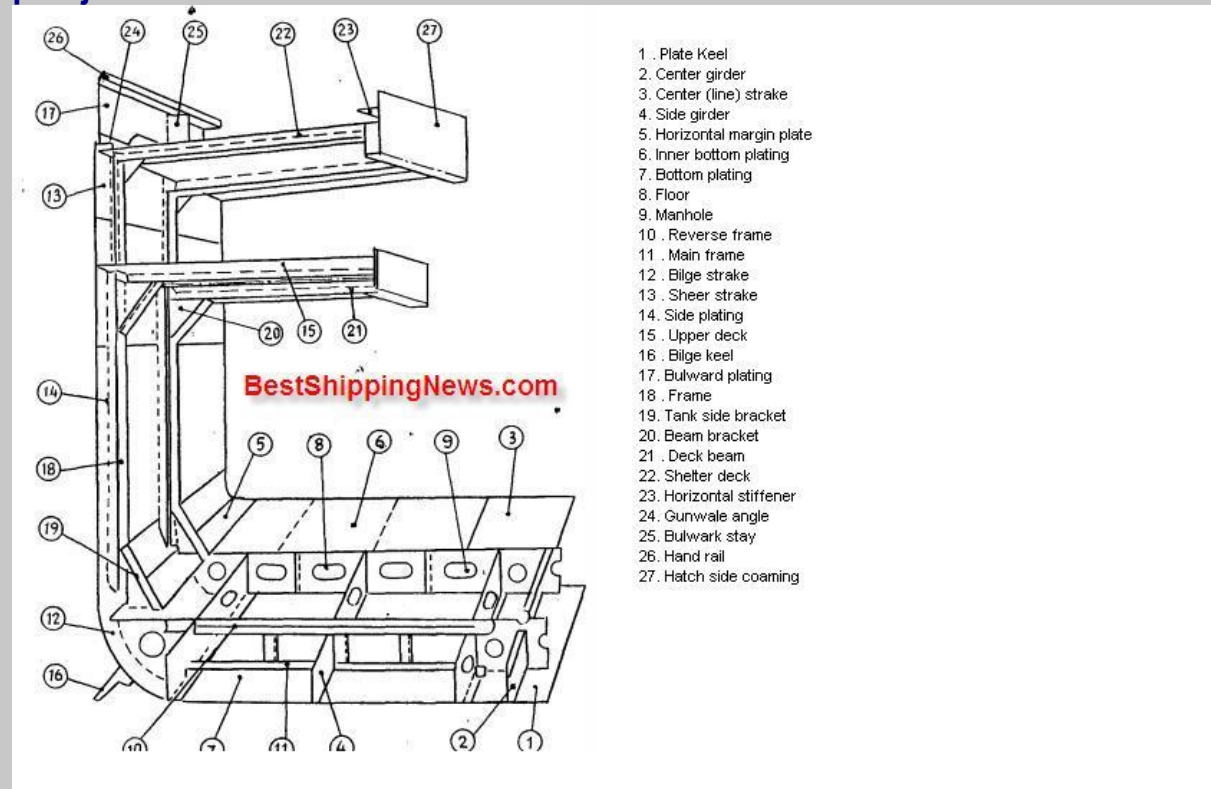

zz_general_cargo_ship (n) (nav arch) COMPARE general cargo ship brod za generalni teret

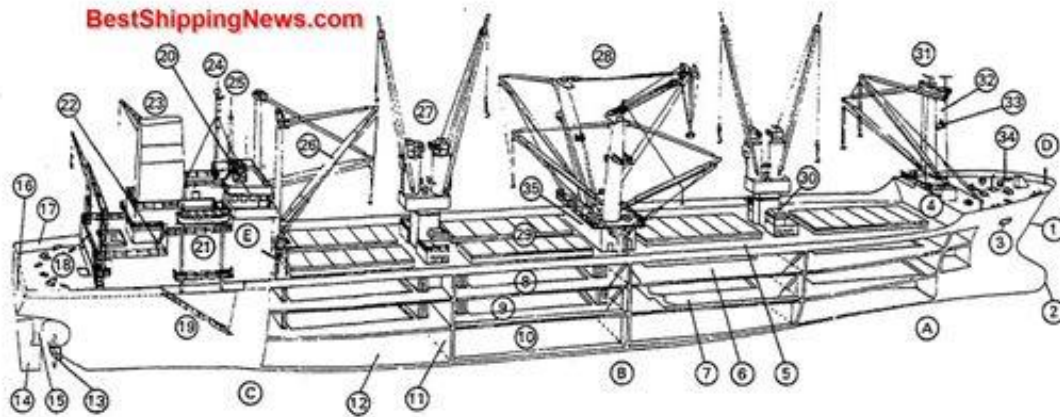

- | | | |
|--|--|----------------------------|
| A bow | 13 propeller | 25 aerials |
| B midship body | 14 rudder | 26 cargo derricks |
| C quarter | 15 stern frame | 27 cargo cranes |
| D forecastle | 16 counter stern | 28 heavy lift rig |
| E bridge castle | 17 bulwark | 29 hatch covers |
| 1 stem, bow | 18 mooring gear | 30 ventilator |
| 2 bulb | 19 accommodation ladder | 31 mast top, mast platform |
| 3 hawse pipe | 20 bridge, flying bridge,
"monkey island" | 32 samson post, king post |
| 4 forecastle break, forecastle
bulkhead | 21 lifeboat | 33 navigation light |
| 5 main deck | 22 ladder | 34 hawse gear |
| 6 second deck | 23 funnel | 35 deck house |
| 7 third deck or orlop deck | 24 signal mast, "Christmas tree" | |
| 8 upper 'tween deck | | |
| 9 lower 'tween deck | | |
| 10 lower hold | | |
| 11 transverse bulkhead | | |
| 12 tank top plating | | |