

ENCAPSULATED SPECIALIST NOZZLES

NOZZLES FOR ENCAPSULATED - SPATULAS - POTS - SCRAPERS – HEATERS



JURBLAMI® S.L.

GENERAL CATALOG 2020
GENERAL CATALOG 2020



We are a company dedicated to the manufacture of tools for working with composite materials, whether plastic, carbon fiber, aluminum, etc.

We are introducing accessories for applying sealants, silicones etc.

Our main specialty is nozzles for encapsulating nuts, rivets and tools for working materials silicone sealant resins, glues, paints, etc.

These tools are designed not to damage the aluminum compounds or materials that are treated with primers against corrosion, etc.

Our goal is to help improve the quality, aesthetics and cleanliness in the field of automotive, marine, rail and aviation.

We are bringing to market new products that will appear shortly.

We are at your disposal, for any information you need about our products.

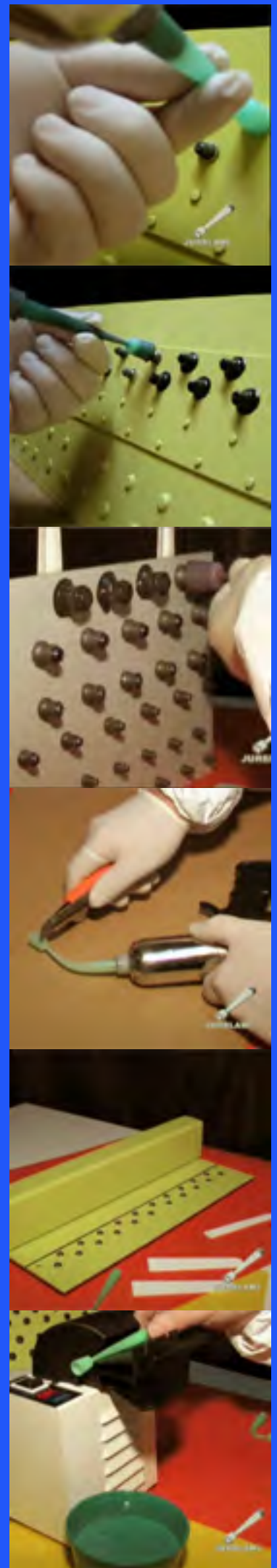

INDEX

INDEX

INJECTORS SEALANT	Pg. 5
SEALANT-APPLICATOR NOZZLE WITH BELL ENCAPSULATING REF: 100	Pg. 6
TEMPLATE FOR ELECTION OF BELL BY SIZE OR RIVET NUT	Pg. 7
SPECIAL NOZZLE FOR ENCAPSULATING SEALANT DEL (Type- A)	Pg. 8
FORMAT NOZZLES ANGLE 30 °	Pg. 8
NOZZLE TO ENCAPSULATING REF: 90	Pg. 9
NOZZLE TO ENCAPSULATING REF: 120	Pg. 10
TEMPLATE FOR BETTER CHOICE OF NOZZLE	Pg. 11
ENCAPSULATING WITH SPECIAL NOZZLES FOR SEALING OF (Type- B)	Pg. 12
NOZZLE FOR ENCAPSULATED ANGLE 30 °	Pg. 12
NOZZLE FOR ENCAPSULATED OF NUTS AND RIVETS REF. 120	Pg. 13
NOZZLE FOR ENCAPSULATED ANGLE 30 °	Pg. 13
NOZZLE FOR SEALING OF NUTS MANUALLY SMOKING PIPE SHAPE	Pg. 14 ,16
NOZZLE FOR ENCAPSULATING SMOKING PIPE SHAPE WITH THREAD	Pg. 15 ,16
NOZZLES FOR ENCAPSULATING OF WATERTIGHT NUTS	Pg. 17
NOZZLE FOR SPECIAL ENCAPSULATING REF: 90 And REF: 120	Pg. 18
TEMPLATE FOR ELECTION SPECIAL NOZZLES	Pg. 19
ENCAPSULATING NOZZLE WITH SPECIAL SEALANT DEL (Type- B)	Pg. 20
SHORT NOZZLE BELL FOR ENCAPSULATING NUTS IN DIFFICULT ACCESS AREAS	Pg. 21
NOZZLE OF MANUAL APPLICATION AND AIR HEATER TO CONFORM PLASTIC NOZZLES	Pg. 22
INJECTION BUTTON	Pg. 23
REMOVABLE BELLS	Pg. 25 , 26
EXTENSIONS	Pg. 27
STRAIGHT AND CURVED NOZZLES WITH ANGLE OF 30° FOR THE APPLICATION OF SEALANT BEAD	Pg. 28
SYRINGES AND MIXING NOZZLES	Pg. 29
ACCESSORIES	Pg. 30
SEALANT SPATULA AND TOOTHED SPATULA	Pg. 32
CUSTOMIZABLE SPATULAS SET	Pg. 33
METHACRYLATE SCRAPER IN FORM OF A SPATULA AND BLADES TO REMOVE OVERFLOWS	Pg. 34
SPECIAL TRANSPARENT POTS	Pg. 36
CUSTOMERS	Pg. 37





SEALANT- APPLICATOR NOZZLE WITH BELL



JURBLAMI[®]S.L.

SEALANT-APPLICATOR NOZZLE WITH BELL

Nozzles designed for the application of sealants or silicones. These nozzles are for encapsulating rivets and aim the protection against corrosion of nuts and rivets, when exposed to water, corrosive oils, sudden changes in temperature, etc. With these nozzles you get dual functionality, such as making encapsulated and applying ribbons to make holes or fill cavities with just cutting the bell and discard we can perform this function. This type of nozzle tip bell could equally be applied in any part of the field of naval, railway, automotive and aviation.

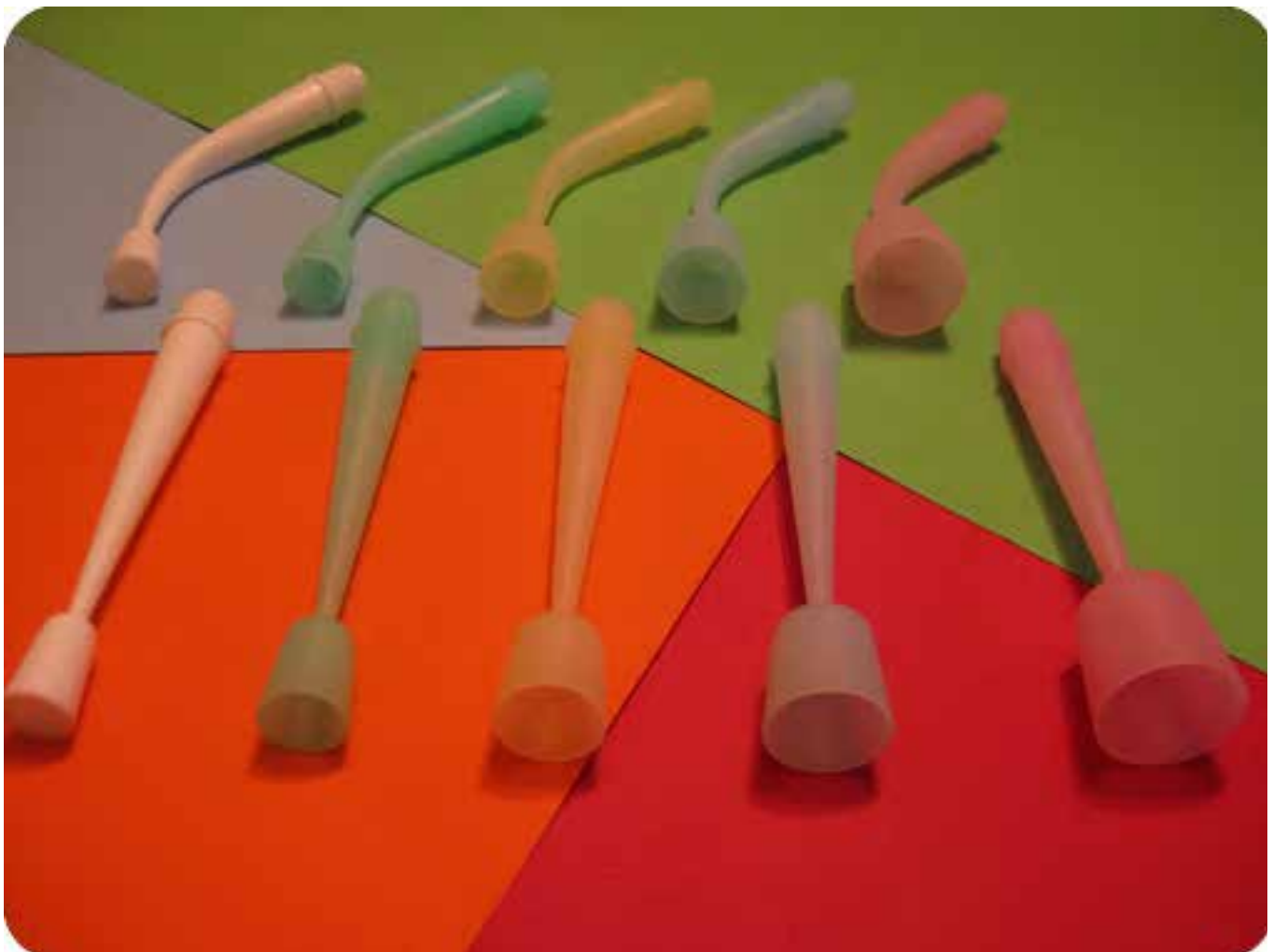

KEY BENEFITS

- I. - Time savings for its encapsulating speed.
- II.- Dual functionality, allowing using it as a normal nozzle.
- III.- And its cleaning, being disposable we save abrasive liquids, rags, etc.

SEALANT-APPLICATOR NOZZLE WITH BELL ENCAPSULATING REF: 100

PLANTILLA Nº 1

BOQUILLA DE ENCAPSULADO

4 1/8" LONG.

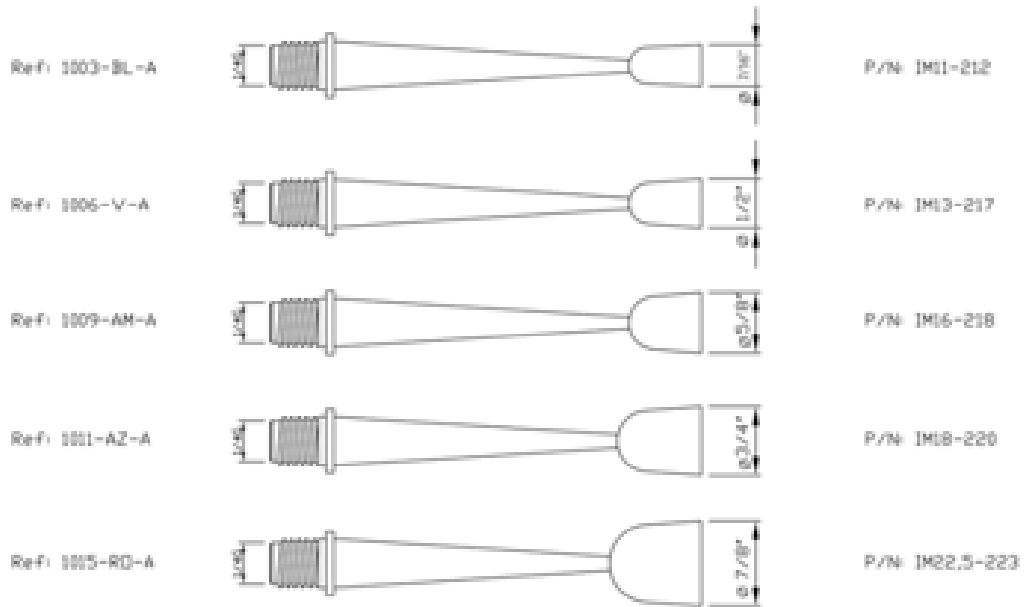

BOQUILLA DE ENCAPSULADO FORMATO
 ANGULO DE 30°

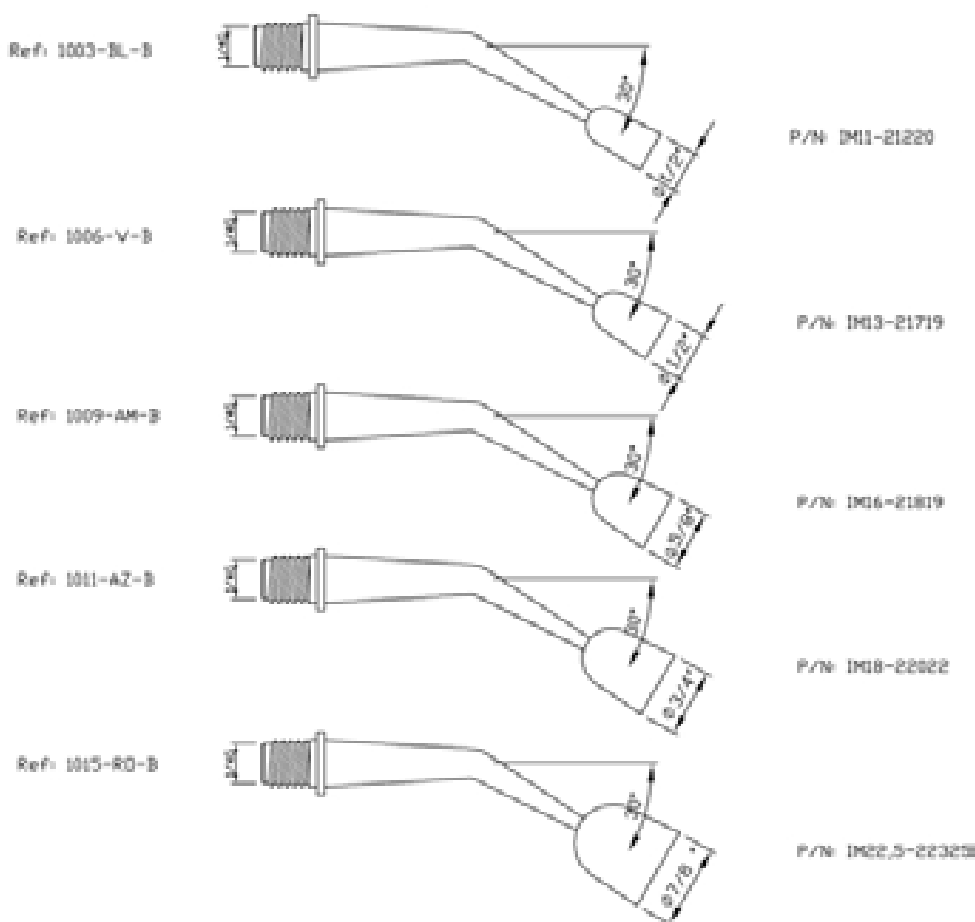

DETALLE TIPO

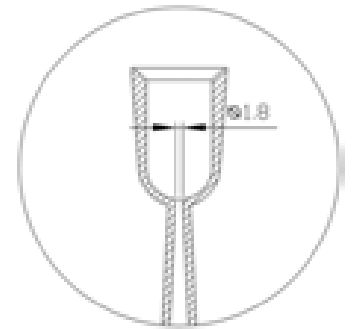

TEMPLATE FOR ELECTION OF BELL BY SIZE OR RIVET NUT

JURBLAMI – 1^a REF: 100 TEMPLATE FOR ELECTION BELL BY SIZE OF RIVET AND / OR NUT. PASS DIAMETER 1,8 M/M

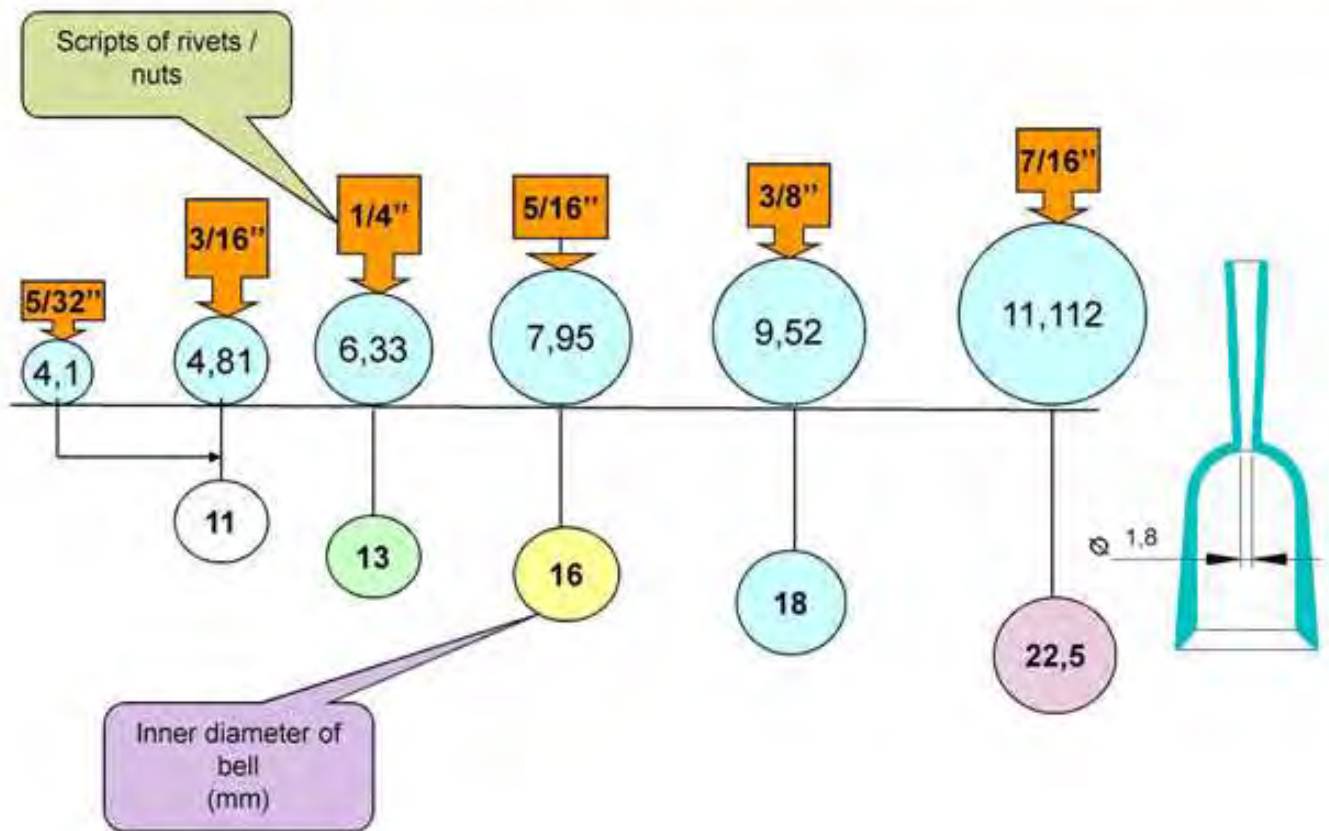

SPECIAL NOZZLE FOR ENCAPSULATING SEALANT DEL (Type- A)



NOZZLE TO ENCAPSULATE RIVETS AND NUTS

REFERENCE	1003 - BL - A	1006 - V - A	1009 - AM - A	1011 - AZ - A	1015 - RO - A
P/N	IM11 - 212	IM13 - 217	IM16 - 218	IM18 - 220	IM22,5 - 223
UNITS PER BOX	500	500	500	500	500

FORMAT NOZZLES ANGLE 30 °.



FORMAT NOZZLES ANGLE 30 °.

REFERENCE	1003 - BL - B	1006 - V - B	1009 - AM - B	1011 - AZ - B	1015 - RO - B
P/N	IM11 - 21219	IM13 - 21719	IM16 - 21819	IM18 - 22022	IM22,5 - 22325
UNITS PER BOX	500	500	500	500	500

NOZZLE TO ENCAPSULATING REF: 90

PLANTILLA Nº 2 REF: 90

90 mm de LONG

BOQUILLA DE ENCAPSULADO

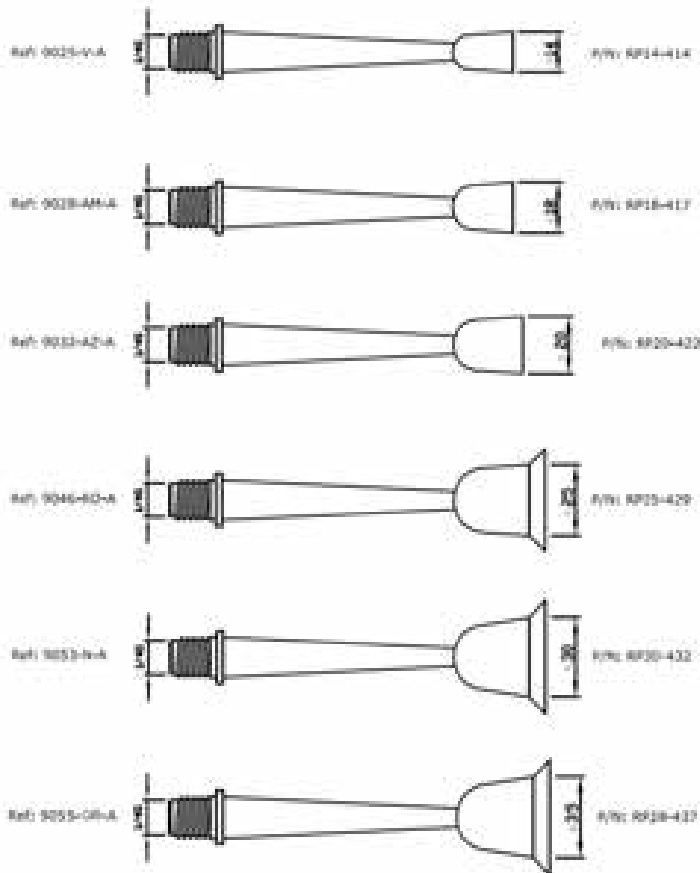

BOQUILLA DE ENCAPSULADO FORMATO
ANGULO DE 30°

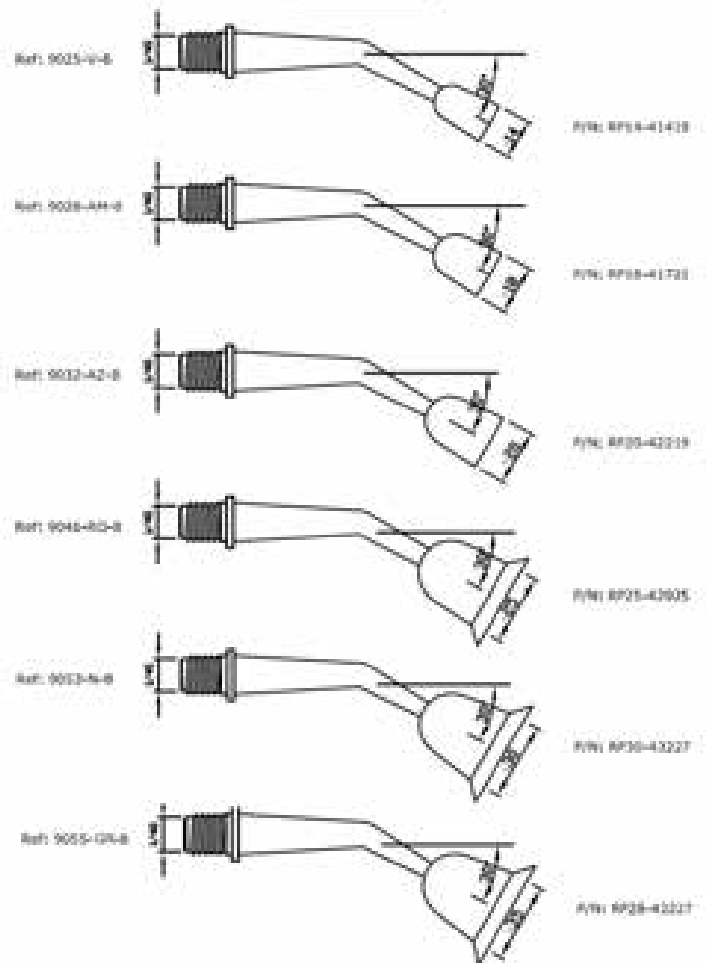

DETALLE TÍPO

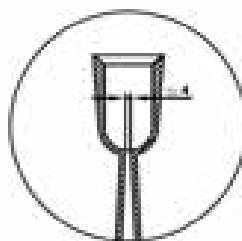

NOZZLE TO ENCAPSULATING REF: 120

PLANTILLA Nº 3 REF: 120

(en mm.)

BOQUILLA DE ENCAPSULADO

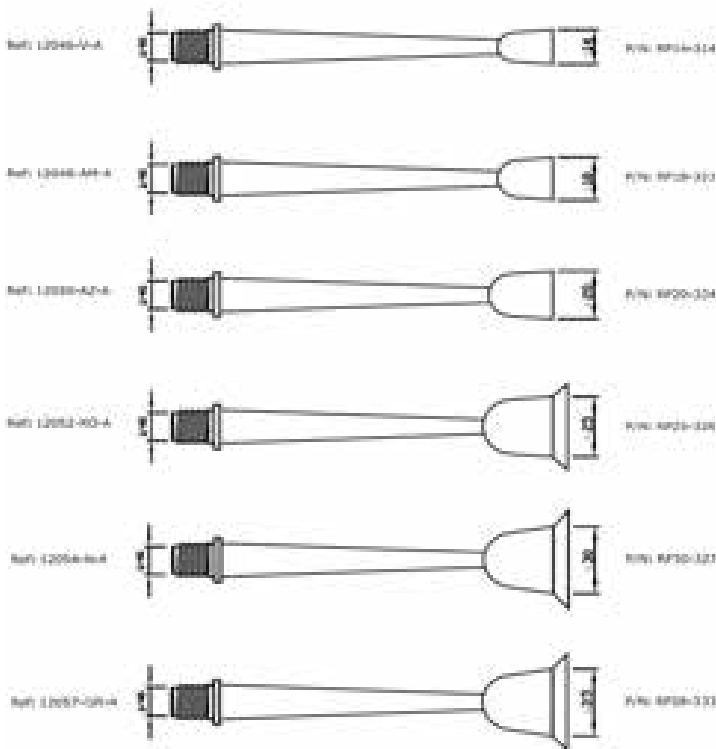

BOQUILLA DE ENCAPSULADO FORMATO
 ACORTADO DE 30"

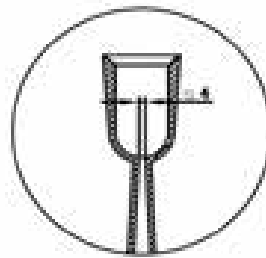
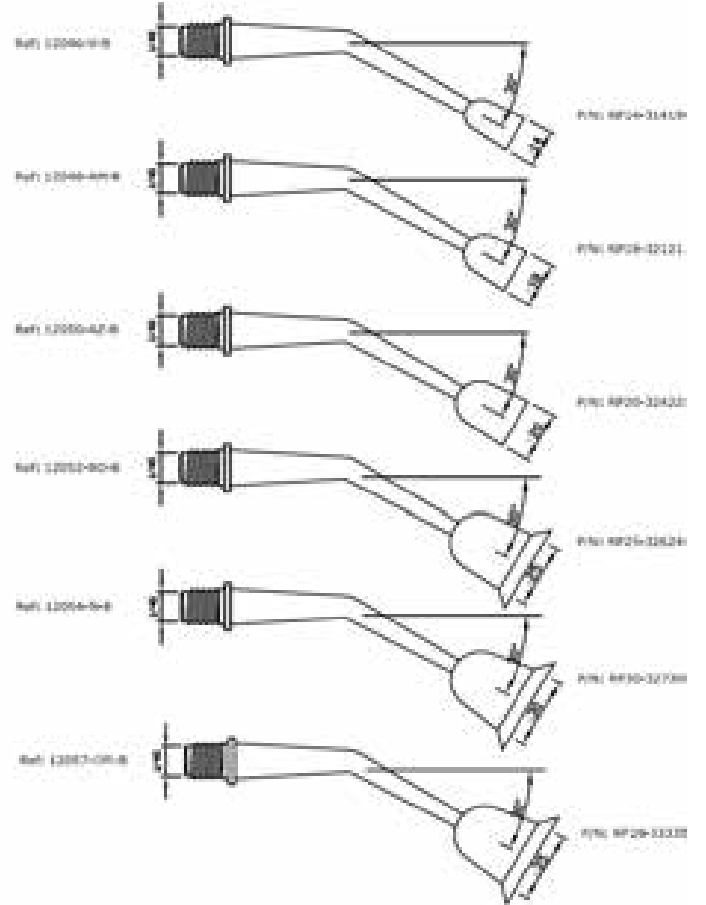

TEMPLATE FOR BETTER CHOICE OF NOZZLE

JURBLAMI – 2° REF: 90 y 120 TEMPLATE FOR ELECTION BELL BY SIZE OF RIVET AND / OR NUT. PASS DIAMETER 4 M/M

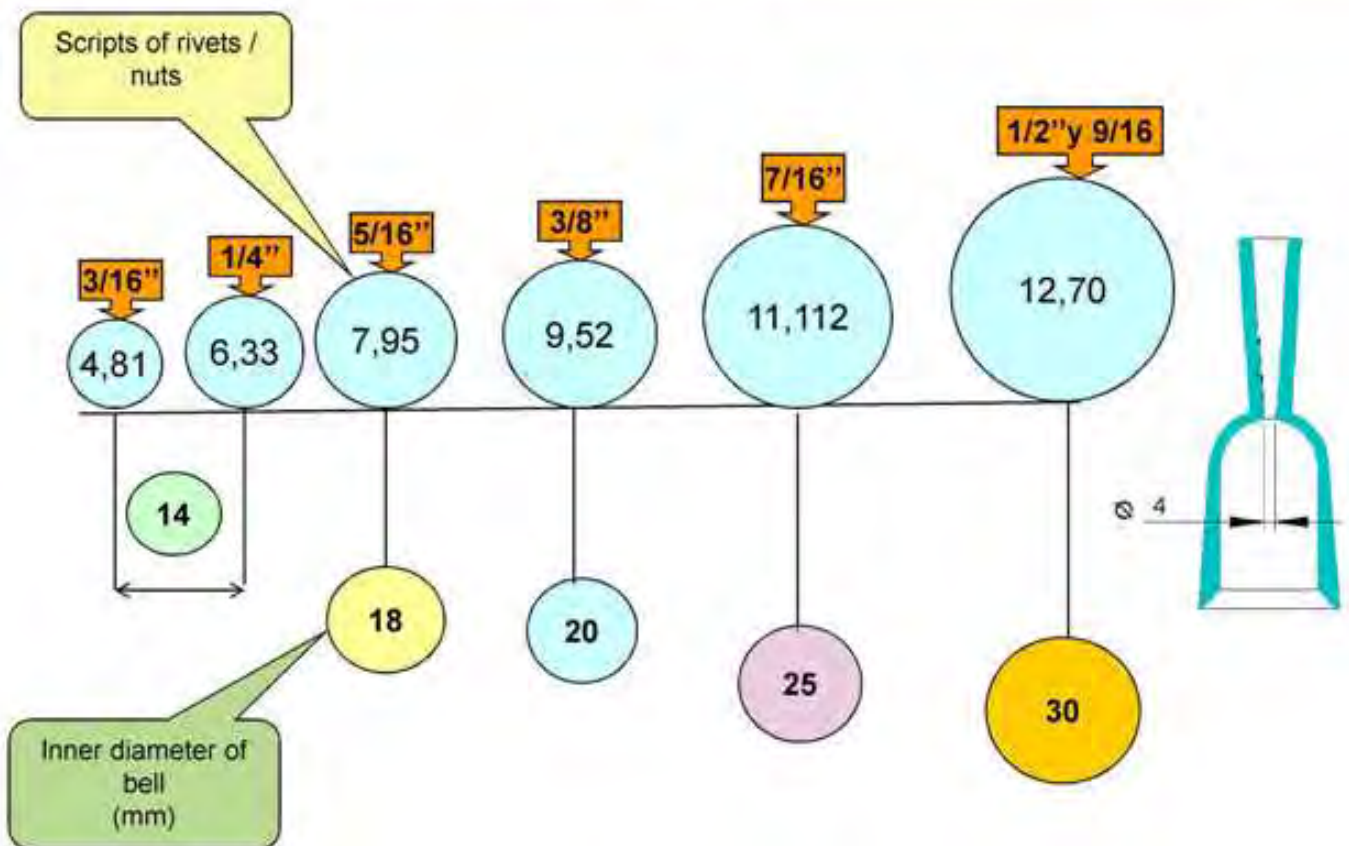

ENCAPSULATING WITH SPECIAL NOZZLES FOR SEALING OF (Type- B)



STRAIGHT NOZZLE

REFERENCE	9025-V-A	9028-AM-A	9032-AZ-A	9046-RO-A	9053-N-A	9055-GR-A
P/N	RP14-414	RP18-417	RP20-422	RP25-429	RP30-432	RP28-437
UNITS PER BOX	500	500	500	500	500	350

NOZZLE FOR ENCAPSULATING ANGLE 30 °



NOZZLES ANGLE 30 °

REFERENCE	9025-V-B	9028-AM-B	9032-AZ-B	9046-RO-B	9053-N-B	9055-GR-B
P/N	RP14-41419	RP18-41721	RP20- 42219	RP25- 42925	RP30-43227	RP28-43227
UNITS PER BOX	500	500	500	500	500	350

NOZZLES FOR ENCAPSULATING THE NUTS AND RIVETS REF. 120



STRAIGHT NOZZLE

REFERENCE	12046-V-A	12048-AM-A	12050-AZ-A	12052-RO-A	12054-N-A	12057-GR-A
P/N	RP14-314	RP18-321	RP20-324	RP25-326	RP30-327	RP28-333
UNITS PER BOX	500	400	350	350	350	300

NOZZLES FOR ENCAPSULATING WITH ANGLE 30 °



NOZZLES ANGLE 30 °

REFERENCE	12046-V-B	12048AM-B	12050AZ-B	12052-RO-B	12054-N-B	12057-GR-B
P/N	RP14-31419	RP18-32121	RP20-32422	RP25-32624	RP30-32730	RP28-33335
UNITS PER BOX	500	400	350	350	350	300

NOZZLE FOR SEALING
 OF NUTS MANUALLY

TEMPLATE N° 5

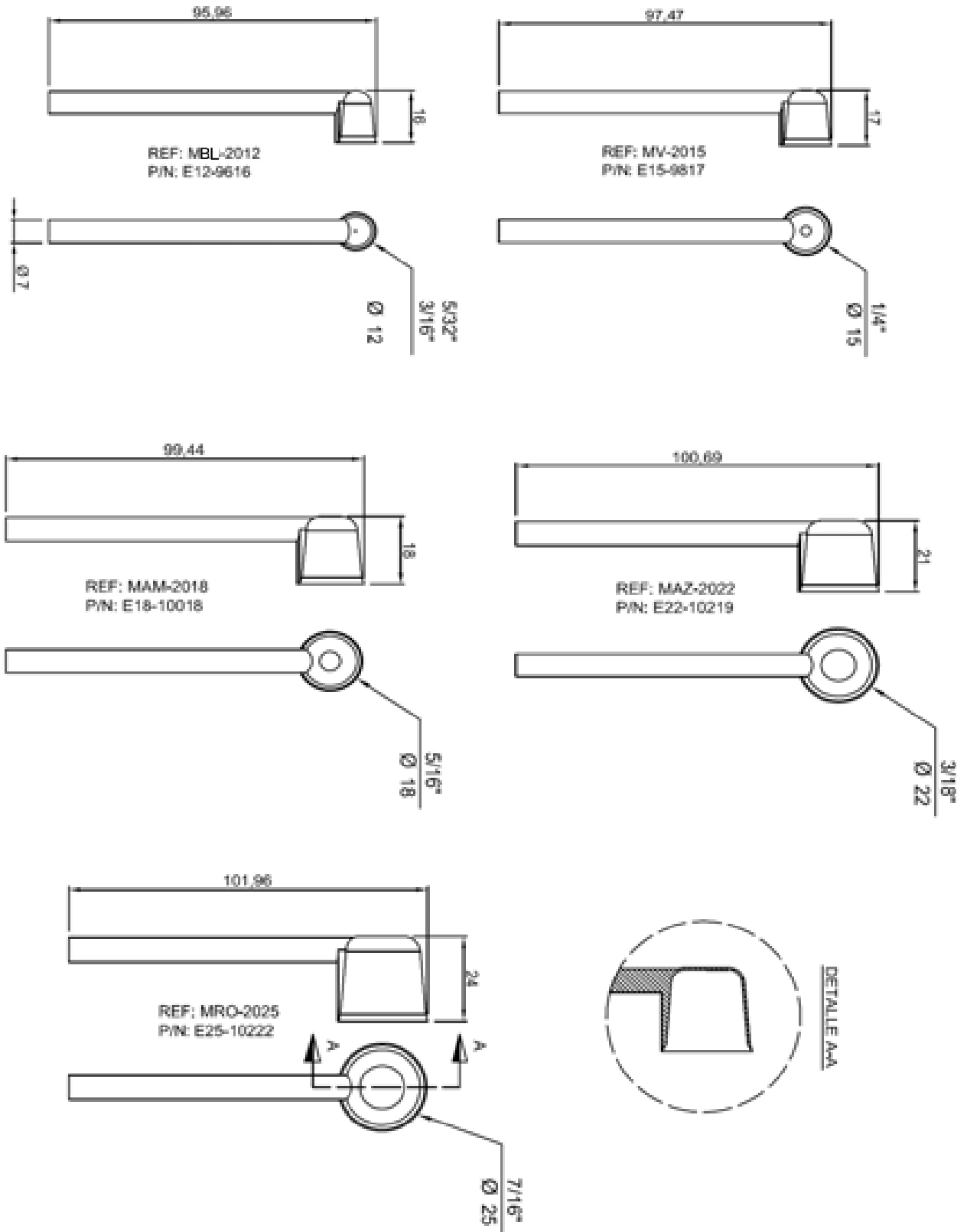

NOZZLE FOR ENCAPSULATING
SMOKING PIPE SHAPE WITH THREAD

TEMPLATE N° 4

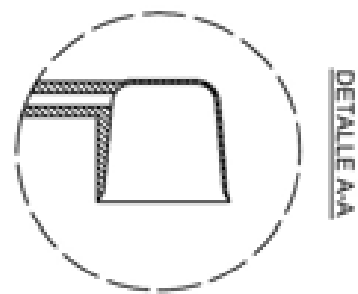
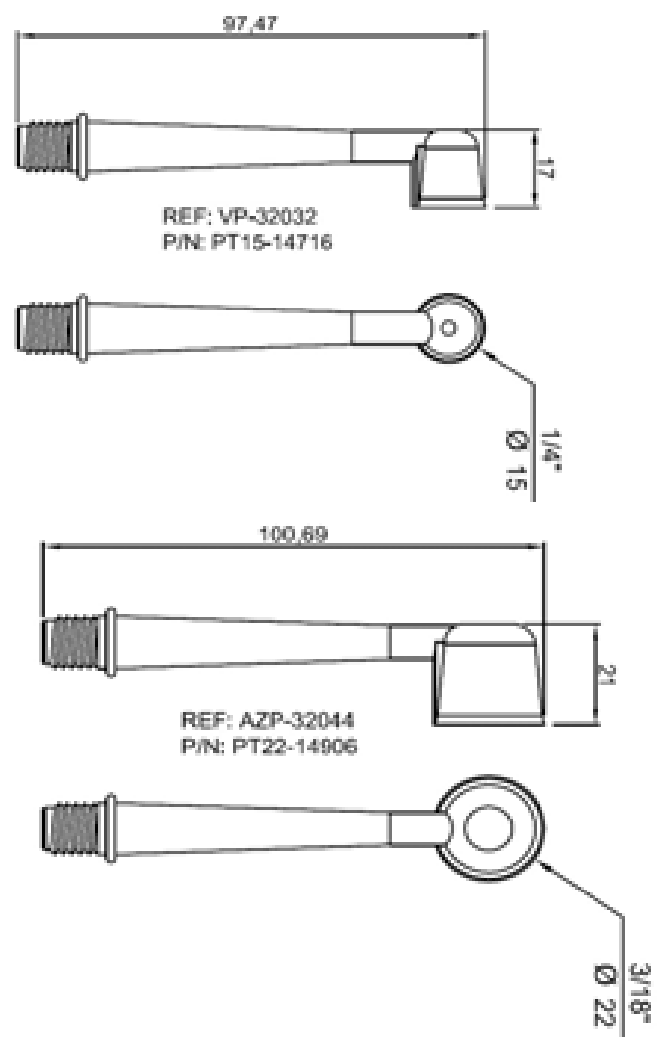
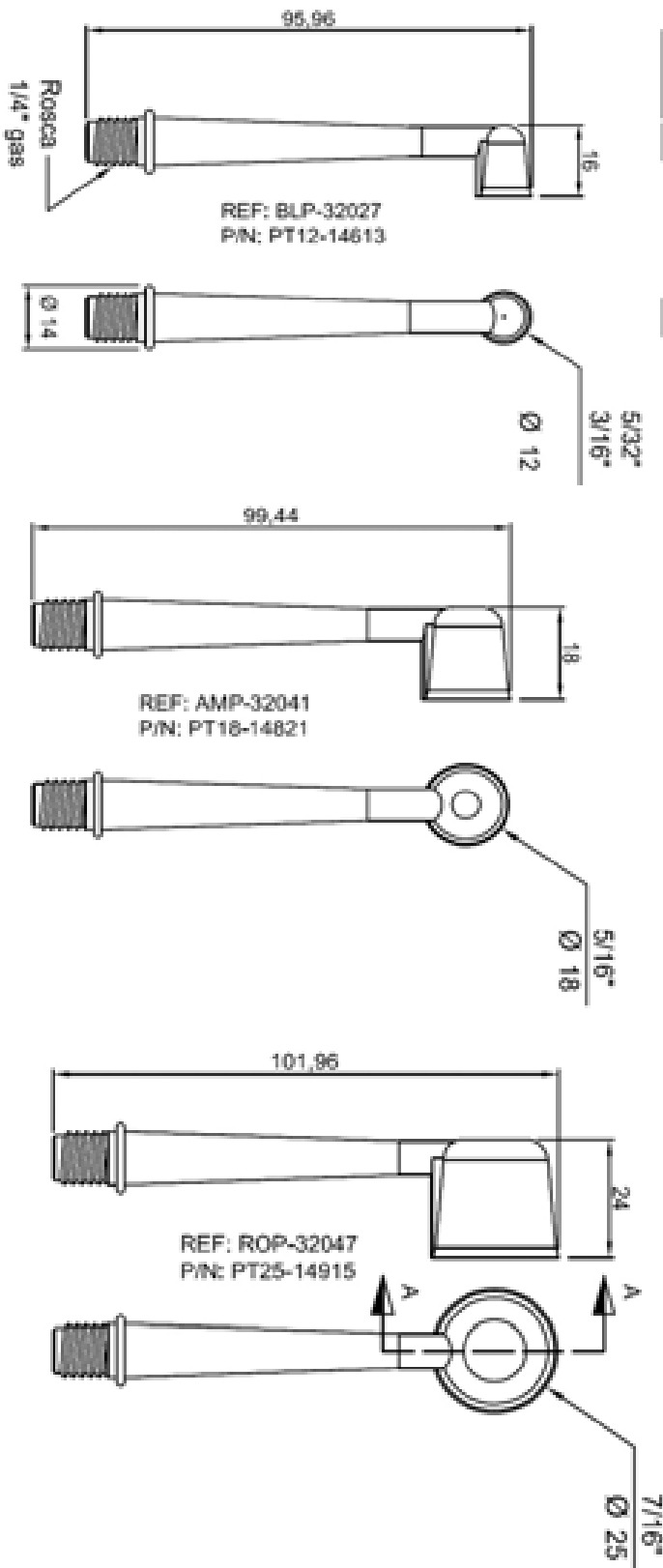

**NOZZLE WITH SMOKING PIPE SHAPE
FOR MANUAL WORKS IN DIFFICULT ACCESS AREAS**



NOZZLES FOR ENCAPSULATING OF RIVETS

REFERENCE	MBL - 2012	MV-2015	MAM-2018	MAZ-2022	MRO-2025
P/N	E12 - 9616	E15- 9817	E18 - 10018	E22 - 10219	E25 - 10222
UNITS PER BOX	500	500	500	500	500

**NOZZLE WITH SMOKING PIPE SHAPE FOR MANUAL WORKS
IN DIFFICULT ACCESS AREAS WITH EXTRUSION GUN.**



NOZZLES FOR ENCAPSULATING OF RIVETS

REFERENCE	BLP - 32027	VP - 32032	AMP - 32041	AZP - 32044	ROP - 32047
P/N	PT12 - 14613	PT15 - 14716	PT18 - 14821	PT22 - 14906	PT25 - 14915
UNITS PER BOX	500	500	500	500	500

NOZZLES FOR ENCAPSULATING OF WATERTIGHT NUTS



THIS NOZZLE IS SPECIAL FOR SEALING THE WATERTIGHT NUTS IN AVIATION FUEL TANKS.

FOR MORE INFORMATION, DOWNLOAD TECHNICAL DATA SHEET.



NOZZLE TO ENCAPSULATE THE WATERTIGHT NUTS

REFERENCE	2232 - A	2439 - A	3039 - A
P/N	ES - 3627	ES - 3630	ES - 3634
UNITS PER BOX	500	500	500

NOZZLE FOR SPECIAL ENCAPSULATING REF: 90

PLANTILLA N° 4 REF: 90

BOQUILLA DE ENCAPSULAR ESPECIALES

90 mm LONG.

DETALLE TIPO

Ref: 9060-VZ-A

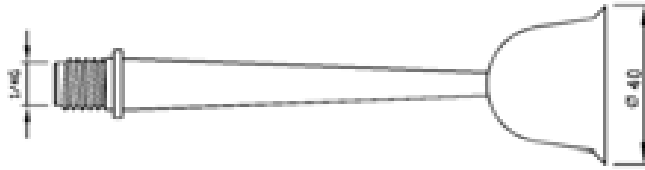

P/N: RP40-810

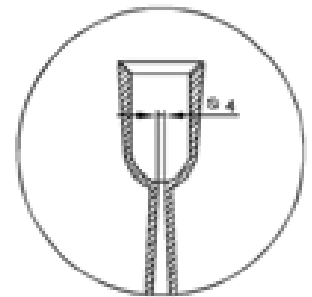

Ref: 9065-AD-A

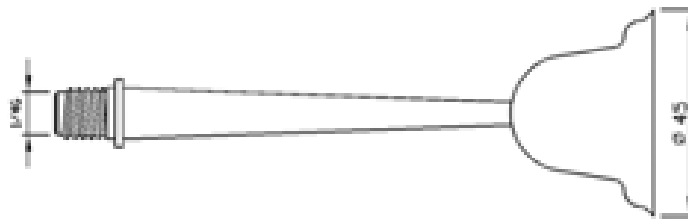

P/N: RP45-830

NOZZLE FOR SPECIAL ENCAPSULATING REF: 120

PLANTILLA N° 5 REF: 120

BOQUILLA DE ENCAPSULAR ESPECIALES

120 mm LONG.

DETALLE TIPO

Ref: 12058-VZ-A

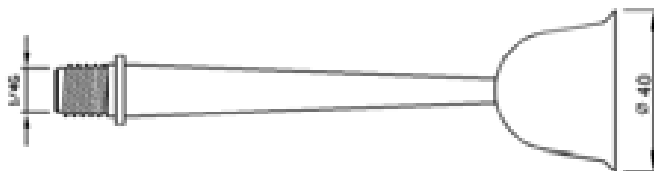

P/N: RP40-840

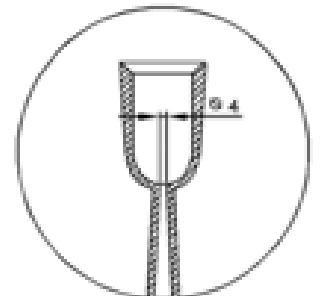

Ref: 12062-AD-A

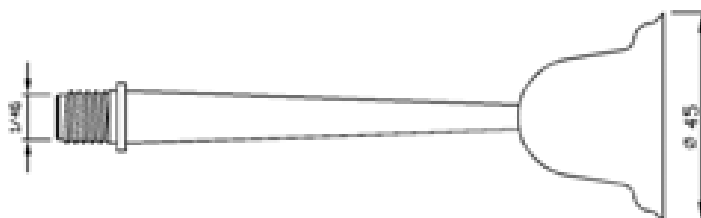

P/N: RP45-845

TEMPLATE FOR ELECTION SPECIAL NOZZLES

JURBLAMI – 3^a REF: 90 Y 120 TEMPLATE FOR ELECTION BELL BY SIZE OF RIVET AND / OR NUT. PASS DIAMETER. 4 M/M

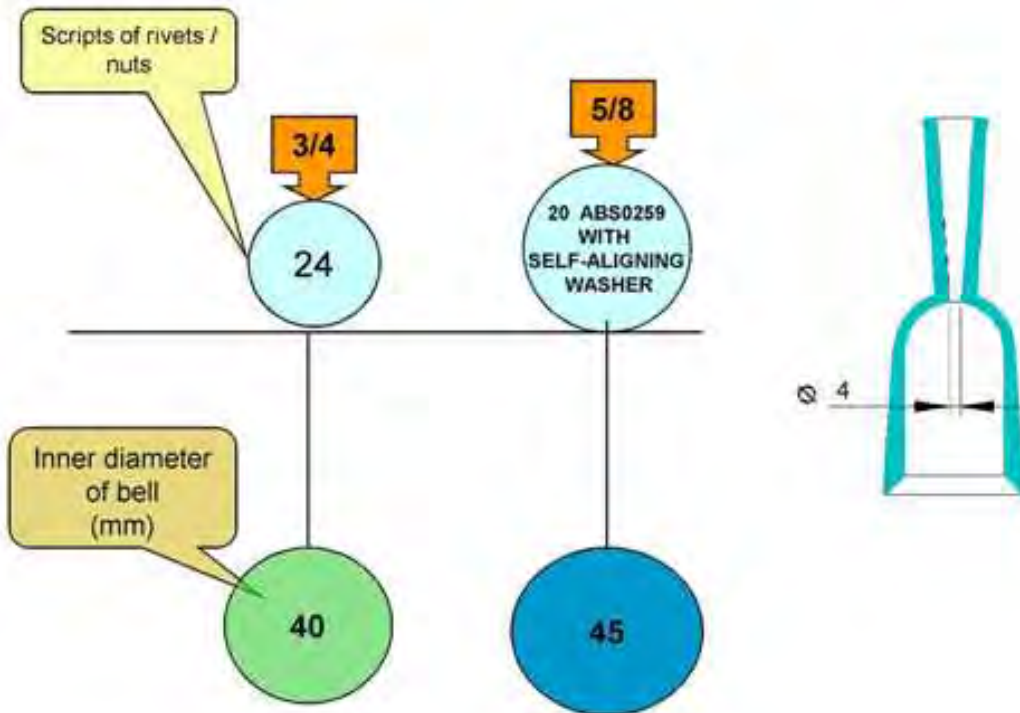

ENCAPSULATING WITH SPECIAL NOZZLES FOR SEALING OF (Type- B)



NOZZLES FOR ENCAPSULATING OF NUTS AND RIVETS REF: 90

REFERENCE	9060-VZ-A	9065-AO
P/N	RP-40-810	RP-45-830
UNITS PER BOX	350	350



NOZZLES FOR ENCAPSULATING OF NUTS AND RIVETS REF: 120

REFERENCE	12058-VZ-A	12062-AO-A
P/N	RP-40-840	RP-45-845
UNITS PER BOX	225	225

SHORT NOZZLE BELL FOR ENCAPSULATING NUTS IN DIFFICULT ACCESS AREAS

BOQUILLA DE ENCAPSULAR ESPECIALES

100 mm LONG.

Ref: 13009-AM-A



P/N: MJ16-207

DETALLE TIPO

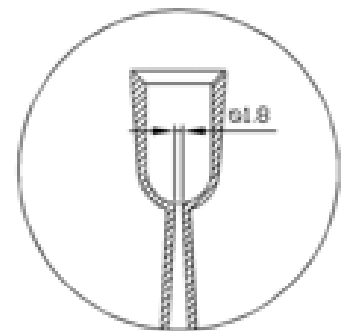

Ref: 13009-AM-B

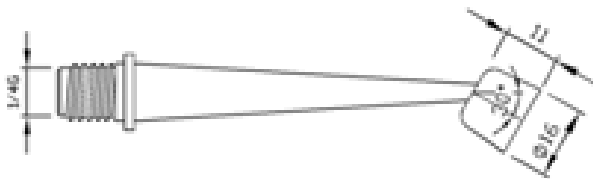

P/N: MJ16-20711



SHORT NOZZLE BELL FOR ENCAPSULATING NUTS IN DIFFICULT ACCESS AREAS

REFERENCE
P/N
UNITS PER BOX

13009-AM-A
MJ16-207
500

13009-AM-B
MJ16-20711
500

MANUAL NOZZLE

This type of bell serves to encapsulate by hand. It is very manageable and requires no training to use.



MANUAL NOZZLE

REFERENCE	1054 - BL
P/N	1 - 4,8
UNITS PER BOX	500

AIR HEATER TO SHAPE PLASTIC NOZZLE

With this heater we can give nozzles different forms heating them by 20 "and put them into the desired shape with a gentle stretch; and finally wait for it to cool or cool it with water to speed cooling, in the shape we have given to the nozzle.



AIR HEATER TO SHAPE PLASTIC NOZZLE

REFERENCE	AC - 33025
P/N	3125
UNITS PER BOX	1

INJECTION BUTTON



INJECTION BUTTON

Is a system that has been designed, developed and patented by JURBLAMI® to apply wet sealant to the rivet heads, mainly aviation. The manner of application may be performed mechanically, with gun or by robotic extrusion. In this way, you get cleaning, speed, security sealing and pressurization is achieved.

BOQUILLA

BOTÓN DE INYECCIÓN

Ref: 1006-V-A

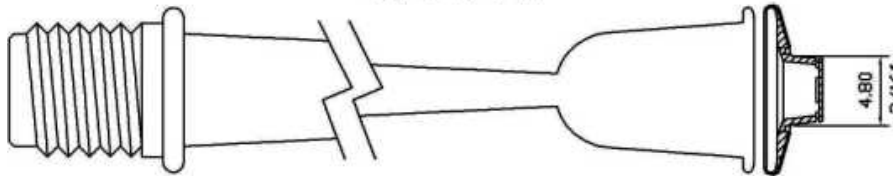

REF: 8632-T

Ref: 1009-AM-A

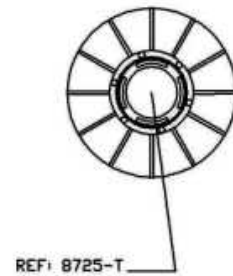
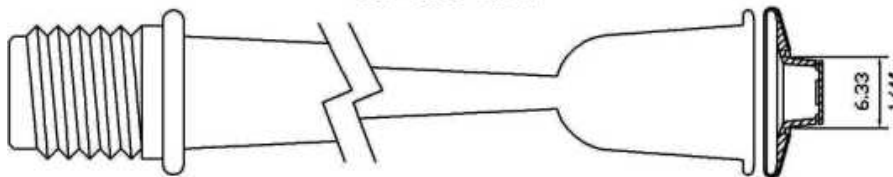

REF: 8725-T

INJECTION BUTTON

REFERENCE	8632-T	8725-T
P/N	ES782	ES856
UNITS PER BOX	250	250



DEMOLDABLE BELL MOLD

JURBLAMI[®]S.L.

MOULD DEMOLDED BELL

MOULD DEMOLDED BELL



It is a new system developed by JURBLAMI® to seal rivet nuts with fresh and frozen sealant. The geometry of the bell-shaped mold can be adapted to the customer's sealant tolerances and dimensions of rivet nuts, especially the world of aviation.

Application method: It can be applied in various ways. With extrusion gun, we can fill the bell with sealant on the bell-shaped inside, pointed the gun nozzle at the bottom of the nozzle and filling up a third of it. Once filled, it is submerged within the rivet, supporting the guide on the hexagonal portion of the bolt, which makes guide for centering the mold. Then we do a few turns with your fingers on the area of the nozzle until the sealant flows onto base, which indicates that the nozzle is full and there is no air trapped inside. It can also be applied directly, with a special nozzle, which allows us to introduce a guide on the handle portion or nozzle of the mold filling sealant, until a small external sealant ring is formed, indicating that there is no trapped air within the mold. Finally, once the sealant is dry, the bell is demolded and we get an encapsulated, clean, bright and spectacular finish.



HI-LOCK



JISI

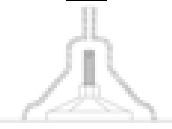

Ø 8,33 K4

ALCOA



Ø 11,88 K7

NOZZLE GUIDE FOR DEMOLDED BELL

REFERENCE	18BG093
P/N	A1- 1736
UNITS PER BOX	500

MOULD DEMOLDED BELL TO HI-LOCK

REFERENCE	H - 5247	H - 5253	H - 5262	H - 5278
P/N	1 - 027	1 - 031	1 - 035	1 - 039
DIÁMETER	5/32" - 3/16"	1/4"	5/16"	3/8"
UNITS PER BOX	500	500	500	500

MOULD DEMOLDED BELL TO JISI

REFERENCE	1 - 6520
P/N	2 - 303
UNITS PER BOX	500

MOULD DEMOLDED BELL TO ALCOA

REFERENCE	A - 7020
P/N	3 - 125
UNITS PER BOX	500

**BLIND REMOVABLE BELL MOULD HI-LITE
FOR ENCAPSULATE OF HI-LITE TYPE RIVETS**



HI-LITE

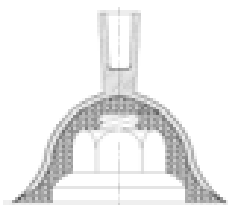

BLIND DEMOLDABLE BELL MOULD HI-LITE						
REFERENCE	HI - 8945	HI - 8956	HI - 8965	HI - 8960	HI - 8963	HI - 8970
P/N	TU - 35029	TU - 35027	TU - 35031	TU - 35034	TU - 35038	TU - 35040
UNITS PER BOX	500	500	500	500	500	500

**BLIND DEMOLDABLE BELL FOR SCREW HEAD
TO ENCAPSULATE PROTRUDING HEADS OF SCREWS OR RIVETS**

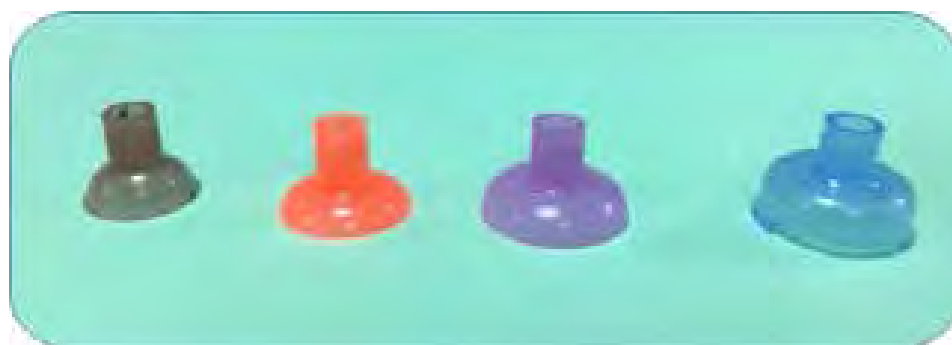

**FOR PROTRUDING
HEADS**

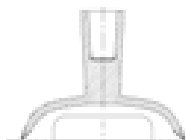

BLIND DEMOLDABLE BELL FOR SCREW HEAD				
REFERENCE	PR - 6033	PR - 6035	PR - 6039	ES - 7087
P/N	T - 45114	T - 45116	T - 45118	TR - 9640
UNITS PER BOX	500	500	500	500

EXTENSIONS

Flexible extensions for sealing in hard to reach areas.



EXTENSIONS

REFERENCIA	FLEXIBLE NOZZLE 138 mm	FLEXIBLE NOZZLE 270 mm	FLEXIBLE NOZZLE 320 mm
P/N	FL - 1962	FLC - 2618	FLC - 2630
UNIDADES POR CAJA			

**FINE TIP STRAIGHT NOZZLE
FOR APPLICATION OF SEALANT BEAD**



STRAIGHT NOZZLE FOR APPLICATION OF SEALANT BEAD

REFERENCE	14106 - A	14228 - A	312548 - A
P/N	CO - 10516	CO - 10820	B - 1438
UNITS PER BOX	500	500	500

**30° DEGREES ANGLE NOZZLE
FOR APPLICATION OF SEALANT INTO HARD TO REACH AREAS**

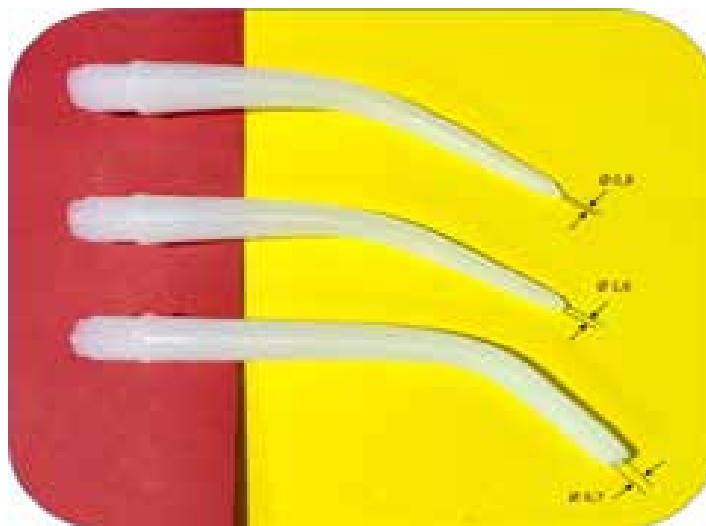

NOZZLE 30° FOR APPLICATION OF SEALANT BEAD

REFERENCE	14106 - B	14228 - B	312548 - B
P/N	CO - 30506	CO - 10830	B - 1450
UNITS PER BOX	500	500	500

STERILIZED SYRINGES, FOR APPLICATION OF ADHESIVES, SEALANTS, PAINTS, ETC.



SYRINGES

DESIGNATION	SYRINGES 5 ml. DB CONE TIP CJ 100	SYRINGES 10 ml. DB CONE TIP CJ 100	SYRINGES 5 ml. LUER LOCK CJ 100	SYRINGES 10 ml. LUER LOCK CJ 100	BLUE PLUG FOR SEALED CLOSURE	NOZZLE S-BLUNT LUER LOCK TIPS FOR THREADED SYRINGES
REFERENCE	06-27326	10-28873	06-36821	10-28962	A-5320	98016-J
P/N	J-7205	J-9615	J-8630	J-9335	T-2010	B-37231

MIXING NOZZLES FOR APPLICATION OF ADHESIVES AND SHIM.



MIXING NOZZLES

DESIGNATION	STATIC OF 6 " SHIM APPLICATION	STATIC OF 5 " SHIM APPLICATION	QUADRO MIXING
REFERENCE	BM-13010	BM-13040	97CU-125
P/N	83630-2	83520-2	85422-2

ACCESSORIES

Accessories for sealant application with extrusion gun model 250A .



ACCESSORIES (COVERS)

REFERENCE	RED PLUG	BLUE PLUG	RED COVER	BLUE COVER
P/N	T - 7520	T - 6550	T - 7540	T - 6530
UNITS PER BOX	250	250	250	250



ACCESSORIES (CARTRIDGES)

REFERENCE	PLUNGER TR.	CARTRIDGE 2,5 OZ	CARTRIDGE 6 OZ
P/N	E - 0319	C - 42100	C - 63180
UNITS PER BOX	250	250	250



SPATULAS



JURBLAMI[®]S.L.



SPATULA FOR SMOOTHING SEALANT

Special spatula for smoothing sealant on uneven surfaces, sealant mix, adhesive, resin, paints and liquid supplements.

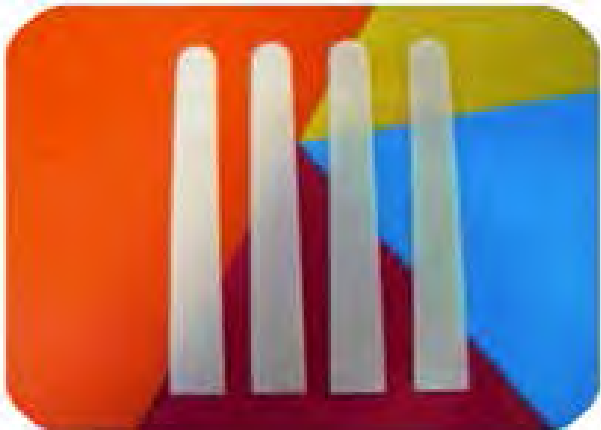

SPATULA FOR SMOOTHING SEALANT

REFERENCE

1140 - BL - II

1145 - BL - I

P/N

20 - P

30 - R

UNITS PER BOX

200

200

TOOTHED SPATULA

Special toothed spatula to apply sealant interposition.



TOOTHED SPATULA

REFERENCE

F - 1325

P/N

3 - 682

UNITS PER BOX

100

SPECIAL ESPATULAS GAMES CUSTOMIZABLE FOR RETEACH OF SEALANT'S RIBBONS

Adaptable spatulas set for reteach of aerodynamic sealing ribbons.

Ref: 6.225-CEA



CUSTOMIZABLE SPATULAS SET FOR SPECIAL AREAS (FOD)

This model is made of phosphorescent material (FOD prevents lost objects).

What is special in this model?

It is a system that allows us to work in dark areas with poor light, once the portable lamp is removed or the light goes out. Being phosphorescent, this material glows in the dark and stays glowing long enough to detect it early, before withdrawing from risk areas, such as an aviation fuel tank.

Ref: 7.205 - FOS



CUSTOMIZABLE SPATULAS SET

CUSTOMIZABLE SPATULAS SET		
REFERENCE	6.225 - CEA	7.205 - FOS
P/N	3821297	3821297-2
UNITS PER BOX	100	100

SCRAPER OF METHACRYLATE AND FORM OF SPATULA

These scrapers eliminate overflows of sealant, silicone, paint, etc., avoiding damage to the composite or metal surfaces.



SCRAPER OF METHACRYLATE AND FORM OF SPATULA

REFERENCE	1240 - RS
P/N	20 - CB
UNITS PER BOX	100

PLASTIC BLADES TO ELIMINATE SEALANT OF AVIATION

These blades are to eliminate overflows of sealant, silicone, paint, etc., avoiding damaging metallic surfaces or composite materials.



PLASTIC BLADES TO ELIMINATE SEALANT OF AVIATION

REFERENCE	1246 - N (orange)	1255 - A (yellow)	1267 - R (pink)
P/N	C - 6771 / 12mm	C - 6781 / 20 mm	C - 6791 / 40 mm
UNITS PER BOX	50	50	50

SCRAPERS SET TO REMOVE SEALANT OVERFLOW OR SILICONE

This set of scrapers eliminates sealants overflows or silicone in round and square format. It is accompanied by a sheet of sandpaper for sitting or sharpening.

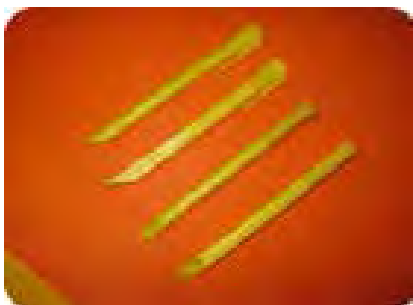

SCRAPERS SET TO REMOVE SEALANT OVERFLOW OR SILICONE

REFERENCE	1210 - RBS - I - I
P/N	C - 1030
UNITS PER BOX	100



POT FOR SEALANTS

JURBLAMI[®]S.L.



SPECIAL TRANSPARENT POT

Decorated in Offset, with a tight lid and sealed for the preparation of chemicals such as paints, sealants, resins, adhesives, liquid supplements, etc

Airtight and watertight pots, which can be introduced into microwave, and allow freezing. They are special to work chemicals for aviation. With the information and caution about working risk, hazard and safety for these chemicals.



TRANSPARENT POTS

REFERENCE	ST – 10050	ST – 10270	STP - 10280
P/N	4225	4157	4211
CAPACITY	115 ML	280 ML	520 ML

Thank you for trusting our brand, products and services, more and more companies put their trust in us. We hope to help improve the method of application of sealants for cleanliness and aesthetics.

From JURBLAMI we work thinking of you, of your satisfaction and that of their customers.



We are suppliers of:

AIRBUS GROUP
AIRBUS MILITARY
EADS CASA
OREXAD
CONSUR S. A

PINTURE INDUSTRIE EQUIPEMENT MATERIELS

CROMWELL GROUP HOLDINGS (INTERNACIONAL)

AIRTIFICIAL AEROSPACE OPERATIONS, S. A. U.

ACITURRI COMPOSISTEN

AERNNOVA

S.A.B.C.A.

AyA (Aeronáutica y Automoción)

PREMIUM AEROTEC

ITP INDUSTRIA DE TURBOPROPULSORES, S.A.

IBERIA. Líneas Aéreas de España

QANTAS

HERGAL, S. L. Tecnologías Aeronáuticas.

A&G Sevilla, S. L.

Titanea, Ensayos y Proyectos Industriales S. L. U.

ISS. Logistique & Producción

INESPASA

Cramer & mundt

CHEMENTAL

Torsesa Suministros Industriales

Embraer

FIGEAL AEREO

and others.

NOZZLES FOR ENCAPSULATED - SPATULAS - POTS - SCRAPERS - HEATERS



This document and all information contained herein is the exclusive property of JURBLAMI, SL. The furnishing of this document or the disclosure of its contents grants no intellectual property rights to its receptor. This document may not be used for any purpose other than the one for which it is given and can not be reproduced or disclosed to others without the express permission of JURBLAMI, SL.

The demonstrations expressed in this document do not constitute a commercial offer. They are based on the assumptions mentioned therein and have been made in good faith. For any clarification contact JURBLAMI, SL

www.jurblami.com

**Commercial management: Isabel Molina Marquina - isabel.molina@jurblami.com
Telf.: +34 913 033 444 - Mobile: +34 625 061 502**

**Commercial: Patricia Jurado Molina – patricia.jurado@jurblami.com
Mobile +34 646 135 396
Telf.: +34 913 854 518**

**Technical Advisor:: Miguel Jurado Blazquez - miguel.jurado@jurblami.com
Mobile: +34 625 402 896**

Registered office - C/ Cleopatra 6 Portal 1 -5º A - CP: 28018 Madrid

**Office - C/ Luis I, 17 1ºB Polígono Empresarial Villa de Vallecas.
CP: 28031 Madrid**