

*The Faster, Smarter, More Efficient*

# KIP 900 | COLOUR SERIES



**SYSTEM K  
SOFTWARE**

| KIP 970

| KIP 980

| KIP 990

*The Faster, Smarter, More Efficient*

# KIP 900 | COLOUR SERIES

**Faster** The most advanced high demand wide format colour print system, delivers consistent productivity.

**Smarter** Brilliant multi-tasking with KIP Smart multi-function touchscreen and KIP Image Pro software, which is intelligently integrated with all KIP Accessories.

**More Efficient** KIP 900 Series technology lowers operating costs.

## SIGNATURE FEATURES:

### *Productivity*

- Colour Printing - 535 m<sup>2</sup> per Hour
- Black & White Printing 670 m<sup>2</sup> per Hour
- KIP ImagePro

### *Design*

- 4 Roll with 725 m<sup>2</sup> Media Capacity
- High Capacity Toner Cartridges
- Professional Edge Alignment Stacking

### *Configurations*

- High Demand Dual Footprint Design
- Production or Convenience Scanning



*The cutting edge just got a lot sharper!*





# HIGH DEMAND CONSISTENT PRODUCTIVITY

Engineered to deliver:

- Superb Print Quality
- Reliable Performance
- Efficient Operation
- Remarkable Value

The KIP 900 Colour Series systems are designed for print centres that require high demand output, precise imaging and bold, expressive colour fidelity.

KIP 900 Colour Series systems produce amazingly vibrant colours, subtle tints and hues with unsurpassed colour stability from the first to final print.

All prints and copies generated by the KIP 900 Colour Series systems deliver the highest image durability and are fully lightfast; they will not fade or exhibit colour deterioration from exposure to light over extended periods. The CMYK dry toner system employed by the KIP 900 Colour Series produces 100% waterproof images that are suitable for outdoor applications, even in inclement weather.

The KIP 900 Colour Series systems are a comprehensive wide format solution for a range of printing tasks spanning from architectural, engineering and construction documents – to maps, posters and signs – without sacrificing quality or performance.

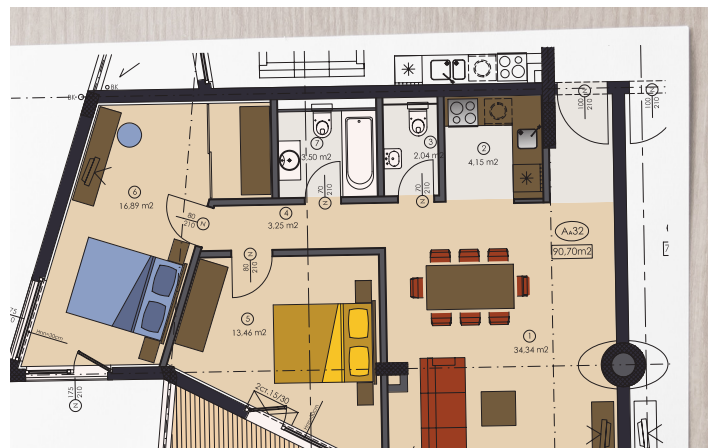
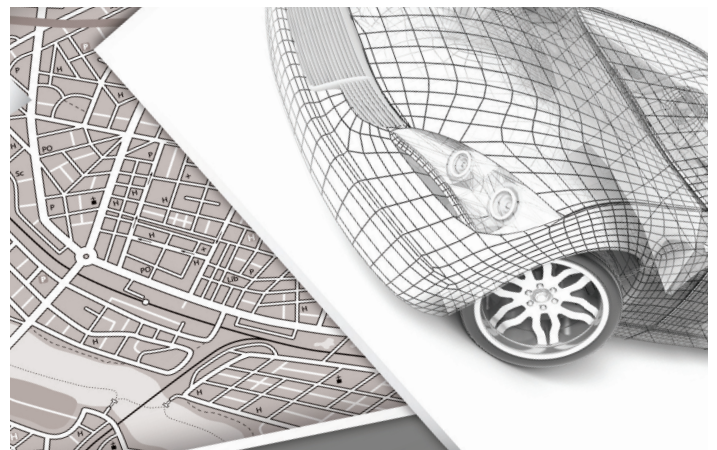
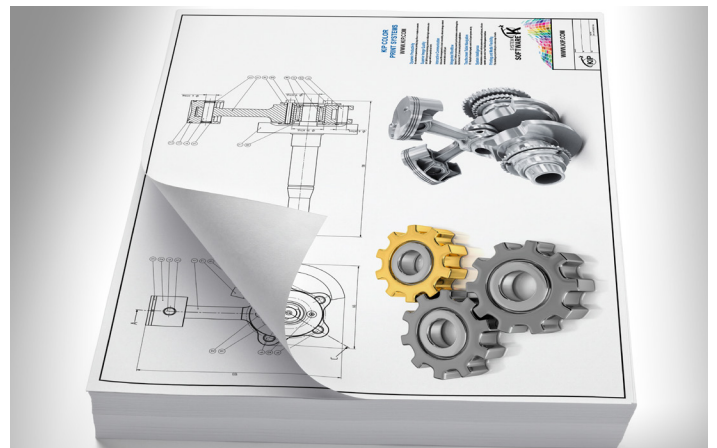



KIP 970



## KIP 970

*High demand multi-touch colour print system*

### *Transforms High Demand Print Efficiency*

- High demand network production print system
- 4 x 200 linear metres rolls
- 725 m<sup>2</sup> media capacity
- 670 m<sup>2</sup> per hour black & white productivity
- 535 m<sup>2</sup> per hour colour productivity
- High capacity toner cartridges
- 12" Smart System K multi-function touchscreen
- Professional edge alignment stacking
- KIP System K 2.0 with KIP ImagePro
- Robust build quality for maximum reliability

**HIGH DEMAND  
KIP 900 | COLOUR SERIES**



## KIP 980



## KIP 990



## KIP 980

*High demand colour multi-function system*

### *Intelligently Accelerates Productivity*

- High demand multifunction production print system with KIP 720 CIS convenience scanner
- 4 x 200 linear metres rolls
- 725 m<sup>2</sup> media capacity
- 670 m<sup>2</sup> per hour black & white productivity
- 535 m<sup>2</sup> per hour colour productivity
- High capacity toner cartridges
- 12" Smart System K multi-function touchscreen
- Professional edge alignment stacking
- KIP System K 2.0 with KIP ImagePro
- Robust build quality for maximum reliability

## KIP 990

*High demand colour multi-function system*

### *Brilliantly Advanced Multifunction Production Performance*

- High demand multifunction production print system with KIP 2300 CCD production scanner
- 4 x 200 linear metres rolls
- 725 m<sup>2</sup> media capacity
- 670 m<sup>2</sup> per hour black & white productivity
- 535 m<sup>2</sup> per hour colour productivity
- High capacity toner cartridges
- 12" Smart System K multi-function touchscreen
- Professional edge alignment stacking
- KIP System K 2.0 with KIP ImagePro
- Robust build quality for maximum reliability

# High Demand KIP 900 Colour Series

## TECHNOLOGY HIGHLIGHTS

### Consistent Productivity

- Single Pass Black
- Full Colour

### Professional Edge Alignment Stacker

### Enhanced Drivetrain Performance

### Page Accuracy

### Expanded Media Capacity

### High Capacity Toner Cartridges

### Permanent High Definition Print Head

### Quick Switch Technology

### KIP ImagePro Print Management Suite



### KIP ImagePro

KIP ImagePro is a single software solution designed to simplify every stage of colour and black & white wide format workflow.



### Consistent Productivity

High quality single pass black and full colour images at consistent print speed. The KIP 900 Series technology lowers operational costs. Print image is lightfast, waterproof and does not smear when using mark-up highlighters.

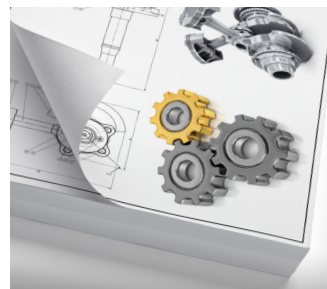

### Production Printing

The KIP 900 Colour Series print systems offer superb high quality resolution at remarkable consistent print speeds of up to 7,200 square feet or 670 m<sup>2</sup> per hour, in black & white or 5,760 square feet or 535 m<sup>2</sup> per hour, in colour.



### Professional Edge Alignment

Professional edge alignment stacking reduces post printing interaction.



### Quick Switch Technology

Mixed print size sets at full production speed. The KIP 900 Colour Series print technology eliminates roll switching delays for increased productivity.

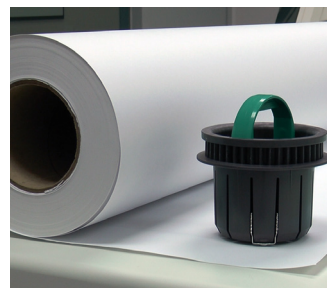

### Expanded Media Capacity

An ergonomic roll cap system simplifies the process of loading the 7,800 square foot / 725 m<sup>2</sup> media capacity.

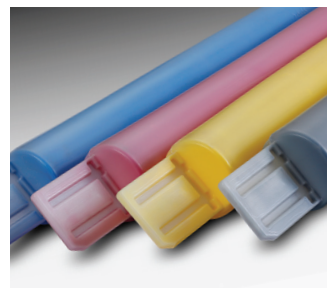

### Large Capacity Toner

Each CMYK cartridge contains 1,500 gms of toner for a total capacity of 6,000 gms - allowing longer uninterrupted colour and black & white print runs for continuous system productivity.



### Automatic Calibration

For colour images that compliment the highest standards, an exclusive single belt imaging system performs automatic calibrations for precise imaging and bold, expressive colour output.





PRINT



COPY



SCAN

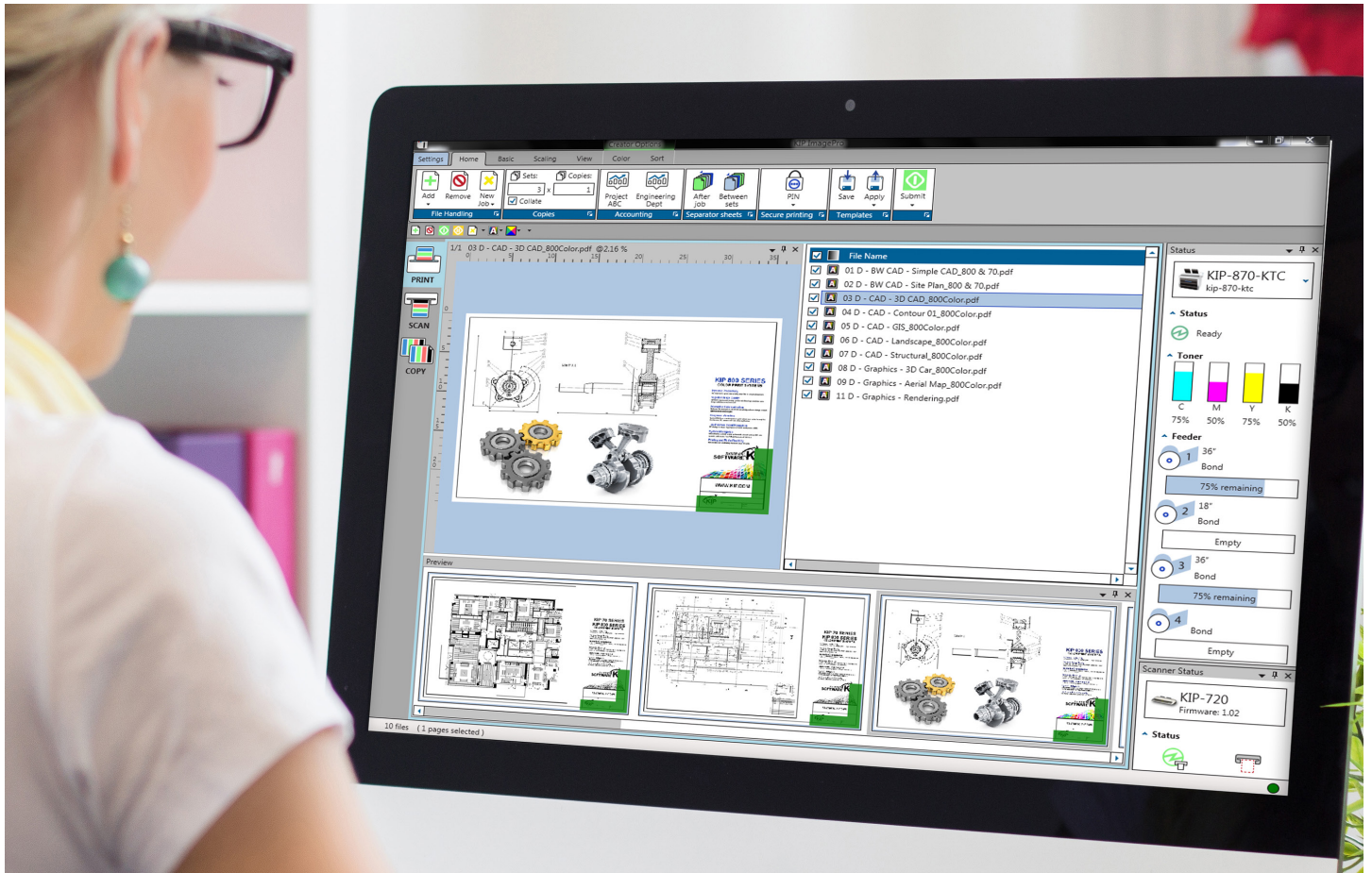

KIP ImagePro is a single software solution designed to simplify every stage of colour and black & white wide format workflow.

### STANDARD MODE

- Fast and Easy Print Control
- Quick Access Tool Bar
- Column Logic
- High Definition Viewer
- Image Clean Up
- Area of Interest

### EXPANDED MODE

Features for Technical Production and Colour Graphic Professionals:

- Colour Management
- Nest, 2 Up, Paneling
- Job Validation
- Customisable Interface Pop Out
- Flexibility in System Configurations

## KIP 70 Series



### KIP 70 and KIP Colour Series Multi-touch Solutions

- Copy & Scan to Local/USB/LAN/Cloud (MFP)
- Print from Local/USB/LAN/Cloud
- Super View with Area of Interest
- Cloud Connect
- Data Security
- Smart Scan
- KIPFold Control

#### OPTIONS:

- Removable HD
- Card Reader

MFP

Printer

## NETWORK

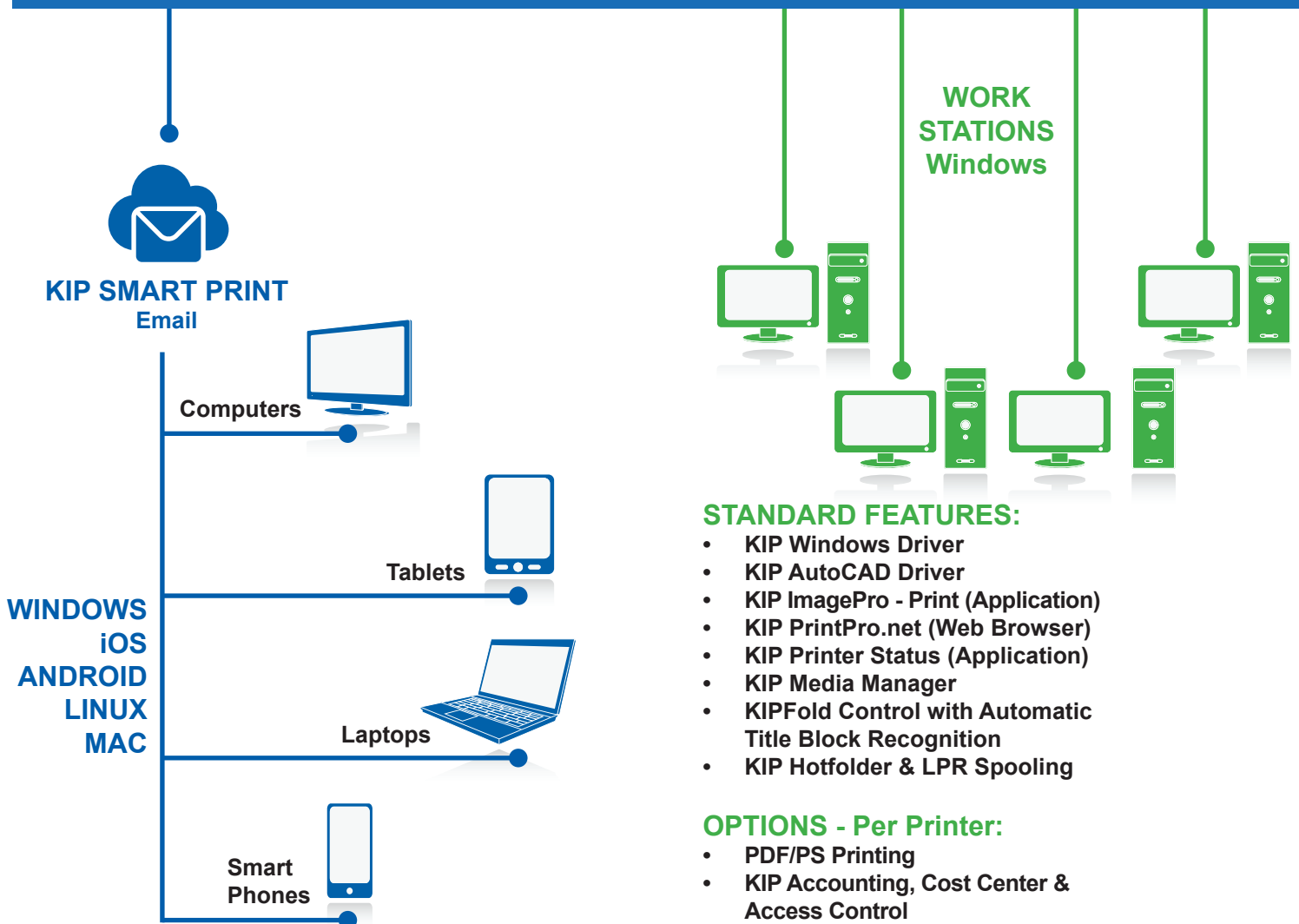

#### STANDARD FEATURES:

- KIP Windows Driver
- KIP AutoCAD Driver
- KIP ImagePro - Print (Application)
- KIP PrintPro.net (Web Browser)
- KIP Printer Status (Application)
- KIP Media Manager
- KIPFold Control with Automatic Title Block Recognition
- KIP Hotfolder & LPR Spooling

#### OPTIONS - Per Printer:

- PDF/PS Printing
- KIP Accounting, Cost Center & Access Control



# Systems Diagram

## KIP Colour Series



MFP  
Printer



MFP  
Printer

## KIP Scan Systems Scan, Copy & Print



### KIP ImagePro - Scan & Copy:

- Scan - Local/USB/LAN/Cloud
- Copy - To KIP Colour or B&W printer
- Print - To KIP Colour or B&W printer
- Colour Adjustment / Management
- High Definition Viewer
- Area of Interest
- KIPFold Control

### WORK STATIONS

#### MAC

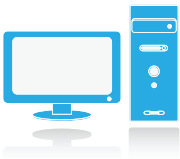

#### STANDARD FEATURES:

- KIP PrintPro.Net (Web Browser)
- PostScript Printer Description File
- KIP Hotfolder Support
- LPR Spooling

#### LINUX

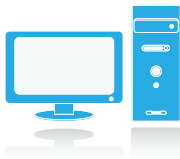

#### STANDARD FEATURES:

- KIP PrintPro.Net (Web Browser)
- KIP Hotfolder Support
- LPR Spooling

### KIP DIGITAL DATA SECURITY



#### STANDARD FEATURES:

- Image Overwrite
- Removable Hard Disk Drive Accessory Kit
- Standard Security Updates
- KIP Secure Print
- KIP Accounting Center Integration

Comprehensive KIP System K features are available in the following brochures:

- KIP Multi-touch Solutions
- KIP PC & Web Print Solutions
- KIP Admin, Accounting & Access Control

# KIP 900 Colour Series Specifications

4 Roll Colour and Black & White Printer	Colour and black & white printer with intelligent KIP System K touchscreen
4 Roll Colour and Black & White Print/Copy/STF	Colour and black & white printer with intelligent KIP System K touchscreen for Print/Copy and STF functions
System Scanners	KIP 980: KIP 720 CIS Scanner / KIP 990: KIP 2300 CCD Scanner
Scanner Stand	KIP 720 / KIP 2300 Scanner Stand (for the KIP 980-990 or optional for stand-alone scan applications)
Stacking Systems (standard)	KIP 900 Stacker
Finishing Systems (optional)	KIPFold 2800
Description	High production colour and black & white wide format print/copy/scan
Type	LED Array Electro photography with organic photoconductor (OPC drum) Contact Development using non magnetic mono-component toner
Configurations	Printer or multi-function system (print/copy/scan)
Speed	Up to 7,200 sq. ft (670 m <sup>2</sup> ) in single pass black or 5,760 sq. ft. (535 m <sup>2</sup> ) per hour in colour regardless of image type or print resolution
Warm Up Time	Instant from standby, less than 4 minutes from power on
Toner	Four colour (CMYK), dry toner, print images are UV resistant and waterproof
Input Power	North America: 2x 208-240VAC +6%/-10% 50/60Hz, 16 A EU/UK: 2x 220-240 V, 50/60 Hz, 16 A
Power Consumption	Printing 2.4 kWh (Average), Ready 630 W (Average), Sleep Mode 3.4 W
Acoustic Noise	< 65 db (printing), < 60 db (standby) (ISO 7779)
Ozone	< 0.05 ppm (average of 8 hours)
Dimensions	KIP 970 60" x 43" x 48" / 1500 x 1080 x 1220 mm (W x D x H) KIP 980 78" x 43" x 48" / 1970 x 1080 x 1220 mm (W x D x H) KIP 990 78" x 43" x 48" / 1970 x 1080 x 1220 mm (W x D x H)
Weight	1,212 lbs / 550 kgs NOTE: Weight of the optional scanner or stacker is not included

## Printer

Print Resolution	600 x 1,800 dpi
Paper Capacity	7,800 sq ft / 724 sq m ( 4 rolls + cut sheet )
Output Sizes Width (roll media)	11" - 36" / 297 mm - 914 mm (3" Core)
Output Sizes Length (roll media)	8.5" / 210 mm minimum, 210' / 64 m maximum (actual length may be dependent on media type and file type limitations)
Paper Weight (roll media)	See KIP Media Guide
Sheet Bypass	Up to 40 lbs. / 150 gsm bond   Maximum sheet size 36" / 914 mm x manageable length   Minimum sheet size 11" x 17" / A3
Media Types	See KIP Media Guide

## Scanner / Copier

Resolution	600 dpi (optical)
Original	Single Sheet, image viewable/face up
Widths	8.5" - 36" / 210 mm - 914 mm (international standard page sizes to include ANSI, ARCH, ISO A & B, CHN, JPN)
Length	8.5" - 19.7' / 210 mm - 6 m

Please see the KIP 2300 Production CCD Scanner and KIP 720 CIS Convenience Scanner documentation for additional specification details.

## Controller

Controller Type	System K Embedded, Microsoft® IoT Enterprise
Memory	16 GB (min)
Solid State Drive	Minimum 256 GB (Upgradable)
Compatible File Formats	Raster Colour: TIFF, JPG, JPG2000, PNG, BMP, GIF, TGA, RLE/RLC Vector Colour/B&W: HPGL, HPGL/2, HP-RTL, Postscript (PS/EPS), PDF, Autodesk DWF, Multipage PDF & DWF Raster B&W: TIFF Group 3 & 4, CALS Group 4, Grayscale TIFF Vector B&W: Calcomp 906/907

## Space, Electrical & Environmental Requirements

Total Space (minimum)	132" x 182" / 3350 mm x 4610 mm ( W x D ) (KIP 900 Series with stacker)  The flexibility of the KIP 980 / 990 system permits the scanner to be placed perpendicular or parallel to the KIP printer for individual workflows which can result in special requirements that may differ than noted above.
Electrical Requirements	KIP 970 = Dual 208 V - 240 V 50/60 Hz, 16 A KIP 980 / 990 = North America - the above, plus one 110 V - 120 V 50/60 Hz, 6 A or higher (for KIP scanner) EU & UK - three 220V - 240V 50/60 Hz 16A (for printer and scanner)
Electrical Receptacle	North America = two NEMA 6-20 R (plus one NEMA 5-20 R for the KIP 980 / 990) Europe = CEE 7 (x3 for KIP 980 / 990) UK = BS 546 (x3 for KIP 980 / 990) All other regions = please refer to your local standards
Network Port	RJ-45 port-CAT5 or higher. LAN rated at least at 100 mb. Recommended is 1000 mb
Room Temperature	50-86 °F / 10-30 °C
Humidity	15-80% RH
Site Survey	KIP 900 Series site survey documentation is to be completed prior to system installation
Min. Door Width	32" / 813 mm

# KIP 900 Colour Series Accessories

---

## Stacker

---

The KIP 900 Colour Series professional edge alignment stacker reduces post printing interaction, improving the efficiency and workflow. Neatly stacks a multitude of various page sizes. Unattended print runs can be scheduled with peace of mind.



## KIPFold 2800

---

The KIPFold 2800 system automates wide format document folding requirements by providing folding, stacking and collation in a compact design. KIP online folders intelligently communicate with KIP printers and are fully integrated with KIP software applications & print drivers to provide seamless workflow integration.

*Optional for KIP 970, 980, 990*

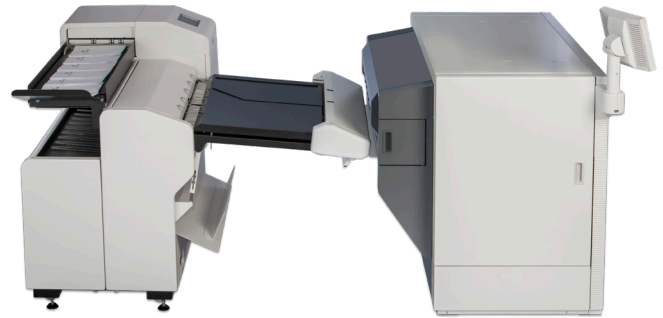

## Copying & Scanning

---

The KIP 900 Colour Series delivers efficient, high speed hard copy reproduction workflow. Exceptional image quality is achieved through true 600 x 600 dpi optical resolution via a choice of integrated KIP scanners, with advanced optics and delicate original transport processes for pixel-perfect images.

*KIP 720 scanner included with KIP 980*

*KIP 2300 scanner included with KIP 990*



# THE COLOUR OF KIP IS GREEN.

KIP is committed to product designs that promote environmental health and sustainability. KIP's goal is to consistently improve and refine the technologies in products that keep our planet green. KIP considers the total product life cycle - from the manufacturing process to final device disposal - in our shared ecosystems.

## LOW EMISSIONS – HIGH EFFICIENCY

- KIP products all have a variety of sleep modes and power usage timers to reduce power consumption. All KIP systems are Energy Star qualified.
- During operation, the power consumption of KIP products are one of the lowest in the industry, thanks to efficiency in design.
- KIP's manufacturing processes have reduced electricity consumption by 33%, all while increasing productivity.



[KIP.COM/GREEN](https://www.kip.com/green) | FOR MORE INFORMATION

[WWW.KIP.COM](https://www.kip.com)

KIP is a registered trademark of the KIP Group. All other product names mentioned herein are trademarks of their respective companies. All product features and specifications are subject to change without notice. Complete product specifications are available at [www.kip.com](https://www.kip.com). © 2020

V06/30/21\_EU

