



iB

INSPIRED
BLINDS™

2018

Budget
Blinds



ENJOY THE LOOK AND FEEL OF FABRIC WITH THE FUNCTIONALITY OF STANDARD BLINDS.

SOUND DAMPENING UV LIGHT BLOCKAGE

Fabric blinds provide effective sound dampening features, light filtration, and UV blockage.



MADE OF DURABLE POLYESTER FABRIC WITH A FINISHING COAT THAT REPELS DUST AND LIQUIDS, IDEAL FOR HIGH HUMIDITY AREAS.

FLAME RETARDANT

Our blind's flame retardant performance is recognized by the National Fire Protection Association (*NFPA*), and no harmful chemicals are released while burning.



WITHOUT LIGHT REFLECTION, SUNLIGHT FILTERS THROUGH THE BLINDS AND BRIGHTENS THE ROOM WITH A SOFT GLOW.

TABLE OF CONTENTS

| | |
|--|----|
| ORDERING INSTRUCTIONS | 1 |
| TERMS & CONDITIONS | 2 |
| PRODUCTS | |
| • CORDLESS BLINDS: PRODUCT DETAIL | 3 |
| • E-Z LIFT BLINDS: PRODUCT DETAIL | 4 |
| • CORDLESS / E-Z LIFT BLINDS: OPTIONS | 5 |
| • ROUTLESS BLIND: PRODUCT DETAIL | 6 |
| • STANDARD BLIND: PRODUCT DETAIL | 7 |
| • ROUTLESS / STANDARD BLIND: OPTIONS | 8 |
| ADDITIONAL FEATURES | 9 |
| MOTORIZED WAND / REMOTE | 10 |
| MEASURING | 11 |
| SLAT COUNT CHART | 15 |
| COLOR COORDINATION CHART | 16 |
| AVAILABLE COLORS SIGNATURE FABRICS | 17 |
| • WESTMINSTER AND DOVER VALANCE COLORS | 19 |
| PRICE CHARTS | 20 |
| WARRANTY | 24 |

Ordering

Email or Website

For accuracy, place orders through LantexUSA.com or email CustomerService@LantexUSA.com.

Cancellations and Changes

All blinds are custom made and cannot be canceled. There will be a service charge for changes or cancellations made after the products are cut.

How to Order

The total retail price for Budget Blinds is determined by the following information:

- Style & color selection
- The size of the blind ordered
- Options requested

Size of Blind

Pricing options can be found on pages 20-23.

Request Options

Information for available options and surcharges, located on pages 5 and 8.

EZ Lift Slat & Tape Color Selection

Each style uses a separate color number located in the color coordination chart, page 16.

Returns

Because our blinds are custom made, in order to return a blind for any reason, you must obtain a Return Goods Authorization. To obtain authorization for a return, please contact CustomerService@LantexUSA.com or [1.844.516.0996](tel:1.844.516.0996). We are not responsible for any returns without the RGA #.

Important Ordering Information

In addition to the correct price chart, all orders must include the following information:

- Accurate measurements for the width and height (To the nearest 1/8")
- Style, color name, and color number
- Any requested options
- Position of controls, left or right side

Type of mounting required:

- Inside Mount (IB)
- Outside Mount (OB)

Pricing Examples

| Height Up To | Width Up To | | | | | |
|-----------------|-------------|-----|-----|-----|-----|-----|
| | 24" | 32" | 36" | 42" | 48" | 54" |
| 36" | 129 | 152 | 178 | 194 | 208 | 243 |
| 42" | 144 | 167 | 196 | 214 | 233 | 273 |
| 48" | 155 | 184 | 213 | 235 | 255 | 301 |
| 54" | 170 | 201 | 232 | 259 | 281 | 330 |
| 60" | 186 | 216 | 251 | 278 | 306 | 361 |
| 66" | 202 | 236 | 270 | 301 | 339 | 397 |
| 72" | 223 | 251 | 288 | 324 | 368 | 431 |
| 78" | 230 | 259 | 297 | 334 | 378 | 440 |
| 84" | 246 | 276 | 316 | 357 | 405 | 467 |

General Information

Credit Terms

Please fill out our credit application form on LantexUSA.com and submit via website or email to CustomerService@LantexUSA.com.

Credit Approval Terms

- Please allow up to 5-10 business days for credit approval.

Dye Lots

All materials are subject to dye lot variations. We will not assume responsibility for any complication resulting from color match unless a swatch has been sent for approval.

Protect Your Children

Be aware that it is possible for children to become entangled in window cords. To reduce the risk of accidents, all cords must be kept out of reach of children. The use of a Child Safety Device is encouraged to keep children and pets safe.

Shipping / Freight

- Lantex USA currently ships FedEx and UPS to the US, Canada, and Mexico.

FROST 20601J897



2" & 2.5" CORDLESS BLINDS

INSPIRED BLINDS 2018

Product Detail

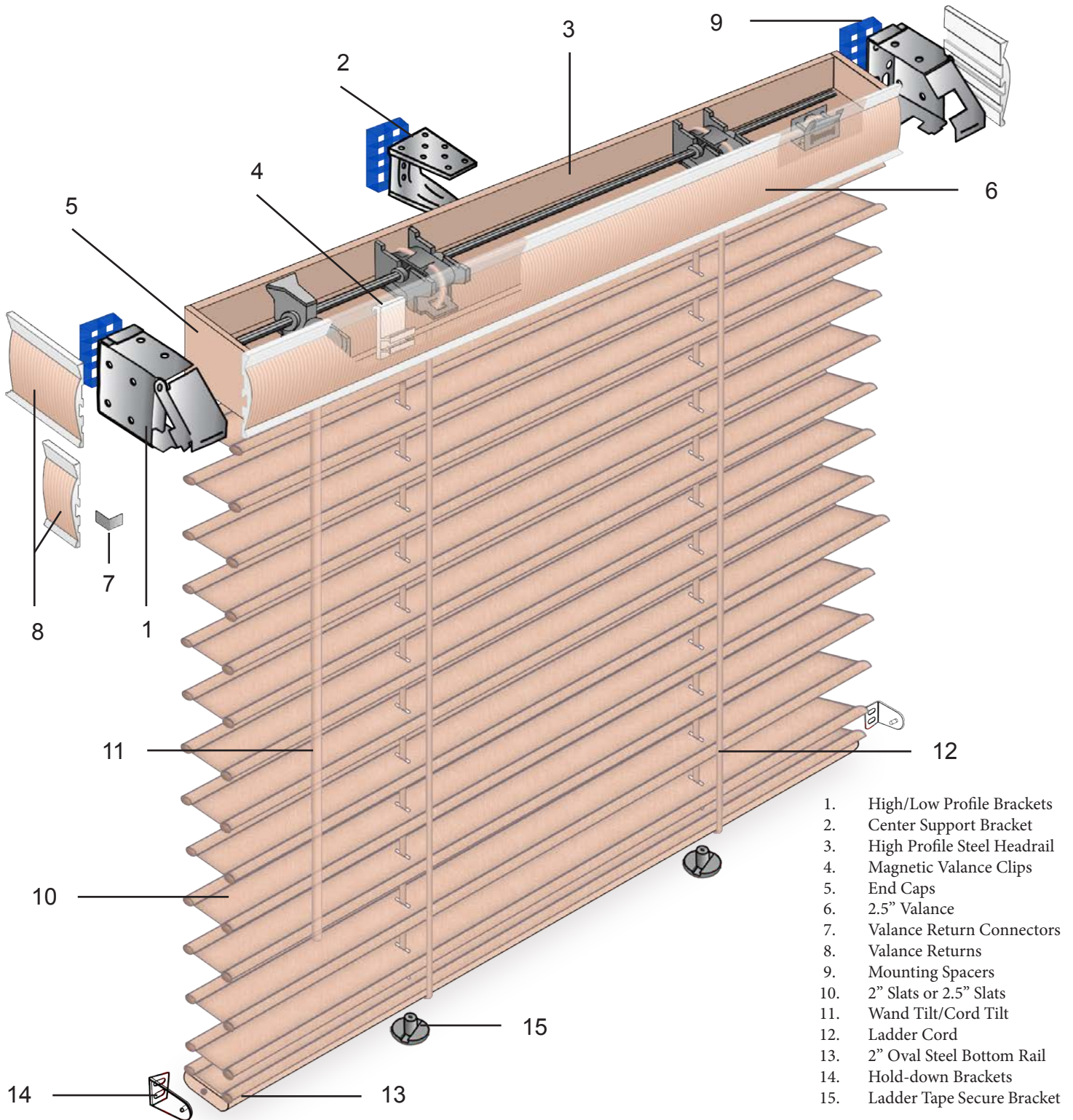

2" & 2.5" E-Z LIFT BLINDS

INSPIRED BLINDS 2018

Product Detail

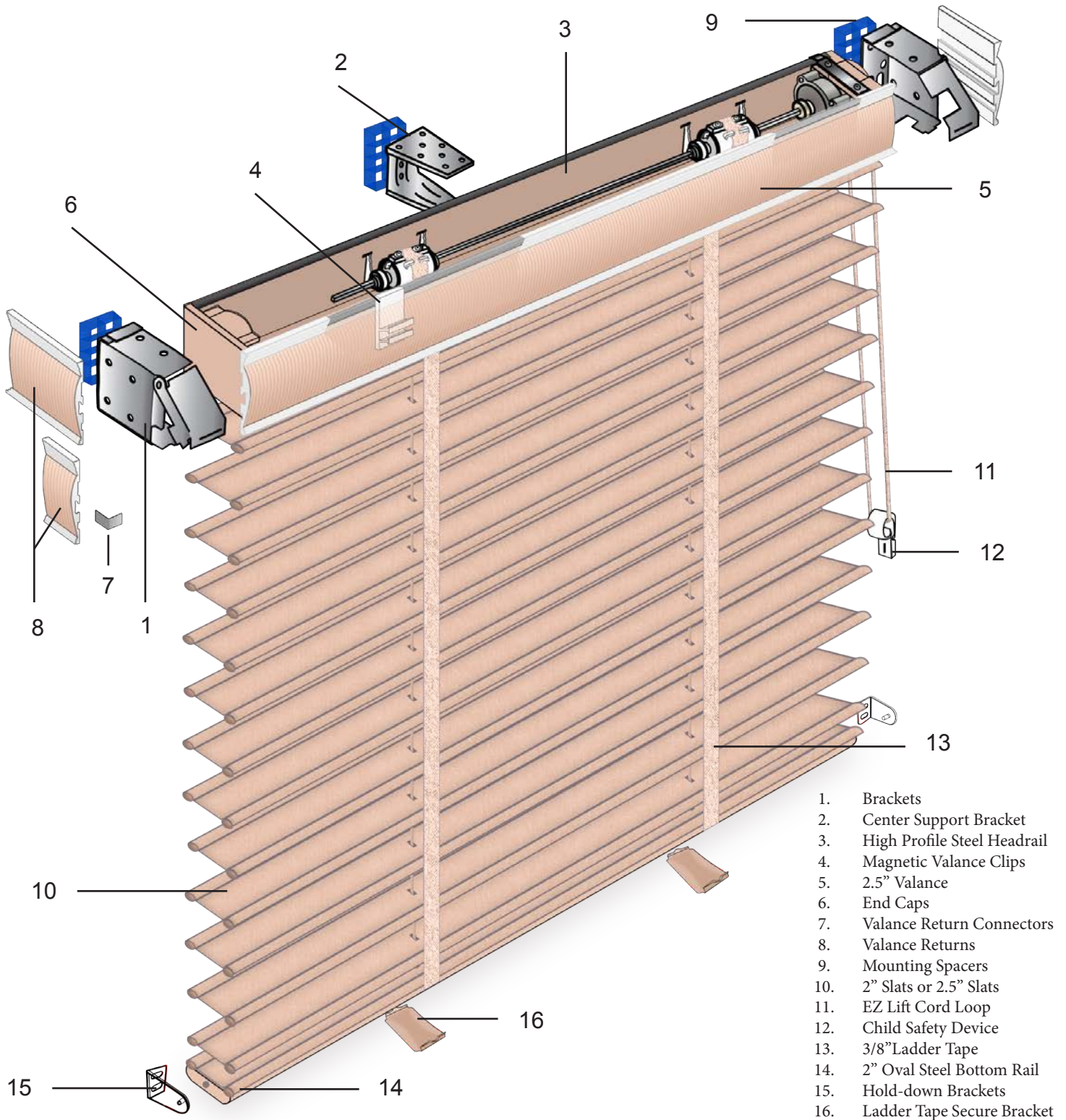

1. Brackets
2. Center Support Bracket
3. High Profile Steel Headrail
4. Magnetic Valance Clips
5. 2.5" Valance
6. End Caps
7. Valance Return Connectors
8. Valance Returns
9. Mounting Spacers
10. 2" Slats or 2.5" Slats
11. EZ Lift Cord Loop
12. Child Safety Device
13. 3/8" Ladder Tape
14. 2" Oval Steel Bottom Rail
15. Hold-down Brackets
16. Ladder Tape Secure Bracket

Options

| Specifications: | Options: |
|------------------------|----------------------------------|
| CORDLESS | |
| Headrail Dimensions | 2" W x 2"H |
| Bottom Rail Dimensions | 2" Oval |
| Valance Styles | 2½" Valance with Fabric Insert |
| Valance Returns | Available by Request - No Charge |
| IB Mount Depth | 1" Minimal |
| EZ LIFT | |
| Headrail Dimensions | 2" W x 2"H |
| Bottom Rail Dimensions | 2" Oval |
| Valance Styles | 2½" Valance with Fabric Insert |
| Valance Returns | Available by Request - No Charge |
| IB Mount Depth | 1" Minimal |
| Tape Slat Spacing | 1.73" |

| Horizontal Stacking Chart | | |
|---------------------------|-----------------------|-------------------------|
| Blind Height | 2" Blind Stack Height | 2.5" Blind Stack Height |
| 24" | 3.99" | 3.71" |
| 36" | 4.66" | 4.28" |
| 48" | 5.33" | 4.85" |
| 60" | 6.00" | 5.42" |
| 72" | 6.76" | 6.00" |
| 84" | 7.43" | 6.57" |
| 96" | 8.10" | 7.05" |
| 108" | 8.86" | 7.62" |
| 120" | 9.53" | 8.19" |

INCLUDING HEADRAIL AND BOTTOM RAIL

| Optional Surcharge | | NET CHARGE |
|-----------------------------------|-----------------------|------------|
| Multiple Blinds on One Headrail | 2 Blinds Per Headrail | \$25.00 |
| Blind Cut Outs | Side Cuts | \$15.00 |
| Blinds Under 15" In Width | | \$15.00 |
| Striping or Multi Slats Per Blind | Each Color Added | \$25.00 |

| Replacement Parts | NET CHARGE | Replacement Parts | NET CHARGE |
|------------------------|--------------------|---------------------|-------------------|
| 2" Brackets | \$10.00 - Per Pair | Hold Down Brackets | \$4.00 - Each |
| Center Support Bracket | \$3.00 - Each | Space Blocks | \$3.00 - Each |
| Cord Tensioner | \$7.20 - Each | Valance Clips | \$3.00 - Each |
| Screws Per Pack of 4 | \$3.00 - Each | Restraining Kit | \$20.00 - Each |
| Dover Valance | \$3.00 - Per Foot | Westminster Valance | \$6.00 - Per Foot |

When Ordering Multi-Color or Striping Blinds, Please Specify:

- Colors for the headrail and bottom rail.
- Numbers of colors required.
- Total number of slats required for each color.
- Slat colors counting from top until the bottom.
- Colors for the ladder and cords.
- Colors for the valance insert.

NOTE: The headrail, bottom rail, and bracket color may not match to the slat's materials 100%.

Product Detail

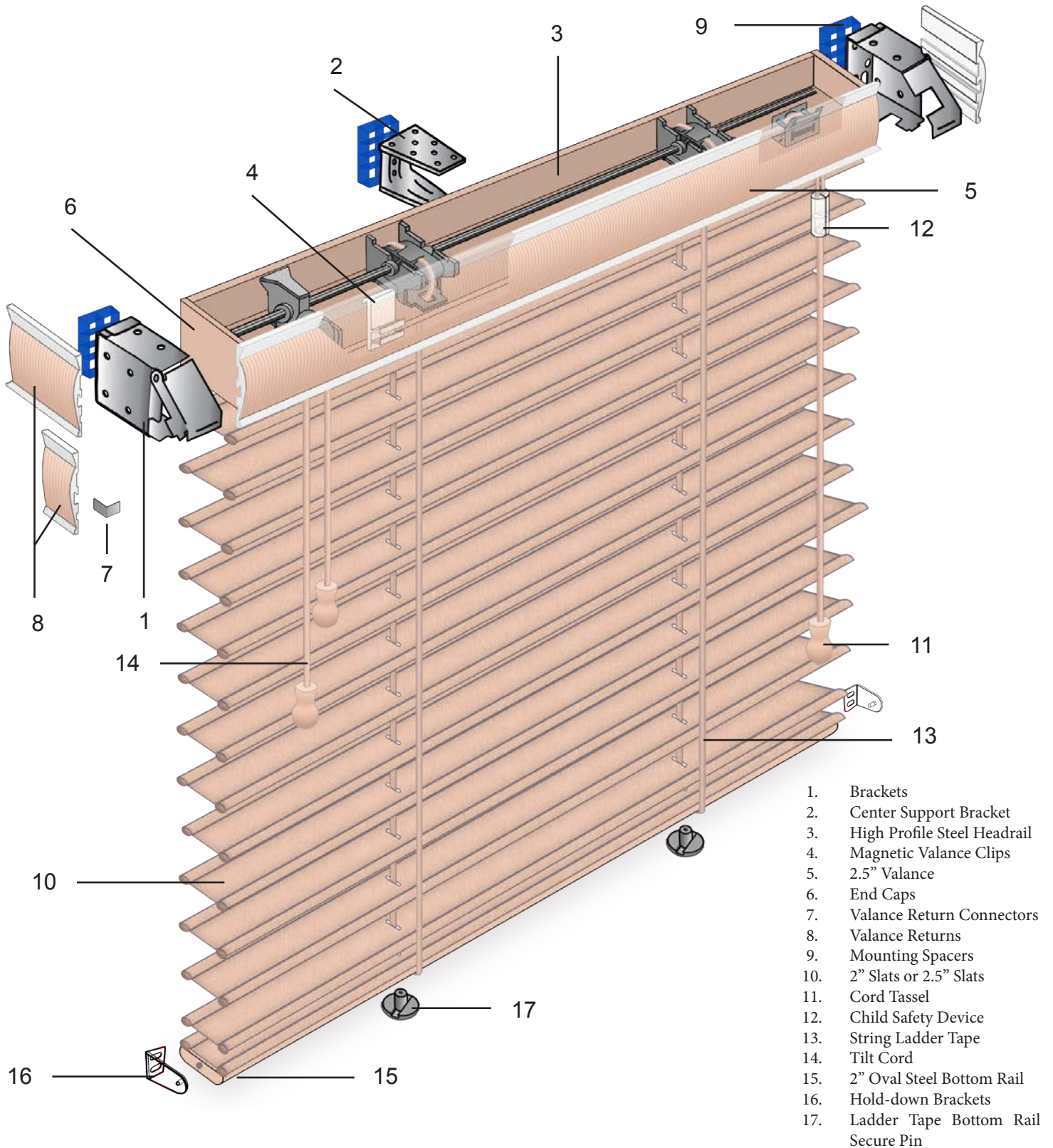

Options

| Specifications: | Options: |
|------------------------|----------------------------------|
| ROUTLESS | |
| Headrail Dimensions | 2" W x 2"H |
| Bottom Rail Dimensions | 2" Oval |
| Valance Styles | 2½" Valance with Fabric Insert |
| Valance Returns | Available by Request - No Charge |
| IB Mount Depth | 1" Minimal |
| STANDARDS | |
| Headrail Dimensions | 2" W x 2"H |
| Bottom Rail Dimensions | 2" Oval |
| Valance Styles | 2½" Valance with Fabric Insert |
| Valance Returns | Available by Request - No Charge |
| IB Mount Depth | 1" Minimal |

| Horizontal Stacking Chart | |
|---------------------------|-----------------------|
| Blind Height | 2" Blind Stack Height |
| 24" | 3.99" |
| 36" | 4.66" |
| 48" | 5.33" |
| 60" | 6.00" |
| 72" | 6.76" |
| 84" | 7.43" |
| 96" | 8.10" |
| 108" | 8.86" |
| 120" | 9.53" |

INCLUDING HEADRAIL AND BOTTOM RAIL

| Optional Surcharge | | NET CHARGE |
|-----------------------------------|-----------------------|------------|
| Multiple Blinds on One Headrail | 2 Blinds Per Headrail | \$25.00 |
| Blind Cut Outs | Side Cuts | \$15.00 |
| Blinds Under 15" In Width | | \$15.00 |
| Striping or Multi Slats Per Blind | Each Color Added | \$25.00 |

| Replacement Parts | NET CHARGE | Replacement Parts | NET CHARGE |
|------------------------|--------------------|---------------------|-------------------|
| 2" Brackets | \$10.00 - Per Pair | Hold Down Brackets | \$4.00 - Each |
| Center Support Bracket | \$3.00 - Each | Space Blocks | \$3.00 - Each |
| Cord Tensioner | \$7.20 - Each | Valance Clips | \$3.00 - Each |
| Screws Per Pack of 4 | \$3.00 - Each | Restraining Kit | \$20.00 - Each |
| Dover Valance | \$3.00 - Per Foot | Westminster Valance | \$6.00 - Per Foot |

When Ordering Multi-Color or Striping Blinds, Please Specify:

1. Colors for the headrail and bottom rail.
2. Numbers of colors required.
3. Total number of slats required for each color.
4. Slat colors counting from top until the bottom.
5. Colors for the ladder and cords.
6. Colors for the valance insert.

NOTE: The headrail, bottom rail, and bracket color may not match to the slat's materials 100%.

2" & 2.5" E-Z Lift Blind Features

- New color palette and patterns
- New 3/8" designer cloth tape selection
- New 2 1/2" valance and safety cord tassel additions
- High profile headrail
- Continuous cord loop

2" & 2.5" Cordless Blind Features

- New color palette and patterns
- New 2 1/2" valance
- High profile headrail
- Tilt Wand or Tilt Cord

2" Routless Blind Features

- New color palette and patterns
- New 2 1/2" valance
- High/Low profile headrail
- Regular pull cord & cord tilt
- Safety Breakaway Tassel

2" Standard Blind Features

- New color palette and patterns
- New 2 1/2" valance
- High/Low profile headrail
- Regular pull cord & cord tilt
- Safety Breakaway Tassel

Size Considerations for all Blinds

| | |
|--|--------------------------------------|
| Minimum Blind Width | |
| Cordless | 14" Outside Mount / 14" Inside Mount |
| EZ Lift | 9" Outside Mount / 9" Inside Mount |
| Routless / Standard | 12" Outside Mount / 12" Inside Mount |
| Maximum Single Blind Width | 120" |
| Maximum Width: Multiple Blinds on One Headrail | 120" |
| Minimum Blind Height | 11" |
| Maximum Blind Height | 120" |

MOTORIZED WAND / REMOTE



TECHNOLOGY THAT ENHANCES YOUR LIVING SPACE

RECHARGABLE MOTORIZED / CONTROL WAND

- Easy installation with no hot wiring
- Long Lasting Lithium Ion Battery
- Simple UP / DOWN / STOP Control Buttons
- Micro USB for charging



REMOTE - ADDITIVE OPTION

- Radio Remote
- Control your Blind with this single channel remote from up to 100 feet between 2 walls. Optional 15 Channel remote available
- Remote attaches to backplate via magnets, just attach backplate in a convenient place
- No Cords mean this is the best product for Child and Pet Safety
- Modern and Sleek Design fits all types of decor

Standard Rectangular Windows

Inside Mount (IB)

Measure exact width A and length B of the window opening as shown. The factory will deduct the necessary allowance off of the shade for clearance. Please mark (IB) as the inside mount. On all inside mounts, a small light gap may appear.

1. IB Mount with IB Valance
2. IB Mount with OB Valance

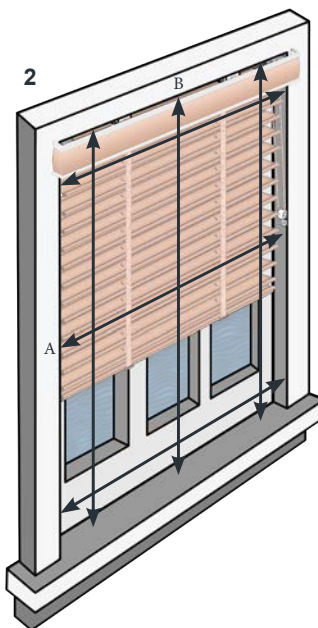
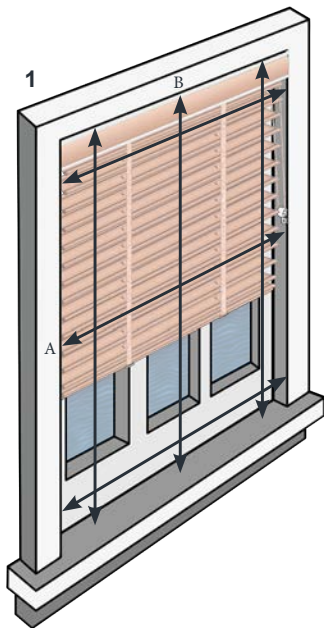

Outside Mount (OB)

Measure exact width A and length B of the window opening you wish to cover. The shade should cover the window opening by at least 2 inches on both the width and length or to cover the sill C. Please mark (OB) as the outside mount.

3. OB Mount with OB Valance

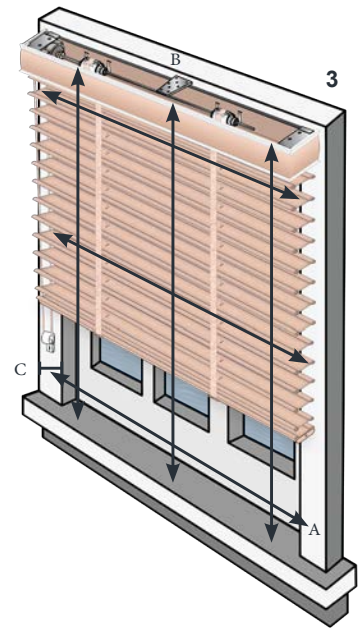

A valance is supplied with your order in one of the following styles, depending on how your blind will be mounted. For a more custom look, the valance and returns may be special ordered to your measurements.

NOTE: Valances with returns are measured and cut from the INSIDE of the miter to ensure the most accurate fit when installed over the headrail or window frame.

Blinds ordered as an OUTSIDE MOUNT will be supplied with returns sized to cover the end of the blind back to the mounting surface. If projection brackets are requested when the blind is ordered, longer returns will be sent automatically. Outside mount blinds are available without returns upon request.

Top View - Outside Mount

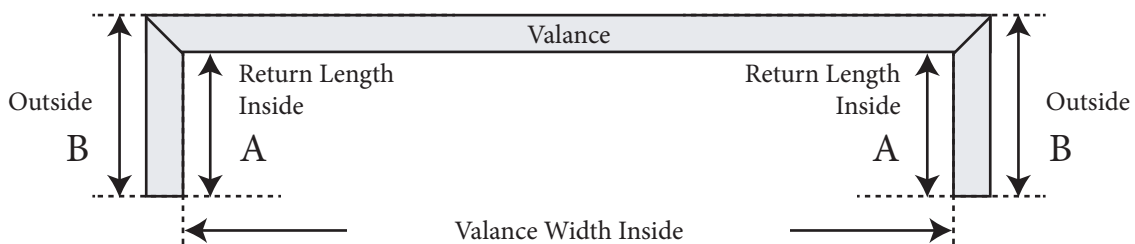

Valance Return Measuring and Ordering

Blind Ordered as an **OUTSIDE MOUNT** with returns

A: Inside Return Measurements - 2 ¾" Standard

B: Outside Return Measurements - Include return measurement + ½" = 3 ¼"

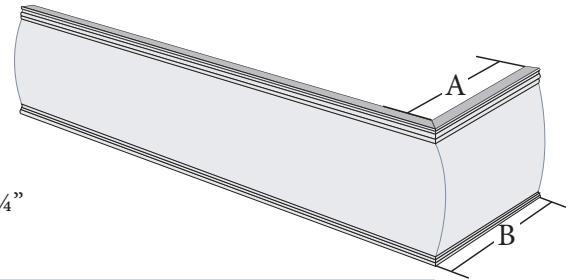

Blind Ordered as an **INSIDE MOUNT** with **OB Valance** will be supplied with ½" returns with cord tilt, ¾" returns with Wand tilt or 2.5" slat sizes.

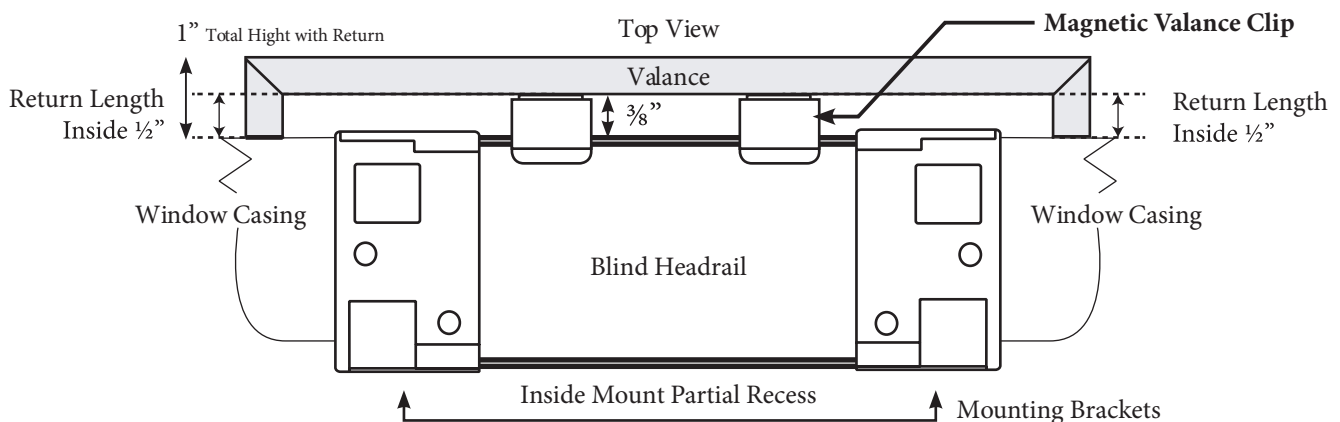

Ordering Information:

Please state at the time of order if the valance and return measurement are for the **EXACT** size required so that no additions or deductions are made.

Different return sizes can be ordered for the same valance. Always provide **LEFT** return **INSIDE** measurements first when ordering.

- **Valance Returns** will have an adhesive strip to ensure a flush seam with the headrail Valance. All standard valance returns come with an "L" clip to support and hold a 90° angle of the Valance Return.
- **Bay and Corner Blind** – must specify return length on inside mount at the time of order.

Valance and Return Specifications

Custom Valance Widths are available upon request. Maximum widths for valance are as follows:

- The maximum continuous width is 110"
- Valance Width greater than 110" will be spliced into 2 sections.

Custom Return Lengths are available upon request.

- The minimum return length is ½"
- The maximum return length is 6"
- Add ½" to the valance for a comfortable fit

- 3 ¼" Return Lengths** are factory adjusted when extension brackets or (1 set of) spacer blocks are ordered.
- Short Extension Brackets = 4 ½"
 - Small Spacer Blocks (1st Set) = 3 ¼"
 - Long Extension Brackets = 6 ½"
 - Large Spacer Blocks (1st Set) = 3 ¼"

NOTE: Valances are cut to measure from the **inside** miter to ensure the most accurate fit when installed over the headrail or window frame.

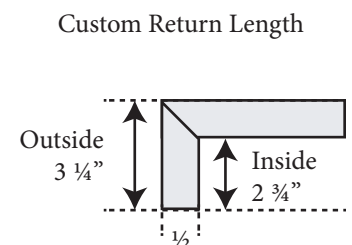
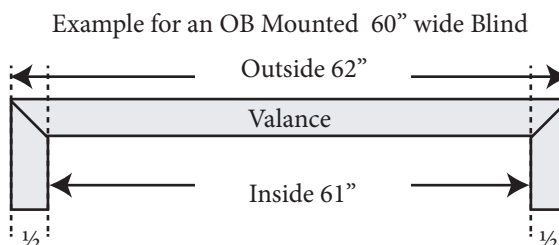

Multiple Blinds on One Headrail

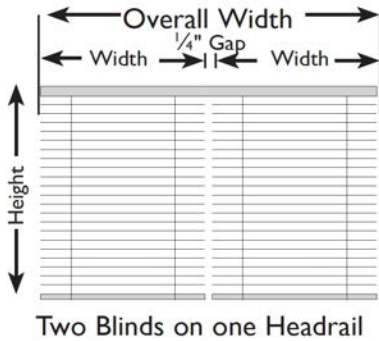

Two or more blinds can be installed on a single headrail to provide a practical treatment for larger windows or sliding patio doors.

Options: Standard Controls

| | | |
|-----------------------------|-------------|----------------------|
| 2 Blinds on One Headrail | Left Panel | Controls Left Blind |
| | Right Panel | Controls Right Blind |

Measuring:

1. Measure overall width of the area to be covered. If space permits, an overlap of 1/2" per side is recommended for outside mounts.
2. Measure the width of the area each blind is to cover. Measure and specify the left blind first, continuing to the right. Allow a minimum of 1/4" between blinds for operating clearance.
3. Total width of all blinds, plus clearance(s) must equal overall width.
4. Measure height as follows:
 - a. For windows, use standard inside or outside measuring procedures.
 - b. For patio doors, measure height within 3/4" of floor, either from ceiling or a point at least 6 1/2" above the door frame.

Ordering:

1. Indicate the quantity of blinds that are to be mounted on one headrail.
2. Specify the total width of the headrail.
3. Indicate each panel width separately, specify left blind first, continuing to the right.
4. Specify control positions, if other than standard.
5. Add applicable surcharge.

Cut Out Blinds

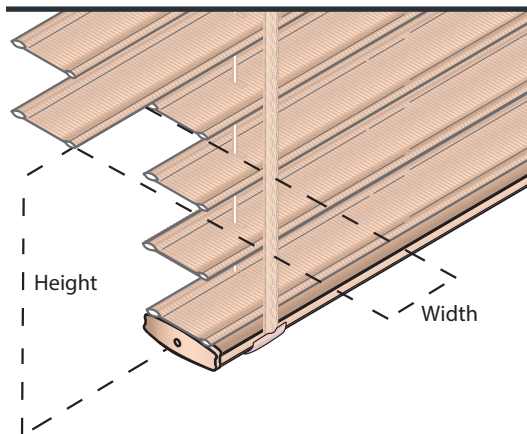

Additional charge

- Maximum cut-out is 1" before route hole or notch (corner and side cut-outs only).
- Cut-outs are measured with the slats tilted in the closed position for maximum clearance.
- The cut-out height may be larger than requested due to slat placement.
- Measure height from the bottom of the blind up to the desired location.

Bay and Corner Windows

- Corner blinds and bay window blinds are used to butt two or more blinds together in a corner or bay window.
- Each blind is on an individual headrail.
- Price each as a standard blind, no additional surcharge. For more than three windows, contact customer service for assistance.

- Control locations can be on the right or left side of each blind; placing controls opposite the corner is recommended.
- Depending on the angle, some corner blinds cannot be raised to the same height.
- Valances will be mitered in the corner for a finished look.
- Horizontal slat alignment between blinds cannot be guaranteed.
- Manufacturer will take appropriate deductions for corner or bay applications.

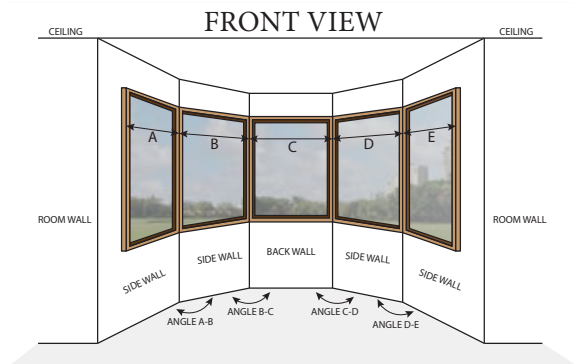
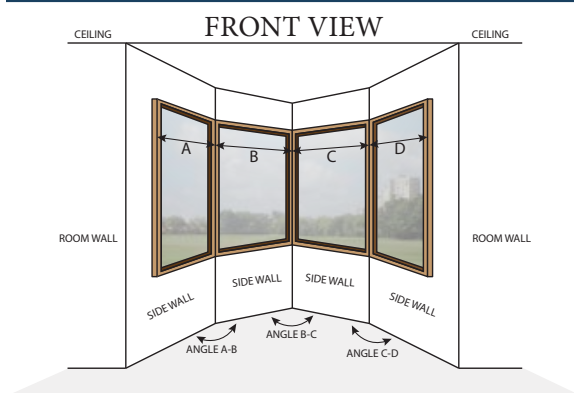
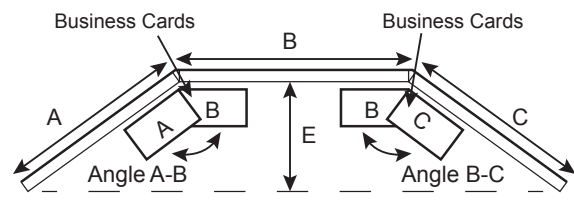
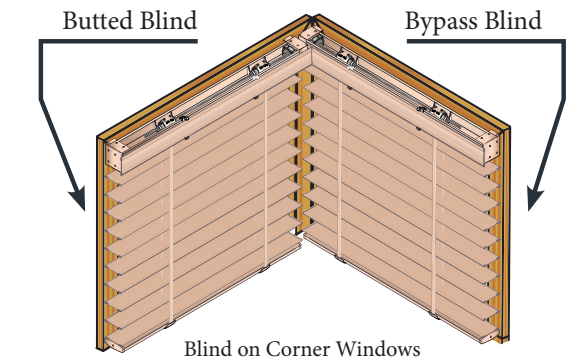

Measuring Information

Corner Window

Measure: Width of each window from corner to the point you would like to cover.

Three-sided Bay Window

Measure:

A&C: Width of side windows from the corners to the point you would like the blind to cover.

B: Width of the center window from corner to corner.

Angle A-B: Angle between windows (A) and (B).

Angle B-C: Angle between windows (B) and (C).

D: Depth from the center of the baseline to the back center window.

NOTE: Measure bay angle using protractor or angle finder, or use two business cards in bay corner as illustrated.

Four-sided Bay Window

Measure:

A & D: Width of side windows from the corners to the point you would like the blind to cover.

B & C: Width of each window from corner to corner.

Angle A-B: Angle between windows (A) and (B).

Angle B-C: Angle between windows (B) and (C).

Angle C-D: Angle between windows (C) and (D).

Five-sided Bay Window

Measure:

A & E: Width of side windows from the corners to the point you would like the blind to cover.

B, C & D: Width of each center window from corner to corner.

Angle A-B: Angle between windows (A) and (B).

Angle B-C: Angle between windows (B) and (C).

Angle C-D: Angle between windows (C) and (D).

Angle D-E: Angle between windows (D) and (E).

SLAT COUNT CHART

INSPIRED BLINDS 2018

Note: Finished blind height includes headrail and bottom rail.

| Blind Height | Slat Count | | Stack Height | |
|--------------|------------|------|--------------|------|
| | 2" | 2.5" | 2" | 2.5" |
| 10" | 6 | 4 | | |
| 11" | 6 | 4 | | |
| 12" | 7 | 5 | 3.32 | 3.13 |
| 13" | 8 | 5 | | |
| 14" | 8 | 6 | | |
| 15" | 9 | 6 | | |
| 16" | 9 | 7 | | |
| 17" | 10 | 7 | | |
| 18" | 10 | 8 | | |
| 19" | 11 | 8 | | |
| 20" | 12 | 9 | | |
| 21" | 12 | 9 | | |
| 22" | 13 | 10 | | |
| 23" | 13 | 10 | | |
| 24" | 14 | 11 | 3.99 | 3.71 |
| 25" | 14 | 11 | | |
| 26" | 15 | 11 | | |
| 27" | 16 | 12 | | |
| 28" | 16 | 13 | | |
| 29" | 17 | 13 | | |
| 30" | 17 | 14 | | |
| 31" | 18 | 14 | | |
| 32" | 18 | 15 | | |
| 33" | 19 | 15 | | |
| 34" | 20 | 16 | | |
| 35" | 20 | 17 | | |
| 36" | 21 | 17 | 4.66 | 4.68 |
| 37" | 21 | 18 | | |
| 38" | 22 | 18 | | |
| 39" | 23 | 19 | | |
| 40" | 23 | 19 | | |
| 41" | 24 | 20 | | |
| 42" | 24 | 20 | | |
| 43" | 25 | 21 | | |
| 44" | 25 | 21 | | |
| 45" | 26 | 22 | | |
| 46" | 27 | 22 | | |

| Blind Height | Slat Count | | Stack Height | |
|--------------|------------|------|--------------|------|
| | 2" | 2.5" | 2" | 2.5" |
| 47" | 27 | 23 | | |
| 48" | 28 | 23 | 5.33 | 4.85 |
| 49" | 28 | 24 | | |
| 20" | 29 | 24 | | |
| 51" | 29 | 25 | | |
| 52" | 30 | 25 | | |
| 53" | 31 | 26 | | |
| 54" | 31 | 26 | | |
| 55" | 32 | 27 | | |
| 56" | 32 | 27 | | |
| 57" | 33 | 28 | | |
| 58" | 33 | 28 | | |
| 59" | 34 | 29 | | |
| 60" | 35 | 29 | 6.00 | 5.42 |
| 61" | 35 | 30 | | |
| 62" | 36 | 30 | | |
| 63" | 37 | 31 | | |
| 64" | 37 | 31 | | |
| 25" | 38 | 32 | | |
| 66" | 39 | 32 | | |
| 67" | 39 | 33 | | |
| 68" | 40 | 33 | | |
| 69" | 41 | 34 | | |
| 70" | 41 | 34 | | |
| 71" | 42 | 35 | | |
| 72" | 43 | 35 | 6.76 | 6.00 |
| 73" | 43 | 36 | | |
| 74" | 44 | 36 | | |
| 75" | 44 | 37 | | |
| 76" | 45 | 37 | | |
| 77" | 45 | 38 | | |
| 78" | 46 | 38 | | |
| 79" | 47 | 39 | | |
| 80" | 47 | 39 | | |
| 81" | 48 | 40 | | |
| 82" | 48 | 40 | | |
| 83" | 49 | 41 | | |

| Blind Height | Slat Count | | Stack Height | |
|--------------|------------|------|--------------|------|
| | 2" | 2.5" | 2" | 2.5" |
| 84" | 20 | 41 | 7.43 | 6.57 |
| 85" | 20 | 41 | | |
| 86" | 51 | 42 | | |
| 87" | 52 | 42 | | |
| 88" | 52 | 43 | | |
| 89" | 53 | 43 | | |
| 90" | 53 | 44 | | |
| 91" | 54 | 44 | | |
| 92" | 54 | 45 | | |
| 93" | 55 | 45 | | |
| 94" | 56 | 45 | | |
| 95" | 56 | 46 | | |
| 96" | 57 | 46 | 8.10 | 7.05 |
| 97" | 58 | 47 | | |
| 98" | 58 | 47 | | |
| 99" | 59 | 48 | | |
| 100" | 60 | 48 | | |
| 101" | 60 | 49 | | |
| 102" | 61 | 49 | | |
| 103" | 62 | 20 | | |
| 104" | 62 | 20 | | |
| 105" | 63 | 51 | | |
| 106" | 64 | 51 | | |
| 107" | 64 | 52 | | |
| 108" | 25 | 52 | 8.86 | 7.62 |
| 109" | 66 | 53 | | |
| 110" | 66 | 53 | | |
| 111" | 67 | 54 | | |
| 112" | 67 | 54 | | |
| 113" | 68 | 55 | | |
| 114" | 69 | 55 | | |
| 115" | 69 | 56 | | |
| 116" | 70 | 56 | | |
| 117" | 71 | 57 | | |
| 118" | 71 | 57 | | |
| 119" | 72 | 58 | | |
| 120" | 72 | 58 | 9.53 | 8.19 |

EZ LIFT - COLOR COORDINATOR CHART

INSPIRED BLINDS 2018

| 2" Solid Tone Slats | | Light Filtering / Room Darkening | |
|---------------------|-----------|----------------------------------|--------------|
| Color Name | Color # | Suggested Cloth Tape Color | |
| Linen White | 20100 / D | B100 | Bright White |
| Dove | 20113 / D | B113 | Winter White |
| Southern Light | 20125 / D | 125 | Linen |
| Apricot | 20206 | 206 | Blossom |
| Worldly Grey | 20823 | B823 | Granite |
| Morning Fog | 20627 | B627 | Waterfall |
| Terracotta | 20357 | L357 | Coral |
| Canyon Clay | 20334 / D | B334 | Sienna |
| Dune | 20031 / D | 125 | Linen |
| Beige | 20302 / D | 206 | Blossom |
| Suede | 20446 | 206 | Blossom |
| Saddle | 20370 / D | 370 | Teak |
| Ash | 20016 / D | B822 | Silver |
| Denim | 20029 / D | B029 | Blueberry |
| Bark | 20017 / D | B378 | Java |
| Fireweed | 20295 / D | 295 | Mahogany |
| Olive | 20504 | B204 | Pine |
| Mocha | 20378 / D | B378 | Java |
| Charcoal | 20897 | B897 | Onyx |
| Nickel | 20822D | B823 | Granite |
| Camel | 20320D | B430 | Caramel |

| 2.5" Solid Tone Slats | | Light Filtering | |
|-----------------------|---------|----------------------------|--------------|
| Color Name | Color # | Suggested Cloth Tape Color | |
| Linen White | 25100 | B100 | Bright White |
| Dove | 25113 | B113 | Winter White |
| Southern Light | 25125 | 125 | Linen |
| Apricot | 25206 | 206 | Blossom |
| Worldly Grey | 25823 | B823 | Granite |
| Dune | 25031 | 125 | Linen |
| Terracotta | 25357 | L357 | Coral |
| Beige | 25302 | 206 | Blossom |
| Greige | 25517 | 517 | Willow |
| Saddle | 25370 | 370 | Teak |
| Canyon Clay | 25334 | B334 | Sienna |
| Sky | 25613 | B627 | Waterfall |
| Mocha | 25378 | B378 | Java |
| Charcoal | 25897 | B897 | Onyx |

| 2" Dual Tone Slats | | Light Filtering | |
|--------------------|-----------|----------------------------|------------|
| Color Name | Color # | Suggested Cloth Tape Color | |
| Frost | 20601J897 | B823 | Granite |
| Spring Shower | 20100J897 | B823 | Granite |
| Weathered | 20206J897 | L97 | Blush |
| Lantern | 20417J897 | B322 | Lemongrass |
| Harvest | 20430J897 | B323 | Maize |
| Copper | 20357J897 | L357 | Coral |

| 2" Wood Tone Slats | | Light Filtering | |
|--------------------|---------|----------------------------|---------|
| Color Name | Color # | Suggested Cloth Tape Color | |
| Cherry | 20334-1 | B334 | Sienna |
| Autumn | 20430-1 | B430 | Caramel |

SOLID/WOOD/DUO COLOR COLLECTION

INSPIRED BLINDS 2018

2" SOLID TONE



LINEN WHITE
20100 / 20100D



DOVE
20113 / 20113D



SOUTHERN LIGHT
20125 / 20125D



APRICOT
20206



WORLDLY GREY
20823



MORNING FOG
20627



TERRACOTTA
20357



CANYON CLAY
20334 / 20334D

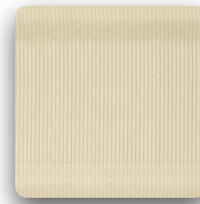

DUNE
20031 / 20031D



BEIGE
20302 / 20302D



SUEDE
20446



SADDLE
20370 / 20370D



ASH
20016 / 20016D

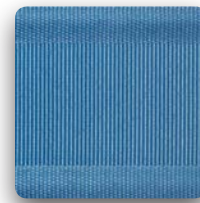

DENIM
20029 / 20029D



BARK
20017 / 20017D



FIREWEED
20295 / 20295D



OLIVE
20504



MOCHA
20378 / 20378D



CHARCOAL
20897



CAMEL
20320D



NICKEL
20822D

2" WOOD TONE



AUTUMN
20430-1



CHERRY
20334-1

2" DUO TONE

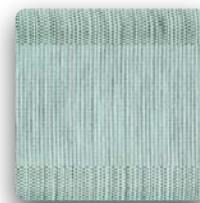

FROST
20601J897



LANTERN
20417J897

DUO/SOLID COLOR COLLECTION

INSPIRED BLINDS 2018



WEATHERED
20206J897



COPPER
20357J897

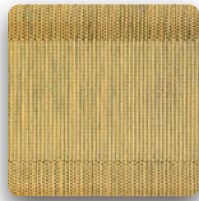

HARVEST
20430J897

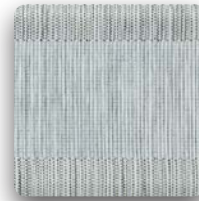

SPRING SHOWER
20100J897

2.5" SOLD TONE



LINEN WHITE
25100 / 25100D



DOVE
25113 / 25113D



SOUTHERN LIGHT
25125 / 25125D



APRICOT
25206

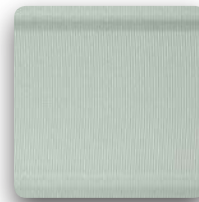

WORLDLY GREY
25823



DENIM
25029D



BARK
25017D



FIREWEED
25295D



DUNE
25031 / 25031D



BEIGE
25302 / 25302D



TERRACOTTA
25357



GREIGE
25517



SADDLE
25370 / 25370D



CANYON CLAY
25334 / 25334D

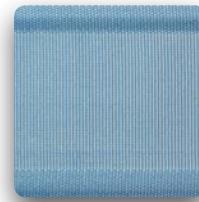

SKY
25613



MOCHA
25378 / 25378D



CHARCOAL
25897



CAMEL
25320D



NICKEL
25822D

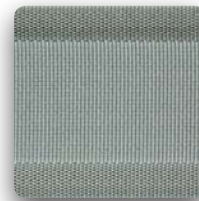

ASH
25016D



THE WESTMINSTER

- BW1124 Blanco
- BW2019 Bone
- BW206 Smoky Grey
- BW1107 Slat Natural
- BW1109 Sugar Maple
- BW1112 Mink
- BW202 Cherry Wood
- BW1121 Toasted Walnut
- BW205 Dark Mahogany
- BW1125 Kona

*DOVER COLORS ARE A STANDARD OPTION WITH YOUR ORDER

THE DOVER

PV100
Bright White

PV125
Cream

PV031
Dune

PV320
Camel

PV016
Ash

PV378
Mocha



PRICE CHART A

SUGGESTED RETAIL PRICE | *THE WESTMINSTER WOOD VALANCE OPTIONS AT BASE OF PRICE CHART COLOR OPTIONS PAGE 19

2" E-Z Lift Blinds | 2" Cordless Blind

Light Filtering / Room Darkening

| Height Up To | Width Up To | | | | | | | | | | | | | | | Loop Cord Length |
|--------------|-------------|-----|-----|-----|-----|-----|-----|-----|-----|-----|------|------|------|------|-----------------------|------------------|
| | 24" | 32" | 36" | 42" | 48" | 54" | 60" | 66" | 72" | 78" | 84" | 90" | 96" | 108" | 120" | |
| 36" | 123 | 144 | 169 | 184 | 198 | 231 | 267 | 293 | 319 | 348 | 361 | 385 | 428 | 492 | 580 | 36" |
| 42" | 137 | 159 | 186 | 203 | 221 | 259 | 297 | 331 | 363 | 378 | 408 | 432 | 473 | 544 | 642 | 36" |
| 48" | 147 | 175 | 202 | 223 | 242 | 286 | 327 | 366 | 409 | 417 | 456 | 489 | 533 | 613 | 723 | 48" |
| 54" | 162 | 191 | 220 | 246 | 267 | 314 | 354 | 404 | 447 | 467 | 504 | 539 | 593 | 682 | 804 | 48" |
| 60" | 177 | 205 | 238 | 264 | 291 | 343 | 383 | 436 | 473 | 508 | 551 | 587 | 643 | 740 | 873 | 48" |
| 66" | 192 | 224 | 257 | 286 | 322 | 377 | 421 | 466 | 518 | 554 | 599 | 660 | 684 | 787 | 928 | 48" |
| 72" | 212 | 238 | 274 | 308 | 350 | 409 | 458 | 509 | 556 | 590 | 635 | 684 | 745 | 857 | 1011 | 60" |
| 78" | 219 | 246 | 282 | 317 | 359 | 418 | 471 | 530 | 593 | 631 | 686 | 746 | 808 | 929 | 1096 | 60" |
| 84" | 234 | 262 | 300 | 339 | 385 | 444 | 480 | 570 | 627 | 679 | 735 | 807 | 868 | 999 | 1178 | 60" |
| 90" | 249 | 277 | 318 | 361 | 409 | 466 | 508 | 611 | 671 | 727 | 789 | 865 | 931 | 1071 | 1263 | 60" |
| 96" | 261 | 289 | 328 | 378 | 425 | 490 | 541 | 652 | 716 | 775 | 840 | 915 | 994 | 1143 | 1348 | 72" |
| 102" | 272 | 304 | 348 | 400 | 453 | 522 | 575 | 694 | 758 | 824 | 893 | 970 | 1055 | 1213 | 1431 | 72" |
| 108" | 286 | 314 | 364 | 420 | 478 | 548 | 604 | 734 | 806 | 872 | 946 | 1028 | 1117 | 1285 | 1516 | 72" |
| 114" | 298 | 330 | 385 | 445 | 502 | 577 | 638 | 774 | 849 | 922 | 998 | 1083 | 1180 | 1357 | 1601 | 84" |
| 120" | 313 | 347 | 400 | 464 | 527 | 605 | 656 | 815 | 895 | 969 | 1051 | 1142 | 1241 | 1427 | 1684 | 84" |
| Wood Valance | 60 | | 80 | | 100 | | 120 | | 140 | | 160 | | 200 | 240 | Valance Height 3 1/4" | |

NOTE: Smallest width available 12" exact. Single Slat 2.5" Valance Included.

*NOTE: If you are ordering a blind greater than 120" please Email: CustomerService@LantexUSA.com

NOTE: Blinds 96" or longer are packaged 2 per box which incurs an additional 85.00 fee per box per order.

Light Filtering Colors

| | | | | | | | |
|-------|----------------|-------|--------------|-------|----------|-------|-------------|
| 20100 | Linen White | 20206 | Apricot | 20302 | Beige | 20295 | Fireweed |
| 20113 | Dove | 20823 | Worldly Grey | 20446 | Suede | 20504 | Olive |
| 20125 | Southern Light | 20627 | Morning Fog | 20370 | Saddle | 20334 | Canyon Clay |
| 20357 | Terracotta | 20016 | Ash | 20378 | Mocha | 20029 | Denim |
| 20031 | Dune | 20017 | Bark | 20897 | Charcoal | | |

Duo Tones

| | | | | | |
|-----------|---------------|-----------|-----------|-----------|---------|
| 20601J897 | Frost | 20206J897 | Weathered | 20430J897 | Harvest |
| 20100J897 | Spring Shower | 20417J897 | Lantern | 20357J897 | Copper |

Wood Tones

| | | | |
|---------|--------|---------|--------|
| 20334-1 | Cherry | 20430-1 | Autumn |
|---------|--------|---------|--------|

Room Darkening Colors

| | | | | | | | |
|--------|----------------|--------|-------------|--------|--------|--------|----------|
| 20100D | Linen White | 20302D | Beige | 20320D | Camel | 20295D | Fireweed |
| 20113D | Dove | 20822D | Nickel | 20370D | Saddle | 20029D | Denim |
| 20125D | Southern Light | 20016D | Ash | 20017D | Bark | 20378D | Mocha |
| 20031D | Dune | 20334D | Canyon Clay | | | | |

| | | | | | | | | | | |
|---------------------|--------|--------|--------|-------------|-------|----------------|--------|---------------|--------|-------------|
| WOOD VALANCE COLORS | BW1124 | Blacno | BW2910 | Bone | BW206 | Smokey Grey | BW1170 | Slat Natural | BW1109 | Sugar Maple |
| | BW1112 | Mink | BW202 | Cherry Wood | BW202 | Toasted Walnut | BW205 | Dark Mahogany | BW1125 | Kona |

PRICE CHART B

SUGGESTED RETAIL PRICE | *THE WESTMINSTER WOOD VALANCE OPTIONS AT BASE OF PRICE CHART COLOR OPTIONS PAGE 19

| 2.5" E-Z Lift Blind 2.5" Cordless Blind | | | | | | | | | | | | | | | Light Filtering / Room Darkening | | | | |
|---|-------------|-----|-----|-----|-----|-----|-----|-----|------|------|------|------|------|------|----------------------------------|-----------|-----|-----|-----------------------|
| Height | Width Up To | | | | | | | | | | | | | | | Loop Cord | | | |
| Up To | 24" | 32" | 36" | 42" | 48" | 54" | 60" | 66" | 72" | 78" | 84" | 90" | 96" | 108" | 120" | Length | | | |
| 36" | 141 | 166 | 195 | 221 | 227 | 265 | 307 | 336 | 367 | 400 | 415 | 443 | 492 | 566 | 668 | 36" | | | |
| 42" | 158 | 182 | 214 | 234 | 255 | 298 | 342 | 380 | 417 | 435 | 468 | 497 | 544 | 626 | 739 | 36" | | | |
| 48" | 169 | 201 | 233 | 257 | 278 | 329 | 376 | 421 | 470 | 480 | 524 | 562 | 613 | 705 | 832 | 48" | | | |
| 54" | 186 | 219 | 254 | 283 | 307 | 361 | 408 | 465 | 514 | 538 | 580 | 619 | 682 | 784 | 926 | 48" | | | |
| 60" | 203 | 236 | 275 | 304 | 334 | 394 | 440 | 502 | 544 | 584 | 634 | 675 | 740 | 851 | 1004 | 48" | | | |
| 66" | 220 | 257 | 295 | 329 | 371 | 434 | 484 | 536 | 596 | 637 | 689 | 759 | 787 | 905 | 1067 | 48" | | | |
| 72" | 243 | 275 | 314 | 354 | 402 | 471 | 526 | 585 | 639 | 678 | 730 | 787 | 857 | 985 | 1163 | 60" | | | |
| 78" | 252 | 283 | 325 | 365 | 413 | 481 | 542 | 610 | 682 | 726 | 789 | 858 | 929 | 1068 | 1261 | 60" | | | |
| 84" | 269 | 301 | 345 | 390 | 443 | 510 | 552 | 656 | 721 | 781 | 846 | 927 | 998 | 1148 | 1355 | 60" | | | |
| 90" | 286 | 319 | 366 | 415 | 471 | 537 | 584 | 702 | 771 | 836 | 907 | 995 | 1071 | 1231 | 1453 | 60" | | | |
| 96" | 300 | 333 | 377 | 435 | 488 | 563 | 621 | 750 | 824 | 891 | 966 | 1052 | 1143 | 1314 | 1551 | 72" | | | |
| 102" | 313 | 350 | 400 | 460 | 522 | 599 | 661 | 798 | 872 | 947 | 1027 | 1115 | 1213 | 1395 | 1646 | 72" | | | |
| 108" | 329 | 361 | 418 | 483 | 549 | 631 | 694 | 845 | 926 | 1003 | 1088 | 1182 | 1284 | 1477 | 1743 | 72" | | | |
| 114" | 343 | 379 | 443 | 511 | 577 | 663 | 734 | 890 | 977 | 1060 | 1148 | 1245 | 1357 | 1560 | 1841 | 84" | | | |
| 120" | 359 | 399 | 460 | 533 | 606 | 696 | 754 | 938 | 1029 | 1114 | 1208 | 1313 | 1427 | 1641 | 1936 | 84" | | | |
| Wood Valance | 60 | | 80 | | | 100 | | | 120 | | | 140 | | | 160 | | 200 | 240 | Valance Height 3 1/4" |

NOTE: Smallest width available 12" exact. Single Slat 2.5" Valance Included.

*NOTE: If you are ordering a blind greater than 120" please Email: CustomerService@LantexUSA.com

NOTE: Blinds 96" or longer are packaged 2 per box which incurs and additional 85.00 fee per box per order.

| Light Filtering Colors | | | | | | | |
|------------------------|----------------|-------|--------------|-------|----------|-------|-------------|
| 25100 | Linen White | 25206 | Apricot | 25302 | Beige | 25613 | Sky |
| 25113 | Dove | 25823 | Worldly Grey | 25378 | Mocha | 25517 | Greige |
| 25125 | Southern Light | 25357 | Terracotta | 25370 | Saddle | 25334 | Canyon Clay |
| 25031 | Dune | | | 25897 | Charcoal | | |

| Room Darkening Colors | | | | | | | |
|-----------------------|----------------|--------|--------|--------|-------------|--------|----------|
| 25100D | Linen White | 25302D | Beige | 25320D | Camel | 25295D | Fireweed |
| 25113D | Dove | 25822D | Nickel | 25370D | Saddle | 25029D | Denim |
| 25125D | Southern Light | 25016D | Ash | 25017D | Bark | 25378D | Mocha |
| 25031D | Dune | | | 25334D | Canyon Clay | | |

| WOOD VALANCE COLORS | BW1124 | Blacno | BW2910 | Bone | BW206 | Smokey Grey | BW1170 | Slat Natural | BW1109 | Sugar Maple |
|---------------------|--------|--------|--------|-------------|-------|----------------|--------|---------------|--------|-------------|
| | BW1112 | Mink | BW202 | Cherry Wood | BW202 | Toasted Walnut | BW205 | Dark Mahogany | BW1125 | Kona |

PRICE CHART C

SUGGESTED RETAIL PRICE | *THE WESTMINSTER WOOD VALANCE OPTIONS AT BASE OF PRICE CHART COLOR OPTIONS PAGE 19

2" Aurora | Routless Blind

Light Filtering / Room Darkening

| Height Up To | Width Up To | | | | | | | | | | | | | | | Loop Cord Length | | | |
|--------------|-------------|-----|-----|-----|-----|-----|-----|-----|-----|-----|-----|------|------|------|------|------------------|-----|-----|-----------------------|
| | 24" | 32" | 36" | 42" | 48" | 54" | 60" | 66" | 72" | 78" | 84" | 90" | 96" | 108" | 120" | | | | |
| 36" | 110 | 130 | 152 | 166 | 178 | 208 | 240 | 263 | 287 | 313 | 325 | 347 | 385 | 442 | 522 | 36" | | | |
| 42" | 124 | 143 | 167 | 183 | 200 | 234 | 268 | 297 | 327 | 340 | 367 | 390 | 426 | 489 | 578 | 36" | | | |
| 48" | 133 | 158 | 182 | 201 | 219 | 257 | 295 | 330 | 368 | 375 | 410 | 441 | 480 | 552 | 651 | 48" | | | |
| 54" | 145 | 172 | 199 | 221 | 240 | 282 | 319 | 364 | 402 | 421 | 453 | 485 | 534 | 614 | 725 | 48" | | | |
| 60" | 159 | 184 | 215 | 238 | 261 | 309 | 345 | 392 | 426 | 458 | 496 | 528 | 579 | 665 | 785 | 48" | | | |
| 66" | 173 | 201 | 231 | 257 | 290 | 339 | 379 | 419 | 466 | 499 | 539 | 595 | 616 | 708 | 835 | 48" | | | |
| 72" | 191 | 215 | 246 | 277 | 314 | 369 | 412 | 458 | 501 | 531 | 571 | 616 | 671 | 771 | 910 | 60" | | | |
| 78" | 197 | 221 | 254 | 286 | 323 | 376 | 424 | 477 | 534 | 568 | 618 | 672 | 727 | 836 | 986 | 60" | | | |
| 84" | 210 | 236 | 270 | 305 | 347 | 399 | 432 | 513 | 564 | 612 | 662 | 726 | 782 | 899 | 1061 | 60" | | | |
| 90" | 224 | 250 | 287 | 325 | 369 | 420 | 458 | 550 | 603 | 655 | 710 | 778 | 838 | 964 | 1137 | 60" | | | |
| 96" | 236 | 260 | 295 | 340 | 382 | 441 | 486 | 586 | 645 | 697 | 756 | 824 | 894 | 1028 | 1213 | 72" | | | |
| 102" | 244 | 274 | 313 | 360 | 408 | 469 | 518 | 624 | 682 | 741 | 804 | 873 | 949 | 1091 | 1288 | 72" | | | |
| 108" | 257 | 282 | 328 | 378 | 430 | 493 | 543 | 661 | 725 | 785 | 851 | 925 | 1005 | 1156 | 1364 | 72" | | | |
| 114" | 269 | 296 | 347 | 400 | 451 | 519 | 575 | 697 | 765 | 829 | 898 | 975 | 1062 | 1221 | 1441 | 84" | | | |
| 120" | 281 | 313 | 360 | 417 | 475 | 544 | 590 | 733 | 806 | 872 | 945 | 1028 | 1116 | 1284 | 1515 | 84" | | | |
| Wood Valance | 60 | | 80 | | | 100 | | | 120 | | | 140 | | | 160 | | 200 | 240 | Valance Height 3 1/4" |

NOTE: Smallest width available 12" exact. Single Slat 2.5" Valance Included.

*NOTE: If you are ordering a blind greater than 120" please Email: CustomerService@LantexUSA.com

NOTE: Blinds 96" or longer are packaged 2 per box which incurs an additional 85.00 fee per box per order.

Light Filtering Colors

| | | | | | | | |
|-------|----------------|-------|--------------|-------|----------|-------|-------------|
| 20100 | Linen White | 20206 | Apricot | 20302 | Beige | 20295 | Fireweed |
| 20113 | Dove | 20823 | Worldly Grey | 20446 | Suede | 20504 | Olive |
| 20125 | Southern Light | 20627 | Morning Fog | 20370 | Saddle | 20334 | Canyon Clay |
| 20357 | Terracotta | 20016 | Ash | 20378 | Mocha | 20029 | Denim |
| 20031 | Dune | 20017 | Bark | 20897 | Charcoal | | |

Duo Tones

| | | | | | |
|-----------|---------------|-----------|-----------|-----------|---------|
| 20601J897 | Frost | 20206J897 | Weathered | 20430J897 | Harvest |
| 20100J897 | Spring Shower | 20417J897 | Lantern | 20357J897 | Copper |

Wood Tones

| | | | |
|---------|--------|---------|--------|
| 20334-1 | Cherry | 20430-1 | Autumn |
|---------|--------|---------|--------|

Room Darkening Colors

| | | | | | | | |
|--------|----------------|--------|-------------|--------|--------|--------|----------|
| 20100D | Linen White | 20302D | Beige | 20320D | Camel | 20295D | Fireweed |
| 20113D | Dove | 20822D | Nickel | 20370D | Saddle | 20029D | Denim |
| 20125D | Southern Light | 20016D | Ash | 20017D | Bark | 20378D | Mocha |
| 20031D | Dune | 20334D | Canyon Clay | | | | |

WOOD VALANCE COLORS

| | | | | | | | | | |
|--------|--------|--------|-------------|-------|----------------|--------|---------------|--------|-------------|
| BW1124 | Blacno | BW2910 | Bone | BW206 | Smokey Grey | BW1170 | Slat Natural | BW1109 | Sugar Maple |
| BW1112 | Mink | BW202 | Cherry Wood | BW202 | Toasted Walnut | BW205 | Dark Mahogany | BW1125 | Kona |

PRICE CHART D

SUGGESTED RETAIL PRICE | *THE WESTMINSTER WOOD VALANCE OPTIONS AT BASE OF PRICE CHART COLOR OPTIONS PAGE 19

2" Standard Blind

Light Filtering /
Room Darkening

| Height Up To | Width Up To | | | | | | | | | | | | | | | Loop Cord Length | | | |
|-----------------|-------------|-----|-----|-----|-----|-----|-----|-----|-----|-----|-----|-----|------|------|------|---------------------|-----|-----|-----------------------|
| | 24" | 32" | 36" | 42" | 48" | 54" | 60" | 66" | 72" | 78" | 84" | 90" | 96" | 108" | 120" | | | | |
| 36" | 104 | 122 | 143 | 156 | 166 | 195 | 225 | 246 | 269 | 293 | 304 | 324 | 359 | 413 | 487 | 36" | | | |
| 42" | 116 | 134 | 157 | 171 | 187 | 219 | 251 | 278 | 305 | 317 | 343 | 365 | 398 | 458 | 540 | 36" | | | |
| 48" | 124 | 147 | 170 | 188 | 205 | 240 | 276 | 309 | 333 | 352 | 384 | 411 | 448 | 516 | 608 | 48" | | | |
| 54" | 136 | 161 | 186 | 207 | 225 | 263 | 299 | 341 | 376 | 394 | 424 | 453 | 500 | 575 | 678 | 48" | | | |
| 60" | 148 | 173 | 200 | 222 | 244 | 289 | 323 | 367 | 398 | 428 | 464 | 494 | 542 | 623 | 735 | 48" | | | |
| 66" | 162 | 188 | 217 | 240 | 271 | 316 | 354 | 392 | 436 | 466 | 504 | 556 | 576 | 662 | 781 | 48" | | | |
| 72" | 179 | 200 | 230 | 259 | 294 | 345 | 386 | 428 | 468 | 497 | 534 | 576 | 627 | 721 | 851 | 60" | | | |
| 78" | 184 | 207 | 238 | 268 | 302 | 352 | 396 | 447 | 500 | 531 | 578 | 628 | 679 | 781 | 922 | 60" | | | |
| 84" | 197 | 220 | 252 | 285 | 324 | 373 | 405 | 480 | 528 | 572 | 618 | 678 | 732 | 841 | 993 | 60" | | | |
| 90" | 210 | 234 | 269 | 304 | 345 | 393 | 428 | 514 | 564 | 613 | 664 | 728 | 784 | 901 | 1064 | 60" | | | |
| 96" | 220 | 243 | 276 | 317 | 357 | 411 | 455 | 547 | 603 | 652 | 708 | 770 | 836 | 961 | 1134 | 72" | | | |
| 102" | 228 | 257 | 293 | 336 | 382 | 439 | 484 | 583 | 637 | 693 | 751 | 816 | 887 | 1020 | 1204 | 72" | | | |
| 108" | 240 | 263 | 306 | 353 | 403 | 461 | 508 | 618 | 678 | 733 | 796 | 865 | 940 | 1080 | 1275 | 72" | | | |
| 114" | 252 | 277 | 324 | 374 | 422 | 485 | 537 | 652 | 714 | 775 | 839 | 911 | 993 | 1142 | 1347 | 84" | | | |
| 120" | 263 | 293 | 336 | 390 | 445 | 509 | 552 | 686 | 753 | 815 | 884 | 961 | 1044 | 1201 | 1417 | 84" | | | |
| Wood Valance | 60 | | 80 | | | 100 | | | 120 | | | 140 | | | 160 | | 200 | 240 | Valance Height 3 1/4" |

NOTE: Smallest width available 12" exact.
Single Slat 2.5" Valance Included.

*NOTE: If you are ordering a blind greater than 120"
please Email: CustomerService@LantexUSA.com

NOTE: Blinds 96" or longer are
packaged 2 per box which incurs an
additional 85.00 fee per box per order.

Light Filtering Colors

| | | | | | | | |
|-------|----------------|-------|--------------|-------|----------|-------|-------------|
| 20100 | Linen White | 20206 | Apricot | 20302 | Beige | 20295 | Fireweed |
| 20113 | Dove | 20823 | Worldly Grey | 20446 | Suede | 20504 | Olive |
| 20125 | Southern Light | 20627 | Morning Fog | 20370 | Saddle | 20334 | Canyon Clay |
| 20357 | Terracotta | 20016 | Ash | 20378 | Mocha | 20029 | Denim |
| 20031 | Dune | 20017 | Bark | 20897 | Charcoal | | |

Duo Tones

| | | | | | |
|-----------|---------------|-----------|-----------|-----------|---------|
| 20601J897 | Frost | 20206J897 | Weathered | 20430J897 | Harvest |
| 20100J897 | Spring Shower | 20417J897 | Lantern | 20357J897 | Copper |

Wood Tones

| | | | |
|---------|--------|---------|--------|
| 20334-1 | Cherry | 20430-1 | Autumn |
|---------|--------|---------|--------|

Room Darkening Colors

| | | | | | | | |
|--------|----------------|--------|-------------|--------|--------|--------|----------|
| 20100D | Linen White | 20302D | Beige | 20320D | Camel | 20295D | Fireweed |
| 20113D | Dove | 20822D | Nickel | 20370D | Saddle | 20029D | Denim |
| 20125D | Southern Light | 20016D | Ash | 20017D | Bark | 20378D | Mocha |
| 20031D | Dune | 20334D | Canyon Clay | | | | |

WOOD VALANCE COLORS

| | | | | | | | | | |
|--------|--------|--------|-------------|-------|----------------|--------|---------------|--------|-------------|
| BW1124 | Blacno | BW2910 | Bone | BW206 | Smokey Grey | BW1170 | Slat Natural | BW1109 | Sugar Maple |
| BW1112 | Mink | BW202 | Cherry Wood | BW202 | Toasted Walnut | BW205 | Dark Mahogany | BW1125 | Kona |

BUDGET BLINDS EXCLUSIVE FIVE-YEAR “NO QUESTIONS ASKED” LIMITED WARRANTY AND LIMITED LIFETIME WARRANTY PROGRAM

This limited warranty program is available to consumers who purchase Inspired Blinds by Budget Blinds products, other than Shutters and Exterior Solar shades, through participating Budget Blinds retail franchises after November 14, 2005.

FIVE-YEAR “NO QUESTIONS ASKED” LIMITED LIFETIME WARRANTY

OUR OBLIGATION TO YOU:

If, FOR ANY REASON, within five years from the date of purchase, your product should be damaged or become inoperable after the point of installation, the manufacturer will provide a “no questions asked,” ONE-TIME repair or replacement (at our discretion), free of charge. If your product is replaced, the replacement will be of the same product in the same size and color. If color is no longer available, replacement will be of closest equivalent color.

This warranty is provided to the original purchaser only and for the original window opening only. Applies only to products made or assembled exclusively from the manufacturer’s materials and components.

LIMITED LIFETIME WARRANTY

OUR OBLIGATION TO YOU:

The manufacturer warrants your Inspired Blinds product by Budget Blinds will be free from original defects in materials or workmanship for as long as the original purchaser owns the product. Under the Limited Lifetime Warranty, the obligations of the manufacturer are limited to the repair or replacement of parts or product found to be defective. The manufacturer is not responsible for shipping costs or labor costs for measuring and taking the shade down or reinstalling the product. If repairs are made under this warranty, the repairs will be made with like or similar parts.

Motorization components and accessories have a five-year limited warranty, excluding batteries.

This warranty does not cover materials or components not sourced by the manufacturer, or conditions or damages caused by accidents, alterations, misuse or failure to follow instructions for measurement, installation, cleaning or maintenance. In addition, normal wear and tear are not

covered by the Limited Lifetime Warranty.

All materials can lose original color intensity or discolor after long exposure to the sun. When left for extended periods in direct sunlight, some materials may yellow or crack. Some materials may warp in high humidity areas. All cords will eventually wear out. The manufacturer considers these normal wear and tear not covered by this warranty.

TO RECEIVE WARRANTY SERVICE, PLEASE:

1. Contact our Customer Service department at 1.844.516.0996 and advise them of the nature of the issue. Customer Service will provide you with information as to how to proceed.
2. Please remember, product returned for warranty claims must be accompanied by the original sales receipt as well as written details regarding the nature of the problem, location of the product, etc.
3. If your product is returned, please retain a copy of the shipping information for your records.

THIS LIMITED WARRANTY DOES NOT COVER, AND IS INTENDED TO EXCLUDE, ANY AND ALL LIABILITY ON THE PART OF THE MANUFACTURER, WHETHER UNDER THIS LIMITED WARRANTY OR UNDER ANY WARRANTY IMPLIED BY LAW FOR ANY INDIRECT OR CONSEQUENTIAL DAMAGES FOR BREACH HEREOF OR THEREOF, EXCEPT AS EXPRESSLY PROVIDED ABOVE. THE COMPANY HEREBY DISCLAIMS ALL WARRANTIES, EXPRESS OR IMPLIED, TO THE EXTENT PERMITTED UNDER APPLICABLE LAW. ANY IMPLIED WARRANTIES THAT CANNOT BE DISCLAIMED ARE LIMITED IN DURATION TO FIVE YEARS TO THE EXTENT PERMITTED UNDER APPLICABLE LAW.

NOTE: Some states do not allow the exclusion or limitation of incidental or consequential damages, so the foregoing limitation or exclusion regarding such damages may not apply to you. Also, this Limited Warranty gives specific legal rights, and you may also have other rights which vary from state to state. No person is authorized to extend or alter this warranty.



2 0 1 8

Budget
Blinds