



DESIGNJET Z6200 Photo printer series
DESIGNJET Z6600 Production Printer
DESIGNJET Z6800 Photo Production Printer

Service manual

© 2014 Hewlett-Packard Development
Company, L.P.

3rd edition

Legal notices

The information contained herein is subject to change without notice.

The only warranties for HP products and services are set forth in the express warranty statements accompanying such products and services. Nothing herein should be construed as constituting an additional warranty.

HP shall not be liable for technical or editorial errors or omissions contained herein.

Notices

| | | |
|--|--|---|
| <p>Warranty</p> <p>The information contained in this document is subject to change without notice.</p> <p>Hewlett-Packard makes no warranty of any kind with regard to this material, including, but not limited to, the implied warranties of merchantability and fitness for a particular purpose.</p> <p>Hewlett-Packard shall not be liable for errors contained herein or for incidental or consequential damages in connection with the furnishing, performance, or use of this material.</p> | <p>WARNING</p> <p>The procedures described in this manual are to be performed by HP-qualified service personnel only.</p> <p>Electrical shock hazard</p> <p>Serious shock hazard leading to death or injury may result if you do not take the following precautions:</p> <ul style="list-style-type: none"> • Ensure that the ac power outlet (mains) has a protective earth (ground) terminal. • Disconnect the printer from the power source prior to performing any maintenance. • Prevent water or any other liquids from running onto electrical components or circuits, or through openings in the enclosure. <p>Electrostatic discharge</p> <p>See the beginning of Service tests and utilities on page 91 for precautions you should take to prevent damage to the printer circuits from electrostatic discharge.</p> <p>Safety symbols</p> <p>General definitions of safety symbols are given immediately after the table of contents.</p> | <p>WARNING</p> <p>The Warning symbol calls attention to a procedure, practice, or the like, which, if not correctly performed or adhered to, could result in personal injury. Do not proceed beyond a Warning symbol until the indicated conditions are fully understood and met.</p> <p>CAUTION</p> <p>The Caution symbol calls attention to an operating procedure, practice, or the like, which, if not correctly performed or adhered to, could result in damage to or destruction of part or all of the product. Do not proceed beyond a Caution symbol until the indicated conditions are fully understood and met.</p> |
| <p>Customer Assurance</p> <p>Customer Experience Section</p> <p>Large Format Printing Division</p> <p>Hewlett-Packard Española, S.A.</p> <p>Avenida Graells, 501</p> <p>08174 Sant Cugat del Vallès</p> <p>Spain</p> | | |

Using this manual

Purpose

This service manual contains information necessary to troubleshoot, test, calibrate and service:

- HP Designjet Z6200 42-inch Photo printer (Model CQ109A/CQ109B)
- HP Designjet Z6200 60-inch Photo printer (Model CQ111A/CQ111B)
- HP Designjet Z6600 60-inch Production printer (Model F2S71A)
- HP Designjet Z6800 60-inch Photo Production printer (Model F2S72A/F2S72B)

For information about using these printers, refer to the *Using your printer* manual.

Readership

The procedures described in this service manual should be performed by HP certified service personnel only.

Part Numbers

Part numbers for printer options, accessories and service parts can be found in [Parts and diagrams on page 199](#).

Table of contents

| | |
|--|----------|
| 1 Troubleshooting | 1 |
| Printer education and training | 3 |
| Firmware update | 3 |
| Print-quality troubleshooting | 4 |
| Troubleshooting system error codes | 4 |
| Performing a service test on a failed assembly | 4 |
| Performing the necessary service calibrations | 4 |
| The printer does not power on | 4 |
| Incorrect Ink Cartridge troubleshooting | 6 |
| The printer continuously rejects printheads | 9 |
| A new maintenance cartridge is incorrectly detected as 'used' | 10 |
| Cover sensors are not working | 10 |
| The Line Sensor has problems detecting paper | 10 |
| Troubleshooting paper jams and printhead crashes | 10 |
| Troubleshooting paper, scan axis and Rewinder Motor shutdown | 11 |
| Vacuum suction much lower at high altitudes | 12 |
| Banding at variable extreme environmental conditions | 13 |
| Printhead crashes/smears on high-density prints using coated paper | 13 |
| Banding due to ink cartridge replacement while printing | 13 |
| 34-inch Rice Paper not supported | 13 |
| Worm marks on HP Coated Paper with light area fills | 13 |
| Solving paper-handling problems | 14 |
| Difficult to load paper: "Too much skew" | 14 |
| Troubleshooting a failure with the Take-Up Reel (TUR) | 14 |
| How to read the power switch LEDs | 18 |
| How to read the Formatter LEDs | 19 |
| If the front panel turns on and then stops | 21 |
| How to interpret the Service Information Pages | 21 |
| When the main window is open and the printer is printing (safety compliance) | 29 |
| How to troubleshoot the 79:04 system error | 30 |

| | |
|---|------------|
| 2 System error codes | 43 |
| What to do if the front panel is blank | 44 |
| System error codes | 44 |
| Explanation of system error codes and warnings | 44 |
| Continuable and non-continuable error codes | 47 |
| | |
| 3 Ink supplies | 77 |
| What are ink supplies? | 78 |
| General information about the ink supplies | 81 |
| General precautions when handling ink supplies | 82 |
| Priming the ink system | 82 |
| When should you replace the ink supplies? | 83 |
| Obtaining Ink Cartridge information | 83 |
| Obtaining Printhead information | 84 |
| Summary of solving ink supplies problems | 87 |
| Troubleshooting Printhead error codes | 88 |
| Carriage Interconnect Wiper | 89 |
| Warranty information for ink supplies | 89 |
| | |
| 4 Service tests and utilities | 91 |
| Introduction | 92 |
| Diagnostics—self test | 92 |
| Phone support | 92 |
| Service tests (diagnostics) | 92 |
| Entering the Service Tests menu | 93 |
| Service utilities | 111 |
| | |
| 5 Service calibrations | 131 |
| Service calibrations | 132 |
| Entering the Service Calibrations menu | 133 |
| | |
| 6 Print quality | 155 |
| Initial print-quality troubleshooting actions | 156 |
| Troubleshooting tools | 157 |
| How to use the Image Quality Service Diagnostic Print | 161 |
| Print-quality issues by symptom | 178 |
| Working with other commercially available papers | 194 |
| | |
| 7 Parts and diagrams | 199 |
| Printer support | 200 |

| | |
|--|------------|
| Center Covers | 202 |
| Electronics Module | 204 |
| Right Cover | 206 |
| Left Cover | 207 |
| Right-Hand Assemblies | 208 |
| Left-Hand Assemblies | 209 |
| Carriage | 211 |
| Scan-Axis Assemblies | 213 |
| Drive Roller and Media-Axis Motor | 215 |
| Paper Path Assemblies | 216 |
| Center Guide and Pinchwheel Assembly | 217 |
| Media Entry Assemblies | 218 |
| Take-Up Reel assembly | 219 |
| Miscellaneous parts | 221 |
| 8 Removal and installation | 223 |
| Service part order | 224 |
| Disassembly order | 227 |
| 9 Preventive maintenance | 447 |
| Preventive maintenance | 448 |
| 10 Appendix: Country lists | 459 |
| North and Latin America | 460 |
| Asia Pacific and Japan | 463 |
| Europe, Middle-East and Africa | 464 |

1 Troubleshooting

- [Printer education and training](#)
- [Firmware update](#)
- [Print-quality troubleshooting](#)
- [Troubleshooting system error codes](#)
- [Performing a service test on a failed assembly](#)
- [Performing the necessary service calibrations](#)
- [The printer does not power on](#)
- [Incorrect Ink Cartridge troubleshooting](#)
- [The printer continuously rejects printheads](#)
- [A new maintenance cartridge is incorrectly detected as 'used'](#)
- [Cover sensors are not working](#)
- [The Line Sensor has problems detecting paper](#)
- [Troubleshooting paper jams and printhead crashes](#)
- [Troubleshooting paper, scan axis and Rewinder Motor shutdown](#)
- [Vacuum suction much lower at high altitudes](#)
- [Banding at variable extreme environmental conditions](#)
- [Printhead crashes/smears on high-density prints using coated paper](#)
- [Banding due to ink cartridge replacement while printing](#)
- [34-inch Rice Paper not supported](#)
- [Worm marks on HP Coated Paper with light area fills](#)
- [Solving paper-handling problems](#)
- [Difficult to load paper: "Too much skew"](#)
- [Troubleshooting a failure with the Take-Up Reel \(TUR\)](#)
- [How to read the power switch LEDs](#)

- [How to read the Formatter LEDs](#)
- [If the front panel turns on and then stops](#)
- [How to interpret the Service Information Pages](#)
- [When the main window is open and the printer is printing \(safety compliance\)](#)
- [How to troubleshoot the 79:04 system error](#)

Printer education and training

Before any attempt is made to troubleshoot the printer, you must have the relevant training on the HP Designjet Z6200/Z6600/Z6800 printer series. If you are not trained on these printers, please contact HP Education or HP Training to enquire about becoming 'HP Service Qualified' for this printer.

Firmware update

The first step to take when trying to clear an error with the printer is to check that the firmware installed in the printer is the latest available. Firmware updates often include fixes for common problems, and simply updating the firmware can often resolve the problem. New firmware can be downloaded here:

<http://www.hp.com/go/designjet/downloads>

USB firmware update

If it is not possible to perform a firmware update using the Embedded Web Server (for instance, if the printer has a System Error and the Embedded Web Server is inaccessible), it is still possible to do it using a USB flash drive.

1. Turn off the printer.
2. Ensure that your USB flash drive contains a valid FMW firmware file and no other files.
3. Connect the USB flash drive to the USB host port on the Formatter.
4. Turn on the printer and follow the instructions on the front panel.

Forced firmware update

When the printer is started for the first time, it may automatically request a firmware update in order to fix some known issues. You can respond in one of the following ways.

- Use the USB flash drive provided in the box with the printer.

When a firmware update is requested, you should find a USB flash drive in the box, containing the new FMW firmware file. Follow the instructions in the flier accompanying the USB flash drive.

 **NOTE:** The USB flash drive is provided only to update the printer's firmware. No other uses of the USB flash drive are supported.

 **NOTE:** If the USB flash drive is not in the printer box, or fails to work properly, then download the firmware instead.

- Download the FWM firmware file from the HP Web site.

Store the file in a standard USB flash drive with no other files. Connect the flash drive to the formatter's USB host port to perform the firmware update, following the instructions on the front panel.

- Skip the firmware update.

If you cannot find the USB flash drive and you have no Internet connection, you can skip the forced firmware update temporarily by pressing the **OK** key on the front panel three times, and the printer will continue with the initialization sequence. Make sure that the firmware update is performed later. The printer will request the firmware update every time that it starts, until the update is performed.

Print-quality troubleshooting

Whenever a print-quality problem appears, it is advisable to print the Diagnostic Print to help diagnose the problem. The Diagnostic Print will help you differentiate between possible printhead errors and other problems such as incorrect front-panel selection, driver or RIP configuration or mechanical problems. For more information on solving print-quality problems, see [Print quality on page 155](#).

Troubleshooting system error codes

[System error codes on page 43](#) contains a list of system error codes and their respective descriptions and recommended corrective actions. Try only one recommended action at a time and check whether the error code has disappeared.

If you have an error code which is not documented in this Service Manual or you have an error which you cannot resolve, then report the error to the HP Response Center or the nearest HP Support Office. When reporting the error, have the following information ready:

- Model and serial number of the printer.
- Which firmware revision the printer is using (see Note below). Check firmware in Utilities / Statistics / Code rev.
- The complete error number.



NOTE: When reporting the system error code, make sure that you supply the full error code and the firmware version. Without this information, HP support personnel cannot help you.

- The service configuration print.
- The current configuration sheet.
- Which software application the customer is using (name, version, etc.).

Performing a service test on a failed assembly

If possible, always perform a Service Test on the component/assembly that you are about to replace, just to make sure that is the component/assembly that has failed.



NOTE: If the test on that component/assembly passes, you should NOT replace it.

For information on the Service Tests and how to use them see [Service tests and utilities on page 91](#).

Performing the necessary service calibrations

Is the printer calibrated correctly after replacing a component? For information on the Service Calibrations and how to use them, see [Service calibrations on page 131](#).



NOTE: Remember that certain calibrations are required even if an assembly has been disassembled only to gain access to another assembly or component.

The printer does not power on

To resolve printer power-up problems, do the following:

1. Check that the power cord is connected correctly to the printer and to the power socket.
2. Check that the power switch at the rear of the printer is in the on position.
3. Check that the front-panel cable is correctly connected to the Electronics Module. Also make sure that the front-panel cable is not damaged.
4. Check to see if any of the LEDs on the power switch are on. If any of the LEDs are on, then see [How to read the power switch LEDs on page 18](#) for more information.

Incorrect Ink Cartridge troubleshooting

When the customer inserts an Ink Cartridge that is not compatible with the region for the printer the following message is displayed:

Incorrect Magenta Ink
 Replace with HP 771 or HP 771C cartridge. Cartridges from other regions can only be used once. Press **w** to accept this one or **↵** to insert the correct cartridge at the end of this process.

If this is the first time that an incorrect ink cartridge of that color is inserted in the printer, the customer can press **OK** to continue using that cartridge and the printer will use and finish the ink cartridge.

Incorrect LC cartridge
 Supported ink cartridges in this region are HP 771 and HP 771C. Press **w** to continue.



After the first time, the printer will reject all ink cartridges of the same color that do not match the selected region of the customer (please refer to the Ink Cartridge family compatibility chart below).

Table 1-1 Compatibility chart for HP 771 A/B/C Ink Cartridges

| | | Z6200 Firmware 01.00.9.5 or earlier | | | Z6200 Firmware 02.00.1 or later | | | Z6600/Z6800 | | |
|--------------------|------------------------|-------------------------------------|-----|------|---------------------------------|-----|------|-------------|-----|------|
| | | AMS | APJ | EMEA | AMS | APJ | EMEA | AMS | APJ | EMEA |
| Universal supplies | HP 771 | X | X | X | X | X | X | X | X | X |
| | HP 771 host cartridges | X | X | X | X | X | X | X | X | X |
| Regional supplies | HP 771A | X | X | X | X | — | — | X | — | — |
| | HP 771B | X | X | X | — | X | — | — | X | — |
| | HP 771C | X | X | X | — | — | X | — | — | X |
| | HP 773A | — | — | — | — | — | — | X | — | — |
| | HP 773B | — | — | — | — | — | — | — | X | — |
| | HP 773C | — | — | — | — | — | — | — | — | X |

Troubleshooting

In case of ink cartridge incompatibility do the following:

1. Check the product family of the ink cartridge used. Make sure that product family matches the region defined for the customer's country (see the country list below).



2. Check the printer region set in the printer, and/or supplies, match the customer country

If the country is not properly set, correct the country as described in xxxx

With both the product family and printer region correctly set (see the compatibility chart above), supplies will work.

As rejected ink cartridges will still work on printers that are compatible, ink cartridges are not replaced by HP under warranty because of this type of mismatch.

Check the region and supplies compatibility

View compatible ink cartridge information by selecting the  icon.

```

Ink cartridge
Color: Magenta
Product name: HP 771B
Supported ink cartridges:
771 / 771C
Product number: 88191A
Serial number: 3410644-15-6
Status: reset
Ink level: 773 ml
  
```

View the region setting in the Printer Information menu by clicking on the  icon:

```

Printer information
Product name:
HP DesignJet Z6200ps 60in
Photo
Product number: CQ111A
Serial number: HV63F6096
Regional information:
Europe, M. East & Africa
  
```

This information is also available in the Current Printer Configuration tab in the Embedded Web Server:

| Current configuration | Current information | Usage information | Event logs | Calibration status | Connectivity configuration | All pages |
|--|---------------------|-------------------|---------------------------------|--------------------|----------------------------|-----------------------|
| Current Media, Printhead and Ink Information (1 of 2) | | | | | | |
| Date: | Jun 22, 2012 | Product: | HP DesignJet Z6200ps 60in Photo | Serial Number: | MY99G0900C | |
| Firmware: | KHAN_02_00_01.1 | Product number: | CQ111A | Service ID: | 22167 | |
| Printer status: | | | | | | Incorrect M cartridge |
| Current Printer Configuration | | | | | | |
| Language: | English | Visual Memory: | 32.0 GB | | | |
| Disk capacity: | 100.0 GB | Physical Memory: | 1.50 GB RAM | | | |
| Supported Ink Cartridges: | 771 / 771C | | | | | |
| Current Temperature: | 28.2°C 82.8°F | | | | | |

Change the printer region

The procedure to change the printer region is described in the User's Guide. To change the printer region:

1. Select the  icon.



2. Open the Ink menu.
3. Scroll to **Replace Ink Cartridges**.
4. Press the **Cancel** key and the **Down** key at the same time, and hold them down for at least two seconds. The Printer will display the following message:

Region Change
 You are able to change your region only one time.
 Press **▶** to continue with the change or **✖** to keep the current region.

5. After selecting the Front Panel language, select the region for the ink cartridges.

Select printer location
 Europe, M. East & Africa
 North & Latin America
 Asia Pacific & Japan

6. The printer will show the selected region.

Press **▶** to continue
 Press **▼** to see countries



Press **▶** to continue
 Press **▼** to see countries



Press **▶** to continue
 Press **▼** to see countries



7. Press the **Down** key to view the countries in the region selected.

Europe, M. East & Africa
 Albania
 Algeria
 Andorra
 Angola
 Armenia
 Austria
 Azerbaijan
 Bahrain

North & Latin America
 American Samoa
 Anguilla
 Antigua and Barbuda
 Argentina
 Aruba
 Bahamas, The
 Barbados
 Belize

Asia Pacific & Japan
 Afghanistan
 Australia
 Bangladesh
 Bhutan
 Brunei
 Cambodia
 China
 Cook Islands

The complete list of countries can be found in the [Appendix: Country lists on page 459](#) at the end of this Service Manual.

8. On confirmation, the Printer will display the the supplies that are compatible with the region selected. Press the **Back** key to select a different region.

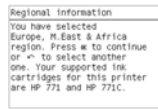

9. At the end of the process the printer will reboot.

After the region has been reset once, the Printer region cannot be changed again by the user. If the user tries to change the region again, the Printer will display the following message with a Code.

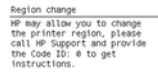

Call agents need to raise a case with GBU through the GCC with the following information:

- Code ID for Region Change of the printer
 - Printer Serial Number
 - Region to be set for this particular printer
 - Customer Name
 - Customer Address
10. GBU will provide an Ink Regional Code.

With the Ink Regional Code customers can proceed with region change.

The printer will show a screen to enter Ink Regional Code then:

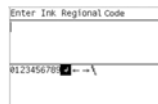

Customers can select the character by pressing **Up**with and **Down**arrows and selecting **Ok**. When the Code is entered correctly, the customer selects the Return symbol and presses**Ok**

This will set the printer Region as requested by the Customer to the GBU.

If the code is not correct, the printer will display the following message:



The printer continuously rejects printheads

To resolve printhead rejection problems, do the following:

1. Clean the flex contacts on the Printhead and in the Carriage Assembly using the Carriage Interconnect Wiper (see [Carriage Interconnect Wiper on page 89](#)) and try again.
2. If all the Printheads are rejected (for each Printhead, the status message on the Front Panel does not show '**OK**') then perform the Carriage Assembly Test ⇒ [Carriage Assembly test on page 98](#).

A new maintenance cartridge is incorrectly detected as ‘used’

This can occur if the printer has detected the previous Maintenance Cartridge was nearly full, and when a new Maintenance Cartridge is installed the front panel displays an error that the cartridge is ‘used’. To resolve the problem, manually reset the counter of the Maintenance Cartridge ⇒ [Reset Life Counters on page 116](#).

Cover sensors are not working

To resolve cover sensor problems, do the following:

1. Check whether the sensor cable is damaged or not connected correctly.
2. Replace the faulty sensor.

The Line Sensor has problems detecting paper

To resolve Line Sensor paper detection problems, do the following:

1. Check the type of paper that is being used: the Line sensor may have problems detecting transparent paper or some types of Non-HP paper. Try loading white HP paper into the printer and check whether the Line Sensor detects it.
2. Excessive ink deposits on the Platen surface can fool the sensor by reflecting the light. Clean the Print Platen.
3. Clean the Encoder Strip ⇒ See [Clean the Encoder Strip on page 450](#).
4. The Line Sensor is not calibrated correctly. Perform the Line Sensor Calibration ⇒ See [Line Sensor calibration on page 139](#).
5. The Line Sensor is damaged or faulty. Replace the Line Sensor ⇒ See [Line Sensor Assembly on page 379](#).

Troubleshooting paper jams and printhead crashes



NOTE: If you were using HP Coated Paper when the problem occurred, see also [Printhead crashes/smears on high-density prints using coated paper on page 13](#).

Paper jams and printhead crashes are grouped together because in many cases a paper jam causes the paper to lift up into the Carriage path and cause a printhead crash, which means that many paper jams are reported as printhead crashes.

| Question | Answer |
|---|--|
| Did the paper jam occur when loading paper? | <p>If paper jams have occurred previously, some pieces of paper may still be stuck in the paper path. Clear the paper path.</p> <p>NOTE: Customers often store used rolls without protecting them from office environmental conditions; when exposed to high humidity, the paper edges tend to curl. This curling can cause paper jams when paper is loaded by feeding paper in without lifting the Media Lever. In these conditions, to avoid paper jams, the recommendation is to load paper by lifting the Media Lever and aligning the paper manually, following the instructions on the front panel.</p> |
| Is the customer using non-HP paper? | <p>The use of non-HP paper can easily be the cause of paper jams and printhead crashes—especially printhead crashes, because HP paper is specially formulated to avoid cockle, one of the primary causes of head crashes. If the paper is not HP-approved, advise the customer to use HP paper and check to see if the problem is now solved.</p> |

 **TIP:** When clearing a paper jam, sometimes paper is stuck in the paper path. To clear this, you must lift the Media Lever and insert thicker paper into the paper path to push out the paper that is still stuck there.

Troubleshooting paper, scan axis and Rewinder Motor shutdown

If a shutdown occurs, you will get the message “Switch Power Off” followed by one of these messages:

- Check Maintenance Cartridge Path
- Check Paper Path
- Check Printhead Path

 **NOTE:** A shutdown in each path will require different steps to resolve the problem as explained below. In each case, make sure that you power off the printer before trying to resolve the problem.

Also check that the Rewinder Motor moves easily (without friction) with the printer turned off.

Maintenance cartridge path

Open the right door of the printer and check for any visible obstacles restricting the movement of the Service Station. Manually move the Service Station, checking for smooth and free movement.

Paper path

To resolve paper path problems, do the following:

1. Open the Window and check for any visible obstacles restricting the movement of the Drive Roller. Make sure that the mylar is not damaged. If there is a wrinkled mass of paper inside the paper path, lift the Pinch wheels (using the Paper Load Handles) and clear the obstruction.
2. If this shutdown happens at the end of a Roll of Paper, it could be because the paper is stuck firmly to the Roll. Lift the Pinch wheels (using the Paper Load Handles) and pull the paper clear.

3. Replace the spindle if broken.
4. Perform the Paper Drive Test to obtain further information on the problem ⇒ [Paper Drive test on page 94](#).

Printhead path

When a shutdown occurs in the Printhead path, you will get the message “Switch Power Off / Check Printhead Path (*). The (*) will be a number, which will give an indication on where the failure occurred.

PWM shutdown

To resolve a PWM shutdown, do the following:

1. Clean Slider Rods and Apply Oil along the complete axis of the Slider Rods. After applying the Oil, perform the Scan-Axis Test ⇒ See [Scan Axis test on page 94](#) and check that the values are within the given limits.
2. Clean the Encoder Strip ⇒ See [Clean the Encoder Strip on page 450](#).
3. Perform the Scan-Axis Test to obtain further information on the problem ⇒ [Scan Axis test on page 94](#).

Velocity shutdown

To resolve a velocity shutdown, do the following:

1. Open the Window and check for any visible obstacles restricting the movement of the Carriage Assembly. Try and move the Carriage Assembly manually, checking for smooth and free movement.
2. Check that the Encoder Strip is clean. If necessary, clean Encoder Strip using a damp cloth.

Energy shutdown

To resolve an energy shutdown, do the following:

1. Clean Slider Rods and Apply Oil along the complete axis of the Slide Rods. After applying the Oil, perform the Scan-Axis Test ⇒ See [Scan Axis test on page 94](#) and check that the values are within the given limits.
2. Clean the Encoder Strip ⇒ See [Clean the Encoder Strip on page 450](#).
3. Perform the Scan-Axis Test to obtain further information on the problem ⇒ [Scan Axis test on page 94](#).

Vacuum suction much lower at high altitudes

At altitudes above 3,000 meters, the vacuum force holding down the paper will be lower, therefore the paper will not be held in place properly causing:

- Ink Smearing on the Paper.
- Printhead crashes against the Paper.
- Roll Paper loading problems (low probability).

Banding at variable extreme environmental conditions

 **NOTE:** This problem is only applicable if the OMAS is disabled.

Since the Accuracy Calibration has been done at normal environmental conditions, printing in extreme environmental conditions will cause banding because the advance of the Drive Roller does not correspond to the same conditions that the calibration was done in. To solve the problem, try the following:

Perform the Accuracy Calibration in the new environmental conditions (see *Using your printer*).

Printhead crashes/smears on high-density prints using coated paper

High-density prints can cause cockle mainly on HP Coated Paper. This causes two main problems:

1. Cockling in the borders - Because the printer places too much ink on the Coated Paper, the borders of the print become raised, causing the Printhead to crash against the paper. To solve the problem, add a 15 mm white margin to the edges of the images.
2. Cockling within the print - If the printer places too much ink within the print, the paper starts to ripple, causing the Printhead to smear against the paper. To solve the problem, try the following:
 - Check in the Front Panel if **Ink Limiting** is ON or OFF. If Ink Limiting is OFF, turn it ON.
 - Avoid using HP Coated Paper for high-density prints. As a substitute, use HP Heavyweight Coated Paper.

Banding due to ink cartridge replacement while printing

Someone has removed an Ink Cartridge while the printer was printing, which has caused the printer to stop. If the user does not replace the Ink Cartridge immediately, when the printer starts to print again, a band will appear in the position where the printing restarted. This is because the wet ink interacts with the dried ink on the paper causing the band to appear. To solve the problem, try the following:

- Do not remove an Ink Cartridge while the printer is printing. Only replace/remove Ink Cartridges between prints.
- If the Ink Cartridge was replaced due to the “Empty” status on the Front Panel, then advise the customer to replace the Ink Cartridge when the “Very Low” status is showing on the Front Panel.
- Reprint the file (without removing the Ink Cartridge).

34-inch Rice Paper not supported

The roll width is 34 inches (non-standard), and the pinch wheels can't control the edge of the paper, causing ink smears and printhead crashes.

Worm marks on HP Coated Paper with light area fills

Light bands (S-shaped) in the direction of the media axis when light area fills are printed, causing an unacceptable print-quality defect.

- Print the Service Configuration Print and check whether the ambient humidity is very low (below 30%). Increasing humidity may help to reduce the severity of the problem.



NOTE: The paper is causing the problem and not the printer. Do not attempt to replace printer parts to solve this problem.

Solving paper-handling problems

The front panel keeps indicating that paper is misaligned or incorrectly positioned.

- The roll may be loaded the wrong way. The paper should load over the roll toward you.
- Check that the paper is correctly loaded onto the spindle.
- The paper may be loaded at an angle. The right-hand edge must be aligned with the blue line on the Print Platen.



NOTE: Ensure that the paper is wrapped tightly on the roll. This is a very important step to remember because if this is not done, the paper may be loaded at an angle, causing the paper to be rejected.

- The Line Sensor may be malfunctioning. See [The Line Sensor has problems detecting paper on page 10](#).

Difficult to load paper: “Too much skew”

If you encounter a high failure rate when loading paper and the Front Panel reports “Too Much Skew” it is likely that:

- The encoder strip must be cleaned (this can be carried out by the customer using the User Maintenance Kit).
- The Line Sensor must be cleaned.
- The Blue Line calibration must be performed. See [Platen blue line calibration on page 148](#).

Troubleshooting a failure with the Take-Up Reel (TUR)

Use this section to troubleshoot failures with the Take-Up Reel.

Take-Up Reel LED status information

| LED status | Issue | Print job interrupted | Possible cause | Print job interrupted? |
|------------------|--------------------------|-----------------------|---|---|
| Blinking quickly | Take-Up Reel not winding | Yes | Sensor beam blocked for more than 3 seconds | Ensure the Take-Up Reel sensors are not blocked by a strip of paper, the collection bin or other objects. Also ensure the Take-Up Reel power switch is in the On position. |
| Blinking slowly | Take-Up Reel not winding | No | The sensor cables are loose or unplugged | Ensure the sensor cables are correctly connected. |

| | | | | |
|-------------|--|----|---|--|
| Solid red | Take-Up Reel not winding | No | There is too much resistance on the Take-Up Reel motor | ENSURE THAT THE TUR Spindle Lever is CLOSED! Ensure the paper is not winding too tightly. A loop-shaping core should be inserted and hanging down. |
| Solid green | Take-Up Reel not winding | No | The Take-Up Reel power switch is in the Off position | Ensure the Take-Up Reel power switch is in the On position. |
| Solid green | Take-Up Reel winding in the wrong direction, and not stopping the job. | No | The Take-Up Reel wind direction switch is in the wrong winding position. After 3 seconds, the printer will recognize the problem and interrupt the print job. In this case, see the first error listed in this table. | Flip the Take-Up Reel wind-direction switch to the correct position. |

 **NOTE:** If the LED is flashing but there is no message on the front panel, restart the printer.

Checking the Take-Up Reel is correctly installed

Many system error codes are displayed as a result of the Take-Up Reel not being installed correctly or because parts have moved or become dislodged from their correct positions. This troubleshooting procedure checks the mechanical installation of the Take-Up Reel.

1. Check that the Take-Up Reel sensor unit is correctly installed on the right foot.

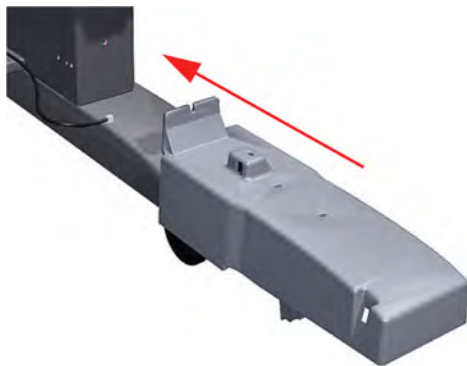

2. To correctly install the foot, the wheel has to be positioned as shown.

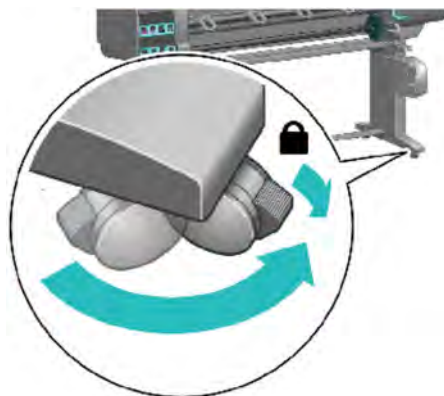

3. Check the cables linking the sensors to the Take-Up Reel Motor Assembly are correctly connected.



4. Check that the Take-Up Reel motor assembly is correctly connected to the rear of the printer.

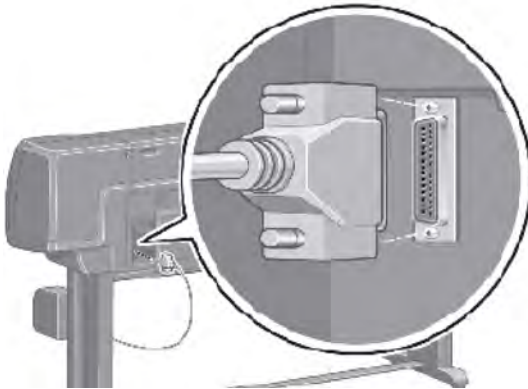

How the Take-Up Reel works

When selecting the front panel's Paper menu, if there is no line **Take-Up Reel installed**, this indicates that the Take-Up Reel has not been enabled at the front panel. This does not mean that the Take-Up Reel will not work; it just means that, if there is a paper jam detected by the Take-Up Reel, there will be no warning system error displayed on the front panel. The printer will not stop.

How to install the Take-Up Reel

From the Paper menu > **Take-Up Reel** > **Enable Take-Up Reel**. After this is done, you will notice the following differences:

- In case of Take-Up Reel Paper jam system error, a warning is reported on the front panel, and the printer pauses.
- The cutter is disabled between jobs.
- When unloading the paper, the front panel will ask you to cut the paper manually.

How it works

When the bottom of the 'loop shaper' is low enough and it cuts the signal between the two sensors, the Take-Up Reel starts to move the motor until the signal between the two sensors is passing through again.

If, after a few seconds of turning the Take-Up Reel, the signal between two sensors is still cut, the Take-Up Reel reports a 'Take-Up Reel paper jam' error:

- In all cases, the LED of the Take-Up Reel is blinking quickly.
- If the Take-Up Reel is enabled at the front panel, a Take-Up Reel paper jam will be displayed.

How to read the power switch LEDs

In certain circumstances, the LEDs located on top of the power switch (located at the rear of the printer) indicate the status of power supply to the printer.



Amber is on the Left
Blue is in the center
Green is on the Right

Make sure you look directly at the LEDs and not at an angle.

1. When only the **Amber LED** is On:
 - The printer has been switched Off from the Front Panel (after having pressed the On/Off button).
 - The Power Supply Unit only delivers a 5 V “Standby”; power that is needed to restart the printer after the Front Panel On/Off button is pressed (the Formatter will start the printer).
2. When the **Blue LED** is On: Deliver standard “ATX” power for the Electronics Module PCAs (+12V, +5V, -5V, -12V, etc...). All the functions of the Electronics Module are fully operational (EWS, etc...).
3. When the **Green LED** is On: Deliver “analog” 24V and 36V to enable printing.

If you turn on the printer at the front panel, and the Blue LED does not come on, there is a problem. Turn off the printer using the switch at the rear, then turn it on again using the same switch. If the Blue LED still does not come on, replace the Power Supply Unit.

If the Blue LED comes on this time, you will probably see an error reported on the front panel as the printer starts up. If no error is reported, but you continue to have problems when turning on the printer from the front panel, see [How to read the Formatter LEDs on page 19](#).

How to read the Formatter LEDs

The LEDs located on the Formatter can help to troubleshoot the printer. The LEDs can either be on or off; different combinations can indicate different problems.

The following image shows the three Formatter LEDs, which are numbered from the top down: number I at the top, number II in the middle, number III at the bottom.



Use the following table to interpret the LEDs and find the source of the problem. Remember that you should read these LEDs when you push the [Power](#) button.

Some combinations may require you to replace two or more components. In this case, always replace one component at a time. Test the printer to see if the problem has disappeared (check the LEDs again). If the same LED sequence continues, replace the next component indicated in the table.

| Power amber LED | Power blue LED | Power green LED | Formatter I LED | Formatter II LED | Formatter III LED | Front panel status | Problem and recommendations |
|-----------------|----------------|-----------------|-----------------|------------------|-------------------|--------------------|--|
| Off | Off | Off | Off | Off | Off | Off | <p>The printer is not receiving electrical power.</p> <ol style="list-style-type: none"> 1. Ensure that the printer is connected to the power outlet. 2. Ensure that the outlet delivers the expected power. 3. Replace the Power Supply Unit. |
| On | Off | Off | Off | Off | Off | Off | <p>The Power key fails to turn on the printer.</p> <ol style="list-style-type: none"> 1. Turn the printer off using the switch at the rear, and disconnect the power cord. Reconnect the power cord and turn on the printer using the switch at the rear. 2. If the problem persists, replace the Front Panel. |

| Power amber LED | Power blue LED | Power green LED | Formatter I LED | Formatter II LED | Formatter III LED | Front panel status | Problem and recommendations |
|-----------------|----------------|-----------------|-----------------|------------------|-------------------|--------------------|---|
| Off | On | Off | Off | Off | Off | Off | <p>There is a power failure in the Formatter.</p> <ol style="list-style-type: none"> 1. Reseat the power connector in the Formatter, and remove the Formatter. 2. Turn the printer on again. 3. If the problem persists, replace the Power Supply Unit. 4. If the problem persists, replace the Formatter. 5. If the boot process starts, replace the Formatter. |
| Off | On | Off | On | Off | Off | Off | <p>The Formatter BIOS is unable to start.</p> <p>If an external Memory Module is installed:</p> <ol style="list-style-type: none"> 1. Reseat the Memory Module. 2. Remove the Memory Module and restart the printer. 3. If the printer is able to start normally, replace the Memory Module. If not, replace the Formatter. <p>If an external Memory Module is not installed, replace the Formatter.</p> |
| Off | On | Off | Flashing | Off | Off | Off | <p>The Formatter BIOS cannot detect the Hard Disk Drive.</p> <ol style="list-style-type: none"> 1. Reseat the Hard Disk Drive connectors. 2. Replace the Hard Disk Drive. |
| Off | On | Off | On | Flashing | Off | Off | <p>The operating system has experienced a fatal error. Replace the Hard Disk Drive.</p> |
| Off | On | Off | On | On | Off | Off | <p>There is a communication failure in the Formatter.</p> <ol style="list-style-type: none"> 1. Reseat the Formatter. 2. Replace the Formatter. |
| Off | On | Off | On | On | Flashing | Off | <p>There is an initialization failure in the Formatter. Replace the Formatter.</p> |
| Off | On | Off | On | On | On | Off | <p>There is an initialization failure in the Front Panel.</p> <ol style="list-style-type: none"> 1. Reseat the Front Panel cable. 2. Replace the Front Panel. |

If the front panel turns on and then stops

If the power-up process stops while the front panel is displaying a number, respond as follows.

1. If the printer's Power-Up process stops when the front panel is displaying the number **17**, this indicates that there is a problem with the file system on the printer's Hard Disk Drive, so the printer is checking the whole file system and making any necessary corrections. This problem can arise when there has been a power cut while the printer was switched On, or if there is a physical problem with the Hard Disk Drive.

Checking the whole file system normally takes about half an hour (but could take much longer). There is nothing that can be done to speed up the file checking process. If you turn Off the printer during the checking process, the file system check will restart whenever you turn it On again

If you experience this problem repeatedly when there has been no power cut, then this could mean that the Hard Disk Drive is faulty. In this case, replace the Hard Disk Drive ⇒ See [Hard Disk Drive \(HDD\) on page 364](#).

2. If the printer's start-up process stops when the front panel is displaying any other number between **1** and **30**, then try the following:
 - Turn the power off at the rear of the printer and disconnect the power cord. Reconnect the power cord and turn on the printer.
 - If the printer continues to stop during the power-up process, replace the Hard Disk Drive ⇒ See [Hard Disk Drive \(HDD\) on page 364](#).

How to interpret the Service Information Pages

The Service Information Pages contain the following information:

- Current Configuration
- Current Information
- Usage Information
- Event Logs
- Calibration Status
- Connectivity Configuration
- All Pages

It is possible to print the Service Information Pages either through the Front Panel or through the Embedded Web Server:

- Front Panel:  icon > **Service information prints.**

- Embedded Web Server: **Support tab > Service support > Printer information.**

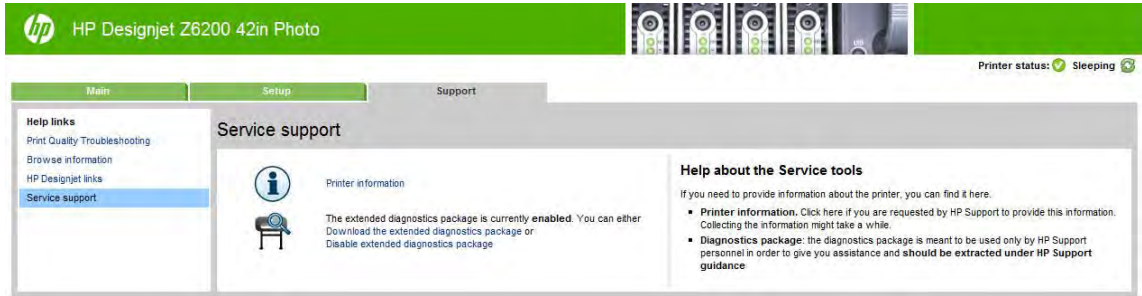

Even if the printer cannot print, the Information Pages are still accessible through the Embedded Web Server.

Main characteristics

- Only available in English (except the current information page).
- From the Front Panel, you can choose to print ALL pages or just select the specific pages that are needed. If ALL pages are printed:
 - Nesting is turned ON automatically (and turned OFF once all the pages have been printed).
 - Nesting cannot be mixed with other jobs in the queue.
- Each page can be printed from the Web browser when using the Embedded Web Server.
- Each page can be sent by e-mail from the Web Browser when using the Embedded Web Server (File ⇒ Send ⇒ Page by E-mail).
- You can see the same information through the Front Panel or the Embedded Web Server.

Current configuration

This page contains full details of the current configuration of the printer.

Current configuration | **Current information** | Usage information | Event logs | Calibration status | Connectivity configuration | All pages

HP Designjet Z6200 42in Photo (CQ109A)

Current configuration

Date: 07-Oct-10
 Serial number: XXXXXXXXXX
 Firmware version: K11N_01_00_05.1
 Virtual Memory: 32.0 GB
 Physical Memory: 1.00 GB RAM
 Disk capacity: 160.0 GB
 Paper Type: Coated Paper
 Paper Source: Roll 2

Connectivity -> Gigabit Ethernet
 - General Configuration
 Link state: Up
 Host name: NP0040CAA6511B.emea.hpqcorp.net
 mDNS service name: HP Designjet Z6200 42in Photo [A6511B]
 MAC address: 0040CAA6511B
 - IPv4 Configuration
 IP address: 16.23.87.3
 Config. by: DHCP
 Subnet mask: 255.255.248.0
 Default gateway: 16.23.80.1
 - IPv6 Configuration
 Link-Local: fe80::240:caff:fea6:511b
 See Connectivity Configuration internal print

Setup -> Front panel options
 Language: English
 Display contrast: 50 %
 Buzzer: On

Setup -> Print retrieval
 Drying time: On
 Cutter: On

Setup -> Printing preferences -> Color options
 Color/Grayscale: Print in color
 RGB input profile: None (Native)
 Printer emulation: Off

Setup -> Job management options
 Queue: On
 When to start printing: Optimized
 Max. number of printed jobs: 32 jobs
 Job recovery mode: Put on hold

Setup -> Printing preferences -> Paper options
 Paper size: Automatic
 Remove top/bottom blanks: Off
 Resize: 100 %
 Rotate: 0 °

Setup -> Printing preferences -> Margins
 Nesting: Off
 Wait time: 1 min

Connectivity -> Advanced
 I/O timeout: 30 sec
 Allow EWS: On
 Allow SNMP: On

Setup -> null
 Unit selection: Metric
 Sleep mode wait time: 30 min

Connectivity -> Advanced -> Web Services
 Printer utility software: Enabled
 Color and paper management: Enabled

Setup -> Printing preferences -> Print quality
 Quality level: Normal
 Maximum detail: Off

Setup -> Printing preferences -> HP-GL/2 options
 Palette: Software
 Merge: Off

Setup -> Printing preferences -> HP-GL/2 options -> Define palette

| Factory | | Palette A | | Palette B | |
|---------|-------------|-----------|-------------|-----------|-------------|
| Pen no. | Width Color | Pen no. | Width Color | Pen no. | Width Color |
| 0 | 0.13 mm | 0 | 0.13 mm | 0 | 0.13 mm |
| 1 | 0.18 mm | 1 | 0.18 mm | 1 | 0.18 mm |
| 2 | 0.25 mm | 2 | 0.25 mm | 2 | 0.25 mm |
| 3 | 0.35 mm | 3 | 0.35 mm | 3 | 0.35 mm |
| 4 | 0.50 mm | 4 | 0.50 mm | 4 | 0.50 mm |
| 5 | 0.65 mm | 5 | 0.65 mm | 5 | 0.65 mm |
| 6 | 0.70 mm | 6 | 0.70 mm | 6 | 0.70 mm |
| 7 | 0.80 mm | 7 | 0.80 mm | 7 | 0.80 mm |
| 8 | 0.90 mm | 8 | 0.90 mm | 8 | 0.90 mm |
| 9 | 1.00 mm | 12 | 1.00 mm | 12 | 1.00 mm |
| 10 | 1.40 mm | 19 | 1.40 mm | 19 | 1.40 mm |
| 11 | 2.00 mm | 27 | 2.00 mm | 27 | 2.00 mm |
| 12 | 3.00 mm | 35 | 3.00 mm | 35 | 3.00 mm |
| 13 | 5.00 mm | 68 | 5.00 mm | 68 | 5.00 mm |
| 14 | 8.00 mm | 100 | 8.00 mm | 100 | 8.00 mm |
| 15 | 12.00 mm | 110 | 12.00 mm | 110 | 12.00 mm |

Current information

This page contains the following information:

- Current Printer Configuration
- Paper Loaded Information
- Current Printhead Kit Information
- Current Ink Cartridge Information
- Supported Cartridges

Current configuration | Current information | Usage information | Event logs | Calibration status | Connectivity configuration | All pages

Current Media, Printhead and Ink Information (1 of 2)

Date: 07-Oct-10 Product: HP DesignJet Z6200 42in Photo Serial Number: XXXXXXXXXX
 Firmware: KHN_01_00_05.1 Product number: CQ109A Service ID: 0
 Printer status: Sleeping

Current Printer Configuration

Language: English Virtual Memory: 32.0 GB
 Disk capacity: 160.0 GB Physical Memory: 1.00 GB RAM

Paper Loaded Information

Current Printhead Kit Info (I)

| | Warranty status | Status | Error ID Code | Product Number |
|-----------------|-----------------|--------|---------------|----------------|
| 1 - Matte black | In warranty | OK | 0 | C5058A |
| 2 - Matte black | In warranty | OK | 0 | C5058A |
| 3 - Dark Gray | In warranty | OK | 0 | C5058A |
| 4 - Dark Gray | In warranty | OK | 0 | C5058A |

Current Printhead Kit Info (II)

| | Product Name | Serial Number | Warranty Date |
|-----------------|--------------|---------------|---------------|
| 1 - Matte black | HP 90 | | 19700101 |
| 2 - Matte black | HP 90 | | 19700101 |
| 3 - Dark Gray | HP 90 | | 19700101 |
| 4 - Dark Gray | HP 90 | | 19700101 |

Current Printhead Kit Info (III)

| | Used non-HP ink | Used expired ink | Ink Used | Warranty Spent |
|-----------------|-----------------|------------------|----------|----------------|
| 1 - Matte black | false | false | 0 ml | 0% |
| 2 - Matte black | false | false | 0 ml | 0% |
| 3 - Dark Gray | false | false | 0 ml | 0% |
| 4 - Dark Gray | false | false | 0 ml | 0% |

Current Printhead Kit Info (IV)

| | Usage Time | Max. Recovery Level | Scan Axis Shutdown |
|-----------------|------------|---------------------|--------------------|
| 1 - Matte black | 0 h | 0 | 0 |
| 2 - Matte black | 0 h | 0 | 0 |
| 3 - Dark Gray | 0 h | 0 | 0 |
| 4 - Dark Gray | 0 h | 0 | 0 |

Current Media, Printhead and Ink Information (2 of 2)

Date: 07-Oct-10 Product: HP DesignJet Z6200 42in Photo Serial Number: XXXXXXXXXX
 Firmware: KHN_01_00_05.1 Product number: CQ109A Service ID: 0
 Printer status: Sleeping

Current Ink Cartridge Info (I)

| | Status | Product Name | Product Number | Serial Number | Install Date |
|-------------|--------|--------------|----------------|---------------|--------------|
| Matte black | OK | | CGGMSA | 2689060-49-9 | 20101005 |
| Dark Gray | OK | | CGGLMA | 2689060-49-9 | 20101005 |

Current Ink Cartridge Info (II)

| | Expiration Date | Manufacturer | Capacity | Level | Used non-HP Ink |
|-------------|-----------------|--------------|----------|-------|-----------------|
| Matte black | 20130221 | | 111 ml | 100 % | false |
| Dark Gray | 20130221 | | 111 ml | 100 % | false |

The first two lines are available at the beginning of each Service Information Page and contains standard information (like Service ID, firmware version).

Printer usage information

This page contains the following information:

- Printer Usage
- Usage per Printhead Slot
- Usage per Cartridge Slot
- Media Usage per Paper Type
- Component Usage
- Spittoon Usage
- Preventive Maintenance Usage

| Current configuration | Current information | Usage information | Event log | Calibration status | Connectivity configuration | All pages | |
|---------------------------------------|--|-------------------------------------|-------------------------------|---|----------------------------|--------------|---|
| Printer Usage Information | | | | | | | |
| Date: | 07-Oct-10 | Product: | HP DesignJet Z6200 42in Photo | | Serial Number: | XXXXXXXXXX | |
| Firmware: | KHN_01_00_05.1 | Product number: | CQ109A | | Service ID: | 0 | |
| Printer status: | | | | | | Sleeping | |
| Printer Usage | | | | | | | |
| Total printed media: | 0.00 m ² / 0.00 ft ² | | Total number of prints: | 0 | | | |
| Usage per Printhead Slot | | | | | | | |
| | Color | Product Number | Printheads Used | Total Insertions | | | |
| Slot 1 | Matte black-Matte black | C5058A | 1 | 1 | | | |
| Slot 2 | Matte black-Matte black | C5058A | 1 | 1 | | | |
| Slot 3 | Dark Gray-Unknown | C5058A | 1 | 1 | | | |
| Slot 4 | Dark Gray-Unknown | C5058A | 1 | 1 | | | |
| Usage per Cartridge Slot | | | | | | | |
| | Product Number | | Usage | | | | |
| 1 - Matte black | | | 0 Cartridges / 0.0 cc | | | | |
| 1 - Matte black | | | 0 Cartridges / 0.0 cc | | | | |
| 1 - Matte black | | | 0 Cartridges / 0.0 cc | | | | |
| 1 - Matte black | | | 0 Cartridges / 0.0 cc | | | | |
| 1 - Matte black | | | 0 Cartridges / 0.0 cc | | | | |
| 2 - Dark Gray | | | 0 Cartridges / 0.0 cc | | | | |
| 2 - Dark Gray | | | 0 Cartridges / 0.0 cc | | | | |
| 2 - Dark Gray | | | 0 Cartridges / 0.0 cc | | | | |
| 2 - Dark Gray | | | 0 Cartridges / 0.0 cc | | | | |
| 2 - Dark Gray | | | 0 Cartridges / 0.0 cc | | | | |
| Media Usage per Media Type | | | | | | | |
| Component Usage | | | | | | | |
| Belt usage (# cycles): | 0 | Motor usage (# cycles): | 0 | Cutter usage (# cycles): | 0 | | |
| Trailing cable usage (# cycles): | 0 | Tube ISS usage (# cycles): | 0 | Tube Primer (cc): | 0 | | |
| Motor usage (Working time in hours): | 0 | Bushings life (# cycles): | 0 | Color Sensor Aerosol Exposure (# cycles): | 0 | | |
| Color sensor life (hours): | 0 | Drop detector working time (hours): | 0 | Power Off Cycles: | 3 | | |
| Power On Cycles: | 18 | Service Station Cycles: | 300 | Pen On/Off Cycles: | 0 | | |
| Plug Time (hours): | 904 | Correct profiles: | 0 | Total Profiles: | 0 | | |
| Scan Axis run distance (meters): | 0 | Line Sensor Life (hours): | 0 | Working time (hours): | 0 | | |
| Number of OMAS Navigation fails: | 0 | Number of OMAS Navigation OK: | 0 | OMAS Paper length (meters): | 0 | | |
| SOL Ink Used (cc): | 0 | Encoder Strip Ink Used (cc): | 0 | Total CLCs: | 0 | | |
| Correct CLCs: | 0 | | | | | | |
| Spittoon Usage | | | | | | | |
| Left Spittoon: | 0 | Maintenance Cartridge: | 0 | Drop Detector Spittoon Ink Volume: | 0 | Aerosol FAN: | 0 |
| Preventative maintenance Usage | | | | | | | |
| Preventive maintenance kit #1 | | | | | | 0 % | |
| Preventive maintenance kit #2 | | | | | | 0 % | |
| Job Accounting | | | | | | | |
| Date | Job name | Optimized for | Image quality | Max detail | | | |

Media used sections

- Total media used in the printer
- Media used for each media type



NOTE: If the Hard Disk Drive is replaced, the media used for each media type will be set to zero.

Printhead section

The Printheads section displays the Printhead usage per slot.

- **Total Insertions:** This is linked with the crane of the Ink Supply Tubes. When the Ink Supply Tubes are replaced, the total insertions will be reset to zero.

Cartridge section

The Ink Cartridges section displays the ink usage per cartridge.

Preventive maintenance section

Once the value reaches 100%, the corresponding Preventive Maintenance Kit should be used. For further details, see [Preventive maintenance on page 447](#).

Component usage

One cycle is counted when the Carriage makes one movement to the left of the printer and then returns to the right.

Spittoon section

This section contains information on the different Spittoons located in the printer.

Event logs

This page contains the following information:

- Last 20 System Error Codes (which prevented the printer from booting)
- Last 20 System Warnings (which did not prevent the printer from booting, but which required the user to acknowledge the problem)
- Printhead Error log

| System Errors | | | | | | | |
|---------------|----------|------------|---------------|------------|-------------|------|------|
| Event # | Severity | Error Code | Internal Code | FW Version | Media Usage | Line | Date |

| System Warnings | | | | | | | |
|-----------------|----------|------------|---------------|------------|-------------|------|------|
| Event # | Severity | Error Code | Internal Code | FW Version | Media Usage | Line | Date |

| Printhead Error Log | | | | | | | |
|---------------------|---------------|--------|------------|------------|--------------------|------------|--|
| Printheads name | Serial Number | Status | Usage time | % Ink Used | Max Recovery Level | Error Code | |

System/Warning error

- The **Line** and **Internal Code** do not provide much information, but are useful in the case of escalating a problem to the division (different internal error codes can point to the same error code (e.g. 01.10:10)).
- **Media Usage** (in square meters) and **Date** (from the printer's Internal Clock (RTC)) help you to understand if the printer has been used (media usage) and how much time has passed since the last error.

Printhead error log

- **Printheads ago:** History of the last three Printheads used ('0' represents the current Printhead used).
- **Status:** '0' = Working, '1' = No Printhead Detected, '2' = Replace, '4' = Reseat, '8' = Remove.
- **% Ink Used:** Percentage of the warranty life (1200 ml).
- **Error Code:** Specific error code generated by the printer when the Printhead has been replaced.
- **Max Recovery:**
 - 0: No manual Printhead recovery has been performed on the Printhead.
 - 1 or higher: At least one Printhead recovery has been performed.

Calibration status

This page contains the following information:

- General Calibrations (performed by service engineers)
- Media-specific Calibrations (performed by the customer)
- Printer Status Codes

| Current configuration | Current information | Usage information | Event logs | Calibration status | Connectivity configuration | All pages |
|---|---------------------|-------------------------------|-------------------------------|-------------------------|----------------------------|------------|
| Calibration Status | | | | | | |
| Date: | 07-Oct-10 | Product: | HP DesignJet Z6200 42in Photo | | Serial Number: | XXXXXXXXXX |
| Firmware: | KHL_01_00_05.1 | Product number: | CQ109A | | Service ID: | 0 |
| Printer status: | | | | | | Sleeping |
| General Calibrations | | | | | | |
| Printhead alignment | not done | Drop Detector calibration | not done | Line Sensor calibration | not done | |
| Media-specific Calibrations | | | | | | |
| Media Name | Color | Date | Paper Advance | Date | | |
| HP Bright White Inkjet Paper | N/A | - | Default | - | | |
| HP Premium Matte Photo Paper | Recommended | - | Default | - | | |
| Proofing Gloss Paper | Recommended | - | Default | - | | |
| HP Artist Matte Canvas | Recommended | - | Default | - | | |
| Bright White Bond Paper | N/A | - | Default | - | | |
| HP Collector Satin Canvas | N/A | - | Default | - | | |
| HP Matte Film | N/A | - | Default | - | | |
| HP Professional Matte Canvas | Recommended | - | Default | - | | |
| Matte Film | N/A | - | Default | - | | |
| Photo Matte Paper | Recommended | - | Default | - | | |
| Canvas | Recommended | - | Default | - | | |
| HP Colorfast Adhesive Vinyl | Recommended | - | Default | - | | |
| Indoor Banner | Recommended | - | Default | - | | |
| Adhesive Vinyl | Recommended | - | Default | - | | |
| HP Everyday Pigment Ink Satin Photo Paper | Recommended | - | Default | - | | |
| HP Universal Instant-dry Photo Semi-Gloss | Recommended | - | Default | - | | |
| HP Super Heavyweight Plus Matte Paper | Recommended | - | Default | - | | |
| Plain Paper | N/A | - | Default | - | | |
| HP Professional Satin Photo Paper | Recommended | - | Default | - | | |
| HP Clear Film | N/A | - | Default | - | | |
| Super Heavyweight Coated Paper | Recommended | - | Default | - | | |
| HP Premium Instant-dry Photo Satin | Recommended | - | Default | - | | |
| Transparent/Clear Film | N/A | - | Default | - | | |
| HP Durable Banner with DuPont™ Tyvek® | Recommended | - | Default | - | | |
| HP Vellum paper | N/A | - | Default | - | | |
| Vellum paper | N/A | - | Default | - | | |
| HP Matte Litho-realistic Paper | Recommended | - | Default | - | | |
| Fine Art Paper (more ink) | Recommended | - | Default | - | | |
| Photo Gloss/Semi-Gloss/Satin Paper (less ink) | Recommended | - | Default | - | | |
| HP Everyday Pigment Ink Gloss Photo Paper | Recommended | - | Default | - | | |
| HP Universal Instant-dry Photo Gloss | Recommended | - | Default | - | | |
| HP Universal Heavyweight Coated Paper | Recommended | - | Default | - | | |
| HP Heavyweight Coated Paper | Recommended | - | Default | - | | |
| HP Premium Instant-dry Photo Gloss | Recommended | - | Default | - | | |
| Heavyweight Coated Paper | Recommended | - | Default | - | | |
| HP Everyday Adhesive Matte Polypropylene | Recommended | - | Default | - | | |
| HP Translucent Bond | N/A | - | Default | - | | |
| Proofing Matte Paper | Recommended | - | Default | - | | |
| Translucent Bond | N/A | - | Default | - | | |
| Adhesive Polypropylene | Recommended | - | Default | - | | |
| Photo Gloss/Semi-Gloss/Satin Paper (more ink) | Recommended | - | Default | - | | |
| Fine Art Paper | Recommended | - | Default | - | | |
| HP Universal Coated Paper | Recommended | - | Default | - | | |
| Backlit Material (more ink) | N/A | - | Default | - | | |
| HP Coated Paper | Recommended | - | Default | - | | |
| HP Recycled Bond Paper | N/A | - | Default | - | | |
| Coated Paper | Recommended | - | Default | - | | |
| HP Premium Vivid Color Backlit Film | N/A | - | Default | - | | |
| Backlit Material | N/A | - | Default | - | | |
| HP Natural Tracing Paper | N/A | - | Default | - | | |
| Proofing Semi-Gloss/Satin Paper | Recommended | - | Default | - | | |
| Natural Tracing Paper | N/A | - | Default | - | | |
| HP Opaque Scrim | Recommended | - | Default | - | | |
| Scrim Banner | Recommended | - | Default | - | | |
| Photo Gloss/Semi-Gloss/Satin Paper | Recommended | - | Default | - | | |
| Canvas (more ink) | Recommended | - | Default | - | | |
| HP Universal Bond Paper | N/A | - | Default | - | | |
| HP Universal Matte Canvas | Recommended | - | Default | - | | |
| Printer Status Codes | | | | | | |
| Nozzle Health | 1111X1X1 | Printhead Alignment | | | 0000X0X0 | |
| Media Advance Calibration | 00000000 | Closed Loop Color Calibration | | | 0000X0X0 | |

General calibrations

- **Printhead Alignment** relates to the Printhead Alignment which changes to 'pending' when a Printhead is replaced and the Printhead Alignment has not been performed.



NOTE: When a component is replaced, the corresponding calibration is not automatically set to 'NOT DONE'. This is because the printer does not know that there is a new part installed.

- **Drop Detector** relates to the Drop Detector or Service Station calibration.
- **Line Sensor** relates to the Line Sensor Calibration.

Media-specific calibrations

This section shows the following for each type of media:

- Media Name
- Color calibration and date
- Paper Advance calibration and date

Printer status codes

This section shows status codes for the following:

- Nozzle Health
- Media Advance Calibration
- Printhead Alignment
- Closed Loop Color Calibration

These codes may be useful to detect potential print-quality issues. Several suggested actions are linked with these codes, and are displayed in the Embedded Web Server and the front panel.

Connectivity configuration

This page contains full details of the current configuration of the printer.

Current configuration | Current information | Usage information | Event logs | Calibration status | Connectivity configuration | All pages

Connectivity Configuration

Date: 07-Oct-10 Product: HP Designjet Z6200 42in Photo Serial Number: XXXXXXXXXXXX
 Firmware: KHN_01_00_05.1 Product number: CQ109A Service ID: 0
 Printer status: Sleeping

```

===== IO DIAGNOSTIC PAGE =====
----- Gigabit Ethernet -----
Installed: yes
IP enabled: yes
Printing enabled: yes
Firewall enabled: yes
----- JetDirect EIO -----
Installed: no
Printing enabled: no
----- USB -----
Installed: yes
Printing enabled: yes
  
```

Connectivity Configuration

Date: 07-Oct-10 Product: HP Designjet Z6200 42in Photo Serial Number: XXXXXXXXXXXX
 Firmware: KHN_01_00_05.1 Product number: CQ109A Service ID: 0
 Printer status: Sleeping

```

===== Gigabit Ethernet =====
----- General Information -----
Status: I/O Card Ready
Model Number: CQ109A
Hardware Address: 0040CARA6511B
Firmware Version: KHN_01_00_05.1
Port Config: AUTO
Auto Negotiation: On
----- Security Settings -----
IPsec: Disabled
Secure Web: HTTPS Optional
Cert Expires: 2015-07-15 00:00 UTC
SNMP Versions: 1:2
SNMP Set Cmty Name: Not Specified/Default
SNMP Get Cmty Name: Not Specified/Default
----- Network Statistics -----
Total Packets Received: 3386513
Unicast Packets Received: 2909483
Bad Packets Received: 0
Framing Errors Received: 0
Total Packets Transmitted: 75580
Unsendable Packets: 0
Transmit Collisions: 0
Transmit Late Collisions: 0
----- TCP/IP -----
IPv4: Enabled
IPv6: Enabled
Host Name: NPI0040CARA6511B
IPv4 Domain Name: emea.hpqcorp.net
IPv6 Domain Name: Not Specified
Primary DNS Server: 16.110.135.51
Secondary DNS Server: 16.110.135.52
DNS (IPv6): Not Specified
WINS Server: 16.234.57.247
Idle Timeout: 280 sec
----- IPv4 -----
Status: Ready
IP Address: 16.23.87.3
Subnet Mask: 255.255.248.0
Default Gateway: 16.23.80.1
Config By: DHCP
DHCP Server: 16.234.57.250
----- IPv6 -----
Status: Ready
Link-Local: fe80::240:caff:fea6:511b
Stateless: Not Configured
DHCPv6: Not Configured
Manual: Not Configured
----- Bonjour Service Name -----
HP Designjet Z6200 42in Photo [A6511B]
  
```

When the main window is open and the printer is printing (safety compliance)

We describe the details of the behavior of the printer when the window is opened while the carriage is moving.

If the main window is opened while the printer is doing something, be it a swath of a print job or a system task, the printer will:

1. Before the carriage stops, it will finish whatever it was doing when the window was opened. It will not finish an image it was printing, but it will finish the current swath, so as to avoid any impact on image quality. If it was performing a system task it will finish it before stopping.
2. If the carriage finishes on the left side of the printer, the carriage will always slowly move to the right side of the printer.
3. The printheads will be placed in their 'capping' positions.

Here are some different scenarios of what happens when the window is opened:

- If the printer is printing an image when the window is opened: The carriage will not stop immediately, the printer will finish the swath and then stop. If the cover is then closed, the printer will start to print from the position it was stopped.
- If the printer is cutting the media: The carriage finishes the cutting procedure.
- If the printer is checking the SKEW while loading the media: During the skew check, the printer does small movements of the carriage on the right side of the printer, and also moves the media when needed. This procedure checks that the edge of the media is moving laterally or not. If the window is opened while the printer is checking the media SKEW, the printer will complete the skew procedure (and it will continue well after the window has been opened). This is the only case when the printer will not stop the carriage at the end of a lateral movement (as a swath).

The safety system in place is designed to detect an object in the path of the carriage as it moves across the printer, any object encountered will cause the system to shut down the driver motor in the carriage. This method of ensuring safety is considered sufficient by the regulatory agencies that inspect and assess the product prior to its placement in the market. The window and its switch are considered a 'supplementary' safety feature, and as such the behavior of the switch has been adjusted as a trade off between the level of safety provided and the printer's functionality.

How to troubleshoot the 79:04 system error

- [Introduction](#)
- [Possible causes](#)
- [Troubleshooting based on symptoms](#)

Introduction

The System error 79:04 is a generic firmware error (equivalent to a blue screen in Windows). It's the System Error that the printer will display when an unknown exception occurs that cannot be pointed to by any specific subsystem of the printer.

Since this is a generic error, there can be multiple causes behind it. This document will cover the most probable causes behind a system error 79:04 and will recommend the most efficient troubleshooting steps to resolve customer issues.

One important point to mention is that, although 79:04 system errors can be caused by a hardware malfunction, the vast majority of 79:04 system errors are pure software or firmware issues. In these cases the issue can only be solved by determining the root cause and implementing a solution. The solution can usually be applied by either correctly configuring a selection, updating the printer's firmware/software that is being used or by fixing an error in the code).

Possible causes

Since the 79:04 system error is a generic error, the number of possible causes behind it is large. The majority can be grouped, however, into the following groups:

Table 1-2 Job related SE79:04

Job related SE79:04

A specific print job that is not correctly formatted for the printer or that is not correctly processed by it can trigger a 79:04 system error.

The incorrect format or processing can come from two sources:

- **Incorrect commands in the job itself. For example, a PS job with some commands that do not have the correct PS format.**

- **Issues applying to the settings in the job**

| Cause | Solution |
|---|---|
| <p>79:04 caused by a print job always have the same symptoms:</p> <ul style="list-style-type: none"> 1. The job is received by the printer and starts to process. 2. In the middle of the processing, the printer stops and displays 79:04. 3. The printer will display the 79:04 system error again immediately after restart. This is due to the fact that the printer will try to reprint the job, which is pending in the queue, after restart. 4. After the second restart, the printer will start up normally 5. If the same job is sent again, it will always produce a 79:04 system error <p>These types of 79:04 system errors are normally caused by jobs that have been generated by 3rd party applications (RIPs, 3rd party drivers, files exported by an application to PS, PDF, HP-GL/2, RTL, ... or any other format supported by the printer). Jobs generated by HP drivers will not normally generate 79:04 system errors, since the output that our drivers generate is very controlled and has been designed taking into consideration the characteristics of our printer's language interpreters.</p> <p>There is an exception to this general rule: there are certain applications that can generate their own PS code (Adobe PhotoShop, Adobe Illustrator, Adobe Acrobat, Corel Draw, Freehand, QuarkXpress, ...). When used with a PS driver, these applications generate the output PS themselves, instead of using the driver's rendering capabilities. This is known as PostScript pass-through. So, when using an HP PostScript driver together with an application that has PS passthrough capabilities, the PS code that comes into the printer has not been rendered by the HP driver, and, should the source file contain any PS commands that are not correctly processed by the printer, a 79:04 system error could occur even though an HP driver is being used.</p> | <p>When a job consistently generates a 79:04 system error, it is either because of a issue in the printer's firmware or because of a defect in the job itself (when it has been generated by 3rd party SW). In order to identify the cause and find out a solution, these issues should always be immediately escalated to the GBU through the GCC.</p> <p>Also, there are a set of workarounds and short term solutions that can be tested in order to get the customer up and running in the shortest possible time:</p> <ol style="list-style-type: none"> 1. Send the job using a variety of different settings. Many times, the issue is caused by a combination of the job contents combined with some specific setting(s). 2. If the customer is sending the file directly to the printer, try using the HP driver instead. 3. If the issue is occurring when printing through the HP PostScript driver from an application with PS passthrough, try changing the options in the application so that it prints PS as raster (the option is typically located in the 'Advanced' options of the application's printing dialog). |

Table 1-3 Data related SE79:04

Data related SE79:04

HP Designjet printers have Hard Disks and non-volatile memories that contain data bases and files that can be modified with user data. Some examples include:

- The printer’s queue
- The hard drive partitions that contain user jobs
- The data base that stores the printer settings
- The data base that stores accounting information

Some of this data is accessed by the printer at start up, and some others are accessed as needed.

If any of this fields contains corrupt data or data with characters or values that cannot be correctly processed by the printer, a 79:04 system error may occur.

| Cause | Solution |
|--|--|
| <p>There are two different types of symptoms for data related 79:04 system errors:</p> <ul style="list-style-type: none"> • <ol style="list-style-type: none"> 1. When the corrupt data is accessed during start up: <ol style="list-style-type: none"> a. The printer will display a 79:04 during the start up process b. Switching the printer off and on again will not solve the issue. The printer will continue displaying the 79:04 system error until the corrupt data has been cleared through a service procedure. 2. When the corrupt data is accessed during normal printer operation: <ol style="list-style-type: none"> a. The printer will start up normally b. When the data is accessed (for example while printing, while navigating the queue or when changing some settings), the printer displays a 79:04 system error c. The printer can restart normally d. When the data is accessed again (typically, under the same conditions as in step “b”), the 79:04 system error is displayed again. | <p>Many times, data related 79:04 errors are resolved by means of hardware intervention. Since data is stored in physical components (RAM, EEROM and Hard Disk), replacing these components with new ones which are empty usually solves the problem. However, there are quicker and more effective solutions to these types of errors:</p> <ol style="list-style-type: none"> 1. Clear all information that has been introduced by the user using the standard tools available in the printer: <ol style="list-style-type: none"> a. Delete all jobs from the queue (from the Front Panel or the EWS) b. Reset to factory defaults to clear the user’s configurations and calibrations c. Delete any non-standard paper preset in the printer (both the ones that have been created by the user and the ones that have been installed as OMES profiles through the EWS or the HP Utility) 2. If step 1 did not resolve the issue, you can use Service Tools to clear additional information that could be causing the issue: <ol style="list-style-type: none"> a. Start the printer in Diagnostics Boot Mode b. Perform an EEROM reset 3. If step 2 did not resolve the issue, it is possible to completely clear the information on the Hard Disk and the different EEROMs, leaving them in an equivalent state to a new part: <ol style="list-style-type: none"> a. Access the Service Utilities Menu b. In the Secure Disk Wipe menu, set the Sanitize level to “Unsecure mode” c. Execute the Disk Wipe. This takes 45-75 minutes and it will completely clear all partitions in the Hard Disk which contain user data, including the partition where the Operating System is installed. After the disk wipe has completed, a backup firmware version will |

Table 1-3 Data related SE79:04

Data related SE79:04

HP Designjet printers have Hard Disks and non-volatile memories that contain data bases and files that can be modified with user data. Some examples include:

- **The printer's queue**
- **The hard drive partitions that contain user jobs**
- **The data base that stores the printer settings**
- **The data base that stores accounting information**

Some of this data is accessed by the printer at start up, and some others are accessed as needed.

If any of this fields contains corrupt data or data with characters or values that cannot be correctly processed by the printer, a 79:04 system error may occur.

| Cause | Solution |
|-------|--|
| | <p>automatically be installed from a backup partition to allow the unit to start up. This firmware version is very old.</p> <p>d. The firmware in the printer should be updated to the latest official version as soon as the printer has restarted.</p> <p>After step "c", any 79:04 which is caused by corrupt data in the printer will be solved.</p> <p>NOTE: It is possible that the corrupt data came to be in the printer as a consequence of some activity in the customer's workflow. In this case, it is possible that the issue will happen again. In these cases, it is very important to understand the sequence of events in the customer's workflow that led to the error occurring. Once the error can be traced in the customer's workflow, escalate the issue to the GBU (through the GCC). This is done to implement any changes in the printer's firmware that can prevent these issues occurring again.</p> |

Table 1-4 Network related SE79:04

Network related SE79:04

Most HP Designjet printers have built-in networking capabilities. Network settings can be set manually, but in the majority of cases, they are obtained automatically from the printer. These settings include many different fields, such as IP address and subnet mask, available gateways, host and domain names, etc.

In some cases, there can be issues in the firmware that can cause a certain value in one of these fields to be interpreted incorrectly, and this can lead to a 79:04 system error.

| Cause | Solution |
|--|---|
| <p>There is no single set of symptoms that can absolutely pinpoint a network related 79:04 system error. However, the following guidelines can be applied:</p> <ul style="list-style-type: none">• It can happen at start up or when accessing the Network Configuration section of the FP• In both cases, repeating the action with the LAN cable disconnected does not cause the 79:04 to occur | <p>In the majority of cases, these issues will be due to an issue in the printer's firmware. As soon as the conditions where the issue happens can be understood, it should be escalated to the GBU through the GCC.</p> <p>At the same time, the following short term solutions and workarounds can help the customer to get up and running in the shortest possible time:</p> <ol style="list-style-type: none">1. Disconnect the network cable to be able to boot the printer and change network settings2. In the Network configuration menu in the Front Panel, disable any protocols that you are not using, including IPv6, SNMP and WebServices.3. If step "2" does not work, try setting a manual configuration of the device:<ol style="list-style-type: none">a. Enter the correct subnet mask and an IP in the valid rangeb. In the GateWay field, set the same value as in the IP address fieldc. Do not set a host name or a domain name4. If step "3" does not work and the customer is using the network card which is part of the printer, try using an accessory Jetdirect card instead. |

Table 1-5 User Interaction related SE79:04

User Interaction related SE79:04

In some cases the printer may not react as expected when a certain set of conditions coincide. In these cases, if the printer doesn't know how to react, it may simply display a 79:04 system error and force a restart. Some examples (not real) that can help to illustrate this:

- **An error occurs when a job is cancelled when it is at the "Finishing print" state and when the queue is disabled**
- **An error occurs if the Window is opened while the printer is checking the printheads**

These errors will most likely only happen in very specific corner cases that have not been identified during the development or the qualification of the printer, so normally, they do not severely impact the customer, as they do not affect their regular working flows.

| Cause | Solution |
|---|---|
| <p>The symptoms here are as numerous as the number of possible interactions between the user and the printer. In any case, it's possible to identify the steps that caused the error to occur and avoid them as the steps will always be the same with no variance.</p> <p>Important: An major element in determining the error is what the state the printer was in at the time the error was displayed. Actions the user has made when the printer is drying for example can produce an error, whereas the same action when the printer is doing something else (or is idle) may not produce any errors.</p> | <p>The recommended action plan in these cases is to identify the previous steps that caused the error and:</p> <ol style="list-style-type: none">1. Escalate the issue to the GBU through the GCC in order to have it corrected in the firmware.2. Recommend to the customer that they try to avoid the same steps to prevent the issue3. If the conditions that cause the error are in the customer's regular workflow, try to identify a different way of achieving the same result out of the printer. |

Table 1-6 Random SE79:04

Random SE79:04: Concurrence issues and memory leaks

Some 79:04 errors can happen randomly when the printer is being heavily used. However, it's impossible to find a single set of conditions that reproduce the problem. It just happens from time to time, without a defined pattern.

These random 79:04 can have two different types of root causes:

- **Memory leaks:** Before a program is executed, it allocates the memory it will need. After the execution is complete, the allocated memory is freed to be used by other programs. If the allocation or the release of the memory are not properly programmed, every time the program is executed some memory will be incorrectly labeled (either as used or as free). This is known as a memory leak. When a program with a memory leak is executed a lot, the memory becomes progressively full (since it is not properly freed). When the leak becomes too big, the printer is left 'out of memory' to execute new processes and a 79:04 is triggered.
- **Concurrence issues:** There are certain resources that can be accessed by multiple programs or by multiple executions of the same program (what is known as multiple threads). Access to these resources must be correctly controlled to prevent unexpected behavior. Issues caused by an incorrect control of these resources are concurrence issues.

In the following you have a simple example: let's imagine that there is a counter that controls the communication between the Jetdirect card and the printer's firmware. Whenever a new packet of information is sent by the Jetdirect card to the printer, the counter increases. When the printer receives the packet and processes it correctly, the counter decreases. Another process checks the counter from time to time to see its value and take conclusions from it. If the counter is near 0, it means that the printer is processing correctly, and if it grows too big, it may mean that there is a bottleneck somewhere and maybe the Jetdirect card throughput is decreased to control its speed to the printer. However, if the access to this counter is not properly controlled, undesirable effects may happen: in a real environment, a Jetdirect card processes thousands of information packets per second, so this counter is updated frequently, both by the Jetdirect and the printer. If at a certain point the Jetdirect and the printer try to access the counter at the same time and the code is not prepared to handle this, it may happen that the Jetdirect cannot increase the counter because the printer is writing to it, and what's worse, that it does not realize this fact. If this happens a few times each second, it may happen that the counter is decreasing faster than it's increasing and that at a certain point it has a negative value. And then, what will the process that is checking this counter do? Most likely, the process will not be prepared to react to a negative value and will launch an exception that will trigger a 79:04 system error.

| Cause | Solution |
|---|--|
| <p>This type of 79:04 always occurs in heavy load conditions, so the symptoms will always be similar to this pattern:</p> <ul style="list-style-type: none"> • A printer that is being heavily used (printing a project or in a reprographics environment) produces 79:04 errors randomly, forcing the user to restart. • After restarting, the printer can be used without any issues for an extended period of time, but if the workload is consistently high, a random error will occur again. • The error can never be associated with a specific file. The file that was being printed when the error occurred the last time can be printed without issues after restart. And a file that has been printed without issues several times can trigger the error in the future. • This error is very dependant of the workflow the customer has. The most common user workflows have been extensively tested both by HP and by our beta sites, so it is highly unlikely to see random 79:04 issues in these cases. These random issues tend to occur in very specific corner cases, and cannot be reproduced unless the exact conditions of the workflow are replicated. They normally happen when sending files generated by external applications (RIPs, 3rd party drivers, etc.). | <p>Random 79:04 errors are, by far, the most complex ones to diagnose and to fix. The only solutions available in these cases are:</p> <ol style="list-style-type: none"> 1. Identify the root cause (either in the files or in the firmware) and fix it in the code, which requires the intervention of the GBU 2. Test any options available to modify the customer's workflow and see if any combination of them solves the issue <p>In both cases, a profound understanding of the customer's workflow is necessary. In particular, the information that is needed is:</p> <ul style="list-style-type: none"> • Printer front panel settings • Application that is being used; RIP or driver that is being used • Application/RIP/Driver settings • Type of output files this application, RIP or driver is generating • Some sample files that are representative of what the customer is using • Operating System • Method of connection to the printer • A description of the normal flow when the issue occurs and the typical frequency of occurrence (i.e. once every hour when sending several files non-stop, each of them with multiple copies) |

Table 1-7 Hardware related SE79:04

Hardware related SE79:04

Hardware is, by far, the least likely cause of a 79:04 system error. Replacing hardware components does not normally fix the issue and increases the total turn around time in finding a workable solution.

In some cases, a failure in a component in the printer's electronics may cause a 79:04 system error, since the printer's electronics are involved in the execution of the firmware and the processing of jobs. It needs to be noted, however, that hardware failures in the electronics tend to produce specific system errors that point directly to the component that is failing.

Some HW causes that could be behind a 79:04 error are:

- **Defective clusters in the Hard Disk drive. If these clusters are used to execute the firmware or to process a job, they may produce a 79:04. It needs to be noted however, that most 79:04 errors that are resolved by an HDD replacement are in fact, data related 79:04 that could have been solved more efficiently and quickly following the steps in Section 3.**
- **Defective memory segments. If the RAM memory has some defective segments, a 79:04 may occur when these segments are used.**
- **Intermittent defects in the electronic components that are involved in the processing of a job: Carriage PCA, Trailing cable, Formatter and Print Mech. This is a highly unlikely cause, since defects in these components will produce subsystem specific errors.**

| Cause | Solution |
|---|---|
| There's no single set of symptoms behind hardware related 79:04 system errors. The most usual ones, however are: <ul style="list-style-type: none">• 79:04 during start up. Restarting the printer may or may not solve the problem• 79:04 while processing or printing a job. Restarting the printer and printing the same job does not always produce the error. | In the following procedure perform each step as it appears in the list and only move on to the next step once you are sure the 79:04 error has not been cleared: <ol style="list-style-type: none">1. Restart the printer in Diagnostics Boot mode and execute the service tests to validate the functionality of all the electronics components<ul style="list-style-type: none">• Execute the troubleshooting for "data related" system errors, refer to page 3, Data related SE79:042. Replace the memory3. Replace the HDD4. Escalate the issue before replacing any additional parts. |

Troubleshooting based on symptoms

This section will describe which troubleshooting steps to perform for a 79:04 system error based on the symptoms of the issue. Perform each step as it appears in the list and only move on to the next step once you are sure the 79:04 error has not been cleared.

Front panel displays 79:04 at start-up

- Restart the printer twice. If the system error has been caused by a job in an incorrect format, restarting twice will clear the error (the first time after restart, the printer will attempt to print the job again, and

this will cause the error to re-appear). If restarting the printer twice solves the issue, then it is an issue related to the job and you should refer to [Possible causes on page 31](#)

- Update the printer's firmware. Even if the currently installed firmware version is the latest one, reinstall it. Since the printer cannot start normally, you will need to update the firmware while booting the printer in Diagnostics Boot Mode. For this, a special file and a special update process will be needed. You can find the specific information for the printer model you are troubleshooting on page 13, Appendix A .
 - Disconnect the network cable and restart the printer. If this solves the problem, then it is a network related 79:04 and you should follow the guidelines for this type of 79:04, refer to [Possible causes on page 31](#).
1. Remove all cartridges, printheads and printhead cleaners (if available). Unload the media. Restart the printer. If the printer can start normally, insert the consumables one by one until you isolate the one that is causing the error. Do NOT insert any of the replaced consumables in another printer.
 2. Restart the printer in Diagnostics Boot Mode and perform the "Electronics test". If an electronic component is identified as faulty, replace it.
 - Restart the printer in Diagnostics Boot Mode and Reset the EEROM. If the issue is solved by this, this is a data related 79:04 system error and you should follow the guidelines, refer to [Possible causes on page 31](#).
 3. If the unit has been used for some time and suddenly has started to show this behavior, replace the Hard Disk Drive (it may be included with the Formatter in some models).
 4. If the issue is new and the issue happens since the first boot, do NOT replace the HDD.
 5. If none of the previous steps solved the issue, escalate the issue with the following information:
 - Unit information: S/N, P/N, accessories
 - Conditions where the problem occurs and conditions prior to the first occurrence of the problem
 - The results of the previous 8 steps
 - The System Error detailed information (this can be obtained by pressing CANCEL + Down)
 - The printer logs.

Front panel displays 79:04 during printer operation – not while sending jobs

1. Restart the printer.
2. Update the printer's firmware. Even if the currently installed firmware version is the latest one, reinstall it.
3. Reset the printer to factory defaults.
4. In order to narrow the scope of the issue, try the following:
 - a. Disable the queue
 - b. Disable any unused network protocols
 - c. Disable SNMP and WebServices (if they are available in the printer)

- d. Disable "Sleep mode" from the Service Utilities menu
 - e. Delete any Paper Presets that you may have uploaded or created using the printer Spectrophotometer.
5. Restart the printer in Diagnostics Boot Mode and perform the "Electronics test". If an electronic component is identified as faulty, replace it.
 6. Restart the printer in Diagnostics Boot Mode and Reset the EEROM. If the issue is solved by this, this is a data related 79:04 system error and you should follow the guidelines for this type error, refer to [Possible causes on page 31](#).
 7. Format the Hard Disk drive. To do so, you will need to start the printer normally, enter the Service Utilities menu and then the Secure Disk Erase option. Set the Erase method to "Fast Erase" and then perform the disk erase process. This will take 45-75 minutes and will erase all user information from the disk, resolving any issue caused by corrupt data. After the erase process, a firmware update will be required. If this solves the issue, this is a data related 79:04 system error and you should follow the guidelines for this type of 79:04, refer to [Possible causes on page 31](#).
 8. Try to identify the combination of settings or actions that led to the system error and try to reach the same result with a different combination. Escalate the issue to fix the original problem.
 9. If none of the previous steps could solve the issue, escalate it with the following information:
 - Unit information: S/N, P/N, accessories
 - Conditions where the problem occurs and conditions prior to the first occurrence of the problem
 - The result of the previous 8 steps
 - The printer information pages (either printed and faxed or obtained through the Embedded Web Server)
 - The System Error detailed information (it can be obtained by pressing CANCEL + Down)
 - The printer logs.

Front panel displays 79:04 while printing

- [A. While printing a single job](#)
- [B. Random 79:04 during continuous printing](#)

A. While printing a single job

The error happens after a single job is sent. It's easy to identify which job that has produced the error, since every time that this same job is sent, the error is replicated.

1. Restart the printer twice (after the first restart, the printer will show the 79:04 system error again, since the printer will attempt to reprint the last job in the queue, which is the one that caused the issue)
2. If you are using an HP driver, update the driver to the latest version
3. Update the printer's firmware. Even if the currently installed firmware version is the latest one, reinstall it. Send the job using different print settings. The following ones can be helpful:
 - a. Try sending the job without selecting a paper preset in the driver
 - b. Try changing the Image Quality settings

- c. If you are using the HP-GL/2 driver, try the option “Send job as bitmap”
 - d. If you are using the PS driver, try using the HP-GL/2 driver instead
 - e. If you are using the PS driver from an Adobe application (or any other application that can handle PS), try changing the application’s print settings so that the PS is generated as Raster.
4. Try the following Front Panel settings:
- a. Change the Print Language option in the Front Panel from “Automatic” (which is the default setting) to the language that is being printed (PS, HP-GL/2, ...)
 - b. Queue = OFF
 - c. Start Printing = After processing
 - d. For PS SKUs, try changing the encoding setting (“Automatic” by default) to Binary or ASCII
5. If you are using a 3rd party application that does not print through the HP driver, try modifying the printing workflow by:
- a. Using an HP driver
 - b. Changing the settings in the application’s printing dialog
6. If you are using an accessory Jetdirect card, try using the internal network connector or USB (if available).
7. Escalate the issue, providing the following information:
- Unit information: S/N, P/N, accessories
 - Conditions where the problem occurs and conditions prior to the first occurrence of the problem.
 - The result of the previous 7 steps
 - The printer information pages (either printed and faxed or obtained through the Embedded Web Server)
 - The System Error detailed information (it can be obtained by pressing **CANCEL + Down**)
 - Information on the workflow:
 - Operating System
 - Application
 - Driver
 - Settings in the driver and the application
 - Settings in the printer
 - Connection method and settings:
 - The original file along with the information on how to reproduce the issue
 - A print to file that can reproduce the issue
 - The printer logs.

B. Random 79:04 during continuous printing

The error does not happen with a single job. It happens randomly during continuous printing, normally while the printer is managing a heavy load (printing a project or in a reprographics environment).

This type of error is caused either by memory leaks or by concurrence issues in the printer's firmware. They normally happen in unusual environments where these memory leaks or concurrence issues that have not been detected during qualification have occurred. These issues cause the printer to crash at a completely random moment during printing, and are not associated to a specific job.

Because of this, troubleshooting these issues is normally quite complex.

1. Restart the printer twice (after the first restart, the printer will show the 79:04 system error again, since the printer will attempt to reprint the last job in the queue. If the issue continues occurring randomly, continue troubleshooting)
2. If you are using an HP driver, update the driver to the latest version
3. Update the printer's firmware. Even if the currently installed firmware version is the latest one, reinstall it.
4. Try the following changes in the workflow:
 - a. Change the Print Language option in the Front Panel from "Automatic" (which is the default setting) to the language that is being printed (PS, HP-GL/2, ...)
 - b. Queue = OFF
 - c. Start Printing = After processing
 - d. For PS SKUs, try changing the encoding setting ("Automatic" by default) to Binary or ASCII
 - e. If you are using the HP-GL/2 driver, try sending the job as a bitmap
5. If you are using a 3rd party application that does not print through the HP driver, try modifying the printing workflow by:
 - a. Using an HP driver
 - b. Changing the settings in the application's printing dialog
6. Escalate the issue with the following information:
 - Unit information: S/N, P/N, accessories
 - The printer information pages (either printed and faxed or obtained through the Embedded Web Server)
 - The System Error detailed information (it can be obtained by pressing **CANCEL + Down**)
 - Information on the workflow:
 - Operating System
 - Application
 - Driver
 - Settings in the driver and the application

- Settings in the printer
- Connection method and settings
- Exact information on how to replicate the environment that reproduces the issue, including some example files that can be sent to the printer to replicate a heavy load environment. These files will need to be:
 - Original application files, if the issue happens printing from an application through our driver
 - Print to files if the issue happens when printing from a third-party application.

2 System error codes

- [What to do if the front panel is blank](#)
- [System error codes](#)
- [Explanation of system error codes and warnings](#)
- [Continuable and non-continuable error codes](#)

What to do if the front panel is blank

No system error message can be displayed when the front panel is blank. In these cases the front panel has not necessarily failed—any other electronic component can be the root cause. The Power Switch and Formatter LEDs can help you to troubleshoot a problem in this situation; see [How to read the power switch LEDs on page 18](#) and [How to read the Formatter LEDs on page 19](#).

System error codes

System error codes are hexadecimal numbers generally caused by internal system errors. The following pages contain a list of system error codes and their respective descriptions and recommended corrective actions. Try one recommended action at a time and check whether the error code has disappeared.

If you have an error code which is not documented in this Service Manual or you have an error which you cannot resolve, then report the error to the HP Response Center or the nearest HP Support Office. When reporting the error, have the following information ready:

- Model and Serial Number of the printer.
- Which firmware revision the printer is using (See Note below). Check firmware in *Setup Menu / Information Menu / Show Printer Information*.
- The complete error number (See Note below).
- The complete error number (See Note below).
- The Service Configuration Print.
- The Current configuration sheet.
- Which software application the customer is using (name, version, etc).

 **NOTE:** When reporting the System Error Code, make sure that you supply the full Internal Error Code and the firmware version. Without this information, HP Support Personnel cannot help you. To view the Internal Error Code, hold the **DOWN** key and press the **CANCEL** key at the same time when the System Error Code is displayed on the Front Panel.

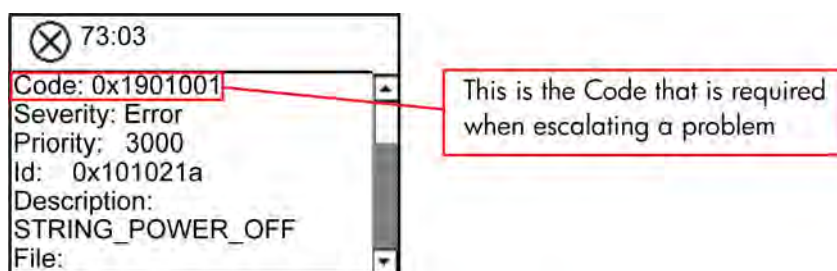

Explanation of system error codes and warnings

System Error Codes explain which component/system is failing and what action should be taken to resolve the problem.

System Error Codes are displayed directly on the front panel (but can also be seen on the Information Page) and have been defined in the format **XX.YZ**, or **XX.n:YZ.m**.

- **XX**: Service Part (2 digits).
- **n**: Service Part Index (if more than one used in the product) - Optional.
 - e.g. Identify the Ink Supply (color and number).
- **Y**: Who should perform the action (1 digit) - (User or Service Engineer).
- **Z**: Action to perform (1 digit).
- **m**: additional actions/information to consider (1 digit) - Optional.
 - e.g. Non-authorized ink was detected, PM was triggered or Printhead in/out of Warranty.

The following table explains the **XX** part of the System Error Code or Warning:

| Code | Component/System |
|------------|-------------------------|
| 01.0 | Main PCA |
| 01.1 | Printmech PCA |
| 01.2 | ISS Top PCA |
| 01.3 | ISS Bottom PCA |
| 02.1 | Carriage PCA |
| 03 | Power Supply Unit |
| 05 | Formatter |
| 05.1 | Formatter Fan |
| 06 | Hard Disk Drive |
| 08 | Front Panel |
| 11 | Trailing Cable |
| 17 | Other cables |
| 21 | Service Station |
| 23 | Pressure System (APS) |
| 24 | Ink Supply Tubes |
| 26.n | Ink Cartridge (color n) |
| 27.n, 28.n | Printhead (color n) |
| 29 | Maintenance Cartridge |
| 32 | Take-up Reel |
| 36 | Duplexer |
| 41 | Media-Axis Motor |
| 42 | Scan-Axis Motor |
| 43 | Vacuum Fan |
| 44 | Aerosol Fan |
| 45 | Rewinder |

| Code | Component/System |
|-------------|---|
| 46 | Primer |
| 50 | OMAS |
| 51 | Window Position Sensor |
| 51.1 | Maintenance Cartridge Door Sensor |
| 52 | Drop Detector |
| 53 | Media Sensor |
| 54 | Media Lever Sensor |
| 55 | Line Sensor |
| 56 | Paper Encoder Sensor |
| 58 | Embedded PhotoSpectrometer (ESP) |
| 59 | Incompatible parts |
| 60 | Initialization |
| 61 | Language Interpreting |
| 61.1 | PS Fonts Missing |
| 64 | Input/Output through USB Port |
| 71 | Memory Management |
| 74 | Firmware Update |
| 75 | Ink consumption |
| 76 | Disk Full |
| 77 | Embedded Web Server |
| 78 | Media Settings |
| 79 | Assertion (Uncontrollable Firmware Error) |
| 81 | Paper Advance |
| 85 | Media-Axis Encoder Reading |
| 86 | Carriage Movement |
| 87 | Scan-axis encoder reading |
| 94 | Color Calibration |

The following table explains the **YZ** part of the System Error Code or Warning:

| Code | Recovery action | Response |
|-------------|--|---|
| 00 | Replace | |
| 01 | Reseat/Reconnect/Clean/Adjust (manually) | Possible for customer to perform action |
| 02 | Calibrate/Adjust (using Automatic Process) | |

| Code | Recovery action | Response |
|------|--|--|
| 03 | Power OFF and Restart the printer | |
| 04 | Update System Firmware | |
| 05 | Upgrade Driver or Computer Software | |
| 06 | Add Accessory | |
| 07 | Escalate | |
| 08 | Send Plot Again | |
| 09 | Wrong Part Installed | |
| 10 | Replace | |
| 11 | Reseat/Reconnect/Clean/Adjust (manually) | |
| 12 | Calibrate/Adjust (using Automatic Process) | |
| 13 | Power OFF | |
| 14 | Update System Firmware | HP qualified personnel assistance required |
| 15 | Upgrade Driver or Computer Software | |
| 16 | Add Accessory | |
| 17 | Escalate | |
| 18 | Send Plot Again | |
| 19 | Wrong Part Installed | |

Continuable and non-continuable error codes

Some of the Error Codes are continuable, which means you can press **OK** on the front-panel and continue working with the printer. Non-Continuable Error Codes do not allow you to continue working with the printer, in this case power the printer **OFF** and **ON** again and see if the System Error disappears. If the Error Code reappears, then the printer requires an on-site visit in order to resolve the problem.



NOTE: If the solution calls for a replacement part, replace one component at a time and check if the error has been cleared before replacing another component. Using this procedure you will be able to determine exactly which component has failed.

SE 01.0:10

Cause: Main PCA hardware failure

Solution: Try the following:

- Turn the power off at the rear of the printer and disconnect the power cord. Reconnect the power cord and turn on the printer.
- Replace the Main PCA ⇒ [Main PCA on page 358](#).

SE 01.1:10

Cause: PrintMech PCA hardware failure

Solution: Try the following:

- Turn the power off at the rear of the printer and disconnect the power cord. Reconnect the power cord and turn on the printer.
- Replace the PrintMech PCA ⇒ [PrintMech PCA on page 372](#).

SE 01.2:10

Cause: ISS Top PCA communication failure

Solution: Try the following:

- Turn the power off at the rear of the printer and disconnect the power cord. Reconnect the power cord and turn on the printer.
- Replace the Ink Supply Tubes and Trailing Cable.



NOTE: If the Ink Supply Tubes are to be replaced, the Ink Cartridges need to be checked beforehand to see if they are capable of purging the new tubes. If they are not, new Ink Cartridges must also be sent with the parts to be replaced. To check the Ink Cartridges, go to ⇒ [Check ink supplies on page 100](#).

SE 01.3:10

Cause: ISS Bottom PCA communication failure

Solution: Try the following:

- Turn the power off at the rear of the printer and disconnect the power cord. Reconnect the power cord and turn on the printer.
- Replace the Ink Supply Tubes and Trailing Cable.



NOTE: If the Ink Supply Tubes are to be replaced, the Ink Cartridges need to be checked beforehand to see if they are capable of purging the new tubes. If they are not, new Ink Cartridges must also be sent with the parts to be replaced. To check the Ink Cartridges, go to ⇒ [Check ink supplies on page 100](#).

SE 02.1:10

Cause: Carriage PCA communication failure

Solution: Try the following:

- Turn the power off at the rear of the printer and disconnect the power cord. Reconnect the power cord and turn on the printer.
- Check that the Trailing Cable is not damaged.
- Check that the Trailing Cable is correctly connected to the Carriage PCA, Interconnect PCA and Main PCA.
- Replace the Carriage PCA ⇒ [Carriage PCA on page 318](#).

SE 03:10

Cause: Power distribution failure

Solution: Try the following:

- Turn the power off at the rear of the printer and disconnect the power cord. Reconnect the power cord and turn on the printer.
- If the Power Supply Unit's blue LED is on, replace the PrintMech PCA. If not, replace the Power Supply Unit.

SE 05:10

Cause: Formatter communication failure with ISS

Solution: Try the following:

- Turn the power off at the rear of the printer and disconnect the power cord. Reconnect the power cord and turn on the printer.
- Check that the Formatter to PrintMech PCA cable is correctly connected.
- If the system error persists, replace the Formatter ⇒ [Formatter on page 361](#).
- If the system error persists and your printer is a Rev. B, replace the Formatter ⇒ [Formatter on page 361](#) and the [Hard Disk Drive \(HDD\) on page 364](#).

SE 05.1:10

Cause: Formatter CPU fan stopped or burnt

Solution: Try the following:

- Turn the power off at the rear of the printer and disconnect the power cord. Reconnect the power cord and turn on the printer.
- If the system error persists, replace the Formatter ⇒ [Formatter on page 361](#).
- If the system error persists and your printer is a Rev. B, replace the Formatter ⇒ [Formatter on page 361](#) and the [Hard Disk Drive \(HDD\) on page 364](#).

SE 06:03

Cause: Main NVM communication failure

Solution: Try the following:

- Turn the power off at the rear of the printer and disconnect the power cord. Reconnect the power cord and turn on the printer.
- If the System Error continues, replace the Hard Disk Drive ⇒ [Hard Disk Drive \(HDD\) on page 364](#).
- If the system error persists and your printer is a Rev. B, replace the Formatter ⇒ [Formatter on page 361](#) and the [Hard Disk Drive \(HDD\) on page 364](#).

SE 06:10

Cause: Main NVM communication failure

Solution: Try the following:

- Turn the power off at the rear of the printer and disconnect the power cord. Reconnect the power cord and turn on the printer.
- If the System Error continues, replace the Hard Disk Drive ⇒ [Hard Disk Drive \(HDD\) on page 364](#).
- If the system error persists and your printer is a Rev. B, replace the Formatter ⇒ [Formatter on page 361](#) and the [Hard Disk Drive \(HDD\) on page 364](#).

SE 08:11

Cause: Front Panel communication failure

Solution: Try the following:

- Turn the power off at the rear of the printer and disconnect the power cord. Reconnect the power cord and turn on the printer.
- See [What to do if the front panel is blank on page 44](#).

SE 11:10

Cause: Trailing Cable does not seem to be connected

Solution: Try the following:

- Check that the Trailing Cable is not damaged.
- Check that the Trailing Cable is correctly connected to the Carriage PCA, Interconnect PCA and Main PCA.
- Replace the Ink Supply Tubes and Trailing Cable.



NOTE: If the Ink Supply Tubes are to be replaced, the Ink Cartridges need to be checked beforehand to see if they are capable of purging the new tubes. If they are not, new Ink Cartridges must also be sent with the parts to be replaced. To check the Ink Cartridges, go to ⇒ [Check ink supplies on page 100](#).

SE 17.0:11

Cause: PrintMech to Interconnect Power cable does not seem to be connected

Solution: Try the following:

- Check that the PrintMech to Interconnect Power cable is not damaged.
- Check that the PrintMech to Interconnect Power cable is correctly connected to the PrintMech PCA and the Interconnect PCA.
- Replace the PrintMech to Interconnect Power cable (which is included in the Electronics Module Cable Kit).

SE 17.1:11

Cause: PrintMech to Interconnect Data 1 cable does not seem to be connected

Solution: Try the following:

- Check that the PrintMech to Interconnect Data 1 cable is not damaged.
- Check that the PrintMech to Interconnect Data 1 cable is correctly connected to the PrintMech PCA and the Interconnect PCA.
- Replace the PrintMech to Interconnect Data 1 cable (which is included in the Electronics Module Cable Kit).

SE 17.2:11

Cause: PrintMech to Interconnect Data 2 cable does not seem to be connected

Solution: Try the following:

- Check that the PrintMech to Interconnect Data 2 cable is not damaged.
- Check that the PrintMech to Interconnect Data 2 cable is correctly connected to the PrintMech PCA and the Interconnect PCA.
- Replace the PrintMech to Interconnect Data 2 cable (which is included in the Electronics Module Cable Kit).

SE 17.3:11

Cause: Main PCA to PrintMech Black 1 cable does not seem to be connected

Solution: Try the following:

- Check that the Main PCA to PrintMech Black 1 cable is not damaged.
- Check that the Main PCA to PrintMech Black 1 cable is correctly connected to the Main PCA and the PrintMech PCA.
- Replace the Main PCA to PrintMech Black 1 cable (which is included in the Electronics Module Cable Kit).

SE 17.4:11

Cause: Main PCA to PrintMech Blue 2 cable does not seem to be connected

Solution: Try the following:

- Check that the Main PCA to PrintMech Blue 2 cable is not damaged.
- Check that the Main PCA to PrintMech Blue 2 cable is correctly connected to the Main PCA and the PrintMech PCA.
- Replace the Main PCA to PrintMech Blue 2 cable (which is included in the Electronics Module Cable Kit).

SE 21:03

Cause: Service Station electrical current limit

Solution: Try the following:

- Turn the power off at the rear of the printer and disconnect the power cord. Reconnect the power cord and turn on the printer.
- Make sure that the Service Station path is clear. Remove any visible obstacles (such as foam from the printer's packaging, screws and plastic parts) restricting the movement of the Service Station.
- If the System Error continues, replace the Service Station ⇒ [Service Station on page 273](#).

SE 21:13

Cause: Service Station jam

Solution: Try the following:

- Turn the power off at the rear of the printer and disconnect the power cord. Reconnect the power cord and turn on the printer.
- Make sure that the Service Station path is clear. Remove any visible obstacles (such as foam from the printer's packaging, screws and plastic parts) restricting the movement of the Service Station.
- If the System Error continues, replace the Service Station ⇒ [Service Station on page 273](#).

SE 23:10

Cause: Air Pressurization System failure; unable to pressurize or depressurize tubes

Solution: Try the following:

- Turn the power off at the rear of the printer and disconnect the power cord. Reconnect the power cord and turn on the printer.
- Check that the APS cable is not damaged and is correctly connected to the PrintMech PCA.
- Check that the air tubes are properly connected and are not kinked or pinched.
- Replace the APS Assembly ⇒ [APS Assembly on page 305](#).

SE 24:03

Cause: Ink Supply Tubes purge failure

Solution: Try the following:

- Turn the power off at the rear of the printer and disconnect the power cord. Reconnect the power cord and turn on the printer.
- Ensure that the dummy printheads are correctly installed and purge the Ink Supply Tubes again.
- If the problem persists, replace the Setup Printhead Kit.

SE 24:10

Cause: A broken bag has been detected in one of the Ink Cartridges

Solution: Try the following:

- Press **Down** + **Cancel** to see which cartridges have a broken bag. Remove the affected cartridges, shake each one three times within 2 seconds through a distance of about 40 cm, and check whether the

cartridge air tower is contaminated with ink. If at least one cartridge is contaminated, replace the Ink Supply Tubes and Trailing Cable ⇒ [Ink Supply Tubes and Trailing Cable on page 287](#).

 **NOTE:** If the Ink Supply Tubes are to be replaced, the Ink Cartridges need to be checked beforehand to see if they are capable of purging the new tubes. If they are not, new Ink Cartridges must also be sent with the parts to be replaced. To check the Ink Cartridges, see [Check ink supplies on page 100](#).

- If no cartridge seems contaminated, follow the broken bag recovery procedure for more information ⇒ [Recover broken bag on page 102](#).

SE 24:11

Cause: PrintMech to ISS Top cable does not seem to be connected

Solution: Try the following:

- Check that the PrintMech to ISS Top cable cable is not damaged.
- Check that the PrintMech to ISS Top cable is correctly connected to the PrintMech PCA and ISS Top PCA.
- Replace the PrintMech to ISS Top cable (which is included in the Electronics Module Cable Kit).

SE 24.1:11

Cause: ISS Top to ISS Bottom cable does not seem to be connected

Solution: Try the following:

- Check that the ISS Top to ISS Bottom cable cable is not damaged.
- Check that the ISS Top to ISS Bottom cable is correctly connected to the ISS Top PCA and ISS Bottom PCA.
- Replace the ISS Top to ISS Bottom cable (which is included in the Electronics Module Cable Kit).

SE 26.0:01

Cause: Bad contact detected in ISS slot 0 floater

Solution: Try the following:

- Remove the Magenta Ink Cartridge (all printers) and reinstall it into the printer.
- Replace the Magenta Ink Cartridge.
- Check that the ISS to Cartridge cable (Magenta Ink Cartridge) is not damaged and is correctly connected to the Ink Supply Tubes PCA.
- Replace the ISS to Cartridge cable (Magenta Ink Cartridge) ⇒ [ISS to Cartridge Cables on page 295](#).

SE 26.1:01

Cause: Bad contact detected in ISS slot 1 floater

Solution: Try the following:

- Remove the Light Magenta (Z6200/Z6800) or Yellow (Z6600) Ink Cartridge and reinstall it into the printer.
- Replace the Light Magenta (Z6200/Z6800) or Yellow (Z6600) Ink Cartridge.
- Check that the ISS to Cartridge cable (Light Magenta or Yellow Ink Cartridge) is not damaged and is correctly connected to the Ink Supply Tubes PCA.
- Replace the ISS to Cartridge cable (Light Magenta or Yellow Ink Cartridge) ⇒ [ISS to Cartridge Cables on page 295](#).

SE 26.2:01

Cause: Bad contact detected in ISS slot 2 floater

Solution: Try the following:

- Remove the Photo Black Ink Cartridge (all printers) and reinstall it into the printer.
- Replace the Photo Black Ink Cartridge.
- Check that the ISS to Cartridge cable (Photo Black Ink Cartridge) is not damaged and is correctly connected to the Ink Supply Tubes PCA.
- Replace the ISS to Cartridge cable (Photo Black Ink Cartridge) ⇒ [ISS to Cartridge Cables on page 295](#).

SE 26.3:01

Cause: Bad contact detected in ISS slot 3 floater

Solution: Try the following:

- Remove the Matte Black Ink Cartridge(all printers) and reinstall it into the printer.
- Replace the Matte Black Ink Cartridge.
- Check that the ISS to Cartridge cable (Matte Black Ink Cartridge) is not damaged and is correctly connected to the Ink Supply Tubes PCA.
- Replace the ISS to Cartridge cable (Matte Black Ink Cartridge) ⇒ [ISS to Cartridge Cables on page 295](#).

SE 26.4:01

Cause: Bad contact detected in ISS slot 4 floater

Solution: Try the following:

- Remove the Yellow (Z6200/Z6800) or Cyan (Z6600) Ink Cartridge and reinstall it into the printer.
- Replace the Yellow (Z6200/Z6800) or Cyan (Z6600) Ink Cartridge.
- Check that the ISS to Cartridge cable (Yellow or Cyan Ink Cartridge) is not damaged and is correctly connected to the Ink Supply Tubes PCA.
- Replace the ISS to Cartridge cable (Yellow or Cyan Ink Cartridge) ⇒ [ISS to Cartridge Cables on page 295](#).

SE 26.5:01

Cause: Bad contact detected in ISS slot 5 floater

Solution: Try the following:

- Remove the Light Cyan/Cyan (Z6200/Z6800) or Light Gray (Z6600) Ink Cartridge and reinstall it into the printer.
- Replace the Light Cyan/Cyan (Z6200/Z6800) or Light Gray (Z6600) Ink Cartridge.
- Check that the ISS to Cartridge cable (Light Cyan/Cyan (Z6200/Z6800) or Light Gray (Z6600) Ink Cartridge) is not damaged and is correctly connected to the Ink Supply Tubes PCA.
- Replace the ISS to Cartridge cable (Light Cyan/Cyan (Z6200/Z6800) or Light Gray (Z6600) Ink Cartridge)-
⇒ [ISS to Cartridge Cables on page 295](#).

SE 26.6:01

Cause: Bad contact detected in ISS slot 6 floater

Solution: Try the following:

- Remove the Light Gray Ink Cartridge (Z6200/Z6800) and reinstall it into the printer.
- Replace the Light Gray Ink Cartridge(Z6200/Z6800).
- Check that the ISS to Cartridge cable (Light Gray Ink Cartridge) is not damaged and is correctly connected to the Ink Supply Tubes PCA.
- Replace the ISS to Cartridge cable (Light Gray Ink Cartridge) ⇒ [ISS to Cartridge Cables on page 295](#).

SE 26.7:01

Cause: Bad contact detected in ISS slot 7 floater

Solution: Try the following:

- Remove the Red Ink Cartridge(Z6200/Z6800) and reinstall it into the printer.
- Replace the Red Ink Cartridge(Z6200/Z6800).
- Check that the ISS to Cartridge cable (Red Ink Cartridge) is not damaged and is correctly connected to the Ink Supply Tubes PCA.
- Replace the ISS to Cartridge cable (Red Ink Cartridge) ⇒ [ISS to Cartridge Cables on page 295](#).

SE 27.1:01

Cause: Calibration failed to due to poor performance of the Magenta/Yellow Printhead (all printers) in slot 1

Solution: This may impact your print quality. If it becomes unacceptable in the future, clean all printheads and check their status.

SE 27.2:01

Cause: Calibration failed to due to poor performance of the Magenta/Yellow Printhead (all printers) in slot 2

Solution: This may impact your print quality. If it becomes unacceptable in the future, clean all printheads and check their status.

SE 27.3:01

Cause: Calibration failed to due to poor performance of the Light Cyan/Light Magenta (Z6200/Z6800) and Photo Black/Light Gray (Z6600) Printhead slot 3

Solution: This may impact your print quality. If it becomes unacceptable in the future, clean all printheads and check their status.

SE 27.4:01

Cause: Calibration failed to due to poor performance of the Light Cyan/Light Magenta (Z6200/Z6800) Printhead or Photo Black/Light Gray (Z6600) in slot 4

Solution: This may impact your print quality. If it becomes unacceptable in the future, clean all printheads and check their status.

SE 27.5:01

Cause: Calibration failed to due to poor performance of the Photo Black/Light Gray (Z6200/Z6800) or Matte Black/Cyan (Z6600) Printhead in slot 5

Solution: This may impact your print quality. If it becomes unacceptable in the future, clean all printheads and check their status.

SE 27.6:01

Cause: Calibration failed to due to poor performance of the Photo Black/Light Gray (Z6200/Z6800) or Matte Black/Cyan (Z6600) Printhead in slot 6

Solution: This may impact your print quality. If it becomes unacceptable in the future, clean all printheads and check their status.

SE 27.7:01

Cause: Calibration failed to due to poor performance of the Matte Black/Red Printhead (Z6200/Z6800) in slot 7

Solution: This may impact your print quality. If it becomes unacceptable in the future, clean all printheads and check their status.

SE 27.8:01

Cause: Calibration failed to due to poor performance of the Matte Black/Red Printhead (Z6200/Z6800) in slot 8

Solution: This may impact your print quality. If it becomes unacceptable in the future, clean all printheads and check their status.

SE 28.1:01

Cause: Magenta/Yellow Printhead (all printers) in slot 1 is deteriorating

Solution: This may impact your print quality. If it becomes unacceptable in the future, replace that printhead with a new one.



NOTE: This system error appears only after the printhead is out of warranty.

SE 28.2:01

Cause: Magenta/Yellow Printhead (all printers) in slot 2 is deteriorating

Solution: This may impact your print quality. If it becomes unacceptable in the future, replace that printhead with a new one.



NOTE: This system error appears only after the printhead is out of warranty.

SE 28.3:01

Cause: Light Cyan/Light Magenta (Z6200/Z6800) and Photo/Light Gray (Z6600) Printhead in slot 3 is deteriorating

Solution: This may impact your print quality. If it becomes unacceptable in the future, replace that printhead with a new one.



NOTE: This system error appears only after the printhead is out of warranty.

SE 28.4:01

Cause: Light Cyan/Light Magenta (Z6200/Z6800) and Photo/Light Gray (Z6600) in slot 4 is deteriorating

Solution: This may impact your print quality. If it becomes unacceptable in the future, replace that printhead with a new one.



NOTE: This system error appears only after the printhead is out of warranty.

SE 28.5:01

Cause: Photo Black/Light Gray (Z6200/Z6800) or Matte Black/Cyan (Z6600) Printhead in slot 5 is deteriorating

Solution: This may impact your print quality. If it becomes unacceptable in the future, replace that printhead with a new one.



NOTE: This system error appears only after the printhead is out of warranty.

SE 28.6:01

Cause: Photo Black/Light Gray (Z6200/Z6800) or Matte Black/Cyan (Z6600) Printhead in slot 6 is deteriorating

Solution: This may impact your print quality. If it becomes unacceptable in the future, replace that printhead with a new one.



NOTE: This system error appears only after the printhead is out of warranty.

SE 28.7:01

Cause: Matte Black/Red Printhead (Z6200/Z6800) in slot 7 is deteriorating

Solution: This may impact your print quality. If it becomes unacceptable in the future, replace that printhead with a new one.



NOTE: This system error appears only after the printhead is out of warranty.

SE 28.8:01

Cause: Matte Black/Red Printhead (Z6200/Z6800) in slot 8 is deteriorating

Solution: This may impact your print quality. If it becomes unacceptable in the future, replace that printhead with a new one.



NOTE: This system error appears only after the printhead is out of warranty.

SE 28.1:02

Cause: Magenta/Yellow Printhead (all printers) in slot 1 nearing the end of its useful life

Solution: This printhead may have reached a degradation level that prevents the printer from producing acceptable prints consistently. If it becomes unacceptable in the future, run the Clean (Recover) Printhead procedure.



NOTE: This system error appears only after the printhead is out of warranty.

SE 28.2:02

Cause: Magenta/Yellow Printhead (all printers) in slot 2 nearing the end of its useful life

Solution: This printhead may have reached a degradation level that prevents the printer from producing acceptable prints consistently. If it becomes unacceptable in the future, run the Clean (Recover) Printhead procedure.



NOTE: This system error appears only after the printhead is out of warranty.

SE 28.3:02

Cause: Light Cyan/Light Magenta (Z6200/Z6800) and Photo/Light Gray (Z6600) Printhead in slot 3 nearing the end of its useful life

Solution: This printhead may have reached a degradation level that prevents the printer from producing acceptable prints consistently. If it becomes unacceptable in the future, run the Clean (Recover) Printhead procedure.



NOTE: This system error appears only after the printhead is out of warranty.

SE 28.4:02

Cause: Light Cyan/Light Magenta (Z6200/Z6800) and Photo/Light Gray (Z6600) Printhead in slot 4 nearing the end of its useful life

Solution: This printhead may have reached a degradation level that prevents the printer from producing acceptable prints consistently. If it becomes unacceptable in the future, run the Clean (Recover) Printhead procedure.

 **NOTE:** This system error appears only after the printhead is out of warranty.

SE 28.5:02

Cause: Photo Black/Light Gray (Z6200/Z6800) or Matte Black/Cyan (Z6600) in slot 5 nearing the end of its useful life

Solution: This printhead may have reached a degradation level that prevents the printer from producing acceptable prints consistently. If it becomes unacceptable in the future, run the Clean (Recover) Printhead procedure.

 **NOTE:** This system error appears only after the printhead is out of warranty.

SE 28.6:02

Cause: Photo Black/Light Gray (Z6200/Z6800) or Matte Black/Cyan (Z6600) in slot 6 nearing the end of its useful life

Solution: This printhead may have reached a degradation level that prevents the printer from producing acceptable prints consistently. If it becomes unacceptable in the future, run the Clean (Recover) Printhead procedure.

 **NOTE:** This system error appears only after the printhead is out of warranty.

SE 28.7:02

Cause: Matte Black/Red Printhead (Z6200/Z6800) in slot 7 nearing the end of its useful life

Solution: This printhead may have reached a degradation level that prevents the printer from producing acceptable prints consistently. If it becomes unacceptable in the future, run the Clean (Recover) Printhead procedure.

 **NOTE:** This system error appears only after the printhead is out of warranty.

SE 28.8:02

Cause: Matte Black/Red Printhead (Z6200/Z6800) in slot 8 nearing the end of its useful life

Solution: This printhead may have reached a degradation level that prevents the printer from producing acceptable prints consistently. If it becomes unacceptable in the future, run the Clean (Recover) Printhead procedure.

 **NOTE:** This system error appears only after the printhead is out of warranty.

SE 29:00

Cause: Maintenance Cartridge almost full

Solution: Replace the Maintenance Cartridge.

SE 29:01

Cause: Maintenance Cartridge not inserted correctly

Solution: Try the following:

- Open the Maintenance Cartridge door on the right-hand side of the printer, make sure that the maintenance cartridge is correctly seated, then close the door.
- If the problem persists, replace the Maintenance Cartridge.

SE 29:02

Cause: Ink Absorber almost full

Solution: Replace the Ink Absorber.

SE 32:01

Cause: Take-up Reel (TUR) communication failure

Solution: Try the following:

- If you want to continue using the TUR, turn off the printer and check that all TUR cables are connected (sensor cables, printer cable).
- If not, you may need to unload the paper from the TUR manually. Remember to cut the paper first (either manually or by pressing the [Form Feed and Cut](#) key).

SE 32:01.1

Cause: Take-up Reel (TUR) early paper jam

Solution: Try the following:

- Check there is no obstacle between the Take-up reel optical sensors.
- Check the paper is attached to the TUR spindle.
- Check the TUR switch is in the correct position.
- If needed, use the TUR arrow keys to wind paper before resume printing.
- To resume printing, press [OK](#).

SE 32:01.2

Cause: Take-up Reel (TUR) paper jam

Solution: Try the following:

- Check that there is no interference around the TUR optical sensors.
- Check the paper is attached to the TUR spindle.
- Check the TUR switch is in the correct position.
- Check there is no obstacle between the TUR optical sensors.

- If required, use the TUR arrow keys to wind paper before resuming the print.
- When the jam is cleared, printing is resumed. Press the **OK** key to clear the warning message.

SE 32:01.9

Cause: Take-up Reel (TUR) disabled because paper was removed unexpectedly

Solution: Remove all paper from the printer and reinstall the TUR.

SE 32:02

Cause: Take-up Reel (TUR) not detected or disconnected while printer was off

Solution: Connect the TUR to the printer and press **OK** to continue.

SE 36.0:01

Cause: Duplexer communication error

Solution: Try the following:

- Reseat the cables between the Duplexer and the printer.
- Uninstall and reinstall the Duplexer.
- If the problem persists, contact the manufacturer of the Duplexer.

SE 36.01:01

Cause: Duplexer paper skew error

Solution: Try the following:

- Unload the paper and try again.
- If the problem persists, uninstall and reinstall the Duplexer. Make sure that the printer and the Duplexer paper path are well aligned and that there are no obstacles in between.

SE 36.02:01

Cause: Duplexer paper incorrect lateral edge position

Solution: Try the following:

- Unload the paper and try again.
- If the problem persists, uninstall and reinstall the Duplexer. Make sure that the printer and the Duplexer paper path are well aligned and that there are no obstacles in between.

SE 36.03:01

Cause: Duplexer unable to detect paper

Solution: Try the following:

- Unload the paper and try again.
- If the problem persists, uninstall and reinstall the Duplexer. Make sure that the printer and the Duplexer paper path are well aligned and that there are no obstacles in between.

SE 36.1:01

Cause: Duplexer not ready for printing

Solution: The Duplexer was in the down position when the job was submitted. It must be in the up position before printing starts.

SE 36.2:01

Cause: Duplexer internal error

Solution: Try the following:

- Reseat the cables between the Duplexer and the printer.
- Uninstall and reinstall the Duplexer.
- If the problem persists, contact the manufacturer of the Duplexer.

SE 41:03

Cause: Paper motor electrical current limit

Solution: Try the following:

- Turn the power off at the rear of the printer and disconnect the power cord. Reconnect the power cord and turn on the printer.
- Open the Window and check for any visible obstacles restricting the movement of the Drive Roller. If there is a wrinkled mass of paper inside the paper path, lift the Pinchwheels (using the Media Lever) and clear the obstruction.
- Replace the Media-Axis Motor ⇒ [Media-Axis Motor on page 336](#).

SE 42:03

Cause: Scan-Axis motor electrical current limit

Solution: Try the following:

- Turn the power off at the rear of the printer and disconnect the power cord. Reconnect the power cord and turn on the printer.
- Open the Window and check for any visible obstacles restricting the movement of the Carriage Assembly. If there is a wrinkled mass of paper blocking the Carriage Assembly, then clear the obstruction.
- Clean the Encoder Strip ⇒ [Clean the Encoder Strip on page 450](#).
- Replace the Scan-Axis Motor ⇒ [Scan-Axis Motor on page 331](#).

SE 43:01

Cause: Vacuum Fan spinning at wrong speed

Solution: Try the following:

- Turn the power off at the rear of the printer and disconnect the power cord. Reconnect the power cord and turn on the printer.
- If the system error persists, replace the Vacuum Fan ⇒ [Vacuum Fan on page 278](#).

SE 43:10

Cause: Vacuum Fan failure

Solution: Try the following:

- Turn the power off at the rear of the printer and disconnect the power cord. Reconnect the power cord and turn on the printer.
- Check that the Vacuum Fan cable is not damaged and is correctly connected to the Vacuum Driver PCA and to both Vacuum Motors.
- Check that the Interconnect to Vacuum Driver cable is not damaged and correctly connected to Vacuum Driver PCA and to the Interconnect PCA.
- Replace the Vacuum Fan ⇒ [Vacuum Fan on page 278](#).

SE 43.1:10

Cause: Vacuum Driver PCA communication or hardware failure

Solution: Try the following:

- Turn the power off at the rear of the printer and disconnect the power cord. Reconnect the power cord and turn on the printer.
- If the system error persists, replace the Vacuum Fan ⇒ [Vacuum Fan on page 278](#).

SE 43:11

Cause: Vacuum Fan PCA cable does not seem to be connected

Solution: Try the following:

- Check that the Interconnect PCA to Vacuum Driver cable is not damaged.
- Check that the Interconnect PCA to Vacuum Driver cable is correctly connected to the Interconnect PCA and the Vacuum Fan PCA.
- If the problem persists, replace the Interconnect PCA to Vacuum Driver cable.

SE 44.1:10

Cause: Left Aerosol Fan stopped

Solution: Try the following:

- Turn the power off at the rear of the printer and disconnect the power cord. Reconnect the power cord and turn on the printer.
- Check that the Left Aerosol Fan cable is not damaged and is correctly connected to the PrintMech PCA.
- Check that there is no obstacle blocking the fan.
- Replace the Left Aerosol Fan.

SE 44.2:10

Cause: Right Aerosol Fan stopped or spinning at lower speed

Solution: Try the following:

- Turn the power off at the rear of the printer and disconnect the power cord. Reconnect the power cord and turn on the printer.
- Check that the Right Aerosol Fan cable is not damaged and is correctly connected to the PrintMech PCA.
- Check that there is no obstacle blocking the fan.
- Replace the Right Aerosol Fan.

SE 44.4:10

Cause: Right Aerosol Fan Filter blocked

Solution: Try the following:

- Turn the power off at the rear of the printer and disconnect the power cord. Reconnect the power cord and turn on the printer.
- Check that the Right Aerosol Fan cable is not damaged and is correctly connected to the PrintMech PCA.
- If the system error persists, replace the Aerosol Filter.

SE 45:03

Cause: Rewinder servo shutdown

Solution: Try the following:

- Turn the power off at the rear of the printer and disconnect the power cord. Reconnect the power cord and turn on the printer.
- Open the Window and check for any visible obstacles restricting the movement of the Drive Roller. If there is a wrinkled mass of paper inside the paper path, lift the Pinch Wheels (using the Media Lever) and clear the obstruction.
- Replace the Rewinder Motor.

SE 46:03

Cause: Primer servo shutdown

Solution: Try the following:

- Check that the Primer Arm is not damaged and there are no obstacles in its way.
- Turn the power off at the rear of the printer and disconnect the power cord. Reconnect the power cord and turn on the printer.
- Replace the Primer Assembly ⇒ [Primer Assembly on page 267](#).

SE 46:13

Cause: Primer test distance failed

Solution: Try the following:

- Check that the Primer Arm is not damaged and there are no obstacles in its way.
- Turn the power off at the rear of the printer and disconnect the power cord. Reconnect the power cord and turn on the printer.
- Replace the Primer Assembly ⇒ [Primer Assembly on page 267](#).

SE 50:03

Cause: OMAS fatal error or disconnected

Solution: Try the following:

- Turn the power off at the rear of the printer and disconnect the power cord. Reconnect the power cord and turn on the printer.
- Check that the Power Supply to OMAS Controller cable is not damaged and is correctly connected to the PSU and the OMAS Controller Card.
- Replace the OMAS Controller Card ⇒ [OMAS Controller Card on page 349](#)

SE 50.1:10

Cause: OMAS Module communication failure

Solution: Try the following:

- Turn the power off at the rear of the printer and disconnect the power cord. Reconnect the power cord and turn on the printer.
- Check that the printer has the latest firmware version. If not, update the firmware to the latest version.
- Check that the OMAS Controller to OMAS Sensor cable is not damaged and is correctly connected to the OMAS Controller Card and the OMAS Module.
- Replace the OMAS Module ⇒ [Optical Media Advance Sensor \(OMAS\) on page 339](#).

SE 50:14

Cause: Firmware version mismatch between the OMAS Controller Card and Hard Disk Drive

Solution: Try the following:

- Turn the power off at the rear of the printer and disconnect the power cord. Reconnect the power cord and turn on the printer.
- Check that the printer has the latest firmware version. If not, update the firmware to the latest version.
- Replace the OMAS Controller Card ⇒ [OMAS Controller Card on page 349](#).

SE 50.2:10

Cause: OMAS Controller Card communication failure

Solution: Try the following:

- Turn the power off at the rear of the printer and disconnect the power cord. Reconnect the power cord and turn on the printer.
- Check that the printer has the latest firmware version. If not, update the firmware to the latest version.
- Replace the OMAS Controller Card ⇒ [OMAS Controller Card on page 349](#).

SE 50.3:11

Cause: Main PCA to OMAS Controller cable does not seem to be connected

Solution: Try the following:

- Check that the Main PCA to OMAS Controller cable is not damaged.
- Check that the Main PCA to OMAS Controller cable is correctly connected to the Main PCA and the OMAS Controller Card.

SE 51:10

Cause: Error detected in the Window Position Sensor

Solution: Try the following:

- Check that the Window Position Sensor cable is not damaged and is correctly connected to the Interconnect PCA.
- Replace the Window Position Sensor ⇒ [Window Position Sensor on page 262](#).

SE 51.1:10

Cause: Error detected in the Maintenance Cartridge Door Sensor (Service Station Door Sensor)

Solution: Try the following:

- Check that the sensor cable is not damaged and is correctly connected to the Interconnect PCA.
- Replace the Maintenance Cartridge Door Sensor ⇒ [Maintenance Cartridge Door Sensor on page 403](#).

SE 52:10

Cause: Drop Detector switch On/Off failure

Solution: Try the following:

- Turn the power off at the rear of the printer and disconnect the power cord. Reconnect the power cord and turn on the printer.
- Check that the Drop Detector cable is not damaged and is correctly connected to the Service Station cable.
- Check that the Service Station cable is not damaged and is correctly connected to the Interconnect PCA.
- Replace the Drop Detector ⇒ [Drop Detector on page 284](#).

SE 53:10

Cause: Media Sensor error

Solution: Try the following:

- Check that the Media Sensor cable is not damaged and is connected correctly to the Interconnect PCA.
- Replace the Media Sensor ⇒ [Media Sensor on page 404](#).

SE 53.1:11

Cause: Media Sensor cable does not seem to be connected

Solution: Try the following:

- Check that the Media Sensor cable is not damaged.
- Check that the Media Sensor cable is correctly connected to the Interconnect PCA.

SE 54:10

Cause: Media Lever Sensor error

Solution: Try the following:

- Check that the Media Lever Sensor cable is not damaged and is connected correctly to the Interconnect PCA.
- Replace the Media Lever Sensor ⇒ [Media Lever Sensor on page 413](#).

SE 55:10

Cause: Line Sensor communication failure

Solution: Try the following:

- Turn the power off at the rear of the printer and disconnect the power cord. Reconnect the power cord and turn on the printer.
- Replace the Line Sensor ⇒ [Line Sensor Assembly on page 379](#).

SE 56:01

Cause: Incorrect readings from paper encoder

Solution: Try the following:

- Turn the power off at the rear of the printer and disconnect the power cord. Reconnect the power cord and turn on the printer.
- Perform Paper Drive diagnostics.
- Replace the Encoder Disc and Sensor ⇒ [Encoder Disc and Sensor on page 407](#).

SE 56:10

Cause: Paper Encoder calibration failed

Solution: Try the following:

- Turn the power off at the rear of the printer and disconnect the power cord. Reconnect the power cord and turn on the printer.
- Perform Paper Drive diagnostics.
- Replace the Encoder Disc and Sensor ⇒ [Encoder Disc and Sensor on page 407](#).

SE 58:01

Cause: Embedded PhotoSpectrometer (ESP) shutter error

Solution: Execute the ESP Shutter Diagnostic Test.

SE 58:10

Cause: Embedded PhotoSpectrometer (ESP) failure

Solution: Try the following:

- Turn the power off at the rear of the printer and disconnect the power cord. Reconnect the power cord and turn on the printer.
- Check that the ESP is installed in the Carriage.
- Check that the ESP is correctly installed and screwed into place.
- Check that the ESP cable is not damaged.
- Check that the ESP cable is correctly connected to the Carriage PCA.
- If the system error persists, replace the ESP ⇒ [Embedded SpectroPhotometer \(ESP\) on page 381](#).
- Perform an ESP basic test (CLC), to ensure that the replaced part is working correctly.

SE 58.1:10

Cause: Embedded PhotoSpectrometer (ESP) Shutter Actuator failure

Solution: Try the following:

- Replace the ESP Shutter Actuator Assembly.
- Perform the ESP Shutter Diagnostic Test to ensure that there is no other problem preventing shutter operation.
- Perform an ESP basic test (CLC) to ensure that the replaced part is working correctly.

SE 58.2:10

Cause: Embedded PhotoSpectrometer (ESP) Shutter Deactivator failure

Solution: Try the following:

- Check that the Shutter Deactivator is correctly screwed into place.
- Replace the Left Spittoon Assembly (which contains the Shutter Deactivator).
- Perform the ESP Shutter Diagnostic Test to ensure that there is no other problem preventing shutter operation.
- Perform a ESP basic test (CLC) to ensure that the replaced part is working correctly.

SE 59.1:09

Cause: Two electrical parts have been replaced at the same time

Solution: Replace one part at a time, and restart the printer before replacing another.

SE 59.2:00

Cause: An unsupported or reused part has been installed

Solution: Install only new parts recommended by HP for this printer.

SE 60.1:11

Cause: Initialization error

Solution: Try the following:

- Turn the power off at the rear of the printer and disconnect the power cord.
- Check that the printer is properly connected in all other respects. In particular, check that the tag cable is well connected to the ISS Top PCA, and the ISS Top PCA is well connected to the PrintMech PCA.
- Reconnect the power cord and turn on the printer.
- If the error persists, contact HP.

SE 60.2:17

Cause: Initialization error

Solution: Contact HP.

SE 61:01

Cause: The file format is incorrect and the printer cannot process the job

Solution: Try the following:

- Turn off the printer using the switch at the rear, and disconnect the power cord. Reconnect the power cord and turn on the printer.
- Check the graphic language setting of the printer (see the *User's Guide*).

SE 61:04.1

Cause: The PostScript fonts are missing

Solution: Perform a full firmware update.

SE 61:04.2

Cause: PostScript unknown Paper ID

Solution: Perform a full firmware update.

SE 61:08

Cause: The paper type specified in the file is incorrect and the printer cannot process the job

Solution: Try the following:

- Turn off the printer using the switch at the rear, and disconnect the power cord. Reconnect the power cord and turn on the printer.
- Change the paper type and resend the file to the printer.

SE 61:08.1

Cause: The file cannot be printed because it is password-protected

Solution: Resend the file without password protection.

SE 61:08.2

Cause: The file contains format errors or incorrect settings and the printer cannot process the job

Solution: Try the following:

- Ensure that the file format sent is supported by the printer.
- Turn off the printer using the switch at the rear, and disconnect the power cord. Reconnect the power cord and turn on the printer.
- Resend the file to the printer using the Embedded Web Server.

SE 61:09

Cause: The file can not be printed because data transfer finished unexpectedly.

Solution: Try the following:

- Reprint job to make sure that no unexpected event interrupted the data processing.
- Increase the I/O timeout using the printer's front panel (see 'Configure network settings' in *Using your printer*).
- Send the job from a faster computer.
- Resend the file to the printer using the Embedded Web Server.

SE 61:10

Cause: A slow computer processing complex files can pause for longer than the default printer timeout, which can be interpreted by the printer as an End Of Job, in which case some elements of the job may be lost

Solution: Try the following:

- Increase the I/O timeout using the printer's front panel (see 'Configure network settings' in *Using your printer*).
- Send the job from a faster computer.
- Send the job from the Embedded Web Server.

SE 64.1:01

Cause: The printer does not recognize the USB Hard Disk Drive accessory

Solution: Try the following:

- Turn off the printer using the switch at the rear.
- Connect the Hard Disk Drive accessory, check that the USB cable is properly connected and turn the printer on. If the Hard Disk Drive accessory is not available (has been lost or broken), proceed to the next step.
- If the problem persists, turn off the printer using the switch at the rear. Turn the printer on again while pressing **Menu**, **OK** and **Cancel** simultaneously until the front panel asks **Printer configured to use External Hard Disk. Do you want to revert the printer to Internal Hard Disk?**. Confirm by pressing **OK** (twice). Remove the Hard Disk Drive accessory (if connected). The printer restarts.
- After the printer reaches the Ready state, try connecting any other USB device (known to work properly) to the printer port where the Hard Disk Drive accessory should be connected. If a message appears on the front panel reacting to the USB device just connected (such as **Please remove USB device** or **Press OK to...**), press **Cancel** and remove the USB Device. This means the Hard Disk Drive accessory is faulty and should be replaced. See Formatter.
- If nothing appears on the front panel reacting to the USB device just connected, the Formatter is faulty and should be replaced. See Formatter.

SE 71:03

Cause: Out of memory failure

Solution: Try the following:

- Turn off the printer using the switch at the rear, and disconnect the power cord. Reconnect the power cord and turn on the printer.
- If the problem persists, resend the job with one or more of the following options:
 - Decrease resolution to 300 dpi.
 - Select **Economode** print mode.
 - Select **Send Job As Bitmap**, to have the main processing of the print job done by the computer rather than the printer.

SE 71:08

Cause: Insufficient display list

Solution: Resend the job with one or more of the following options: decrease resolution to 300 dpi, select Economode print mode, select **Send Job As Bitmap** to have the main processing of the print job done by the computer rather than the printer.

SE 74:01

Cause: Error uploading firmware update file

Solution: Try the following:

- Turn the power off at the rear of the printer and disconnect the power cord. Reconnect the power cord and turn on the printer.
- Resend the firmware update file to the printer.

SE 75.21:10

Cause: Total printer ink consumption reached upper limit

Solution: This is a continuable system error. The customer may continue to print normally but may encounter print-quality issues or ink buildups in the Service Station. To avoid these problems, it's best to apply Preventive Maintenance Kit #2.

SE 76:03

Cause: Hard Disk Drive out of space

Solution: Try the following:

- Turn the power off at the rear of the printer and disconnect the power cord. Reconnect the power cord and turn on the printer.
- Resend the file to the printer.
- Remove any unnecessary files from the Hard Disk Drive using the Web Server.
- If the problem persists, perform Hard Disk Recovery (see [Hard Disk recovery on page 129](#)).

SE 77:04

Cause: Embedded Web Server internal software error

Solution: Try the following:

- Turn the power off at the rear of the printer and disconnect the power cord. Reconnect the power cord and turn on the printer.
- Check that the printer has the latest firmware version. If not, update the firmware to the latest version.

SE 78.1:04

Cause: Media Settings area missing in media settings file

Solution: Resend the file.

SE 79:03

Cause: Generic firmware error

Solution: Try the following:

- Turn the power off at the rear of the printer and disconnect the power cord. Reconnect the power cord and turn on the printer.
- Check that the printer has the latest firmware version. If not, update the firmware to the latest version.
- If the problem persists, perform Hard Disk Recovery (see [Hard Disk recovery on page 129](#)).

SE 79:04

Cause: Generic firmware error

Solution: Try the following:

- Turn the power off at the rear of the printer and disconnect the power cord. Reconnect the power cord and turn on the printer.
- Check that the printer has the latest firmware version. If not, update the firmware to the latest version.
- Try to reprint the image using different selections in the driver.
- Disable nesting and the queue.
- If the problem persists, perform Hard Disk Recovery (see [Hard Disk recovery on page 129](#)).
- For more detailed information, see [How to troubleshoot the 79:04 system error on page 30](#).

SE 79.2:04

Cause: Operating-system signal error

Solution: Try the following:

- Turn the power off at the rear of the printer and disconnect the power cord. Reconnect the power cord and turn on the printer.
- Check that the printer has the latest firmware version. If not, update the firmware to the latest version.
- Try to reprint the image using different selections in the driver.
- Disable nesting and the queue.
- If the problem persists, perform Hard Disk Recovery (see [Hard Disk recovery on page 129](#)).

SE 81:01

Cause: Paper servo shutdown; possible paper jam

Solution: Try the following:

- Open the Window and check for any visible obstacles restricting the movement of the Drive Roller. If there is a wrinkled mass of paper inside the paper path, lift the Pinchwheels (using the Media Lever) and clear the obstruction.
- Check that the OMAS Controller Card to PrintMech PCA cable is not damaged.
- Check that the OMAS Controller Card to PrintMech PCA cable is correctly connected to the OMAS Controller Card and the PrintMech PCA.
- Perform the Media Drive Diagnostic (⇒ [Paper Drive test on page 94](#)) to further troubleshoot the error code.

SE 85:03

Cause: Problem finding the Drive Roller zero

Solution: Perform the Media Drive Diagnostic (⇒ [Paper Drive test on page 94](#)) to further troubleshoot the error code.

SE 86:01

Cause: Carriage servo shutdown; possible paper jam

Solution: Try the following:

- Open the Window and check for any visible obstacles restricting the movement of the Carriage Assembly. If there is a wrinkled mass of paper inside the paper path, lift the Pinchwheels (using the Media Lever) and clear the obstruction.
- Perform the Scan-Axis Diagnostic (⇒ [Scan Axis test on page 94](#)) to obtain further information on the problem.

SE 86:11

Cause: Scan-Axis length requires too much force or energy

Solution: Try the following:

- Check that cutter disengages correctly.
- Lubricate Scan Axis.
- Apply Preventive Maintenance Kit 1.

SE 87:01

Cause: Problem with the Scan Axis encoder sensor readings

Solution: Try the following:

- Check whether the Encoder Strip is dirty. If necessary, clean it. Pay special attention to the area near the Service Station. Follow the instructions on the front panel after selecting the Ink menu and then **Clean Encoder Strip**.
- Check whether the Encoder Strip is broken or damaged. If necessary, replace it.
- If the system error persists, clean the Encoder Sensor.

- If the system error persists, replace the Encoder Sensor.
- Perform the Scan Axis diagnostic test to troubleshoot the problem further.

SE 87:10

Cause: Problem with the Carriage Encoder Sensor readings

Solution: Try the following:

- Check that the Encoder Sensor is correctly connected to the Carriage PCA.
- Check whether the Encoder Strip is broken or damaged. If necessary, replace it.
- Check whether the Encoder Strip is dirty. If necessary, clean it. Pay special attention to the area near the Service Station. Follow the instructions on the front panel after selecting the Ink menu and then **Clean Encoder Strip**.
- If the system error persists, clean the Encoder Sensor.
- If the system error persists, replace the Encoder Sensor.

SE 94:01

Cause: The paper is not suitable for color calibration, being too dark (low L), or too coloured (a or b above thresholds), or transparent

Solution: Try the following:

- If accurate color is important, change to a different paper type (preferably an HP paper type) that satisfies the conditions for color calibration.
- If accurate color is not important, print without color calibration.

SE 94:02

Cause: Color calibration error: some of the consistency checks on the Embedded SpectroPhotometer (ESP) measurements failed, which could have several causes

Solution: Try the following:

- Ensure that the paper type selected corresponded to the paper actually loaded.
- Inspect the CLC printed target to detect any printing defect: banding, missing colors, etc. If an issue is detected, run the Printing IQ Full Calibration procedure to fix any printing problems.
- Check that color calibration is supported for this paper type: translucent, plain and heavily colored papers cannot be color-calibrated.
- If the problem persists, try calibrating an HP coated paper (if available). If this calibration fails, replace the ESP.

SE 94:10

Cause: Embedded SpectroPhotometer (ESP) contaminated by aerosol

Solution: Try the following:

- Replace the ESP ⇒ [Embedded SpectroPhotometer \(ESP\) on page 381](#).
- Perform the ESP basic test (CLC) to ensure that the replaced part is working correctly.

3 Ink supplies

- [What are ink supplies?](#)
- [General information about the ink supplies](#)
- [General precautions when handling ink supplies](#)
- [Priming the ink system](#)
- [When should you replace the ink supplies?](#)
- [Obtaining Ink Cartridge information](#)
- [Obtaining Printhead information](#)
- [Summary of solving ink supplies problems](#)
- [Troubleshooting Printhead error codes](#)
- [Carriage Interconnect Wiper](#)
- [Warranty information for ink supplies](#)

What are ink supplies?

Three different components are classed as ink supplies: the Ink Cartridges, the Printheads and the Maintenance Cartridge.



Ink Cartridges

The HP Designjet Z6200 and Z6800 printer's eight Ink Cartridges provide matte black, photo black, light gray, red, magenta, light magenta, yellow and light cyan ink to the Printheads. The HP Designjet Z6600 printers six Ink Cartridges provide matte black, photo black, light gray, red, magenta, light magenta, yellow and light cyan.

The Introductory Ink Cartridges supplied with the printer have 160 ml of ink, which is an average lifespan of one month beyond the ink used to set up and install the printer. The 'Host' Ink Cartridges which are purchased to replace the Introductory Ink Cartridges hold approximately 775 ml.



The Ink Cartridges for the HP Designjet Z6200/Z6600/Z6800 printer series require no maintenance or cleaning. As long as each Ink Cartridge is inserted correctly into its slot, the ink will flow to the Printheads. Because the Printheads control the amount of ink transferred to the page, you will continue to see high-quality printing results even when the ink levels are getting low.

The front panel displays the status of the Ink Cartridge. Using the front panel, detailed information can be checked on the Ink Cartridges.

The following tables list the Ink Cartridges for the HP Designjet Z6200/Z6600/Z6800 printer series.

Table 3-1 Ink cartridges Z6200/Z6600/Z6800

| Cartridge | Part number | Region |
|--|-------------|-----------------------------|
| HP 771B 775 ml Matte Black Designjet Ink Cartridge | B6X99A | Asia, Pacific, Japan |
| HP 771B 775 ml Chromatic Red Designjet Ink Cartridge | B6Y00A | Asia, Pacific, Japan |
| HP 771B 775 ml Magenta Designjet Ink Cartridge | B6Y01A | Asia, Pacific, Japan |
| HP 771B 775 ml Yellow Designjet Ink Cartridge | B6Y02A | Asia, Pacific, Japan |
| HP 771B 775 ml Light Magenta Designjet Ink Cartridge | B6Y03A | Asia, Pacific, Japan |
| HP 771B 775 ml Light Cyan Designjet Ink Cartridge | B6Y04A | Asia, Pacific, Japan |
| HP 771B 775 ml Photo Black Designjet Ink Cartridge | B6Y05A | Asia, Pacific, Japan |
| HP 771B 775 ml Light Gray Designjet Ink Cartridge | B6Y06A | Asia, Pacific, Japan |
| HP 771C 775 ml Matte Black Designjet Ink Cartridge | B6Y07A | Europe, Middle East, Africa |
| HP 771C 775 ml Chromatic Red Designjet Ink Cartridge | B6Y08A | Europe, Middle East, Africa |
| HP 771C 775 ml Magenta Designjet Ink Cartridge | B6Y09A | Europe, Middle East, Africa |
| HP 771C 775 ml Yellow Designjet Ink Cartridge | B6Y10A | Europe, Middle East, Africa |
| HP 771C 775 ml Light Magenta Designjet Ink Cartridge | B6Y11A | Europe, Middle East, Africa |
| HP 771C 775 ml Light Cyan Designjet Ink Cartridge | B6Y12A | Europe, Middle East, Africa |
| HP 771C 775 ml Photo Black Designjet Ink Cartridge | B6Y13A | Europe, Middle East, Africa |
| HP 771C 775 ml Light Gray Designjet Ink Cartridge | B6Y14A | Europe, Middle East, Africa |
| HP 771A 775 ml Matte Black Designjet Ink Cartridge | B6Y15A | Americas |
| HP 771A 775 ml Chromatic Red Designjet Ink Cartridge | B6Y16A | Americas |
| HP 771A 775 ml Magenta Designjet Ink Cartridge | B6Y17A | Americas |
| HP 771A 775 ml Yellow Designjet Ink Cartridge | B6Y18A | Americas |
| HP 771A 775 ml Light Magenta Designjet Ink Cartridge | B6Y19A | Americas |
| HP 771A 775 ml Light Cyan Designjet Ink Cartridge | B6Y20A | Americas |
| HP 771A 775 ml Photo Black Designjet Ink Cartridge | B6Y21A | Americas |
| HP 771A 775 ml Light Gray Designjet Ink Cartridge | B6Y22A | Americas |

Table 3-2 Ink cartridges Z6600/Z6800

| Cartridge | Part number | Region | Z6600 | Z6800 |
|--|-------------|----------------------|-------|-------|
| HP 773B 775 ml Matte Black Designjet Ink Cartridge | C1Q29A | Asia, Pacific, Japan | x | x |
| HP 773B 775 ml Matte Black Designjet Ink Cartridge | C1Q29A | Asia, Pacific, Japan | x | x |

Table 3-2 Ink cartridges Z6600/Z6800 (continued)

| Cartridge | Part number | Region | Z6600 | Z6800 |
|--|-------------|-----------------------------|-------|-------|
| HP 773B 775 ml Chromatic Red Designjet Ink Cartridge | C1Q30A | Asia, Pacific, Japan | | x |
| HP 773B 775 ml Magenta Designjet Ink Cartridge | C1Q31A | Asia, Pacific, Japan | x | x |
| HP 773B 775 ml Yellow Designjet Ink Cartridge | C1Q32A | Asia, Pacific, Japan | x | x |
| HP 773B 775 ml Light Magenta Designjet Ink Cartridge | C1Q33A | Asia, Pacific, Japan | | x |
| HP 773B 775 ml Cyan Designjet Ink Cartridge | C1Q34A | Asia, Pacific, Japan | x | x |
| HP 773B 775 ml Photo Black Designjet Ink Cartridge | C1Q35A | Asia, Pacific, Japan | x | x |
| HP 773B 775 ml Light Gray Designjet Ink Cartridge | C1Q36A | Asia, Pacific, Japan | x | x |
| HP 773C 775 ml Matte Black Designjet Ink Cartridge | C1Q37A | Europe, Middle East, Africa | x | x |
| HP 773C 775 ml Chromatic Red Designjet Ink Cartridge | C1Q38A | Europe, Middle East, Africa | | x |
| HP 773C 775 ml Magenta Designjet Ink Cartridge | C1Q39A | Europe, Middle East, Africa | x | x |
| HP 773C 775 ml Yellow Designjet Ink Cartridge | C1Q40A | Europe, Middle East, Africa | x | x |
| HP 773C 775 ml Light Magenta Designjet Ink Cartridge | C1Q41A | Europe, Middle East, Africa | | x |
| HP 773C 775 ml Cyan Designjet Ink Cartridge | C1Q42A | Europe, Middle East, Africa | x | x |
| HP 773C 775 ml Photo Black Designjet Ink Cartridge | C1Q43A | Europe, Middle East, Africa | x | x |
| HP 773C 775 ml Light Gray Designjet Ink Cartridge | C1Q44A | Europe, Middle East, Africa | x | x |
| HP 773A 775 ml Matte Black Designjet Ink Cartridge | C1Q21A | Americas | x | x |
| HP 773A 775 ml Chromatic Red Designjet Ink Cartridge | C1Q22A | Americas | | x |
| HP 773A 775 ml Magenta Designjet Ink Cartridge | C1Q23A | Americas | x | x |
| HP 773A 775 ml Yellow Designjet Ink Cartridge | C1Q24A | Americas | x | x |
| HP 773A 775 ml Light Magenta Designjet Ink Cartridge | C1Q25A | Americas | | x |
| HP 773A 775 ml Cyan Designjet Ink Cartridge | C1Q26A | Americas | x | x |
| HP 773A 775 ml Photo Black Designjet Ink Cartridge | C1Q27A | Americas | x | x |
| HP 773A 775 ml Light Gray Designjet Ink Cartridge | C1Q28A | Americas | x | x |

Printheads

The printheads are connected to the ink cartridges. They use jet action to put ink on the paper. Each printhead has two ink cartridge connection points and two jet nozzles, which means that each printhead accommodates two ink cartridges. For example, the following printhead image indicates a printhead that draws and jets ink from the magenta and yellow cartridges.

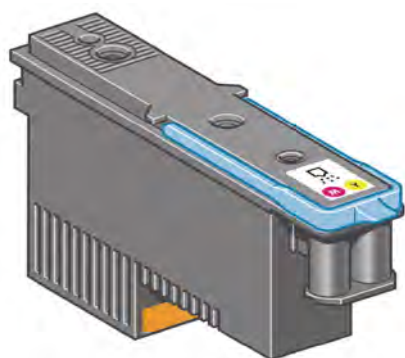

The Printheads are extremely durable and do not need to be replaced every time an Ink Cartridge is replaced. They are independent of the Ink Cartridges and will continue giving excellent image quality results even if the Ink Cartridges are low on ink.

If you notice a decline in print quality such as lines or dots missing from text/graphics, go to [Initial print-quality troubleshooting actions on page 156](#).

The following table lists the Printheads for the HP Designjet Z6200/Z6600/Z6800 printer series.

Table 3-3 Printheads

| Part number | Printhead | Z6200 | Z6600 | Z6800 |
|-------------|--|-------|-------|-------|
| CE017A | HP 771 Matte Black & Chromatic Red Designjet Printhead | x | | x |
| CE018A | HP 771 Magenta & Yellow Designjet Printhead | x | x | x |
| CE019A | HP 771 Light Magenta & Light Cyan Designjet Printhead | x | | x |
| CE020A | HP 771 Photo Black & Light Gray Designjet Printhead | x | x | x |
| C1Q20A | HP 773 Matte Black & Cyan Designjet Printhead | | x | |

Maintenance Cartridge

Use the Maintenance Cartridge to clean and maintain the Printheads, ensure the best possible print quality, and seal the Printheads when they are not in use to prevent them from drying out.



The Maintenance Cartridge for the HP Designjet Z6200/Z6600/Z6800 printer series is the HP 771 Maintenance Cartridge, part number CH644A.

General information about the ink supplies

For optimum results from the printer and modular ink delivery system always follow these guidelines when handling the ink supplies:

- Allow the printer and the Maintenance Cartridge to automatically clean the Printheads.
- Follow the instructions on the front panel of the printer during installation.
- Avoid unnecessary removal of the Ink Cartridges and Printheads.
- When turning off the printer always use the power Off button on the front panel. The Printheads are then stored correctly which prevents them from drying out.
- The Ink Cartridges should never be removed while the printer is printing. They should only be removed when the printer is ready for you to replace them. The front panel will guide you through the removal and installation procedure.

 **NOTE:** The expiration date for the Ink Cartridges, Printheads and Maintenance Cartridge is printed on the packaging.

 **NOTE:** When reporting a system error code, make sure that you supply the full error code and the firmware version. Without this information, HP support personnel cannot help you.

General precautions when handling ink supplies

 **CAUTION:** Do not touch, wipe or attempt to clean the printhead nozzles. This can damage the printhead.

- Handle the ink supplies with care. In particular the Printhead, which is a high precision device and must be handled carefully.
- Do not touch the Printhead nozzles.
- Do not put the Printhead down on the nozzles.
- Do not be rough when handling the Printheads. Always set them down gently.
- Do not drop the Printheads.
- Proper handling will assure optimum performance throughout the Printhead life.
- The Maintenance Cartridge should always be handled and stored upright to avoid a potential spillage of ink.
- Do not touch the end of the Ink Cartridge which is inserted into the printer as there may be a small amount of ink on the connection.
- Avoid storing partially used Ink Cartridges on their ends.

Priming the ink system

When the customer first receives the printer, it is supplied with a set of four Setup Printheads pre-installed in the Carriage Assembly. These Setup Printheads are used for the priming of the tubes in the modular ink delivery system. The customer must not remove the Setup Printheads from the Carriage without following the procedures in the *Assembly Instructions*.

When the printer is powered on for the first time, the printer will automatically perform the priming process. Without the priming process, the customer will not be able to use the printer.

Why does the printer require priming:

- The Tubes System is empty when the customer receives the printer.
- The Tubes System has to be pressurized and filled with ink, ejecting any air bubbles.

CAUTION: If the Printing Printheads are installed in the carriage during the priming process, they will be rejected and the front panel will show a warning message.

When should you replace the ink supplies?

When to change the ink supplies is mostly determined by you with guidance from the front panel. In conjunction with the messages displayed in the front panel and the message explanations in this chapter, you will be able to choose for yourself when is the right time to change the ink supplies.

The printer will also display the ink level and will tell you when the ink supply is low on ink. This means you have constantly updated information about the ink supplies.

Printhead life is anticipated to be 1200 ml or twelve months in the printer, whichever occurs first, provided that the printhead is used under normal operating conditions (using HP Ink Cartridges only) and its “install before date” has not lapsed. However results vary depending on the print-quality setting being used.

Obtaining Ink Cartridge information

Use the following procedure to obtain Ink Cartridge information:

1. At the front panel, select the  icon, then **Ink cartridge information**.
2. In the Ink Cartridge Information submenu, scroll to the **Ink Cartridge** on which you want information and press **OK**.
3. The front panel displays information on the selected Ink Cartridge. You can use the **Up** and **Down** keys to scroll through the information.

The information supplied is:

- The color of the Ink Cartridge
- The product name
- The product number of the Ink Cartridge
- The serial number of the Ink Cartridge
- The current status of the Ink Cartridge
- The current ink level of the ink cartridge in milliliters
- Original capacity of the ink cartridge in milliliters
- The warranty status of the Ink Cartridge
- The manufacturer of the Ink Cartridge (HP is recommended)
- The expiration date of the Ink Cartridge

Obtaining Printhead information

1. At the front panel, select the  icon, then **Printhead information**.
2. In the Printhead Information submenu, scroll to the Printhead on which you want information and press **OK**.
3. The front panel displays information on the selected Printhead.

The information supplied is:

- The make of the Printhead
- The product number of the Printhead
- The serial number of the Printhead
- The current status of the printhead
- How much ink has been fired (consumed) by the Printhead



NOTE: It is possible for a Printhead to consume more than one Ink Cartridge.

- The current warranty status of the Printhead
- The current status of the Maintenance Cartridge

Ink Cartridge status messages

Status Bars

The front panel displays four horizontal bars. These bars represent how much ink is remaining in the Ink Cartridges: as ink is used up the bars get shorter in length. To see how much ink is remaining, go to the **Ink Cartridge Information** submenu. See [Obtaining Ink Cartridge information on page 83](#).

Ink Cartridge status while printing

OK

The Ink Cartridge is operating correctly and no action is required.

Low

The **Low** message is an early warning sign and it is advisable that new supplies should be obtained of that particular color. The amount of ink remaining in the Ink Cartridge depends on its capacity, but there is approximately 14% of ink available for the user.

Very Low

When the **Very Low** message is displayed, overnight printing should not be attempted. Changing the Ink Cartridge is strongly recommended to prevent the printer from stopping halfway through a print. There is approximately 8% of ink available for the user.

Empty

The printer will stop and will not be able to continue printing until a new Ink Cartridge has been installed. If this occurs halfway through printing an image, you should check the quality of this image, as stopping mid-plot can affect the print. It is recommended to reprint the image once a new Ink Cartridge has been installed.

Faulty

The Ink Cartridge is unable to operate correctly. The printer will stop and will not be able to continue printing until a new Ink Cartridge has been installed. If this occurs halfway through printing an image, you should check the quality of this image, as stopping mid-plot can affect the print. It is recommended to reprint the image once a new Ink Cartridge has been installed.

Ink Cartridge status while replacing

The printer can report the following status messages while the Ink Cartridge is being replaced:

Missing

The Ink Cartridge has not been installed or is installed incorrectly. The printer will not print until all Ink Cartridges have been installed correctly.

Reseat

The Ink Cartridge is having continuity problems. Try removing the Ink Cartridge from the printer and inserting it in again.

Replace

The Ink Cartridge is faulty and needs to be replaced before the printer can continue printing.

Incorrect

The Ink Cartridge region doesn't match the Printer Region. Cartridge region can be found on supply label or in the printer information in the Embedded Web Server or in the Ink Supply information menu in EWS.

The Printer region can be found in the Printer Information menu in the Front Panel or in the printer information report in the embedded web server.

1. If the ink cartridge region doesn't match the customer location, the ink cartridge should be replaced.
2. If the Printer region doesn't match the customer location, the Printer region needs to be changed ⇒ [Change the printer region on page 7](#).

Unknown

The Ink Cartridge installed is not approved **but** the user has confirmed that he is using refilled or non-HP Ink Cartridges. Refer to the User's Guide for further information regarding using refilled or non-HP approved Ink Cartridges.

The main actions for all four status messages are as follows:

1. Reseat the Ink Cartridge.
2. If reseating does not resolve the status message, replace the Ink Cartridge.
3. If the Status messages continue to appear, even after replacing the Ink Cartridge, replace the Ink Supply Tubes and Trailing Cable ⇒ [Ink Supply Tubes and Trailing Cable on page 287](#).

Printhead status messages while printing

Detailed below are the printhead status messages that may be displayed while printing.

OK

The printhead is operating correctly and will provide an acceptable level of print quality. To find more information on the printheads, refer to [Obtaining Printhead information on page 84](#).

Replace

The Printhead is faulty and needs to be replaced before the printer can continue printing.

If this message continues to appear (for example after installing new Printheads), try the following:

1. Reseat the Printheads and check if the message disappears.
2. Remove the Drop Detector and make sure that there are no obstacles inside which are blocking the sensor.
3. Print the Diagnostic Print ⇒ [Printing the Image Quality Service Print on page 162](#) to check that the Printhead nozzles are firing correctly.
4. Perform the Service Station test ⇒ [Service Station test on page 104](#).
5. Replace all the Printheads.

Printhead status messages while replacing

The following are the Printhead status messages that may be displayed while replacing the Printheads.

Reseat

In this situation, select the Printhead replacement option through the Front Panel but do not remove the Printheads. If this status message continues to appear then remove the Printheads and install them again.

Remove

The Printhead is not a suitable type for use in printing (for example, a Setup Printhead).

Missing

No Printhead has been detected in that Carriage stall. If a Printhead is installed in the Carriage stall when this status message is shown:

1. Reseat the Printhead, making sure it is installed correctly.
2. Clean the Carriage and Printhead flex circuits using the Carriage Interconnect Wiper ⇒ [Carriage Interconnect Wiper on page 89](#).
3. Replace the Printhead.
4. Perform the Electronic Systems Test ⇒ [Electronics Module test on page 97](#).



NOTE: If all the Printheads are installed but have the Status message “Missing”, it is possible that the Carriage Assembly is faulty.

Maintenance Cartridge status messages while printing

Detailed below are the Maintenance Cartridge status messages that may be displayed while printing.

OK

The Maintenance Cartridge is operating correctly and no action is required.

End of Life

The Maintenance Cartridge has reached the end of its life and should be replaced.

Maintenance Cartridge status messages while replacing

The following are the Maintenance Cartridge status messages that may be displayed while replacing the Printheads.

Reseat Cleaner

In this situation, remove the Maintenance Cartridge and install it again.

Missing

The Maintenance Cartridge has not been installed or is installed incorrectly. The printer will not print until the Maintenance Cartridge has been installed correctly.

Summary of solving ink supplies problems

Most of the problems that you could encounter when working with the ink supplies are solved with guidance from the front panel. A full list of front panel messages are supplied in the User's Guide.

Problems reseating the printhead

If you have inserted the printhead into the printhead carriage assembly and the printer does not "BEEP" try the following steps.

 **CAUTION:** Check that during the priming process, the Setup Printheads are installed in the Carriage. If the printing Printheads are installed in the carriage during the priming process, they will be rejected and the front panel will show a warning message.

- Check that the protective tape has been removed from the printhead.
- Insert the Printhead into the Carriage Assembly but this time correctly close the cover using the latch.
- Clean the electrical contacts on both the printheads and the printhead Carriage Assembly using the carriage interconnect wiper ⇒ [Carriage Interconnect Wiper on page 89](#).
- Replace the Printhead with a new one.

You cannot insert the Ink Cartridge into the printer

1. Ensure that you have the correct HP no. 771/773 Ink Cartridge.
2. Ensure that the Ink Cartridge is the correct color for that slot.
3. Ensure that the Ink Cartridge is the correct orientation, with the color coded label at the top.

 **CAUTION:** Never clean inside the Ink Cartridge slots as this can cause damage to the printer.

You cannot insert the Printhead into the printer

1. Ensure that you have the correct HP no. 771/773 Printhead.
2. Ensure that the printhead is the correct color for that slot.

3. Ensure that the printhead is in the correct orientation.
4. Ensure that the protective cap is removed from the Printhead.

You cannot insert the Maintenance Cartridge into the printer

1. Ensure that you have the correct HP no. 771 Maintenance Cartridge.
2. Ensure that the Maintenance Cartridge is in the correct orientation.

Troubleshooting Printhead error codes

The Printhead Error Codes can be found on the Service Information Print (Setup Menu/Information Menu/Internal Prints/Print Service Information/Current Information). The actual error code is a decimal number and it has to be converted to a binary number before it can be used.

| Current Printhead Kit Info (i) | | | | |
|--------------------------------|-----------------|--------|---------------|----------------|
| | Warranty status | Status | Error ID Code | Product Number |
| 1 - Matte black | In warranty | OK | 0 | C5058A |
| 2 - Matte black | In warranty | OK | 0 | C5058A |
| 3 - Dark Gray | In warranty | OK | 0 | C5058A |
| 4 - Dark Gray | In warranty | OK | 0 | C5058A |

In order to convert the decimal error code to a binary error code, you can use a calculator. For example, if you had the error code 4099, you would enter 4099 as a decimal number and then select the binary option which would give you a binary number of 1000000000011.

The following table explains the meaning of the different bits (0 or 1). When the value of the error code is reported as 0, it means that the Printhead is working correctly:

| Bit | Meaning | Bit | Meaning |
|------------------|---------------------|------------------|--------------------------|
| 1 st | FAILS_LOGICAL_V | 11 th | BAD_ACUMEN_ACCESS |
| 2 nd | FAILS_CONTINUITY | 12 th | WRONG_MODEL |
| 3 rd | SHUTDOWN | 13 th | MISMATCH |
| 4 th | FAILS_VPP | 14 th | CSDATA_NOT_RESPONDING |
| 5 th | TEMP_EXTREMELY_HIGH | 15 th | CSDATA_TRANSMIT_ERROR |
| 6 th | TEMP_EXTREMELY_LOW | 16 th | FAILS_ENERGY_CALIBRATION |
| 7 th | TEMP_TOO_HIGH | 17 th | EMPTY_DUMMY |
| 8 th | TEMP_TOO_LOW | 18 th | FULL_DUMMY |
| 9 th | BAD_ACUMEN_INFO | 19 th | END_OF_LIFE |
| 10 th | NO_PEN | 20 th | OUT_OF_WARRANTY |

The binary number needs to be read from right to left so that the 1st bit corresponds to the right one of the binary number. For example, the error code 4099 is converted to binary number 10000000000011. So using the table above, the error code means “FAILS_LOGICAL_V”, “FAILS_CONTINUITY” and “MISMATCH”.

Carriage Interconnect Wiper

Whenever you replace the Printhead, check the empty slots to see if they need cleaning. In extreme circumstances, when a Printhead is inserted, it is possible that the printer will not recognize it due to the build-up of ink on the electrical connection between the Printhead and the Carriage Assembly.

The Carriage Interconnect Wiper is available as an accessory in a separate package. The package also contains replacement sponges and an instruction sheet. This tool should be used for cleaning the electrical interconnects of both the Carriage Assembly and the Printhead.



If the front panel displays the message **Reset** or **Replace** next to the offending printhead, try cleaning the flex circuits of the Carriage and the Printheads.

⚠ CAUTION: Do not touch, wipe or attempt to clean the printhead nozzles. This can damage the printhead and reduce print quality.

Warranty information for ink supplies

- [Ink Cartridge](#)
- [Printheads](#)

Ink Cartridge

The warranty for an Ink Cartridge ends when one of the following occurs:

- 30 months have passed since the date of manufacture.
- or
- The Ink Cartridge has supplied all the ink that it is advertised as containing.
- or
- The customer confirms that non-HP ink has been used in empty override mode.

The actual end of warranty date is printed on the supply label.

Printheads

The warranty for the Printheads will end when one of the following occurs:

- 24 months have passed since the date of manufacture that is printed on the Printhead.
- or
- 1200 ml (42 oz) of HP original ink has been consumed by the Printhead.

or

- The customer confirms that non-HP ink has been used in empty override mode.

4 Service tests and utilities

- [Introduction](#)
- [Diagnostics—self test](#)
- [Phone support](#)
- [Service tests \(diagnostics\)](#)
- [Entering the Service Tests menu](#)
- [Service utilities](#)

Introduction

This chapter explains how to use the built-in Service Tests and Service Utilities and what to do if any of the Service Tests fail.

 **NOTE:** If possible, always perform a Service Test on the component that you are about to replace, just to make sure that it is the component that has failed. If the test on that component passes, there is no need to replace it.

Diagnostics—self test

Whenever the printer is switched ON, it automatically performs a series of internal self tests and mechanical initialization sequences. If any of the parts fail, a system error will appear and you should consult “System Error Codes” on page 43.

Phone support

In certain circumstances, a Call Agent can try and troubleshoot the printer by requesting the Customer to perform a Service Test via the phone. Using this process, it can be determined whether the printer requires any on-site maintenance.

Remember that the key combination for the customer to enter the Service Tests and Utilities is different from the one that the engineer will use.

Service tests (diagnostics)

The following is a list of all internal Service Tests available in the printer. See page 94 for instructions on how to enter the Service Tests menu.

1. Scan Axis Test ⇒ [Scan Axis test on page 94](#).
The purpose of this test is to check the operation of components related to the Scan Axis.
2. Paper Drive Test ⇒ [Paper Drive test on page 94](#).
The purpose of this test is to check the operation of components related to the Media Axis.
3. Electronics Module Test ⇒ [Electronics Module test on page 97](#).
The purpose of this test is to check the operation of the Formatter.
4. Carriage Assembly Test ⇒ [Carriage Assembly test on page 98](#).
The purpose of this test is to check the operation of the Carriage Assembly.
5. Ink Delivery System Test ⇒ [Ink Delivery System test on page 100](#).
The purpose of this test is to check the operation of the Ink Supply Tubes.
6. Service Station Test ⇒ [Service Station test on page 104](#).
The purpose of this test is to check the operation of the Service Station.

7. Primer Test ⇒ [Primer Motor test on page 105](#).

The purpose of this test is to check the operation of the Primer.

8. Aerosol Test ⇒ [Aerosol Fan test on page 106](#).

The purpose of this test is to check the operation of the Aerosol Fans.

9. I/O Information Test ⇒ [I/O Information test on page 107](#).

The purpose of this test is to display network information about the printer.

10. Enable I/O Interfaces Test ⇒ [Enable I/O Interfaces test on page 107](#).

The purpose of this test is to enable the printer's I/O connections (USB, Ethernet, Jetdirect) after they have been disabled from the Embedded Web Server.

11. Unit Information ⇒ [Unit information on page 108](#).

The purpose of this test is to view the firmware version, part number, serial number and PostScript configuration.

12. EEROM Reset ⇒ [EEROM Reset on page 109](#).

The purpose of this test is to reset the EEROM.

13. Hard Disk Recovery ⇒ [Hard Disk recovery on page 110](#).

The purpose of this service utility is to clean user data on the Hard Disk, to try to recover the printer from an unstable state.

14. File System Check ⇒ [File system check on page 110](#).

The purpose of this service utility is to check the consistency of the file system on the Hard Disk. If the utility detects a problem, it will try to fix it automatically.

15. Front Panel Lock Reset ⇒ [Front Panel Lock Reset test on page 110](#).

The purpose of this test is to unlock the Front Panel.

16. Remove all non factory papers ⇒ Remove all non factory papers

The purpose is to clear from the Printer all the paper presets that may have been created by the customer or by a 3rd party.

Entering the Service Tests menu



NOTE: To enter the Service Utilities Menu, see [Entering the Service Utilities menu on page 112](#).

1. Make sure the printer is switched off with the **Power** key on the front of the printer and **not** with the power switch on the back of the printer.
2. For Call Agents who will request the user to perform certain troubleshooting actions, hold the **Down** and **OK** keys down and turn the printer on using the **Power** key. Wait until you hear one beep (usually after 5 seconds) before releasing all three keys.

- For On-Site Engineers, hold the **Up** arrow key and the **OK** key down and switch the printer **ON** using the front power switch. Wait until you hear one beep (usually after 5 seconds) before releasing ALL three keys.
- The printer accesses the Service Utilities menu when the progress bar reaches 29%. Once inside the Service Tests Menu use the **Arrow** keys to scroll through the **Service Tests** selections. Press the **OK** key to begin a specific test when the required Service Test is highlighted.

 **NOTE:** The Service Tests work in a special mode that does not require full initialization of the printer. Therefore it is important that, once you have finished with the Service Tests, you **must** power off the printer and power on again before trying to print.

In some cases a quick press of a button may not be recognized by the printer. When pressing a button, be sure to press it deliberately and all the way to the bottom of its travel.

If the printer hangs up during a test, switch the printer off and restart from step 1.

Scan Axis test

The purpose of this test is to diagnose a failure in the operation of components related to the Scan Axis.

- In the Diagnostics menu, select **Scan Axis** and press **OK**.

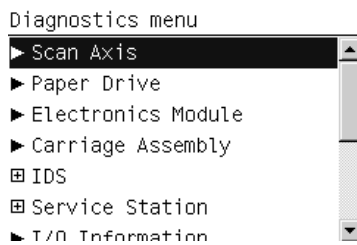

The diagnostic starts checking the Scan-Axis motor; the front panel announces the current activity.

 **NOTE:** The Carriage may move repeatedly during the tests.

- Depending on the results of the tests, you may be asked to open the Window, close the Window, or move the Carriage manually. Follow the instructions on the front panel.

 **CAUTION:** The Carriage should move easily, without resistance. If you feel resistance, do not try to force it: you may damage something.

- When the tests are successfully completed, the following message is displayed.

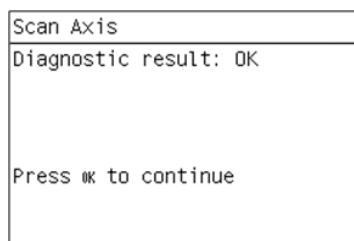

- Press **OK** to return to the menu.

Paper Drive test

The purpose of this test is to diagnose a failure in the operation of components related to the Media Axis.

You must perform the Paper Drive Test after:

- System Error Code 81:YX
- System Error Code 41:YX
- System Error Code 73:YX



NOTE: If possible always perform this test before replacing any component of the Media Axis.

1. In the Diagnostics menu, scroll to **Paper Drive** and press **OK**.

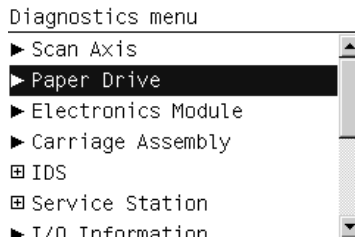

2. The front panel asks you to unload the paper. If there is a roll loaded, unload it manually. Press **OK** when done.

```
Paper Drive
-----
Please unload the paper
Press OK to continue
```

3. The printer performs some movement tests. The drive roller may move repeatedly during the tests. At the end the following message will be shown if the tests succeeded:

```
Paper Drive
-----
Checking movement
Test passed
Press OK to continue
```

4. Depending on the results of the tests, the front panel may display one of the following messages.

- The printer was unable to make the test movements correctly.

```
Paper Drive
-----
Checking movement
Failed to perform movement
Press OK to continue
```

- You are asked to load paper manually, and press **OK**.

```
Paper Drive
-----
Please raise the lever
Please load the paper
Please lower the lever
Press OK to continue
```

- The printer tries the movements again.

```
Paper Drive
-----
Is paper moving?
Press ▲ and ▼ to change the
value
Yes
Press OK to confirm selection
```

5. The printer calibrates the analog encoder.

```
Paper Drive
-----
Calibrating analog encoder
```

6. The calibration results are displayed.

```
Paper Drive
-----
Diagnostic result:
  A      2.0      2.0
  B      2.0      1.0
```

Press OK to continue
Press ✕ to reject

Acceptable values are:

- Gain: between 0 and 5
- DGain: between 0 and 15
- Offset: between -80 and 80

If the results are acceptable, press **OK**. If the results are unacceptable, then press **Cancel**.

7. The printer performs the encoder homing test.

```
Paper Drive
-----
Analog encoder homing test
```

8. The front panel asks you to remove the paper. If you loaded a roll earlier, unload it manually. Press **OK** when done.
9. Some further tests are performed, and the results displayed.

```
Paper Drive
-----
PWM avg: 20820.46
Speed error: 21.00
PWM StDev: 100.89
PWM max: 20975.00
```

Press OK to continue

10. When the whole test has been completed successfully, the following message is displayed. Press **OK** to restart the printer.

```
Paper Drive
-----
Diagnostic result: OK
```

Press OK to restart

Electronics Module test

The purpose of this test is to diagnose a failure in the operation of the Formatter.

1. In the Diagnostics menu, scroll to **Electronics Module** and press **OK**.

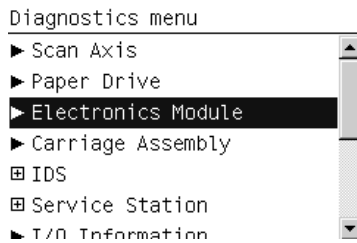

2. A message appears on the Front Panel asking whether you would like to check the Formatter. Press **OK** to continue with the test, or **Cancel** to exit.

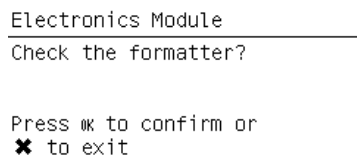

3. The front panel displays the amount of memory installed. “Real memory size” is the real size detected, and “Total memory size” shows the rounded memory size. Press **OK** to continue.

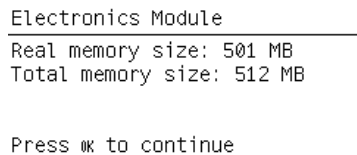

4. The front panel displays the name, type and size of all the partitions on the Hard Disk. Press **OK** to continue.

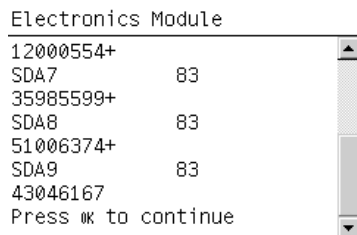

5. The front panel displays the name, size and percentage used of the data and boot partitions on the Hard Disk. Press **OK** to continue.

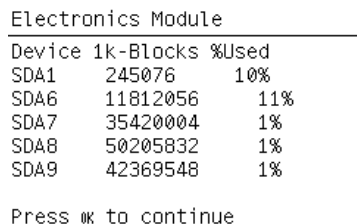

6. When the test is complete, **OK** is displayed on the front panel. Press **OK** to restart the printer.

Carriage Assembly test

The purpose of this test is to check the operation of the Carriage Assembly.

 **NOTE:** If possible, always perform this test before replacing the Carriage Assembly. If this test passes, do not replace the Carriage Assembly.

1. In the Diagnostics menu, select **Carriage Assembly** and press **OK**.

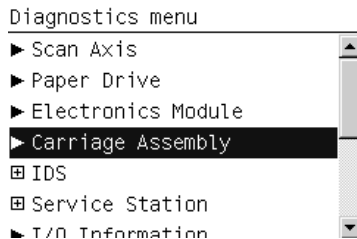

While the diagnostic is testing the Carriage Assembly, it displays announcements of its current activity such as **Initializing**, **Getting information** and **Checking voltages**.

2. When the tests are done, the values of some parameters (mostly voltages) are displayed, together with their allowed or valid range. Press **OK** after each one to continue.

```
Carriage Assembly
-----
Carriage board revision
voltage: 0.497

Valid range is: 0.449 - 0.549

Press OK to continue
```

3. When prompted by the front panel, open the Window, open the Carriage Cover and remove all printheads from the Carriage. Then close the Carriage Cover and the Window and press **OK**.

```
Carriage Assembly
-----
Please remove all printheads
```

Press OK to continue

If a printhead remains in the carriage after you press **OK**, you are reminded to remove it.

```
Carriage Assembly
-----
Printhead 0 detected
```

```
Please remove all printheads
Press OK to continue or X to
exit
```

If you are sure that all printheads were removed before this message appeared, press **Cancel**; the test ends and a system error message is displayed.

4. When the printheads have been removed, some additional parameters are checked, and their values and/or ranges are displayed.

```
Carriage Assembly
-----
Carriage Voltage (HORUS0VAUX-
):
4.190 V

Valid range is: 3.9 - 4.4

Press OK to continue
```

5. The front panel prompts you to put a sheet of blank paper under the Carriage, which is already in the middle of the platen, to perform the LED and sensor checks. The paper should be large enough to cover the whole Carriage area. Press **OK** to continue.

```
Carriage Assembly
-----
Put a piece of blank paper
under the carriage

Press OK when done
```

6. The diagnostic checks the Carriage LEDs and sensors, which can take a few minutes. When the checks are done, the front panel prompts you to remove the paper from under the Carriage.

```
Carriage Assembly
-----
Remove paper

Press OK when done
```

7. When you see the message below, open the Window, open the Carriage Cover and re-insert all the printheads. Then close the Carriage Cover and the Window, and press **OK**.

```
Carriage Assembly
-----
Please insert all printheads

Press OK to continue
```

If a printhead has not been correctly inserted, the front panel reminds you to insert it.

```
Carriage Assembly
-----
Printhead 0 not detected

Please insert all printheads
Press OK to continue or ✖ to
exit
```

If you are sure that all printheads were correctly inserted before this message was displayed, press **Cancel**; the test ends and a system error message is displayed.

- When the printheads have been inserted, some further checks are made. When the tests are completed, the following message is displayed.

```
Carriage Assembly
-----
Diagnostic result: OK
```

Press **OK** to restart

- Press **OK** to return to the menu.

Ink Delivery System test

The purpose of this test is to check the operation of the Ink Delivery System.

To start the Ink Delivery System test, scroll to **IDS** in the Diagnostics menu and press **OK**.

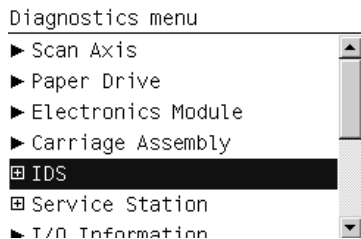

The test consists of a series of subtests as described below.

Air pressure system subtest

The purpose of this test is to check the operation of the Air Pressurization System (APS). You should perform this test before replacing the APS; if it passes the test, you do not need to replace it.

- Select **Air pressure system** from the Ink Delivery System Test menu.
- The front panel asks for confirmation.
- The front panel asks you to insert the Ink Cartridges. Press **OK** after inserting all of them.
- The printer initializes various electrical subsystems, pressurizes the APS, holds the pressure for while, then depressurizes it. The current pressure is displayed on the front panel at each stage.
- If the test finishes successfully, the front panel displays **OK**.

Check ink supplies

The purpose of this test is to check which Ink Cartridges are valid for the purge process, and their current available ink levels. The status of some Ink Cartridges may not be accessible if they have previously suffered a failure (faulty, broken bag, etc.).

- Select **Check ink supplies** from the Ink Delivery System Test menu.
- After a brief delay, the front panel displays information on the status of the ink supplies, or an error message if any problem is found.
- If the test finishes successfully, the front panel displays **OK**.

Clean air tubes

The purpose of this procedure is to remove ink that may have got into the air tubes after a bag has broken in an Ink Cartridge. This is the first stage in recovering from a broken bag. It should be performed if there is any ink visible in the air tubes of the APS.

1. Remove the Left Cover and check that the tubes from the APS to the ISS are clean. If the tubes are clean of ink this procedure does not need to be performed. However, if there are sections of tube that have ink in them, such as the examples indicated below with the red arrows, then you should proceed with the following steps.

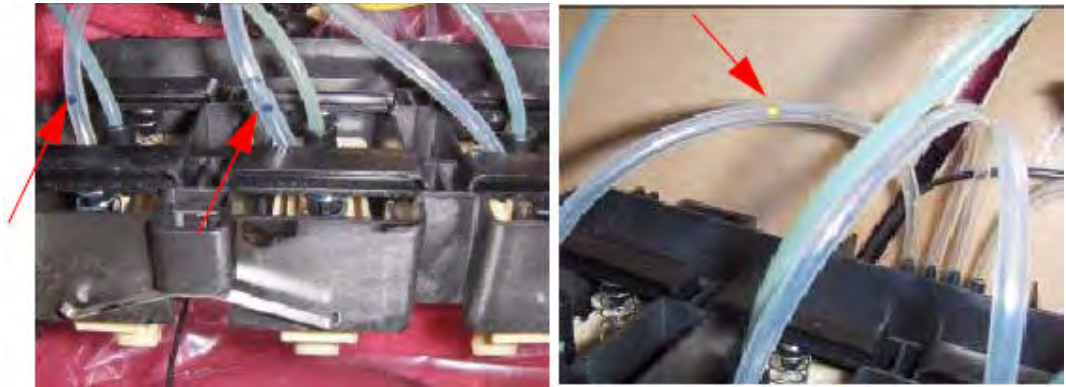

2. Remove all the Ink Cartridges and install the dummy Ink Cartridges from the Broken Bag Fixing Tools kit (part number CH955-67076).
3. One of the dummy Ink Cartridges has two holes at the top. This dummy Ink Cartridge must be inserted into the slot with the Broken Bag error.

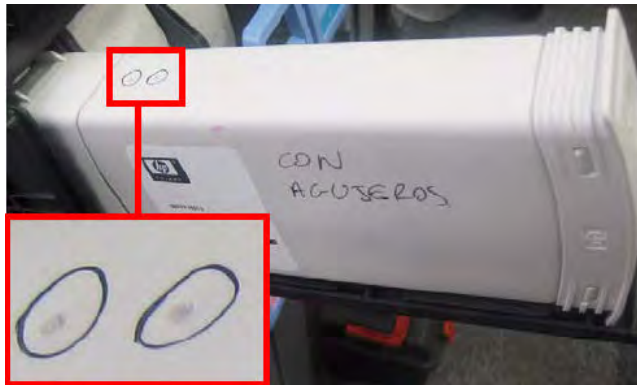

4. Select **Clean air tubes** from the Ink Delivery System Test menu.
5. The front panel asks for confirmation.
6. The front panel asks you to confirm that the dummy Ink Cartridges are installed.
7. The printer pumps air through the air tubes, pushing any ink into the dummy Ink Cartridge with the two holes at the top.
8. The front panel asks whether you want to repeat the process with a different cartridge. If you choose to do so, move the dummy Ink Cartridge with the two holes to a different slot. If not, the printer will shut down.

Recover broken bag

The purpose of this procedure is to return the printer to normal ready status after a broken bag has been detected in one of the Ink Cartridges.

A badly broken bag will stop the printer from functioning and will need to be fixed and cleared of the error before the printer can continue printing normally. If ink leaks from the broken bag and leaves the confines of the ink cartridge, it could damage various parts of the printer.

1. Clean any ink out of the air tubes: see [Clean air tubes on page 101](#).
2. Replace the Ink Cartridge that has the broken bag with a new Ink Cartridge.
3. Select **Recover broken bag** from the Ink Delivery System Test menu.
4. The front panel asks you to confirm that the air tubes are clean (contain no ink).
5. The front panel asks whether you want to remove the broken bag condition.
6. If you confirm, the printer checks all the Ink Cartridges for a broken bag and displays a message if any are found.
7. When the procedure is complete, the printer shuts down.
8. Refill the ink tubes: see [Refill ink tubes on page 102](#).

Refill ink tubes

A broken bag in an Ink Cartridge is likely to cause air bubbles in the ink tubes. It is important to remove the air bubbles because they can damage the Printheads.

The purpose of this procedure is to refill the ink tubes, removing any air bubbles, after an Ink Cartridge with a broken bag has been replaced. This is the third and final stage in recovering from a broken bag, and it should be performed only in that context. See [Recover broken bag on page 102](#).

1. Remove all the dummy Ink Cartridges and replace them with normal Ink Cartridges.



NOTE: Be careful not to reinstall the Ink Cartridge with the broken bag; it should be replaced with a new Ink Cartridge.

2. Select **Refill ink tubes** from the Ink Delivery System Test menu.
3. The printer initializes various electrical subsystems.
4. When the front panel displays a screen similar to the following, use the **Up** and **Down** keys to select the ink color that had the broken bag, and press **OK**.

```
Refill Ink Tubes...
```

```
Slot1: M <-  
Slot2: LM  
Slot3: PK  
Slot4: MK  
Slot5: Y  
Slot6: LC  
Slot7: LG  
Slot8: R
```

5. The front panel asks whether there is air in the ink tubes. If not, the situation is correct and there is no need to continue. If there is air, press **OK** to continue the procedure.

6. The front panel asks you to confirm that the new cartridges are installed.
7. The front panel asks you to open the Window and the Carriage Cover.
8. The front panel asks you to remove the two printheads of the color you already selected (which had the broken bag). Remove the printheads and press **OK** to continue.
9. The front panel asks you to introduce the needle of the syringe into one of the FI towers of the selected color. Use the syringe from the Broken Bag Fixing Tools kit. Use the FI tower that is closer to the rear of the Carriage, as shown. Press **OK** to continue.



10. The front panel displays a status message.

```

Refill Ink Tubes...
Pumping air 2 minutes.
Time      : 13 sec.
Pressure  : 5755 milipsi.
  
```

Ink is now pumping through the ink tube, pushing any air bubbles from the ink tube into the syringe. The amount of ink pumped through the ink tube into the syringe is 33 ml + air.



11. After two minutes, the front panel asks you to confirm that there is now 35 ml of ink + air in the syringe.
12. The front panel explains that the printer is accounting for the ink used.

13. The front panel displays **OK**, then asks if you want to repeat the procedure. If you want to repeat (because there is still some air in the ink tube, or because more than one bag was broken), press **OK**. Otherwise press **Cancel** and continue with the remaining steps.



NOTE: If you cannot clear the bubbles from the ink tube, replace the complete SRK Tubes Assembly.

14. The front panel asks you to remove the syringe from the FI tower.
15. The front panel asks you to reinstall the printheads that you removed earlier.
16. The front panel asks you to close the Carriage Cover and the Window.

Service Station test

The purpose of this test is to check the operation of the Service Station.

1. In the **Diagnostics** menu, scroll to **Service Station** and press **OK**.

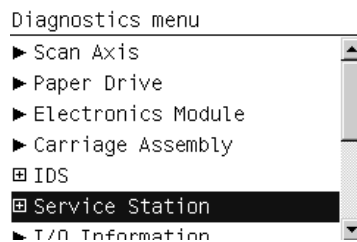

2. Within the **Service Station** submenu, select the **Service Station** test.

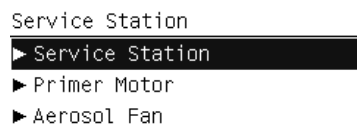

3. The front panel then prompts you to check the status of the printer.

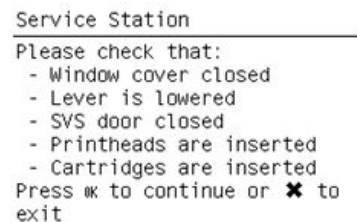

4. Check that:
 - The window is closed.
 - The service station door is closed.
 - The media lever is lowered.
 - All printheads are inserted.
 - All cartridges are inserted.
5. Press **OK** to continue.

6. The printer performs a series of movements numbered from 1 to 10. It takes about 2 minutes to perform all the movements.

```
Service Station
-----
Performing movements

Step 1 of 10
```

7. The front panel asks if you want to cap the printheads. Press **OK** to cap the service station or **Cancel** to leave the printheads uncapped.

```
Service Station
-----
Do you want to leave the
service station in the
default position (capping
the printheads)?

Press OK for yes or X for no
```

8. The front panel announces the result of the test. Press **OK** to turn off the printer.

```
Service Station
-----
Diagnostic result: OK

Press OK to shut down
```

 **TIP:** If a system error message appears during the above procedure, see [System error codes on page 43](#).

Primer Motor test

The purpose of this test is to prime a specified printhead.

 **NOTE:** If possible always perform this test before replacing the primer. If this test passes, do not replace the primer.

1. In the Diagnostics menu, scroll to **Service Station** and press **OK**.

```
Diagnostics menu
└─▶ Scan Axis
└─▶ Paper Drive
└─▶ Electronics Module
└─▶ Carriage Assembly
└─▶ IDS
└─▶ Service Station
└─▶ T/O Information
```

2. Within the Service Station submenu, select the **Primer Motor** test.

```
Service Station
└─▶ Service Station
└─▶ Primer Motor
└─▶ Aerosol Fan
```

3. The printer will ask you to check that the printer covers, the doors and the pinch lever are closed, and the printheads and cartridges correctly inserted. After checking those things, press **OK**.

```
Primer
-----
Please check that:
- Window cover closed
- Lever is lowered
- SVS door closed
- Printheads are inserted
- Cartridges are inserted
Press OK to continue or ESC to
exit
```

4. The printer will initialize some subsystems and move the carriage out of the service station. After that it will ask you to select the printhead to prime. Use the **Up/Down** keys to change the printhead number, and press **OK** to select.

```
Primer
-----
Select the printhead you want
to prime:

Printhead 1

Use UP/DOWN to scroll,
ENTER to confirm or
CANCEL to exit.
```

While the printhead is being primed, a message saying **Priming printhead** will appear in the front panel, indicating the number of the selected printhead. If any error occurs, a system error will identify the part that has failed.

5. Once the printhead has been primed correctly, the message below appears. Press **OK** to turn off the printer.

```
Primer
-----
Diagnostic result: OK

Press OK to shut down
```

Aerosol Fan test

The purpose of this test is to check the operation of the Aerosol Fan(s).

1. In the Diagnostics menu, scroll to **Service Station** and press **OK**.

```
Diagnostics menu
├─▶ Scan Axis
├─▶ Paper Drive
├─▶ Electronics Module
├─▶ Carriage Assembly
├─▣ IDS
├─▣ Service Station
├─▶ I/O Information
```

2. Within the Service Station submenu, select the **Aerosol Fan** test.

```
Service Station
├── Service Station
├── Primer Motor
└── Aerosol Fan
```

3. The test is automatic and needs no user intervention. After the test, the front panel shows that the diagnostic result is OK, and asks you to press **OK** to continue. If there is any failure, an error message will identify the part that failed.

```
Aerosol Fans Diagnostic
Diagnostic result: OK
```

Press **OK** to continue

I/O Information test

The purpose of this test is to display network information about the printer.

1. In the Diagnostics menu, scroll to **I/O Information** and press **OK**.

```
Diagnostics menu
├── Scan Axis
├── Paper Drive
├── Electronics Module
├── Carriage Assembly
├── IDS
├── Service Station
└── I/O Information
```

2. The front panel displays the printer's IP address, default gateway and subnet mask. Press **OK** to return to the menu.

Enable I/O Interfaces test

The purpose of this test is to enable the printer's I/O interfaces (USB, Ethernet, Jetdirect) after they have been disabled from the Embedded Web Server.

1. In the Diagnostics menu, scroll to **Enable I/O interfaces** and press **OK**.

```
Diagnostics menu
├── IDS
├── Service Station
├── I/O Information
├── Enable I/O interfaces
├── Unit Information
├── EEPROM Reset
└── Hard Disk Recovery
```

2. Use the arrow keys if necessary to enable the I/O interfaces.

```
Enable Connectivity
-----
Enable Connectivity?

Yes

Press ▲ and ▼ to change the
value
```

3. The front panel confirms the result of the operation. Press **OK** to restart the printer.

```
Enable Connectivity
-----
Starting CDS...
Enabling connectivity...
OK
Press ⌘ to restart
```

Unit information

This option allows you to view the following printer information:

- Firmware version
 - Serial number
 - Part number
 - PostScript language (if applicable)
1. In the Diagnostics menu, scroll to **Unit Information** and press **OK**.

```
Diagnostics menu
├─ I/O
├─ Service Station
├─ I/O Information
├─ Enable I/O interfaces
├─ Unit Information
├─ EEROM Reset
├─ Hard Disk Recovery
```

2. The printer starts to initialize and the front panel displays the following messages:

- Starting Nvm
- Getting FW version
- Getting Serial Number
- Getting Part Number

If there is a failure at this point, the front panel displays **System Error Code 79:03**. For more information on troubleshooting this error code, see [SE 79:03 on page 73](#).

- Getting PS Language (if the PostScript accessory is installed)

If there is a failure at this point, the front panel displays an error.

3. Once the unit information is obtained, it is displayed on the front panel. Press **OK** to exit.

```
Unit Information
-----
Firmware: KHN_01_00_06.1
Serial number: MY99F0902HK042
Part number: CQ109A
PS type: Roman

Press OK to continue
```

EEROM Reset

The purpose of this diagnostic is to reset the EEROM values.

 **NOTE:** Once the EEROM has been reset, the printer will act as if it is being started for the first time, except that the Ink Supply Tubes have already been primed.

1. In the Diagnostics menu, scroll to **EEROM Reset** and press **OK**.

```
Diagnostics menu
├─▶ I/O Information
├─▶ Enable I/O interfaces
├─▶ Unit Information
├─▶ EEROM Reset
├─▶ Hard Disk Recovery
├─▶ File System Check
├─▶ Front Panel Lock Reset
```

2. The front panel advises you that all user information/files will be removed. Press **OK** to reset the EEROM or **Cancel** to exit.

```
EEROM Reset
-----

User information will be
lost. Do you want to
continue?
Press OK to continue or ✕ to
exit
```

3. While the EEROM is being reset, the front panel displays the following message.

```
EEROM Reset
-----
Initializing
```

4. When the EEROM has been reset, the front panel displays the following message. Press **OK** to shut down the printer.

```
EEROM Reset
-----
Diagnostic result: OK

Press OK to shut down
```

Hard Disk recovery

This option is a utility that is also available from the Service Utilities menu. See [Hard Disk recovery on page 129](#).

File system check

This option is a utility that is also available from the Service Utilities menu. See [File system check on page 130](#).

Front Panel Lock Reset test

The purpose of this test is to unlock the front panel after it has been locked from the Embedded Web Server.

1. In the Diagnostics menu, scroll to **Front Panel Lock Reset** and press **OK**.

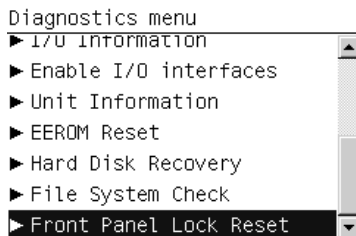

2. Press **OK** again to confirm.

```
Front Panel Lock Reset
-----
Do you want to unlock the
front panel access?
```

```
Press OK to continue or X to
exit
```

3. The front panel is unlocked, and displays the diagnostic result as **OK**. Press **OK** to continue.

```
Front Panel Lock Reset
-----
Diagnostic result: OK
```

```
Press OK to continue
```

Remove all non-factory papers

The purpose of this test is to unlock the front panel after it has been locked from the Embedded Web Server.

1. In the Diagnostics menu, scroll to **Remove all non-factory paper** and press **OK**.

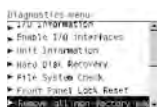

2. Press **OK** again to confirm.

```
Remove all non-factory papers
Press o to continue
Press x to exit
```

3. The non-factory papers (created by customer or a 3rd party) are removed from the Printer. The Printer will show the confirmation for 2 seconds and return to the Diagnostics menu. Press **OK** to continue.

```
Remove all non-factory papers
Press o to continue
Press x to exit
Custom papers deleted
```

Service utilities

The following is a list of all internal Service Utilities available in the printers. Instructions for entering the Service Utilities menu are given on [Entering the Service Utilities menu on page 112](#).

1. Turn Drive Roller ⇒ [Turn Drive Roller on page 113](#).

The purpose of this Service Utility is to rotate the Drive Roller and the Overdrive in order to clean them.

2. Prime Tubes ⇒ [Prime Tubes on page 114](#).

The purpose of this Service Utility is to Prime the Tubes when the Ink Tubes are NOT new and they need to be re-primed or automatic priming was not completed correctly.

3. Reset Life Counters ⇒ [Reset Life Counters on page 116](#).

The purpose of this Service Utility is to reset the internal life counters. There are two submenus that allow you to:

- Reset ALL the counters related to a Preventive Maintenance Kit (PMK).
- Reset only the counters related to a specific replaced part.

4. Diagnostic Print ⇒ [Diagnostic Print on page 117](#).

The purpose of this Service Utility is to print the Diagnostic Print in order to identify image quality problems.

5. Replace Cutter ⇒ [Replace Cutter on page 118](#).

The purpose of this Service Utility is to move the Carriage to a position where the Cutter can be replaced easily.

6. Enable/Disable Firewall ⇒ [Enable/Disable Firewall on page 119](#).

The purpose of this Service Utility is to enable or disable the printer's firewall.

7. Disk Wipe DoD 5330.22'M ⇒ [Disk Wipe DoD 5220.22'M on page 120](#).

The purpose of this Service Utility is to securely erase data on the Hard Disk.

8. Show/Hide Front Panel Info ⇒ [Show/Hide Front Panel info on page 121](#).

The purpose of this service utility is to show or hide network information in the front panel.

9. Test the ESP Shutter ⇒ [ESP Shutter diagnostic on page 122](#).

This test checks that the Embedded SpectroPhotometer (ESP) shutter is working correctly.

10. Test the ESP ⇒ [ESP Measurement test on page 126](#).

This test checks that the Embedded SpectroPhotometer (ESP) is correctly calibrating the color for the printer.

11. Soft Printhead Servicing ⇒ [Soft Printhead servicing on page 128](#).

The purpose of this Service Utility is to enable or disable the soft printhead servicing mode, which may be enabled when spitting is visible on the print and the print quality is poor.

12. I/O tests ⇒ [I/O tests on page 128](#).

The purpose of this service utility is to test the printer's built-in network adaptor.

13. Test Cutter ⇒ [Test Cutter on page 128](#).

The purpose of this service utility is to check that the Cutter works properly.

14. Hard Disk Recovery ⇒ [Hard Disk recovery on page 129](#).

The purpose of this service utility is to clean user data on the Hard Disk, to try to recover the printer from an unstable state.

15. File System Check ⇒ [File system check on page 130](#).

The purpose of this service utility is to check the consistency of the file system on the Hard Disk. If the utility detects a problem, it will try to fix it automatically.

16. Remove all non factory papers.

The purpose of this Service Utility is to eliminate non-factory papers created and installed on the printer.

Entering the Service Utilities menu

1. Once the **Ready** message is displayed on the front panel, select the  icon.
2. For Call Agents who will request the user to perform certain Service Utilities, once inside the Setup menu, press the **Down** arrow key and the **Cancel** key together. You are now in the Service Tools menu.
3. For On-Site Engineers, once inside the Setup menu, press the **Up** arrow key and the **Cancel** key together. You are now in the Service Tools menu.
4. Use the **arrow** keys to scroll to the Service Utilities menu and press the **OK** key.

```
Service menu
▣ Service utilities
▣ Service calibrations
```

5. Use the **arrow** keys to scroll through the Service Utilities selections and press the **OK** key to begin a specific operation when the required service utility is highlighted.

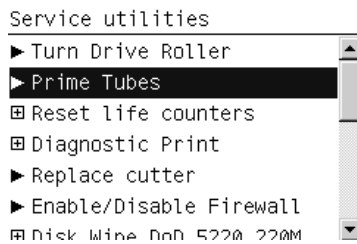

NOTE: If the printer is not used for 135 seconds, the printer exits from the Service Utilities menu and you must repeat the above steps to enter Service Utilities again.

In some cases a quick press of a button may not be recognized by the printer. When pressing a button, be sure to press it deliberately and all the way to the bottom of its travel.

Turn Drive Roller

The purpose of this Service Utility is to rotate the Drive Roller and the Overdrive in order to clean them.

1. If paper is loaded in the printer, unload it.
2. Open the Window and activate the Window Position Sensor, using a piece of paper.

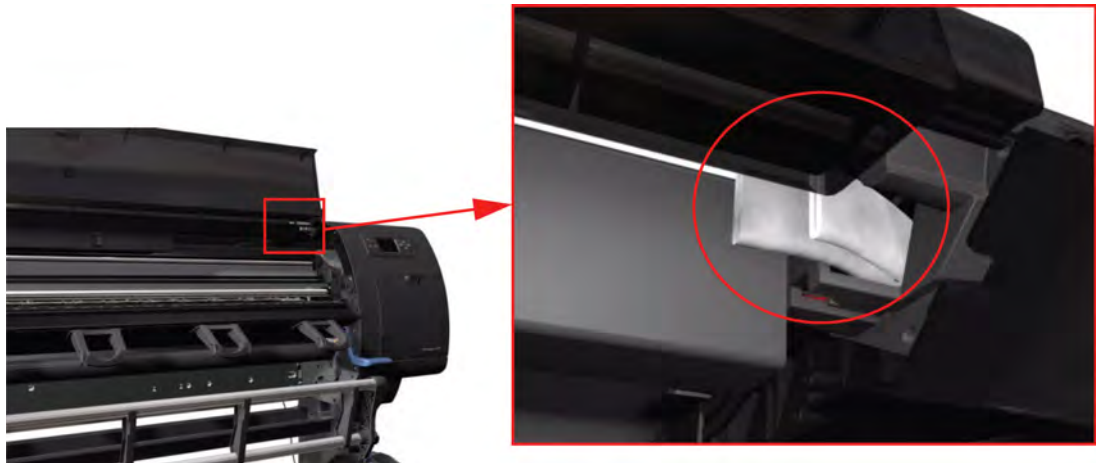

3. In the Service Utilities submenu, scroll to **Turn Drive Roller** and press **OK**.

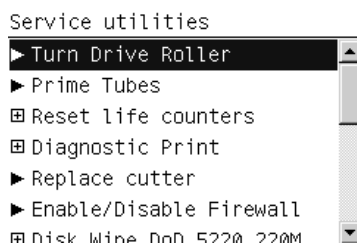

4. The printer checks to see if paper is loaded. If paper is loaded, the front panel will display the following message. Unload the paper and start again from the beginning.

```
Turn Drive Roller
-----
Paper detected

Please remove paper and
start again

Press OK to continue
```

5. The Drive Roller begins to turn slowly and the following message is displayed on the front panel:

```
Turn Drive Roller
-----
Rotation started.
Please clean the drive
roller.
Distance covered: 11
Remaining time: 577

Press X to exit
```

6. Refer to the cleaning instructions ⇒ [Cleaning the Drive Roller and Overdrive on page 449](#).
7. Once you have finished cleaning the Drive Roller and the Overdrive, press the **Cancel** key to finish the utility.
8. If the utility exits correctly, **OK** will be displayed on the front panel.

 **NOTE:** Please remember to remove the piece of paper from the Window Position Sensor before closing the Window, as it could damage the Window and the Sensor.

Prime Tubes

The purpose of this Service Utility is to prime the Tubes when the Ink Tubes are not new and they need to be re-primed or automatic priming was not completed correctly.

 **NOTE:** Make sure that new Ink Cartridges are installed or that the ink volume remaining in the Ink Cartridges is below 88% before starting to prime the tubes. Otherwise, you will see a warning message.

1. In the Service Utilities submenu, scroll to **Prime Tubes** and press **OK**.

```
Service utilities
└─▶ Turn Drive Roller
└─▶ Prime Tubes
└─▶ Reset life counters
└─▶ Diagnostic Print
└─▶ Replace cutter
└─▶ Enable/Disable Firewall
└─▶ Disk Wipe On 5220 220M
```

2. If the Ink Cartridges are not suitable for priming, the following message will appear on the front panel. Replace the installed Ink Cartridges with Ink Cartridges that are new or contain less than 88% of ink. Press any key to exit.

```

Prime Tubes
-----
Some of the current ink
supplies are not valid
for purge:
0 1 2 3 4 5 6

Please replace them with
valid cartridges for
purge and start again.
  
```

3. When the following message appears on the front panel, press **OK** to continue or **Cancel** to exit.

```

Prime Tubes
-----
Ink Supply Tubes ready for
priming. Do you want to
Continue?

Press ENTER to continue or
BACK/CANCEL to exit.
  
```

4. The front panel displays the following message, then restarts the purge process.

```

Prime Tubes
-----
The system is going to
reboot... After then, the
procedure for priming the
tubes will start
automatically.
  
```

5. When the printer has restarted, the front panel asks you to open the Window and remove all the Printheads.

```

Lift printhead cover.
Replace printheads
  
```

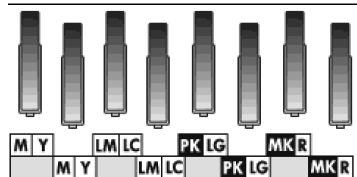

The diagram shows eight ink cartridges arranged in two rows. The top row contains eight individual cartridges labeled M, Y, LM, LC, PK, LG, MK, and R. The bottom row shows a printhead assembly with eight slots, each labeled with the corresponding cartridge color: M, Y, LM, LC, PK, LG, MK, and R.

6. When you have removed all the Printheads, the front panel asks you to install the Setup Printheads.
7. When you have installed the Setup Printheads, the front panel displays the following message.

```

Close printhead cover and
window
  
```

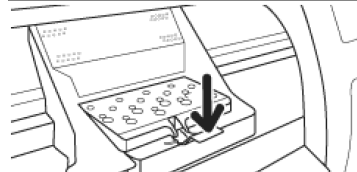

The diagram shows a top-down view of the printer's printhead area. A black arrow points downwards to a latch mechanism on the right side of the printhead cover, indicating where to press to close it.

8. When you have closed the Printhead Cover and the Windows, the printer begins to purge the tubes.
9. When the tubes have been purged, the front panel asks you to open the Window.
10. When prompted by the front panel, check that all the Setup Printheads have some ink.

Are all labeled setup printhead windows filled with ink?

All with some ink
 NOT all with ink

11. The front panel asks you to change the ink funnel and waste bottle, but you should ignore this request. Continue the purge procedure, pressing OK to advance through the procedure, but without changing any parts.
12. At the end of the procedure, the printer aligns the Printheads.

Reset Life Counters

The purpose of this Service Utility is to reset the internal life counters. There are two submenus that allow you to:

- Reset all the counters related to a Preventive Maintenance Kit (PMK).
- Reset only the counters related to a specific replaced part.



NOTE: Reset the life counter of a part only after replacing that part.

1. In the Service Utilities submenu, scroll to **Reset life counters** and press **OK**.

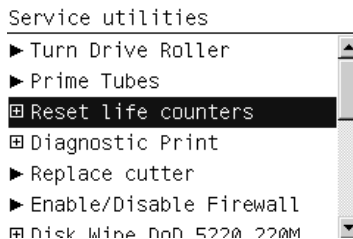

2. You will be given an option either to reset the life counter for all the parts related to a Preventive Maintenance Kit (PMK) or to reset the life counter for a particular part only.

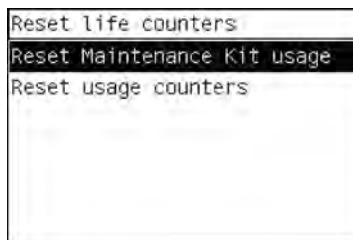

- a. If you select to reset the life counter for all the parts related to a Preventive Maintenance Kit (PMK), you will be given an option to reset the life counter of:

- Preventive Maintenance Kit 1 (PMK1)
- Preventive Maintenance Kit 2 (PMK2)

b. If you select to reset the life counter for a particular part, you will be given an option to reset the life counter of the:

- Carriage ME
- Tubes and Trailing Cable
- Scan Motor
- Left Spittoon
- Drop Detector
- Line Sensor
- Maintenance Cartridge Spittoon
- Paper Motor
- OMAS Module
- Primer Mech
- SVS
- Embedded SpectroPhotometer (ESP)

There are two ESP life counters:

- Shutter cycles is the percentage of shutter open/close life cycles consumed so far.
- Working time is the percentage of ESP expected life consumed so far.

3. Once you have selected a life counter to reset, a message similar to the following will be displayed on the front panel. Press **OK** to reset the selected life counter or press **Cancel** to exit without resetting the life counter.

```
Reset life counters PMK1
-----
Current usage: 0%
```

```
Reset these life counters?
Press OK to continue or ✕ to
exit
```

If the life counter information cannot be read, the front panel will display **Unable to get usage counter**. This could point to a possible firmware error.

4. If the utility exits correctly, **OK** will be displayed on the front panel.

Diagnostic Print

The purpose of this Service Utility is to print the Diagnostic Print in order to identify image-quality problems.

1. In the Service Utilities submenu, scroll to **Diagnostic Print** and press **OK**.

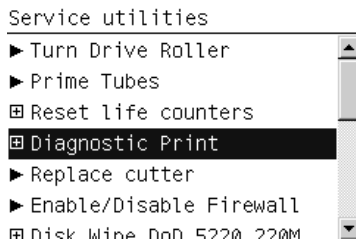

2. The front panel lists the available Diagnostic Prints. Use the arrow keys to make the selection and press the **OK** key to start printing the required Diagnostic Print.

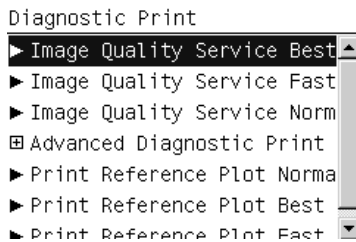

If you select **Advanced Diagnostic Print**, the front panel shows another list of prints.

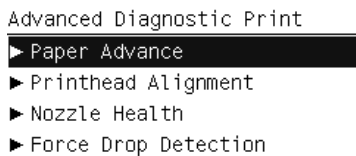

If the OMAS sensor is enabled, the front panel displays a message: **Do you want to disable the OMAS sensor?** Select **Yes** or **No**.

3. Make sure paper is loaded, the Media Lever is lowered and the Ink System is correctly installed. Press the **OK** key to print the Diagnostic Print or press **Cancel** to exit without printing the Diagnostic Print.

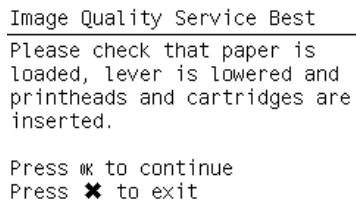

4. The selected Diagnostic Print is printed. For further information on how to troubleshoot print-quality problems, see [How to use the Image Quality Service Diagnostic Print on page 161](#).

Replace Cutter

The purpose of this Service Utility is to move the Carriage to a position where the Cutter can be replaced easily.

1. In the Service Utilities submenu, scroll to **Replace cutter** and press **OK**.

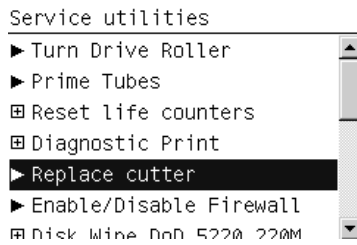

2. When the following message appears on the front panel, press **OK** to continue with the Cutter replacement, or **Cancel** to exit.

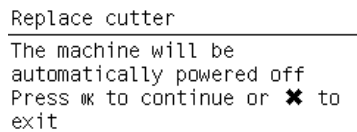

3. The Carriage moves to the Cutter replacement position and the following message is displayed on the front panel. After a few seconds the printer will begin to shut down.

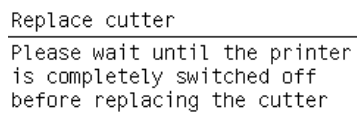

4. Before replacing the Cutter, make sure that you turn the printer off at the rear switch.

Enable/Disable Firewall

The purpose of this Service Utility is to enable or disable the printer's firewall.

1. In the Service Utilities submenu, scroll to **Enable/Disable Firewall** and press **OK**.

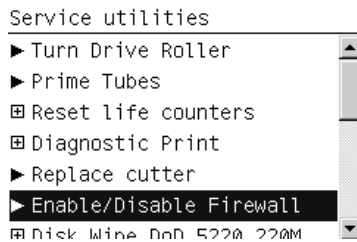

2. The printer checks whether the firewall is currently enabled or disabled.
3. When the following message appears on the front panel, you must select whether you would like to enable or disable the firewall. Use the **Up** and **Down** keys to make your selection and press the **OK** key.

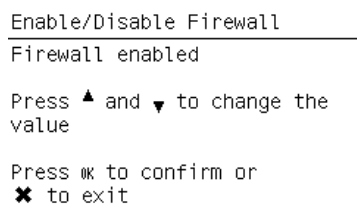

4. The system upgrades the internal memory to reflect the chosen selection.
5. If the utility exits correctly, **OK** is displayed on the front panel.

Disk Wipe DoD 5220.22'M

The purpose of this Service Utility is to erase data from the Hard Disk securely, according to the directive DoD 5220.22-M.

The printer's hard disk is used as a temporary storage area for print jobs. The Secure Disk Erase facility can completely erase your information from the hard disk to protect it from unauthorized access.

Secure Disk Erase provides three different levels of security:

- **Insecure Mode:** All pointers to the information are erased. The information itself remains on the hard disk until the disk space it occupies is needed for other purposes, and it is then overwritten. While it remains on the disk, it is difficult for most people to access, but may be accessed using software designed for the purpose. This is the normal method in which files are erased on most computer systems; it is the fastest method but the least secure. This is the default security level when using Secure Disk Erase.
- **1-Pass Mode:** All pointers to the information are erased, and the information itself is also overwritten with a fixed character pattern. This method is slower than Insecure Mode, but more secure. It may still be possible to access fragments of the erased information by using special tools to detect residual magnetic traces.
- **5-Pass Mode:** All pointers to the information are erased, and the information itself is repetitively overwritten using an algorithm designed to eliminate any residual traces. This is the slowest method, but the most secure. 5-Pass Mode meets the US Department of Defense 5220-22.m requirements for clearing and sanitization of disk media.

Use the Disk Wipe DoD 5220.22-M utility as follows:

1. In the Service Utilities submenu, scroll to **Disk Wipe DoD 5220.22-M** and press **OK**.

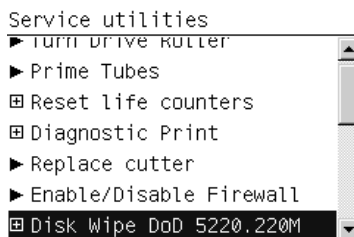

2. In the Disk Wipe DoD 5220.22-M submenu, scroll to **Sanity Level** and press **OK**.



3. In the Sanity Level submenu, scroll to the required Sanity Level and press **OK**.

 **NOTE:** Erasing the Hard Disk drive using anything but Insecure Mode is a very slow process: 6 hours for the 1-Pass Mode and 40 hours for the 5-Pass Mode.

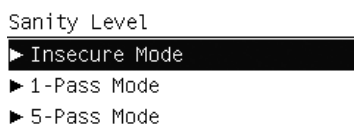

4. Press **Back** to return to the Disk Wipe DoD 5220.22-M submenu.

- In the Disk Wipe DoD 5220.22-M submenu, scroll to **Disk Wipe DoD 5220.22-M** and press **OK**.
- When the following message appears on the front panel, press **OK** to perform a complete erase of the Hard Disk Drive using the previously selected erase mode, or press **Cancel** to exit.

```

Disk Wipe (DoD 5220.22-M)
-----
This test will perform a
complete and secure erase
of the HDD, in accordance
with the requirements of
DoD 5220.

Press OK to continue
Press X to exit

```

- When the following message appears on the Front Panel, press **OK** to continue and completely erase the Hard Disk Drive, or press **Cancel** to exit.

```

Disk Wipe (DoD 5220.22-M)
-----
Warning: The HDD will be
erased and data will be lost

Press OK to continue
Press X to exit

```

- The erase process starts and the front panel shows the total time required to erase the Hard Disk Drive using the selected Sanity Level along with a progress bar.



DoD 5220.22-M

 invent
 Total Time: 6 Hours

1-Pass Mode



DoD 5220.22-M

 invent
 Total Time: 40 Hours

5-Pass Mode

Show/Hide Front Panel info

The purpose of this service utility is to show or hide network information in the front panel.

- In the Service Utilities submenu, scroll to **Show/Hide Front Panel Info** and press **OK**.
- Use the arrow keys if necessary to show or hide network information. Press **OK** to confirm your selection, or **Cancel** to exit.

```

Show/Hide Front Panel Info
-----
SHOW network information
in front panel

Press ^ and v to change the
value

Press OK to confirm or
X to exit

```

ESP Shutter diagnostic

This Service Utility checks that the Embedded SpectroPhotometer (ESP) shutter is working correctly.

1. In the Service Utilities submenu, select **ESP Shutter Diagnostic** and press **OK**.

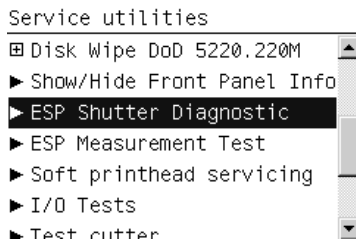

2. Press **OK** to proceed with the test.

COLOR SENSOR SHUTTER TEST
Do you want to run the test?
Press **OK** to continue or **X** to
exit

The Carriage moves to the Shutter Actuator in order to open the ESP shutter, then moves to the right-hand side of the scan axis and stops.

3. Open the window when prompted by the front panel.

Open window

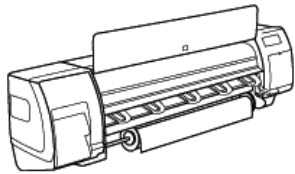

4. Look at the ESP Sensor as directed by the front panel, and press **OK** if it is emitting light downwards onto the platen (as it should be); press **Cancel** if you see no light.

Press **OK** if you see
the light and **X** if not

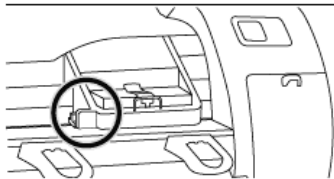

5. Close the window when prompted by the front panel.

Close window

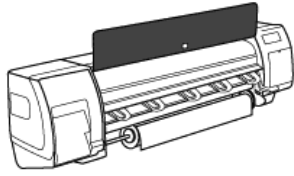

The Carriage moves to the left bump of the printer in order to close the ESP shutter, then moves back to the same location to the right of the scan axis.

6. Open the window again when prompted by the front panel, and check again for light from the ESP Sensor.

Press OK if you see the light and X if not

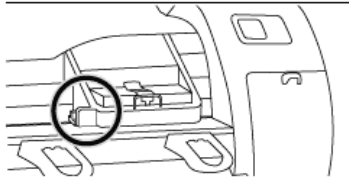

This time, you should see no light, because the shutter should be closed. Any light indicates a problem with the shutter mechanism: either something is broken in the shutter itself, or the shutting mechanism does not work.

7. If you saw the light the first time and not the second time, the shutter is working correctly, and the test ends.

COLOR SENSOR SHUTTER TEST

Diagnostic result: OK

Press OK to continue

Shutter not working correctly

1. If you found a shutter problem, first locate the Shutter Actuator:

Press OK once you locate the U part shown below.

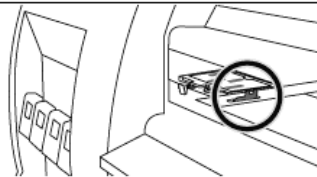

2. When you can see the Shutter Actuator, press **OK**. The Shutter Actuator should move up for one second and then move back down. If nothing moves up and down, the actuator may be faulty. The following screen appears:

```
COLOR SENSOR SHUTTER TEST
-----
Do you want to repeat the
test?
Press OK for yes or X for no
```

If you press **OK**, the Shutter Actuator should move up and down again. You can repeat this operation as many times as you like, until you feel sure about the result.

 **NOTE:** A delay of about 10 seconds is necessary between activations of the Shutter Actuator. This means that, if you press **OK** again within 10 seconds, the Shutter Actuator will not move immediately. This is completely normal and does not indicate any malfunction.

3. After you press **Cancel** to stop the shutter test, the front panel asks whether the Shutter Actuator moved correctly and looked undamaged. Press **OK** if all is well, or **Cancel** if you saw some problem.

```
Press OK if U part moved and
is not broken or X otherwise
```

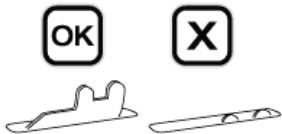

4. If you press **Cancel**, the appropriate system error message is shown:

```
COLOR SENSOR SHUTTER TEST
-----
Diagnostic result: FAIL
Error: 58.1:10
The actuator of the color
sensor shutter is faulty.
```

```
Press OK to continue
```

If the shutter actuator appears undamaged, the problem could be electrical. Check that the Shutter Actuator cables are properly connected. If not, connect them.

If the connections are good, replace the Shutter Actuator, because the problem could be the motor.

If the shutter actuator looks broken, replace it.

In each of these cases, stop the test at this point and start it again from the beginning.

5. If you press **OK** (the Shutter Actuator is OK), the front panel asks you to locate the Shutter Lid and check it for damage.

```
Press OK if inverted T part
is not broken and X if it is
```

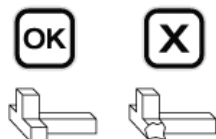

6. If you press **Cancel** (the Shutter Lid is broken), the appropriate system error message is shown:

```
COLOR SENSOR SHUTTER TEST
-----
Diagnostic result: FAIL
Error: 58:10
The color sensor shutter
is not working properly.
```

Press **OK** to continue

7. If you confirm that the Shutter Lid is not broken, the Carriage moves to the left to reach the Shutter Deactivator, a metal piece inside the printer used to close the shutter. Then the Carriage moves back to the right of the platen and the front panel asks you to check again for light.

Press **OK** if you see
the light and **X** if not

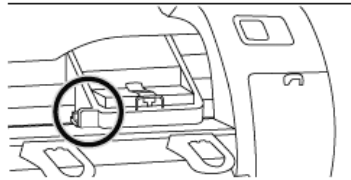

8. If you see light, then the shutter has not closed correctly and the test tries to determine whether the problem is in the shutter itself or in the metal piece that the carriage bumps in order to close the shutter. The Shutter Deactivator is located inside the printer and can be seen only with the help of a torch. With the window open, look inside the left of the printer with the torch. The Shutter Deactivator is at the bottom of the left side and protrudes over the platen as shown in the front panel. The dotted lines indicate that it is inside the printer.

Press **OK** if metal part is not
missing/broken or **X** if it is

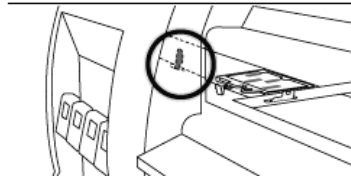

9. Check that the Shutter Deactivator is present (it could be completely missing). Touch it with a finger to check that it is not loose. Check that it is vertical. Check that it is not broken. It is normal for the Shutter Deactivator to flex a little when pressed. If you find anything wrong with the Shutter Deactivator, press **Cancel**, and the appropriate system error message is shown:

```
COLOR SENSOR SHUTTER TEST
-----
Diagnostic result: FAIL
Error: 58.2:10
The color sensor shutter
switch is faulty.
```

Press **OK** to continue

10. If you confirm that the Shutter Deactivator is OK, the following message indicates that the ESP should be replaced because the problem is in the Shutter Lid.

```
COLOR SENSOR SHUTTER TEST
-----
Diagnostic result: FAIL
Error: 58:10
The color sensor shutter
is not working properly.
```

Press **OK** to continue

The illustration below shows the location of the Shutter Deactivator and the Shutter Actuator motor in the Left Spittoon Assembly.

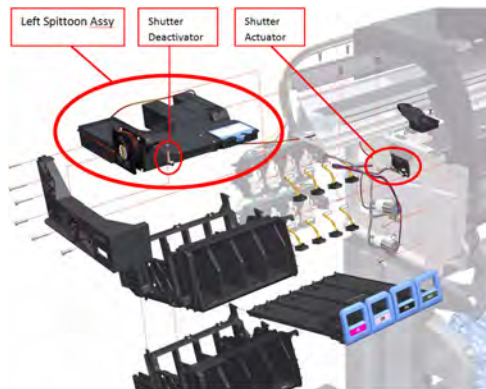

ESP Measurement test

This Service Utility checks that the Embedded SpectroPhotometer (ESP) is functioning within predefined color specifications. The test involves measuring the lightness of the white of the paper.



NOTE: To perform this test correctly the printer must have the latest firmware available.

1. Make sure that the paper loaded is suitable for the test: there are certain paper types that cannot be used for this type of test. The best results can be achieved by using HP Universal Instant-dry Gloss Paper (part number Q1273-60232). There are some other paper types that can be used:
 - HP Bright White Paper
 - HP Premium Instant Dry Gloss Paper
 - HP Premium Instant Dry Photo Satin Paper
 - HP Universal Coated Paper
 - HP Universal Heavyweight Coated Paper

- In the Service Utilities submenu, select **ESP Measurement Test** and press **OK**.

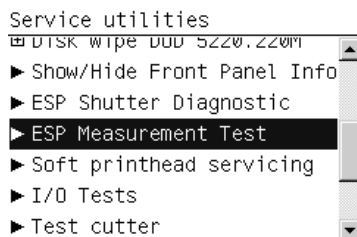

- The front panel displays information about the Spectrophotometer installed in the printer.

```
ESP Measurement Test
-----
Firmware: V4.080D
Sensor type: GE3
Serial number: 115
Manufacturing date: 0925

Do you want to run the test?
Press OK to continue or X to
exit
```

 **NOTE:** The manufacturing date is shown in YYWW format, where YY is the year and WW is the week of manufacturing.

- The paper is advanced 4 inches to cover the platen, and then the Spectrophotometer is used to measure paper white at five different positions along the scan axis. The measured Lab values are averaged and displayed.

```
ESP Measurement Test
-----
Read (L, a, b): ( 90.08 , -
0.10 , -1.65 )
Press OK to continue
```

- Compare the values from the front panel with the expected results for the loaded paper type.

If, for example, the value seen for L is 93 when HP Bright White Paper is loaded, this would indicate that the Spectrophotometer is functioning correctly. The nominal values are shown here for information only:

| Paper | Min L* | Max L* | Nominal L* |
|------------------------------------|--------|--------|------------|
| HP Bright White | 90.12 | 95.70 | 91.91 |
| HP Premium Instant Dry Gloss | 92.38 | 97.24 | 93.81 |
| HP Premium Instant Dry Photo Satin | 92.13 | 97.36 | 93.74 |
| HP Universal Coated | 89.51 | 94.65 | 91.08 |
| HP Universal Heavyweight Coated | 88.38 | 96.55 | 91.46 |
| HP Universal Instant Dry Gloss | 90.95 | 96.71 | 92.83 |

- After you press **OK**, the front panel displays the following message. The test itself does not detect whether the values are in or out of range.

```
ESP Measurement Test
-----
Diagnostic result: OK
```

Press **OK** to continue

Soft Printhead servicing

The purpose of this Service Utility is to enable or disable the soft printhead servicing mode, which is disabled by default, but may be enabled when spitting is visible on the print and the print quality is poor.

- In the Service Utilities submenu, scroll to **Soft printhead servicing** and press **OK**.

```
Service utilities
▶ replace cutter
▶ Enable/Disable Firewall
▣ Disk Wipe DoD 5220.220M
▶ Show/Hide Front Panel Info
▶ ESP Shutter Diagnostic
▶ ESP Measurement Test
▶ Soft printhead servicing
```

- Press **OK** to enable soft printhead servicing, or **Cancel** to disable it.

```
Soft printhead servicing
-----
Press OK to enable
soft printhead servicing
X to disable it.
```

- The front panel confirms your selection.

```
Soft printhead servicing
-----
Soft printhead
servicing enabled
```

```
Soft printhead servicing
-----
Soft printhead
servicing disabled
```

If you change your mind, you can just enable or disable it again.

I/O tests

The purpose of this service utility is to test the printer's built-in network adaptor.

- Ensure that the printer is connected to the network, otherwise the test will certainly fail.
- In the Service Utilities submenu, scroll to **I/O Tests** and press **OK**.
- The result of the test is displayed. If the test fails, replace the Formatter with a new one.

Test Cutter

The purpose of this service utility is to check that the Cutter works properly.

1. In the Service Utilities submenu, scroll to **Test Cutter** and press **OK**.

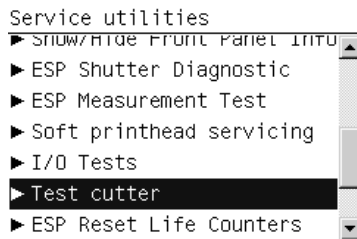

2. Make sure that paper is loaded, then press **OK** to proceed with the test.

```
Cutter
-----
Press OK to continue
```

3. The printer advances the paper, prepares the Cutter, and tries to cut the paper.
4. When it has finished cutting, the printer disengages the Cutter.
5. The front panel asks you to confirm that the Cutter has cut the paper.

```
Cutter
-----
Cutter seems to be OK.
Was the paper cut?

Press OK for yes,
Cancel for no.
```

Hard Disk recovery

The purpose of this service utility is to clean user data on the Hard Disk, to try to recover the printer from an unstable state.

1. In the Service Utilities submenu, scroll to **Hard Disk Recovery** and press **OK**.



2. When the following message appears on the front panel, press **OK** to perform a Hard Disk recovery, or **Cancel** to exit.

```
Hard Disk Recovery
-----
Please unload the paper

Press OK to continue
Press X to exit
```

3. When the following message appears on the front panel, again press **OK** to perform a Hard Disk recovery, or **Cancel** to exit.

```
Hard Disk Recovery
-----
This test will clean some
folders on the hard disk

Press OK to continue
Press X to exit
```

File system check

The purpose of this service utility is to check the consistency of the file system on the Hard Disk. If the utility detects a problem, it will try to fix it automatically.

1. In the Service Utilities submenu, scroll to **File System Check** and press **OK**.

```
Service utilities
▶ Soft Printhead Servicing
▶ I/O Tests
▶ Test cutter
▶ ESP Reset Life Counters
▶ Hard Disk Recovery
▶ File System Check
▶ Enabled/Disable Port280
```

2. When the following message appears on the front panel, press **OK** to perform a file system check, or **Cancel** to exit.

```
File System Check
-----
Do you want to launch
the file system check?

This will restart the printer
and will take several minutes
to complete.
Press OK to continue or X to
exit
```

5 Service calibrations

- [Service calibrations](#)
- [Entering the Service Calibrations menu](#)

Service calibrations

The printer has several calibration procedures that must be performed under certain conditions.

The following is a list of all internal service calibrations available in the printer. See [Entering the Service Calibrations menu on page 133](#).



NOTE: Remember that certain calibrations are required even if an assembly has been disassembled to gain access to another assembly or component.

1. ESP Shutter Calibration ⇒ See [ESP Shutter calibration on page 133](#)

The purpose of this Service Calibration is to fine-tune where the Carriage stops so that the Shutter Actuator can successfully open the shutter.

2. ESP Sensor Calibration ⇒ See [ESP Sensor calibration on page 134](#)

The purpose of this Service Calibration is to perform the internal calibration of the Embedded SpectroPhotometer (ESP).

3. Paper Advance Calibration ⇒ See [Paper-advance calibration on page 134](#)

The purpose of this Service Calibration is to calibrate the nominal advance of the paper. This calibration is necessary to control the exact movement of the paper in order to avoid print-quality problems like banding.

4. Drop Detector Calibration ⇒ See [Drop Detector calibration on page 137](#)

The purpose of this Service Calibration is to calibrate the Drop Detector (located in the Service Station) in relation to the Carriage Assembly.

5. Line Sensor Calibration ⇒ See [Line Sensor calibration on page 139](#)

The purpose of this Service Calibration is to calibrate the intensity of the Line Sensor. An incorrect calibration can result in edge-detection failures during paper loading and incorrect reading of prints that are used for alignment or calibration.

6. Calibrate Rewinder ⇒ See [Calibrate Rewinder on page 142](#)

The purpose of this Service Calibration is to calibrate the Rewinder Motor.

7. Primer Calibration ⇒ See [Primer calibration on page 143](#)

The purpose of this Service Calibration is to calibrate the Primer.

8. Reset Vacuum Calibration ⇒ See [Reset vacuum calibration on page 147](#)

The purpose of this Service Calibration is to reset the nominal values of the Vacuum Calibration. Should be used only if the vacuum fans are working, but the vacuum pressure is incorrect and there are carriage crashes.

9. Platen Blue Line Calibration ⇒ See [Platen blue line calibration on page 148](#)

The purpose of this Service Calibration is to calibrate the blue line which is marked on the Print Platen.

10. OMAS Calibration ⇒ See [OMAS Calibration on page 150](#)

The purpose of this Service Calibration is to calibrate the Optical Media Advance Sensor.

If all the calibrations need to be performed (for example, when both the HDD and the ISS PCA have been replaced), you should perform them in the following order:

- Vacuum Calibration
- Drop Detector/Service Station Calibration
- Line Sensor Calibration
- Paper Advance Calibration
- Platen Blue Line Calibration
- Calibrate Rewinder

Entering the Service Calibrations menu

1. Once the message **Ready** is displayed on the front panel, press the **Menu** key.
2. Once inside the Printer menu, press the **Down** key first, and hold it down while pressing the **Cancel** key. You are now in the Service menu.
3. Select **Service calibrations** and press the **OK** key.

```
Service menu
-----
▣ Service utilities
▣ Service calibrations
```

4. Scroll through the various service calibrations and press the **OK** key to begin the highlighted calibration.

 **NOTE:** If the printer is not used for 135 seconds, the printer leaves the Service Calibrations menu and you must repeat the above steps to return to it.

ESP Shutter calibration

This Service Calibration tries to open and close the Embedded SpectroPhotometer (ESP) shutter, and checks optically, using the ESP light, that it opens and closes. If it cannot open the shutter with the default values, it tries to fine-tune the location where the carriage stops so that the Shutter Actuator can hook the shutter lid and open it successfully. It will try over a range of ± 1 cm around the nominal position, moving by 1 mm after each attempt, starting at the rightmost position (nominal +1 cm), until the actuator hooks the shutter. If, by nominal -1 cm, the shutter has not been successfully opened, the test fails. If a successful position is found, it is stored in the NVM as the new position to be used in future.

1. In the Service Calibrations submenu, select **ESP Shutter Calibration** and press **OK**.

```
Service calibrations
└─▶ ESP Shutter Calibration
└─▶ ESP Sensor Calibration
  ▣ Paper advance calibration
  ▣ Drop Detector calibration
  ▶ Line Sensor calibration
  ▶ Calibrate Rewinder
  ▶ Primer calibration
```

2. During calibration, the Carriage moves back and forth and the front panel displays a brief description of what is happening. When calibration is complete, the following message is displayed.

```
ESP Shutter Calibration
-----
Diagnostic result: OK
```

Press **OK** to continue

3. Press **OK** to return to the menu.

If the calibration fails, you can use the ESP Shutter Diagnostic in the Service Utilities submenu to identify which failed part is preventing the shutter from working correctly.

ESP Sensor calibration

The purpose of this Service Calibration is to perform the internal calibration of the Embedded SpectroPhotometer (ESP). This requires the shutter lid to be closed. An open shutter lid will cause an error message. You can perform the ESP Shutter Test to check the shutter mechanism.

1. In the Service Calibrations submenu, select **ESP Sensor Calibration** and press **OK**.

```
Service calibrations
├─▶ ESP Shutter Calibration
├─▶ ESP Sensor Calibration
├─▶ Paper advance calibration
├─▶ Drop Detector calibration
├─▶ Line Sensor calibration
├─▶ Calibrate Rewinder
└─▶ Primer calibration
```

2. Press **OK** again to start the test. The front panel displays:

```
ESP Sensor Calibration
-----
Calibrating...
```

and then:

```
ESP Sensor Calibration
-----
Diagnostic result: OK
```

Press **OK** to continue

3. Press **OK** to return to the menu.

Paper-advance calibration

The purpose of this Service Calibration is to calibrate the nominal advance of the paper to compensate for any irregularities in the drive roller, which is not a perfect cylinder. Calibration is necessary to control the precise movement of the paper in order to avoid print-quality problems such as banding.

1. In the Service Calibrations submenu, select **Paper Advance Calibration** and press **OK**.

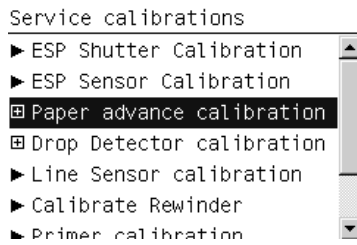

2. The Paper Advance Calibration submenu offers four options.

- **Check calibration status** tests whether the current calibration values are valid.
- **Perform new calibration** performs a calibration in order to obtain a new set of calibration values. The calibration values are automatically set to zero when a calibration process is launched.
- **Reset current calibration** sets all the calibration values to zero.
- **Show current calibration values** displays the current calibration values.

Check calibration status

This option tests whether the current calibration values are valid. The process is very similar to the calibration process. The printer makes a series of paper advances, and the OMAS sensor registers the distance covered in each advance.



NOTE: Before starting the process, make sure that HP Coated Paper is loaded and ready to print.

At the end of the process, the printer checks whether the current calibration values are valid, using the data obtained during the paper advances. If the values are considered valid, then the following message will be shown.

```
Check Current Parameters
```

```
-----  
The current calibration  
values are valid  
Press OK to continue
```

If they are not valid, the front panel displays the reason (for example, the AMP1 parameter value is greater than the maximum allowed).

```
Check Current Parameters
```

```
-----  
The obtained calibration  
values are not valid  
AMP1 (23) > 20  
Press OK to continue
```

Press **OK** to return to the main screen.

Perform new calibration

This option performs a calibration in order to obtain a new set of calibration values. The printer makes a series of paper advances, and the OMAS sensor registers the distance covered in each advance. When all the paper advances have been performed, the calibration values are calculated based on the data obtained.



NOTE: Before starting the process, make sure that HP Coated Paper is loaded and ready to print.

1. The printer checks that there is paper ready to print. If there is no paper ready, the following message is displayed. After a few seconds, the front panel automatically returns to the Paper Advance Calibration submenu.

```
Perform Calibration Process
-----
Paper not ready
```

2. If there is paper ready, the printer performs the zero search for the Paper Motor. During this phase, the following message is displayed.

```
Perform Calibration Process
-----
Performing paper advance
calibration...
```

3. When the Paper Motor has been initialized, the printer starts to perform the series of paper advances. During this process, the front panel displays the current iteration number and the total number of iterations.

```
Perform Calibration Process
-----
Performing paper advance
calibration...
Iteration 32 of 90
Press X to exit
```

You can cancel the calibration process at any time by pressing **Cancel**. In this case, the previous calibration values are restored and the cancelled process has no effect on the printer.

4. If the calibration process finishes without errors, the new calibration values are checked. If the values are considered valid, they are displayed and saved for use in future. Press **OK** to return to the main screen.

```
Perform Calibration Process
-----
SLOPE: 0.001672
AMP1: 13.000000
PH1: 3.359320
FREQ1: 1.000000
AMP2: 0.000000
PH2: 0.000000
FREQ2: 2.000000
AMP3: 0.000000
```



NOTE: Both the Automatic and the Manual Paper Advance Calibration (which can be launched from the user menu), if they exist, are automatically set to zero for each kind of paper.

5. If the calibration values are not valid, the front panel displays the reason (for example, the percentage of good navigations is less than 90%). In this case the calibration process has no effect on the printer. Press **OK** to return to the main screen.

```
Perform Calibration Process
-----
The obtained calibration
values are not valid
GOOD NAVS (17.8) < 90%
Press OK to continue
```

Reset current calibration

This option sets all the calibration values to zero.

1. The front panel asks for confirmation before proceeding with the reset operation. Press **Cancel** to exit or **OK** to continue with the reset operation.

```
Reset Calibration Parameters
WARNING: The current paper
advance calibration will be
deleted
Press OK to continue or ✕ to
exit.
```

2. If you press **OK**, the printer resets the calibration values, after which the following message is displayed. Press **OK** to return to the main screen.

```
Reset Calibration Parameters
The paper advance calibration
values have been deleted
Press OK to continue
```

Show current calibration values

This option displays the current calibration values. There are ten calibration parameters in total: SLOPE, AMP1, PH1, FREQ1, AMP2, PH2, FREQ2, AMP3, PH3, and FREQ3. Press **OK** to return to the main screen.

```
Show Calibration Parameters
SLOPE: 0.001672
AMP1: 13.000000
PH1: 3.359320
FREQ1: 1.000000
AMP2: 0.000000
PH2: 0.000000
FREQ2: 2.000000
AMP3: 0.000000
```

Drop Detector calibration

The purpose of this Service Calibration is to calibrate the Drop Detector (located in the Service Station) in relation to the Carriage Assembly. Perform Drop Detector calibration whenever the Drop Detector is disassembled or replaced.

There are two menu options to calibrate the Drop Detector:

- Reset Calibration Flag
- Calibrate Drop Detector

Reset Calibration Flag

Always reset the calibration flag before replacing the Drop Detector, so that the printer will not try to perform drop detection until the new Drop Detector has been calibrated.

1. In the Service Calibrations submenu, select **Drop Detector calibration** and press **OK**.

```
Service calibrations
▶ ESP Shutter Calibration
▶ ESP Sensor Calibration
▣ Paper advance calibration
▣ Drop Detector calibration
▶ Line Sensor calibration
▶ Calibrate Rewinder
▶ Primer calibration
```

2. In the Drop Detector Calibration menu, select **Reset Calibration Flag** and press **OK**.

```
Drop Detector calibration
└─▶ Calibrate Drop Detector
└─▶ Reset Calibration Flag
```

3. When the following message appears on the front panel, press **OK** to continue with the calibration; press **Cancel** to exit.

```
Reset Calibration Flag
Current value: 1

Clear drop detector
calibration flag?
Press OK to continue or ✘ to
exit
```

4. The printer resets the calibration flag. Press **OK** to return to the menu.

```
Reset Calibration Flag
Diagnostic result: OK
```

Press **OK** to continue

5. Turn off the printer and replace the Drop Detector.
6. Turn on the printer and calibrate the Drop Detector.

Drop Detector calibration

1. In the Service Calibrations submenu, select **Drop Detector calibration** and press **OK**.

```
Service calibrations
└─▶ ESP Shutter Calibration
└─▶ ESP Sensor Calibration
└─▶ Paper advance calibration
└─▶ Drop Detector calibration
└─▶ Line Sensor calibration
└─▶ Calibrate Rewinder
└─▶ Primer calibration
```

2. In the Drop Detector Calibration submenu, select **Calibrate Drop Detector** and press **OK**.

```
Drop Detector calibration
└─▶ Calibrate Drop Detector
└─▶ Reset Calibration Flag
```

3. When the following message appears on the front panel, press **OK** to continue with the calibration, or press **Cancel** to exit.

```
Calibrate Drop Detector
-----
Do you want to perform the
drop detection calibration?

Press OK for yes or X for no
```

4. The printer will start to calibrate the Drop Detector, which takes about 1 minute.

```
Calibrate Drop Detector
-----
Calibrating...

Step 1 of 18
```

5. Once the Drop Detector has been calibrated, the results are displayed on the front panel.

```
Calibrate Drop Detector
-----
Offset: 18
(valid range -70..70)
Window width: 12
(minimum 5)

Press OK to accept or X to
reject values
```

The offset is the displacement from the nominal Carriage position for drop detection. The window width refers to values captured by the drop detector sensor. The offset should be within the valid range, and the window width should be at least the minimum shown. If the values are correct, press **OK** to accept them. If not, the Drop Detector is not correctly installed, either because the Service Station has not been correctly installed in the Scan Axis or because the Drop Detector is not correctly installed or not working properly. Press **Cancel** to reject the values.

⚠ CAUTION: Do not accept these values if they are not within the right range, as the printer will not work properly.

6. Press **OK** to end the calibration.

```
Calibrate Drop Detector
-----
Diagnostic result: OK

Press OK to continue
```

Line Sensor calibration

The purpose of this Service Calibration is to calibrate the intensity of the Line Sensor in the Carriage PCA. An incorrect calibration can result in edge-detection failures during paper loading and incorrect reading of prints that are used for alignment or calibration.

Perform Line Sensor Calibration whenever:

- The edge-detect procedure fails during paper loading.
- The Carriage is disassembled or replaced.

- The Line Sensor is disassembled or replaced.
 - Banding is detected in prints.
 - Misalignment between colors is detected.
1. Load the printer with glossy paper at least 24 inches wide, if feasible. If you have difficulty in loading the paper (which can happen if the Line Sensor is miscalibrated), continue with no paper loaded.
 2. In the Service Calibrations submenu, select **Line Sensor calibration** and press **OK**.

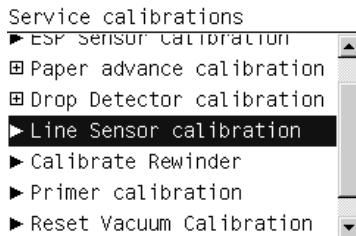

3. When the following message appears on the front panel, press **OK** to continue the calibration, or press **Cancel** to exit.

```

Line Sensor calibration
-----
Press OK to continue or ✘ to
exit
  
```

4. If no paper is loaded, the following message is displayed.

```

Line Sensor calibration
-----
Paper needed for this
calibration. Press OK to
load paper manually.
Press Cancel to exit and
load paper normally.
Press OK to continue or ✘ to
exit
  
```

If the wrong type of paper is loaded, the following message is displayed.

```

Line Sensor calibration
-----
Invalid paper type (HP, 1101)
Please use any glossy paper
Please change paper
Press OK to exit
  
```

If you choose to load the paper manually, follow the instructions on the front panel.

```

Line Sensor calibration
-----
Open back door

Please feed paper
to cover right side
of print platen

Close back door
Press OK to continue
  
```

5. The printer starts to calibrate the Line Sensor. When the Line Sensor has been calibrated, the results are displayed on the front panel. Press **OK** to continue or **Cancel** to exit.

```

Line Sensor calibration
-----
(WHITE-BLACK)  RANGE
B:   833      700-900
R:   841      700-900
O:   851      700-900
G:   835      700-900

```

Press **OK** to confirm or
X to exit

If the values are not within the range specified, an error will appear on the front panel. In this case, try the following:

- Repeat the calibration.
 - Replace the Line Sensor ⇒ See [Line Sensor Assembly on page 379](#).
- 6.** If you loaded the paper manually, you must now unload it and then reload it in the normal way, before the calibration can continue. In this case, the following message is displayed.

```

Line Sensor calibration
-----
Please raise the lever

Please unload the paper

Please lower the lever
Press OK to continue

```

When you have unloaded the paper, the front panel prompts you to load it in the normal way.

```

Line Sensor calibration
-----
Diagnostic result: OK
Please load paper and start
again.

```

Press **OK** to continue

Load the paper, then press **OK**.

- 7.** The printer starts to calibrate the Line Sensor position to the black printhead. It prints a line of black dots and then scans them:



- 8.** When the Line Sensor has been calibrated, the results are displayed on the front panel. Press **OK** to finish the calibration or **Cancel** to exit.

```

Line Sensor calibration
-----
Y offset range: 30 to 59
Y offset got: 45
X offset range: -20 to 20
X offset got: 4

```

Press **OK** to confirm or
X to exit

9. The printer now aligns the printheads. When the following message appears, press **OK** to continue or **Cancel** to exit.

```
Line Sensor calibration
-----
Printhead Alignment
Calibration
Press OK to continue or X to
exit
```

10. When the printhead alignment is completed, the following message is displayed. Press **OK** to continue.

```
Printhead alignment
-----
Printhead alignment
successfully completed.

Press OK to continue
```

If the printhead alignment fails for any reason, a warning message will appear on the front panel. In this case, try the following:

- Enter the front panel menu and retry the printhead alignment.
 - If the printhead alignment fails again, check the alignment pattern to see whether any of the printheads are printing incorrectly. If necessary, perform a printhead recovery through the front panel and retry the printhead alignment.
11. When the whole Line Sensor calibration is completed successfully, the following message is displayed.

```
Line Sensor calibration
-----
Diagnostic result: OK

Press OK to continue
```

Calibrate Rewinder

The purpose of this Service Calibration is to calibrate the printer's Rewinder Motor parameters.

1. Load an empty spindle into the printer.
2. Select **Calibrate Rewinder** from the Calibrations menu.

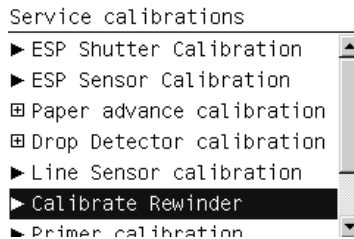

```
Service calibrations
├─▶ ESP Shutter Calibration
├─▶ ESP Sensor Calibration
├─▣ Paper advance calibration
├─▣ Drop Detector calibration
├─▶ Line Sensor calibration
├─▶ Calibrate Rewinder
├─▶ Primer calibration
```

3. Press **OK** to continue, then there is a short delay while the calibration is performed.

```
Calibrate Rewinder
-----
Press OK to continue
Press X to exit
```

4. If the calibration completes successfully, the front panel shows the result and prompts you to press **OK** to save values; or **Cancel** if you prefer not to save values.

```
Calibrate Rewinder
-----
Store Values: -101 -191
Press OK to continue
Press X to exit
```

5. If the calibration fails, the front panel displays the reason.

Primer calibration

The purpose of this Service Calibration is to compute the optimum position of the Primer Assembly with respect to the Carriage.

The calibration is a visual procedure, so you will have to remove the Right Cover before starting.

1. Remove the Right Cover ⇒ See [Right Cover on page 235](#).
2. Block the Maintenance Cartridge door switch in the closed position.
3. In the Service Calibrations submenu, scroll to **Primer Calibration** and press **OK**.

```
Service calibrations
▶ ESP Shutter Calibration
▶ ESP Sensor Calibration
▣ Paper advance calibration
▣ Drop Detector calibration
▶ Line Sensor calibration
▶ Calibrate Rewinder
▶ Primer calibration
```

4. When the following message appears on the front panel, you must press **OK** to continue, or **Cancel** to exit the calibration.

```
Primer Calibration
-----
Remove the service station
cover carefully.
Hold the service station door
sensor pressed
Beware of moving parts.
Press OK to continue or X to
exit
```

5. The calibration process starts, and the front panel shows the following message:

```
Primer Calibration
-----
Initializing
```

- When the printer is ready, the front panel prompts you to use the **Up/Down** keys to move the carriage until the right-hand edge of the left alignment mark on the Carriage Cover is correctly aligned with the Primer Positioning Indicator. When the carriage is correctly aligned, press **OK**.

Primer Calibration

Use the up/down buttons to move the carriage until the primer's long piece of plastic falls from the plastic piece of the carriage latch. Press OK when done.

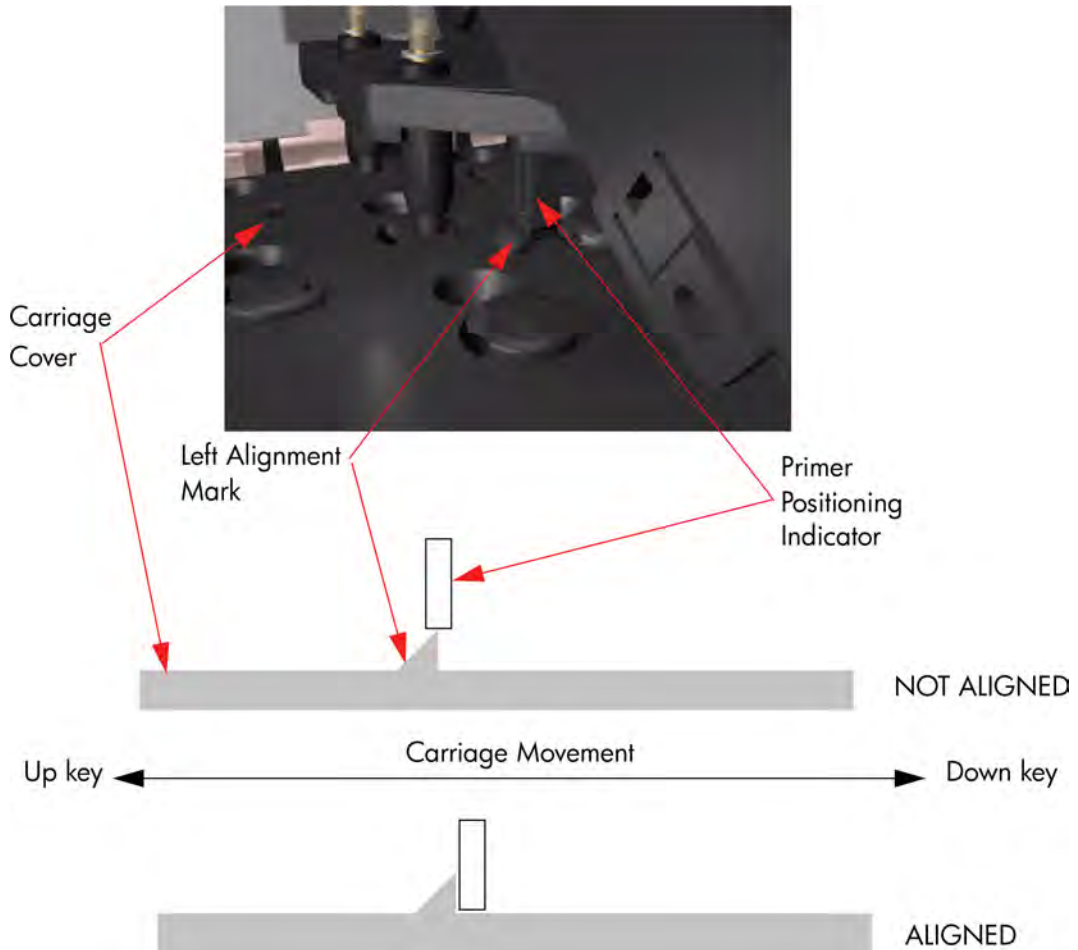

TIP: To see the exact position while aligning the Carriage to the Primer, it is a good idea to press down lightly on the Primer while you are moving the Carriage.

While the Carriage is moving, the front panel shows the actual position and the direction of movement and prompts you to press **OK** when done.

Primer Calibration

Moving left...
Current position 25888
Press OK when done.

7. The front panel shows the actual left offset value and then the left alignment position.

Primer Calibration

The left offset between
nominal and real value was
374

Primer Calibration

The left alignment between
Carriage and Primer was found
at the position 25984

- When the printer is ready, the front panel prompts you to use the **Up/Down** keys to move the carriage until the right-hand edge of the left alignment mark on the Carriage Cover is correctly aligned with the Primer Positioning Indicator. When the carriage is correctly aligned, press **OK**.

Primer Calibration

Use the up/down buttons to move the carriage until the primer's long piece of plastic falls from the plastic piece of the carriage latch. Press **OK** when done.

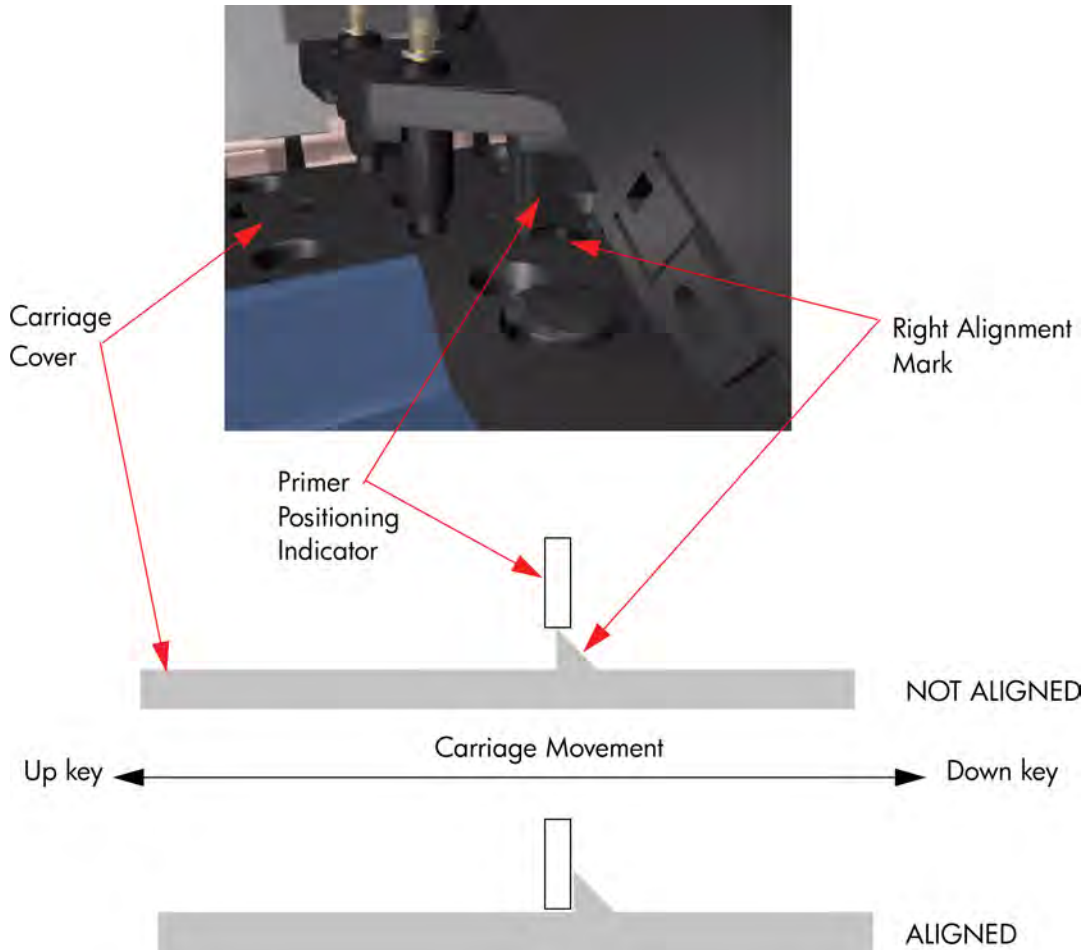

TIP: To see the exact position while aligning the Carriage to the Primer, it is a good idea to press down lightly on the Primer while you are moving the Carriage.

While the Carriage is moving, the front panel shows the actual position and the direction of movement and prompts you to press **OK** when done.

Primer Calibration

Moving right...
Current position 95808
Press **OK** when done

9. The front panel shows the actual right offset value and then the right alignment position.

```
Primer Calibration
-----
The right offset between
nominal and real value was
527
```

```
Primer Calibration
-----
The right alignment between
Carriage and Primer was found
at the position 95680
```

10. The calibration process continues, and the front panel shows the new nominal offset value. Press **OK** to continue.

```
Primer Calibration
-----
Nominal offset is 4800...
New nominal offset is 5298...
Press OK to continue
```

11. When the calibration is complete, the result is displayed on the front panel. Press **OK** to leave the calibration process.

```
Primer Calibration
-----
Diagnostic result: OK
```

Press **OK** to continue

12. Replace the Right Cover ⇒ See [Right Cover on page 235](#).

Reset vacuum calibration

The purpose of this Service Calibration is to reset the nominal values of the Vacuum Calibration.

 **NOTE:** Reset the vacuum calibration only if the vacuum fans are working (the printer can turn them on without system errors), but the vacuum pressure is incorrect and there are carriage crashes. The existing calibration will be lost.

1. In the Service Calibrations submenu, select **Vacuum Calibration** and press **OK**.

```
Service calibrations
▶ ESP sensor calibration
▣ Paper advance calibration
▣ Drop Detector calibration
▶ Line Sensor calibration
▶ Calibrate Rewinder
▶ Primer calibration
▶ Reset Vacuum Calibration
```

2. When the following message appears on the front panel, press **OK** to continue, or press **Cancel** to exit.

```
Reset Vacuum Calibration
-----
The original calibration
will be lost. Reset this
calibration only if the
printer is having
vacuum problems.
Press OK to continue or X to
exit
```

3. The front panel asks for confirmation. If you are sure that you want to reset the calibration, press **OK** to continue, or press **Cancel** to exit.

```
Reset Vacuum Calibration
-----
The original calibration will
be lost. Are you sure that
you want to reset the
calibration?
Press OK to continue or X to
exit
```

4. The printer resets the nominal values of the Vacuum Calibration. If all goes well, an acknowledgement is displayed.

```
Reset Vacuum Calibration
-----
Vacuum calibration
reset successfully.
```

5. Press **OK** to return to the menu.

Platen blue line calibration

The purpose of this Service Calibration is to calibrate the blue line that is marked on the Print Platen.

You should calibrate the blue line whenever the Print Platen is disassembled or replaced.

1. If paper is loaded in the printer, unload it.
2. In the Service Calibrations submenu, scroll to **“Platen blue line calib.”** and press **OK**.

```
Service calibrations
▣ Paper advance calibration
▣ Drop Detector calibration
▶ Line Sensor calibration
▶ Calibrate Rewinder
▶ Primer calibration
▶ Reset Vacuum Calibration
▶ Platen blue line calib.
```

3. When the following message appears on the front panel, you can press **OK** to continue with the calibration, or **Cancel** to exit.

```
Platen blue line calib.
-----
Press OK to continue or X to
exit
```

4. Follow the instructions on the front panel, using a sheet of white paper. Then press **OK** to continue with the calibration, or **Cancel** to exit.

Platen blue line calib.

1) Open window and bk door.
2) Align sheet with platen blue line.
3) Close bk door and window.
Press **OK** to continue or **X** to exit

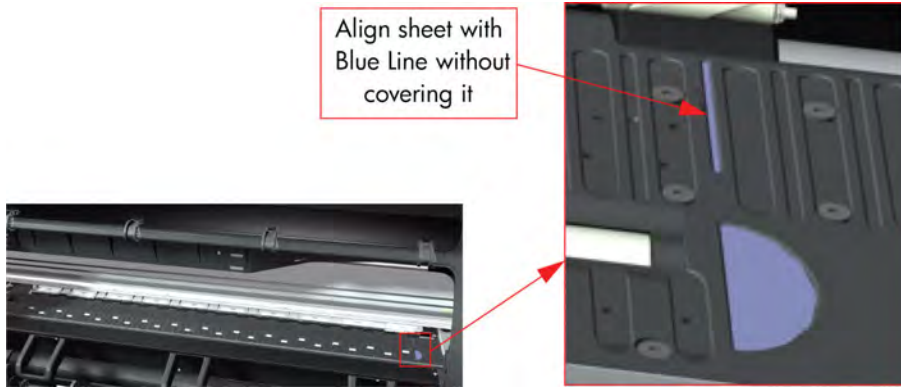

5. The printer starts to calibrate the blue line.

Platen blue line calib.

Calibrating blue line...

6. The results of the calibration are displayed on the front panel. Press **OK** to continue.

Platen blue line calib.

Calibrating blue line...
Tolerances: 8707 +/- 47 .
Measured value: 8675
Blue line correctly calibrated
Press **OK** to continue

7. Follow the instructions on the front panel. Then press **OK** to continue.

Platen blue line calib.

1) Open window and lift pinch lever.
2) Remove paper.
3) Lower pinch lever and close window.
Press **OK** to continue

8. The front panel announces the success of the calibration. Press **OK** to return to the menu.

Platen blue line calib.

Diagnostic result: OK

Press **OK** to continue

OMAS Calibration

The purpose of this Service Calibration is to calibrate the OMAS Module. The calibration process consists of printing a special calibration plot and then scanning it with the printer. The resulting scanned values are compared with the actual printed values to obtain a PASS/FAIL result.

 **NOTE:** In order to perform this calibration, you should order the Paper Advance Calibration Kit (part number CQ109-67042), which contains a 150-ft roll of HP Coated Paper, 36 inches wide (part number C6020B).

Print OMAS Calibration Pattern

1. Load the roll of HP Coated Paper from the Paper Advance Calibration Kit into the printer.
2. In the Service Calibrations menu, scroll to **OMAS Calibration** and press **OK**.

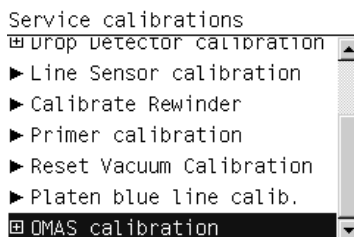

3. In the OMAS Calibration submenu, scroll to **Print Calibration Pattern** and press **OK**.

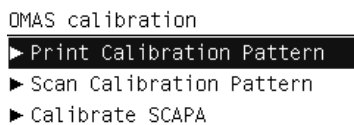

4. When the following message appears on the front panel, press **OK** to continue with the calibration, or press **Cancel** to exit.

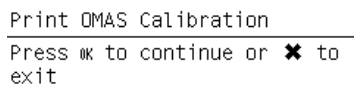

5. The front panel prompts you to unroll 1 meter of paper to avoid back tension. Unroll 1 meter of paper and press **OK**.

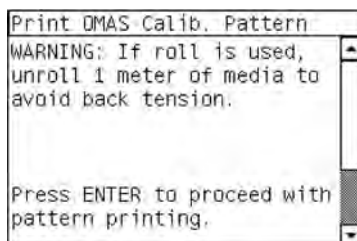

6. The printer starts to print the OMAS Calibration Pattern. This could take several minutes, during which the following message is displayed on the front panel.

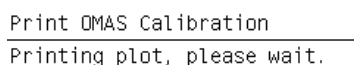

- Once the OMAS Calibration Pattern has been printed successfully, the following message is displayed on the front panel. Press the **OK** key to continue.

```
Print OMAS Calibration
-----
Diagnostic result: OK
```

Press **OK** to continue

If the OMAS Calibration fails for any reason, a warning message appears on the front panel. In this case, try the following:

- Retry the Paper Advance Calibration.

 **NOTE:** Remove the pattern from the printer and leave it to dry for a few minutes before continuing with the calibration.

 **NOTE:** Make sure no paper is loaded in the printer before starting to scan the OMAS calibration pattern.

Scan OMAS Calibration Pattern

- Re-enter the OMAS Calibration submenu, scroll to **Scan Calibration Pattern** and press **OK**.

```
OMAS calibration
-----
▶ Print Calibration Pattern
▶ Scan Calibration Pattern
▶ Calibrate SCAPA
```

- When the following message appears on the front panel, press **OK** to continue with the calibration, or press **Cancel** to exit.

```
Scan Calibration Pattern
-----
Press OK to continue or X to
exit
```

- A message will appear advising you to load the OMAS Calibration Pattern into the printer. Make sure that you rotate the printed pattern 90° clockwise and reload it with the printed side down. Press the **OK** key to continue.

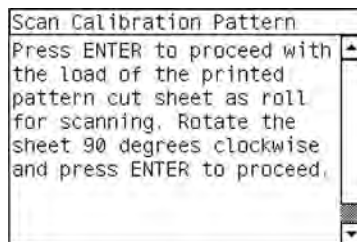

```
Scan Calibration Pattern
Press ENTER to proceed with
the load of the printed
pattern cut sheet as roll
for scanning. Rotate the
sheet 90 degrees clockwise
and press ENTER to proceed.
```

4. Load the OMAS Calibration Pattern, following the instructions on the front panel.

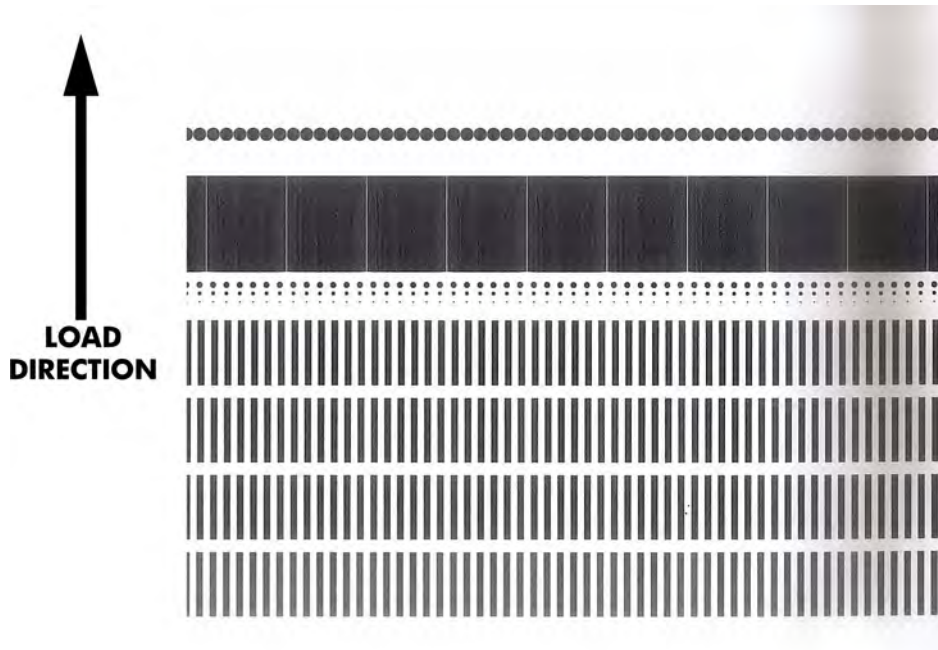

5. Once the OMAS Calibration Pattern is loaded correctly, the following message is displayed on the front panel. Press the **OK** key to continue.

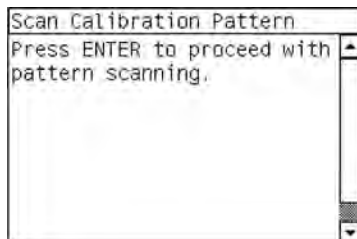

6. The printer scans the OMAS Calibration Pattern, which could take several minutes. When the calibration has finished, the front panel confirms success. Press the **OK** key to continue.

If the calibration fails for any reason, a warning message appears on the front panel. In this case, try the following:

- Check that the OMAS Calibration Pattern was not incorrectly cut (trimming the actual pattern) during the paper load process. If this is the case, perform the OMAS Calibration again from **step 1**.
- Replace the OMAS Sensor ⇒ See [Optical Media Advance Sensor \(OMAS\) on page 339](#).
- Replace the OMAS Controller Card ⇒ See [OMAS Controller Card on page 349](#).
- If the problem continues, replace the Media-Axis Motor ⇒ See [Media-Axis Motor on page 336](#).

SCAPA Calibration

The purpose of this calibration is to calibrate the Scan Axis Pen Alignment (SCAPA) compensation/adjustment factor.

 **NOTE:** For this calibration process you need to have paper loaded in the printer.

1. Re-enter the OMAS Calibration submenu, scroll to **Scan Calibration Pattern** and press **OK**.

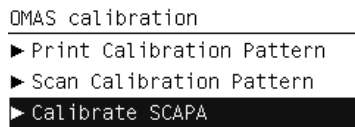

2. When the following message appears on the front panel, press **OK** to continue with the calibration, or press **Cancel** to exit.

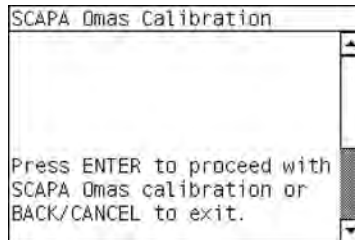

3. The calibration process executes, and the front panel will display the result in mDeg.

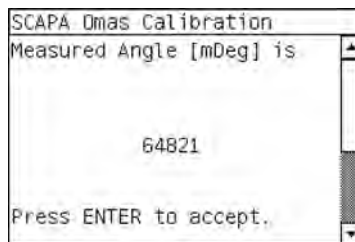

4. Press **OK** to accept the result.

6 Print quality

- [Initial print-quality troubleshooting actions](#)
- [Troubleshooting tools](#)
- [How to use the Image Quality Service Diagnostic Print](#)
- [Print-quality issues by symptom](#)
- [Working with other commercially available papers](#)

Initial print-quality troubleshooting actions

For the majority of print-quality problems, a Call Agent can try to troubleshoot the printer by requesting that the customer performs the following troubleshooting actions. Using this process, most problems can be resolved without the need of an on-site visit.

Perform the following actions in the order described:

1. Printer Configuration:





- Make sure that the **paper type** selected in the Front Panel is the same as the paper type loaded into the printer. To check this, use the [View paper information](#) key on the front panel. At the same time, check that the paper type has been calibrated. Also make sure that the paper type selected in your software is the same as the paper type loaded into the printer.
- Check that the customer is printing on the correct side of the paper.
- Check that the customer is using the most appropriate print-quality settings. If **Fast** or **Normal** has been selected, the customer may not achieve the most accurate colors. Set the print-quality setting to **Best**. See also “Select print quality” in *Using your printer*.



NOTE: If the customer has set the print quality with the printer driver or with the Embedded Web Server, this will override a print-quality setting from the front panel.



NOTE: You cannot change the print quality of pages that the printer is already receiving or has already received (even if they have not started to print yet).

- Dry time should be set to “Optimal”.
2. Check if the latest version of the firmware is installed. If not, install the latest firmware revision.
 3. Check that your ink cartridges and printheads have not passed their expiration dates.
 4. Perform Printhead recovery:  icon, then **Clean printheads**.
 5. Perform Printhead alignment:  icon, then **Align printheads**.
 6. If a new paper type has been created from the Color Center, check that the correct parent paper type has been used. This is because there are some ‘high ink’ and ‘low ink’ paper types for some categories of paper used, such as the photo category.
 7. Perform color calibration:  icon, then **Calibrate color**.
 8. Perform paper advance calibration:  icon, then **Calibrate paper advance**.
 9. If you are using Application Color Management check the following:
 - Ensure the within the color tab of the driver, **Application manage colors** has been selected.
 - That the color profile you are using in the application corresponds to the paper type and printquality settings.
 - In addition for PostScript printers check the following:

- If you have doubts about the installed 'output' ICC profiles on the computer, perform the following from the Color Center: **Manage papers > Update profiles**.
 - If you need to create a color profile, go through the Color Center: **Create and Install ICC profile**.
 - If you have any doubt about the created ICC profile, recreate it, or re-install the default one (from the Color Center: **Create and Install ICC profile** or **Manage paper > Restore factory ICC profile**).
10. If the issue is the color difference between the printer and the monitor, ensure that the monitor has been calibrated, refer the customer to the HP LFP Knowledge Center for details on how to perform this: http://www.hp.com/go/knowledge_center/djZ6200/.
 11. Check that your environmental conditions (temperature, humidity) are in the recommended range. Avoid touching the paper while printing is in progress.
 12. If PANTONE colors are inaccurate, refer to the Color Management chapter within *Using your printer*. The section is called 'HP Professional PANTONE Emulation'.
 13. Color accuracy using EPS or PDF images in page layout applications such as Adobe InDesign and QuarkXPress do not support color management of EPS, PDF or Grayscale files.

If these types of files have to be used, try to ensure that the EPS, PDF or grayscale images are already in the same color space that is to be used later on in Adobe InDesign or QuarkXPress. For example, if the final objective is to print the job in a press that follows the SWOP standard, at the time of creating the EPS, PDF or grayscale the image should be converted into SWOP.

14. Check the procedures described in [Colors are inaccurate on page 187](#).

 **NOTE:** The HP LFP Knowledge Center is an excellent source of color accuracy information, the database includes step-by-step procedures on achieving the best color image quality when using various applications. Go to http://www.hp.com/go/knowledge_center/djZ6200/.

Troubleshooting tools

To access the troubleshooting tools in the Embedded Web Server, select the **Support** tab. The first two tools can also be accessed from the front panel's Image quality maintenance menu.

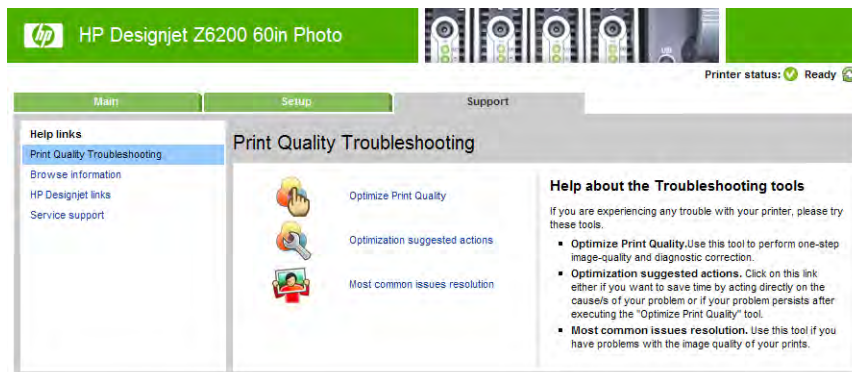

Optimize print quality

This option ensures that printer and supplies are adjusted to deliver optimum print quality. Click **Next** to execute all calibration and recovery procedures automatically. The following procedures are included:

- Printhead cleaning
- Media advance calibration
- Printhead alignment
- Color calibration

The whole process consumes 80 cm (31.5 in) of paper and may take up to 20 minutes.



NOTE: This option can also be selected from the front panel. From the main menu, select , then **Optimize print quality**.

Optimization suggested actions

This option suggests a series of recommended actions to improve print quality, based on the results of internal checks. These actions may include reseating a printhead, changing paper to run a specific calibration, cleaning some printer component, etc. Execute them in the proposed order.



TIP: Use this option if you want to save time by acting directly on the causes of your problem, or if your problem persists after the automatic **Optimize print quality** process.



NOTE: This option can also be selected from the front panel. From the main menu, select , then **Optimization suggested actions**.

Most-common issues resolution

This option is designed to help you resolve some of the most common print-quality issues that users encounter in large-format printing:

- Dark or light horizontal lines across the image (banding)
- Graininess
- Poor line quality
- Inaccurate colors

In the first window, select the print-quality issue that you are experiencing and click **Next**.

A list of suggestions for corrective action appears along with help to guide you through each action.

Status codes

After running any of the print-quality troubleshooting tools, the Embedded Web Server updates and displays status codes that may be helpful if any further troubleshooting is required. To see the status codes, select the **Support** tab, then **Service Support** > **Printer Information** > **Calibration Status**. Look for the Printer Status Codes section at the end of the page.



NOTE: If no problem has been reported, the status codes are irrelevant and should be ignored.



TIP: When troubleshooting a print-quality problem, you are recommended to execute **Optimize print quality** to ensure that the status codes are up to date.

Nozzle health

The status code consists of 16 digits, one for each group of nozzles. For the Z6200 and Z6800 printers the order is as follows: magenta 1, yellow 1, magenta 2, yellow 2, light magenta 1, light cyan 1, light magenta 2, light cyan 2, photo black 1, light gray 1, photo black 2, light gray 2, matte black 1, red 1, matte black 2, red 2. For the Z6600 printer the order is as follows: magenta 1, yellow 1, magenta 2, yellow 2, photo black 1, light gray 1, photo black 2, light gray 2, matte black 1, cyan 1, matte black 2, cyan 2 (non-used colors will show an X).

Each digit can take one of the following values:

- 0 : no data, or error
- 1 : nozzle health OK, printhead in warranty
- 2 : nozzle health at risk (level 1), printhead in warranty
- 3 : nozzle health at risk (level 2), printhead in warranty
- 4 : nozzle health OK, printhead out of warranty
- 5 : nozzle health at risk (level 1), printhead out of warranty
- 6 : nozzle health at risk (level 2), printhead out of warranty

If nozzle health is at risk, you are recommended to check the maintenance cartridge, and replace the printhead if necessary.

If all digits are 0 or more than 50% of printheads are at risk, check the Drop Detector (cleaning it to make sure there are no fibers blocking it), perform a Drop Detector calibration, and replace it if the problem persists.

Media advance calibration

The status code consists of 8 digits, each of which can take one of the following values:

- 0 : no data, or error
- 1 : parameter OK
- 2 : parameter at risk (level 1)
- 3 : parameter at risk (level 2)
- 8 : non-navigable paper type
- 9 : OMAS disconnected

If all digits are 0, media advance calibration has not been performed on that paper type. In this case, perform media advance calibration.

If the 4th or 7th digits are not 1, there is some mismatch between OMAS and the printer calibration. Clean the Media Advance Sensor, and replace it if the problem does not disappear.

If you see a 9 anywhere, the OMAS sensor has been disconnected. Clean the Media Advance Sensor, and replace it if the problem does not disappear.

If you see a 2 or 3 anywhere, the calibration has not worked well. Check that the paper is correctly loaded and that the calibration is correctly printed (otherwise clean the printheads), and try the calibration again.

Printhead alignment

The status code consists of 16 digits, one for each group of nozzles. For the Z6200 and Z6800 printers the order is as follows: magenta 1, yellow 1, magenta 2, yellow 2, light magenta 1, light cyan 1, light magenta 2, light cyan 2, photo black 1, light gray 1, photo black 2, light gray 2, matte black 1, red 1, matte black 2, red 2. For the Z6600 printer the order is as follows: magenta 1, yellow 1, magenta 2, yellow 2, photo black 1, light gray 1, photo black 2, light gray 2, matte black 1, cyan 1, matte black 2, cyan 2 (non-used colors will show an X).

Each digit can take one of the following values:

- 0 : no data, or error
- 1 : scans and corrections OK
- 2 : corrections at risk (level 1)
- 3 : scans at risk (level 1)
- 4 : scans and corrections at risk (level 2)
- 5 : corrections at risk (level 2)
- 6 : scans at risk (level 2)
- 7 : scans and corrections at risk (level 2)

If all digits are 0, printhead alignment is pending. In this case, perform printhead alignment.

If you see 3, 4, 6 or 7 anywhere, the results of the pattern scan are worse than expected. Try loading photo paper to ensure that the problem is not the paper. If the problem persists, calibrate the Line Sensor, and replace it if necessary.

If you see 2 or 5 anywhere, the pattern scan is OK, but the corrections are out of the expected range. Try reseating the affected printhead(s) and then perform the alignment again. If the problem persists, replace the affected printhead(s).

Closed-loop color calibration

The status code consists of 16 digits, one for each group of nozzles. For the Z6200 and Z6800 printers the order is as follows: magenta 1, yellow 1, magenta 2, yellow 2, light magenta 1, light cyan 1, light magenta 2, light cyan 2, photo black 1, light gray 1, photo black 2, light gray 2, matte black 1, red 1, matte black 2, red 2. For the Z6600 printer the order is as follows: magenta 1, yellow 1, magenta 2, yellow 2, photo black 1, light gray 1, photo black 2, light gray 2, matte black 1, cyan 1, matte black 2, cyan 2 (non-used colors will show an X).

Each digit can take one of the following values:

- 0 : no data, or error
- 1 : corrections OK
- 2 : corrections at risk (level 1)
- 3 : corrections at risk (level 2)

If all digits are 0, color calibration is pending for this paper type. In this case, perform color calibration.

If you see 3 anywhere, the corrections are out of the expected range. Try repeating the color calibration. If the problem persists, replace the affected printhead(s).

How to use the Image Quality Service Diagnostic Print

- [What is the Image Quality Service Diagnostic Print?](#)
- [Considerations for printing the Diagnostic Print](#)
- [Printing the Image Quality Service Print](#)
- [Diagnostic Part 1: Printhead Problems](#)
- [Diagnostic Part 2: Alignment test](#)
- [Diagnostic Part 3: Printheads and paper advance test](#)
- [No printing defects found in the diagnostic print](#)
- [Force drop detection](#)
- [Disable Paper Advance Sensor](#)
- [Fix paper advance issues](#)
- [Clean the paper advance sensor window](#)
- [The user advance calibration](#)
- [Visual paper advance plot](#)
- [Interpreting plot results](#)

What is the Image Quality Service Diagnostic Print?

The printer contains a series of internal image-quality tests that help you to diagnose image-quality defects. These tests are available from the Service Utility menu and are come in several categories:

- **Printhead reliability tests:** To identify which Printhead is faulty.
- **Printhead alignment tests:** To check any color-to-color and bi-directional misalignment the printer may have.
- **Printheads and paper advance tests:** To check whether the Printheads and the paper advance mechanism are working correctly.

The following diagnostic prints are available:

1. **Image Quality Service Best:** This print helps you to diagnose in more detail the possible source of any image-quality defects.
2. **Image Quality Service Normal:** This print is the same as the Image Quality Service Best print but uses the Normal print mode and does not contain the Printhead Alignment test. This print can be used to find banding that would be hidden if the Best print were used.

3. **Image Quality Service Fast:** This print is the same as the Image Quality Service Best print but uses the Fast print mode and does not contain the Printhead Alignment test. This print can be used to find banding that would be hidden if the Best print were used.
4. **Advanced diagnostic prints.** These tests provide more information than the Image Quality prints:
 - **Paper Advance:** To check visually whether the paper advance calibration is correct or not.
 - **Printhead Alignment:** To check visually whether the printheads are correctly aligned.
 - **Nozzle Health:** To identify which nozzles are blocked.
 - **Force Drop Detection:** To reset the nozzle-health historic data base and force a new drop detection.

Considerations for printing the Diagnostic Print

1. You must have paper loaded.
2. Use the same type of paper on which the image-quality problem occurred.
3. If the customer is using non-HP paper and after the Image Quality Test you still have the same image-quality problem, change to genuine HP paper and repeat the Image Quality Test.
4. If you do not see any problems with the Image Quality Test, then the problem may not be with the printer itself. The problem may be with the RIP or the driver, for example.

However, if you do see problems with the Image Quality Test, then continue with the Advanced Diagnostic procedures, which will help you to diagnose the problem.

Printing the Image Quality Service Print

1. In the Service Utilities submenu, scroll to **Diagnostic Print** and press **OK**.

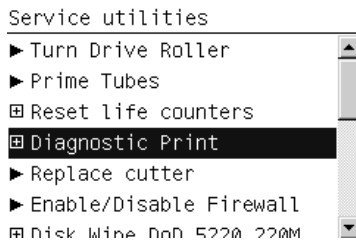

2. The front panel lists the available Diagnostic Prints. Use the arrow keys to make the selection and press the **OK** key to start printing the required Diagnostic Print.

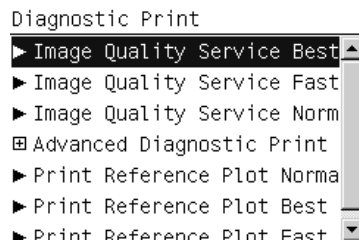

If you select **Advanced Diagnostic Print**, the front panel shows another list of prints.

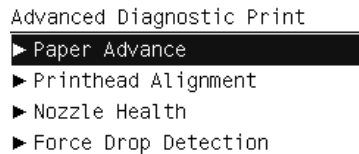

If the OMAS sensor is enabled, the front panel displays a message: **Do you want to disable the OMAS sensor?** Select **Yes** or **No**.

3. Make sure paper is loaded, the Media Lever is lowered and the Ink System is correctly installed. Press the **OK** key to print the Diagnostic Print or press **Cancel** to exit without printing the Diagnostic Print.

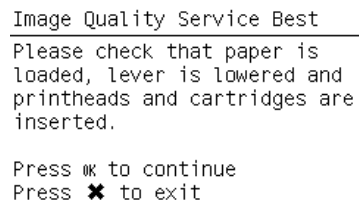

4. The selected Diagnostic Print is printed.

Diagnostic Part 1: Printhead Problems

The Nozzle print test is designed to check if the Printhead nozzles print correctly. The Image Quality Service Best should always be used to print this plot.

The nozzles check (bottom of the plot) is printed in a one-pass full swath mode. The diagnostics test prints out every single nozzle of each Printhead without applying an error hiding or alignment algorithm.

For each Printhead, you can see both the adjacent and the consecutive nozzles. For every Printhead there is a different horizontal band that can be identified with the help of the template marked with the colors of the Printhead used at the right of every band.



There are a series of numbered stepped diagonal lines. If one or more of the nozzles are malfunctioning or mis-positioned, you will see that the stepped lines are broken or misdirected in one or more places.

This is an example of nozzles out. You can see the broken or the skewed line, in this case marked in yellow to help you to understand the issue. In the service plot there are no yellow marks.



This is an example of nozzles mis-positioned or malfunctioning. You can see the broken or the skewed line, in this case marked in yellow to help you to understand the issue. In the service plot there are no yellow marks.

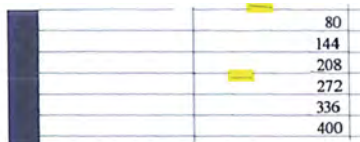

Corrective Action

If the printer has nozzle defects, it does not mean that you will not get perfect print quality results because the printer can automatically compensate for this so there is no need to replace the Printhead.

The method of improving Nozzle Defects is to:

1. To clean the printheads, go to the printer's front panel and select the ink, then Image quality maintenance > Clean printheads. Then select which printheads you would like cleaned. You can clean all of the printheads or only some of them. Your choices are:
 - Clean all
 - Clean M-Y
 - Clean LM-LC
 - Clean PK-LG
 - Clean MK-C

Cleaning all of the printheads takes about five minutes. Cleaning any two printheads takes about three minutes. Purging the ink takes about six minutes.

2. Reprint the Printhead Nozzles Test Plot to check that the defective nozzles have been corrected.
3. If the problem continuous, replace the defective Printhead.

Diagnostic Part 2: Alignment test

This test is designed to check any color-to-color and bi-directional misalignment the printer may have. The Image Quality Service Best should always be used to print this plot.

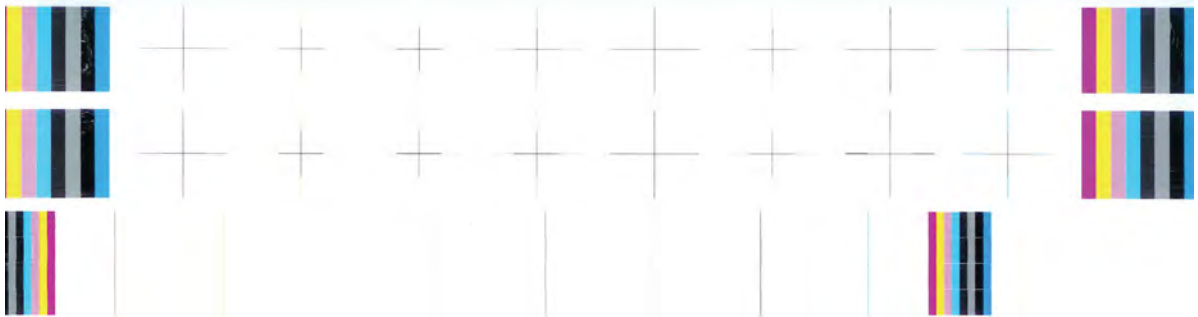

1. If the printer is experiencing horizontal misalignment problems, the Alignment Test will show something like this:

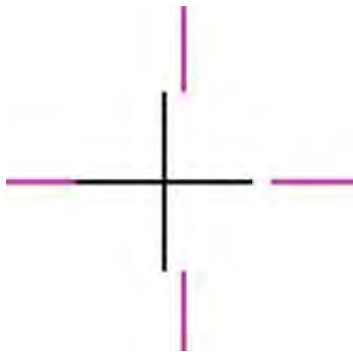

2. If the printer is experiencing vertical misalignment problems, the Alignment Test will show something like this:

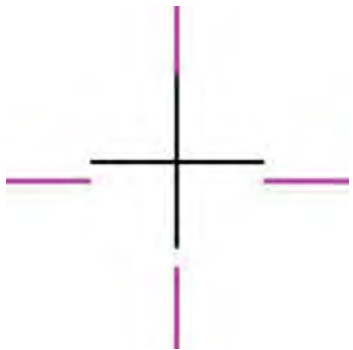

3. If the printer is experiencing **bi-directional** misalignment problems, the Alignment Test will show something like this:



Corrective Action

- ▲ Perform a Printhead Alignment, using the same paper type with which you were experiencing unacceptable image quality, if feasible (some paper types are not suitable for Printhead Alignment).

Diagnostic Part 3: Printheads and paper advance test

This test is designed to check whether the Printheads and the Paper Advance Mechanism are working correctly. This part of the Image Quality Test should not be used to check for color consistency or accuracy.

Banding

If the printer is experiencing a banding problem, you will see repetitive horizontal bands within the printed image.

- Dark line banding repeated along the band (from top to bottom at the same distance).
- White line banding repeated along the band (from top to bottom at the same distance).

The plot is printed in Best or Normal mode (according to the menu option selected) with Error Hiding ON. The first top band has 100% ink density patches while the bottom band has 50% ink density.



Troubleshooting Banding Problems

If banding **does not** occur in ALL the colors, then it is more than likely a Printhead problem. In this case, try the following:

1. Check that the appropriate print quality settings are being used.
2. Recover the printheads using the option through the Front Panel (**Image quality maintenance > Clean printheads**). Reprint the Diagnostic Print or the print file and if the problem persists, replace the faulty Printhead.

If banding does occur in ALL the colors, then it is more than likely a Paper Advance problem:

- If the bands are light, it means that the paper has advanced too much.
- If the bands are dark, it means that the paper hasn't advanced enough.
- In high quality modes, graininess in ALL colors can indicate problems either with alignment or Paper Advance.

In order to solve any of these problems, try the following:

1. Check that the appropriate print quality settings are being used.
2. Check that the loaded paper is the same type as selected in the printer. Check this through the front panel (at the front panel, select the  icon, then **View loaded paper > View paper details**).
3. If the customer is using low-quality paper, try recommending better quality paper (preferably HP paper). Printer performance can only be guaranteed by using recommended papers.
4. Check the advance with the help of the Visual Paper Advanced Diagnostic.



NOTE: If there is white point banding in only one color band and the problem cannot be fixed using the Printhead recoveries, in some cases using the force a drop detection option can fix this issue (see Others Diagnostics: Force Drop Detection).

No printing defects found in the diagnostic print

If all the test patterns from the Diagnostic Print are correct and you still experience Image Quality problems, you can use the following procedures to resolve the problem.

- Visual Alignment Diagnostics
- Visual Paper Advanced Diagnostic
- Plot for escalation only
- Force Drop Detection
- Disable Paper Advance Sensor

Visual Alignment Diagnostic Print

This print helps you to check any alignment problems of the printer.

You can use it to measure the alignment error with an accuracy of one dot row.

The print is split into three areas. The first two are the same print, printed at different speeds: 40 and 60 ips to check most of the printhead alignment. The print modes associated with these speeds are shown in the following table:

| PM by Paper Category | | ips |
|----------------------|-----------------|-----|
| Paper Type Category | Quality Setting | |
| Plain | Econofast | 60 |
| | Fast | 40 |
| | Normal | |

| | | |
|--|--------------|----|
| | Best | |
| Coated | Econofast | 60 |
| | Fast | |
| | Normal | |
| | Best | 40 |
| Heavyweight and Super Heavyweight Coated | Econofast | 60 |
| | Fast | |
| | Normal | 40 |
| | Best | |
| Other DFA | Econofast | 60 |
| | Fast | 40 |
| | Normal | |
| | Best | |
| Glossy | Econofast | 60 |
| | Fast | |
| | Normal | |
| | Best | |
| | High Quality | 40 |

The third part is to check the same color staggered printhead overlap.

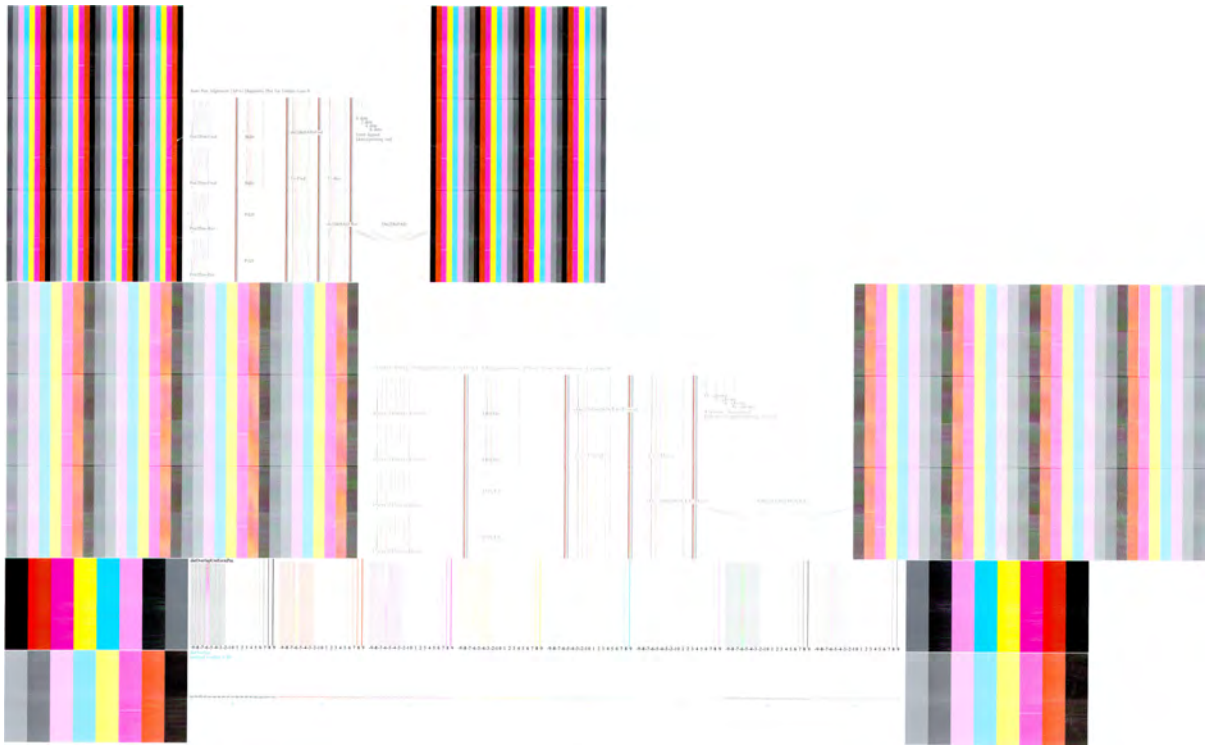

What to see in the Auto Printhead Alignment Diagnostics:

1. At the left we have four checks for the printhead to printhead alignment in scan axis direction (Pen2Pen-Fwd or Pen2Pen-Rev). It is forward and reverse.
 - The top pattern is related to the front printhead (nearest to the user when doing the printhead replacement).
 - The bottom pattern is related to the rear printhead (more far to the user when doing the printhead replacement)

The area to check is the junction (marked with a “-”) of the black with the rest of colors.
2. The bidirectional check is at the top, marked as number 2 (Bidir)
 - The top pattern is related to the front printhead (nearest to the user when doing the printhead replacement).
 - The bottom pattern is related to the rear printhead (more far to the user when doing the printhead replacement)

Check that the lines are continuous without a gap. The junction is marked with a “-”
3. The printhead to printhead alignment in paper advance direction (PAD) is marked as number 3.
 - The top pattern is related to the front printhead (nearest to the user when doing the printhead replacement).
 - The bottom pattern is related to the rear printhead (more far to the user when doing the printhead replacement)

The area to check is the junction (marked with a “-”) of the black with the rest of colors.

- The alignment in scan axis direction between both printhead of the same color is marked as 4a (in forward direction die2dieSAD-Fwd) and 4b (in reverser direction die2dieSAD-Rev).

The area to check is the junction (marked with a “-”). The lines have to be continuous.

- The ThetaZ of the printhead are checked in the area marked as 5. It checks in forward (Tz-Fwd) and reverse directions (Tz-Rev).

The area to check is the junction (marked with a “-”). The lines have to be continuous.

- The area marked as number 6 is a reference legend that shows junction misalignments of 2, 4 and 6 dots. The junction to check has to be below 4 in all cases. If the error is above 4 dots, then realign the printheads.

In the next example, the Bidir is above this 4 dots and the unit should be realigned. The rest of the pattern shows a right alignment.

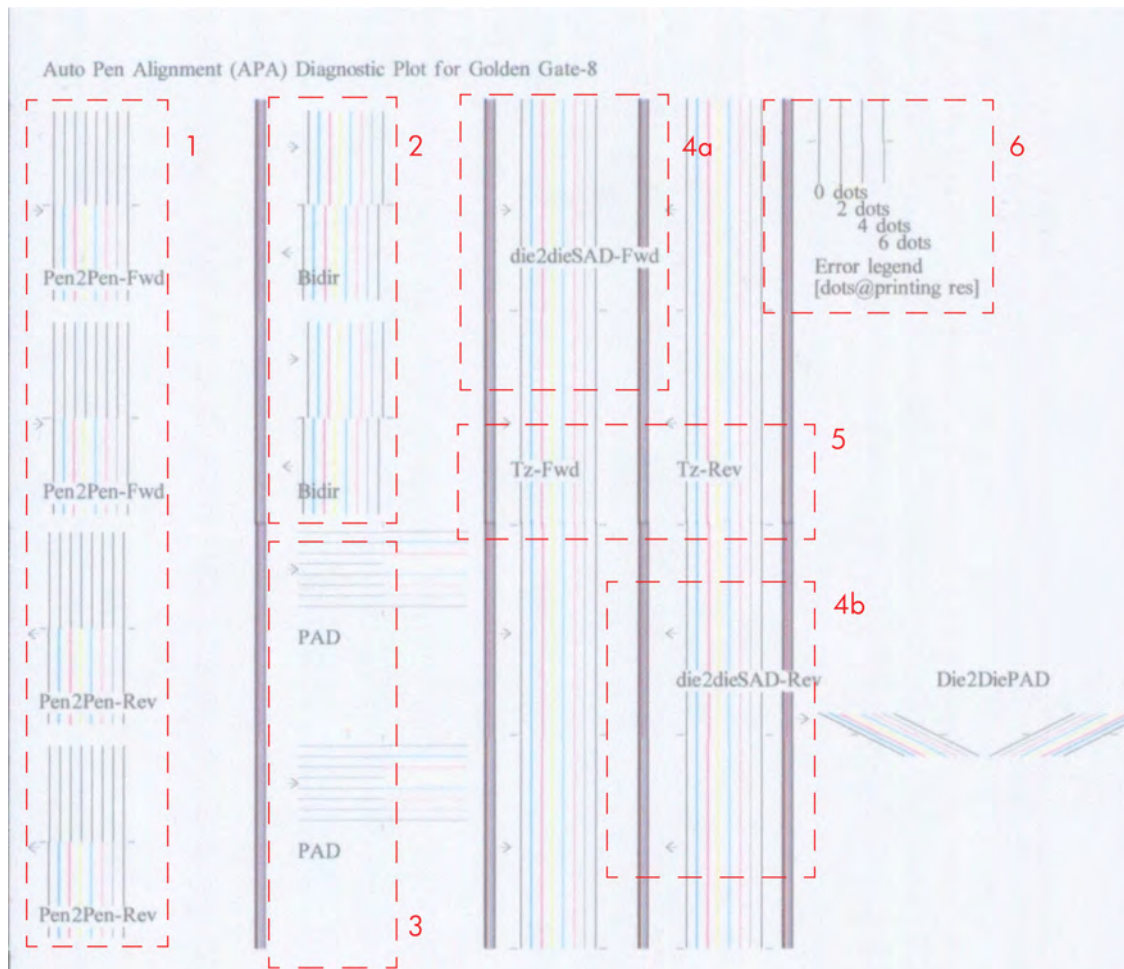

What to see in the Dye Overlap Alignment.

The area to check is only the bottom junction pattern for all the colors. The clearest band has to be around the 0 (± 3 dots). Every band is equal to 1 dot error.



In order to solve any problem in the alignment, try the following:

- Repeat the printhead alignment. You are recommended to use glossy paper, which gives the most accurate printhead alignment. There are some paper types that are not suitable for Printhead Alignment (transparent, translucent, ...)
- If the alignment process shows the message **Printhead alignment may use up to 3m of paper** in the front panel, it is because the OMAS is not working. This is normal for a few paper types that cannot be controlled by OMAS. To check whether your paper is OMAS or non-OMAS, go to the Service Menu, then select **Diagnostic print > Others > Visual Media Diagnostic**.
- If the issue cannot be fixed after repeating the printhead alignment, then try to clean the printheads. To clean the printheads, go to the front panel and select the  icon, then **Clean printheads**.
- If the issue cannot be fixed, then replace the printhead color that is failing in the align check pattern.
- If there is an issue in the ThetaZ and it cannot be fixed, check whether the paper works with OMAS. If so, the issue could be that the OMAS subsystem is malfunctioning. Go to the advance troubleshooting and apply the OMAS process.

Force drop detection

If the Nozzle Print Test plot has persistent white-point banding in only one color that cannot be fixed with a printhead recovery, you can use this option to resolve the problem by resetting the nozzle health database so that all nozzles are assumed to be correct. Once the nozzle health database has been reset, drop detection is forced.

The normal cause of this white-point banding in a single color is the incorrect detection of failed nozzles by the drop detector.

Perform the test as follows.

1. Go to the Service utilities menu and select **Diagnostic Print**.

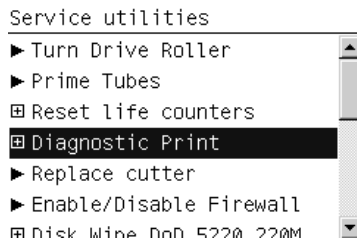

2. Select **Advanced Diagnostic Print**.

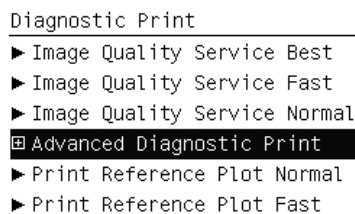

3. Select Force Drop Detection.

```
Advanced Diagnostic Print
-----
▶ Paper Advance
▶ Printhead Alignment
▶ Nozzle Health
▶ Force Drop Detection
```

4. Make sure that the Media Lever is lowered and the ink system is ready, then press OK.

```
Force Drop Detection
-----
Please check that:
-Ink system is ready
-Covers and doors are closed
Press OK to continue or X to
exit
```

5. The printer performs drop detection.

```
Force Drop Detection
-----
Running drop detection
process
```

6. When the process has ended, press OK to return to the menu.

Disable Paper Advance Sensor

This option allows the disabling of the Paper Advance Sensor and forces the advance control to use the analog encoder system. The Paper Advance sensor will return to the default status after the unit is restarted. The Paper Advance Sensor is also known as the Optimal Media Advance Sensor or OMAS.

Fix paper advance issues

HP Designjet Z6200 Photo printers have a Paper Advance Sensor system that corrects the advance error automatically. This system avoids the use of the traditional advance calibration system.

However, there are some types of paper where this system cannot operate correctly because the type of material used for the paper. To work with these types of paper the traditional advance system based on an Analog Encoder Sensor is provided in the printer. This analog encoder calibration requires the Advance Calibration (carried out at the factory or in service through the service menu) to work properly.

Some of the papers type that will not work with the new Paper Advance Sensor are: Clear Film, Backlit, Some types of Matte film, Some types of Polypropylene.

To check if your paper can use the Paper Advance Sensor go to the *Service Menu > Diagnostic print > Others > Visual Paper Advance Diagnostic*. The test will allow you to check if advance control is used. The reference paper to use for the Paper Advance Calibration is HP Universal Photo Gloss. If the customer does not have this media, order support part: Q1272-60296 (Inst. dry photo glossy Calibration Sheets). The flow to fix and advance issues is as follows:

^a List of types of media which are NOT used (non navigable) by the OMAS media sensor:

HP or HP Approved Clear Film

HP or HP Approved Backlit

HP or HP Approved types of Matt film

HP or HP Approved types of Polypropylene

A non HP or HP Approved Media

^b In order to perform this Calibration, you should order the Paper Advance Calibration Kit (Part Number Q1273-60296) which contains two cut sheets of HP Universal Instant-dry Gloss Photo media (36-inches wide by 42-inches long).

^c 'OMAS Blinking' means that the red LED in the OMAS lens blinks ON/OFF during paper advance when OMAS is operating.

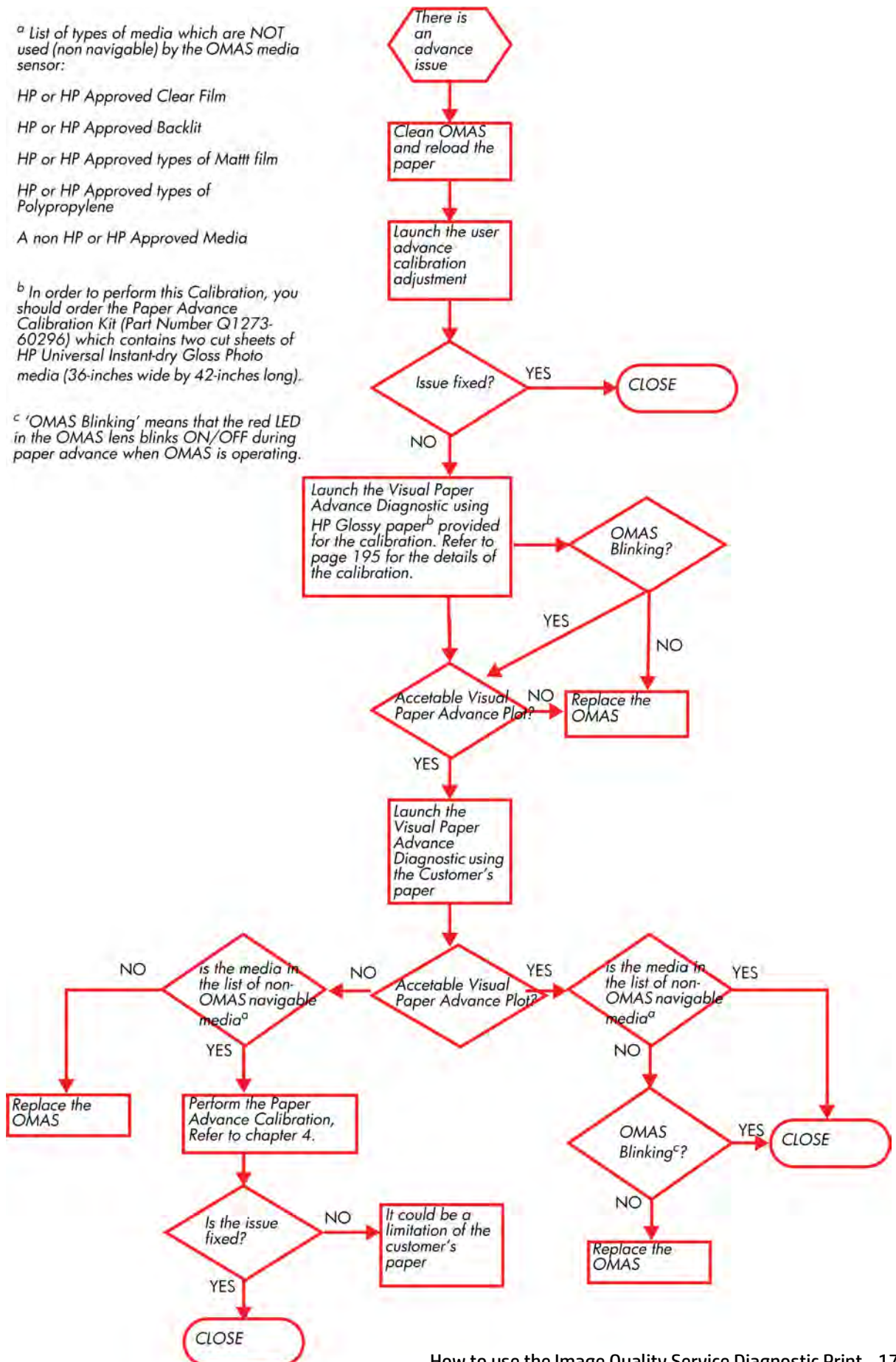

Clean the paper advance sensor window

The paper advance sensor is the very small rectangular window (less than 1 square centimeter in size and shown in the graphic below) found near the sixth platen roller from the right.

Very gently wipe off any dust and loosened ink deposits from the sensor window, using a clean, absorbent, lint-free cloth, slightly dampened with isopropyl alcohol.

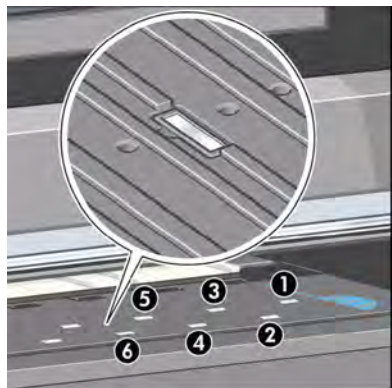

The user advance calibration

If the paper does not advanced the correct distance between passes of the printheads in the Carriage Assembly, light and dark bands appear in the print job and the image may look grainy.

The printer is calibrated to advance correctly with all the papers in the front panel. When you select the type of loaded paper, the printer adjusts the rate at which to advance the paper while printing. However, if you are using custom paper or are not satisfied with the default calibration of your paper, you may need to calibrate the rate at which the paper advances.

You can check the paper advance calibration status of the currently loaded paper at any time. Select the  icon > View loaded paper > View paper details. There are three types of status:

- **DEFAULT:** This status is displayed when loading an HP paper. HP papers in the front panel have been optimized by default and unless you experience image quality problems in your printed image such as banding or graininess it is not recommended to calibrate the paper advance.
- **RECOMMENDED:** This status appears when a new paper is created. The paper advance values for this paper are inherited from the family type. In cases such as these it is recommended that you perform a paper advance calibration to optimize the values.
- **OK:** This status indicates that the loaded paper has been calibrated before. However you may need to repeat the calibration if you experience image quality problems such as banding or graininess in your printed image.

 **NOTE:** Whenever you update the printer's firmware, the paper advance calibration values will be reset to factory default.

 **NOTE:** Colored papers and transparent materials such as translucent bond, clear film, matte film, tracing paper, and vellum are not suitable for paper advance calibration.

 **NOTE:** User advance calibration works in both advance control systems: paper advance sensor and analog encoder system.

The Paper Advance Calibration procedure

If your paper is not suitable for paper advance calibration, override steps 1 and 2 (Calibrate Paper Advance) and go directly to step 3 (Adjust Paper Advance).

1. At the front panel, select the  icon, then **Paper advance calibration > Calibrate paper advance**. The printer automatically calibrates the paper advance and prints a paper advance calibration image.
2. Wait until the front panel displays the status screen and re-print your print.

 **NOTE:** The calibration procedure takes approximately three minutes. Do not worry about the paper advance calibration image. The front-panel display shows any errors in the process.

- If you are satisfied with the image quality of the print after performing the calibration you can stop here.
 - If you can detect an improvement in the image quality of the print but want to fine tune the settings further, continue to step 3.
 - If you are dissatisfied with the calibration, you can return to the default calibration, refer to the next procedure 'Return to default calibration' seen below.
3. If you would like to fine-tune the calibration, select the  icon, then **Paper advance calibration > Adjust paper advance**.
 4. Select the percentage of change from -100% to 100%. To correct light banding, decrease the percentage. To correct dark banding, increase the percentage.
 5. Press the **OK** key on the front panel, to save the value.
 6. Wait until the front panel displays the status screen and re-print your print.

Return to default calibration

Returning to the default calibration sets all the corrections made by the paper advance calibration to zero. To return to the default paper advance calibration value, you must reset the calibration.

1. At the front panel, select the  icon, then **Paper advance calibration > Reset paper advance**.
2. Wait until the front panel displays the operation has completed successfully before pressing the **Back** key to return to the main menu.

Visual paper advance plot

The Visual Paper Advance Diagnostic prints a test plot to check that the paper advance is operating correctly. The plot is accessible from Service Utilities submenu > Diagnostic Print > Others > Visual Paper Advance Diagnostic menu option. It consists of three plots printed at the left, center, and right of the paper. These three plots are the same and contain seven numbered columns. The following illustration shows an example of the Visual Paper Advance Diagnostic plot.



Interpreting plot results

The three plots are all printed using Photo Black ink in 6-pass print mode (even on Gloss paper) and should each be similar. The white/lightest band of must be within the center ± 1 area for a PASS result. This should be true for all three plots or the printer will have differential banding (a difference of advance between the left and right). There is a 3-inch white band before the plots to ensure there is no platen noise causing advance errors while the media is covering the platen.

Example acceptable plot

The following illustration shows an example of a PASS plot.

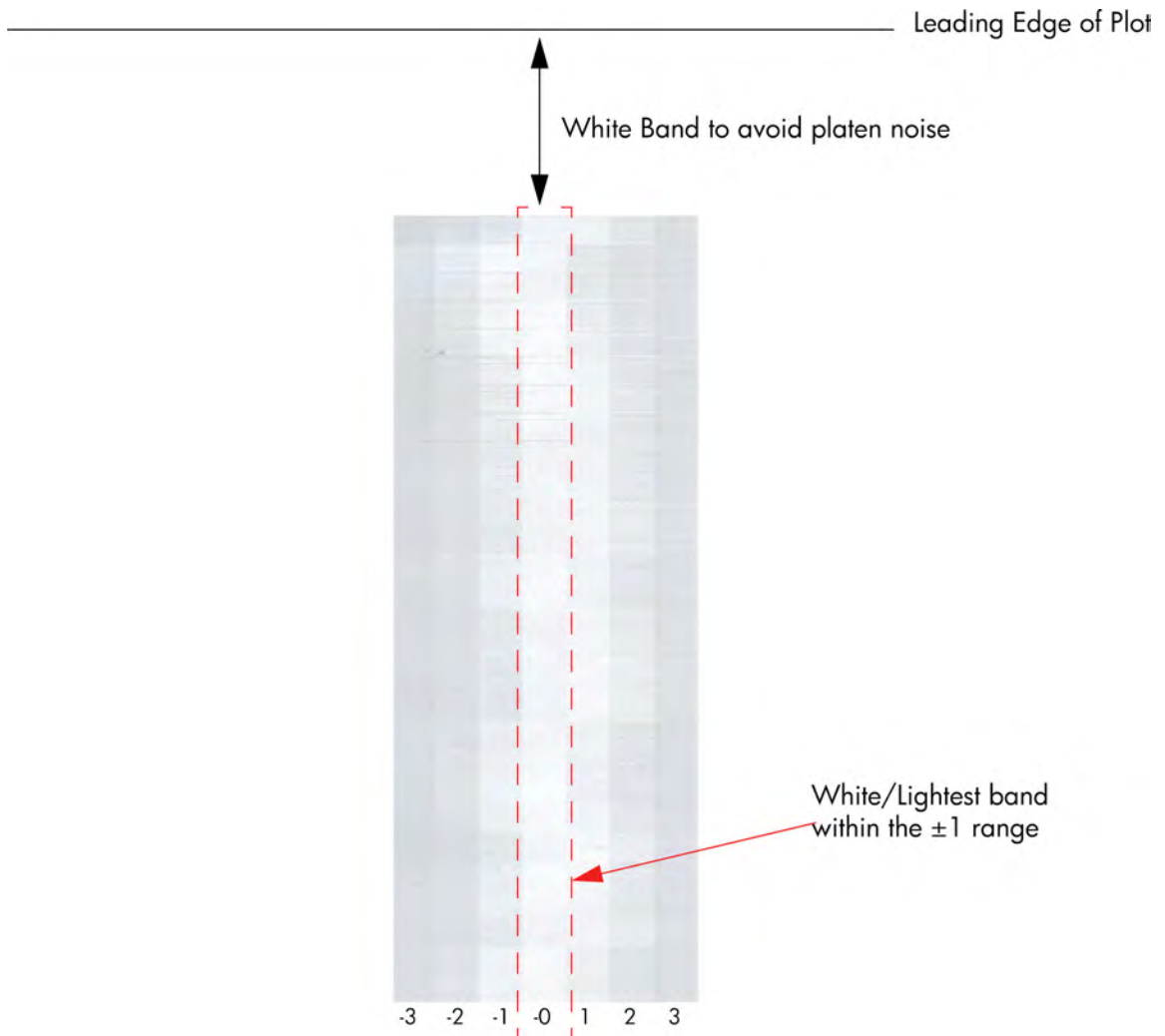

Example defective advance plot

This defect has the follow possible causes:

- OMAS is not clean or is defective so you should repeat the plot with OMAS disabled. This will allow you to establish if this is an OMAS related fault. If the same fault is detected the problem cannot be attributed to OMAS.
- The Drive roller is not clean so it slips against the media.
- Any other component affecting the media advance:
 - Spindle/Back Tension
 - Input roller
 - Pinchwheels

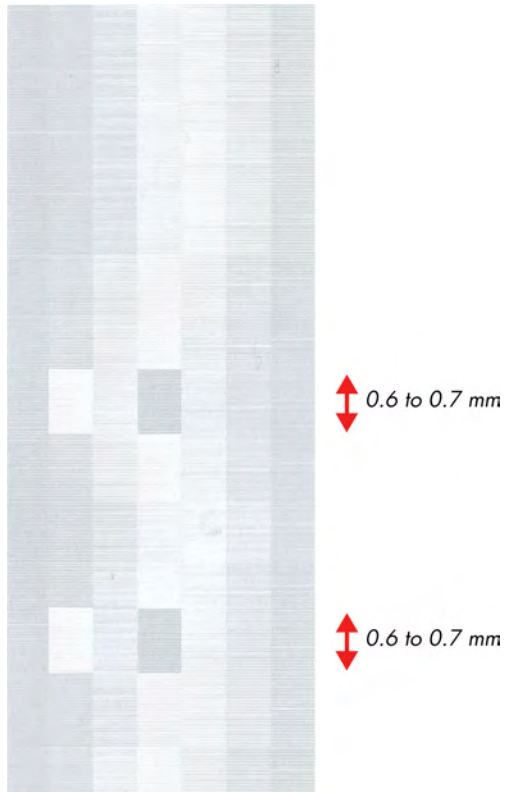

Example defective nozzle plot

This example is caused by a defective nozzle so there is no issue with the paper advance.

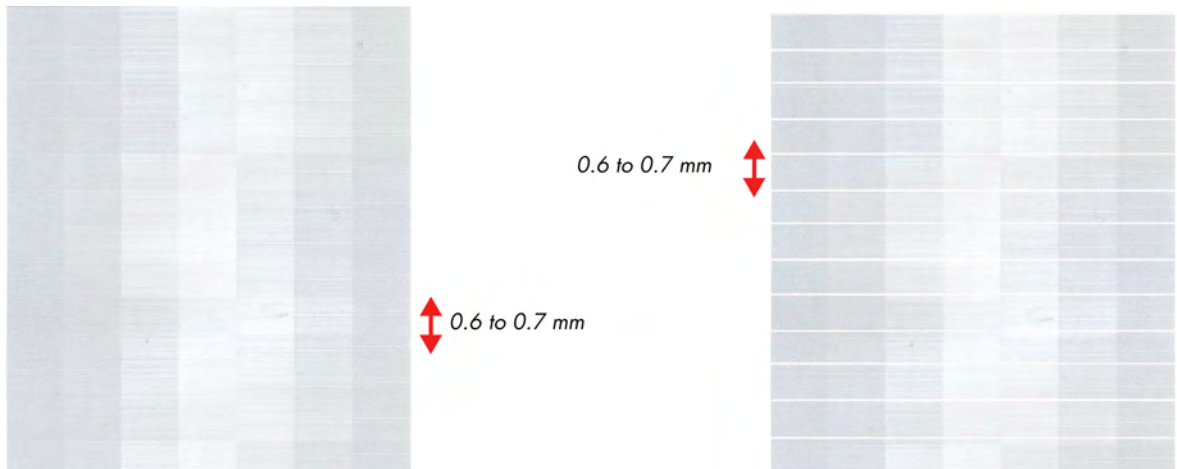

Print-quality issues by symptom

This section describes the common symptoms seen, and how to solve the issues.

There is banding in the image

If banding **does not** occur in ALL the colors, then it is probably a printhead problem. In this case, try the following:

1. Check that the appropriate print quality settings are being used.
2. Recover the printheads using the option through the Front Panel (📄 icon, then **Clean printheads**). Reprint the Diagnostic Print or the print file and if the problem persists, replace the faulty Printhead.

If banding **does** occur in ALL the colors, then it is probably a paper advance problem:

- If the bands are light, it means that the paper has advanced too much.
- If the bands are dark, it means that the paper hasn't advanced enough.
- In high quality modes, graininess in ALL colors can indicate problems either with alignment or paper advance.

In order to solve any of these problems, try the following:

1. Check that the appropriate print quality settings are being used.
2. Check that the loaded paper is the same type as selected in the printer. Check this through the front panel (at the front panel, select the 📄 icon, then **View loaded paper > View paper details**).
3. If the customer is using low-quality paper, try recommending better-quality paper (preferably HP paper). Printer performance can only be guaranteed by using recommended papers.
4. Check the advance with the help of the Visual Paper Advanced Diagnostic, refer to [Visual paper advance plot on page 175](#).

 **NOTE:** If there is white point banding in only one color band and the problem cannot be fixed using Printhead recovery, in some cases using the Force Drop Detection option can fix this issue (see Others Diagnostics: Force Drop Detection).

Lines are too thick, too thin, or missing

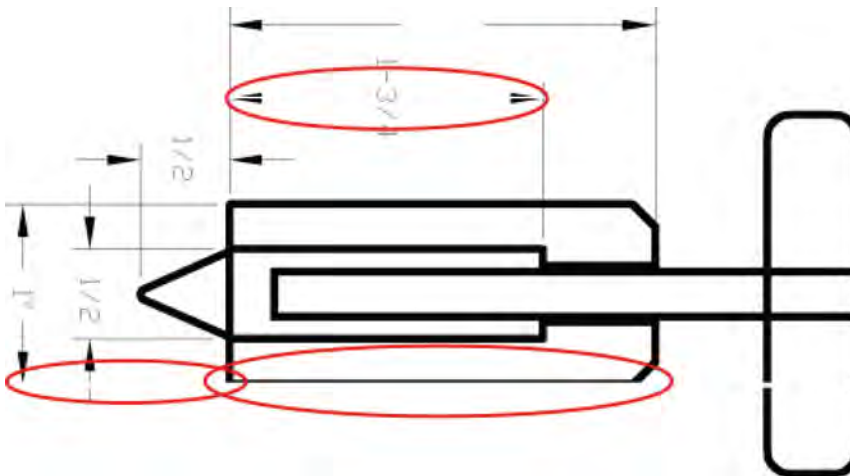

1. Check that the paper type you have loaded corresponds to the paper type selected in the front panel and in your software. To check on the front panel, use the [View paper information](#) key.
2. Check that you are using appropriate print-quality settings for your purposes. See Select print quality on User Guide.
3. If the resolution of your image is greater than the printing resolution, you may notice a loss of line quality. You can find the Max. Application Resolution option in the Windows driver dialog's Advanced

tab, under Document Options > Printer Features. If you change this option, you may wish to reprint your job at this point in case the problem has been solved.

4. If lines are too thin or missing, print the Image Diagnostics Print.
5. Try aligning the printheads. After alignment, you may wish to reprint your job in case the problem has been solved.
6. Select the  icon from the printer's front panel, then **View loaded paper** to see the paper advance calibration status. If the status is PENDING, you should perform paper advance calibration if the paper does not use OMAS advance control.

Lines appear stepped or jagged

If lines in your image appear stepped or jagged when printed:



1. The problem may be inherent in the image. Try to improve the image with the application you are using to edit it.
2. Check that you are using appropriate print-quality settings. See “Select print quality” in the *User's Guide*.
3. Change your image rendering resolution to 300 dpi or 600 dpi depending on your printing needs. You can find the Max. Application Resolution option in the Windows driver dialog's Advanced tab, under Document Options > Printer Features.

Parts of lines or text are missing

Large quantities of data may be necessary to print a high-quality large format print job, and in some specific workflow there may be issues that can lead to some objects missing from the output. Here are some suggestions to help you to avoid this problem.

- Select a smaller page size and scale to the desired final page size in the driver or in the front panel.
- Save the file in another format, such as TIFF or EPS, and open it with another application.
- Use a RIP to print the file.
- Reduce the resolution of bitmap images in your application software.
- Select a lower print quality in order to reduce the resolution of the printed image.
- In the Advanced tab of the Windows driver dialog, select Document options, Printer features, then:
 - Set Send job as bitmap to Enabled (HP-GL/2 driver only).
 - Set 16-bit App. Compatibility to Enabled.
 - Set Max. Application resolution to 300.

 **NOTE:** The above settings are mentioned for troubleshooting purposes and may adversely affect the final output quality or the time necessary to generate the print job. Therefore, they should be restored to their default values if they do not help to solve the problem.

Lines are printed double or in wrong colors

This problem can have various visible symptoms:

- Colored lines are printed double, in different colors.

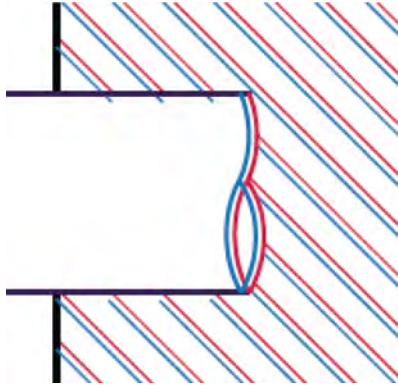

- The borders of colored blocks are wrongly colored.



To correct this kind of problem:

1. Align the printheads.
2. Check that you are using appropriate print-quality settings.

Lines are blurred (ink bleeds from lines)



Humidity can cause ink to soak into the paper, making the lines blurred and fuzzy. Try the following:

1. Check that your environmental conditions (temperature, humidity) are suitable for high-quality printing.
2. Check that the paper type selected in the front panel is the same as the paper type you are using. To check, select the  icon from the printer's front panel, then **View loaded paper**.
3. Try changing to a heavier paper type, such as HP Heavyweight Coated Paper, HP Super Heavyweight Coated Paper, or Digital Fine Art paper.
4. If you are using glossy paper, try changing to a different type of glossy paper.
5. Align the printheads.

Lines are slightly warped

The paper itself may be warped. This can happen if it has been used or stored in an extreme environment.

Dark or light horizontal lines across the image (banding)

If your printed image suffers from added horizontal lines as shown (the color may vary):



1. Check that the paper type you have loaded corresponds to the paper type selected in the front panel and in your software. To check on the front panel, use the [View paper information](#) key.
2. Check that you are using appropriate print-quality settings for your purposes. See Select print quality on User Guide. In some cases, you can overcome a print-quality problem merely by selecting a higher print quality level. For instance, if you have set the print-quality slider to Fast, try setting it to Best. If you change the print-quality settings, you may wish to reprint your job at this point in case the problem has been solved.
3. Print the Image Diagnostics Print. See Use the Image Diagnostics Print.
4. If the printheads are working correctly, go to the front panel and press the [View paper information](#) key to see the paper advance calibration status. If the status is **PENDING**, you should perform paper advance calibration if the paper does not use OMAS advance control.

The image is grainy



1. Check that the paper type you have loaded corresponds to the paper type selected in the front panel and in your software. To check on the front panel, use the [View paper information](#) key.
2. Check that you are printing on the correct side of the paper.
3. Check that you are using appropriate print-quality settings. See Select print quality on User Guide. In some cases, you can overcome a print quality problem merely by selecting a higher print-quality level. For instance, if you have set the print-quality slider to Fast, try setting it to Best. If you change the print-quality settings, you may wish to reprint your job at this point in case the problem has been solved.
4. Try aligning the printheads. After alignment, you may wish to reprint your job in case the problem has been solved.
5. Go to the front panel and press the [View paper information](#) key to see the paper advance calibration status. If the status is **PENDING**, you should perform paper advance calibration if the paper does not use OMAS advance control.

The image has a metallic hue (bronzing)

Bronzing is a term used to describe an image that has a metallic hue when viewing it from specific angles, as if the print were made of bronze. Bronzing occurs most commonly when printing pigmented inks on non-matte paper such as photo paper. If your image is bronzing, and you are using standard print-quality options, ensure that the slider is set to **Quality**. See Select print quality on User Guide.

If you are experiencing bronzing when printing grayscale images on glossy paper, try using the Full Set of Inks printing option. To do so from the Windows driver, select the **Color tab** and select **Print In Grayscale**, then select the **Full Set of Inks** option from the drop-down menu.

If you experience bronzing when printing colors on the HP Designjet Z6800, try the Z6200 emulation available in the driver. On the HP Designjet Z6600 printer you can enable the Paper Preset "Photo Full set of Inks" in the Embedded Web Server and use it when loading the paper.

The printed output is not flat

If the paper does not lie flat when it comes out of the printer, but has shallow waves in it, you are likely to see defects in the printed image, such as vertical stripes. This can happen when you use thin paper that becomes saturated with ink.



1. Check that the paper type you have loaded corresponds to the paper type selected in the front panel and in your software. To check on the front panel, use the [View paper information](#) key.
2. Try changing to a thicker paper type, such as HP Heavyweight Coated paper, HP Super Heavyweight Coated Paper, or thicker Digital Fine Art papers.

The print smudges when touched

The black ink pigment can smudge when touched by a finger or pen. This is particularly noticeable on the following materials: vellum, translucent bond, films, productivity photo paper, and natural tracing paper. To reduce the smudging:

- Try to print in an environment which is not too humid for the printer.
- Change pure black objects in your image to a dark color, such as dark brown, so that they will be printed with colored inks instead of black ink.
- Use HP Heavyweight Coated.
- Increase the drying time.

Defects near the top of a print

There is a type of defect that affects only the start of a print, within 5.5 cm of the leading edge of the paper. You may see a thin or thick band of inconsistent color.

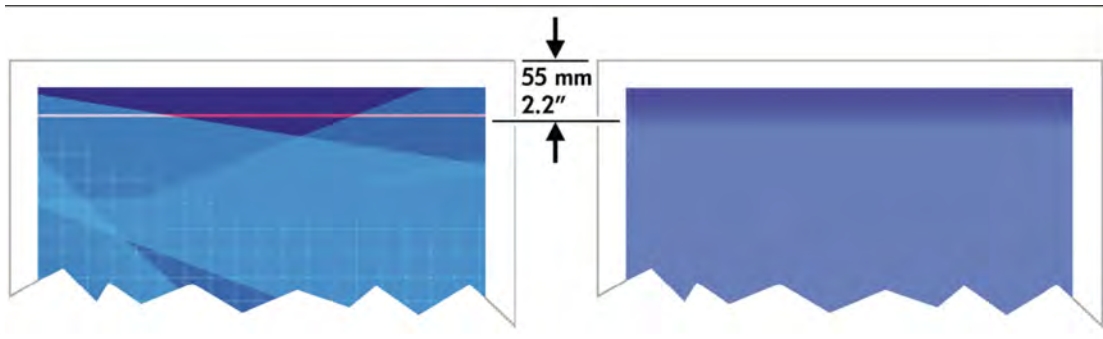

To avoid this problem:

1. The easiest solution may be to increase the margins by relocating the image within the page in your software application, so that the area of the paper affected by the problem (at the start of the page) will be blank. Also, Extended Margins can be selected in the PS Driver.
2. Align the printheads.
3. Check that you are using appropriate print-quality settings.

There are ink marks on the paper

This problem may occur for several different reasons.

Smears on the front of coated paper

If a lot of ink is used on coated paper, the paper absorbs the ink quickly and expands. As the printheads move over the paper, the printheads come into contact with the paper and the printed image is smeared.

Whenever you notice this problem, you should cancel the printing job. Press the Cancel key on the front panel and also cancel the job from your computer application. Otherwise the soaked paper may damage the printheads.

Try the following suggestions to avoid this problem:

- Use a recommended paper type
- If the image you are printing contains intense color, try using HP Heavyweight Coated Paper
- Use extended margins (see Adjust margins and layout options on User Guide), or try to increase the margins by relocating the image within the page using your software application
- If necessary, try changing to a non-paper-based material such as transparent film
- Increase vacuum by editing the paper type in the Designjet Utility
- Use the Take up Reel.

Smears or scratches on the front of glossy paper

Glossy paper may be extremely sensitive to the bin or to anything else that it contacts soon after printing. This will depend on the amount of ink printed and the environmental conditions at the time of printing. Avoid any contact with the paper surface and handle the print with care.

Ink marks on the back of the paper

Ink residues on the platen or on the input rollers are likely to mark the back of the paper.

Colors are inaccurate



Refer to this section if the customer complains of inaccurate colors which do not match their expectations.

Update the firmware

To ensure that the image quality and color troubleshooting tools that are available in the printer are the most up to date, check that the firmware is the latest available.

Basic image quality troubleshooting

As a first step to improving the accuracy of the color ensure that the basic image quality of the printer is good. Good all round image quality is a pre-requisite to achieving color accuracy and color consistency.

1. Refer to the steps in [Initial print-quality troubleshooting actions on page 156](#).
2. Perform the Color Calibration Procedure via the Front Panel: **Image Quality Maintenance > Calibrate Color**.
3. Ensure the media being used has an ICC color profile created. This can be done by using the HP Color Center to select Create and Install an ICC Profile.
4. Perform the Image Quality diagnostic procedures, refer to [How to use the Image Quality Service Diagnostic Print on page 161](#).

Checking the Spectrophotometer

If none of the above solutions fix the problem and the customer notices a slight degradation of color over time perform the following steps:

1. Perform the ESP Measurement Test, see [ESP Measurement test on page 126](#) for details (firmware 6.0.0.9 or greater). This tests the Spectrophotometer's ability to function within predefined color specifications.
2. Turn on the error log and check to see if there is a warning error 94:08. This would indicate that the measured values displayed when performing the color calibration were out of specification.
3. If the Spectrophotometer fails the test replace the Spectrophotometer (service part Q6651-60039).
4. If the Spectrophotometer passes the test successfully and the customer continues to complain about the color:

- If the customer is not using an external Spectrophotometer, the problem should not come from the Spectrophotometer, as the error will be less than $4\Delta E_{2000}$ and almost invisible to the human eye.
 - If the customer is using an external Spectrophotometer
 - There are scenarios where two different Spectrophotometers (internal & external) can display different values.
 - The case should be escalated to an expert in color.
5. Finally as a workaround we can suggest to the customer that they use an external Spectrophotometer as in previous HP Designjets

Colors between different HP Designjets do not match

If you print an image on two different printer models (for instance, on an HP Designjet Z6200 Photo printer series and an HP Designjet Z6100 printer series), you may find that the colors of the two prints do not match well.

Matching two printing devices that use different ink chemistry, paper chemistry, and printheads is unlikely to be completely successful. The information provided here is the best way to emulate one printer with another. Even so, the end result may not be a perfect match.

Print via separate PostScript drivers

The situation is that you are printing on each printer using the PostScript driver installed for that printer. In this example, we are using an HP Designjet Z6200 Photo printer series and an HP Designjet Z6100 printer series.

1. Ensure that both printers have been updated to the latest firmware version.
2. Ensure that you have the latest printer driver for both printers. You can download the latest versions for any HP printer from <http://www.hp.com/go/designjet>.
3. Ensure that color calibration is turned on in both printers. At the front panel of the HP Designjet Z6200, select the  icon, then **Enable color calibration**.
4. Load the printers with similar paper types.
5. Ensure that the Paper Type setting on the front panel corresponds to the paper you have loaded.
6. Print your image on the HP Designjet Z6100 using your normal settings.
7. Now prepare to print the same image on the HP Designjet Z6200.
8. In your application, set the color space of the image to emulate the HP Designjet Z6100 and the specific paper type that you used in that printer. The data sent to the driver must be already converted to this emulation color space. See your application's online help for information on how to do this. In this way, the Z6200 will emulate the colors that the Z6100 can produce when printing on that paper type.
9. In the PostScript driver for the HP Designjet Z6200, go to the Color Management section and set the input profile to the same HP Designjet Z6100 color space that you selected in the application (the emulation color space).

10. Set the rendering intent to Relative Colorimetric, or to Absolute Colorimetric if you want to emulate the whiteness of the paper.
11. Print the image on the HP Designjet Z6200.

Print via separate HP-GL/2 drivers

The situation is that you are printing on each printer using the HP-GL/2 driver installed for that printer.

1. Ensure that both printers have been updated to the latest firmware version.
2. Ensure that you have the latest printer driver for both printers. You can download the latest versions for any HP printer from <http://www.hp.com/go/designjet>.
3. Ensure that color calibration is turned on. At the front panel of the HP Designjet Z6200, select the  icon, then **Enable color calibration**.
4. Load the printers with similar paper types.
5. Ensure that the Paper Type setting on the front panel corresponds to the paper you have loaded.
6. With the HP-GL/2 driver for the HP Designjet Z6200, select the **Color** tab, and select **Printer Emulation** from the list of color management options. Then choose the HP Designjet Z6100 from the list of emulated printers.
7. With the HP-GL/2 driver for the HP Designjet Z6100, select the **Color** tab, then **Printer manages color**, and choose the appropriate source profile (sRGB, Adobe, etc.) according to the image source profile. Also select the **Paper Size** tab, then **Paper Type**.

Print the same HP-GL/2 file

The situation is that you have produced an HP-GL/2 file (also known as a PLT file) using the HP-GL/2 driver installed for one printer, and you intend to send the same file to both printers.

1. Ensure that both printers have been updated to the latest firmware version.
2. Ensure that color calibration is turned on. At the front panel of the HP Designjet Z6200, select the  icon, then **Enable color calibration**.
3. Load the printers with similar paper types.
4. Ensure that the Paper Type setting on the front panel corresponds to the paper you have loaded.
5. If you have an HP-GL/2 file produced for an HP Designjet Z6100 and you want to print it on an HP Designjet Z6200, proceed as follows using the Embedded Web Server or the front panel.
 - Using the Embedded Web Server: leave the color options set to Default.

Using the front panel: select the  icon, then **Printing preferences > Color options > Emulate printers > HP Designjet Z6100 Series**.

For other HP Designjet printers, set both printers to match the screen colors (sRGB if selectable), as when printing with separate HP-GL/2 drivers.

The output is completely blank

If the front-panel graphic language setting is Automatic (the default), try the other settings: PostScript for a PostScript file, HP-GL/2 for an HP-GL/2 file, etc. Then send the file again.

When you have finished this particular print, remember to reset the graphic language to Automatic.

The output contains only a partial print

- If you pressed **Cancel** before all the data were received by the printer, you ended the data transmission and will have to print the page again.
- The I/O time-out setting may be too short. This setting determines how long the printer waits for the computer to send more data, before deciding that the job is finished. From the front panel, increase the I/O time-out setting to a longer period and then send the print again. From the front panel, select the  icon, then **Advanced > Select I/O time-out**.
- There may be a communications problem between your computer and the printer. Check your USB or network cable.
- Check to make sure that your software settings are correct for your current page size (for example, long-axis prints).
- If you are using network software, make sure it has not timed out.

The image is clipped

Clipping normally indicates a discrepancy between the actual printable area on the loaded paper and the printable area as understood by your software. You can often identify this kind of problem before printing by previewing your print.

- Check the actual printable area for the paper size you have loaded. printable area = paper size - margins
- Check what your software understands to be the printable area (which it may call “printing area” or “imageable area”). For example, some software applications assume standard printable areas that are larger than those used in this printer.
- If you have defined a custom page size with very narrow margins, the printer may impose its own minimal margins, clipping your image slightly. You may want to consider using a larger paper size.
- If your image contains its own margins, you may be able to print it successfully by using the Clip Contents by margins option.
- If you are trying to print a very long image on a roll, check that your software is capable of printing an image of that size.
- You may have asked to rotate the page from portrait to landscape on a paper size that is not wide enough.
- If necessary, reduce the size of the image or document in your software application, so it fits between the margins.

There is another possible explanation for a clipped image. Some applications, such as Adobe Photoshop, Adobe Illustrator and CorelDRAW, use an internal 16-bit coordinate system which means that they cannot handle an image of more than 32,768 pixels. If you try to print an image larger than this from these applications, the bottom of the image will be clipped. To print the whole image, try these suggestions:

- Reduce the resolution so that the whole image requires fewer than 32,768 pixels. The Windows driver dialog includes an option called **16-bit App. Compatibility**, which can be used to reduce the resolution of such images automatically. You can find this option in the **Advanced** tab, under **Document Options > Printer Features**.
- Save the file in another format, such as TIFF or EPS, and open it with another application.
- Use a RIP to print the file.

The image is in one portion of the printing area

- Have you selected too small a page size in your application?
- Does your application think that the image is in one portion of the page?

The image is unexpectedly rotated

- At the front panel, select the  icon, then **Printing preferences > Paper > Rotate**. Check that the setting is what you wanted.
- For non-PostScript files: if Nesting is On, pages may be automatically rotated to save paper.

The print is a mirror image of the original

At the front panel, select the  icon, then **Printing preferences > Paper > Enable mirror image**. Check that the setting is what you wanted.

The print is distorted or unintelligible



- The interface cable connecting your printer to your network (or to your computer) could be faulty. Try another cable.
- If the front-panel graphic language setting is Automatic (the default), try the other settings: PostScript for a PostScript file, HP-GL/2 for an HP-GL/2 file etc. Then send the file again.
- Depending on the software, drivers, and RIPs you are using with your printer, there will be different ways of solving this problem. Refer to the vendor's user documentation for details.

One image overlays another on the same print

The I/O time-out setting may be too long. From the front panel, decrease the setting and print again. Select the  icon, then **Advanced > Select I/O time-out**.

Pen settings seem to have no effect

Here are some possible explanations:

- You have changed the settings in the front panel by selecting the  icon, then **Printing preferences** > **HP-GL/2** > **Define palette**, but you have forgotten to select that palette in **Printing preferences** > **HP-GL/2** > **Select palette**.
- If you want the software-driven pen settings, you must remember to go to the front panel and select the  icon, then **Printing preferences** > **HP-GL/2** > **Select palette** > **Software**.

The image has a wood-grain appearance (aeroworms)

Aeroworms are wavy, horizontal bands produced by air-induced dot placement error (DPE). In extreme cases aeroworms give the image a wood-grain appearance. The problem occurs most commonly on print jobs set for low quality and high speed. It will not occur when the custom print quality setting is set to “best.”

- To eliminate aeroworms, select a higher IQ print setting. See Selecting Print Quality in the User’s Guide.

CAD Lines look misaligned, images are blurred

This issue can be seen even after the customer has performed the Printhead Alignment procedure. The misalignment is most highlighted in CAD drawings, there are double-lines and images are ‘ghosted’. See the two examples below.

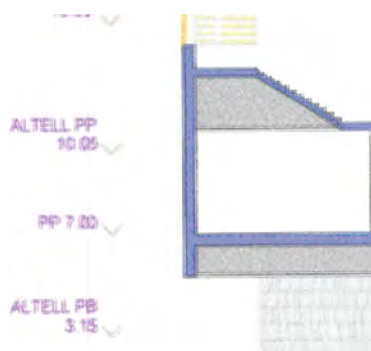

Here the CAD drawing has the issue, the CAD lines are misaligned and the image looks blurred/grainy

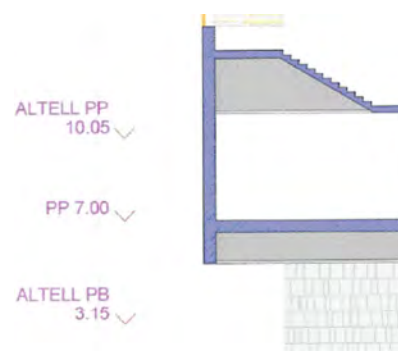

Here the CAD drawing does not have the issue and the drawing looks ok.

This issue can be solved by updating the firmware to the latest version.

Some paper types may deform when printing high area fill

This issue is known as PEPA: Paper Expansion Paper Advance. The quality of some images might be reduced if you use a paper type that is unsuitable for your image. This is especially important to consider when printing on fiber-based papers such as HP Universal Coated Paper, HP Coated Paper, HP Heavyweight Coated Paper and HP Universal Heavyweight Coated Paper. Printing images that contain high-saturation area fills on fiber-based papers can create unwanted wavy patterns as a result of paper expansion. This can ultimately contribute to more severe problems. Consider using Super Heavyweight Coated Paper and other cockle-free papers when printing high-saturation area fills.

Finally, as this paper expansion is increasing when a high quantity of ink is placed at once, the HP Designjet Z6200 might exhibit this paper expansion more than when compared to the HP Designjet 5x00 or 10x0 series.

Printheads fail repeatedly

If you encounter intermittent quality issues that are not solved after replacing Printheads or repeated replacement of the same Printheads there might be a capping problem. This could be caused damage to the Maintenance Cartridge or even the actual Carriage Assembly which is preventing the Printheads from being correctly capped.

The Maintenance Cartridge provides the capping for all the Printheads and contains integrated Printhead caps, wipers, cleaners, and waste ink disposal.

The following illustration shows the components that make up the Maintenance Cartridge.

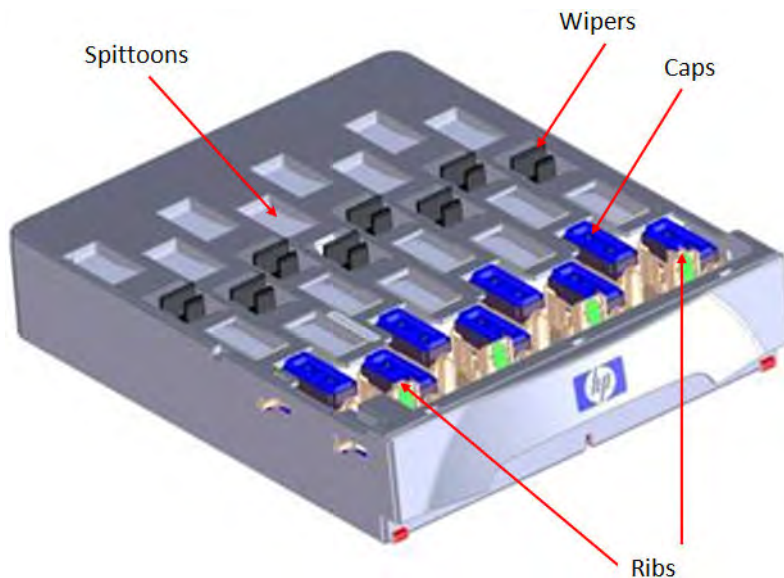

To cap the Printheads:

- The Carriage Assembly is first positioned over the Service Station.
- The Maintenance Cartridge moves towards the back of the printer which allows Pin #1 and Pin #2 on the Carriage Assembly to push against Rib #1 and Rib #2 to lift the caps into contact with the Printheads.

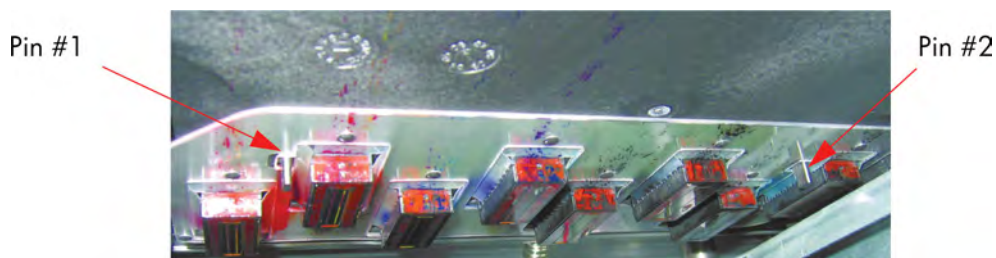

Improper capping of printheads will occur when any of the following elements break:

- Rib #1 or Rib #2 of the Maintenance Cartridge,
- Pin #1 or Pin #2 of the Carriage Assembly

You should also check all the other elements of the Maintenance Cartridge (plastic of each cap etc.) and make sure the vacuum ports are clear. If they are blocked, you can clear them with a T-8 Torx bit but you should also check to make sure the Aerosol Fan is operating correctly.

Working with other commercially available papers

This section provides a quick reference guide to selecting the correct settings in the printer so that the printer achieves the best possible image quality when using a paper type that does not come from HP.

For papers available in the market from sources other than HP, please refer to the information in Tables 1, 2 and 3 in order to choose the correct category.

Table 1 defines the print characteristics used in Tables 2 and 3.

For optimum results, first load the paper with the recommended settings, then calibrate and profile the paper. To create an ICC profile, there are two different options:

- Profile the paper using the HP Color Center
- Use an alternative profile (often available from the paper’s manufacturer).

Selecting the correct paper presets

Table 1 defines the print characteristics used in Table 2: Other Commercially-available Paper Print Characteristics and Table 3: Original HP Printing Material Print Characteristics.

| Table 1: Definition of Print Characteristics | | |
|--|---|---|
| Paper Type | The name displayed in the driver and the front panel (the English version) | |
| Printing Black | Photo Black (P) / Matte Black (M) / Light Gray (lg): This setting indicates which inks are used when printing black: <ul style="list-style-type: none"> • All black inks (All) • P and lg only (P lg) | |
| Ink Limit | | |
| Print Mode “Best Quality” or slider in the right position | Rendering Resolution (RR) | Resolution at which the image is rasterized/processed in the host (in pixels per printed inch, or pppi) |
| | Printing Resolution (PR) | Resolution at which the image is printed (in dots per inch, or dpi) |
| | # passes Other info (O)Bidirectional | Typically, the higher the number of passes, the better the image quality, but at a lower speeds. Also, papers such as glossy paper need a longer drying time that will generally require a higher number of passes. Whether printing when the carriage is traveling in a single direction only (Unidirectional) or in both directions (Bidirectional). Unidirectional modes typically provide better image quality – depending on the number of passes – but at lower speeds. |
| Automatic Cutter | Yes (Y) / No (N): Indicates whether cutting will be performed. Even if “Yes” is selected, cutting can be disabled later through the driver. However, if “No” is selected here, cutting cannot be re-enabled through the driver. | |

Notes:

- Make sure the most similar paper is chosen to create your own paper presets, taking into account type and finishing (Matt or Gloss) but also weight and thickness. For example, use “HP Universal Instant-dry Gloss” (190 g/m², 7.4mil/188 microns) if you are loading a similar 190 g/m² gloss-like paper. Good examples of these are “dtec Photobase Universal 190 gsm” or “Océ Smart Dry Photo Paper Gloss” (190 g/m², 188 microns). In this case, do **not** use the “HP Premium Instant-Dry Gloss”, which is much heavier and thicker (260 g/m², 10.3 mil/260 microns).
- Selecting the wrong basic paper type to create a paper preset can result in printing issues such as poor color performance or the paper not being advanced accurately.
- Do not use the cutter on Fine Art papers.

For paper settings that can be downloaded from the HP Knowledge Center, refer to Downloading Paper Presets. After downloading and installing a paper preset, the new paper will display inside the ‘Custom’ category, both in the driver and in the front panel.

| Table 2: Commercially available paper types | | | | | | | |
|---|---|--------------|-------------------|-----|-----------|--------------------------------|-----|
| Paper type | Printing black | Ink limiting | Print mode (Best) | | | Auto Cutter | |
| | | | RR | PR | OI | | |
| Bond and Coated Paper | Plain Paper | All | 24 | 600 | 1200×1200 | 4p bidi | Yes |
| | Bright White Bond Paper | All | 24 | | | 4p bidi | |
| | Coated Paper | All | 24 | | | 8p bidi | |
| | Heavyweight Coated Paper | All | 30 | | | 10p bidi 12p bidi for Z6600 | |
| | Super Heavyweight Coated Paper | All | 60 | | | 10p bidi | |
| Photo Paper | Photo Matte Paper | All | 30 | 600 | 600×1200 | 10p bidi | Yes |
| | Photo Gloss/Semi-Gloss/Satin Paper | P Lg | 37 | | | 12p bidi | |
| | Photo Gloss/Semi-Gloss/Satin Paper (more ink) | P Lg | 45 | | | 12p bidi | |
| | Photo Gloss/Semi-Gloss/Satin Paper (less ink) | P Lg | 32 | | | 12p bidi | |
| Proofing Paper | Proofing Gloss Paper | P Lg | 45 | 600 | 600×1200 | 12p bidi | Yes |
| | Proofing Semi-gloss Satin Paper | P Lg | 45 | | | 12p bidi | |
| | Proofing Matte Paper | All | 30 | | 1200×1200 | 10p bidi | |
| Technical Paper | Natural Tracing Paper | All | 24 | 600 | 1200×1200 | 4p bidi | Yes |
| | Translucent Bond | All | 24 | | | | |
| | Vellum | All | 24 | | | | |
| Film | Transparent Clear Film | All | 24 | 600 | 1200×1200 | 10p bidi | Yes |
| | Matte Film | All | 24 | | | | |
| Backlit | Backlit Material | P Lg | 57 | 600 | 1200×1200 | 16p bidi | Yes |

| | | | | | | | |
|-----------------------------------|-----------------------------|------|----|-----|-----------|----------|-----|
| | Backlit Material (more ink) | P Lg | 72 | | | | |
| Fine Art Paper | Canvas | All | 44 | 600 | 1200×1200 | 16p bidi | No |
| | Canvas (more ink) | All | 60 | | | 10p bidi | |
| | Fine Art Paper | All | 44 | | | | |
| | Fine Art Paper (more ink) | All | 60 | | | | |
| Banner & Sign Material | Indoor Banner | P Lg | 45 | 600 | 1200×1200 | 16p bidi | Yes |
| | Scrim Banner | All | 60 | | | 10p bidi | |
| Self Adhesive | Adhesive Vinyl | All | 60 | 600 | 1200×1200 | 16p bidi | Yes |
| | Adhesive Polypropylene | All | 60 | | | 10p bidi | |

Table 3: Original HP paper types

| | Paper type | Printing black | Ink limiting | Print mode (Best) | | | Auto Cutter |
|------------------------------|--|----------------|--------------|-------------------|-----------|---|-------------|
| | | | | RR | PR | OI | |
| Bond and Coated Paper | HP Bright White Inkjet Bond Paper | All | 24 | 600 | 1200×1200 | 6p bidi | Yes |
| | HP Universal Bond Paper | All | 24 | | | 4p bidi | |
| | HP Coated Paper | All | 24 | | | 8p bidi | |
| | HP Universal Coated Paper | All | 24 | | | 8p bidi | |
| | HP Heavyweight Coated Paper | All | 30 | | | 10p bidi | |
| | HP Universal Heavyweight Coated Paper | All | 30 | | | 12p bidi for both heavyweight coated types on Z6600 | |
| | HP Super Heavyweight Coated Plus Matte Paper | All | 60 | | | | |
| | HP Recycled Bond Paper | All | 24 | | | 4p bidi | |
| Photo Paper | HP Premium Instant-dry Photo Gloss | P Lg | 45 | 600 | 600×1200 | 12p bidi | Yes |
| | HP Universal Instant-dry Photo Gloss | P Lg | 37 | | | | |
| | HP Everyday Pigment Ink Gloss Photo Paper | P Lg | 37 | | | | |
| | HP Premium Instant-dry Photo Satin | P Lg | 45 | | | | |
| | HP Professional Satin Photo Paper | P Lg | 45 | | | | |
| | HP Universal Instant-dry Photo Semi-gloss | P Lg | 37 | | | | |
| | HP Everyday Pigment Ink Satin Photo Paper | P Lg | 37 | | | | |
| | HP Premium Matte Photo Paper | All | 60 | | 1200×1200 | 10p bidi | |

| | | | | | | | |
|-----------------------------------|--|------|----|-----|-----------|----------|-----|
| Technical Paper | HP Natural Tracing Paper | All | 24 | 600 | 1200×1200 | 4p bidi | Yes |
| | HP Translucent Bond Paper | All | 24 | | | | |
| | HP Vellum | All | 24 | | | | |
| Film | HP Clear Film | All | 24 | 600 | 1200×1200 | 10p bidi | Yes |
| | HP Matte Film | All | 24 | | | | |
| Backlit | HP Premium Vivid Color Backlit Film | P Lg | 72 | 600 | 1200×1200 | 16p bidi | Yes |
| Fine Art Paper | HP Professional Matte Canvas | All | 44 | 600 | 1200×1200 | 16p bidi | No |
| | HP Collector Satin Canvas | All | 44 | | | 14p bidi | |
| | HP Artist Matte Canvas | All | 44 | | | 14p bidi | |
| | HP Universal Matte Canvas | All | 44 | | | 14p bidi | |
| | HP Matte Litho-realistic Paper | All | 44 | | | 10p bidi | |
| Banner & Sign Material | HP Durable Banner with Dupont Tyvek | All | 60 | 600 | 1200×1200 | 10p bidi | Yes |
| | HP Opaque Scrim | All | 60 | | | | |
| Self Adhesive | HP Everyday Adhesive Matte Polypropylene | All | 60 | 600 | 1200×1200 | 16p bidi | Yes |
| | HP Colorfast Adhesive Vinyl | All | 60 | | | 10p bidi | |

Downloading paper presets

A 'paper preset' is a file that contains the set of instructions that enables the printer to print on a specific type of paper. It resides in the printer's firmware or it can be downloaded from a Web page to update the printer's firmware for a new paper type.

To download a paper preset from the HP Knowledge Center, use the following link: http://www.hp.com/go/knowledge_center/djZ6200/.

7 Parts and diagrams

- [Printer support](#)
- [Center Covers](#)
- [Electronics Module](#)
- [Right Cover](#)
- [Left Cover](#)
- [Right-Hand Assemblies](#)
- [Left-Hand Assemblies](#)
- [Carriage](#)
- [Scan-Axis Assemblies](#)
- [Drive Roller and Media-Axis Motor](#)
- [Paper Path Assemblies](#)
- [Center Guide and Pinchwheel Assembly](#)
- [Media Entry Assemblies](#)
- [Take-Up Reel assembly](#)
- [Miscellaneous parts](#)

Printer support

| Number in figure | HP part number | Description | Model | Cross-reference |
|------------------|----------------|--|-----------------|-----------------|
| 1 | Q6651-60257 | Leg Cover | All | N/A |
| 2 | CQ109-67039 | Foot Assembly | All | N/A |
| 3 | Q6651-60260 | Bin Assembly (Includes the Bin Support) | 42-inch | N/A |
| 4 | Q6651-60259 | Foot Brace Assembly | 42-inch | N/A |
| | Q6651-60262 | | 60-inch | N/A |
| 5 | CQ109-67040 | Legs Assembly | Z6200 (All) | N/A |
| | F2571-67012 | | Z6600/ Z6800 | |
| 6 | Q6651-60258 | Cross-Brace Assembly | 42-inch | N/A |
| | Q6651-60261 | | 60-inch | N/A |
| 7 | Q6651-60264 | Stand Supports | All | N/A |
| - | Q6651-60256 | Hardware Kit (Includes screws for Legs Assembly) | All | N/A |
| - | F2L45-67008 | X-Bars | Z6600/ Z6800 | N/A |

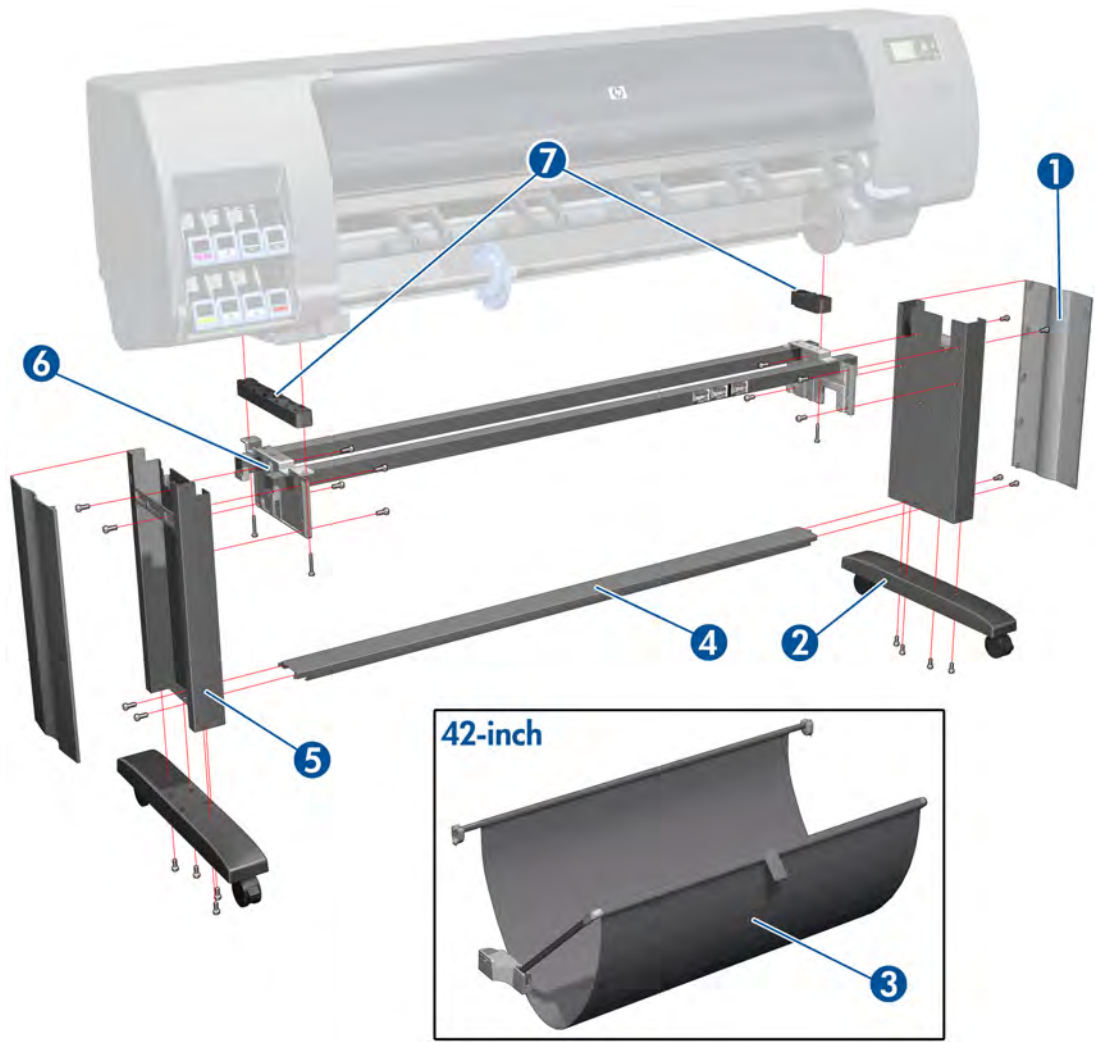

Center Covers

| Number in figure | HP part number | Description | Model | Cross-reference |
|------------------|----------------|------------------------------|---------|---|
| 1 | Q6651-60333 | Rear Door | 42-inch | Rear Door (42-inch) on page 254 |
| | Q6652-60124 | | 60-inch | Rear Door (60-inch) on page 256 |
| 2 | Q6651-60331 | Left Connector Cover | 42-inch | Left Connector Cover (42-inch) on page 260 |
| | CQ111-67005 | Electronics Module Extension | 60-inch | Electronics Module Extension (60-inch only) on page 261 |
| 3 | CQ109-67033 | Right Connector Cover | All | Right Connector Cover on page 258 |
| 4 | CQ109-67013 | Window Position Sensor | All | N/A |
| 5 | CQ109-67041 | Window | 42-inch | Window (42-inch) on page 231 |
| | F2571-67010 | | 60-inch | |
| 6 | Q6651-60291 | Top Cover | 42-inch | Top Cover (60-inch) on page 249 |
| | Q6652-60113 | | 60-inch | |

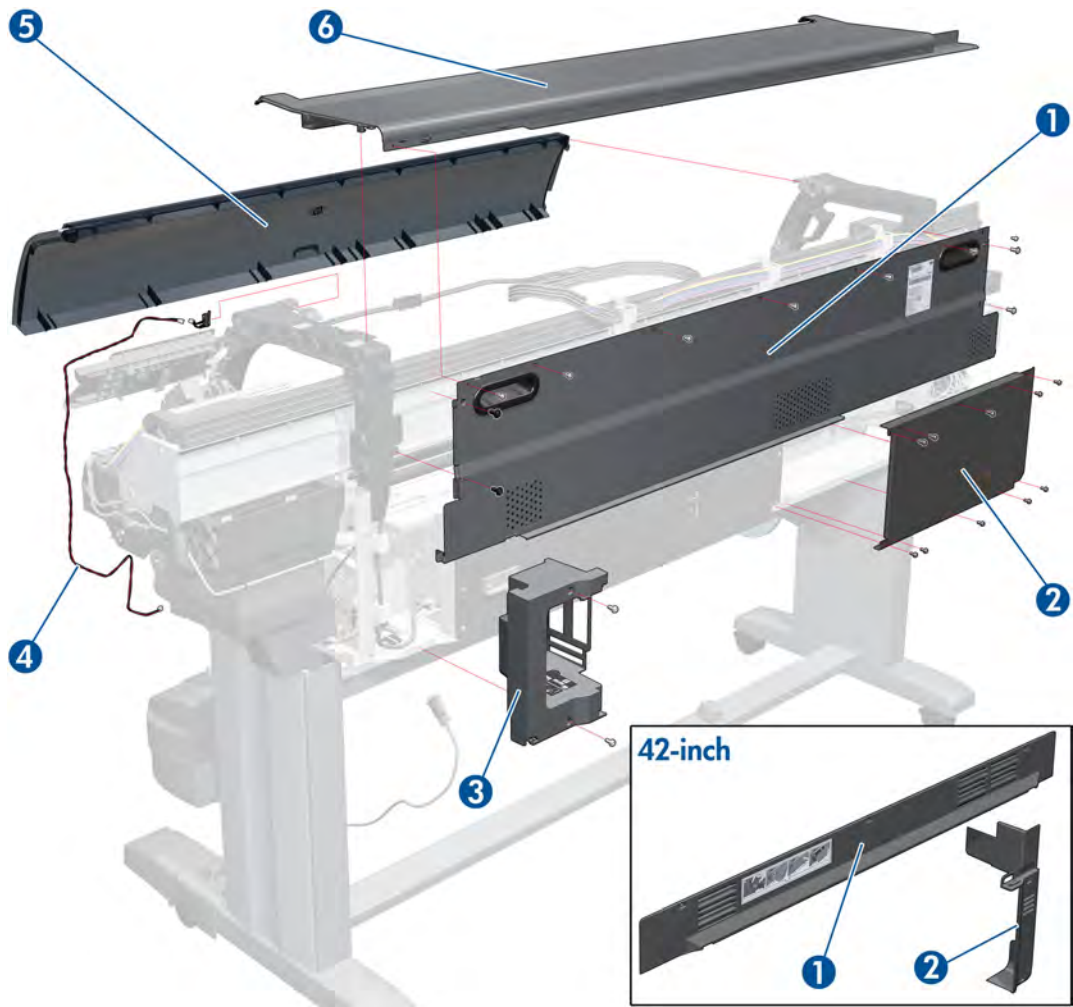

Electronics Module

| Number in figure | HP part number | Description | Model | Cross-reference |
|------------------|----------------|---|-----------------|--|
| 1 | CQ109-67029 | Electronics Module Cables Kit | 42-inch | N/A |
| | CQ111-67008 | | 60-inch | |
| 2 | Q1273-60237 | EIO to PCI Interface Card | All | EIO to PCA Interface Card on page 348 |
| 3 | CQ109-67014 | OMAS Controller Card | All | OMAS Controller Card on page 349 |
| 4 | CQ109-67028 | Main PCA | All | Main PCA on page 358 |
| 5 | CQ109-67020 | Formatter (includes Processor, Heatsink & Fan)(Only for Rev A printers) | All | Formatter on page 361 |
| 6 | CQ109-67012 | Interconnect PCA | All | Interconnect PCA on page 347 |
| 7 | CQ109-67030 | Empty Electronics Module Assembly | All | N/A |
| 8 | CQ109-67026 | Electronics Module Metal Parts Kit | All | N/A |
| 9 | CQ109-67006 | Power Supply Unit (PSU) | All | Power Supply Unit (PSU) on page 368 |
| 10 | CQ109-67035 | PrintMech PCA | All | PrintMech PCA on page 372 |
| 11 | CQ109-67015 | Hard Disk Drive (includes Holder and screws) (Only for Rev A printers) | Z6200 | Hard Disk Drive (HDD) on page 364 |
| | F2S71-67004 | | Z6600 | |
| | F2S72-67001 | | Z6800 | |
| | F2S72-67006 | | Z6800 F2S72B | |
| 12 | CQ111-67005 | Ebox Extension | 60-inch | |
| 5 + 11 | CQ109-67044 | Encrypted Hard Disk + Formatter | Z6200 | Hard Disk Drive (HDD) on page 364 Formatter on page 361 |

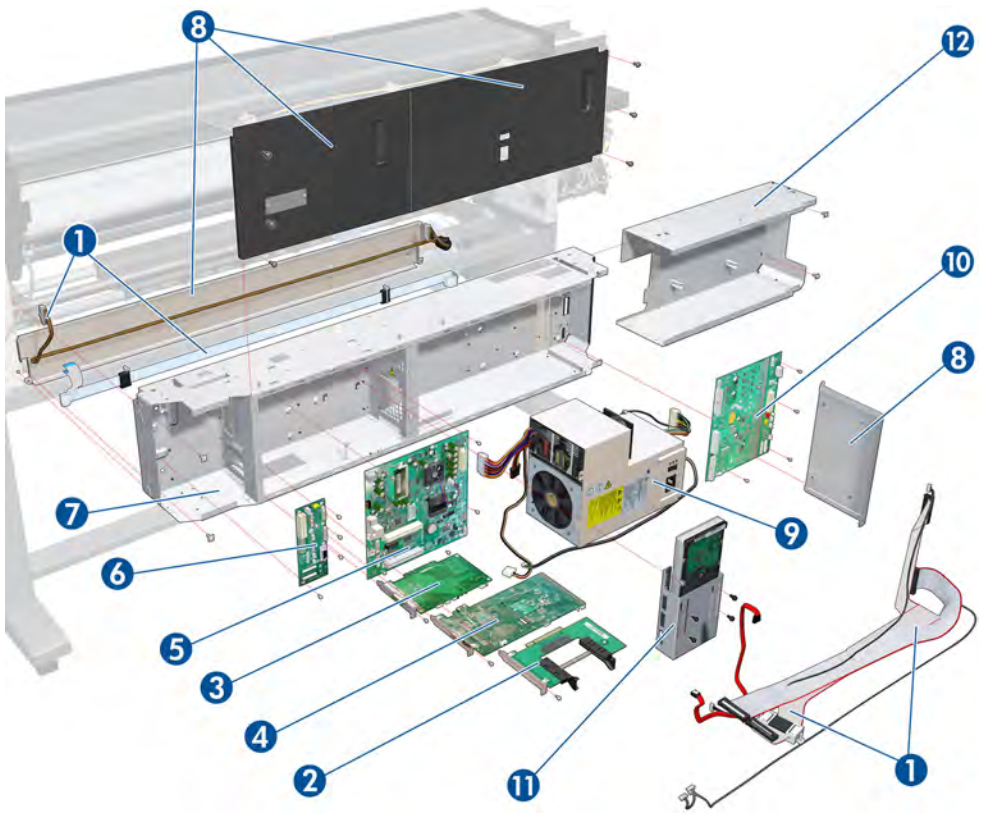

Right Cover

| Number in figure | HP part number | Description | Model | Cross-reference |
|------------------|----------------|--|-------|--|
| 1 | Q6651-60293 | Right Cover (without Service Station Door) | All | Right Cover on page 235 |
| 2 | CQ109-67031 | Right Service Station Door | Z6200 | Maintenance Cartridge Door on page 402 |
| | F2S71-67011 | | Z6600 | |
| | F2S72-67007 | | Z6800 | |
| 3 | Q6651-60321 | Right Trim | All | Right Trim on page 237 |
| 4 | CQ109-67005 | Front Panel ^a | All | Front Panel on page 265 |

a. Including cable and ferrite cores

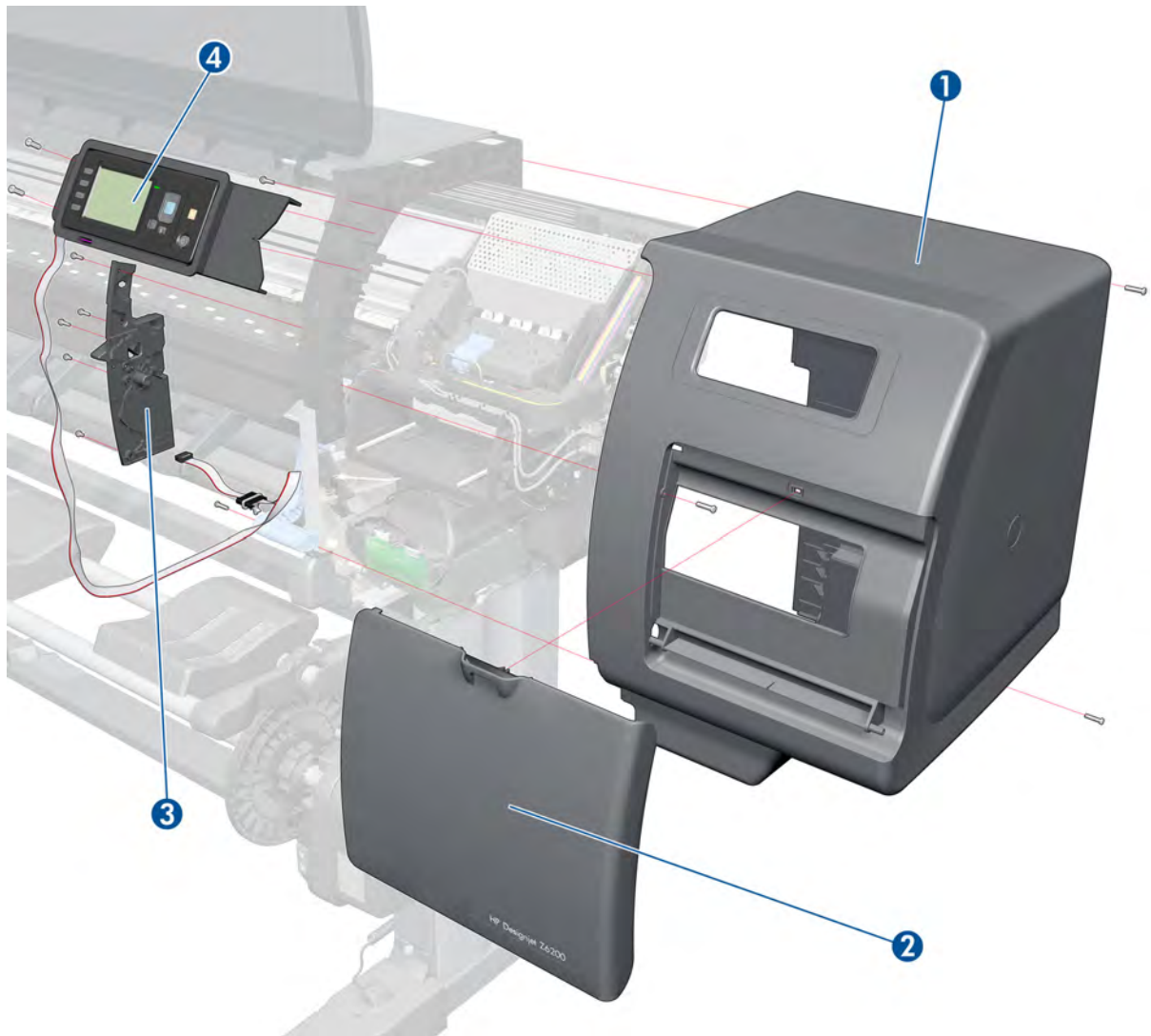

Left Cover

| Number in figure | HP part number | Description | Model | Cross-reference |
|------------------|----------------|-------------|-------|--|
| 1 | Q6651-60322 | Left Trim | All | Left Trim on page 242 |
| 2 | Q6651-60292 | Left Cover | All | Left Cover on page 240 |

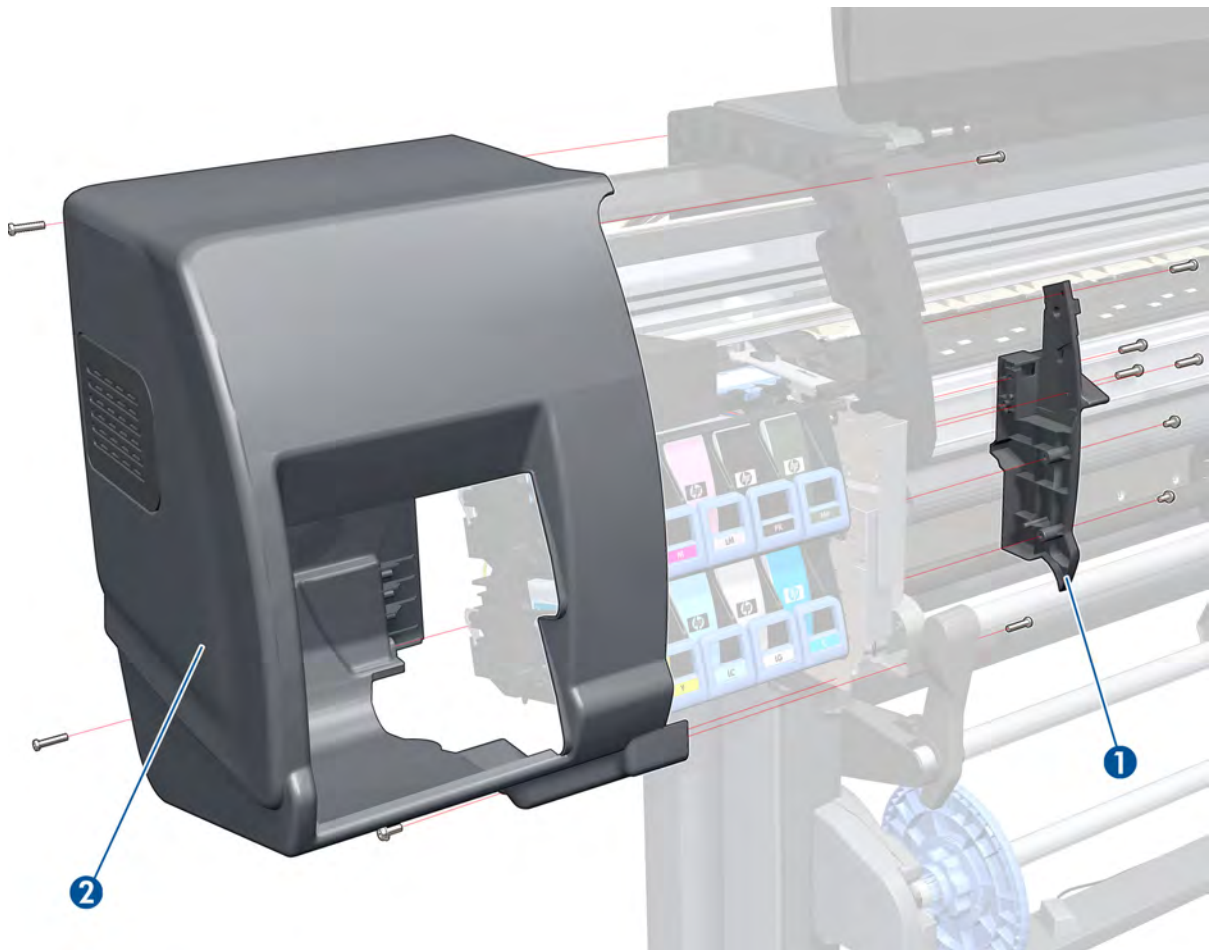

Right-Hand Assemblies

| Number in figure | HP part number | Description | Model | Cross-reference |
|------------------|----------------|--|-------|--|
| 1 | Q1273-60086 | Right Scan-Axis Bracket | All | - |
| 2 | CQ109-67021 | Service Station Assembly and Cable | All | Service Station on page 273 |
| 3 | CQ109-67017 | Primer Valves and Primer Tubes Assembly | All | Primer Valves on page 270 |
| 4 | Q1273-60084 | Aerosol Filter | All | Aerosol Fan and Filter on page 282 |
| 5 | CQ109-67003 | Aerosol Fan Assembly | All | Aerosol Fan and Filter on page 282 |
| 6 | CQ109-67007 | Service Station Cable (Includes Maintenance Cartridge Door Sensor) | All | Service Station on page 273 |
| 7 | CQ109-67022 | Vacuum Fan Assembly | All | Vacuum Fan on page 278 |
| 8 | Q1273-60236 | Drop Detector | All | Drop Detector on page 284 |
| 9 | CQ109-67016 | Primer Assembly | All | Primer Assembly on page 267 |

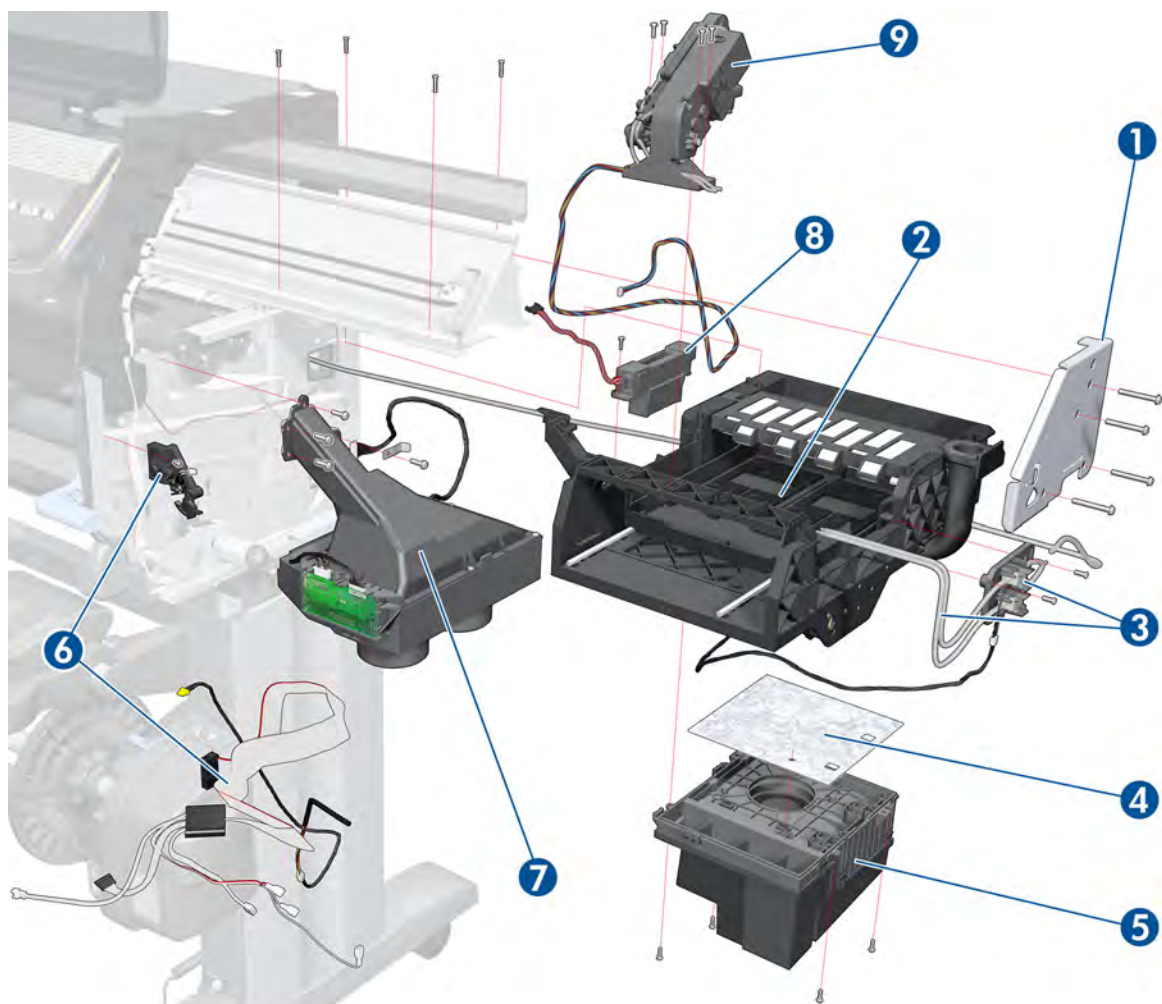

Left-Hand Assemblies

| Number in figure | HP part number | Description | Model | Cross-reference |
|------------------|----------------|--|------------|---|
| 1 | CQ109-67032 | Cartridge Trays | Z6200 | Cartridge Tray on page 399 |
| | F2S71-67007 | | Z6600 | |
| | F2S72-67003 | | Z6800 | |
| 2 | CQ109-67024 | Lower Ink Supply Station (without APS Assembly but including Cartridge Tray) | Z6200 | Ink Supply Station (ISS) on page 298 |
| | F2S71-67006 | | Z6600 | |
| | F2S72-67002 | | Z6800 | |
| 3 | CQ109-67023 | Upper Ink Supply Station (without APS Assembly but including Cartridge Tray) | Z6200/6800 | Ink Supply Station (ISS) on page 298 |
| | F2S71-67005 | | Z6600 | |
| 4 | Q6651-60315 | Left Scan-Axis Bracket | All | N/A |
| 5 | Q6651-60325 | Left Spittoon | All | Left Spittoon on page 311 |
| 6 | Q1273-60245 | ISS to Cartridge Cable | All | N/A |
| 7 | CQ109-67027 | APS Assembly with Pump, Holder and Relief Valve | 42-inch | APS Assembly on page 305 |
| | CQ111-67002 | | 60-inch | |
| 8 | CQ109-67018 | Embedded SpectroPhotometer (ESP) Actuator | 42-inch | Embedded SpectroPhotometer (ESP) Actuator on page 384 |
| | CQ111-67009 | | 60-inch | |
| 9 | Q6651-60326 | Blanking Plate (Spittoon) | All | Encoder Strip and Encoder Sensor on page 315 |

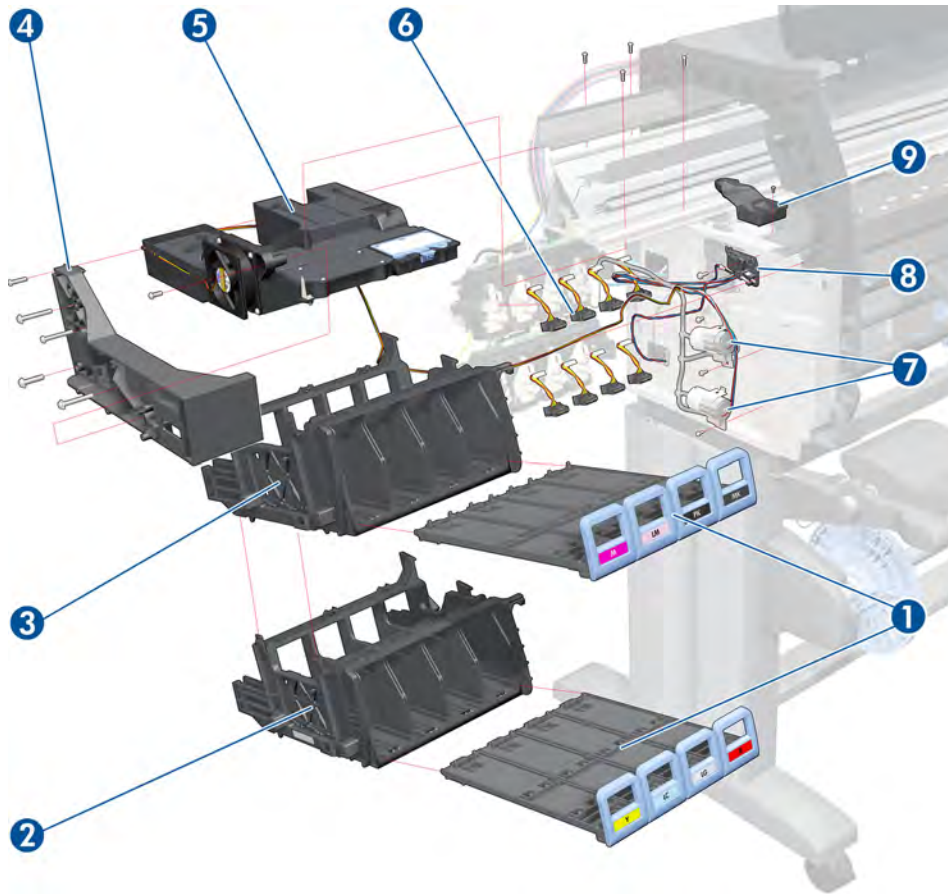

Carriage

| Number in figure | HP part number | Description | Model | Cross-reference |
|------------------|----------------|---|------------|--|
| 1 | CQ105-60130 | Line Sensor Assembly with Holder and Cable | All | Line Sensor Assembly on page 379 |
| 2 | Q6651-60051 | Encoder Sensor (includes Encoder Strip) | 42-inch | Encoder Strip and Encoder Sensor on page 315 |
| | Q6652-60148 | | 60-inch | |
| 3 | CQ109-67011 | Carriage Assembly with Encoder Sensor, without PCA and ESP | Z6200/6800 | Carriage Assembly on page 323 |
| | F2571-67002 | | Z6600 | |
| 4 | Q6651-60039 | Embedded SpectroPhotometer (ESP) | All | Embedded SpectroPhotometer (ESP) on page 381 |
| 5 | Q6651-60341 | Carriage Stopper (includes Carriage Stopper Screw and Media-Axis Motor Bracket) | All | Carriage Assembly on page 323 |
| 6 | CH955-67007 | Cutter Assembly | All | Cutter Assembly on page 297 |
| 7 | Q6651-60335 | Setup Printhead Kit | All | N/A |
| 8 | Q6651-60337 | Carriage Flex Cables | All | Carriage Flex Cables on page 321 |
| 9 | CQ109-67034 | Carriage PCA | All | Carriage PCA on page 318 |

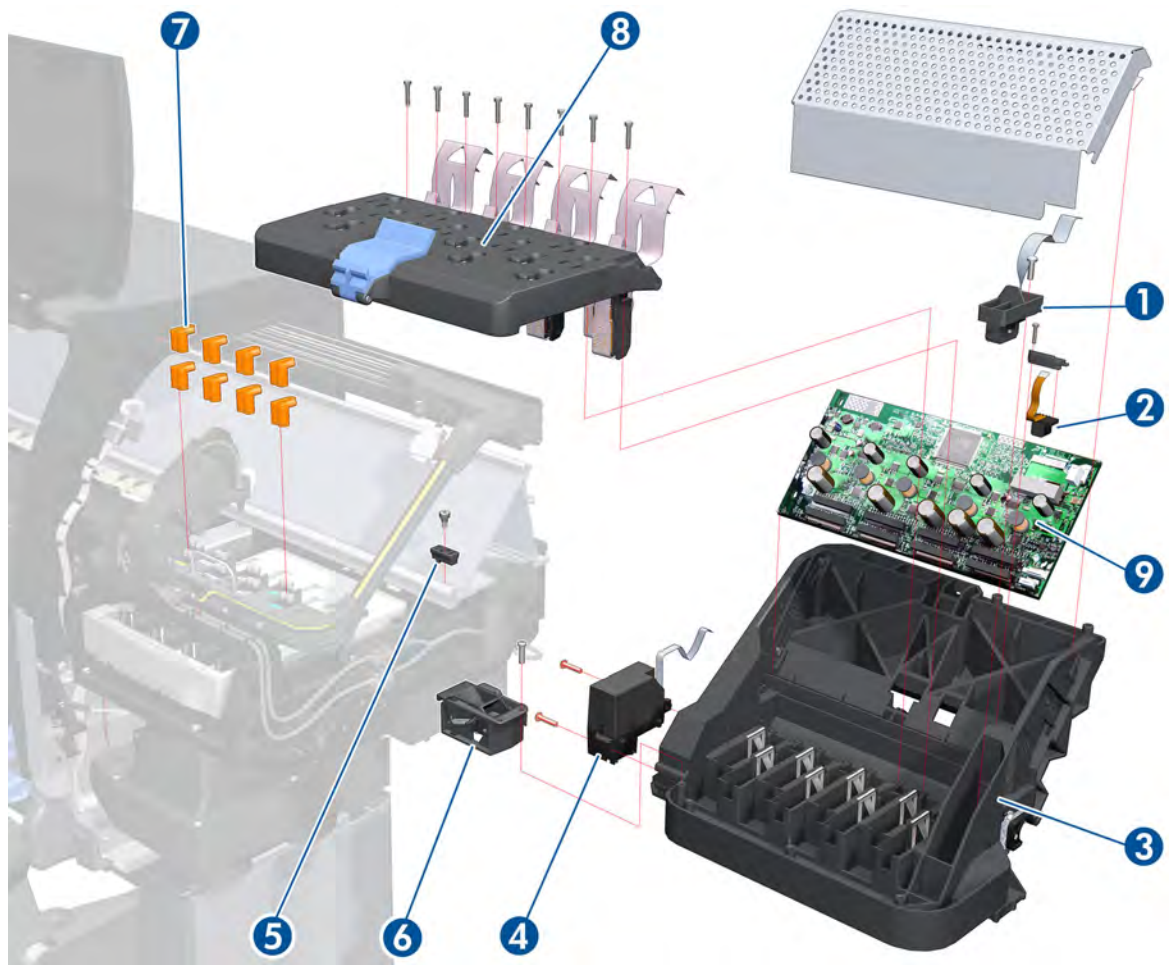

Scan-Axis Assemblies

| Number in figure | HP part number | Description | Model | Cross-reference |
|------------------|----------------|--|-----------------|---|
| 1 | Q6651-60051 | Encoder Strip and Encoder Sensor Kit | 42-inch | Encoder Strip and Encoder Sensor on page 315 |
| | Q6652-60148 | | 60-inch | |
| 2 | CQ109-67001 | Scan-Axis Motor | 42-inch | Scan-Axis Motor on page 331 |
| | Q6652-60128 | | 60-inch | |
| 3 | CQ109-67025 | Ink Supply Tubes and Trailing Cable (includes setup printhead kit) | 42-inch | Ink Supply Tubes and Trailing Cable on page 287 |
| | CQ111-67001 | | 60-inch | |
| 4 | Q6651-60334 | Ink Supply Tubes Clips | Z6200 (42-inch) | Ink Supply Tubes and Trailing Cable on page 287 |
| | Q6652-60125 | | Z6200 (60-inch) | |
| | F2571-67008 | | Z6600 | |
| | F2572-67004 | | Z6800 | |
| 5 | Q6651-60336 | Rear Tube Shelf and Brackets | 42-inch | Ink Supply Tubes and Trailing Cable on page 287 |
| | Q6652-60126 | | 60-inch | |
| 6 | CQ109-67004 | Belt and Tensioner Assembly | 42-inch | Cutter Assembly on page 297 |
| | CQ111-67003 | | 60-inch | |

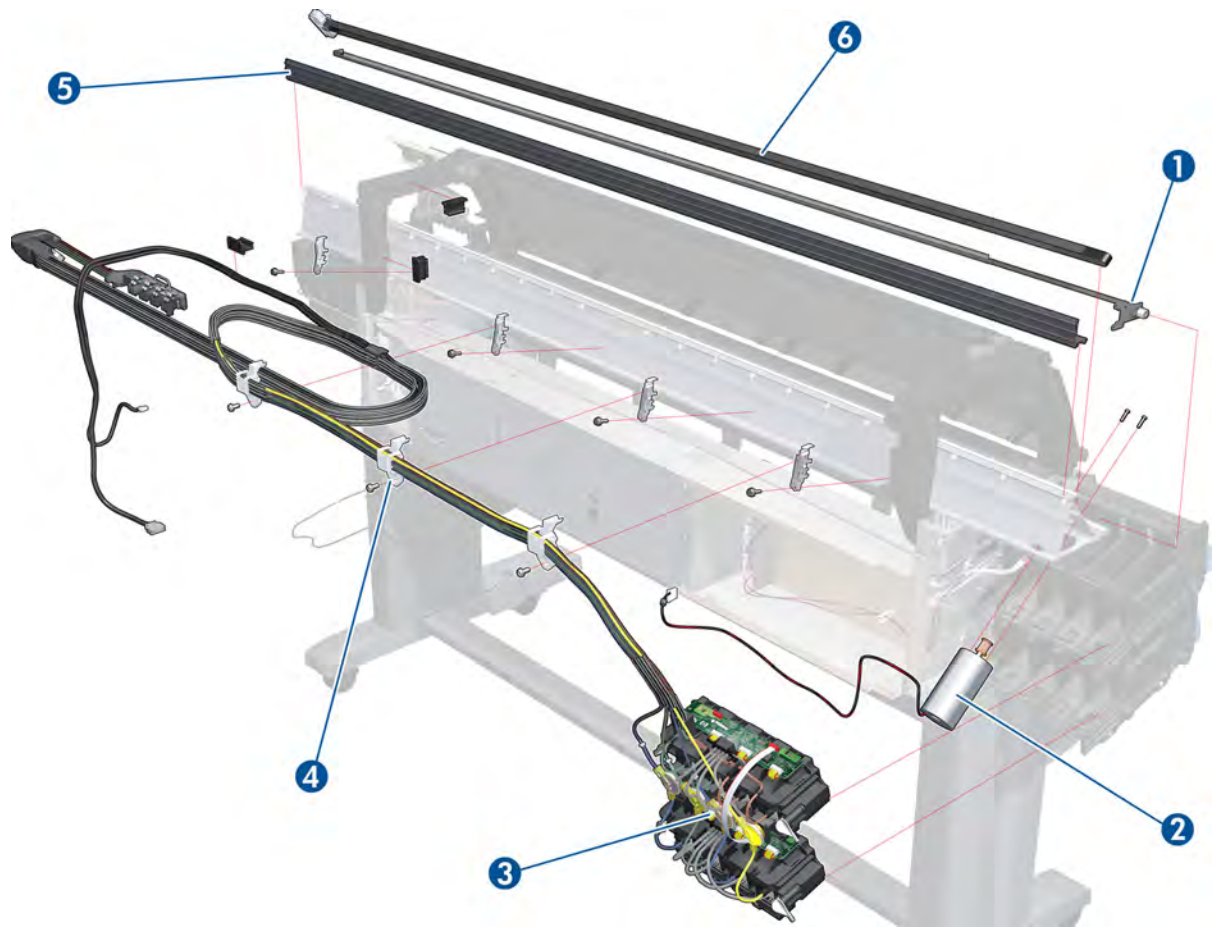

Drive Roller and Media-Axis Motor

| Number in figure | HP part number | Description | Model | Cross-reference |
|------------------|----------------|--|---------|--|
| 1 | Q6651-60320 | Drive Roller Encoder Kit | 42-inch | Scan-Axis Motor on page 331 |
| | Q6652-60123 | | 60-inch | |
| 2 | Q1273-60242 | Drive Roller Gears and Drive Roller Brake Kit | All | Drive Roller on page 426 |
| 3 | Q1273-60039 | Drive Roller | 42-inch | Drive Roller on page 426 |
| | Q6652-60109 | | 60-inch | |
| 4 | Q1273-60247 | Media Advance Drive Motor, Drive Mount and Cable | 42-inch | Media-Axis Motor on page 336 |
| | Q6652-60108 | | 60-inch | |

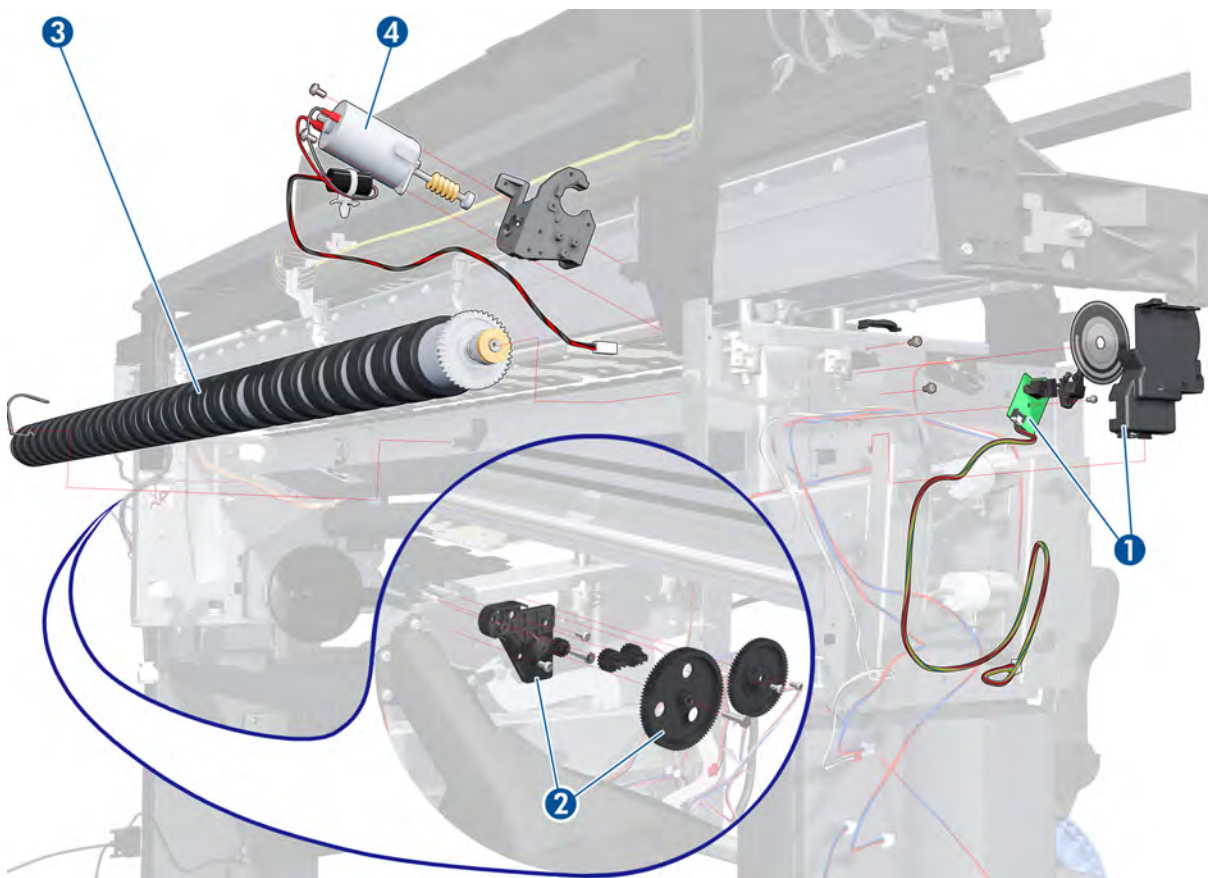

Paper Path Assemblies

| Number in figure | HP part number | Description | Model | Cross-reference |
|------------------|----------------|---|---------|---|
| 1 | Q6651-60281 | Print Platen with Attachment Screw Retainer | 42-inch | Print Platen on page 388 |
| | Q6652-60111 | | 60-inch | |
| 2 | Q6651-60295 | Front Platen | 42-inch | Output Platen on page 387 |
| | Q6652-60115 | | 60-inch | |
| 3 | Q6652-60120 | Media Deflector | All | Media Deflector on page 386 |
| 4 | Q1273-60103 | Input Roller Lever | All | Input Roller on page 401 |
| 5 | Q1273-60058 | Input Roller | 42-inch | Input Roller on page 401 |
| | Q6652-60114 | | 60-inch | |
| 6 | Q6651-60270 | OMAS Module | All | Optical Media Advance Sensor (OMAS) on page 339 |
| 7 | Q6651-60269 | OMAS Cable | All | OMAS Cable on page 352 |
| | CQ109-67042 | HP Coated roll | All | |

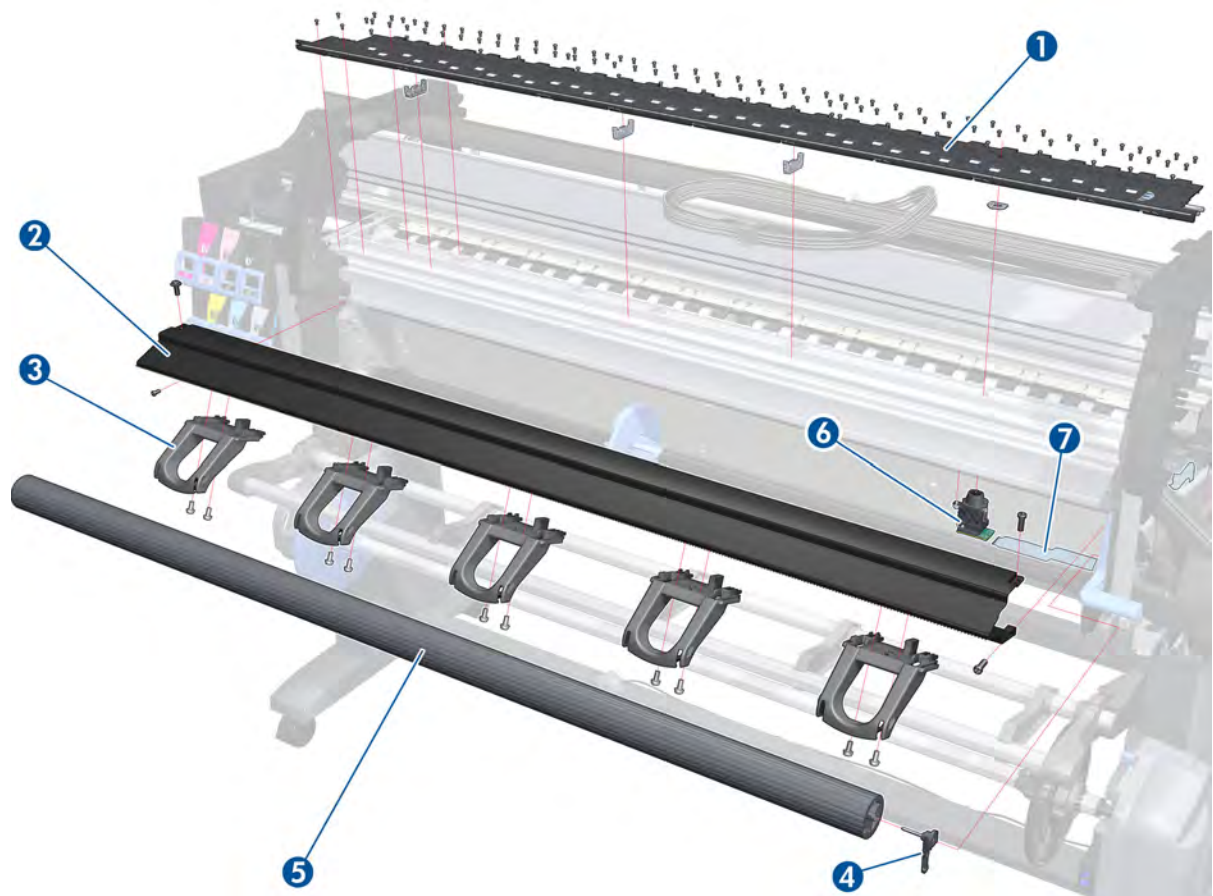

Center Guide and Pinchwheel Assembly

| Number in figure | HP part number | Description | Model | Cross-reference |
|------------------|----------------|--|---------|---|
| 1 | CH955-67122 | Complete Pinchwheel Assembly with Media Sensor | 42-inch | Pinchwheel Assembly on page 417 |
| | CH956-67047 | | 60-inch | |
| 2 | Q6651-60345 | Center Guide | 42-inch | Center Guide on page 422 |
| | Q6652-60130 | | 60-inch | |
| 3 | Q1273-60079 | Media Sensor | All | Media Sensor on page 404 |
| 4 | Q6651-60319 | Media Lever Assembly | All | Media Lever on page 410 |
| 5 | CQ109-67002 | Media Lever Sensor | All | Media Lever Sensor on page 413 |
| 6 | Q6651-60066 | Pinchwheel Kit | All | Pinchwheel Assembly on page 417 |

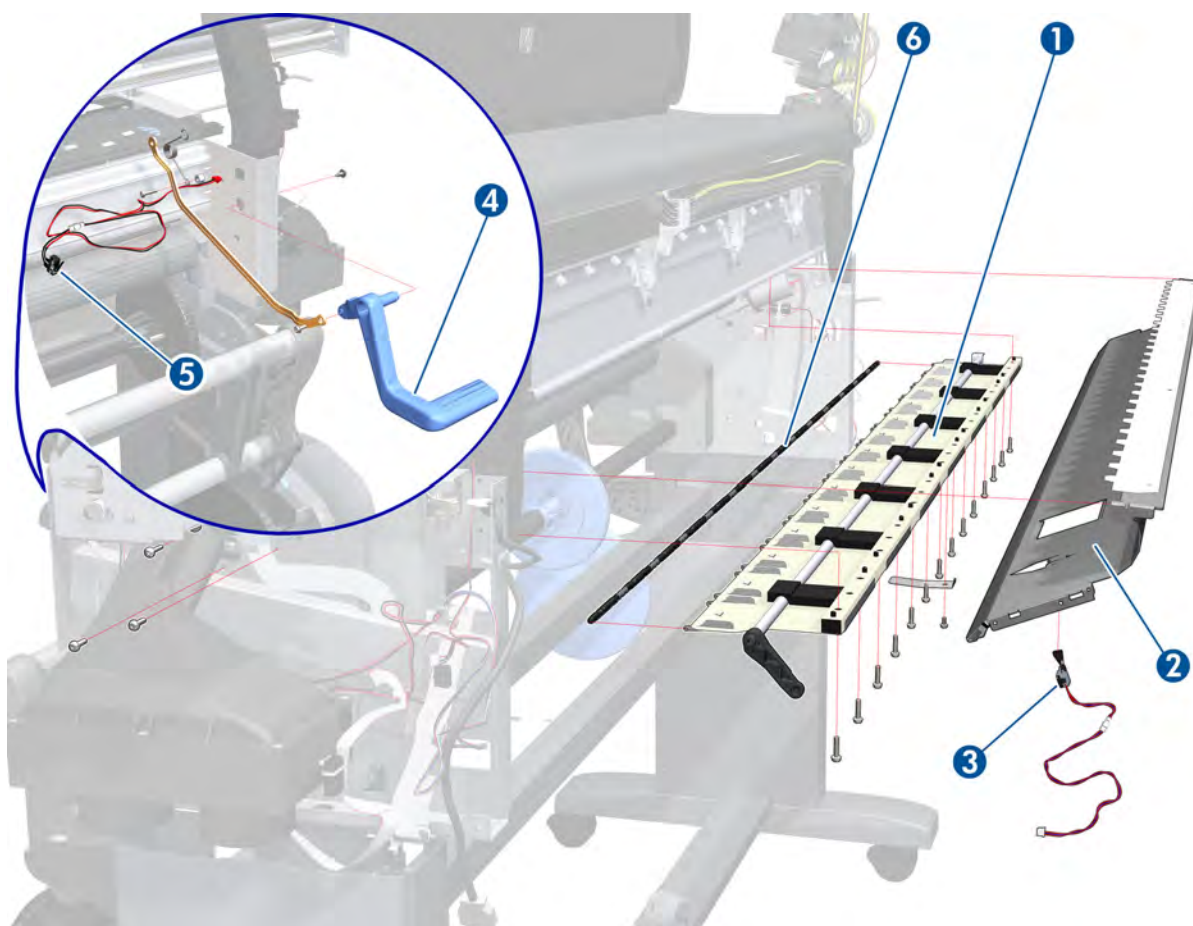

Media Entry Assemblies

| Number in figure | HP part number | Description | Model | Cross-reference |
|------------------|----------------|---|---------|--|
| 1 | CH955-67040 | Right Roll-feed Module Assembly and Rewinder components | All | Right Roll-feed Module on page 434 |
| 2 | CQ109-67009 | Spindle | 42-inch | N/A |
| | CQ111-67006 | | 60-inch | |
| 3 | Q6675-60093 | 3-inch Spindle Adaptor | All | N/A |
| 4 | Q6651-60274 | Spindle Hub | All | N/A |
| 5 | Q1273-60274 | Left Roll-feed Module Assembly | All | Left Roll-feed Module on page 435 |
| 6 | CQ109-67037 | Khan Rewinder and Gear Serv | All | |

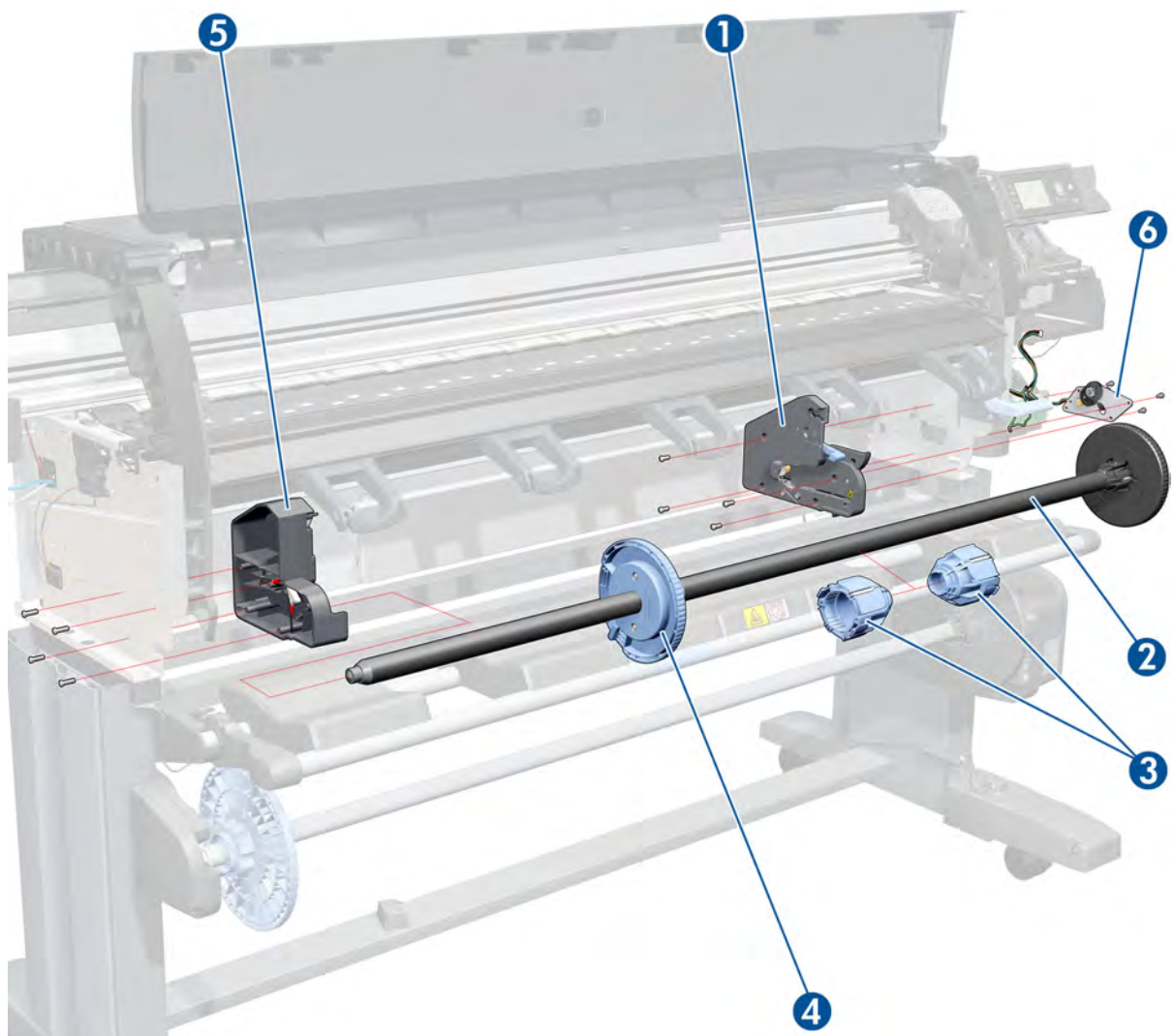

Take-Up Reel assembly

| Number in figure | HP part number | Description | Model | Cross-reference |
|------------------|----------------|--|---------|---|
| 1 | Q6706-60902 | Take-Up Reel Deflector Support Assembly | All | Right Roll-feed Module on page 434 |
| 2 | CQ109-67036 | Take-Up Reel Motor | All | Take-Up Reel Motor on page 437 |
| 3 | Q6706-60910 | Thumbscrew | All | Take-Up Reel Sensors on page 442 |
| 4 | CH955-67118 | Take-Up Reel Receiver Sensor Housing Assembly | All | Take-Up Reel Sensors on page 442 |
| 5 | CH955-67117 | Take-Up Reel Sensors Assembly | All | Take-Up Reel Sensors on page 442 |
| 6 | CH955-67033 | Take-Up Reel Spindle Assembly with Tubes, but not Spindle Hubs | 42-inch | N/A |
| | CH956-67012 | | 60-inch | |
| 7 | CH955-67082 | Take-Up Reel Shelf | 42-inch | Take-Up Reel Deflector Supports on page 440 |
| | CH956-67032 | | 60-inch | |
| 8 | Q6706-60906 | Take-Up Reel Tubes Assembly | 42-inch | N/A |
| | Q6652-60902 | | 60-inch | |
| 9 | Q6706-60901 | Take-Up Reel Spindle Hubs | All | N/A |
| 10 | Q6706-60903 | Take-Up Reel Left-hand Module | All | |

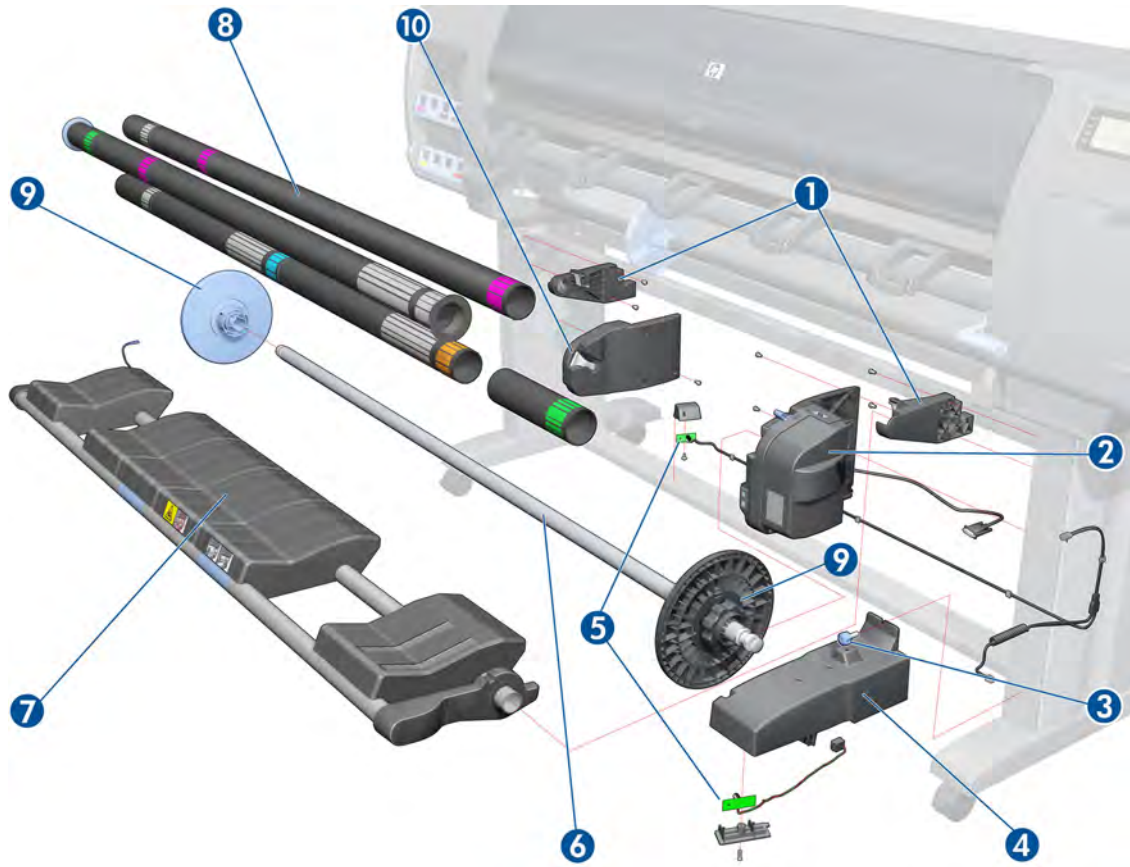

Miscellaneous parts

| HP part number | Description | Model | Cross-reference |
|----------------|---|-----------------|-----------------|
| Q1273-60097 | Right Arc | All | |
| Q1273-60098 | Left Arc | All | |
| Q6715A | User's Maintenance/cleaning kit ^a | All | N/A |
| CQ109-67010 | Preventive Maintenance Kit # 1: | Z6200 (42-inch) | |
| CQ111-67007 | <ul style="list-style-type: none"> Scan-Axis Motor (see Scan-Axis Assemblies on page 213) | Z6200 (60-inch) | |
| F2S71-67009 | <ul style="list-style-type: none"> Encoder Strip (see Scan-Axis Assemblies on page 213) | Z6600 | N/A |
| F2S72-67005 | <ul style="list-style-type: none"> Belt Assembly (see Scan-Axis Assemblies on page 213) Carriage Assembly without PCA, Cutter, and ESP | Z6800 | |
| | Preventive Maintenance Kit # 2: | | |
| | <ul style="list-style-type: none"> Aerosol Filter (see Service Station on page 273) Service Station Aerosol Assembly (see Service Station on page 273) Ink Absorber (see User's Guide) | | |
| CQ109-67019 | <ul style="list-style-type: none"> Left spittoon (see Left Spittoon on page 311) ESP (see Embedded SpectroPhotometer (ESP) on page 381) Line Sensor (see Line Sensor Assembly on page 379) Encoder Strip (see Scan-Axis Assemblies on page 213) | All | N/A |
| CQ533-60001 | Power Cord Kit for Europe (EU, Switzerland, Middle East, South Africa) | All | N/A |
| CQ533-60002 | Power Cord Kit for America (USA, Canada, Mexico, Argentina, Brazil, Chile) | All | N/A |
| CQ533-60003 | Power Cord Kit for Asia (Singapore, Hong Kong, India, Thailand, Philippines, Vietnam, Cambodia, Korea, Indonesia, Japan, China, Taiwan, Australia, New Zealand) | All | N/A |
| | CPU Fan | All | N/A |
| | Jumper Cord for Chile, Uruguay, Argentina | All | N/A |
| CQ871-90022 | Air Tubes Kit | All | N/A |

a. This accessory is available to be purchased by the customer. In case of warranty replacement you can use part number Q6651-60276

8 Removal and installation

Two contents lists are provided for this chapter to help you to quickly find the service part you want to replace. The first list is provided in Service Part Order and the second in *Disassembly Order*.

- [Service part order](#)
- [Disassembly order](#)

Service part order

- [Introduction on page 229](#)
- [Screw types on page 230](#)
- [Aerosol Fan and Filter on page 282](#)
- [APS Assembly on page 305](#)
- [Belt Assembly on page 330](#)
- [Carriage Assembly on page 323](#)
- [Carriage Flex Cables on page 321](#)
- [Carriage PCA on page 318](#)
- [Cartridge Tray on page 399](#)
- [Center Guide on page 422](#)
- [Print Platen on page 388](#)
- [Cutter Assembly on page 297](#)
- [Drive Roller on page 426](#)
- [Drop Detector on page 284](#)
- [EIO to PCA Interface Card on page 348](#)
- [Electronics Module Extension \(60-inch only\) on page 261](#)
- [Electronics Module on page 376](#)
- [Embedded SpectroPhotometer \(ESP\) on page 381](#)
- [Embedded SpectroPhotometer \(ESP\) Actuator on page 384](#)
- [Encoder Disc and Sensor on page 407](#)
- [Encoder Strip and Encoder Sensor on page 315](#)
- [Formatter on page 361](#)
- [Formatter Battery on page 375](#)
- [Front Panel on page 265](#)
- [Hard Disk Drive \(HDD\) on page 364](#)
- [Ink Supply Station \(ISS\) on page 298](#)
- [Ink Supply Tubes and Trailing Cable on page 287](#)
- [Input Roller on page 401](#)
- [Interconnect Cables on page 416](#)
- [Interconnect PCA on page 347](#)

- [ISS to Cartridge Cables on page 295](#)
- [Left Connector Cover \(42-inch\) on page 260](#)
- [Left Cover on page 240](#)
- [Left Roll-feed Module on page 435](#)
- [Left Spittoon on page 311](#)
- [Left Trim on page 242](#)
- [Line Sensor Assembly on page 379](#)
- [Main PCA on page 358](#)
- [Maintenance Cartridge Door on page 402](#)
- [Maintenance Cartridge Door Sensor on page 403](#)
- [Media Deflector on page 386](#)
- [Media Lever on page 410](#)
- [Media Lever Sensor on page 413](#)
- [Media Sensor on page 404](#)
- [Media-Axis Motor on page 336](#)
- [OMAS Cable on page 352](#)
- [OMAS Controller Card on page 349](#)
- [Optical Media Advance Sensor \(OMAS\) on page 339](#)
- [Output Platen on page 387](#)
- [Pinchwheel Assembly on page 417](#)
- [Power Supply Unit \(PSU\) on page 368](#)
- [Primer Assembly on page 267](#)
- [Primer Valves on page 270](#)
- [Primer Valve Cables on page 271](#)
- [PrintMech PCA on page 372](#)
- [Rear Door \(42-inch\) on page 254](#)
- [Rear Door \(60-inch\) on page 256](#)
- [Rear Ebox Cover on page 415](#)
- [Rewinder Motor on page 303](#)
- [Right Connector Cover on page 258](#)
- [Right Cover on page 235](#)

- [Right Roll-feed Module on page 434](#)
- [Right Trim on page 237](#)
- [Scan-Axis Motor on page 331](#)
- [Service Station on page 273](#)
- [Take-Up Reel Deflector Supports on page 440](#)
- [Take-Up Reel Left-Hand Module on page 439](#)
- [Take-Up Reel Motor on page 437](#)
- [Take-Up Reel Sensors on page 442](#)
- [Top Cover \(42-inch\) on page 243](#)
- [Top Cover \(60-inch\) on page 249](#)
- [Vacuum Fan on page 278](#)
- [Vacuum Fan Cable on page 280](#)
- [Window \(42-inch\) on page 231](#)
- [Window \(60-inch\) on page 233](#)
- [Window Position Sensor on page 262](#)

Disassembly order

- [Introduction](#)
- [Screw types](#)
- [Window \(42-inch\)](#)
- [Window \(60-inch\)](#)
- [Right Cover](#)
- [Right Trim](#)
- [Left Cover](#)
- [Left Trim](#)
- [Top Cover \(42-inch\)](#)
- [Top Cover \(60-inch\)](#)
- [Rear Door \(42-inch\)](#)
- [Rear Door \(60-inch\)](#)
- [Right Connector Cover](#)
- [Left Connector Cover \(42-inch\)](#)
- [Electronics Module Extension \(60-inch only\)](#)
- [Window Position Sensor](#)
- [Front Panel](#)
- [Primer Assembly](#)
- [Primer Valves](#)
- [Primer Valve Cables](#)
- [Service Station](#)
- [Vacuum Fan](#)
- [Vacuum Fan Cable](#)
- [Aerosol Fan and Filter](#)
- [Drop Detector](#)
- [Ink Supply Tubes and Trailing Cable](#)
- [ISS to Cartridge Cables](#)
- [Cutter Assembly](#)
- [Ink Supply Station \(ISS\)](#)
- [Rewinder Motor](#)

- [APS Assembly](#)
- [Left Spittoon](#)
- [Encoder Strip and Encoder Sensor](#)
- [Carriage PCA](#)
- [Carriage Flex Cables](#)
- [Carriage Assembly](#)
- [Belt Assembly](#)
- [Scan-Axis Motor](#)
- [Media-Axis Motor](#)
- [Optical Media Advance Sensor \(OMAS\)](#)
- [Interconnect PCA](#)
- [EIO to PCA Interface Card](#)
- [OMAS Controller Card](#)
- [OMAS Cable](#)
- [Main PCA](#)
- [Formatter](#)
- [Hard Disk Drive \(HDD\)](#)
- [Power Supply Unit \(PSU\)](#)
- [PrintMech PCA](#)
- [Formatter Battery](#)
- [Electronics Module](#)
- [Line Sensor Assembly](#)
- [Embedded SpectroPhotometer \(ESP\)](#)
- [Embedded SpectroPhotometer \(ESP\) Actuator](#)
- [Media Deflector](#)
- [Output Platen](#)
- [Print Platen](#)
- [Cartridge Tray](#)
- [Input Roller](#)
- [Maintenance Cartridge Door](#)
- [Maintenance Cartridge Door Sensor](#)

- [Media Sensor](#)
- [Encoder Disc and Sensor](#)
- [Media Lever](#)
- [Media Lever Sensor](#)
- [Rear Ebox Cover](#)
- [Interconnect Cables](#)
- [Pinchwheel Assembly](#)
- [Center Guide](#)
- [Drive Roller](#)
- [Right Roll-feed Module](#)
- [Left Roll-feed Module](#)
- [Take-Up Reel Motor](#)
- [Take-Up Reel Left-Hand Module](#)
- [Take-Up Reel Deflector Supports](#)
- [Take-Up Reel Sensors](#)

Introduction

This chapter is a step-by-step guide to the removal and installation of the key components of the printer. You may find it useful to tick off the steps as they are performed. Use the illustrations for each procedure to identify the parts referred to in the text.

The procedures appear in order of removal. So the whole machine can be stripped down by starting at the beginning of this chapter and working through the subsequent procedures.



NOTE: Before using this chapter to remove and install a new component, always make sure that you have performed the relevant service test from [Service tests and utilities on page 91](#). If the test passes you will not need to replace the component.

Safety Precautions

Review the instructions identified by WARNING and CAUTION symbols before you service the printer. Follow these warnings and cautions for your protection and to avoid damaging the printer.



WARNING! Serious shock hazard leading to death or injury may result if you do not take the following precautions:

- Ensure that the AC power outlet (mains) has a protective earth (ground) terminal.
- Switch the plotter **off**, and disconnect it from the power source prior to performing any maintenance.
- Prevent water or other liquids from running onto electrical components or circuits, or through openings in the module.

Electrostatic Discharge (ESD) Precautions

To prevent damage to the printer circuits from high-voltage electrostatic discharge (ESD):

1. Do not wear clothing that is subject to static build-up.
2. Do not handle integrated circuits (ICs) in carpeted areas.
3. Do not remove an IC or a printed circuit assembly (PCA) from its conductive foam pad or conductive packaging until you are ready to install it.
4. Ground (earth) your body while disassembling and working on the printer.
5. After removing a cover from the printer, attach an earthing (ground) lead between the PCA common and earth ground. Touch all tools to earth ground to remove static charges before using them on the printer.
6. After removing any PCA from the printer, place it on a conductive foam pad or into its conductive packaging to prevent ESD damage to any ICs on the PCA.

Required Tools

The following tools are required to disassemble and repair the printer.

- A long Torx Screwdriver with the following attachments: T8, T10, T15, T20, and T25.
- A long thin-bladed T-10 Torx Screwdriver to remove the Primer. The blade must be longer than 12 cm with a maximum diameter of 10 mm.
- A long thin-bladed T-20 Torx Screwdriver to remove the OMAS Sensor. The blade must be longer than 11 cm with a maximum diameter of 4 mm.
- A T8 Torx Screwdriver to remove the left cover. The blade must be longer than 5 cm with a maximum diameter of 9 mm.

Screw types

| Type | Torx | Length (mm) | Head Type | Thread Type | Part Number |
|------|------|-------------|-----------|-------------|-------------|
| A | T-20 | 17 | Pan | Taptite | 0515-1743 |
| B | T-20 | 10 | Pan | Taptite | 0515-2282 |
| C | T-10 | 7.0 | Pan | Machined | 0515-4613 |
| D | T-8 | 5.5 | Pan | Taptite | 0515-2850 |
| E | T-15 | - | Pan | - | C3180-20001 |
| F | T-15 | 9.5 | Pan | Plastite | 0515-2981 |
| G | T-15 | 12.7 | Pan | Taptite | 0624-0769 |
| H | T-15 | 12.7 | Pan | Taptite | 0515-4706 |
| I | T-10 | 8.0 | Pan | Taptite | 0515-2200 |
| J | T-15 | 20 | Pan | Plastite | 0624-0771 |
| K | T-8 | 9.5 | Pan | Taptite | 0624-0680 |
| L | T-8 | 12.7 | Pan | Taptite | 0624-0768 |
| M | T-20 | - | Pan | - | 0515-2521 |
| N | T-20 | 35 | Pan | Sheet Metal | C6071-20025 |

| | | | | | |
|---|------|------|-----|----------|-------------|
| O | T-20 | 12.7 | Pan | - | 0624-1062 |
| P | T-15 | 11.6 | Pan | Machined | C2847-20018 |
| Q | T-20 | - | Pan | Taptite | 0515-2916 |
| R | T-15 | - | Pan | Taptite | 0515-1916 |
| S | T-15 | 18.4 | Pan | Machined | Q6651-20179 |

Window (42-inch)

Removal

⚠ WARNING! Switch **off** the printer and remove the power cable.

1. Open the Window.



2. Unclip the Window hinges from the Top Cover.

📝 NOTE: Since the hinges are very hard to unclip, it is recommended that you use a screwdriver or other tool to forcefully unclip the Window hinges from the Top Cover.

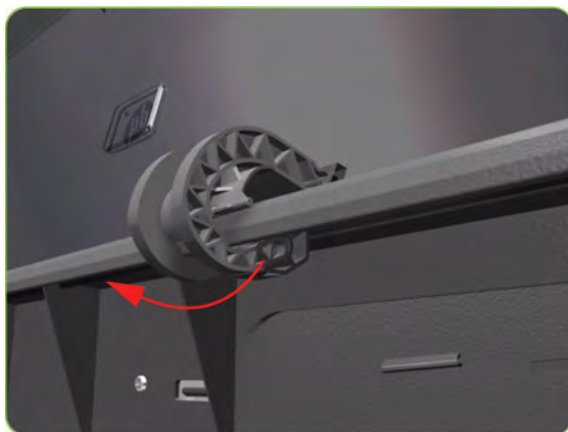

3. Remove the Window from the printer.

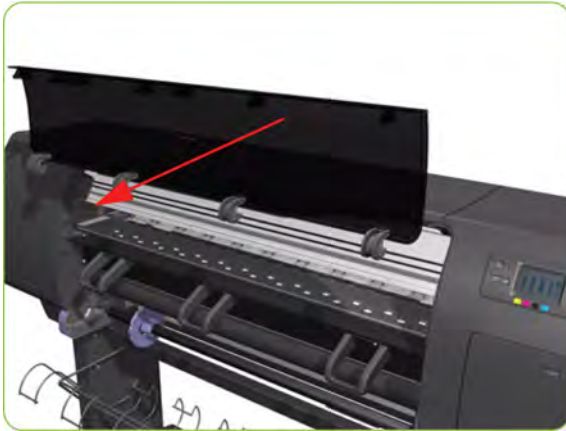

Installation of New Window

1. Identify the two ends of the Window hinge (four in total) - one end is clipped to the Window and the other to the Top Cover.

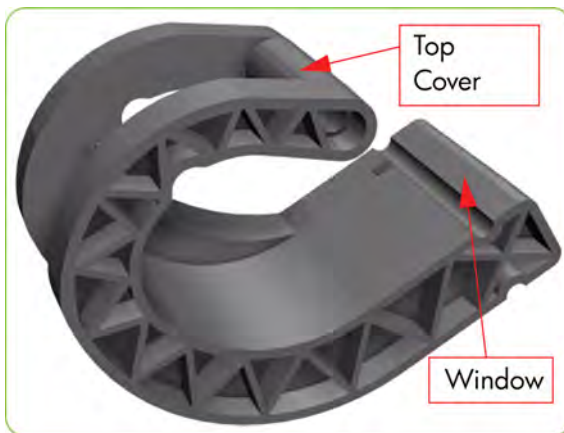

2. Slide the Window hinges on to the Window.



3. Clip the Window Hinges to the Top Cover.

 **NOTE:** Since the hinges are very hard to clip, you will need to forcefully clip the Window hinges to the Top Cover.

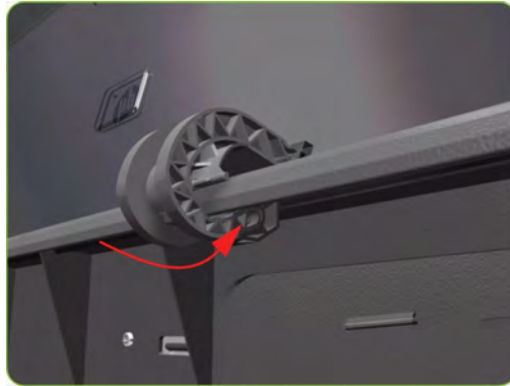

Window (60-inch)

Removal

 **WARNING!** Switch **off** the printer and remove the power cable.

1. Open the Window.



2. Use a flat bladed screwdriver to compress and hold the spring compressed.



3. Pull the window towards you enough to release it from the left attachment.

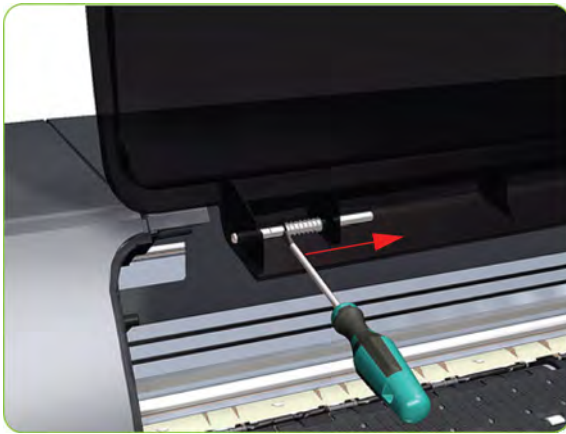

4. Slide the Window to the left to release it from the right attachment.



5. Remove the Window from the printer.

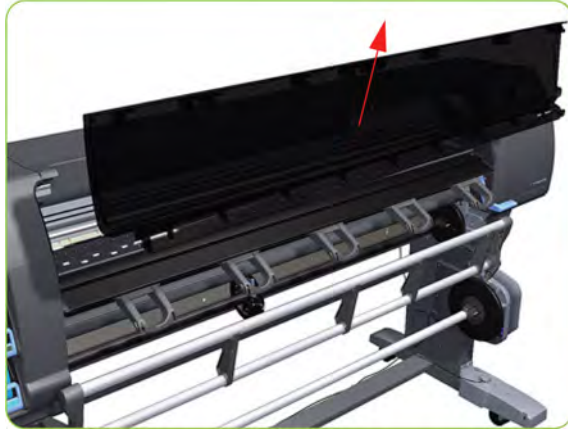

Right Cover

Removal

⚠ WARNING! Switch off the printer and remove the power cable.

1. Open the Service Station Door.

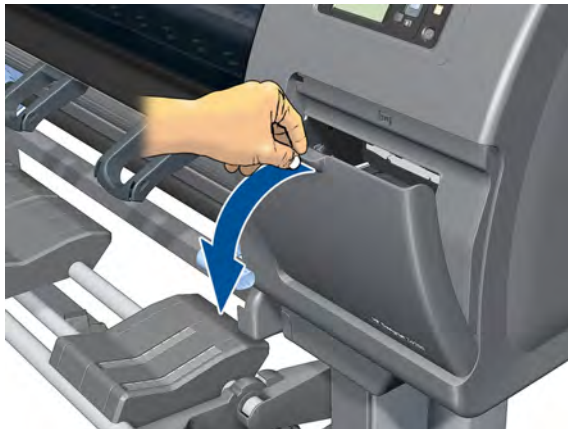

2. Remove one T-15 screw (**Type J**) that secures the Right Cover.



3. Open the Window.

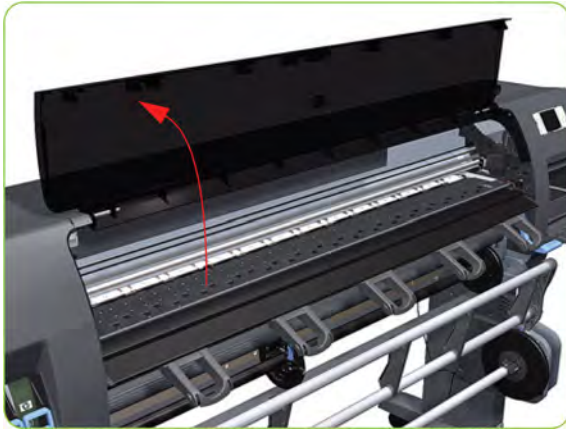

4. Remove two T-15 screws (**Type J**) that secure the Right Cover.



5. Remove one T-15 screw (**Type J**) and one T-20 screw (**Type A**) that secure the Right Cover from the rear of the printer.

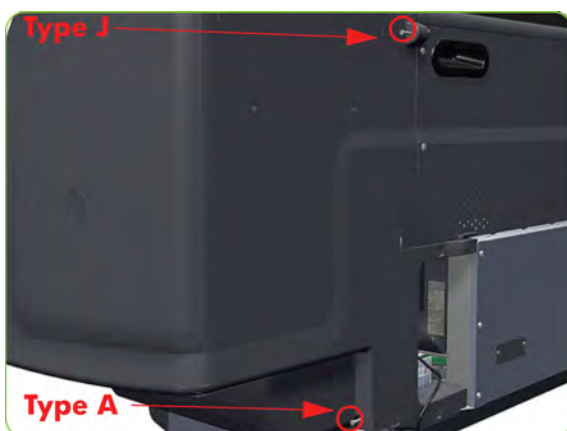

6. Remove the Right Cover from the printer.

⚠ CAUTION: When installing the Right Cover, make sure you leave the Maintenance Cartridge Door open, otherwise you could damage the Maintenance Cartridge Door Sensor.

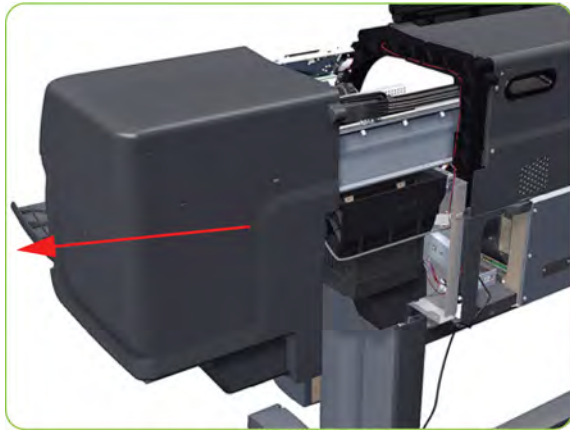

Right Trim

Removal

⚠ WARNING! Switch **off** the printer and remove the power cable.

1. Remove the Right Cover ⇒ See [Right Cover on page 235](#).
2. Remove the Output Platen ⇒ See [Output Platen on page 387](#).
3. Raise the Media Lever.



4. Remove one T-15 screw (**Type F**) that secures the Media Lever to the Linkage.



5. Disconnect the Media Lever from the Linkage.

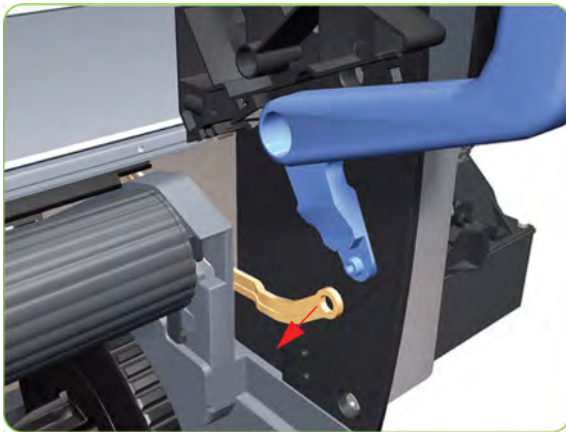

6. Remove one T-20 screw that secures the Media Lever to the Right Trim.

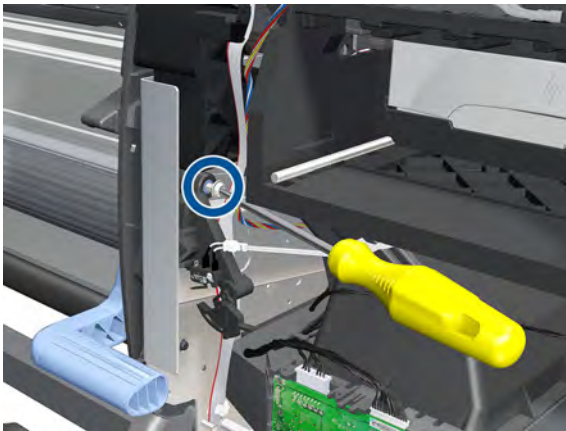

7. Remove the Media Lever from the printer.

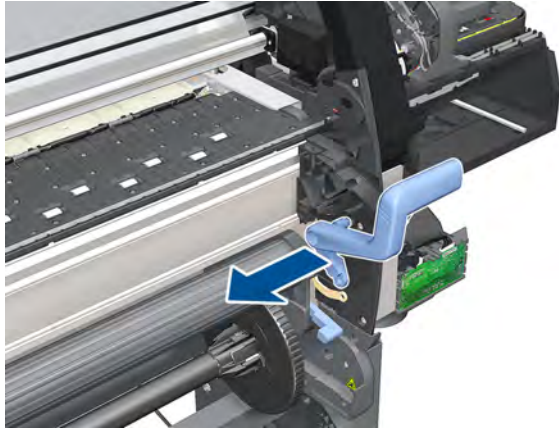

8. Remove one T-20 and four T-15 screws that secure the Right Trim.



9. Carefully rotate the Right Trim sufficiently to gain access to the Media Lever Position Sensor.

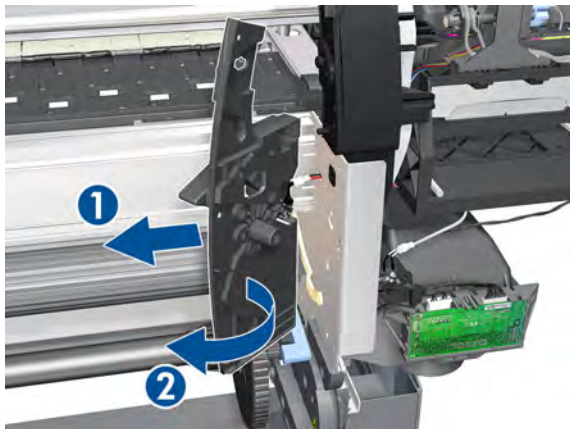

10. Disconnect the cable from the Media Lever Position Sensor.

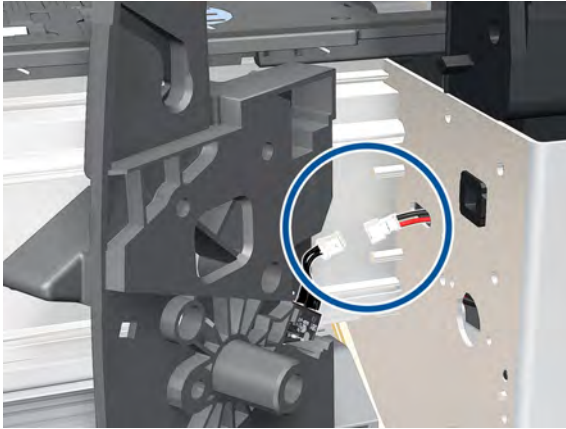

11. Unclip the Media Lever Position Sensor from its mounting lugs on the Right Trim.



12. Remove the Right Trim from the printer.

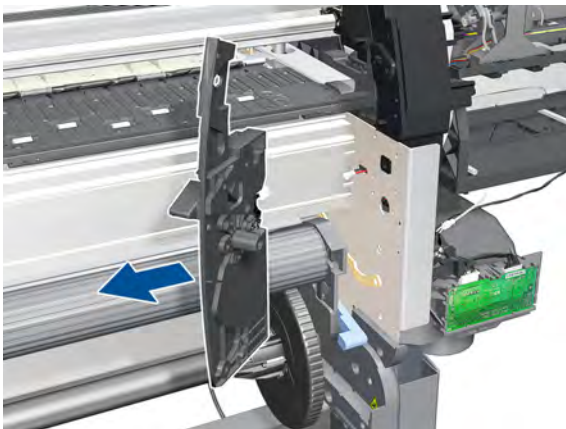

Left Cover

Removal

 **WARNING!** Switch **off** the printer and remove the power cable.

1. Open the Window.

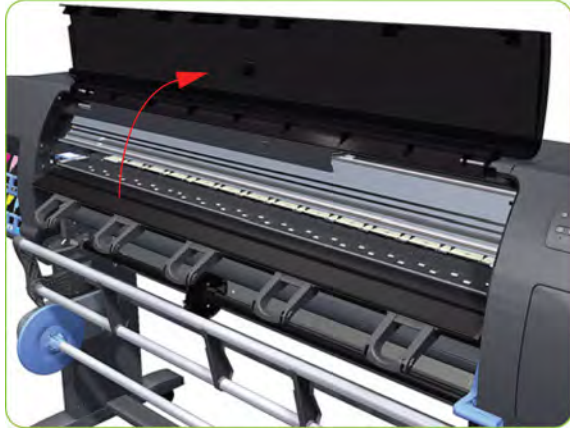

2. Remove two T-15 (**Type J**) screws that secure the Left Cover.



3. Remove one T-20 screw that secures the Left Cover.



4. Remove one T-15 screw and one T-20 screw that secure the Left Cover.



5. Remove the Left Cover from the printer.

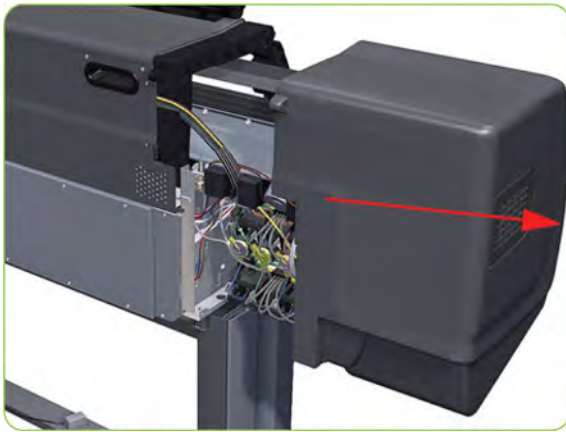

Left Trim

Removal

⚠ WARNING! Switch **off** the printer and remove the power cable.

1. Remove the Output Platen ⇒ See [Output Platen on page 387](#).

2. Remove two T-15 screws and four T-20 screws that secure the Left Trim.

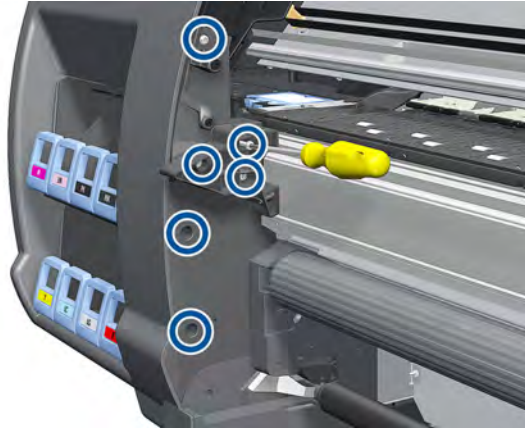

3. Carefully remove the Left Trim from the printer.



Top Cover (42-inch)

Removal

 **WARNING!** Switch **off** the printer and remove the power cable.

 **NOTE:** Throughout this section the graphics actually show the HP Designjet 4000 printer series but the steps of the procedure are identical for the HP Designjet Z6000 printer series.

1. Remove the Right Cover ⇒ See [Right Cover on page 235](#).
2. Remove the Left Cover ⇒ See [Left Cover on page 240](#).

3. Release the three clips securing the Ink Supply Tubes and the Trailing Cable to the Top Cover.



4. Release the Ink Supply Tubes and Trailing Cable from the clip underneath the Top Cover.

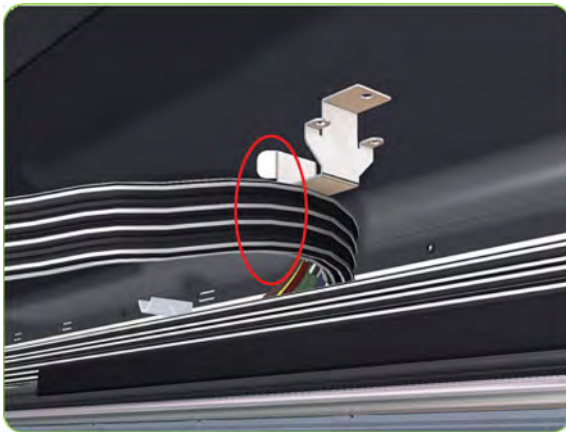

5. Remove the Ink Supply Tubes and Trailing Cable from within the Top Cover and lay them on the Print Platen.



6. Remove one T-10 (Type I) screw that secures the ESD Strip to the Top Cover (on the left-hand side of the printer).

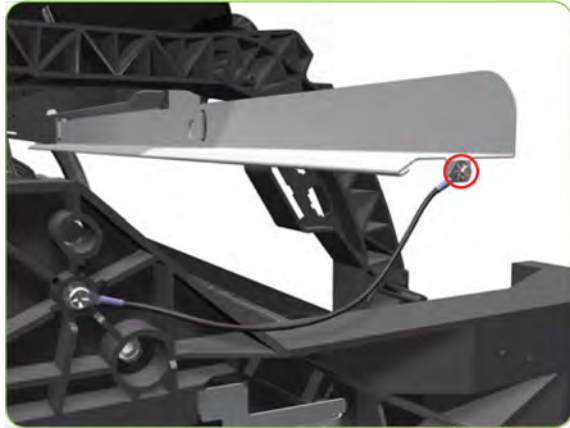

7. Disconnect the ESD Strip from the Top Cover.

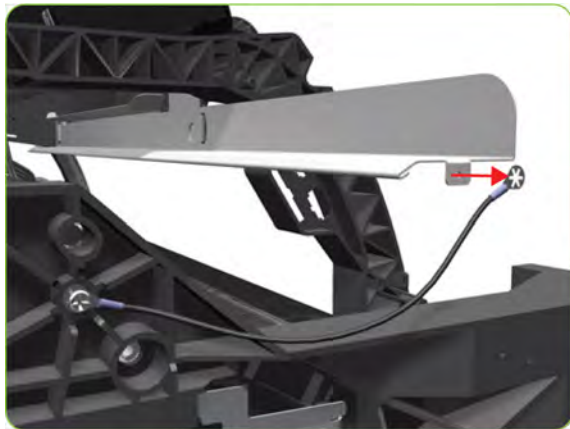

8. Remove the three T-15 screws (Type G) that secure the Rear Door.

 **NOTE:** Each screw includes a washer (part number 3050-1267).



9. Open the Rear Door.



10. Remove four T-15 screws (Type H) that secure the Top Cover from the rear of the printer.



11. Using a flat-head screwdriver, release the Top Cover from the right-hand side of the printer.



12. Release the Top Cover from the rear of the printer.

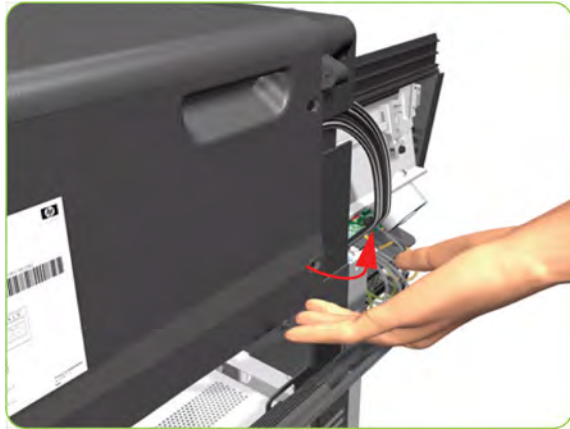

13. Raise the right-hand side of the Top Cover and pull out to the right.

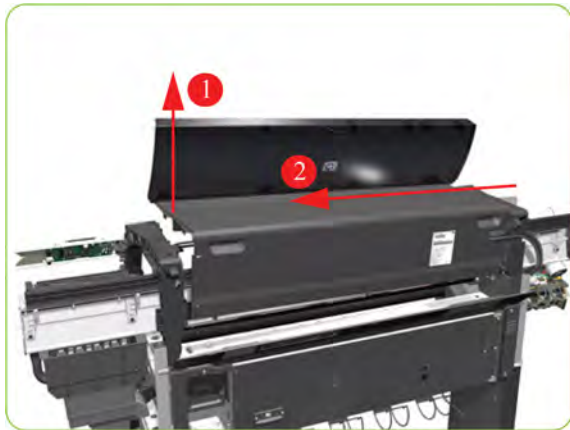

 **NOTE:** If a NEW Top Cover is to be installed, take note of the following instructions before assembling the Top Cover on to the printer:

1. Position the Metallic Support on to the Top Cover.



2. Lock the Metallic Support on to the Top Cover.



3. Install the T-20 screw that secures the Metallic Support to the Top Cover.



4. Remove the Window (⇒ See [Window \(42-inch\) on page 231](#)) from the old Top Cover and install it on the new Top Cover.



 **NOTE:** When installing the Ink Supply Tubes and Trailing Cable on to the Top Cover, take note of the of the two red marks on the Ink Supply Tubes. These two red marks should be aligned with the first slot in the Top Cover as this will help with the rest of the installation.

Top Cover (60-inch)

Removal

 **WARNING!** Switch off the printer and remove the power cable.

1. Remove the Right Cover ⇒ See [Right Cover on page 235](#).
2. Remove the Left Cover ⇒ See [Left Cover on page 240](#).
3. Remove the Rear Door ⇒ See [Rear Door \(60-inch\) on page 256](#).
4. Release the clip securing the Ink Supply Tubes and the Trailing Cable to the Top Cover.

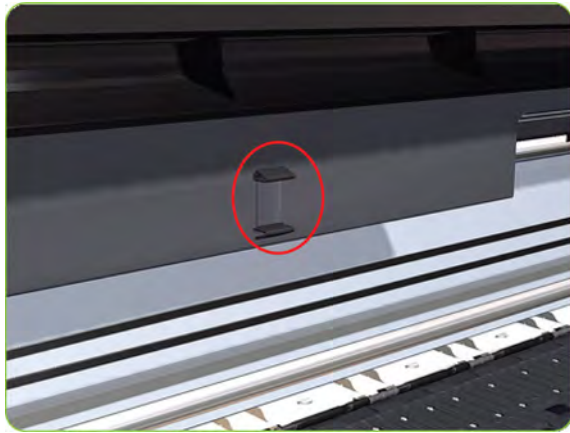

5. Release the Ink Supply Tubes and Trailing Cable from the clip underneath the Top Cover.

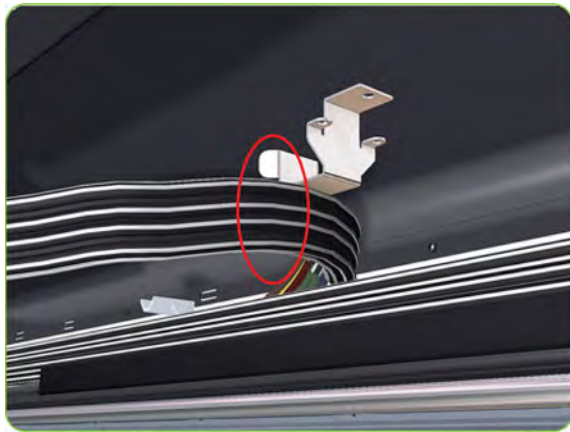

6. Press the clip to release it from the Top Cover.



7. Remove the clip from the Top Cover.



8. Unroute the Trailing Cable from the Top Cover.



9. Unroute the Trailing Cable from the Top Cover.



10. Remove a T-10 screw as shown.

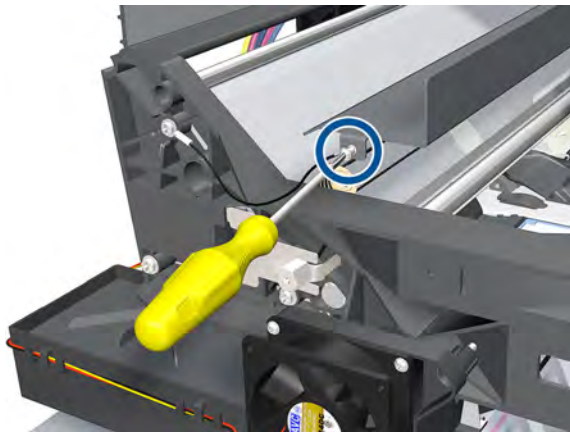

11. Remove two T-20 screws as shown.



12. Unclip and slide the part shown.

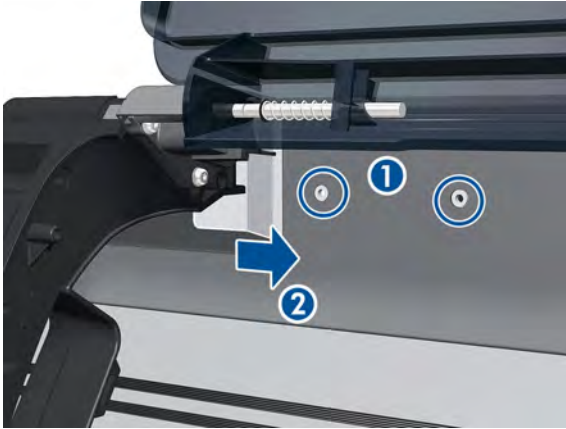

13. Remove the part.



14. Close the Window.



15. Remove the two locking plates.



16. Slide the Top Cover fully to the right to release the two locking clips.



17. Lift the right end of the Top Cover to release it from the right arch.



18. Slide the Top Cover to the right to release the two locking clips.



19. Remove the Top Cover from the printer.

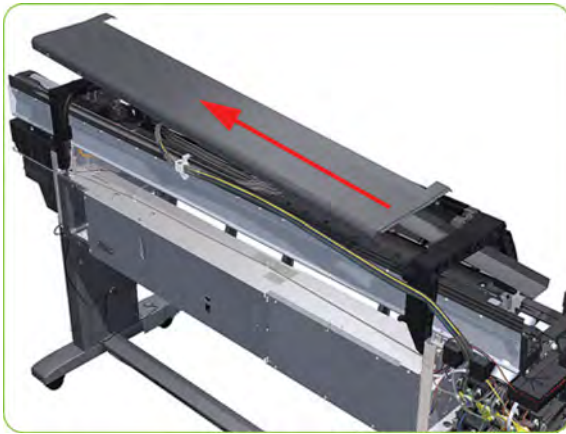

Rear Door (42-inch)

Removal

 **WARNING!** Switch off the printer and remove the power cable.

 **NOTE:** Throughout this section the graphics actually show the HP Designjet 4000 printer series but the steps of the procedure are identical for the HP Designjet Z6000 printer series.

1. Remove three T-15 screws (**Type G**) from the Rear Door.

 **NOTE:** Each screw includes a washer (part number 3050-1267).



2. Open the Rear Door slightly (as shown).



3. To release the right-hand hinge of the Rear Door, move the Rear Door to the right (1) and towards you (2).



4. To release the left-hand hinge of the Rear Door, move the Rear Door to the right (1) and then bend the hinge slightly (2).

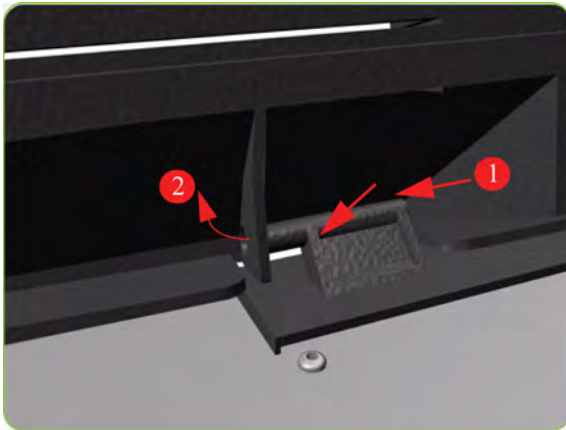

5. Remove the Rear Door from the printer.



Rear Door (60-inch)

Removal

 **WARNING!** Switch **off** the printer and remove the power cable.

1. Remove the Left Cover ⇒ See [Left Cover on page 240](#).
2. Remove the Right Cover ⇒ See [Right Cover on page 235](#).

3. Remove seven T-20 screws and the four T-15 screws (Type X) from the Rear Door.

 **NOTE:** Each Type X screw includes a washer (part number 3050-1267).



4. Open the Rear Door slightly (as shown, approximately 30 degrees).



5. Lift the left side of the rear door sufficiently to release it from the three location studs.

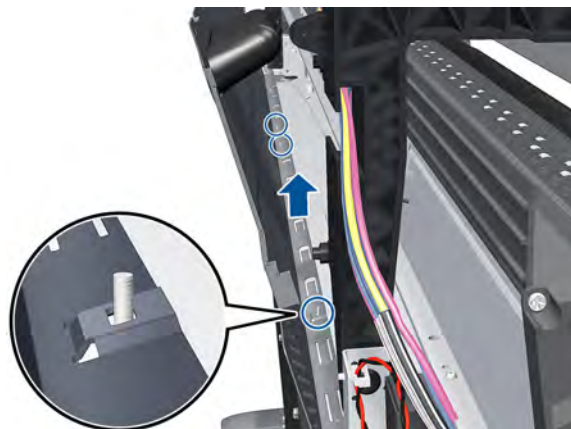

6. Remove the Rear Door from the printer.



Right Connector Cover

Removal

WARNING! Switch off the printer and remove the power cable.

1. For the 42-inch model, remove the Rear Door ⇒ See [Rear Door \(42-inch\) on page 254](#).
2. For the 60-inch model, and optionally the 42-inch model, disconnect the TUR connector.



3. For the 60-inch model, and optionally the 42-inch model, unroute the TUR cable from the Right Connector Cover.

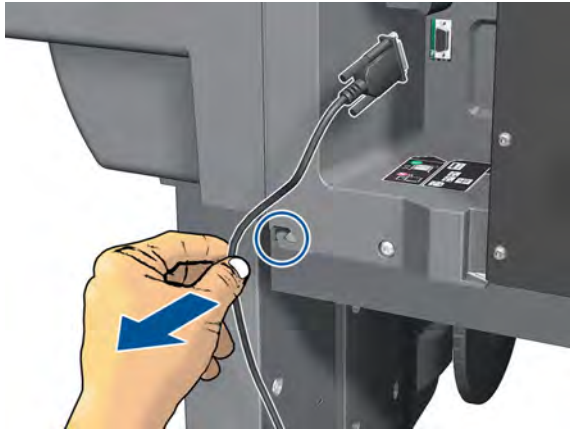

4. Remove two T-20 screws (**Type B**) from the Right Connector Cover.



5. Rotate the Right Connector Cover a few degrees counter-clockwise so it can be removed completely. Rotate the Right Connector Cover a few degrees counter-clockwise so it can be removed completely.



6. Remove the Right Connector Cover from the printer.

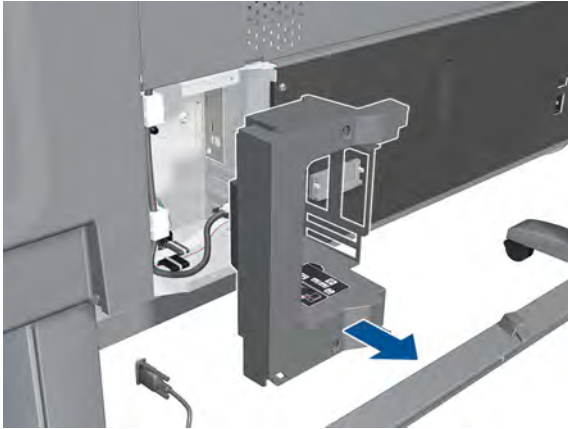

Left Connector Cover (42-inch)

Removal

 **WARNING!** Switch **off** the printer and remove the power cable.

 **NOTE:** Throughout this section the graphics actually show the HP Designjet 4000 printer series but the steps of the procedure are identical for the HP Designjet Z6000 printer series.

1. Remove the Rear Door ⇒ See [Rear Door \(42-inch\) on page 254](#).
2. Remove two T-20 screws (**Type B**) from the Left Connector Cover.

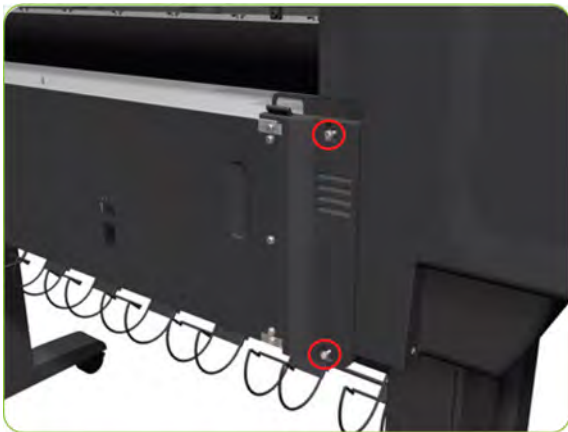

3. Remove the Left Connector Cover from the printer.



Electronics Module Extension (60-inch only)

Removal

⚠ WARNING! Switch off the printer and remove the power cable.

1. Remove ten T-20 screws (**Type B**) from the Electronics Module Extension.

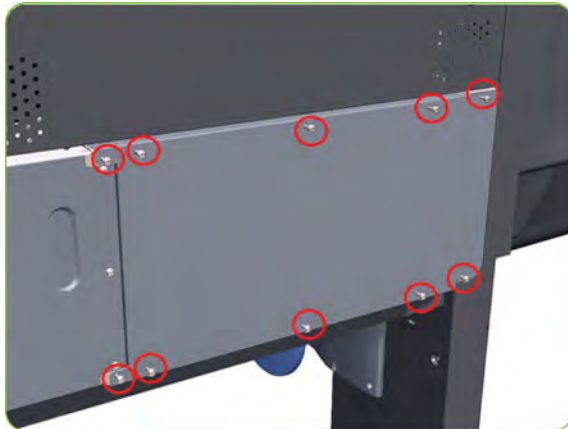

2. Rotate the Electronics Module Extension approximately 90 degrees counter-clockwise.

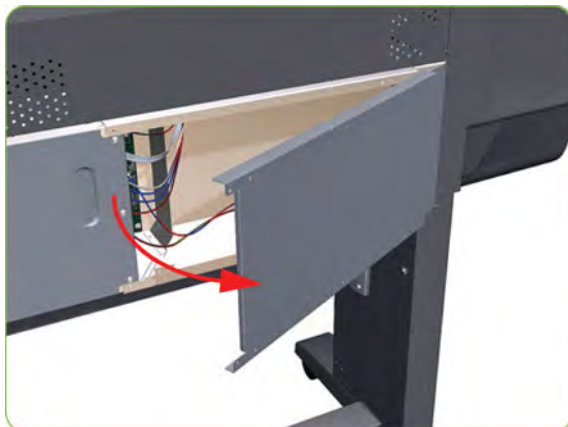

3. Remove the Electronics Module Extension from the printer.

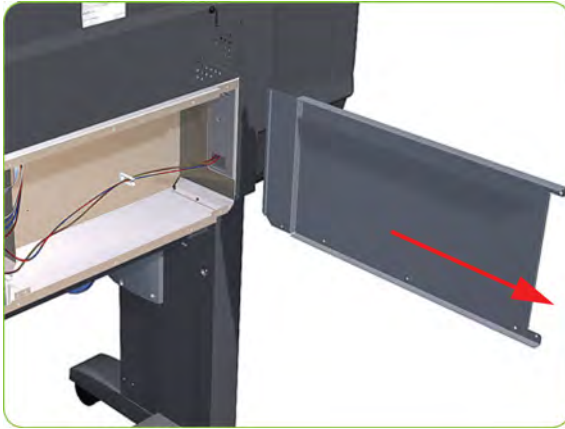

Window Position Sensor

Removal

WARNING! Switch **off** the printer and remove the power cable.

1. Remove the Window:
 - For the 42-inch ⇒ See [Window \(42-inch\) on page 231](#).
 - For the 60-inch ⇒ See [Window \(60-inch\) on page 233](#).
2. Remove the Left Cover ⇒ See [Left Cover on page 240](#).
3. Remove the Right Cover ⇒ See [Right Cover on page 235](#).
4. Remove the Top Cover:
 - For the 42-inch ⇒ See [Top Cover \(42-inch\) on page 243](#).
 - For the 60-inch ⇒ See [Top Cover \(60-inch\) on page 249](#).
5. Remove the Right Connector Cover ⇒ See [Right Connector Cover on page 258](#).
6. 60-inch printer only: Remove three T-15 screws.

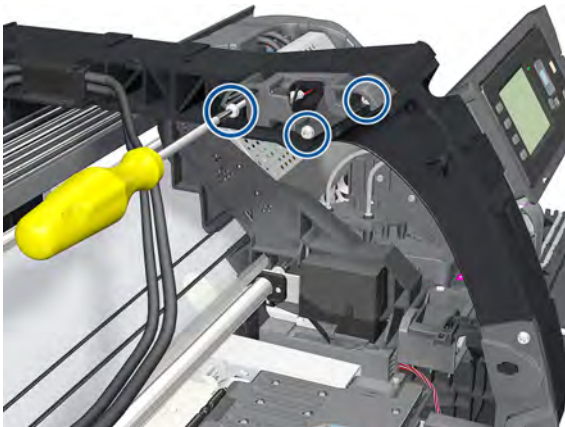

7. 60-inch printer only: Carefully gain access to the window position sensor.

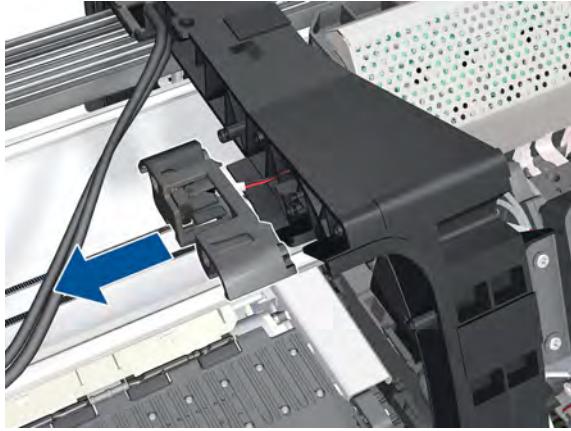

8. Press the clip.

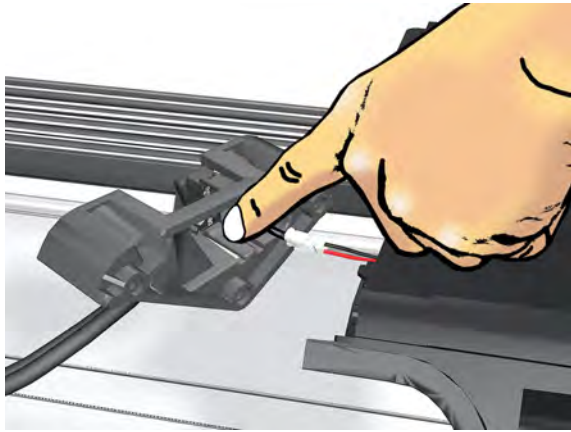

9. Remove the Window Position Sensor holder.



10. Disconnect and remove the sensor.



11. Pull the cable through the hole.

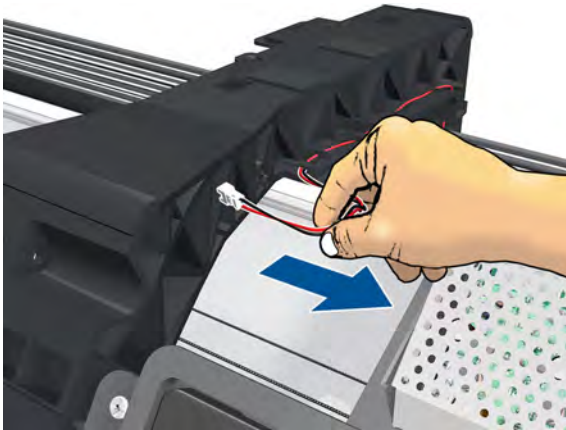

12. Unroute the cable from the right arc.

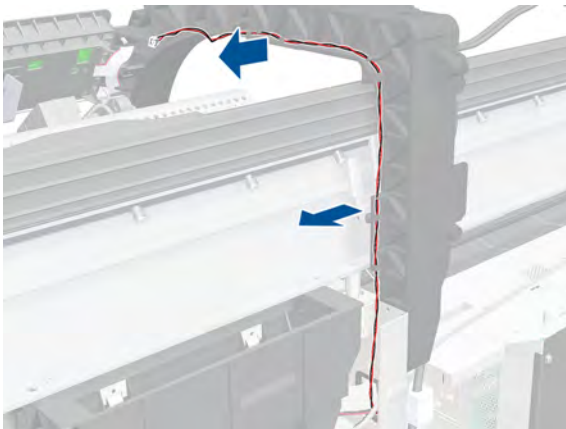

13. Disconnect the cable from the Main PCA.

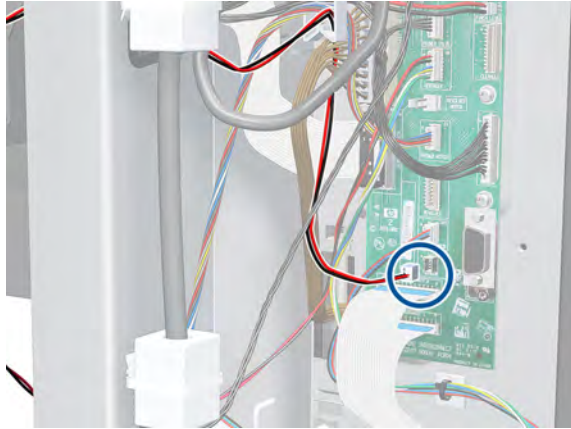

14. Unroute the cable from the cable clamp, and remove the cable.

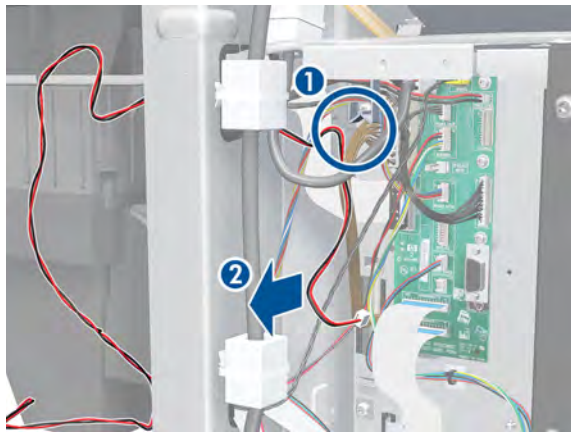

Front Panel

Removal

⚠ WARNING! Switch **off** the printer and remove the power cable.

1. Remove the Right Cover ⇒ See [Right Cover on page 235](#).
2. Remove the Right Connector Cover ⇒ See [Right Connector Cover on page 258](#).

3. Disconnect the Front Panel Cable from the Main PCA.

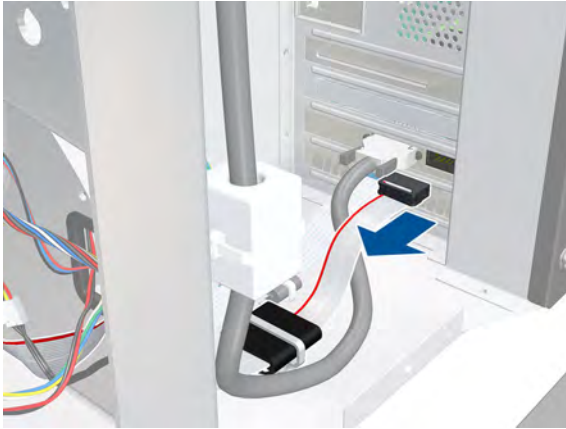

4. Disconnect the Ferrite Clip (located on the rear of the Electronics Module).

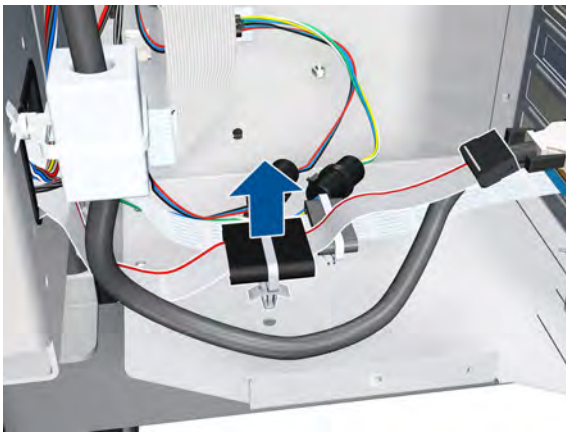

5. Move the Front Panel Cable (including the ferrite) out of the Electronics Module.

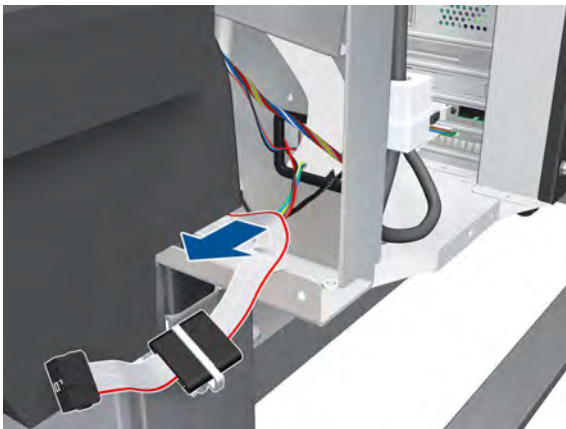

6. Release the Front Panel Cable from the Right Arc.



7. Remove two T-15 screws (Type G) that secure the Front Panel to the printer.



8. Remove the Front Panel from the printer.



Primer Assembly

Removal

 **WARNING!** Switch off the printer and remove the power cable.

1. Remove the Right Cover ⇒ See [Right Cover on page 235](#).
2. Remove the Right Connector Cover ⇒ See [Right Connector Cover on page 258](#).
3. Remove the Front Panel ⇒ See [Front Panel on page 265](#).
4. Disconnect the Primer Assembly cable from the Interconnect PCA.

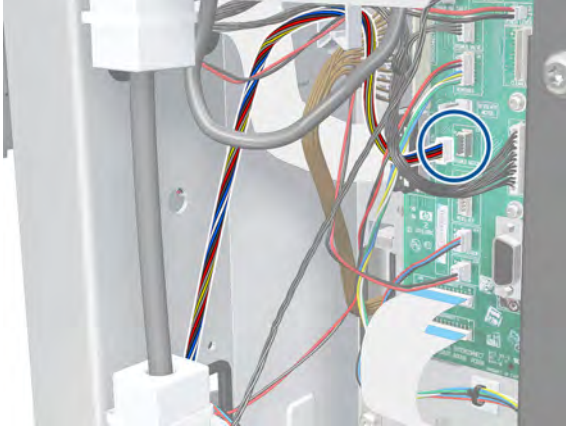

5. Unroute the cable from the cable clamp.

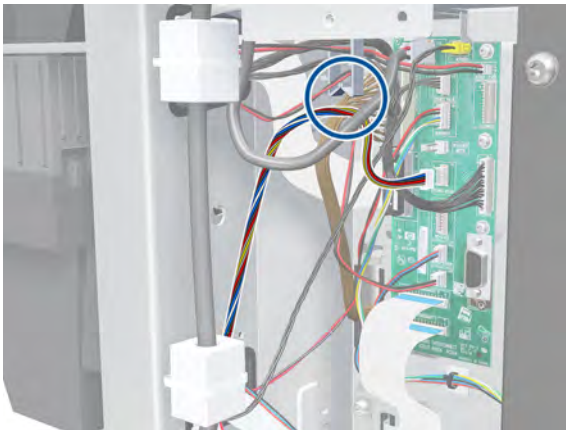

6. Move the cable out of the Electronics Module.



7. Disconnect the two Primer Assembly tubes.

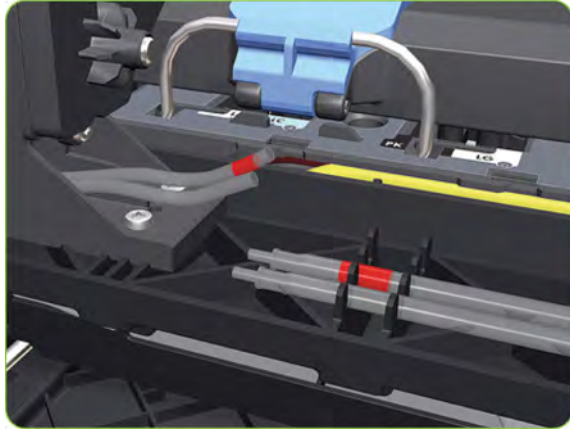

8. Remove four T-10 screws that secure the Primer Assembly to the Service Station.

 **NOTE:** Use a short screw driver, less than 10 cm in length.

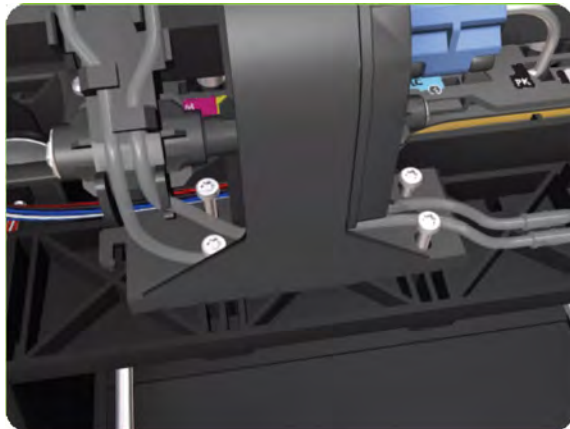

9. Remove the Primer Assembly from the Service Station.

 **NOTE:** When installing the Primer Assembly, use the identification marks on the Primer Assembly Tubes to ensure they are correctly connected.



Primer Valves

Removal

⚠ WARNING! Switch **off** the printer and remove the power cable.

1. Remove the Right Cover ⇒ See [Right Cover on page 235](#).
2. Disconnect the Primer Valve Cables.

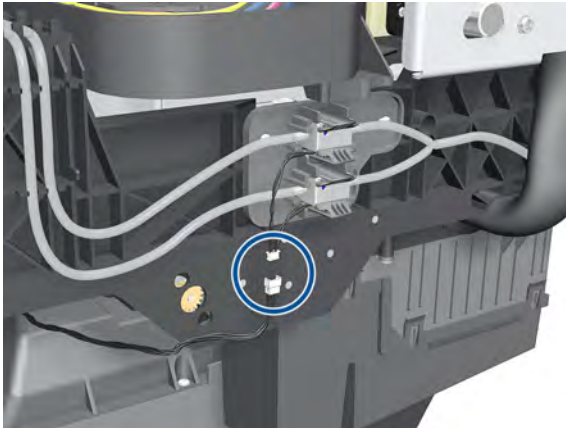

3. Disconnect the Primer Valve tubes.

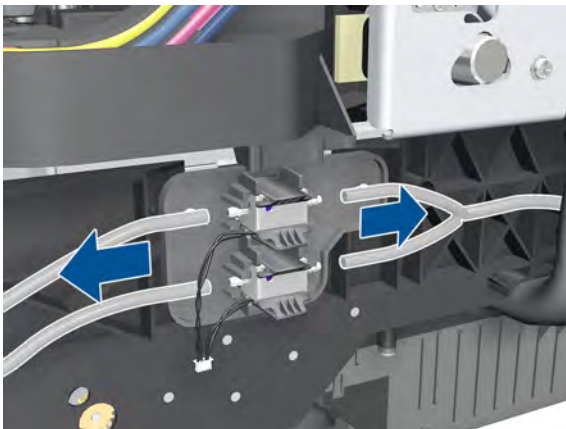

4. Remove two T-15 screws.

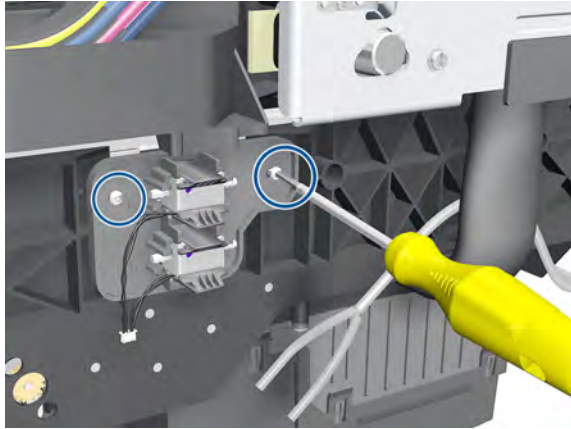

5. Remove the Primer Valves.

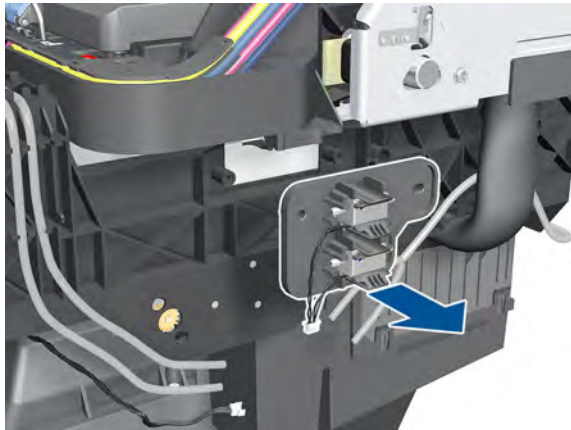

Primer Valve Cables

Removal

⚠ WARNING! Switch **off** the printer and remove the power cable.

1. Remove the Right Cover ⇒ See [Right Cover on page 235](#).
2. Remove the Right Connector Cover ⇒ See [Right Connector Cover on page 258](#).

3. Disconnect both Primer Valves from the Interconnect PCA.

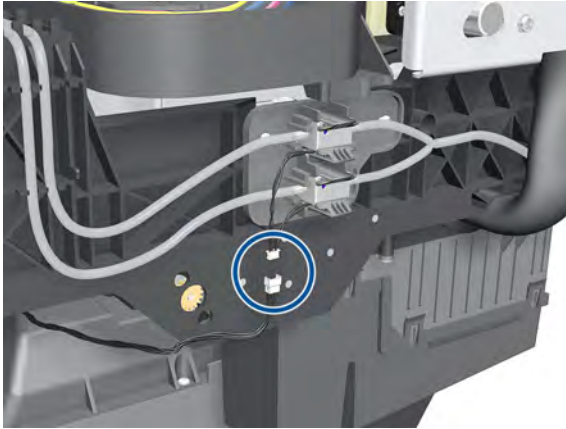

4. Unplug the power cable.

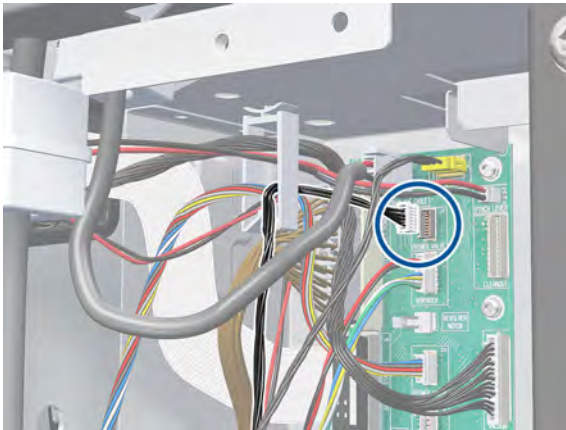

5. Unroute the Primer Valve cables from the cable clamp.

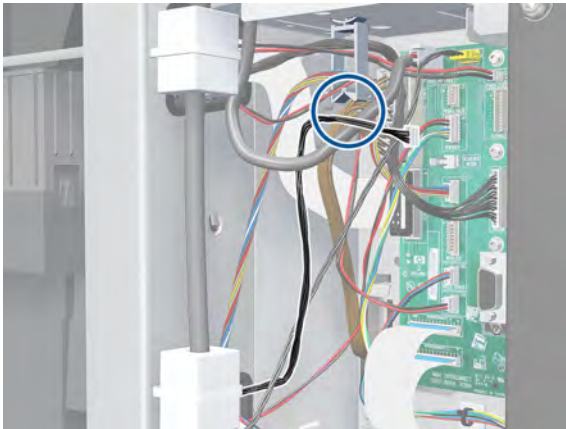

6. Unroute the power cable.

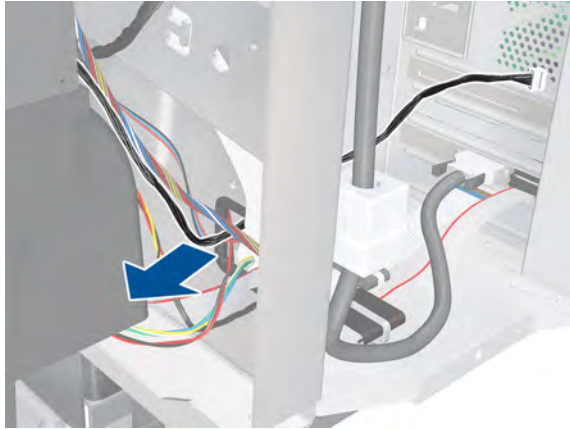

7. Completely unroute the Primer Valve cables from the Service Station.



Service Station

Removal

 **WARNING!** Switch **off** the printer and remove the power cable.

1. Remove the Right Cover ⇒ See [Right Cover on page 235](#).
2. Remove the Primer Assembly ⇒ See [Primer Assembly on page 267](#).
3. Remove the Primer Valves ⇒ See [Primer Valves on page 270](#).
4. Remove the Drop Detector ⇒ See [Drop Detector on page 284](#).
5. Remove the Right Connector Cover ⇒ See [Right Connector Cover on page 258](#).
6. Remove the Maintenance Cartridge ⇒ See the User's Guide.

7. Disconnect the cable from the Maintenance Cartridge Door Switch.

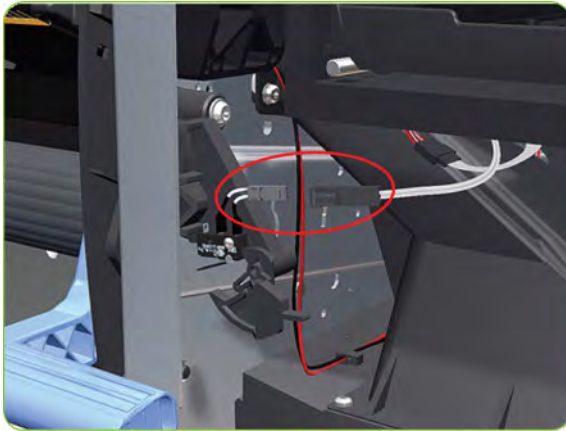

8. Disconnect the Service Station cable (labelled "SS and DD") from the Interconnect PCA.

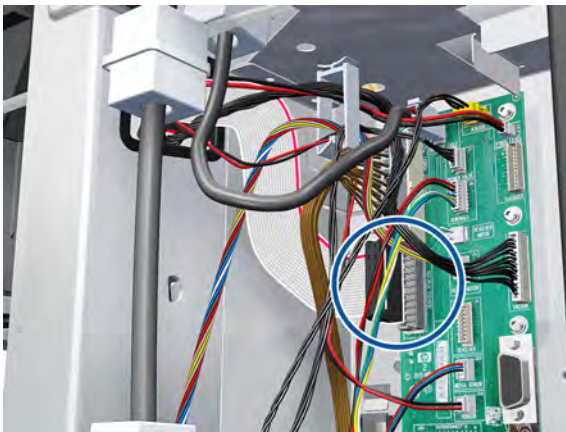

9. Unroute the Service Station cable.

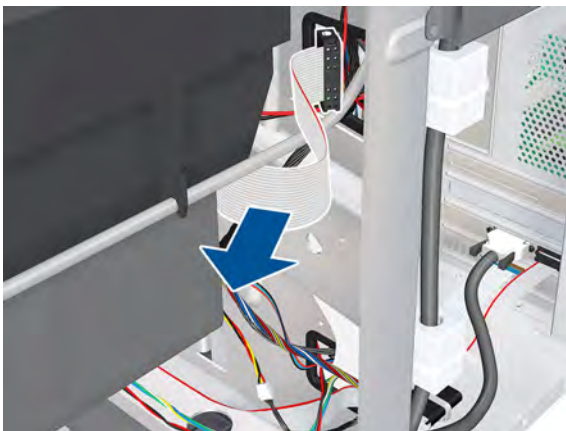

10. Disconnect the Aerosol Fan cable.

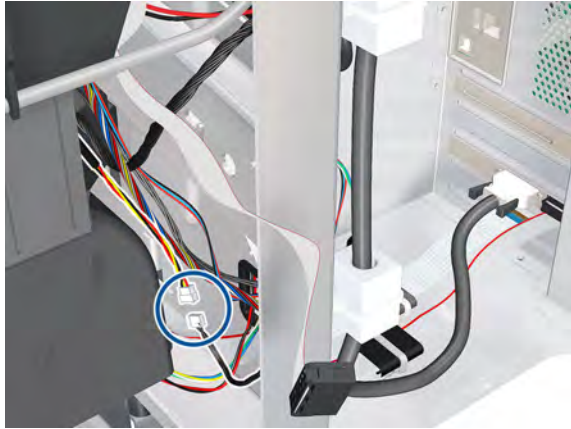

11. Unroute the Primer Assembly Valves tube from the Service Station.

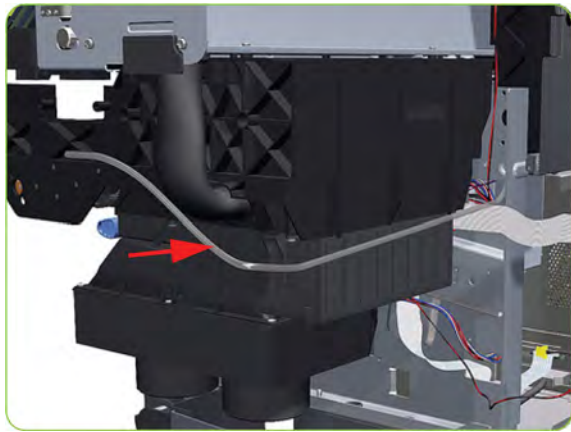

12. Remove two T-15 screws (**Type J**) that secure the rear of the Service Station to the Chassis.

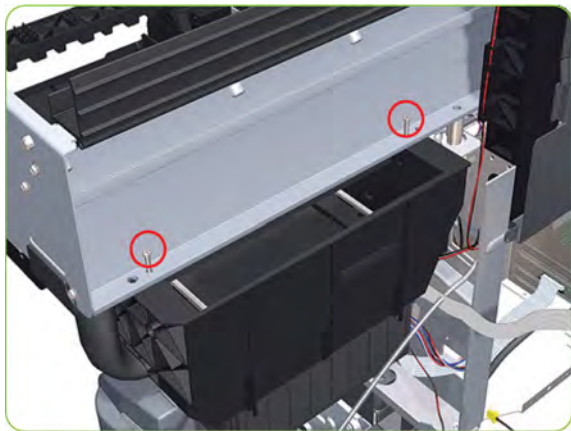

13. Remove four T-15 screws (**Type J**) that secure the Service Station to the Chassis.

 **CAUTION:** When removing the screws, please be very careful NOT to damage the Encoder Strip.

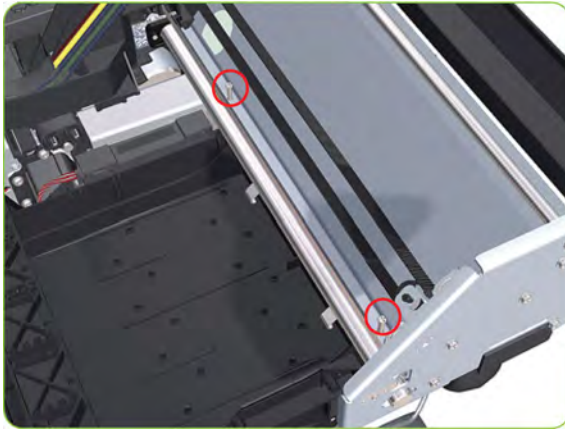

14. Disconnect the Aerosol Fan Tube from the Chassis.

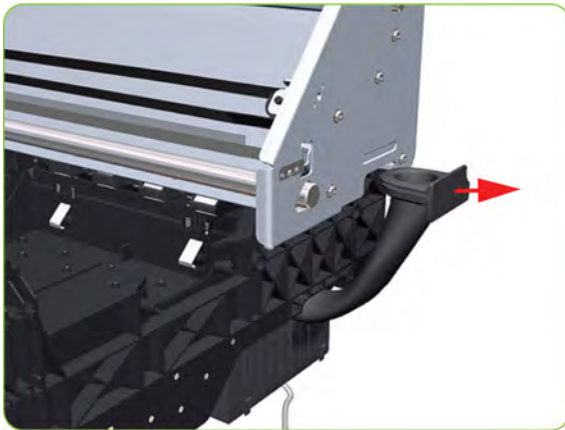

15. Lower the right side of the Service Station.



16. Remove the Service Station from the printer.

 **NOTE:** After installing the NEW Service Station, make sure you perform the following Service Utility:

- Reset Counter PHC spittoon ⇒ [Reset Life Counters on page 116.](#)

 **NOTE:** After installing the NEW Service Station, make sure you perform the following Service Calibration:

- Drop Detector calibration ⇒ [Drop Detector calibration on page 137.](#)

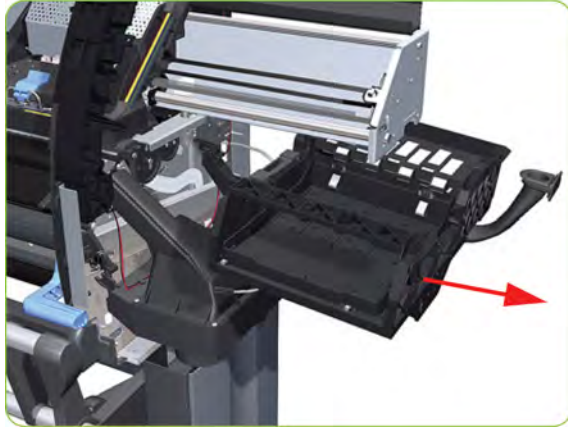

Removal of the Service Station Scraper

1. Release the clip securing the Scraper to the Service Station.

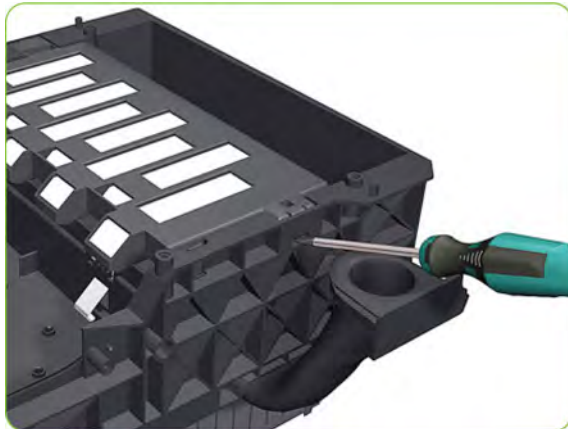

2. Remove the Scraper from the Service Station.



Vacuum Fan

Removal

⚠ WARNING! Switch off the printer and remove the power cable.

1. Remove the Right Cover ⇒ See [Right Cover on page 235](#).
2. Remove the Primer Assembly ⇒ See [Primer Assembly on page 267](#).
3. Remove the Primer Valves ⇒ See [Primer Valves on page 270](#).
4. Remove the Maintenance Cartridge ⇒ See the User's Guide.
5. Remove the Service Station ⇒ See [Service Station on page 273](#).
6. Disconnect the cable labelled on the Vacuum Fan PCA as "Interconnect Cable".

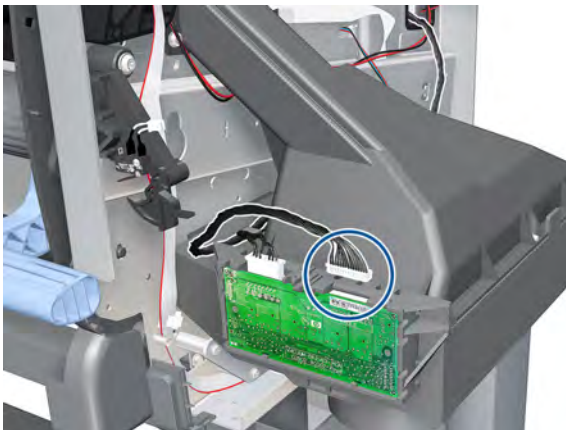

7. Unroute the cable.

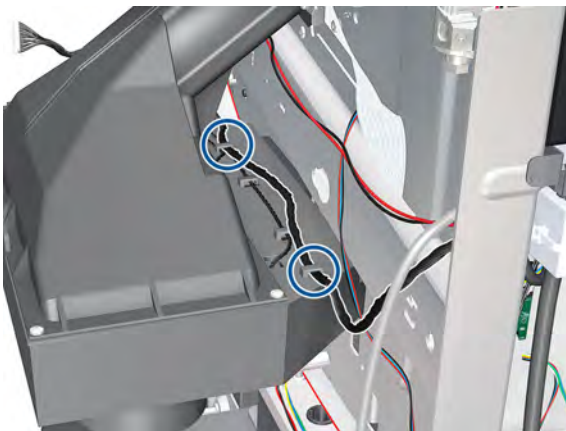

8. Remove four T-20 screws (**Type B**) that secure the Vacuum Fan to the printer.

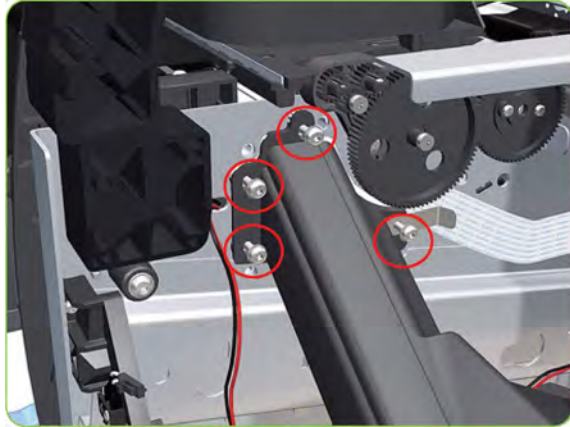

9. Remove the OMAS cable clamp from the printer.

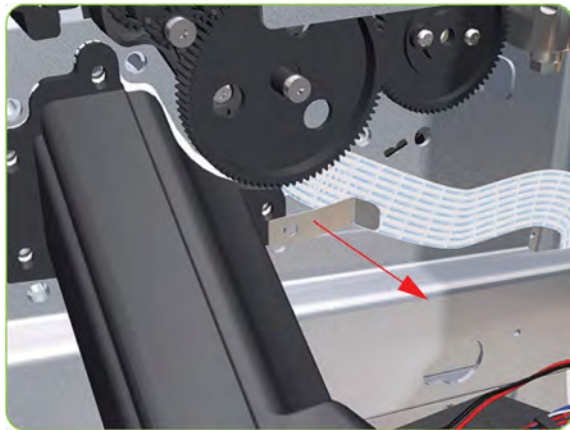

10. Lower then lift the Vacuum Fan out of its attachment.

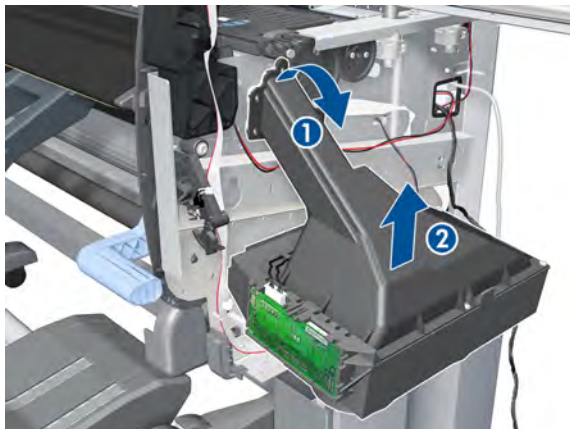

11. Remove the Vacuum Fan from the printer.

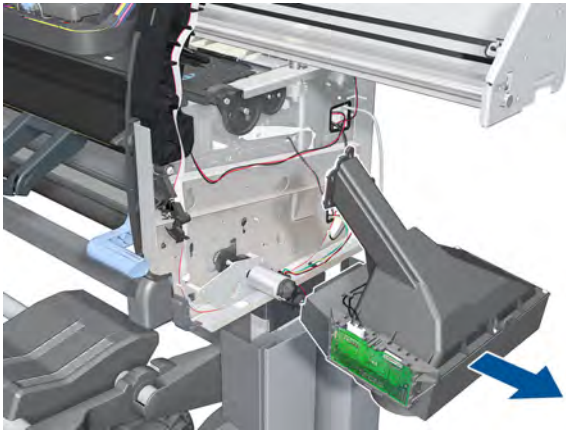

 **NOTE:** After installing the new Vacuum Fan, make sure you perform the following Service Calibration:

- Paper-advance calibration ⇒ [Paper-advance calibration on page 134](#).

Vacuum Fan Cable

Removal

 **WARNING!** Switch off the printer and remove the power cable.

1. Remove the Right Cover ⇒ See [Right Cover on page 235](#).
2. Remove the Right Connector Cover ⇒ See [Right Connector Cover on page 258](#).
3. Disconnect the cable labelled on the Vacuum Fan PCA as “Interconnect Cable”.

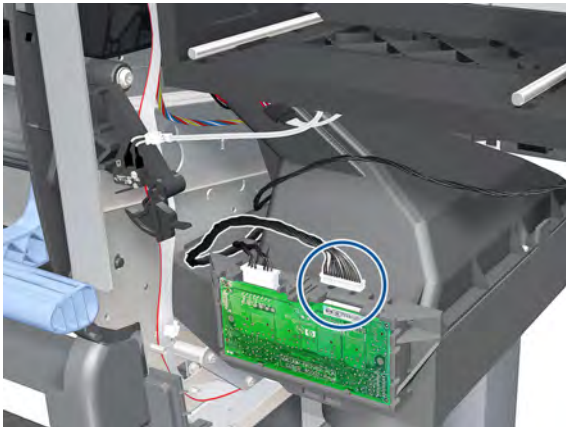

4. Unroute the cable.

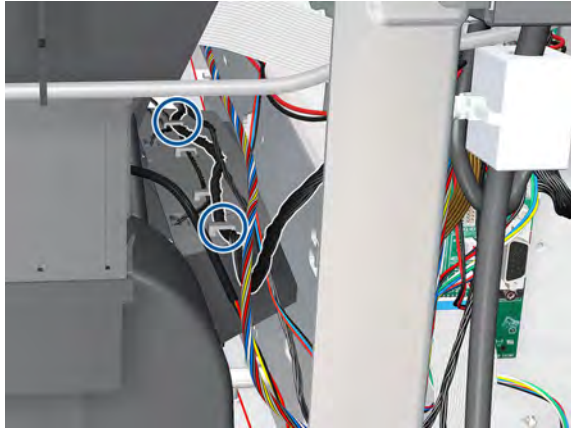

5. Disconnect the cable.

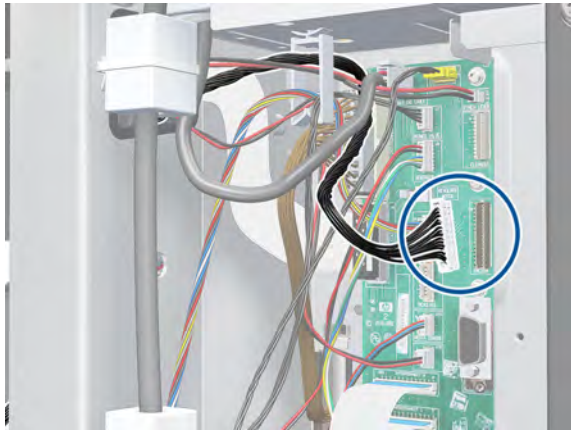

6. Unroute the cable from the cable clamp.

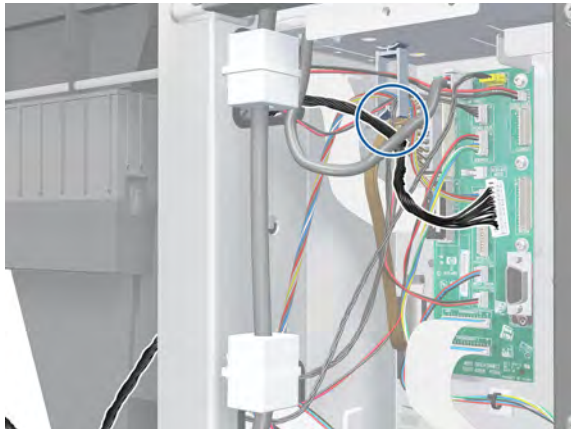

7. Remove the cable.

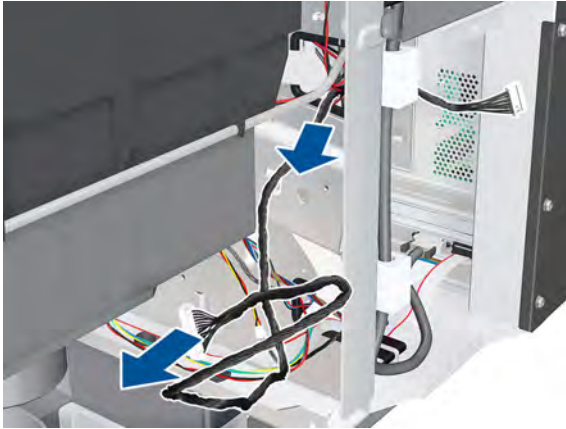

 **NOTE:** After installing the new Vacuum Fan, make sure you perform the following Service Calibration:

- Paper-advance calibration ⇒ [Paper-advance calibration on page 134.](#)

Aerosol Fan and Filter

Removal

 **WARNING!** Switch off the printer and remove the power cable.

1. Remove the Right Cover ⇒ See [Right Cover on page 235.](#)
2. Remove the Rear Door:
 - For the 42-inch model ⇒ See [Rear Door \(42-inch\) on page 254.](#)
 - For the 60-inch model ⇒ See [Rear Door \(60-inch\) on page 256.](#)
3. Remove the Right Connector Cover ⇒ See [Right Connector Cover on page 258.](#)
4. Remove the Service Station ⇒ See [Service Station on page 273.](#)
5. Remove four T-15 screws (**Type G**) that secure the Aerosol Fan to the Service Station.



6. Remove the Aerosol Fan from the Service Station.

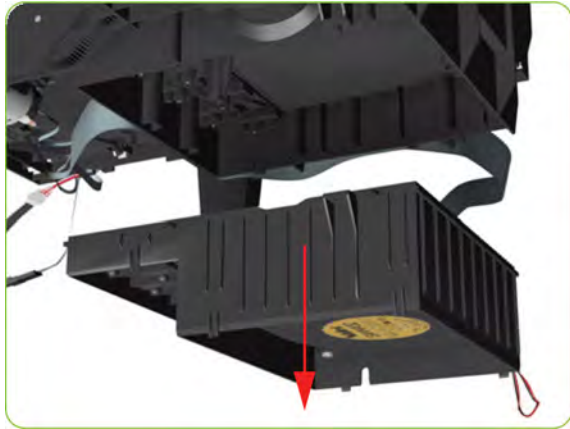

7. If necessary, remove the Aerosol Fan Filter from the Aerosol Fan.

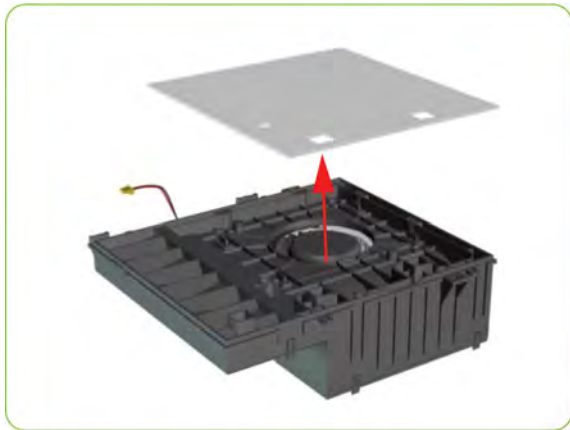

Installing

When the new aerosol Fan and Filter have been installed, it is important to check that the fan is functioning correctly, otherwise the printer will suffer from Aerosol spray. To check that the fan is working correctly, make sure the printer is printing and check for airflow in the area of the rear of the Service Station.

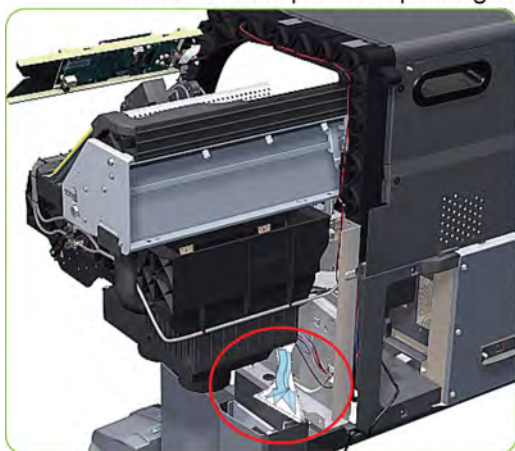

Drop Detector

Removal

⚠ WARNING! Switch off the printer and remove the power cable.

1. Remove the Right Cover ⇒ See [Right Cover on page 235](#).
2. Disconnect the Drop Detector Cable from the Service Station Cable.

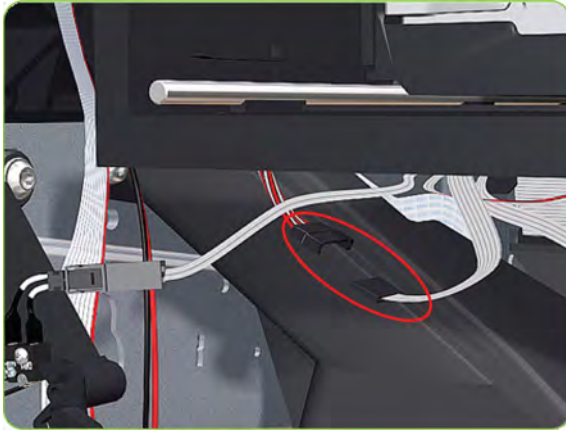

3. Release the Drop Detector Cable from the Service Station.

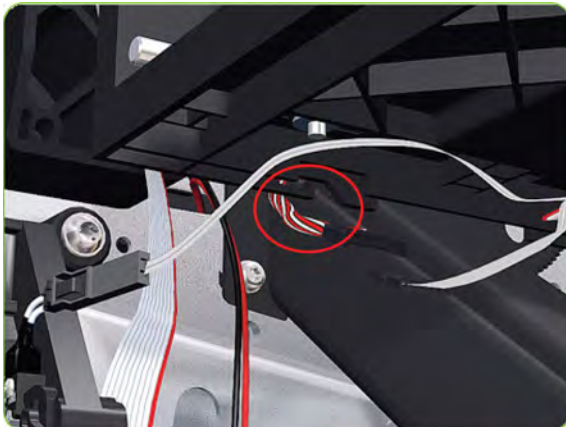

4. Pull out the Maintenance Cartridge fully from the Service Station to release the Carriage Assembly.



5. Lift the Primer and hold it as high as possible to avoid damaging it when you move the Carriage Assembly in the next step.

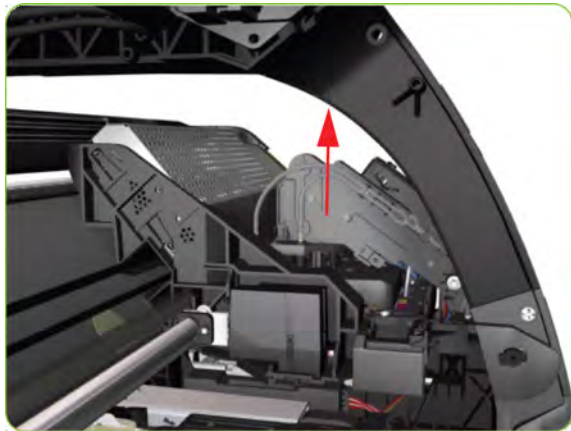

6. Slide the Carriage Assembly leftwards into the print path so that you can reach the Drop Detector.

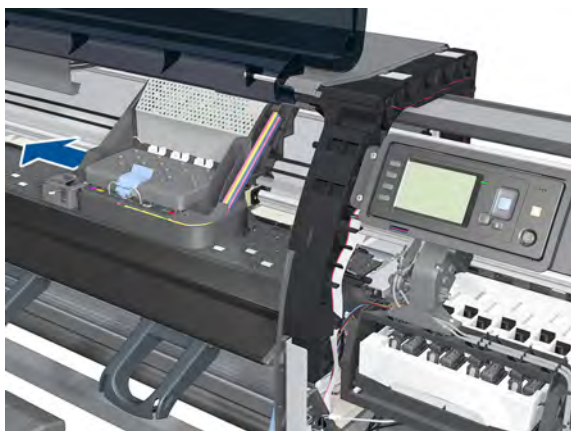

7. Remove one T-8 screw (**Type K**) that secures the Drop Detector to the Service Station.

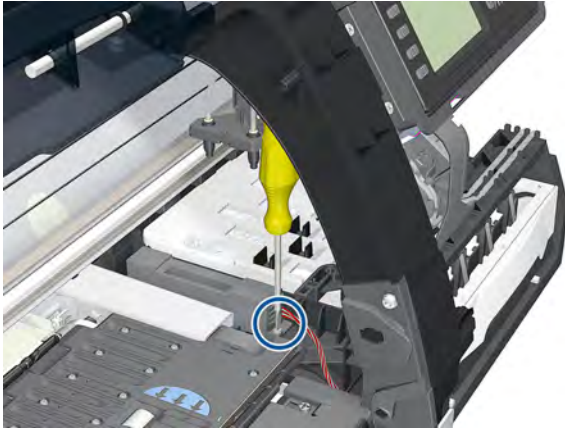

8. Slide the Drop Detector forward so you can release it from the Service Station.



9. Remove the Drop Detector from the printer.

 **NOTE:** After installing the new Drop Detector, make sure you perform the following Service Calibration:

- Drop Detector calibration ⇒ [Drop Detector calibration on page 137.](#)

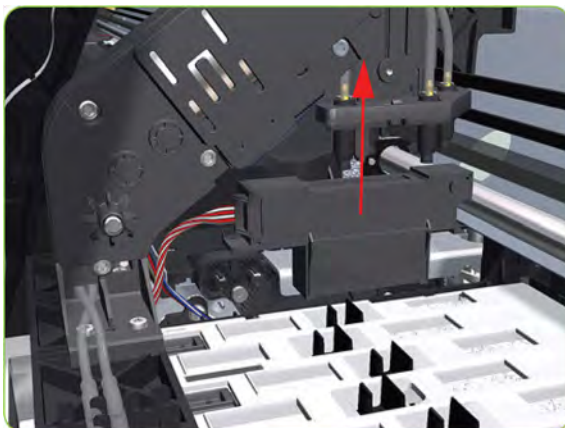

Ink Supply Tubes and Trailing Cable

Removal

⚠ WARNING! Switch off the printer and remove the power cable.

⚠ CAUTION: You MUST NEVER replace both the Hard Disk Drive and the Ink Supply Tubes and Trailing Cable at the same time. If both parts need to be replaced, you MUST first replace one part and then power **ON** the printer until it completely initializes. Then you can power **OFF** the printer and replace the other part.

1. Remove the Window:
 - For the 42-inch ⇒ See [Window \(42-inch\) on page 231](#).
 - For the 60-inch ⇒ See [Window \(60-inch\) on page 233](#).
2. Remove the Right Cover ⇒ See [Right Cover on page 235](#).
3. Remove the Left Cover ⇒ See [Left Cover on page 240](#).
4. Remove the Top Cover ⇒ See [Top Cover \(60-inch\) on page 249](#).
5. Remove the Rear Door ⇒ See [Rear Door \(60-inch\) on page 256](#).
6. Remove the Right Connector Cover ⇒ See [Right Connector Cover on page 258](#).
7. Disconnect the Trailing Cable from the Interconnect PCA and the Main PCA.

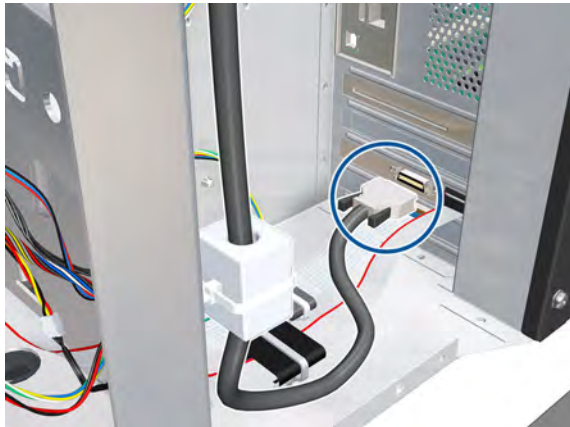

8. Unclip the Trailing Cable ferrites from the left side of the Electronic Module.

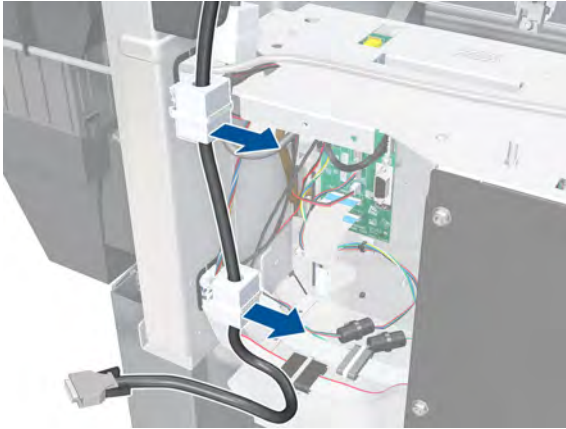

9. Disconnect the Trailing Cable.

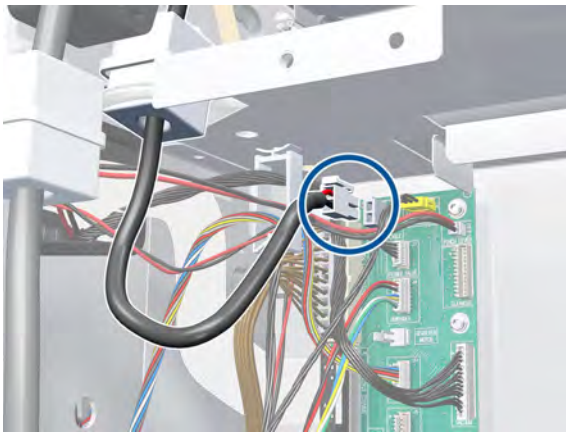

10. Unclip the Trailing Cable ferrite.

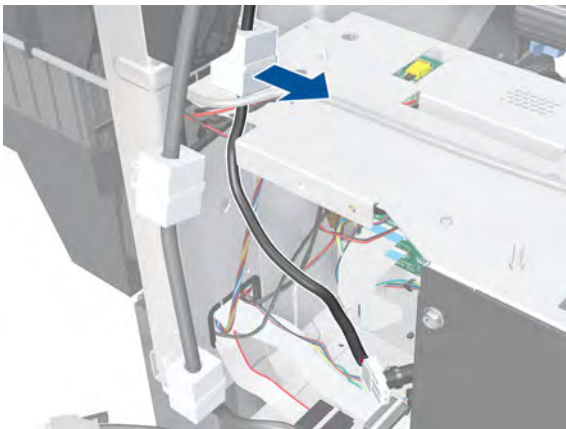

11. Release the two plastic clips securing the Trailing Cable to the Right Arc.

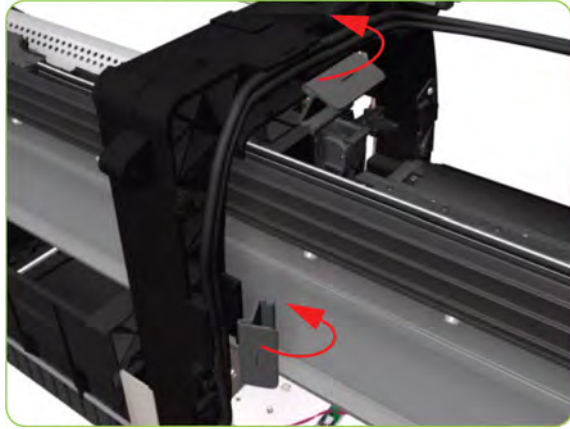

12. Slide out the Maintenance Cartridge.
13. Move the Carriage to the center of the Platen.

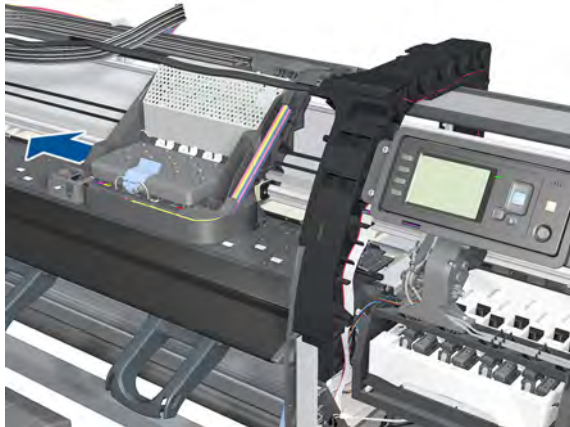

14. Press the two side of the Carriage PCA Cover and unclip from the Carriage Assembly.

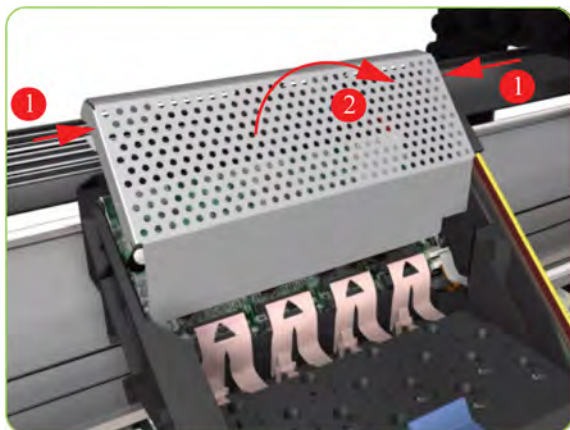

15. Disconnect the Trailing Cable from the Carriage PCA.

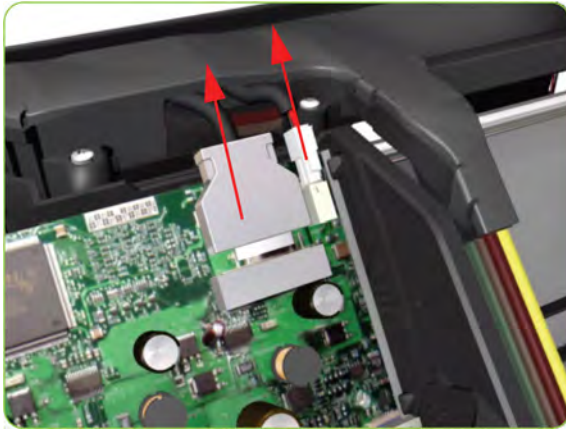

16. Open the Carriage Cover and remove all the Printheads from the Carriage Assembly.

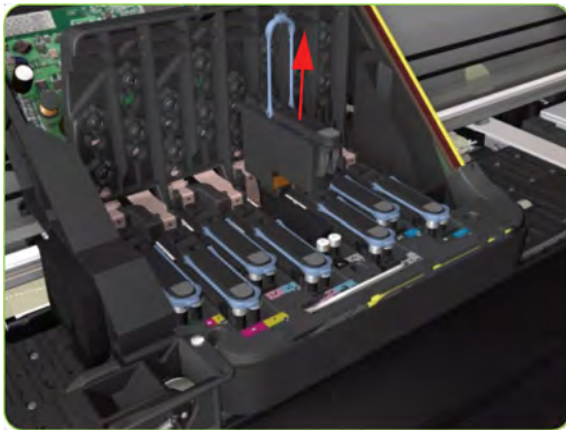

17. Remove five T-15 screws (**Type G**) that secure the Ink Supply Tubes to the Carriage Assembly.

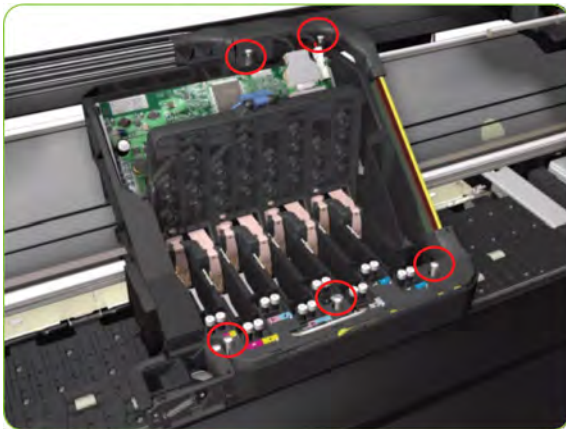

18. Remove the Ink Supply Tubes from the Carriage Assembly and safely place to one side of the printer.

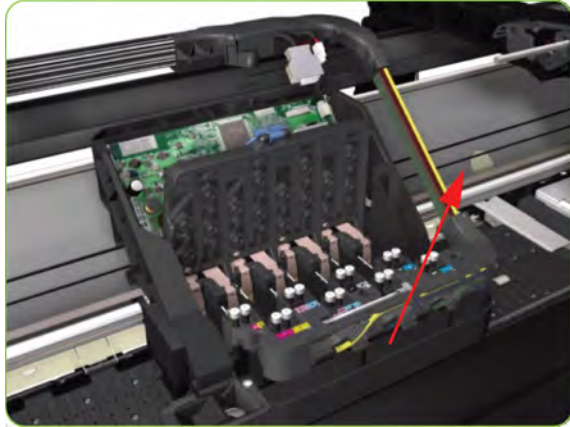

19. Remove one T-20 screw that attaches the bonding cable to the printer chassis.

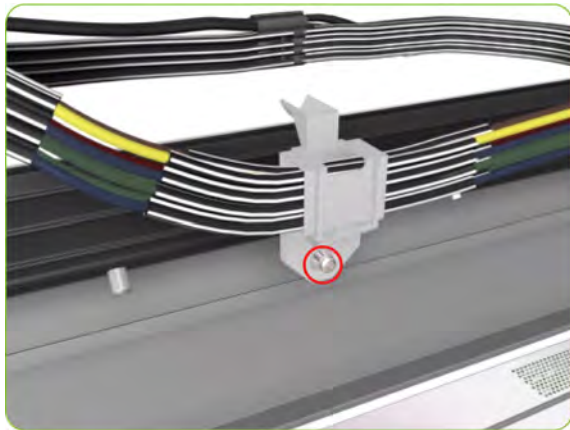

20. Remove two T-20 screws from the ISS Shielding.

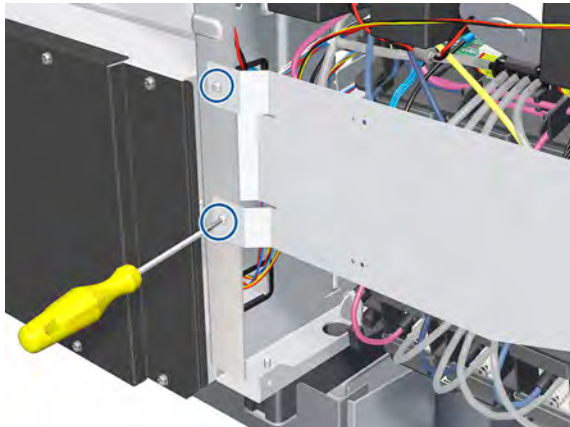

21. Remove the ISS Shielding.

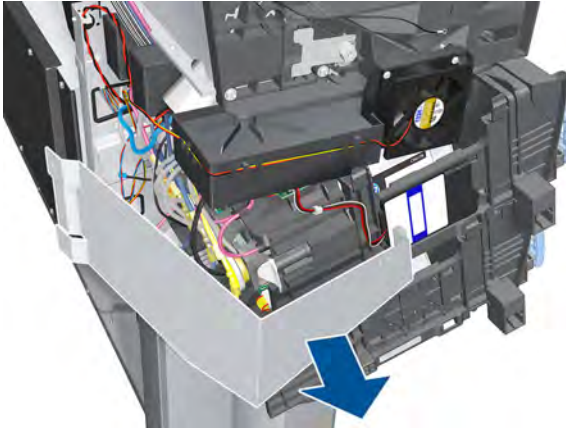

22. Unroute the RFDI cable from the bridle.

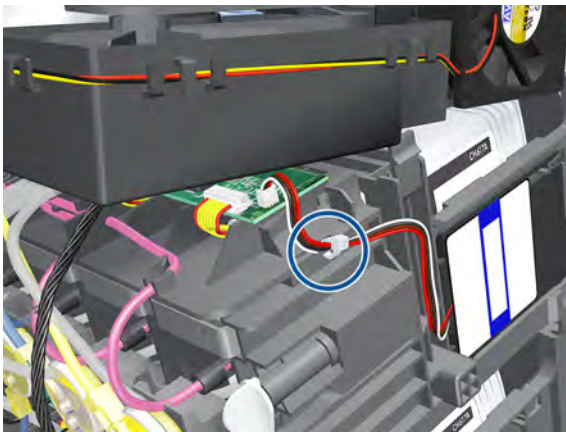

23. Disconnect the RFDI cable.

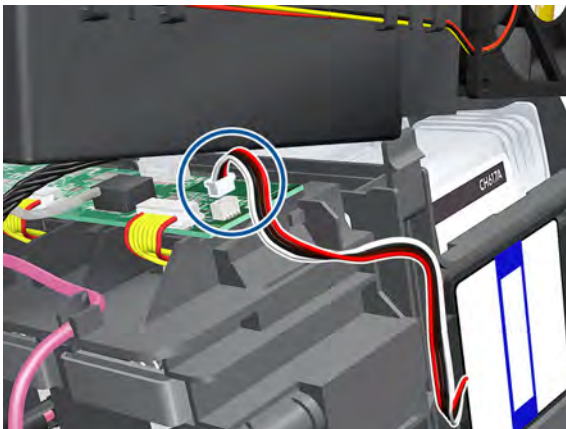

24. Remove the grounding screw.

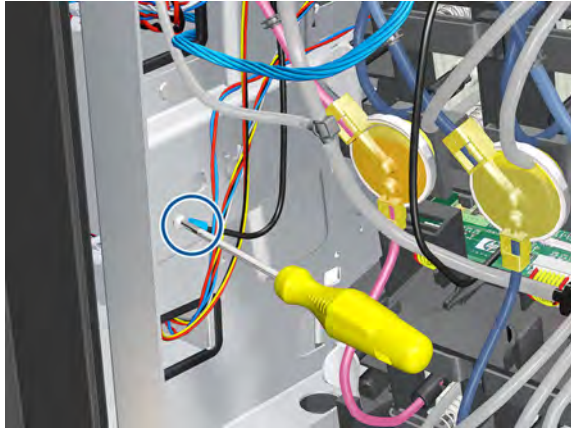

25. Slide out the Ink Cartridges.

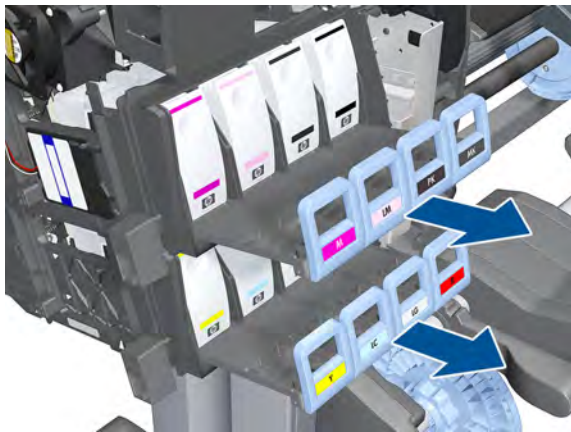

26. Disconnect the Air Tubes from the Ink Cartridge Tube Connector.

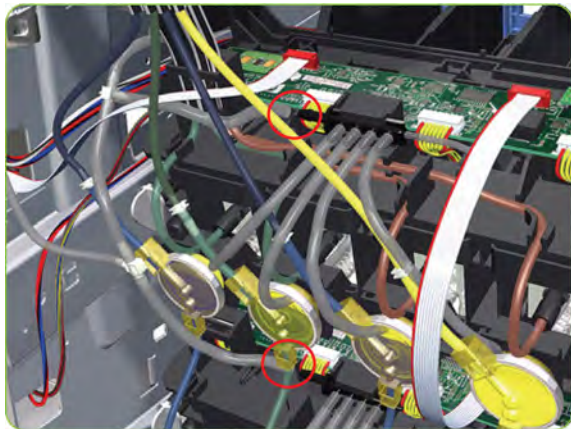

27. Twist the four latches at the rear of the Ink Cartridge Tube Connector and release the complete assembly.

 **NOTE:** Be careful not to damage the interconnecting cable.

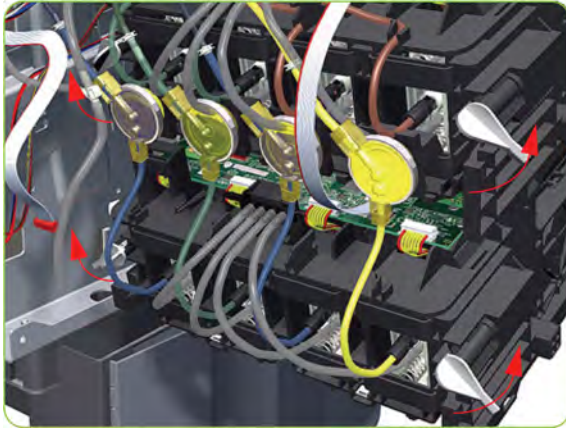

28. Carefully slide the Ink Cartridge Tube Connector off the Ink Supply Station.

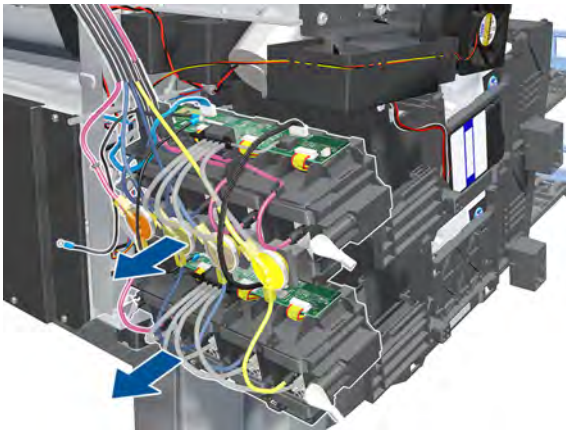

29. Disconnect the cable.

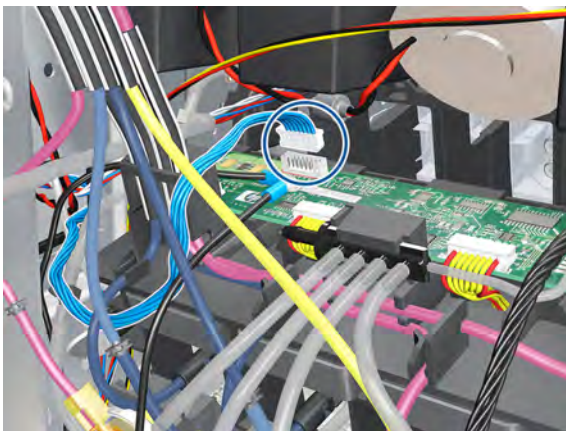

30. Remove the Ink Supply Tubes and Trailing Cable from the printer.

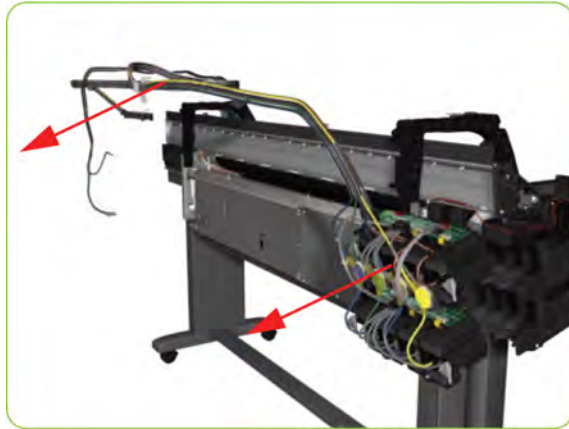

Installation of the Ink Supply Tubes and Trailing Cable

 **NOTE:** After installing the NEW Ink Supply Tubes and Trailing Cable, make sure you perform the following Service Utility:

- Reset life counter scan cycles tubes/cable ⇒ [Reset Life Counters on page 116](#).

 **NOTE:** When installing the Ink Supply Tubes and Trailing Cable on to the Top Cover, take note of the of the two red marks on the Ink Supply Tubes. These two red marks should be aligned with the first slot in the Top Cover as this will help with the rest of the installation.

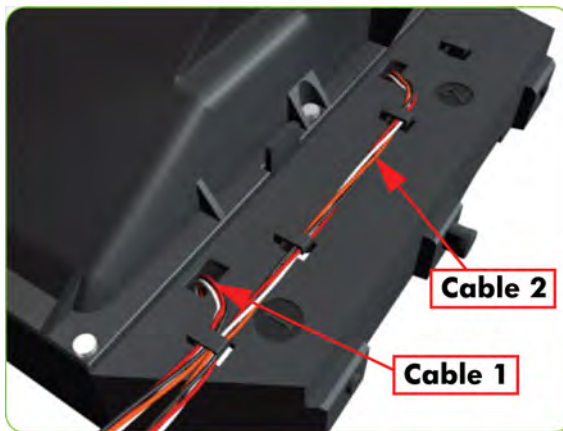

ISS to Cartridge Cables

Removal

 **WARNING!** Switch off the printer and remove the power cable.

1. Remove the Left Cover ⇒ See [Left Cover on page 240](#).

2. Remove two screws.

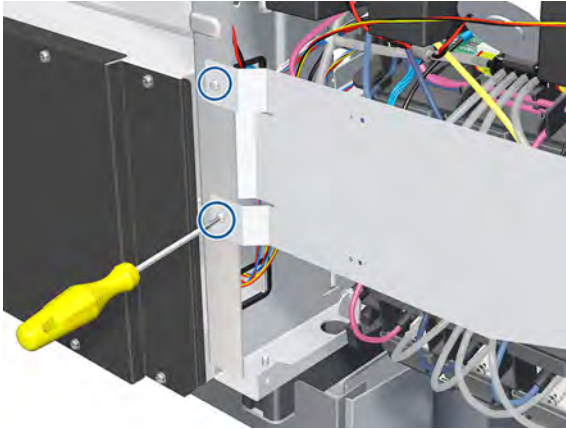

3. Slide out the ISS Shielding.

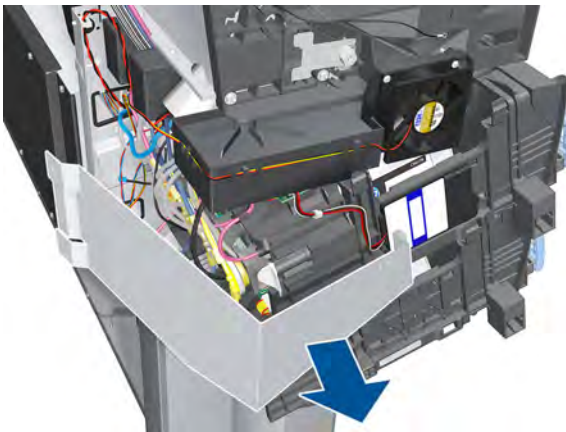

4. Disconnect the ISS to Cartridge Cable from the ISS PCA.

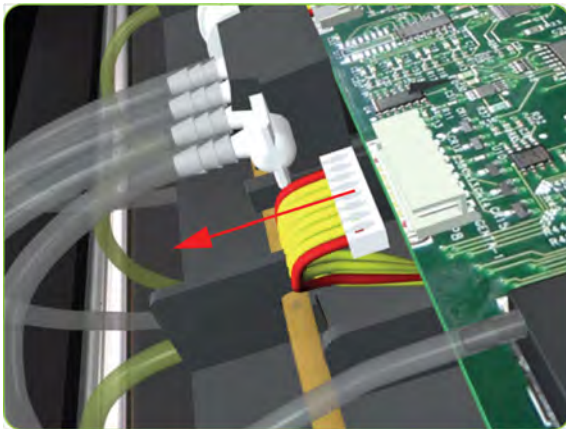

5. Release the clips securing the ISS to Cartridge Cable.

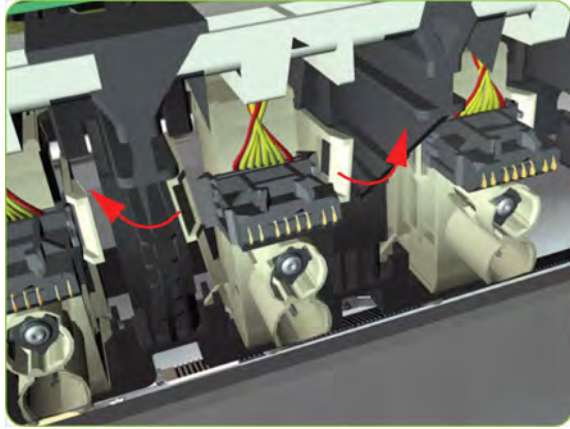

6. Remove the ISS to Cartridge Cable from the printer.

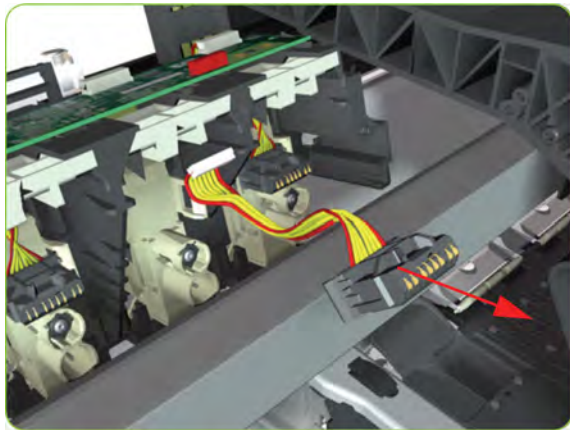

Cutter Assembly

Removal

1. Select **Replace cutter** from Service Menu (see [Replace Cutter on page 118](#)) and follow the instructions on the front panel.
2. Open the Window.



3. Open the Carriage Cover.

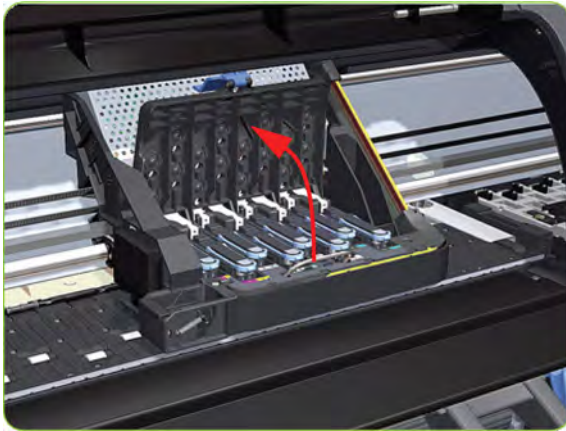

4. Remove one T-15 screw (**Type G**) that secures the Cutter Assembly to the Carriage Assembly.



5. Slide the Cutter Assembly to the left and remove from the printer.



Ink Supply Station (ISS)

Removal

 **WARNING!** Switch off the printer and remove the power cable.

1. Remove the Scan-Axis Motor ⇒ See [Scan-Axis Motor on page 331](#).
2. Remove the Left Spittoon ⇒ See [Left Spittoon on page 311](#).
3. Unroute the RFDI cable from the bridle.

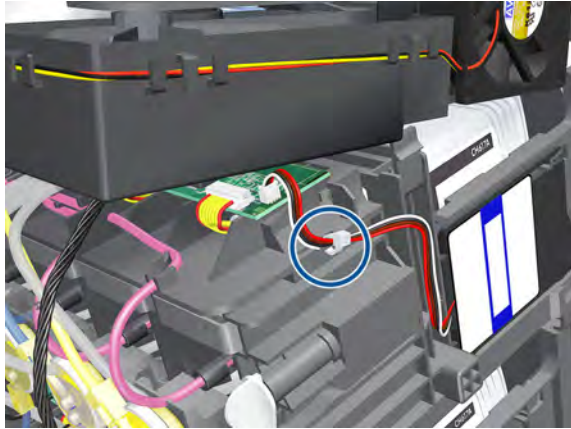

4. Disconnect the RFDI cable.

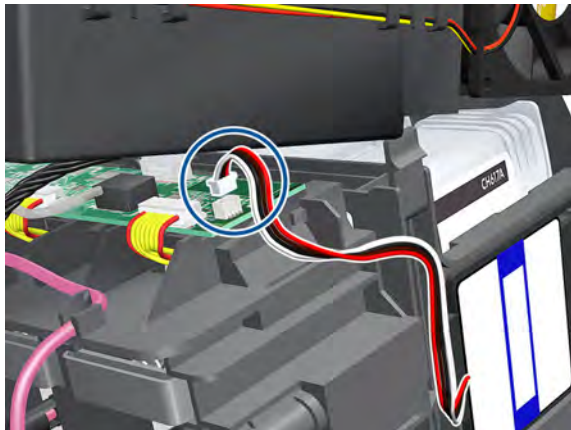

5. Remove the grounding screw.



6. Pull out the top row of Cartridge Trays and remove the Ink Cartridges.

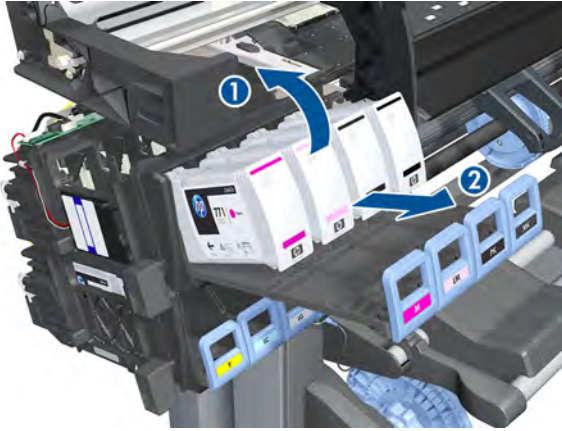

7. Close the top row of Cartridge Trays and pull out the bottom row.

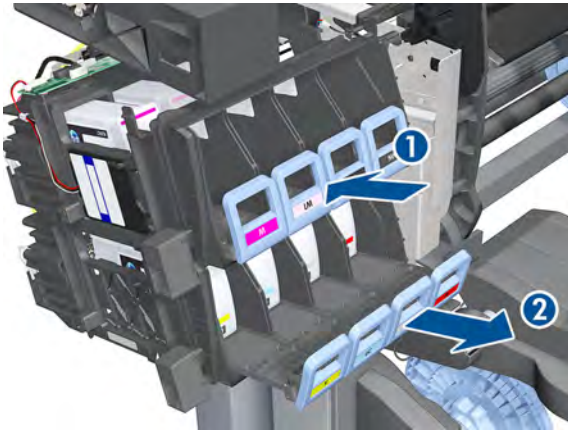

8. Remove the Ink Cartridges and close the bottom row of Cartridge Trays.

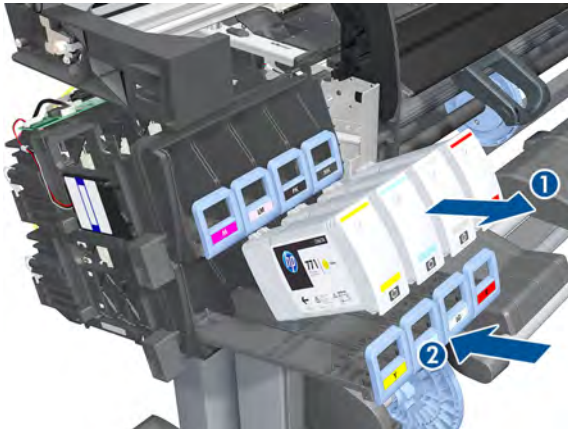

9. Disconnect the top and bottom Air Tubes from the Ink Supply Tubes.

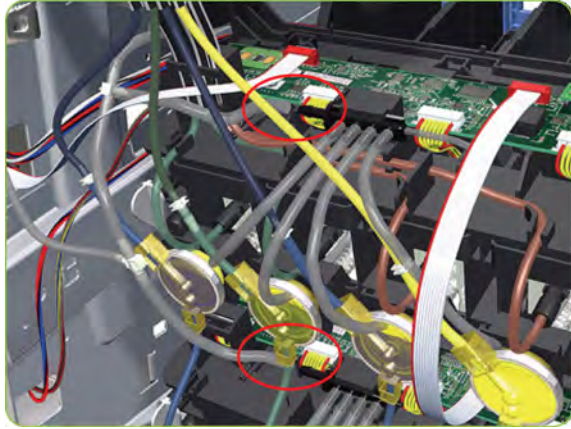

10. Unroute the Air Tubes and Electrical Connector.

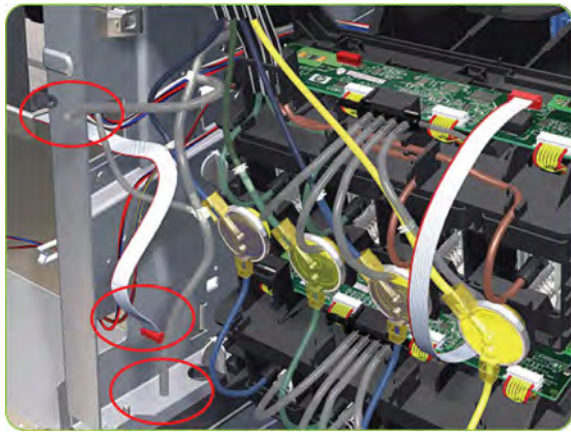

11. Twist the four latches at the rear of the lower Ink Cartridge Tube Connector and release the complete assembly.

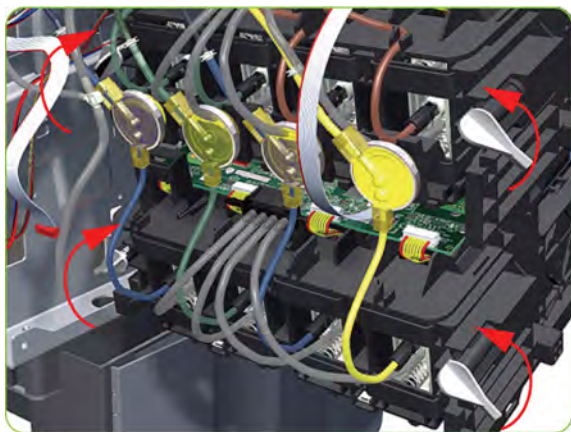

12. Lift the Cartridge Tube Connector off the Ink Supply Station.

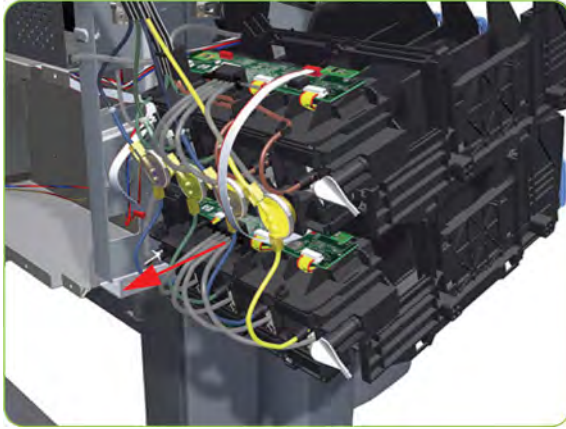

13. Disconnect the cable.

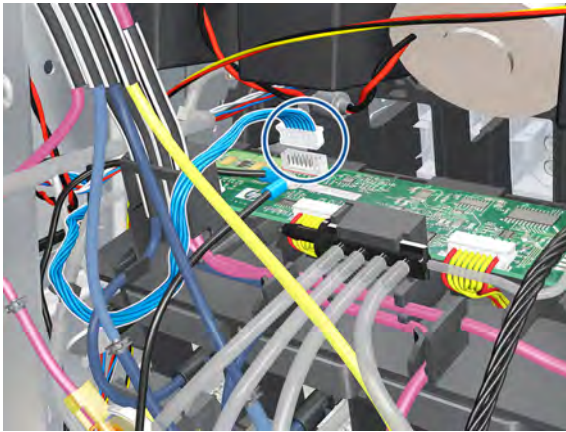

14. Remove the Cartridge Tube Connector from the Ink Supply Station.

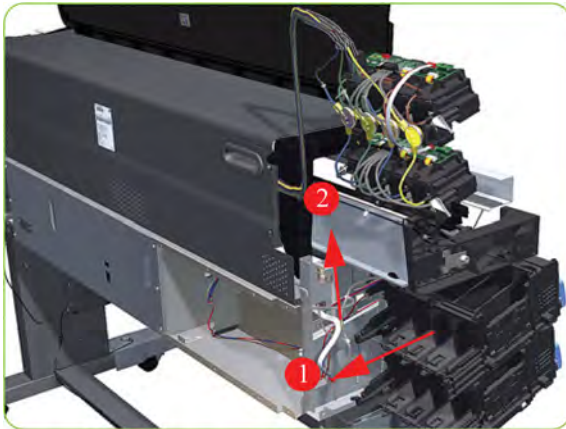

15. Unhook Ink Supply Station cables from the printer.

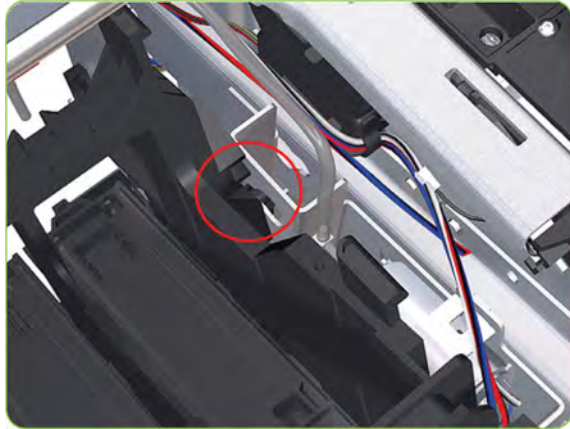

16. Remove the complete Ink Supply Station (upper and lower assemblies) from the printer.

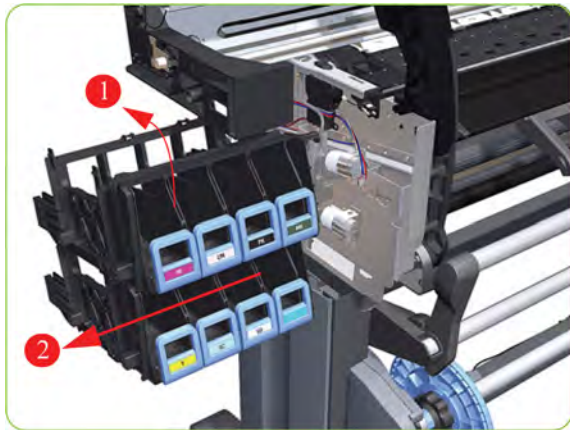

Rewinder Motor

Removal

1. Remove the Right Cover ⇒ See [Right Cover on page 235](#).
2. Remove the Right Leg Cover.

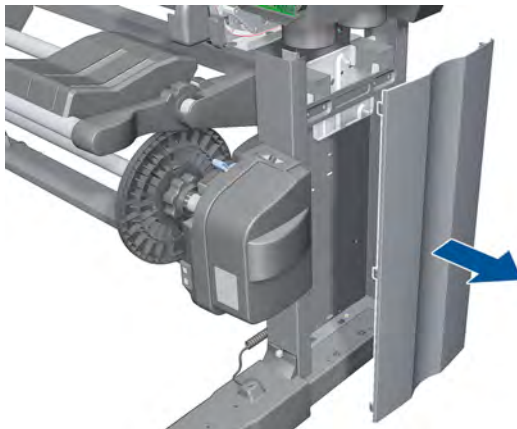

3. Remove the Right Connector Cover ⇒ See [Right Connector Cover on page 258](#).
4. Unclip the ferrite in the Rewinder Plate.

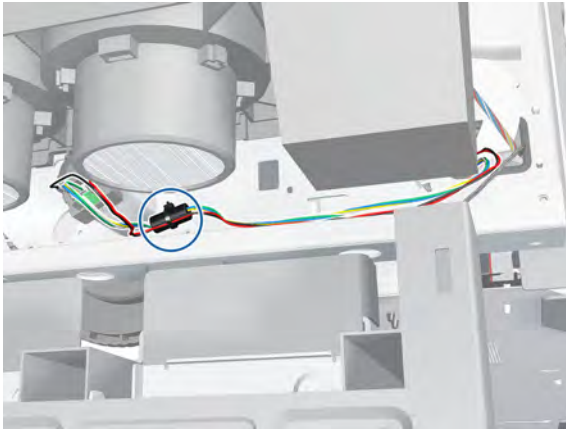

5. Disconnect the two Rewinder cables from the Interconnect PCA.

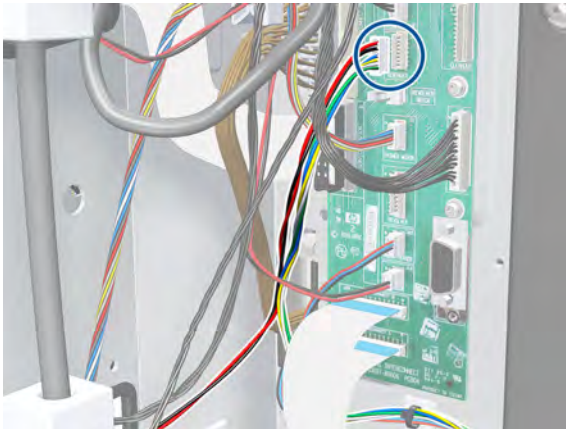

6. Unclip the ferrite from the Rewinder Cable.

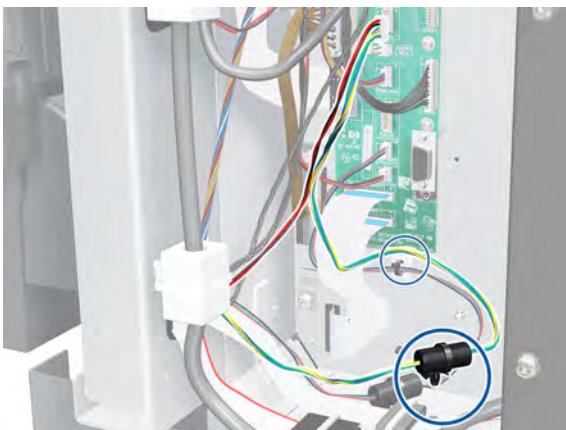

7. Remove four T-20 screws from the Rewinder Motor.

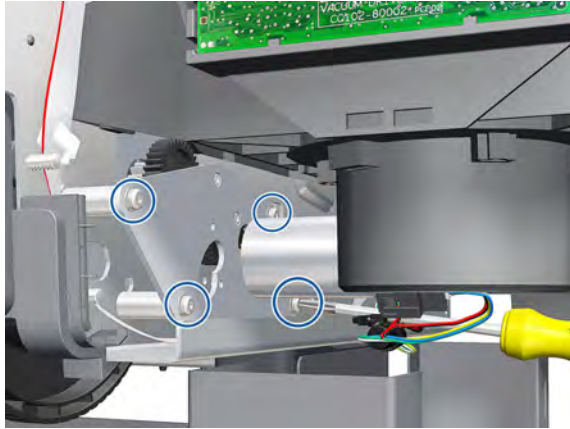

8. Remove the Rewinder Motor.

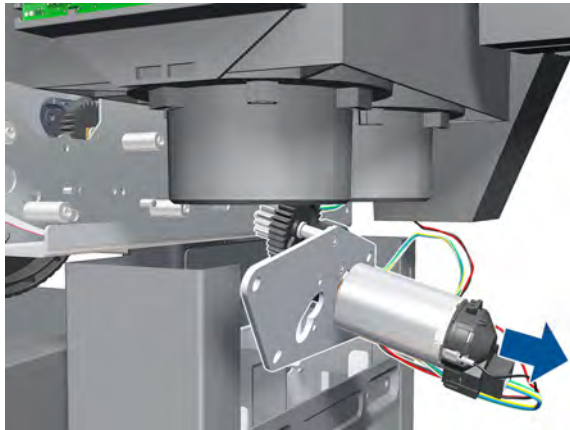

APS Assembly

Removal

⚠ WARNING! Switch off the printer and remove the power cable.

1. Remove the Left Cover ⇒ See [Left Cover on page 240](#).
2. Remove:
 - The Left Connector Cover or the 42-inch model ⇒ See [Left Connector Cover \(42-inch\) on page 260](#).
 - The Electronics Module Extension the 60-inch model ⇒ See [Electronics Module Extension \(60-inch only\) on page 261](#).
3. Remove the Scan-Axis Motor ⇒ See [Scan-Axis Motor on page 331](#).
4. Remove the Left Spittoon ⇒ See [Left Spittoon on page 311](#).
5. Remove the ISS ⇒ See [Ink Supply Station \(ISS\) on page 298](#).

6. Disconnect the Relief Valve cable and the white Air Pump 1 cable.

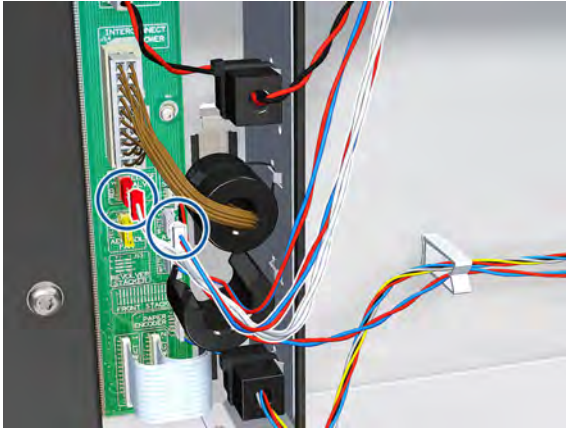

7. Remove both cables from the ferrite.



8. Unroute both cables from the cable clamps.

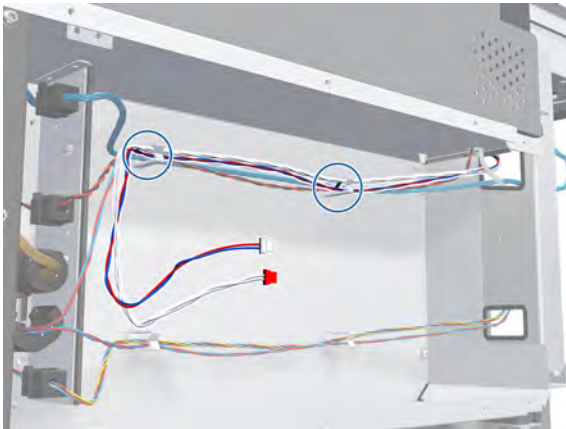

9. Unroute the APS 1 electrical connections from the left connector panel.

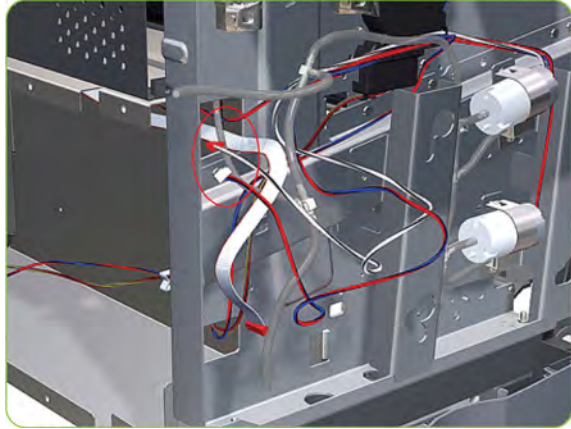

10. Unroute the electrical connections from the printer.

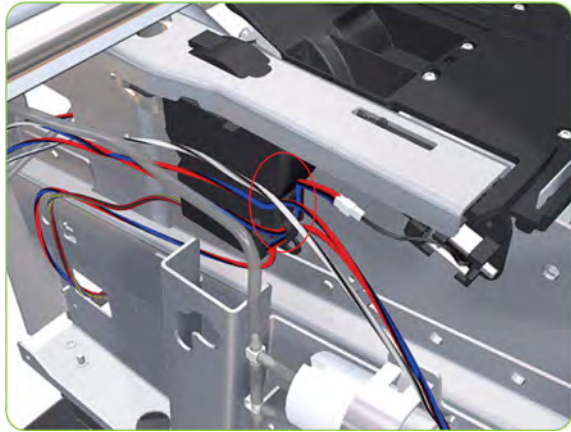

11. Disconnect both air tubes from APS 1.

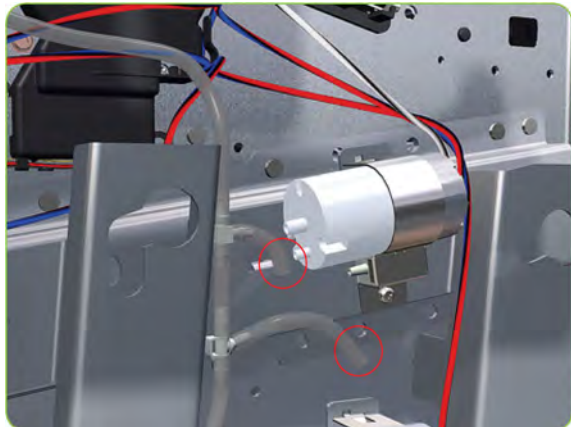

12. Remove one T-20 attachment screw from APS 1 (Top unit).

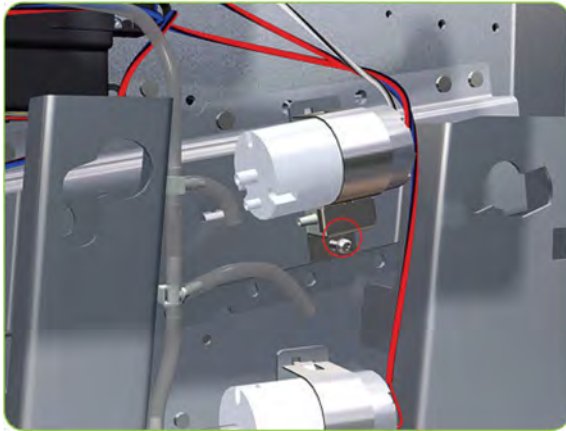

13. Remove APS 1 (Top unit) from the printer.

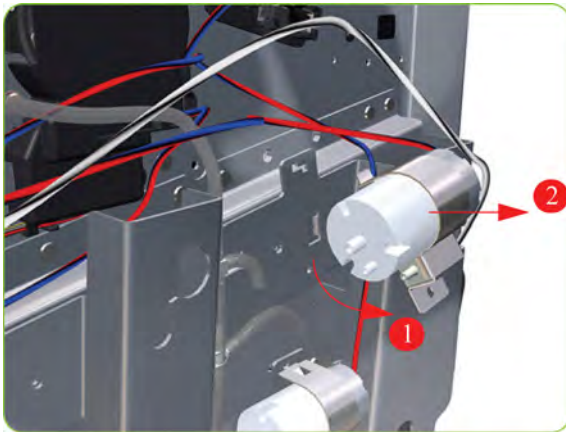

14. Disconnect the white Air Pump 2 cable.

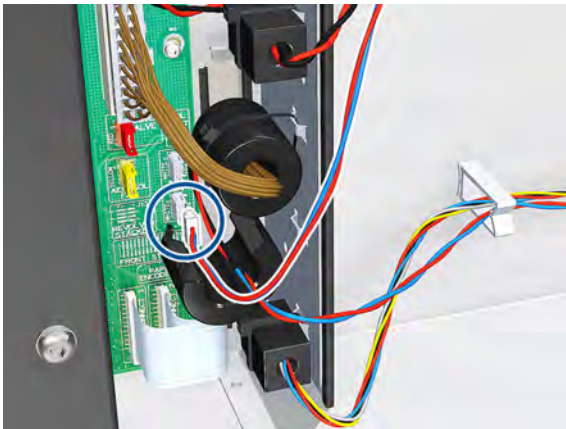

15. Remove the cable from the ferrite.

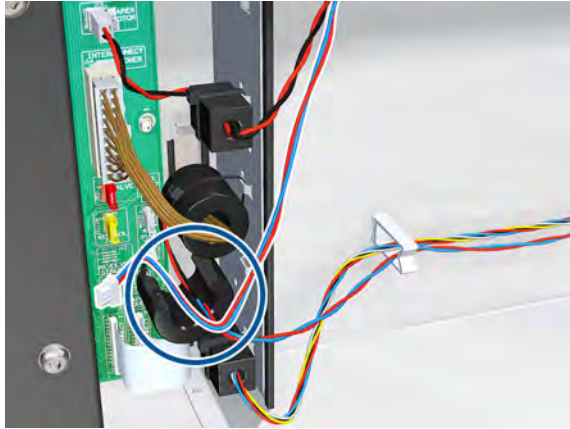

16. Unroute the APS 2 electrical cable from the cable clamps in the left connector panel

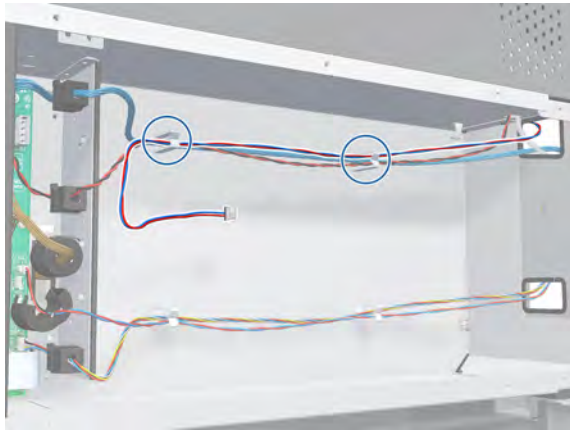

17. Unroute the APS 2 electrical connection from the Media Path Cover Encoder.

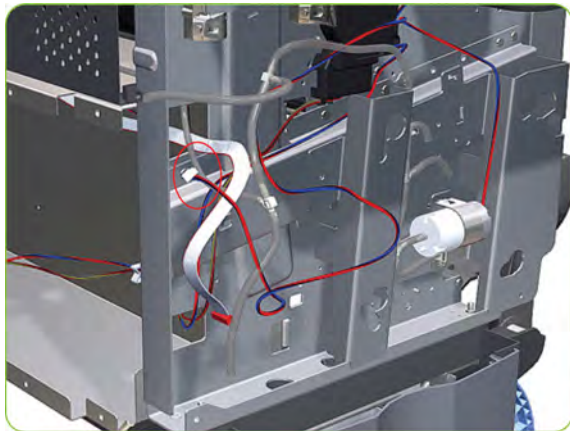

18. Unroute the APS 2 electrical connection from the printer.

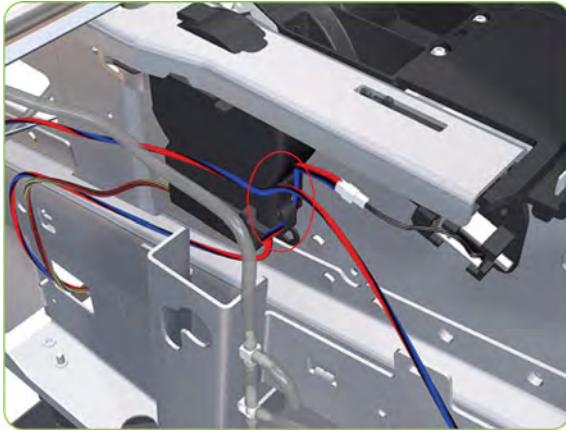

19. Disconnect both air tubes from APS 2.

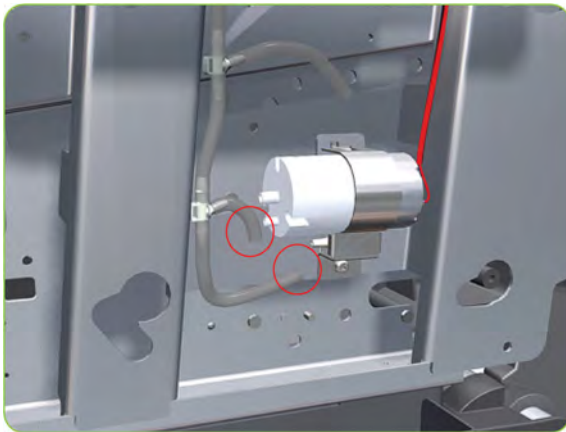

20. Remove one T-20 attachment screw from APS 1 (Top unit).

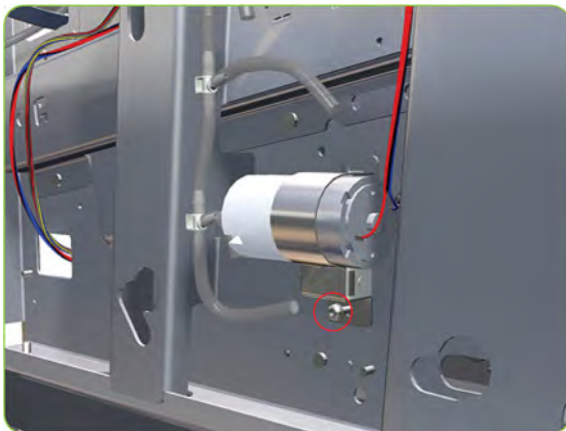

21. Remove APS 2 (Bottom unit) from the printer.

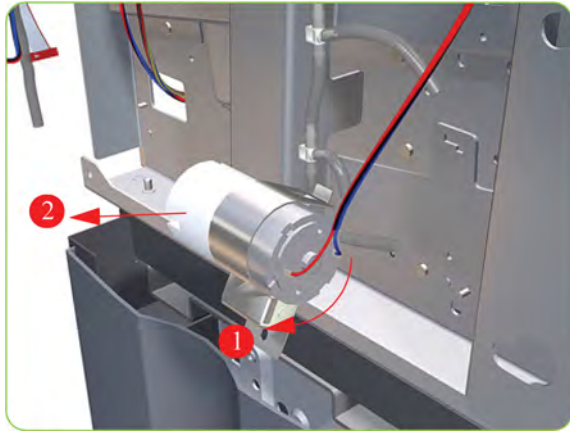

Left Spittoon

Removal

⚠ WARNING! Switch off the printer and remove the power cable.

1. Remove the Left Cover ⇒ See [Left Cover on page 240](#).
2. Remove:
 - The Left Connector Cover or the 42-inch model ⇒ See [Left Connector Cover \(42-inch\) on page 260](#).
 - The Electronics Module Extension the 60-inch model ⇒ See [Electronics Module Extension \(60-inch only\) on page 261](#).
3. Remove the Scan-Axis Motor ⇒ See [Scan-Axis Motor on page 331](#).
4. Disconnect the Left Spittoon Fan cable from the PrintMech PCA.

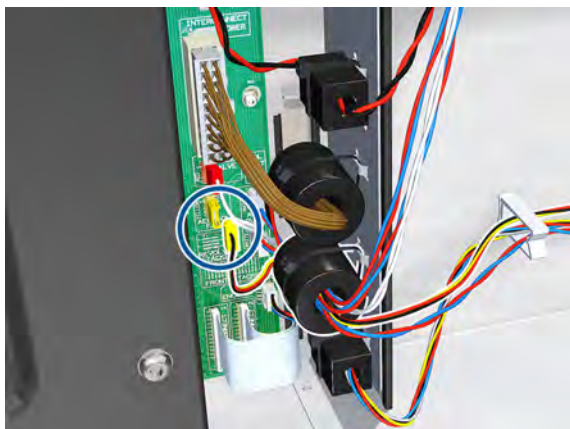

5. Remove the cable from the ferrite.

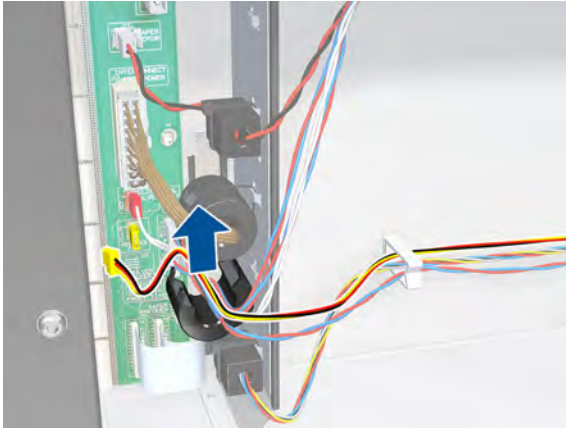

6. Remove the Left Spittoon Fan cable from the clamps.

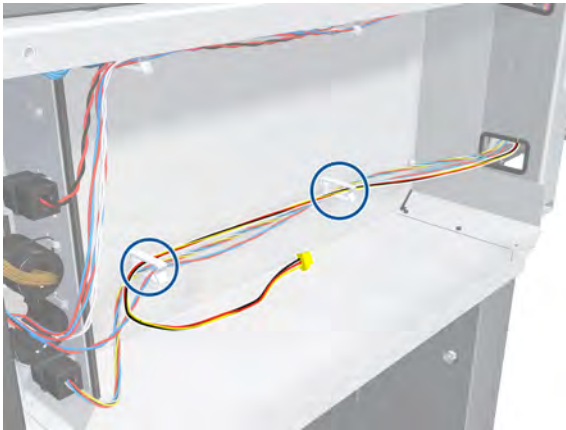

7. Unroute the Left Spittoon Fan cable.

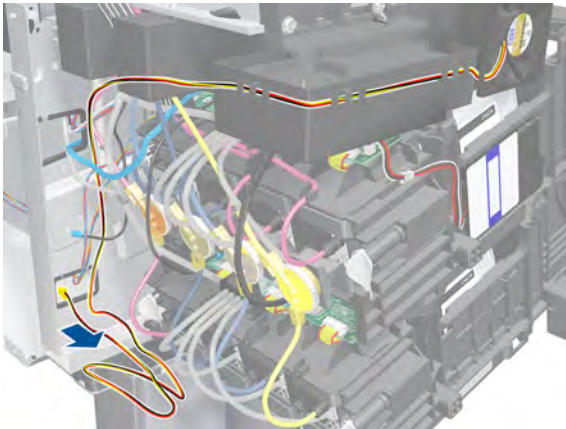

8. Remove two T-15 attachment screws (**Type J**) from the Scan-Axis Beam.

 **NOTE:** Be very careful not to damage the encoder strip while removing the attachment screws.

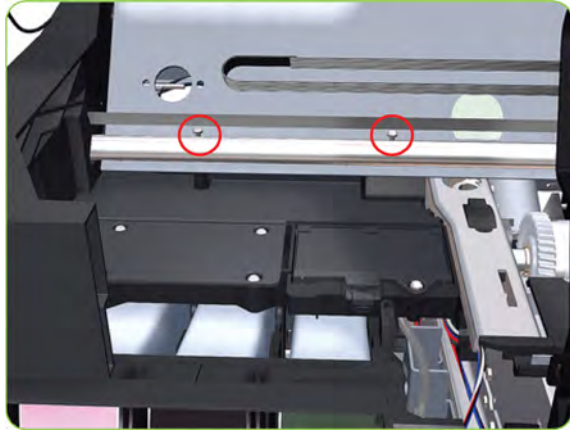

9. Remove two T-15 attachment screws from the Scan-Axis Beam.

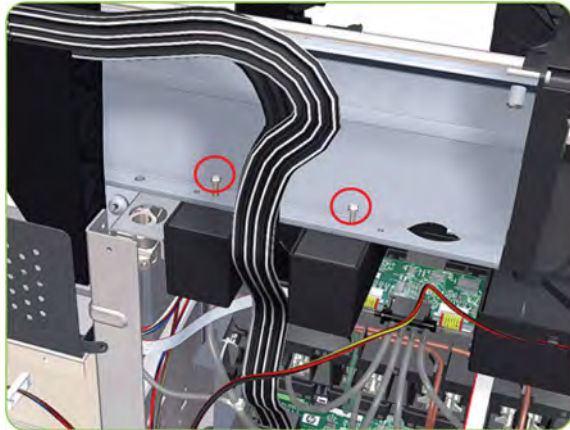

10. Remove one T-15 attachment screw.



11. Unclip the Spittoon attachment point so that you can rotate it in the next step.

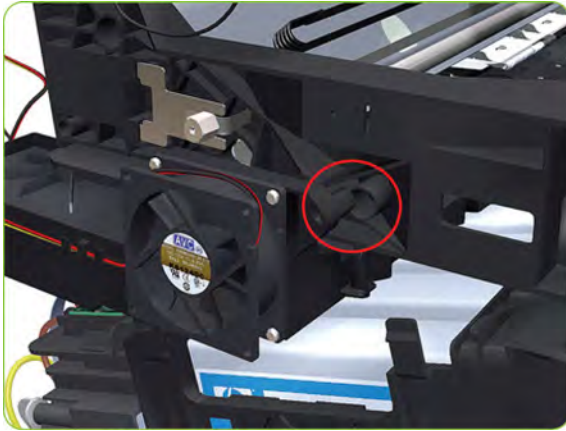

12. Rotate the Left Spittoon clockwise.

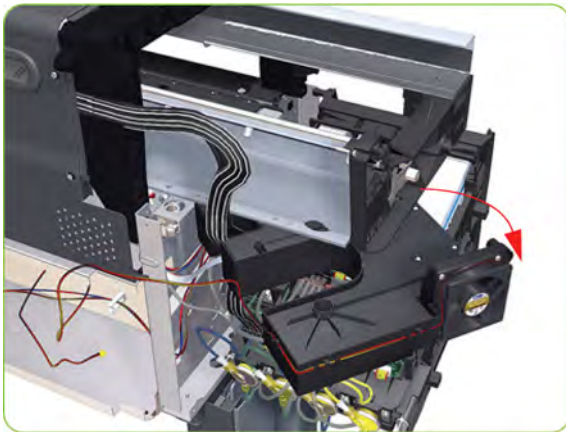

13. Remove the Left Spittoon from the printer.

 **NOTE:** After installing the new Left Spittoon, make sure you perform the following Service Utility:

- Reset life counter left spittoon ⇒ [Reset Life Counters on page 116](#).

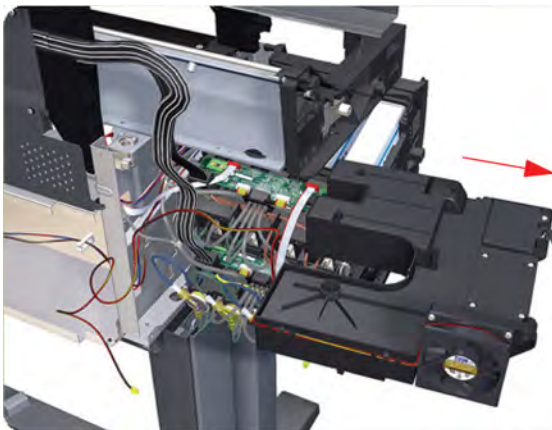

Encoder Strip and Encoder Sensor

Removal

 **WARNING!** Switch off the printer and remove the power cable.

1. Remove the Right Cover ⇒ See [Right Cover on page 235](#).
2. Remove the Left Cover ⇒ See [Left Cover on page 240](#).
3. Uncap the Carriage Assembly by manually pulling out the Printhead Maintenance Cartridges tray.

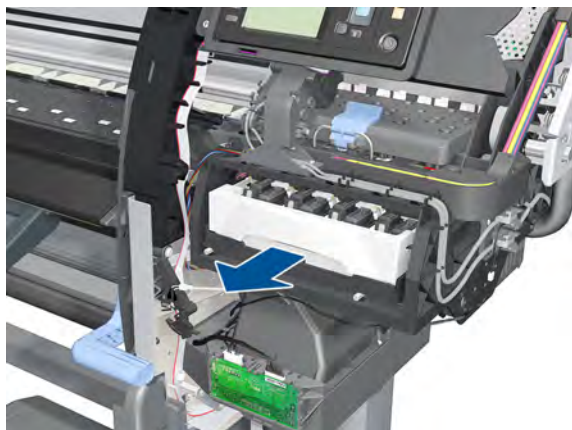

4. Lift the Primer and hold the Primer to its maximum position to avoid damaging it when you move the Carriage Assembly in the next step.

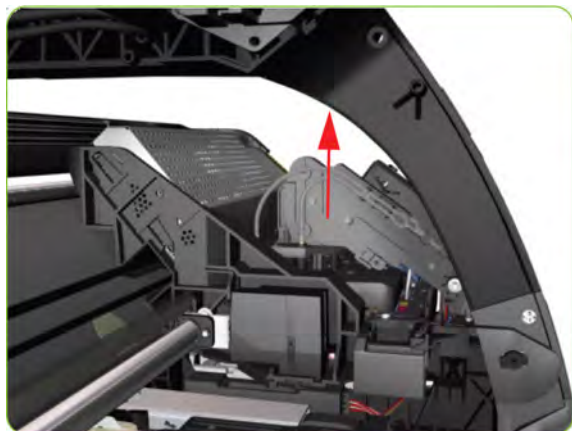

5. Move the Carriage Assembly out of the Service Station.

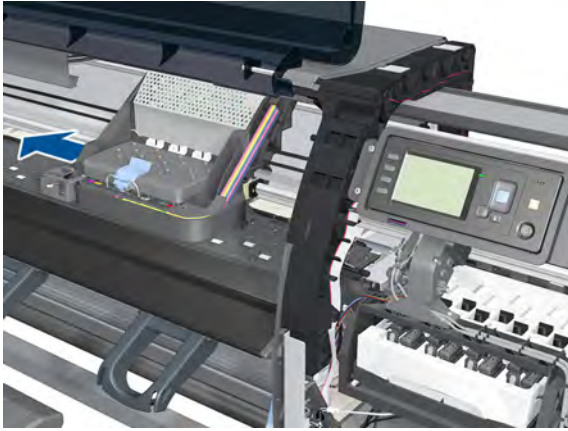

6. Remove one T-10 screw (**Type I**) that secures the Encoder Strip on the right-hand side of the printer.



7. Release the Encoder Strip from the locating pins on the right-hand side of the printer.



8. Release the Spring Clip from the Bracket on the left-hand side of the printer.

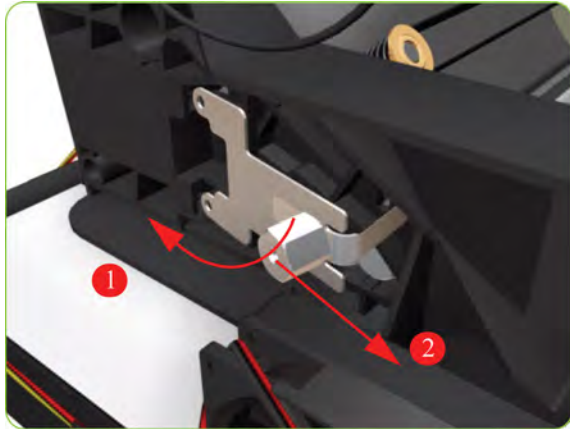

9. Carefully pull the Encoder Strip out of the left-hand side of the printer.

10. Remove the Carriage PCA ⇒ See [Carriage PCA on page 318](#).

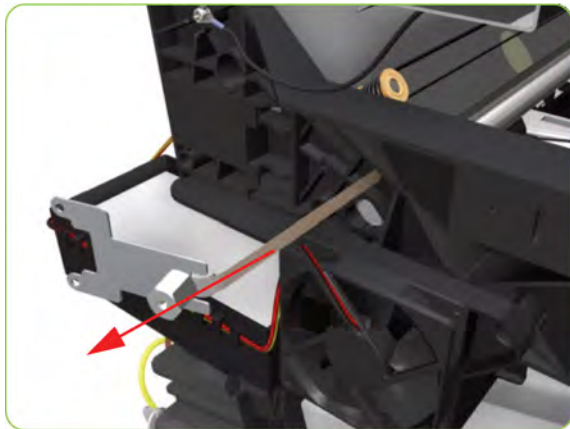

11. Remove one T-8 (**Type L**) screw that secures the Encoder Sensor to the Carriage Assembly.



12. Remove the plastic cover from the Encoder Sensor.

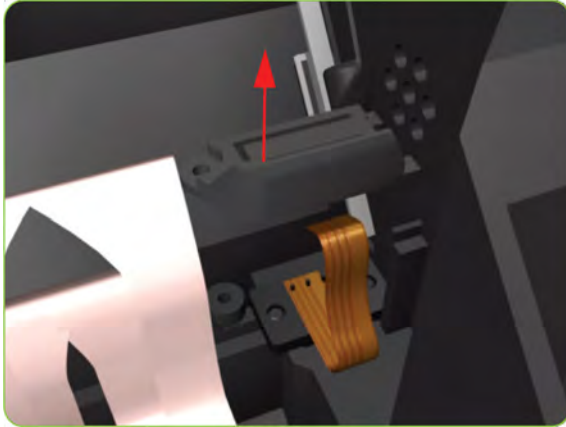

13. Remove the Encoder Sensor from the printer.

 **NOTE:** After installing the new Encoder Strip and Encoder Sensor, make sure you perform the following Service Calibration:

- Scan-Axis Calibration ⇒ ????

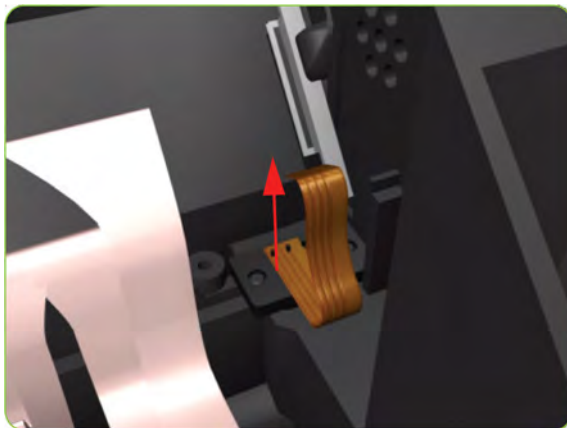

Carriage PCA

Removal

 **WARNING!** Switch off the printer and remove the power cable.

1. Remove the Right Cover ⇒ See [Right Cover on page 235](#).

2. Press the two side of the Carriage PCA Cover and unclip from the FPCA.

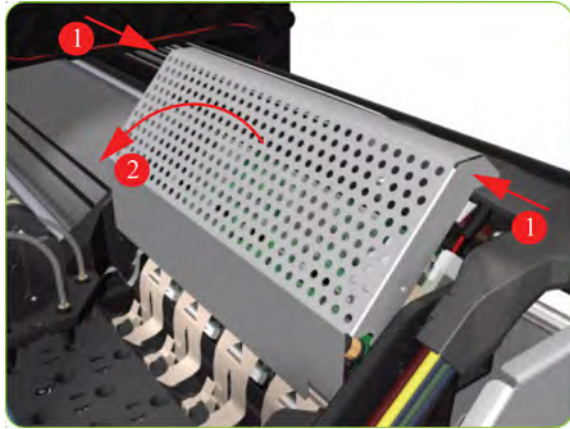

3. Disconnect the Trailing Cable from the Carriage PCA.

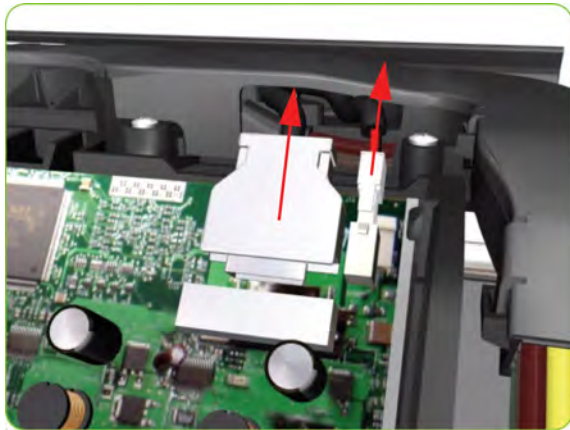

4. Use a flat bladed screwdriver to release the ALL the clips, securing the Carriage Flex Cables to the Carriage Assembly, by pulling upwards.



5. Disconnect the Flex Cables from the Carriage PCA.



6. Disconnect the Line Sensor Cable and the Encoder Sensor Cable from the Carriage PCA.

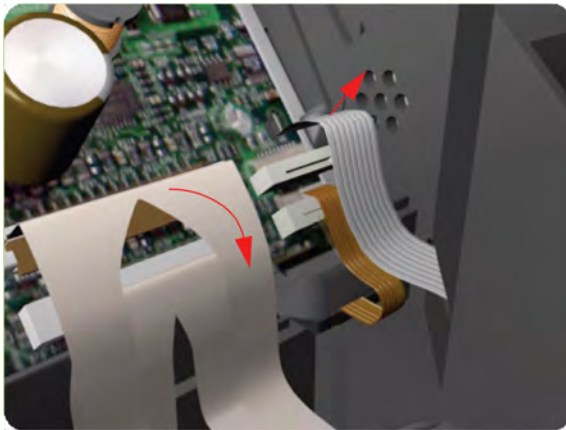

7. Disconnect the ESP Cable from the Carriage PCA.

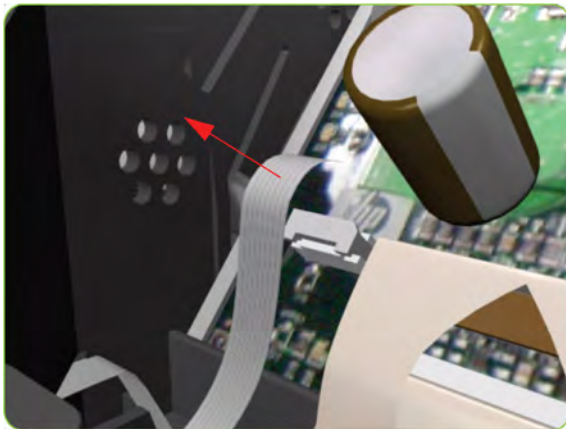

8. Push inwards the four clips that secure the Carriage PCA.



9. Remove the Carriage PCA from the printer.

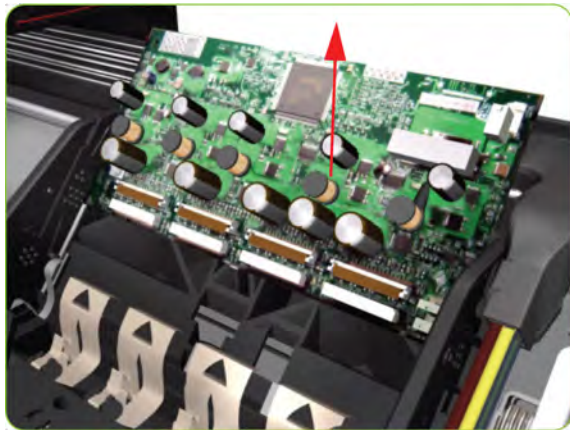

Installation

Once you have installed a new Carriage PCA, you must perform the following steps to ensure that the printer will function correctly:

1. Power on the printer.
2. Execute the Carriage Setup utility from the Service Utility menu (see ??? for more information).
3. Install the Printheads once the utility has been completed successfully.
4. Reset life counter Carriage PCA ⇒ [Reset Life Counters on page 116](#).

Carriage Flex Cables

Removal

⚠ WARNING! Switch off the printer and remove the power cable.

1. Remove the Right Cover ⇒ See [Right Cover on page 235](#).
2. Remove the Front Panel ⇒ See [Front Panel on page 265](#).
3. Disconnect the Trailing Cable from the Carriage PCA.

4. Press the two side of the Carriage PCA Cover and unclip from the Carriage Assembly.

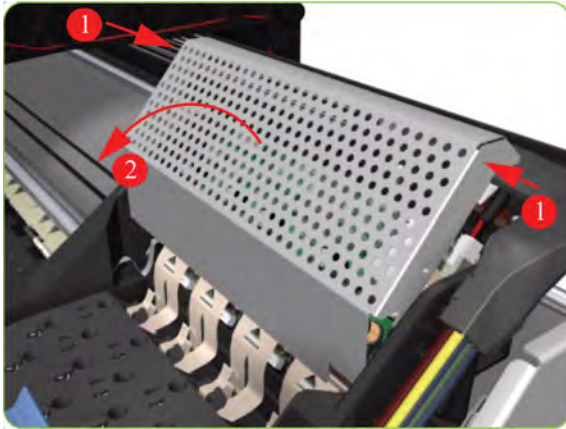

5. Use a flat bladed screwdriver to release the ALL the clips, securing the Carriage Flex Cables to the Carriage Assembly, by pulling upwards.



6. Remove eight T-8 screws (**Type L**) that secure the Carriage Flex Cables to the Carriage Assembly.



7. Open the Carriage Cover and remove ALL the Printheads from the Carriage Assembly.

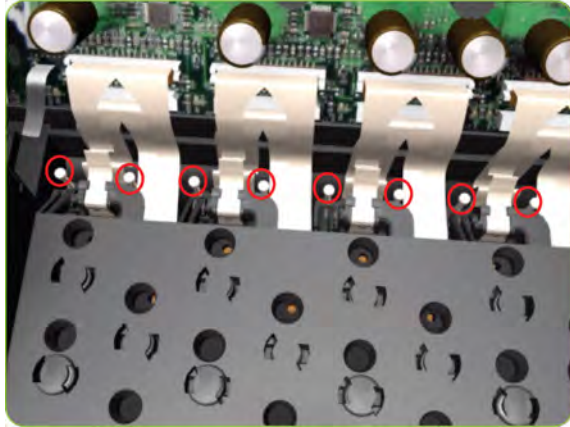

8. Open the Carriage Cover and remove ALL the Printheads from the Carriage Assembly.

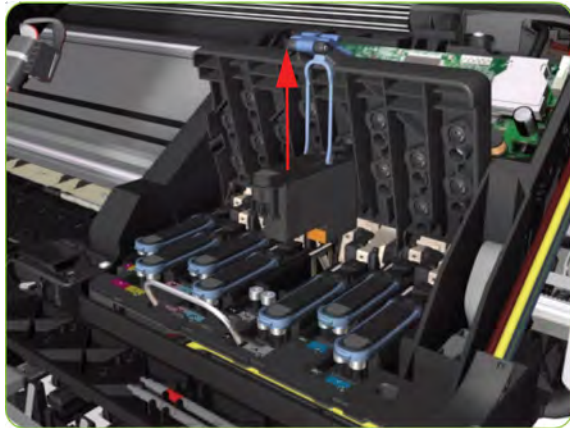

9. Remove the Carriage Flex Cable from the printer.

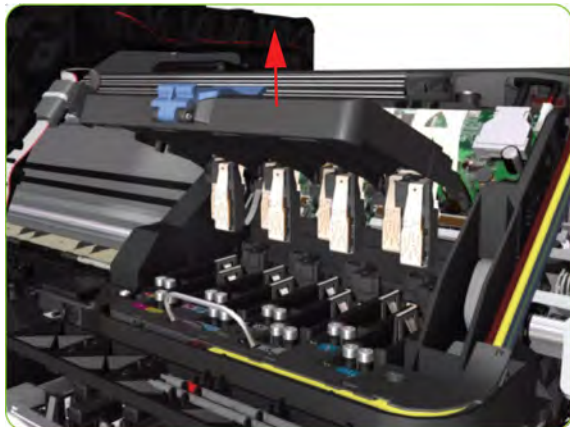

Carriage Assembly

Removal

 **WARNING!** Switch off the printer and remove the power cable.

1. Remove the Right Cover ⇒ See [Right Cover on page 235](#).
2. Remove the Front Panel ⇒ See [Front Panel on page 265](#).
3. Remove the Primer Assembly ⇒ See [Primer Assembly on page 267](#).
4. Remove the Left Cover ⇒ See [Left Cover on page 240](#).
5. Remove the Encoder Strip ⇒ See [Encoder Strip and Encoder Sensor on page 315](#).
6. Pull out the Printhead Maintenance Cartridges tray.

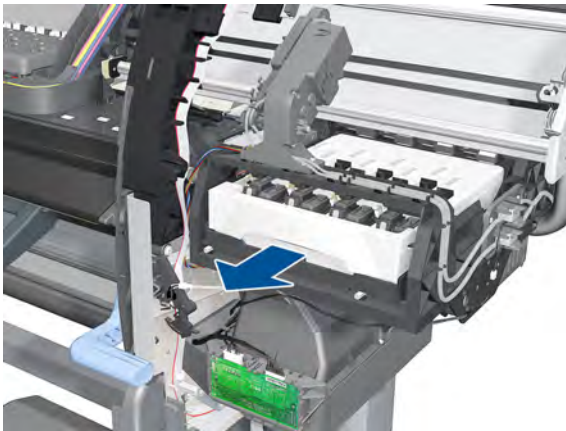

7. Lift the Primer and hold the Primer to its maximum position to avoid damaging it when you move the Carriage Assembly in the next step.

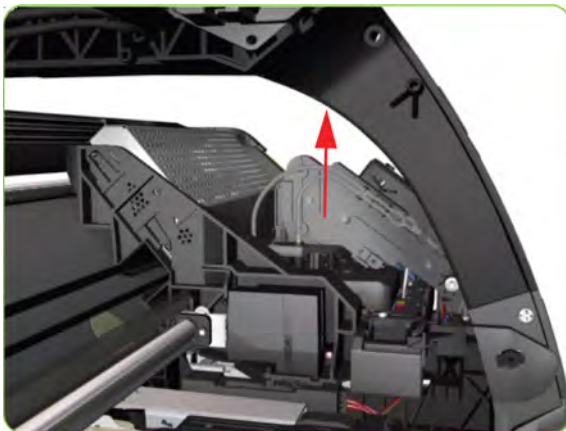

8. Move the Carriage Assembly to the extreme right of the printer.

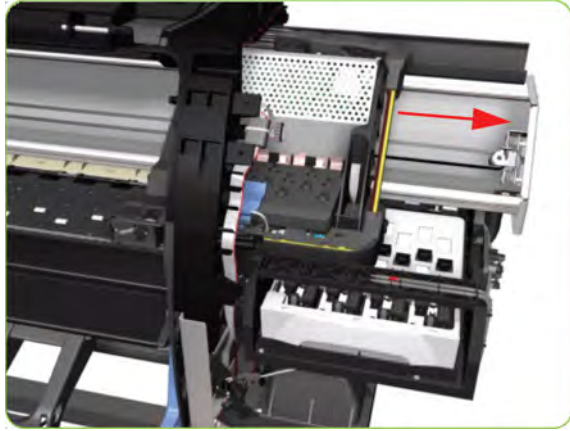

9. Press the two side of the Carriage PCA Cover and unclip from the Carriage Assembly.

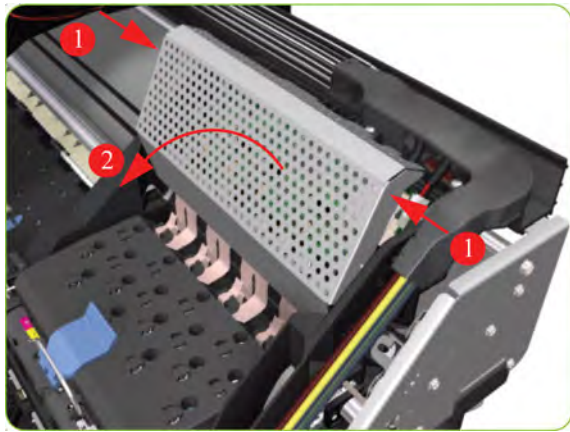

10. Disconnect the Trailing Cable from the Carriage PCA.



11. Open the Carriage Cover and remove ALL the Printheads from the Carriage Assembly.



12. Remove five T-15 screws (Type G) that secure the Ink Supply Tubes to the Carriage Assembly.

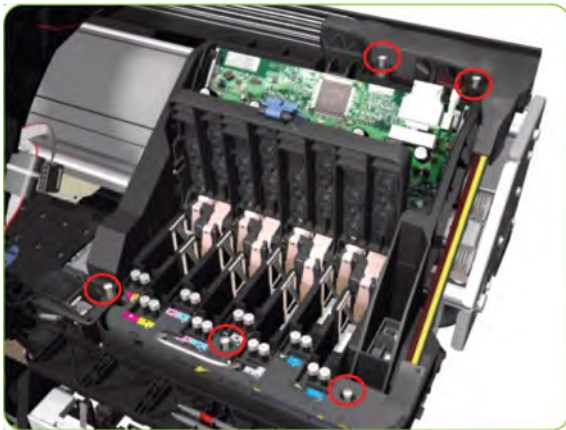

13. Remove the Ink Supply Tubes from the Carriage Assembly and safely place to one side of the printer.



14. Disconnect the Aerosol Fan Tube from the Chassis.



15. Remove one T-20 screw (**Type A**) that secures the Belt Tensioner to the Chassis.



16. Lift the Primer and hold the Primer to its maximum position to avoid damaging it when you move the Carriage Assembly in the next step.

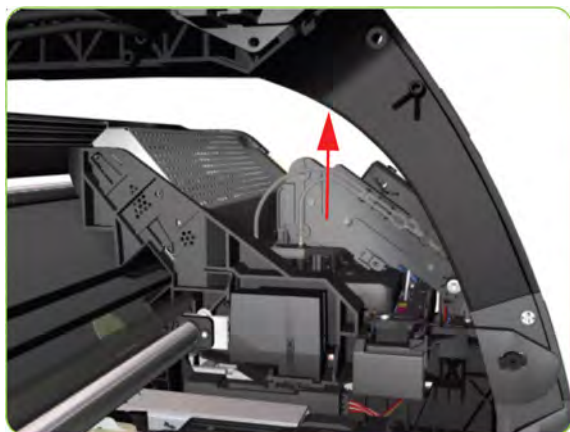

17. Move the Carriage Assembly slightly away from the right Scan-Axis Bracket.



18. Release the Carriage Belt from the Scan-Axis Motor on the left-hand side of the printer.



19. Remove one T-10 screw (**Type C**) that secure the Encoder Strip.



20. Remove four T-20 screws (**Type N**) that secure the right Scan-Axis Bracket.

 **NOTE:** Note that these are Chassis screws and in normal circumstances should NEVER be removed, but in this case we need to remove them in order to remove the Carriage Assembly.



21. Remove the right Scan-Axis Bracket from the printer.

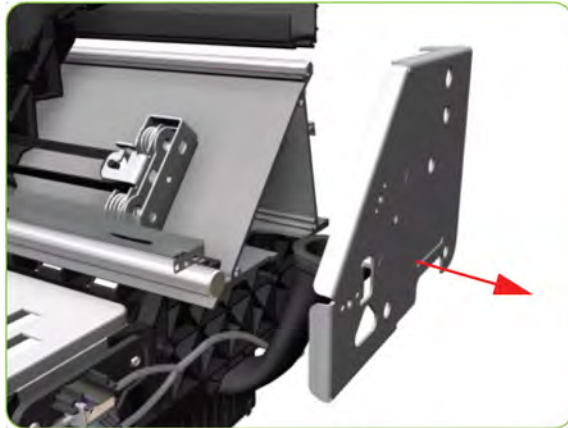

22. Remove the Carriage Stopper Screw (T-20) from the Chassis.



23. Remove the Carriage Stopper from the printer.

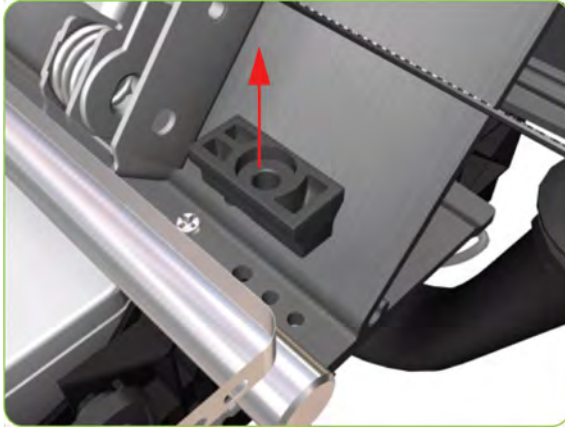

24. Slide the Carriage Assembly (including the belt) to the right and out of the printer.
25. If the Carriage Assembly is to be replaced, make sure that you remove the Belt, the Carriage PCA, ESP, Encoder and Line Sensors and the Cutter Assembly (in order to install them on the new Carriage Assembly).

 **NOTE:** After installing the NEW Carriage Assembly, make sure you perform the following Service Utility:

- Reset life counter Carriage ME ⇒ [Reset Life Counters on page 116](#).

 **NOTE:** After installing the new Carriage Assembly, make sure you perform the following Service Calibrations:

- Scan-Axis Calibration ⇒ ????
- Drop Detector Calibration ⇒ [Drop Detector calibration on page 137](#).
- Line Sensor Calibration ⇒ [Line Sensor calibration on page 139](#).



Belt Assembly

Removal

 **WARNING!** Switch off the printer and remove the power cable.

1. Remove the Right Cover ⇒ See [Right Cover on page 235](#).
2. Remove the Left Cover ⇒ See [Left Cover on page 240](#).
3. Remove the Top Cover ⇒ See [Top Cover \(60-inch\) on page 249](#).
4. Remove the Encoder Strip ⇒ See [Encoder Strip and Encoder Sensor on page 315](#).
5. Remove the Carriage Assembly ⇒ See [Carriage Assembly on page 323](#).
6. Release the Belt from the bottom of the Carriage Assembly.

 **NOTE:** After installing the NEW Belt Assembly, make sure you perform the following Service Utility:

- Reset life counter scan cycles belt ⇒ [Reset Life Counters on page 116](#).

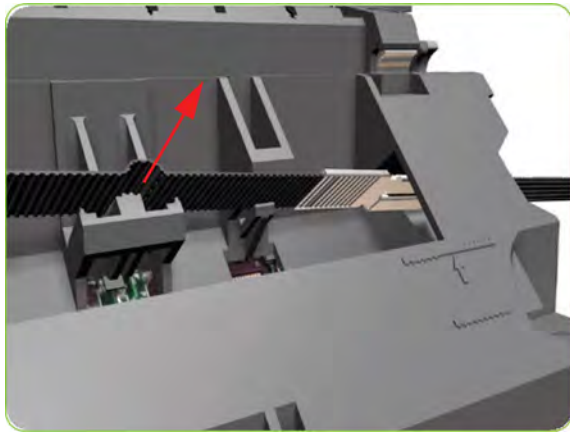

Scan-Axis Motor

Removal

 **WARNING!** Switch off the printer and remove the power cable.

1. Remove the Right Cover ⇒ See [Right Cover on page 235](#).
2. Remove the Left Cover ⇒ See [Left Cover on page 240](#).
3. Remove:
 - For the 42-inch model, the Left Connector Cover ⇒ See [Left Connector Cover \(42-inch\) on page 260](#).
 - For the 60-inch model, the Electronics Module Extension ⇒ See [Electronics Module Extension \(60-inch only\) on page 261](#).

4. Uncap the Carriage Assembly by manually pulling out the Printhead Maintenance Cartridges tray.

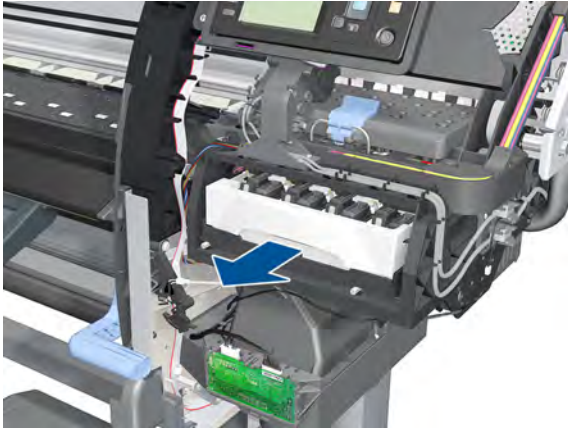

5. Lift the Primer and hold the Primer to its maximum position to avoid damaging it when you move the Carriage Assembly in the next step.

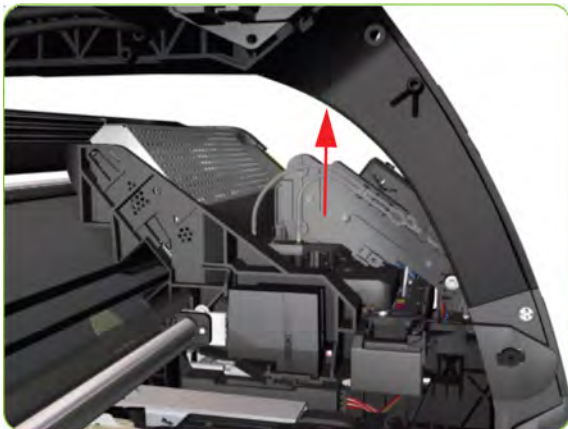

6. Move the Carriage Assembly slightly away from the right Scan-Axis Bracket.

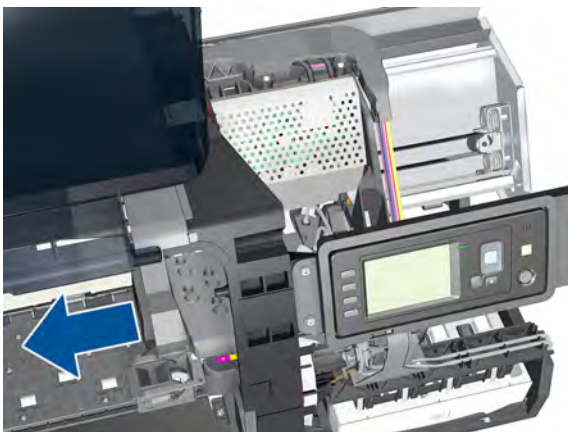

7. Remove one T-20 screw that secures the Belt Tensioner to the Chassis.



8. Release the Carriage Belt from the Scan-Axis Motor on the left-hand side of the printer.

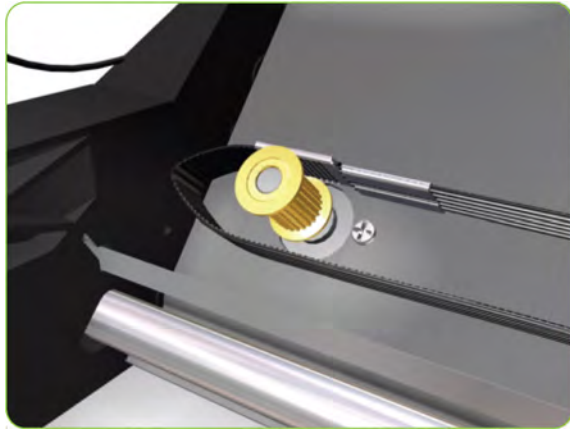

9. Remove two T-20 screws.

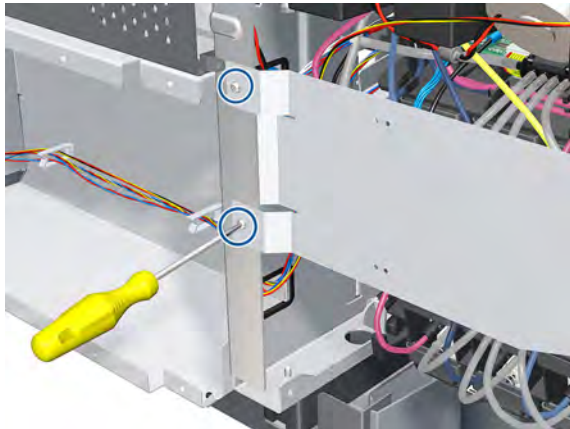

- 10.** Remove the ISS Shielding.

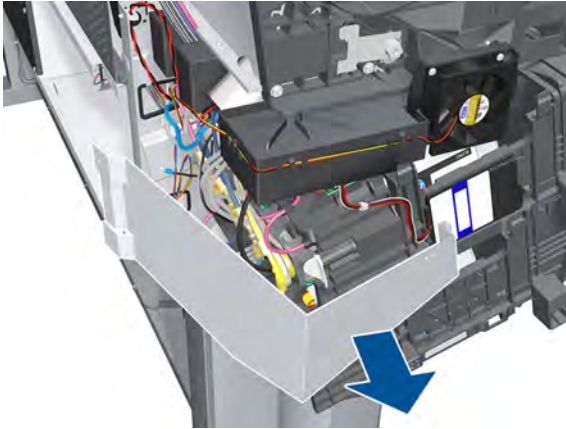

- 11.** Disconnect the Scan-Axis Motor cable from the PrintMech PCA and its ferrite.

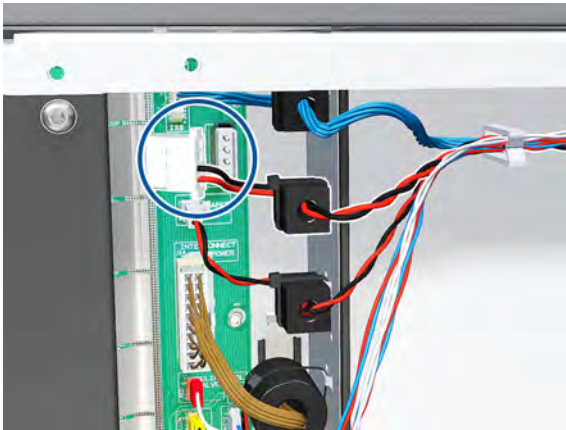

- 12.** Remove the cable from the ferrite.

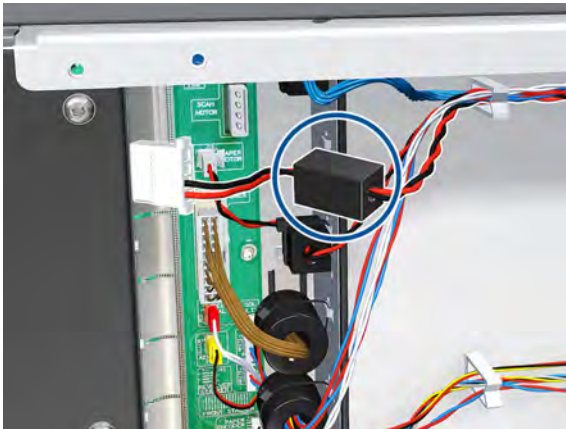

13. Remove the Scan-Axis Motor cable from the clamps.

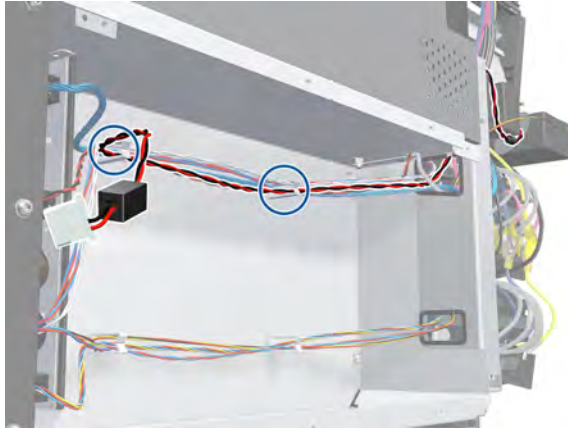

14. Remove the Scan-Axis Motor cable from the chassis.

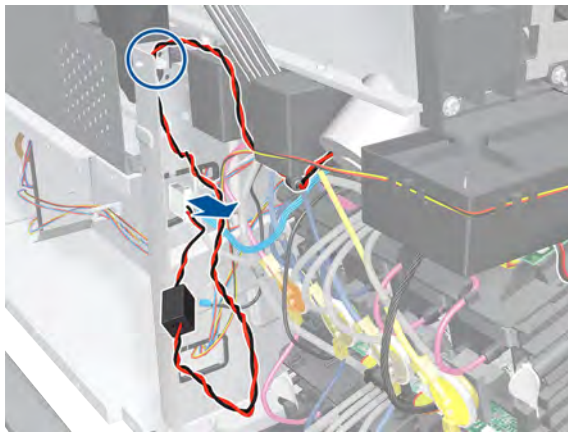

15. Remove two T-20 screws (**Type A**) that secure the Scan-Axis Motor.



NOTE: Make sure you hold the Scan-Axis Motor securely when removing the screws.

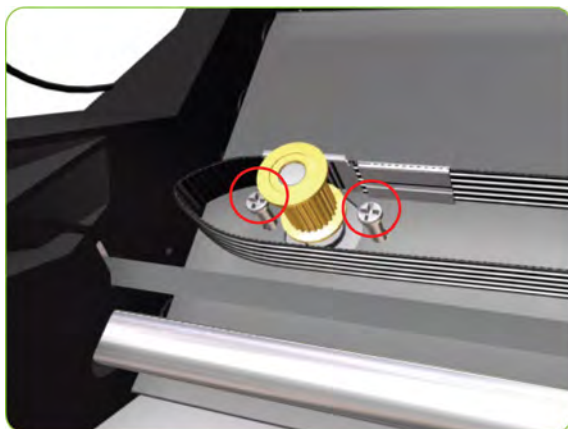

16. Remove the Scan-Axis Motor from the printer.

NOTE: After installing the new Scan-Axis Motor, make sure you perform the following Service Utility:

- Reset scan motor life counter ⇒ [Reset Life Counters on page 116](#).

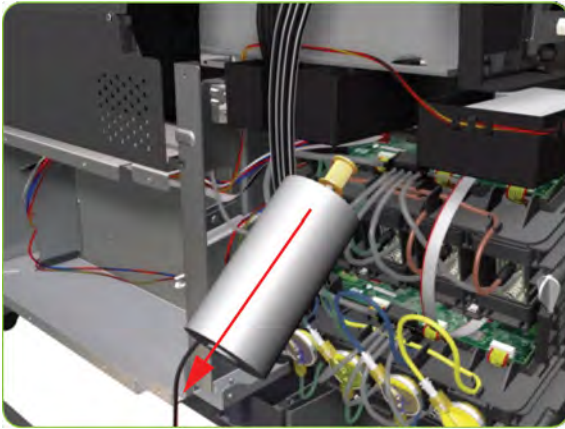

Media-Axis Motor

Removal

⚠ WARNING! Switch off the printer and remove the power cable.

1. Remove the Left Cover ⇒ See [Left Cover on page 240](#).
2. Remove the Rear Door ⇒ See [Rear Door \(60-inch\) on page 256](#).
3. Remove:
 - For the 42-inch model, the Left Connector Cover ⇒ See [Left Connector Cover \(42-inch\) on page 260](#).
 - For the 60-inch model, the Electronics Module Extension ⇒ See [Electronics Module Extension \(60-inch only\) on page 261](#).
4. Disconnect the Media-Axis Motor cable from the PrintMech PCA.

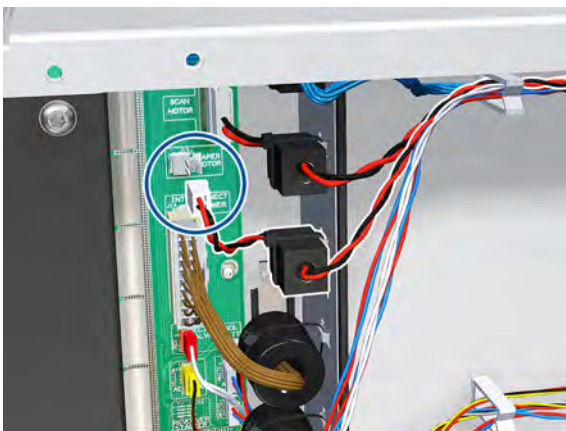

5. Remove the ferrite from the plate.

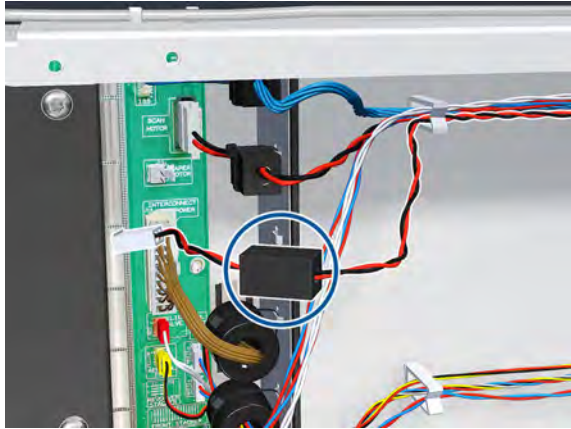

6. Remove the cable from the clamps.

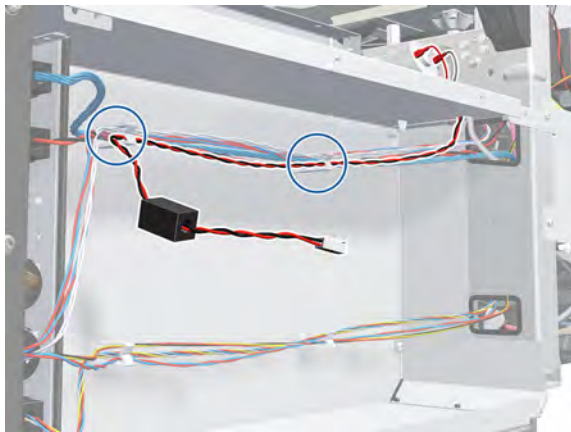

7. Detach the clamp of the ferrite core of the Media-Axis Motor cable from the printer chassis.

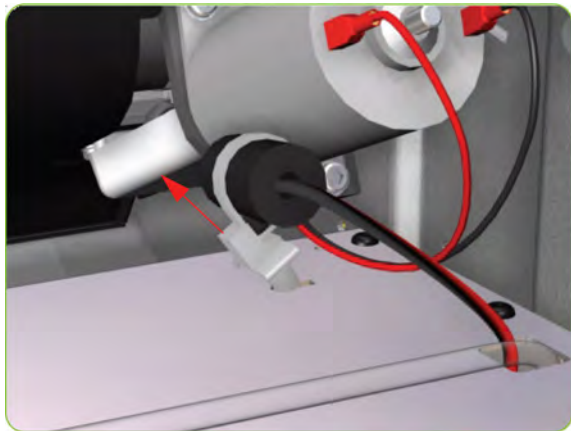

8. Remove the T-15 screws (**Type R**) identified (A) and loosen the T-15 screws (**Type R**) identified (B) that secure the Media-Axis Motor.

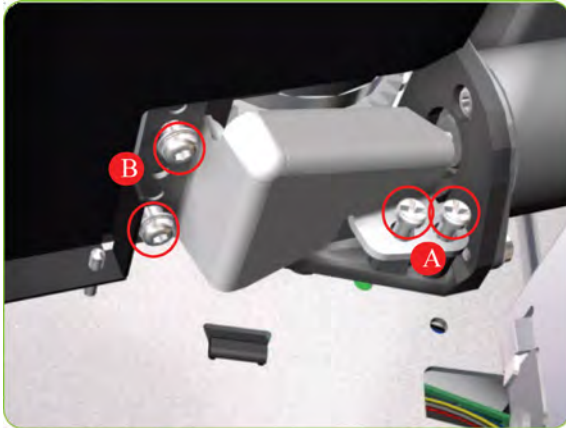

9. Remove the Media-Axis Motor Bracket.

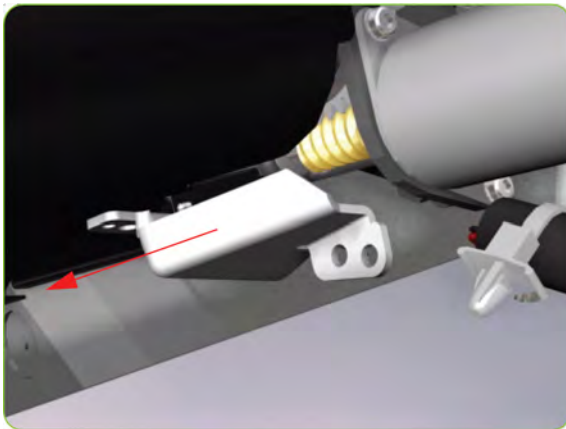

10. Remove two T-20 screws (**Type B**) that secure the Media-Axis Motor Bracket.

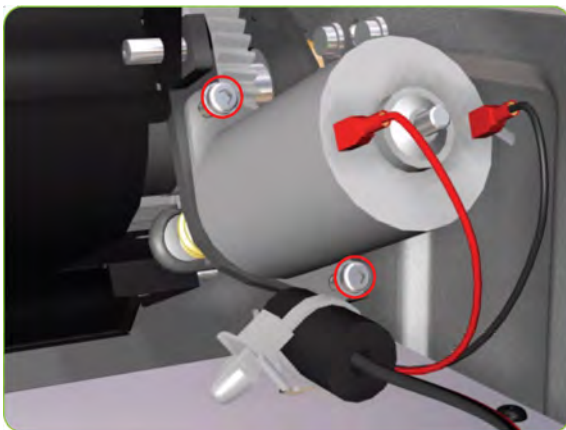

11. Remove the Media-Axis Motor from the printer.

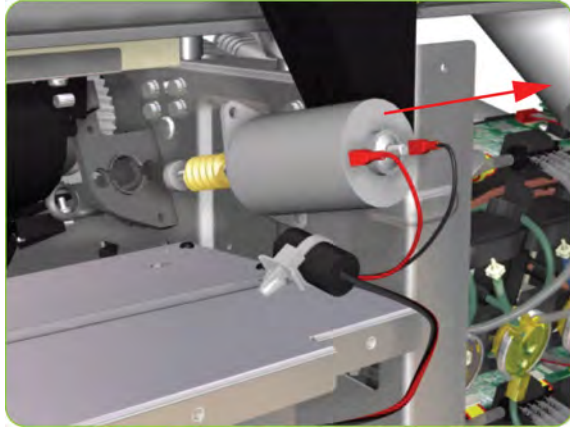

Installation

When reinstalling the parts, make sure you apply the grease (included with the support part) to the gears.

After installing the new Media-Axis Motor, make sure you perform paper-advance calibration ⇒ [Paper-advance calibration on page 134](#).

Optical Media Advance Sensor (OMAS)

Removal

 **WARNING!** Switch off the printer and remove the power cable.

 **NOTE:** The removal procedure differs depending on the printer model, 42-inch or 60-inch.

1. 42-inch model ONLY

Open the Rear Door. and go to step 4.

2. 60-inch model ONLY

Remove the Left Cover ⇒ See [Left Cover on page 240](#).

3. Remove the Rear Door ⇒ See [Rear Door \(60-inch\) on page 256](#).

4. Both models

Remove media if installed.

5. Squeeze the clips to unclip the Media Sensor from the Center Guide.

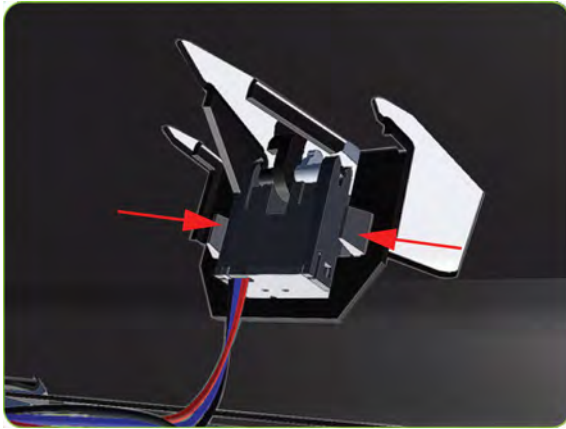

6. Let the Media Sensor hang below the Center Guide. This is to ensure it does not get damaged by the ribbon cable of the OMAS during the removal procedure.

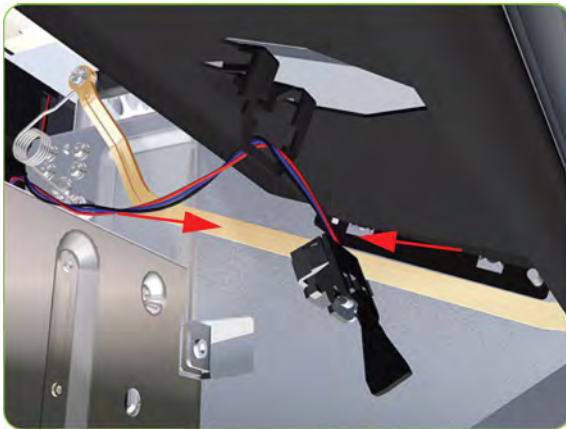

7. Squeeze the corners of the OMAS Access Cover release it from the bottom of the printer.



8. Remove the OMAS Access Cover the printer.

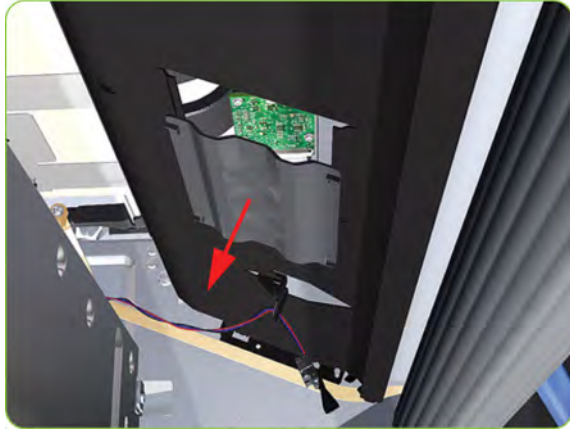

9. Insert the T-20 thin bladed torx screwdriver (supplied with the replacement OMAS) into the access hole at the rear of the printer.



10. Remove and discard one T-20 screw which secures the OMAS horizontally to the printer.



11. From the bottom of the printer, remove and discard one T-20 screw which secures the OMAS vertically to the printer.



12. Carefully lower the OMAS from the printer as far as you can with the large ribbon cable still connected.



13. Release the two locking clips of the large ribbon cable connector.

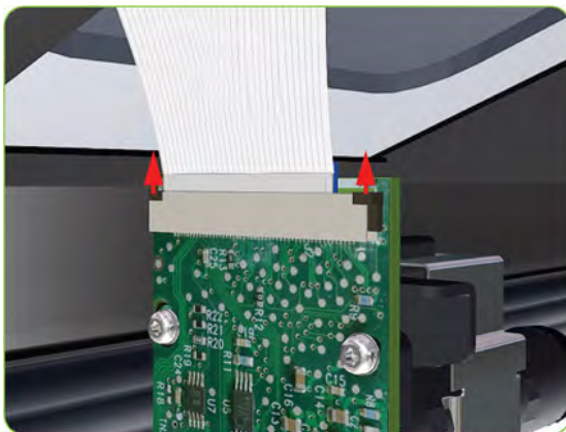

14. Disconnect the large ribbon cable from the OMAS.

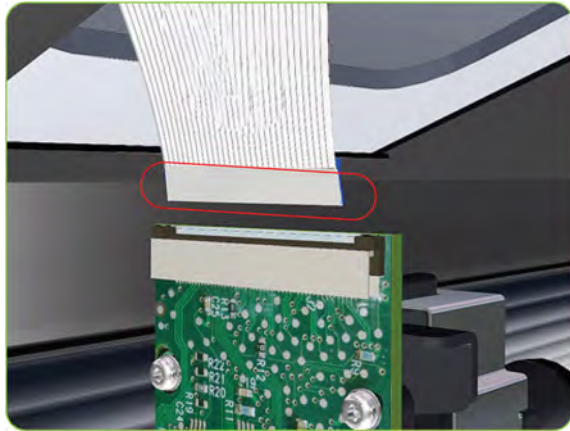

15. Remove the OMAS Sensor from the printer.

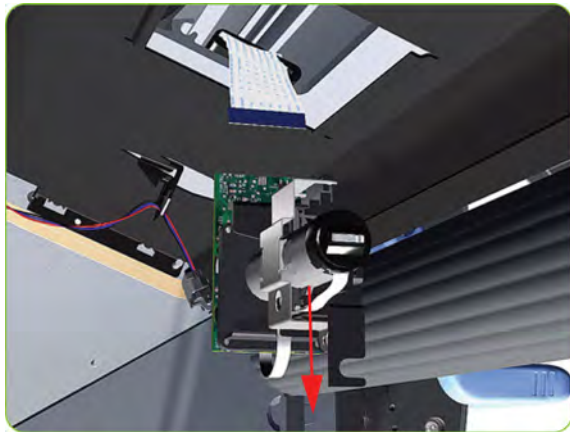

Installation

 **NOTE:** To simplify the installation of the OMAS an Attachment Screw Retainer has been added to hold the two T-20 attachment screws. This part is delivered attached to the replacement OMAS unit with the two attachment screws. It is also delivered as a separate part with the Print Platen in case the OMAS is completely removed during its replacement.

1. Check that the two T-20 attachment screws are correctly positioned in the Attachment Screw Retainer.



2. Position the OMAS under the printer and connect the large ribbon.

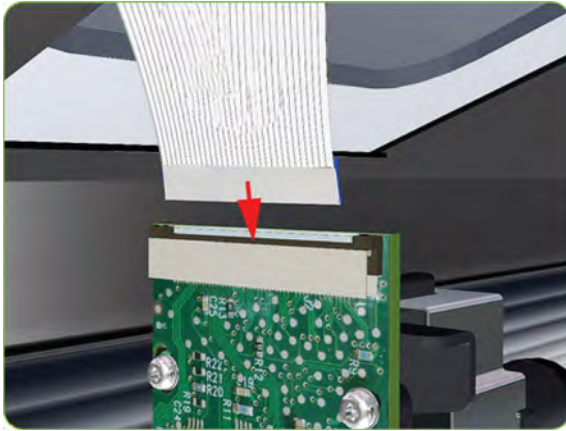

3. Lock the clips of the large ribbon cable connector.

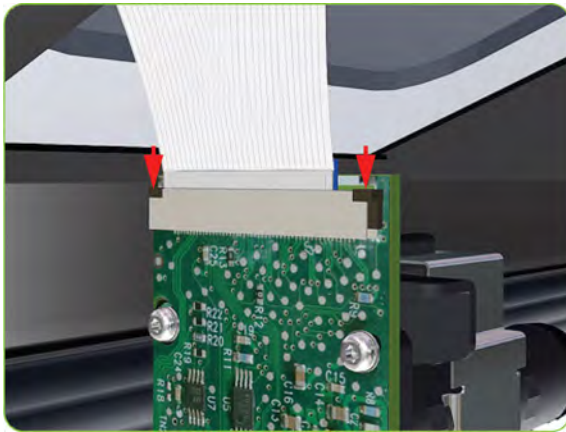

4. Carefully push the OMAS fully up into its mounting so that the OMAS window protrudes slightly **ABOVE** the Print Platen (approximately 0-2 mm). To ensure the OMAS is correctly positioned, slide a sheet of paper over the Platen Ribs until it is stopped by the OMAS. This ensures the OMAS is protruding slightly above the platen.

⚠ CAUTION: Make sure the OMAS is pushed completely up into its mounting or you will encounter an error during the OMAS calibration because it will not be able to focus on the paper.



5. Slide a sheet of paper over the OMAS window, if the paper is not stopped by the OMAS, repeat step 4 to ensure the OMAS is pushed fully up into its the mounting.



6. **FULLY** tighten the T-20 vertical attachment screw.



7. Insert the T-20 thin bladed torx screwdriver into the access hole at the rear of the printer.



8. Fully tighten the T-20 horizontal attachment screw which secures the OMAS to the printer.

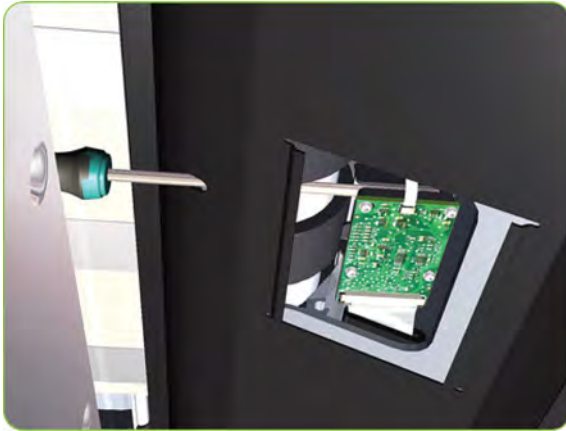

9. Clip the Media Sensor to the Center Guide.

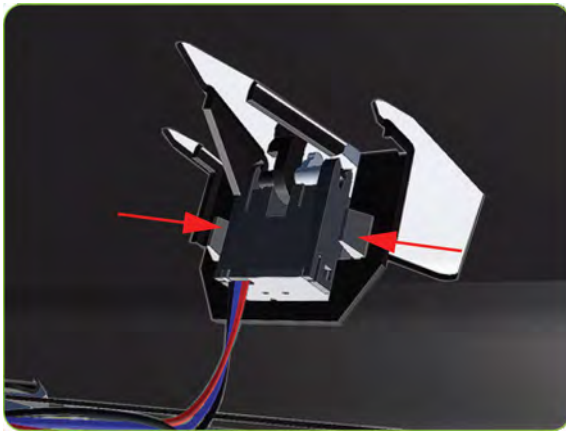

10. Clip the OMAS access cover back into place by sliding one edge of the cover into the slot and then applying enough pressure to it so you can clip it into the other slot.
11. Calibrate the OMAS ⇒ See [OMAS Calibration on page 150](#).
12. If the calibration fails, repeat the procedure from step 4 1 above to ensure it is correctly positioned.



Interconnect PCA

Removal

 **WARNING!** Switch off the printer and remove the power cable.

1. Remove the Right Connector Cover ⇒ See [Right Connector Cover on page 258](#).
2. Disconnect all cables from the Interconnect PCA.



3. Remove five T-10 screws that secure the Interconnect PCA.

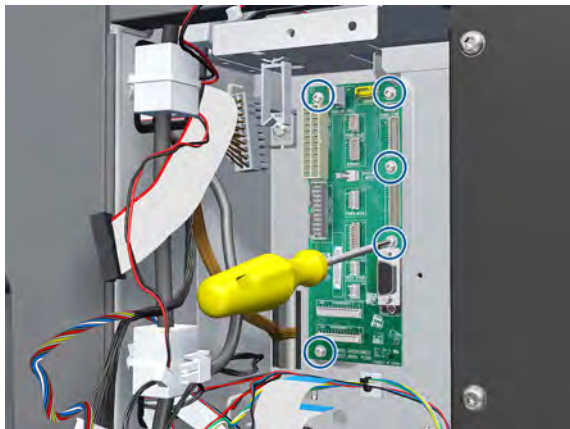

4. Remove the Interconnect PCA.

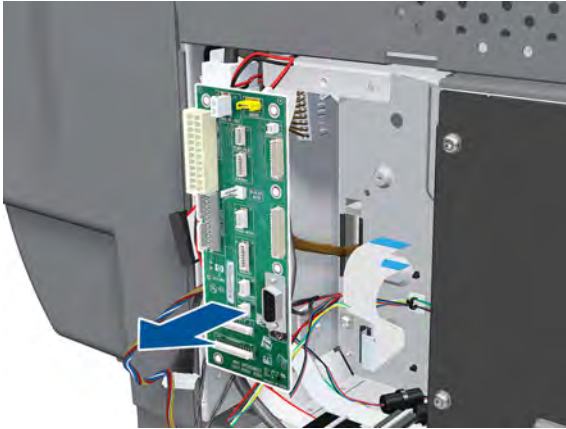

EIO to PCA Interface Card

Removal

WARNING! Switch off the printer and remove the power cable.

1. Remove the Jetdirect Card (if installed).

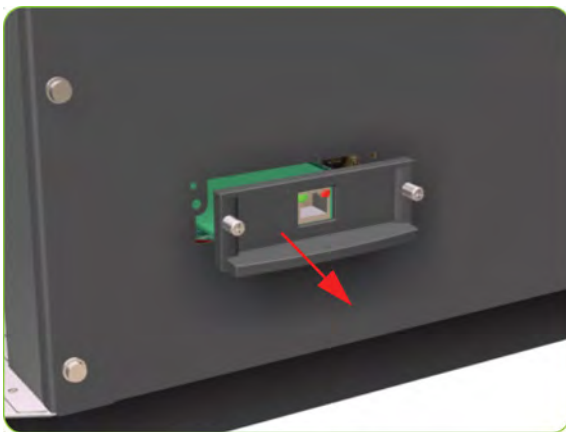

2. Remove three T-20 screws that secure the Formatter cover.

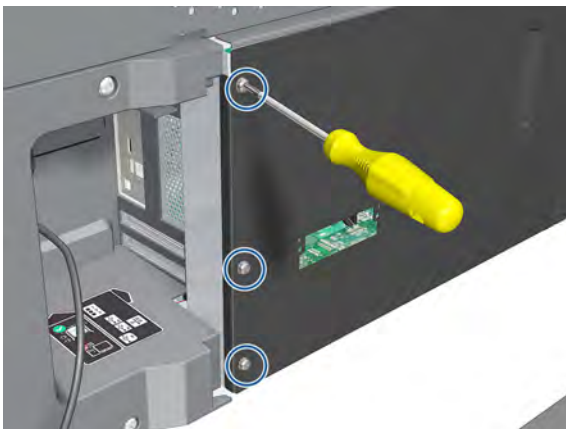

3. Remove the Formatter Cover from the printer.

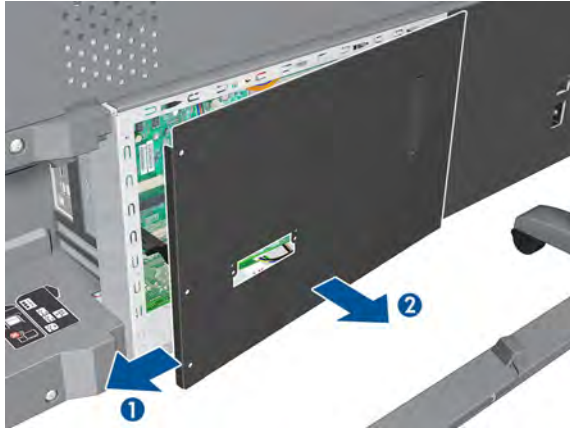

4. Remove one T-10 screw (**Type I**) that secures the Interface Card.



5. Disconnect the Interface Card from the Formatter and remove from the printer.



OMAS Controller Card

Removal

⚠ WARNING! Switch off the printer and remove the power cable.

1. Remove the Right Connector Cover ⇒ See [Right Connector Cover on page 258](#).
2. Remove the Jetdirect Card (if installed).

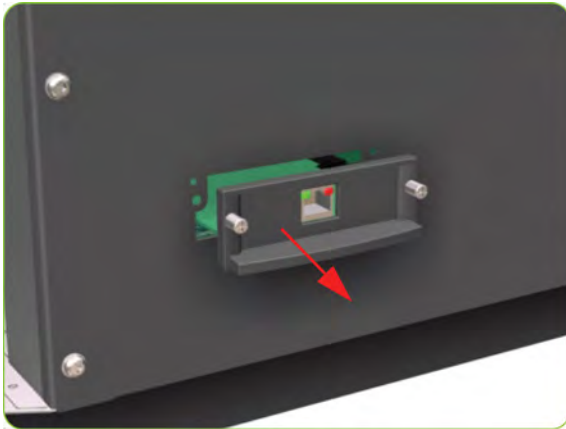

3. Remove three T-20 screws that secure the Ebox Cover Left.

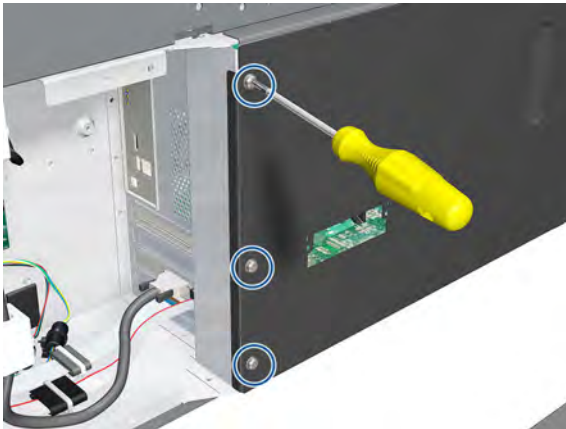

4. Remove the Ebox Cover Left from the printer.

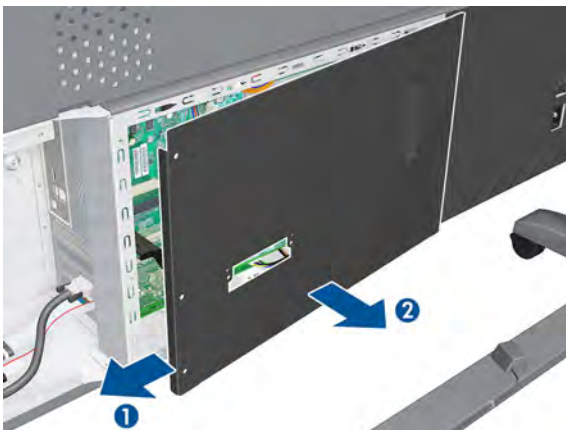

5. Disconnect the Trailing Cable to make the next step easier.

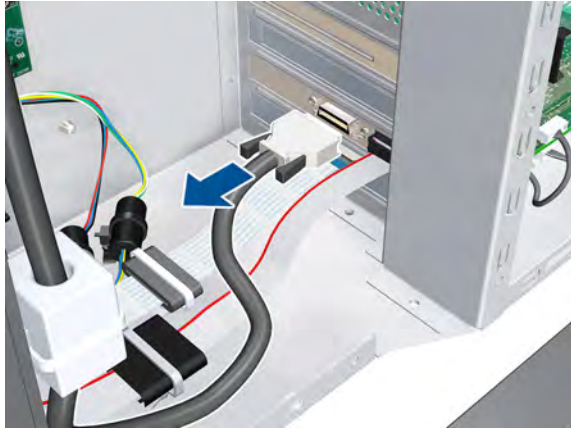

6. Unclip the connector, then disconnect the OMAS Controller Card.

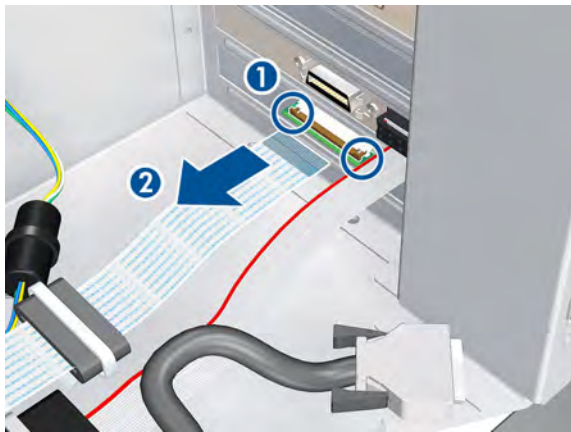

7. Disconnect three cables.



8. Remove one T-10 screw (**Type I**) that secures the OMAS Controller Card.



9. Disconnect the OMAS Controller Card from the Formatter and remove it from the printer.

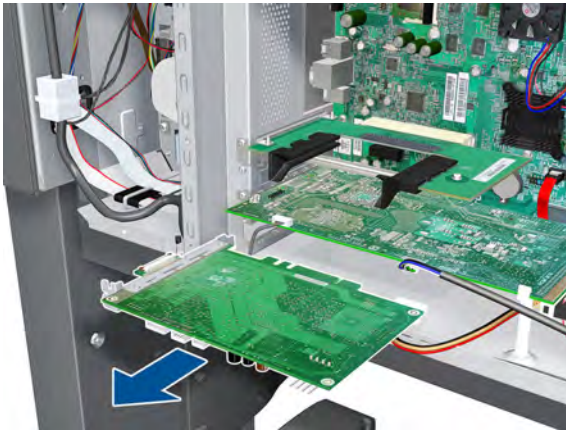

OMAS Cable

Removal

⚠ WARNING! Switch off the printer and remove the power cable.

1. Remove the Right Cover ⇒ See [Right Cover on page 235](#).
2. Remove the Right Connector Cover ⇒ ⇒ See [Right Connector Cover on page 258](#).
3. Remove the Service Station ⇒ See [Service Station on page 273](#).
4. Remove the OMAS ⇒ See [Optical Media Advance Sensor \(OMAS\) on page 339](#).

5. Remove one T-15 screw that secures the OMAS Cable clamp from the printer.

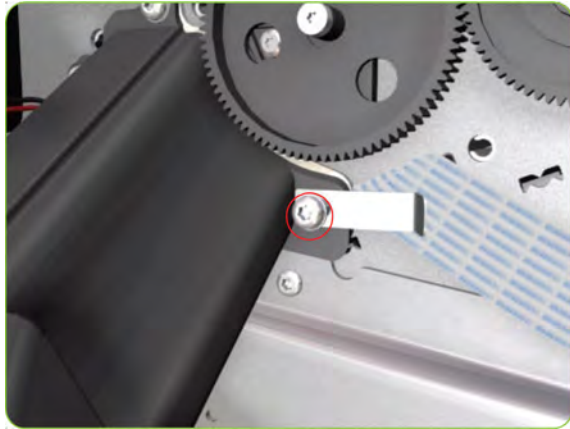

6. Remove the OMAS Cable clamp from the printer.

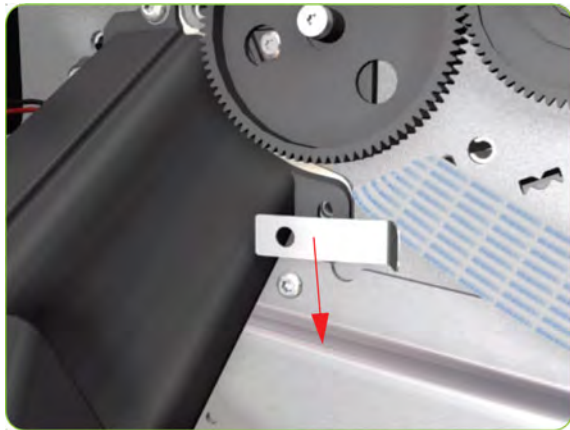

7. Carefully Pull the OMAS Cable out of the Vacuum Beam.

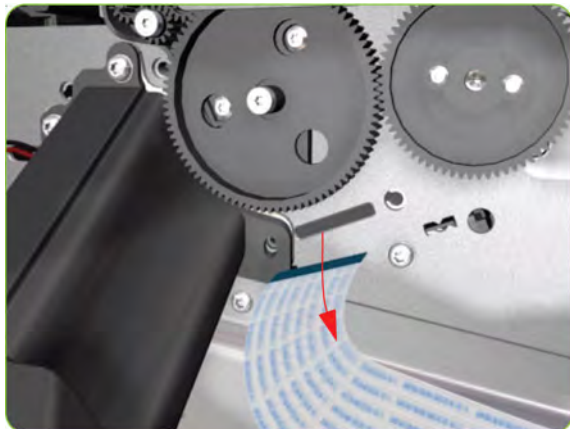

8. Disconnect the OMAS Cable from the OMAS Controller Card.

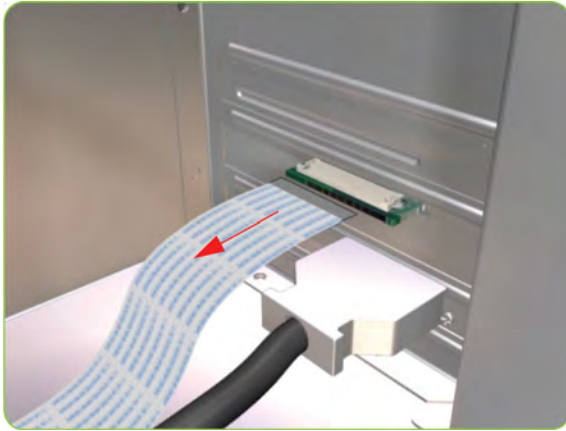

9. Unroute the OMAS Cable from the Ferrite Core.

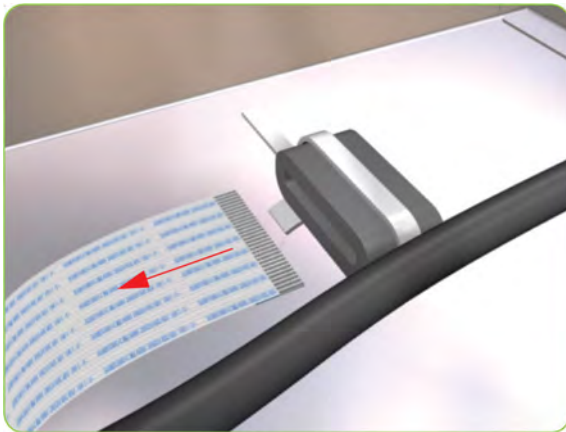

10. Unroute and remove the OMAS Cable from the printer.

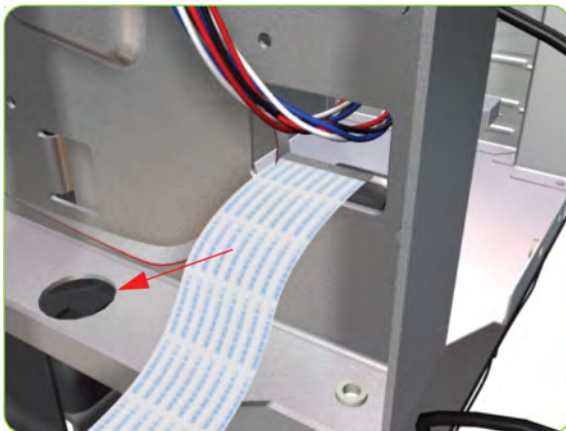

Installation

⚠ CAUTION: It is critical that the OMAS Cable is correctly positioned in the Vacuum Beam so that it does not cause physical interference to the Media Sensor.

The following illustration shows a cross-section of the Vacuum Beam with the OMAS Cable correctly routed to avoid interference to the Media Sensor.

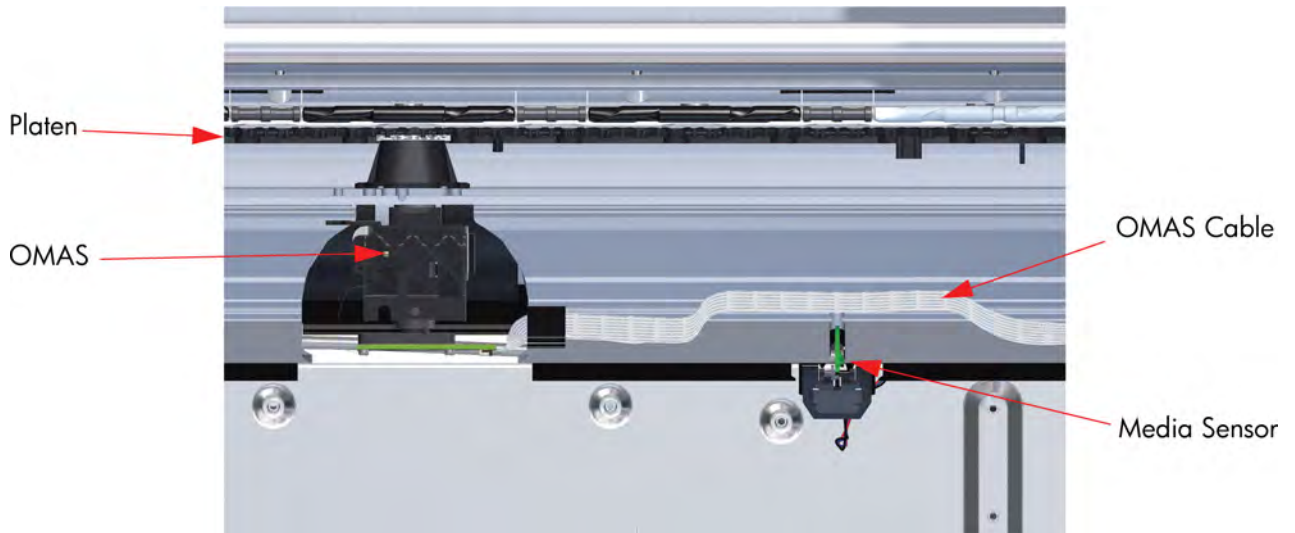

- ▲ Before you can start to install the OMAS Cable you must first identify which end connects to which component. The end of the cable that has the most perpendicular and diagonal folds is the end that connects to the OMAS with the blue reinforcing on the top. The other end must be connected to the OMAS Controller Card with the blue reinforcing on the bottom.

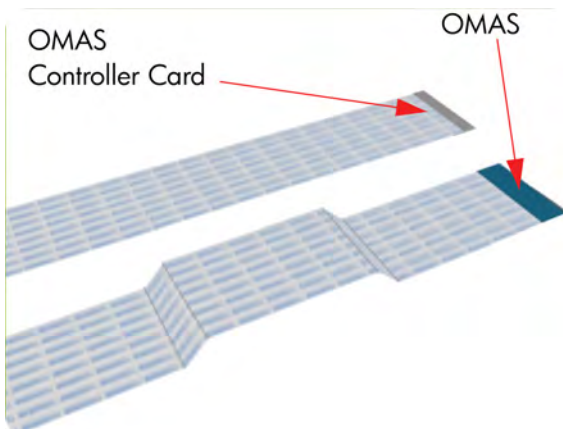

1. Carefully slide the Ferrite Core and its associated attachment plate out of the vacuum beam.



2. Position the OMAS Cable in the Vacuum Beam slot so that the blue reinforcement enters first.

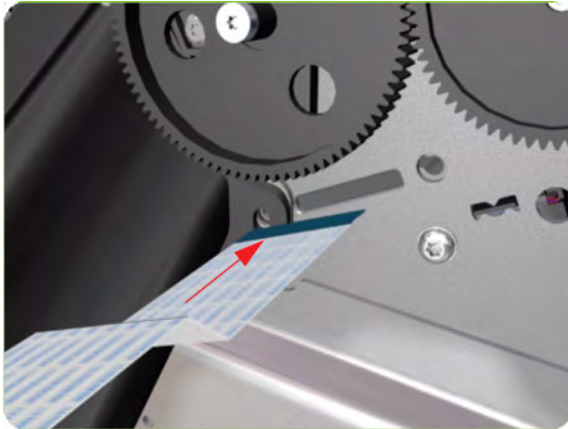

3. Carefully feed the OMAS cable through the Vacuum Beam sufficiently to have approximately 20 cm hanging from the OMAS installation position.

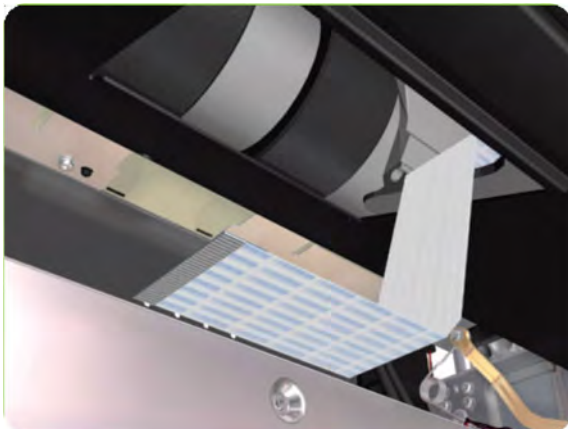

4. Slide the Ferrite Core and its associated Attachment Plate (on the top) onto the OMAS Cable.

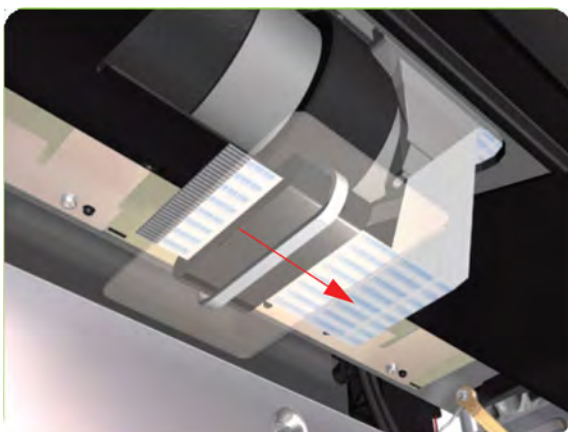

5. Push the Attachment Plate into its slot in the Vacuum beam until it is level with the edge of OMAS installation position.

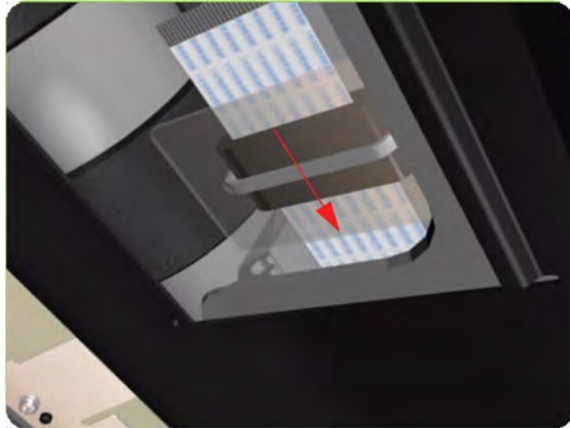

6. Carefully pull the OMAS Cable back into the Vacuum Beam (from the Service Station end) until the straight fold immediately before the first diagonal fold (from the OMAS sensor end) is aligned with the slot, fold the OMAS Cable across the diagonal fold, and install the cable clamp to lock the OMAS Cable in the correct position.

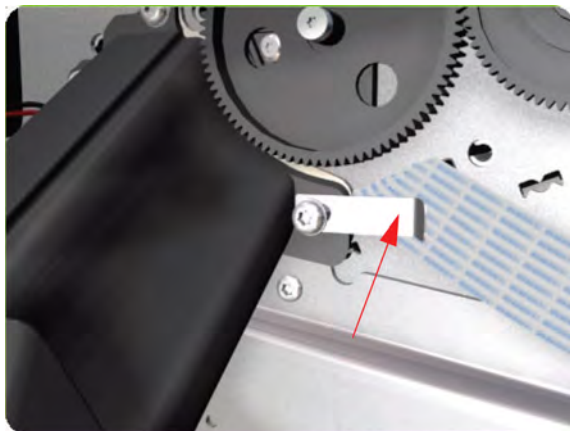

7. Route the OMAS Cable to the Ferrite Core in the Right Interconnect panel.



8. Feed the OMAS Cable through Ferrite Core.

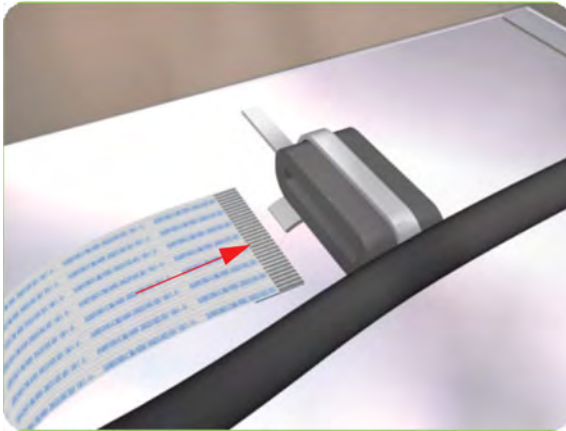

9. Connect the OMAS Cable to the OMAS Controller Card with the connections on the top.

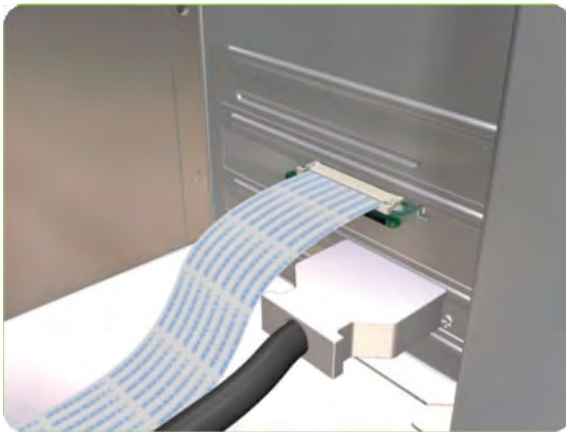

Main PCA

Removal

⚠ WARNING! Switch off the printer and remove the power cable.

1. Remove the Right Connector Cover ⇒ See [Right Connector Cover on page 258](#).

2. Remove the Jetdirect Card (if installed).

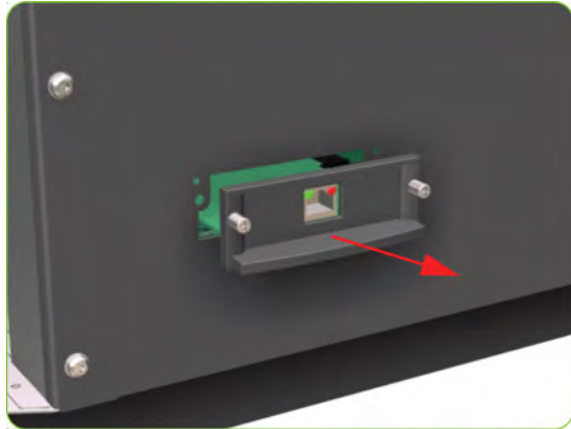

3. Remove three T-20 screws that secure the Ebox Cover Left.

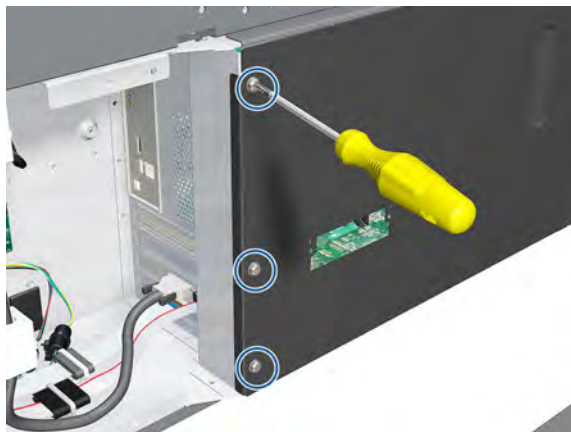

4. Remove the Ebox Cover Left from the printer.

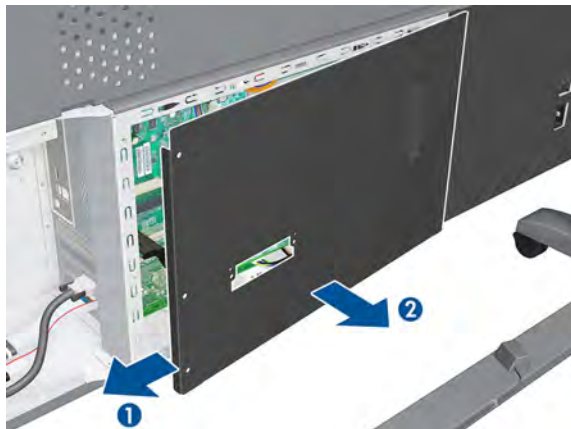

5. Disconnect the Trailing Cable and the Front Panel cable from the Main PCA.

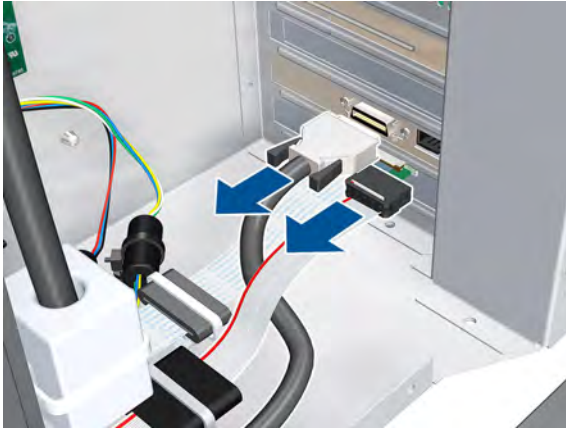

6. Disconnect two ribbon cables.

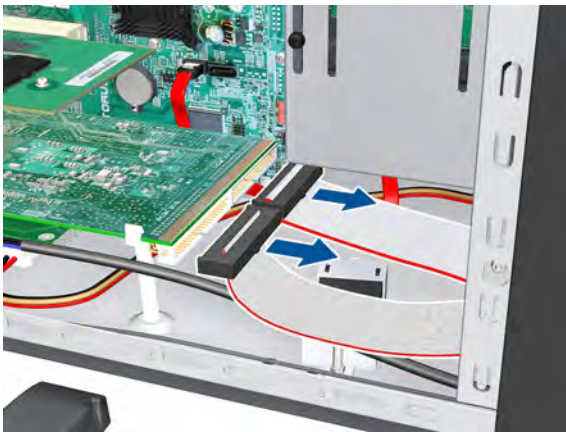

7. Disconnect two cables.

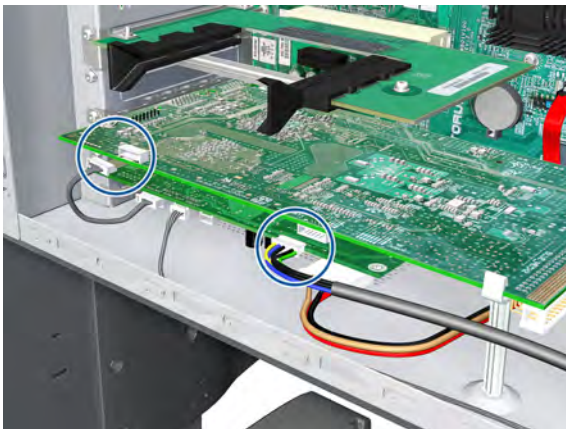

8. Remove one T-10 screw (**Type I**) that secures the Main PCA.



9. Unclip the Main PCA.

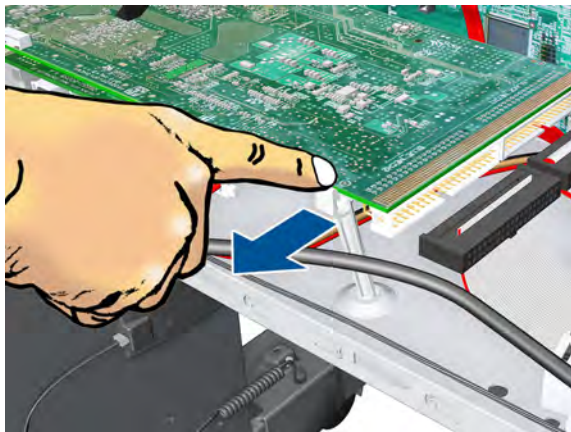

10. Remove the Main PCA.

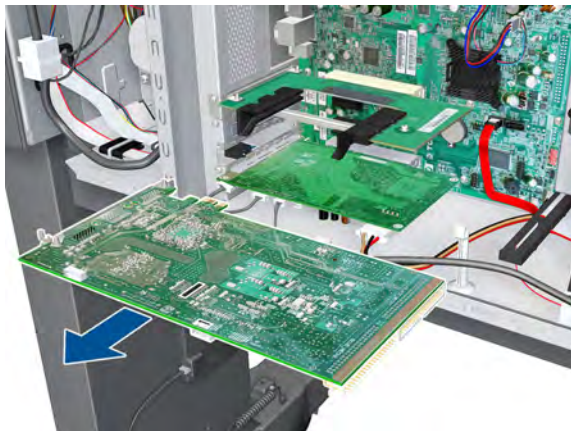

Formatter

Removal

 **WARNING!** Switch off the printer and remove the power cable.

CAUTION: Do not remove the Fan or the Processor (located under the Fan) from the Formatter. The Fan and the Processor are part of the Formatter support part and should be replaced as one assembly.

1. Remove the EIO to PCI Interface Card ⇒ See [EIO to PCA Interface Card on page 348](#).
2. Remove the Main PCA ⇒ See [Main PCA on page 358](#).
3. Remove the OMAS Controller Card ⇒ See [OMAS Controller Card on page 349](#).
4. Disconnect all cables connected to the Formatter.



5. Remove eight T-10 screws (**Type I**) that secure the Formatter.



6. Release the plastic locating pin that secures the Formatter.

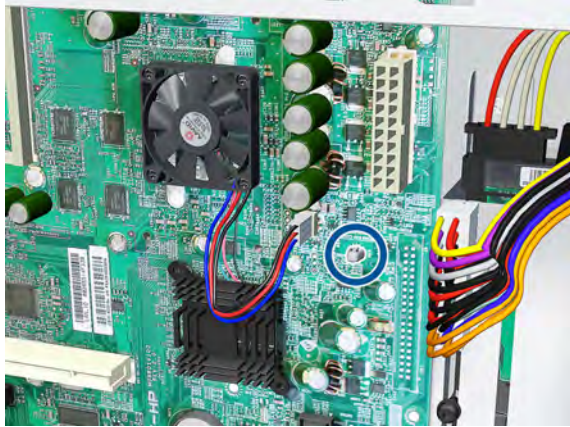

7. Remove the Formatter from the printer.



 **NOTE:** When installing the Formatter, make sure that you first locate it on the plastic locating pin and then install the screws.

After installing a new Formatter board in a Rev B printer, make sure your Password is reset.

Installation (Rev B printers only)

1. Locate the Formatter on the plastic locating pin, then install the screws.
2. Move the jumper from the default connection to the password reset connection.

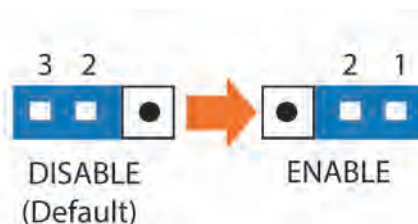

3. Cover the EBox temporarily, with a couple of screws to hold the cover in place.
4. Turn on the printer, wait until it has completely started up, then turn it off again.
5. When the printer is completely turned off, remove the power cable.

6. Remove the cover from the EBox.
7. Move the jumper from the password reset connection to the password default connection.

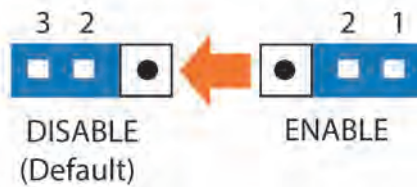

8. RCover the Ebox again.

TIP: When you first start a printer with a new Hard Disk Drive, encrypted or not, it may display an error message (79:04). Turn off the printer and restart. The printer should start normally.

CAUTION: Turning off the printer during the start-up procedure with a new Formatter and Hard Disk Drive may corrupt the BIOS password, leaving the system useless with no ability to restart.

TIP: After installing a new Formatter board in a Rev B printer, reset the password.

Hard Disk Drive (HDD)

Removal

After installing a new Formatter board in a Rev B printer, make sure your Password is reset.

WARNING! Switch off the printer and remove the power cable.

NOTE: You must never replace both the Hard Disk Drive and the Ink Supply Tubes and Trailing Cable at the same time. If both parts need to be replaced, you must first replace one part and then power on the printer until it initializes completely. Then you can power off the printer and replace the other part.

1. Remove the Jetdirect Card (if installed).

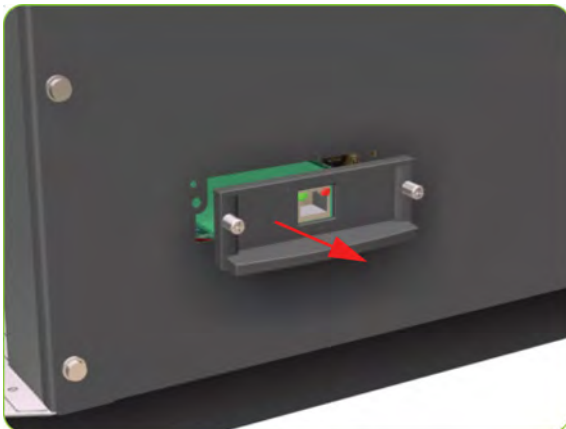

2. Remove three T-20 screws that secure the Formatter cover.

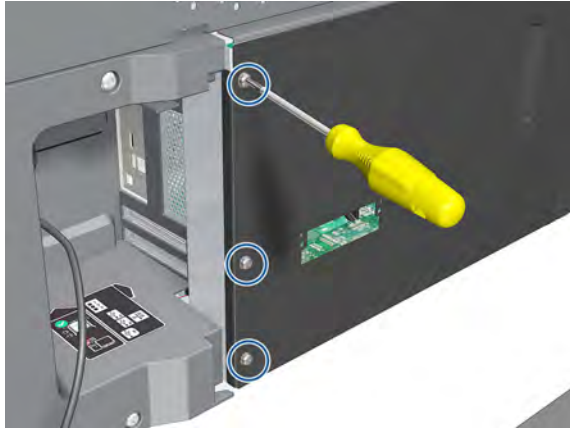

3. Remove the Formatter Cover from the printer.

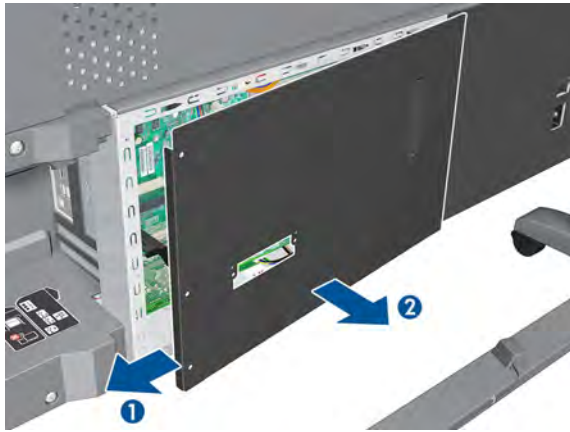

4. Disconnect the power and data cables connected to the Hard Disk Drive.



5. Remove one T-10 screw (**Type I**) from the HDD Holder.

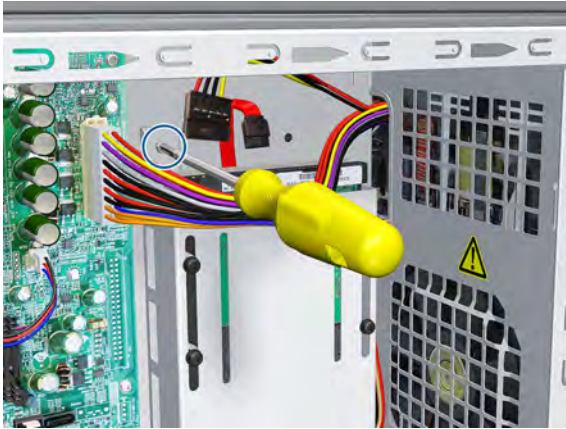

6. Slide the Hard Disk Drive upwards and remove from the printer.

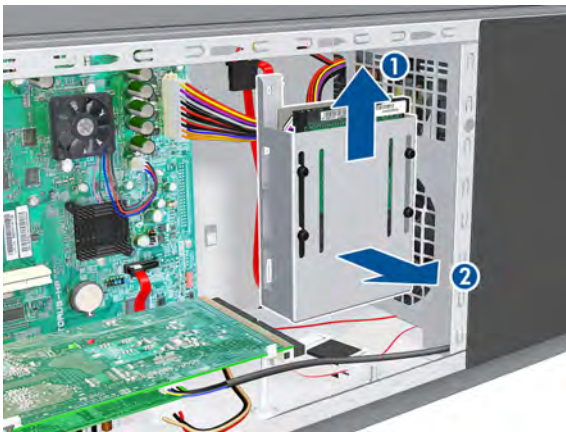

 **NOTE:** It is not necessary to remove the screws securing the HDD inside the metal casing.

Installation (Rev A printers only)

After installing a new HDD in Rev A printer, make sure you perform the following User Calibrations:

- Printhead Alignment.
- Paper Advance Calibration.
- Color Calibration.

Installation (Rev B printers only)

1. Install the new HDD assembly and T-10 screw.
2. Connect the SATA cable to the Formatter SATA connector and the other end to the HDD SATA connector.
3. Connect the SATA power cable to the HDD power cable from the PSU to the SATA power connector.

4. Identify the HDD Protect Jumper.



5. Move the jumper from the default connection to the password reset connection.

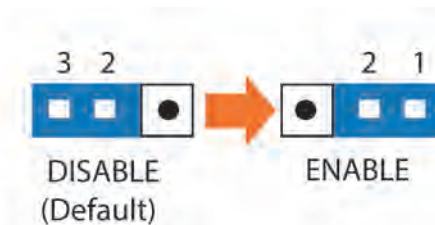

6. Cover the EBox temporarily, with a couple of screws to hold the cover in place.
7. Turn on the printer, wait until it has completely started up, then turn it off again.
8. When the printer is completely turned off, remove the power cable.
9. Remove the cover from the EBox.
10. Move the jumper from the password reset connection to the default position.

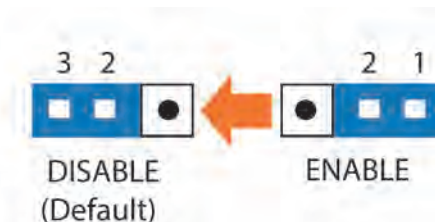

11. Cover the Ebox again.

 **TIP:** When you first start a printer with a new Hard Disk Drive, encrypted or not, it may display an error message (79:04). Turn off the printer and restart. The printer should start normally.

 **CAUTION:** Turning off the printer during the start-up procedure with a new Formatter and Hard Disk Drive may corrupt the BIOS password, leaving the system useless with no ability to restart.

After installing a new HDD in Rev A printer, make sure you perform the following User Calibrations:

- Printhead Alignment.
- Paper Advance Calibration.
- Color Calibration.

Power Supply Unit (PSU)

Removal

⚠ WARNING! Switch off the printer and remove the power cable.

1. Remove:
 - For the 42-inch model, the Left Connector Cover ⇒ See [Left Connector Cover \(42-inch\) on page 260](#).
 - For the 60-inch model, the Electronics Module Extension ⇒ See [Electronics Module Extension \(60-inch only\) on page 261](#).
2. Remove the Jetdirect Card (if installed).

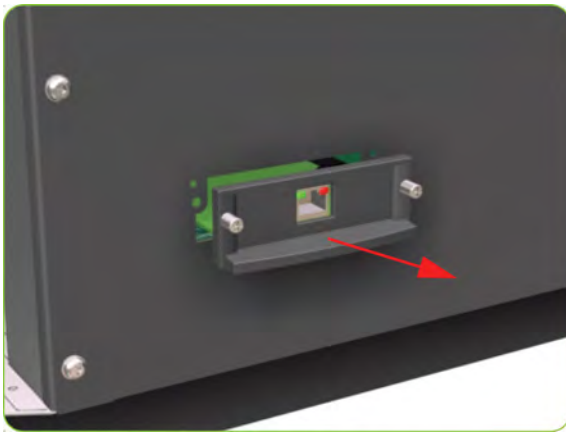

3. Remove three T-20 screws that secure the Formatter cover.

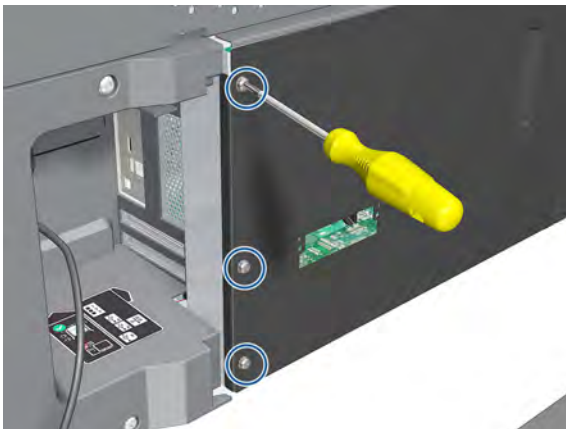

4. Remove the Formatter Cover from the printer.

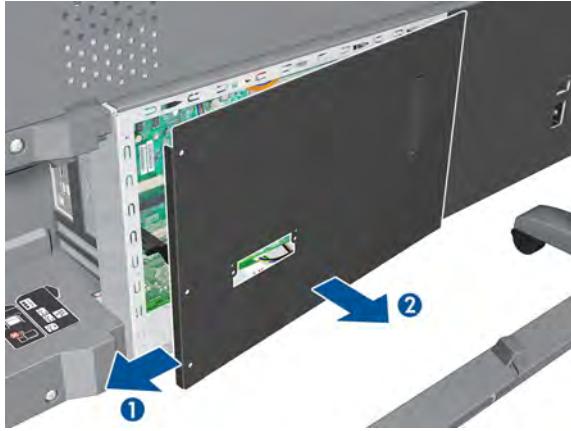

5. Remove three T-20 screws that secure the PSU cover.

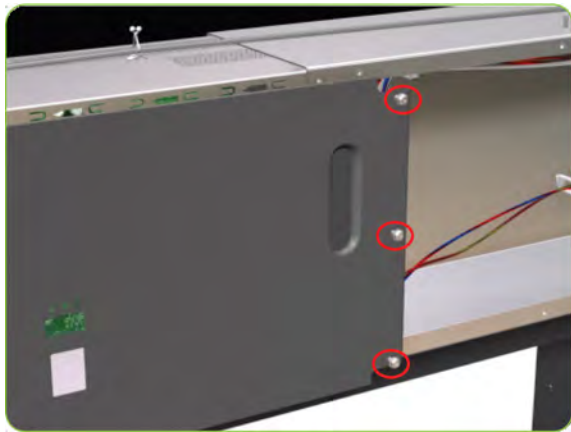

6. Remove the PSU Cover from the printer.

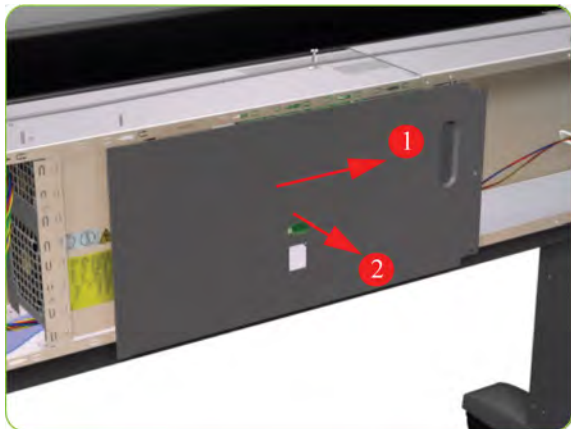

7. Disconnect the Power Supply from the PrintMech PCA.

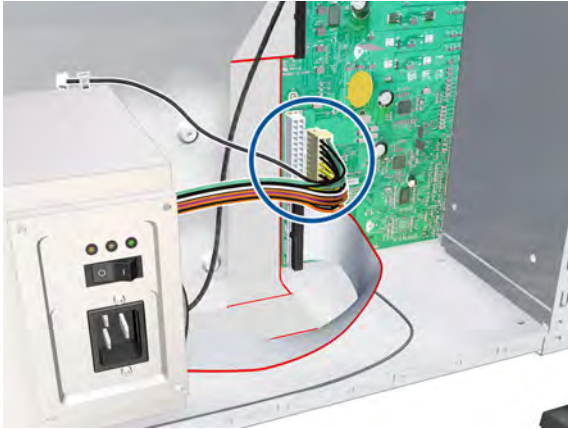

8. Disconnect the power supply cable from the Formatter.

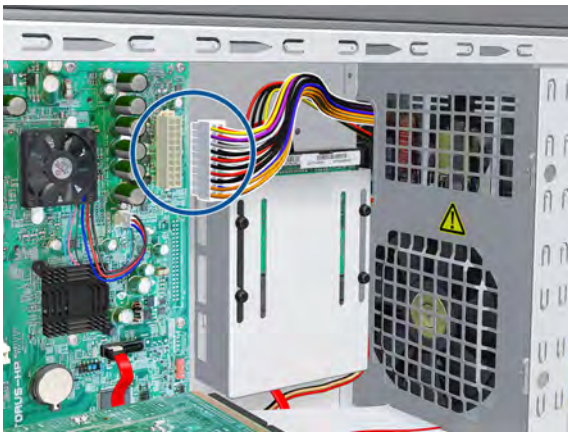

9. Disconnect one cable from the Hard Disk Drive.

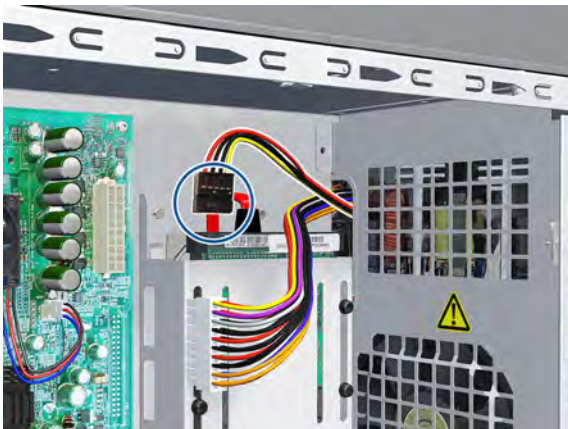

10. Disconnect the cable as shown.

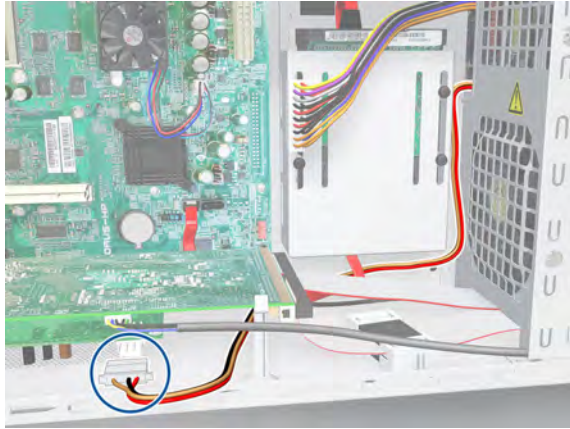

11. Disconnect the cable and pass it through the hole.

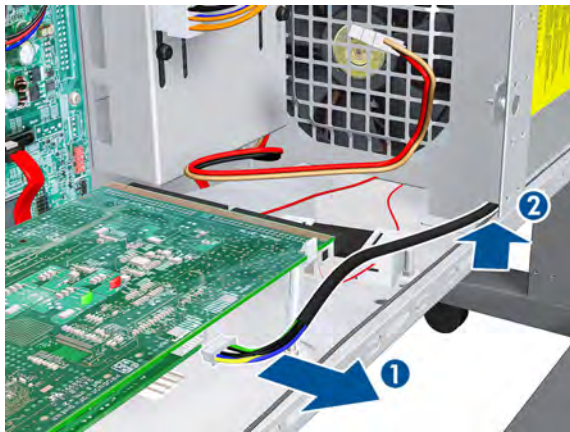

12. Remove four T-10 screws (**Type I**) that secure the Power Supply Unit.



13. Route the cables through the hole in the Electronics Module.

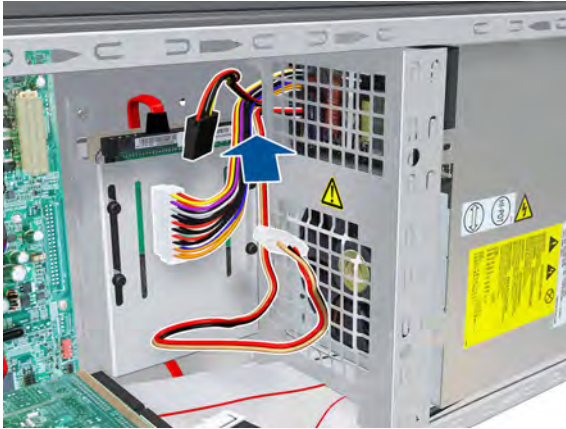

14. Remove the Power Supply Unit from the printer.

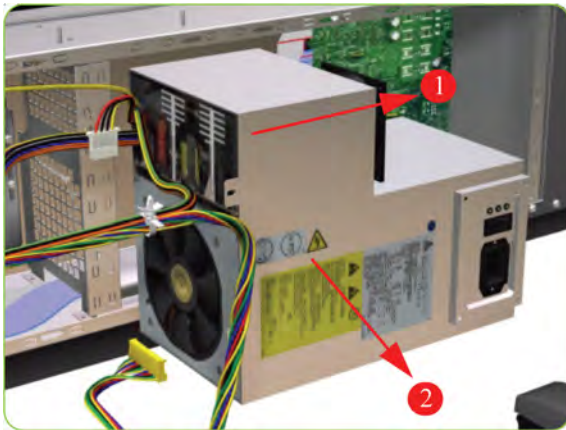

PrintMech PCA

Removal

WARNING! Switch off the printer and remove the power cable.

1. Remove:
 - For the 42-inch model, the Left Connector Cover ⇒ See [Left Connector Cover \(42-inch\)](#) on page 260.
 - For the 60-inch model, the Electronics Module Extension ⇒ See [Electronics Module Extension \(60-inch only\)](#) on page 261.

2. Remove three T-20 screws that secure the PSU Cover.

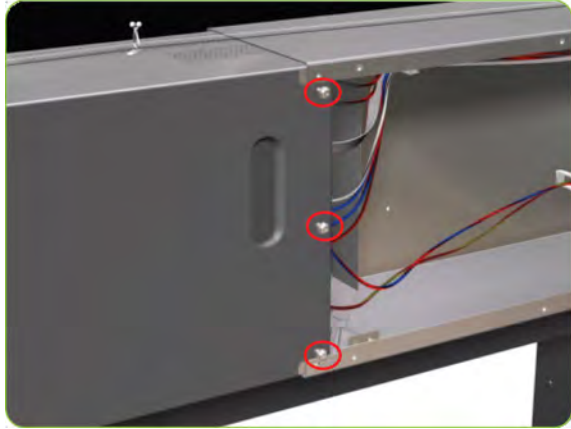

3. Remove the PSU Cover from the printer.

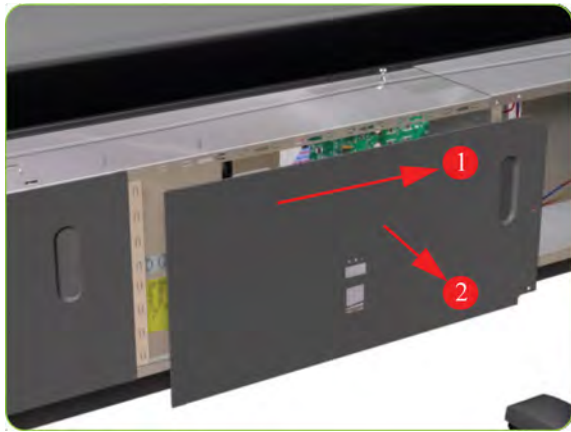

4. 42-inch printer only: Remove two T-20 screws from the PrintMech Cover.

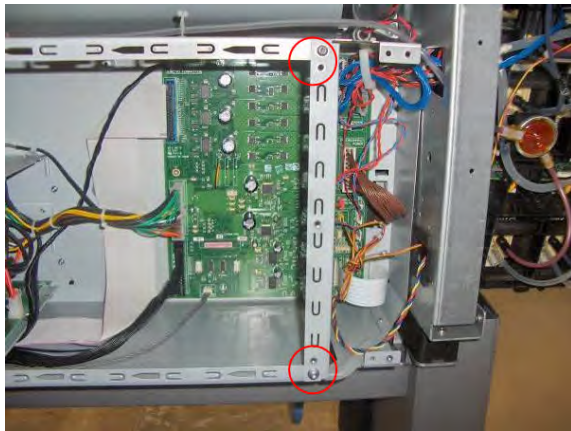

5. Deform the electronic chassis and slide it out.

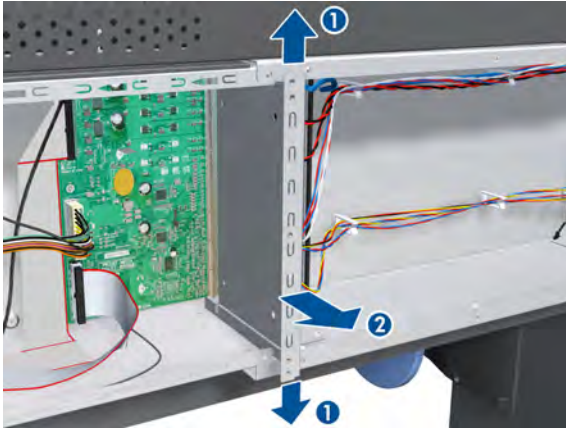

6. Slide the PrintMech Cover out of the printer.

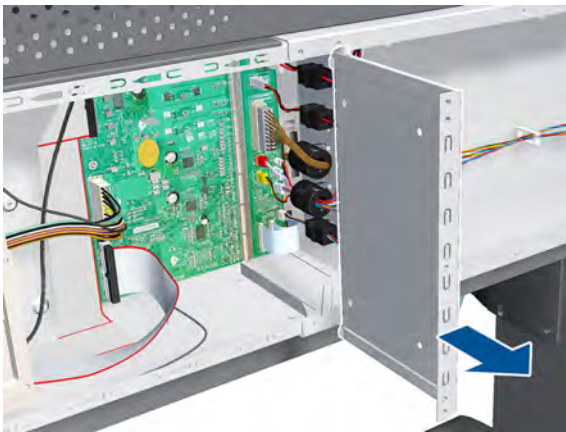

7. Disconnect all cables from the PrintMech PCA.

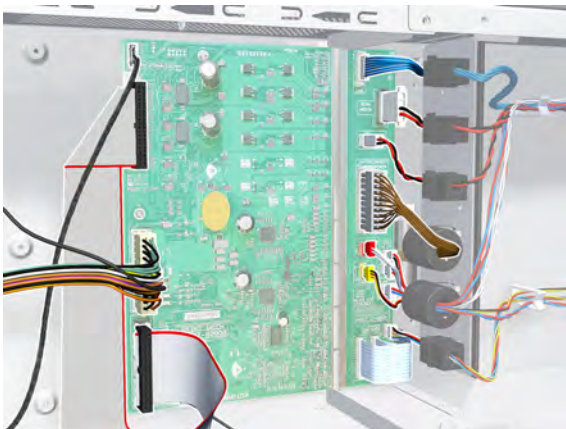

8. Remove five T-10 screws (**Type I**) that secure the PrintMech PCA.

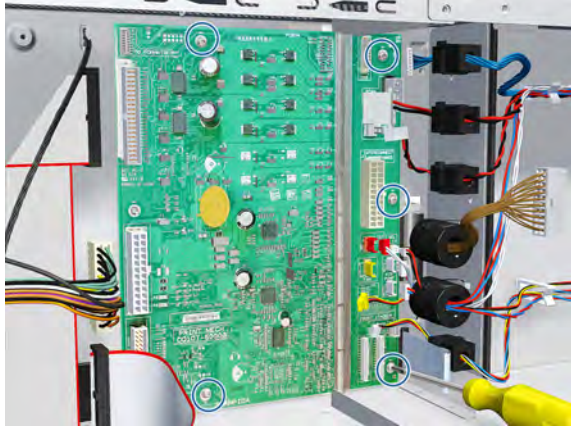

9. Remove the PrintMech PCA from the printer.

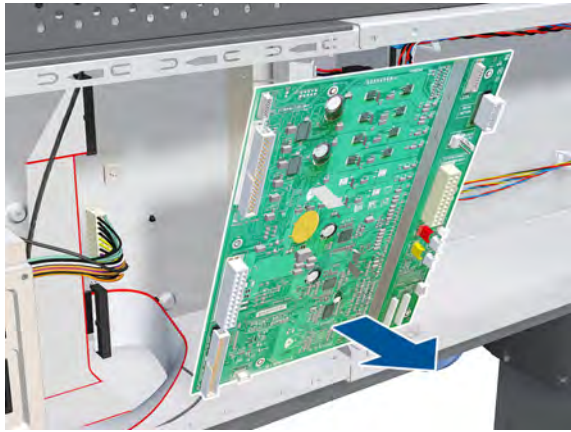

Formatter Battery

Removal

⚠ WARNING! Switch off the printer and remove the power cable.

1. Remove the Jetdirect Card (if installed).

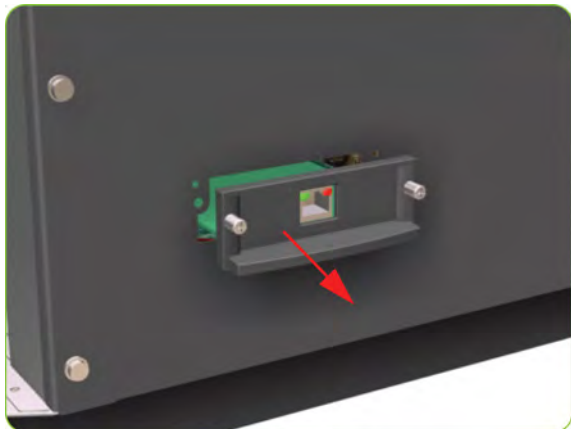

2. Remove three T-20 screws that secure the Formatter cover.

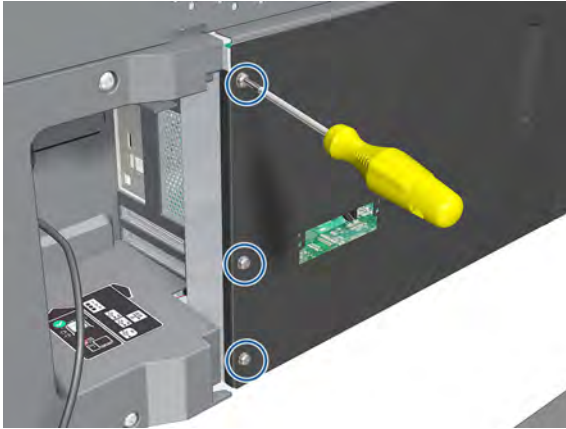

3. Remove the Formatter Cover from the printer.

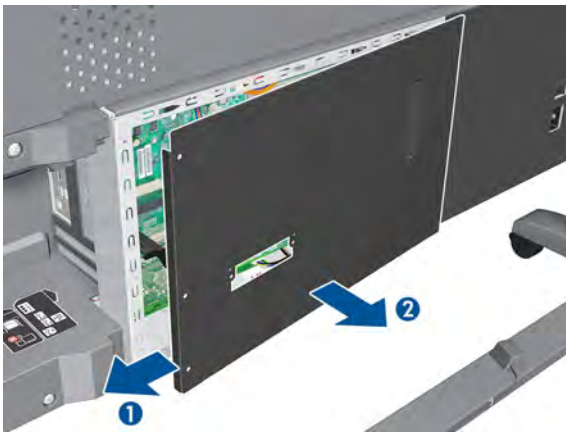

4. Remove the EIO to PCA Interface Card ⇒ See [EIO to PCA Interface Card on page 348](#).

5. Push the clip down and release the battery from the Formatter.

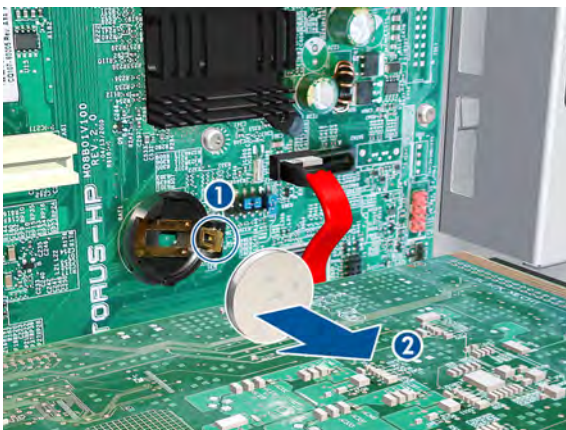

Electronics Module

Removal

⚠ WARNING! Switch off the printer and remove the power cable.

1. Remove the Right Cover ⇒ See [Right Cover on page 235](#).
2. Remove the Left Cover ⇒ See [Left Cover on page 240](#).
3. Remove the Rear Door:
 - For the 42-inch model ⇒ See [Rear Door \(42-inch\) on page 254](#).
 - For the 60-inch model ⇒ See [Rear Door \(60-inch\) on page 256](#).
4. Remove the Right Connector Cover ⇒ See [Right Connector Cover on page 258](#).
5. Remove the Left Connector Cover:
 - For the 42-inch model ⇒ See [Left Connector Cover \(42-inch\) on page 260](#).
 - For the 60-inch model ⇒ See [Electronics Module Extension \(60-inch only\) on page 261](#).
6. Disconnect all the cables connected to the right Interconnect PCA and the Main PCA.



7. Unroute all the disconnected cables so they are clear of the Electronics Module.



8. Remove two T-20 screws (**Type B**) that secure the right-hand-side Electronics Module.

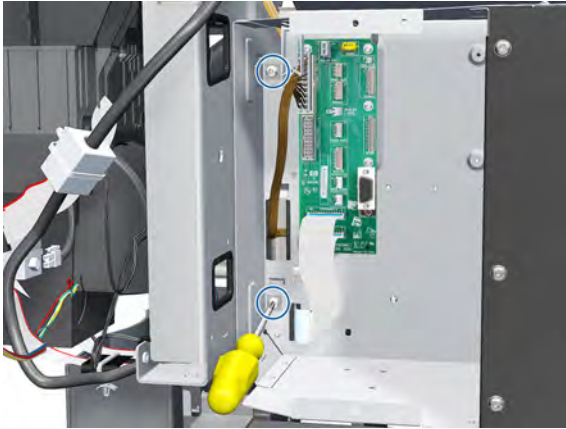

9. Remove two T-20 screws (**Type B**) that secure the left-hand-side Electronics Module.

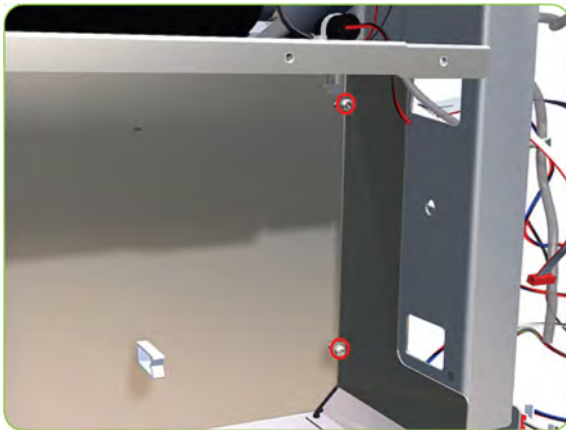

10. Lift the Electronics Module sufficiently (approximately 2 cm) to release it from the attachments.

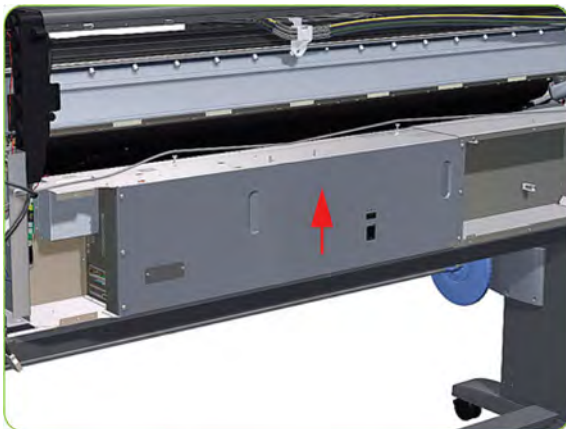

11. Remove the Electronics Module from the printer.



Line Sensor Assembly

Removal

⚠ WARNING! Switch off the printer and remove the power cable.

1. Remove the Right Cover ⇒ See [Right Cover on page 235](#).
2. Press the two side of the Carriage PCA Cover and unclip from the Carriage Assembly.

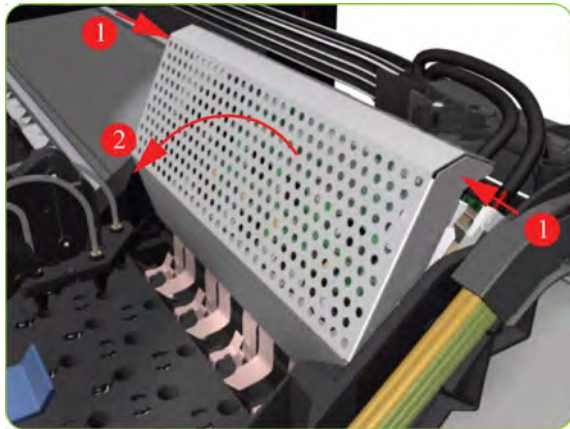

3. Release the clip and disconnect the Line Sensor cable from the Carriage PCA.



4. Remove the Line Sensor from the Carriage Assembly.

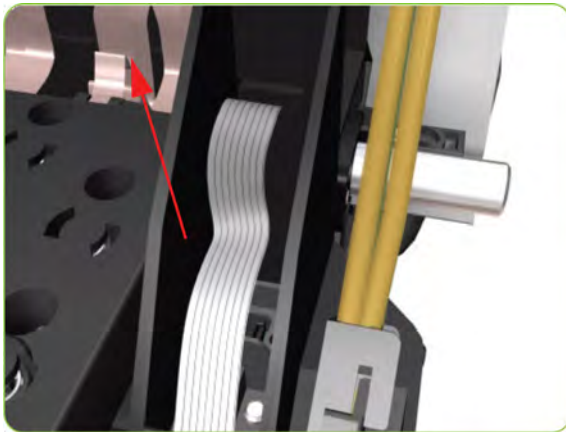

5. Remove the protective foam from around the sensor.

 **NOTE:** After installing the new Line Sensor, make sure you perform the following Service Calibrations:

- Line Sensor Calibration ⇒ [Line Sensor calibration on page 139](#).



Embedded SpectroPhotometer (ESP)

Removal

 **WARNING!** Switch off the printer and remove the power cable.

1. Open the Window.
2. Remove the Right Cover ⇒ See [Right Cover on page 235](#).
3. Remove the Left Cover ⇒ See [Left Cover on page 240](#).
4. Uncap the Carriage Assembly by manually pulling out the Printhead Maintenance Cartridge tray.



5. Lift the Primer and hold it as high as possible to avoid damaging it when you move the Carriage Assembly in the next step.

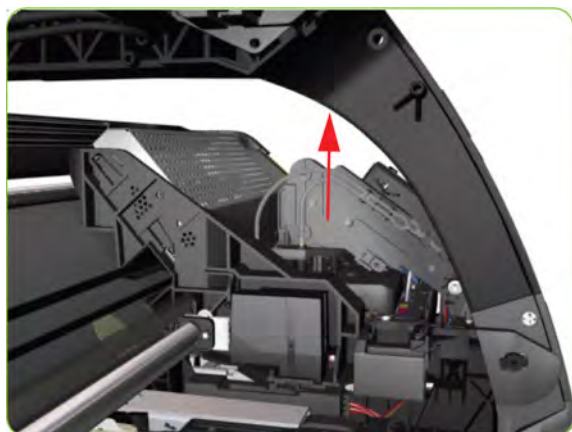

6. Move the Carriage Assembly out of the Service Station.

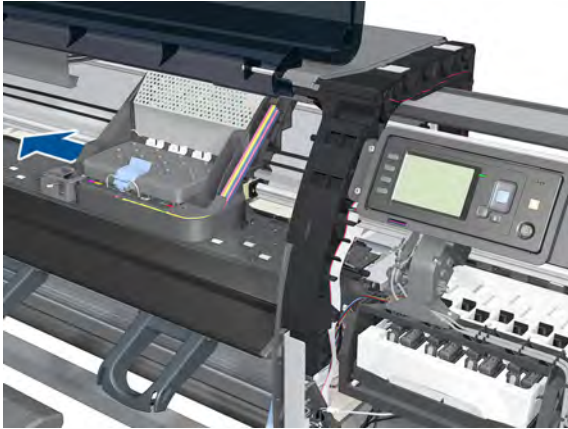

7. Move the Carriage all the way to the left side of the printer.

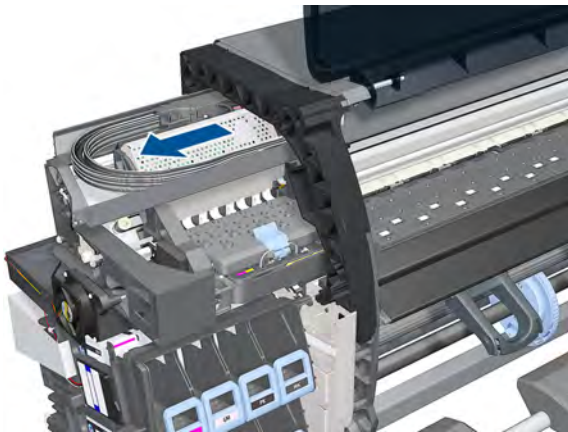

8. Press the two sides of the Carriage PCA Cover, unclip it from the Carriage Assembly and remove it.

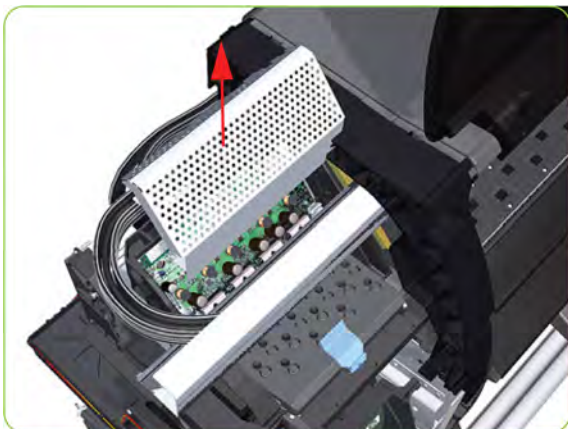

9. Release the clip and disconnect the ESP cable from the Carriage PCA.

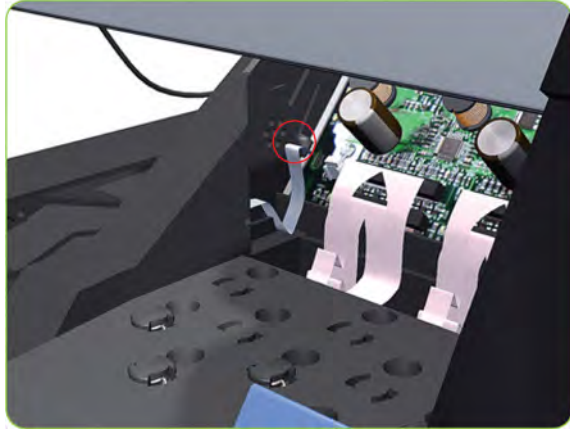

10. Move the carriage sufficiently to the right to gain access the ESP attachment screws.

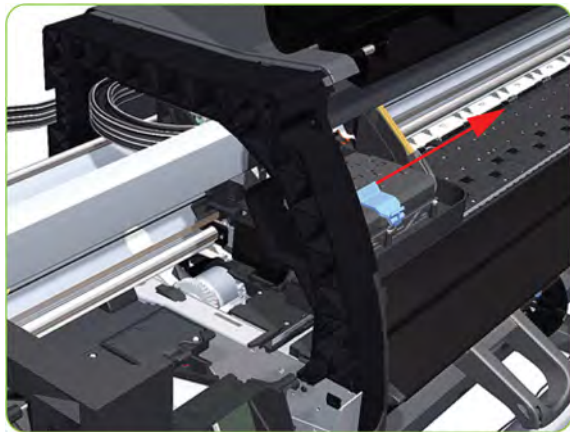

11. Remove one T-10 screw and one T-15 screw that secure the ESP to the Carriage Assembly.

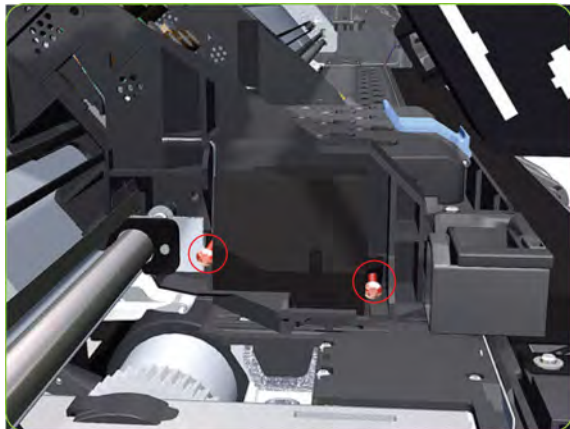

12. Tilt the ESP so that it can be removed.



13. Remove the ESP from the Carriage Assembly.

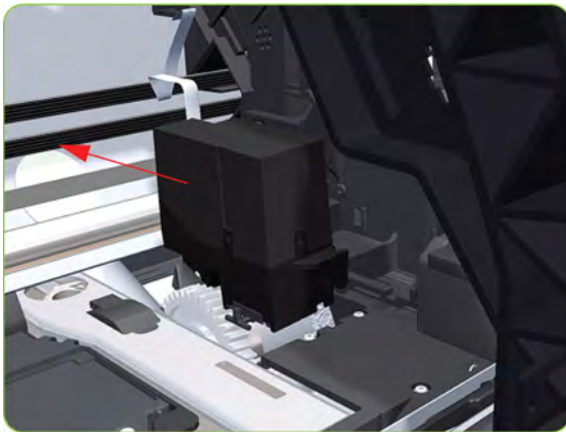

Embedded SpectroPhotometer (ESP) Actuator

Removal

⚠ WARNING! Switch off the printer and remove the power cable.

1. Remove the Left Cover ⇒ See [Left Cover on page 240](#).
2. Remove the Left Spittoon ⇒ See [Left Spittoon on page 311](#).

3. Slide out the top row of Ink Cartridges from the Ink Supply Station.

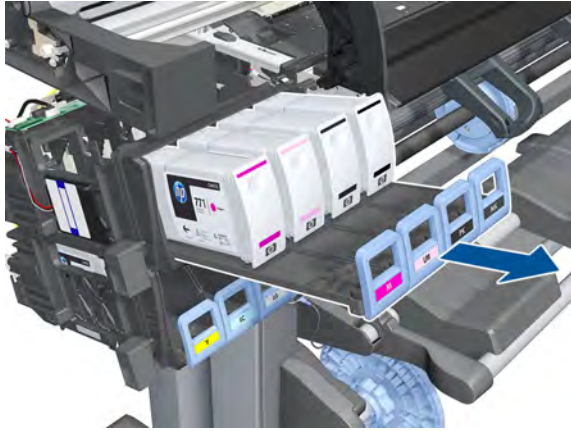

4. Disconnect the ESP Actuator.

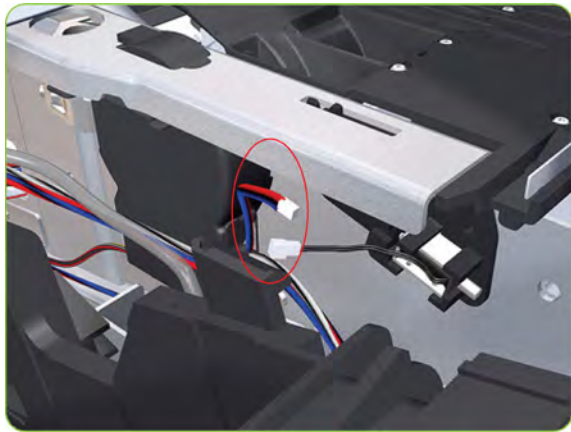

5. Remove one T-15 screw (**Type G**) that secures the ESP Actuator to the printer.

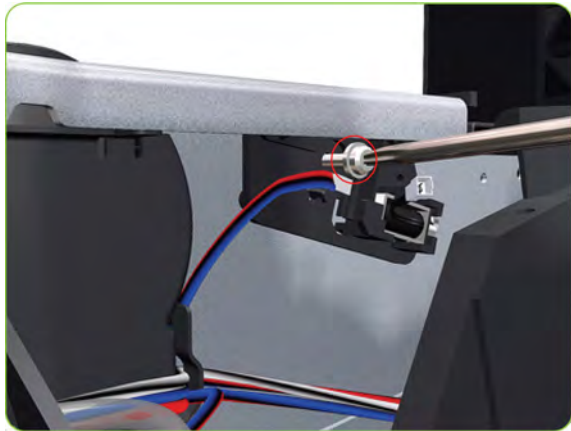

6. Remove the ESP Actuator.

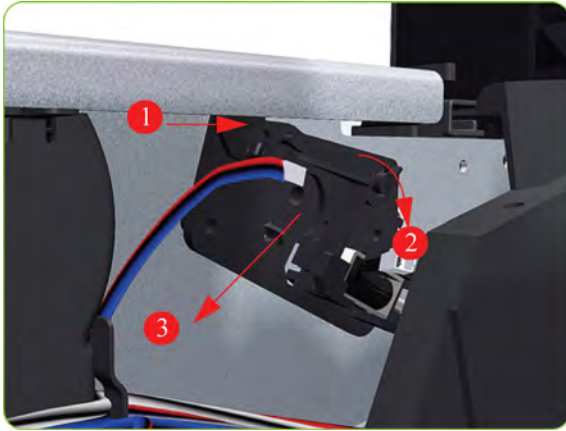

Media Deflector

Removal

WARNING! Switch off the printer and remove the power cable.

1. Remove two T-20 screw (**Type B**) that secures the Media Deflector that needs to be replaced.



2. Remove the Media Deflector (slide upwards first) from the printer.

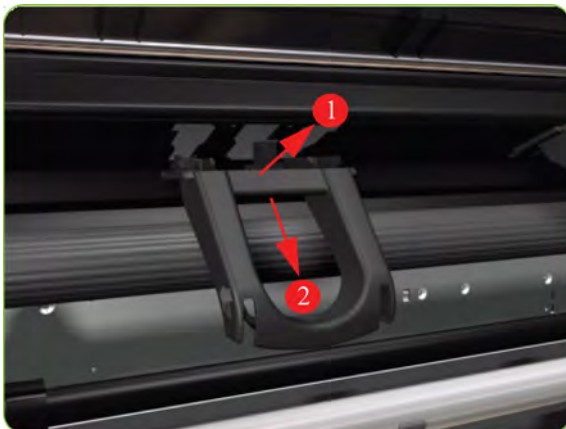

Output Platen

Removal

 **WARNING!** Switch off the printer and remove the power cable.

1. Open the Window.



2. Remove four T-15 screws and two cross-head screws that secure the Output Platen.



3. Remove one T-10 screw at the bottom left of the Output Platen.



4. Release the clips on the left- and right-hand sides of the Front Platen.

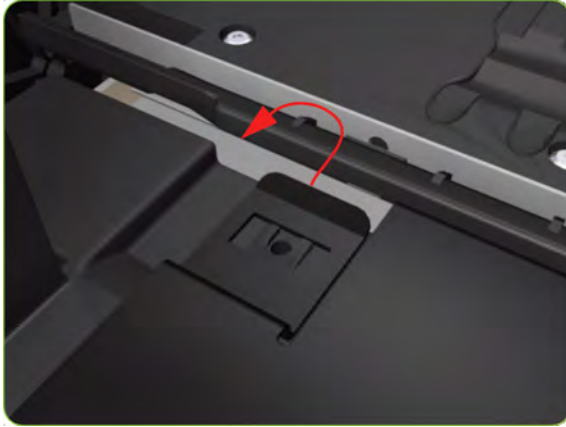

5. Pull out the right-hand side of the Front Platen.



6. Carefully slide the Front Platen to the right and then remove from the printer.



 **NOTE:** If a new Front Platen is to be installed, make sure that you first remove all Media Deflectors (see [Media Deflector on page 386](#)) from the old Front Platen and install them on the new Front Platen.

Print Platen

Removal

⚠ WARNING! Switch off the printer and remove the power cable.

1. Remove the Right Cover ⇒ See [Right Cover on page 235](#).
2. Remove the Left Cover ⇒ See [Left Cover on page 240](#).
3. Remove the Top Cover ⇒ See [Top Cover \(60-inch\) on page 249](#).
4. Remove the Service Station ⇒ See [Service Station on page 273](#).
5. For the 42-inch model, remove the Rear Door ⇒ See [Rear Door \(42-inch\) on page 254](#).
6. Squeeze the corners of the OMAS Access Cover release it from the bottom of the printer.

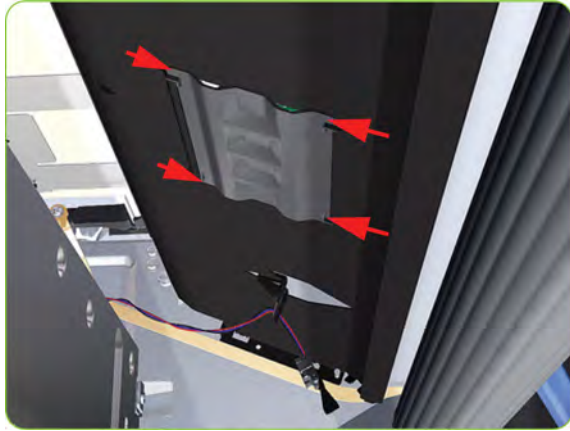

7. Remove the OMAS Access Cover from the printer.

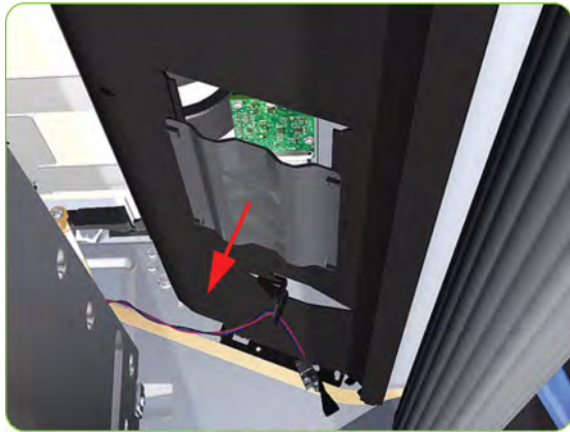

8. Insert the T-20 thin bladed torx screwdriver (supplied with the replacement OMAS) into the access hole at the rear of the printer.

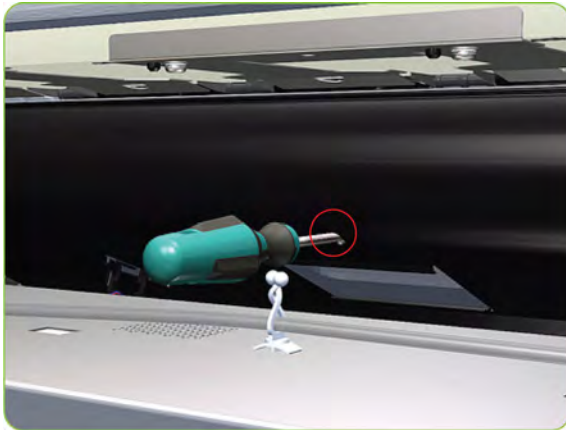

9. Loosen approximately two turns the T-20 screw which secures the OMAS horizontally to the printer.



10. From the bottom of the printer, loosen approximately two turns the T-20 screw which secures the OMAS vertically to the printer.



11. Remove one T-15 screw (**Type P**) that secures the Print Platen Gear.



12. Remove the Print Platen Gear from the printer.

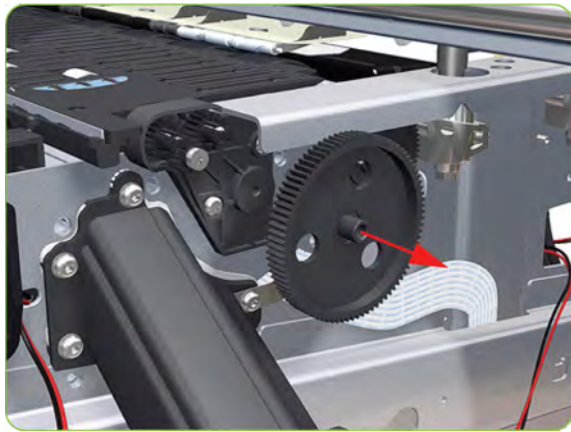

13. Remove one T-15 screw that secures the small Gear.



14. Remove the small Gear from the printer.



15. Remove the two small Platen Gears by releasing the clips.



16. Remove two T-20 screws (**Type Q**) that secure the Gear Bracket.



17. Remove the Gear Bracket from the printer.

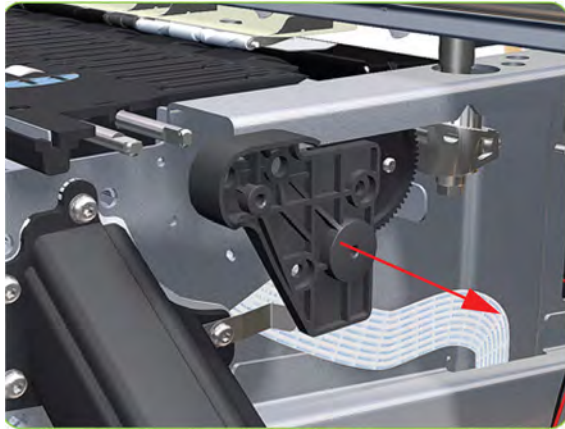

18. Move the Carriage Assembly fully to the right.



19. Remove all the T-10 screws (Type C) that secure the Print Platen:

- 80 T-10 screws for the 42-inch model
- 116 T-10 screws for the 60-inch model.

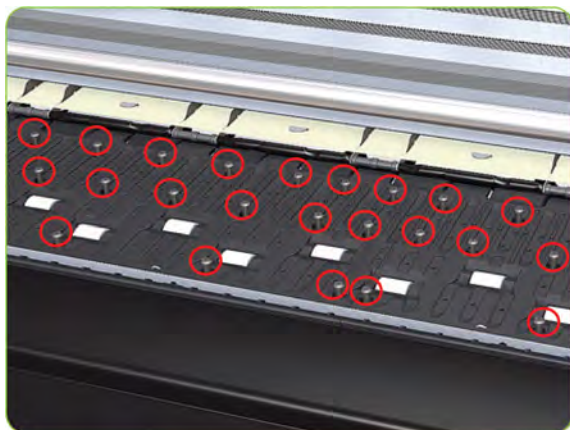

20. Remove the Secondary Spittoon Blank.



21. Remove the Print Platen from the printer.







Installation of the Foams

Before installing the Print Platen, make sure you check the foams that are stuck on the Vacuum Beam. These foams should ONLY be changed if they are damaged. In the circumstance where they do need to be changed, use the following illustrations to guide you:



Foams will need to be trimmed when stuck to the Vacuum Beam

-  **NOTE:** Make sure you take note of the positions of the Foams located underneath the Print Platen.
-  **NOTE:** When reinstalling the parts, make sure you apply the grease (included with the support part) to the gears.
-  **NOTE:** After installing the new Print Platen, make sure you perform paper-advance calibration ⇒ [Paper-advance calibration on page 134](#).
-  **NOTE:** To simplify the installation of the OMAS an Attachment Screw Retainer has been added to hold the two T-20 attachment screws. This part is delivered with the Print Platen in case either of the OMAS attachment screws are completely removed during the removal of the Print Platen.

OMAS Attachment Screws Completely Removed during Print Platen Removal

1. Completely remove OMAS from the printer ⇒ See [Optical Media Advance Sensor \(OMAS\) on page 339](#).
2. Install the Print Platen.

-  **NOTE:** When reinstalling the parts, make sure you apply the grease (included with the support part) to the gears.

3. Position the Attachment Screw Retainer on the OMAS and secure it with the T-8 attachment screw provided with Print Platen.



4. Check that the two T-20 attachment screws are correctly positioned in the Attachment Screw Retainer.



5. Position the OMAS under the printer and connect the large ribbon.

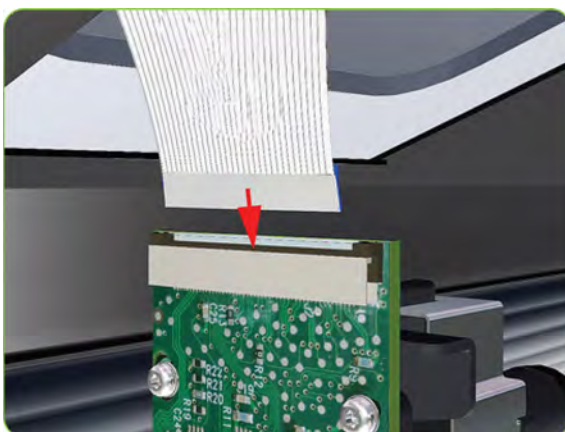

6. Lock the clips of the large ribbon cable connector.

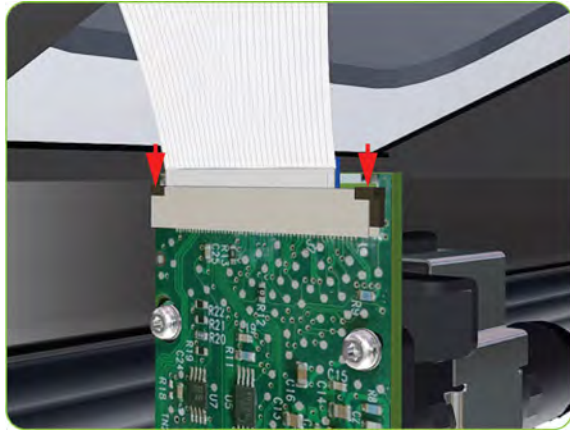

7. Carefully push the OMAS fully up into its mounting so it protrudes slightly (approximately 0.1 mm) above the Print Platen. To ensure the OMAS is correctly positioned, slide a sheet of paper over the Platen Ribs until it is stopped by the OMAS. This ensures the OMAS is protruding slightly above the platen.

⚠ CAUTION: Make sure the OMAS is pushed completely up into its mounting or you will encounter an error during the OMAS calibration because it will not be able to focus on the paper.



8. If the paper is not stopped by the OMAS, repeat step 4 to ensure the OMAS is pushed fully up into its the mounting.



9. Fully tighten the T-20 vertical attachment screw.



10. Insert the T-20 thin bladed torx screwdriver into the access hole at the rear of the printer.



11. Fully tighten the T-20 horizontal attachment screw which secures the OMAS to the printer.

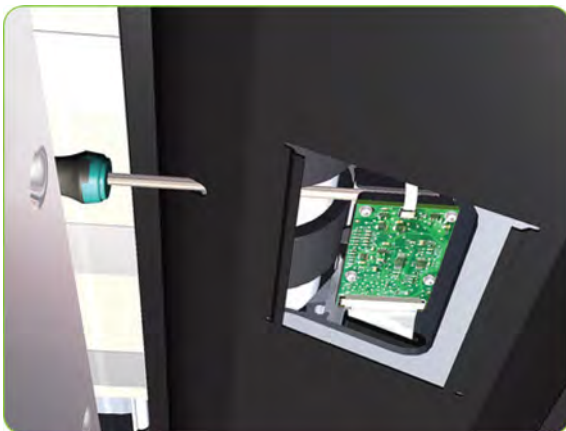

12. Clip the Media Sensor to the Center Guide.

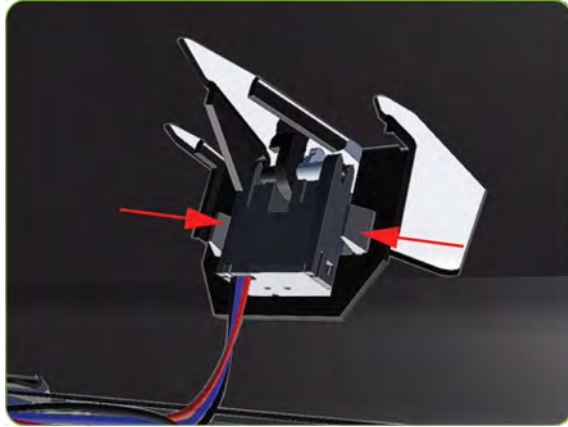

13. Clip the OMAS access cover back into place by sliding one edge of the cover into the slot and then applying enough pressure to it so you can clip it into the other slot.

14. Calibrate the following:

- OMAS ⇒ See [OMAS Calibration on page 150](#).
- Paper Advance Calibration ⇒ See [Paper-advance calibration on page 134](#).



Cartridge Tray

Removal

⚠ WARNING!

1. Release the Tray Lever of the required color and pull out the Tray.

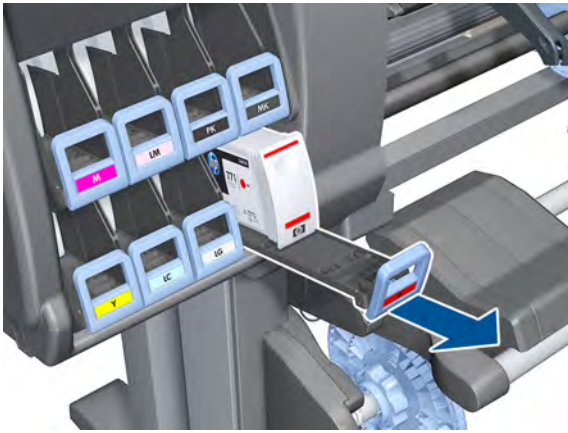

2. Remove the Ink Cartridge if installed.



3. Press down on the Tray clip.

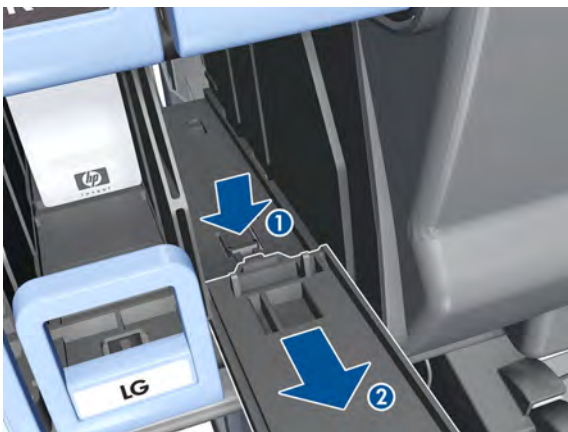

4. Pull the Tray completely out of the printer.

 **NOTE:** Note that each Cartridge Tray is different even though they look very similar. When selecting the Cartridge Tray from the Support Part (it contains eight Cartridge Trays), choose the Tray that exactly matches the one that you have just removed.



Input Roller

Removal

 **WARNING!** Switch off the printer and remove the power cable.

1. Raise the right lever to release the right-hand end of the Input Roller.



2. Pull out the right-hand end of the Input Roller from the printer.

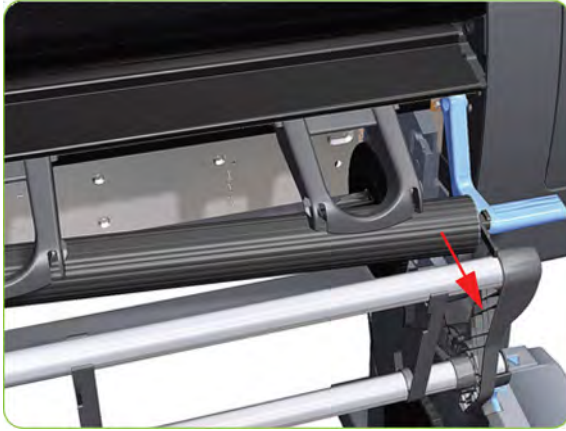

3. Move the Input Roller to the right to disengage it from the printer.



4. Remove the Input Roller from the printer.



Maintenance Cartridge Door

Removal

 **WARNING!** Switch off the printer and remove the power cable.

1. Open the Maintenance Cartridge Door.



2. Unclip and remove the Maintenance Cartridge Door from Right Cover.



Maintenance Cartridge Door Sensor

Removal

⚠ WARNING! Switch off the printer and remove the power cable.

1. Remove the Right Cover ⇒ See [Right Cover on page 235](#).

2. Disconnect the Maintenance Cartridge Door Sensor cable.

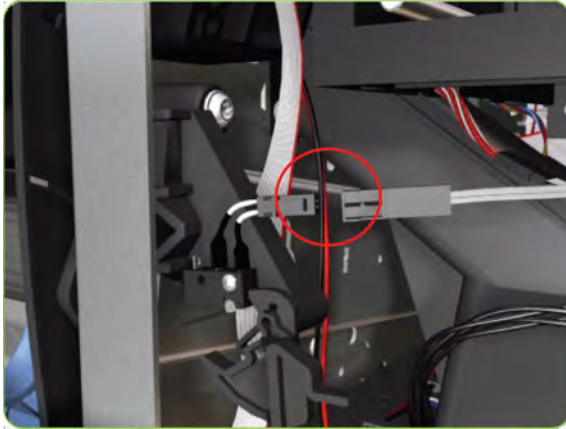

3. Release one T-10 screw that attaches the Maintenance Cartridge Door Sensor assembly to the printer.

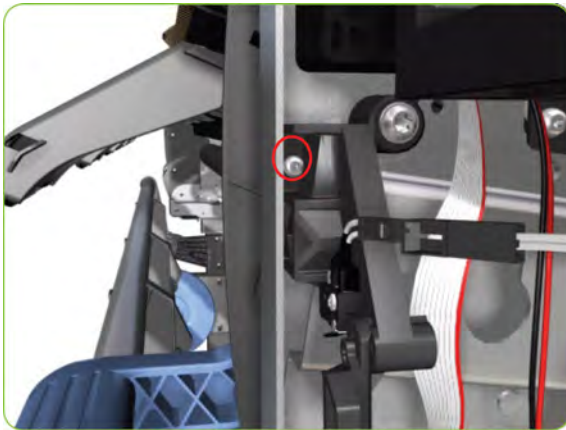

4. Remove the Maintenance Cartridge Door Sensor assembly from the printer.

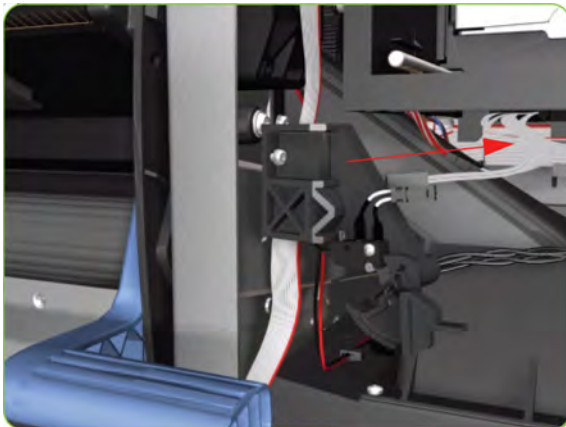

Media Sensor

Removal

1. Remove the Right Cover ⇒ See [Right Cover on page 235](#).
2. Remove the Rear Door ⇒ See [Rear Door \(60-inch\) on page 256](#).
3. Remove the Right Connector Cover ⇒ See [Right Connector Cover on page 258](#).
4. Disconnect the Media Sensor cable just below the Media Sensor.

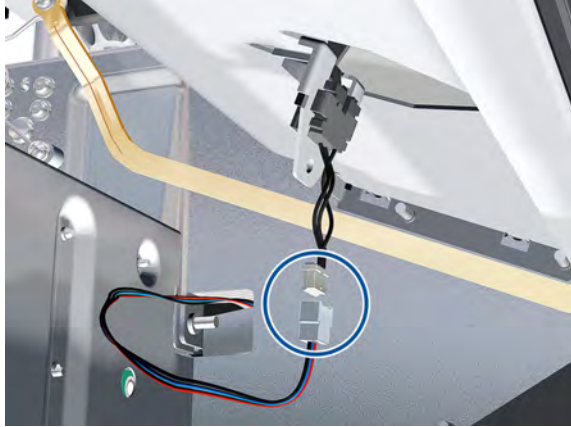

5. Unclip the Media Sensor from the Center Guide.

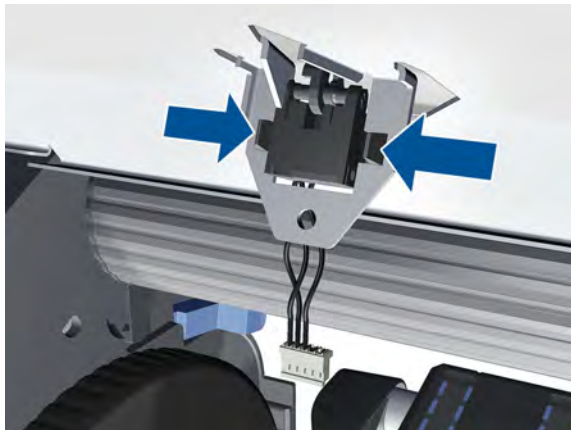

6. Pull the cable and connector through the mounting hole and remove the Media Sensor from the printer.



7. Push the other end of the Media Sensor cable through the hole.

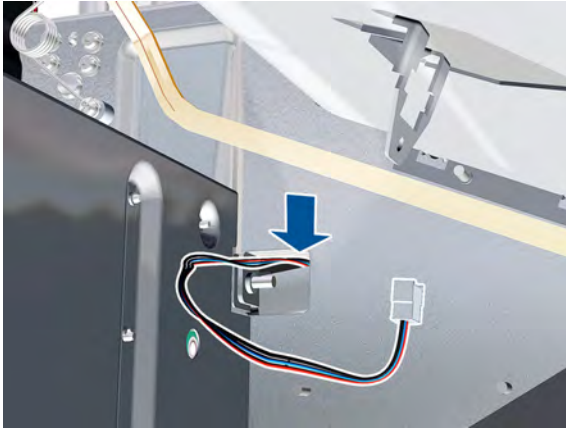

8. Collect the cable on the other side of the hole.



9. Disconnect the cable from the Interconnect PCA.

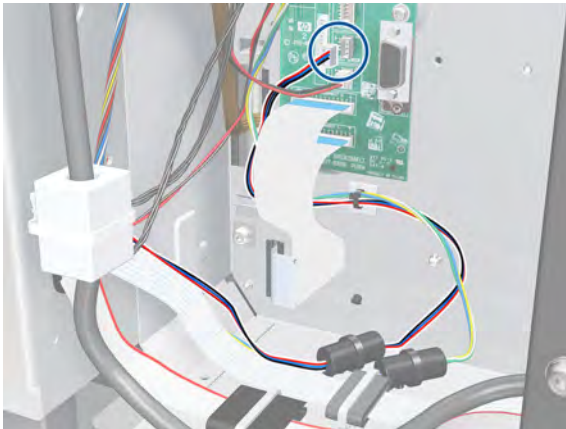

10. Extract the cable.

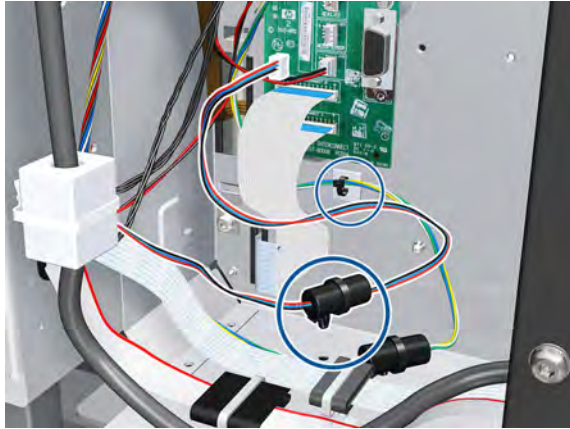

11. Remove the cable.

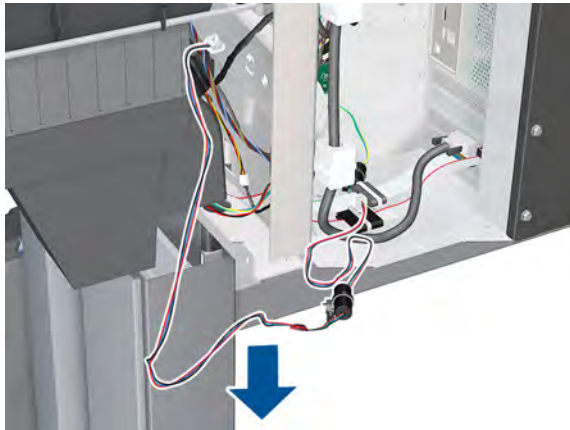

Encoder Disc and Sensor

Removal

-
- ⚠ WARNING!** Switch off the printer and remove the power cable.
- ⚠ CAUTION:** Please handle the Encoder Disc very carefully since any finger prints, scratches or stains could cause the printer to malfunction.
-

1. Remove the Left Cover ⇒ See [Left Cover on page 240](#).
2. Remove:
 - For the 42-inch model, the Left Connector Cover ⇒ See [Left Connector Cover \(42-inch\) on page 260](#).
 - For the 60-inch model, the Electronics Module Extension ⇒ See [Electronics Module Extension \(60-inch only\) on page 261](#).
3. Remove the Ink Supply Station ⇒ See [Ink Supply Station \(ISS\) on page 298](#).

4. Disconnect the Encoder Sensor cable from the PrintMech PCA.

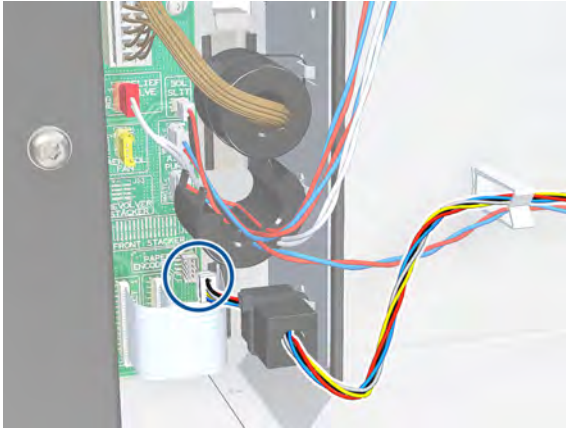

5. Release the Encoder Sensor cable from the clip located on the Electronics Module.

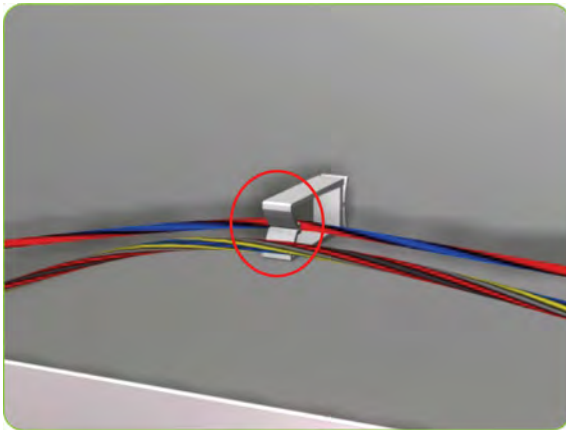

6. Release the Encoder Sensor cable from the clip located on the Encoder Disc Cover.

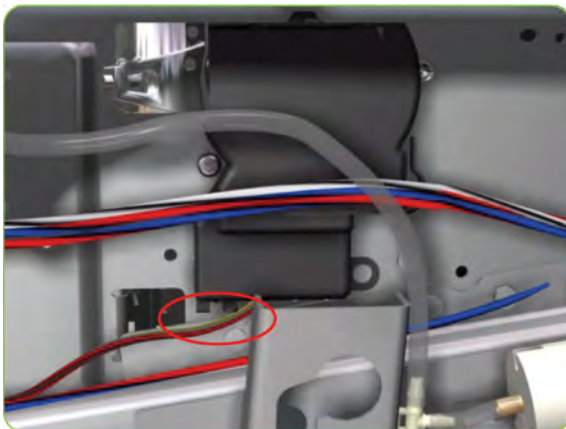

7. Unclip the Encoder Disc Cover and remove from the printer.

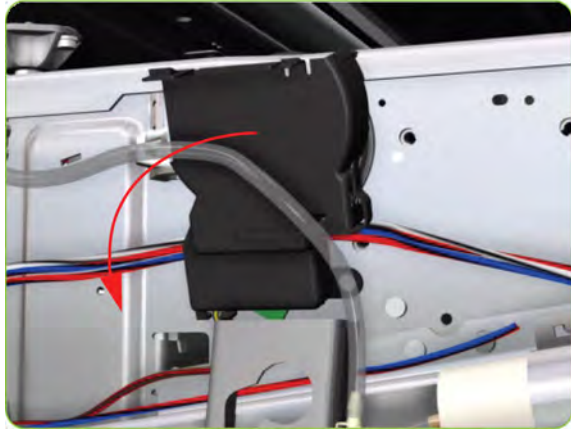

8. Remove one T-8 screw (**Type D**) that secures the Encoder Sensor to the Chassis.

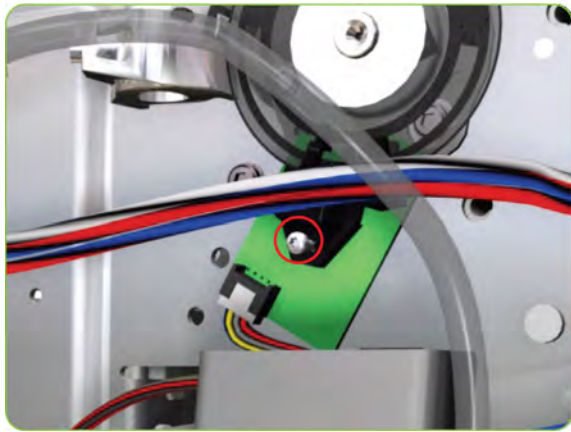

9. Remove the Encoder Sensor from the printer.

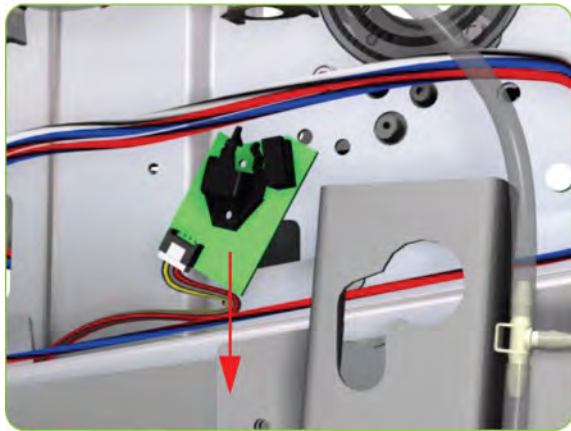

10. Carefully peel the Encoder Disc from the Drive Roller.

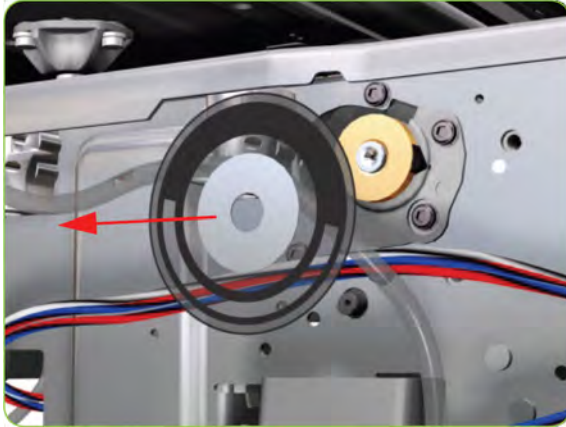

Media Lever

Removal

WARNING! Switch off the printer and remove the power cable.

1. Remove the Right Cover ⇒ See [Right Cover on page 235](#).
2. Remove the Rear Door ⇒ See [Rear Door \(60-inch\) on page 256](#).
3. Raise the Media Lever.

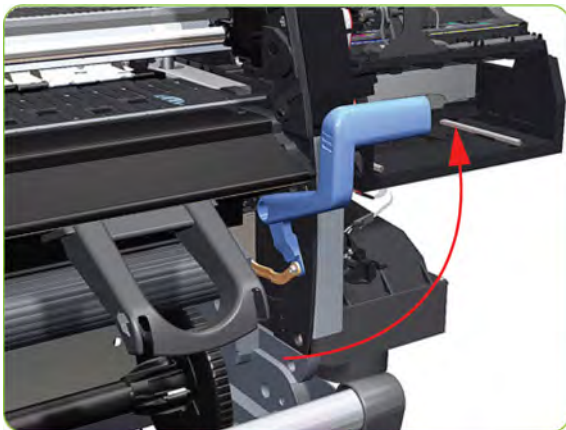

4. Remove one T-15 screw (**Type F**) that secures the Linkage to the Spring.

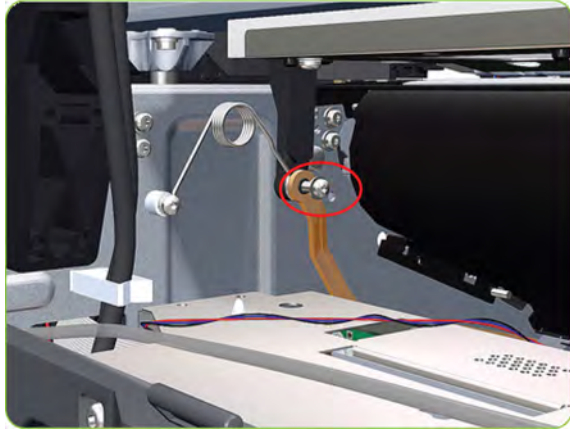

5. Remove the Linkage from the Spring.



6. Remove one T-20 screw (Type A) that secures the Spring to the Spacer.

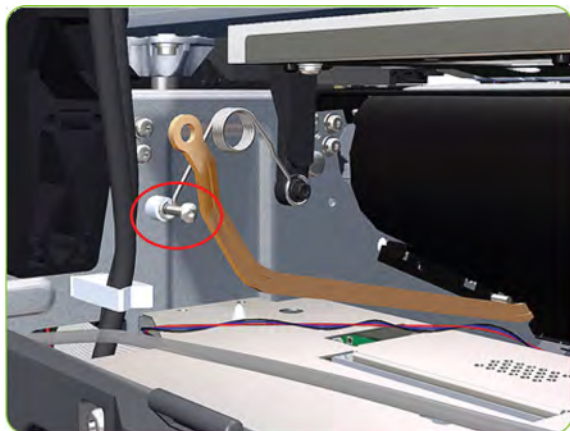

7. Remove the Spring and plastic washer.

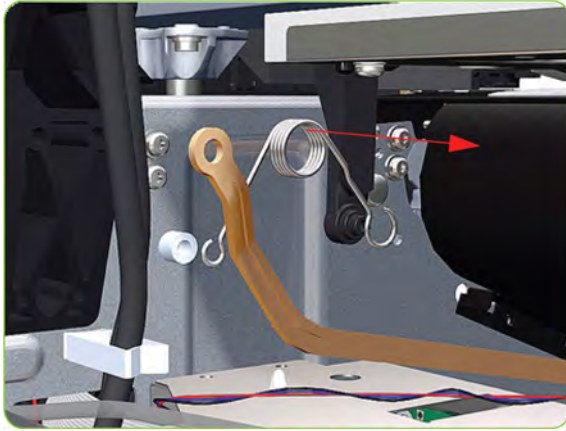

8. Raise the Media Lever to gain access to the linkage attachment screw.



9. Remove one T-15 screw (**Type F**) that secures the Media Lever to the Linkage.



10. Remove the Media Lever Linkage from the printer.

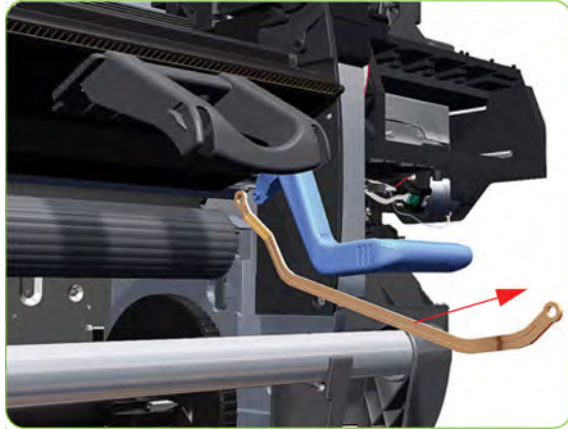

11. Remove one screw that secures the Media Lever to the Right Trim.

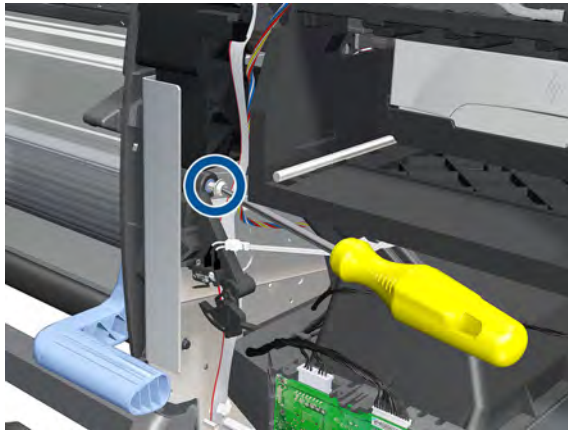

12. Remove the Media Lever from the printer.

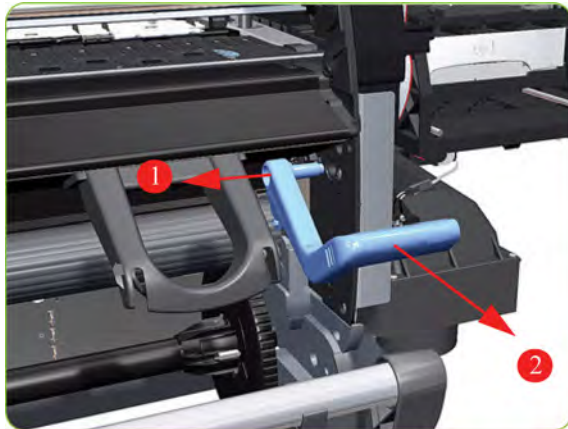

Media Lever Sensor

Removal

 **WARNING!** Switch off the printer and remove the power cable.

1. Remove the Right Cover ⇒ See [Right Cover on page 235](#).
2. Remove the Right Trim ⇒ See [Right Trim on page 237](#).
3. Remove the Right Connector Cover ⇒ See [Right Connector Cover on page 258](#).
4. Remove the Output Platen ⇒ See [Output Platen on page 387](#).
5. Disconnect and remove the Media Lever Sensor, and push the other end of the cable through the hole.

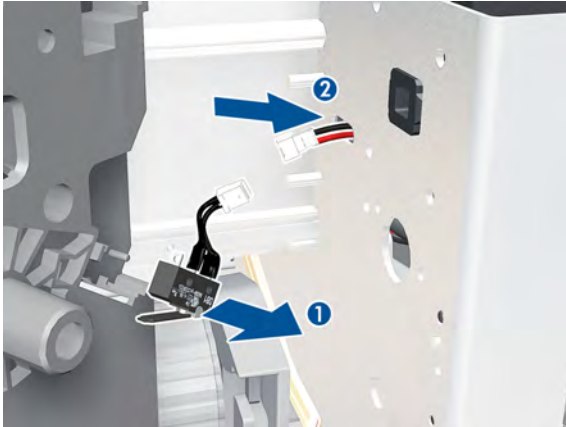

6. Disconnect the Media Lever Sensor cable from the Interconnect PCA.

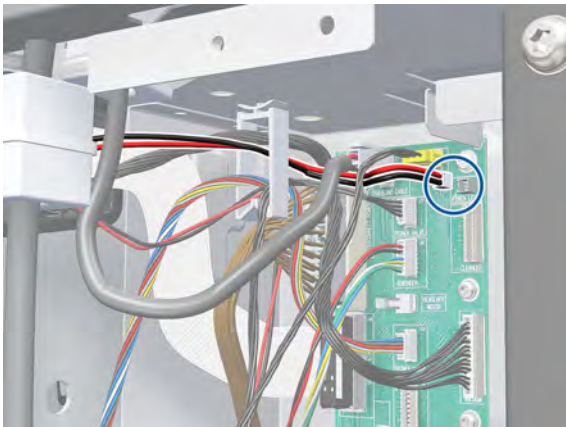

7. Unroute the Media Lever Sensor cable from the cable clamp.

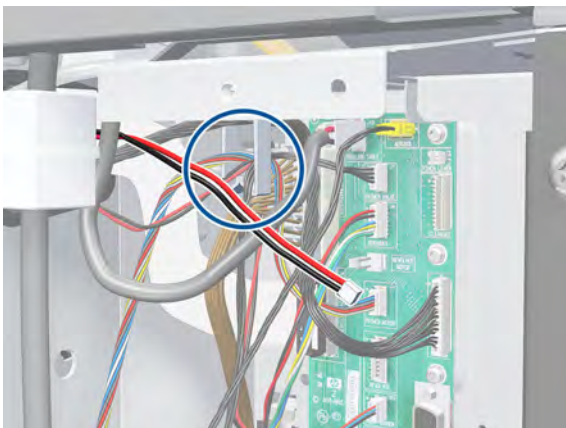

8. Remove the Media Lever Sensor cable from the printer.

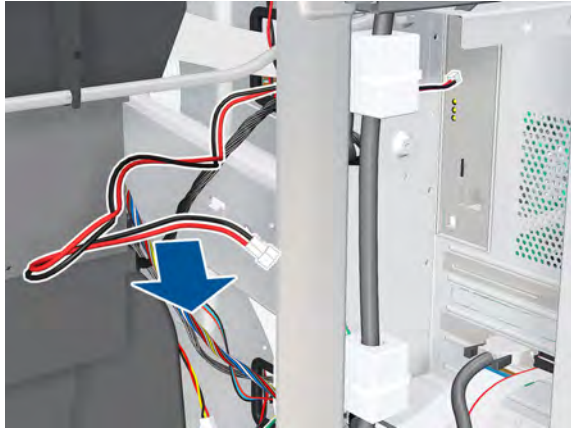

Rear Ebox Cover

Removal

1. Open the Loading Table.

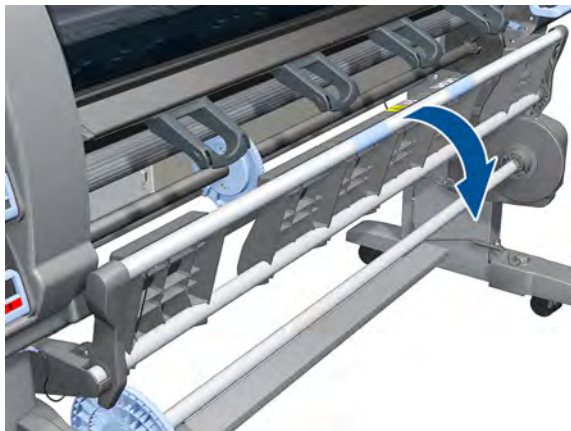

2. Remove the Spindle.

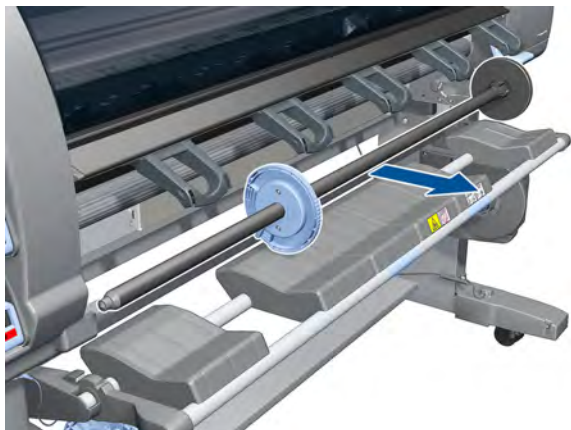

3. Remove two T-8 screws from the Rear Ebox Cover.

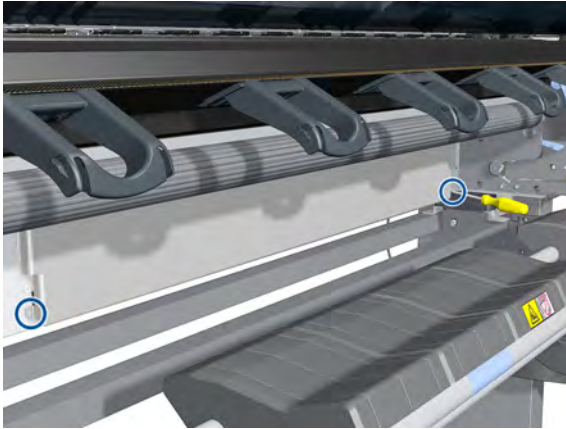

4. Lift and remove the Rear Ebox Cover.

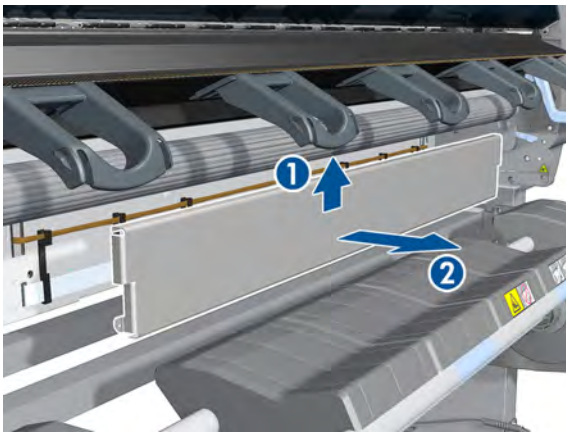

Interconnect Cables

Removal

1. Disconnect the Interconnect Cable from the Interconnect PCA.

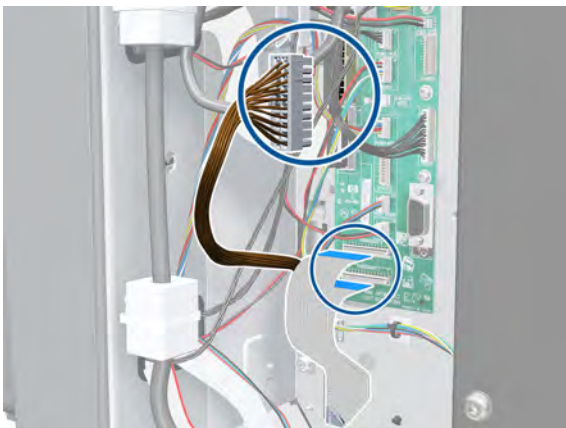

2. Disconnect the Interconnect Cable and the Interconnect Power Cable from the PrintMech PCA.

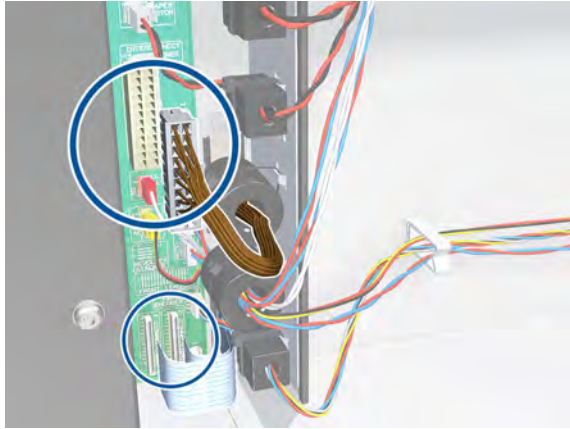

3. Unclip the seven cable holders.

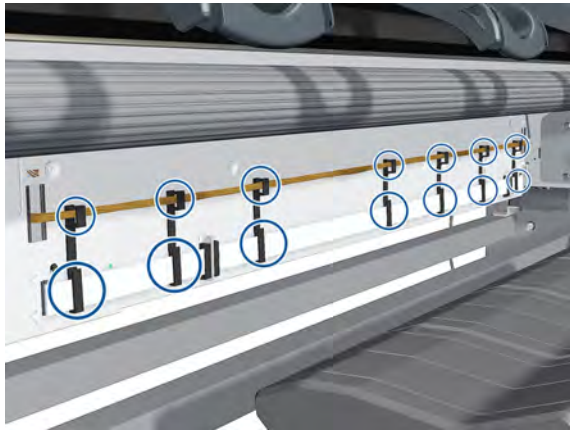

4. Remove the Interconnect Cable and the Interconnect Power Cable.

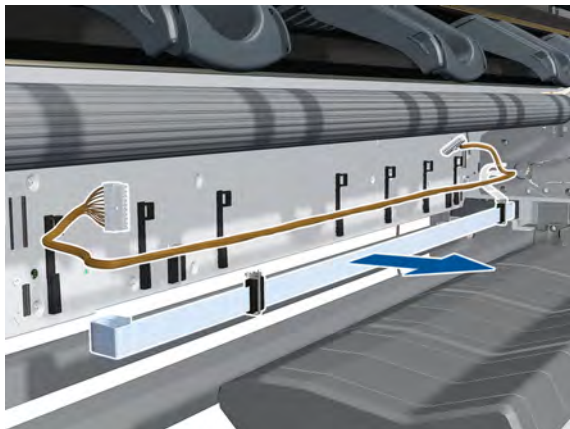

Pinchwheel Assembly

Removal

 **WARNING!** Switch off the printer and remove the power cable.

1. Remove the Right Cover ⇒ See [Right Cover on page 235](#).
2. Remove the Rear Door ⇒ See [Rear Door \(60-inch\) on page 256](#).
3. Remove the Service Station ⇒ See [Service Station on page 273](#).
4. Raise the Media Lever.

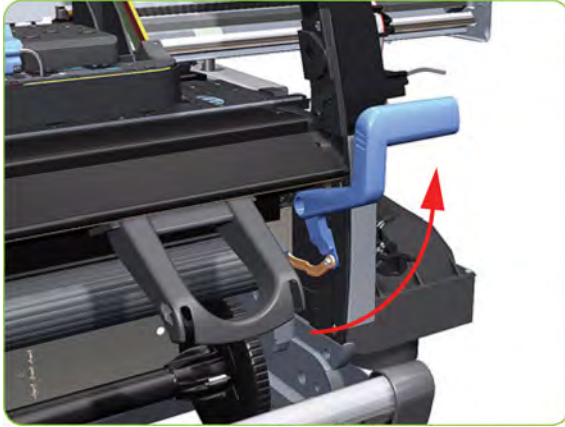

5. Remove one T-20 screw that secures the Linkage to the Spring.

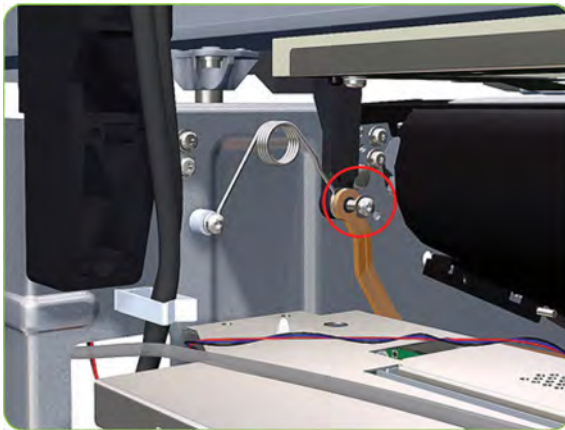

6. Disconnect the linkage from the Pinch Wheel cam-arm.

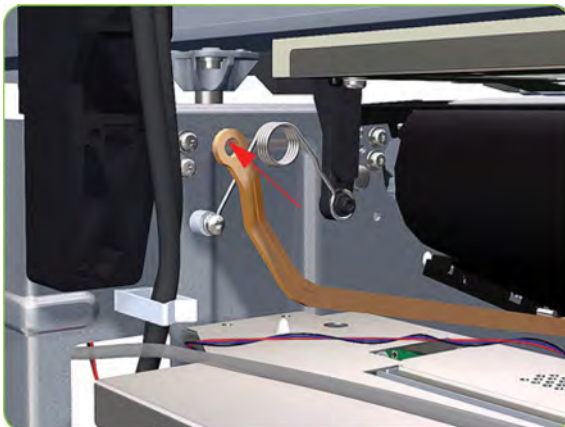

7. Disconnect the spring from the Pinch Wheel cam-arm.

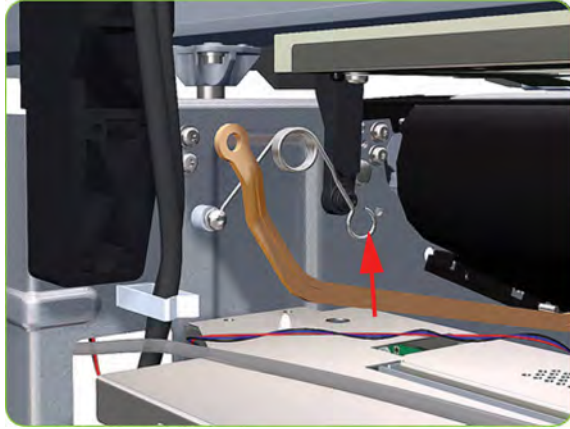

8. Remove one T-20 screw that secures the Cam to the Cam Lever.

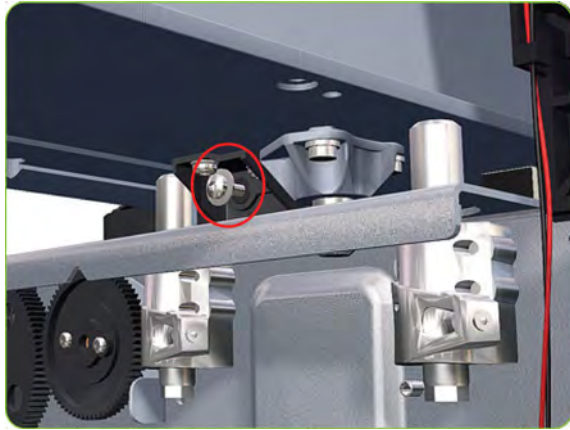

9. Insert a plastic stud into each Pinchwheel Subassembly (the Plastic Studs can be found in the replacement Pinchwheel Assembly kit).



10. For the 60-inch model, remove one T-20 screw that secures the attachment plate to the center Pinchwheel Subassembly.

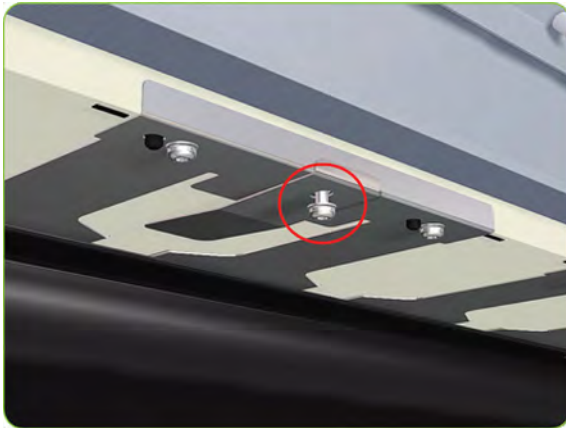

11. For the 60-inch model, remove the attachment plate from the center Pinchwheel Subassembly.

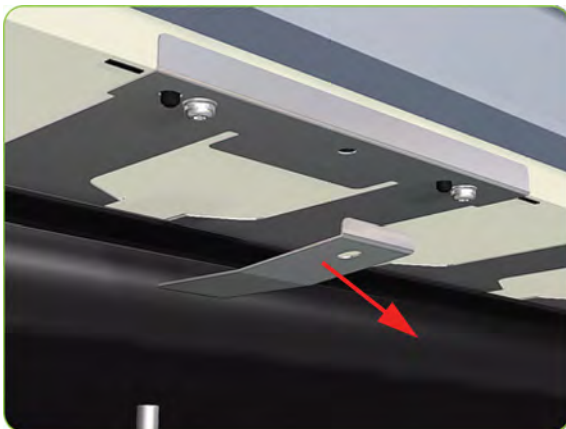

12. Remove two T-20 screws (**Type M**) from each Pinchwheel Subassembly (a 90 degree angle screwdriver is included with the replacement Pinchwheel Assembly).

 **NOTE:** The illustration shows the 60-inch model center Pinchwheel Subassembly.



13. Remove the complete Pinchwheel Assembly (including the Cam and Cam Lever) from the printer.



 **NOTE:** Before installing the NEW Pinchwheel Assembly, insert the plastic studs into each Pinchwheel subassembly. This will make it easier to install the complete Pinchwheel Assembly.



Removing individual Pinchwheel Rollers

- ▲ To remove an individual Pinchwheel roller, push apart the metal part that secures the Pinchwheel roller and then pull out the individual Pinchwheel roller.



Important Information on Installation of Pinchwheels

The Pinchwheel Assembly contains 3 white Pinchwheels and several black Pinchwheels. The black Pinchwheels are symmetrical so can be installed without any problems, BUT the white Pinchwheels are NOT symmetrical so it is VERY IMPORTANT to install them correctly using the following illustration:

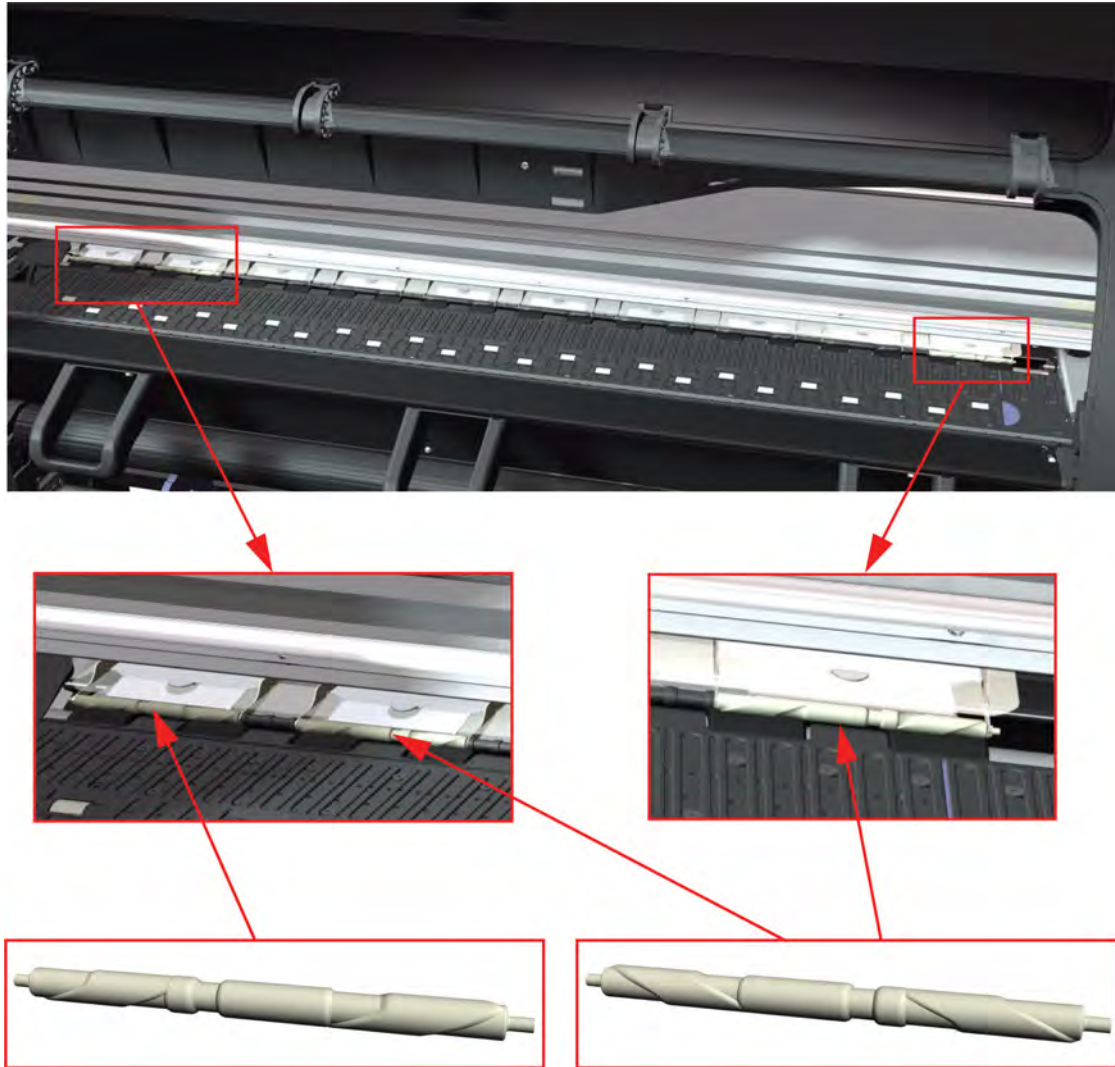

Check the orientation of the Pinchwheel before installing

Center Guide

Removal

⚠ WARNING! Switch off the printer and remove the power cable.

1. Remove the Right Cover ⇒ See [Right Cover on page 235](#).
2. Remove the Left Cover ⇒ See [Left Cover on page 240](#).
3. Remove the Primer Assembly ⇒ See [Primer Assembly on page 267](#).
4. Remove the Right Connector Cover ⇒ See [Right Connector Cover on page 258](#).

5. Remove:
 - For the 42-inch model, the Left Connector Cover ⇒ See [Left Connector Cover \(42-inch\) on page 260](#).
 - For the 60-inch model, the Electronics Module Extension ⇒ See [Electronics Module Extension \(60-inch only\) on page 261](#).
6. Remove the Service Station ⇒ See [Service Station on page 273](#).
7. Remove the Ink Supply Station ⇒ See [Ink Supply Station \(ISS\) on page 298](#).
8. Remove the Media Sensor ⇒ See [Media Lever Sensor on page 413](#).
9. Disconnect ALL the cables connected to the right Interconnect PCA and the Main PCA.



10. Unroute all the disconnected cables so they are clear of the Electronics Module.



11. Remove two T-20 screws (**Type B**) that secure the right side Electronics Module.

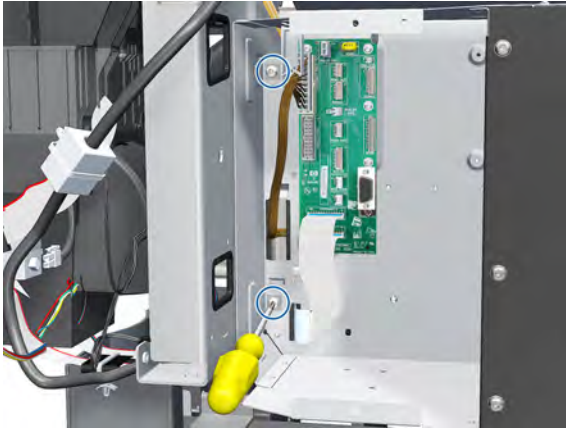

12. Remove two T-20 screws (**Type B**) that secure the left side Electronics Module.



NOTE: The illustration shows the 60-inch model center Pinchwheel Subassembly.

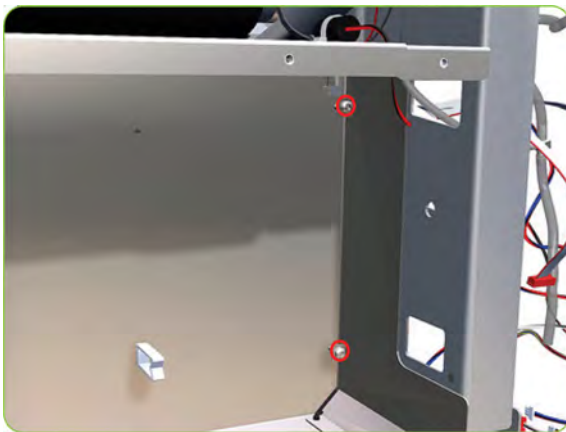

13. Lift the Electronics Module sufficiently (approximately 2 cm) to release it from the attachments.

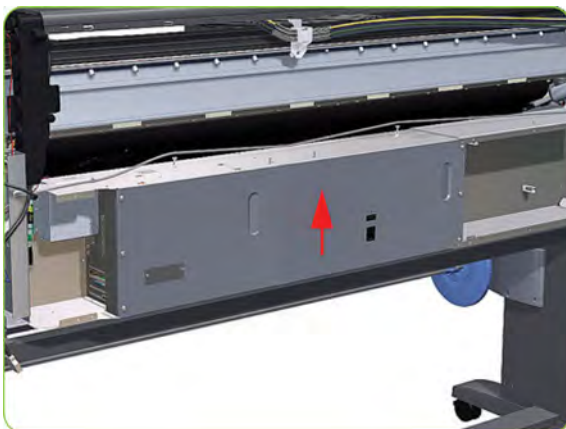

14. Remove the Electronics Module from the printer.



15. Remove one T-15 screw (**Type E**) and two T-20 screws (**Type A**), that secure the Center Guide, from the right-hand side of the printer.

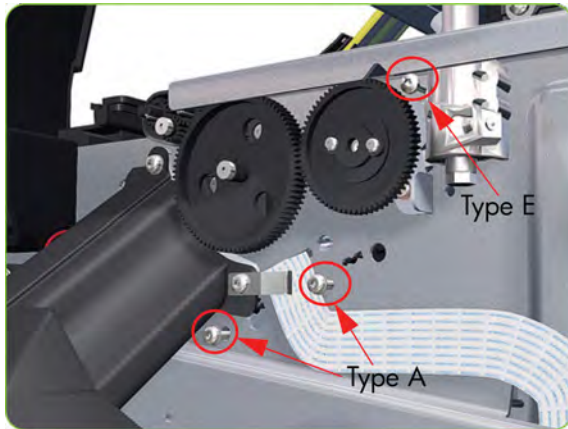

16. Remove two T-15 screws (**Type E**), that secure the Center Guide, from the left-hand side of the printer.

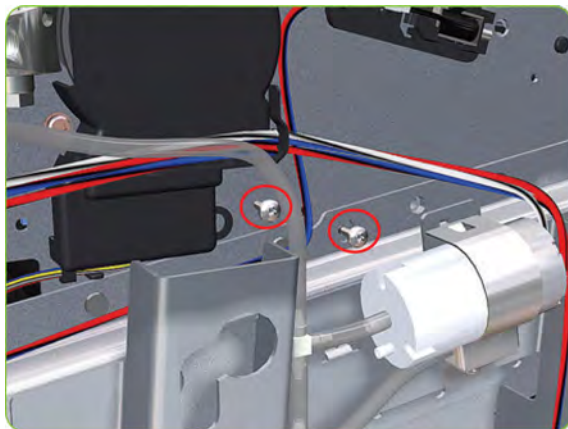

17. Remove one T-15 screw (**Type S**), that secures the Center Guide, from underneath the printer.

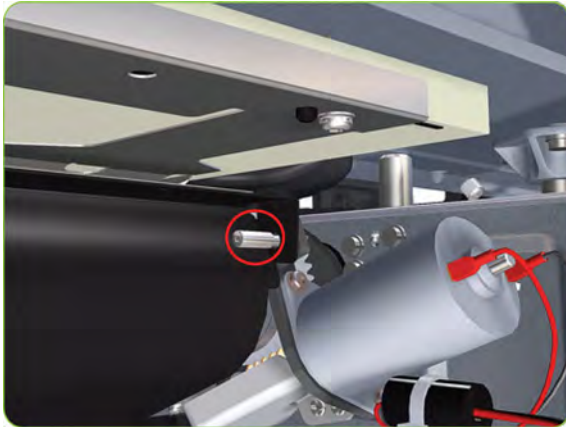

18. Remove the Center Guide from the printer.



Drive Roller

Removal

WARNING! Switch off the printer and remove the power cable.

1. Remove the Right Cover ⇒ See [Right Cover on page 235](#).
2. Remove the Left Cover ⇒ See [Left Cover on page 240](#).
3. Remove the Right Connector Cover ⇒ See [Right Connector Cover on page 258](#).
4. Remove:
 - For the 42-inch model, the Left Connector Cover ⇒ See [Left Connector Cover \(42-inch\) on page 260](#).
 - For the 60-inch model, the Electronics Module Extension ⇒ See [Electronics Module Extension \(60-inch only\) on page 261](#).
5. Remove the Service Station ⇒ See [Service Station on page 273](#).
6. Remove the Ink Supply Station ⇒ See [Ink Supply Station \(ISS\) on page 298](#).

7. Remove the Media-Axis Motor ⇒ See [Media-Axis Motor on page 336](#).
8. Remove the Encoder Disc and Sensor ⇒ See [Encoder Disc and Sensor on page 407](#).
9. Remove the Media Lever Assembly ⇒ See [Media Lever on page 410](#).
10. Remove the Media Lever Sensor ⇒ See [Media Lever Sensor on page 413](#).
11. Remove the Center Guide ⇒ See [Center Guide on page 422](#).
12. Remove two T-10 screws that secure the Drive Roller Gear.

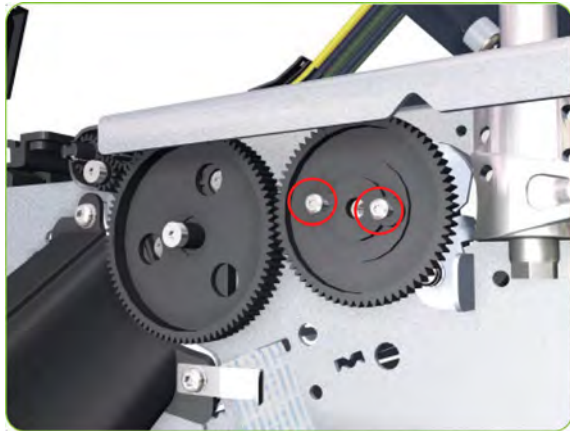

13. Remove the Drive Roller Gear from the printer.

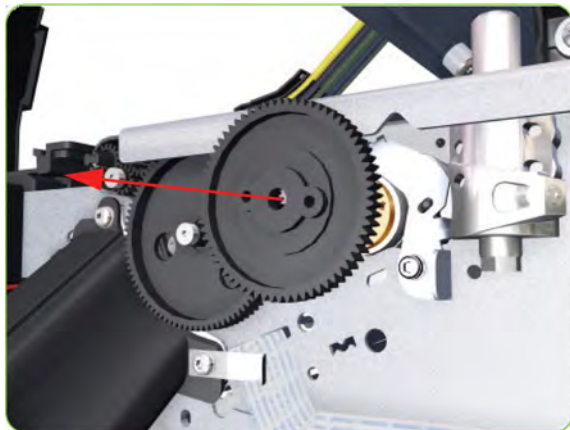

14. Remove one T-20 screw (**Type B**) that secures the cover on the right-hand side of the printer.

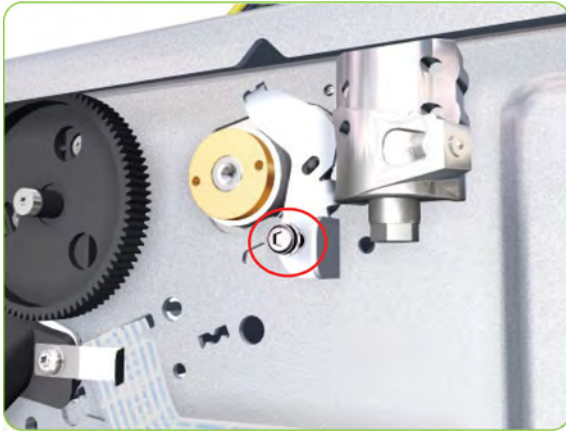

15. Remove the Cover.

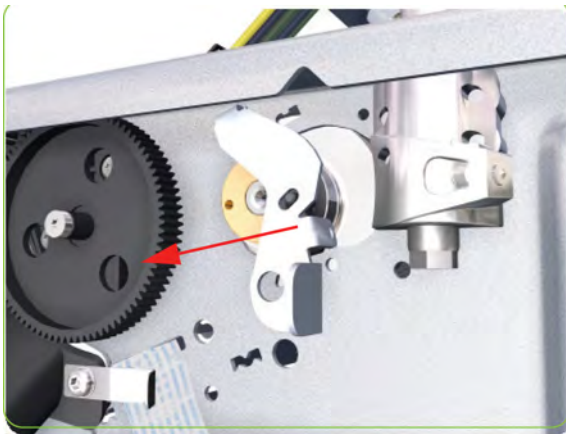

16. Remove three T-20 screws that secure the cover on the left-hand side of the printer.

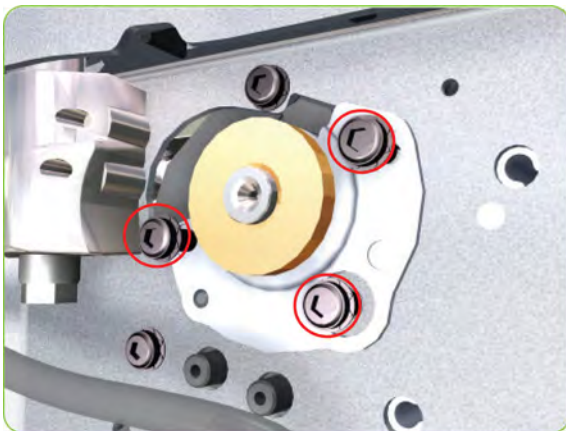

17. Remove the Cover.

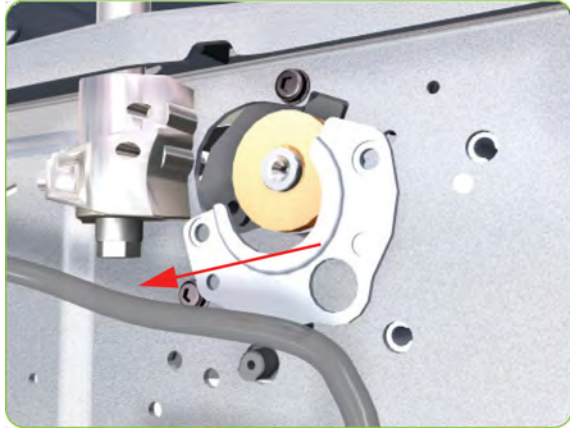

18. Remove T-20 screws that secure the Media-Axis Motor Bracket to the side-plate.

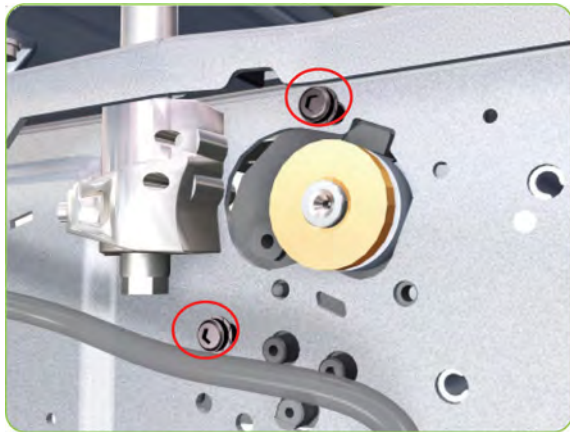

19. Remove two T-20 screws (Type A) that secure the Media-Axis Motor Bracket to the Chassis.



20. Remove the Media-Axis Motor Bracket from the printer.

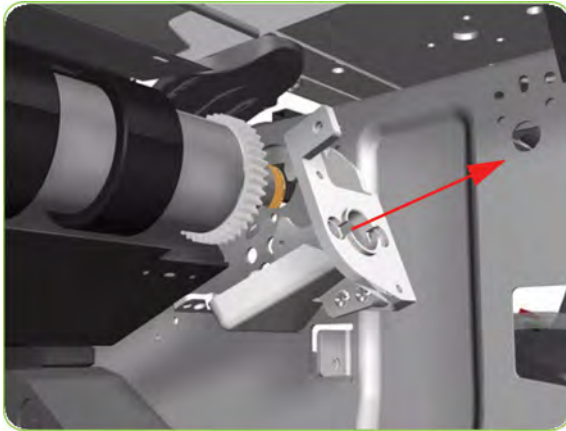

21. For the 60-inch model, use a flat bladed screwdriver to unclip the Roller Middle Support Cover.

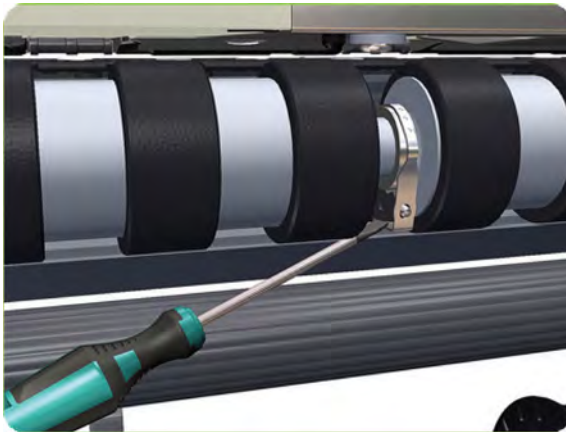

22. For the 60-inch model, rotate the Roller Middle Support Cover vertically.

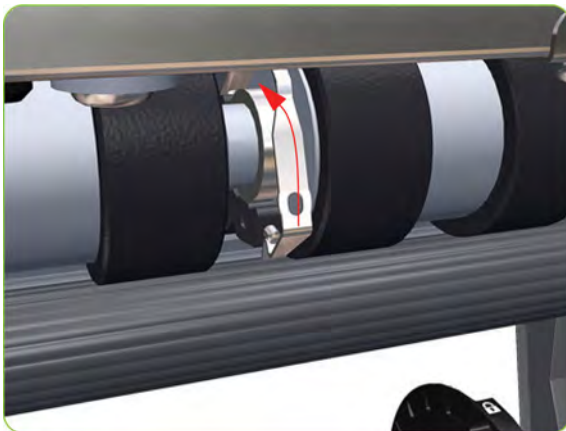

23. For the 60-inch model, release the Roller Middle Support Cover from its attachment point.

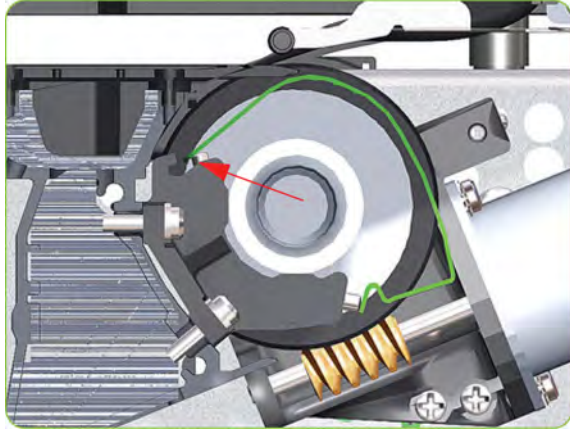

24. For the 60-inch model, remove the Roller Middle Support Cover.

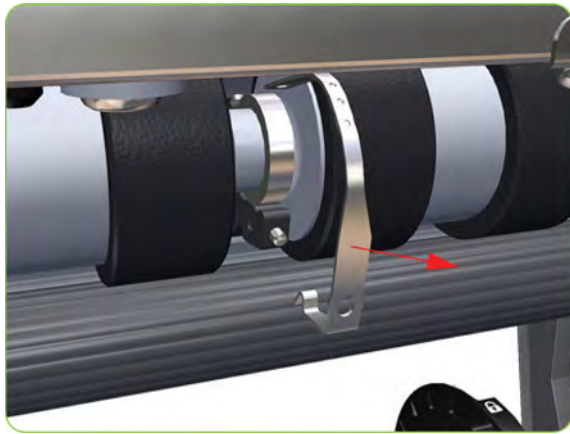

25. Remove the Drive Roller by sliding it to the right, then downwards and then out of the printer.

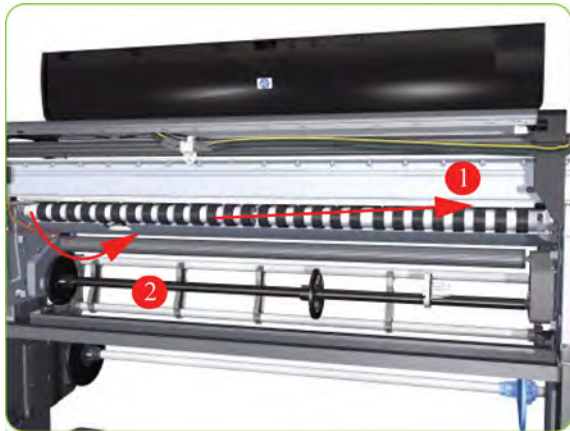

Installation of the Drive Roller

 **NOTE:** When reinstalling the parts, make sure you apply the grease (included with the support part) to the gears.

 **NOTE:** After installing the new Drive Roller, make sure you perform paper-advance calibration ⇒ [Paper-advance calibration on page 134](#).

When installing the Drive Roller, several different datums have to be met in order to ensure that the Drive Roller has no axial play. Use the following illustrations to ensure that ALL the datums are met:

Figure 8-1 Left-Hand Side of the printer

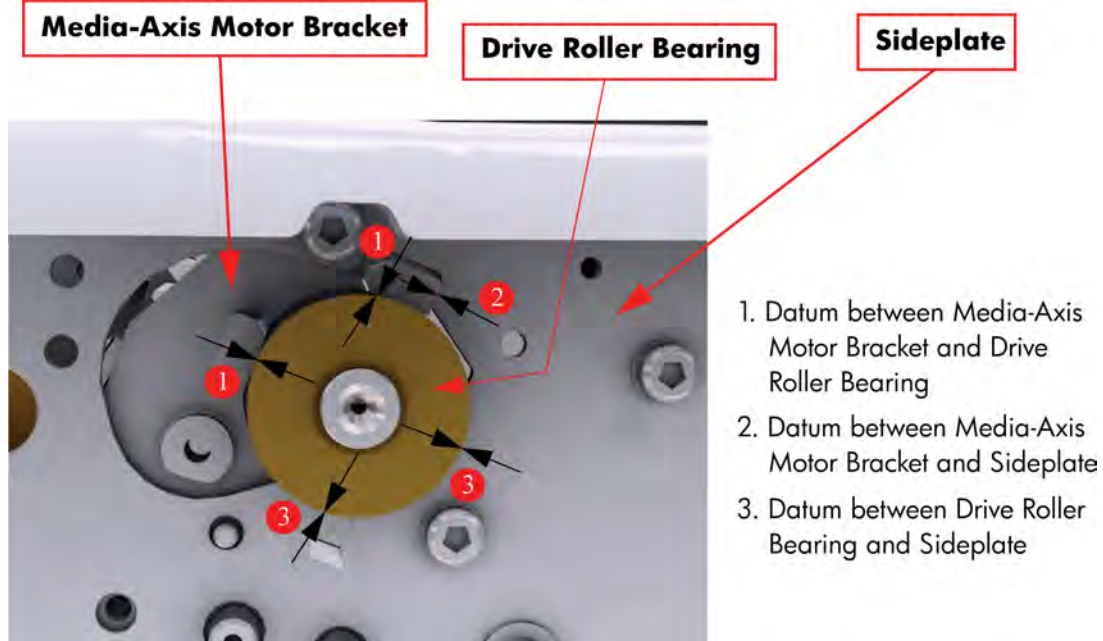
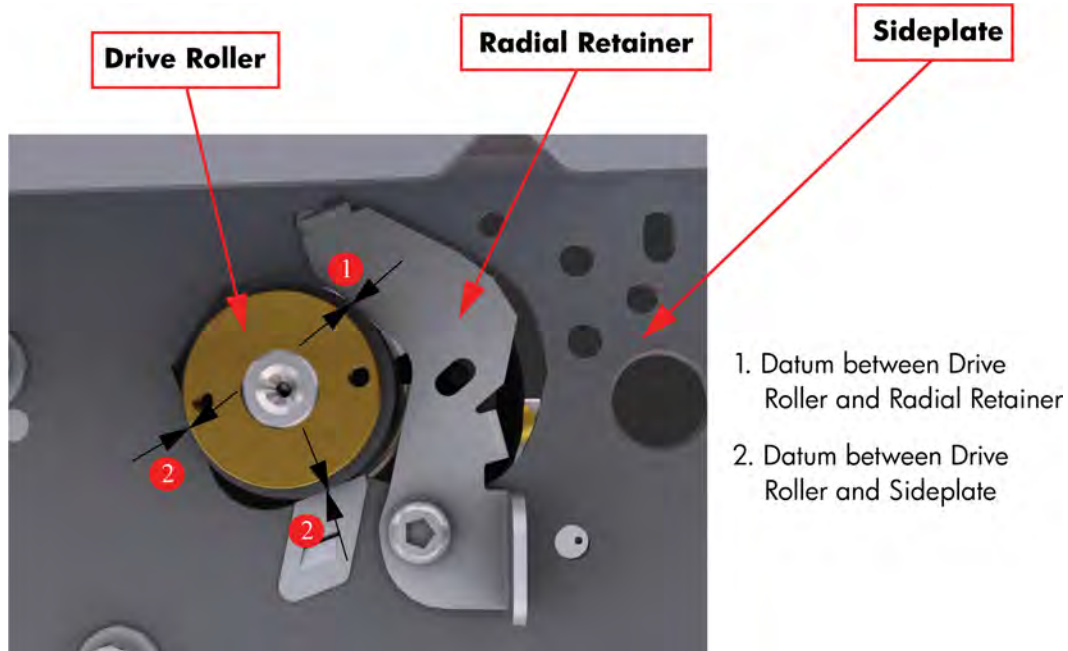
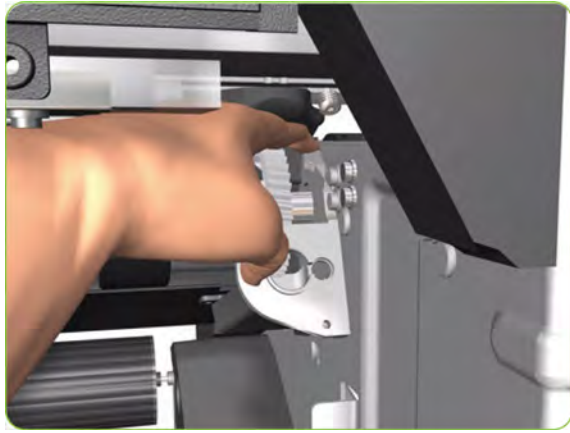

Figure 8-2 Right-Hand Side of the printer



To make sure that ALL the datums are met when installing the Media-Axis Motor Bracket, make sure you follow these

1. Place the Media-Axis Motor Bracket in the correct position on the printer. Make sure you keep it pushed down (as shown in the illustration) until the first screw has been installed and fully tightened.



2. Install the first screw (T-15) in the position shown. Make sure you tighten the screw fully so that the Media-Axis Motor Bracket cannot be moved.



3. Check that there is no play (movement) between the Media-Axis Motor Bracket and the Drive Roller. If there is play, then check that the screw installed in the previous step is fully tightened.

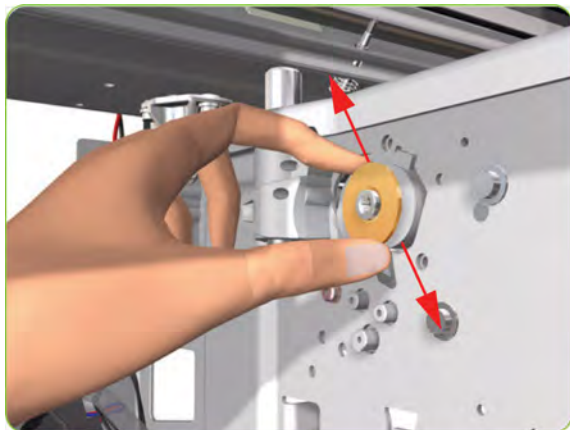

4. Install the remaining two screws (T-15) that secure the Media-Axis Motor Bracket.



Right Roll-feed Module

Removal

⚠ WARNING! Switch off the printer and remove the power cable.

1. Remove the Input Roller ⇒ See [Input Roller on page 401](#).
2. Remove the Media Spindle (if installed).
3. Remove four T-20 screws that secure the Right Roll-feed Module.

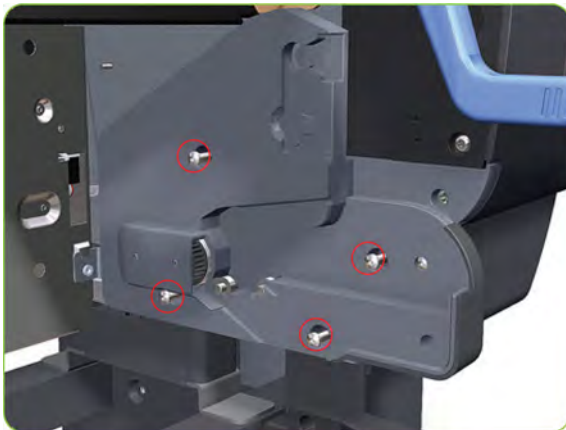

4. Remove the Right Roll-feed Module from the printer.

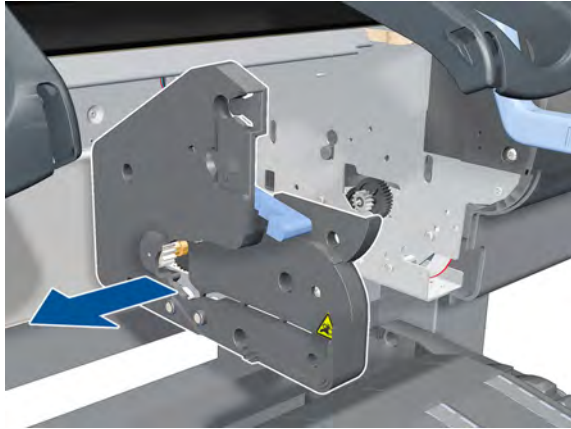

Left Roll-feed Module

Removal

⚠ WARNING! Switch off the printer and remove the power cable.

1. Remove the Left Cover ⇒ See [Left Cover on page 240](#).
2. Remove the Ink Supply Station ⇒ See [Ink Supply Station \(ISS\) on page 298](#).
3. Remove the Input Roller ⇒ See [Input Roller on page 401](#).
4. Remove the APS Assembly ⇒ See [APS Assembly on page 305](#).
5. Remove the Left Spittoon ⇒ See [Left Spittoon on page 311](#).
6. Remove the Media Spindle (if installed).
7. Remove one T-15 screw that secures the APS Mounting Plate to the printer.

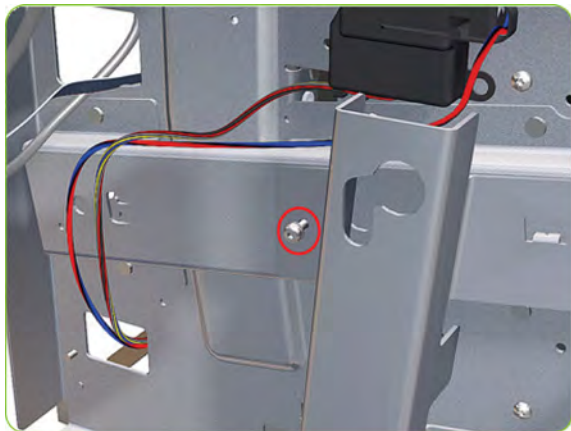

8. Tilt out the top of the APS Mounting Plate support.

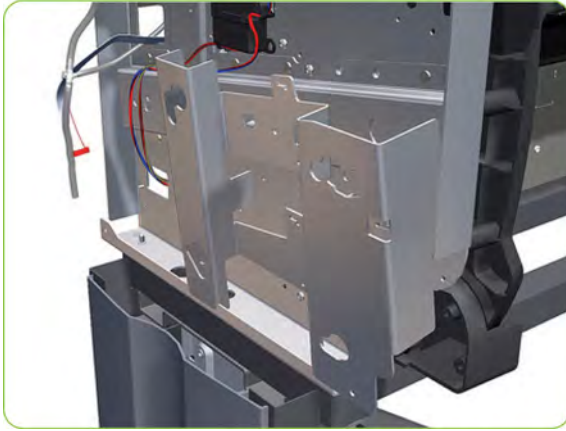

9. Remove the APS Mounting Plate support from the printer.

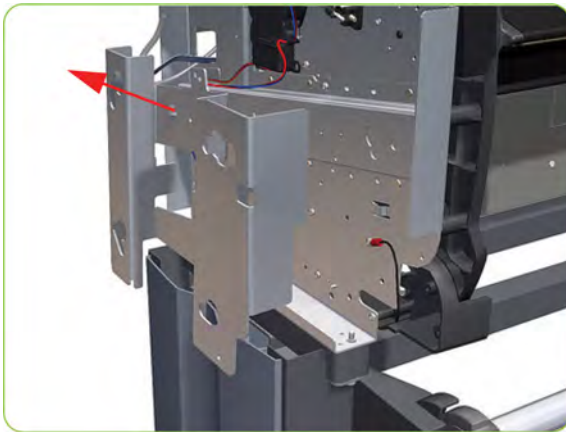

10. Remove four T-20 screws that secure the Left Roll-feed Module to the printer.

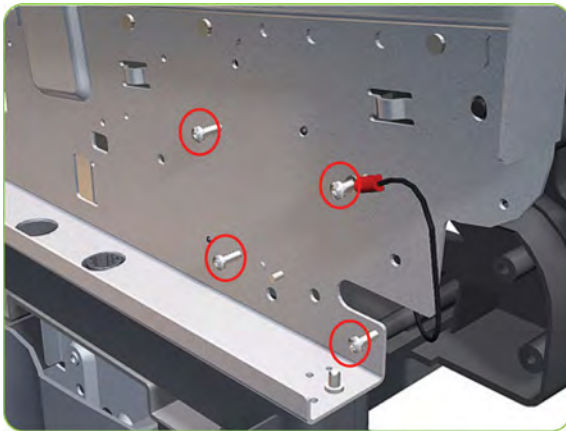

11. Remove the Left Roll-feed Module from the printer.

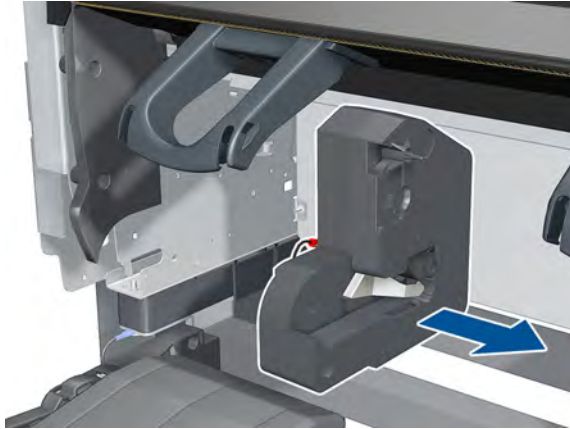

Take-Up Reel Motor

Removal

⚠ WARNING! Switch off the printer and remove the power cable.

1. Close the Paper Bin (if open).
2. Disconnect the Take-Up Reel Motor from the Parallel Port on the rear of the printer.



3. Remove the two rear T-20 screws that attach the Take- Up Reel Motor to the Right Leg Assembly.



4. Loosen the two front T-20 screws that attach the Take- Up Reel Motor to the Right Leg Assembly.



5. Disconnect the Take-Up Reel Sensors from the Take-Up Reel Motor.



6. Lift the Take-Up Reel Motor sufficiently so you can remove it from the Right Leg Assembly.

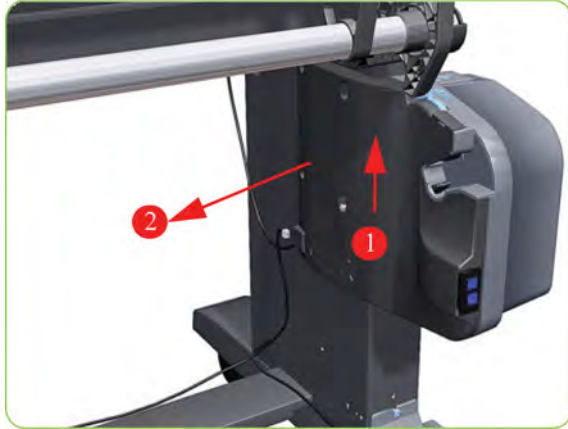

Take-Up Reel Left-Hand Module

Removal

⚠ WARNING! Switch off the printer and remove the power cable.

1. Close the Paper Bin (if open).
2. Remove one rear T-20 screws that attaches the Take-Up Reel Left-Hand Module to the Left Leg Assembly.



3. Loosen the two front T-20 screws that attach the Take- Up Reel Left-Hand Module to the Left Leg Assembly.



4. Lift the Take-Up Reel Left-Hand Module sufficiently so you can remove it from the Left Leg Assembly.



Take-Up Reel Deflector Supports

Removal

⚠ WARNING! Switch off the printer and remove the power cable.

1. Close the Paper Bin (if open).

2. Disconnect the grounding cable from the Stand.



3. Remove the Take-Up Reel Deflector from the printer.

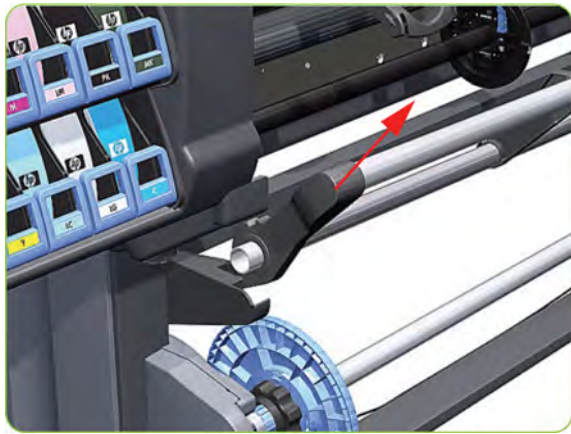

4. Remove the two T-20 screws that attach the Left-Hand Deflector Support to the Left Leg Assembly.

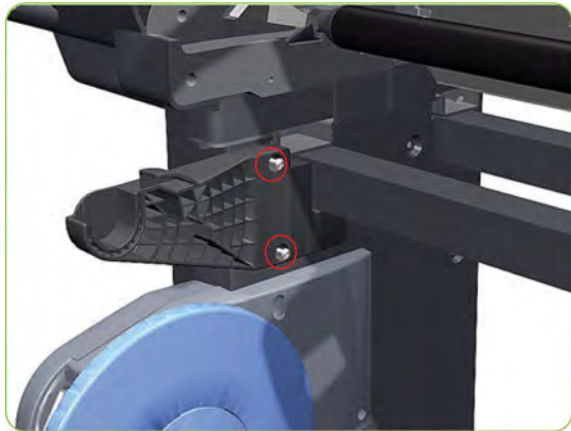

5. Remove the Left-Hand Deflector Support.

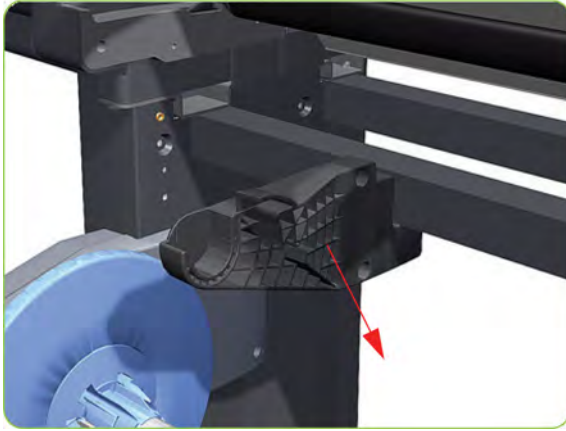

6. Remove the two T-20 screws that attach the Right-Hand Deflector Support to the Right Leg Assembly.

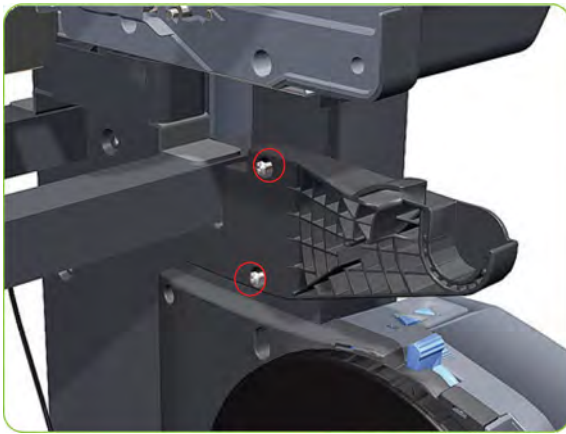

7. Remove the Right-Hand Deflector Support.

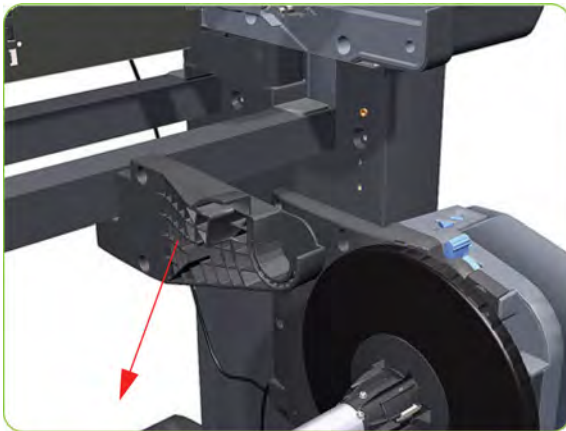

Take-Up Reel Sensors

Removal

 **WARNING!** Switch off the printer and remove the power cable.

1. Close the Paper Bin (if open).
2. Disconnect the Take-Up Reel Sensors.

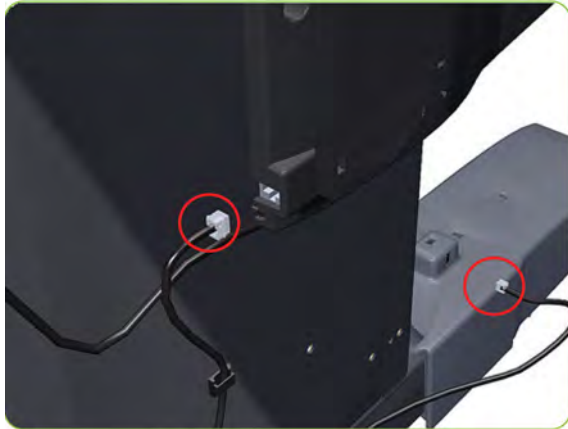

3. Remove the blue thumbscrew that attaches the Take-Up Reel Sensors to the Right Foot Assembly.



4. Slide the Take-Up Reel Sensors off the Right foot Assembly.

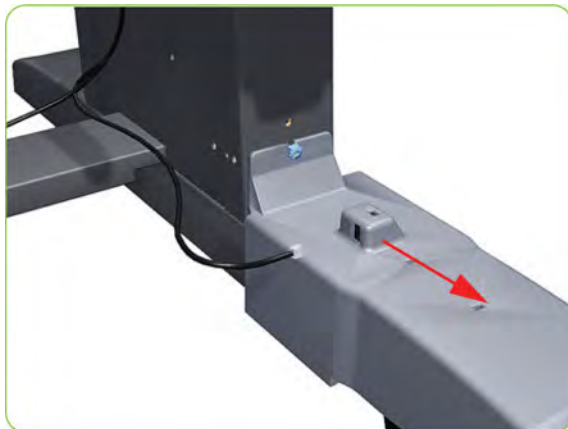

5. Remove one T-15 screw that attaches the cover of the receiver sensor to the housing.

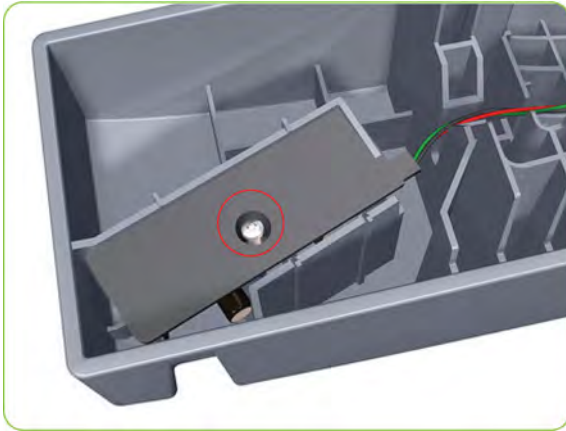

6. Remove the cover of the receiver sensor to the housing.

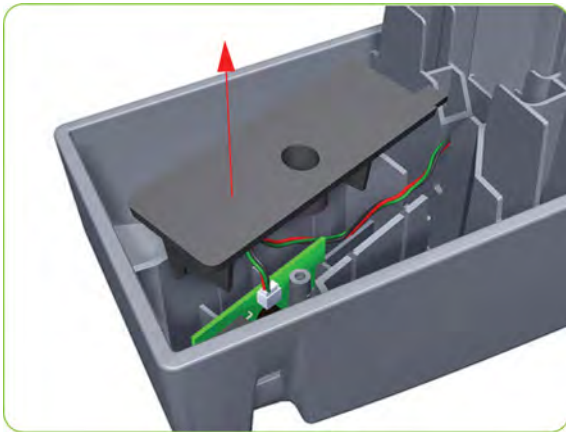

7. Disconnect the connector from the receiver sensor.

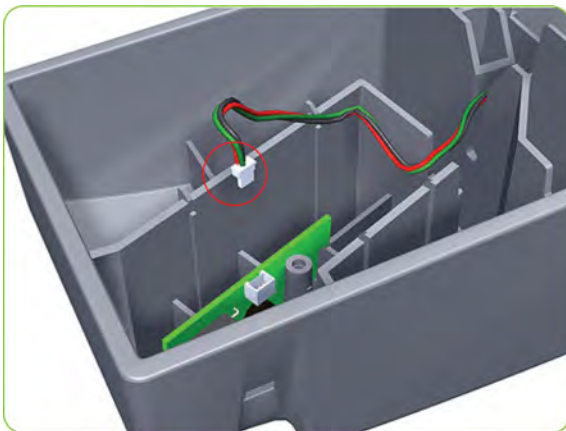

8. Remove the receiver sensor from the housing.

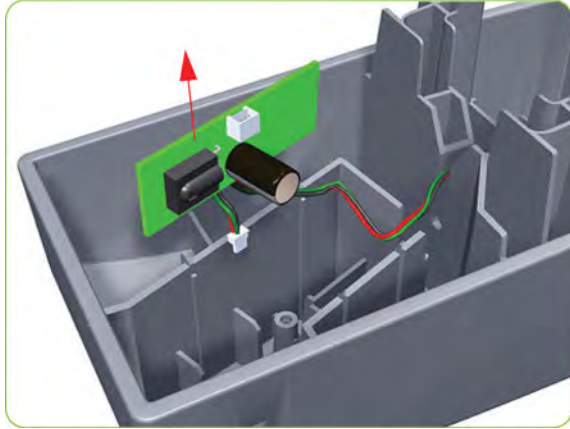

9. Unroute the Take-Up Reel Transmitter Sensor cable.



10. Unclip and remove the Take-Up Reel Transmitter Sensor from the X-Brace Assembly.

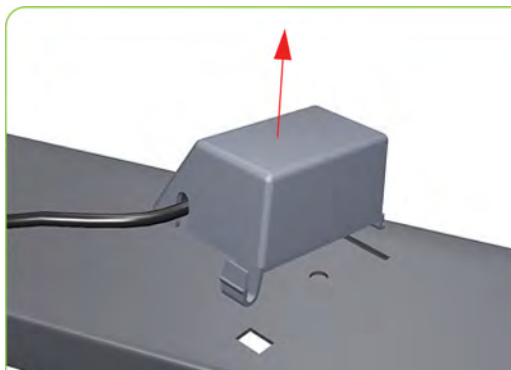

9 Preventive maintenance

- [Preventive maintenance](#)

Preventive maintenance

- [Moisture on the printer](#)
- [Noisy Carriage Bushing](#)
- [Belt Swelling](#)
- [Cleaning the printer](#)
- [General cleaning](#)
- [Cleaning the Drive Roller and Overdrive](#)
- [Cleaning the Platen](#)
- [Clean the Encoder Strip](#)
- [Clean the paper-advance sensor window](#)
- [Applying oil to the Overdrive](#)
- [Lubricating the Carriage Assembly](#)
- [Change the maintenance absorber](#)
- [Scheduled maintenance](#)
- [Level of printer usage](#)

Moisture on the printer

Users should use the printer in an environment between 20% and 80% relative humidity. To recover from moisture condensation, turn the printer **Off**, and, using the main roller as a reference, wait until the printer is completely dry before using it again.

Noisy Carriage Bushing

To prevent noisy movement of the carriage, remove aluminum or dust particles from the bushing at the back of the carriage, and from the slider path along which the bushing moves.

Belt Swelling

To prevent new belts from swelling incorrectly, keep them in their bags with desiccant until you need to install them.

Cleaning the printer

To maintain the printer in good operating condition, keep it free of dust accumulation, ink, and other contamination. Cleaning intervals are determined by the printer environment and by the types of printer supplies used.

General cleaning

Proper general cleaning should include the following:

⚠ WARNING! To prevent an electric shock, make sure that the printer is switched **OFF** and unplugged before any cleaning is performed. Do **NOT** let any water get inside the printer.

1. Clean the outer surface of the printer with a damp sponge or cloth. Use a mild soap and water solution if necessary. Do not use abrasive cleaners.
2. Wipe the printer dry with a soft lint-free cloth.

Cleaning the Drive Roller and Overdrive

⚠ CAUTION: If ink is spilled on the Overdrive, remove the ink immediately. Due to the ink's reflectance, ink on the Overdrive can disrupt the printer's edge-sensing function. To remove any ink from the Overdrive, perform the following procedure.

CAUTION: Prevent water or other liquids from running onto electrical components or circuits, or through openings in the Electronics Module.

1. Perform the Turn Drive Roller Utility (Refer to [Turn Drive Roller on page 113](#)).
2. Open the window and apply any common household cleaning solution (water based only) to a soft, lint-free rag and apply it to the Drive Roller and Overdrive surface while it is rotating. Make sure that you thoroughly clean the Drive Roller and Overdrive surface.
3. Press **OK** when you have completed the cleaning procedure.
4. Allow the Drive Roller to dry before loading media into the printer.

Cleaning the Platen

⚠ CAUTION: If wide paper is used to print after narrower paper is used for some time, you may find that the left-hand side of the Print Platen has become dirty and will leave marks on the back of the paper if not cleaned.

It is recommended to clean the Print Platen on a regular basis (at least every few months or when required) as follows:

1. Unload any media loaded from the printer.
2. Open the Window and with a dry brush remove ink deposits from the Cutter Groove and the Print Platen surface.

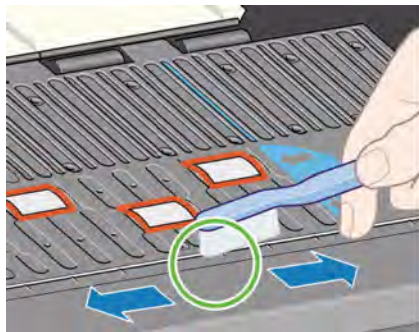

Cutter Groove

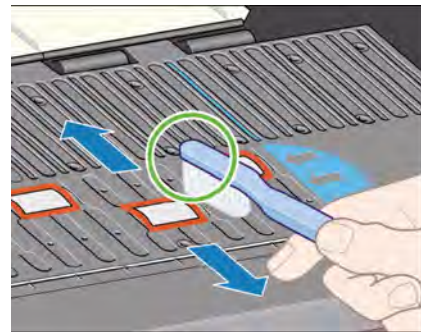

Print Platen Surface

3. Use a clean, absorbent lint-free cloth, dampened with Isopropyl Alcohol (not supplied in the Maintenance Kit), to wipe loosened ink deposits from the Print Platen.

CAUTION: Do NOT:

- Use commercial cleaners or abrasive cleaners.
- Wet the Print Platen directly because you will leave too much moisture behind.
- Wet the rubber wheels at all (not even with the cloth).

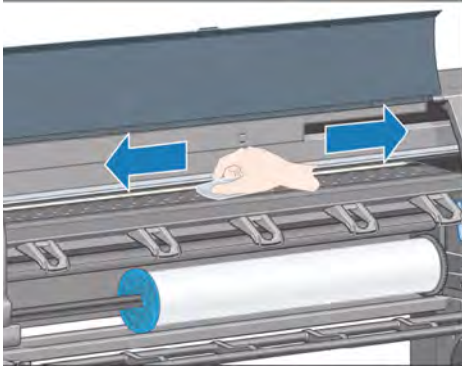

4. Clean the Cutter ramp with the damp cloth.

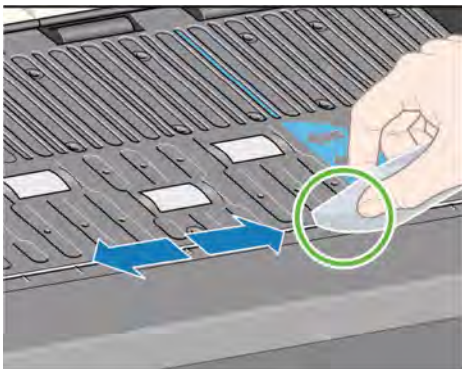

5. Clean the exposed part of the wheels with a dry cloth. Ideally, clean the whole circumference of these wheels (you can use Turn Drive Roller Utility on [Turn Drive Roller on page 113](#)).

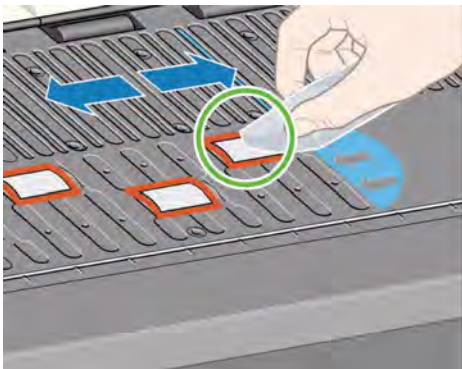

Clean the Encoder Strip

Cleaning the Encoder Strip is a vital part of the printer's maintenance and can clear a variety of system errors:

- 86:01 or 87:01 system errors and related mispositioning of the Carriage Assembly errors, such as the carriage bumping into the side of the printer.
- 42:10 system error, related to failures starting and homing the carriage on the scan axis.
- 29:01 and 29:02 system errors which cannot be cleared even after installing new Maintenance Cartridges.
- There are occasions when an Encoder Strip that needs cleaning can cause paper loading issues, as the Carriage cannot correctly detect the position of the paper.

With the type of pigmented ink that is used in the printer, the Encoder Strip cleaning must be performed at regular intervals. Cleaning must be performed after every 10 liters of ink used. The front panel will display a message when cleaning is required:

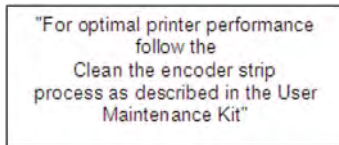

This message is displayed after every 5th job until the cleaning is performed, and the counter has been reset. This procedure is normally performed by the customer. Instructions and materials are provided within the User Maintenance kit. A kit is provided with each printer shipment. The kit can also be ordered using part number Q6715A (HP Designjet Z6X00 User Maintenance Kit).

 **NOTE:** When the message is displayed on the front panel, a 'silent' warning message is added within the system error log '8:01'. This helps when reviewing the error log history, to see if the message has been displayed.

Cleaning procedure

1. At the front panel, select **Clean Encoder Strip** from the Ink menu.

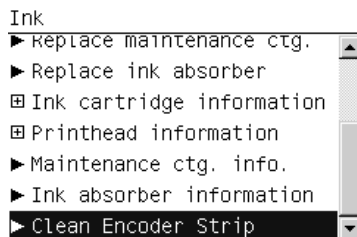

2. The front panel explains what you need to clean the Encoder Strip. Press **OK** to continue or **Cancel** to exit.

```
Clean Encoder Strip
-----
Get a cloth from the cleaning
kit and wet it 'ONLY' with
water.
Press OK to continue or X to
cancel.
```

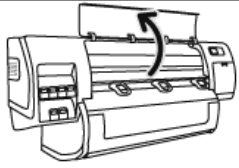

3. Open the Window.

Open window

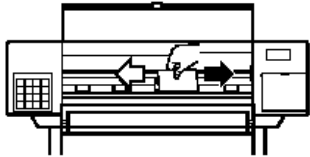

4. Clean the Encoder Strip as shown in the front panel, and press **OK when finished.**

Clean encoder strip on both sides with cloth, press **OK**



5. Close the Window. The Carriage moves to the left-hand side of the printer.

Close window to continue

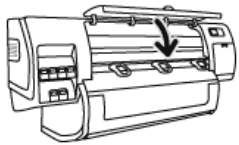

6. The front panel prompts you to reopen the Window and clean the right-hand side of the encoder strip (inside the Service Station). Press **OK when finished.**

Clean encoder strip inside service station, then Press **OK**

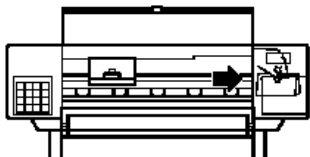

7. Close the Window. The Carriage returns to its ready position in the Service Station.

Close window

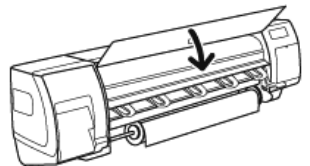

Clean the paper-advance sensor window

The paper advance sensor is the very small rectangular window (less than 1 square centimeter in size and shown in the following graphic) near the sixth platen roller from the right.

Use a clean, absorbent, lint-free cloth that you have slightly dampened with isopropyl alcohol to very gently wipe any dust and loosened ink deposits from the sensor window.

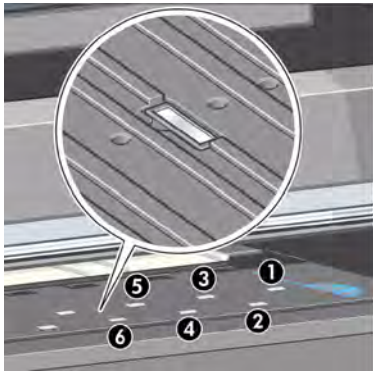

Applying oil to the Overdrive

Occasionally, it maybe necessary to oil the Overdrive in order to stop the rollers from squeaking:

1. Open the Window.
2. There are small holes in the Print Platen beside some of the rollers.
3. A bottle of oil is supplied with service kit CQ869-67081. Insert the pointed end of the bottle into each hole in turn, and put three drops into each.

⚠ CAUTION: Do not use the oil supplied in the User Maintenance Kit.

4. Be very careful not to spill any oil onto the Print Platen.
5. If there is oil on the Print Platen, wipe it away with the cloth supplied with the Maintenance Kit.
6. Close the Window.

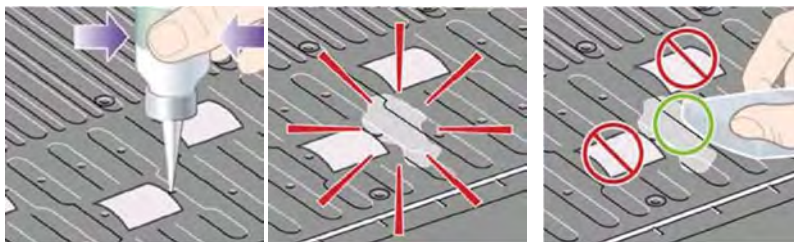

Lubricating the Carriage Assembly

The Carriage Assembly needs to be lubricated occasionally (at least once a year) so that it can slide easily along the Slider Rod.

1. Using the Front Panel, in the Printheads menu, select “Replace printheads now”. The Carriage Assembly will move to the center of the printer.
2. Open the Window and apply a few drops of oil (bottle of oil can be found in the Maintenance Kit) to the pads on either side of the Carriage Assembly.
3. Apply a few drops of oil directly to the Slider Rod on either side of the Carriage Assembly.

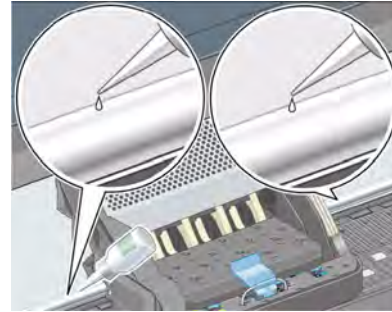
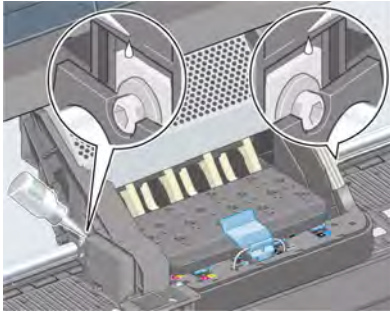

Change the maintenance absorber

An alert appears on the printer front panel when the maintenance absorber is reaching its maximum saturation and again when the absorber should be changed. A replacement is included in the HP Designjet User Maintenance Kit, part number Q6715A.

CAUTION: The absorber can become excessively dry and fail to function correctly in climates where the relative humidity is consistently below 25%.

CAUTION: A saturated or excessively dry maintenance absorber can cause severe damage to the printheads and other parts of the printer. HP strongly recommends that you promptly change the maintenance absorber when alerted.

Remove the maintenance absorber

1. Find the maintenance absorber and disposable plastic gloves that are included in the maintenance kit.
2. On the printer's front panel, select the  icon, then **Replace ink absorber**.
3. Open the printer window.
4. Identify the left spittoon.

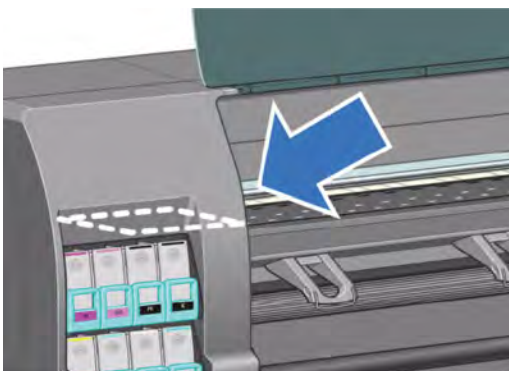

5. Locate the maintenance absorber.

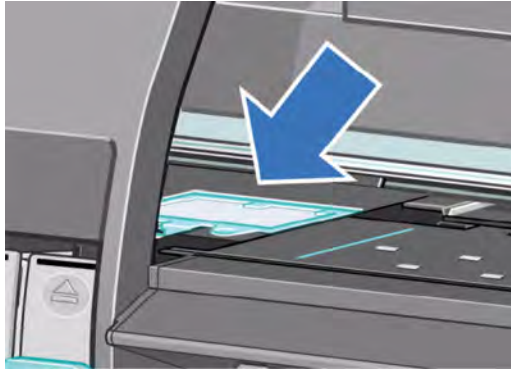

6. Lift the tab that extends from the front edge of the absorber.



NOTE: Use the disposable plastic gloves to avoid getting ink on your hands.

7. Lift the tab on the absorber until it is clear of the spittoon and you can easily grip the tab.



8. Lift and remove the absorber from the spittoon.

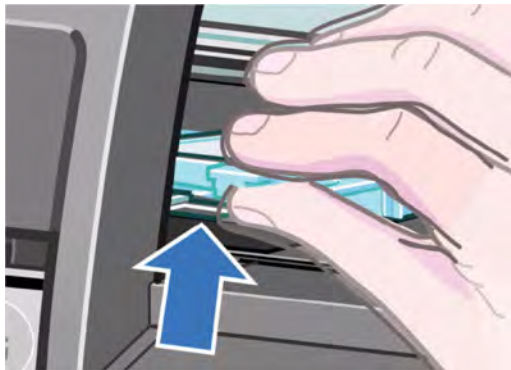

9. Dispose of the soiled maintenance absorber according to your local regulations.

Insert the maintenance absorber

1. Grip the new maintenance absorber as shown.
2. Insert the back edge of the absorber into the fitting in the spittoon.
3. Use your thumb to slide the absorber to the back of the fitting in the spittoon.

4. Push down on the tabbed edge until you hear the absorber click into place. Make sure that the top of the maintenance absorber is seated flatly and that none of the corners are higher than the plane of the platen.
5. Press the **OK** button on the front panel. The printer checks that the maintenance absorber is correctly seated. If the front panel shows a message that it is not seated correctly, remove the maintenance absorber, insert it again, and then press the **OK** button.

Scheduled maintenance

In some segments of the printer market, the customer tends to print more than the maximum number of prints that the throughput allows, exceeding by far the limit of the design. When this happens the customer runs into print quality problems and continuous printer failures.

The purpose of scheduled preventive maintenance is to avoid these failures - ensuring a good performance during all the product life.

Level of printer usage

Normal printer use means 6,000,000 Carriage Cycles (which corresponds to approximately 100,000 A0 prints on average). Under normal usage conditions, it will be approximately 5 years before the printer needs maintenance. If the printer is used more than the normal usage conditions, then it will need maintenance service much more frequently.

One of the EEROM counters is assigned to counting the number of carriage cycles. When certain components of the printer exceed this amount, the front panel displays the following message:

“Maintenance #1 required”

The following message is triggered depending on the total quantity of ink spitted in each Spittoon.

“Maintenance #2 required”

Once one of the maintenance advised messages is displayed, the preventive maintenance kit must be used to replace the most worn parts of the printer. Use [Removal and installation on page 223](#) as a guide to replace the necessary parts.

The following PM Kit covers both Maintenance advised messages:

Preventive Maintenance Kit #1

This Preventive Maintenance Kit #1 contains the following components:

- Encoder Strip ⇒ [Encoder Strip and Encoder Sensor on page 315](#)
- Encoder spring+Nut ⇒ [Encoder Strip and Encoder Sensor on page 315](#), step 8
- Carriage PCA Cover ⇒ [Carriage PCA on page 318](#)
- Belt Tensioner Assembly ⇒ [Scan-Axis Motor on page 331](#), step 7
- Cutter Assembly ⇒ [Cutter Assembly on page 297](#)
- Redial Retainer Assembly ⇒ [Installation of the Drive Roller on page 431](#)
- Line Sensor Cable ⇒ [Line Sensor Assembly on page 379](#)
- Air Purges (Setup Printheads)

- Aerosol foam protector ⇒ [Line Sensor Assembly on page 379](#), step 6
- Carriage Assembly (with Encoder sensor) ⇒ [Carriage Assembly on page 323](#) (does not include PCA, Cutter, ESP)
- Ink Supply Tubes and Trailing Cable ⇒ [Ink Supply Tubes and Trailing Cable on page 287](#)
- Tubes retaining clip ⇒ [Top Cover \(60-inch\) on page 249](#), step 7
- Scraper Assembly and Absorber Foams ⇒ [Removal of the Service Station Scraper on page 277](#)
- Scan-Axis Motor ⇒ [Scan-Axis Motor on page 331](#)
- Belt Assembly ⇒ [Belt Assembly on page 330](#)

You must also clean the holes in the Service Station which are located under the Maintenance Cartridge and check that the Aerosol Fan is functioning correctly.

Preventive Maintenance Kit #2

This Preventive Maintenance Kit #2 contains the following components:

- Aerosol Filter ⇒ [Service Station on page 273](#)
- SVS Aerosol Fan assembly ROHS ⇒ [Service Station on page 273](#)
- Ink Absorber ⇒ See User's Guide
- Left spittoon ⇒ [Left Spittoon on page 311](#)
- ESP ⇒ [Embedded SpectroPhotometer \(ESP\) on page 381](#)
- Line Sensor ⇒ [Line Sensor Assembly on page 379](#)
- Encoder Strip ⇒ [Encoder Strip and Encoder Sensor on page 315](#)

You must also clean the holes in the Service Station which are located under the Maintenance Cartridge and check that the Aerosol Fan is functioning correctly.

10 Appendix: Country lists

North and Latin America

American Samoa

Anguilla

Antigua and Barbuda

Argentina

Aruba

Australia

Bahamas, The

Barbados

Belize

Bermuda

Bolivia

Brazil

British Virgin Islands

Canada

Cayman Islands

Chile

Colombia

Cook Islands

Costa Rica

Curacao

Dominica

Dominican Republic

East Timor

Ecuador

El Salvador

Fiji

Grenada

Guam

Guatemala

Guyana

Haiti
Honduras
Hong Kong, China
Jamaica
Kiribati
Macao, China
Marshall Islands
Mexico
Micronesia, Fed. Sts.
Montserrat
Nauru
Netherlands Antilles
New Zealand
Nicaragua
Niue
Northern Mariana Islands
Palau
Panama
Papua New Guinea
Paraguay
Peru
Pitcairn Islands
Puerto Rico
Samoa
Singapore
Solomon Islands
St. Kitts and Nevis
St. Lucia
St. Vincent and the Grenadines
Suriname
Taiwan

Tokelau
Tonga
Trinidad and Tobago
Turks and Caicos Islands
Tuvalu
United States
Uruguay
Vanuatu
Venezuela, RB
Virgin Islands (U.S.)

Asia Pacific and Japan

Afghanistan

Bangladesh

Bhutan

Brunei

Cambodia

China

India

Indonesia

Japan

Korea, South

Lao PDR

Malaysia

Maldives

Mongolia

Myanmar

Nepal

Pakistan

Philippines

Sri Lanka

Thailand

Vietnam

Europe, Middle-East and Africa

Albania
Algeria
Andorra
Angola
Armenia
Austria
Azerbaijan
Bahrain
Belarus
Belgium
Benin
Bosnia and Herzegovina
Botswana
Bulgaria
Burkina Faso
Burundi
Cameroon
Cape Verde
Central African Republic
Chad
Channel Islands
Comoros
Congo, Dem. Rep.
Congo, Rep.
Croatia
Cyprus
Czech Republic
Denmark
Djibouti
Egypt, Arab Rep.

Equatorial Guinea
Eritrea
Estonia
Ethiopia
Faeroe Islands
Falkland Islands
Finland
France
French Antilles
French Guiana
French Polynesia
Gabon
Gambia, The
Georgia
Germany
Ghana
Gibraltar
Greece
Greenland
Guadeloupe
Guinea
Guinea-Bissau
Hungary
Iceland
Iraq
Ireland
Isle of Man
Israel
Italy
Ivory Coast
Jordan

Kazakhstan
Kenya
Kuwait
Kyrgyz Republic
Latvia
Lebanon
Lesotho
Liberia
Libya
Liechtenstein
Lithuania
Luxembourg
Macedonia, FYR
Madagascar
Malawi
Mali
Malta
Martinique
Mauritania
Mauritius
Mayotte
Moldova
Monaco
Morocco
Mozambique
Namibia
Netherlands
New Caledonia
Niger
Nigeria
Norway

Oman
Poland
Portugal
Qatar
Reunion
Romania
Russian Federation
Rwanda
Saint-Martin
San Marino
Sao Tome and Principe
Saudi Arabia
Senegal
Seychelles
Yugoslavia, FR (Serbia/Montenegro)
Sierra Leone
Slovak Republic
Slovenia
Somalia
South Africa
Spain
St. Helena
St. Pierre and Miguelon
Swaziland
Sweden
Switzerland
Tajikistan
Tanzania
Togo
Tunisia
Turkey

Turkmenistan
Uganda
Ukraine
United Arab Emirates
United Kingdom
Uzbekistan
Vatican City
Wallis and Futuna
West Bank and Gaza
Yemen, Rep.
Zambia
Zimbabwe