

THE PLANT ALKALOIDS

BY

THOMAS ANDERSON HENRY

D.Sc.(Lond.),

*Formerly Director, Wellcome Chemical Research
Laboratories and Superintendent of Laboratories,
Imperial Institute, London.*

FOURTH EDITION



THE BLAKISTON COMPANY

Philadelphia · Toronto

1949

First edition . . . 1913
Second edition . . . 1924
Third edition . . . 1939
Fourth edition . . . 1949

This book is copyright. It may not be reproduced by any means, in whole or in part, without permission. Application with regard to copyright should be addressed to the Publishers.

*Printed in Great Britain
and published in London by
J. & A. Churchill Ltd.
104 Gloucester Place, W.1.*

PREFACE TO THE FOURTH EDITION

So much information concerning alkaloids has been published since the third edition of this book was issued in 1939, that the preparation of a new edition has involved re-writing a large part of the volume and adding considerably to its bulk.

The material available has been dealt with, as in the previous edition, primarily on the basis of a chemical classification according to nuclear structure, but as Nature does not produce alkaloids to meet the needs of either botanical or chemical systematists, strict observance of such a system would in some measure obscure those biological relationships among alkaloids which are at present attracting much attention from research workers. Accordingly this primary chemical classification has been modified, in cases where an extensive series, including several chemical types, occurs in one plant, or in closely related plants. When this results in a chemical group being dealt with in more than one place, cross references have been provided as a convenience to the reader.

The author is much indebted to Mr. L. G. Goodwin, B.Sc., B.Pharm., for reading certain of the pharmacological sections, and to Dr. S. Smith and Dr. A. C. White for advice on various points on which they are recognised experts. He also owes grateful thanks to Mrs. Henry for unstinted help in checking references, reading proofs and the maintenance of an index to the literature of alkaloids. The preparation of the typescript, and the typing of the numerous new and complicated graphic formulæ, in a form suitable for photographic reproduction, was undertaken by Miss I. Bellis, to whom the author is greatly indebted for the untiring patience and meticulous care she has devoted to this task. He has also to thank the publishers for the kindly and sympathetic consideration they have given to all the technical problems raised in the course of printing the volume. Finally, the author owes to the customary generosity of the Wellcome Foundation Limited office accommodation and working facilities, without which this book could not have been prepared.

LONDON.

T. A. HENRY.

PREFACE TO THE FIRST EDITION

IN certain respects the plant alkaloids rank among the most interesting of naturally occurring substances. For the most part they are of complex structure, so that the determination of their constitution and the discovery of methods of producing them synthetically offer attractive problems to the chemist ; and though a great deal has been accomplished, much still remains to be done in this direction. Their mode of origin and their function in plants are still unknown, and these two questions, with the more important one of correlating the structure of the alkaloids with their physiological action, form still almost untouched fields for combined work on the part of physiologists and chemists. Many of the alkaloids are of great importance in medicine, and the manufacture of these alkaloids and of products containing them constitutes an important branch of the " fine chemical " industry.

In compiling this volume the author has kept in view these various aspects of the subject, and the articles on all the more important alkaloids describe not only the properties and the chemistry of these products, but also their occurrence, methods of estimation, and physiological action. In most cases the original memoirs have been consulted, and references to these are given in footnotes, but for descriptions of the physiological action of the better-known alkaloids Professor Cushny's " Textbook of Pharmacology and Therapeutics " has been largely utilised. The chemical nomenclature and the system of abbreviations used are, with a few unimportant exceptions, those employed in the " Abstracts " published by the Chemical Society of London, with which most English-speaking chemists are familiar.

For much laborious work in checking formulæ and references and in reading proofs, the author is indebted to Mrs. Henry, B.A., B.Sc. (Lond.), and to Miss A. Holmes, B.A. (Lond.).

CONTENTS

	PAGE
Introduction	ix
Pyridine Group. Piperine, Piperovatine, Leucenol, Mimosine, Alkaloids of <i>Ricinus communis</i> , Fœnugrec, Areca Nut, Hemlock, Lobelia, Tobacco (<i>Nicotiana</i> spp.), <i>Anabasis aphylla</i> , Pomegranate Root Bark	1
Tropane Group. Solanaceous Alkaloids, Convolvine and Allied Alkaloids, Dioscorine, Alkaloids of Coca Leaves (<i>Erythroxylon coca</i>)	64
Lupinane Group. Alkaloids of the Papilionacæ: Lupinine, Lupanine, Sparteine, Anagyrine, Cytisine, Matrine and Associated Bases	116
isoQuinoline Group. Alkaloids of	
Cactacæ: Mezcaline, etc.	154
<i>Hydrastis canadensis</i> : Hydrastine	162
Rhœadales	169
Opium (<i>Papaver somniferum</i>): Benzylisoquinolines; Phthalideisoquinolines; Morphine Sub-group, <i>Sinomenium acutum</i>	175
Other <i>Papaver</i> spp.: Rhœadine, etc.	274
Other Papaveraceous Genera: α -Naphthaphenanthridines	277
<i>Corydalis</i> and Allied Genera: Tetrahydroprotoberberines; Cryptopine Sub-Group; Aporphine Sub-group	284
Anonacæ, Lauracæ, Monimiacæ; Anolobine, etc.	317
Berberis and Related Bases; Berberine, Canadine, Palmatine, Coptisine, etc.	328
BISBENZYLisoQUINOLINE SUB-GROUP	
Berbamine, Oxyacanthine	346
Alkaloids of the Menispermacæ; Coclaurine, Dauricine, Magnoline, Tetrandrine, Bebeerine, etc.	349
Alkaloids of Curare; Curine, Tubocurarine, Protocuridine, Calabash-curare I, etc., including Erythrina alkaloids	371
Alkaloids of Ipecacuanha	394
Phenanthridine Group. Alkaloids of the Amaryllidacæ; Lycorine, etc.	406

	PAGE
Quinoline Group. Dictamnine, Skimmianine, Fagarine.	413
Alkaloids of	
Cusparia Bark	415
<i>Cinchona</i> spp.	418
Indole Group. Abrine, Gramine, Calycanthine	484
Alkaloids of	
<i>Peganum harmala</i>	488
<i>Evodia rutæcarpa</i>	498
Yohimbé, Quebracho, etc.	500
Ergot	517
Calabar Bean	539
<i>Strychnos</i> spp.	553
Pyrrolidine Group	599
Pyrrolizidine Group	601
Quinazoline Group	617
Glyoxaline Group	621
Alkaloidal Amines	630
Steroidal Alkaloid Group	661
Alkaloids of Undetermined Constitution	716
Minor Alkaloids	771
Recorded Occurrences of Alkaloids	779
Index	784

PLANT ALKALOIDS

INTRODUCTION

THE literature of alkaloids can conveniently be divided into five sections, dealing with (1) the occurrence and distribution of these substances in plants ; (2) biogenesis, or the methods by which alkaloids are produced in the course of plant metabolism ; (3) analysis, ranging from the commercial and industrial estimation of particular alkaloids to the separation, purification and description of the individual components of the natural mixture of alkaloids, which normally occurs in plants ; (4) determination of structure ; and (5) pharmacological action.

In the period that has elapsed since the third edition of this book was published there have been additions to each of these sections, and to some of them the new contributions have been numerous and important.

Many new alkaloids have been described and new occurrences recorded. An interesting feature of this section of work is the operation of a number of what may be called alkaloidal surveys, ranging from searches for alkaloidal plants to investigations of plants of a particular botanical order, or of a selected botanical genus, or of geographical or other variants of a single species. In Soviet Russia, Massagetov ¹ has made a preliminary examination of 113 species collected in Central Asia, out of which he has found promising materials among lichens, mosses and liverworts, some varieties of maize, cotton and beans, certain species of *Picea* and *Pinus*, and a specially rich source in *Dipsacus azureus* belonging to the Dipsacaceæ, a botanical family which like the allied Compositæ, has not been a frequent source of alkaloids. In the same country, in 1939, Lazur'evskii and Sadikov ² examined over 200 plants collected by various expeditions in Central Asia and recorded alkaloids in a number of species, including *Aconitum talassicum* and *Convolvulus hamadæ*, the alkaloids of which have since then been investigated in detail as described later. Mention may also be made of the comprehensive volume on "The Poison Plants of New South Wales," compiled by Evelyn Hurst under the direction of the Poison Plants Committee of the University of Sydney. It includes numerous monographs on plants containing toxic alkaloids and should be of great value to research workers concerned with plant chemistry.

In the course of the intensive campaign carried on in the United States of America during the war for the discovery of effective anti-malarial drugs, a team of workers ³ made anti-malarial tests on 600 different plants belonging to 123 families of phanerogams and three families of cryptogams, and it is recorded that the suppressive activity shown by some of these plants appeared to be associated with alkaloidal fractions of their extracts.

Of surveys with a narrower alkaloidal objective, mention may be made of the systematic work done by E. P. White and his collaborators in ascertaining the distribution of perlorline in *Lolium* and allied grasses in New Zealand, and that of the same author in the examination of over 200 leguminous species, to ascertain the nature of their alkaloidal components and the effect of conditions on the alkaloidal content of various organs. Manske's work on alkaloids of Fumaraceous plants and of *Lycopodium* species also needs mention in this connection; it has not only resulted in new and interesting additions to the list of alkaloids, but the results, like those of White, have a bearing on the suggestion sometimes made that the nature of the substances present in plants may usefully be taken into account in some taxonomical problems. This suggestion is not as novel as is sometimes supposed, and Raymond-Hamet,⁴ in his paper maintaining the separation of Chevalier's genus *Pseudocinchona* from *Corynanthe*, on the ground that *Pseudocinchona africana* contains the alkaloids corynanthine and corynantheine, whereas *Corynanthe paniculata* yields yohimbine, makes the following statement: "Alphonse de Candolle a affirmé que les phénomènes de physiologie (et par conséquent les propriétés biochimiques et notamment la composition chimique) peuvent être envisagés . . . comme caractères d'une espèce, d'un genre, d'une famille, d'une classe de végétaux." ⁵

In this connection Manske ⁶ has suggested that the question whether Fumariaceæ and Papaveraceæ, together forming the order Rhœadales, should continue to be regarded as separate botanical families or be merged, can be settled in favour of the second alternative by a consideration of the nature of the alkaloids present in the plants, and he provides in support an interesting summary of existing information on this point. On the other hand, the number of cases of the occurrence of the same alkaloid in plants, which cannot be regarded as closely related botanically, justifies taxonomists in being cautious about freely accepting chemical evidence of this kind. Nicotine, for example, is found not only in the Solanaceous genera *Nicotiana* and *Duboisia*, but also in *Asclepias* (Asclepiadaceæ), *Equisetum* (Equisetaceæ), *Lycopodium* (Lycopodiaceæ), *Sedum acre* (Crassulaceæ) and *Eclipta alba* (Compositæ), and as further instances, anabesine occurs both in *Nicotiana glauca* and *Anabasis aphylla* (Chenopodiaceæ), whilst ephedrine is not only present in *Ephedra* spp. (Ephedraceæ), but has also been recorded from *Taxus baccata* (Taxaceæ) and *Sida rhombifolia* (Malvaceæ) and its near relative *d*-nor- ψ -ephedrine is the "cathine" of *Catha edulis* (Celastraceæ). More remarkable still is the case of berberine, which occurs in at least sixteen genera belonging to six different botanical families. Further, alkaloids of quite different types may occur in the same plant, for example in the opium poppy, and in *Aconitum Napellus*, in which ephedrine and sparteine have been recorded, as well as the typical aconite alkaloids. More information is in fact needed of the kind provided by the surveys undertaken by White and by Manske before chemical knowledge of plant constituents can be safely and generally applied to problems of plant classification. In the introduction to his

series of papers on the alkaloids of the Leguminosæ, White points out that although this order has been investigated perhaps more than any other for alkaloids, there is still uncertainty regarding the nature and distribution of alkaloids even in some common species, that little is known of the alkaloid content of common European plants grown under new conditions, for example in the Southern Hemisphere, that a large number of factors are capable of altering the alkaloidal content in quantity and nature, and that in much of the older European literature there is uncertainty due to incomplete chemical investigation.

Although the number of alkaloids still in use in medicine is small, serious difficulty was caused by the war, due to the cutting-off of the usual sources of supply of the natural drugs which yield essential alkaloids, such as atropine, cocaine, hyoscyne, morphine, emetine and ergometrine. Shortages were met as far as possible by new sources of supply and by local cultivation of the opium poppy, belladonna and other necessary drugs. This necessity provided new opportunities for the collection of experimental data regarding the possibility of plant selection and of the effects of environment and of changes in cultural conditions on yield of alkaloids. An interesting account of the kind of work this involves will be found in the paper by W. O. James referred to below. One outcome of this work is the observation by workers in several countries that in solanaceous plants the tropane alkaloids are formed mainly in the roots.⁷ The plants generally used were belladonna, stramonium and *Duboisia* spp., and the necessary cultivation experiments were similar to those briefly described under the alkaloids of tobacco. The problem is, however, more complex than the results of these special observations seem to imply, and W. O. James,⁸ in the course of an account of work done by the Oxford Medicinal Plants Scheme on the biosynthesis of the belladonna alkaloids, states that alkaloids are first formed in the meristem of the radicle and can be detected when the radicles are 3 mm. long, but also shows that detached belladonna leaves can be induced to increase their alkaloidal content. He concludes that on the evidence available it is possible that the leaf alkaloids have a dual origin : by synthesis *in situ* and by translocation from the root.

A curious observation, first made by Barnard and Finnemore⁹ in the course of a systematic examination of *Duboisia myoporoides* in the whole range of its distribution in Australia, is that in this plant the relative proportions of the two main alkaloids is extremely variable, hyoscyne being predominant in plants of the northern area and hyoscyamine in those of the southern region. Hills, Trautner and Rodwell,⁹ continuing this work, confirmed this general result, but in the course of selection trials found that individual trees could exhibit the same variation ; the leaves of one specimen at Nambour, Queensland, contained in October about 3 per cent. of almost pure hyoscyamine and in April about the same amount of almost pure hyoscyne. Trautner,¹⁰ in a paper dealing with these anomalies, and also discussing the possible modes of origin of the various amino-alcohols, tropine, ψ -tropine, scopine, etc., and of the acids, tropic, benzoic,

veratric, tiglic and *isovaleric*, which esterify them, suggests that in *Duboisia* and other solanaceous species two systems are in operation.

The *hyoscyne* system occurs alone in certain northern *Duboisia myoporoides*, and forms scopine, ψ -tropine, dihydroxytropine and, in *Datura meteloides*, teloidine. Of these amino-alcohols, all the scopine is esterified by tropic acid and the minor bases by tiglic, methylbutyric or *isovaleric* acid, which contain the isoprene skeleton and are presumed to arise from that source.

The *hyoscyamine* system is found alone in some adult *Duboisia Leichhardtii* and possibly in some southern *D. myoporoides*. It produces tropine and *nortropine* only, which are esterified with tropic acid, or as in *apoptropine* found in belladonna, with atropic acid, and to a small extent with the isoprene acids referred to above. Some tropine or *nortropine* may occur as such. Scopine, ψ -tropine and dihydroxytropine are absent.

The hyoscyne system occurs alone in all young plants and may continue throughout life in specimens in the northern area: it may represent the original alkaloid metabolism of the plant. The hyoscyamine system appears only at the age of four to six months, and in the southern area it replaces the hyoscyne system almost completely; it appears to be an adapted system and may represent the adult alkaloid metabolism of the plant. Usually both systems are present in varying proportions.

It may be noted that *Datura Metel*, in which hyoscyne is usually the predominant alkaloid, has been recorded in one instance by Libizov¹¹ as containing hyoscyamine, but no hyoscyne, and a similar difference is mentioned for *Scopolia lurida*.¹¹

In Robinson's now well-known suggestions,¹² regarding the processes by which alkaloids may be produced in plants, two main reactions are used; the aldol condensation and the similar condensation of carbinolamines, resulting from the combination of an aldehyde or ketone with ammonia or an amine, and containing the group $\cdot\dot{C}(\text{OH})\cdot\dot{N}\cdot$, with substances in which the group $\cdot\dot{C}\text{H}\cdot\text{CO}\cdot$ is present. By these reactions it is possible to form the alkaloid skeleton, and the further necessary changes postulated include oxidations or reductions and elimination of water for the formation of an aromatic nucleus or of an ethylene derivative.

This theory has stimulated activity in two main directions, suggestions for changes in detail in the steps of processes for particular alkaloids, and work on laboratory syntheses of known alkaloids, using the reactions specified and operated under conditions which might obtain in a plant, *i.e.*, under what are now described as physiological conditions. All the results indicate that the theory is well-founded, and it seems possible that a technique may eventually be found by which the process may be observed in operation, directly or indirectly, *in situ*, say in a solanaceous plant.

After determination of the seasonal variation in alkaloidal content of the leaves, stems and roots of belladonna and the production of evidence that there is a considerable movement of alkaloid upwards from root to leaves and a small transport in the opposite direction, Cromwell¹³ found that of a large number of amines injected, with or without glucose, into

belladonna plants, significant increases in alkaloidal content were produced only by arginine, $\text{NH}_2 \cdot \text{C}(\text{NH}) \cdot \text{NH} \cdot (\text{CH}_2)_3 \cdot \text{CH}(\text{NH}_2)\text{COOH}$ with glucose, putrescine, $\text{NH}_2 \cdot (\text{CH}_2)_4 \cdot \text{NH}_2$, alone or with glucose, hexamine with glucose, and "formamol" (hexamethylenetetramine-anhydromethylene citrate) with glucose. It is known that by bacterial action arginine can be converted *via* ornithine,



into putrescine, and Cromwell has been able to demonstrate the presence of both arginine and putrescine in belladonna. He has also shown that belladonna extracts are capable of oxidising added putrescine to ammonia and a product, reacting with 2 : 4-dinitrophenylhydrazine as an aldehyde and estimated colorimetrically by that means, which is assumed to be either succinaldehyde or δ -aminobutyraldehyde, or a mixture of the two, though neither could be isolated and identified. Quite recently James and Beevers,¹⁴ in a preliminary announcement, record the isolation from belladonna leaves and roots of a polyphenolase which under specified conditions oxidises *l*-ornithine to α -keto- δ -aminovaleric acid. In the simplest form of Robinson's tropinone synthesis, as described in the atropine section, succinaldehyde was condensed with methylamine and acetone, so that if Cromwell's assumption is correct that succinaldehyde is formed in the experiment he describes, a further confirmation of Robinson's theory is provided and an interesting first step has been taken towards at least indirect observation of such a synthesis in plant material.

One of the most attractive features of Robinson's theory is that it makes understandable, on the basis of a slight change in either a primary material or in the metabolic process, the fact that a plant may produce more than one type of alkaloid, or that two closely related plants may each form alkaloids of distinct types. Thus, still keeping to the Solanaceæ, which seem to be popular as material for biogenetic experiments, the two *Duboisia* species *D. myoporoides* and *D. Leichhardtii* always produce hyoscyne or hyoscyamine or both, while a third species, *D. Hopwoodii*, produces nicotine or *normicotine*,¹⁵ or both. The two latter alkaloids are characteristic of all the species, so far examined, of another solanaceous genus, *Nicotiana*. For the biogenesis of nicotine Robinson suggested (1917)¹² the initial formation from ornithine by the methylating and oxidising action of formaldehyde of a pyrrolidylcarbinol-amine. This by condensation with a molecule of acetonedicarboxylic acid could furnish a product, which with formaldehyde and ammonia could yield a γ -keto-piperidine ring. From this stage, by steps that are easy to imagine, involving, in succession, reduction of a carbonyl to a secondary carbinol group, elimination of water and finally dehydrogenation to pyridyl, nicotine could be formed. In a later paper (1934)¹² lysine,



the next higher homologue of ornithine, is considered as a possible source of the pyridine ring, but this raises the difficulty of explaining the attachment of the pyrrolidine nucleus in the β -position, though it is suggested that the

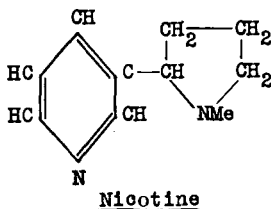
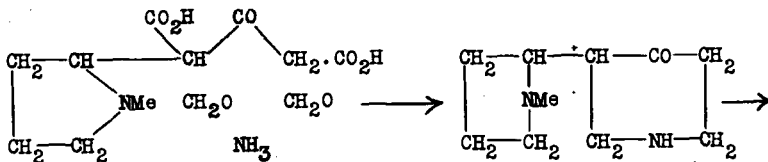
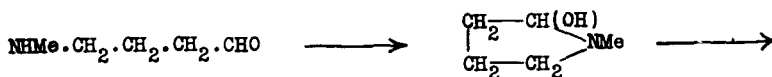

γ -ketopiperidine nucleus may be regarded as an oxidised lysine or *proto*-lysine derivative.

Of the remaining types of solanaceous alkaloids, the *nor*-bases, such as *nor*hyoscyamine, could be provided for by an alternative suggestion, based on the observation that a mixture of the ammonium salts of $\alpha\alpha'$ -diaminoadipic and citric acids could be oxidised by hydrogen peroxide to *nortropinone*.

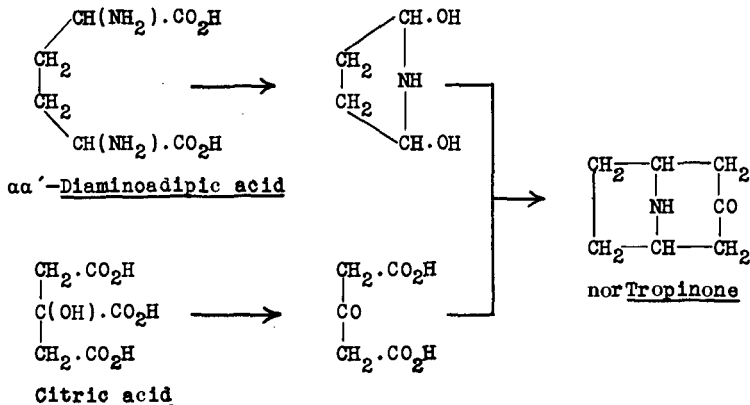

Teloidine, the basic hydrolytic product of meteloidine, has been synthesised recently under physiological conditions by Schöpf and Arnold,¹⁶ on the lines of the tropinone synthesis, *mesotartaric* aldehyde $(\text{CHOH} \cdot \text{CHO})_2$, being condensed at 25° with acetonedicarboxylic acid and methylamine hydrochloride to teloidinone (5-keto-1:2-dihydroxy-tropane) which on catalytic hydrogenation yielded teloidine (1:2:5-trihydroxytropane).

The hygrines have until recently only been found associated with the cocaines, which are tropane derivatives found in the Erythroxylaceæ of the order Malpighiales, *i.e.*, in a family, which is botanically remote from the Solanaceæ, the typical source of the tropane group. The presence of cuskhygrine has, however, been recorded recently in *Scopolia lurida*, which seems to establish a special connection between the hygrines and the tropane bases, and lends unusual interest to the following diagram based on one of Robinson's suggestions.

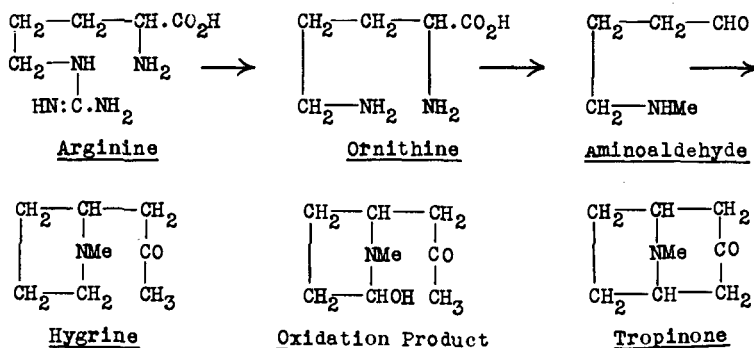

In the large group of *isoquinoline* alkaloids a considerable number of transformations from one type to another are described later in the appropriate sections; for example, from papaverine through laudanosine to glaucine and from the berberine to the cryptopine type, and the possibility of such changes may account for the association in the same plant of alkaloids of markedly different types. Winterstein and Trier first suggested the possible formation of *isoquinoline* alkaloids from 2 mols. of dihydroxyphenylalanine, according to the following scheme, leading to *norlaudanosine*, from which laudanosine is obtainable by methylation and dehydrogenation.

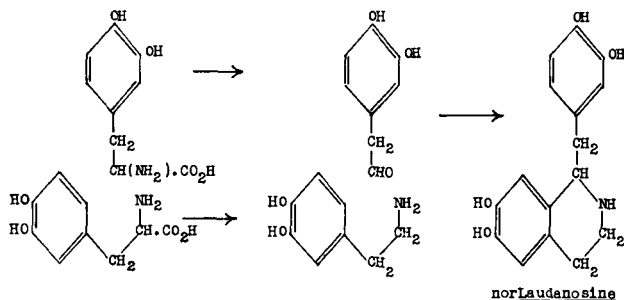

Robinson¹² (1934) has elaborated this into a scheme embracing hydrastine, berberine, *epicryptopine*, corydaline, sanguinarine and homochelidonine, though he points out that dihydroxyphenylalanine is labile and too easily convertible into indole derivatives to be capable of

the transformation suggested, under any ordinary conditions. It is, however, of interest to note that a definite approach towards possible biological conditions of synthesis of benzyltetrahydroisoquinolines by Späth and Berger and by Hahn and Schales is described later in the papaverine section.

The biogenesis of isoquinoline alkaloids was also discussed by the late Prof. Barger,¹⁷ who regarded as generally accepted the view that in the heterocyclic ring of these bases the nitrogen atom and four atoms of carbon come from an amino-acid and the fifth carbon from an aldehyde as illustrated in the second stage of the *nor*laudanosine synthesis already referred to. Barger was of opinion that the known structure of many isoquinoline alkaloids and the biological evidence available implies that tyrosine (β -*p*-hydroxyphenyl- α -aminopropionic acid,

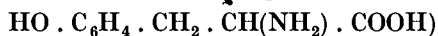

is the precursor of a large group of these alkaloids. For other alkaloids of this and other groups the original papers should be consulted, but mention may be made here of Robinson and Sugawara's synthesis of *protosinomenine*,¹² since that is a practical outcome of an investigation based on the view that the blocked hydroaromatic structure of the alkaloids of the morphine group has its biogenesis in an intramolecular union of the two aromatic nuclei of a base of the laudanosine type, concerning which two postulates are laid down:—

(1) If the union occurs in such a position that loss of hydrogen with re-formation of a true aromatic nucleus is feasible, an aporphine base will result.

(2) If the union occurs in a position already bearing a substituent, loss of hydrogen is impossible except by migration and a morphine type of alkaloid is formed.

The first postulate may be illustrated by the still unrealised conversion of laudanosine into glaucine by oxidation, resulting in the loss of one atom of hydrogen from each aromatic nucleus and union of these as shown by the dotted line.

The second may be illustrated by *protosinomenine*, for which the two formulæ shown are identical but differently written, which, on suitable oxidation, should pass into sinomenine.

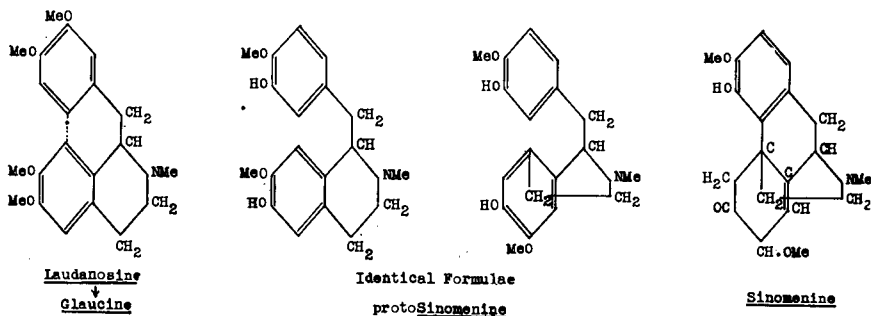

These suggestions and the practical realisation of some of them *in vitro* stimulated interest in this type of synthesis, and especially in the hands of Schöpf and his collaborators,¹⁸ have resulted in a series of syntheses simple in method and efficient in yield, which form a striking contrast to the classical processes of the organic chemist, though it is true to say that no synthesis of this type has yet been effected until the organic chemist has paved the way by an accurate experimental dissection of the molecule to be dealt with. Schöpf's successes have been due in part to his investigation of the effect of varying the hydrogen ion concentration of his reaction mixtures. Thus Schöpf and Bayerle found that an aqueous solution of β -(3 : 4-dihydroxyphenyl)-ethylamine hydrobromide with acetaldehyde in slight excess at a pH 3 to 5 and temperature 25° gave an 83 per cent. yield of 1-methyl-6 : 7-dihydroxy-1 : 2 : 3 : 4-tetrahydroisoquinoline hydrobromide, which only differs from the natural alkaloids carnegine (1 : 2-dimethyl-6 : 7-dimethoxy-1 : 2 : 3 : 4-tetrahydroisoquinoline) and salsoline (1-methyl-6-hydroxy-7-methoxy-1 : 2 : 3 : 4-tetrahydroisoquinoline) in degree of methylation. It is interesting to note that the naturally-occurring salsoline and carnegine are optically inactive in spite of the presence of a centre of asymmetry at C¹, so that this synthesis of a *nor*-form of these two alkaloids makes a close approach to physiological conditions even in this respect. In the same way these authors prepared from "epinine" (3 : 4-dihydroxyphenylethylmethylamine :



and acetaldehyde at pH 4 and 25°, 1 : 2-dimethyl-6 : 7-dihydroxy-1 : 2 : 3 : 4-tetrahydroisoquinoline.

Schöpf and Lehmann synthesised by similar methods, which are referred to later, tropinone, ψ -pelletierine and lobelanine. These syntheses illustrate the dependence of yield on the pH of the reaction mixture, as the following table for yields of lobelanine hydrochloride shows :—

M/93 Glutardialdehyde, M/50 Methylamine Hydrochloride,
M/37.5 Benzoylacetic Acid, M/10 Buffer

Exp. I (40 hours)							
pH	2	3	4	5	7	9	13
Yield, per cent.	1	21	56	38	1	traces	
Exp. II (8 days)							
Yield, per cent.	1.4	15	54	40	3	traces	

In a comprehensive review of this subject Schöpf (1937) gave a preliminary description of a number of other syntheses of this kind, including that of teloidine, already referred to. Suggestions for other alkaloidal syntheses were also made and the conditions under which such reactions might take place in plants discussed.

Other examples of syntheses under physiological conditions will be found under arecaidine, lobelia, papaverine, cusparia bark alkaloids, harmala alkaloids, rutæcarpine and yohimbine.

In this account ornithine has been frequently referred to as a possible primary material in the biogenesis of certain alkaloids, and it is on that account of interest to note that the presence of acetylornithine has been recorded by Manske in *Corydalis cornuta*, *C. ochotensis* and *C. sibirica*.¹⁹

Numerous contributions have been made to the analytical section of alkaloidal literature and, apart from descriptions of new general or special alkaloidal reagents, or new methods of using old ones, three main trends are noticeable, the development of micro-methods for detection and estimation, the replacement of purely chemical processes of estimation by colorimetric or other physical methods of measurement, and the increasing application of chromatography, for both the estimation and the isolation of alkaloids. There are also a considerable number of papers describing improvements in extraction processes and a few dealing with special titration methods, such as that of Trautner and Shaw,²⁰ in which the final alkaloidal residue in an assay of a drug, or a galenical preparation, is titrated in chloroform solution with *p*-toluenesulphonic acid. In physical methods of measurement special interest attaches to the papers by Kirkpatrick²¹ on a polarographic study of alkaloids, the results of which are summarised in the last paper of the series and their practical applications, for example in certain types of pharmaceutical assays, discussed.

The first suggestion that an adsorption column might be used in pharmaceutical analyses was made by Valentin and was successfully used by Merz and Franck on tinctures and extracts of cinchona, belladonna and Strychnos, the results obtained being concordant and in good agreement with those given by the processes of the German Pharmacopœia (D.A.B. VI).²² Since then chromatographic methods for the assay of solanaceous drugs have been published by several authors, and Brownlee,²³ in addition, deals with nux vomica and ergot. The results obtained are comparable with those got by established processes, and chromatographic methods are stated to take less time and to be easier to operate; that of Roberts and James²⁴ is designed to use only about 1 gramme dry weight of belladonna or similar material. Special attention has been given by Reimers, Gottlieb and Christensen²⁵ to the chromatographic analysis of alkaloidal salts, and a general method has been devised which answers with a number of alkaloids, but has to be modified for use with others owing to slow elution of the base, incomplete adsorption of the anion, or to difficulties of titration. In some cases these difficulties cannot be surmounted. The quality of aluminium oxide for use as an adsorbent is also considered and tests for its control are described. Gottlieb has recently used partition chromatography for the separation of tropic and atropic acids in hydrolysates of solanaceous alkaloids (1948).²⁵

After the removal of all the alkaloids which can be isolated as such, or as derivatives, from the total alkaloids of a plant, there usually remains an intractable, amorphous residue. Chromatographic methods are beginning to be applied to such materials with some success. With a new technique of this kind it is useful to have it applied experimentally to more- or less-known mixtures. Evans and Partridge,²⁶ after preliminary

experiments on a known mixture of hyoscyne and hyoscyamine, to determine conditions for separation, applied a form of partition chromatography to the total alkaloids of *Datura ferox*, *D. Stramonium* and *Atropa Belladonna*. In the case of the two latter plants the graph of eluate fractions showed only two peaks corresponding to hyoscyne and hyoscyamine, as shown by the constants of the related fractions isolated, and the sum of the two fractions was close to the amount of total alkaloids as previously determined. The graph for *D. ferox* was more complex but the fractions corresponding to the two main peaks were proved to be hyoscyne and meteloidine respectively and the sum of the fractions representing the remaining peaks amounted to only 0.08 out of 0.610 per cent. total alkaloids, calculated as hyoscyamine. Meteloidine had previously been recorded only from *D. meteloides*. The results show that partition chromatography provides a simple method of isolating separately hyoscyne and hyoscyamine from small quantities of solanaceous drugs. The *Datura ferox* used was grown in England from seed collected in Rhodesia. Previous analyses by Barnard and Finnemore⁹ of Australian-grown plants of this species and by Libizov²⁷ of Crimean plants, recorded hyoscyamine as the chief alkaloid. This seems therefore to be an addition to the solanaceous plants referred to above, which are liable to change the nature of their alkaloidal components.

According to Rowson,²⁸ polyploids of solanaceous plants, induced by the action of colchicine, show an increased content of alkaloids, but the relative proportions of hyoscyne and hyoscyamine remain the same and are characteristic for the species.

A notable change in methods of isolating alkaloids from plant materials has been described by Applezweig,²⁹ depending on the use of a suitable ion-exchange material and capable of application on a semi-micro scale or for industrial use. It has been applied to the preparation of the total alkaloids of cinchona bark (totaquina) and according to Sussman, Mindler and Wood, is also used industrially for the recovery of hyoscyne.

Many alkaloids are obtained in such small quantities that it is not possible to describe them in detail, and recourse must be had to giving characteristics for picrates, aurichlorides and similar compounds. The reineckates, first used by Christensen and later by Rosenthaler,³⁰ are a useful addition to such compounds, and have been so used recently by Evans and Partridge²⁶ for the characterisation of solanaceous alkaloids.

In spite of their importance, basicity constants rarely figure in descriptions of alkaloids. Figures for a series of alkaloids and related substances were published by Kolthoff in 1925 and have been extensively used. Recently a few more have been added by Schoorl, and Adams and Mahan have provided figures for the whole group of necines, the amino-alcohols resulting from the hydrolysis of the pyrrolizidine group of alkaloids.³¹

For the purposes of this book, an alkaloid is regarded as a relatively complex, organic base, occurring naturally in a plant and usually possessing marked pharmacological activity. This excludes simple, naturally occurring bases and the biological amines, which are adequately dealt with

elsewhere.³² The purines are also omitted, as these are now well described in text-books of organic chemistry for advanced students and recent interest in them is centred chiefly on derivatives, which are more appropriately dealt with in a text-book of biochemistry than in a work on alkaloids.

The material is arranged, as in previous editions, primarily on the basis of nuclear structure, which it must be admitted is arbitrary, for most of the more complex alkaloids could be dealt with under more than one structural heading. Most of these structural groups are, however, almost traditional in alkaloidal literature and seem to have arisen usually from the nature of the products obtained in early, drastic degradation experiments. Two new groups have been added, the components of which formerly occupied considerable space among "alkaloids of undetermined constitution." The pyrrolizidine group consists so far, only of the "necylneenes," characteristic of the genus *Senecio*, but also found less extensively in other genera. The steroidal alkaloid group is so named because there is reason to believe it consists mainly of alkaloids containing a tetracyclic system identical with, or closely related to, that of the steroids: it includes the extensive series of alkaloids found in *Aconitum*, *Delphinium* and *Veratrum* species and the glucosidal alkaloids of *Solanum* spp. A preliminary statement by Haworth *et al.*³³ published after the section on *Holarrhena* alkaloids had been passed for press, indicates that the carbon atoms of conessine are accounted for by the *allopregnane* structure, but the position of the ethylenic linkage and the points of attachment of the three N-methyl groups are still uncertain. On this basis conessine also belongs to the steroidal alkaloid group and as several of its associates are convertible by simple reactions into conessine, the nature of an important fraction of the sixteen *Holarrhena* alkaloids is becoming clear.

In future a third new group will be required, according to another preliminary statement published quite recently by a team of Australian chemists, Messrs. Hughes, Lahey, Price and Webb. They have isolated six alkaloids from three rutaceous species of that country, five of which have been definitely shown to be acridine derivatives. This appears to be the first-fruits of a survey of the type referred to above, which is being carried out on the Australian flora under the auspices of the Council for Scientific and Industrial Research and several of the Australian Universities.³⁴

Within the alkaloidal groups there have been a considerable number of additions, notably, as might be expected, in the already large *isoquinoline* group.

Under the heading "Alkaloids of Undetermined Constitution," have been included bases about which a good deal of information is available, though they cannot yet be allocated to structural groups, either because sufficient, definite information is not available, or because such data are available only about one or two members of an extensive series found in one plant or one genus. The *Dichroa* bases are probably *quinazolines*. Of the *Erythrophloeum* alkaloids some might be placed in the group of

alkaloidal amines as they are esters of alkylamino- alcohols, but they have several associates about which little is yet known. Similarly in the Gelsemium bases, sempervirine is now known to be closely related to yohimbine and there are indications that gelsemine may also be an indole alkaloid, but there are several associates, including gelsemicine, the most potent of the set about which there is little chemical information.

The section "Minor Alkaloids" covers plants arranged in alphabetical order of their botanical names, from which well-defined alkaloids have been isolated but which have not yet been examined in detail or for some reason do not readily fit into preceding groups. Following "Minor Alkaloids" is a list, also arranged alphabetically under botanical names, of plants in which the presence of alkaloids has been recorded but from which well-defined and recognisable alkaloids have not yet been isolated, although in some cases names and empirical formulæ have been assigned to amorphous products. Information is apt to arise rapidly and unexpectedly in these days and too late for transfer to its appropriate section one of the plants in this list, *Talauma mexicana*, has been shown to contain an alkaloid *aztequine*, belonging to the *bisbenzylisoquinoline* series.

Comparatively few alterations have been made since 1939 in the structures accepted for well-known alkaloids. A slight but important change has been adopted in the formula of strychnine and contributions to the chemistry of that alkaloid and its associates are still being made,³⁵ though the formula seems now so well established that Woodward has recently suggested and discussed a scheme for the biogenesis of strychnine on which Robinson has commented favourably.³⁶ Robinson has also proposed a scheme for the biogenesis of emetine. This involves a modification in the formula of that alkaloid, which is supported by Dewar's interpretation of the results of recent chemical work on emetine by Karrer *et al.*, by Späth and by Pailer.³⁷

Another alteration is the proposed 7-membered ring in the formula of colchicine which receives substantial support from a preliminary announcement just made by Buchanan, Cook, Loudon and MacMillan³⁸ that they have synthesised 9 : 12 : 13 : 14-tetramethoxy-3 : 4 : 5 : 6-dibenz- $\Delta^{1:3:5}$ -; *cycloheptatriene-7-one* and shown it to be identical with the $\alpha\beta$ -unsaturated ketone obtained by oxidation of deaminocolchinol methyl ether.

The chemistry of yohimbine is also under active discussion and new papers have appeared, or are promised, dealing with the structure and synthesis of ketoyohyrine.³⁹

A modification of the formula of α -fagarine just announced establishes its close relationship to the alkaloids of cusparia bark, which like Fagara is derived from a rutaceous genus.⁴⁰

The advent of the sulphanilamide group of drugs and the development of the biological products known as anti-biotics, presented biochemists and pharmacologists with many interesting problems and in view of these and other like attractions, it is not surprising that the pharmacology of alkaloids seems to be receiving less attention

now than at one time it attracted. Much work has been done in determining details of the pharmacological activity of the many new alkaloids, such as those of the pyrrolizidine group, that have been described in the last ten years, but the most striking development is probably the number of synthetic replacement products for alkaloids made available, and the remarkable variation in structure shown both as regards the prototype to be replaced and among the substitutes themselves. As shown in the appropriate sections, much research has been expended on modifying the tropane and cinchona alkaloids, but in both cases effective synthetic drugs have been found in substances structurally different from the prototypes. There is, for example, little or no structural similarity between quinine, mepacrine and paludrine, though all three are in use as anti-malarial drugs. A like absence of structural similarity is found in the new synthetic replacements for quinidine in the control of auricular fibrillation. These substances are also local anæsthetics and spasmolytics. Similarly, as pointed out in connection with physostigmine, a considerable number of alkaloids and other substances share with this alkaloid the capacity to inhibit the action of choline-esterase on acetylcholine, and it is beginning to be suggested that the action of many chemical substances, including alkaloids, in the body is to be accounted for by modification of, or interference with, the production or action of potent biological amines such as acetylcholine, histamine or epinephrine.

Burn⁴¹ has pointed out that the grouping together of many properties as fundamentally the same, brings into some sort of order the long list of apparently pharmacologically unrelated alkaloids, and that the similarity in many properties of atropine, papaverine and quinine, and of conessine and quinine, suggests points of biochemical similarity.

REFERENCES

(The simple page references are to pages in this volume)

- (1) *Farmatsiya*, 1946, 9, No. 3, 22 (*Chem. Abstr.*, 1948, 42, 2728). (2) *Trud. Uzbekskogo Gosudarst. Univ. Sbornik Trudov Khim.*, 1939, 15, 182 (*Chem. Abstr.*, 1941, 35, 4154). (3) SPENCER, KONIUSZY, ROGERS, SHAVEL, EASTON, KACZKA, KUEHL, PHILLIPS, WALTI, FOLKERS, MALANGA and SEELER, *Lloydia*, 1947, 10, No. 3, p. 145. (4) *Rev. Bot. appl. Agric. trop.*, 1939, 19, 564. (5) A. de CANDOLLE, "La Phytographie," Paris, 1880, p. 174. (6) *Ann. Rev. Biochem.*, 1944, 13, 543. (7) See, for example, KRAEVOI and NETSCHAËV, *C. R. Acad. Sci. U.R.S.S.*, 1941, 31, 69 (*Brit. Chem. Abstr.*, 1944, Aiii, 154); HIEKE, *Planta*, 1942, 33, 185 (*Chem. Abstr.*, 1943, 37, 6001); TUSHNIAKOVA, *Proc. Lenin. Acad. Agr. Sci. U.R.S.S.*, 1944, No. 10, 24 (*Chem. Abstr.*, 1947, 41, 4197); SHMUK, *ibid.*, 1945, Nos. 1-2, 3 (*Chem. Abstr.*, 1947, 41, 4198); PEACOCK, LEYERLE and DAWSON, *Amer. J. Bot.*, 1944, 31, 463; BLANK, *Experientia*, 1945, 1, 111 (*Brit. Abstr.*, 1946, A iii, 875); HILLS, TRAUTNER and RODWELL, *Austr. J. Sci.*, 1945, 8, 20; 1946, 9, 24; VINCENT and DULUCQ-MATHOU, *C. R. Soc. Biol.*, 1946, 140, 535; LOWMAN and KELLY, *Proc. Amer. Soc. Hort. Sci.*, 1946, 48, 249. (8) *Nature*, 1946, 158, 377, 654; 1947, 159, 196. (9) BARNARD and FINNEMORE, *J. Council Sci. Ind. Res. Austr.*, 1945, 18, 277; HILLS, TRAUTNER and RODWELL, *ibid.*, p. 234; 1946, 19, 295. (10) *J. Proc. Austr. Chem. Inst.*, 1947, 14, 411. (11) See pp. 65-6. (12) ROBINSON, *J. Chem. Soc.*, 1917, 111, 876; IX *Congreso Internacional de Quimica*, Madrid, 1934, Vol. V, Group IV, p. 17; *J. Chem. Soc.*, 1936, 1079; (with SUGASAWA), *ibid.*, 1931, 3163; 1932,

789; 1933, 280. (13) *Biochem. J.*, 1937, 31, 551; 1943, 37, 717, 722. (14) *Ibid.*, 1948, 43, No. 1, xi. (15) See p. 35 and STANTON-HICKS and SINCLAIR, *Austr. J. Exp. Biol. Med. Sci.*, 1947, 25, 191 (*Chem. Abstr.*, 1948, 42, 2399). (16) See p. 84 and SCHÖPF and ARNOLD, *Annalen*, 1947, 558, 109 (*Chem. Abstr.*, 1948, 42, 2602). (17) *Brit. Assoc. Reports*, 1929, 51; *IX Congreso Internacional de Química*, Madrid, 1934, Vol. IV, Group III, p. 97. (18) SCHÖPF, *IX Congreso Internacional de Química*, Madrid, 1934, Vol. V, Group IV, p. 189; *Annalen*, 1935, 518, 1; *Angew. Chem.*, 1937, 50, 779, 797; (with BAYERLE), *Annalen*, 1934, 512, 190; (with LEHMANN), *ibid.*, 1935, 518, 1; (with SALZER), *ibid.*, 1940, 544, 1; (with THIERFELDER), *ibid.*, 1932, 497, 22. (19) See pp. 170-1. (20) *Austr. Chem. Inst. J. and Proc.*, 1945, 12, 232, 405. (21) *Quart. J. Pharm. Pharmacol.*, 1945, 18, 245, 338; 1946, 19, 8, 127, 526; 1947, 20, 87. (22) VALENTIN, *Pharm. Zeit.*, 1935, 80, 469; (with FRANCK), *ibid.*, 1936, 81, 943; MERZ and FRANCK, *Arch. Pharm.*, 1937, 275, 345. (23) BROWNLEE, *Quart. J. Pharm. Pharmacol.*, 1945, 18, 163, 172; see also BROWN, KIRCH and WEBSTER, *J. Amer. Pharm. Assoc.*, 1948, 37, 24. (24) *Quart. J. Pharmacol.*, 1947, 20, 1. (25) REIMERS, GOTTLIEB and CHRISTENSEN, *ibid.*, 1947, 20, 99; see also *Dansk. Tids. Farm.*, 1943, 17, 54; 1945, 19, 129, 167; GOTTLIEB, *ibid.*, 1947, 21, 92 *J. Amer. Chem. Soc.*, 1948, 70, 423. (26) EVANS and PARTRIDGE, *Quart. J. Pharm. Pharmacol.*, 1948, 21, 126; see also TRAUTNER and ROBERTS, *Analyst*, 1948, 73, 140. (27) LIBIZOV, *Proc. Lenin. Acad. Sci. (Biochem.)*, 1941, 3, 23. (28) ROWSON, *Quart. J. Pharm. Pharmacol.*, 1945, 18, 175, 185; cf. BEESLEY and FOSTER, *Nature*, 1948, 161, 561. (29) APPELZWEIG, *Ind. Eng. Chem. (Anal)*, 1946, 18, 82; *J. Amer. Chem. Soc.*, 1944, 66, 1990; (with RONZONE), *Ind. Eng. Chem.*, 1946, 38, 576; SUSSMAN, MINDLER and WOOD, *Chem. Industries*, 1945, 57, 455, 549. (30) CHRISTENSEN, *J. pr. Chem.*, 1892, [2], 45, 213, 356; ROSENTHALER, *Arch. Pharm.*, 1927, 265, 684. (31) KOLTHOFF, *Biochem. Zeit.*, 1925, 162, 289; SCHOORL, *Pharm. Weekbl.*, 1939, 76, 1497; ADAMS and MAHAN, *J. Amer. Chem. Soc.*, 1942, 64, 2588. (32) See, for example, "Die biogenen Amine," M. GUGGENHEIM, 1940; Verlag von S. Karger, Basle and New York. (33) HAWORTH, MCKENNA and SINGH, *Nature*, 1948, 162, 22; *Chem. and Ind.*, 1948, 716. (34) *Nature*, 1948, 162, 223. (35) ROBINSON (with BAILEY), *J. Chem. Soc.*, 1948, 703; (with PAUSACKER), *ibid.*, p. 951; WOODWARD and BREHM, *J. Amer. Chem. Soc.*, 1948, 70, 2107; PRELOG (with KOCOR), *Helv. Chim. Acta*, 1948, 31, 237; (with VEJDELEK), *ibid.*, p. 1178. (36) WOODWARD, *Nature*, 1948, 162, 155; ROBINSON, *ibid.*, p. 156. (37) ROBINSON, *Nature*, 1948, 162, 524; KARRER, EUGSTER and RÜTTNER, *Helv. Chim. Acta*, 1948, 31, 1219; SPÄTH, *Monats.*, 1948, 78, 348; PAILER, *ibid.*, 1948, 79, 127. (38) BUCHANAN, COOK, LOUDON and MACMILLAN, *Nature*, 1948, 162, 692; *this volume*, p. 654. (39) WOODWARD and WITKOP, *J. Amer. Chem. Soc.*, 1948, 70, 2409; SCHLITTLER and SPEITEL, *Helv. Chim. Acta*, 1948, 31, 1199; CLEMO and SWAN, *Nature*, 1948, 162, 693. (40) DEULOFEU, LABRIOLA and BERINZAGHI, *Nature*, 1948, 162, 694. (41) BURN, *Chem. and Ind.*, 1948, 659.

PLANT ALKALOIDS

PYRIDINE GROUP

ALTHOUGH pyridine has been recorded as occurring in plants, the evidence does not as a rule amount to more than a pyridine-like odour, though more definite evidence has been provided by Goris and Larssonneau¹ for its occurrence in belladonna leaves and by Kuhn and Schäfer² for its presence in the roots of the same plant. 3-Methoxypyridine, b.p. 40°/1 mm. characterised as picrate, m.p. 139°, mercurichloride, m.p. 120°, aurichloride, m.p. 176°, and platinichloride, m.p. 194°, has been found by Manske³ in *Thermopsis rhombifolia* (Nutt) Richards, and in *Equisetum arvense* L.

Piperidine has been obtained from pepper,⁴ from *Psilocaulon absimile* N.E.Br (Aizoaceæ) in which it occurs to the extent of 4.5 per cent.,⁵ and in *Petrosimonia monandra*.⁶ N-Methylpiperidine has been recorded in *Girgensohnia* spp.

REFERENCES

(1) *Bull. Sci. Pharmacol.*, 1921, **28**, 497, 499. (2) *Deut. Apoth. Zeit.*, 1938, **53**, 405, 424. (3) *J. Can. Res.*, 1942, **B**, **20**, 265. (4) SPÄTH and ENGLAENDER, *Ber.*, 1935, **68**, 2218; cf. PICTET and PICTET, *Helv. Chim. Acta*, 1927, **10**, 593. (5) RIMINGTON, *S. Afr. J. Sci.*, 1934, **31**, 184. (6) JURASCHEVSKI and STEPANOV, *J. Gen. Chem.*, U.R.S.S., 1939, **9**, 1687.

Piperine (piperoylpiperidide), $C_{17}H_{19}O_3N$. This substance occurs in several peppers and was isolated from the fruits of *Piper nigrum*, which furnish the black and the white peppers of commerce, by Oersted.¹ Later it was obtained from long pepper (*P. longum* and *P. officinarum*) by Flückiger and Hanbury,² from Ashanti black pepper (*P. clusii*) by Stenhouse,³ and recently Sabetay and Trabaud^{3(a)} have recorded its presence in Kissi pepper (*P. farnechoni*). An alkaloid-like substance has also been found in *P. marginatum* by de Nunez and Johnson.⁴ The amount of piperine varies from 1 to 2 per cent. in long pepper, to from 5 to 9 per cent. in the white and the black peppers of commerce. It may be prepared by treating the solvent-free residue from an alcoholic extract of black pepper, with a solution of sodium hydroxide to remove resin (said to contain *chavicine*, an isomeride of piperine) and solution of the washed, insoluble residue in warm alcohol, from which the alkaloid crystallises on cooling. Piperine forms monoclinic needles, m.p. 128–129.5°, is slightly soluble in water and more so in alcohol, ether or chloroform; the solution in alcohol has a pepper-like taste. It yields salts only with strong acids. The platinichloride $B_4 \cdot H_2PtCl_6$ forms orange-red needles. Iodine in potassium iodide added to an alcoholic solution of the base in presence of a little hydrochloric acid gives a characteristic periodide, $B_2 \cdot HI \cdot I_2$, crystallising in steel-blue needles, m.p. 145°.

Anderson⁵ first hydrolysed piperine by alkalis into a base and an acid, which were named by Babo and Keller⁶ piperidine and piperic acid respectively. The chemistry of these products is so well known that it need not be discussed here. The alkaloid was synthesised by Rugheimer⁷ by the action of piperoyl chloride on piperidine.

Piperovatine, $C_{16}H_{21}O_2N$, isolated by Dunstan and Garnett⁸ from *Piper ovatum*, crystallises in colourless needles, m.p. 123°. It forms no salts. Heated with water at 160°, a volatile base, probably a pyridine derivative, is formed together with an acid and an oil having the odour of anisole. According to Cash⁸ piperovatine is a temporary depressant of motor and sensory nerve fibres and of sensory nerve terminations. It acts as a heart poison and as a stimulant to the spinal cord in frogs, causing a tonic spasm somewhat similar to that induced by strychnine.

Pungent Principles of Plants. It has been customary to include piperine among the alkaloids, though it has no marked pharmacological action and is the earliest and best known example of the pungent acid amides, some of which are used in medicine as irritants or carminatives. The group includes chavicine,⁹ an isomeride of piperine and found with it in pepper, capsaicin (decenovanillylamide),¹⁰ spilanthol¹¹ and pelltitorine¹² (from *Anacyclus pyrethrum*), two isomerides which both yield *n*-decoisobutylamide on hydrogenation, fagaramide,¹³ the isobutylamide of piperonylacrylic acid and affinin.¹⁴ This and other members of the group have received some attention as insecticides.¹⁵

REFERENCES

- (1) *Schweigger's Journal*, 1819, 29, 80. (2) *Pharmacographia* (London: Macmillan & Co., 1879), p. 584. (3) *Pharm. J.*, 1855, 14, 363. (3a) *Indust. parfum.*, 1946, 1, 44, 46. (4) *J. Amer. Pharm. Assoc.*, 1943, 32, 234. (5) *Annalen*, 1850, 75, 82; 84, 345, cf. WERTHEIM and ROCHELEDER, *ibid.*, 1845, 54, 255. (6) *Journ. pr. chem.*, 1857, 72, 53. (7) *Ber.*, 1882, 15, 1390. (8) *J. Chem. Soc.*, 1895, 67, 94; cf. DUNSTAN and CARR, *Proc. Chem. Soc.*, 1895, 177. (9) STAUDINGER *et al.*, *Ber.*, 1923, 56, 699, 711; OTT *et al.*, *Annalen.*, 1921, 425, 314; *Ber.*, 1922, 55, 2653; 1924, 57, 214. (10) NELSON, *J. Amer. Chem. Soc.*, 1919, 41, 1115; SPÁTH and DARLING, *Ber.*, 1930, 63, 737. (11) ASAHINA and ASANÔ, *J. Pharm. Soc. Japan*, 1920, 503; 1922, 85; ASANÔ and KANEMATSU, *ibid.*, 1927, 521; *Ber.*, 1932, 65, 1602; GOKHALE and BHIDE, *J. Ind. Chem. Soc.*, 1945, 22, 250. (12) GULLAND and HOPTON, *J. Chem. Soc.*, 1930, 6. (13) THOMS and THÜMEN, *Ber.*, 1911, 44, 3717; GOODSON, *Biochem. J.*, 1921, 15, 123. (14) ACREE, JACOBSEN and HALLER, *J. Org. Chem.*, 1945, 10, 236, 449; 1947, 12, 731. (15) HARTZELL (with STRONG), *Contrib. Boyce Thompson Inst.*, 1944, p. 253; (with SYNERHOLM and ARTHUR, *ibid.*, 1945, p. 433); (with HARVILL and ARTHUR, 1943, p. 87).

Leucenol, $C_8H_{10}O_4N_2$. This substance, first isolated from the seeds of *Leucena glauca* Benth. (Leguminosæ) by Mascré,¹ was later investigated by Adams, Cristol, Anderson and Albert.² It has m.p. 291° (*dec.*; Maquenne block), $[\alpha]_D \pm 0^\circ$, contains 50 per cent. of its nitrogen as a primary amino-group and behaves as an α -amino-acid. *Salts*—B. HCl, m.p. 174.5–5° (*dec.*); B. HBr, m.p. 179.5° (*dec.*); B. HI, m.p. 183–3.5° (*dec.*). Leucenol cannot be acylated but the ferric chloride and Folin reactions indicate the presence of a phenolic hydroxyl group. Heated at 220–250°/2 mm.

leucenol yields a pale yellow substance, $C_5H_5O_2N$, m.p. $242-4^\circ$, which gives a violet colour with ferric chloride. Leucenol is probably the *dl*-form of mimosine (p. 4) and the constitution provisionally proposed was β -N-(3-hydroxy-6-pyridone)- α -aminopropionic acid.

Leucenol was also examined by Bickel and Wibaut³. They propose to re-name the substance LEUCÆNINE. Their specimen had m.p. $226-7^\circ$ and $[\alpha]_D -9^\circ$ (H_2O) or $+6.7^\circ$ (dil. HCl). They provide evidence for the empirical formula, $C_8H_{10}O_4N_2$, and agree that the alkaloid contains a pyridine ring with two substituents—a phenolic hydroxyl group and a side-chain $.O \cdot CH_2 \cdot CH(NH_2) \cdot COOH$, the orientation of these substituents being uncertain. On treatment with dimethyl sulphate in presence of alkali a product, $C_7H_{11}O_3N$, m.p. $92.0-92.5^\circ$, is formed, which contains one methoxyl group, gives a dibromide $C_7H_{11}O_3NBr_2$, m.p. 168° (*dec.*), does not absorb hydrogen in presence of Adams's platinic catalyst, yields pyridine on distillation with zinc dust and forms salts with loss of a molecule of water, e.g., the chloride, $C_7H_{10}O_2NCl$, m.p. $209-210^\circ$ (*dec.*), indicating that it is a quaternary base with a hydroxyl group attached to nitrogen. On oxidation with permanganate it produces methylamine and once there was also obtained a substance, $C_5H_5O_7$, m.p. $142-3^\circ$, which it is considered may have been a mixture of trihydroxyglutaric acids,



The chloride, $C_7H_{10}O_2NCl$, on heating at 15 mm. pressure, yields a sublimate, $C_6H_7O_2N$, m.p. $227-8^\circ$ formed by loss of a molecule of methyl chloride. This substance contains a methylimino but no methoxyl group, gives a violet colour with ferric chloride and has the properties of a N-methylhydroxypyridone, of which six isomerides are possible, *viz.*, with the orientations $OH : CO = (a) 4 : 2 ; (b) 2 : 4 ; (c) 3 : 2 ; (d) 6 : 2 ; (e) 5 : 2 ; (f) 3 : 4$. The first two have been synthesised by Späth and Tschelnitz⁴ and (c) and (d) were prepared by the authors. None of the four is identical with the substance from leucenol, which should therefore be either N-methyl-5-hydroxypyridone-2 or N-methyl-3-hydroxypyridone-4. The authors tentatively prefer the latter. Leucenol combines with only one molecule of monobasic acids but the methyl ester forms a dihydrochloride, $C_7H_9O_2N_2(CO_2Me)_2 \cdot 2HCl \cdot 0.5H_2O$, m.p. $175-6^\circ$. This and results of titration experiments by the Willstätter-Waldschmidt-Leitz method, the formation of a characteristic copper salt and other evidence indicate that leucenol is an α -amino-acid, *viz.*, a β -[hydroxypyridoxy]- α -aminopropionic acid such as I.

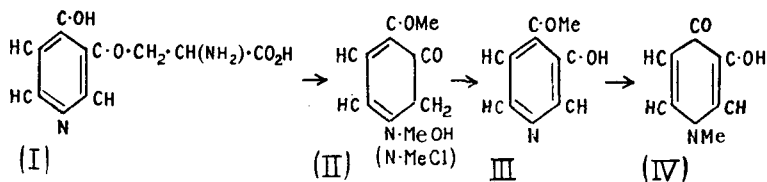

In the action of dimethyl sulphate and alkali on leucenol it is assumed that the hydroxyl and amino-groups in (I) are methylated, and that the

product of this action is hydrolysed by the alkali, to a hydroxymethoxy-pyridine which adds on a molecule of methyl alcohol to form (II). This, as the methochloride, in losing a molecule of methyl chloride must, at the high temperature involved, undergo further rearrangement to give the N-methylhydroxypyridone (IV) *via* the supposed intermediate (III).

This explanation has been revised recently by Bickel,⁵ who has shown that the product, $C_7H_{11}O_3N$, first formed in this reaction, is the monohydrate of N-methyl-3-methoxy-pyridone-4, $MeO \cdot C_5H_3ONMe, H_2O$, the "chloride," $C_7H_{10}O_2NCl$, is the hydrochloride, $MeO \cdot C_5H_3ONMe, HCl$ of the same base, and the substance formed when the "chloride" is heated is N-methyl-3-hydroxypyridone-4. The constitution of the latter had already been established by Wibaut and Kleipol,³ who had synthesised it by the action of methylamine on meconic acid (V) and decarboxylation of the resulting product (VI) to the desired substance (VII = IV).

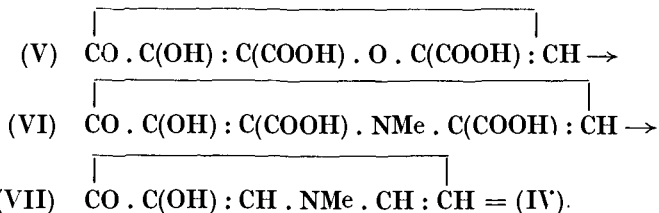

The substance, $C_5H_5O_2N$, which Adams *et al.*² obtained by the pyrolysis of leucenol and tentatively suggested might be 2 : 5-dihydroxypyridine, later disproved by Adams and Govindachari,⁶ has been synthesised by Bickel⁷ and shown to be 3 : 4-dihydroxypyridine, and this has been confirmed by Adams, Jones and Johnson.⁸

There still remains to be settled the point of attachment of the α -aminopropionic acid side-chain in leucenol. As the latter is unaffected by boiling hydrobromic or hydriodic acid, an ether linkage at C³ in 3-hydroxypyridone-4 is unlikely and as the side-chain is eliminated by either pyrolysis or the action of alkali C⁶ for the location, as suggested by Kostermanns (*see* mimosine below) is improbable. The balance of evidence seems to be in favour of attachment to the N-atom and additional data supporting this view have been provided by Adams and Jones.⁹

Bickel and Wibaut³ found in feeding experiments with rats and mice that leucenol is probably the toxic constituent of *Leucæna glauca* seeds, but they did not observe with these animals the loss of hair which seems to occur when these seeds are fed to cattle.¹⁰

REFERENCES

- (1) *Compt. rend.*, 1937, 204, 890. (2) *J. Amer. Chem. Soc.*, 1945, 67, 89. (3) *Rec. Trav. Chim.*, 1946, 65, 65; WIBAUT, *Helv. Chim. Acta*, 1946, 29, 1669; (with KLEIPOL), *Rec. Trav. Chim.*, 1947, 66, 24, 459. (4) *Monats.*, 1921, 42, 251. (5) *J. Amer. Chem. Soc.*, 1947, 69, 1801. (6) *Ibid.*, p. 1806. (7) *Ibid.*, p. 1805. (8) *Ibid.*, p. 1810. (9) *Ibid.*, p. 1803. (10) MASCRÉ and OTTENWÄLDER, *Bull. Sci. Pharmacol.*, 1941, 3, 4, 65.

Mimosine, $C_8H_{10}O_4N_2$, was isolated by Renz¹ from *Mimosa pudica* L. and *Leucæna glauca* Benth. It has m.p. 231° (*dec*) $[\alpha]_D^{22} - 21^\circ$ (H_2O) and yields a copper salt, $C_8H_8O_4N_2, Cu, 2H_2O$. Nienburg and Taubock²

suggested that it might be a β -hydroxypyridylalanine and both Adams *et al.* and Wibaut and Bickel in their work on leucenol (*see above*) have suggested, that it is an optically active form of leucenol. Kostermanns³ has also investigated mimosine with results indicating that it is a derivative of 3:4-dihydroxypyridine. In particular he has prepared from it, by the process used by Wibaut for leucenol, the substance $C_6H_7O_2N$, m.p. 224°, and confirms that this is *N*-methyl-3-hydroxypyridone-4, by comparison with a specimen of the latter synthesised by the action of methylamine on pyromeconic acid. He points out that there are difficulties in accepting either position 3 or 4 for the location of the side-chain and that it may be at 1 or 6.

Feeding experiments with horses seemed to indicate that the alkaloid caused toxic symptoms and loss of hair when large doses were administered.

REFERENCES

(1) RENZ, *Zeit. physiol. Chem.*, 1936, 244, 153. (2) NIENBURG and TAUBOCK, *ibid.*, 1937, 250, 80. (3) *Rec. Trav. Chim. Pays-Bas*, 1946, 65, 319; 1947, 66, 93; *Nat. Tijds. Ned. Ind.*, 1940 (for a comment on this paper see WIBAUT, *Rec. Trav. Chim. Pays-Bas*, 1946, 65, 392).

ALKALOID OF RICINUS COMMUNIS

Ricinine, $C_8H_8O_2N_2$, was isolated by Tuson¹ from castor-oil seed and was subsequently examined by Soave,² Schulze³ and Evans.⁴ It crystallises in prisms, m.p. 201.5°, sublimes at 170–180°/20 mm., is neutral in reaction, optically inactive, and forms no salts. It is precipitated by solutions of iodine or mercuric chloride, but not by Mayer's reagent. Evaporated with nitric acid it leaves a yellow residue, which becomes purple on addition of ammonia solution.

Maquenne and Philippe⁵ first recorded the hydrolysis of ricinine by alkalis to methyl alcohol and ricinic acid, $C_7H_6O_2N_2$, brilliant, slender needles, m.p. 296°–8° (*dec.*); the latter is decomposed by hydrochloric acid at 150°, into ammonia, carbon dioxide and a base, $C_6H_7O_2N$, which was regarded by these authors as 1-methyl-3-hydroxy-4-pyridone. Böttcher⁶ pointed out that ricinine showed many of the reactions of glyoxaline and found that, on heating with 50 per cent. sulphuric acid, ricinic acid yielded an acid, m.p. 216°, which contains a methylimino-group, gives the reactions of a pyridinecarboxylic acid, yields a pyrrole on distillation with lime and forms Maquenne and Philippe's base, $C_6H_7O_2N$, on hydrolysis with hydrochloric acid at 150°. Winterstein, Keller and Weinhagen⁷ had, in the meantime, shown that although both ricinine and ricinic acid yield ammonia and the base, $C_6H_7O_2N$, with 57 per cent. sulphuric acid as the hydrolytic agent the same base is yielded by ricinic acid whilst ricinine furnishes a new base, $C_7H_9O_2N$. Späth and Tschelnitz⁸ re-examined both these products and showed that the base, $C_6H_7O_2N$, was 1-methyl-4-hydroxy-2-pyridone, or possibly 1-methyl-2-hydroxy-4-pyridone and that the base, $C_7H_9O_2N$, was the methyl ether of this substance. Both bases were synthesised. These authors, like Böttcher, at first proposed formulæ containing a glyoxaline ring for ricinine, but these were shown to be

untenable as a result of Späth and Koller's⁹ synthesis of ricinidine, $C_7H_8ON_2$, which is obtained from ricinine by replacement of the methoxyl group by hydroxyl, chlorine and hydrogen in succession. Ricinidine, on hydrolysis, yields first an amide, $C_7H_8O_2N$, and then a carboxylic acid, by

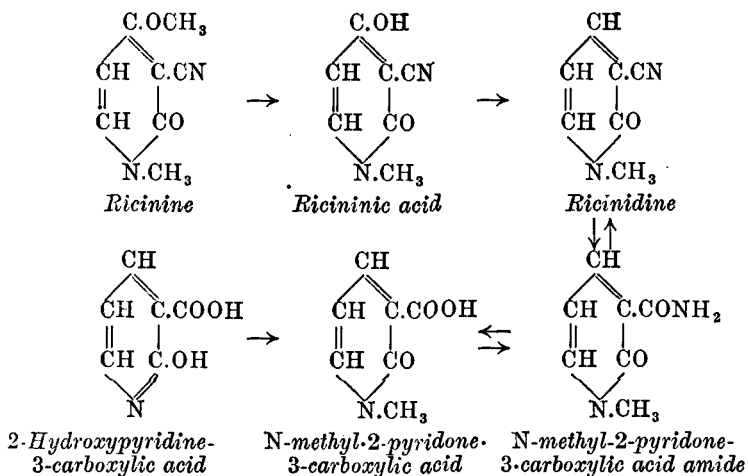

the hydrolysis of a —CN group, so that the acid appeared to be a *N*-methyl-2-pyridonecarboxylic acid. It was synthesised by the action of methyl iodide on the di-silver salt of 2-hydroxypyridine-3-carboxylic acid and hydrolysis of the resulting ester to *N*-methyl-2-pyridone-3-carboxylic acid. The latter was then converted to the amide which, on dehydration, yielded ricinidine. The steps in the formation of ricinidine from ricinine and by synthesis are shown in the foregoing set of formulæ.

The validity of this formula for ricinine was established by the same authors' synthesis¹⁰ of the alkaloid from 4-chloroquinoline (I). The

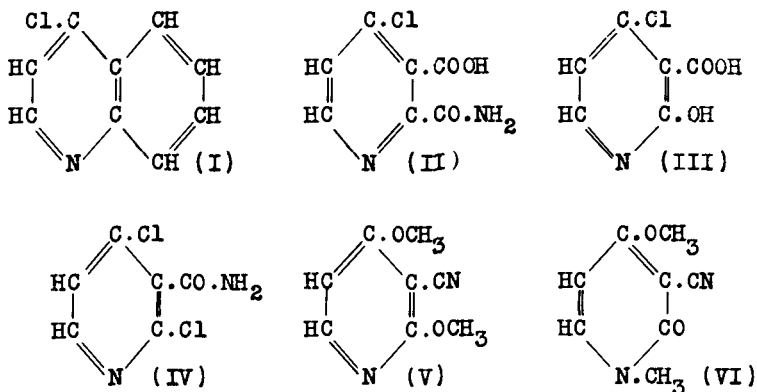

latter was oxidised by potassium permanganate to 4-chloropyridine-2:3-dicarboxylic acid, the anhydride of which on treatment with ammonia

furnished 4-chloro-2-carbamidopyridine-3-carboxylic acid (II). Potassium hypobromite converted this into the corresponding amine, which was transformed by nitrous acid in sulphuric acid into 4-chloro-2-hydroxypyridine-3-carboxylic acid (III). As the latter could not be methylated, it was converted by treatment with phosphoryl and phosphoric chlorides into the dichloro-acid chloride and this, by the action of ammonia into 2:4-dichloropyridine-3-carboxylamide (IV), which was then de-hydrated by phosphoryl chloride to 2:4-dichloro-3-cyanopyridine. The two chlorine atoms were replaced by methoxyl groups, when this product was boiled with sodium methoxide in methyl alcohol, and the resulting 3-cyano-2:4-dimethoxypyridine (V) was finally converted into ricinine, *N*-methyl-3-cyano-4-methoxy-2-pyridone (VI) by heating it with methyl iodide at 120–130° in an evacuated tube.

In a second synthesis¹¹ the same authors start with ethyl 2:4-dihydroxy-6-methylpyridine-3-carboxylate, and by a shorter series of reactions reach 3-cyano-2:4-dimethoxypyridine (V), which is then converted into ricinine (VI) as before.

A third synthesis which has resulted in the preparation of ricinine and a number of its derivatives is due to Schroeter, Seidler, Sulzbacher and Kanitz,¹² who found that cyanoacetyl chloride polymerises spontaneously to 6-chloro-2:4-dihydroxy-3-cyano-pyridine. The di-sodium derivative of this with methyl sulphate produces *N*-methyl-6-chloro-4-hydroxy-3-cyano-2-pyridone (6-chlororicininic acid), the mono-sodium derivative of which, with methyl bromide or sulphate, is converted into 6-chlororicinine and the latter is reduced by zinc and sulphuric acid to ricinine. A fourth synthesis, starting from 3-nitro-4-pyridone, is due to Reitmann.¹³

Ricinine is not markedly toxic; the poisonous character of castor-oil seeds is due to a more complex substance, ricin, the activity of which can be destroyed by heat.

REFERENCES

- (1) *J. Chem. Soc.*, 1864, 17, 195. (2) *Chem. Soc. Abstr.*, 1896, i, 386. (3) *Ibid.* 1898, i, 42; 1905, ii, 112. (4) *J. Amer. Chem. Soc.*, 1900, 22, 39. (5) *Compt. rend.*, 1904, 138, 506; 139, 840. (6) *Ber.*, 1918, 51, 673. (7) *Arch. Pharm.*, 1917, 255, 513. (8) *Monats.*, 1921, 42, 251. (9) *Ber.*, 1923, 56, 880. (10) *Ibid.*, p. 2454, (11) *Ibid.*, 1925, 58, 2124. (12) *Ibid.*, 1932, 65, 432; 1938, 71, 671. (13) *Brit. Chem. Abstr.*, 1935, A, 97.

ALKALOID OF FÆNUGREC

Trigonelline, C₇H₇O₂N. This base occurs in plants belonging to a number of botanical families. It was isolated by Jahns¹ from fœnugrec seeds (*Trigonella Fœnumgræcum*) and has also been found in garden peas,² hemp seed,² oats,² potatoes, *Stachys* spp., dahlia,³ *Strophanthus* spp.,⁴ coffee,⁵ and *Dichapetalum cymosum*.⁶ Holtz, Kutscher and Theilmann⁷ have recorded its presence in a number of animals. The fact that nicotinic acid (vitamin PP¹) is excreted as trigonelline⁸ has stimulated interest in the latter; its development has been studied by de Almida,⁹ reactions for its detection have been suggested by Raffaele¹⁰

and methods for its estimation in foodstuffs and in urine by Kodicek and Wang and other authors.¹¹

Trigonelline crystallises as a monohydrate from alcohol in hygroscopic prisms, m.p. 130° or 218° (*dry, dec.*). It is readily soluble in water or warm alcohol, less so in cold alcohol and slightly so in chloroform or ether. The salts crystallise well, the hydrochloride, B . HCl, in leaflets, m.p. 260° (*dec.*), sparingly soluble in dry alcohol. The picrate forms shining prisms, m.p. 198–200°, soluble in water, but sparingly soluble in dry alcohol or ether. The platinichloride is soluble in water, but scarcely so in dry alcohol. The alkaloid forms several aurichlorides: the normal salt, B . HCl . AuCl₃, is precipitated when excess of gold chloride is added to the hydrochloride, and after crystallisation from dilute hydrochloric acid containing some gold chloride has m.p. 198°. Crystallised from water or very dilute hydrochloric acid, slender needles, B₄ . 3HAuCl₄, m.p. 186°, are obtained.¹

When trigonelline is heated in closed tubes with baryta water at 120°, it gives rise to methylamine, whilst similar treatment with hydrochloric acid at 260° furnishes methyl chloride and nicotinic acid (pyridine-3-carboxylic acid), indicating that it is the methylbetaine of nicotinic acid.

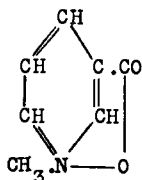

Trigonelline

Hantzsch¹² prepared this betaine by treating nicotinic acid methiodide with silver hydroxide and Jahns¹³ subsequently identified trigonelline with Hantzsch's synthetic base.

Trigonelline appears to exert no marked physiological action.¹⁴ Ackermann¹⁵ first observed that nicotinic acid administered to dogs appears in the urine as trigonelline.

REFERENCES

- (1) *Ber.*, 1885, 18, 2518. (2) SCHULZE and FRANKFURT, *ibid.*, 1894, 27, 709.
- (3) SCHULZE and TRIER, *Zeit. physiol. Chem.*, 1912, 76, 258. (4) THOMS, *Ber.*, 1891, 31, 271, 404. (5) GORTER, *Annalen*, 1910, 372, 237; cf. POLSTORFF, *Chem. Soc. Abstr.*, 1910, ii, 234; PALLADINO, *ibid.*, 1894, ii, 214; 1895, i, 629; GRAF, *ibid.*, 1904, i, 915; NOTTBOHM and MAYER, *Zeit. Unters. Lebensmitt.*, 1931, 61, 429. (6) RIMINGTON, *Onderstepoort J.*, 1935, 5, 81. (7) *Zeit. Biol.*, 1924, 81, 57. (8) SARETT, PERLZWEIG and LEVY, *J. Biol. Chem.*, 1940, 135, 483; KUHNAU, *Vitamine u Hormone*, 1942, 3, 74 (see also HUFF, *J. Biol. Chem.*, 1946, 166, 581; 1947, 171, 639). (9) *Agron. Lusit.*, 1940, 2, 307 (*Chem. Abstr.*, 1943, 37, 410). (10) *Ann. Chim. farm. (ital.)*, 1939, 7, 46 (*Chem. Abstr.*, 1941, 35, 5643). (11) *Nature*, 1941, 148, 23; cf. FOX, McNEIL and FIELD, *J. Biol. Chem.*, 1943, 147, 445; SLOTTA and NEISSER, *Ber.*, 1938, 71, 1987; CIUSA and DESSI, *Ann. chim. appl.*, 1947, 37, 88. (12) *Ber.*, 1886, 19, 31, see also ref. (8). (13) *Ibid.*, 1887, 20, 2840; cf. WEIJLARD *et al.*, *J. Amer. Chem. Soc.*, 1944, 66, 1319. (14) For recent observation see VOLMER and FURST, *Bull. Acad. Méd.*, 1939, 122, 241 (*Chem. Abstr.*, 1940, 34, 4805). (15) *Zeit. Biol.*, 1912, 59, 17; cf. KOHLRAUSCH, *ibid.*, 1911, 57, 273 and ref. (8).

ALKALOIDS OF ARECA NUT

The areca or betel nut palm (*Areca catechu*) is indigenous to the Sunda Islands, but is widely cultivated in Far Eastern tropical countries, where

the seeds are employed as a masticatory. In India and China ground areca nut is used as a vermifuge, and it is also so employed in Europe in veterinary medicine. After preliminary work by Bombelon,¹ Jahns² isolated, in addition to choline, the alkaloids arecoline, arecaidine, arecaine and guvacine, of which the second and third are identical. Emde³ added arecolidine and K. Hess⁴ guvacoline. A sixth alkaloid, whose existence was first indicated by Jahns, was named *isoguvacine* by Trier,⁵ and was examined by Winterstein and Weinhausen.⁶ Methods for the isolation of the alkaloids are given by Jahns² and by Chemnitius⁷ and for their recovery from technical areca residues by von Euler *et al.*⁷

Arecoline is usually stated to be present to the extent of 0.1 per cent., but Chemnitius⁷ gives the yield of hydrobromide as 0.35 to 0.4 per cent. Arecaidine and guvacine occur in smaller quantities, whilst guvacoline and arecolidine are found only in minute amounts. Alkaloidal assay processes for areca nuts have been published by Bourcet,⁸ and the National Formulary Committee,⁸ and Bond⁸ has described a method of estimation for arecoline hydrobromide. A microchemical test for the identification of arecoline has been devised by Gornyi.⁹

Guvacine, $C_6H_9O_2N$. This, the simplest of the areca nut alkaloids, forms small lustrous prisms, m.p. 271–2° (J.²), 293–5° (W. and W.⁶), $[\alpha]_D \pm 0^\circ$, is neutral to litmus, and moderately soluble in water or dilute alcohol, but almost insoluble in other solvents. The hydrochloride, B . HCl, crystallises in prisms, m.p. 316° (Freudenberg¹⁰), sparingly soluble in dilute hydrochloric acid; the platinichloride, $B_2 . H_2PtCl_6 . 4H_2O$, separates from water in hexagonal prisms, m.p. 211° (J.), 233° (W. and W.), 220–1° (F.), and the aurichloride, B . HAuCl₄, in broad, flattened prisms, m.p. 197–9° (F.). The base and its salts decompose on melting.

Guvacine behaves as a secondary amine furnishing an acetyl derivative, m.p. 189–90°, and a nitroso-derivative, m.p. 167–8°, the methyl ester of which on treatment with liquid ammonia forms *N*-nitroso-4-amino-piperidine-3-carboxylamide, m.p. 172° (von Euler *et al.*⁷). On distillation with zinc dust guvacine yields β -picoline (β -methylpyridine). On treatment with sodium methoxide and potassium methyl sulphate, Jahns obtained arecaine (arecaidine, p. 10) and an isomeride of the latter, and since he was unable to prove the presence of a carboxyl group, assigned to guvacine and arecaine formulæ different in type from those attributed to arecaidine and arecoline. Though Trier⁵ first suggested that guvacine might be Δ^1 -tetrahydropyridine-3-carboxylic acid, it was Freudenberg¹⁰ who first called attention to the similarity of guvacine and Δ^3 -tetrahydropyridine-3-carboxylic acid (synthesised by Wohl and Losanitsch),¹¹ and subsequently demonstrated their identity. The same author showed that guvacine, contrary to Jahn's experience, does yield a methyl ester, which was subsequently accepted by K. Hess¹² as identical with guvacoline (p. 10). The latter on treatment with methyl iodide gives a mixture of arecoline methiodide and hydriodide. Arecoline on hydrolysis furnishes arecaidine, so that this series of reactions demonstrates the relationship of the four chief alkaloids of areca nut.

Guvacine, $C_6H_9O_2N$ = Δ^3 -tetrahydropyridine-3-carboxylic acid

Guvacoline, $C_7H_{11}O_2N$ = guvacine methyl ester

Arecaidine, $C_7H_{11}O_2N$ = *N*-methylguvacine

Arecoline, $C_8H_{13}O_2N$ = *N*-methylguvacine methyl ester

Guvacoline, $C_7H_{11}O_2N$. K. Hess¹³ assigned this name to an alkaloid, obtained by E. Merck from areca nut, which yields a hydrobromide, short prisms, m.p. 144–5°, that he identified with guvacine methyl ester hydrobromide (*see above*). The base¹⁰ is a colourless oil, b.p. 114°/13 mm., which yields a hydrochloride, m.p. 121–2°, a platinichloride, m.p. 211°, and on methylation furnishes a mixture of arecoline methiodide and hydriodide (p. 12).

*iso*Guvacine. Along with guvacine, Jahns obtained a small fraction of another crystalline alkaloid which Trier⁵ named *isoguvacine* and regarded as Δ^2 -tetrahydropyridine-3-carboxylic acid. According to Winterstein and Weinagen,⁶ the base has m.p. 220°, $[\alpha]_D \pm 0^\circ$, is faintly acid to litmus and yields crystalline salts: hydrochloride, m.p. 231°; platinichloride, m.p. 235°; and aurichloride, m.p. 198–200°. It gives a dimethyl derivative, the platinichloride of which melts at 252°. These melting-points indicate that the substance may be mainly arecaidine, but as it yields, on distillation with zinc dust, a substance giving a pyrrole reaction, the authors suggested that it is a simple pyrrole derivative isomeric with guvacine.

Arecaidine (Arecaine), $C_7H_{11}O_2N \cdot H_2O$. This alkaloid forms colourless four- or six-sided tablets, m.p. 222–3° (J.),² 232° (H. and L.),¹² is soluble in water, but not in most organic solvents. The hydrochloride, B . HCl, forms slender, colourless needles, m.p. 261° (*dec.*), the hydrobromide has m.p. 242–3°; the platinichloride $B_2 \cdot H_2PtCl_6$ crystallises in octahedra, m.p. 225–6° (*dec.*), and the aurichloride, B . HAuCl₄, in prisms, m.p. 197–8° (*dec.*), from hot, dilute hydrochloric acid.

The fact that arecaidine furnishes a methyl ester (arecoline), and must therefore contain a carboxyl group, led Jahns to attempt its synthesis by methylating the potassium salt of nicotinic acid (pyridine-3-carboxylic acid) and reducing, and incidentally hydrolysing, the methyl ester methochloride so formed. The product was a mixture of arecaidine and dihydroarecaidine, so that the former must be a 1-methyltetrahydropyridine-3-carboxylic acid. Since natural arecaidine is optically inactive and the synthetic product could not be resolved, Mayer¹⁴ suggested that it must be 1-methyl- Δ^3 -tetrahydropyridine-3-carboxylic acid, and this was confirmed by Wohl and Johnson's¹⁵ synthesis of the alkaloid from acrolein (I).—The latter was converted into β -chloropropaldehyde acetal (II), and this condensed with methylamine to β -methylimino-dipropaldehyde tetraethylacetal (III), which on treatment with hydrochloric acid gave 1-methyl- Δ^3 -tetrahydropyridine-3-aldehyde (IV), from the oxime of which was obtained by the action of thionyl chloride, 3-cyano-1-methyl- Δ^3 -tetrahydropyridine (V). This, on hydrolysis, gave the corresponding carboxylic acid, which is arecaidine, and this, on esterification with methyl alcohol, yielded arecoline (*see p. 12*). Hess and

Liebbrandt¹² have prepared arecaidine by bromination of methyl *N*-methylpiperidine-3-carboxylate, scission of hydrogen bromide from the resulting bromo-compound (VI) and hydrolysis of the resulting arecoline, but Preobrachenski and Fischer¹⁶ were unable to confirm this observation.

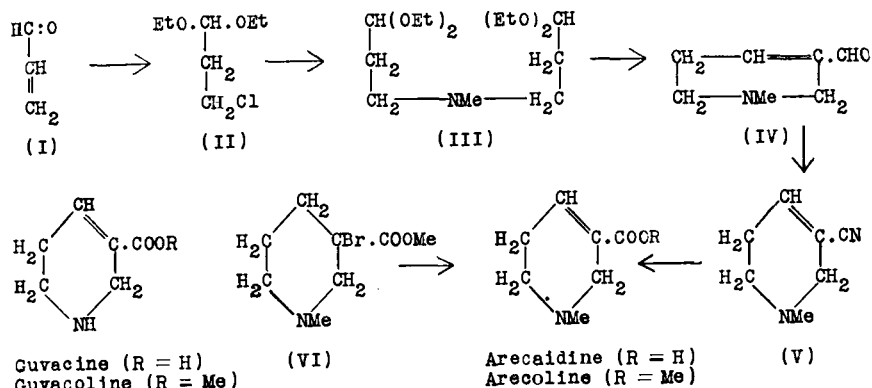

Mannich¹⁵ has prepared arecaidine aldehyde (IV) by allowing a mixture of formaldehyde, acetaldehyde and methylamine hydrochloride to stand at 70° and pH 3. Some dialdehyde, $\text{MeN}(\text{CH}_2 \cdot \text{CH}_2 \cdot \text{CHO})_2$, is formed and this by loss of water produces arecaidine aldehyde. The latter is, converted into arecoline by the Wohl and Johnson process described above.

Merck and Maeder¹⁷ have patented the manufacture of arecaidine by loss of water from 1-methyl-4-hydroxypiperidine-3-carboxylic acid. A method of producing the latter has been described by Mannich and Veit¹⁸ and has been developed by Ugriumov¹⁹ for the production of arecaidine and arecoline. With the same objective, Dankova, Sidorova and Preobrachenski²⁰ use what is substantially McElvain's process,¹⁷ but start by converting ethylene oxide, *via* the chlorohydrin and the cyanohydrin, into β -chloropropionic acid. The ethyl ester of this with methylamine in benzene at 140° furnishes methylbis(2-carbethoxyethyl) amine (I) which on refluxing with sodium or sodium *iso*amyloxide in xylene yields 1-methyl-3-carbethoxy-4-piperidone (II). The latter is reduced by sodium amalgam in dilute hydrochloric acid at 0° to 1-methyl-3-carbethoxy-4-hydroxypiperidine (III) which on dehydration, and hydrolysis, yields arecaidine (IV: R = H), convertible by methylation into arecoline (IV: R = CH₃).

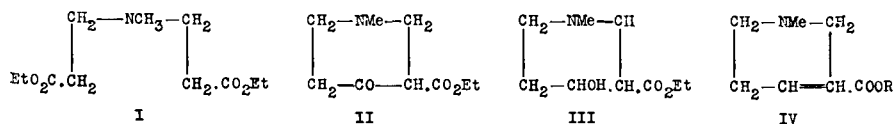

Starting with *N*-benzoyl-di-(β -carbethoxyethyl)amine



(compare I), McElvain and Stork, by a similar series of reactions have synthesised guvacine¹⁷ (1946).

Arecoline, $C_8H_{13}O_2N$. This, the most important alkaloid of areca nut, is an odourless, alkaline oil, b.p. 209° , volatile in steam, miscible with most organic solvents and water, but extractable from the latter by ether in presence of dissolved salts. The salts are crystalline, but usually deliquescent; the hydrobromide, B. HBr, forms slender prisms, m.p. $177-9^\circ$, from hot alcohol: the aurichloride, B. HAuCl₄, is an oil, but the platinichloride, B₂. H₂PtCl₆, m.p. 176° , crystallises from water in orange-red rhombs. The methiodide forms glancing prisms, m.p. $173-4^\circ$.

On heating arecoline with ammonia in alcohol, addition occurs at the ethylenic linkage followed by amination at the ester group; the products formed are: *N*-methyl-4-aminopiperidine-3-carboxamide, m.p. 180° ; *N*-methyl-4-aminopiperidine-3-carboxylic acid, m.p. 241° (*dec.*) and *N*-methyltetrahydropyridinamide, m.p. 148° (arcecaidineamide).²¹

Arecoline is hydrolysed by acids or alkalis to the corresponding acid, arecaidine, and conversely the latter, on esterification with methyl alcohol, yields arecoline, and with ethyl alcohol *homoarecoline*. Syntheses of arecaidine, and therefore of arecoline, are described above.

Arecolidine, $C_8H_{13}O_2N$. This alkaloid, obtained by Emde,³ is a weak base, which crystallises from dry ether in glassy needles, m.p. 105° , but after sublimation has m.p. 110° and is hygroscopic. The hydrochloride, B. HCl. H₂O, m.p. $95-8^\circ$, hydrobromide, m.p. $268-71^\circ$ (*dec.*), aurichloride yellow leaflets, m.p. $219-20^\circ$ (*dec.*), and platinichloride, thick, dark orange needles, m.p. $222-3^\circ$ (*dec.*), were prepared. The base gives a methiodide, prisms, m.p. 264° (*dec.*), and methylarecolidine, $C_9H_{15}O_2N$, derived from this, yields a normal aurichloride, m.p. 252° (*dec.*). Emde suggests that arecolidine is 3:4-dimethoxy-1-methyl-1:2-dihydropyridine.

Pharmacological Action of the Areca Nut Alkaloids. Of these alkaloids arecoline alone exhibits markedly toxic properties. It belongs to the muscarine-pilocarpine group,²² which show parasympathetic stimulant action. Its central stimulant action is more powerful than that of pilocarpine, and with large doses central paralysis may ensue. The pharmacological action of the quaternary bases derived from arecaidine and arecoline has been investigated by Kadonaga.²³ Arecoline hydrobromide has been recognised in a number of Continental Pharmacopœias, being used in small doses as a sialogogue, diaphoretic and anthelmintic. It has also been used as a miotic, but its main use is in veterinary medicine as an anthelmintic²⁴ and bowel stimulant. According to von Euler *et al.*⁷ guvacine is as potent a growth factor for certain bacteria as nicotinic acid.

The cultivation and marketing of areca nuts has been described by Kannagara²⁵ and its use as a masticatory in the Far East is discussed by Mercier.²⁶

REFERENCES

- (1) *Pharm. Zeit.*, 1886, 146. (2) *Ber.*, 1888, 21, 3404; 1890, 23, 2972; 1891, 24, 2615; *Arch. Pharm.*, 1891, 229, 669. (3) *Apoth. Zeit.*, 1915, 30, 240 (*Chem. Soc. Abstr.*, 1915, i, 981). (4) *Ber.*, 1918, 51, 1004. (5) *Zeit. Physiol. Chem.*, 1913, 85, 372. (6) *Ibid.*, 1918, 104, 48. (7) *J. pr. Chem.*, 1927, [ii], 117, 147; VON EULER *et al.*, *Helv. Chim. Acta*, 1944, 27, 382. (8) BOURCET, *Bull. Sci. Pharmacol.*, 1933, 40, 98; *Bull. Nat. Formulary Cttee.* (U.S.A.), 1939, 8, 6; cf. WILLIAMS and HINER,

J. Amer. Pharm. Assoc., 1945, 34, 45; BOND, *J. Assoc. Off. Agr. Chem.*, 1941, 24, 817; 1942, 25, 817. (9) FARMATSIYA, 1939, No. 5, p. 13 (*Chem. Abstr.*, 1940, 34, 7064). (10) *Ber.*, 1918, 51, 976, 1669. (11) *Ibid.*, 1907, 40, 4701. (12) *Ibid.*, 1918, 51, 806; 1919, 52, 206. (13) *Ibid.*, 1918, 51, 1004. (14) *Monats.*, 1902, 23, 22. (15) *Ber.*, 1907, 40, 4712; MANNICH, *ibid.*, 1942, 75, 1480. (16) *J. Gen. Chem. U.S.S.R.*, 1941, 11, 140 (*Chem. Abstr.* 1941, 35, 5505). (17) D.R.P., 485, 139; cf. McELVAIN, *J. Amer. Chem. Soc.*, 1924, 46, 1721; (with STORK), *ibid.*, 1946, 68, 1049. (18) *Ber.*, 1935, 68, 506. (19) *Compt. rend. Acad. Sci. U.S.S.R.*, 1940, 29, 48; *J. Gen. Chem. U.S.S.R.*, 1941, 11, 829; 1944, 14, 997. (20) *Ibid.*, 1941, 11, 934. (21) KARRER and RUCKSTUHL, *Helv. Chim. Acta*, 1944, 27, 1698. (22) DIXON, *Heffer's Handb.*, 1924, 2, 813; ZUNZ, *Elém. Pharmacodyn. spec.*, 1932, 329; EULER and DOMELJ, *Acta Pharm. Toxicol.*, 1945, 1, 263. (23) *Folia pharmacol. Jap.*, 1938, 26, 44; 1940, 28, 72. (24) SCHLEGEL, *Arch. exp. Path. Pharm.*, 1939, 192, 389; FINGER, *Rev. Med. Vet. Buenos Aires*, 1944, 26, 6 BATHAM, *Parasitology*, 1946, 37, 185. (25) *Trop. Agr.*, 1941, 96, 187. (26) *Bull. mens Suc. linnienne Lyon*, 1944, 13, 28, 46, 58.

ALKALOIDS OF HEMLOCK

The common hemlock, *Conium maculatum*, contains five alkaloids. Power and Tutin found a similar mixture in fool's parsley,¹ and a volatile alkaloid resembling coniine is stated to occur in certain aroids.² According to Svagr,³ "water hemlock" (*Cicuta virosa*) owes its poisonous properties to toxins and not to "cicutine," a name sometimes used as a synonym for coniine. The toxic properties of hemlock juice have been known from very early times; thus it was the chief ingredient in the poison administered to criminals by the Greeks. The leaves and the unripe fruits are the parts used in medicine. The following are the names and formulæ of the alkaloids:—

d- and *l*-Coniine, $C_8H_{17}N$

Conhydrine, $C_8H_{17}ON$

d- and *l*-*N*-Methylconiine, $C_8H_{16}N \cdot CH_3$

ψ -Conhydrine, $C_8H_{17}ON$

γ -Conicëine, $C_8H_{15}N$

Madaus and Schindler⁴ have investigated the changes in alkaloidal content occurring in hemlock during the vegetative period.

Farr and Wright, who devised processes for the estimation of the total alkaloids as hydrochlorides, give the following percentages for the various parts of the plant: stem, 0.01–0.06; leaves, 0.03–0.18; flowers, 0.09–0.24; green fruit, 0.73–0.98. The same authors quote 0.096–0.83 as the range of variation found in commercial samples of the fruit in 1904 and 1.05–3.6 as the range in fruits collected in England.⁵ The British Pharmaceutical Codex, 1934, quotes 0.2 per cent. for the leaves and 2.5 per cent. for the fruits. In British Columbia, where the plant has a larger habit than in England, Clark and Offord⁶ found 0.025 per cent. in the stems and 0.92 per cent. in the fruits. An assay process for the fruits was given in the Eighth Revision of the United States Pharmacopœia and 0.5 per cent. of total alkaloids was specified as a minimum.

Dilling⁷ has provided a scheme for distinguishing between the hemlock bases and other alkaloids, such as sparteine, nicotine and lobeline.

Of the total alkaloids of hemlock isolated by the method of Chemnitius⁸ and fractionally distilled, the portion boiling up to 190° contains most of the coniine, γ -conicëine and *N*-methylconiine, the conhydrine and

ψ -conhydrine remaining in the higher boiling residues. For the separation of coniine from conicéine, Wolffenstein⁹ recommends conversion into hydrochlorides. These are dried and extracted with acetone, which dissolves conicéine hydrochloride, leaving the coniine salt, from which the base may then be regenerated. For final purification the coniine is converted into the *d*-hydrogen tartrate. It is sometimes necessary to start crystallisation by adding a crystal of the desired salt. von Braun¹⁰ distils the crude mixed alkaloids until the temperature rises to 190°, benzoylates the distillate, extracts the tertiary bases by shaking an ethereal solution with dilute acid, pours the concentrated ethereal solution into light petroleum to precipitate most of the benzoyl- δ -aminobutyl propyl ketone formed by the action of benzoyl chloride on conicéine, distils the solvent from the filtrate and collects from the residue the fraction boiling at 200–10°/16 mm., which is nearly pure benzoylconiine (b.p. 203–4°/16 mm.). From this a mixture of *d*- and *l*-coniines is obtained by hydrolysis, the former predominating.

Coniine, C₈H₁₇N. The alkaloid was first isolated by Giesecke,¹¹ but the formula was suggested by Blyth¹² and definitely established by Hofmann.¹³

d-Coniine is a colourless alkaline liquid, with a penetrating odour and a burning taste; it boils at 166–7°, has D⁰ 0.8626 and D¹⁹ 0.8438, refractive index n_D^{23} 1.4505, and is dextrorotatory, $[\alpha]_D^{19} + 15.7^\circ$. It solidifies to a soft crystalline mass at –2°.

Coniine is slightly soluble (1 in 90) in cold water, but less so in hot water, so that a clear cold solution becomes turbid when warmed. On the other hand, the base dissolves about 25 per cent. of water at atmospheric temperature. It mixes with alcohol in all proportions, is readily soluble in ether and most organic solvents. Coniine slowly oxidises in the air. The salts crystallise well and are soluble in water or alcohol. The hydrochloride, B. HCl, crystallises from water in rhombs, m.p. 220°, $[\alpha]_D^{20} + 10.1^\circ$ (liquid ammonia); the hydrobromide, in needles, m.p. 211°, and the *d*-acid tartrate, B. C₄H₆O₆ · 2H₂O, in rhombic crystals, m.p. 54°. The platinichloride, (B. HCl)₂ · PtCl₄ · H₂O, separates from concentrated solution as an oil, which solidifies to a mass of orange-yellow crystals, m.p. 175° (*dry*). The aurichloride, B. HAuCl₄, crystallises on standing, m.p. 77°. The picrate forms small yellow needles, m.p. 75°, from hot water. The 2 : 4-dinitrobenzoyl- and 3 : 5-dinitrobenzoyl-derivatives have m.ps. 139–139.5° and 108–9° respectively (Späth, Kuffner and Ensfellner).¹⁴ Coniine dissolves in carbon disulphide, forming a complex thiocarbamate.¹⁵ It gives no coloration with sulphuric or nitric acid. The precipitate afforded by potassium cadmium iodide solution is crystalline, m.p. 118°, whilst that given by nicotine with this reagent is amorphous. Sodium nitroprusside gives a deep red colour, which disappears on warming, but reappears on cooling, and is changed to blue or violet by aldehydes.¹⁶

l-Coniine has $[\alpha]_D^{21} 15^\circ$ and in other respects resembles its *d*-isomeride, but the salts have slightly different melting points; the platinichloride has m.p. 160° (175° L. and F.), the aurichloride m.p. 59°.¹⁷

Constitution. When coniine is distilled with zinc dust¹⁸ or heated with silver acetate,¹⁹ a new base, conyryne, $C_8H_{11}N$, differing from coniine by six atoms of hydrogen, is formed. This on oxidation yields pyridine-2-carboxylic acid and, since it is not identical with 2-isopropylpyridine,²⁰ must be 2-propylpyridine (I). When coniine is heated with hydriodic acid at 300° it yields *n*-octane (II). These and other observations due mainly to A. W. Hofmann,²¹ made it clear by 1885 that coniine was probably α -propylpiperidine (III), and this has been amply confirmed by other reactions of the alkaloid and by syntheses. Thus, Wolffenstein showed that on oxidation with hydrogen peroxide, coniine is converted into amino-*n*-propylvaleraldehyde (IV)²²

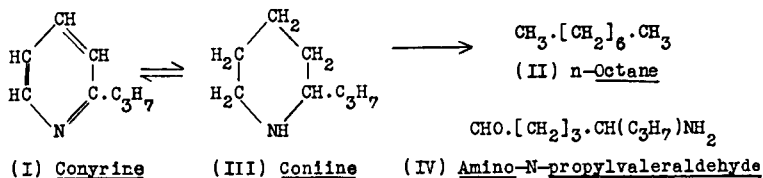

Similarly, von Braun and Schmitz²³ found that *N*-benzoylconiine, on distillation with phosphorus pentachloride, underwent ring scission with elimination of the nitrogen atom and formation of the dichlorooctane, $\text{CH}_2\text{Cl} \cdot (\text{CH}_2)_3 \cdot \text{CHCl} \cdot \text{CH}_2 \cdot \text{CH}_2 \cdot \text{CH}_3$.

In 1884¹⁸ Hofmann showed that conyryne (I), when heated with hydriodic acid at 200–300°, could be reduced to coniine (III), but the first complete synthesis, which was also the first synthesis of an alkaloid, was achieved by Ladenburg in 1886.²⁴ He condensed 2-methylpyridine with paraldehyde to 2-propenylpyridine (V) and reduced the latter by sodium in alcohol to 2-propylpiperidine (VI). This, on deracemisation by crystallisation of the hydrogen *d*-tartrate, yielded *d*-coniine. The initial reaction, which takes place at 250°, gives a poor yield and was improved by interaction of the two reagents at 150° in sealed tubes to give methyl-2-picolylalkine (VII), which was then heated at 185° with hydrochloric acid for ten hours, producing a mixture of 2-propenylpyridine (V) and 2-chloropropylpyridine (VIII). This mixture was reduced to *dl*-coniine by sodium in alcohol. In 1907 the process was still further improved by reducing methyl-2-picolylalkine (VII) with phosphorus and hydriodic acid at 125° and treating the product with zinc dust and water, the resulting 2-propylpyridine being then reduced with sodium in alcohol,²⁵

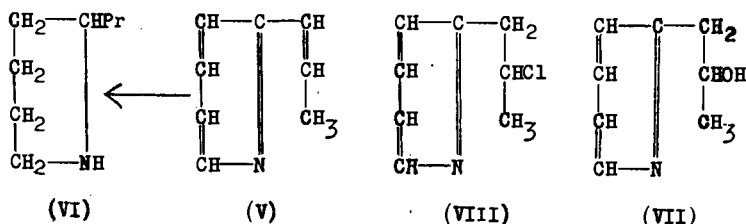

In 1893 Ladenburg found that when coniine is distilled with zinc dust there is produced along with conyryne a substance only distinguishable from *d*-coniine by its higher specific rotation. This substance, *isoconiine*, was a subject of discussion for many years.²⁵ It was also found in his synthetic coniine, the *d*-coniine isolated from the latter having $[\alpha]_D + 19^\circ$, which was reduced to that of *d*-coniine by heating the product at 290° for ten hours. The modified synthetic method adopted by Ladenburg in 1907 designed to avoid the possible presence of propenylpiperidine, as suggested by Löffler, in the finished product also yielded a *d*-coniine of high rotation, $+ 17.85^\circ$. This method, in the hands of Hess and Weltzien,²⁵ gave similar results, but these authors found that if Ladenburg's second process is modified by catalytic hydrogenation of methyl-2-picolyalkine (VII) to the corresponding piperidine derivative, which is then reduced by hydriodic acid and phosphorus, followed by zinc and sulphuric acid, the 2-propylpiperidine (VI) formed is *dl*-coniine and yields *d*-coniine, $[\alpha]_D^{17} + 14.96^\circ$ on deracemisation, and they suggest that "*isoconiine*" is *d*-coniine containing an impurity of higher optical rotation.

A number of other syntheses of coniine have been effected,²⁶ of which that of Diels and Alder is of special interest. The initial adduct of pyridine and methyl acetylenedicarboxylate, *viz.*, tetramethylquinolizine-1 : 2 : 3 : 4-tetracarboxylate (IX) on oxidation with dilute nitric acid is converted into methyl indolizinetricarboxylate (X). This, on hydrolysis and decarboxylation, furnishes indolizine, the octahydro-derivative (XI) of which, also known as octahydropyrrocoline,²⁷ is converted by the cyanogen bromide method (as applied by Winterfeld and Holschneider to lupinine, p. 123) successively into the bromocyanamide (XII), cyanoamide (XIII) and *dl*-coniine (XIV). A synthesis of the alkaloid, starting from indolizine (pyrrocoline) is described by Ochiai and Tsuda.²⁸

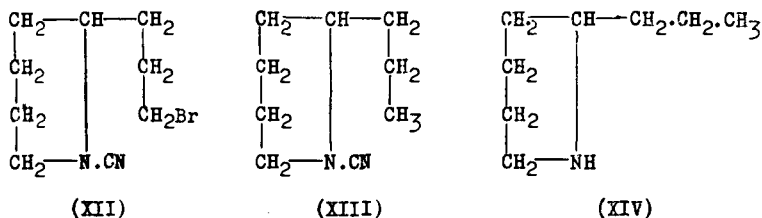
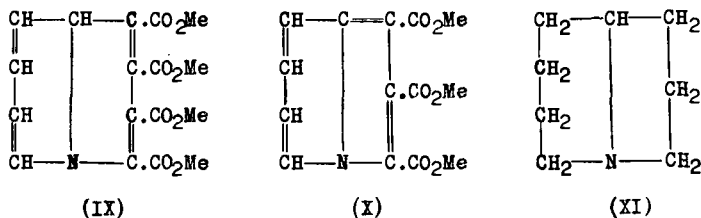

The preparation of *l*-coniine by the reduction of β -coniceine (*l*-propenylpiperidine, p. 20) by Löffler and Friedrich²⁹ is interesting as a

means of passing from conhydrine (*see below*) to *l*-coniine. Hess and Eichel³⁰ have shown that pelletierine (p. 55), is the aldehyde (β -2-piperidyl-propaldehyde), corresponding to coniine, and yields *dl*-coniine when its hydrazone is heated with sodium ethoxide in alcohol at 156–70°. According to these authors, *d*-coniine is rendered almost optically inactive when heated with barium hydroxide and alcohol at 180–230°. Leithe³¹ has shown by observation of the optical rotation of (+)-pipercolinic acid (piperidine-2-carboxylic acid) and certain of its derivatives under varying conditions,³² that it must belong to the *d*-series of amino-acids, and since (+)-conhydrine can be oxidised to (–)-pipercolinic acid,³³ and transformed through β -conicéine into (–)-coniine,³⁴ it follows that (+)-coniine, (+)-2-methylpiperidine (α -pipercoline) and (+)-piperidine-2-carboxylic acid must all have similar spatial configurations.

***N*-Methyl-*d*-Coniine**, $C_8H_{16}N \cdot CH_3$. This alkaloid is stated to occur in hemlock in small quantities,³⁵ and methods for its isolation are described by Wolfenstein⁹ and by von Braun.¹⁰ It was prepared by the action of potassium methyl sulphate on coniine by Passon.³⁶ It is a colourless, oily, coniine-like liquid, b.p. 173–4°, $D_{24}^{24.3^\circ}$ 0.8318 and $[\alpha]_D^{24.3^\circ} + 81.33^\circ$. The salts are crystalline; the hydrochloride, B. HCl, forms masses of needles, m.p. 188°; the platinichloride, $B_2 \cdot H_2PtCl_6$, has m.p. 158°.

***N*-Methyl-*l*-coniine** was obtained by Ahrens¹⁷ from residues left in the isolation of coniine as hydrobromide or by removing coniine as the nitroso-compound. It is a colourless, coniine-like liquid, b.p. 175.6°/767 mm., D_{20}^{20} 0.8349, $[\alpha]_D^{20}$ –81.92°. The hydrochloride, B. HCl, crystallises in leaflets, m.p. 191–2°; the hydrobromide, B. HBr, in leaflets, m.p. 189–90°; the platinichloride in orange crystals, m.p. 153–4°; the aurichloride in leaflets, m.p. 77–8°, and the picrate in long needles, m.p. 121–2°.

Hess and Eichel³⁷ have shown that *d*-coniine with formaldehyde and formic acid yields an active *N*-methyl-*d*-coniine, and that methyl*iso*-pelletierine hydrazone (*see* p. 57) yields *N*-methyl-*dl*-coniine when heated with sodium ethoxide at 150–70°.

Conhydrine, $C_8H_{17}ON$. This oxygenated alkaloid was isolated by Wertheim.³⁸ It crystallises in colourless leaflets, has a coniine-like odour, can be sublimed and is strongly basic, m.p. 121°, b.p. 226°, $[\alpha]_D + 10^\circ$. It is soluble in alcohol or chloroform, moderately so in water and in ether, from which it crystallises readily. The salts are crystalline; the aurichloride small rhombs or prisims, m.p. 133°; the benzoyl derivative m.p. 132°.

Constitution. On oxidation with chromic acid, conhydrine yields *l*-piperidyl-2-carboxylic acid.³³ It is converted into *l*-coniine either by reduction of the iodo-derivative (iodoconiine), $C_8H_{16}NI$, formed by the action of hydriodic acid and phosphorus at 180°³⁹ or by hydrogenation of the mixture of conicéines produced, when it is dehydrated by phosphorus pentoxide in toluene.⁴⁰ These and other observations indicate that the oxygen atom must occur as a hydroxyl group, in the *n*-propyl side-chain in either the α - (XV) or β - (XVI) position, since the γ -position would involve

the production of piperidyl-2-propionic acid on oxidation. 2- β -Hydroxypropylpiperidine (XVI) suggested by Willstätter³³ seemed to be excluded, since neither of the two forms of this product prepared by Löffler and Tschunke⁴¹ resembled conhydrine, and these authors suggested the alternative (XV) as probably representing the alkaloid. Support for this view was provided by Hess and collaborators,⁴² who showed that *dl*-*N*-methylconhydrinone is *N*-methyl-2-piperidyl ethyl ketone (XVII), that *dl*-conhydrine (m.p. 69–70°), produced by a somewhat indirect method, is identical with the product, m.p. 69.5–71.5°, prepared by Engler and Bauer⁴³ by the reduction with sodium in ethyl alcohol of 2-pyridyl ethyl ketone, and that conhydrine on dehydrogenation over platinised or palladised asbestos gives rise to a mixture of tetrahydropyridyl-2-ethyl ketone and 2- α -hydroxypropylpyridine. Späth and Adler⁴⁰ have shown that conhydrine can be degraded in two stages (XIX) by exhaustive methylation to trimethylamine and a mixture of two products, an oil, C₈H₁₄O, b.p. 157–9°/744 mm., and a crystalline substance, C₈H₁₆O₂, m.p. 75–6°. The oil, when heated with water at 170° is converted, by addition of a molecule of water, into the crystalline substance. The latter contains two active hydrogen atoms (Zerewitinoff estimation), and on exposure to hydrogen over palladised charcoal absorbs enough to saturate one ethylenic linkage producing a new substance, m.p. 94–6°. On oxidation with permanganate in dilute sulphuric acid, propionaldehyde and succinic acid are produced, whilst the saturated substance, m.p. 94–6°, is oxidised to *n*-valeric acid. These results indicate that the substance of m.p. 75–6° is $\epsilon\zeta$ -dihydroxy- Δ^{α} -*n*-octene (XXI), that the oil, C₈H₁₄O, is the corresponding oxide (XX), and that the representation of conhydrine as 2- α -hydroxypropylpiperidine (XV) accounts for their production.

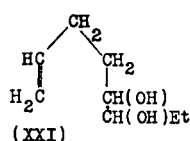
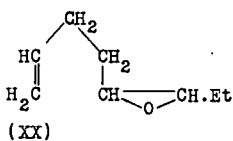
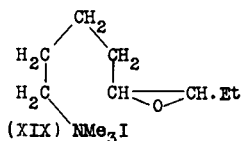
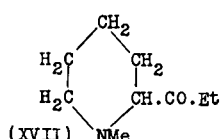
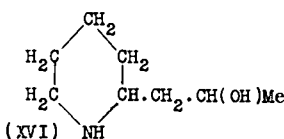
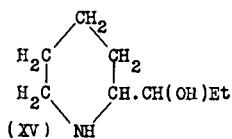

ψ -Conhydrine, C₈H₁₇ON, was isolated by Merck and examined by Ladenburg and Adam.⁴⁴ It closely resembles conhydrine, from which it can be separated by crystallising the mixed hydrochlorides, that of conhydrine being hygroscopic, whilst the ψ -conhydrine salt crystallises well from alcohol. The base was re-examined by Löffler.⁴⁵ It crystallises from dry ether in needles, m.p. 105–6°, b.p. 236–236.5°, $[\alpha]_D + 10.98^\circ$, or from wet ether in plates, m.p. 80° (*approx.*), and is a strongly alkaline base. The hydrochloride has m.p. 212–3° and the aurichloride, m.p. 133–4°; the platinichloride, m.p. 185–6°, forms golden-yellow needles.

Constitution. The close relationship of ψ -conhydrine to coniine was established by Löffler,⁴⁵ who showed that it must be a hydroxyconiine, since it is convertible into an iodoconiine, reducible to *d*-coniine. Conhydrine, on the contrary, yields *l*-coniine, but the two cannot be stereoisomerides, since they give structurally different conicëines on dehydration, that from ψ -conhydrine being ψ -conicëine, which on hydrogenation yields *d*-coniine.⁴⁶ Löffler concluded that ψ -conhydrine must have the hydroxyl group in position 4 in the ring of the 2-propylpiperidine. This formula cannot be reconciled with Willstätter's³⁵ statement that ψ -conhydrine on oxidation yields piperidine-2-carboxylic acid, and, as an attempt⁴⁶ has failed to confirm this observation, it was possibly due to the use of ψ -conhydrine containing conhydrine. Späth and collaborators⁴⁶ have investigated the exhaustive methylation of ψ -conhydrine and obtained at the end of the first stage ψ -conhydrinemethine, $C_{10}H_{21}ON$, b.p. 101.5–103.5°/14 mm., $[\alpha]_D^{15} + 18.7^\circ$, which was hydrogenated, in presence of palladised charcoal, to dihydro- ψ -conhydrinemethine, $C_{10}H_{23}ON$, b.p. 99–100.5°/11 mm., $[\alpha]_D^{15} + 12.2^\circ$. This, in the next stage, yields octylene- $\alpha\beta$ -oxide (b.p. 60–70°/17 mm.; $[\alpha]_D^{17} - 12.2^\circ$) and octane- $\alpha\beta$ -diol (m.p. 35–7°; $[\alpha]_D^{17} - 4.7^\circ$), the latter being also formed by the action of water on the oxide at 180°. Benzoyl- ψ -conhydrine, m.p. 132–3°, $[\alpha]_D^{17} + 23.4^\circ$, on oxidation with faintly alkaline permanganate gives the benzoyl derivative of two amino-acids (*a*) $C_7H_{15}O_2N$ and (*b*) $C_6H_{13}O_2N$. The former is γ -aminoheptonic acid and was isolated as the lactam, m.p. 45–7°; (*b*) proved to be β -amino-*n*-hexoic acid, m.p. 205–7°. These observations confirm Löffler's view that the hydroxyl group must be in the piperidyl nucleus, but not as he suggested in position 4 (XXII), and this applies equally to positions 2 and 3. Of the remaining positions 6 (XXIII) would imply that dihydro- ψ -conhydrinemethine is an addition product of *n*-octaldehyde and dimethylamine and, as such, would be unstable to acids. Späth *et al.*, therefore, selected 5 as the position of choice and represent ψ -conhydrine as 5-hydroxy-2-propylpiperidine (XXIV).

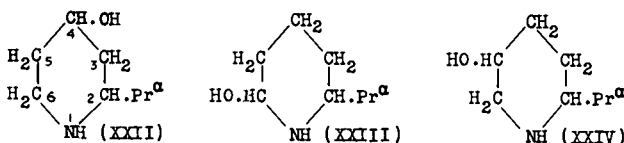

This has been confirmed by Späth and Lorenz,⁴⁶ who have shown that dihydro- ψ -conhydrinemethine must be α -dimethylamino-octan- β -ol, $Me_2N \cdot CH_2 \cdot CHOH \cdot CH_2 \cdot (CH_2)_4 \cdot CH_3$, since it is oxidised by chromic acid in acetic acid to α -dimethylamino-octan- β -one, which has been synthesised from *n*-heptoylchloride by the action of diazomethane in ether, and treatment of the resulting α -chloro-*n*-octan- β -one with dimethylamine.

γ -Conicëine, $C_8H_{15}N$. This base may be isolated by Wolfenstein's method (p. 14), or recovered from the benzoyl- δ -aminobutyl propyl ketone, into which it is converted in von Braun's process, by heating with

hydrochloric acid at 120°. It is a conine-like oil, b.p. 171-2°/746 mm., D^{18}_4 0.8740 (Bruhl), volatile in steam, almost insoluble in water, strongly alkaline and optically inactive. Its salts are crystalline; the hydrochloride, m.p. 143°, is hygroscopic; the hydrobromide, m.p. 139°, is readily soluble in acetone; the aurichloride, m.p. 69°, and the picrate, m.p. 62°, are precipitated as oils, but soon become crystalline. The platinichloride has m.p. 192°. The cadmium iodide salt, B. HI. CdI₂, m.p. 146-7°, crystallises from water in long needles.

γ -Coniceine is a secondary base, and on reduction yields *dl*-conine. It was prepared by Hofmann⁴⁷ by the action of alkalis on bromoconine, and, according to Löffler, is formed by the action of fuming hydrochloric acid on conhydrine.⁴¹ These reactions are explained by formula (I) below, suggested by Lellman⁴⁸ and Wolffenstein.⁹ γ -Coniceine has been synthesised by Gabriel by hydrolysing δ -phthaliminobutyl propyl ketone.⁴⁹

The Conicëines, C₈H₁₅N. Six of these products have been obtained in various ways from the two conhydrines.⁵⁰ Their chief characteristics are tabulated below. α -Coniceine is perhaps the least well-defined of the six; it is one component of the mixture resulting from the action of hydrochloric acid on conhydrine, and is described by Löffler⁵¹ (1904) as stereoisomeric with ϵ -coniceine (II).

β -Coniceine is the chief product of the action of phosphoric oxide on conhydrine and was shown by Löffler and collaborators⁵² to be 2-propenylpiperidine, C₈H₉NH . CH : CH . CH₃.

Name	Boiling point	Melting-point of aurichloride	Specific rotation, $[\alpha]_D$	Relative density	Amino-character
α Coniceine	158°	196°	+ 18.4°	0.8930 at 15°	Tertiary
β Coniceine	168°	122.5°	- 52.99°	0.8519 at 50°	Secondary
γ Coniceine	(m.p. 41°)				
δ Coniceine	171°-172°	69°	inactive	0.8825 at 22.5°	Secondary
ϵ Coniceine	158°	207°	lævorotatory	0.896 at 23°	Tertiary
ζ -Coniceine	161°	192°	inactive	0.904 at 15°	Tertiary
η -Coniceine	150°-151°	173°	+ 42.34°	0.8836 at 15°	Tertiary
composed of					
{ 2-methylconidine and	151°-154°	167°-168°	+ 67.4°	0.8856 at 15°	Tertiary
{ iso-2-methylconidine	143°-145°	198°-199°	- 37.34°	0.8624 at 15°	Tertiary
ψ Coniceine	171°-172°	(only)	+ 122.6°	0.8776 at 15°	Secondary

γ -Coniceine (2-propyl-1 : 4 : 5 : 6-tetrahydropyridine, I), is a hemlock alkaloid already dealt with above.

δ -Coniceine (2-piperolidine), is prepared by the action of sulphuric acid on bromoconine. It has a multiplicity of names. It was first characterised by Lellmann,⁵³ who assigned to it formula (III) and was synthesised by Löffler and Kaim⁵³ who distilled piperidylpropionic acid to obtain piperolid-2-one (IV) and reduced this to 2-piperolidine (III) which proved

to be identical with *dl*- δ -conicëine, made from *dl*-coniine. The same bicyclic nucleus was named "pyrindole" by Angeli.⁵⁴ Scholtz⁵⁵ synthesised the base (V) which he named pyrrocoline, though he subsequently adopted Angeli's name pyrindole. Later Tschitschibabin⁵⁶ prepared the substance (VI) and called it 2-methylindolizine. Indolizine has been accepted by Diels and Alder⁵⁷ and pyrrocoline by Clemo and Ramage.⁵⁸ δ -Conicëine may therefore be called octahydroindolizine, octahydro-pyrrocoline, or 2-piperolidine, with 1-*azabicyclo*-[4 : 3 : 0]-nonane as the latest variant.⁵⁹ δ -Conicëine is of interest owing to the occurrence of the same or closely related nuclei among the papilionaceous alkaloids.

\epsilon-Conicëine is made by the action of alkalis on bromo- or iodo-coniine and has been shown by Löffler⁶⁰ to contain two asymmetric carbon atoms (Formula II) and to consist of the two forms (+, -) and (-, -) named respectively 2-methylconidine and *iso*-2-methylconidine (*cf.* α -conicëine).

\psi-Conicëine obtained by the dehydration⁴⁶ of *\psi*-conhydrine (p. 18) must be either 2-propyl-1 : 2 : 3 : 6- (or 1 : 2 : 3 : 4-) tetrahydropyridine.⁶¹

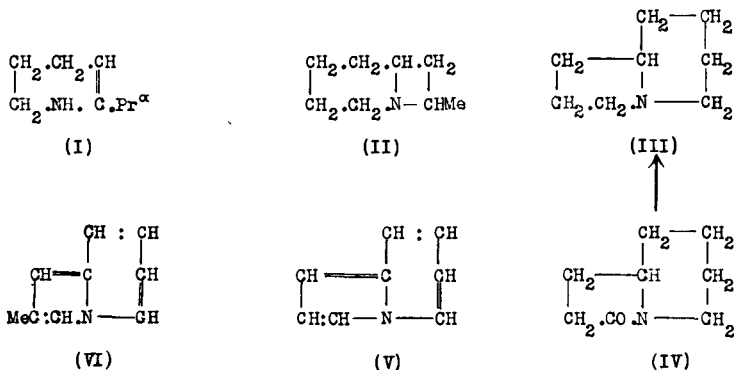

Pharmacological Action of Hemlock Alkaloids. Hemlock has ceased to be used in medicine owing to the uncertainty of action shown by its galenical preparations.⁶² All the hemlock alkaloids are poisonous. They produce paralysis of the motor nerve terminations and stimulation followed by depression of the central nervous system, though some authorities maintain that they exert little or no central action. They cause nausea and vomiting at an early stage of their action. Large doses cause slowing of the heart's action. Respiration is generally accelerated and deepened at first, but eventually becomes slow and laboured and finally ceases, while the heart is still strong and consciousness has just disappeared. According to Albahary and Löffler,⁶³ *d*- and *l*-conines are identical in action. By the introduction of a double linking as in γ -conicëine, the toxicity is increased, whilst by the substitution of a hydroxyl group, as in the conhydrines, it is reduced. Tullock and McElvain⁵⁸ have shown that the benzoates of *N*-alkyl derivatives of 2-piperidylpropyl alcohols of the types $\text{C}_5\text{H}_9\text{N}(\text{R}) \cdot \text{CH}_2 \cdot \text{CH}_2 \cdot \text{CH}_2\text{OH}$ and $\text{C}_5\text{H}_9\text{N}(\text{R}) \cdot \text{CH}_2 \cdot \text{CHOH} \cdot \text{CH}_3$ (*cf.* XVI, p. 18) possess local anæsthetic properties⁶⁴.

REFERENCES

- (1) *J. Amer. Chem. Soc.*, 1905, 27, 1461. (2) HÉBERT and HEIM, *Bull. Soc. chim.*, 1898, [iii], 17, 664. (3) *Chem. Listy*, 1923, 17, 166. (4) *Arch. Pharm.*, 1938, 276, 280. (5) *Pharm. J.*, 1887-8, [iii], 18, 13, 511; 1891, [iii], 21, 857, 936; 1895-6, [iv], 1, 89; 1904, [iv], 18, 185. (6) *Trans. Roy. Soc. Canada*, 1926, [iii], 20, 111, 153. (7) *Pharm. J.*, 1909, [iv], 29, 34, 70, 102. (8) *J. pr. Chem.*, 1928, 118, 25. (9) *Ber.*, 1894, 27, 2615; 1895, 28, 302. (10) *Ibid.*, 1905, 38, 3108; 1917, 50, 1477. (11) *Arch. Pharm.*, 1827, 20, 97. (12) *Annalen*, 1849, 70, 73. (13) *Ber.*, 1881, 14, 705. (14) *Ibid.*, 1933, 66, 596. (15) MELZER, *Arch. Pharm.*, 1898, 236, 701; *cf.* DILLING, *loc. cit.*⁷ (16) GABUTTI, *Chem. Soc. Abstr.*, 1906, [ii], 711. (17) AHRENS, *Ber.*, 1902, 35, 1330; *cf.* LÖFFLER and FRIEDRICH, *ibid.*, 1909, 42, 107. (18) HOFMANN, *ibid.*, 1884, 17, 825. (19) TAFEL, *ibid.*, 1892, 25, 1619. (20) LADENBURG, *ibid.*, 1885, 18, 1587. (21) *Ibid.*, 1881, 14, 705; 1882, 15, 2313; 1883, 16, 558; 1884, 17, 825; 1885, 18, 5, 109. (22) *Ibid.*, 1895, 28, 1459. (23) *Ibid.*, 1906, 39, 4365. (24) *Ibid.*, 1886, 19, 439, 2579. (25) *Ibid.*, 1893, 26, 854; 1894, 27, 853, 859, 3063; 1896, 29, 2706; 1901, 34, 3416; 1906, 39, 2486; 1907, 40, 3734; *cf.* WOLFFENSTEIN, *ibid.*, 1894, 27, 2611, 2615; 1896, 29, 1956; SIMON, *Bull. Soc. chim.*, 1894, [iii], 9, 949; LANDOLT, *Ber.*, 1894, 27, 1362; HESS and WELTZIEN, *ibid.*, 1920, 53, 139. (26) ENGLER and BAUR, *ibid.*, 1891, 24, 2530; 1894, 27, 1775; LAUTENSCHLAGER and ONSAGER, *ibid.*, 1918, 51, 602; KOLLER, *Monats.*, 1926, 47, 393; DIELS and ADLER, *Annalen*, 1932, 498, 16. (27) CLEMO and RAMAGE, *J. Chem. Soc.*, 1932, 2969. (28) *Ber.*, 1934, 67, 1011. (29) *Ibid.*, 1909, 42, 107. (30) *Ibid.*, 1917, 50, 1192, 1386. (31) *Ibid.*, 1932, 65, 927. (32) COMPARE CLOUGH, *J. Chem. Soc.*, 1918, 113 526. (33) WILLSTÄTTER, *Ber.*, 1901, 34, 3166. (34) LÖFFLER and FRIEDRICH, *ibid.*, 1909, 42, 107. (35) *Cf.* PLANTA and KEKULÉ, *Annalen*, 1854, 89, 150. (36) *Ber.*, 1891, 24, 1678. (37) *Ibid.*, 1917, 50, 1386; 1919, 52, 1622; 1920, 53, 129. (38) *Annalen*, 1856, 100, 1329. (39) HOFMANN, *Ber.*, 1885, 18, 5; LELLMANN, *Annalen*, 1890, 259, 193; LÖFFLER and FRIEDRICH, *Ber.*, 1909, 42, 107. (40) SPÄTH and ADLER, *Monats.*, 1933, 63, 127. (41) *Ber.*, 1909, 42, 929. (42) *Ibid.*, 1917, 50, 1386; 1919, 52, 964; 1920, 53, 119; *Annalen*, 1925, 441, 101; *cf.* MEISENHEIMER and MAHLER, *ibid.*, 1928, 462, 301. (43) *Ibid.*, 1891, 24, 2530; 1894, 27, 1775. (44) *Ibid.*, 1891, 24, 1071. (45) *Ibid.*, 1909, 42, 116, 960. (46) SPÄTH, KUFFNER and ENSFELLNER, *Ber.*, 1933, 66, 591; SPÄTH and LORENZ, *ibid.*, 1941, 74, 599. (47) *Ibid.*, 1885, 18, 109. (48) *Ibid.*, 1890, 23, 680. (49) *Ibid.*, 1909, 42, 4059. (50) WERTHEIM, *Annalen*, 1863, 127, 75; HOFMANN,³⁹ LELLMANN,³⁹ (51) HOFMANN,³⁹ LELLMANN, *Ber.*, 1890, 23, 2141; LÖFFLER, *ibid.*, 1904, 37, 1895; 1909, 42, 946. (52) WERTHEIM, *Annalen*, 1856, 100, 75; LÖFFLER, *Ber.*, 1905, 38, 3326; (with FRIEDRICH), *ibid.*, 1909, 42, 107; (with TSCHUNKE), *ibid.*, p. 929. (53) LELLMANN,⁵¹ also *Annalen*, 1890, 259, 197; LÖFFLER, (with KAIM), *Ber.*, 1909, 42, 94; (with FLUGEL) *ibid.*, p. 3420. (54) *Gazzetta*, 1890, 20, 761; *Ber.*, 1890, 23, 1793, 2154. (55) *Ibid.*, 1912, 45, 734; 1913, 46, 1069. (56) *Ibid.*, 1927, 60, 1607. (57) *Annalen*, 1932, 498, 16. (58) *J. Chem. Soc.*, 1931, 49; 1932, 2969; *cf.* TULLOCK and McELVAIN, *J. Amer. Chem. Soc.*, 1939, 61, 961. (59) PRELOG and BALENOVIC, *Ber.*, 1941, 74, 1508. (60) *Ibid.*, 1909, 42, 948. (61) LÖFFLER, *ibid.*, p. 122; SPÄTH *et al.*⁴⁶ (62) *Pharmacographia*, 1879, 299. (63) *Compt. rend.*, 1903, 147, 996. (64) See also HUNT and FOSBINDER, *Anæsthesiology*, 1940, 1, 305.

ALKALOIDS OF LOBELIA

The presence of alkaloids in *Lobelia inflata*, Linn., was first recorded by Proctor.¹ Lobeline was prepared by Lewis² as a basic oil from which Siebert³ made and analysed a series of salts and proposed the formula, $C_{18}H_{23}O_2N$. In 1921 Böhringer and Söhne⁴ protected a process for the isolation and separation of three alkaloids, α -, β and γ -lobelines. In the same year Wieland published the first⁵ of a series of papers in which is described the isolation of several groups of alkaloids, to most of which constitutional formulæ have been assigned and, in some cases, confirmed

by synthesis. These alkaloids are remarkable for their close inter-relationship and the fact that three of them can be synthesised⁶ by a variant of Robinson's general process which is a possible phytochemical method.

Lobelia is recognised in several pharmacopœias, but standards are not usually prescribed for its alkaloidal content, which should be from 0.3 to 0.4 per cent.

Numerous methods for the alkaloidal assay of lobelia and its galenical preparations have been published and two recent critical surveys, by a special committee of the Society of Public Analysts⁷ and by Caulkin,⁸ indicate that the process of Markwell⁸ is satisfactory. Processes for the isolation and separation of the various alkaloids have been protected by patent.⁹ Balandin^{9(a)} states that *Lobelia sessiliflora* contains less alkaloid than *L. inflata* but yields a high-quality lobeline.

According to Wieland, the typical lobelia alkaloids so far isolated and examined belong to three groups (Table A), all of which can be represented by the general Formula I.

TABLE A. *Lobeline Group*

<i>nor</i> Lobelanine.	$C_{21}H_{23}O_2N$.	$R = H$; R^1 and $R^2 = C_6H_5 \cdot CO$
Lobelanine.	$C_{22}H_{25}O_2N$.	$R = Me$; R^1 and $R^2 = C_6H_5 \cdot CO$
<i>l</i> -Lobeline	} $C_{22}H_{27}O_2N$.	$R = Me$; $R^1 = C_6H_5 \cdot CO$; $R^2 = C_6H_5 \cdot CHO$
<i>dl</i> -Lobeline		
<i>nor</i> Lobelanidine.	$C_{21}H_{27}O_2N$.	$R = H$; R^1 and $R^2 = C_6H_5 \cdot CHO$
Lobelanidine.	$C_{22}H_{29}O_2N$.	$R = Me$; R^1 and $R^2 = C_6H_5 \cdot CHO$

Lelobine Group

*nor*Lelobanidine.

$C_{17}H_{27}O_2N$. $R = H$; $R^1 = CH_3 \cdot CH_2 \cdot CHO$; $R^2 = C_6H_5 \cdot CHO$
Lelobanidine.

$C_{18}H_{29}O_2N$. $R = Me$; $R^1 = CH_3 \cdot CH_2 \cdot CHO$; $R^2 = C_6H_5 \cdot CHO$

Lobinine Group

Lobinine. $C_{18}H_{25}O_2N$. $R = Me$; $R^1 = CH_3 \cdot CH_2 \cdot CHO$; $R^2 = C_6H_5 \cdot CO$.
Ethylenic linkage from C_3 to C_4 .

*iso*Lobinine. $C_{18}H_{25}O_2N$. Possibly stereoisomeric with lobinine, or with ethylenic linkage C_4 to C_5 instead of at C_3 to C_4 , or with $R^1 = \cdot CH_2 \cdot CHO \cdot CH_3$ instead of $CH_3 \cdot CH_2 \cdot CHO$

Lobinanidine. $C_{18}H_{27}O_2N$. $R = Me$; $R^1 = CH_3 \cdot CH_2 \cdot CHO$; $R^2 = C_6H_5 \cdot CHO$. Ethylenic linkage C_3 to C_4 .

*iso*Lobinanidine. $C_{18}H_{27}O_2N$. As lobinanidine for $R \cdot R^1 \cdot R^2$, but source of difference undetermined.

There are also present at least four subsidiary, unnamed alkaloids, which have not been fully characterised.

B_{BASE} . $C_{19}H_{26}O_3N_2$, m.p. 232° (*dec.*), $B \cdot HCl$, m.p. $299-300^\circ$ (*dec.*);
 $B \cdot HI$, m.p. 279° ; $B \cdot HClO_4$, m.p. $254-5^\circ$; $B \cdot MeI$, m.p. 244° (*dec.*).
Monobenzoyl derivative, m.p. 220° . Bromo-compound, m.p. 288° (*dec.*).

B_{BASE} . $C_{14}H_{21}ON$, m.p. 103° ; oxalate, m.p. 176° (*dec.*).

BASE. $C_{14}H_{21}ON$, m.p. 81° , $B.HAuCl_4$, m.p. 182° ; monobenzoyl derivative, m.p. 118° . Oxidised by chromic acid to a keto-base, $C_{14}H_{19}ON$, $B.HCl, H_2O$, m.p. 109° . On more vigorous oxidation by chromic acid, benzoic acid and an amino-acid, $C_7H_{13}O_2N$, m.p. 235° are formed.

BASE. $C_9H_{19}ON$, m.p. $85-7^\circ$.

Taking the three groups of typical lobelia alkaloids, Table A shows that the chief difference between the lobeline and the other two groups is the replacement of one of the two aromatic side-chains in the former by an aliphatic side-chain, *i.e.*, $C_6H_5 \cdot CO$ or $C_6H_5 \cdot CHOH$ by $C_2H_5 \cdot CO$, or $C_2H_5 \cdot CHOH$, and that the principal changes within the groups are (1) from secondary to tertiary base, *e.g.*, *norlobelanine* to *lobelanine*, (2) keto-alcohol base to diketo-base, *e.g.*, *lobeline* to *lobelanine*, or (3) keto-alcohol base to dihydric alcohol base, *e.g.*, *lobeline* to *lobelanidine*. The lobinine group is exceptional in having an ethylenic linkage in the nucleus.

The carbonyl groups in the diketo- and keto-alcohol bases are not readily detected by the usual reagents and as these bases can be reduced to the dihydric alcohols, it was assumed at first that lobeline and lobelanine contained one and two ether linkages respectively and formulæ based on this assumption, and satisfying the other experimental evidence then available, were put forward¹⁰ by Wieland, Schöpf and Hermsen, of which that for lobeline (II) may be quoted as an example.

LOBELINE GROUP. The inter-relationships of the five members of this group have been given in Table A by reference to the general Formula I. The chief data on which this formula is based are as follows:—

All five alkaloids must have the same nuclear structure since lobeline is convertible into lobelanidine by hydrogenation and into lobelanine by oxidation, and *norlobelanidine* and *norlobelanine* yield lobelanidine and lobelanine respectively on *N*-methylation.

All five alkaloids yield acetophenone usually on heating dry, alone or in presence of a catalyst. Lobelanine hydrochloride on distillation with zinc dust produces more than one molecular proportion of acetophenone.

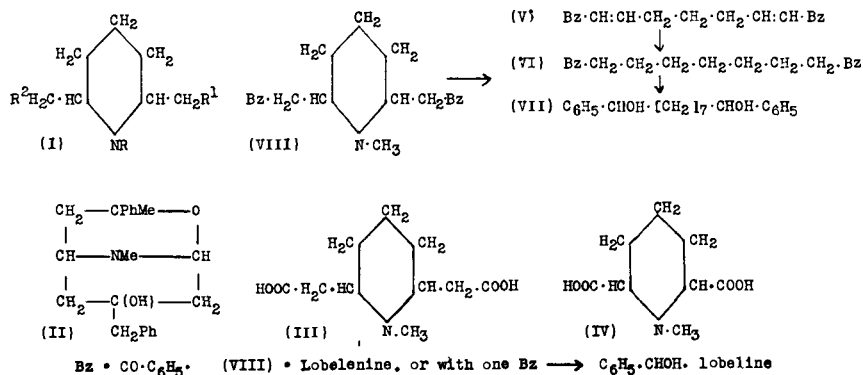

Lobelanine dioxime, obtainable in poor yield, undergoes a Beckmann transformation into the dianilide of 1-methylpiperidine-2 : 6-diacetic acid (lobelinic acid (III)). On oxidation by chromic acid in sulphuric acid lobelanine furnished 1-methylpiperidine-2 : 6-dicarboxylic acid (scopolinic acid (IV)) and benzoic acid.

From lobelanine methiodide, by the action of silver oxide, trimethylamine was produced along with a base, which is probably $C_6H_5 \cdot CO \cdot CH_2 \cdot CHNMe_2 \cdot CH_2 \cdot CH_2 \cdot CH_2 \cdot CH(OH) \cdot CH_2 \cdot CO \cdot C_6H_5$, and a neutral product (V). The latter on hydrogenation by (a) palladium black in alcohol gave 1 : 7-dibenzoyl-*n*-heptane (VI) or (b) palladium black in acetic acid, 1 : 9-dihydroxy-1 : 9-diphenyl-*n*-nonane¹¹ (VII). Formula (VIII), deduced from these results, represents lobelanine as a β -aminoketone, and thus accounts for the ease with which it hydrolyses with loss of methylamine and acetophenone, followed by ring closure with the formation of fluorene (diphenylenemethane) or diphenylcarbinol.¹⁰ The known inter-relationships of the other four alkaloids to lobelanine (Table A, p. 23) allow formulæ to be developed for them by the following changes in the lobelanine formula (VIII).

<i>nor</i> Lobelanine	: NCH ₃ becomes : NH.
Lobeline	One Bz group becomes C ₆ H ₅ · CHOH.
Lobelanidine	Both Bz groups become C ₆ H ₅ · CHOH.
<i>nor</i> Lobelanidine	Lobelanidine with : NCH ₃ becoming : NH.

Syntheses of members of the lobeline group have been effected by Wieland and Drishaus¹² and by Scheuing and Winterhalder.¹³ *nor*Lobelane was prepared by the former authors by condensing 2 : 6-dimethylpyridine with benzaldehyde to 2 : 6-distyrylpyridine¹⁴ (IX), which was then reduced by sodium in alcohol, giving a mixture of *meso*- and *trans*- forms of 2 : 6-di- β -phenylethylpiperidine (*nor*lobelane). From this by crystallisation of the mixed hydrochlorides, *meso-nor*lobelane was separated, which on *N*-methylation yielded lobelane (X) as the methiodide.

Scheuing and Winterhalder¹³ treated 2 : 6-distyrylpyridine tetrabromide with potassium hydroxide in alcohol, so producing 2 : 6-di- β -phenylacetylenylpyridine (XI) which by the action of 50 per cent. sulphuric acid was converted into 2 : 6-diphenacylpyridine (XII), and this, on hydrogenation in presence of platinic oxide, barium sulphate and methyl alcohol, was reduced to 2 : 6-di- β -hydroxy- β -phenylethylpyridine, and the hydrochloride of this, on similar catalytic hydrogenation, yielded *nor*lobelanidine (XIII). This can be methylated to lobelanidine, from which in turn *dl*-lobeline and lobelanine can be obtained.

The *N*-methyl bases may be reached more directly by converting 2 : 6-di- β -phenylacetylenylpyridine (XI) metho-*p*-toluenesulphonate, by treatment with slightly diluted sulphuric acid at 125°, into 2 : 6-diphenacylpyridine (XII) metho-*p*-toluenesulphonate. This, on direct hydrogenation, gives, with 3 mols. of hydrogen, lobelanine (VIII), or, with 5 mols. of hydrogen, lobelanidine (XIII : NH → NMe).

Wieland and Drishaus¹² effected a more fundamental synthesis by

condensing methyl glutarate with acetophenone in presence of sodamide, to obtain 1 : 7-dibenzoyl-*n*-heptane-2 : 6-dione (XIV), which dry ammonia at 100° converted into 2 : 6-di(benzoylmethylene)piperidine (XV). This, on hydrogenation in presence of platinum oxide and pyridine, furnished at 40–50° a mixture of the still unsaturated glycols α (racemic)- and β (meso)-*norlobelanidienes*, $C_{21}H_{23}O_2N$ (XVI), m.p. 148° and 172° respectively. The *meso*-form, on further reduction with aluminium amalgam and moist ether, gave *norlobelanidine* (XIII), m.p. 120° (hydrochloride, m.p. 244°), but the main product is an oily stereoisomeride, which on oxidation by chromic oxide in acetic acid yielded *norlobelanine*, m.p. 120° (hydrochloride, m.p. 195°). The α -form, on similar reduction and subsequent oxidation of the product, also furnished *norlobelanine* (VIII : $NCH_3 \rightarrow NH$). The more important steps in these syntheses may be represented as follows :—

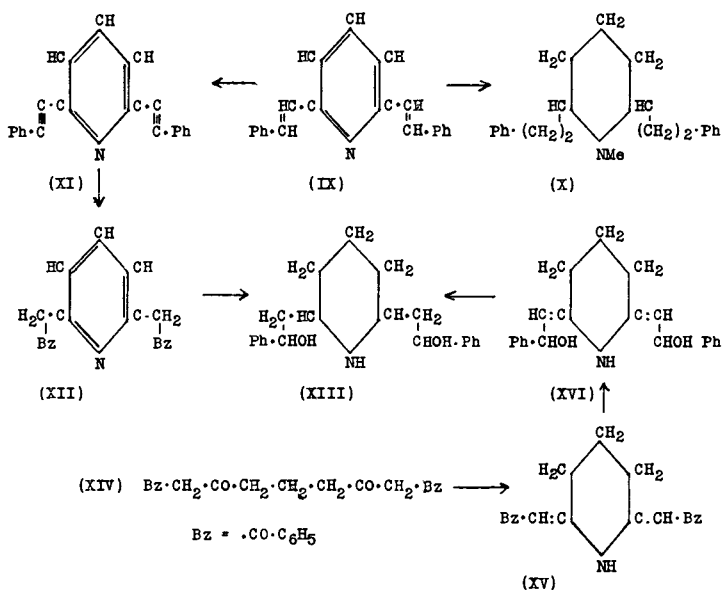

Schöpf and Lehmann⁶ found that lobelanine could be synthesised by keeping at 25° a mixture of glutardialdehyde, methylamine hydrochloride and benzoylacetic acid in a buffered solution. The best yield was obtained at pH 4–5, and appeared to be complete in forty hours. At pH 7 or 9, 11 or 13, the yield was very small. This synthesis under “physiological conditions” is represented as occurring in accordance with the following scheme :—

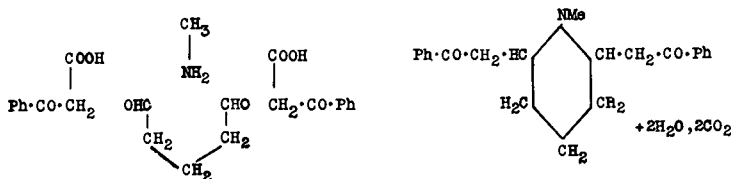

The principal characteristics of the naturally occurring members of the lobeline group (see also Table A, p. 23) are as follows:—

***l*-Lobeline**, $C_{22}H_{27}O_2N$, separates from alcohol, ether or benzene in glistening needles, m.p. $130-1^\circ$, $[\alpha]_D^{15} - 42-85^\circ$ (EtOH), readily soluble in hot alcohol or benzene, sparingly in light petroleum or water. The hydrochloride forms rosettes of needles, m.p. 182° , and is soluble in chloroform. The sulphate, nitrate and hydrobromide are crystalline; the platinichloride and mercurichloride amorphous. On warming with water, lobeline produces acetophenone. With benzoyl chloride it yields benzoyl-lobeline hydrochloride, m.p. $155-7^\circ$ (*dec.*); phosphorus trichloride converts it into chlorolobelide hydrochloride, $C_{22}H_{26}ONCl, HCl$, m.p. $172-4^\circ$ (*dec.*).^{4,5} On reduction with sodium amalgam in acetic acid, lobeline furnishes lobelanidine (*see below*) by reduction of the benzoyl group to $\cdot CHOH$. Ph, and is oxidised by chromic oxide in acetic acid to lobelanine (*see below*), by the conversion of the Ph $\cdot CHOH$ group into Bz (VIII). As the lobelanine so formed is optically inactive, the asymmetric carbon atoms in the heterocyclic nucleus of lobeline must have the *meso*-configuration.¹⁵

***dl*-Lobeline**, $C_{22}H_{27}O_2N$. First isolated⁵ as “lobelidine” and assigned the formula $C_{20}H_{25}O_2N$; was subsequently shown by Wieland, Koschara and Dane¹⁵ to be *dl*-lobeline. It forms stellate groups of prisms, m.p. 110° . The hydrochloride darkens at 160° and melts at 170° ; sodium tartrate precipitates from its aqueous solution, the sparingly soluble *l*-lobeline *d*-tartrate.

Lobelanine, $C_{22}H_{25}O_2N$. This, after lobeline, is the most abundant alkaloid in lobelia. It forms rosettes of needles from ether or light petroleum, melts at 99° , is easily soluble in alcohol, benzene or chloroform, and gives well-crystallised salts: B, HCl, m.p. 188° (*dec.*); B, HBr, m.p. 188° ; B, HI, m.p. $169-172^\circ$; B, HNO₃, m.p. $153-4^\circ$; B, HClO₄, m.p. $173-4^\circ$. It yields with difficulty a dioxime, m.p. 209° (*dec.*). On reduction with sodium amalgam in acetic acid, lobelanine (VIII) produces lobelanidine (XIII: NH \rightarrow NMe), the two benzoyl groups being converted into Ph $\cdot CHOH$ groups,¹⁰ and is itself formed when either lobeline or lobelanidine is oxidised with chromic oxide in acetic acid. Hydrogen peroxide converts it into lobelanine N-oxide, m.p. $84-6^\circ$.

***nor*Lobelanine**, $C_{21}H_{23}O_2N$. First isolated as *isobobelanine*¹⁰ but subsequently¹⁵ shown to be *norlobelanine* (VIII: NCH₃ \rightarrow NH). It melts at $120-1^\circ$ and gives well-crystallised salts: B, HNO₃, m.p. 193° (*dec.*); B, HCl, m.p. $201-2^\circ$. On reduction it furnishes *dl-norlobeline* (VIII: NCH₃ \rightarrow NH and one Bz \rightarrow C₆H₅ $\cdot CHOH$) and eventually *norlobelanidine* (XIII),¹³

Lobelanidine, $C_{22}H_{29}O_2N$. Crystallises from alcohol in laminæ, m.p. 150° , $[\alpha]_D^{15} \pm 0^\circ$, distils unchanged in a vacuum and is readily soluble in acetone or benzene, sparingly so in ether. The hydrochloride, m.p. $135-8^\circ$, forms needles from alcohol; the hydrobromide has m.p. $188-190^\circ$. The dibenzoyl derivative melts at $109-10^\circ$ and the hydrochloride of the diacetyl derivative at $214-5^\circ$. The methiodide becomes turbid at $173-5^\circ$ and clears at 200° . Phosphorus trichloride converts the base into dichlorolobelane

hydrochloride, $C_{22}H_{27}NCl_2$, m.p. 158–9°. The latter, on reduction, furnishes *lobelane* (X), $C_{22}H_{29}N$, b.p. 175° (in a high vacuum); B, HCl, m.p. 194–5°; B, MeI, m.p. 234–5°. ¹⁰ On oxidation with potassium permanganate in presence of sulphuric acid, lobelanidine (XIII: NH → NMe), yields *dl*-lobeline (VIII: one Bz → $C_6H_5 \cdot CHOH$). ¹⁵

*nor*Lobelanidine, $C_{21}H_{27}O_2N$. This substance (XIII) forms long needles, m.p. 120°; the hydrochloride, needles, m.p. 244° (*dec.*); the nitrate has m.p. 179–180°. On treatment with methyl *p*-toluene-sulphonate the base is converted into lobelanidine, whilst chromic oxide in acetic acid oxidises it to *nor*lobelanine. ¹⁵

LELOBINE AND LOBININE GROUPS. These include the minor alkaloids of lobelia isolated from factory residues accumulated during the manufacture of lobeline. Their isolation and separation involve complicated processes of fractionation for which the original paper ¹⁶ should be consulted. Their inter-relationships (Table A, p. 23 and general formula, I, p. 24) are similar to those among members of the lobeline group, but the effect of the presence of three or more asymmetric carbon atoms is more evident, thus there are already known six forms of the basic dihydric alcohol, lobelanidine.

The methods of investigation used are the same in principle as those used successfully with the diketo-base, lobelanine (p. 24) in the lobeline series.

Oxidation by Chromic Acid. Under mild conditions, *e.g.*, in acetic acid at atmospheric temperature; this converts the dihydric alcohol or keto-alcohol bases to diketo-bases, *e.g.*, the lelobanidines, $C_{18}H_{25}O_2N$, to lelobanines, $C_{18}H_{25}O_2N$. Under more vigorous action the keto-alcohol and the diketo-bases are oxidised to benzoic acid (side-chain, Ph · CO.), acetic and propionic acids (side-chain, $C_2H_5 \cdot CO.$) and either scopolinic acid 1-methylpiperidine-2:6-dicarboxylic acid (IV) or methylgranatic acid (1-methylpiperidine-2-carboxylic-6-acetic acid) or both, these being from the methylpiperidine nucleus with residues of the two side-chains.

Exhaustive Methylation. As in the lobeline group it is the diketo-bases, lelobanines (p. 30) in the lelobine series and lobinanines (p. 31) in the lobinine group, which give methiodides amenable to this mode of degradation. They are decomposed by alkali yielding an unsaturated neutral oil, which is hydrogenated and then, if necessary, oxidised to the saturated open chain diketone, *e.g.*, see under lelobanine.

The chief descriptive characters and reaction products of the lelobine series are recorded in Table B, and those of the lobinine group in Table C. The constitutional formulae assigned to the principal members of each group are shown on p. 32.

Lobelanidines, $C_{18}H_{29}O_2N$ (Formula XVII). Six forms of this alkaloid are known, of which Table B deals with four, *viz.*, the naturally occurring *dl*-, II and III forms and the *d*- equivalent of II, obtained by resolution of the *dl*- form. The remaining two are dealt with in Table C, *viz.*, the α - and β - forms obtained by hydrogenation of the natural alkaloids lobinanidine and lobinine respectively.

TABLE B. *Lelobine Group*

Natural Alkaloid	Derivative	[α] _D	Melting point of			
			Base	B. HCl	B. HI	B. HClO ₄
<i>nor</i> Lelobanidine, C ₁₇ H ₂₇ O ₂ N	—	+ 63°†	90°	193°	190°	141°
	methylated to <i>d</i> -lelobanidine	+ 41°*	—	86°	171°	176°
	oxidised to <i>d-nor</i> lelobanine	- 11.5°*	—	174°	—	—
<i>dl</i> -Lelobanidine, C ₁₈ H ₂₉ O ₁ N	—	± 0°	68°	79°	159°	152°
	resolved to <i>d</i> -lelobanidine	+ 41°*	—	86°	171°	176°
	oxidised to <i>dl</i> -lelobanine, C ₁₈ H ₂₅ O ₂ N	± 0°	—	142°	—	136°
<i>l</i> -Lelobanidine I.	—	- 41°*	—	86°	171°	176°
	oxidised to <i>l</i> -lelobanine	+ 20°*	—	(dihydrate) 186°	—	—
<i>l</i> -Lelobanidine II	—	- 41°*	—	102-5°	165°	158°
	oxidised to <i>l</i> -lelobanine	+ 20°*	—	(1.5 H ₂ O) 186°	—	—

* B. HCl in alcohol; † Base in alcohol.

All forms have not been fully examined but *dl*-lelobanidine is probably typical. It contains two hydroxyl groups (dibenzoyl derivative m.p. 178°) and is a tertiary base (methiodide m.p. 162–4°). On mild chromic acid oxidation it yields *dl*-lelobanine (XVIII) and on vigorous oxidation, benzoic (Ph. CHO. side-chain), acetic and propionic (Et. CHO. side-chain) acids, while the methylpiperidine nucleus survives in the forms of 1-methylpiperidine-2 : 6-diacetic (scopolinic acid, IV, p. 24) and 1-methyl-2-carboxylic-6-acetic (methylgranatic) acids, the latter being identical with that obtained from methylgranatoline (p. 59), whence it is concluded that the configuration of *dl*-lelobanidine and methylgranatoline includes both *cis*-forms and that *l*-lelobanidine I which is oxidised to *l*-lelobanine and *l*-methylgranatic acid is an optically active *cis*-form.

As *l*-lelobanidine II also yields *l*-lelobanine on oxidation the difference between the I and II forms must be stereochemical and lie in one of the side-chains, in spite of the quantitative identity of their specific rotations. The four asymmetric centres might have the following individual directional effects *l.l.d.d.* and *d.l.d.l.* in the two forms, but the total effect might be identical.

It should be noted that *d*-norlelobanidine, $[\alpha]_D + 62.8^\circ$ (EtOH), on oxidation yields *d*-norlelobanine, of which the hydrochloride has $[\alpha]_D - 11.5^\circ$.

Lelobanines, $C_{18}H_{25}O_2N$ (Formula XVIII). These are diketo-bases resulting from the chromic acid oxidation of the corresponding lelobanidines. Those recorded in Table B are *l*- and *dl*-forms, derived from II and III, and *dl* forms of lelobanidine respectively, *dl*-lelobanine is the best known of these products. The methiodide, not isolated, on treatment with silver oxide yields dimethylamine and a neutral, deep-yellow oil convertible by hydrogenation into a glycol, $C_{17}H_{28}O_2$, b.p. 117–8°/0.03 mm., which was oxidised by chromic acid to 1-benzoyl-7-propionyl-*n*-heptane (XIX), m.p. 51°, semicarbazone, m.p. 186° (*dec.*), the identity of which was established by synthesis.

LOBININES, $C_{18}H_{25}O_2N$ (Table C). These are keto-alcohol bases. Lobinine, and probably *isolobinine*, differ from the lelobanidines (XVII) in having (1) a side-chain, $\cdot CH_2 \cdot CO \cdot Ph$ in place of $\cdot CH_2 \cdot CHO \cdot Ph$, and (2) an ethylenic linkage in the heterocyclic nucleus probably at C³ — C⁴ in lobinine (XX) and possibly at C⁴ — C⁵ in *isolobinine*. On mild oxidation by chromic acid they yield the diketo-bases, lobinanines, $C_{18}H_{23}O_2N$ (XXIII), and are reduced by sodium amalgam in acetic acid to lobinanidines, $C_{18}H_{27}O_2N$ (XXII). On hydrogenation they are converted into lelobanidines (XVII).

Lobinine, $C_{18}H_{25}O_2N$. First isolated by Wieland, Ishimasa and Koschara¹⁷ who, on the evidence then available, regarded it as 2-phenacyl-1-methyl-7- β -hydroxypropylhexamethyleneimine, $C_{18}H_{27}O_2N$ (XXI), which was modified to (XX) in 1939.¹⁶ It furnishes an oxime (B. HCl, m.p. 182°) and a benzoyl derivative (B. HCl, m.p. 146–7°). On reduction by sodium in acetic acid it is converted into the unsaturated dihydric alcohol for which the original name "lobinol" has been changed to β -lobinanidine,

TABLE C. *Lobinine Group*

Natural Alkaloid	Derivative	[α] _D	Melting point of			
			Base	B. HCl	B. HI	B. HClO ₄
Lobinine, C ₁₈ H ₂₅ O ₂ N . . .	—	— 130 ^{o*} — 106 ^{o‡}	—	144 ^o	130 ^o	146 ^o
Reduced to	β -lobinanidine, C ₁₈ H ₂₇ O ₂ N	—	—	180 ^o	—	—
Hydrogenated to	β -lelobanidine, C ₁₈ H ₂₉ O ₂ N	— 39.2 ^{o†}	—	—	181 ^o	152 ^o
Oxidised to	lobinanine, C ₁₈ H ₂₃ O ₂ N . . .	— 65 ^{o*}	—	94 ^o	—	133 ^o
Lobinanidine, C ₁₈ H ₂₇ O ₂ N . . .	—	— 120 ^{o*}	95 ^o	169 ^o	200 ^o	—
Hydrogenated to	α -lelobanidine	— 37 ^{o†}	—	—	174 ^o	142 ^o
Oxidised to	lobinanine	— 65 ^{o*}	—	94 ^o	—	133 ^o
<i>iso</i> Lobinine	—	— 76 ^{o‡}	78 ^o	154 ^o (dry)	—	—
Reduced to	β - <i>iso</i> lobinanidine	—	—	161 ^o	—	—
Hydrogenated to	<i>l</i> -lelobanidine I	— 41 ^{o*}	—	86 ^o	171 ^o	176 ^o
Oxidised to	<i>iso</i> lobinanine	— 11 ^{o*}	—	150 ^o	—	—
<i>iso</i> Lobinanidine	—	— 28 ^{o‡}	—	111 ^o	164 ^o	169 ^o
Hydrogenated to	<i>l</i> -lelobanidine I	— 41 ^{o*}	—	86 ^o	171 ^o	176 ^o

* B. HCl in alcohol ; † B. HI in alcohol ; ‡ B. HCl in water.

$C_{18}H_{27}O_2N$ (XXII) (see below and Table C). On hydrogenation of lobinine hydriodide in methyl alcohol with platonic oxide as catalyst, the product is β -lelobanidine, $C_{18}H_{29}O_2N$ (XVII : Table C, p. 31).

On oxidation at 100° by chromic acid in dilute sulphuric acid lobinine yields benzoic acid and lobinic acid, $C_9H_{13}O_4N$, m.p. $207-8^\circ$, which absorbs 1.85 mols. of hydrogen and so might have been expected to yield methylgranatic acid (1-methylpiperidine-2-carboxylic-6-acetic acid, $C_9H_{15}O_4N$) but no well-defined product could be isolated. Milder oxidation of lobinine by chromic acid produces the diketo-base formerly called "lobinoue" ¹⁷ but now re-named LOBINANINE, $C_{18}H_{23}O_2N$ (XXIII : see Table C). The methiodide of this substance on treatment with alkali yields dimethylamine and a deep-yellow diketone, $C_{17}H_{20}O_2$, or possibly $C_{17}H_{18}O_2$, which gives a deep violet colour with alkali and is probably $Bz \cdot CH_2 \cdot CH : CH - CH : CH - CH \cdot COEt$, and on hydrogenation is converted into 1-benzoyl-7-propionyl-*n*-heptane (XIX) identical with that similarly obtained from *dl*-lelobanidine (XVII) *via* lelobanine (XVIII).

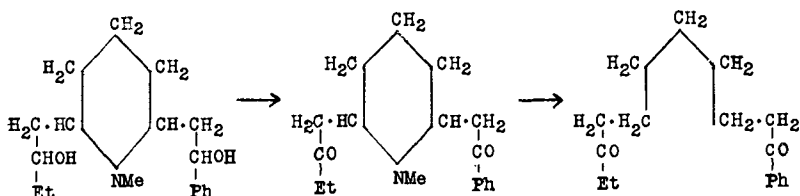

(XVII). Lelobanidine

(XVIII). Lelobanine

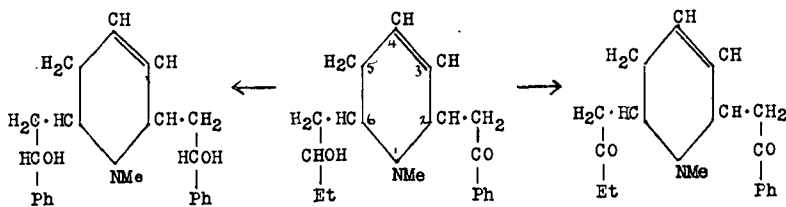
(XIX). 1-Benzoyl-7-propionyl-*n*-heptane

(XXII). Lobinanidine

(XX). Lobinine (1939)

(XXIII). Lobinanine

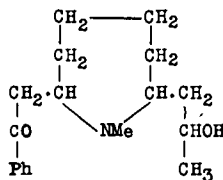

(XXI). Lobinine (1931)

*iso*Lobinine, $C_{18}H_{25}O_2N$. First isolated by Thoma, this alkaloid was tested pharmacologically by Richter as T 64, and was later investigated

chemically by Wieland *et al.*¹⁶ (Table C, p. 31). Its reactions parallel those of lobinine (*see above*) and give analogous products. Reduction with sodium amalgam in acetic acid yields the unsaturated dihydric alcohol β -*isolobinanidine* isomeric with β -lobinanidine (XXII) from lobinine. On catalytic hydrogenation *isolobinine* and β -*isolobinanidine* yield *l*-lelobanidine I (*see p. 28* and Formula XVII), which indicates that they both have the *cis*-configuration (*cf. p. 30*). On vigorous oxidation with chromic acid, *isolobinine* yields benzoic, acetic and scopolinic acids (Thoma¹⁶). On milder oxidation with chromic acid it is converted into *isolobinanine* (Table C), the methiodide of which on treatment with alkali yields a diketone, $C_{17}H_{18}O_2$, isomeric and possibly stereoisomeric with that from lobinine. It is suggested that lobinine and *isolobinine* are stereoisomerides, and less probably that in *isolobinine*, the ethylenic linkage may be at $C^4 - C^5$ instead of $C^3 - C^4$ as in lobinine (XX).

LOBINANIDINES, $C_{18}H_{27}O_2N$ (XXII). Four of these substances are known: two, lobinanidine and *isolobinanidine*, occur naturally and, two, β -lobinanidine and β -*isolobinanidine*, are produced by the reduction of lobinine and *isolobinine* respectively with sodium amalgam in acetic acid, the carbonyl group (as in XX) being reduced without saturation of the nuclear ethylenic linkage. For descriptive characters, see Table C.

Lobinanidine is oxidised by chromic acid at 70–80° to lobinanine (XXIII). On more vigorous oxidation by this reagent benzoic acid is formed and also lobininic acid, $C_9H_{13}O_4N$, identical with that obtained from lobinine. On hydrogenation it furnishes α -lelobanidine, which closely resembles the β -lelobanidine from lobinine (*see Table C*), but is not identical with it.

isoLobinanidine. Little is known about this base beyond the data recorded in Table C, but it appears to be oxidised to a lelobanine which yields a diketone resembling that from lobinine in giving a violet colour with alkali.

Lobinaline, $C_{28}H_{38}ON_2$. This alkaloid was isolated by Manske¹⁸ from *Lobelia cardinalis*, L. It crystallises with difficulty in prisms, m.p. 94–5°, $[\alpha]_D^{25} + 22.3^\circ$ ($CHCl_3$), yields a hydrochloride, B. HCl, 1.5 H₂O, m.p. 220°, and on oxidation by permanganate yields benzoic acid.

Pharmacological Action. Lobeline belongs to a pharmacologically similar group, which includes nicotine, cytisine, gelsemine, coniine and sparteine. These alkaloids act chiefly on the central nervous system, the sympathetic ganglia and the myoneural junctions in voluntary muscle. Nicotine may be regarded as the typical alkaloid of the group. Lobeline is a potent, respiratory stimulant and is used in medical practice as an analeptic, *e.g.*, in cases of collapse due to poisoning by noxious gases, narcotics, etc., and there is now an extensive pharmacological and clinical literature on the drug.¹⁹

An interesting pharmacological application of lobeline is its use in determining blood circulation times.²⁰ Lobeline does not account for all the therapeutical applications of lobelia, and Richter,²¹ in particular, has investigated the spasmolytic activity of the residual lobelia alkaloids and

has sought to associate these with particular features of the action of lobelia, e.g., *isolobinine* is said to be responsible for the emetic and asthma-relieving properties of the crude drug. A detailed study of the action of *isolobinine* has been made by Pannier and De Backer.²²

Lobinaline, according to Unna, as quoted by Manske,¹⁸ exerts none of the actions characteristic of lobeline.

Kubota *et al.* have recorded the presence of a lobeline-like alkaloid in *L. sessilifolia*.²³ According to Mukerji and Ghosh²⁴ lobeline is present in *L. nicotinæfolia*. Heyne and Bendezu have also found it in *L. decurrens*.²⁵

Lobelan (2 : 6- β -diphenylethyl-1-methylpiperidine) may be regarded as the parent from which the chief lobelia alkaloids are derived. Lee and Freudenberg²⁶ have synthesised it and a series of related substances and have submitted them to pharmacological tests. The most active spasmolytic agent in this series is 2 : 6-di- β -*p*-anisylethyl-1-methylpiperidine, which has a neurotropic activity one-tenth that of atropine and musculotropic potency seven times that of papaverine ; its broncholytic activity is about $\frac{1}{20}$ th that of adrenaline. The most active analeptic found is 2 : 6-di- β -*p*-anisylethylpiperidine, which is more active than lobeline. Spasmolytic activity has not been recorded for Lobelia alkaloids, but it is now shown that lobelan has a slight neurotropic and a similar musculotropic activity.

REFERENCES

- (1) *Amer. J. Pharm.*, 1836, 9, 98 ; cf. BASTICK, *Pharm. J.*, 1850, [i], 10, 270, 456.
- (2) *Ibid.*, 1877-8, [iii], 8, 56. (3) *Inaug. Diss.*, Marburg, 1891. (4) *Brit. Pat.*, 145, 621-2. (5) *Ber.*, 1921, 54, 1784. (6) SCHÖFF and LEHMANN, *Annalen*, 1935, 518, 12. (7) *Analyst*, 1939, 64, 581. For a study of the polarographic method with lobeline see NYMAN, *Svensk. Farm. Tid.*, 1943, 47, 401, 429. (8) *Quart. J. Pharm.*, 1939, 12, 438 ; MARKWELL, *Pharm. J.*, 1936, 136, 617 ; see also UFFELIC, *Pharm. Weekbl.*, 1946, 81, 41. (9) E.g., *Brit. Pat.* 145,621-2 ; 156,190 ; 314,532. *Ger. Pat.* 336,335 ; 340,116 ; 362,380 ; 389,816 ; 532,535. *Russ. Pat.* 54,334. (9a) *Farmatsiya*, 1946, 9, 17. (10) *Annalen*, 1925, 444, 40 ; SCHÖFF and BOETTCHER, *ibid.*, 1926, 448, 1. (11) WIELAND and DRAGENDORFF, *ibid.*, 1929, 473, 83. (12) WIELAND and DRISHAUS, *idem.*, p. 102. (13) *Idem.*, p. 126 ; cf. *Brit. Pat.* 312,919 ; 314,019. (14) SCHUSTER, *Ber.*, 1892, 25, 2398. (15) WIELAND, KOSCHARA and DANE. *Annalen*, 1929, 473, 118. (16) WIELAND, KOSCHARA, DANE, RENZ, SCHWARZE and LINDE, *ibid.*, 1939, 540, 103 ; also THOMA, *idem.*, p. 99, and RICHTER.²¹ (17) *Annalen*, 1931, 491, 14. (18) *Can. J. Research*, 1938, 16, B. 445 includes pharmacological note by UNNA. (19) For example : CURTIS and WRIGHT, *Lancet*, 1926, 211, 1255 ; 1929, 216, 439 ; KING, HOSMER and DRESBACH, *J. Pharm. Exp. Ther.*, 1928, 32, 241 ; WHITEHEAD, *Univ. Colorado Studies*, 1942, 27, 1 (Analeptic action). (20) STANOJEVIC and DJORDJEVIC, *C. R. Soc. Biol.*, 1938, 127, 1362 ; VON EULER, LILJESTRAND and ZOTTERMANN, *Upsala Läkarefören Förh.*, 1939, 45, 373 ; BERLINER, *Arch. int. Med.*, 1940, 65, 896 ; (with LILIENFELD), *ibid.*, 1942, 69, 739 ; *Amer. J. Med. Sci.*, 1942, 203, 349 ; ROTOR, DAMIAN and AUSTRIA, *Acta Med. Philippina*, 1941, 2, 435 ; PICCIONE and BOYD, *J. Lab. Clin. Med.*, 1941, 26, 766. (21) RICHTER, *Arch. exp. Path. Pharm.*, 1938, 190, 280 ; 1939, 193, 117, 256. (22) *Verh. Kon. Vl. Acad. Geneesk Belg.*, 1945, 7, 1 ; see also LENOLLE and RUPPERT, *ibid.*, 1942, 199, 478, 497 ; DE BACKER, *C. R. Soc. Biol.*, 1944, 138, 901. (23) *China J. Physiol.*, 1929, 3, 279. (24) *Curr. Sci.*, 1945, 14, 198. (25) *Chem. Abstr.*, 1945, 39, 3814. (26) *J. Org. Chem.*, 1944, 9, 537 ; see also FOSTER, MOENCH and CLARK, *J. Pharm. Exp. Ther.*, 1946, 87, 78.

ALKALOIDS OF NICOTIANA SPP

The following are the names and formulæ of this group of alkaloids:—

Nicotine, $C_{10}H_{14}N_2$ ✓	<i>l</i> -N-Methylanatabine, $C_{11}H_{14}N_2$
Nicotimine, $C_{10}H_{14}N_2$ /	Nicotyrine, $C_{10}H_{10}N_2$ — ✗
Anabasine, $C_{10}H_{14}N_2$	Nicotelline, $C_{10}H_8N_2$ ✓ ✗
<i>N</i> -Methylanabasine, $C_{11}H_{16}N_2$	2 : 3'-Dipyridyl, $C_{10}H_8N_2$
<i>iso</i> Nicotine, $C_{10}H_{12}N_2$ ✓ ✗	<i>nor</i> Nicotine, $C_9H_{12}N_2$
Anatabine, $C_{10}H_{12}N_2$	Nicotine, $C_8H_{11}N$.

Until recently none of these alkaloids had been found outside the genus *Nicotiana* (Solanaceæ), and in the mixture of alkaloids present in species of that genus, nicotine was always predominant. In 1935 Späth, Hicks and Zajic found *d*-normicotine in *Duboisia Hopwoodii* (Solanaceæ), subsequently shown by Bottomley *et al.*¹ to contain both nicotine and *normicotine*. The only other *Duboisia* sp. examined up to that time contained tropane alkaloids (p. 65). In the same year C. R. Smith² found that the predominant alkaloid in *Nicotiana glauca* is anabasine, first isolated by Orekhov³, from *Anabasis aphylla* (Chenopodiaceæ), along with lupinine, aphylline and aphyllidine, all typical leguminous bases. A close relative of anabasine is aminodendrine (p. 139), also isolated from a leguminous plant, *Ammodendron Conollyi*. Nicotine has also been found in *Eclipta alba*, Hassk. (Compositæ) by Pal and Narasinhani⁴ and by Marion⁵ in *Asclepias syriaca* (Asclepiadaceæ) and *Sedum acre* of the botanical family, Crassulaceæ. These observations provide an alkaloidal connection between five botanical families and indicate that the phytosynthesis of a particular type of alkaloid is not a specific activity of plants of one botanical type, though it still seems to be generally true that within one genus the alkaloids found are structurally similar, though there are exceptions, such as *Duboisia* spp., even to this narrow generalisation.

Of the alkaloids listed above, nicotine has only been found in the Turkish type of tobacco⁶; the *isonicotine* recorded at the same time has been shown by Späth and Biniecki⁶ to be 2 : 3'-dipyridyl. According to Shmuk and Borozdina,⁷ 42 *Nicotiana* spp. examined by them can be arranged in four groups according to the predominant alkaloid present: (1) nicotine ("dipicrate," m.p. 215–224°), (2) *normicotine* ("dipicrate," m.p. 175–200°), (3) mixtures of (1) and (2) ("dipicrate," m.p. 190–215°), (4) anabasine. They describe methods for the separation and identification of these three bases. The melting-points of the "dipicrates," quoted in brackets, are given by Markwood and Barthel⁸ as those of the mixed dipicrates of the total alkaloids of tobacco plants, in which nicotine or *normicotine* predominates, the former being the more common.

The best source of the alkaloids is commercial "nicotine" or the concentrated tobacco extracts, used as horticultural insecticides. The average alkaloidal content of tobacco leaf is about 4; and does not as a rule exceed 6, per cent. In 1,026 parts of the total alkaloids of Kentucky tobacco, Pictet and Rotschy⁹ found "nicotine" 20, *nicotimine* 5 and *nicotelline* 1, the rest being nicotine, but, as Markwood⁸ has pointed out,

the selective breeding of tobacco now in progress is probably changing this predominance of nicotine. "Nicotine" was subsequently shown by Ehrenstein¹⁰ to be a mixture of *normicotine* and *l-anabasine*. According to Klein and Herndlhofer¹¹ the leaves and root contain most alkaloid and only traces occur in other organs such as seeds and flowers. There are also present in the plant a number of simple bases¹²—pyrrolidine and *N*-methylpyrrolidine were found by Pictet and Court, *isoamylamine* by Ciamician and Ravenna, ammonia, trimethylamine, piperidine and 2 : 3'-dipyridyl (b.p. 292–4°; dipicrate, m.p. 167–8°) by Späth and Zajic, and *N*-methylpyrrolidine (picrate, m.p. 223–5°; aurichloride, m.p. 226°) by Späth and Biniecki.⁶

Tobacco and its alkaloids have long ceased to have any therapeutic importance, but their extensive use as insecticides and the demand for nicotine for the manufacture of nicotinic acid have stimulated interest in processes of extraction¹³ and methods of estimation. On the latter subject there is a voluminous literature, of which critical *résumés* have been published by various authors.¹⁴ Recent work on this subject has been specially concerned with (1) the development of micro- and semi-micro-methods suitable for estimating nicotine in tobacco smoke and the distribution of nicotine on sprayed garden produce, in treated soils and in tobacco leaves,¹⁵ (2) the study of conditions necessary to ensure satisfactory results in using particular processes,^{16(a)} and (3) methods of separation and estimation of nicotine, *normicotine* and anabasine in mixtures of these bases.^{16(b)} In the United States and in Russia considerable interest is being shown in the cultivation of types of tobacco rich in nicotine, in finding new industrial uses for tobacco and its alkaloids, and in possible by-products from tobacco plants such as citric and malic acids.^{16(c)} Surveys of information on tobacco alkaloids have been published by Jackson,^{16(d)} Marion^{16(e)} and Späth and Kuffner.¹²

Nicotine, $C_{10}H_{14}N_2$. The pure alkaloid is a colourless oil, b.p. 246.1°/730.5 mm., D_{20}^{20} 1.0180, D_{20}^{20} 1.00925, $[\alpha]_D^{20}$ – 163.66°.¹⁷ It can be purified through the crystalline zincchloride, $B \cdot ZnCl_2 \cdot 2HCl \cdot H_2O$,¹⁸ the regenerated base being distilled under reduced pressure (20–40 mm.) in presence of nitrogen or hydrogen. It distils unchanged in a current of steam and is readily soluble in alcohol, ether or light petroleum. The behaviour of nicotine with water has been studied by several workers.¹⁹ It is miscible in all proportions with water below 60° and above 210°; at intervening temperatures soluble hydrates are not formed and miscibility is limited. According to Kelly *et al.*,¹⁹ an azeotrope is formed, which contains 2.45 per cent. of nicotine and boils at 99.6°/760 mm. The salts are readily soluble in water, do not crystallise easily and are dextrorotatory. This reversal in direction of rotation on salt formation is not uncommon among alkaloids, and has been the subject of some investigation.²⁰ The hydrochloride, $B \cdot HCl$, has $[\alpha]_D + 102.2°$; the sulphate, $B_2 \cdot H_2SO_4$, $[\alpha]_D + 84.8°$. When an aqueous solution of either of these salts is heated in a closed vessel at 180–250° it becomes optically inactive.²¹ The acid *d*-tartrate, $B \cdot 2H_2C_4H_4O_6 \cdot 2H_2O$, m.p. 88–9° (*hydrated*), $[\alpha]_D^{27} + 26.6°$ (*dry salt*) and

the neutral *d*-tartrate, m.p. 68.5° (*hydrated*), $[\alpha]_D^{20} + 29.5^\circ$ (*dry salt*), both crystallise from alcohol on addition of ether. The dipicrate, B. $2C_6H_2(NO_2)_3OH$, short yellow prisms, m.p. 224°, and the tetrachloroiodide,²² $C_{10}H_{14}N_2 \cdot 2(HICl_4)$, orange prisms, m.p. 150° (*dec.*), are characteristic. The *p*-toluenesulphonamide has m.p. 212–3° and is soluble (20 per cent.) in water. On exposure to ultra-violet light nicotine is converted to nicotine oxide (picrate, m.p. 169°), nicotinic acid and methylamine.²³

By the action of sodamide on nicotine Tschitschibabin^{23(a)} obtained 2-aminonicotine, m.p. 124–5° (dipicrate, m.p. 223–5°) and 6-aminonicotine, m.p. 60°, b.p. 300° (dipicrate, m.p. 225° (*dec.*)). The interaction of these substances with alkyl halides has been investigated by Goldfarb and Kondakova and with chloroacetone by Goldfarb and Katrenko. The analogous 2-aminonicotyrine, $C_{10}H_{11}N_3$, m.p. 77–8°, picrate, m.p. 189–190° and 6-aminonicotyrine, m.p. 97–8°, monopicrate, m.p. 257° (*dec.*) have been prepared by Clemo and Swan^{23(a)} by the action of sodamide on nicotyrine and also by the dehydrogenation of the 2- and 6-aminonicotines respectively.

Nicotine may be detected by the colourless, crystalline mercurichloride obtained when an aqueous solution is added to a solution of mercuric chloride, by the black precipitate formed under similar conditions with potassium platonic iodide and the characteristic crystalline periodide, $BI_2 \cdot HI$, m.p. 123°, produced on admixture, under specified conditions,²⁴ of ethereal solutions of nicotine and iodine (*cf* Anabasin, p. 43). A polarographic study of nicotine has been made by Kirkpatrick.^{24(a)}

*nor*Nicotine, $C_9H_{12}N_2$. The base was first obtained by M. and M. Polonovski²⁵ and was subsequently prepared by von Braun and Weissbach²⁶ along with *metan*nicotine by the action of boiling benzoic acid on nicotine. The isolation of *l*-normicotine from tobacco by Ehrenstein¹⁰ and of *d*-normicotine from *Duboisia Hopwoodii* by Späth, Hicks and Zajic¹ has been referred to already. The chief constants of von Braun's *norm*nicotine are given in the following table with those of the natural *d*- and *l*-forms as first isolated.

	<i>nor</i> Nicotine from		
	Nicotine (von Braun)	Tobacco (Ehrenstein)	<i>D. Hopwoodii</i> (Späth et al.)
Boiling point	139–140°/12mm.	130.5–131.3/11mm.	117°/3.6 mm.
Specific Gravity	D_4^{19} 1.044	$D_4^{19.5}$ 1.0737	D_4^{18} 1.0757
Refractive index	—	$n_D^{18.5}$ 1.5378	$n_D^{18.3}$ 1.5490
Specific rotation	$[\alpha]_D - 5.5^\circ$	$[\alpha]_D^{20} - 17.7^\circ$	$[\alpha]_D^{24} + 38.3^\circ$
Melting points of			
Dipicrate	188–190°	191–192°	191–192°
Dipicrolonate	223 – 225°	250–253°	252–253°

The nicotine formed by methylation (Eschweiler's process²⁷) of *d*-nornicotine from *D. Hopwoodii* had $[\alpha]_D^{24} + 48.3^\circ$. Späth and Zajic¹ showed that *l*-nornicotine isolated from Kentucky tobacco and purified through the diperchlorate, had $[\alpha]_D^{25} - 88.8^\circ$, gave a dipicrate, m.p. 191–2°, and on methylation furnished pure *l*-nicotine. In their second paper Späth, Hicks and Zajic¹ showed that from the partially racemised *d*-nornicotine obtained from *D. Hopwoodii* a fraction having $[\alpha]_D^{25} + 86.3^\circ$ could be prepared by crystallisation of the diperchlorate and Späth and Keszler¹ (1937) found that, although the *l*-isomeride appears to be the form usually found in tobacco, the *dl*-form could be isolated from the mother liquors of *l*-nicotine diperchlorate and suggested that it may occur preformed in tobacco. The same authors (1936) found that *dl*-nornicotine can be resolved by successive treatment in methyl alcohol with *l*- and *d*-6 : 6'-dinitro-2 : 2'-diphenic acid and purification of the crude optically active bases through their diperchlorates. *nor*Nicotine is a colourless liquid with a faintly basic odour. With methyl iodide it yields nicotine dimethiodide, m.p. 214–6°, which is readily racemised to the *dl*-dimethiodide.²¹ On oxidation with nitric acid it furnishes nicotinic acid. The method of formation from nicotine already mentioned, to which may be added the observation of Späth, Marion and Zajic,¹ that nicotine can be oxidised by potassium permanganate or silver oxide to *l*-nornicotine, under carefully controlled conditions, leave no doubt of the relationship of *nornicotine* [2-(3'-pyridyl)-pyrrolidine] to nicotine [1-methyl-2-(3'-pyridyl)-pyrrolidine], and this is confirmed by the syntheses described below. A detailed account of *nornicotine* has been published by Markwood.²⁸

Constitution of Nicotine, norNicotine and Nicotyrine. The presence of a pyridine nucleus in nicotine was established by the work of several chemists²⁹ who, using various oxidising agents, obtained from the base nicotinic acid (pyridine-3-carboxylic acid). As this acid is now a product of commercial importance new processes for its manufacture have been devised.²⁹ Liebrecht³⁰ added the further evidence that hexahydronicotine was formed by reduction of the base by sodium in amyl alcohol. The empirical formula of nicotine may, therefore, be extended to $C_5H_4N \cdot C_5H_{10}N$, and the later work is chiefly concerned with the nature of the residue $C_5H_{10}N$. The latter has the composition of piperidine and the behaviour of nicotine in many reactions is explicable on the assumption that it is 2-(3'-pyridyl)piperidine, and that view of its structure was accepted until Laiblin³¹ found that nicotine zincchloride on distillation with lime furnished not only pyridine, but pyrrole and methylamine. This view of its constitution was finally disposed of by Blau,³² who prepared 2 : 3'-dipiperidyl and showed that it was not identical with hexahydronicotine.

The nature of the $C_5H_{10}N$ residue became apparent from Pinner's investigation of the action of bromine on nicotine³³ (Formula A). So treated in acetic acid nicotine yielded a hydrobromide perbromide, $C_{10}H_{10}ON_2Br_2 \cdot HBr \cdot Br_2$, from which, after treatment with aqueous sulphurous acid, the free base, dibromocotinine (Formula D), $C_{10}H_{10}ON_2Br_2$,

colourless prisms, m.p. 125°, was recovered. This cannot be acylated and gives neither an oxime nor a phenylhydrazone. When heated with sulphurous and sulphuric acids at 130–140° it yields methylamine, oxalic acid and 3-acetylpyridine (*see diagram below*).

By the action of bromine on nicotine in hydrobromic acid, dibromotonicine (Formula B), $C_{10}H_{10}O_2N_2Br_2$, nodular crystals, m.p. 196°, is obtained. This with zinc dust in warm alkali yields methylamine and pyridyl- β : γ -dihydroxybutyric acid,



and when heated with barium hydroxide in a sealed tube at 100° decomposes into methylamine and malonic and nicotinic acids, probably *viâ* the intermediate product C.

These reactions indicate that the residue $C_5H_{10}N$ includes a series of three primary carbon atoms ending in a group $\cdot NCH_3$ thus :



and, since difficulty is experienced in reducing nicotine beyond hexahydronicotine, this residue must be cyclic, *i.e.*, it is *N*-methylpyrrolidine as in (A). On this view these series of changes may be represented thus :—

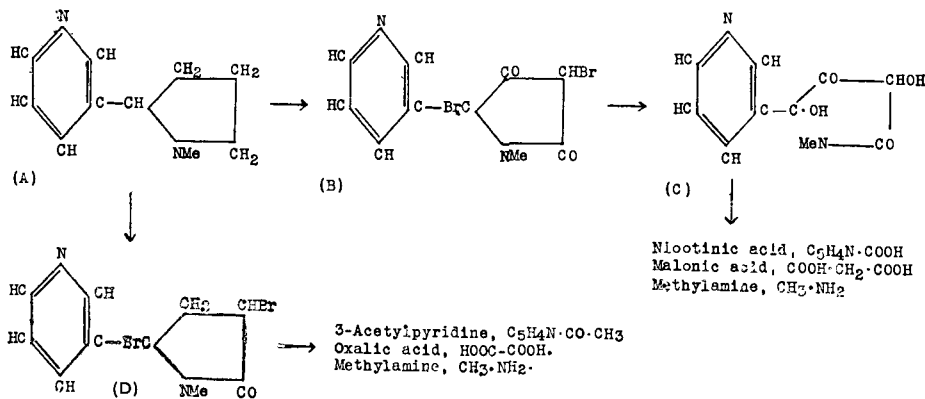

The objection that Formula (A) for nicotine does not provide for the benzoyl derivative of nicotine obtained by Étard³⁴ was overcome when Pinner³⁵ showed that in this reaction the pyrrolidine ring is opened, giving rise to *metanicotine* (*isonicotine*), and that the supposed benzoylnicotine is benzoyl*metanicotine*,

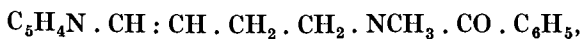

from which *metanicotine* (b.p. 275–8°; picrate, m.p. 163° (*dry*)) can be recovered by heating with hydrochloric acid under pressure at 100°. Confirmation of this constitution for *metanicotine* is provided by its conversion by hydriodic acid into iododihydro*metanicotine*, which is reduced by zinc and hydrochloric acid to dihydro*metanicotine*, of which a

series of alkyl derivatives has been described by Hromatka.³⁶ It yields a *N*-bromo-derivative, and this, on treatment with sulphuric acid, furnishes *dl*-nicotine.³⁷ Pinner's formula also explains Blau's observation³⁸ that nicotine on reduction furnishes both a hexahydro- and an octahydro-derivative, the former being due to complete reduction of the pyridine ring and the latter to the further action of opening the pyrrolidine ring by the addition of two atoms of hydrogen, the octahydronicotine being in reality octahydro*metan*icotine, $C_5H_{10}N \cdot CH_2 \cdot CH_2 \cdot CH_2 \cdot CH_2 \cdot NH \cdot CH_3$.³⁹ It also accounts for Pictet and Genequand's⁴⁰ observation that nicotine with methyl iodide furnishes nicotine methiodide, $C_5H_4N \cdot C_4H_7N(CH_3)_2I$, whilst nicotine hydriodide with this reagent gives the *isomethiodide*, $C_5H_4N(CH_3I) \cdot C_4H_7N \cdot CH_3$, which on oxidation furnishes trigonelline (betaine of pyridine-3-carboxylic acid).

SYNTHESES OF NICOTINE. Pictet and Crépieux⁴¹ found that 3-aminopyridine mucate on dry distillation yielded 1-(3-pyridyl)pyrrole (I), and this, in accordance with the usual behaviour⁴² of such pyrrole derivatives, transfers its pyridyl substituent from the 1- to the 2-position at a red heat giving 2-(3-pyridyl)pyrrole (II), which is *norm*nicotyryne. The potassium derivative of this reacts with methyl iodide to form 1-methyl-2-(3-pyridyl)-pyrrole methiodide, which is identical with nicotyryne methiodide (III), and on distillation with lime yields nicotyryne⁴³ (IV : CI \rightarrow CH). For a re-investigation of this synthesis see Späth and Kainrath.⁴³

Nicotyryne, $C_{10}H_{10}N_2$. This important base, the occurrence of which in the cigar type of tobacco has been recorded by Wenusch,⁴⁴ and confirmed by Späth and Kesztlér,⁴⁴ boils at 280–1° or 150°/15 mm., has D^{13} 1.124 and yields a crystalline picrate, m.p. 170–1°, a platinichloride, m.p. 158° (*dec.*) and a metl iodide, m.p. 211–3°. It can be prepared by oxidation of nicotine by potassium ferricyanide (Cahours and Étard),⁴⁵ silver oxide (Blau) or silver acetate (Tafel). Pictet and Crépieux⁴⁶ were unable to reduce it to nicotine (tetrahydronicotyryne) directly, but reached this objective by converting it into idonicotyryne (IV), which proved reducible to 4:5-dihydronicotyryne (V). This in turn was converted into the perbromide and the latter reduced to *dl*-nicotine (VI). Wibaut and Oberhoff dehydrogenated nicotine to nicotyryne by platinised asbestos at 320°⁴⁷ and Wibaut and Hackmann⁴⁸ found that nicotyryne could be reduced by zinc and hydrochloric acid to nicotine (yield 12 per cent.) and a dihydronicotyryne (V) (b.p. 244–6°; dipicrate m.p. 164°), subsequently shown by Späth, Wibaut and Kesztlér⁴⁸ to be 4:5-dihydronicotyryne (*N*-methylmyosmine, p. 47). This could be reduced further by hydrogenation in presence of Adams's platinic oxide as catalyst, yielding dihydro*metan*icotine (dipicrate, m.p. 161–2°) with nicotine and nicotyryne, the regeneration of the latter being attributed to a redistribution of hydrogen between 2 mols. of the dihydronicotyryne by the action of the catalyst, thus : $2C_{10}H_{12}N_2 = C_{10}H_{10}N_2 + C_{10}H_{14}N_2$, the reaction being considered analogous with the conversion of *cyclohexene* into *benzene* and *cyclohexane*.⁴⁹ Späth and Kuffner succeeded in converting nicotyryne into

dl-nicotine in one operation by carefully controlled hydrogenation in presence of palladised charcoal.⁵⁰

The tetrahydronicotyrine produced by these methods is identical with *dl*-nicotine, and this, by crystallisation of the *d*-ditartrate, was separated into *d*- and *l*-nicotine.⁴³ The salient steps in Pictet's original synthesis may be represented as follows :—

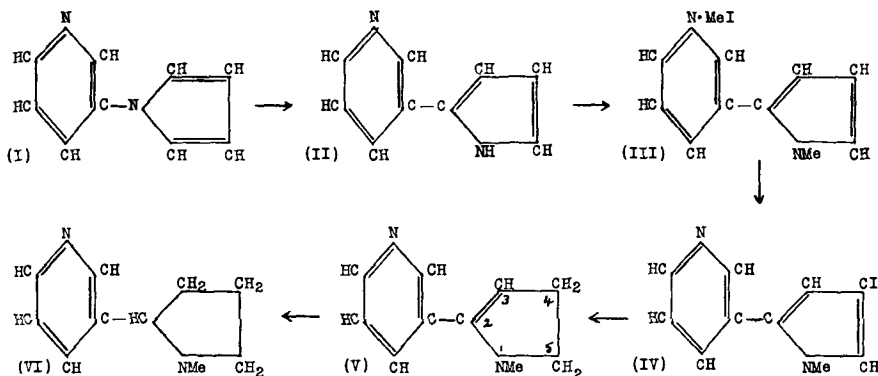

Another synthesis of nicotine was effected by Späth and Bretschneider⁵¹ (*see diagram*, p. 42), beginning with the condensation of ethyl nicotinate with 1-methyl-2-pyrrolidone in presence of sodium ethoxide to give 3'-(1'-methylpyrrolid-2'-onyl)-3-pyridyl ketone (I), which with hydrochloric acid at 130° is hydrolysed to 3-pyridyl γ -methylamino-*n*-propyl ketone (II). This, on hydrogenation in presence of palladised charcoal, yields 3-pyridyl- γ -methylamino-*n*-propylcarbinol (III), which with fuming hydriodic acid at 100° furnishes α -3-pyridyl- δ -methylamino-*n*-butyl iodide (IV), and this in alkaline solution passes into *dl*-nicotine. Since nicotine can be converted into *norm*nicotine in various ways (p. 38), and *dl*-*norm*nicotine has been resolved by Späth and Keszler¹ (1936), this also constitutes a synthesis of *d*- and *l*-*norm*nicotines.

Craig's synthesis⁵² of nicotine (V to VII, p. 42) proceeds *via norm*nicotine. Nicotinic acid nitrile reacts with the Grignard reagent derived from ethyl γ -bromopropyl ether to give 3-pyridyl- γ -ethoxypropyl ketone (V). This yields an oily oxime (VI) reducible to α -(3-pyridyl)- α -amino- δ -ethoxy-*n*-butane (VII), which with 48 per cent. hydrobromic acid at 150–5° gives *norm*nicotine, and this on methylation yields *dl*-nicotine.

A novel synthesis of *norm*nicotyrine has been described by Lions and Ritchie,⁴³ who condensed ethyl nicotinylacetate hydrochloride with $\alpha\beta$ -dichlorodiethyl ether in presence of ammonia at –10° to –15° and then at room temperature, producing mainly ethyl 2-(3'-pyridyl)furan-3-carboxylate, but also some ethyl 2-(3'-pyridyl)pyrrole-3-carboxylate,

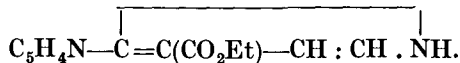

The latter on hydrolysis and decarboxylation yielded *norm*nicotyrine (II, *above*), rosettes of flattened needles, m.p. 98–9°, picrate, m.p. 203–4° (*dec.*), in good agreement with the data of previous authors.

PYRIDINE GROUP

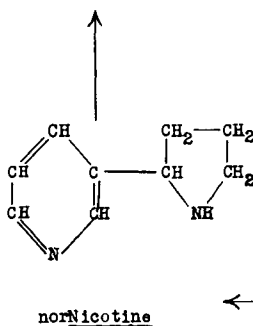
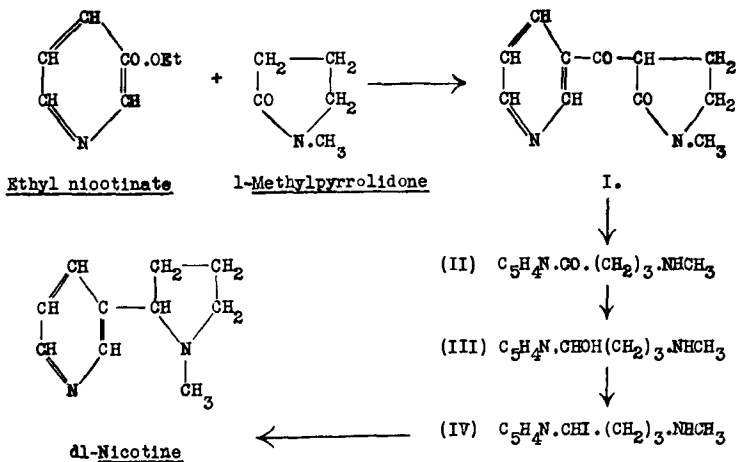
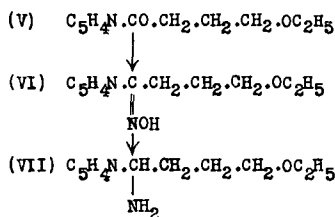
Craig's Synthesis.

In the oxidation of nicotine, the pyrrolidine ring is usually destroyed first, leaving the pyridine ring as nicotinic acid, which when nitric acid is the oxidising agent is accompanied by 3-nitro-5-(3'-pyridyl)pyrazole.⁵³ It has, however, been shown by Karrer and Widmer⁵⁴ that if nicotine *isomethiodide* (p. 40) is oxidised with potassium ferricyanide, *N*-methylnicotone (VIII) is obtained, and this on further oxidation by chromic acid is converted into *l*-hygrinic acid (IX), $C_6H_{11}O_2N.H_2O$, m.p. 116° , $[\alpha]_D -80.12^\circ$, which yields the corresponding betaine, *l*-stachydrine, identical with the naturally occurring base and with that prepared from natural *l*-proline. It follows that nicotine, stachydrine and proline as found in Nature have the same configuration, to which *d*-nornicotine in *Duboisia Hopwoodii* is an exception.

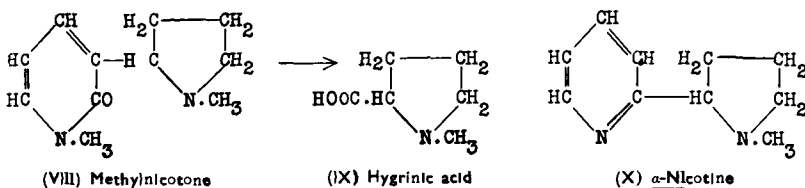

α-Nicotine and Other Isomerides. This is a synthetic isomeride, which differs from nicotine in having the methylpyrrolidine nucleus substituted in position 2, instead of 3, in the pyridine ring (X), and the names *α-nornicotine* and *α-nicotyrine* have been applied to the derivatives, isomeric with the similarly named nicotine products. *α-Nicotyrine* (*N*-methyl-2-(2'-pyridyl)pyrrole) is described as a liquid of peculiar odour, b.p. 149–50°/22 mm. or 273°/764 mm., yielding a dipicrate m.p. 143°, and was prepared⁵⁵ by the Pictet and Crepieux process for the synthesis of nicotyrine (p. 40), but starting with 2-amino- in place of 3-amino-pyridine. A synthesis of *α-nicotine* was described by Wibaut and Oosterhuis⁵⁶ by the reduction of *α-nicotyrine* with zinc and hydrochloric acid in presence of platinic chloride, but the product (b.p. 120°/1 mm. : dipicrate, m.p. 179° (*dec.*) platinichloride, m.p. 218–9° (*dec.*)) differs a little in character from the *α-nicotine* (b.p. 122°/25 mm. : dipicrate, m.p. 169°), subsequently synthesised by Craig⁵⁷ *via α-nornicotine* by the process used by the same author (p. 41) for nicotine, but starting with 2-cyano- in place of 3-cyanopyridine (nicotinic acid nitrile). Gitsels and Wibaut⁴³ (1941) have described the preparation of 3-(3'-pyridyl)pyrrole and its conversion into 3:3'-*nornicotine* dipicrate, m.p. 236–7° (*dec.*) and *dl*-3:3'-nicotine yielding a dipicrate, m.p. 193–5° (compare Späth and Kainrath⁴³). They have also reduced 3-(2'-pyridyl)pyrrole with zinc and hydrochloric acid to *dl*-3-(2'-pyridyl)pyrrolidine (picrate, m.p. 214–6°) and methylated this to the corresponding nicotine (named *dl*-2:3'-nicotine) characterised by its dipicrate, m.p. 175–7°.

Anabasine, C₁₀H₁₄N₂. In 1929 Orekhov isolated a liquid alkaloid, anabasine, from *Anabasis aphylla*, and in 1931, suggested that it was probably *l*-2-(3'-pyridyl)piperidine.⁵⁸ In the same year C. R. Smith⁵⁹ isolated 2-(3'-pyridyl)piperidine from the mixture of products formed by the action of sodium on pyridine, and named it "neonicotine." In 1935, the same author found that the chief alkaloid of *Nicotiana glauca* is anabasine, no nicotine being detected. In 1931, Ehrenstein¹⁰ stated that Pictet's "nicotine" is a mixture of *l-nornicotine* and *l*-2-(3'-pyridyl)piperidine, and suggested that anabasine is probably identical with the latter, that Smith's "neonicotine" is the *dl*-form, and that nicotimine (p. 45), for which Pictet tentatively suggested this constitution, is probably a pyrogenic decomposition product of different structure. The characters of these four products, so far as they are given in common by their authors, are collected in the table on p. 44.

Comparison of these results indicates identity of the two substances isolated independently by Orekhov and Ehrenstein, but Späth and Keszler⁶⁰ have suggested that Pictet's nicotine and Ehrenstein's base, consisted of impure *l*-anatabine (p. 46). In this connection it may be noted that Ehrenstein's base was levorotatory in acid solution, whereas salts of anabasine are dextrorotatory. These authors have themselves isolated *l*-anabasine from tobacco. The identity of synthetic 2-(3'-pyridyl)piperidine with *dl*-anabasine seems to have been definitely established.⁶¹ *Anabasis aphylla* is the source of the anabasine manufac-

Product described by			
	Orehhov	Ehrenstein	Smith : Pictet
Boiling point	145-6°/14 mm. 276°/760 mm.	137.5-8.5°/10.5 mm. 155°/19 mm.	Smith, 280-1°/775 mm. Pictet, 250-5°
Specific rotation	- 81° * (base)	- 72.9° (base) - 14.7° (in N-HCl)	— —
Specific gravity	D ₂₀ ⁴⁰ 1.0455	D ₄ ¹⁵ 1.0761	—
Refractive index	n _D ²⁰ 1.5430	n _D ^{18.5} 1.5423	—
Dipicrate, m.p.	200-5°	201-4°	Smith, 213° Pictet, 163°
Dipicrolonate, m.p.	235-7°	233-5°	—

* According to Norkina *et al.*⁵⁸ the specific rotation varies with the solvent and racemisation is apt to occur during extraction. Values much lower than - 81° have been given by Smith.⁵⁹ The salts are dextrorotatory.

tured in Russia but *N. glauca* has been proposed as a source of supply in the United States.^{64(a)}

l-N-Methylanabasine, b.p. 127–8°/12 mm., D_4^{18} 1.003, $[\alpha]_D^{15}$ –136.9° (base) was first prepared by Orekhov and Norkina,⁶¹ and was found in minute quantity in tobacco by Späth and Keszler.⁴⁴ The dipicrate has m.p. 237–8° (*dec.*), the dipicolonate, m.p. 234–6° (*dec.*), and methiodide hydriodide, m.p. 245–7°. On oxidation the base yields either anabasine or nicotinic acid, depending on the oxidising agent used and the conditions (Sadykov).⁶¹ Other *N*-alkylanabasines have been prepared by Zhdanovich and Menshikov,⁶¹ and the combination of ethylene and propylene oxides with the base to form *N*-(β -hydroxyalkyl)-anabasines has been studied by Sadykov and Ashrapova.^{61(a)}

On hydrogenation in presence of platinic oxide, anabasine yields a mixture of bases including *l*-2 : 3-dipiperidyl, m.p. 66–8°, b.p. 113–4°/5 mm., $[\alpha]_D^{20}$ – 5° (EtOH); picrate, m.p. 214–5°.⁶² On treatment with sodamide at 135–145° in presence of dimethylaniline, anabasine gives a mixture of 2-(2'-amino-3'-pyridyl)piperidine, m.p. 89.5–90°; picrate, m.p. 244.5–245° (*dec.*) and 2-(6'-amino-3'-pyridyl)piperidine, m.p. 109°; picrate, m.p. 233–233.5°.⁶³ This orientation of the entering amino-group is based on the two corresponding chloro-compounds obtained by diazotisation, which on oxidation furnish 2- and 6-chloronicotinic acids respectively. On oxidation under conditions similar to those adopted by Karrer⁵⁴ for nicotine, the pyridine ring in anabasine is oxidised first, the final product being pipercolinic acid (piperidine-2-carboxylic acid)⁶³; on oxidation with nitric acid it yields nicotinic acid.^{63(a)} Shaikova²⁴ states that with Dragendorff's reagent anabasine gives characteristic crystals suitable for its microchemical detection and according to Katz,²⁴ unlike nicotine, it does not give Kippenberger's periodide test. Estimation of the alkaloid has been dealt with by Wenusch and Bilowitzki and by Fuks.⁶² Späth and Mamoli⁶⁴ have synthesised anabasine by condensing 1-benzoylpiperidone, m.p. 110–2°, with ethyl nicotinate and submitting the product to the action of hydrochloric acid at 130° with the formation of Δ^2 -2-(3'-pyridyl)tetrahydropyridine, which is named *anabaseine*, $C_{10}H_{12}N_2$, b.p. 110–120°/1 mm. (bath temp.); dipicrate, m.p. 174° (*vac.*, *dec.*). This on reduction gave *dl*-anabasine (dipicolonate, m.p. 258–9°; dipicrate, m.p. 213–4°) which was resolved by Späth and Keszler⁶⁴ by the use of *l*-6 : 6'-dinitro-2 : 2'-diphenic acid to separate *l*-anabasine, $[\alpha]_D^{18}$ – 82.45°, dipicrate, m.p. 198–199.5° (*dec.*), and from the mother liquors *d*-6 : 6'-dinitro-2 : 2'-diphenic acid was used to isolate *d*-anabasine, $[\alpha]_D^{18}$ + 82.11°, dipicrate, m.p. 198–9°. A comprehensive review of the chemistry, production and uses of anabasine has been published by Roark.^{64(a)}

Nicotimine, $C_{10}H_{14}N_2$. This isomeride of nicotine was isolated by Pictet and Rotschy⁹ from crude nicotine as the nitrosoamine from which it was regenerated by boiling with hydrochloric acid. It can be purified by fractional distillation of the benzoyl derivative (oil, b.p. above 350°). Nicotimine is a colourless, alkaline oil, b.p. 250–5°, miscible with water and the usual organic solvents. The hydrochloride is crystalline, but

deliquescent; the platinichloride forms minute yellow crystals, and begins to decompose at 270° ; the aurichloride occurs in bright yellow leaflets, m.p. $182-5^{\circ}$ (*dec.*); the mercurichloride separates from hot water in slender needles, and decomposes at 190° ; the picrate is precipitated as an oil, and slowly solidifies to yellow prisms, m.p. 163° . According to Pictet,⁶⁵ nicotimine does not contain a pyrrole nucleus, but his suggestion that it is 2-(3'-pyridyl)piperidine (anabasine) is no longer tenable.

isoNicotine, $C_{10}H_{12}N_2$. This base, obtained by Noga⁶⁶ from Turkish tobacco, is a viscous, colourless liquid, b.p. 293° (*dec.*), $D_4^{20^{\circ}}$ 1.0984, $n_D^{20^{\circ}}$ 1.5749, $[\alpha]_D \pm 0^{\circ}$, readily soluble in most organic solvents, but sparingly so in water or light petroleum. It has been shown by Späth and Binięcki⁶ to be 2 : 3'-dipyridyl.

Nicotelline, $C_{10}H_8N_2$. This base, isolated by Pictet and Rotschy,⁹ forms colourless needles, m.p. $147-8^{\circ}$, b.p. above 300° ; its aqueous solution is neutral to litmus. Unlike other tobacco bases it yields a sparingly soluble, crystalline dichromate. It does not decolorise acid permanganate, and appears not to be a pyrrole derivative.⁶⁵

Nicotine, $C_8H_{11}N$, obtained by Noga⁶⁶ from Turkish tobacco, is a colourless, alkaline liquid, b.p. 208° , $D_4^{21^{\circ}}$ 0.9545, $n_D^{20^{\circ}}$ 1.5105, and is stated to yield well-crystallised salts.

Anatabine, $C_{10}H_{12}N_2$. In work on the subsidiary bases of tobacco, Späth and Kesztlér⁶⁰ examined a fraction b.p. $120-40^{\circ}/1$ mm., which was further fractionated as the dihydrochloride and the products converted into dipicrates, of which one had m.p. $195-6^{\circ}$, and yielded a base, $[\alpha]_D - 141^{\circ}$. This, after purification through the *l*-6 : 6'-dinitro-2 : 2'-diphenate (m.p. $238-238.5^{\circ}$), had b.p. $145-6^{\circ}/10$ mm., $[\alpha]_D^{17^{\circ}} - 177.8^{\circ}$ (as base), gave a monohydrochloride, $[\alpha]_D^{17^{\circ}} - 61.9^{\circ}$ (H_2O); a dihydrochloride, $[\alpha]_D^{17^{\circ}} - 65.4^{\circ}$ (H_2O); dipicrate, m.p. $191-3^{\circ}$ (*vac., dec.*), and dipicrolonate, m.p. $234-5^{\circ}$ (*vac., dec.*), and was named *l*-anatabine. From the mother liquors *dl*-anatabine was isolated as the diperchlorate, m.p. $129-130^{\circ}$, and furnished a dipicrate, m.p. $201-201.5^{\circ}$ (*vac., dec.*), dipicrolonate, mp. $233-5^{\circ}$ (*vac., dec.*), and *p*-nitrobenzoyl derivative, m.p. $95-6^{\circ}$. On dehydrogenation *l*-anatabine yields 2 : 3'-dipyridyl, and on hydrogenation is partially converted into *l*-anabasine. The benzoyl derivative is oxidised by permanganate to benzoic, hippuric and nicotinic acids, no scission of a ring having occurred on benzoylation. These results indicate that the alkaloid is a 2 : 3'-dipyridyl in which one pyridine ring is partially hydrogenated. Taking optical activity also into account, anatabine must be either 2-(3'-pyridyl)- Δ^3 or Δ^4 tetrahydropyridine, of which the Δ^4 -isomeride is considered the more probable.

l-*N*-Methylanatabine, prepared by the action of formaldehyde and formic acid on the alkaloid, has $D_4^{18^{\circ}}$ 1.036, $[\alpha]_D^{19^{\circ}} - 167^{\circ}$ (base), yields a dipicrate, m.p. $207-8^{\circ}$ and was isolated in minute quantity from tobacco by Späth and Kesztlér.⁴⁴

Alkaloids of Tobacco Smoke. The following alkaloids, apart from normal alkaloidal constituents of tobacco, have been isolated by Wenusch and Schoeller⁶⁷ from tobacco smoke.

Bases Volatile in Steam. Myosmine (see below), *obeline* (picrate, m.p. 270–80°), *α-socratine* (picrolonate, m.p. 104°), *β-socratine* (picrolonate, m.p. 130°), and *γ-socratine* (picrolonate, m.p. 256°).

Bases not Volatile in Steam. *Anodmine* (picrolonate, m.p. 310°), *lathreine* (picrolonate, m.p. 150°), and *lohitam*.

They are obtainable only in minute quantity, but one of them, myosmine, has been fully investigated.

Myosmine, $C_9H_{10}N_2$, has m.p. 42–3° (*vac.*, *dec.*), b.p. 80–100°/1 mm. (air-bath temp.) is optically inactive and soluble in ether or light petroleum. The dipicrate has m.p. 182–3° (*vac.*, *dec.*), and the dipicrolonate m.p. 204°. The base was examined by Späth, Wenusch and Zajic,⁶⁷ who found that on dehydrogenation it yielded 2-(3'-pyridyl)-pyrrole (C_9H_8N) (picrate, m.p. 200°) identical with that similarly obtained from *normicotine*. It must, therefore, be a 2-(3'-pyridyl)-dihydropyrrole and, since it is optically inactive and with benzoic anhydride suffers ring-scission and benzylation to a product, $C_{16}H_{16}O_2N_2$, m.p. 118° (probably 3- γ -benzamidobutryl-pyridine), its constitution should be 2-(3'-pyridyl)-4:5-dihydropyrrole. This was confirmed by Späth and Mamoli⁶⁸ who, using the method of Späth and Bretschneider⁵¹, and starting with ethyl nicotinate and benzoylpyrrolidone, obtained 2-(3'-pyridyl)-4:5-dihydropyrrole, which proved to be identical with myosmine. It was subsequently shown by Späth, Wibaut and Keszler⁴⁸ that *N*-methylmyosmine is identical with 4:5-dihydrionicotyrine (p. 40). According to Woodward, Eisner and Haines,^{68(a)} myosmine is one of several products formed when nicotine is dehydrogenated over prepared quartz at 570°. The same authors state that it is readily hydrolysed in water to 3-pyridyl γ -aminopropyl ketone; thus in aqueous solution it gives with phenylhydrazine hydrochloride, 3-pyridyl γ -amino-*n*-propyl ketone phenylhydrazone, m.p. 201–2°.

Biological Work on Nicotine and Related Alkaloids. Much activity is being shown in developing (a) tobacco of low nicotine and protein content for the use of smokers, and (b) types giving high yields of nicotine,^{16(c)} needed for the manufacture of nicotinic acid and nicotinamide and for the production of insecticides. In pursuit of these objectives three main lines of work seem to be in operation. Reference has been made already to the examination in Russia of 42 species of *Nicotiana*. A similar investigation by H. and C. Smith⁷² of 29 wild *Nicotiana* spp. showed that four contained nicotine, five *normicotine*, two mainly anabasine, and the rest mixtures of nicotine and *normicotine*. None of these species contained more than 2 per cent. of alkaloids and most of them less than 0.5. In 23 species the dominant alkaloid formed 84 to 100 per cent. of the total. The wild species, presumed to be the parents of the present day *N. tabacum* and *N. rustica*, all had a low content of alkaloid and contained *normicotine*, so that continued cultivation seems to have increased the yield of alkaloid and favoured the replacement of *normicotine* by nicotine. Attention is also being given to the effects on yield and distribution of alkaloid of change in the conditions of cultivation of tobacco plants,⁶⁹ and of various cultural operations such as topping and plucking.⁷⁰ Topping appears to

have little effect on the yield of alkaloid, but does affect its distribution in the plant. Of more fundamental interest are the effects on the nature and distribution of alkaloid produced in grafting⁷¹ and hybridisation⁷² experiments. Dawson⁷¹ found that when tomato plants were grafted on tobacco, nicotine was found in the leaves, stems and fruit of the scion, whereas in the reverse grafts no appreciable amount of nicotine appeared in the tobacco scions. Similarly, Shmuk, Smirnov and Ilyin⁷¹ found that when *Solanum nigrum*, stramonium or tomato was grafted on *N. tabacum* or *N. rustica*, nicotine appeared throughout stock and scion, but when tobacco was used as the scion on the same three species nicotine could not be detected in stock or scion. Shmuk, Kostov and Borozdina on the other hand grafted *N. glauca* (yielding anabasine) on *N. tabacum* and found that stock and scion then contained a mixture of nicotine and anabasine, the latter predominating, and when the grafting was reversed anabasine replaced nicotine entirely in stock and scion. In hybrids of *N. rustica* (yielding nicotine) with *N. glauca*, the influence of the latter seemed to predominate and the crosses contained anabasine only, but progeny of the back cross (*N. rustica* × *N. glauca* × *N. rustica*) included plants in which anabasine or nicotine might occur alone and others containing a mixture of the two. Results of such experiments are influenced to some extent by external factors and it is not surprising that the results of workers in different countries do not always agree. Dawson⁷¹ (1945), after an interesting and comprehensive analysis of the accumulation patterns in graft combinations involving *N. tabacum*, *N. glauca*, *N. glutinosa* and tomato and in the hybrid *N. tabacum* × *N. glauca*, has come to the conclusion that *normicotine* is produced only in the leaf, and at the expense of nicotine formed in the root. This is taken to mean that of the three major alkaloids, nicotine, anabasine and *normicotine*, only the first two are formed by total synthesis *in situ*, and the third is a secondary product. Contrary to previous findings, anabasine does not predominate over nicotine in the hybrid *N. tabacum* × *N. glauca*. Nicotine is formed in the roots and translocated to the leaves, where it is converted into *normicotine*, by a transmethylation reaction. Nicotine is produced in the roots of all three species. Anabasine is produced in both root and shoot of *N. glauca*. *normicotine* is produced in the leaves of *N. glutinosa* and in the leaves of some strains of *N. glauca* and *N. tabacum*, but always at the expense of preformed nicotine. Either *normicotine* or nicotine may be a normal constituent of *N. glauca*, depending on the strain examined. Dawson has also shown⁷³ that excised tobacco root tips grown *in vitro* in sterile culture synthesise nicotine, which accumulates in the surrounding tissue and synthesis in the roots seems also to be supported by results obtained in the investigation of the distribution of alkaloid in various organs of the tobacco plant.⁷⁴

Efforts are still being made to estimate that elusive notion "quality in smoking tobacco" by chemical analysis⁷⁵; it does at least seem to be clearly established that a low content of protein and of nicotine is desirable, and in that connection the isolation by Bucherer⁷⁶ of several species of

bacteria capable of destroying nicotine is of interest, as it is suggested that by inoculation with such organisms the nicotine content of unfermented tobacco leaf can be reduced by 50 per cent. in a few days.

Much work has also been done in improving the use of nicotine, *nor*nicotine and anabasine as insecticides. Though there are apparently differences in the toxicity of the three alkaloids to certain insect pests, there seems on the whole to be little to choose between them.⁷⁷ Beall ^{77(a)} has made the interesting observation that the larvæ of the tobacco moth, *Phlegethontius quinque maculata*, Haw, are unaffected by immersion for one minute in a 2.5 per cent. solution of nicotine, and a few survived from a 40 per cent. concentration of the alkaloid. The dead specimens showed the nervous degeneration characteristic of insects killed by nicotine. Frank, Holley and Wikholm ⁷⁸ have found that certain azo-derivatives of 3 : 2'-nicotyrine dye wool and also protect it against attacks by the black carpet beetle (*Attagenus piceus*). According to Ripper ⁷⁹ experience gained in large-scale insecticidal campaigns has shown that two undesirable results may follow : (1) the destruction of organisms predatory or parasitic on the pests and (2) the survival, and subsequent increase, of specimens of the pest more resistant to insecticides than their forerunners. To avoid such consequences, biological, as well as chemical, control of insecticidal campaigns is required, and, as one example, a method is described which takes advantage of the difference in toxicity of nicotine vapour to aphides and to their predators or parasites.

The useful reviews of chemical and biological work on the tobacco alkaloids by Jackson,^{16(d)} Roark,^{64(a)} and Markwood ²⁸ issued in the United States have been referred to already and to these may be added that of Holman ⁸⁰ published in the United Kingdom, and the handbook of reference tables on the biochemistry of tobacco issued by Smirnov *et al.*⁸¹ in Russia.

Nicotine and tobacco are no longer of direct therapeutic interest, though both are still employed as veterinary anthelmintics.⁸² Nicotine, lobeline, gelsemine, cytisine and sparteine form a group of alkaloids having in common the property of inducing an initial and transient stimulation, followed by depression, and finally paralysis of the autonomic ganglion. The secondary effects are complex and it is probably on this account that so much work has been expended on the pharmacology of nicotine, which is the typical representative of the group.⁸³ This nicotine type of action is not restricted to the members of this group, and recently Bender, Spirtes and Sprinson ⁸⁴ have observed a nicotine-like action of carbaminocholines and King ⁸⁵ has isolated from the marine worm, *Amphiporus lactifloreus*, a minute quantity of a base, amphiporine, resembling nicotine in pharmacological action. The smoking and chewing of tobacco can induce what may be described as a chronic intoxication, and this has given rise to a considerable literature ⁸⁶ dealing with its therapeutic, social, hygienic and even moral aspects. To this may be added some references to papers on the action of nicotine ⁸⁷ and the absorption and excretion ⁸⁸ of the alkaloid. Werle ⁸⁹ has isolated from the lung, liver and kidney of the rabbit and various other animals an enzyme which changes nicotine so

that it is no longer detectable by pharmacological tests. According to Hicks, Brücke and Huber,⁹⁰ *d*-normicotine closely resembles nicotine in action but is more toxic. Macht and Davies⁹¹ found that in both the α - and β -nicotines and normicotines, the *l*-forms are more potent than the *d*- or *dl*-forms, but the behaviour of the two series is not parallel in all species of animals and that is also true for the comparison of nicotines and normicotines. Nicotine is more toxic than α -nicotine. With the *N*-alkyl-2(or 6)-dehydronicotines, the paralysing action on the respiratory centre and the lowering of blood pressure in dogs increase with the size of the alkyl group from methyl to butyl. The *N*-alkylnicotones are less toxic than nicotine and show no pressor action.⁹²

The action of anabasine is similar to that of nicotine.⁹³ When the piperidine ring of anabasine is opened to produce δ -amino- δ -3-pyridyl-*n*-valeric acid the activity is reduced, and this is also true of the corresponding lactam and the benzoyl derivative.⁹⁴ According to De Eds myosmine is less toxic than nicotine but more active on isolated guinea-pig intestine.⁹⁵

REFERENCES

- (1) *Ber.*, 1935, **68**, 1388 ; 1936, **69**, 250 ; SPÄTH (with ZAJIC), 1935, **68**, 1667 ; (with MARION and ZAJIC), 1936, **69**, 251 ; (with KESZLER), 1936, **69**, 2725 ; 1937, **70**, 704 ; see also HICKS, *Aust. J. exp. Biol.*, 1936, **14**, 39 ; WENUSCH, *Pharm. Zeit.*, 1936, **77**, 141 ; BOWEN, *J. Econ. Entom.*, 1944, **37**, 293 ; BOTTMOLLEY, NOTTLE and WHITE, *Austr. J. Sci.*, 1945, **8**, 18. For early work see LIVERSIDGE on "piturine," *Chem. News*, 1881, **43**, 124 ; PETIT, *Pharm. J.*, 1879, [iii], **9**, 819 ; ROTHERA, *Biochem. J.*, 1910, **5**, 193. (2) *J. Amer. Chem. Soc.*, 1931, **53**, 277 ; 1935, **57**, 959 ; NELSON, *ibid.*, 1934, **56**, 1989 ; KIMURA, *J. Appl. Chem. U.S.S.R.*, 1938, **11**, 109. (3) *Compt. rend.*, 1929, **189**, 945 ; (with MENSCHIKOV), *Ber.*, 1931, **64**, 266 ; 1932, **65**, 234 ; (with NORKINA and MAXIMOVA), 1934, **67**, 1845. (4) *J. Ind. Chem. Soc.*, 1943, **20**, 181 ; cf. *Pharmacographia Indica*, London, 1891, Vol. II, p. 266. (5) *Can. J. Res.*, 1939, **17**, B, 21 ; 1945, **23**, 165. (6) NOGA, *Fachl. Mitt. Öst. Tabakregie*, 1914 (*Chem. Soc. Abstr.*, 1915, i, 711) ; cf. SPÄTH and BINIECKI, *Ber.*, 1939, **72**, 1809. (7) *Compt. rend. Acad. Sci. U.S.S.R.*, 1941, **32**, 62 ; *J. Appl. Chem. Russ.*, 1939, **12**, 1582 ; 1940, **13**, 776 ; 1941, **14**, 864 ; see also SHMUK and KIMURA, *Bull. Appl. Bot. U.S.S.R.*, 1935, A, 111 (*Chem. Abstr.*, 1937, **31**, 5513) ; MARKWOOD and BARTHEL, *J. Assoc. Off. Agric. Chem.*, 1943, **26**, 280 ; BOWEN and BARTHEL, *Ind. Eng. Chem.*, 1944, **36**, 475 ; *Anal. Edit.*, 1943, **15**, 740 ; 1944, **16**, 377. (8) *J. Assoc. Off. Agric. Chem. (U.S.A.)*, 1943, **26**, 283 ; MARKWOOD, *Science*, 1940, **92**, 204. (9) *Ber.*, 1901, **34**, 696. (10) *Arch. Pharm.*, 1931, **269**, 627. (11) *Osterr. Bot. Zeit.*, 1927, **76**, 222. (12) PICTET and COURT, *Ber.*, 1907, **40**, 3771 ; CIAMICIAN and RAVENNA, *Atti. Accad. Lincei*, 1911, **20**, i, 614 ; SPÄTH and ZAJIC, *Ber.*, 1936, **69**, 2448 ; SPÄTH and KUFFNER, *Fortsch. Chem. Org. Naturstoffe*, 1939, ii, 248. (13) See, for example: KAN and LIN, *J. Chin. Chem. Soc.*, 1941, **8**, 1 ; ASKEW, *N.Z. J. Sci. Tech.*, 1942, **24** B, 41 ; FRITZSCHE, *Syracuse Chem.*, 1942, **35**, No. 7, 3, 6 ; BOWEN and BARTHEL, *J. Assoc. Off. Agric. Chem.*, 1944, **27**, 224 ; the following U.S. Patents: GARNER, 2,128,043 ; MCCOY, 2,162,738 ; RADER, 2,235,589 ; EDWARDS, 2,251,041 ; TIGER and DEAN, 2,293,954, and Russian Patents: SHMUK *et al.*, 54,879 ; SAFRONOV, 57, 144 ; MEDRIKOV, 58,981. SUBRAMANIAN and VARIYAR, *J. Sci. Ind. Res. (India)*, 1944, **3**, 143. (14) SEKA, Klein's "Handbuch der Pflanzenanalyse," 1933, **4**, Pt. 3, p. 544 ; TONKIN, "Allen's Commercial Organic Analysis," Edit. 5, Vol. 7, 625 ; DÖRR, *Z. Unters. Lebensm.*, 1934, **67**, 118 ; PYRIKI, *ibid.*, 1943, **86**, 89 ; SCHWEITZER, *Lands. Jahrb.*, 1943, **93**, 331. The Pfyl-Schmitt picrate process (*ibid.*, 1927, **54**, 60) is modified by various authors in *Tabak*, 1940, **3**, 93-123 and by SPAIKOV^{16(a)} and RASMUSSEN and KOFOED.^{16(b)} (15) HOFMANN, *Biochem. Zeit.*, 1933, **260**, 26 ; *Mikrochem.*, 1935, **18**, 24 ; BODNÁR and NAGY, *Z. Unters. Lebensmitt.*, 1937, **73**, 191 ; WENUSCH, *ibid.*, **74**, **48**, 46 ; RIPAN-TILICI and CRISTEA, *ibid.*, 1938, **76**, 44 ; *Deut. Zeit. ges. gericht. Med.*, 1988-9,

30, 231; SPIES, *Ind. Eng. Chem. Anal.*, 1937, 9, 46; BOWEN and BARTHEL, *ibid.*, 1943, 15, 596; SUTHERLAND, DAROGA and POLLARD, *J. Soc. Chem. Ind.*, 1939, 58, 284; DAWSON, *Proc. Indiana Acad. Sci.*, 1939, 49, 91; CORCORAN, HELMER and PAGE, *J. Biol. Chem.*, 1939, 129, 89; BIELEFELDT and JENSEN, *Kem. Maanedssblad.*, 1940, 21, 68; POLICARPO, *Anales farm. bioquímica (Buenos Aires)*, 1941, 12, 117, 126; WERLE and BECKER, *Biochem. Z.*, 1942, 313, 182; MCCORMICK and SMITH, *Ind. Eng. Chem. (Anal.)*, 1946, 18, 508. (16a) MARKWOOD, *J. Assoc. Off. Agric. Chem.*, 1939, 22, 427; 1940, 23, 792, 800, 804; 1942, 25, 474; BOWEN, *ibid.*, 1947, 30, 315; RAPP, WOODMANSEE and MCHARGUE, *ibid.*, 1942, 25, 760; BOWEN, *ibid.*, 1945, 28, 578; AVENS and PIERCE, *Ind. Eng. Chem.*, 1939, 31, 505; SPAIKOV, *Ann. Univ. Sofia. Fac. Agron. Sylv.*, 1941-2, 20, 415 (*Chem. Abstr.*, 1945, 39, 3627); RASMUSSEN and KOFOED, *Dansk. Tids. Pharm.*, 1944, 18, 233; TRAUTNER and NEUFELD, *Aust. Chem. Inst. Journ. Proc.*, 1946, 13, 70. (16b) SHMUK *et al.*⁷; MARKWOOD⁸; KHMURA, *Vsesoyuz. Nauch. Issledovatel. Inst. Tabach Makhoroch Prom.*, 1939, No. 140, 97 (*Chem. Abstr.*, 1940, 34, 4862); C. R. SMITH, *Ind. Eng. Chem.*, 1942, 34, 251; LARSON and HAAG, *ibid.* (Anal. Edit.), 1944, 16, 86; EDWARDS, *J. Soc. Chem. Ind.*, 1944, 63, 186. (16c) COPLEY, ESKEW and WILLAMAN, *Chem. Eng. News*, 1942, 20, 1220; MCMURTRAY, BACON and READY, *U.S. Dept. Agric. Tech. Bull.*, 1942, No. 820; SHMUK, *Tabachm. Prom.*, 1933, No. 3, pp. 4-6. (16d) JACKSON, *Chem. Rev.*, 1941, 29, 123; MARION, *Rev. trimestr. Can.*, 1938, 24, 170; SPÄTH and KUFFNER.¹² (17) JEPHCOTT, *J. Chem. Soc.*, 1919, 115, 105; PATTERSON and FULTON, *ibid.*, 1925, 127, 2435; PATTERSON, LAMBERTON and CUNNINGHAM, *ibid.*, 1932, 962; LOWRY and LLOYD, *ibid.*, 1929, 1376, 1771; TATE and WARREN, *Chem. and Ind.*, 1937, 56, 39T. (18) RATZ, *Monats.*, 1905, 26, 1241. (19) JEPHCOTT¹⁷; HUDSON, *Zeit. Phys. Chem.*, 1904, 47, 113; TSAKALATOS, *Bull. Soc. Chim.*, 1909, [iv], 5, 397; KELLY, O'CONNOR and REILLY, *Nature*, 1941, 148, 438; *J. Chem. Soc.*, 1941, 275; 1942, 511; *cf.* C. R. SMITH,^{16(b)} ASKEW,¹³ NORTON, BIGELOW and VINCENT, *J. Amer. Chem. Soc.*, 1940, 62, 261. For behaviour in salt solutions see FITZGERALD, *J. Council Sci. Ind. Res. Austr.*, 1945, 18, 266. (20) See, for example, LIQUIER, *Compt. rend.*, 1924, 179, 269; LOWRY, *Nature*, 1926, 117, 417; (with Lloyd).¹⁷ (21) PICTET and ROTSCHY, *Ber.*, 1900, 33, 2533; *cf.* SPÄTH and BOBENBERGER, *Ber.*, 1944, 77, 362. (22) CHATTAWAY and PARKES, *J. Chem. Soc.*, 1929, 1314. (23) RAYBURN, HARLAN and HAMMER, *J. Amer. Chem. Soc.*, 1941, 63, 115. (23a) TSCIITSIBABIN (with BUCHHOLZ), *J. Russ. Phys. Chem. Soc.*, 1920, 50, 548; (with KIRSSANOV), *Ber.*, 1924, 57, 1163; GOLDFARB (with KONDAKOVA), *C. R. Acad. Sci. U.S.S.R.*, 1945, 48, 484; 49, 421; (with KATRENKO), *ibid.*, 1940, 27, 673; CLEMO and SWAN, *J. Chem. Soc.*, 1946, 603. (24) KIPPENBERGER, *Zeit. Anal. Chem.*, 1903, 42, 275; KATZ, *ibid.*, 1937, 108, 408; SHAIKOVA, *Pharm. u. Pharmakol.*, 1938, 10; *see also* FUKS, *J. Appl. Chem. U.S.S.R.*, 1946, 19, 102. (24a) *Quart. J. Pharm.*, 1946, 19, 530. (25) *Compt. rend.*, 1927, 184, 331, 1333. (26) *Ber.*, 1930, 63, 2018. (27) Ger. Pat. 80,520; *Ber.*, 1905, 38, 880, 882; *cf.* SPÄTH and ZAJIC, 1935.¹ (28) *U.S. Dept. Agric. Bur. Entom.*, E561, 1942. (29) HUBER, *Annalen*, 1867, 141, 271; WEIDEL, *ibid.*, 1873, 165, 328; LAIBLIN, *Ber.*, 1877, 10, 2136. For recent industrial methods see WOODWARD *et al.*, *Ind. Eng. Chem.*, 1944, 36, *Indust. Edit.*, pp. 540, 544; VASIUNINA, *J. Appl. Chim. Russ.*, 1943, 16, 206. (30) *Ber.*, 1886, 19, 2587. (31) *Annalen*, 1879, 196, 172. (32) *Ber.*, 1891, 24, 326; 1893, 26, 628, 1029. (33) *Ibid.*, 1892, 25, 2807; 1893, 26, 292, 765. (34) *Compt. rend.*, 1893, 117, 170, 278. (35) *Ber.*, 1894, 27, 1053, 2861; 1895, 28, 456. (36) *Ibid.*, 1942, 75, 522. (37) LÖFFLER and KOBER, *ibid.*, 1909, 42, 3431. (38) *Ibid.*, 1893, 26, 628, 1029; *cf.* HARLAN and HIXON, *J. Amer. Chem. Soc.*, 1930, 52, 3385. (39) MAASS *et al.*, *Ber.*, 1905, 38, 1831; 1906, 39, 3697; 1914, 47, 1164. (40) *Ibid.*, 1897, 30, 2117. (41) *Ibid.*, 1895, 28, 1904. (42) *Ibid.*, 1885, 18, 1828; 1887, 20, 698; 1889, 22, 659, 2518. (43) PICTET and ROTSCHY, *ibid.*, 1904, 37, 1225; *cf.* SPÄTH and KAINRATH, 1938, 71, 1276; *see also* WIBAUT (with DINGEMANSE), *Rec. Trav. Chim.*, 1923, 42, 1033; (with GITSLS), *ibid.*, 1938, 57, 755; 1941, 60, 176, and LIONS and RITCHIE, *Proc. Roy. Soc. N.S. Wales*, 1940, 74, 110. (44) *Biochem. Zeit.*, 1935, 275, 361; SPÄTH and KESZTLER, *Ber.*, 1937, 70, 2450. (45) *Bull. Soc. Chim.*, 1880, [ii], 34, 449; *cf.* BLAU, *Ber.*, 1894, 27, 2535; TAFEL, *ibid.*, 1892, 25, 1619; *see also* MORTON and HORVITZ, *J. Amer. Chem. Soc.*, 1935, 57, 1860. (46) *Ber.*, 1895, 28,

- 1904; 1898, 31, 2018; 1900, 33, 2355. (47) *Rec. trav. Chim.*, 1928, 47, 935; see also FRANK, HOLLEY and WIKHOLM, *J. Amer. Chem. Soc.*, 1942, 64, 2835. (48) *Ibid.*, 1932, 51, 1157; SPÄTH, WIBAUT and KESZTLER, *Ber.*, 1938, 71, 100. (49) ZELINSKI, *ibid.*, 1925, 58, 185; cf. ZELINSKI and JURGEV, *ibid.*, 1931, 64, 101. (50) *Ibid.*, 1935, 68, 494, 1125. (51) *Ibid.*, 1928, 61, 327. (52) *J. Amer. Chem. Soc.*, 1933, 55, 2854. (53) GOUGH and KING, *J. Chem. Soc.*, 1931, 2968; 1932, 2768; 1933, 350; LUND, *ibid.*, 1933, 686; 1935, 418; and CLEMO and HOLMES, *ibid.*, 1934, 1739. (54) *Helv. Chim. Acta*, 1925, 8, 364; KARRER and TAKAHASHI, *ibid.*, 1926, 9, 458. (55) TSCHITSCHIBABIN and BYLINKIN, *Ber.*, 1923, 56, 1745; WIBAUT and DINGEMANSE, *Rec. trav. Chim.*, 1923, 42, 1033; 1926, 45, 657, 671. (56) *Ibid.*, 1933, 52, 941. (57) *J. Amer. Chem. Soc.*, 1934, 56, 1144. (58) *Compt. rend.*, 1929, 189, 945; *Ber.*, 1931, 64, 266; (with NORKINA and NARKUZIEV), *J. Gen. Chem. Russ.*, 1937, 7, 951. (59) *J. Amer. Chem. Soc.*, 1931, 53, 277; 1935, 57, 959; NELSON, *ibid.*, 1934, 56, 1989. (60) SPÄTH and KESZTLER, *Ber.*, 1937, 70, 239, 704. (61) OREKHOV and NORKINA, *ibid.*, 1932, 65, 742, 1126; ZDANOVICH and MENSCHIKOV, *J. Gen. Chem. U.S.S.R.*, 1945, 15, 116; SADYKON, *ibid.*, 1947, 17, 1710; SMITH, *J. Amer. Chem. Soc.*, 1932, 54, 397. (61a) *J. Gen. Chem. U.S.S.R.*, 1947, 17, 1212. (62) OREKHOV and BRODSKI, *Ber.*, 1933, 66, 466; cf. WENUSCH (with SCHOELLER) *ibid.*, 1934, 67, 1344; (with BILOWITZKI) *Biochem. Zeit.*, 1934, 270, 15; FUKS, *Lab. Prakt. U.R.S.S.*, 1941, 16, 23. (63) KABATSCNIK and KATZNELSON, *Bull. Soc. Chim.*, 1935, [v], 2, 521, 576; *Ber.*, 1935, 68, 399, 1247; cf. *Compt. rend. Acad. Sci. U.R.S.S.*, 1934, 1, 406; 4, 47; 1935, 3, 169; also OREKHOV and NORKINA, *Ber.*, 1932, 65, 1126; and MENSCHIKOV, GRIGOROVITCH and OREKHOV, *ibid.*, 1934, 67, 289, 1157, 1398. (63a) VILJAMS and MAVLEIRNOV, *J. Appl. Chem. Russ.*, 1944, 17, 228. (64) SPÄTH (with MAMOLI), *Ber.*, 1936, 69, 1082; (with KESZTLER, *ibid.*, 1937, 70, 70. (64a) *U.S. Dept. Agric. Bur. Entom.*, E537 (1941). (65) *Arch. Pharm.*, 1906, 244, 388. (66) *Fachl. Mitt. öst. Tabakregie*, (1914) (*Chem. Soc. Abstr.*, 1915, [i], 711). (67) Quoted by SPÄTH, WENUSCH and ZAJIC, *Ber.*, 1936, 69, 393. (68) *Ibid.*, 1936, 69, 757. (69) GREBINSKY, *Compt. rend. Acad. Sci. U.S.S.R.*, 1941, 32, No. 4 (*Nature*, 1944, 151, 338). (70) VLADESCU and DIMOFTE, *Bull. cult. ferment. Tutunului*, 1940, 29, 153; 1941, 30, 115, 226; 1942, 31, 32 (*Chem. Abstr.*, 1942, 36, 6578; 1943, 37, 3473, 3566; 1944, 38, 145). (71) DAWSON, *Amer. J. Bot.*, 1942, 29, 66; 1944, 31, 351; 1945, 32, 416; *J. Amer. Chem. Soc.*, 1945, 67, 503; SHMUK (with SMIRNOV and ILYIN), *Compt. rend. Acad. Sci. U.S.S.R.*, 1941, 32, 365; (with KOSTOV and BOROZDINA), *ibid.*, 1939, 25, 477. (72) SHUKOV, *ibid.*, 1939, 22, 116; KOSTOV, *idem.*, p. 121; KUZ'MENKO TIKHVINSKAYA, *Bull. Acad. Sci. U.S.S.R., Biol. ser.*, 1940, 576 (*Chem. Abstr.*, 1941, 4802); H. and C. SMITH, *J. Agric. Res.*, 1942, 65, 347; BOWEN, *J. Amer. Pharm. Assoc.*, 1945, 34, 199. (73) DAWSON, *Science*, 1941, 94, 396; *Amer. J. Bot.*, 1942, 29, 813; cf. MOTHES and HIEKE, *Naturwiss.*, 1943, 31, 17; WENUSCH, *Wien. Chem. Zeit.*, 1943, 46, 196. (74) ANDREADIS *et al.*, *Z. Unters. Lebensm.*, 939, 77, 262; PYRIKI, *ibid.*, 1942, 83, 221; FATON, *Pharm. Weekbl.*, 1939, 76, 1183. (75) BLICK, *N.Z. J. Sci. Tech.*, 1943, 25, 53; NAGSKI, BEINHART and COUCH, *Ind. Eng. Chem. (Ind. edit.)*, 1944, 36, 556; WENUSCH, *Wien. Chem. Zeit.*, 1943, 46, 178; PYRIKI, *Z. Unters. Lebensm.*, 1942, 84, 36. (76) *Zentr. Bakt. Parasitenk.*, 1942, Abt. II, 105, 166; 1943, Abt. II, 105, 445; ENDERS and GLAWE, *Biochem. Zeit.*, 1944, 312, 277. (77) For anabasine, see especially SMITH, RICHARDSON and SHEPARD, *J. Econ. Entom.*, 1930, 23, 863; GINSBERG, SCHMITT and GRANETT, *J. Agric. Res.*, 1935, 51, 349; ROARK ^{64(a)}; NABOKOV, *Amer. Rev. Soviet Med.*, 1945, 2, 449. (77a) BEALL, *Ann. Rept. Entom. Soc. Ontario*, 1941, 72, 32. (77b) Nicotine aerosols, SMITH and GOODHUE, *J. Econ. Entom.*, 1943, 36, 904; review of nicotine as insecticide, MCINDOO, *ibid.*, p. 473. (78) *J. Amer. Chem. Soc.*, 1942, 64, 2835. (79) *Nature*, 1944, 153, 448. (80) "A Survey of Insecticidal Materials of Vegetable Origin," Imperial Institute, London, 1940. (81) *Inst. Biochem. Acad. Sci. U.S.S.R.*, 1940, 1-203. (82) WILLMAN and BAKER, *Cornell Vet.*, 1943, 33, 365. (83) For useful bibliographies see ZUNZ, "Elements de Pharmacodynamie speciale," I, 1932, 268; CUSHNY, "Pharmacology and Therapeutics," London, 1934, 335; for a recent survey of information see HAAG and LARSON, *Virg. Med. Monthly*, 1944, 71, 235. (84) *J. Pharm. Exp. Ther.*, 1943, 77, 107. (85) *J. Chem. Soc.*, 1939, 1365. (86) For an informative article on this subject see Sir

Humphrey ROLLESTON, *Lancet*, 1926, 210, 961; CORTE, "A History of Smoking," English translation by England, New York, 1932. For information on the development of tolerance to nicotine in animals, see BEHREND and THIENES, *J. Pharm. Exp. Ther.*, 1933, 48, 317; PEARL, *Science*, 1938, 87, 216. (87) STRAUB and AMANN, *Klin. Woch.*, 1940, 19, 169; LESSING, *Med. Welt.*, 1938, 12, 1485; COON and ROTHMAN, *Proc. Soc. Exp. Biol. Med.*, 1939, 42, 231; *J. Pharm. Exp. Ther. Proc.*, 1941, 72, 9; HUEPER, *Arch. Path.*, 1943, 35, 846; ROTH, McDONALD and SHEARD, *J. Amer. Med. Assoc.*, 1944, 125, 761; *Med. Clin. N. America*, 1945, 29, 949; BURN, TRUELOVE and BURN, *Brit. Med. J.*, 1945, i, 403. (88) PERLMAN, DANNESBORG and SOKOLOFF, *J. Amer. Med. Assoc.*, 1942, 120, 1003; HAAG and LARSON, *Fed. Proc.*, 1942, II, 1, 142; *Science*, 1943, 97, 187; *J. Pharm. Exp. Ther.*, 1942, 76, 235, 240; 1943, 77, 343 (with NEALE), *ibid.*, 1940, 69, 289; (with FINNEGAN), *ibid.*, 1945, 85, 356; 1946, 86, 239; 1947, 91, 357; (with SCHWARTZ), 1946, 88, 82; PYRIKI, *Zeit. Physiol. Chem.*, 1943, 277, 233; *Z. Unters. Lebensm.*, 1943, 85, 337; LOCKETT, *J. Physiol.*, 1944, 103, 68, 185. (89) *Biochem. Zeit.*, 1938, 298, 268; (with MULLER), *ibid.*, 1941, 308, 355; (with BECKER), *ibid.*, 1943, 313, 182. (90) *Arch. int. Pharmacodyn.*, 1935, 51, 335; HICKS and SINCLAIR, *Aust. J. Exp. Biol. Med.*, 1947, 25, 83; cf. LARSON, HAAG and FINNEGAN, *Proc. Soc. Exptl. Biol. Med.*, 1945, 58, 231. (91) *J. Pharm. exp. Ther.*, 1934, 50, 93; cf. MAYER, *Arch. Sci. phys. nat.*, 1904, 17, 418; OOSTERHUIS and WATERMAN, *J. Pharm. Exp. Ther.*, 1938, 63, 318; HEYMANS and BOUCKAERT, *Arch. int. Pharmacodyn.*, 1941, 65, 196. (92) KARRER *et al.*, *Helv. Chim. Acta*, 1926, 9, 458, 461. (93) HAAG, *J. Pharm. exp. Ther.*, 1933, 48, 95; see also ROARK^{64(a)} and for aminoanabasines, POLUEKTOV, *Farmakol Toksikol.*, 1939, 2, 49 (*Chem. Abstr.*, 1940, 34, 3818); KABATSCNIK and ZITZER, *J. Gen. Chem. Russ.*, 1940, 10, 1007 (*Chem. Abstr.*, 1941, 35, 3640) (94) MENSCHIKOV *et al.*, *Ber.*, 1934, 67, 1157; for methylanabasine see SAKSONOV, *Farmakol. Toksikol.*, 1946, 9, 13. (95) *Proc. Soc. Exptl. Biol. Med.*, 1946, 63, 423.

ALKALOIDS OF ANABASIS APHYLLA

Anabasis aphylla occurs on the Russian steppes from the Caspian Sea to Turkestan and has the reputation of a poisonous plant. The interest evinced in its alkaloids is due to the insecticidal properties of the principal constituent, anabasine, described already as a constituent of tobacco (p. 43). Methods¹ for the extraction of anabasine have been described by Sokolov and by Smirnov, for its separation from associated lupinine by Sadykov and Spasokukotski, and its oxidation to nicotinic acid by Sadykov. The crude anabasine sulphate of commerce appears to be a mixture of sulphates of anabasis alkaloids.² In it Smith³ found methyl-anabasine (picrate, m.p. 222–3°, *corr.*), but Orekhov and Norkina⁴ were unable to confirm this. According to Orekhov⁵ the plant contains 2.3 per cent. of alkaloids separable into low-boiling (136–8.5°/12 mm.) and high-boiling (b.p. 200°/12 mm.) fractions, of which the former consists of anabasine, and lupinine (p. 120), whilst the high-boiling fraction comprises, in addition to still unidentified bases, the three alkaloids described below, which are separated by fractional precipitation of the crude hydrochlorides by alkali. In the purification of aphyllidine a minute quantity of an alkaloid, m.p. 162–4°, $[\alpha]_D + 54.5^\circ$ was isolated.⁶

Aphyllidine, $C_{15}H_{22}ON_2$, is purified through the perchlorate, $B. HClO_4$, m.p. 210–2°; the recovered crystalline base has m.p. 112–3°, $[\alpha]_D^{20} + 6.5^\circ$ (MeOH), and is readily soluble in alcohol or ether, sparingly in light petroleum and slightly in water. The hydrochloride, $B. HCl$, has m.p. 235–7°. The picrolonate forms small yellow prisms, m.p. 235–6°, and the methiodide, $B. MeI$, yellowish needles, m.p. 225–7° (*dec.*). With bromine

in chloroform the base forms an unstable dibromide, which changes into bromoaphyllidine hydrobromide, colourless needles, m.p. 210–1°, from which bromoaphyllidine, m.p. 150–2° is readily recovered.

Aphylline, $C_{15}H_{24}ON_2$, finally purified through the hydrochloride, is an oil, which distils at 200°/4 mm. and then crystallises when rubbed. It melts at 52–3°, has $[\alpha]_D^{20} + 10.3^\circ$ (aqueous methyl alcohol) and is soluble in all ordinary organic solvents. The hydrochloride, $B \cdot HCl \cdot xH_2O$, has $[\alpha]_D^{20} + 13.6^\circ$ (H_2O). The picrolonate forms small yellow prisms, m.p. 230–1° (*dec.*), and the methiodide large colourless needles, n.p. 219–221° (*dec.*).

Reactions of Aphyllidine and Aphylline. The work done by Orekhov⁶ and by Späth *et al.*⁷ is interlinked, and establishes a close relationship between aphylline and aphyllidine. According to Orekhov, aphyllidine is hydrogenated in presence of platinic oxide to aphylline. Späth *et al.* did not isolate aphylline in this reaction, but found that the oily, dihydro-base so formed, on acid hydrolysis, followed by esterification, yielded ethyl aphyllate, $C_{17}H_{30}O_2N_2$, b.p. 150° (*high vac.*), monohydrate, m.p. 76–7°, $[\alpha]_D^{18} + 25.3^\circ$ (MeOH: $c = 9.96$). Aphyllic acid, $C_{15}H_{26}O_2N_2$, m.p. 218–221°, prepared from this ester, and repeatedly distilled at 140–150° (*high vac.*) yields aphylline (*see above*), $[\alpha]_D^{18} + 10.08^\circ$ (MeOH: $c = 7.94$) from which ethyl aphyllate can also be produced directly by acid hydrolysis followed by esterification.

According to Orekhov,⁶ aphyllidine on acid hydrolysis and esterification yields ethyl aphyllidate, m.p. 210–2°.

On hydrogenation at 80°, or on electrolytic reduction, aphyllidine is converted into *d*-sparteine (p. 133). On exhaustive methylation one nitrogen atom is eliminated in three stages, leaving a product, b.p. 235–255°/11 mm., as a viscous, yellow, alkaline oil of uncertain composition. Aphylline, on similar treatment, yields hemiaphylline, $C_{15}H_{21}ON$, b.p. 217–220°, as a viscous, yellow oil, not markedly basic.

These observations suggest a similarity in structure to sparteine, and Orekhov⁵ has proposed for aphylline a formula identical with Clemo's formula for oxysparteine (p. 138 (VIII)) with the change of CH_2 at position 10 into CO), aphyllidine having in addition an ethylenic linkage at C⁵—C⁶.

Base V, $C_{16}H_{24}$ or $26O_2N_2$. This substance is present in small quantity (about 1.5 per cent.) in crude aphylline hydrochloride and when the base is liberated into ether from this salt, the solution deposits Base V on standing. It is sparingly soluble in ether or light petroleum, readily in benzene or alcohol and crystallises from benzene-light petroleum in colourless tablets, m.p. 137° (*dec.*).

REFERENCES

- (1) SOKOLOV, *J. Chem. Ind. U.R.S.S.*, 1941, 18, 15; SMIRNOV, *Russ. Pat.*, 59, 807; SADYKOV and SPASOKUKOTSKI, *J. Gen. Chem. U.R.S.S.*, 1943, 13, 830; SADYKOV, *ibid.*, 1945, 15, 252.
- (2) DASHKEVICH, *Trudy Leningrad Inst. Sovet Torgovli*, 1939, No. 2, p. 8 (*Chem. Abstr.*, 1943, 37, 3228).
- (3) *J. Amer. Chem. Soc.*, 1932, 54, 397.
- (4) *Ber.*, 1932, 65, 724.
- (5) *Compt. rend.*, 1929, 189, 945; (with MENSCHIKOV), *Ber.*, 1931, 64, 266; 1932, 65, 234; (with NORKINA and MAXIMOVA), 1934, 67, 1845.
- (6) *J. Gen. Chem. Russ.*, 1937, 7, 2048 (*Brit. Chem. Abstr.*, 1938, A, ii, 74).
- (7) *Ber.*, 1942, 75, 805.

ALKALOIDS OF POMEGRANATE ROOT BARK

From the root bark of the pomegranate tree (*Punica Granatum*, L.) Tanret¹ isolated four alkaloids, *pseudopelletierine*, $C_9H_{15}ON$, *pelletierine*, $C_8H_{15}ON$, *isopelletierine*, $C_8H_{15}ON$, and *methylpelletierine*, $C_9H_{17}ON$. To these Piccinini² added a fifth, *isomethylpelletierine*, which Hess and Eichel³ suggested was identical with Tanret's *methylpelletierine*. Tanret's description of *pelletierine* and *isopelletierine* indicates that the only difference between the two is that the latter is optically inactive, and as Hess and Eichel³ could find no optically active base in the bark they re-named *isopelletierine* as *pelletierine*. There is, however, little doubt that *l*-*pelletierine* does occur in the bark (Tanret, 1920; Goodson, 1944).³ Hess and Eichel³ also found that Tanret's *methylpelletierine* is not derived from *pelletierine* and on that ground re-named it *methylisopelletierine*. Hess eventually isolated *isopelletierine* from the bark,⁴ together with a supposed new base, α -*N*-methylpiperidyl-2-propan- β -one,⁴ $C_9H_{17}ON$, which proved to be *methylisopelletierine*.⁵

The minute structure of the bark has been investigated by Griffiths⁵ and the distribution of alkaloids in various parts of the plant by Chaze.⁶ Various methods have been described by the authors already named⁷ for the extraction and separation of the alkaloids. By his process Hess obtained per kilogram of bark, *pelletierine* 0.52, *pseudopelletierine* 1.8, *methylisopelletierine* 0.2 and *isopelletierine* 0.01 gm. Methods for the estimation of the total alkaloids, or of active fractions, in the bark have been described by Ewers,⁸ Stöder,⁸ and in the French Codex (1926). The British Pharmaceutical Codex (1934) states that the alkaloidal content varies from 0.5 to 0.9 per cent. but in an examination of commercial samples of bark Goodson³ found great variation, *viz.*, 0.074 to 0.58 per cent. using Ewers's method. The "pelletierine tannate" and "pelletierine sulphate" of commerce should consist of the mixed salts of the active bases, excluding *pseudopelletierine*, but according to G. Tanret⁸ commercial samples are not always of this character, and this has been confirmed by Goodson,³ who found that about 50 per cent. of the total alkaloids from good bark might rank as "pelletierine" for medicinal use.

Pelletierine, $C_8H_{15}ON$. Hess's *dl*-base is a colourless, alkaline oil, b.p. 106°/21 mm., which readily absorbs oxygen becoming dark and resinous; it is soluble in water, ether or chloroform. The hydrochloride has m.p. 143–4°; the hydrobromide melts at 140°, the picrate at 150–1°; the picrolonate at 172–3° and the aurichloride, which crystallises in orange leaflets, at 82–82.5°. ^{12(a)} By slow evaporation of an aqueous solution of *pelletierine* hydrogen *d*-tartrate, Hess and Eichel⁹ have resolved the *dl*-base into *d*- and *l*-forms, the latter being finally purified through the *l*-acid tartrate of which the pure *l*-form has m.p. 129°, $[\alpha]_D^{20}$ — 20.94° and the sulphate $[\alpha]_D^{18}$ — 5.89°; the constants of *d*-*pelletierine d*-acid tartrate are m.p. 129° and $[\alpha]_D^{20}$ + 21° (EtOH); the *d*-base sulphate has $[\alpha]_D^{18}$ + 5.86°. *Pelletierine* was originally described as dextrorotatory and giving lævorotatory salts but later (1920) G. Tanret³ assigned to the free base the specific rotation — 31.1° and described a number of lævorotatory salts :

hydrochloride, — 41.2°, sulphate, — 30.3°, hydrobromide, — 32.5°. The *N*-acetyl derivative, b.p. 205–10°/40 mm., has $[\alpha]_D + 32.6^\circ$ and the *N*-benzoyl derivative, m.p. 75° (Hess), $[\alpha]_D + 18.7^\circ$. The semicarbazone hydrochloride melts at 168–170° and has $[\alpha]_D - 10.8^\circ$.

Methylpelletierine, $C_9H_{17}ON$. Though Hess and Eichel³ were unable to confirm the existence of Tanret's methylpelletierine, G. Tanret³ has re-affirmed its occurrence and described it as an oily liquid, b.p. 106–8°/45 mm., $[\alpha]_D + 27.7^\circ$, forming a hydrochloride, m.p. 168–170°, $[\alpha]_D + 41.2^\circ$; hydrobromide, m.p. 165–7°, $[\alpha]_D + 33.5^\circ$; sulphate, $[\alpha]_D + 38^\circ$, picrate, m.p. 157–9° and platinichloride, m.p. 206–8°.¹⁴ The *N*-methylpelletierine which Hess⁴ obtained by treating pelletierine with formaldehyde and formic acid had b.p. 98–102°/14 mm., and gave a hydrobromide m.p. 152° and a semicarbazone hydrochloride m.p. 168–9° (*dec.*), (*cf.* methylisopelletierine below).

Constitution. Pelletierine behaves as a secondary amine and the oxygen atom of the alkaloid is present in the form of an aldehyde group,¹¹ since the base yields an oxime, convertible by the action of phosphorus pentachloride into a nitrile, b.p. 104–6°/15 mm., which is hydrolysed by caustic potash in alcohol to an acid, the ethyl ester of which is Löffler and Kaim's¹¹ ethyl β -2-piperidylpropionate. Pelletierine is not directly oxidisable to this acid. It also yields a liquid hydrazone, b.p. 150°/20 mm., which with sodium in alcohol at 156–70° reduces to *dl*-coniine. These reactions are explained by the following formulæ,¹⁰ in which pelletierine is represented as β -2-piperidylpropionaldehyde.

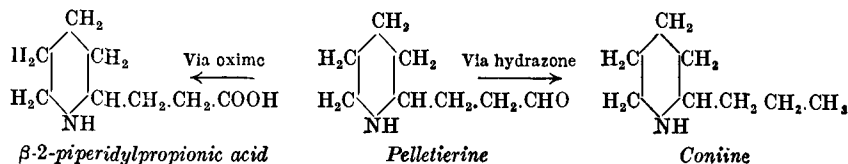

Some progress has been made towards a synthesis of pelletierine by Wibaut and Beets^{12(a)} and by Spielman, Swadesh and Mortenson.^{12(b)} Roth started by condensing α -picoline with bromoacetal with the aid of lithium phenyl, so producing β -(2-pyridyl)-propionaldehyde acetal, $C_5H_4N \cdot CH_2 \cdot CH_2 \cdot CH(OEt)_2$, which Wibaut and Beets isolated as the mercurichloride, m.p. 98.5°. From this the acetal, b.p. 85.0°/0.1 mm., was recovered by the action of sodium sulphide, and hydrogenated in glacial acetic acid with platonic oxide as catalyst. The products were predominantly either δ -conicëine (p. 20) or β -(2-piperidyl)-propionaldehyde acetal (pelletierine acetal), $C_5H_{10}N \cdot CH_2 \cdot CH_2 \cdot CH(OEt)_2$, depending on the initial concentration. The second of these products was isolated as the monoacetate, $B \cdot C_2H_4O_2$, b.p. 93–4°/0.33 mm., m.p. 72–4°, from which the acetal was recovered as a liquid, b.p. 101–2°/1.3 mm., giving a picrolonate, m.p. 162–3°. In view of the production of δ -conicëine on hydrogenation, Beets^{12(a)} has suggested that pelletierine may exist in tautomeric forms, one of which is bicyclic.

Spielman *et al.* record b.p. 123°/8 mm. and n_D^{25} 1.5070 for the β -(2-pyridyl)-propionaldehyde they hydrogenated using Raney nickel as catalyst in alcohol at 150° and 170 atm. pressure. The pelletierine acetal produced had b.p. 91–2°/1 mm. and n_D^{25} 1.4568 and yielded a benzoyl derivative, b.p. 177–8°, n_D^{25} 1.5229, from which by hydrolysis *N*-benzoyl-pelletierine, m.p. 74–6°, was obtained; by similar procedure *N*-acetyl-pelletierine, b.p. 174°/18 mm., n_D^{26} 1.4908, and pelletierine ϵ -thylurethane, b.p. 119–21°/1 mm., n_D^{25} 1.4771, the constants recorded being in satisfactory accord with those given by Hess³ for these pelletierine derivatives. No method has yet been found of recovering pelletierine from the acetal.

*iso*Pelletierine, C₈H₁₅ON. This name, originally applied by Tanret to a base, now regarded as *dl*-pelletierine, has been adopted by K. Hess¹³ for a different alkaloid. This is an oily liquid having b.p. 102–7°/11 mm., $[\alpha]_D \pm 0^\circ$; the hydrobromide melts at 149° and the picrate at 147–8°. *iso*Pelletierine is also obtained by demethylation of methyl*iso*pelletierine and is convertible into the latter by methylation. Its constitution is discussed below.

Methyl*iso*pelletierine, C₉H₁₇ON. This base, isolated by Piccinini² under the name *isomethylpelletierinc*, was re-examined by K. Hess¹⁵ *et al.* It is an oily alkaline liquid, b.p. 114–7°/26 mm., miscible with water and optically inactive. The hydrochloride has m.p. 156°; hydrobromide, m.p. 151–2°; the picrate melts at 158° and the aurichloride forms orange-yellow rosettes, m.p. 115–7°. The base can be resolved into *d*- and *l*-forms having b.p. 109°/24 mm., and specific rotations $[\alpha]_D^{18}$ of 6.7° and 9.9° in dilute sulphuric and hydrochloric acids respectively. *d*-Methyl-*iso*pelletierine *d*-hydrogen tartrate has m.p. 133–4° and $[\alpha]_D^{20} + 22.7^\circ$, and the antipode has m.p. 132–4° and $[\alpha]_D^{18} - 20.83^\circ$, whilst the two hydrochlorides have $[\alpha]_D^{18} + 11.08^\circ$ and -10.64° respectively.

Constitution. The alkaloid yields a crystalline semicarbazone, m.p. 169°, a liquid hydrazone, b.p. 154–5°/29 mm., and a liquid oxime, b.p. 160°/12 mm., from which a crystalline picrate, m.p. 106°, can be prepared. The methiodide crystallises in cubes, m.p. 156°. On oxidation with chromic acid in sulphuric acid solution the base yields *N*-methylpiperidine-2-carboxylic acid, and the hydrazone on reduction with sodium in alcohol at 150–70° forms *N*-methylconiine (p. 17).

In view of these reactions methyl*iso*pelletierine must be *N*-methylpiperidine with one of the following side-chains in position 2: (a) —CH₂.CH₂.CHO; (b) —CO.CH₂.CH₃; (c) CH₂.CO.CH₃. If the side-chain were (a) methyl*iso*pelletierine should be formed by *N*-methylation of pelletierine, which is not the case. Decision between (b) and (c) proved difficult. If the side-chain were (c) the alkaloid should be α -*N*-methylpiperidyl-2-propan- β -one (I). This substance was synthesised by Hess and Eichel³ and appeared not to be identical with methyl*iso*pelletierine, and Hess was, therefore, led to the conclusion that the side-chain must be (b), which would make methyl*iso*pelletierine structurally identical with methylconhydrinone. The difficulty was

solved by Meisenheimer and Mahler,⁵ who found that the synthetic product of the earlier workers was a mixture and devised the following new synthesis. 2- β -Hydroxy-*n*-propylpyridine (II) as the methosulphate was hydrogenated, with platinum-platinum oxide as catalyst, to *N*-methyl-2- β -hydroxy-*n*-propylpiperidine, b.p. 110–20°/22 mm., which on oxidation with chromic anhydride in acetic acid gave methylisopelletierine (I). Catalytic hydrogenation of 2- β -hydroxy-*n*-propylpyridine (II) gave 2- β -hydroxypropylpiperidine, m.p. 69–70° (not 45–7° as stated by Ladenburg). This, on oxidation with chromic anhydride in acetic acid, gave isopelletierine (III) (α -piperidyl-2-propan- β -one), which on methylation by formaldehyde yielded methylisopelletierine (I).

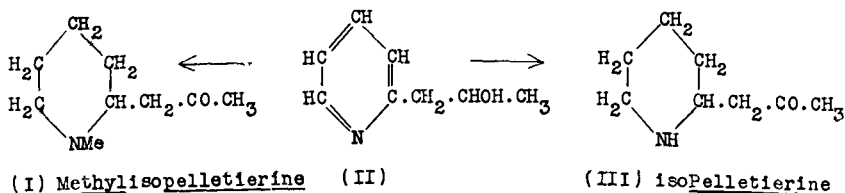

New syntheses of isopelletierine and its *N*-methyl derivative have been provided by Wibaut *et al.*^{12(c)} by an extension of the process used for the preparation of *dl*-pelletierine acetal. By the action of acetic anhydride on lithium picolyl in nitrogen, an acetyl group was inserted in the methyl group of α -picoline and the resulting α -2-pyridylpropane- β -one (α -picolyl methyl ketone), $C_5H_4N \cdot CH_2 \cdot CO \cdot CH_3$, b.p. 92°/1.5 mm., characterised as the picrate, m.p. 140–140.5°, and picrolonate, m.p. 179.5–181°, was hydrogenated in acetic acid with platinum oxide as catalyst, to *dl*-isopelletierine, $C_5H_{10}N \cdot CH_2 \cdot CO \cdot CH_3$, b.p. 62°/0.8 mm., identified as the picrate, m.p. 147.5–148.5°, and picrolonate, m.p. 177–9°.

α -2-Pyridylpropane- β -one was converted by methyl sulphate to the methyl methosulphate, $C_8H_9ONMe \cdot MeSO_4$, a crystalline precipitate, which hydrogenated as before, yielded *dl*-methylisopelletierine $C_5H_{10}NMe \cdot CH_2 \cdot CO \cdot CH_3$, b.p. 43°/0.16 mm., identified as the picrate, m.p. 157°.

pseudo-Pelletierine, $C_9H_{15}ON$ (*N*-Methylgranatonine). This, the best known of the pomegranate bark alkaloids, was isolated by Tanret in 1879. It crystallises from light petroleum in prismatic tablets, m.p. 48°, b.p. 246°, $[\alpha]_D \pm 0^\circ$, dissolves readily in ether, alcohol or chloroform, less readily in light petroleum. It is a strong base and gives well-crystallised salts; the hydrochloride, $B \cdot HCl$, forms rhombohedra; the platinum-chloride, $B_2 \cdot H_2PtCl_6$, reddish needles, and the aurichloride yellow crystals, m.p. 162°. The picrate is readily soluble in hot water and melts at 252–3° (*dec.*). The dipiperonylidene derivative crystallises from alcohol in yellow, triangular microscopic plates, has m.p. 226–7°, is sparingly soluble in most organic solvents and gives an intensely royal blue colour in strong sulphuric acid, the colour changing to green and yellow on dilution with water.¹⁶ ψ -Pelletierine in sulphuric acid solution gives an intense green colour on addition of a trace of potassium dichromate.

Constitution. The alkaloid behaves as a tertiary base, forming a methiodide (colourless cubes, m.p. above 280°). It forms an oxime (tablets, m.p. 128°) and on reduction is converted into the secondary alcohol, *N*-methylgranatoline, C₉H₁₇ON, which crystallises from light petroleum in slender needles, m.p. 100°, and b.p. 251°. It forms a benzoyl derivative, and when heated with hydriodic acid gives *N*-methylgranatyl iodide, C₉H₁₆NI. The latter, on longer heating with the reagent, loses a molecule of hydriodic acid and forms the unsaturated *N*-methylgranatenine C₉H₁₅N. This series of changes may be represented thus ¹⁷ :

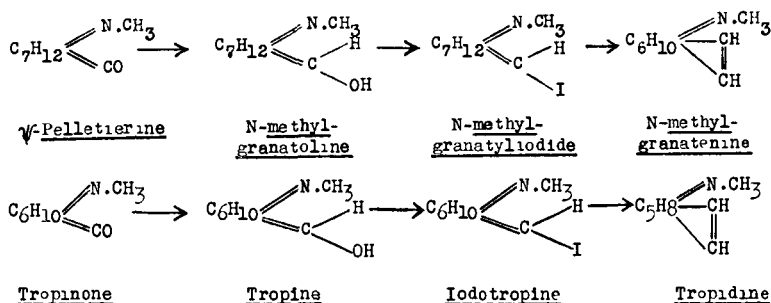

On comparing these reactions with those effected similarly with tropinone (p. 74), it is evident that a close parallelism exists, suggesting that ψ pelletierine is a ring homologue of tropinone. This similarity in behaviour is also shown in the conversion of *N*-methylgranatoline (IV) into *nor*granatanine (V) by the prolonged action of hydriodic acid and phosphorus, which parallels the change of tropine (VI) into *nor*hydrotropidine (VII),¹⁸ and by the oxidation of *N*-methylgranatoline (IV) by permanganate to *N*-methylgranatic acid (VIII) just as tropine (VI) is oxidised to tropinic acid (IX).

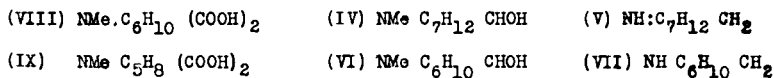

This has led to the adoption for ψ -pelletierine of formulæ based on those suggested at various times for tropinone ¹⁸ ; thus Piccini found that the alkaloid reacts with amyl nitrite to form a diazonitroso-derivative, and with benzaldehyde to give a dibenzylidene compound (yellow prisms, m.p. 200°)¹⁹ and on that ground suggested that the alkaloid must contain two reactive methylene groups thus : —CH₂.CO.CH₂—. The same author proposed the formula finally adopted as the result of a study of the exhaustive methylation ²⁰ of the dimethyl ester of *N*-methylgranatic acid (VIII), (methiodide, m.p. 167°) which yielded in the first stage of the degradation, dimethyl *N*-di-methylgranatenate, C₆H₉(NMe₂):(COOMe)₂, an oil yielding a crystalline, methiodide, m.p. 143–4°, which on boiling with alkali, decomposed into trimethylamine and *homopiperyl*enedicarboxylic acid (X) ; the latter on reduction furnishes suberic acid (XI). Under like conditions

tropic acid yields piperylenedicarboxylic acid (XII), which can be reduced to pimelic acid (XIII).

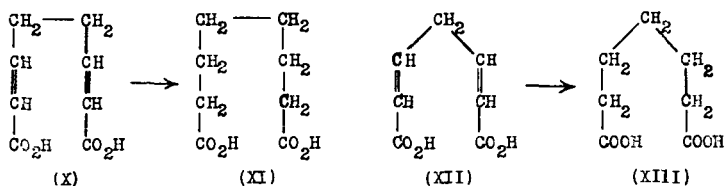

Piccinini, therefore, adopted formula (XIV) for ψ -pelletierine, which is based on Willstätter's tropinone formula (p. 77) by change from a heptamethylene to an octamethylene ring.²¹

The degradation of the alkaloid to a methylpyridine derivative can be effected through *N*-methylgranatic acid (XV) and granatic acid (XVI). The latter, when heated with mercuric acetate and acetic acid at 150° yields 2-methylpyridinecarboxylic acid, which on distillation furnishes 2-methylpyridine.

This formula for ψ -pelletierine received confirmation from the results of the exhaustive methylation of *N*-methylgranatanine, produced by the

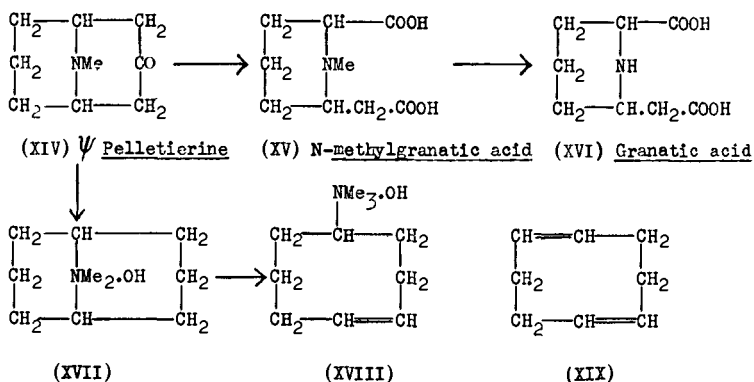

electrolytic reduction of the parent base.²² Willstätter and Vcraguth²³ converted this, through the corresponding ammonium hydroxide base (XVII), the resulting Δ^4 -dedimethylgranatanine and the quaternary base (XVIII) derived from this, to a hydrocarbon, C_8H_{12} , which was eventually shown by Harries to be $\Delta^{1:5}$ cyclooctadiene (XIX). Later Willstätter and Waser²³ degraded *N*-methylgranatanine, $\text{C}_8\text{H}_{12}\text{NMe}$, m.p. 17.2–17.4°, D_4^{20} 0.961, *viâ* the quaternary base derived from α -dimethylgranatanine, which on distillation *in vacuo* decomposes into trimethylamine and cyclooctatriene, C_8H_{10} , b.p. 147.2–148.2°, D_4^0 0.925, n_D^{20} 1.52810. The dibromide of this hydrocarbon, when heated with dimethylamine, produces dimethylaminocyclooctatriene and tetramethyldiaminocyclooctadiene, $\text{C}_8\text{H}_{10}(\text{NMe}_2)_2$, b.p. 126–7°/14 mm., D_4^0 0.944. The latter forms a methio-

dide, m.p. 170–1° (*dec.*), which with silver oxide gives *cyclooctatetraene*

$\text{CH} : \text{CH} . \text{CH} : \text{CH} . \text{CH} : \text{CH} - \text{CH} : \text{CH} : \text{CH}$, m.p. -27° , b.p. $42.2-42.4^\circ$, D_4^0 0.943, n_D^{20} 1.5389. These results were confirmed later by Willstätter and Heidelberger.²³ This tetraene has evoked a considerable amount of interest both as regards its constitution^{23(a)} and as a primary material for polymerisation. It has been prepared again from *pseudopelletierine* by Cope and Overberger,^{23(a)} who record m.p. -5.8 to -5.4° , n_D^{25} 1.5342, and describe the maleic acid adduct, m.p. $166.7-168.2^\circ$, and state that the m.p.s of the hydrocarbon and its adduct are not depressed by *cyclooctatetraene* and its adduct, synthesised from acetylene, that the ultra-violet absorption spectra of the two hydrocarbons are identical and there are no important differences in the infra-red absorption spectra of the two.

The following synthesis of *pseudopelletierine* is of special interest, since it involves only materials and conditions which could occur in plants and is therefore a possible bio-synthesis. Menzies and Robinson¹⁶ showed that when calcium acetonedicarboxylate, glutardialdehyde and methylamine are mixed in aqueous solution under specified conditions and the mixture is kept for twenty-four hours, a product (XX) is formed, which can be decarboxylated to ψ -*pelletierine* (XXI) and the latter isolated as the picrate, which after recrystallisation yields the pure base (m.p. 48.5°), the identity of which can be established by conversion to the characteristic dipiperonylidene derivative. The course of the synthesis is represented as follows:—

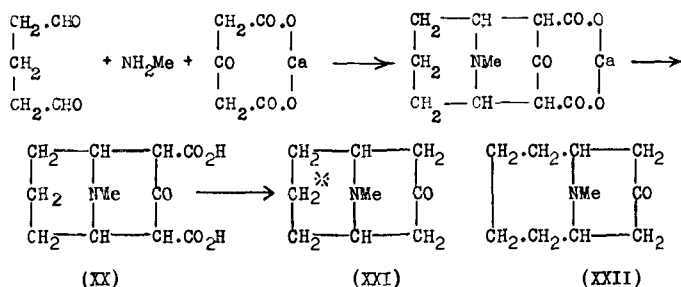

Note. In thiotropinone, selenotropinone and *N*-methylaztropinone (*see below*) $-\text{CH}_2^*$ —in (XXI) is replaced by $-\text{S}-$ as in (XXIV), $-\text{Se}-$ or $-\text{NMe}-$.

Blount and Robinson²⁴ have extended this mode of synthesis to the preparation of *N*-methylhomogranatonine (XXII) by the use of adipaldehyde,²⁵ $\text{CHO} . [\text{CH}_2]_4 . \text{CHO}$. The base, on reduction with sodium in butyl alcohol, yields *N*-methylhomogranatoline (XXII: $\text{CO} \rightarrow \text{CHOH}$), the benzoyl derivative of which possesses marked local anæsthetic action. Similarly Blount,²⁶ by condensing β -(*o*-formylphenyl)propaldehyde, $\text{CHO} . \text{C}_6\text{H}_4 . \text{CH}_2 . \text{CH}_2 . \text{CHO}$, with methylamine and calcium acetonedicarboxylate, has prepared 8:9-benz- $\Delta^{8:9}$ -homogranatene-3-one (XXIII), which was reduced to the ψ -alcohol (*cf.* reduction of tropinone to ψ -tropine) and the latter converted to the benzoyl-derivative (m.p. 98°),

thus providing an analogue to tropacocaine (p. 100) and, like it, possessing local anæsthetic properties.

The same authors²⁷ have made a number of analogues of ψ -pelletierine in which sulphur, selenium, or a second atom of nitrogen, is introduced into

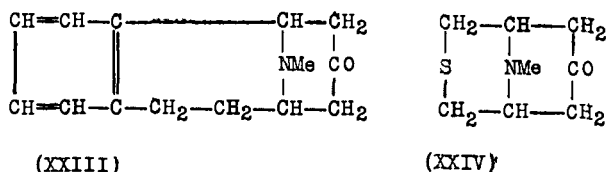

the bicyclic system, *e.g.*, thiotropinone (XXVI), was obtained by condensing thiobisacetaldehyde,²⁸ $\text{CHO} \cdot \text{CH}_2 \cdot \text{S} \cdot \text{CH}_2 \cdot \text{CHO}$, with calcium acetonedicarboxylate and methylamine; it crystallises in thick six-sided plates, m.p. $126-7^\circ$, and yields a dipiperonylidene derivative, m.p. 241° .

Schöpf and Lehmann²⁹ have effected syntheses on this principle under varying conditions. Thus, using buffered solutions of glutardialdehyde, methylamine hydrochloride and acetonedicarboxylic acid, they have obtained yields of 60–72 per cent. of ψ -pelletierine working at pH 3–7, with smaller, but still important, yields at pH 9.0–13.0.

Pharmacological Action. Pomegranate root bark is now little used in medicine. The active constituent is believed to be pelletierine, which, according to von Schroeder,³⁰ is highly toxic to tapeworms and explains the use of the bark, or a fraction of the total alkaloids in the form of “pelletierine tannate” and “pelletierine sulphate,” as anthelmintics. The “tannate” is official in the British Pharmacopœia, 1932, and the “sulphate” in the French Codex. Some interest has been shown in ψ -pelletierine and its derivatives as sources of local anæsthetics. Some of these have been mentioned already, and reference may also be made to Tanret's³¹ investigation of benzoyl and other esters of *N*-methylgranatoline, from which he draws the conclusion that the bicyclic system of granatane is a source of more potent local anæsthetics than that of tropane. On the other hand, McElvain and Adams³² found that ethyl benzoylgranatolinecarboxylate, a ring homologue of *nor*cocaine with the positions of the ether and ester groups interchanged, is less active as a local anæsthetic than cocaine and more toxic. A detailed study of the pharmacology of pelletierine and ψ -pelletierine has been made by Shibata.³³

REFERENCES

- (1) *Compt. rend.*, 1878, 86, 1270; 1879, 88, 716; 1880, 90, 696. (2) *Gazzetta*, 1899, 29, ii, 811. (3) *Ber.*, 1917, 50, 368, 1386; *cf.* TANRET, *Compt. rend.*, 1920, 170, 1118, and GOODSON, *Quart. J. Pharm.*, 1940, 13, 57. (4) *Ber.*, 1919, 52, 964, 1005; 1917, 50, 380. (5) MEISENHEIMER and MAHLER, *Annalen*, 1928, 462, 301; *cf.* HESS and LITTMANN, *ibid.*, 1932, 494, 7. (6) GRIFFITHS, *Quart. J. Pharm.*, 1935, 8, 622; CHAZE, *Compt. rend. Soc. Biol.*, 1935, 118, 1065. (7) TANRET¹; HESS, *Ber.*, 1917, 50, 1395; 1919, 52, 1005. (8) EWERS, *Arch. Pharm.*, 1899, 237, 49; STÖDER, *Pharm., Zeit.*, 1902, 46, 451; *cf.* VAN ITALLIE, *Pharm. Weekbl.*, 1916, 53, 1661; TANRET, *J. Pharm. Chim.*, 1928, [viii], 8, 112. (9) *Ber.*, 1918, 51, 741; *cf.* HESS and WELTZIEN, *ibid.*, 1920, 53,

119. (10) HESS and EICHEL, *Ber.*, 1917, 50, 1192. (11) *Ibid.*, 1909, 42, 97. (12) (a) *Rec. Trav. Chim.*, 1940, 59, 653; 1941, 60, 905; BEETS, *ibid.*, 1943, 62, 553, (b) *J. Org. Chem.*, 1941, 6, 780; (c) (with KLOPPENBURG and BEETS), *Rec. Trav. Chim.*, 1944, 63, 134, (with KLOPPENBURG), 1946, 65, 100. (13) *Ibid.*, 1919, 52, 1005. (14) *Compt. rend.*, 1880, 90, 696, 1920, 170, 1118 (15) *Ber.*, 1917, 50, 344, 1386, 1918, 51, 741; 1919, 52, 964, 1005 (16) MENZIES and ROBINSON, *J Chem Soc*, 1924, 2163. (17) CIAMICIAN and SILBER, *Ber.*, 1892, 25, 1601, 1893, 26, 156, 2740 (18) CIAMICIAN and SILBER, *ibid.*, 1894, 27, 1851, 2860, 1896, 29, 482 (19) *Gazzetta*, 1899, 29, 1, 408; 11, 115 (20) *Ibid.*, 1899, 29, 11, 104. (21) *Real Accad Lincei*, 1899, [v], 11, 219. (22) CIAMICIAN and SILBER, *Ber.*, 1893, 26, 2738, PICCININI, *Gazzetta*, 1902, 32, 1, 260. (23) *Ber.*, 1905, 38, 1975, 1984, 1907, 40, 957, WILLSTATTER (with WASER), *ibid.*, 1910, 43, 1176, 1911, 44, 3423, HARRIES, *ibid.*, 1908, 41, 671, (with HEIDELBERGER), 1913, 46, 517 (23a) *J. Chem Soc*, 1945, 259 (with a review of the relevant literature), COPE and OVERBERGER, *J. Amer Chem Soc*, 1947, 69, 976, 1948, 70, 1433 For other comments on the tetraene see *Final Rept*, No 137, Item No 22, B I O S, London, H.M Stationery Office, *Nature*, 1947, 160, 128, 502, SPEEKMAN, *Chem. Weekbl*, 1946, 42, 347. (24) *J Chem Soc*, 1932, 1429, pharmacological action, ELPHICK and GUNN, *Quart J. Pharm*, 1932, 5, 220 (25) *Ber.*, 1931, 64, 260 (26) *J Chem Soc*, 1933, 553, 1936, 287 (phenyl- ψ pelletierine) (27) *Ibid.*, 1932, 2485 (28) FISCHER, *Ber.*, 1909, 42, 1071 (29) *Annalen*, 1935, 518, 1 (30) *Arch exp, Path. Pharm*, 1884, 19, 290, see also KLEIN, *Arch Schiffs Trop Hyg*, 1926, 30, 250 (31) *Compt rend.*, 1923, 176, 1659 (32) *J Amer Chem Soc*, 1923, 45, 2738 (33) *Folia pharmacol Jap.*, 1943 39, 200 (*Chem Abstr*, 1947, 41, 5217)

TROPANE GROUP

DERIVATIVES OF TROPINE AND ALLIED AMINO-ALCOHOLS

THE names, formulæ and structures of these alkaloids are given in the following table. The esters of tropine or ψ -tropine are known as tropeines or ψ -tropeines respectively. The first eleven items in the table are sometimes called the "solanaceous alkaloids," but they are not the only alkaloids, or even the only type of alkaloid, found in the botanical family Solanaceæ. They are also sometimes referred to as the "mydriatic alkaloids" though other alkaloids also exert this action.

TABLE A

No.	Name of Alkaloid	Formula	Structure	
			Amino-alcohol	Esterifying Acid
1	<i>apo</i> Atropine	$C_{17}H_{21}O_2N$	Tropine	Atropic acid
2	Belladonnine	$C_{34}H_{42}O_4N_2$	Tropine	β -Isatropic acid
3	Atropine	$C_{17}H_{23}O_3N$	Tropine	<i>dl</i> -Tropic acid
4	Hyoscyamine	$C_{17}H_{23}O_3N$	Tropine	<i>l</i> -Tropic acid
5	<i>nor</i> Atropine	$C_{16}H_{21}O_3N$	<i>nor</i> Tropine	<i>dl</i> -Tropic acid
6	<i>nor</i> Hyoscyamine	$C_{16}H_{21}O_3N$	<i>nor</i> Tropine	<i>l</i> -Tropic acid
7	Benzoyltropine	$C_{15}H_{19}O_2N$	Tropine	Benzoic acid
8	Tropacocaine	$C_{15}H_{19}O_2N$	ψ -Tropine	Benzoic acid
9	Hyoscine	$C_{17}H_{21}O_4N$	Scopine	<i>l</i> -Tropic acid
10	Meteloidine	$C_{13}H_{21}O_4N$	Teloidine	Tiglic acid
11	Tigloidine	$C_{13}H_{21}O_2N$	ψ -Tropine	Tiglic acid
12	Valeroidine	$C_{13}H_{23}O_3N$	Dihydroxy-tropine	<i>iso</i> Valeric acid
13	Poroidine	$C_{12}H_{21}O_2N$	<i>nor</i> Tropine	<i>iso</i> Valeric acid
14	<i>iso</i> Poroidine	$C_{12}H_{21}O_2N$	<i>nor</i> Tropine	<i>d</i> - α -Methylbutyric acid
15	Convolvine	$C_{16}H_{21}O_4N$	<i>nor</i> Tropine	Veratric acid
16	Convolamine	$C_{17}H_{23}O_4N$	Tropine	Veratric acid
17	Convolvidine	$C_{32}H_{42}O_6N_2$	Alkamine, m.p. 274-6°	Veratric acid
18	Convolvicine	$C_{10}H_{16}N_2$	—	—

The nature and percentage of total alkaloids in plants yielding bases of this type are detailed in the following statement. Supplies of these drugs in normal times came chiefly from central Europe and largely from Hungary.¹ As the war stopped this trade, strenuous efforts were made to organise both the collection of wild supplies and the cultivation of these drugs, especially in Great Britain,² Australia,³ New Zealand⁴ and the United States.⁵ Some supplies also became available from India⁶ and Russia and in some countries, which had not previously manufactured solanaceous alkaloids, processes for their preparation from these new

sources of supply were devised, e.g., from *Duboisia* spp. by Ralph *et al.*,⁷ from Indian belladonna root by Srivastava and Basu⁸ and from local plants in Hungary by Zalav.¹ The extraction of hyoscyamine and its conversion to atropine is, for some purposes, the replacement of a potent by a less active alkaloid and also inevitably entails the loss of some valuable alkaloid by hydrolysis. A device adopted in England to avoid these losses was the preparation and use of the total alkaloids of Egyptian henbane (*Hyoscyamus muticus*)⁹ in the form of the mixed sulphates containing 80 per cent. of hyoscyamine.

Atropa acuminata Royle ex Lindl. (*A. lutescens* Jacquemont.) "Indian belladonna." Whole plant, grown from Indian seed in the United States,⁵ 0.32 to 0.38; large stems, 0.14. According to Corfield, Kassner and Collins,¹⁰ the leaves and roots, as imported from India, contain on the average 0.45 and 0.47 of non-volatile alkaloid, respectively. Much volatile alkaloid (Markwell¹¹). Recognised in the British Pharmacopœia 1932, Addendum V.

Atropa Belladonna Linn. Leaves, 0.4; roots, 0.5; seeds, 0.8; whole plant, 0.2 to 1.0; hyoscyamine with some hyoscyne; atropine has been found but may have resulted from racemisation during extraction; apoatropine and possibly belladonnine (Kreitmair¹²).

Atropa bœtica. Leaves, 0.82–1.06; roots, 0.94; fruit, 1.09; hyoscyamine and atropine.¹³

Datura alba Nees. Pericarps, leaves, stems; hyoscyne. Seeds, hyoscyne with a little hyoscyamine.¹⁴

Datura arborea. Leaves, 0.44; seeds, 0.23; hyoscyne; with some hyoscyamine in young stems and roots (Kircher¹⁵). Roots, 0.16; leaves, 0.15; flowers or seeds, 0.12; alkaloid described as "daturine" (Montesinos¹⁵) which should be atropine.

Datura fastuosa. Variety "niger"; fruits, 0.2; leaves and stems, 0.12; roots, 0.1. Variety "flor œerul. plen"; seeds, 0.25. Variety "flor alb. plen"; seeds, 0.22. In all three varieties, hyoscyne alone, or with hyoscyamine.¹⁶

Datura Metel. Fruits, 0.12; leaves, 0.2 to 0.5; roots, 0.1 to 0.2; seeds, 0.2 to 0.5. Usually mainly hyoscyne; occasionally a little atropine or hyoscyamine.¹⁶ *nor*Hyoscyamine has also been found.¹⁷ No hyoscyne (Libizov¹⁶).

Datura meteloides. Whole plant, 0.4. Hyoscyne, atropine, meteloidine¹⁸; *nor*hyoscyamine.¹⁷

D. quercifolia. Leaves, 0.42; seeds, 0.29. Hyoscyne and hyoscyamine (Kircher¹⁵).

D. Stramonium Linn. Leaves, 0.2 to 0.45; seeds, 0.2 to 0.5 (chiefly hyoscyamine¹⁹); roots, 0.21 to 0.25 (hyoscyamine and hyoscyne); leaves and tops, 0.6 to 0.7.⁵

Duboisia Leichhardtii von Muell. Leaves examined by Mitchell²⁰ yielded *l*-hyoscyamine, 1.97; *l*-hyoscyne, 0.06; *dl*-hyoscyne, 0.05; *nor*hyoscyamine, 0.01 and a new alkaloid, D, 0.06 (C₁₃H₂₃O₂N, HBr,

m.p. 231°). In leaf samples collected from 28 individual trees, Hills, Trautner and Rodwell²¹ found hyoscyamine usually the dominant alkaloid though hyoscyamine was the chief component in five cases, and both were present in about equal amounts in two cases. In a few instances a tree yielding no hyoscyamine in one season might yield it in the next season. The total alkaloid varied from 0.8 to 3.7.

Duboisia myoporoides. Yields of 3 per cent., mostly hyoscyamine, have been mentioned,³ but great variation in nature of alkaloidal content is on record, e.g., hyoscyamine, ψ -hyoscyamine, hyoscyamine.²² Hyoscyamine and *norhyoscyamine*, but no hyoscyamine.¹¹ Hyoscyamine or hyoscyamine or both.³ *dl*-Hyoscyamine, tigloidine, valeroidine, poroidine and *isoporoidine* present; hyoscyamine and *norhyoscyamine* absent.²³ The limits of these variations, at least as regards the two principal alkaloids, hyoscyamine and hyoscyamine, have probably been settled by Hills, Trautner and Rodwell,²¹ who confirmed the statement of Barnard and Finemore²⁴ that in the northern portion of the distribution area of this plant, it yields mainly hyoscyamine and in the southern section mainly hyoscyamine. In 54 samples of leaves from individual trees they found 0.9 to 4.0 total alkaloids in those from the northern section, with hyoscyamine as the chief component, and 1.0 to 2.7 from those of the southern section, with hyoscyamine replacing hyoscyamine.

Hyoscyamus albus. Leaves, 0.2 to 0.56; roots, 0.1 to 0.14; seeds, 0.16; hyoscyamine and hyoscyamine.

Hyoscyamus muticus. Leaves, 1.4; leaves and stems, 0.6; seeds, 0.9 to 1.34; stems, 0.6; hyoscyamine.²⁵

Hyoscyamus niger. Leaves, 0.045 to 0.08; roots, 0.16; seeds, 0.06 to 0.1; tops, 0.07 to 0.1. Chiefly hyoscyamine with some atropine and hyoscyamine: cf. Sievers and Lowman,⁵ Allan.⁴ A historical account of this drug has been published by Hocking.^{5(a)}

Hyoscyamus reticulatus. Seeds, 0.08; whole plant, 0.12 to 0.24. A little hyoscyamine.²⁶

Mandragora scopoliæ. Leaves and stems said to contain about 0.6; chiefly hyoscyamine.

Mandragora vernalis. Hyoscyamine, hyoscyamine, ψ -hyoscyamine, mandragorine (p. 83).²⁷

Scopolia carniolica (*S. atropoides*, *S. Hladnikiana*). Rhizomes, 0.43 to 0.51; hyoscyamine and hyoscyamine.²⁸

Scopolia japonica. Leaves, 0.18; hyoscyamine and *norhyoscyamine*.²⁹

Scopolia lurida (*Anisodus luridus*). Roots, 2 to 2.8, of which about one-fifth is hyoscyamine (Kreier³⁰). According to Rabinovich and Konovalova, the root contains hyoscyamine and cuscohygrine (p. 103) but no hyoscyamine.^{30(a)}

Solandra levis Hook. (*S. longiflora* Tussac), 0.16; *norhyoscyamine*, *noratropine*, hyoscyamine, atropine (Petrie).³¹

The plants listed above are all species of the botanical family Solanaceæ. A considerable number of convolvulus species, which like

the Solanaceæ belong to the natural order Solanales, were examined for alkaloids by Lazur'evskii³² of which he selected one for detailed investigation, *viz.*

Convolvulus hamadæ. The roots contained 0.42, from which he isolated hygrine and cuscohygrine (p. 103) and a third alkaloid hamadine, still awaiting detailed description.

Convolvulus pseudocantabricus Schrenk. Seeds contain 0.5; convolvine, convolamine, convolvidine and convolvicine (p. 91).³³

The British Pharmacopœia (1932) recognises three of these solanaceous drugs and specifies for them minimum requirements per cent. of total alkaloids, calculated as hyoscyamine, *viz.*: belladonna, leaves 0.3, root 0.4; henbane, leaves and flowering tops 0.05; stramonium, leaves and flowering tops 0.25. The United States Pharmacopœia, XIII, specifies the same minimum limits for belladonna leaves and stramonium and for henbane, 0.04.

Simple Bases. In addition to the alkaloids proper, 1:4-TETRAMETHYLDIAMINOBTANE, $\text{Me}_2\text{N} \cdot (\text{CH}_2)_4 \cdot \text{NMe}_2$, has been found in *Hyoscyamus muticus* by Merck³⁴ and in *H. reticulatus* by Konovalova and Magidson.²⁶ It was described by Willstätter and Heubner³⁴ as a colourless liquid, D^{15} 0.7941, b.p. 169°, with a pungent, acrid taste. The hydrochloride, $\text{C}_8\text{H}_{20}\text{N}_2 \cdot \text{HCl}$, m.p. 273° (*dec.*), forms triangular prisms; the platinichloride, $\text{B} \cdot \text{H}_2\text{PtCl}_6 \cdot 2\text{H}_2\text{O}$, prisms, m.p. 234° (*dec.*) and the aurichloride, m.p. 206–7°, golden yellow prisms. The dimethiodide (hexamethyltetramethylenediammonium iodide),



has m.p. 305–8°, was used to prepare the quaternary picrate, m.p. 285° (*dec.*), platinichloride, m.p. 279° (*dec.*) and aurichloride, m.p. 304–9° (*dec.*), each of which was found identical with the corresponding derivative of the quaternary compound, resulting from the methylation of 1:4-diaminobutane (putrescine). 1:4-Tetramethyldiaminobutane is of possible interest in the biosynthesis of tropane alkaloids, and it may be noted that Willstätter and Heubner found that the dimethochloride, on distillation, yielded 1-METHYLPYRROLIDINE, one of the simple bases Goris and Larssonneau³⁵ found in belladonna leaves, along with 1-METHYLPYRROLINE, PYRIDINE, and a 1:4-diamine, which may have been tetramethyldiaminobutane.

In an exhaustive investigation of Bulgarian belladonna root, King and Ware¹² found, in addition to the usual alkaloidal components, TROPINE and a minute quantity of a new base BELLARADINE, $\text{C}_7\text{H}_{13}\text{ON}$. The latter is an oil, giving the pyrrole pine splinter colour reaction, and furnishing a crystalline, hygroscopic hydrochloride, a picrate, m.p. 224–5°, crystallising in rods, an unstable aurichloride, m.p. about 189°, a methiodide, m.p. 253°, and a methopicate, m.p. 228°, crystallising from boiling water in long, orange needles.

The volatile bases known to occur in *Atropa acuminata* (p. 65) do not appear to have been examined.

During the war years much more attention seems to have been given to biological research on Solanaceous spp. than to chemical research on the solanaceous alkaloids. With extension of the range of supply of these drugs the attention of pharmacognosists has naturally been given to the diagnostic characters of possible substitutes for the official drugs. George³⁶ has determined the palisade ratio values of *Atropa Belladonna* and its Indian replacement product *A. acuminata* and Melville³⁷ has made a detailed, histological study of the roots of both species. In Hungary, Halmai³⁸ has dealt with the detection of *Scopolia carniolica* in belladonna leaves. The allied species, *S. japonica*, was the subject of histological examination by Fujita and Higashi³⁹ in 1937. On the cultivation side Prasad⁴⁰ has investigated the effects of mineral deficiency on *Datura alba* Nees and *Hyoscyamus niger* L. and other points of cultivation interest with regard to *Datura* spp. are dealt with by Ramstad and Fretheim⁴¹ and for belladonna by Brewer and Laurie⁴² and by Sievers, Lowman and Kelly.⁵ Procter⁴³ has described a virus disease of *Hyoscyamus niger* in New Zealand.

REFERENCES

- (1) ZALAV, *J. Hung. Chem. Soc.*, 1941, 2, 13. (2) Bulletin No. 121, "The Cultivation of Medicinal Plants." H.M. Stationery Office; MELVILLE, *Pharm. J.*, 1942, 149, 202. (3) ASHBY, *J. Roy. Soc. Arts*, 1942, p. 138; *Ann. Repts. Council Sci. Ind. Res. Austr.*, 1941-2, p. 11; 1942-3, p. 11. (4) ALLAN, *J. New Zealand Dept. Sci. Ind. Res.*, 1940-1, 15, 15. (5) SIEVERS and LOWMAN, *J. Amer. Pharm. Assoc.*, 1944, 33, 45; (with KELLY), 1945, 34, 28; WOLFRED, *Amer. J. Pharm.*, 1943, 115, 108. (5a) *Econ. Bot.*, 1947, 1, 306. (6) *Rept. Sci. Advis. Board Indian Res. Fund Assoc.*, 1943, 103. (7) RALPH (with LEAN and WILLIS), *J. Proc. Roy. Soc. N.S.W.*, 1944, 77, 96, 99; ROSENBLUM, *Aust. J. Pharm.*, 1944, 26, 89. (8) *Ind. J. Pharm.*, 1944, 6, 3. (9) AMOR, FOSTER, GREEN and STEPHENSON, *Quart. J. Pharm.*, 1946, 19, 359. (10) *Ibid.*, 1943, 16, 103. (11) *Pharm. J.*, 1941, 146, 259. (12) For recent work on alkaloids in belladonna, see SZENTGALI, *Magyar Gyog. Tars. Ert.*, 1937, 13, 619; KUHN and SCHÄFER, *Pharm. Zentr.*, 1939, 80, 151, 163; *Deut. Apoth. Zeit.*, 1938, 53, 405, 424; POTLOG, *Heil u. Gewürz Pflanzen*, 1940, 19, 55; ALLAN⁴; DE CONNO, *Bull. Ort Bot. Univ. Napoli*, 1941, 15, 73; LAURIE and STILLINGS, *Chemurgic Digest*, 1943, 2, 29; SIEVERS and LOWMAN,⁵ CORFIELD *et al.*¹⁰ The following are concerned with Bulgarian belladonna, for which special virtues have been claimed: KREITMAIR, *Merck's Jahresh.*, 1938, 52, 39; KING and WARE, *J. Chem. Soc.*, 1941, 331; MÄRKI, *Pharm. Acta Helv.*, 1943, 18, 229. (13) CABALLERON and ROYO, *Farm Nueva*, 1936, 4, 82; MUGICA, *Anal. Fis. Quim.*, 1936, 34, 100. (14) PRADISH and SANTOS, *Rev. filipina med. farm.*, 1939, 30, 170; 1940, 31, 1. (15) KIRCHER, *Arch. Pharm.*, 1905, 243, 309; 1906, 244, 66; MONTESINOS, *Bol. Soc. Quim. Peru*, 1939, 5, 99; VILLABA *et al.*, *Anales. Soc. biol. (Bogota)*, 1945, 1, 189. (16) ANDREWS, *J. Chem. Soc.*, 1911, 99, 1876; SCHMIDT, *Arch. Pharm.*, 1906, 244, 66; 1910, 248, 641; but cf. LIBIZOV, *Farmatsiya*, 1939, No. 9, p. 17 and SOVA, *ibid.*, 1946, No. 6, p. 27. (17) CARR and REYNOLDS, *J. Chem. Soc.*, 1912, 101, 946. (18) PYMAN and REYNOLDS, *ibid.*, 1908, 93, 2077. (19) ANDREWS¹⁶; CHEN and KAO, *J. Chin. Pharm. Assoc.*, 1936, 1, 38; SANDFORTH, *Angew. Botan.*, 1940, 22, 1; ALLAN⁴; EBY, SCHOLL and PHILLIPS, *J. Amer. Pharm. Assoc.*, 1938, 27, 474; YOUNGKEN and FISCHER, *ibid.*, 1942, 31, 257; JOHNSTON and NUNEZ-MELENDEZ, *ibid.*, p. 166; DYSON and COETZEE, *S. African J. Sci.*, 1943, 40, 162. (20) *J. Chem. Soc.*, 1944, p. 480. (21) *J. Council Sci. Ind. Res. (Austr.)*, 1945, 18, 234. (22) MERCK, *Arch. Pharm.*, 1893, 231, 117. (23) BARGER, MARTIN and MITCHELL, *J. Chem. Soc.*, 1937, 1820; 1938, 1685; MARTIN and MITCHELL, 1940, 1155; MITCHELL and TRAUTNER, *ibid.*, 1947, 1330. (24) *Council Sci. Ind. Res. (Austr.) Rept.*, 1941-2, p. 11. (25) GADAMER, *Arch. Pharm.*, 1898, 236, 704; DUNSTAN and BROWN, *J. Chem. Soc.*, 1899, 75, 72; 1901, 79, 71; see also AMOR *et al.*⁹ (26) *Bull. Imp. Inst.*, 1911, 9, 115; KONOVALOVA

and MAGIDSON, *Arch. Pharm.*, 1928, 266, 449. (27) AHRENS, *Annalen*, 1889, 251, 312; *Ber.*, 1889, 22, 2159; THOMS and WENTZEL, *ibid.*, 1898, 31, 2031; 1901, 34, 1028; HESSE, *J. pr. Chem.*, 1901, [ii], 64, 274; CARR and REYNOLDS.¹⁷ (28) DUNSTAN and CHASTON, *Pharm. J.*, 1889, [iii], 20, 461; RANSOM, *ibid.*, p. 462; JERMSTAD, *Medd. Norsk Farm. Selsk.*, 1942, 4, 93 (*Chem. Abstr.*, 1944, 38, 1075). (29) SCHMIDT and HENSCHKE, *Arch. Pharm.*, 1888, [iii], 26, 185; WATANABE, *Chem. Soc. Abstr.*, 1911 [ii], 427; CARR and REYNOLDS.¹⁷ (30) *Farmatsiya*, 1939, No. 10, 21 (*Chem. Abstr.*, 1942, 36, 3910), *cf.* SIEBERT, *Arch. Pharm.*, 1890, 228, 145. (30a) *J. Gen. Chem. U.S.S.R.*, 1946, 16, 2121. (31) PETRIE, *Proc. Linn. Soc., N.S.W.*, 1907, 32, 789; 1917, 41, 118, 137. (32) *Trudy Uzbekskego Gosudarst Univ. Sbornik Rabot Khim.*, 1939, 15, 43 (*Chem. Abstr.*, 1941, 35, 4029). (33) OREKHOV and KONOVALOVA, *Arch. Pharm.*, 1933, 271, 145; *Ber.*, 1934, 67, 1153; 1935, 68, 814; *J. Gen. Chem. Russ.*, 1937, 7, 646, 673. (34) Quoted by WILLSTÄTTER and HEUBNER, *Ber.*, 1907, 40, 3869. (35) *Bull. Sci. Pharmacol.*, 1921, 28, 499. (36) *Quart. J. Pharm.*, 1946, 19, 144. (37) *Ibid.*, 1944, 17, 201, 213; 1945, 18, 331. (38) *Ber. Ungar. pharm. Ges.*, 1943, 19, 132, *cf.* MARKOVIC, *Deut. Heilpflanze*, 1944, 10, 9. (39) *J. Pharm. Soc. Jap.*, 1937, 57, 158. (40) *Ind. J. Pharm.*, 1944, 6, 13; *J. Amer. Pharm. Assoc.*, 1946, 35, 121; 1947, 36, 180; JAMES, *Econ. Bot.*, 1947, 1, 230. (41) *Medd. Norsk. Farm. Selsk.*, 1942, 4, 177 (*Chem. Abstr.*, 1944, 38, 3780). (42) *Chemurg. Digest*, 1944, 3, 65. (43) *N. Z. Journ. Sci. Tech.*, 1944, 26A, 83.

ANALYTICAL METHODS. Methods for the isolation of individual solanaceous alkaloids from plants have been greatly improved and typical examples will be found in the references given under the various plants listed above. For quantitative analysis for commercial purposes, it is usually sufficient to determine the total, non-volatile alkaloids, the results being expressed as hyoscyamine. Methods of assay are provided in the British Pharmacopœia 1932, Addendum VII, and the United States Pharmacopœia, XIII. Useful critical reviews of processes both for the crude drugs and galenical preparations have been published by various authors.¹ A colorimetric method has been described by Allport and Wilson² depending on the Vitali-Morin reaction of which a study of the nature and limits of applicability has been made by James and Roberts.³ Precipitation as silicotungstate has been proposed by Vallery,⁴ while for quaternary atropine compounds Reimers⁵ has suggested estimation of the tropic acid produced on hydrolysis, a method extended later to tropic acid esters of the atropine series in general. Kirkpatrick⁶ has investigated the suitability of polarographic methods for the estimation of individual alkaloids, and Brownlee⁷ has found the chromatographic process satisfactory with preparations of solanaceous drugs. In connection with work on the biogenesis of these alkaloids it has become necessary to estimate quantitatively at least the three chief solanaceous alkaloids, hyoscyamine, hyoscyamine and atropine, and Rowson⁸ has made a critical survey of methods available for this purpose. All these processes are chemical and some attention has been given to biological methods since so far as total, non-volatile alkaloids are concerned, the results may include atropine, hyoscyamine and hyoscyamine of which atropine is in some pharmacological activities less potent than either of the other two. Gunn,⁹ who uses as a biological test the antagonistic action of belladonna alkaloids against the effect of carbamylcholine on isolated mammalian intestine, has found that the alkaloids from *Atropa Belladonna* and from *A. acuminata*

are identical in their biological action and twice as active in the biological test as atropine sulphate, but that is only true when the chemical process of estimation used, eliminates the volatile alkaloids, which have no atropine-like action. A similar biological method has been used by Levy¹⁰ for the assay of galenical preparations of belladonna and various kinds of pharmacological tests have been used by other authors.¹⁰

For the detection and microchemical estimation of these alkaloids, the precipitation, crystalline form and melting-points of the perbromides, periodides, aurichlorides or picrates and the mydriatic test have been used.¹¹

Atropine, $C_{17}H_{23}O_3N$. This alkaloid does not normally occur in more than traces in solanaceous plants and in its preparation by Mein¹² and by Geiger and Hesse,¹³ the hyoscyamine originally present in the plant was probably converted into atropine in the process of extraction. The present formula is due to Liebig, and von Planta¹⁴ showed that atropine was identical with "daturine" obtained from stramonium. Commercially the alkaloid is prepared by racemisation of *l*-hyoscyamine with dilute alkali or by heating in chloroform solution. Methods for the preparation of atropine and its salts have been described by Chemnitius¹⁵ and by Duilius.¹⁵ The alkaloid crystallises from alcohol on addition of water, or from chloroform on addition of light petroleum, or from acetone, in long prisms, m.p. 118°, sublimes unchanged when heated rapidly, is readily soluble in alcohol or chloroform, less soluble in ether or hot water, sparingly so in cold water (1 in 450 at 25°), and almost insoluble in light petroleum. The aqueous solution is bitter to the taste and alkaline to litmus. Atropine is optically inactive, but the commercial alkaloid may contain hyoscyamine and be slightly levorotatory.

Atropine causes dilation of the pupil of the eye. A drop or two of an aqueous solution, containing 1 part in 130,000 parts of water, introduced into the eye of a cat is sufficient to produce this effect. When warmed with sulphuric acid and a small crystal of potassium dichromate, atropine develops a bitter almond odour. Evaporated to dryness on a water-bath with concentrated nitric acid, it gives a residue which becomes violet on adding a drop of sodium hydroxide solution in alcohol (Vitali's test). With a solution of mercuric chloride atropine gives a yellow to red precipitate of mercuric oxide.

Of the salts of atropine the sulphate, $B_2 \cdot H_2SO_4 \cdot H_2O$, is that usually employed in medicine. It occurs as a colourless, crystalline powder, m.p. 195-6°, when dried at 130°, soluble in water (1 in 0.38) or alcohol (1 in 3.7), and sparingly so in chloroform (1 in 620) or ether (1 in 2,140). It can be recrystallised by adding acetone to its solution in alcohol. The hydrobromide, $B \cdot HBr$, m.p. 163-4°, forms slender needles, and the oxalate, $B_2 \cdot H_2C_2O_4$, opaque warty masses of minute prisms, m.p. 198°. The platinichloride, $B_2 \cdot H_2PtCl_6$, being soluble in dilute hydrochloric acid, is not precipitated when atropine hydrochloride is added to platinic chloride solution containing free hydrochloric acid. On evaporation it is obtained in monoclinic crystals, m.p. 207-8°. The aurichloride,

B. HAuCl_4 , separates as an oil, but solidifies on standing and may be recrystallised from water containing hydrochloric acid. The crystals melt at $137-9^\circ$ or below 100° when heated under water. This salt and the picrate, rectangular plates, m.p. $175-6^\circ$, are well adapted for the identification of the alkaloid. The methobromide, m.p. $223-5^\circ$, and the methonitrate, m.p. $166-8^\circ$, are now both used in medicine.

The constitution of atropine is discussed later (p. 72).

apoAtropine (*Atropamine*), $\text{C}_{17}\text{H}_{21}\text{O}_2\text{N}$. This anhydride of atropine, first obtained by Pesci,¹⁶ and subsequently prepared by Merck,¹⁷ Hesse¹⁸ (1893), and others, by the action of dehydrating agents upon atropine or hyoscyamine, was isolated as "atropamine" by Hesse¹⁸ (1891) from belladonna root, the identity of the two being established by Merck.¹⁷ It crystallises from ether in prisms, m.p. 60° ; is slightly soluble in water, but readily dissolves in other ordinary solvents except light petroleum. The hydrochloride forms thin plates, m.p. 237° , and the aurichloride needles, m.p. 110° . The base and its salts are optically inactive, and not mydriatic. When *apoatropine* is heated alone, or evaporated with moderately strong hydrochloric acid, it partly passes into belladonnine (*see below*), and is partly decomposed into tropine and atropic acid. Ladenburg¹⁹ prepared it by esterification of tropine with atropic acid. *apoAtropine* is, therefore, atropyltropine.

Belladonnine ($\text{C}_{17}\text{H}_{21}\text{O}_2\text{N}$)₂. This substance was obtained by Hübschmann²⁰ from henbane berries and was subsequently examined by Kraut²¹ and by Merling²² who regarded it as isomeric with *apoatropine*. According to Hesse¹⁸ when hyoscyamine is heated at $120-130^\circ$, it changes successively into atropine, *apoatropine* and belladonnine. Kussner²³ has prepared it by heating *apoatropine* at 110° until the bromine titration figure is at a minimum, usually about forty-eight hours. The base is then purified *via* the hydrochloride, which permits of the removal of any *apoatropine* salt by extraction with chloroform from aqueous solution of the mixed hydrochlorides, and the crystalline sulphate, from which the pure base may be recovered and dissolved in hot ethyl acetate from which it crystallises, m.p. 129° . It does not absorb bromine and is stable to permanganate, is easily soluble in ethyl acetate, alcohol, benzene or chloroform, and sparingly so in water or petroleum. It gives Vitali's colour reaction (p. 70). Molecular weight determinations show that it is a dimeride ($\text{C}_{17}\text{H}_{21}\text{O}_2\text{N}$)₂. It hydrolyses with alcoholic soda solution at 100° in a sealed tube yielding β -isatropic acid, m.p. $215-6^\circ$ and tropine. The hydrochloride forms spear-like crystals, m.p. $195-6^\circ$ (*dry*).

M. and M. Polonovski²⁴ have shown that Hesse's¹⁸ (1893) BELLATROPINE is a mixture of bases, of which chlorotropine is the chief component.

l-Hyoscyamine, $\text{C}_{17}\text{H}_{23}\text{O}_3\text{N}$. This, the most commonly occurring alkaloid of the group, was obtained by Geiger and Hesse²⁵ from henbane. Its hydrolysis into a base and an acid was observed by Höhn and Reichardt.²⁶ The accepted, empirical formula is due to Ladenburg,²⁷ who showed that it was a physical isomeride of atropine. Hyoscyamine

crystallises from dilute alcohol in silky needles, m.p. 108.5° , and is lævorotatory, $[\alpha]_D - 22^{\circ}$ in 50 per cent. alcohol or $- 32.4^{\circ}$ for the basic ion as salt in water.²⁸ It is readily soluble in benzene, chloroform or alcohol, less so in ether or cold water. The ordinary salts are crystalline. The sulphate, $B_2 \cdot H_2SO_4 \cdot 2H_2O$, m.p. 206° (*dry*), $[\alpha]_D - 27.8^{\circ}$ (H_2O),²⁸ crystallises in needles from alcohol, is bitter, neutral and readily soluble in water. The hydrobromide, $B \cdot HBr \cdot 2H_2O$, m.p. 151.8° , forms prisms. The aurichloride, $B \cdot HAuCl_4$, m.p. 165° , crystallises in golden-yellow, hexagonal plates from dilute hydrochloric acid; unlike atropine aurichloride, it does not melt when heated under water. This salt is less soluble in dilute hydrochloric acid than atropine aurichloride, from which it may be separated by fractional crystallisation. The platinumchloride, orange-coloured prisms, m.p. 206° , is obtained by spontaneous evaporation of solutions containing hyoscyamine hydrochloride and platinum chloride. The picrate, m.p. 165° , crystallises in plates.

Hyoscyamine is readily converted into the *dl*-form, atropine, by melting or by the addition of small quantities of caustic alkali to its cold alcoholic solution. The same change is brought about by sodium carbonate or ammonia.²⁹

When heated with acids or alkalis, hyoscyamine undergoes hydrolysis into tropine and *dl*-tropic acid probably *via* conversion into atropine, and it is this alkaloid which is hydrolysed. According to Gadamer,¹⁵ when hyoscyamine is hydrolysed with cold water the products are inactive tropine and *l*-tropic acid. Amenomiya³¹ has shown that Ladenburg and Hundt's partially synthetic *d*- and *l*-atropines³⁰ were probably mixtures of atropine with *d*- and *l*-hyoscyamines. He resolved *dl*-tropic acid into the *d*- and *l*-forms, esterified these with tropine in 5 per cent. hydrochloric acid, and so obtained *d*- and *l*-hyoscyamines, the latter identical with the natural alkaloid. *d*- and *l*-Hyoscyamines have also been obtained by Barrowcliff and Tutin³² by the resolution of atropine by means of *d*-camphorsulphonic acid.

Constitution of Atropine and Hyoscyamine. Atropine is readily hydrolysed by warming with alkalis, dilute acids, or even with water.³³ By heating it with concentrated hydrochloric acid at 130° in a closed vessel, or with baryta water at 60° , it is completely resolved into tropine, $C_8H_{15}ON$, and tropic acid, $C_9H_{10}O_3$.³⁴ At higher temperatures the tropic acid first produced loses water and becomes atropic acid, $C_9H_8O_2$, accompanied by isotropic acid. M. and M. Polonovski have shown that the tropeines as a class on prolonged heating with hydrochloric acid or hydrobromic acid at 140° yield chlorotropine and bromotropine respectively.²⁴

TROPIC ACID. The constitution of both tropic and atropic acids is known from syntheses by Ladenburg *et al.*³⁵ from acetophenone. The ketone (I) by treatment with phosphorus pentachloride was converted into α -dichloroethylbenzene (II), and this, by the action of potassium cyanide in alcohol, into ethoxycyanoethylbenzene (III), which on hydrolysis yielded ethylatrolactic acid (IV). The latter was converted by strong

hydrochloric acid into atropic acid (V), and this in turn on addition of hypochlorous acid gave chlorotropic acid (VI), which on reduction with zinc dust and iron filings in alkaline solution passed into tropic acid (VII).

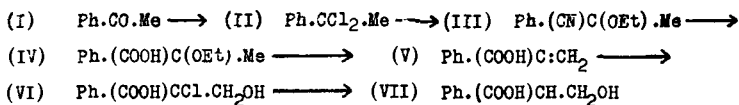

Other syntheses of tropic acid have been accomplished by Spiegel,³⁶ Muller,³⁷ Wislicenus and Bilhuber,³⁷ Chambon³⁸ and Natarajan and Swamina^{38(a)}. Of these, the most interesting is the reduction of ethyl formylphenylacetate (VIII) $\text{CHO} \cdot \text{CHPh} \cdot \text{COOC}_2\text{H}_5$ in moist ethereal solution by aluminium amalgam to ethyl tropate, from which the acid (IX) $\text{HO} \cdot \text{CH}_2 \cdot \text{CHPh} \cdot \text{COOH}$, is obtainable by hydrolysis with baryta.

Mackenzie and Wood³⁹ obtained low yields by this method, which is the basis of both the Muller and Wislicenus processes, and recommended instead the hydrolysis of acetophenonecyanohydrin (X) into atrolactic acid (XI), conversion of the latter by distillation under reduced pressure into atropic acid (XII), which was then treated in ethereal solution with hydrochloric acid and the halogen in the resulting β -chlorohydratropic acid replaced by hydroxyl, by boiling the acid with aqueous sodium carbonate solution, giving tropic acid (XIII), thus :

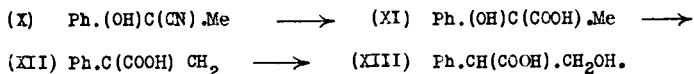

Tropic acid crystallises in prisms and melts at 117° . It contains an asymmetric carbon atom and can be resolved into *d*- and *l*-forms, which, according to King,⁴⁰ melt at $128-9^\circ$, and have $[\alpha]_D + 81.6^\circ$ and $- 81.2^\circ$ (H_2O) respectively.

TROPINE, $\text{C}_8\text{H}_{15}\text{ON}$. This base forms rhombic tablets, m.p. 63° , b.p. 233° , is soluble in water, ether, alcohol or benzene, and crystallises from toluene on addition of light petroleum. It is optically inactive and in aqueous solution is strongly alkaline and readily absorbs carbon dioxide from the air. The salts crystallise well, the hydrochloride in plates, the picrate in golden-yellow needles, which decompose at 275° . The aurichloride forms golden-yellow plates, m.p. 210° (*dec.*), and the platinumchloride orange-coloured, monoclinic needles, m.p. 198° (*dec.*). The base contains a hydroxyl group and yields a series of esters called tropenes,⁴¹ some of which have found application in medicine as substitutes for atropine (*dl-tropyltropene*), e.g. :—

Atrolactyltropene (ψ -atropine), α -hydroxy- α -phenylpropionyltropene, $\text{C}_{17}\text{H}_{23}\text{O}_3\text{N}$. Needles, m.p. 119° .

α -Hydroxy- β -phenylpropionyltropene, $\text{C}_{17}\text{H}_{23}\text{O}_3\text{N}$. Rosettes of needles, m.p. $89-90^\circ$.

Atroglyceryltropine, $C_{17}H_{23}O_4N$. Rectangular oblong plates, m.p. 124–5°.

Phenylglycollyltropine (*Mandelyltropine*, *homatropine*), $C_{16}H_{21}O_3N$. This is largely used as a substitute for atropine. It crystallises in prisms, m.p. 95.5–98.5°. The hydrobromide, the salt usually employed in medicine, is a crystalline powder, m.p. 217–8° (*dec.*); the hydrochloride, m.p. 224–5°, and the salicylate are also used. All three are freely soluble in water. The methobromide has m.p. 192–6°. The aurichloride, $B \cdot HAuCl_4$, forms prisms and is sparingly soluble in water. Homatropine, unlike atropine, does not give the Vitali colour reaction (p. 70). Its mydriatic effect is more rapid and transient than that of atropine.

Constitution of Tropine. Tropine readily suffers dehydration by the action of strong sulphuric or hydrochloric acid, forming a new tertiary base, TROPIDINE,⁴² $C_8H_{13}N$, an oily alkaline liquid, b.p. 162°, having a coniine-like odour. Tropidine methiodide heated with potassium hydroxide yields TROPILENE, $C_7H_{10}O$, and dimethylamine, the latter affording evidence of the existence of the group $N \cdot CH_3$ in tropidine, and consequently in tropine. By the action of bromine on tropidine, Ladenburg obtained three substances, *viz.*, ethylene dibromide, *N*-methyldibromopyridine and 3 : 5-dibromopyridine. When hydriodic acid reacts with tropine at temperatures below 150° an iodocompound, $C_8H_{14}NI$, is formed in which iodine replaces the —OH group; by reduction of this substance with nascent hydrogen, dihydrotropidine, $C_8H_{15}N$, results, which has not been obtained by direct reduction of tropidine. Its hydrochloride, on distillation, loses methyl chloride and gives rise to *nordihydrotropidine*, $C_7H_{13}N$, and this in turn furnishes 2-ethylpyridine on distillation with zinc dust.

The results so far recorded are those upon which Ladenburg⁴² chiefly based his formulæ representing tropine and tropidine as *N*-methyl- Δ^2 -tetrahydropyridines, substituted in position 2 by the residues $\cdot CH_2 \cdot CH_2OH$ (or $\cdot CHOH \cdot CH_3$) for tropine (XIV) and $\cdot CH : CH_2$ for tropidine (XV) thus :



The inadequacy of these formulæ became evident when the oxidation of tropine was studied. With potassium permanganate, in presence of acid, or with chromic acid, tropine and tropidine give rise to a series of oxidation products, the interrelationships of which are shown in the scheme on p. 75.

The most important of these products are the following :

Tropinone, $C_8H_{13}ON$. This substance, first prepared by Willstätter,⁴³ crystallises in spear-shaped needles, m.p. 41°, b.p. 219–20°/714 mm., dissolves in ordinary solvents, is a strong base and has the properties of a ketone, giving an oxime, m.p. 111°, and a semicarbazone, m.p. 212°. It is a tertiary base and the methiodide is decomposed by alkalis producing dimethylamine and $\Delta^{4:6}$ dihydrobenzaldehyde.⁴⁴ When reduced by sodium

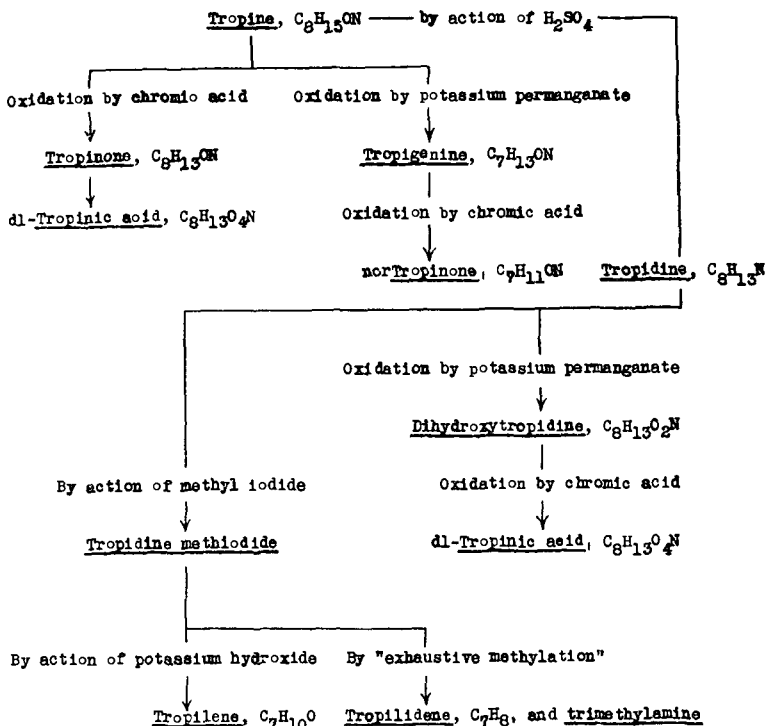

amalgam, tropinone forms, not tropine, but ψ -tropine (p. 100), identical with that obtained by the hydrolysis of benzoyl- ψ -tropine (*tropacocaine*), found in coca leaves. When reduced electrolytically or by zinc dust in hydriodic acid, a mixture of tropine and ψ -tropine is produced, which can be separated by fractional precipitation of the picrates, tropine picrate being the less soluble (0.46 per cent. in water at 16°). It is possible in this way to convert ψ -tropine into tropine by oxidising the former to tropinone and reducing the latter electrolytically.⁴⁵ Some tropane (p. 87) is also formed in this reduction.

dl-Tropinic acid, $C_8H_{13}O_4N$. This oxidation product of tropine and ψ -tropine, is a substance of great importance in this group, and its constitution and relation to tropine gave rise to much discussion.⁴⁶ It crystallises in small needles, m.p. 248° (*dec.*), is soluble in water and almost insoluble in other media. It is a dibasic acid and yields salts, both with bases and acids. Its formation by the oxidation of tropine is not explicable in any simple manner by Ladenburg's tropine formula, and it was this difficulty which led Merling to propose his formula for this base. By crystallisation of the cinchonine salt, *dl*-tropinic acid can be resolved into *d*- and *l*-forms.

Tropigenine (*nortropine*), $C_7H_{13}ON$. This product of the action of potassium permanganate on tropine is a strong base, which crystallises from ether in colourless needles, m.p. 161°; b.p. 233° (picrate, m.p. 170-1°:

nitrate, m.p. 186–7°). It sublimes at 100° *in vacuo*, absorbs carbon dioxide from the air, and is liberated from solutions of its hydrochloride by silver oxide, but not by caustic soda. It is a secondary base giving a nitroso-derivative, and combines with methyl iodide to form tropine methiodide showing that in its formation from tropine a methyl group attached to the nitrogen atom is replaced by hydrogen.⁴⁷ When boiled with sodium amyloxyde in amyl alcohol it produces *nor-ψ-tropine* (*see below*).

norTropinone, C₇H₁₁ON. This base results from the action of chromic acid on tropigenine and bears the same relation to the latter as tropinone does to tropine.⁴⁸ It crystallises in deliquescent needles, m.p. 69°, is readily soluble in water or alcohol, and less so in ether. It furnishes an oxime, microscopic leaflets, m.p. 181°, and as a secondary amine, forms a nitroso-derivative, crystallising in needles, m.p. 121°. On reduction with sodium amalgam *nortropinone* yields *ψ-tropigenine*, which is more appropriately named *nor-ψ-tropine*, since it corresponds with *ψ-tropine*. The same substance has been obtained⁴⁸ by M. and M. Polonovski's general method of treating *N*-oxides with acetic anhydride and hydrolysing the resulting acyl derivative: in this way tropacocaine *N*-oxide furnishes *O*-benzoyl-*N*-acetyl-*nor-ψ-tropine*, which can be hydrolysed to *nor-ψ-tropine*. King and Ware have also prepared the latter by the action of sodium amyloxyde on *nortropine* (*see above*).

The formation of these oxidation products, and, in particular, of tropinic acid, led Merling⁴⁴ to represent tropine as a bicyclic system, composed of a piperidine and a hexahydrobenzene ring with four carbon

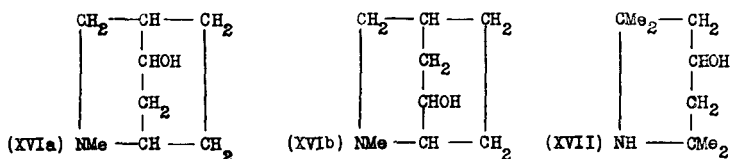

atoms in common (XVIa or XVIb). Of these two forms Merling preferred (XVIa) owing to its similarity to Fischer's triacetonealkamine (XVII),⁴⁹ the mandelic ester of which exhibits mydriatic properties. Merling's formula remained in use until Willstätter⁵⁰ found that tropinone gave a dibenzylidene derivative (yellow prisms, m.p. 152°) and a series of other derivatives, which established clearly the presence of the chain :C.CH₂.CO.CH₂.C: in tropinone and the corresponding chain :C.CH₂.CHOH.CH₂.C: in tropine and *ψ-tropine*. To meet this requirement three formulæ were considered (XVIII to XX) for tropine, of which (XX) was rejected on the grounds that it did not account for the

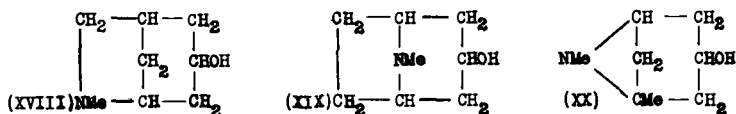

formation of 4^{4:6}dihydrobenzaldehyde from tropinone methiodide by the action of sodium carbonate, and the production of adipic acid on oxidation

of tropilene⁵¹ and by the action of fused potash on methyl tropinate methiodide.⁵² Decision between (XVIII) and (XIX) became possible on finding that methyl tropinate methiodide was decomposed by boiling with soda into trimethylamine, methyl alcohol and an unsaturated seven-carbon acid, which on reduction with sodium amalgam took up four atoms⁵³ of hydrogen forming pimelic acid (XXII). The unsaturated acid was, therefore, represented by formula (XXI) and tropinic acid by (XXIII), which establishes (XIX) for tropine and ψ -tropine, (XXIV) for tropinone,

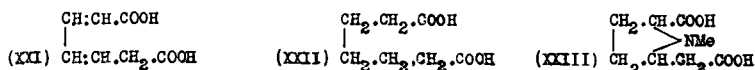

(XXV) for tropidine and since tropilene, $\text{C}_7\text{H}_{10}\text{O}$, gives a monobenzylidene derivative and must contain a $-\text{CO}-\text{CH}_2-$ group it is represented by (XXVI), which was confirmed by Kötze and Rosenbusch,⁵² who succeeded in hydrogenating it to suberone.

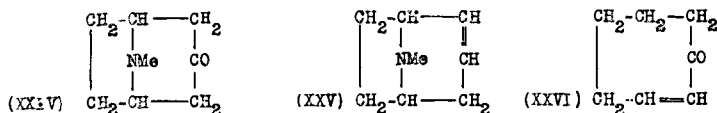

Willstätter's formula for tropine was confirmed by his syntheses of tropidine, tropine and ψ -tropine from the heptacyclic ketone, suberone as a starting-point.⁵³ The latter was converted into the oxime, which was

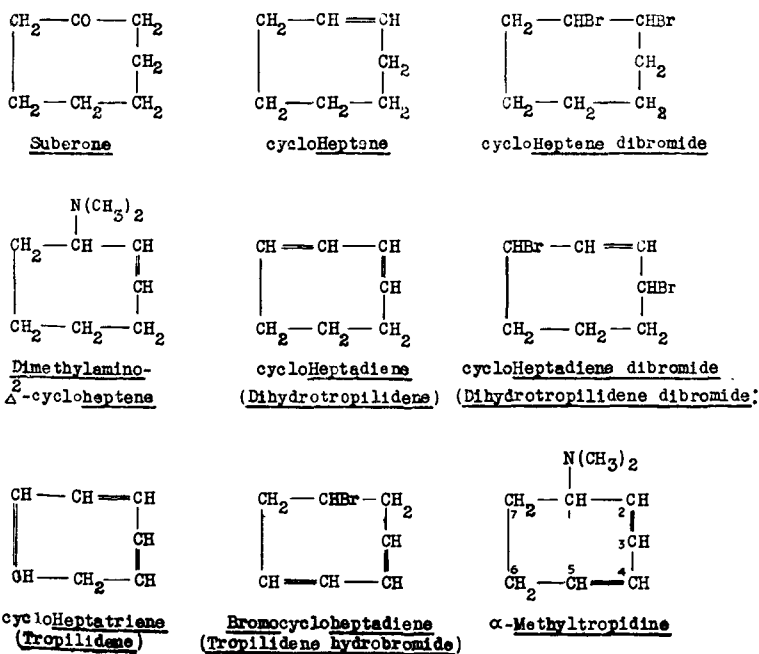

reduced to suberylamine and this transformed by exhaustive methylation into *cycloheptene*. The latter was brominated and the *cycloheptene* dibromide heated with dimethylamine in benzene, forming dimethylamino- Δ^2 -*cycloheptene*, which by exhaustive methylation and subsequent distillation, yielded *cycloheptadiene*, identical with dihydrotropilidene, obtainable from dihydrotropidine. The hydrocarbon was in turn converted into the dibromide, and this, by heating with quinoline, transformed into a *cycloheptatriene* identical with tropilidene, from which, on adding hydrogen bromide in acetic acid, bromo*cycloheptadiene* was formed. This substance reacts with dimethylamine, forming dimethylaminocycloheptadiene, identical with α -methyltropidine, obtained by Merling by the distillation of tropidinemethylammonium hydroxide.⁴⁴

Hofmann had shown in 1881 that by the action of hydrochloric acid on dimethylpiperidine, methyl chloride and methylpiperidine result; Merling in reinvestigating this reaction⁵⁴ found that, not methylpiperidine but the isomeric 2:6-dimethylpyrrolidine was formed. In the case of a substance represented by the formula given above for α -methyltropidine, if either of the carbon atoms 4 or 5 be chlorinated and the resulting product distilled, such intramolecular methylation might occur with the production of tropidine. This method of reproducing tropidine from α -methyltropidine had already been employed by Merling,⁴⁴ but on repeating the experiment Willstätter was unable to obtain a pure tropidine and so had recourse to the use of α -methyl dihydrotropidine (Δ^4 -methyltropane), formed by the reduction of α -methyltropidine with sodium in alcohol. This was converted into the dibromide by bromine dissolved in hydrobromic acid, and the latter warmed in ethereal solution, when it changed into bromodihydrotropidine methobromide (bromotropane methobromide), which when warmed with alkali lost a molecule of hydrobromic acid, forming tropidine-methobromide. This, by the action of potassium iodide, passed into the corresponding methiodide, and the latter by digestion with silver chloride gave the methochloride, which on heating furnished tropidine.

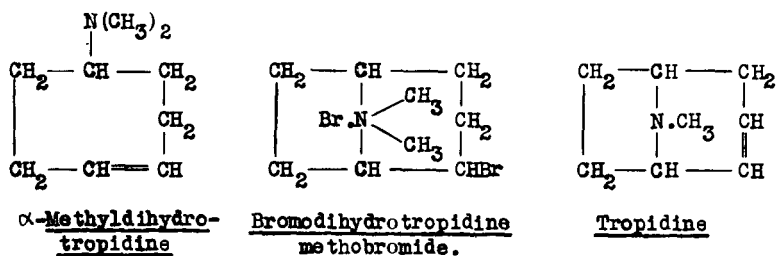

The conversion of α -methyltropidine into tropidine methiodide was subsequently achieved in another way.⁵³ By saturating a solution of the base in hydrochloric acid with hydrogen chloride, the elements of the latter were added on in the Δ^2 -position and the product on treatment with sodium carbonate solution yielded methyl- ψ -tropine. The latter was next brominated in positions 4 and 5. The dibromide, thus formed,

undergoes spontaneous isomerisation into bromo- ψ -tropine-methylammonium bromide, and this on reduction with zinc dust and hydriodic acid yielded, not, as was expected, tropine (or ψ -tropine), but, by elimination of water and bromine, tropidine methiodide, from which tropidine can be obtained as already stated.

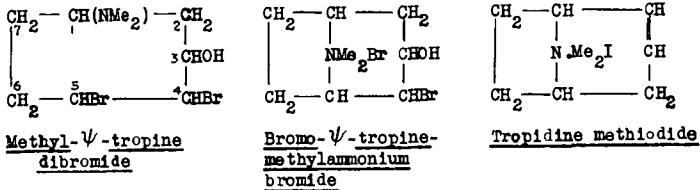

This synthetic tropidine was converted into bromodihydrotropidine by hydrogen bromide in acetic acid, and the solution heated with 10 per cent. sulphuric acid at 200–10°, when it passed into ψ -tropine,⁵³ and, since this may be partially converted into tropine by oxidation to tropinone and reduction of the latter by zinc dust and hydriodic acid,⁴⁵ this series of reactions affords a complete synthesis of tropine and of the tropeines. Combining the formula given above for tropine with that of tropic acid, atropine and hyoscyamine are represented as follows :

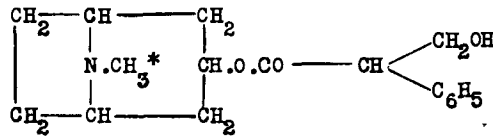

Atropine (dl-tropyltropine) and Hyoscyamine (l-tropyltropine).

* In *norhyoscyamine* and *noratropine* (p. 83) this -CH₃ group is replaced by -H.

The importance of tropinone as a possible starting-point for the production of the therapeutically valuable alkaloids atropine, hyoscyamine, cocaine, tropacocaine and the artificial tropeines (p. 73) led Robinson⁵⁵ to consider the possibility of preparing this substance by a simple method. Starting with the idea that the formula for tropinone (XXX) may be regarded as made up of the formulæ of the residues of succinaldehyde (XXVII), methylamine (XXVIII) and acetone (XXIX), he found that a mixture of these substances in water, when allowed to stand for thirty minutes produced tropinone, which could be detected by means of its characteristic dipiperonylidene derivative (bright yellow needles, m.p. 214°).

A better yield was obtained when, in place of acetone, calcium acetonedicarboxylate was used, the initial product in this case being calcium tropinonedicarboxylate, from which the free dibasic acid is readily isolated and can be decarboxylated by heating in acid solution, yielding tropinone. This idea was taken up in Germany, and a number of processes for the production of tropinone derivatives have been described, mostly in patent literature. According to Willstätter and Pfannenstiel,⁵⁶ a yield of

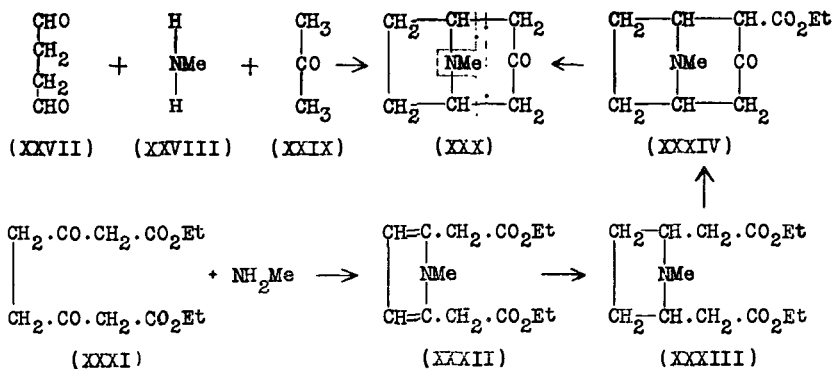

about 60 per cent. of acetonedicarboxylic acid can be obtained by treating citric acid with fuming sulphuric acid and the potassium-potassio derivative of the ethyl ester of this acid, on electrolysis furnishes ethyl succinyldiacetate (XXXI), which reacts with methylamine acetate to give ethyl *N*-methylpyrrole-2:5-diacetate (XXXII), which is then reduced to the corresponding pyrrolidine ester (XXXIII); the latter, probably a mixture of the *cis*- and *cis-trans* isomerides, of which only the *cis*-form is suitable for further ring closure, when heated in cymene solution with sodium, is condensed to ethyl tropinone carboxylate (XXXIV), and the latter, on boiling with 10 per cent. sulphuric acid yields tropinone (XXX),⁵⁷ from which tropine and ψ -tropine can be obtained, as already described. The pyrrolidine ester (XXXIII) has recently been prepared by Karrer and Alagil⁵⁷ by a new method, and van de Kamp and Sletzinger^{57(a)} have found that under certain conditions tropinone can be hydrogenated to tropine with little or no ψ -tropine.

Mannich and Veit⁵⁸ obtained a 60 per cent. yield of dimethyl tropinone-2:4-dicarboxylate by heating together dimethyl acetonedicarboxylate, methylamine hydrochloride and succindialdehyde, and Schopf and Lehmann⁵⁸ have shown that the conditions under which Robinson's synthesis is carried out affect the yield considerably; thus, using succindialdehyde, methylamine hydrochloride and acetonedicarboxylic acid in appropriately buffered solution at pH 3-11 and temperature varying from 20-25°, yields of 47-86 per cent. of tropinone can be obtained. Under these conditions tropinone itself is formed, but when the pH is changed to 13 tropinonedicarboxylic acid is produced, so that, although the direct yield of tropinone falls to 5 per cent. or less, a further indirect yield of about 65 per cent. is obtained after decarboxylation. Keagle and Harting^{58(a)} have investigated methods for the preparation of the primary materials and optimal conditions for the condensation and have begun the preparation of a series of *N*-homologues of tropinone by their modified method.

Using maleic aldehyde, acetonedicarboxylic acid and methylamine hydrochloride in aqueous solution, in presence of sodium acetate, Preobrazhenskii, Rubtsov, Dankova and Pavlov⁵⁸ have prepared *tropenone*,

$C_8H_{11}ON$, m.p. 40–40.5°, giving a picrate, m.p. 191–191.5° and a dipiperonylidene derivative, m.p. 206–206.5°.

Though the dialdehyde-tropinone synthesis does not succeed when the dialdehyde is replaced by a diketone, Blount and Robinson⁵⁹ have shown that 1-methyltropinone (XXXV) can be obtained by the interaction of the keto-aldehyde, lævulinaldehyde, $Me \cdot CO \cdot CH_2 \cdot CH_2 \cdot CHO$, with methylamine and calcium acetonedicarboxylate, and from this by reduction to 1-methyl- ψ -tropine and benzylation, 1-methyltropacocaine (b.p. 210°/15 mm. ; picrate, m.p. 163–4°) has been prepared.

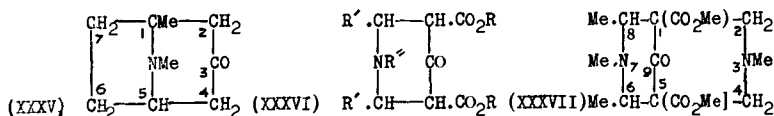

Connected with these syntheses is Mannich's⁶⁰ development of an observation first made by Petrenko-Kritschenko and Zoneff on the condensation of ammonia and amines with benzaldehyde and dimethyl acetonedicarboxylate to substituted piperidones. By the interaction of acetaldehyde with primary amines and either methyl acetonedicarboxylate or potassium methyl potassioacetonedicarboxylate, Mannich has prepared a number of substituted piperidones of the type represented by (XXXVI), in which the pyrrolidine ring of tropane is replaced by two alkyl groups to produce "open" tropines or egonines, from which corresponding "tropecines" and "cocaines" have been prepared, the former showing mydriatic and the latter local anæsthetic action. Mannich and Veit⁶¹ have also produced a variant on the tropane and granatane types by condensing methyl 4-keto-1 : 2 : 6-trimethylpiperidine-3 : 5-dicarboxylate with formaldehyde and methylamine hydrochloride to methyl 9-keto-3 : 6 : 7 : 8-tetramethylpiperidine-1 : 5-dicarboxylate (XXXVII).

REFERENCES

- (1) EVERS, *Pharm. J.*, 1926, **117**, 179; CAINES, *Quart. J. Pharm.*, 1930, **3**, 342; EXLER, *Pharm. Weekbl.*, 1928, **65**, 1152; EVANS and GOODRICH, *J. Amer. Pharm. Assoc.*, 1933, **22**, 824; FRICKE and KAUFMAN, *ibid.*, 1939, **3**, 215; MARKWELL, *Pharm. J.*, 1941, **166**, 259; CORFIELD, *et al.*, *Quart. J. Pharm.*, 1943, **16**, 108; OHBLUM, *Farm. Notesbl.*, 1940, **42**, 191 (*Quart. J. Pharm. Abstr.*, 1941, **14**, 188); GILLILAND, KAUFMAN and BANG, *J. Amer. Pharm. Assoc.*, 1943, **32**, 326; EDER and RUCKSTUHL, *Pharm. Acta Helv.*, 1943, **18**, 605. (2) *Quart. J. Pharm.*, 1939, **12**, 99. (3) *Ibid.*, 1945, **18**, 29; 1947, **20**, 1. (4) *Compt. rend.*, 1942, **214**, 171, cf. H. A. ARD, *Bull. Soc. Chim.*, 1939, [v], 6, 1077. (5) *Arch. Pharm.*, 1940, **278**, 136; *Dansk. Tids. Farm.*, 1944, **18**, 217. (6) *Quart. J. Pharm.*, 1945, **18**, 245; 1946, **19**, 526. (7) *Ibid.*, 1945, **18**, 163; cf. REIMERS and GOTTLIEB, *Dansk. Tids. Farm.*, 1943, **17**, 54, and BROWN, KIRCH and WEBSTER, *J. Amer. Pharm. Assoc.*, 1948, **37**, 24. (8) *Quart. J. Pharm.*, 1944, **17**, 226, 224. (9) *Ibid.*, 1944, **18**, 7. (10) *Bull. Soc. chim. Biol.*, 1945, **27**, 431. For other biological methods see, for example, NOLLE, *Arch. exp. Path. Pharm.*, 1929, **143**, 184; JENDRASSIK and WILL, *ibid.*, 1930, **153**, 94; FERNANDEZ, *ibid.*, 1928, **127**, 197, 204, and PULEWKA, *ibid.*, 1932, **168**, 307; KEIL and KLUGE, *ibid.*, 1934, **174**, 493; WATSON, HEARD and JAMES, *Quart. J. Pharm.*, 1941, **14**, 253; GUNN, *ibid.*, 1944, **17**, 7. (11) See, for example, WAGENAAR, *Pharm. Weekbl.*, 1928, **65**, 197, 549, 1226; FULTON, *J. Assoc. Off. Agric. Chem.*, 1929, **12**, 812; CARR, Allen's "Organic Analysis," 5th edition, **7**, 819. (12) *Annalen*, 1838, **6**, 67.

(13) *Ibid.*, 1833, 5, 43; 6, 44; 7, 269. (14) *Arch. Pharm.*, 1850, 74, 245; cf. PESCI, *Gazzetta*, 1882, 12, 59. (15) WILL and BREDIG, *Ber.*, 1888, 21, 1717, 2797; SCHMIDT, *ibid.*, 1829; cf. GADAMER, *Arch. Pharm.*, 1901, 239, 294; CHEMNITIUS, *J. pr. chem.*, 1927, [ii], 116, 276; DUILIUS, *Chem. Zeit.*, 1930, 54, 182. (16) *Gazzetta*, 1881, 11, 538; 1882, 12, 60. (17) *Arch. Pharm.*, 1891, 229, 134; 1893, 231, 110. (18) *Annalen*, 1891, 261, 87; 1892, 271, 124; 1893, 277, 290. (19) *Ibid.*, 1883, 217, 102. (20) *Jahresb.*, 1858, 376. (21) *Ber.*, 1880, 13, 165. (22) *Ber.*, 1884, 17, 381. (23) KÜSSNER, *Arch. Pharm.*, 1938, 276, 617. (24) *Bull. Soc. chim.*, 1929, [iv], 45, 304. (25) *Annalen*, 1833, 7, 270. (26) *Ibid.*, 1871, 157, 98. (27) *Ibid.*, 1880, 206, 282. (28) CARR and REYNOLDS, *J. Chem. Soc.*, 1910, 97, 1329; cf. GORIS and COSTY, *Bull. Sci. Pharmacol.*, 1922, 29, 113; KING and WARE, *J. Chem. Soc.*, 1941, 331. (29) For suggestions as to mechanism of racemisation, see GADAMER, *J. pr. Chem.*, 1913, [ii], 87, 312, and FRANKLAND, *J. Chem. Soc.*, 1913, 103, 722. (30) *Arch. Pharm.*, 1902, 240, 498. (31) *Ber.*, 1889, 22, 2590. (32) *J. Chem. Soc.*, 1909, 95, 1969. (33) GADAMER, *Arch. Pharm.*, 1901, 239, 294. (34) KRAUT, *Annalen*, 1863, 128, 280; 1865, 133, 87; 1868, 148, 236; LOSSEN, *ibid.*, 1864, 131, 43; 1866, 138, 230. (35) *Ber.*, 1880, 13, 376, 2041; 1889, 22, 2590; cf. MACKENZIE and STRATHERN, *J. Chem. Soc.*, 1925, 127, 82; KERR, *ibid.*, 1927, 1943. (36) *Ber.*, 1881, 14, 235. (37) *Ibid.*, 1918, 51, 252; WISLICENUS and BILHÜBER, *ibid.*, 1237; cf. VON BRAUN, *ibid.*, 1920, 53, 1409. (38) *Compt. rend.*, 1928, 186, 1630. (39) *J. Chem. Soc.*, 1919, 115, 828. (40) *Ibid.*, 1919, 115, 490; cf. LADENBURG and HUNDT, *Ber.*, 1889, 22, 2591; GADAMER, *Arch. Pharm.*, 1892, 230, 207; AMENOMIYA, *ibid.*, 1902, 240, 501. (41) See especially, JOWETT and PYMAN, *J. Chem. Soc.*, 1909, 95, 1020; JOWETT, PYMAN and DALE, *Seventh Internat. Cong. Applied Chem.*, 1909, IV, A, 1335; and PYMAN, *J. Chem. Soc.*, 1917, 111, 1104. (42) LADENBURG, *Annalen*, 1883, 217, 117; *Ber.*, 1887, 20, 1647. (43) *Ibid.*, 1896, 29, 396; cf. CIAMICIAN and SILBER, *ibid.*, 490. (44) Cf. WILLSTÄTTER, *Ber.*, 1896, 29, 393; MERLING, *ibid.*, 1891, 24, 3108; EICHENGRÜN and EINHORN, *ibid.*, 1890, 23, 2870. (45) WILLSTÄTTER and IGLAUER, *ibid.*, 1900, 33, 1170; cf. Ger. Pat. 96,362. (46) MERLING, *Annalen*, 1883, 216, 348; WILLSTÄTTER, *Ber.*, 1896, 29, 398; 1897, 30, 2679. (47) MERLING, *Annalen*, 1883, 216, 343; WILLSTÄTTER, *Ber.*, 1896, 29, 1579, 1637. (48) WILLSTÄTTER, *ibid.*, 1896, 29, 1581, 1638; M. and M. POLONOVSKI, *Bull. Soc. chim.*, 1927, [iv], 41, 1190; 1928, [iv], 43, 364. (49) *Ber.*, 1883, 16, 1604. (50) *Ibid.*, 1897, 30, 731, 2679. (51) CIAMICIAN and SILBER, *ibid.*, 1896, 29, 481. (52) WILLSTÄTTER, *ibid.*, 1895, 28, 3275; 1898, 31, 1535, 2498. For tropilene, cf. KÖTZ and ROSENBUSCH, *ibid.*, 1911, 44, 464. (53) *Ibid.*, 1901, 34, 129, 3163; *Annalen*, 1901, 317, 204, 267, 307; 1903, 326, 1, 23; cf. LADENBURG, *Ber.*, 1902, 35, 1159. (54) *Annalen*, 1891, 264, 310. (55) *J. Chem. Soc.*, 1917, 111, 762. (56) *Annalen*, 1921, 422, 1. (57) WILLSTÄTTER and BOMMER, *ibid.*, 1921, 422, 15; KARRER *et al.*, *Helv. Chim. Acta*, 1947, 30, 1776. (57a) *U.S. Pat.* 2,366,760. (58) *Ibid.*, 1935, 518, 12; cf. MANNICH and VEIT, *Ber.*, 1935, 68, 511; PREOBRAZHENSKII *et al.*, *J. Gen. Chem. U.S.S.R.* 1945, 15, 952; (58a) *J. Amer. Chem. Soc.*, 1946, 68, 1608. (59) *J. Chem. Soc.*, 1933, 1511. (60) *Arch. Pharm.*, 1934, 273, 323; cf. PETRENKO-KRITSCHENKO and ZONEFF, *Ber.*, 1906, 39, 1358; *J. Russ. Phys. Chem. Ges.*, 1915, 47, 1126. (61) MANNICH and MOHS, *Ber.*, 1930, 63, 608; MANNICH and VEIT, *ibid.*, 1935, 68, 506.

*nor*Hyoscyamine, $C_{16}H_{21}O_3N$. Carr and Reynolds¹ have shown that this alkaloid occurs in minute quantity in *Scopolia japonica*, *Datura Metel*, *D. meteloides*, *Duboisia myoporoides* and *Mandragora vernalis*; and Petrie has found it in *Solandra longiflora* from which he first described it under the name "solandrine."²

The alkaloid may be separated from accompanying hyoscyamine by extracting most of it with ether and then crystallising the mixed oxalates from water, that of *nor*hyoscyamine separating first. It crystallises in colourless prisms, m.p. 140°, $[\alpha]_D - 23.0^\circ$ (50 per cent. EtOH), is soluble in alcohol or chloroform, less so in ether or acetone, and sparingly in water

(1 in 270 at 14°), and is a strongly alkaline base. The hydrochloride, B. HCl, forms rosettes of needles, m.p. 207°; the sulphate, B₂. H₂SO₄. 3H₂O, silky needles, m.p. 249°; and the oxalate, B₂. H₂C₂O₄, long prisms, m.p. 245–6°, soluble in water (1 in 20 at 15°). The aurichloride, B. HAuCl₄, forms yellow scales, m.p. 178–9°; and the platinichloride, B₂. H₂PtCl₆. 3H₂O, forms handsome, reddish-yellow prisms of indefinite melting point. The picrate crystallises in needles, m.p. 220°. *nor*Hyoscyamine yields a nitrosoamine, and is converted by methyl iodide into hyoscyamine. In presence of alkali it undergoes racemisation to *nor*atropine (*see below*), and on hydrolysis by baryta water yields tropic acid and *nortropine* already described (p. 75).

*nor*Hyoscyamine closely resembles ψ -hyoscyamine isolated from *Duboisia myoporoides* by E. Merck,³ and later from *Mandragora officinarum* by Hesse⁴; and Carr and Reynolds suggest that they are identical.

*nor*ATROPINE, C₁₆H₂₁O₃N. This racemisation product of *nor*hyoscyamine, crystallises from dry acetone, and has m.p. 113–4°. It is readily soluble in alcohol, chloroform or ethyl acetate; less so in ether, acetone or water; is optically inactive, and forms a monohydrate, m.p. 73°. The hydrochloride, B. HCl, forms silky filaments, m.p. 193°; the sulphate B₂. H₂SO₄, long needles, m.p. 257°, from water; the aurichloride occurs in dull rosettes of opaque, yellow needles, m.p. 157°, and resembles atropine aurichloride in melting under water. The picrate crystallises in needles, m.p. 227°. On treatment with methyl iodide *nor*atropine is converted by N-methylation into atropine. The relationship of *nor*hyoscyamine and *nor*atropine to hyoscyamine may be represented as follows:—

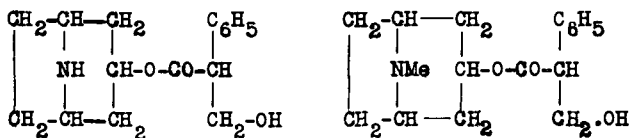

*nor*Hyoscyamine or *nor*Atropine Hyoscyamine or Atropine

Mandragorine. An alkaloid so named was isolated by Ahrens⁵ from the root of *Mandragora officinarum*, a plant which, in the form of “wine of mandragora,” was probably the first anaesthetic used in surgical operations.⁶ Thoms and Wentzel⁷ showed that Ahrens’s mandragorine was a mixture of hyoscyamine and hyoscyne, with perhaps a minute quantity of a third alkaloid. Hesse, however, stated that this root contains, in addition to hyoscyamine and hyoscyne, ψ -hyoscyamine (probably *nor*hyoscyamine, *see above*), and a new mandragorine, C₁₅H₁₉O₂N, which forms a crystalline aurichloride, m.p. 124–6°, and on hydrolysis yields tropic acid and a base resembling tropine.⁸

Meteloidine, C₁₃H₂₁O₄N, was found by Pyman and Reynolds in *Datura meteloides*.⁹ It crystallises from benzene in tabular needles, m.p. 141–2°, [α]_D ± 0°, is readily soluble in alcohol or chloroform, sparingly so in water, ether or benzene. The hydrobromide, B. HBr. 2H₂O, occurs in chisel-shaped needles, m.p. 250° (*dry*); the aurichloride, B. HAuCl₄. $\frac{1}{2}$ H₂O,

forms short yellow needles, m.p. 149–50°; the picrate has m.p. 177–80°. Meteloidine is physiologically inactive.

On hydrolysis by baryta the alkaloid is resolved into tiglic acid, $\text{CH}_3\text{CH} : \text{C}(\text{CH}_3) \cdot \text{COOH}$, and a base, TELOIDINE, $\text{C}_8\text{H}_{15}\text{O}_3\text{N}$, H_2O , which crystallises from boiling acetone diluted with a little water in chisel-shaped needles, m.p. 168–9° (*dry*). It is not volatile; the hydrochloride, m.p. above 300°, hydrobromide, m.p. 295°, and aurichloride, B. $\text{HAuCl}_4 \cdot \frac{1}{2}\text{H}_2\text{O}$, m.p. 225°, are all crystalline. King¹⁰ has suggested that tropine, $\text{C}_8\text{H}_{15}\text{ON}$, oscine, $\text{C}_8\text{H}_{15}\text{O}_2\text{N}$, and teloidine, $\text{C}_8\text{H}_{15}\text{O}_3\text{N}$, are related to each other in the following way :—

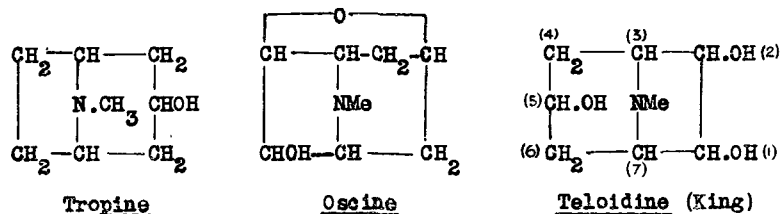

Hyoscine (*Scopolamine*, *Atroscine*), $\text{C}_{17}\text{H}_{21}\text{O}_4\text{N}$. The name hyoscine was first used by Höhn and Reichardt¹¹ for the basic hydrolytic product of hyoscyamine, now known as tropine. It was subsequently used by Ladenburg¹² for a supposed isomer of atropine, $\text{C}_{17}\text{H}_{23}\text{O}_3\text{N}$, isolated from the mother liquors of hyoscyamine. This was found by Schmidt, Hesse and others¹³ to be identical with scopolamine, $\text{C}_{17}\text{H}_{21}\text{O}_4\text{N}$, obtained by Schmidt from *Scopolia japonica*.¹⁴ The name hyoscine has priority and is in use, but scopolamine is also employed, especially in Germany.

The alkaloid can usually be obtained from the mother liquors of hyoscyamine, but *Datura Metel*, in which hyoscine is the chief constituent, was the better primary source but may now prove less valuable than selected *Duboisia* spp. (p. 66). A process of manufacture has been described by Chemnitius,¹⁵ and a method for the recovery of *l*-hyoscine from racemised base by Schukina *et al.*¹⁵ A method for its estimation in presence of opium alkaloids has been devised by Wallen and Canbäck.^{15(a)}

The free base is a syrup, soluble in ordinary solvents, least readily in light petroleum or benzene. It is levorotatory $[\alpha]_{\text{D}}^{20} - 18^\circ$ (EtOH), $- 28^\circ$ (H_2O). The hydrobromide, B. $\text{HBr} \cdot 3\text{H}_2\text{O}$, m.p. 193–4° (*dry*), $[\alpha]_{\text{D}} - 15 \cdot 72^\circ$ (EtOH), $- 25 \cdot 93^\circ$ (anhydrous salt : H_2O),¹⁶ forms rhombic tablets, is readily soluble in water or alcohol, sparingly in chloroform, insoluble in ether. It is bitter and acrid to the taste, and is slightly acid to litmus. This salt is that mostly used in medicine. The aurichloride, B. HAuCl_4 , m.p. 208–9° (*dec.*) crystallises in needle-shaped growths serrated on both edges. The auribromide, B. HAuBr_4 , m.p. 191–2°, forms long, rectangular, chocolate-red leaflets from boiling 2·5 per cent. hydrochloric acid. The picrate crystallises in slender, primrose-yellow needles, m.p. 187–8°; but on recrystallisation from boiling water, forms flat irregular six-sided scales, m.p. 187·5–188·5° (191–2° *corr.*).

Hyoscine, like hyoscyamine, is readily racemised by dilute alkalis, and

commercial hyoscine hydrobromide not infrequently contains some optically inactive salt. Hesse¹⁸ isolated from such material an optically inactive alkaloid, isomeric with hyoscine, which he named ATROSCINE. According to Schmidt,¹⁹ this substance is *dl*-hyoscine; and Gadamer²⁰ showed that Hesse's atroscine and Schmidt's *dl*-hyoscine were respectively di- and mono-hydrates of the same alkaloid. *dl*-Hyoscine may be prepared by the action of dilute sodium hydroxide solution in alcohol, on the *lævo*-form at atmospheric temperature. Merck has stated that hyoscine hydrobromide from henbane seed has a rotation of -24° to -25° , whilst that from *Scopolia* rhizome has a rotation of -13.47° , due to the presence of racemic base. From such material, according to Gadamer,²⁰ the optically inactive alkaloid can be separated by adding sodium carbonate to an aqueous solution and extracting with a mixture of chloroform and ether. On rubbing the residue with alcohol and water and cooling, the dihydrate (Hesse's atroscine), rosettes of needles, m.p. $37-8^{\circ}$ ($36-7^{\circ}$ Hesse; prisms, $38-40^{\circ}$ King) forms, whilst seeding with the monohydrate (Schmidt's *dl*-hyoscine) leads to the separation of the latter form in monoclinic needles, m.p. $56-7^{\circ}$. King²¹ prepared from residues accumulated in the manufacture of *l*-hyoscine, the dextro-form of the alkaloid, and by combining this with an equal weight of the *lævo*-isomeride, obtained the *dl*-form, and was thus able to characterise the three forms of the

Derivative		<u>l</u> -Hyoscine	<u>d</u> -Hyoscine	<u>dl</u> -Hyoscine
Base	Character	Syrup	Syrup	Prisms containing $2H_2O$, m.p. $38-40^{\circ}$ (<u>corr.</u>). Anhydrous substance, syrup ²² .
Hydrobromide	Character	Rhombic tablets with $3H_2O$	Rhombic tablets with $3H_2O$	Rhombic tablets with $3H_2O$, efflorescent.
	M.p. (dry salt)	$193-194^{\circ}$ $197-198^{\circ}$ (<u>corr.</u>)	$193-194^{\circ}$ $197-198^{\circ}$ (<u>corr.</u>)	$181-182^{\circ}$ $185-186^{\circ}$ (<u>corr.</u>)
	(α) _D (dry salt in water).	-25.9°	$+26.3^{\circ}$	-
Picrate	Character	Slender matted needles.	Slender matted needles.	Needles.
	M.p.	$187-188^{\circ}$ $191-192^{\circ}$ (<u>corr.</u>) ²³	$187-188^{\circ}$ -	$173.5-174.5^{\circ}$ $177.5-178.5^{\circ}$ (<u>corr.</u>) ²³
Aurichloride	Character	Needles, both edges serrated	Needles, both edges serrated	Needles, one edge serrated.
	M.p.	$204-205^{\circ}$ $208-209^{\circ}$ (<u>corr.</u>) ²⁴	$204-205^{\circ}$ $208-209^{\circ}$ (<u>corr.</u>) ²⁴	$214-215^{\circ}$ $218-219^{\circ}$ (<u>corr.</u>) ²⁴
Auribromide	Character	Chocolate-red leaflets	-	Chocolate-red leaflets
	M.p.	$187-188^{\circ}$ $191-192^{\circ}$ (<u>corr.</u>) ²⁵	- -	$209-210^{\circ}$ $213-214^{\circ}$ (<u>corr.</u>) ²⁵

alkaloid and some of their chief derivatives (*see table on p. 85*). The reactions of hyoscyne are for the most part similar to those of atropine and hyoscyamine, but it gives a white precipitate with mercuric chloride. It may best be distinguished from these alkaloids by means of its aurichloride or picrate.

When warmed with barium hydroxide, dilute alkalis or acids, hyoscyne is hydrolysed, yielding tropic acid and a new base, $C_8H_{13}O_2N$, oscine or scopoline. Depending on the conditions of experiment, the tropic acid obtained may be either the pure *l*-form or the partially racemised acid; but the oscine obtained is invariably inactive.

It appeared to follow from this that the three known forms of hyoscyne are respectively *l*-troyl-*dl*-oscine, *d*-troyl-*dl*-oscine and *dl*-troyl-*dl*-oscine, the optical activity of the first two being conditioned solely by the activity of the troyl radicle. This subject was discussed by King,²¹ who confirmed

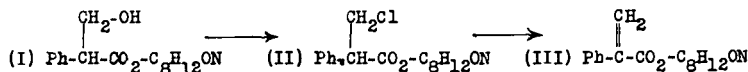

his own results, arrived at from the resolution of *dl*-hyoscyne by means of *d*- α -bromo- π -camphorsulphonic acid, by converting *l*-hyoscyne (I) into β -chlorohydratropyloscine (II), and then into *apohyoscyne*²⁶ (III) (thus destroying the asymmetry of the troyl radicle), and showing that the resulting *apohyoscyne* was not only inactive, but could not be resolved into optically active forms. The same author has shown that oscine can be resolved into *d*- and *l*-forms; and some years previously benzoyloscine had been resolved by Tutin.²⁷

OSCINE, $C_8H_{13}O_2N$. This substance, for which the name SCOPOLINE is in use in continental Europe, was first examined by Hesse²⁸ and later by Luboldt.²⁹ It forms colourless, hygroscopic prismatic crystals, m.p. 109° , from ether or light petroleum, and boils at $241-3^\circ$. *dl*-Oscine has been resolved into the *d*- and *l*-forms by King²¹ by crystallisation of the *d*-hydrogen tartrates. The characters of the three forms of oscine and of their picrates and hydrochlorides are tabulated on p. 87.

Up to 1915 it had been established that oscine was a tertiary base, containing one hydroxyl group, and that the second oxygen atom was probably present in an etheric linkage. It was also known that on oxidation with chromic acid, oscine furnished scopoligenine, $C_7H_{10}O_2:NH$, analogous with the tropigenine (*nortropine*) yielded by tropine. Schmidt observed³⁰ that on heating at 130° with excess of saturated hydrobromic acid, scopoline formed hydrobromoscopoline hydrobromide, $C_8H_{14}O_2NBr \cdot HBr$ (plates, m.p. 202°), which on reduction yielded dihydroscopoline, $C_8H_{15}O_2N$ (aurichloride, m.p. $200-1^\circ$). The latter was shown to contain two hydroxyl groups and on oxidation with chromic acid gave a dibasic acid³¹ (scopolic acid, Hess), eventually identified as *N*-methylpiperidine-2 : 6-dicarboxylic acid³² (VIII) by means of its methyl ester methiodide, first prepared by Willstätter and Lessing,³³ thus indicating that dihydroscopoline is a dihydroxytropine (IX), which brings it into

Derivative	Characteristics	<u>l</u> -Oscine	<u>d</u> -Oscine	<u>dl</u> -Oscine
Base	Crystalline form. M.p. [α] _D in water	Needles 109.5° -52.4°	Needles 109.5° +54.8°	Needles or tablets. 109-110° -
Picrate	Crystalline form. M.p.	Dimorphous: rhombs and needles 237-238°	Dimorphous: rhombs and needles 237-238°	Flattened rhombs 237-238°
Hydrochloride	Crystalline form. M.p. [α] _D (basic ion) in water	Prisms in warty masses Deliquescent 273-274° 281-282° (corr.) -24.2°	Prisms in warty masses Deliquescent 273-274° +24.0°	Prisms in warty masses (anhydrous) Tablets (hydrated) 273-274°

close relationship with tropine. Hess and his collaborators³⁴ obtained and synthesised the same acid independently and drew the same conclusion regarding dihydroscopoline, which Hess confirmed³⁵ by showing that, on reduction with hydriodic acid and phosphonium iodide at 200°, it yields TROPANE, C₈H₁₅N (X), b.p. 167°, D¹⁵ 0.9259, n_D¹⁰ 1.47950, platinumchloride, B₂ · H₂PtCl₆, bright orange-red needles, m.p. 219° (*dec.*), 229-30° (*dec.* Hess), aurichloride, B · HAuCl₄, small, thick prisms, m.p. 242-3° (*dec.*), picrate, m.p. 281° (*dec.*). Tropane has been synthesised by Coleman and Carnes^{35(a)} by the action of sulphuric acid at 65° on *N*-chloro-*N*-methylcycloheptylamine.

In oscine, therefore, one oxygen atom must be attached to carbon atom 6 or 7 as a hydroxyl group and the second must form an oxygen bridge between 7 or 6 and another carbon atom in the ring. Hess investigated *dl*-scopoline (*dl*-oscine) by Hofmann's method in the hope of determining this point of attachment.³⁶ Unfortunately the reactions did not proceed smoothly: the products showed that the nitrogen bridge is not alone affected, the oxygen bridge being ruptured and reconstituted: substances containing two ethylenic linkages are formed and an *O*-methyl ether was one of the end products. Hess suggested that the oxygen bridge must lie

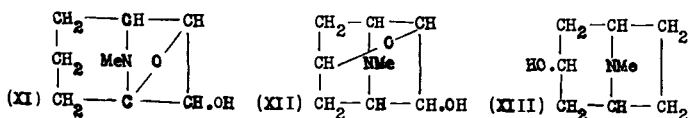
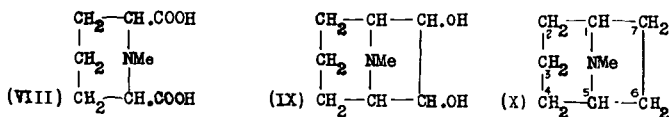

between positions 5 and 7 (XI), to account for its rupture in the first stage of the operations. Gadamer and Hammer,³⁷ repeating this work with the optically active forms of oscine, found that their results could be better explained by an oxygen bridge between positions 3 and 7 (XII), a suggestion first made by King²¹ and subsequently accepted by Hess and Wahl,³⁷ who provided an explanation of the course of the Hofmann degradation on this basis. This formula makes one attachment of the second oxygen atom in scopoline similar to that of tropine (XIII).

These results left unexplained the observation that while oscine and benzoyloscine can each be resolved into two optically active forms, *dl*-hyosicine can only be resolved into two forms, the optical activities of which are conditioned by the troyl radicle. King suggested²¹ that this might be due to the basic residue in hyosicine having a symmetrical and, therefore, different configuration from that of oscine and capable of yielding the latter on hydrolysis, but preferred to regard the *d*- and *l*-hyoscines as partial racemates. Hess and Wahl³⁷ were unable to synthesise either *l*-hyosicine (from *l*-tropic acid and *dl*-oscine) or *apophyosicine* (from atropic acid and oscine), but did prepare by reduction of *apophyosicine*, a deoxyhyosicine, which occurred in only one racemic form, although on hydrolysis it furnished *dl*-oscine and deoxytropic acid (phenylpropionic acid). On the other hand, they found that esterification of *dl*-oscine with *dl*-deoxytropic acid produced two racemic alkaloids (deoxytropylo-scopoleines) neither of which was identical with deoxyscopolamine. To explain these facts, they adopted King's first view that in hyosicine the amino-alcohol is symmetrical and is converted into oscine during hydrolysis. This idea was shown to be correct by Willstätter and Berner,³⁸ who found that hyosicine is slowly hydrolysed by pancreatic lipase, in presence of ammonia-ammonium chloride as a buffer, to SCOPINE, $C_8H_{13}O_2N$ (with partial conversion of the latter into oscine), which is the real basic component of hyosicine. Scopine crystallises in long needles, m.p. 76°, is optically inactive and is readily converted, by heat or by the action of acids or especially of alkalis, into oscine. The hydrochloride crystallises in leaflets, and the picrate in thin leaflets, m.p. 231°. Scopine is clearly distinguished from oscine by the characters of its platinumchloride and aurichloride.

	<i>Platinichloride</i>	<i>Aurichloride</i>
Scopine	$B_2 \cdot H_2PtCl_6 \cdot 2H_2O$ Long, domatic prisms, m.p. 219°.	$B \cdot HAuCl_4 \cdot \frac{1}{2}H_2O$ Small prisms, m.p. 216° (<i>dec.</i>).
Oscine	$B_2 \cdot H_2PtCl_6 \cdot H_2O$ Plates, m.p. 203°.	$B \cdot HAuCl_4 \cdot \frac{1}{2}H_2O$ Prismatic plates, m.p. 220° (<i>dec.</i>).

M. and M. Polonovski³⁹ found that when scopolamine is treated with hydrogen peroxide, there is formed in addition to scopolamine *N*-oxide [α]_D - 14° (H₂O), [B. HBr, m.p. 153°] the quaternary base scopinium, isolated in the form of its bromide, m.p. 209-10°. The latter is reduced by sodium amalgam to a tertiary base, stereoisomeric with scopine and related to the latter as ψ -tropine is to tropine and, therefore, named ψ -SCOPINE. It yields crystalline salts; B. HCl, m.p. 257-8°, aurichloride,

m.p. 239–40°, platinichloride, m.p. 223°, picrate, m.p. 234° and, unlike scopine, is stable to acids and alkalis. When treated with silver oxide, scopinium bromide is decomposed into methylamine and *m*-hydroxybenzaldehyde: these two products are also formed when ψ -scopine is oxidised with chromic acid, probably through scopinone as an intermediary. With alkaline barium permanganate ψ -scopine is converted into *nor*- ψ -scopine.

The formula of hyoscine may now be written as tropylscopine (tropyloscopine by analogy with the tropeines) and the relationship of scopine to oscine, teloidine and tropine, the other principal hydrolytic products of this group, are shown by the following formulæ.

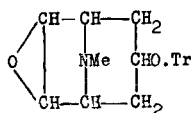
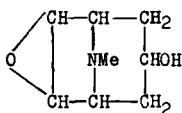
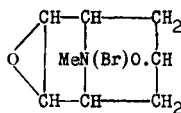
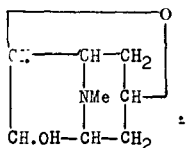
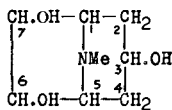
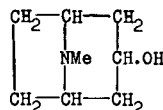
HyoscineScopine and ψ -scopineScopinium BromideOscineTeloidineTropine and ψ -Tropine

dl-*nor*Hyoscine (*dl*-*nor*Scopolamine), $C_{16}H_{19}O_4N$. This alkaloid was found in the residual liquors from the manufacture of hyoscine.⁴⁰ It forms silvery filaments, m.p. 101–3°, $[\alpha]_D \pm 0^\circ$, is converted by methyl bromide to hyoscine methobromide, m.p. 216–7° and hydrolyses to *dl*-tropic acid and *nor*oscine (*norscopoline*), the latter characterised as the aurichloride, m.p. 242°.

ALKALOIDS OF *DUBOISIA MYOPOROIDES*

The variations in alkaloids recorded for this species have been stated already (p. 66). The following account refers to four alkaloids (Barger *et al.*, ref. 23, p. 68) which have so far been observed only in this species **Tigloidine**, $C_{13}H_{21}O_2N$. The hydrobromide of this syrupy base forms tabular crystals, m.p. 234–5°, $[\alpha]_D \pm 0^\circ$; picrate rectangular plates, m.p. 239° from dilute alcohol; the aurichloride, golden-yellow plates, m.p. 213.5–214° and the methiodide, square plates, m.p. 244–5°. The base is unsaturated; the hydrobromide on hydrogenation yields *dihydrotigloidine* (picrate, m.p. 134.5°), and on treatment with bromine in chloroform produces *dibromodihydrotigloidine*, m.p. 187° (*dec.*). On hydrolysis by boiling with barium hydroxide in water, tigloidine furnishes tiglic acid and ψ -tropine (p. 100), and this evidence that it is tiglyl- ψ -tropeine, was confirmed by synthesis of the latter. Tiglyltropine hydrobromide, prepared for comparison, had m.p. 207°; the picrate melted at 200°.

Valeroidine, $C_{13}H_{23}O_3N$. This occurs in colourless, nacreous plates, m.p. 85° , $[\alpha]_D^{20} - 9.0^\circ$ ($c = 5$; EtOH) or -4° ($c = 5$; H_2O). It yields a hydrobromide, needles, m.p. $170-2^\circ$, $[\alpha]_D^{20} + 5^\circ$ ($c = 20$; H_2O), a picrate, m.p. $152-3^\circ$, a methiodide, m.p. 205.5° , and an acetyl-derivative of which the hydrobromide has m.p. 197° .

Treatment of valeroidine hydrobromide with thionyl chloride in an attempt to replace the hydroxyl group by chlorine resulted in demethylation with the formation of *norvaleroidine*, a syrup yielding a crystalline hydrobromide, $C_{12}H_{21}O_3N \cdot HBr$, m.p. 270° , $[\alpha]_D^{20} + 1^\circ$ ($c = 20$; H_2O) and furnishing valeroidine methiodide on treatment with methyl iodide. On hydrolysis, by boiling with barium hydroxide in water, valeroidine yields *isovaleric acid* and dihydroxytropane, the latter identical with the product from coca leaves (p. 100). On oxidation with permanganate in acetone valeroidine yields *norvaleroidine* (see above) and a new base, $C_{13}H_{19}O_4N$, m.p. 136° , $[\alpha]_D^{20} - 16.6^\circ$ ($c = 7.4$; EtOH), which on boiling with hydrogen chloride in alcohol is converted into *norvaleroidine* and is regarded as formed by the oxidation of the methyl group attached to nitrogen, to a carbamic acid (*a*), which then loses water to form an inner urethane (*b*) as represented by the following partial formulæ:—

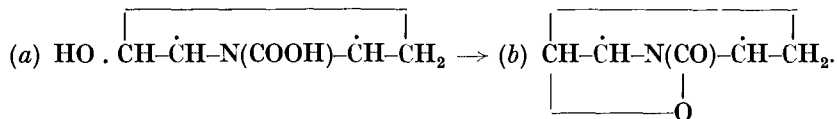

It is suggested that in valeroidine the free hydroxyl group is at C^6 or C^7 , as in the above partial formulæ, and the esterified hydroxyl group at C^3 , as is usual in this series (cf. hyosecyamine, p. 79).

Base Z, $C_{12}H_{21}O_2N$. This name was provisionally applied to a syrupy base which yielded a crystalline oxalate, $B_2 \cdot H_2C_2O_4$, m.p. $296-7^\circ$, a hydrobromide m.p. $219-20^\circ$; $[\alpha]_D^{20} + 2.9^\circ$ ($c = 6$; H_2O), a methiodide m.p. 301° , and a picrate m.p. 172° . On hydrolysis it furnished *nortropine* (tropigenine, p. 75) and a liquid acid, eventually shown to be a mixture of *isovaleric* and *d*- α -methylbutyric acids. Base Z is therefore a mixture of *isovaleryl**nortropeine* (which has been named *poroidine*) and *d*- α -methylbutyryl*nortropeine* (*isoporoidine*). Separation has not been effected but the two components have been synthesised and described.

Poroidine, $C_{12}H_{21}O_2N$. The synthetic product was isolated as the hydrobromide, colourless plates, m.p. $224-5^\circ$. A mixture (10 parts) of this with synthetic *isoporoidine* hydrobromide (1 part) had m.p. 220° which was not depressed by addition of the hydrobromide of either natural or racemised "base Z." The other salts prepared included oxalate, m.p. $301-2^\circ$, picrate, m.p. 172° and methiodide, m.p. 289° .

isoPoroidine, $C_{12}H_{21}O_2N$. The natural product is the *d*-form but only the synthetic *dl*-form was described. It was isolated as the hydrobromide, m.p. $201-2^\circ$. The picrate has m.p. 188° , the methiodide, m.p. 295° and the oxalate $B_2 \cdot H_2C_2O_4$, m.p. $296-7^\circ$.

ALKALOIDS OF *CONVOLVULUS PSEUDOCANTABRICUS*, Schrenk

The seeds contain about 0.5 per cent. of alkaloids, from which Orekhov and Konovalova (p. 69, ref. 33) have isolated four components by fractional crystallisation of the crude mixed hydrochlorides.

Convulvine, $C_{16}H_{21}O_4N$. This, on hydrolysis by alkalis, yields *nortropine* and veratric acid, and is, therefore, veratroyl*nortropine*. It has m.p. 115° and yields well-crystallised salts; hydrochloride, B. HCl, m.p. $260-1^\circ$; oxalate, m.p. $265-6^\circ$ (*dec.*); nitrate, m.p. $212-3^\circ$; picrate, m.p. $261-3^\circ$; and aurichloride, m.p. 217° . It has local anæsthetic properties.⁴¹

Convolumine, $C_{17}H_{23}O_4N$. This alkaloid is hydrolysed by boiling alcoholic potash into tropine and veratric acid, and is, therefore, veratroyltropine. It has m.p. $114-5^\circ$ and yields a picrate, m.p. $263-4^\circ$ (*dec.*); aurichloride, m.p. $201-2^\circ$; platinichloride, m.p. $216-7^\circ$, and methiodide, m.p. $273-5^\circ$.

Convolidine, $C_{32}H_{42}O_8N_2$ or $C_{33}H_{44}O_8N_2$. This is also a veratroyl ester, but the alkamine (m.p. $274-6^\circ$; picrate, m.p. $229-31^\circ$) has not been identified. The alkaloid has m.p. $192-3^\circ$, $[\alpha]_D \pm 0^\circ$.

Convulvicine, $C_{10}H_{16}N_2$, b.p. $250-60^\circ/760$ mm., yields a picrate, m.p. $260-2^\circ$.

Dioscorine, $C_{13}H_{19}O_2N$. This alkaloid was obtained from the tubers of *Dioscorea hirsuta*, Blume, by Boorsma,⁴² and was afterwards investigated by Schutte⁴³ and by Gorter.⁴⁴ It forms greenish-yellow plates, m.p. 43.5° , distils unchanged *in vacuo*, is soluble in water, alcohol or chloroform, and sparingly so in ether or benzene. The hydrochloride, B. HCl. $2H_2O$, forms colourless needles, m.p. 204° , $[\alpha]_D + 4.6^\circ$; the platinichloride, $(B. HCl)_2PtCl_4 \cdot 3H_2O$, orange-yellow tablets, m.p. $199-200^\circ$ (*dry*); the aurichloride, B. $HAuCl_4$, yellow needles, m.p. 171° (*dry*). With sulphuric acid and potassium iodate, dioscorine gives a blue-violet coloration and a reddish-violet with sodium nitroprusside in presence of alkalis.

According to Gorter, it decolorises permanganate immediately and contains a methylimino, but no hydroxyl or carbonyl group. With hot alkali it behaves as a γ -lactone. On exhaustive methylation dioscorine gives first demethyldioscoridine, $C_{13}H_{21}N$, and eventually trimethylamine and a hydrocarbon, $C_{11}H_{14}$, which appears to be a butenylcycloheptatriene (XIV). On these and other grounds Gorter⁴⁵ assigned formula (XV) to the alkaloid:—

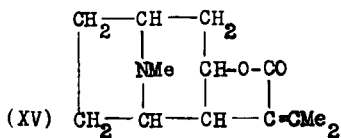
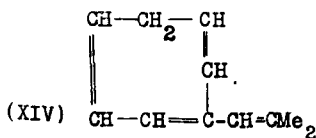

Dioscorine is bitter and poisonous; it produces paralysis of the central nervous system, and, in general, behaves like picrotoxin. This action appears to be correlated with the $-\text{CO}-\text{C}=\text{C}-$ group, since on the

suppression of this, as in the corresponding acid, or the reduced product, bisdihydrodioscorine ($C_{13}H_{20}O_2N$)₂, the picrotoxin-like action disappears.

Dioscorine has also been found in *D. hispida* tubers by Zeyva and Gutierrez.⁴⁶

REFERENCES

- (1) *J. Chem. Soc.*, 1912, 101, 946; cf. BARGER *et al.*, *ibid.*, 1937, 1820. (2) *Proc. Linn. Soc. N.S.W.*, 1907, 32, 1789; 1917, 41, 815. (3) *Arch. Pharm.*, 1893, 231, 117. (4) *J. pr. Chem.*, 1901, [iii], 64, 274. (5) *Ber.*, 1889, 22, 2159. (6) *Asclepiad*, June, 1888. (7) *Ber.*, 1901, 34, 1023. (8) *J. pr. Chem.*, 1901, [iii], 64, 274. (9) *J. Chem. Soc.*, 1908, 93, 2077, (10) *Ibid.*, 1919, 115, 487. (11) *Annalen*, 1871, 157, 98. (12) *Ibid.*, 1880, 206, 209. (13) SCHMIDT, *Arch. Pharm.*, 1892, 230, 207; 1894, 232, 409; HESSE, *Annalen*, 1892, 271, 120; 1893, 276, 84. (14) *Arch. Pharm.*, 1890, 228, 139, 435; cf. DUNSTAN and CHASTON, *Pharm. J.*, 1889, [iii], 20, 461. (15) *J. pr. Chem.*, 1928, [ii], 120, 221; SECHUKINA *et al.*, *J. Gen. Chem. U.S.S.R.*, 1940, 10, 803. (15a) *Farm. Revy.*, 1947, 46, 221. (16) *Arch. exp. Path. Pharm.*, 1941, 197, 275. (17) KING, *J. Chem. Soc.*, 1919, 115, 504; cf. CARR and REYNOLDS, *ibid.*, 1910, 97, 1330. (18) *Ber.*, 1896, 29, 1776. (19) *Arch. Pharm.*, 1898, 236, 9, 47. (20) *Ibid.*, 1898, 236, 382; cf. HESSE, *Annalen*, 1899, 309, 75; *J. pr. Chem.*, 1901, [ii], 64, 353; 1902, [ii], 66, 194; and KUNZ-KRAUSE, *ibid.*, 1901, [ii], 64, 569. (21) *J. Chem. Soc.*, 1919, 115, 476. (22) Cf. HESSE, *Ber.*, 1896, 29, 1776; GADAMER, *Arch. Pharm.*, 1898, 236, 382. (23) Cf. CARR and REYNOLDS, *J. Chem. Soc.*, 1912, 101, 949; SCHMIDT, *Arch. Pharm.*, 1894, 232, 409; FINNEMORE and BRAITHWAITE, *Pharm. J.*, 1912, 89, 136. (24) Cf. SCHMIDT, *Arch. Pharm.*, 1910, 248, 641; HESSE, *J. pr. Chem.*, 1901, [ii], 64, 274; THOMS and WENTZEL,⁷; FINNEMORE and BRAITHWAITE.²³ (25) Cf. JOWETT, *J. Chem. Soc.*, 1897, 71, 680. (26) *Ibid.*, 1919, 115, 974; cf. WILLSTÄTTER and HUG, *Zeit. physiol. Chem.*, 1912, 79, 146. (27) *J. Chem. Soc.*, 1910, 97, 1793. (28) *Annalen*, 1892, 271, 114; 1893, 276, 84. (29) *Arch. Pharm.*, 1898, 236, 11. (30) *Apoth. Zeit.*, 1902, 17, 592 (*Chem. Soc. Abstr.*, 1903, [i], 51); *Arch. Pharm.*, 1905, 243, 559. (31) *Arch. Pharm.*, 1909, 247, 79. (32) *Ibid.*, 1916, 253, 497; cf. HESS and WISSING, *Ber.*, 1915, 48, 1907. (33) *Ibid.*, 1902, 35, 2065. (34) *Ibid.*, 1915, 48, 1907, 2057. (35) *Ibid.*, 1918, 51, 1013; cf. WILLSTÄTTER and IGLAUER, *ibid.*, 1900, 33, 1175. (35a) *Proc. Iowa. Acad. Sci.*, 1942, 49, 288. (36) *Ber.*, 1919, 52, 1947; cf. GADAMER and HAMMER, *Arch. Pharm.*, 1921, 259, 110. (37) *Ber.*, 1922, 55, 1972; cf. GADAMER, *ibid.*, 1923, 56, 130. (38) *Ibid.*, 1923, 56, 1079. (39) *Compt. rend.*, 1925, 180, 1755; 1928, 186, 147; *Bull. Soc. Chim.*, 1928, [iv], 43, 79, 590. (40) GMELIN, *Arch. Pharm.*, 1941, 279, 112. (41) NOLLE, *Khim. Farm Prom.*, 1934, No. 5, 39; AWRUTOWA, *Chem. Zentr.*, 1938, [i], 496. (42) *Meded. uit's Lands Plant*, 1894, 13. (43) *Chem. Zentr.*, 1897, [ii], 130. (44) *Ann. Jard. Bot. Buit.*, 1909, [ii], *Suppl.*, 3, 385. (45) *Rec. trav. Chim.*, 1911, 30, 161. (46) *J. Phil. Isl. Med. Assoc.*, 1937, 17, 349.

ALKALOIDS OF ERYTHROXYLON COCA

The habitat of *Erythroxylon* spp. is principally the western side of South America, and although indigenous species occur in India, Africa and Australia, they have no economic value. Two kinds of coca leaves are available in commerce, Bolivian or Huanuco leaves derived from *E. coca* Lam. and Peruvian or Truxillo leaves obtained from *E. truxillense* Rusby; both are cultivated in Java. In South America coca leaves are chewed with lime by the Indians as a stimulant, and are exported to Europe for use in medicine and for the preparation of cocaine, but the principal source of coca leaves is Java. Crude cocaine is manufactured in South America and exported for refining and some aspects of this industry have been discussed recently.¹

The alkaloids of coca leaves belong to six groups :—

1. *Cocaines* (methylacylecgonines): Cocaine (methylbenzoylecgonine); cinnamylcocaine (methylcinnamoylecgonine); α -truxilline (methyl- α -truxilloylecgonine), β -truxilline (methyl- β -truxilloylecgonine).

2. *Tropeines* or ψ -*tropeines*: Benzoyltropine; tropacocaine (benzoyl- ψ -*tropeine*).

3. *Acylecgonines*: Benzoylecgonine.

4. *Alkylecgonines*: Methylecgonine, methylecgonidine.

5. *Dihydroxytropane*.

6. *Hygrines*: Hygrine, β -hygrine, cuscohygrine (cuskhygrine), hygroline.

The alkaloidal content of coca leaves varies from 0.5 to 1.5 per cent., but higher percentages have been recorded by de Jong² for Java leaves (season 1908, 1.0–2.5). Truxillo and Java cocas are richer in alkaloid than Bolivian coca, but the proportion of cocaine present is said to be about 50 per cent., whereas it may be 70–80 per cent. of the total alkaloid in Bolivian leaves. Coca leaves grown experimentally in India and examined by Howard contained 0.4–0.8 per cent. of alkaloid, largely cocaine. Small quantities of alkaloids have also been found in the leaves of *E. pulchrum* (South America), *E. monogynum* (India), *E. montanum*, *E. laurifolium*, *E. retusum*, *E. areolatum* and *E. ovatum*.^{2a} de Jong has pointed out that the youngest leaves are richest in cinnamylcocaine; in the older leaves this is replaced by cocaine or truxilline.³

A process of estimation for the total alkaloids was given in the 8th Revision of the U.S. Pharmacopœia and a survey of methods available was published by Bierling, Pape and Viehover in 1910.⁴ More recently processes have been described by Peyer and Gstirner⁵ and Goris and Chalmers,⁵ who provide a critical review of methods. The proportion of cocaine in the total alkaloids is important and various methods are available by which this may be estimated.⁶ Most of the cocaine of commerce is not obtained directly from the leaves, but from ecgonine got by the hydrolysis of the secondary alkaloids and for that reason methods for estimation of the total ecgonine obtainable from coca leaves are of importance and have been devised by Greshoff and by de Jong.⁷

Cocaine, C₁₇H₂₁O₄N. Cocaine is made either from the crude alkaloid as exported from *South America*⁸ or from ecgonine obtained by hydrolysis of the total alkaloids extracted from Java coca leaves,⁹ the ecgonine being then methylated and benzoylated to cocaine by recognised methods.¹⁰ According to Merck the conversion of ecgonine into cocaine may be accomplished in one operation by heating the former with methyl iodide and benzoic anhydride under pressure.¹¹ Einhorn and Willstätter¹² found that the truxillines and cinnamylcocaine can be converted into ecgonine methyl ester by boiling their solutions in methyl alcohol (6 parts) containing sulphuric acid (2 parts) for several hours, or by passing hydrogen chloride into a solution of the alkaloids in methyl alcohol. The methyl ester can then be benzoylated to cocaine.

Cocaine crystallises from alcohol in monoclinic, four- to six-sided prisms, m.p. 98°, and is slowly volatile above 90°, b.p. 187–8°/0.1 mm. It

is lævorotatory, $[\alpha]_D - 15.8^\circ$, slightly soluble in cold water, readily soluble in alcohol, ether, benzene or light petroleum. The aqueous solution is alkaline to litmus, has a slightly bitter taste and when applied to the tongue produces a characteristic numbness. The hydrochloride, B. HCl, the salt chiefly used in medicine, crystallises from alcohol in short prisms, m.p. $200-2^\circ$ (*dry*), $[\alpha]_D - 71.95^\circ$ ($c = 2$; H_2O), $- 67.5^\circ$ (aqueous alcohol). It is readily soluble in water (1 in 0.4 at 25°) or alcohol (1 in 2.6 at 25°), but insoluble in ether or light petroleum. To ensure absence of cinnamylcocaine and α -truxilline (*isoatropylcocaine*) a permanganate test, and some form of Maclagan's test are used respectively: the latter depends on the fact that on adding ammonia to a solution of cocaine hydrochloride, a wholly crystalline precipitate is formed if the salt is not contaminated with appreciable quantities of truxilline. The chromate, B. $H_2CrO_4 \cdot H_2O$, is precipitated as orange-yellow leaflets, m.p. 127° , when potassium chromate is added to an acid solution of the hydrochloride. The platinichloride, $B_2 \cdot H_2PtCl_6$, is microcrystalline and sparingly soluble in water. Aqueous mercuric chloride gives with a solution of cocaine hydrochloride a bulky precipitate of the mercurichloride B. HCl. $HgCl_2$, which may be crystallised from alcohol. The nitrate, B. $HNO_3 \cdot 2H_2O$, m.p. $58-63^\circ$, periodide, B. $HI \cdot I_2$, m.p. 161° , formate, m.p. 42° , salicylate, which is triboluminescent and other salts, have also been used in medicine.

When heated with mineral acids *l*-cocaine is hydrolysed into *l*-ecgonine (p. 96), benzoic acid and methyl alcohol and a like change takes place with baryta water. If the alkaloid is boiled with water, methyl alcohol is split off and a new base, benzoyl-*l*-ecgonine is formed, which in turn can be hydrolysed by acids or alkalis into *l*-ecgonine and benzoic acid. Cocaine is, therefore, methylbenzoyl-*l*-ecgonine.

Detection. Owing to the illegitimate use of cocaine much ingenuity has been expended in devising easy means of detecting and identifying it alone, or in admixture with synthetic local anæsthetics and other organic materials. A useful and critical summary of tests has been given by Evers.¹³ Cocaine may be detected by the numbness it produces when a drop of a solution is applied to the tongue. In a half-saturated solution of alum it gives a characteristic crystalline precipitate with a drop of saturated solution of potassium permanganate.¹⁴ The alkaloid forms a colourless solution with sulphuric acid, which on warming at 100° followed by addition of a little water, develops an odour of methyl benzoate and deposits crystals of benzoic acid on cooling.

Reference may also be made to descriptions of tests, classified as indicated in brackets, published by various authors,¹⁵ ((*a*) microchemical); ((*b*) distinction from ψ -cocaine); ((*c*) distinction from other local anæsthetics, especially procaine). The series of papers by Offerhaus and Baert (*c*) may be specially mentioned as dealing exhaustively with means of identification of drugs of this type, and especially with the detection of small quantities of cocaine in mixtures likely to be met with in illicit traffic in drugs. Strait, Aird and Weiss have described a method for the isolation and spectrographic measurement of cocaine from brain tissue.¹⁶

d-ψ-Cocaine (*isoCocaine*, *d-Cocaine*). This substance was isolated from coca leaves by Liebermann and Giesel,¹⁷ but is believed to have been produced by the action of alkali on *l-cocaine* in the process of extraction. It was synthesised from *ψ-ecgonine* (*d-ψ-ecgonine*) by Einhorn and Marquardt¹⁸ and was obtained by Willstätter and collaborators¹⁹ by the resolution of *dl-ψ-ecgonine* methyl ester, followed by benzylation. It differs considerably from *l-cocaine* in character; m.p. 45°, the salts crystallise well and are less soluble than those of *l-cocaine*; B. HCl, m.p. 205°, $[\alpha]_D^{20} + 43.0$ (H₂O); hydrogen *d-tartrate*, m.p. 139°, $[M]_D^{20} + 191$ °; aurichloride, B. HAuCl₄, m.p. 148°. The nitrate is sparingly soluble in water.

dl-ψ-Cocaine. This was prepared by Willstätter and collaborators¹⁹ from synthetic *dl-ψ-ecgonine*. It crystallises in hexagonal plates, m.p. 81.5°, gives a hydrochloride, m.p. 208°, and differs from natural *l-cocaine* in giving a sparingly soluble nitrate, m.p. 172°. The hydrogen *d-tartrate* has m.p. 164°, $[M]_D^{20} + 39$ ° and the *d-α-bromocamphor-β-sulphonate*, m.p. 182-3°, $[M]_D^{20} + 312$ °. The aurichloride, B. HAuCl₄ · 2H₂O is crystalline, m.p. 65-70° or 164-5° (*dry*).

Cinnamylcocaine, C₁₉H₂₃O₄N. This alkaloid was isolated by Giesel²⁰ from Java coca leaves after it had been prepared by Liebermann²¹ by heating *ecgonine* at 100° with cinnamic anhydride and methylating the resulting cinnamoyl*ecgonine* (colourless needles, m.p. 216°). It is almost insoluble in water, but easily soluble in organic solvents and crystallises from benzene or light petroleum in rosettes of needles, m.p. 121°. $[\alpha]_D - 4.7$ ° (CHCl₃). The hydrochloride, B. HCl · 2H₂O, forms flattened needles, m.p. 176° (*dry*) from water. The platinichloride, m.p. 217°, as precipitated, is amorphous, but crystallises on standing. The aurichloride forms yellow needles, m.p. 156°. When warmed with hydrochloric acid the base is hydrolysed, furnishing *l-ecgonine*, cinnamic acid and methyl alcohol.

The isomeric *d-CINNAMYLCOCAINE* (methyleinnamoyl-*d-ψ-ecgonine*) prepared by Einhorn and Deckers²² by the action of cinnamoyl chloride at 150-60° on *d-ψ-ecgonine* methyl ester, crystallises in prisms, m.p. 68°, $[\alpha]_D + 2$ ° (EtOH). The hydrochloride, B. HCl, forms needles, m.p. 186°; the platinichloride, needles, m.p. 208°, and the aurichloride orange needles, m.p. 164°.

Truxillines, C₃₈H₄₆O₈N₂. In 1887 Hesse isolated from Peruvian coca leaves an amorphous alkaloid which he named *cocamine*²³; a year later Liebermann²⁴ examined this material, and by fractionation of its solutions by addition of petroleum proved it to be a mixture of at least two isomeric bases, which he named *α-* and *β-truxillines*. The pure alkaloids have not been obtained from coca leaves owing to the difficulty of separating them, but each has been prepared synthetically.²⁵

α-TRUXILLINE (*Cocamine*, *γ-isatropylcocaine*). An amorphous white powder, m.p. 80°, easily soluble except in light petroleum and water. Solutions of the base are levorotatory and possess a bitter taste. When warmed with hydrochloric acid the base undergoes hydrolysis with the production of *l-ecgonine*, methyl alcohol and *α-truxillic acid* (C₉H₈O₂)₂

(γ -isatropic acid), m.p. 228°. The synthesis of the alkaloid was accomplished by the action of α -truxillic anhydride on *l*-ecgonine and methylation of the resulting α -truxilloylecgonine.

β -TRUXILLINE (isoCocamine, δ -isatropylocaine). This base sinters at 45° and decomposes above 120°, $[\alpha]_D - 29.3^\circ$. It undergoes hydrolysis, furnishing β -truxillic acid (δ -isatropic acid), m.p. 206°, with ecgonine and methyl alcohol. It also has been synthesised by Liebermann and Drory.²⁵

Methylcocaine (*Ethylbenzoylecgonine*). This base was isolated by Günther²⁶ from commercial cocaine, by dissolving the latter in an alcoholic solution of hydrogen chloride and fractional precipitation with ether, the new alkaloidal hydrochloride being precipitated last. The base melts at 110°, possesses the same physiological properties as cocaine and yields an aurichloride and a platinichloride closely resembling the corresponding salts of that base. It probably results from the use of ethyl alcohol as a solvent in the commercial preparation of cocaine from ecgonine, but it is stated by Günther to be isomeric, not identical, with cocaethylene (ethylbenzoylecgonine) prepared synthetically by esterifying benzoylecgonine with ethyl alcohol.²⁷

Benzoylecgonine, $C_9H_{14}(CO \cdot C_6H_5)_3N$. This acyl ester of ecgonine was isolated about the same time by Skraup and by Merck from Peruvian coca leaves. According to de Jong²⁸ it does not occur in Java coca. It was subsequently prepared by Paul^{28(a)} by the action of water on cocaine and later synthesised by Liebermann and Giesel²⁹ by the action of benzoic anhydride on ecgonine. It crystallises from water with 4H₂O in needles, m.p. 86° or 195° (*dry, dec.*), $[\alpha]_D - 63.3^\circ$, and dissolves readily in alkaline liquids forming salts. When boiled with dilute hydrochloric acid, it is hydrolysed into ecgonine and benzoic acid, and on esterification with methyl alcohol furnishes cocaine, and with other aliphatic alcohols yields homologues of cocaine: of these the ethyl ester (cocaethylene), m.p. 108–9°, the propyl ester (cocapropylene), m.p. 78–79.5°, and the *isobutyl* ester, m.p. 61–2°, among others, have been prepared.

l-ECGONINE, $C_9H_{15}O_3N \cdot H_2O$. This substance was first obtained by Lossen³⁰ as the final basic hydrolytic product of the action of acids on cocaine, and is obtainable in like manner from several of the alkaloids occurring with cocaine (*see above*). It crystallises from dry alcohol in monoclinic prisms, m.p. 198° (*dec.*), 205° (*dry*), $[\alpha]_D - 45.4^\circ$, is soluble in water, sparingly so in alcohol, insoluble in most organic liquids. Ecgonine forms salts with bases and acids; the hydrochloride crystallises in rhombs, m.p. 246°, $[\alpha]_D - 57.1^\circ$; the aurichloride, B. HAuCl₄, forms yellow prisms, m.p. 202° (*dry*) and the platinichloride, red needles, m.p. 226° (*dry*). Barium-ecgonine $[Ba(C_9H_{14}O_3N)_2]$ crystallises in prismatic needles, readily soluble in water or alcohol.

Ecgonine is readily esterified in presence of hydrogen chloride, and in this way various alkylecgonines have been prepared. The most important of these is the methyl ester, b.p. 177°/15 mm., which according to de Jong³¹ occurs in Java coca. It was prepared by Einhorn and Klein¹⁰ in 1888 as the hydrochloride crystallising, with 1 H₂O, in colourless prisms, m.p. 212°

(*dec.*). When benzoylated it furnishes cocaine. Ecgonine also reacts with acid chlorides and anhydrides to form acyl derivatives and in addition to benzoyl-ecgonine, cinnamoyl-, isovaleroyl-, anisoyl- and truxilloyl-ecgonines have been prepared; these, in turn, by esterification with methyl alcohol furnish the corresponding cocaines.

d-ψ-ECGONINE (*d*-ECGONINE). This isomeride of ecgonine was prepared by Einhorn and Marquardt³¹ by the action of potassium hydroxide solution on ecgonine and is formed when the cocaines are hydrolysed by alkalis. It crystallises from dry alcohol in tablets, for which m.p. 254°, 257° and 264° have been recorded, $[\alpha]_D + 21.1^\circ$ ($c = 4.3$; H₂O): the hydrochloride forms monoclinic prisms, m.p. 236°, $\alpha_D + 1.6^\circ$ ($c = 4.4$; $l = 2$ dcm.); the aurichloride, B. HAuCl₄, has m.p. 220° (*dec.*). It forms esters like those yielded by *l*-ecgonine, and from it *d-ψ*-cocaine (*methylbenzoyl-d-ψ-ecgonine*) has been prepared (p. 95).

dl-ψ-ECGONINE. This was prepared by Willstätter and Bode by the reduction of tropinonecarboxylic acid.³² It forms rhombic crystals, m.p. 251° (*dec.*) and yields a hydrochloride, B. HCl. $\frac{1}{2}$ H₂O crystallising in slender needles, m.p. 149° (*dry, dec.*) and an aurichloride, glistening needles, m.p. 213°. On benzoylation and methylation it yields *dl-ψ*-cocaine (p. 95). According to Willstätter and Bommer,³³ the *d*-ecgonine of the earlier workers has the same relation to natural *l*-ecgonine as *ψ*-tropine has to tropine and they renamed the *d*- and *dl*-ecgonines, *d-ψ*-ecgonine and *dl-ψ*-ecgonine respectively, and these names have been used throughout the foregoing descriptions, with the derivatives benzoyl-*d-ψ*-ecgonine and *d-ψ*-cocaine, etc., in their appropriate places.

Constitution of Ecgonine, C₉H₁₅O₃N. The facts recorded above furnish evidence of the existence of a hydroxyl and a carboxyl group in ecgonine. Einhorn observed³⁴ that dehydrating agents remove the elements of a molecule of water from ecgonine, forming ANHYDROECGONINE, C₉H₁₃O₂N (ecgonidine), which crystallises in needles, m.p. 235°, $[\alpha]_D - 84.6^\circ$, is unsaturated, combining with two atoms of bromine, and still contains the —COOH group of the parent base, since it esterifies alcohols. The methyl ester, $D_{25}^{20} 1.0921$; $n_D^{20} 1.5040$; $[\alpha]_D^{20} - 54.96^\circ$; B. HBr, m.p. 147°, has been prepared by Ugriumov.³⁴ Ethyl anhydroecgonine has been found in residues obtained in working up the secondary alkaloids of coca leaves³⁵ and may be formed in this process, but Matchett and Levine³⁵ have isolated the methyl ester (methylecgonidine) from both Java and Peruvian coca seeds. When heated with hydrochloric acid at 280°, anhydroecgonine loses a molecule of carbon dioxide with the formation of tropidine (p. 74), whence it appears that anhydroecgonine is a carboxylic acid of tropidine.³⁶

The close relationship of ecgonine to tropine is brought out by its oxidation products, which when chromic anhydride in acetic acid is the agent used are³⁷: tropinone, C₈H₁₃ON (p. 74), tropinic acid, C₈H₁₃O₄N (p. 75) and ecgoninic acid, C₇H₁₁O₃N. The latter crystallises from benzene in colourless needles, m.p. 93°, and has been shown by Willstätter and Bode to be *N*-methylpyrrolidone-2-acetic acid,³⁸ and this was confirmed by Willstätter and Hollander's³⁹ synthesis of the acid.

When ecgonine is treated with permanganate in acid solution a new base, *norecgonine*, $C_8H_{13}O_3N$, is the principal product. It stands in the same relation to ecgonine as the similarly produced *tropigenine* (*nortropine*) does to *tropine* (p. 75) and, like its analogue, is a secondary base produced by the oxidation of a methyl group attached to nitrogen. It crystallises in long needles, m.p. 233° , is very soluble in water and gives a characteristic aurichloride, m.p. 211° , crystallising in yellow needles.⁴⁰ Similarly on degradation by Hofmann's reaction⁴¹ anhydroecgonine gives rise to δ -*cycloheptatrienecarboxylic acid*, $C_8H_8O_2$, whilst *tropidine* yields the corresponding *cycloheptatriene* (p. 77).

The close relationship existing between ecgonine and *tropine* is evident from the following diagrammatic summary of the results of reactions:—

DEHYDRATION :

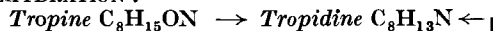

DEHYDRATION AND DECARBOXYLATION :

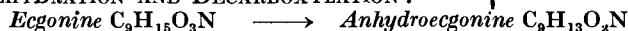

OXIDATION : (a) Chromic acid

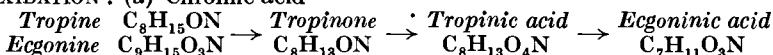

(b) Permanganate

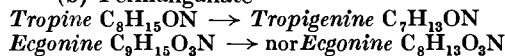

EXHAUSTIVE METHYLATION :

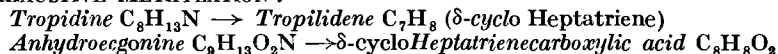

It will be seen that ecgonine and its derivatives differ from *tropine* and its derivatives throughout by CO_2 , so that the former probably stands to the latter in the relation of a carboxylic acid, and hence the formulæ assigned at various times to *tropine* by Ladenburg, Merling and Willstätter have been suitably modified to represent ecgonine : thus Einhorn⁴² at first represented ecgonine as *N*-methyltetrahydropyridyl- β -hydroxypropionic acid, $C_8H_7NMe \cdot CHO \cdot CH_2 \cdot COOH$, which was modified to (I) (after Merling) by Einhorn and Tahara.⁴³

There are two probable formulæ (II) and (III) for ecgonine derivable⁴⁴ from Willstätter's representation of *tropine* (p. 76).

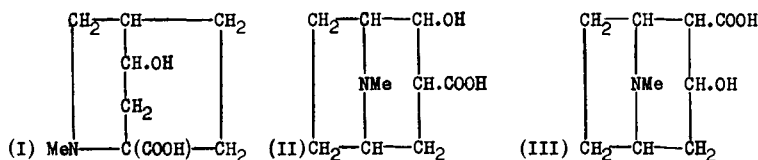

The position assigned to the hydroxyl group in formula (III) explains (1) the formation of anhydroecgonine by loss of water between the $-CHOH$ group and the neighbouring $-CH_2$ group ; and (2) Willstätter and Müller's observation⁴⁵ that an unstable β -ketonic acid precedes the formation of *tropinone*, when ecgonine is oxidised by chromic acid. Further, when anhydroecgonine ethyl ester is reduced by sodium in alcohol, it yields

dihydroecgonidine (VI), a $-\text{CHOH}-$ group in ecgonine having been converted into $-\text{CH}_2-$ and the amide corresponding to this on oxidation with sodium hypobromite yields *isotropylamine*, isomeric with *tropylamine* (or ψ -*tropylamine* (IV)) obtained by the reduction of *tropinoneoxime*, but not identical with either; it follows that the amino group in the latter amines must occupy a position different from that in *isotropylamine* (V) and, therefore, from the carboxyl group in dihydroecgonidine (VI) and in ecgonine.

Accepting this view of the constitution of ecgonine, the formulæ of its derivatives and of cocaine may be written as follows: anhydroecgonine (VII), ecgonine (VIII), *norecgonine* (IX) and cocaine (X).

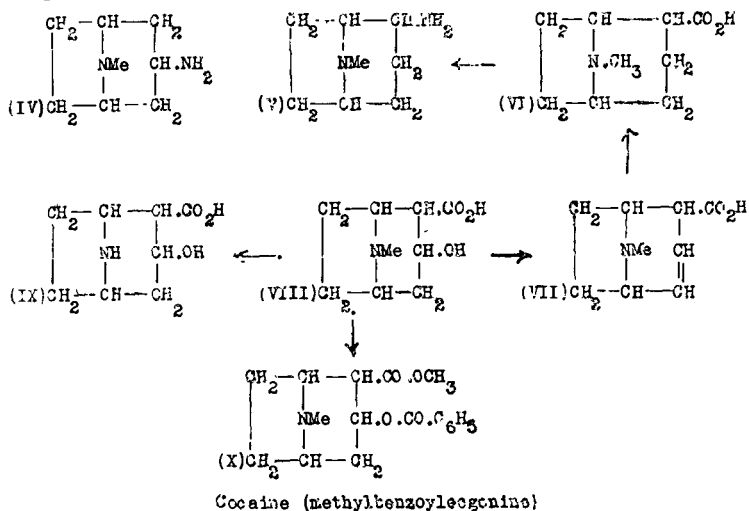

Willstätter and Bommer⁴⁶ made it clear that the synthesis of ecgonine and consequently of cocaine had not been effected, a point on which there had been some confusion owing to the fact that the alkali labile natural ecgonine had been regarded as the optical antipode of the alkali-stable so-called *d*-ecgonine, whilst the optically inactive isomeride synthesised by Willstätter and Bode⁴⁷ has been regarded as the *dl*-form of natural ecgonine. The view taken by the former authors is that the alkali-stable form (*d*-ecgonine) is a ψ -ecgonine having the same relation to natural *l*-ecgonine as ψ -*tropine* (p. 101) has to *tropine*, whilst the inactive form is one of four possible racemates.⁴⁸

Willstätter and Bode⁴⁹ converted *tropinone* into ψ -ecgonine by treating sodium *tropinone* with carbon dioxide and sodium, when it yielded sodium *tropinone*carboxylate. This on reduction with sodium in alcohol gave some *dl*- ψ -ecgonine (p. 97), which on esterification with methyl alcohol and benzoylation yielded a *dl*-cocaine. A simpler synthesis of ψ -ecgonine was achieved by Willstätter and Bommer,⁴⁶ and reference is made on p. 80 to this and other processes, some of which have been protected by patents. These improvements having enabled the prepara-

tion of methyl tropinonecarboxylate to be undertaken, Willstätter, Wolfes and Mäder⁵⁰ reinvestigated the reduction of this ester and found that both *dl*- ψ -ecgonine and *dl*-ecgonine methyl esters are formed, and from these the corresponding *dl*- ψ -cocaine and *dl*-cocaine were obtained by benzoylation. *dl*-Cocaine was resolved into its optically active components by crystallisation of the hydrogen-*d*-tartrate to give the *l*-base (natural cocaine) and of the hydrogen *l*-tartrate to give the *d*-base. *dl*- ψ -Cocaine could not be resolved directly, but its components were obtained by resolving *dl*- ψ -ecgonine methyl ester and benzoylating the two forms.

α -ECGONINE (XII) is the name given to a base, isomeric with ecgonine, and prepared by Willstätter⁵¹ by the addition of hydrocyanic acid to tropinone (XI) and hydrolysis of the cyanohydrin so formed :

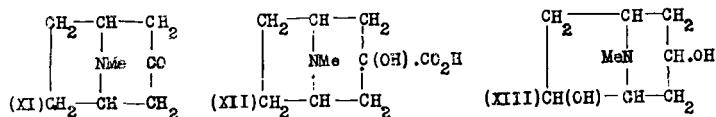

It occurs in brilliant snow-white crystals, m.p. 305° (*dec.*) and is readily soluble in water or aqueous alcohol. The benzoyl derivative, m.p. 209° is crystalline and on methylation gives α -cocaine, a base crystallising in prisms, m.p. 87°, and yielding an aurichloride, m.p. 222° (*dec.*), crystallising in leaflets. It is bitter to the taste but has no local anæsthetic action.

Dihydroxytropine, $\text{C}_8\text{H}_{15}\text{O}_2\text{N}$. This base was isolated from the mixture of hydrolysed bases obtained in working up the alkaloids of Java coca ; it occurs in the fraction less soluble in ether than tropine and ψ -tropine, has m.p. 209–209.5°, $[\alpha]_D^{27} - 22^\circ$ (EtOH), yields a hydrochloride, $[\alpha]_D^{27} + 1.75^\circ$ (H_2O), a picrate, m.p. 253° (*dec.*) and furnishes a dibenzoate, whose sulphate has $[\alpha]_D^{26} + 52.1^\circ$ (EtOH) and hydrochloride, B. HCl. $2\text{H}_2\text{O}$, m.p. 115° or 205° (*dry*), $[\alpha]_D^{22} + 41.8^\circ$ (dilute alcohol) and nitrate, B. HNO_3 , m.p. 197°. On reduction with hydriodic acid and red phosphorus the dihydroxytropine is converted into tropine and on treatment with phosphorus oxychloride it yields a base, $\text{C}_8\text{H}_{13}\text{ON}$, b.p. 188°/752 mm., picrate, m.p. 177° (*dec.*). This dihydroxytropine is probably represented by formula (XIII).⁵² The dibenzoyl-derivative has local anæsthetic properties. The *isovaleryl* ester is the alkaloid valeroidine found in *Duboisia myoporoides* (p. 90).

Tropacocaine (*Benzoyl- ψ -tropine*), $\text{C}_{15}\text{H}_{19}\text{O}_2\text{N}$, was discovered by Giesel⁵³ in Java coca leaves and has since been found in Peruvian coca.⁵⁴ Its preparation from the former source has been described by Hara and Sakamoto.⁵⁵ It crystallises in needles, m.p. 49°, is insoluble in water, but soluble in alcohol, ether or dilute ammonia and is generally prepared by benzoylating ψ -tropine, and purified as the hydrochloride. Its alcoholic solution is alkaline and optically inactive. The hydrochloride forms needles, m.p. 271° (*dec.*), and the hydrobromide leaflets. The aurichloride separates in minute yellow needles, m.p. 208°, from hot aqueous solutions ; the picrate has m.p. 238–9°. When heated with hydrochloric acid or baryta water the alkaloid is hydrolysed to benzoic acid and ψ -tropine.⁵⁶

ψ -TROPINE, $\text{C}_8\text{H}_{15}\text{ON}$. This base is a stereoisomeride of tropine

(p. 73). It crystallises in colourless tablets or prisms, m.p. 108°, b.p. 240°, is miscible with water, ether or alcohol, alkaline in reaction and optically inactive. The hydrochloride forms hygroscopic needles; the aurichloride crystallises in brilliant yellow plates, m.p. 225° (*dec.*), and the picrate in long needles, m.p. 258–9° (*dec.*). ψ -Tropine esterifies with organic acids, furnishing a series of derivatives, which from their analogy with the tropeines have been called ψ -tropëines, but unlike the former exert little or no mydriatic action.

Mandelyl- ψ -tropëine (ψ -homatropine), $C_{16}H_{21}O_3N$, is a thick uncrystallisable oil. *Tropyl- ψ -tropëine*, $C_{17}H_{23}O_3N$, crystallises in colourless needles, m.p. 86°.

Tropine and ψ -tropine are mutually convertible as already described. Mixtures of tropine and ψ -tropine can be separated by means of the picrates, that of ψ -tropine being the more soluble in water⁵⁷ (1.48 per cent. in water at 16°). By the action of sodium amyloxyde on tropine, Willstätter has shown that ψ -tropine is produced⁵⁸ and this has been confirmed by Barrowcliff and Tutin,⁵⁹ who also support Willstätter's view that both bases are internally compensated, the relation being that of *cis-trans*-isomerism.⁶⁰ The synthesis of ψ -tropine has been described already (p. 77).

Tröger and Schwarzenberg⁶¹ have isolated a base (m.p. 53°, b.p. 225–30°; picrate, m.p. 237° (*dec.*)) isomeric with tropine and ψ -tropine, from coca leaves.

HYGRINES. This group of coca alkaloids was discovered by Lossen⁶² in an ethereal extract of a slightly alkaline percolate of Peruvian coca leaves. Liebermann and his pupils⁶³ re-investigated Lossen's supposed homogeneous base, and observed that by distillation under reduced pressure it could be separated into two products, hygrine and β -hygrine. Hygrine has also been found in *Convolvulus hamadæ* (p. 67).

Hygrine, $C_8H_{15}ON$, b.p. 92–4°/20 mm., 111–3°/50 mm. or 193–5°/760 mm., D_4^{17} 0.940, $[\alpha]_D$ –1.3°, is a colourless, strongly alkaline liquid which absorbs carbon dioxide from the air and decomposes on exposure to light. It forms an aurichloride and a characteristic picrate, yellow needles, m.p. 158°, *dl*-form, 149–50°. On oxidation by chromic acid hygrine yields hygric acid, $C_6H_{11}O_2N$, m.p. 164°, which heated alone or with strong sulphuric acid loses carbon dioxide, giving *N*-methylpyrrolidine, $C_5H_{11}N$. Both hygric acid and hygrine are tertiary amines and hygrine gives a crystalline oxime, m.p. 116–20° (*dl*-form, m.p. 125°).

Hygric acid was synthesised by Willstätter by the following method.⁶⁴ Ethyl bromopropylmalonate, $CH_2Br \cdot CH_2 \cdot CH_2 \cdot CH(CO_2Et)_2$, obtained by condensation of trimethylene bromide with ethyl sodiomalonate, on bromination yielded ethyl $\alpha\delta$ -dibromopropylmalonate, $CH_2Br \cdot CH_2 \cdot CH_2 \cdot CBr(CO_2 \cdot C_2H_5)_2$. This reacts with methylamine forming two products both derived from *N*-methylpyrrolidire-2:2-dicarboxylic acid, viz., the dimethylamide (XIV) and the diethyl ester. The former on heating with hydrochloric acid at 125°, and the diethyl ester with water at 160°, both undergo hydrolysis and partial decarboxylation

to *N*-methyl-pyrrolidine-2-carboxylic acid, which proved to be *dl*-hygric acid (XV) (m.p. 169–170° (*dry*)): aurichloride (m.p. 190–5° (*dec.*)). Subsequently Karrer and Widmer⁶⁴ obtained *l*-hygric acid by oxidising *N*-methylnicotone with chromic acid. This product as a monohydrate had m.p. 116°, $[\alpha]_D -80.12^\circ$ (H₂O). Willstätter suggested that of the two formulæ (XVI and XVII) available for the representation of hygrine, (XVII) was the more probable and this was confirmed by K. Hess's synthesis⁶⁵ of *dl*-hygrine. The secondary alcohols corresponding to the ketones represented by the two formulæ (XVI and XVII) were prepared (1) by treating magnesium pyrrol bromide with propionyl chloride, reducing the 2-propionylpyrrole so formed and methylating the product to (XVIII); (2) by the addition of propylene oxide to magnesium pyrrol bromide, hydrogenation of the product in presence of spongy platinum and methylation of the resulting pyrrolidylisopropyl alcohol, giving (XIX).

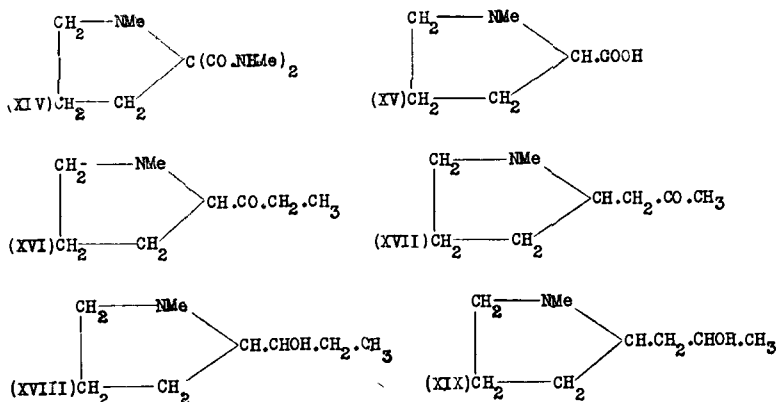

When the final methylation of either product is effected with formaldehyde, oxidation of the secondary alcohol group occurs simultaneously in each case, and of the two resulting ketones that from product (XIX) proved to be *dl*-hygrine, which must therefore have formula (XVII) given above. Another synthesis of *dl*-hygrine has been effected recently by Sorm.⁶⁵

Hygroline, C₈H₁₁ON. This alkaloid was isolated by Späth and Kittel^{65(a)} from a fraction, b.p. 78–82°/12 mm., of the residual liquid alkaloids of coca leaves. It has m.p. 33–4°, $[\alpha]_D^{23} -63.2^\circ$, ($c = 11.4$, H₂O) is soluble in water or organic solvents and yields an oily *O*-benzoyl derivative, b.p. 105–10°/0.003 mm., characterised by an aurichloride, m.p. 114–5°, a platinichloride, m.p. 150–2° and a 3 : 5-dinitrobenzoate, m.p. 65°. On oxidation by chromic acid it furnishes hygrine, which is optically inactive, possibly due to racemisation, identified by the picrate, m.p. 153–4° and oxime, m.p. 124–5°. Hygroline is therefore regarded as the alcohol, (XIX) corresponding to the ketone hygrine (XVII).

β -Hygrine, C₁₄H₂₄ON₂. This, the second fraction of Lossen's hygrine,⁶⁶ decomposes when distilled under atmospheric pressure, but boils at

215°/50 mm. and has specific gravity 0.982 at 18°. It gives an aurichloride, $C_{14}H_{24}ON_2 \cdot 2HAuCl_4$, and forms a colourless crystalline dimethiodide. When oxidised by chromic acid, it yields a small quantity of hygric acid.

Cuscohygrine, $C_{13}H_{24}ON_2$ (*Cuskygrine*). This third hygrine, first recognised in "cusco" leaves by Liebermann and Cybulski,⁶⁷ was characterised by these authors and by Hess and Bappert.⁶⁸ It has now been found in *Convolvulus hamadae*. It boils at 169–70°/23 mm., has specific gravity 0.9767 at 17°, is optically inactive, absorbs carbon dioxide forming an unstable carbonate, is miscible with water and gives a crystalline hydrate, $B \cdot 3\frac{1}{2}H_2O$, m.p. 40°. The alkaloid forms crystalline salts with acids; hydrobromide, m.p. 234°, nitrate, m.p. 209° (*dec.*), and yields a methiodide, m.p. 244°, and a crystalline oxime, m.p. 53–4°. It contains two tertiary nitrogen atoms and, on oxidation with chromic acid, furnishes hygric acid. Liebermann assigned to it formula (XX), which Hess and Fink⁶⁹ modified to (XXI) mainly on the following evidence. On long standing in ethereal solution over potassium hydroxide, the alkaloid is partly converted into *dl*-hygrinc. It does not condense with benzaldehyde as it should if it contained the chain $-CH_2 \cdot CO \cdot CH_2-$. Cuscohygrine yields two hydrazones, regarded as stereoisomeric, which on reduction furnish di-*N*-methyl-2-pyrrolidylmethane (XXII) and α -di-*N*-methylpyrrolidylpropane (XXIII). On treatment with nitric oxide in presence of sodium ethoxide,⁷⁰ the alkaloid yields homohygric acid (*N*-methyl-2-pyrrolidylacetic acid (XXV)) and a mixture of bases believed to be of the type (XXIV), since on reduction they furnish di-*N*-methyl-2-pyrrolidylmethane (XXII). Sohl and Shriner⁷¹ have confirmed the formation of *N*-methyl-2-pyrrolidylacetic acid from cuscohygrine and have synthesised the acid. The latter has also been prepared by King, Clifton and Openshaw⁷² but the acid has not yet been converted into substance (XXII). The identity of the di-*N*-methylpyrrolidylmethane (XXII) formed in these reactions remains in doubt, since the synthetic product, which exists in two stereoisomeric forms, subsequently prepared by Hess and Anselm⁷³ proved not to be identical with the substance derived from cuscohygrine. Hess and Bappert⁶⁸ found that, although cuscohygrine could not be exhaustively methylated, it yielded on reduction two stereoisomeric

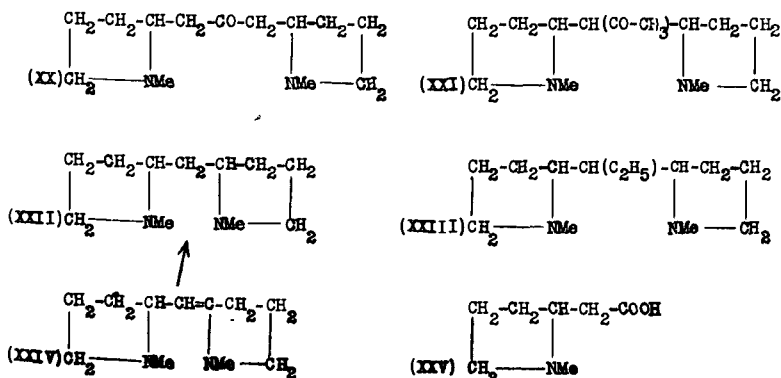

alcohols, which proved amenable to this process and furnished *n*-undecane and *n*-undecan- ζ -ol as final products. This piece of evidence supports Liebermann and Cybulski's formula (XX) for cuscohygrine, for which Sohl and Shriner⁷¹ have also provided further evidence on several points.

REFERENCES

- (1) LUZIO, *Agronomia*, 1938, 3, No. 15, 44 (*Chem. Abstr.*, 1939, 33, 3075); BINDA, *Actas y trabajos Congr. peruano quim.*, 1943, 2, 1, 375 (*Chem. Abstr.*, 1945, 39, 3629). (2) *Teysmannia*, 1910, 21, 201; HARTWICH, *Arch. Pharm.*, 1903, 241, 617; for Ceylon and Malayan leaves see *Bull. Imp. Inst.*, 1912, 10, 37; for Russian leaves see TARAN, *Farmatsiya*, 1940, No. 6, 28 (*Chem. Abstr.*, 1941, 35, 2678). (2a) *Kew Bulletin*, 1889, 8; CHOPRA and GHOSH, *Arch. Pharm.*, 1938, 276, 340. (3) *Rec. trav. Chim.*, 1906, 25, 233. (4) *Arch. Pharm.*, 1910, 248, 303. (5) *Pharm. Zeit.*, 1931, 76, 1440; *Bull. Sci. Pharmacol.*, 1932, 39, 69; cf. CHALMETA and CHALMETA, *ibid.*, 1933, 40, 193, 641. (6) GRANDVAL and LAJOUX, *J. Pharm.*, 1893, [v], 28, 102; GARSED, *Pharm. J.*, 1903, [iv], 17, 784; cf. DE JONG, *Rec. trav. Chim.*, 1906, 340, 1. For a review of this subject and a process, see *Bull. Health Org. League of Nations*, 1938, 7, 429 and cf. DE JONG, *Rec. trav. Chim.*, 1938, 57, 1218; 1940, 59, 27; VAN ITALLIE, *Pharm. Weekbl.*, 1938, 75, 909; VAN HULSSEN, *Berg cultures*, 1940, 14, 1444 (*Chem. Abstr.*, 1941, 35, 3035); EDER and RUCKSTUHL, *Pharm. Acta Helv.*, 1943, 18, 687. (7) *Pharm. Weekbl.*, 1907, 44, 961; DE JONG, *ibid.*, 1908, 45, 42; *Rec. trav. Chim.*, 1906, 25, 1; 1911, 30, 204; 1923, 42, 980; 1940, 59, 687; *Indische Mercuur*, 1923, 46, 305; GORIS, CHALMETA and CHALMETA³; TORRICELLI, *Mitt. Lebensm. Hyg.*, 1938, 29, 48. *Detection of ecgonine*, see AMELINK, *Pharm. Weekbl.*, 1938, 75, 861. (8) LUZIO¹; BINDA¹; DE ROSEMONT, *Bull. Sci. Pharmacol.*, 1920, 27, 359 (*Chem. and Drugg.*, 1920, 394). CHEMNITIUS, *J. pr. Chem.*, 1927, [ii], 116, 276; SQUIBB, *J. Soc. Chem. Ind.*, 1899, 8, 724, 1013. (9) DE JONG, *Rec. trav. Chim.*, 1906, 25, 311; 1923, 42, 980; DUILIUS, *Chem. Zeit.*, 1930, 54, 31. (10) LIEBERMANN and GIESEL, *Ber.*, 1888, 21, 3196, cf. EINHORN and KLEIN, *ibid.*, 3335; DE JONG, *Rec. trav. Chim.*, 1940, 59, 27; 1942, 61, 54; 1947, 66, 544. (11) *Ibid.*, 1885, 18, 2953. (12) *Ibid.*, 1894, 27, 1523. (13) ALLEN'S "Commercial Organic Analysis," 5th Edition, Vol. 7, p. 513, London, J. and A. Churchill: Philadelphia, P. Blakiston's Sons & Co. Inc.; cf. PESEZ, *J. Pharm. Chim.*, 1939, [viii], 30, 200; MARTINI and GRAF, *Mikrochemie*, 1939, 26, 233. (14) SEITER, *Amer. J. Pharm.*, 1911, 83, 195, 265; HANKIN, *Analyst*, 1911, 35, 2; CECCONI, *Ann. Chim. Applic.*, 1936, 26, 218; GAUTIER, *Ann. Chim. Anal.*, 1943, 25, 172. (15) (a) WAGENAAR *Pharm. Weekbl.*, 1930, 67, 229; MARTINI, *Mikrochem.*, 1932, 12, 111; VAN ZIJP, *Pharm. Weekbl.*, 1933, 70, 606; (b) ROSENTHALER, *Mikrochem.*, 1924, 2, 121; FERRARIS, *Boll. chim. Farm.*, 1927, 66, 577; (c) WEISS, *Apoth. Zeit.*, 1930, 45, 724; EMDE, *Chem. Zeit.*, 1931, 55, 537; PASSARELLI, *Boll. Chim. Farm.*, 1931, 70, 891; FULTON, *Amer. J. Pharm.*, 1933, 105, 326; OFFERHAUS and BAERT, *Pharm. Weekbl.*, 1933-1935; NICHOLLS, *Analyst*, 1936, 61, 155; BAGCHI *et al.*, *Ind. Med. Gaz.*, 1939, 74, 29; BERISSO, *Chem. Abstr.*, 1942, 36, 370; MILOS, *Amer. J. Pharm.*, 1940, 112, 403; FLORENTIN and HÉROS *Chem. Abstr.*, 1943, 37, 5550; BRUNING, *Zeit. Unters. Lebensm.*, 1940, 79, 93. (16) STRAIT, AIRD and WEISS, *J. Pharmacol. Exp. Ther.*, 1941, 73, 363. (17) *Ber.*, 1890, 23, 508, 926. (18) EINHORN and MARQUARDT, *ibid.*, 1890, 23, 468, 981. (19) *Ber.*, 1901, 34, 1457; *Annalen*, 1903, 326, 42; 1923, 434, 111; *Münch. med. Woch.*, 1924, 71, 849; E. MERCK, *Brit. Pat.* 210,050. (20) *Pharm. Zeit.*, 1889, 34, 516; cf. PAUL, *Pharm. J.*, 1889 [iii], 20, 166. (21) *Ber.*, 1888, 21, 3372; 1889, 22, 2661. (22) *Ibid.*, 1891, 24, 7. (23) *Pharm. Zeit.*, 1887, 407, 668; *Ber.*, 1889, 22, 665. (24) *Ibid.*, 1888, 21, 2342. (25) LIEBERMANN and DRORY, *ibid.*, 1889, 22, 682. (26) *Chem. Soc. Abstr.*, 1899, [i], 963; cf. LIEBERMANN and GIESEL, *Ber.*, 1890, 23, 508, and EINHORN and MARQUARDT, *ibid.*, 979. (27) MERCK, *ibid.*, 1885, 18, 2954; EINHORN, *ibid.*, 1888, 21, 48. (28) DE JONG, *Rec. Trav. chim.*, 1939, 58, 107; 1940, 59, 687. (28a) PAUL, *Pharm. J.*, 1887-88, [iii], 18, 781. (29) *Ber.*, 1888, 21, 8196. (30) *Annalen*, 1865, 133, 351. (31) *Ber.*, 1890, 23, 468, 981; cf. LIEBERMANN and GIESEL, 511 and DE JONG, *Rec. trav. Chim.*, 1947, 66, 99. (32) *Ibid.*, 1901, 34, 1457. (33) *Annalen*, 1921, 422,

15. (34) *Ber.*, 1887, 20, 1221; UGRUMOV, *J. Gen. Chem. Russ.*, 1944, 14, 997. (35) LIEBERMANN, *ibid.*, 1907, 40, 3602; MATCHETT and LEVINE, *J. Amer. Chem. Soc.*, 1941, 63, 2444. (36) EINHORN, *ibid.*, 1890, 23, 1338. (37) LIEBERMANN, *ibid.*, 1890, 23, 2518; 1891, 24, 606; WILLSTÄTTER and MÜLLER, 1898, 31, 178. (38) *Ibid.*, 1901, 34, 519. (39) *Ibid.*, 1818; see also RUGGLI and MAEDER, *Helv. Chim. Acta*, 1942, 25, 936. (40) EINHORN, *ibid.*, 1888, 21, 3031. (41) EINHORN and FRIEDLÄNDER, *ibid.*, 1893, 26, 1482; cf. WILLSTÄTTER and MÜLLER, *ibid.*, 1898, 31, 2498, 2655; GADAMER and JOHN, *Arch. Pharm.*, 1921, 259, 227; DE JONG, *Rec. trav. Chim.*, 1937, 56, 186, 198, 678. (42) *Ibid.*, 1887, 20, 1221. (43) *Ibid.*, 1893, 26, 324. (44) WILLSTÄTTER, *ibid.*, 1897, 30, 2679; 1898, 31, 1534, 2655. (45) *Ibid.*, 1898, 31, 1212, 2655. (46) *Annalen*, 1921, 422, 1, 15. (47) *Ibid.*, 1903, 326, 42. (48) Compare, however, GADAMER and JOHN, *Arch. Pharm.*, 1921, 259, 227, 241. (49) *Ber.*, 1901, 34, 1457; for conversion into ethyl tropinonecarboxylate, see PREOBRAZHENSKI, SCHTSCHUKINA and LAPINA, *ibid.*, 1936, 69, 1615. (50) *Annalen*, 1923, 434, 111; cf. Brit. Pat. 214,917. (51) *Ber.*, 1896, 29, 2216. (52) WOLFE and HROMATKA, *Merck's Jahresb.*, 1934, 47, 45; KREITMAIR, *ibid.*, 54; see also SCHÖPF *et al.*, *Angew. Chem.*, 1937, 50, 785. (53) *Ber.*, 1891, 24, 2336. (54) HESSE, *J. pr. Chem.*, 1902, [ii], 66, 401. (55) *J. Pharm. Soc. Japan*, 1924, No. 504, 89; cf. DE JONG, *Rec. trav. Chim.*, 1923, 42, 980. (56) LIEBERMANN, *Ber.*, 1891, 24, 2338. (57) WILLSTÄTTER, *ibid.*, 1900, 33, 1167, 1170; cf. LADENBURG, *ibid.*, 1902, 35, 1159. (58) *Ibid.*, 1896, 29, 936. (59) *J. Chem. Soc.*, 1909, 95, 1970. (60) Cf. WILLSTÄTTER, *Annalen*, 1901, 317, 204; 1903, 326, 1; 1921, 422, 15. (61) *Arch. Pharm.*, 1921, 259, 207. (62) *Annalen*, 1862, 121, 374. (63) *Ber.*, 1889, 22, 675; 1891, 24, 407; 1893, 26, 851; 1895, 28, 578; 1896, 29, 2050; 1897, 30, 1113. (64) *Ibid.*, 1900, 33, 1160; *Annalen*, 1903, 326, 91; cf. KARRER and WIDMER, *Helv. Chim. Acta*, 1925, 8, 364; HESS, *Ber.*, 1913, 46, 3114, (footnote) HESS, EICHEL and UBRIG, *ibid.*, 1917, 50, 355. (65) *Ibid.*, 1913, 46, 3113, 4104; SORM, *Coll. Czechoslov. Chem. Comm.*, 1947, 12, 245 (*Chem. Abstr.*, 1948, 42, 558). (65a) *Ber.*, 1943, 76, 942. (66) *Ibid.*, 1889, 22, 675; 1895, 28, 580. (67) *Ibid.*, 1895, 28, 578; 1896, 29, 2050. (68) *Annalen*, 1925, 441, 137. (69) *Ber.*, 1920, 53, 781. (70) TRAUBE, *Annalen*, 1898, 300, 81. (71) *J. Amer. Chem. Soc.*, 1933, 55, 3828. (72) *J. Chem. Soc.*, 1942, 422. (73) *Ber.*, 1921, 54, 2310.

Pharmacological Action in the Tropane Series. *Atropine.* When administered internally in toxic doses, atropine at first stimulates but eventually depresses the central nervous system, giving rise to hallucinations, inconsequent speech, delirium and convulsions, followed by stupor and coma. It paralyzes muscles and secretory glands to the effects of stimulation by post-ganglionic, cholinergic, nerve fibres. It is to this action that the dryness of throat and mouth characteristic of belladonna poisoning is due. The kidney is but little affected; consequently there is little or no change in the secretion of urine. The initial, transitory, slowing of the heart, results from stimulation of the vagus nuclei in the medulla and the later quickening is due to paralysis of the pacemaker to inhibitory vagal stimuli. Respiration becomes quicker and deeper, but eventually slower and shallower, and death is due to respiratory failure. There is often a marked rise in temperature. Atropine affects all organs containing unstriated muscle, lessening their movements, and is antagonistic in this respect to muscarine and nicotine, and in general to the action of pilocarpine.

The alkaloid is principally used in medicine to cause dilatation of the pupil of the eye (mydriasis), due to paralysis of the circular muscle of the iris. The accommodation is also paralysed as a result of action on the ciliary muscle (cycloplegia). Atropine is also used in conditions where

paralysis of parasympathetic nervous activity is desired, *e.g.*, in bronchial or intestinal spasm. An atropine-like action has been claimed for platyphylline of the Senecio group (p. 604).

Hyoscyamine. The natural alkaloid, *l*-hyoscyamine and its *d*-isomeride resemble atropine (*dl*-hyoscyamine) qualitatively in action, but the *l*-form acts more strongly on the peripheral nerves than the *d*- or *dl*-forms, though the isomerides appear to have an equal central action.

Hyoscyne. This substance has an action similar to, but more transitory than, that of atropine on the peripheral, cholinergic, autonomic nervous system. Its action on the central nervous system is different. Generally it induces a feeling of fatigue and drowsiness passing into sleep. In some cases there may be a preliminary stage of excitement, and with large doses excitement indistinguishable from that of atropine intoxication may occur. The respiratory centre is depressed from the start. The *l*-isomeride has the more powerful peripheral action, although the central action of both isomerides is the same. Hyoscyne is chiefly used in medicine as a sedative and it has been found useful in the prevention of sickness arising from unusual motion.

A comparison of the activities of these three alkaloids has been made by Graham and Gunn¹ using their antagonism to the effects of carbamylcholine chloride on isolated mammalian intestine. The relative activities found were, atropine sulphate 1; *l*-hyoscyamine sulphate 2.4; hyoscyne hydrobromide 1.5. The results of previous authors are discussed and reasons suggested for some of the differences found.

A clinical comparison has been made by Vollmer^{1(a)} of their value in the treatment of Parkinson's syndrome.

Cocaine. This has a bitter taste, is mydriatic, produces local anaesthesia and is toxic. After absorption, or when taken internally, it acts chiefly by stimulation of the central nervous system, succeeded by depression. Since the two phases may be present in different areas simultaneously, a mixed result may ensue. With large doses the chief symptoms are those of medullary depression. Death is due to paralysis of the respiratory centre. The main use of cocaine in medicine is as a local anaesthetic.

Tropacocaine (Benzoyl- ψ -tropine). This resembles cocaine in action, but produces local anaesthesia more rapidly and for a shorter time and causes little or no mydriasis.

Of the other tropane alkaloids, convolvine (veratroylnortropine), convolamine (veratroyltropine) and a number of their derivatives have been examined. All are stated to be local anaesthetics.²

Neither tropine nor ψ -tropine is mydriatic, though the former is stated to produce mydriasis in cats when injected in large doses. The pharmacological properties of these two bases have been compared by Hazard,^{2(a)} who points out that these *cis-trans* isomerides show qualitative differences in pharmacological action, whereas among optical isomerides there are usually only quantitative differences in activity. It has been stated that rabbits are immune from poisoning by belladonna and, in that connection,

it has been observed that the blood of some rabbits contains an enzyme, atropinesterase, which hydrolyses atropine, and presumably hyoscyamine, into the relatively harmless tropine and tropic acid.³ According to Denys and Levy, genatropine (atropine *N*-oxide) is not hydrolysed by this esterase.^{3(a)} A similar enzyme has been found by Bernheim and Bernheim in guinea-pig liver.³

Effect of Change in Structure on Pharmacological Action. More effort has been expended in attempts to correlate pharmacological action with chemical constitution in this than in any other group of alkaloids, probably because the types of action most characteristic of the two sub-sections of the group, local anæsthesia, and mydriasis, are relatively easy to observe and can be at least roughly measured. Recently attention has also been given to the investigation of spasmolytic action in this group.

These investigations have followed three main lines, (1) alterations in the amino-alcohol nucleus, (2) variation in the alkyl or acyl side-chains, (3) influence of stereoisomerism. Tropine and ecgonine, the basic components of atropine and cocaine, lend themselves to such investigations, but scopine, the amino-alcohol of hyoscyine is so labile that systematic modification of this alkaloid has not yet been possible.

Of the proximate derivatives of atropine, the methobromide and the methonitrate are in use for much the same purposes as atropine, but the methonitrate has received special attention for the treatment of pyloric stenosis.⁴ *apo*Atropine has been found by Mancini to retain the same type of action as atropine but to be less potent in peripheral and more active in central nervous action.⁵

According to Nyman^{5(a)} the pharmacological action of hyoscyine is considerably modified in the quaternary compounds of the alkaloid, *e.g.*, the inhibiting action on salivary secretion is greatly increased in the methonitrate, as is also the spasmolytic activity, but the mydriatic action is unchanged and the central sedative activity disappears.

Whilst tropyltropine (atropine) is mydriatic, this property is of a low order in benzoyltropine and is absent in benzoyl- ψ -tropine. The former is a weak and the latter a potent local anæsthetic. This parallelism in the influence of the tropanyl and benzoyl radicals in developing mydriatic and local anæsthetic action respectively, has been shown by von Braun and his co-workers to occur through an extensive series of hydroxyalkylamines in addition to tropine. Considerable modification may be made in the structure of tropine without impairing its capacity for yielding mydriatics and local anæsthetics. Thus von Braun, Müller and Râth⁶ found that the tropanyl- and benzoyl-esters respectively of *homotropine* (I) and of *N*-hydroxyalkyl*nortropanes* (III) are comparable with atropine and tropacocaine (derived from tropine (II) and ψ -tropine (II)), respectively

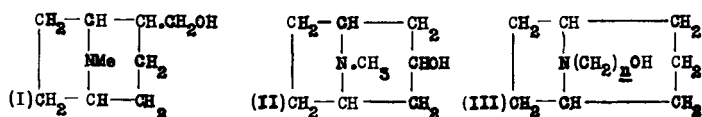

as mydriatics and local anæsthetics, while Rao ⁶ found that 1-methyl-tropacocaine (p. 81) has a general effect similar to that of tropacocaine.

In the case of the *N*-hydroxyalkyl*nortropans* (III) anæsthetic action is at its maximum when the hydroxyl group (in the chain of *n*-carbon atoms attached to the nitrogen atom) is in the γ -position, whilst the β -position is the most favoured for the development of mydriatic action, the esterifying acyl group being benzoyl- and troyl- respectively. This relationship holds throughout a series of similar substances, prepared from aliphatic amines, piperidine, pyrrolidine, coniine, *isoquinoline* and *isoindole*.⁸ For example, in the substances represented by the following formulæ, (IV) is more active as a mydriatic than (V), and (V) more potent as a local anæsthetic than (IV), when the troyl group (Tr) is replaced by benzoyl (Bz).

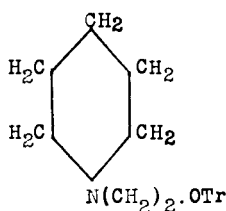

(IV)

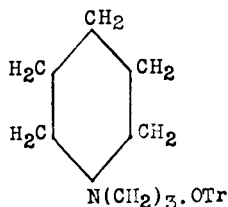

(V)

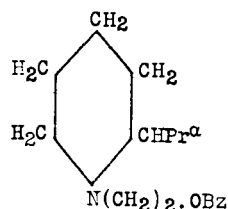

(VI)

Substitution in the α -position in the heterocyclic ring has only a slight effect in enhancing either action, whence the conclusion is drawn that the bicyclic system of tropane is not specific in its influence on pharmacological action, and the second ring may be regarded as ballast. Thus the coniine derivative (VI) corresponding to (IV) is scarcely more active than (IV) (Bz replacing Tr) as a local anæsthetic. It is generally assumed that the sole function of the esterifying methyl group in cocaine is to ensure neutrality but it has been shown that when the methyl group is replaced by benzyl, phenylethyl and certain of their hydroxy-derivatives, the anæsthetic power is notably increased.⁹

Not only may tropane be extended externally, as in *homotropine* (I), but a new methylene group may be inserted in the heptamethylene ring; thus Werner has shown that ψ -pelletierine (VII), on reduction in different ways, yields two granatolines (VIII), corresponding, no doubt, to tropine

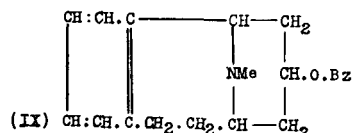
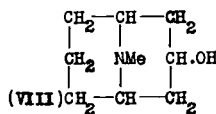
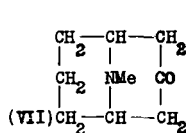

and ψ -tropine, one of which on esterification with tropic or mandelic acid yields mydriatic comparable with atropine in activity.¹⁰ Tanret has found that these aminoalcohols on esterification with benzoic acid or certain of its derivatives yield local anæsthetics, and it has been shown by Elphick and Gunn ¹⁰ that benzoyl-*N*-methyl*homogranatoline* (p. 61), though slower

in action, produces local anæsthesia of longer duration than tropacocaine, and Rao¹⁰ has stated that this is also true of benzoyl- ψ -8:9-benz- $\Delta^{8:9}$ homogranaten-3-ol (IX). McElvain and Adams have synthesised a ring homologue of ecgonine and esterified this with ethyl alcohol and benzoic acid, and so produced a substance which is less anæsthetic and more toxic than cocaine.¹¹

The results of more recent investigations by Blicke with Maxwell and with Kaplan¹² covering a wide range of basic components and of acyl residues, do not lend themselves to a simple generalisation. The basic components were mainly dialkylamino-derivatives of aliphatic hydrocarbons from ethane to pentane, *e.g.*, $\cdot\text{CH}_2\cdot\text{CH}_2\cdot\text{NMe}_2$ to $\cdot\text{CH}_2\cdot\text{CMe}_2\cdot\text{CH}_2\cdot\text{NEt}_2$, and similar but shorter series of derivatives of piperidine ($\text{C}_5\text{H}_{10}\text{N}$), morpholine, *e.g.*, $\cdot\text{CH}_2\cdot\text{CH}_2\cdot\text{NC}_4\text{H}_8\text{O}$, and methylcyclohexylamine such as $\cdot\text{CH}_2\cdot\text{CH}_2\cdot\text{N}(\text{CH}_3)$ (C_6H_{11}). The acyl residues used included mandelic, benzilic, $\beta\beta$ -diphenylhydroxypropionic, tropic (α -phenyl- β -hydroxypropionic) and three isomerides of the latter, *viz.*, atrolactic (α -phenyl- α -hydroxypropionic), β -phenyl- α -hydroxypropionic and β -phenyl- β -hydroxypropionic: neither of the two latter isomerides gave either a mydriatic or local anæsthetic in the series tried. The most promising of the basic components was β -piperidinoethyl, with which, out of eighteen acids tried, five gave "moderate" mydriatics, one, dicyclohexylglycollic (C_6H_{11})₂.C(OH).CO.O, was "good" and that with tropic acid "excellent." Benzilic acid was the best of the esterifying acids and out of thirty bases used with it there were obtained eight mydriatics classed as "excellent," four as "good," and two as "moderate," and where these mydriatics were also tested for local anæsthetic action they were similarly classed for that activity. In general throughout these series potent mydriatics proved to be also potent local anæsthetics, but $\beta\beta$ -dimethyl- γ -dimethylaminopropyl α -phenyl- α -hydroxypropionate (atrolactate) classed as a "good" mydriatic was inactive as a local anæsthetic. There are also two esters of atrolactic acid with the basic components $\cdot\text{CH}_2\cdot\text{CH}_2\cdot\text{N}(\text{C}_4\text{H}_9)_2$ and $\cdot\text{CH}_2\cdot\text{CH}_2\cdot\text{NC}_5\text{H}_{10}$ and three of $\beta\beta$ -diphenyl- β -hydroxypropionic acid with the basic components: $\cdot\text{CH}_2\cdot\text{CH}_2\cdot\text{N}(\text{C}_3\text{H}_7)_2$; $\cdot\text{CH}_2\cdot\text{CMe}_2\cdot\text{CH}_2\cdot\text{NMe}_2$ and $\cdot\text{CH}_2\cdot\text{CH}_2\cdot\text{CH}_2\cdot\text{NC}_5\text{H}_{10}$, which are classified as "excellent" local anæsthetics but do not produce mydriasis.

Homatropine (mandelyltropine) being a useful mydriatic it is surprising that of nine esters of mandelic acid tried, none showed mydriatic activity though three were local anæsthetics, two of them being described as "good." Only one of the tropic acid esters tried showed local anæsthetic action and that was "poor."

As is not uncommon in homologous series, close homologues sometimes showed anomalous behaviour, *e.g.*, of the benzilic acid esters with the following basic components:—

- | | |
|---|---|
| (1) $\cdot\text{CH}_2\cdot\text{CH}_2\cdot\text{NMe}_2$ | (3) $\cdot\text{CH}_2\cdot\text{CH}_2\cdot\text{N}(\text{C}_3\text{H}_7)_2$ |
| (2) $\cdot\text{CH}_2\cdot\text{CH}_2\cdot\text{NEt}_2$ | (4) $\cdot\text{CH}_2\cdot\text{CH}_2\cdot\text{N}(\text{C}_4\text{H}_9)_2$ |

(1) and (2) were potent mydriatics while (3) and (4) were inactive and,

an even more striking example, is the mydriatic activity of $\cdot\text{CH}_2\cdot\text{CMe}_2\cdot\text{CH}_2\cdot\text{NMe}_2$ and the inactivity of $\cdot\text{CH}_2\cdot\text{CMe}_2\cdot\text{CH}_2\cdot\text{NEt}_2$, both being used as esters of atrolactic acid, $\text{CH}_3\cdot\text{C}(\text{C}_6\text{H}_5)(\text{OH})(\text{COOH})$.

Most of the esters were given as hydrochlorides, but where methobromides were used to ensure solubility they were in some cases less irritant and at least as active as the usual salt.

These results indicate that in these new ester mydriatics, the structural factors, which influence the development of this type of pharmacological action are similar to those made evident by the chemical investigations of Jowett and Pyman and the pharmacological work of Marshall, Dale, Laidlaw and Cushny on the tropeines. The nature of the basic component is obviously important since mydriasis is produced by simple bases such as ephedrine. As regards the nature of the esterifying acid, Jowett and Pyman¹³ drew the following conclusions:—

I. Tropeines of aliphatic acids exert no mydriatic effect.

II. The replacement of the benzene residue by that of pyridine in the acyl group of a mydriatic tropeine does not cause the activity to vanish.

III. In tropeines containing a disubstituted benzene ring, those in which the replacing groups occupy the *para*-position have the least mydriatic action; thus *o*- and *m*-hydroxybenzoyltropeines are active, but not the *p*-isomeride.

IV. No generalisation as to the relation between the mydriatic action and chemical constitution of the tropeines can be made which will explain the observed facts.

To these may be added Blicke and Kaplan's conclusion, that the nature of the basic nucleus and the relative positions of the phenyl and hydroxyl groups in the esterifying acid are of prime importance. These conclusions do not provide a full explanation of the results of these investigations. It seems clear that chemical structure alone provides an insufficient basis and that molecular size and shape and other physical properties of the substance play a considerable part in determining the pharmacological action.

Stereoisomerism in either the alkamine nucleus or the acyl residue has a considerable effect on the pharmacological action of the tropeines and cocaines. Differences in activity of tropine and ψ -tropine and their benzoyl derivatives have been mentioned already, and there seems to be a consensus of opinion that the ψ -cocaines (alkyl- or aryl- acyl esters of ψ -ecgonine) are less toxic and more potent local anaesthetics than the corresponding cocaines, derived from *l*-ecgonine.¹⁴

Cushny has compared the action of *d*- and *l*-hyoscyamines with that of atropine, and of *d*-homatropine with that of *dl*-homatropine in antagonising the action of pilocarpine, and finds that the order of activity of the first three is in the ratio 1 : 40 : 20, and of the second two in the ratio 4 : 2.5. He drew attention also to the important influence of the acyl radical in the tropeines, which exercises the maximum effect when it is a hydroxyalkyl aromatic residue and is laevorotatory; and in illustration of this point gives the following table of relative activities on the basis of capacity to antagonise pilocarpine in the salivary fistula dog¹⁵:—

<i>l</i> -Hyoscyamine	600	<i>dl</i> -Homatropine	10
<i>d</i> -Hyoscyamine	15	Phenylacetyltropine	1
<i>dl</i> -Hyoscyamine	300	Benzoyltropine	1
Methylatropine	450	<i>o</i> -Hydroxybenzoyltropine.	1
<i>d</i> -Tartryltropine	0	<i>m</i> -Hydroxybenzoyltropine < 1	
<i>l</i> -Homatropine	14	<i>p</i> -Hydroxybenzoyltropine < ½	
<i>d</i> -Homatropine	7		

The same author found *l*-hyoscyne sixteen to eighteen times as active as the *d*-isomeride in antagonising the action of pilocarpine¹⁶ on the termination of nerves in the salivary glands, while both isomerides are equally active on nerve ends in striated and unstriated muscle and on the central nervous system.

The influence of the acyl group in the production of local anæsthetics has also been discussed by Jowett and Pyman,¹³ who point out that this property is shown by alkamine esters of widely different structure, but possessing the following characters :—

- (1) The acyl group may be benzoyl or a substituted aromatic residue.
- (2) The amino group may be secondary or tertiary, or be associated with simple or bridged ring complexes.
- (3) The alcohol group may be primary, secondary, or tertiary, and may separate the acyl and amino groups by a chain of two or three carbon atoms.

Illustrations of the variation in structure associated with capacity to produce local anæsthesia may be found among the numerous synthetic alkaline esters that have been introduced and used as cocaine substitutes, e.g., amylocaine (I), amydricaine (II) and benzamine (III).

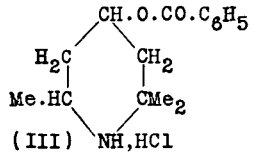
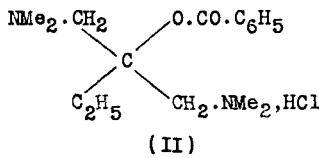
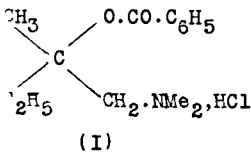

The property of producing local anæsthesia is also shown by other products than alkamine esters, e.g., benzyl alcohol and its homologues, saligenin, and the esters of aminoaromatic acids; such as the ethyl and diethylaminoethyl esters of 4-aminobenzoic acid.

Several of these cocaine substitutes contain asymmetric carbon atoms, and King has shown¹⁷ that in the case of benzamine (III) there is no difference in the anæsthetic action of the *d*- and *l*-forms, but that the *l*-form is twice as toxic as the *d*-form.

Enterprise in the synthesis of new local anæsthetics shows no sign of diminution and several useful reviews^{17(a)} dealing with the correlation of structure and local anæsthetic action have been published of which that by Moore deals generally with the subject, while Gilman, Goodman, Thomas, Hahn and Prütting discuss structure and activity in

several series, ranging in type from alkamine esters of diphenylacetic and allied acids to dialkylaminoalkyl benzyl ethers, and Dawes deals with the remarkable observation that many local anæsthetics and some spasmolytics have a quinidine-like action in auricular fibrillation. Of general interest also is Burn's description of various methods available for comparison of the relative potencies of local anæsthetics, of which cocaine, procaine, β -eucaine and nupercaine are used as examples.^{17(b)} A series of papers dealing with the investigation of cocaine addiction may also be noted.^{17(c)}

Spasmolytic Action. In virtue of its action in inhibiting stimulation by the parasympathetic nervous system, atropine belongs to the neurotropic group of spasmolytics, while papaverine which has also become a model for the synthesis of spasmolytics is musculotropic (myotropic) in action. Atropine has the disadvantage that it acts on so many organs that its use as a spasmolytic is accompanied by undesirable side actions and much work has been done in the hope of eliminating these side effects by modifying atropine, or making and testing esters similar in chemical type. A second objective has been to combine in one substance both neurotropic and musculotropic action, leading eventually to the group of drugs known as anti-histamines, on which much synthetic work is now being expended.

The pharmacological tests used in this work are usually measurement of the relaxation of intestinal muscle contracted by acetylcholine as an indication of neurotropic activity and for musculotropic action similar observation is made on relaxation of spasm induced by histamine or barium chloride. For promising substances these tests may be supplemented by *in vivo* tests of various kinds.¹⁸ The chemical work has followed much the same lines as that already described for mydriatics, esterification of tropine by various acids, or of tropic acid by a range of amino-alcohols, and more recently of amino-alcohols, such as diethyl-aminoethyl alcohol and its homologues, by a range of acids. Halpern¹⁹ has suggested that the amino-alcohol is responsible for the nature of spasmolytic action and the esterifying acid for its intensification and has pointed out that while the lower amino alcohol esters are chiefly neurotropic the esters of the higher homologues such as the aminopentanol are mainly musculotropic.

Among the numerous compounds of this type which have been tested, the following may be mentioned as examples:—

Benzilic and other esters of tropine and ψ -tropine²⁰; α -phenylvaleric,¹⁹ diphenylacetic,²¹ fluorene-9-carboxylic,²² tropic, and other esters of β -diethylaminoethanol²²; tropic and other esters of γ -diethyl-amino- $\beta\beta$ -dimethylpropanol (Fromherz¹⁸); esters of morpholinoalkyl alcohols.²³

Comparable figures for a satisfactory range of substances tested as spasmolytics cannot be provided as authors state their results in different ways. The following short series is taken from Burtner and Cusic's paper.²²

	Substance	Activity in Spasm due to	
		Acetylcholine	Histamine
1	Atropine (<i>dl</i> -tropylopropine)	0.14	4
2	1-Methyl-4-hydroxypiperidyl diphenylacetate	1.8	0.5
3	β -Diethylaminoethyl <i>dl</i> -tropate	1.0	20.0
4	„ α -phenyltropate	5.0	2.0
5	„ benzilate	0.7	0.7
6	„ diphenylacetate	6.0	1.5
7	„ fluorene-9-carboxylate	1.0	1.0
8	γ -Diethylaminopropyl „ „	4.0	5.0
9	β -Diethylaminopropyl „ „	>10.0	4.5
10	β - <i>iso</i> Butylaminoethyl „ „	5.0	2.5
11	β -Di- <i>n</i> -butylaminoethyl „ „	>12.0	9.0
12	γ -Diethylamino- $\beta\beta$ -dimethylpropyl <i>dl</i> -tropate as phosphate	15.0	30.0

The activities are expressed as reciprocal functions and are referred to No. 7 as unity, so that the smaller the number the greater the activity. The results with Nos. 3 to 7 indicate that the esterifying acid has considerable influence both on the nature of the action and its intensity. None of the amino-alcohols used matches tropine as a source of spasmolytic action of the neurotropic type.

Reviews of recent developments in synthetic anti-spasmodics have been published by Raymond and by Blicke, and on the pharmacology of anti-histamine compounds by Loew.²⁴ Mention may also be made of the useful description by Henderson and Sweeten²⁵ of the effect of atropine on the gastro-intestinal canal and its glands.

In addition to producing mydriasis atropine paralyses accommodation. This latter property seems to have received little systematic study in connection with atropine substitutes, but Swan and White²⁶ have prepared a series of choline derivatives of the type $X_3 \cdot N(Cl) \cdot CH_2 \cdot CHR \cdot O \cdot CO \cdot NY_2$, where X may be a C₁ to C₃ alkyl group, R, H or CH₃ and Y, butyl, amyl or phenyl. In this series the most promising compound proved to be dimethylethyl- β -hydroxyethylammonium di-*n*-butylcarbamate sulphate, $[(C_4H_9)_2 \cdot N \cdot CO \cdot O \cdot CH_2 \cdot CH_2 \cdot NMe_2Et]_2, SO_4$, which is said to produce mydriasis and cycloplegia comparable with that due to homatropine. Ing, Dawes and Wadja²⁷ have examined pharmacologically an extensive series of benzilic esters of alkamines of the choline type, of which the most promising compound was benzilyloxyethyl-dimethyl-ethylammonium chloride,

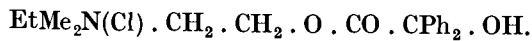

It resembles atropine in its range of activity but in particular types of action it may differ quantitatively: thus its action on the pupil is equal to that of atropine but shorter in duration, and that is also true of its antagonism to the effect of acetylcholine on the isolated perfused cat's heart, but its activity on the salivary gland and the blood pressure of the cat, is greater than that of atropine, while its action on smooth muscle

equals it. Clinically it is regarded as a useful, short-acting mydriatic and cycloplegic, which will have special utility in treating cases allergic to atropine and belladonna.

REFERENCES

- (1) *Quart. J. Pharm.*, 1944, 17, 88; for other comparisons see BÜLBRING and DAWES, *J. Pharm. exp. Ther.*, 1945, 84, 177; LÉVY, *Bull. Soc. Chim. biol.*, 1945, 27, 425. (1a) *Arch. Neur. Psychiat.*, 1942, 48, 72; see also LOMAN, MYERSON and MYERSON, *Trans. Amer. Neurol. Assoc.*, 1941, 67, 201. (2) AVRUTOVA, *Chem. Abstr.*, 1940, 34, 2930; RABINOVITCH, KONOVALOVA and URETSKAYA, *J. Gen. Chem. Russ.*, 1939, 9, 41 (*Brit. Chem. Phys. Abstr.*, 1939, A ii, 349); SAKUSOV, *J. Physiol. U.S.S.R.*, 1938, 24, 1150; RAYMOND-HAMET, *C. R. Soc. biol.*, 1943, 137, 44. (2a) "Tropanol et pseudo-tropanol." Masson et Cie., Paris, 1937. (3) GLICK, *J. Biol. Chem.*, 1940, 134, 617; SAWIN and GLICK, *Proc. Nat. Acad. Sci., U.S.A.*, 1943, 29, 55; BLASCHKO, CHOU and WAJDA, *Brit. J. Pharmacol.*, 1947, 2, 108; ELLIS, *ibid.*, p. 370. BERNHEIM and BERNHEIM, *J. Pharm. Exp. Ther.*, 1938, 64, 209; LÉVY and MICHEL, *Bull. Soc. Chim. biol.*, 1945, 27, 570; LÉVY, *C. R. Soc. biol.*, 1946, 140, 813. (3a) DENYS and LÉVY, *Bull. Soc. chim. biol.*, 1947, 29, 273. (4) DOBBS, *Lancet*, 1939, 236, 12; GRAHAM and LAZARUS, *Journ. Pharm. Exp. Ther.*, 1940, 70, 165. (5) *Boll. Soc. ital. Biol. Sper.*, 1939, 14, 273; DUENSING, *Klin. Woch.*, 1938, 17, 1550; KREITMAIR and WOLFES, *ibid.*, p. 1547. (5a) *Acta. Physiol. Scand.*, 1943, 6, 256; *Acta. med. Scand.*, 1944, 118, 466. (6) *Ber.*, 1918, 51, 235; 1920, 53, 601; 1932, 65, 888. (7) *Quart. J. Pharm.*, 1934, 7, 227. (8) VON BRAUN, BRAUNSDORF and RÄTH, *Ber.*, 1922, 55, 1666; cf. LAUNOY and FUJIMORI, *Compt. rend. Soc. Biol.*, 1919, 82, 732. (9) GRAY and TREVAN, *J. Chem. Soc.*, 1925, 1152; cf. POULSSON and WEIDEMANN, *Arch. exp. Path. Pharm.*, 1925, 105, 58. (10) *J. Amer. Chem. Soc.*, 1918, 40, 669; cf. TANRET, *Compt. rend.*, 1923, 176, 1659; ELPHICK and GUNN, *Quart. J. Pharm.*, 1932, 5, 220; RAO, *ibid.*, 1934, 7, 46. (11) *J. Amer. Chem. Soc.*, 1923, 45, 2738. (12) BLICKE (with MAXWELL), *ibid.*, 1942, 64, 428, 431; (with KAPLAN), *ibid.*, 1943, 65, 1967. (13) *Proc. 7th Int. Cong. Appl. Chem.*, London, 1909; PYMAN, *J. Chem. Soc.*, 1917, 91, 1104. See also *ibid.*, 1906, 89, 357; 1907, 91, 92; 1909, 95, 1020. (14) GOTTLIEB, *Zeit. Physiol. Chem.*, 1923, 130, 374; WAGNER, *Arch. exp. Path. Pharm.*, 1925, 109, 64; GRUHN, *ibid.*, 1925, 106, 115; MERCIER and REGNIER, *Compt. rend.*, 1929, 189, 872; *Bull. Sci. Pharmacol.*, 1930, 65, 219. (15) *J. Pharm. exp. Ther.*, 1920, 15, 105; cf. *J. Physiol.*, 1904, 30, 176; see also GRAHAM and GUNN¹ and FORST and KANDA, *Arch. exp. Path. Pharm.*, 1939, 192, 405. (16) *J. Pharm. exp. Ther.*, 1921, 17, 41; 1926, 29, 5; cf. *J. Physiol.*, 1905, 32, 501; *Arch. exp. Path. Pharm.*, 1912, 70, 433; HUG, *ibid.*, 1912, 69, 45. See also NYMAN, *Acta. Physiol. Scand. Suppl.*, 1942, 10, 127. (17) *J. Chem. Soc.*, 1924, 125, 46. (17a) MOORE, *Journ. Amer. Pharm. Assoc.*, 1944, 33, 193; GILMAN *et al.*, *J. Pharm. exp. Ther.*, 1942, 74, 290; DAWES, *Brit. Med. J.*, 1946, i, 43; *Brit. J. Pharmacol.*, 1946, i, 90. (17b) *Brit. Med. Bull.*, 1946, 4, 82; see also CHANCE and LOBSTEIN, *J. Pharm. exp. Ther.*, 1944, 82, 203; BÜLBRING and WAJDA, *ibid.*, 1945, 85, 78; cf. SOMERS and EDGE, *Quart. J. Pharm.*, 1947, 20, 380, 447. (17c) GUTIERREZ, *Rev. Med. exptl.*, 1944, 3, 329; (with ZAPATA ORTIZ), *ibid.*, p. 279; ZAPATA ORTIZ, *ibid.*, p. 307; MENDIZABAL, *ibid.*, p. 321. (18) See, for example, FROMHERZ, *Arch. Exp. Path. Pharm.*, 1933, 173, 86; *Klin. Woch.*, 1934, 13, 6; *J. Pharm. Exp. Ther.*, 1937, 60, 1; KREITMAIR, *Klin. Woch.*, 1936, 15, 676; KRONER, *ibid.*, p. 678; LEHMANN and KNOEFEL, *J. Pharm. Exp. Ther.*, 1942, 74, 217, 274. (19) *Compt. rend. Soc. Biol.*, 1937, 126, 678; *Arch. inter. Pharmacodyn.*, 1938, 59, 149; cf. WAGNER-JAUREGG *et al.*, *Ber.*, 1939, 72, 1551. (20) WOLFES and HROMATKA, U.S. Pat. 2,127,547 (1938); 2,221,828 (1940); 2,235,661 (1941); KREITMAIR¹⁸; KRONER¹⁸; SOC. CHEM. IND. BASLE, B.P. 483,258 (1937). (21) SOC. CHEM. IND. BASLE,²⁰ B.P. 448,181 (1934); 483,258 (1937); MEIER, *Klin. Woch.*, 1936, 15, 1408, cf. WAGNER JAUREGG *et al.*¹⁹; BURTNER and CUSIC²²; GRAHAM and LAZARUS, *J. Pharm. exp. Ther.*, 1940, 69, 331; NECHELES, NEUWELT *et al.*, *Amer. J. Digest. Dis.*, 1939, 6, 89, 387; HOFFMANN, *Helv. Chim. Acta*, 1941, 24, 36E; (with MIESCHER), *ibid.*, 1941, 24, 458; (with MEIER), *Helv. Med. Acta*, 1040-1, 7, *Suppl. VI*, 106. (22)

BURTNER and CUSIC, *J. Amer. Chem. Soc.*, 1943, 65, 262; BURTNER, U.S.P. 2,334,310; see also LEHMAN and KNOEFEL,¹⁸ (23) CHENEY and BYWATER, *J. Amer. Chem. Soc.*, 1942, 64, 970; BLICKE and FELDKAMP, *ibid.*, 1944, 66, 1087. (24) *J. Amer. Pharm. Assoc.*, 1943, 32, 249; BLICKE, *Ann. Rev. Biochem.*, 1944, 13, 549; LOEW, *Physiol. Rev.*, 1947, 27, 542. (25) *Amer. J. Digest. Dis.*, 1943, 10, 241. (26) *Proc. Soc. Biol. Med.*, 1943, 53, 164; *Arch. Ophthalmol.*, 1944, 31, 289; 1945, 33, 16; *J. Pharmacol. exp. Ther.*, 1944, 80, 285; FEATHERSTONE and WHITE, *ibid.*, 1945, 84, 105; PETERSON and PETERSON, *ibid.*, p. 236. (27) *Ibid.*, 1945, 85, 85; BÜLBRING and DAWES, *ibid.*, 1945, 84, 177; ING, *Brit. Med. Bull.*, 1946, 4, 91; MANN, *Brit. J. Ophthalmol.*, 1946, 30, 8; LAW, *Pharm. J.*, 1946, 157, 215; FORD-MOORE and ING, *J. Chem. Soc.*, 1947, 55.

LUPINANE GROUP

ALKALOIDS OF THE PAPILIONACEÆ

It has become customary to call the principal members of this group "the lupin alkaloids," but in view of their wide distribution in the Papilionaceæ, a better title is that suggested above, since they appear to be the characteristic alkaloids of this leguminous sub-family. This is not the only type of alkaloid found in the Leguminosæ; other types occur, e.g., in *Acacia* (p. 631), *Crotalaria* (p. 601), *Erythrina* (p. 386), *Mimosa* (p. 4) and *Pentaclethra* (p. 776).

The group has attracted much attention from investigators interested, in the distribution of alkaloids in plants. Plugge^{1(a)} examined a large number of *Cytisus* spp., for cytisine. Klein and Farkass^{1(b)} devised microchemical tests for the detection of cytisine in plant tissues and investigated the distribution of this alkaloid in *Genista*, *Ulex*, *Sophora*, *Baptisia*, *Euchresta*, *Anagyris* and *Thermopsis*. Jaretzky and Axer^{1(c)} examined 115 papilionaceous species and found sparteine in twenty-three, all belonging to *Lupinus*, *Genista* or *Cytisus*. The largest percentages were found in the twigs and leaves of *G. aetnensis* (2.1–2.2) *G. purgans* (1.96–2.1), *C. albus* (2.1–2.2), *C. præcox* (2.4–2.5) and *C. scoparius* (broom) (2.7). The amount present in broom tops varied from 2.3 in March to 3.0 in May; it fell to 1.25 in June and slowly rose to 2.8 in November, then remaining constant until February. An even more extensive investigation is in progress in New Zealand, where E. P. White has examined the alkaloidal contents of over 200 leguminous species, the percentage and nature of the alkaloids present in various organs being determined, and changes in these factors, traceable to season, locality and conditions of growth noted.^{1(d)} Three alkaloids of the group, *l*-sparteine, methylcytisine and lupinine, have been found in plants of other botanical families, the first in *Chelidonium majus* (Papaveraceæ), the second in *Caulophyllum thalictroides* (Berberidaceæ), and the third in *Anabasis aphylla* (Chenopodiaceæ), which also contains aphylline and aphyllidine belonging to this group (p. 53).

The following table gives the more important occurrences of these alkaloids in plants.

PAPILIONACEÆ

- (1) *Ammodendron Conollyi* Bge. *d*-Sparteine, ammodendrine.²
- (1a) *Ammothamnus lehmanni* Bge. *d*-Sparteine, sophocarpine and AMMOTHAMNINE, C₁₅H₂₄O₃N₂, m.p. 199–201°, [α]_D ± 0°, picrate, m.p. 212–4° (dec.).^{2(a)}
- (2) *Anagyris fetida* L. Anagyryne, *d*-sparteine, cytisine.³
- (3) *Baptisia australis*, *B. tinctoria* R. Br. and other species. Cytisine. A

- Canadian specimen of *Baptisia australis* (L) R. Br. contained *N*-methylcytisine, *d*-sparteine, cytisine and a new base, P^2 , $C_{11}H_{18}ON_2$, m.p. 300° , forming a perchlorate, m.p. 198° , and a picrate, m.p. 238° (Marion and Ouellet).^{1(d)}
- (4) *Calycotome spinosa* L. (Link). In seeds *d*-calycotomine (p. 146), with traces of the *dl*- form, and of a second base, calycotamine.^{1(d)}
 - (5) *Cytisus* and *Genista* spp. White ^{1(a)} divides these two genera into six groups according to the principal alkaloid present, (a) sparteine, e.g., *C. scoparius*; (b) lupanine with or without some sparteine, e.g., *C. ratisbonensis*⁴ containing *d*-lupanine and *l*-sparteine, and *C. caucasicus*⁴ in which *d*-lupanine, *d*-sparteine and a third base (needles, m.p. $120-2^\circ$) are present; (c) cytisine or allied bases, usually without sparteine, e.g., *C. linifolius* having anagryne in the tops and cytisine in the seeds; (d) sparteine, with cytisine or allied bases, e.g., *G. aetnensis* with tops containing sparteine, but cytisine in the seeds; (e) calycotomine (cf. item 4) as in *C. nigricans* var. *elongatus* Willd., where this is the main alkaloid, or *C. proliferus* in which the tops contain *l* and *dl*-sparteine and the seeds *dl*-calycotomine; (f) no alkaloids present. *C. canariensis* and *C. stenopetalus* belong to group (c) and contain up to 0.4 per cent. of alkaloids mainly cytisine and methylcytisine with traces of anagryne in some specimens of the second species. *C. monspessulanus* also belongs to group (c) and contains 0.9 per cent. of alkaloids chiefly methylcytisine with some cytisine and a new alkaloid *monspessulanine* (p. 146), probably of the lupanine group.^{1(d)} (1946).
 - (6) *Cytisus scoparius* L. *l*-Sparteine and isomerides,^{1(e)} sarothamiine (p. 138), genisteine (p. 139); 3:4-dihydroxyphenylethylamine.^{1(f)}
 - (7) *Cytisus Laburnum* L. (*Laburnum vulgare* Presl.) and *Euchresta Horsfieldii*. Cytisine.^{1(d)}
 - (8) *Genista aetnensis*. Seeds contain cytisine; plants contain retamine, a little cytisine, and a trace of a cytisine-like base; sparteine is recorded in one sample.^{1(d)}
 - (8a) *G. tinctoria*. Cytisine, methylcytisine, anagryne and a fourth base (picrate, m.p. $244-6^\circ$).⁴
 - (9) *Lupinus albus*. *d*- and *dl*-Lupanine; hydroxylupanine (Ueno).⁵
 - (10) *L. Andersonii*. Wats. Nonalupine (p. 132).^{4(a)}
 - (11) *L. angustifolius*. L. *d*-Lupanine, hydroxylupanine.⁵
 - (12) *L. barbiger* S. Wats. Sparteine, dilupine, trilupine (p. 132).⁶
 - (13) *L. caudatus* Kel. Monolupine (p. 132).⁶
 - (14) *L. corymbosis* Heller. Hexalupine (p. 132).⁷
 - (14a) *L. hilarianus*. Hydroxylupanine.^{7(a)}
 - (15) *L. Kingii* Wats. *d*-Lupanine.⁸
 - (16) *L. laxiflorus* var. *silvicola* C. P. Smith. Anagryne.^{7(b)}
 - (17) *L. latus* Rydb. Sparteine, *d*-lupanine, trilupine (p. 132) and a fourth base, $C_{15}H_{24}O_2N_2$, m.p. $176-7^\circ$, $[\alpha]_D + 133.2^\circ$ (H_2O).⁷
 - (18) *L. luteus* and *L. niger*. Lupanine and *l*-sparteine.⁹

- (18a) *L. macounii* Rydb. Rhombinine, hydrorhombinine and base P¹, C₁₅H₂₂ON₂, b.p. 120–2°/0·1 mm., m.p. 126°^{9(a)} (cf. item 38).
- (19) *L. palmeri* Wats. Lupinine, tetralupine and pentalupine (p. 132).¹⁰
- (20) *L. perennis*. *d*-Lupanine and hydroxylupanine.
- (21) *L. polyphyllus* Lindl. *d*-Lupanine, hydroxylupanine.⁹
- (22) *L. sericeus*. Pursh. Spathulatine and nonalupine (p. 132).^{11(a)}
- (23) *L. sericeus* var. *flexuosus*. C. P. Smith. Octalupine (p. 132).^{11(b)}
- (24) *L. spathulatus*. Rydb. Spathulatine (p. 132).^{(7) (11)}
- (25) *L. termis*. *dl*-Lupanine.¹²
- (25a) *Piptanthus nepalensis* Sweet. Cytisine in seeds.^{1(d)}
- (25b) *Podalyria* spp. Lupanine; *dl*- and *l*- forms in *P. buxifolia*; *l*- form in *P. calyptrata*; *d*- and *dl*- forms in *P. sericea*.^{1(d)}
- (26) *Retama sphaerocarpa*. Retamine (p. 139) and sparteine.
- (26a) *Sesbania tripeti* Hort. Lupanine-like alkaloid.^{1(d)}
- (27) *Sophora angustifolia* var. *flavescens*. S. and Z. Matrine, sophocarpine¹³ (p. 150), oxymatrine^{13(a)} (p. 150).
- (28) *S. alopecuroides*. Matrine, sophocarpine (p. 150), sophoridine (p. 150), sophoramine (p. 150), aloperine (p. 150).¹⁴
- (29) *S. chrysophylla*. Anagryne, cytisine, sophochrysin (p. 150).^{14(a)}
- (30) *S. microphylla*. Cytisine, methylcytisine, matrine, sophochrysin (p. 150) and a *fifth base*, m.p. 168–171°.^{14(b)}
- (31) *S. pachycarpa*. Pachycarpine (*d*-sparteine), sophocarpine (p. 150), sophocarpidine (matrine).¹⁵
- (32) *S. secundiflora*, *S. speciosa*. Cytisine.
- (33) *S. tetraptera*. Matrine, methylcytisine, sophochrysin^{14(c)} (p. 150).
- (34) *S. tomentosa*. Cytisine.
- (35) *Spartium junceum*. Sparteine¹⁶; cytisine only in New Zealand plants.^{1(d)}
- (36) *Thermopsis alpina* (Pall.). Led. *T. alternifolia*. Rgb. and Schm. unspecified alkaloids.¹⁷
- (37) *T. lanceolata*. *d*-Sparteine, thermopsine (p. 150), homothermopsine (p. 151), anagryne, methylcytisine, cytisine.¹⁸
- (38) *T. rhombifolia* (Watt), Richards. Cytisine, methylcytisine, thermopsine (p. 150), rhombifoline (p. 151), rhombinine (p. 151), 3-methoxypyridine.¹⁹
- (39) *Ulex europæus*. Anagryne and a *second alkaloid*, C₁₅H₂₀O₅N₂, plates, m.p. 170.²⁰ Cytisine in flowers and seed grown in New Zealand.^{1(d)}
- (39a) *Virgilia capensis* Lam. Virgiline (p. 147), virgilidine (p. 147), a syrup resembling a mixture of *d*- and *dl*-lupanine, and unidentified bases.^{1(d)}

CHENOPODIACEÆ

- (40) *Anabasis aphylla*. Lupinine and other bases (p. 53).

BERBERIDACEÆ

- (41) *Caulophyllum thalictroides*. Methylcytisine (caulophylline).²¹

PAPAVERACEÆ

(42) *Chelidonium majus*. l-Sparteine.²²

Smirnova and Moshkov²³ have investigated the effects of the removal of leaves or buds and of grafting on the alkaloidal content of lupins, and Wallebroek has studied the alkaloidal and nitrogenous metabolism of *Lupinus luteus* seeds on germination.²⁴

Owing to the use of lupin seeds for feeding animals, much attention has been given to the selection of species free from the more toxic alkaloids of the group, particularly sparteine, to methods of removing alkaloids from the seeds, a subject on which there is an extensive literature²⁵ and to methods of estimating alkaloids in lupins on which a critical review has been published by Brahm and Andresen.²⁵

REFERENCES

- (1) For a more comprehensive list the following papers dealing with the distribution of these alkaloids in leguminous species should be consulted: (a) PLUGGE, *Arch. Pharm.*, 1895, 233, 294; (with RAUWERDA), *ibid.*, 1896, 234, 685; (b) KLEIN and FARKASS, *Österr. bot. Zeit.*, 1930, 79, 107; (c) JARETZKY and AXER, *Arch. Pharm.*, 1934, 272, 164; (d) WHITE, *N. Z. J. Sci. Tech.*, 1943, B. 25, 93-114; 1944, B. 25, 137-162; 1946, B. 27, 335, 339, 474, 478. Parts I to XIII issued as a reprint (Govt. Printer, Wellington, N.Z.); MARION *et al.*, *J. Amer. Chem. Soc.*, 1948, 70, 691; (e) WINTERFELD and NITZSCHE, *Arch. Pharm.*, 1940, 278, 393; (f) MERCK's *Jahresb.*, 1936, 50, 111. (2) OREKHOV and PROSKURNINA, *Ber.*, 1935, 68, 1807; *Bull. Soc. Chim.*, 1938, [v], 5, 29. (2a) SADYKOV and PROSKURNINA, *J. Gen. Chem. Russ.*, 1943, 13, 314. (3) ING, *J. Chem. Soc.*, 1935, 1053. (4) OREKHOV *et al.*, *Arch. Pharm.*, 1935, 273, 369; *J. Gen. Chem. Russ.*, 1937, 7, 743, 853 (*Genista*), 906 (*Brit. Chem. Abstr.*, 1937, A, ii, 311). (4a) COUCH, *J. Amer. Chem. Soc.*, 1940, 63, 986. (5) SCHMIDT, *Arch. Pharm.*, 1897, 235, 192; DAVIS, *ibid.*, p. 199, 218; BECKEL, *ibid.*, 1911, 249, 333; 1912, 250, 691; UENO, *J. Pharm. Soc. Jap.*, 1930, 50, 68. (6) COUCH, *J. Amer. Chem. Soc.*, 1932, 54, 1691; 1936, 58, 686, 1296; SOINE and JENKINS, *Pharm. Arch.*, 1941, 12, 65. (7) COUCH, *J. Amer. Chem. Soc.*, 1934, 56, 155; 1937, 59, 1469 (7a) DEULOFEU and GATTI, *J. Org. Chem.*, 1945, 10, 179. (7b) COUCH, *J. Amer. Chem. Soc.*, 1939, 61, 3327. (8) *Ibid.*, 1925, 47, 2584. (9) SCHMIDT⁵; GERHARD, *Arch. Pharm.*, 1897, 235, 342, 355; BERGH, *ibid.*, 1904, 242, 416; WILLSTÄTTER and MARX, *Ber.*, 1904, 37, 2351. (9a) MARION, *J. Amer. Chem. Soc.*, 1946, 68, 759. (10) COUCH, *J. Amer. Chem. Soc.*, 1934, 56, 2434. (11) *Ibid.*, 1924, 46, 2507; (a) *ibid.*, 1940, 62, 554; (b) *ibid.*, 1939, 61, 1523. (12) CLEMO and LEITCH, *J. Chem. Soc.*, 1928, 1812. (12a) RIBAS *et al.*, *Anales fis. y quim., Madrid*, 1946, 42, 516. (13) OREKHOV *et al.*, *Ber.*, 1935, 68, 429. (13a) KONDO *et al.*, *Arch. Pharm.*, 1937, 275, 493. (14) OREKHOV *et al.*, *Ber.*, 1933, 66, 948; 1935, 68, 431; *Arch. Pharm.*, 1934, 272, 673; (14a) BRIGGS (with RUSSELL), *J. Chem. Soc.*, 1942, 507, 555. (14b) (with RICKETTS), *ibid.*, 1937, 1795; 1942, 555; (14c) (with TAYLOR), *ibid.*, 1938, 1206. (15) OREKHOV *et al.*, *Ber.*, 1933, 66, 621; 1934, 67, 1850. (16) SANNA and CHessa, *Ann. Chim. Applic.*, 1927, 17, 283. (17) LAZUR'EVSKII and SADYKOV, *Chem. Abstr.*, 1941, 35, 4154; STRUVE, *ibid.*, p. 5256. (18) OREKHOV *et al.*, *Ber.*, 1933, 66, 625; 1934, 67, 1394; TSAREV, *C. R. Acad. Sci. U.R.S.S.*, 1944, 42, 122; 45, 191; SAI MOISEEVA, *Trudy Vostock Sibirsk. Gosud. Univ.*, 1940, No. 4, 158. (19) MANSKE and MARION, *Can. J. Res.*, 1942, B. 20, 265; 1943, B. 21, 144. (20) CLEMO and RAPER, *J. Chem. Soc.*, 1935, 10. (21) POWER and SALWAY, *ibid.*, 1913, 191. (22) SPÄTH and KUFFNER, *Ber.*, 1931, 64, 1127. (23) *Soviet Plant Ind. Rec.*, 1940, No. 2, 68. (24) *Rec. trav. bot. Neerland.*, 1940, 37, 78. See also MOTHES and KRETSCHNER, *Naturwiss.*, 1946, 33, 26. (25) MIÈGE, *Rev. bot. appl. agr. trop.*, 1940, 20, 16; SENG-BUSCH, *Landw. Jahr.*, 1942 91, 719; BRAHM and ANDRESEN, *Z. angew. Chem.*, 1926, 39, 1348. For some recent

methods see WIERZCHOWSKI, *Biochem. Zeit.*, 1937, 293, 192; MAKARO and KONDRATYEVA, *Chem. Abstr.*, 1942, 36, 6700; SOKOLOV, *ibid.*, 1940, 34, 7065; GUILLAUME, *Bull. Sci. Pharmacol.*, 1940, 47, 187; MEYER, *Landw. Jahrb.*, 1941, 91, 418; (*Chem. Abstr.*, 1943, 37, 3565).

Lupinine, $C_{10}H_{19}ON$. The alkaloids of yellow lupin seeds were isolated by Cassola,¹ but lupinine was first obtained by Baumert,² and was characterised by Schmidt and Berend³ and other workers.⁴ A process of isolation is described by Karrer, Canal, Zohner and Widmer,⁵ and a method of separating lupinine and anabesine has been devised by Sadykov and Spasokukotski.⁵ The alkaloid crystallises from light petroleum in rhombs, m.p. 68.5–69.2°, 70–1° (Clemo and Raper),⁶ b.p. 255–7°, in a current of hydrogen, $[\alpha]_D^{17} - 19^\circ$, $- 25.9^\circ$ (Couch); it is a strong base, liberating ammonia from its salts. The hydrochloride, B. HCl, forms rhombic prisms, m.p. 212–3°, $[\alpha]_D - 14^\circ$ (H_2O); methiodide, m.p. 295–6°; *d*-tartrate, m.p. 171°; aurichloride, B. HAuCl₄, needles, m.p. 196–7°; platinichloride, B₂. H₂PtCl₆, yellow crystals, m.p. 163–4° and picrate, m.p. 136–7°. According to Clemo and Raper, an orange-coloured precipitate is formed when hydrogen sulphide is passed through a suspension of sulphur in an ethereal solution of the base.

Constitution. Evidence of the presence of a primary alcohol group in lupinine is provided by the benzoyl derivative (minute needles, m.p. 49–50°) the phenylcarbimide addition product, $C_{10}H_{18}N \cdot O \cdot CONHPh$ (prisms, m.p. 94–5°), the oxidation of the alkaloid to lupinic (lupinic) acid, $C_9H_{16}N \cdot COOH$ (long needles, m.p. 255°), and the dehydration to anhydrolupinine, $C_{10}H_{17}N$, a colourless oil of unpleasant odour, b.p. 216–7°/726 mm.; picrate, m.p. 94°; aurichloride, B. HAuCl₄, m.p. 140–1°; platinichloride, B₂. H₂PtCl₆, m.p. 216° (*dec.*); and methiodide, B. MeI, m.p. 180° (*dec.*). Anhydrolupinine is optically inactive, but a *l*ævorotatory isomeride has been obtained by Clemo and Raper,⁶ and named *ψ*-anhydrolupinine, $C_{10}H_{17}N$, b.p. 63°/0.5 mm., $[\alpha]_D - 35.3^\circ$ (acetone); picrate, m.p. 154°; platinichloride, m.p. 210° (*dec.*). Karrer and Vogt⁶ have also prepared a *l*ævorotatory anhydrolupinine, $C_{10}H_{17}N$, b.p. 86–8°/15 mm., $[\alpha]_D^{23.5} - 49.8^\circ$. These differences have not yet been accounted for. Lupinine contains no methylimino-group and behaves as a tertiary base. On exhaustive methylation it yields in three stages trimethylamine and an unsaturated alcohol, $C_{10}H_{15}OH$. This and other observations recorded above are due to Willstätter and Fourneau,⁷ who first suggested a bicyclic system as a nucleus for lupinine.

Schöpf and Thomä⁸ found that lupinic acid yielded a methyl ester (b.p. 120–2°/10 mm.) which had $[\alpha]_D - 19.4^\circ$ to $+ 5.8^\circ$ in different batches. The *l*-ester furnished a gummy picrate, $[\alpha]_D^{16} - 41.8^\circ$, and on hydrolysis by hydrochloric acid gave a crystalline lupinic acid hydrochloride, m.p. 275°, $[\alpha]_D^{21} - 13.1^\circ$, identical with that described by Willstätter and Fourneau,⁷ whilst the *d*-ester, or ester of *l*-rotation below $- 19.4^\circ$, furnished a crystalline picrate, m.p. 185°, $[\alpha]_D + 61.8^\circ$, from which pure *d*-*epi*-ester, b.p. 126°/11 mm., $[\alpha]_D + 54.8^\circ$, was prepared, this in turn yielding amorphous *d*-lupinic acid hydrochloride. The *l*-ester is convertible into

the *d*-ester by the action of sodium methoxide, and the *l*-acid, by phosphorus pentachloride suspended in benzoyl chloride, into an acid chloride, which with methyl alcohol furnishes the *d*-methyl ester and with ammonia yields the *d*-*epi*-amide, m.p. 228°, b.p. 250°/11 mm. (bath temp.), $[\alpha]_D^{18} + 41.3^\circ$, with some *d*-*epi*-nitrile, b.p. 120°/11 mm. The two series of derivatives were assumed to indicate the existence in lupinic acid of two centres of asymmetry, one of which ($>CH \cdot CO_2H$) is (—) in the *l*-vortatory series and (+) in the *d*-*epi*-series, whilst the other is dextrorotatory in both series.

Anhydrolupinine is oxidised by permanganate in acid solution to a glycol, $C_{10}H_{19}O_2N$, b.p. 165–7°/11 mm. On hydrogenation it furnishes lupinane,⁹ $C_{10}H_{19}N$, b.p. 75–7°/11 mm., separable by fractionation of the picrate of the crude preparation into two forms, α - (picrate, m.p. 185°) and β - (picrate, m.p. 164–5°). Karrer and Vogt's *l*-anhydrolupinine furnished a *l*-lupinane, b.p. 80–1°/14 mm., $[\alpha]_D^{25} - 0.65^\circ$, and from chlorolupinane, obtained by the action of thionyl chloride on lupinine, by treatment with sodium in alcohol, they prepared a more active *l*-lupinane, b.p. 84–6°/15 mm., $[\alpha]_D^{25} - 9.4^\circ$; these were both of the α -lupinane type, picrate, m.p. 185° (cf. Clemo, Raper and Tenniswood⁶). β -Lupinane has b.p. 85–6°/15 mm., or 76–7°/11 mm. and yields the following salts:— B. HI, m.p. 261–2°; B. HAuCl₄, m.p. 143–4°; B₂, H₂PtCl₆, m.p. 215°; B. MeI, 241° (Winterfeld and Kneuer; Kondo and Saito).⁹ It is assumed that in the formation of the two lupinanes one asymmetric centre of lupinine is destroyed in the production of anhydrolupinine and that in the reduction of the latter a new asymmetric centre is formed. Throughout these operations a second asymmetric centre of lupinine remains intact. If this is indicated by (*a*) and the new centre by (*b*) the optical state of the two epimeric lupinanes may be represented thus

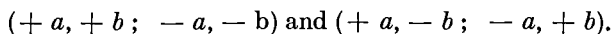

Lupinine is isomeric with a hypothetical ethylquinuclidine carbinol but attempts to correlate the two structures were unsuccessful.¹⁰

Willstätter and Fourneau⁷ found the degradation of lupinine by exhaustive methylation complex, and Karrer, Canal, Zohner and Widmer¹¹ endeavoured to simplify it by hydrogenation of the unsaturated products formed at each of the three stages necessary to eliminate the nitrogen as trimethylamine. The intermediate products are mixtures of structural isomerides due to more than one of the three *N*-linkages being broken at one operation, and there are also components due to secondary reactions. The final product, obtained by hydrolysis of tetrahydrodimethylupinine methiodide, $C_{10}H_{21}ON(CH_3)_3I$, with moist silver oxide followed by distillation, is a mixture of tetrahydrodimethylupinine (b.p. 140–8°/10–11 mm.) and an oil boiling from 81° to 101°/10–11 mm. The latter was separated into two main fractions, b.p. 86–96°/10–11 mm. (48 per cent.) and b.p. 100–1°/10–11 mm. (26.5 per cent.). These had $\alpha_D + 0.335^\circ$ and $+ 0.34^\circ$ (0.25 dcm. tube), and were water-bright, pleasant smelling liquids, the former giving analytical results required by the formula, $C_{10}H_{20}O$. On oxidation

first with zinc permanganate and then with chromic anhydride and sulphuric acid, there was formed a lactone, $C_9H_{16}O_2$, b.p. $253-5^\circ$, probably

β -hydroxymethyloctoic acid lactone, $CH_3 \cdot [CH_2]_4 \cdot CH(CH_2) \cdot CH_2 \cdot CO \cdot O$, indicating the presence of δ -hydroxymethyl- Δ^8 -nonene (I) in the mixture of unsaturated alcohols. On reduction the latter furnished the corresponding saturated alcohol, $C_{10}H_{22}O$, (II), b.p. $95-103^\circ/10-11$ mm., $\alpha_D + 0.32^\circ$ to $+ 0.39^\circ$ (0.25 dm. tube). The validity of this formulation of the main component (I) of the unsaturated alcohols was established by the results of a series of reactions represented as follows, the residue $CH_3 \cdot CH_2 \cdot CH_2 \cdot CH_2 \cdot CH_2$ being indicated by C_5H_{11} . Products (I) to (IV) were optically active, but this property disappeared in the unsaturated hydrocarbon (V).

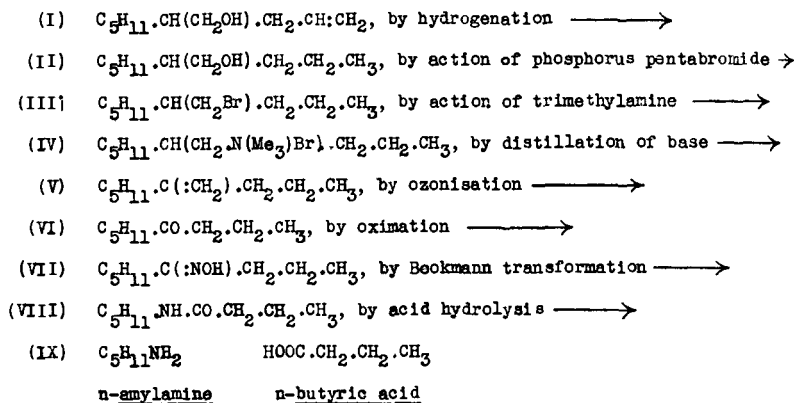

Of the various methods of inserting a nitrogen atom in the saturated alcohol, $C_{10}H_{22}O$ (II), to form lupinine, the most probable are represented by formulæ (X) and (XI), of which the latter was preferred.

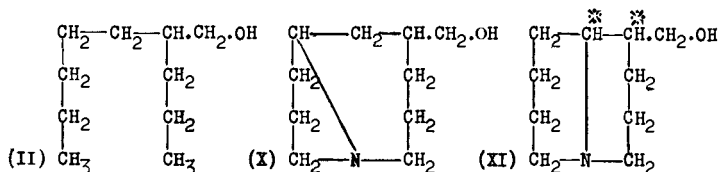

Although lupinine is thus a comparatively simple alkaloid its detailed chemistry has been difficult to unravel owing (a) to the presence in its molecule of two asymmetric carbon atoms as asterisked in (XI), and (b) the possibility of *cis-trans* isomerism in certain of its proximate derivatives. Winterfeld and Holschneider¹² have pointed out that a further complexity arises from the presence in natural *l*-lupinine of a structural isomeride, *allolupinine* for which formula (XII) is suggested. They also quote Kreig's¹³ observation that by the action of sodium on a benzene solution of *l*-lupinine (m.p. $68-9^\circ$; $[\alpha]_D - 23.52^\circ$), the latter is converted

into *isolupinine* (m.p. 76–8°; $[\alpha]_D + 38.17^\circ$), which is also produced by the reduction of *l*-lupinic acid instead of the expected *l*-lupinine. They suggested that lupinine and *isolupinine* are related to each other as *cis*- and *trans*-forms respectively, the latter being the more stable.

The same authors have investigated the degradation of lupinane (XIII), cf. (XIV), by the cyanogen bromide process, the steps and products being as follows :—

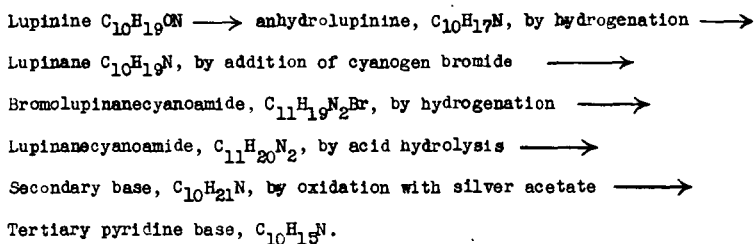

The nature of the base, $C_{10}H_{15}N$, varies. When produced from pure *l*-lupinine, m.p. 68–9°, it furnishes on oxidation only 3-methylpyridine-2-carboxylic acid (XV) and pyridine-2:3-dicarboxylic acid. If, however, lupinine, m.p. 63–5°, is used, the resulting pyridine base on oxidation furnishes in addition 2-*n*-butylpyridine-6-carboxylic acid (XVI) and 6-methylpyridine-2-carboxylic acid (XVII). The conclusion is drawn that lupinine, m.p. 63–5°, is a mixture of *l*-lupinine (XI) with *allolupinine* (XII), each of these components furnishing its own lupinane (XIII and XIV), and that these two lupinanes contribute to the final degradation product, "the tertiary pyridine base, $C_{10}H_{15}N$," the two isomerides 2-*n*-butyl-3-methylpyridine (XVIII) and 2-*n*-butyl-6-methylpyridine (XIX) respectively. These interrelationships are shown by the following scheme :—

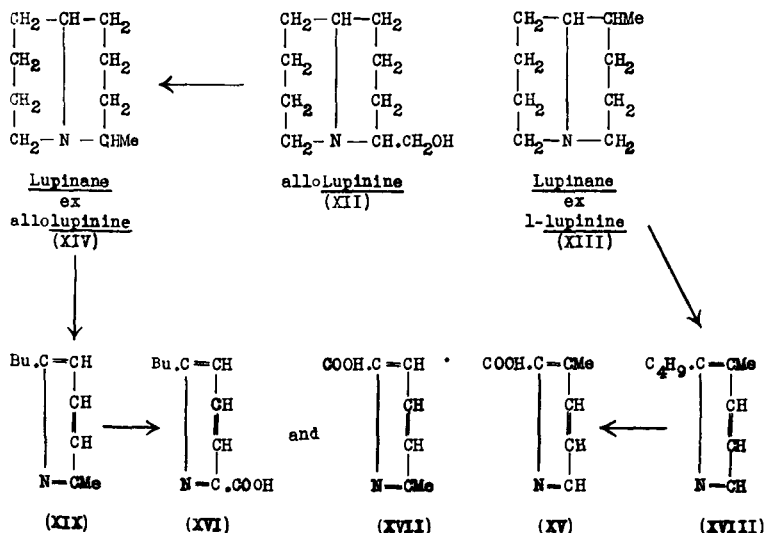

Confirmation of Karrer's formula has been provided by the investigation of special reactions of lupinine and lupinic acid¹⁴, and by syntheses of *nor*lupinane and β -lupinane.

*nor*Lupinane, $C_9H_{17}N$, is an oil, b.p. $43-5^\circ/0.5$ mm., giving a picrate, m.p. $193-4^\circ$; methiodide, m.p. $340-3^\circ$ (*dec.*); and an aurichloride, m.p. $166-7^\circ$. It can be obtained by distilling lupinic acid with soda lime and hydrogenating the partly unsaturated basic fraction of the resulting oil, or by a Curtius degradation of lupinine hydrazide.¹⁵ On the basis of Karrer's lupinine formula (XI), lupinic acid is represented by (XX), anhydrolupinine by (XXI) and *nor*lupinane, which has also been named octahydropyridocoline,¹⁵ octahydroquinolizine, quinolizidine and 1-azadicyclo-[0, 4, 4]-decane, by (XXII).

A process which should have produced *nor*lupinane was worked through by Clemo and Ramage.¹⁵ They condensed ethyl piperidine-2-carboxylate with γ -bromobutyronitrile and, as the resulting γ -2-carbethoxy-piperidinobutyronitrile could not be cyclised, hydrolysed it with alcoholic hydrogen chloride to the dicarboxylic ester (XXIII), which by the Dieckmann reaction, gave ethyl 1-ketooctahydropyridocoline-2-carboxylate (XXIV). This on boiling with dilute sulphuric acid furnished 1-keto-

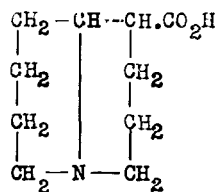

(XX)

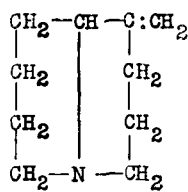

(XXI)

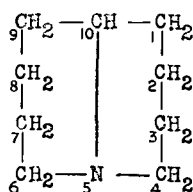

(XXII)

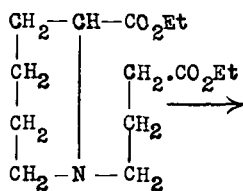

(XXIII)

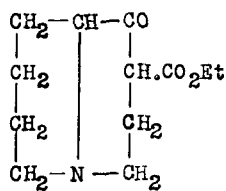

(XXIV)

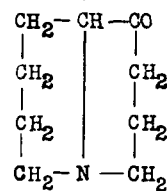

(XXV)

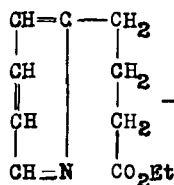

(XXVI)

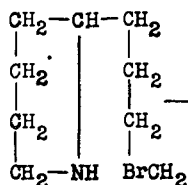

(XXVII)

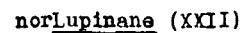

octahydropyridocoline (XXV) which was reduced by the Clemmensen method to a supposed octahydropyridocoline believed to be (XXII). It gave a picrate, m.p. 213° (*dec.*), a methiodide, m.p. 283°, and an aurichloride, m.p. 170°, all different from the corresponding derivatives of *norlupinane* (p. 124). This substance has been named *norlupinane* (B), that derived from natural lupinine being *norlupinane* (A). (*See also* p. 126).

A further synthesis by Clemo, Ramage and Raper¹⁷ was more successful. It consisted in subjecting ethyl γ -2-pyridylbutyrate (XXVI) to a combined Bouveault and nuclear reduction, followed by bromination (XXVII) and withdrawal of hydrogen bromide. The octahydropyridocoline so formed was identical with *norlupinane* (A) (XXII). In the meantime this substance had also been synthesised by Winterfeld and Holschneider¹⁸ and by Diels and Alder,¹⁶ and later on a further preparation was accomplished by Clemo, Morgan and Raper.¹⁵ *norLupinane* (A) has also been prepared by Galinovsky and Stern,^{17(a)} both by electrolytic reduction and by catalytic hydrogenation of α -*norlupinone* (4-keto-octahydropyridocoline). $C_8H_{15}ON$, oil, b.p. 146°/20 mm., obtained by Clemo, Ramage and Raper¹⁷ by refluxing ethyl γ -2-pyridylbutyrate (XXVI) with hydrochloric acid.

It was also suggested that the relationship of the two forms (A) and (B) might be that of stereoisomerides of the *cis-trans* decalin type and a good deal of work was done to provide experimental evidence for this view or the alternative that they are structural isomerides. It was also found that of the methods used¹⁹ to synthesise the pyridocoline system all but one gave *norlupinane* (A) on reduction, the exceptional formation of *norlupinane* (B) being limited to reduction of the 1-keto compound by the Clemmensen method.

Prelog and Bozicevic²⁰ applied to this problem a method for the preparation of dicyclic bases of this type, which may be represented by the following summary of generalised formulæ.

$EtO(CH_2)_x$ Br is condensed with ethyl malonate to \rightarrow

$EtO(CH_2)_x \cdot CH(CO_2Et)_2$, which by interaction with $EtO(CH_2)_y$ Br yields \rightarrow

$\begin{matrix} EtO(CH_2)_x \\ | \\ EtO(CH_2)_y \end{matrix} C(CO_2Et)_2$. This on hydrolysis and decarboxylation gives \rightarrow

$\begin{matrix} EtO(CH_2)_x \\ | \\ EtO(CH_2)_y \end{matrix} CH \cdot CO_2H$. which by the Curtius-Schmidt reaction²¹, followed by treatment with hydrogen bromide yields \rightarrow

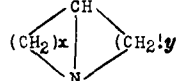
$\begin{matrix} Br(CH_2)_x \\ | \\ Br(CH_2)_y \end{matrix} CH \cdot NH_2$ and this by the action of dilute alkali gives $(CH_2)_x$  $(CH_2)_y$

When $x = y = 4$ the product is *norlupinane* (A) (XXII) and the substance obtained gave a picrate, m.p. 196°, a picrolonate, m.p. 249°, aurichloride, m.p. 167–8°, and platinichloride, m.p. 333° (*dec.*), in good agreement with the corresponding derivatives of *norlupinane* of natural origin.

Prelog and Seiwert²² also prepared the compound of this type, in which $x = 5$ and $y = 3$, viz., 1-azadicyclo-[0, 3, 5]-decane, which proved to be identical with *nor*lupinane (B) yielding a picrate, m.p. 213–4°, picrolonate, m.p. 191.5°, and methiodide, m.p. 282.5° to 283° (cf. p. 125).

In the synthesis of β -lupinane (p. 121) effected by Winterfeld and Holschneider,²³ a Grignard reagent prepared from ethyl γ -bromopropyl ether was used to convert 2-acetylpyridine (XXVIII) into 2-pyridylmethyl- γ -ethoxypropylcarbinol (XXIX), which was hydrogenated to the corresponding piperidine. The latter, on boiling with hydriodic acid, was converted into β -lupinane (XXX), giving a picrate, m.p. 163°, and aurichloride, m.p. 143–4° (cf. p. 121). Treatment of (XXIX) with phosphorus pentabromide also leads to a base, resembling but not identical with lupinane.

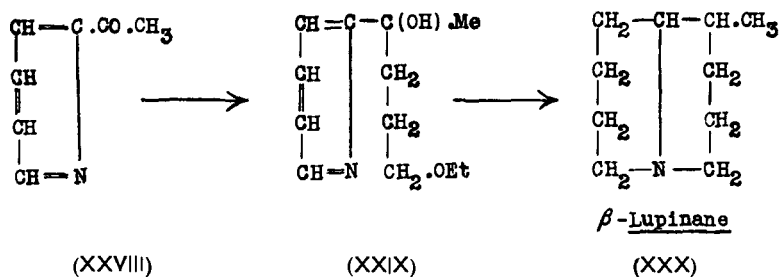

A further synthesis of *nor*lupinane and α -*nor*lupinone has been effected by Bockelheide and Rothchild.^{23(a)}

The results of numerous attempts to find a practicable route to the synthesis of lupinine are recorded by Clemo and his colleagues.²⁴ Success was finally achieved by condensing ethyl pyridyl-2-acetate with γ -phenoxy-*n*-propyl bromide to give (XXXI), which, on hydrogenation, followed by a Bouveault reduction, yielded the corresponding ϵ -phenoxy- β -2-piperidyl-*n*-amyl alcohol. This with hydrobromic acid gave mainly the dibromide (XXXII), which was cyclised by phosphorus pentabromide into *dl*-bromolupinane (1-bromomethyloctahydropyridocoline (XXXIII), b.p. 110°/1 mm., of which the picrolonate separated into the two racemic forms, m.p. 202° (a) and m.p. 169° (b), from which the two bromo-bases were recovered and converted by ebullition in sodium acetate solution into the corresponding 1-octahydropyridocolylcarbinols, which should be identical with *dl*-lupinine and *dl*-isolupinine (XI) (*epi*lupinine) (p. 123) respectively. The characters of these final products are as follows:—

(a) Picrolonate, m.p. 202°, gives a bromo-base, b.p. 107°/1 mm., yielding a methiodide, m.p. 216°, a picrate, m.p. 135°, and the corresponding carbinol, m.p. 59°, picrate, m.p. 127°. This base, m.p. 59°, on crystallisation as the *d*-tartrate yielded *l*-lupinine *d*-tartrate, m.p. 170°, $[\alpha]_D + 15.5^\circ \pm 0.5^\circ$ ($c = 1.084$; EtOH) from which the recovered *l*-lupinine had m.p. 69–70°, $[\alpha]_D - 20.35^\circ$ ($c = 5.64$; EtOH) and gave a picrolonate, m.p. 192° (cf. p. 120).

d-Lupinine *l*-tartrate, m.p. 167–8°, $[\alpha]_D - 15.8^\circ$ yielded *d*-lupinine base, m.p. 68°, $[\alpha]_D + 19.9^\circ$.

(b) Picrolonate, m.p. 169°, gives a bromo-base, b.p. 107°/1 mm., yielding a methiodide, m.p. 186°, picrate, m.p. 144°, and the corresponding carbinol, m.p. 81°, giving a picrate, m.p. 139°, and a methiodide, m.p. 248°.

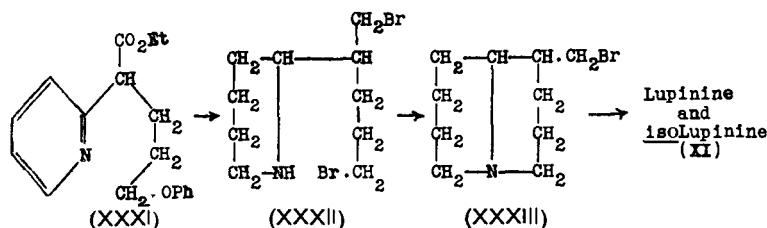

dl-Lupinine has also been synthesised by Winterfeld and Cosel,²⁴ starting from 2-pyridyl hydroxymethyl ketone, and using a method similar to that adopted for β -lupinane (p. 126). The product was characterised as the picrolonate, m.p. 179° (*dec.*). Cf. Clemo's *dl*-lupinine (p. 126).

*allo*Lupininc, the structural isomeride of lupinine referred to already (p. 122), has been synthesised by Winterfeld and Holschneider.²⁵ δ -Ethoxy-

γ -valerolactone, $\text{EtO} \cdot \text{CH}_2 \cdot \text{CH} \cdot \text{CH}_2 \cdot \text{CH}_2 \cdot \text{CO} \cdot \text{O}$ was condensed with ethyl pyridine-2-carboxylate to 2-pyridyl α -(δ -ethoxy- γ -valerolactonyl)

ketone, $\text{EtO} \cdot \text{CH}_2 \cdot \text{CH} \cdot \text{CH}_2 \cdot \text{CH}(\text{CO} \cdot \text{O}) \cdot \text{CO} \cdot \text{C}_5\text{H}_4\text{N}$, which with boiling hydrochloric acid furnished 2-pyridyl γ -hydroxy- δ -ethoxy-*n*-butyl ketone, $\text{EtO} \cdot \text{CH}_2 \cdot \text{CHOH} \cdot \text{CH}_2 \cdot \text{CH}_2 \cdot \text{CO} \cdot \text{C}_5\text{H}_4\text{N}$. This was hydro-

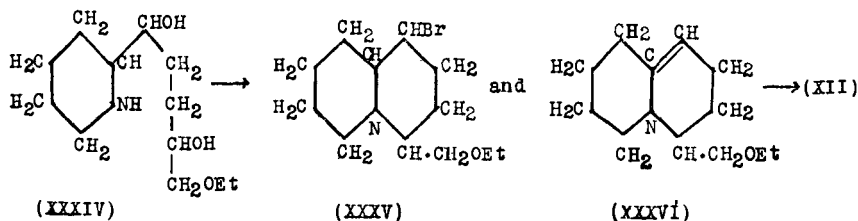

genated to $\alpha\delta$ -dihydroxy- ϵ -ethoxy- α -2-piperidyl-*n*-pentane (XXXIV) and the latter treated with phosphorus tribromide followed by sodium ethoxide, which produced a mixture of 1-bromo-4-ethoxymethyloctahydro- (XXXV) and 4-ethoxymethyl- Δ^{10} -hexahydro-pyridocoline (XXXVI) converted wholly by hydrogenation in presence of calcium carbonate into (XXXVI) which was dealkylated by hydriodic acid to 4-hydroxymethyloctahydro-pyridocoline (*allo*lupinine (XII), p. 123). The product had m.p. 123–5°, and gave a mercurichloride B. HgCl_2 , m.p. 201° (*dec.*), and reineckate, m.p. 152–3°: the picrate and aurichloride were oils.

REFERENCES

(1) *Annalen*, 1835, 13, 308. (2) *Landw. Versuchs.-Stat.*, 1881, 27, 15 (this paper gives a *résumé* of the work done by CASSOLA, EICHOHN, BEYER, SIEWERT, SCHULTZ

and LIEBESCHER; *Ber.*, 1881, 14, 1150, 1321, 1880, 1882; 1882, 15, 631, 1951). (3) *Arch. Pharm.*, 1897, 235, 263. (4) SCHMIDT and others, *ibid.*, 1897, 235, 192; (DAVIS) 199, 218, 229; (GERHARD) 342, 355; (CALLSEN) 1899, 237, 566; (BERGH) 1904, 242, 416; (BECKEL) 1912, 250, 691. (5) *Helv. Chim. Acta*, 1928, 11, 1062; see also COUCH, *J. Amer. Chem. Soc.*, 1934, 56, 2434; SADYKOV (with LAZUR'EVSKI), *J. Gen. Chem. U.R.S.S.*, 1943, 13, 319; (with SPASOKUKOTSKI), *ibid.*, p. 830. (6) *J. Chem. Soc.*, 1929, 1927; for general information see also CLEMO, RAPER and TENNISWOOD, 1931, 429 (with RAMAGE), 1932, 2963; *cf.* KARRER and VOGT, *Helv. Chim. Acta*, 1930, 13, 1073. (7) *Ber.*, 1902, 35, 1910. (8) *Annalen*, 1928, 465, 97, *cf.* SCHÖPF, SCHMIDT and BRAUN, *Ber.*, 1931, 64, 683, and STEINSIEK, *Inaug. Diss.*, Marburg, 1928. (9) *Ger. Patent* 386,936; 396,508; SCHÖPF and THOMA⁸; WINTERFELD (with KNEUER), *Ber.*, 1931, 64, 150; (with HOLSCHNEIDER), *Arch. Pharm.*, 1939, 277, 192; KONDO and SAITO, *J. Pharm. Soc. Jap.*, 1921, 659. (10) SCHÖPF and SCHMIDT, *Annalen*, 1928, 465, 117. (11) *Helv. Chim. Acta*, 1928, 11, 1062. (12) *Ber.*, 1931, 64, 137,692; *Arch. Pharm.*, 1939, 277, 192. (13) *Inaug. Diss. Marburg*, 1928, *cf. Bied. Zent.*, 1932, 3, A. 51. (14) See, for example, KARRER and VOGT⁶; SCHÖPF *et al.*⁶ (1931). (15) CLEMO (with RAMAGE), *J. Chem. Soc.*, 1931, 437; (with RAPER), 3190. For a third synthesis see CLEMO, MORGAN and RAPER, 1935, 1743. (16) DIELS and ALDER, *Annalen*, 1932, 498, 21; 1933, 505, 119. (17) *J. Chem. Soc.*, 1932, 2959; 1936, 606, 1429; *cf.* OCHIAI *et al.*, *Ber.*, 1935, 68, 2291; SUGASAWA and LEE, *J. Pharm. Soc. Jap.*, 1939, 59, 113. (17a) *Ber.*, 1943, 76B, 1034. (18) *Annalen*, 1932, 499, 109; *Arch. Pharm.*, 1935, 273, 305. (19) CLEMO *et al.* refs. (15), (17) and *J. Chem. Soc.*, 1931, 3185; 1932, 2969; 1937, 1518; 1938, 1183, 1318. (20) *Ber.*, 1939, 72, 1103. (21) OESTERLIN, *Angew. Chem.*, 1932, 45, 536. (22) *Ber.*, 1939, 72, 1638. (23) *Ibid.*, 1933, 66, 1751; *Arch. Pharm.*, 1935, 273, 315. (23a) *J. Amer. Chem. Soc.*, 1947, 69, 3146. (24) *J. Chem. Soc.*, 1931, 3190; 1937, 965; 1938, 1574. See also WINTERFELD and COSEL, *Arch. Pharm.*, 1940, 278, 70. (25) *Ibid.*, 1939, 277, 192, 221.

Lupanine,¹ C₁₅H₂₄ON₂. This alkaloid occurs naturally in *d*-, *l*- and *dl*-forms. It may be prepared from the blue lupin seed by the process described by Davis,¹ and modified by Ranedo,¹ and can be purified by distillation, b.p. 185–95°/1 mm., and finally by crystallisation from light petroleum; it forms colourless, prismatic plates, m.p. 98–9°, is strongly alkaline and soluble in all ordinary solvents. It behaves as a monoacidic base, but does yield a deliquescent dihydrochloride, B. 2HCl (colourless prisms, m.p. 185°). The monohydrochloride, B. HCl. 2H₂O, also deliquescent, has m.p. 127–8° (*hydrated*) or 250–2° (*dry*); the hydriodide, B. HI. 2H₂O, m.p. 184–5° (*dry*); the aurichloride, m.p. 177–8° (*dec.*), 200° (Beckel); and the thiocyanate, m.p. 124°.

***d*-Lupanine**. This form can be obtained from blue lupin seed,² or by deracemisation of the *dl*-base by crystallisation of the *d*-camphorsulphonate from acetone.³ It distils at 185–6°/0.08 mm. and crystallises on standing, m.p. 40° (44° Davis); [α]_D + 61.4° (acetone). The hydrochloride, B. HCl. 2H₂O, has m.p. 127° (*dry*); the hydriodide, B. HI. 2H₂O, forms colourless prisms, m.p. 189°, [α]_D + 45.5° (H₂O); the thiocyanate softens at 143° (loss of water) and melts at 184°. The *d*-camphorsulphonate crystallises in colourless prisms, m.p. 112–5°, [α]_D + 42.5° (H₂O) and the picrate² in needles, m.p. 180°.

***l*-Lupanine**. After separation of *d*-lupanine from *dl*-lupanine (*see above*), the bases are recovered from the mother liquors as lupanine hydriodide, from which clean base is regenerated. This, on combination with *l*-camphorsulphonic acid in acetone, yields *l*-lupanine *l*-camphorsulphonate.

The base recovered *via* the hydriodide, B. HI. 2H₂O, m.p. 190°, is a viscous oil, b.p. 186–8°/1 mm., $[\alpha]_D^{20}$ – 61.0° (acetone). A mixture of equal parts of *d*- and *l*-lupanines has m.p. 98° after recrystallisation from acetone.³

Constitution. Lupanine normally behaves as a monoacidic base, and only one of the nitrogen atoms present reacts with alkylating agents; the methiodide forms stout prisms, m.p. 258–60° (*dec.*), from alcohol, and on treatment with silver oxide, gives the corresponding methohydroxide, which, on distillation *in vacuo*, regenerates lupanine and methyl alcohol.² Clemo and Leitch⁴ found that the methiodide on distillation with a mixture of solid potash and soda yielded a mixture of α -methyllylupanine (m.p. 123°) and β -methyllylupanine (oily, water-soluble base). Both these products yield crystalline methiodides, but continuation of the degradation with α -methyllylupanine methiodide gave anomalous results. Attempts to degrade lupanine by means of cyanogen bromide were made by Thoms and Bergerhoff,² and by Winterfeld and Kneuer,⁴ who were able to obtain good yields of bromolupanine cyanoamide, C₁₅H₂₄ON₂ · CNBr (m.p. 123°, $[\alpha]_D^{18}$ + 82.8° (EtOH)), its amorphous reduction product, lupaninecyanoamide, and the hydrolytic product of the latter, the secondary base, C₁₅H₂₆ON₂ which is also amorphous, but yields a crystalline benzoyl derivative, m.p. 195°, scission of which could not be effected by phosphorus pentachloride or pentabromide. Hofmann degradation of the secondary base proved unpromising owing to poor yields.

The oxidation of lupanine has been investigated by a number of workers.⁵ Beckel noted that *d*-lupanine formed a perbromide, which on treatment with alcohol yielded ethoxylupanine dihydrobromide, C₁₅H₂₅ON₂ · OC₂H₅ · 2HBr (colourless needles, m.p. 227–8°, $[\alpha]_D^{17}$ – 129.4°), from which a number of interesting substances were obtained in yields too small for characterisation.

Clemo and Leitch⁴ found that *dl*-lupanine was oxidised by permanganate in acetone to oxylupanine, C₁₅H₂₂O₂N₂ (b.p. 210°/1 mm., m.p. 123°; platinichloride, brown prisms, m.p. 232° (*dec.*)), a deliquescent substance, neutral to litmus, having no reactive carbonyl, hydroxyl or methylene group. The same authors found that deoxylupanine (*dl*-sparteine, *see below*) is oxidised by permanganate to *isolupanine*, C₁₅H₂₄ON₂ (colourless plates, m.p. 113°, depressed to 78–80° on admixture with lupanine; methiodide, m.p. 208°). It was shown by Davis¹ that the oxygen atom of lupanine is not present as hydroxyl or a reactive carbonyl group. The fact that lupanine, though usually appearing to contain only one basic nitrogen atom, can act as a diacidic base, does not necessarily imply the absence of a lactam group and the possibility that lupanine may be an oxygen derivative of sparteine led Clemo and Leitch to investigate its reduction. Prolonged heating with fuming hydriodic acid and red phosphorus furnished a substance provisionally named deoxylupanine, and which, from a study of its derivatives, was closely related to sparteine. Identity was established when Clemo, Raper and Tenniswood³ applying the same procedure to the optically active forms of lupanine, obtained *l*-sparteine from *d*-lupanine and *d*-sparteine from *l*-lupanine. There is a

difference of opinion as to the product of this reaction, Winterfeld and his collaborators maintaining that the chief product is β -lupinane (p. 126). Galinovsky and Stern^{4(a)} have also found recently that *d*-lupanine can be catalytically hydrogenated to *l*-sparteine ($[\alpha]_D^{18} - 16.03^\circ$ (EtOH); picrate, m.p. 205–6° (*dec.*)). The results of Clemo and his colleagues are supported by Ing's⁶ discovery that anagryne, $C_{15}H_{20}ON_2$, can be reduced electrolytically to hexahydroanagryne, $C_{15}H_{26}N_2$, which is *d*-sparteine, and by catalytic hydrogenation to tetrahydroanagryne, $C_{15}H_{24}ON_2$ (b.p. 186–190°/1 mm.; $[\alpha]_D^{20} - 61.45^\circ$ (acetone)), which proved to be *l*-lupanine (b.p. 186–8°/1 mm.; $[\alpha]_D - 61.0^\circ$ (acetone)), the close agreement of the constants of the bases being confirmed by mixed melting-point determinations with the two hydriodides (m.p. 190°) and the two thiocyanates (m.p. 183–5° after softening at 124°); the perchlorate forms prisms (m.p. 210°, with softening at 195°) from alcohol.

The first complete formula (I) suggested for lupanine was that of Thoms and Bergerhoff,² based mainly on the formation of 2-ethylpyridine when lupanine was distilled with zinc dust, which seemed to indicate a similarity between tropane and lupanine.

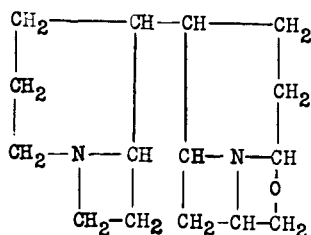

(I) Thoms and Bergerhoff

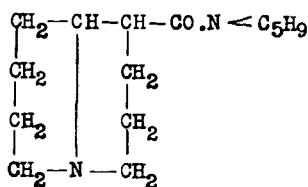

(II) Winterfeld and Kneuer

In 1931 Winterfeld and Kneuer,⁴ as a result of their observation that β -lupinane can be obtained from lupanine, and the formation of 2-methylpyrrolidine by the oxidation of sparteine, combined these two features in a partial formula (II) for lupanine, which could be developed in various ways depending on the mode of attachment of the methylpyrrolidine residue. In view, however, of Ing's demonstration of the relationship of anagryne, $C_{15}H_{20}ON_2$, to *l*-lupanine, $C_{15}H_{24}ON_2$, and *d*-sparteine, $C_{15}H_{26}N_2$, it was clearly necessary to consider formulæ for lupanine derivable from the two alternatives, which Ing⁶ had proposed for anagryne and which are shown below as (III) and (IV) with the formulæ for lupanine derived from them (V) by Ing and (VI) by Clemo and Raper.⁷ Sparteine would be represented by (V) or (VI) with the change $\text{CO} \rightarrow \text{CH}_2$.

Formula (VI) has received support in two ways. The investigations of Winterfeld⁸ (with Rönseberg) on the oxidation of dehydrosparteine methoacetate and of α -didehydrosparteine, indicated that D was a piperidine ring and this was finally established by Clemo, Morgan and Raper's

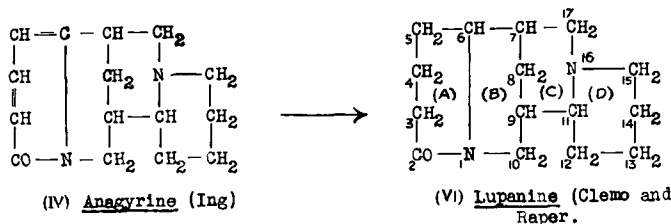
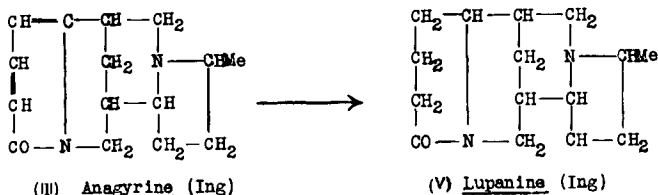

synthesis of oxysparteine⁹ (p. 138). The existence of the piperidone ring (A) was demonstrated by Winterfeld, Hoffmann and Holschneider's scission of this ring by concentrated hydrochloride acid at 150° with formation of the imino-acid (ethyl ester platinichloride, m.p. 245° (*dec.*)) in which rings (B), (C), (D) are intact and the piperidone ring (A) has been opened as shown in partial formula (VII). In a further series of papers Winterfeld¹¹ *et al.* described the preparation and degradation of a series of alkyl- and aryl-sparteines obtained by the action of Grignard reagents on lupanine and subsequent treatment as indicated in the partial formulæ (VIII) to (XI) indicating the resulting changes at positions 1, 2, 3 in formula (VI).

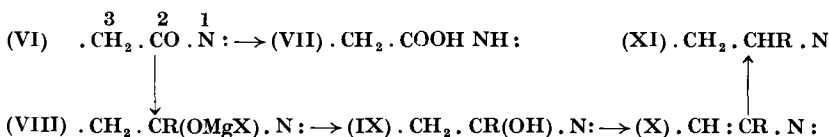

Hydroxylupanine, C₁₅H₂₄O₂N₂ (Nos. 9, 11, 14a; list, p. 117). This alkaloid was first isolated by Bergh,¹⁰ and was further investigated by Beckel.¹¹ It crystallises in rhombic prisms with 2H₂O, m.p. 76–7° or 172–4° (*dry*), [α]_D + 64·12°, and yields crystalline but very soluble salts. The aurichloride, B. HAuCl₄, m.p. 205–6°, forms prisms from dry alcohol. Ueno¹² has demonstrated the presence of a primary alcohol group by the preparation of a benzoyl derivative, m.p. 199–199·5°, and oxidation of the base to an aldehyde, C₁₅H₂₂O₂N₂ (semicarbazone, m.p. 221–3°, and oxime, m.p. 217–8°). The alkaloid also yields two methiodides. It is reduced to *d*-lupanine by hydriodic acid¹¹ and is dehydrated by sulphuric acid to an anhydro-base, C₁₅H₂₂ON₂, which, on catalytic hydrogenation, also yields *d*-lupanine.¹² Couch¹³ suggests it is 15-hydroxylupanine (for numbering see formula (VI)) or 10-hydroxylupanine on his alternative numbering for the sparteine formula (p. 137).

Couch¹⁴ has suggested that dilupine and trilupine (*see below*) are near relatives of lupanine.

MINOR ALKALOIDS OF *Lupinus* spp.

In the following account the numbers in brackets after the name and formula of the alkaloid are the numbers of the plants in which it occurs as given in the list (p. 117).

Monolupine. $C_{16}H_{22}ON_2, \frac{1}{2}H_2O$ (No. 13). Amorphous, b.p. 257–8°/4 mm.; n_D^{25} 1.569, $[\alpha]_D^{25} - 40.8^\circ$ (EtOH). *Salts.* B. 2HCl, 2H₂O, m.p. 115–6°; passes on drying into B. HCl, m.p. 280°. B, 2HAuCl₄, 3H₂O, m.p. 167–8°. B. MeI. H₂O, m.p. 259°. Monolupine may be a C-methylanagryrine.¹³

Dilupine. $C_{16}H_{26}O_2N_2$ (No. 12). Oil, $[\alpha]_D^{20} + 65.6^\circ$ (H₂O). Derivatives have one oxygen less than the base. Methiodide, $C_{16}H_{26}ON_2$, MeI, m.p. 253°; hydrobromide, $C_{16}H_{26}ON_2$, HBr, m.p. 233–4°. Regarded as a C-methylupanine N-oxide.¹⁴

Trilupine. $C_{15}H_{24}O_3N_2, 2H_2O$ (Nos. 12, 17). Needles, m.p. 127° or 252° (*dry*); $[\alpha]_D^{30} + 63.8^\circ$ (H₂O). Hydrochloric acid in acetone converts it into lupanine dihydrochloride, $C_{15}H_{24}ON_2, 2HCl, H_2O$, m.p. 163–4°. Methyl iodide gives lupanine N-oxide methiodide, $C_{15}H_{24}O_2N_2$, MeI, m.p. 127°. B, H₂PtCl₆, 4H₂O, m.p. 224° (*dec.*); B, 2HAuCl₄, 4H₂O, m.p. 188–9° (*dec.*). The base can be prepared by the action of calcium peroxide on *d*-lupanine and is regarded as lupanine di-N-oxide.¹⁴

Tetralupine. $C_{10}H_{19}ON$ (No. 19). M.p. 81–3°; D_4^{25} 1.0194; n_D^{26} 1.5128, $[\alpha]_D^{20} + 4.63^\circ$. *d*-Camphorsulphonate, m.p. 164–5°. Identity with isolupinine uncertain.¹⁵

Pentalupine. $C_{16}H_{30}ON_2$ (No. 19). B.p. 175–182°/2 mm.; n_D^{25} 1.5155; $[\alpha]_D^{20} - 3.197.15$

Hexalupine. $C_{15}H_{20}ON_2, \frac{1}{3}H_2O$ (No. 14). M.p. 197–8°; $[\alpha]_D^{20} + 126.1^\circ$ (EtOH). *Salts.* B, 2HCl. 3H₂O, m.p. 116°, passes into B.HCl, m.p. 304–5°, on slow heating. The aurichloride B₂, 2HAuCl₄, 5H₂O, melts at 204° (*dec.*) and the picrate at 245–6°.¹⁶

Octalupine. $C_{15}H_{22}O_2N_2$ (No. 23). M.p. 167.5–169.5°; b.p. 270–80°/6 mm.; $[\alpha]_D^{25} + 52.3^\circ$ (EtOH). *Salts.* B, 2HCl, 1.5H₂O, m.p. 298–9°; $[\alpha]_D^{25} + 36.3^\circ$ (H₂O). B. HAuCl₄, m.p. 208–9°; B. MeI., m.p. 259°. Reduced electrolytically to *d*-lupanine (p. 128) and *l*-sparteine (p. 133) and regarded as 2 : 10-diketosparteine (formula V or VI, p. 131) with CH₂ at C¹⁰→CO.¹⁷

Nonalupine. $C_{15}H_{24}ON_2, 2H_2O$ (Nos. 10, 22). M.p. 91.5–92.5° or 235° (*dry*); b.p. 260–270°/18 mm.; $[\alpha]_D^{25} - 21.3^\circ$ (EtOH). Aurichloride, m.p. 177.5–178° (*dec.*), picrate, m.p. 185–6°. No salts with mineral acids. No N-oxide group. Oxidised by permanganate to oxynonalupine, $C_{15}H_{24}O_3N_2$, m.p. 168.5–170.5°; aurichloride, m.p. 238–9°.¹⁸

Spathulatine. $C_{32}H_{64}O_5N_4, 4.5H_2O$ (Nos. 22, 24). M.p. 227°; $[\alpha]_D - 1.88^\circ$ (CHCl₃). The mercuriodide, B, 3HgI₂, m.p. 164°, is characteristic. The picrate melts at 182.4° and the methiodide at 250.2°. Three oxygen atoms are stated to be present as N-oxide groups. Boiling dilute

hydrochloric acid converts the base into a substance, $C_{15}H_{24}N_2$ (perchlorate, m.p. 216–7°; picrate, m.p. 214–6°), which is isomeric with spartyrine.¹⁹

REFERENCES

(1) HAGEN, *Annalen*, 1885, 230, 367; SIEBERT, *Arch. Pharm.*, 1891, 229, 531; SOLDAINI, *Gazzetta*, 1892, 22, i, 177; 1893, 23, i, 143; 1895, 25, i, 352; 1897, 27, ii, 191; 1902, 32, i, 389; 1903, 33, i, 428; SCHMIDT, *Arch. Pharm.*, 1897, 235, 192; DAVIS, *ibid.*, 199, 218, 229; CALLEN, *ibid.*, 1899, 237, 577; VON AMMON and SZOMBATHY, *Brit. Pat.* 288,637; RANEDO, *Anal. Fis. Quim.*, 1922, 20, 527. (2) THOMS and BERGERHOFF, *Arch. Pharm.*, 1925, 263, 4. (3) CLEMO, RAPER and TENNISWOOD, *J. Chem. Soc.*, 1931, 432; cf. DAVIS, *Arch. Pharm.*, 1897, 235, 211, and COUCH, *J. Amer. Chem. Soc.*, 1934, 56, 1423. (4) *J. Chem. Soc.*, 1928, 1813; cf. WINTERFELD (with KNEUER), *Ber.*, 1931, 64, 150; (with HOLZSCHNEIDER), *ibid.*, p. 2415. (4a) *Ber.*, 1944, 77B, 132. (5) SIEBERT, *Arch. Pharm.*, 1891, 229, 544; CALLEN, *ref.* (1); BECKEL, *ibid.*, 1912, 250, 691; cf. SOLDAINI, *Gazzetta*, 1903, 33, 428. (6) *J. Chem. Soc.*, 1933, 504. (7) CLEMO and RAPEE, *ibid.*, 1933, 644. (8) (With RÖNSBERG), *Arch. Pharm.*, 1935, 273, 521; 1936, 274, 40, 48; (with HOFFMANN and HOLSCHNEIDER), *ibid.*, 1937, 275, 65; (with HOFFMANN), *ibid.*, 5, 526; (with SCHIRM), *ibid.*, 630. (9) *J. Chem. Soc.*, 1936, 1025. (10) *Arch. Pharm.*, 1904, 242, 416; cf. SCHMIDT, *loc. cit.*, 409. (11) *Ibid.*, 1910, 248, 451; 1912, 250, 691. (12) *J. Pharm. Soc. Japan*, 1930, 50, 68. The following references are to papers by J. F. COUCH in the *Journal of the American Chemical Society*. (13) 1936, 58, 686. (14) 1936, 58, 1296; 1937, 59, 1471. (15) 1934, 56, 2434. (16) 1934, 56, 155. (17) 1939, 61, 1523. (18) 1940, 62, 554, 986. (19) 1924, 46, 2507; 1940, 62, 554.

Sparteine (*Lupinidine*), $C_{15}H_{26}N_2$ (Nos. 1, 2, 4, 5, 6, 12, 17, 18, 31, 35, 37, 42; list, pp. 116–8). The alkaloid may be prepared by concentrating a dilute sulphuric acid extract of ground broom tops, adding excess of alkali and distilling in steam. The distillate is neutralised with hydrochloric acid, evaporated to dryness and the residue distilled over solid potash; the product is purified by distillation in a current of hydrogen, sodium being used to remove traces of water. Sparteine is a colourless, alkaline oil, D^{20}_D 1.0196, $[\alpha]^{21}_D$ – 16.42° (EtOH), b.p. 188°/18 mm. or 325°/154 mm. (in hydrogen). It has a bitter taste, a characteristic odour, and is sparingly soluble in water (1 in 328 at 22°), but readily so in alcohol, chloroform or ether. The base is monoacidic to litmus or phenolphthalein, but diacidic to methyl orange. The salts crystallise well; the sulphate, $B \cdot H_2SO_4 \cdot 5H_2O$, m.p. 159–62° (*dry*), $[\alpha]^{15}_D$ – 27° (H_2O), forms columnar crystals and is the salt used in medicine. The dihydriodide, $B \cdot 2HI$, has m.p. 257–8°, the monoperchlorate melts at 171–2°. The platinichloride, $B \cdot H_2PtCl_6 \cdot 2H_2O$, forms rhombic prisms, m.p. 243.5° (*dec.*), from dilute hydrochloric acid; the aurichloride melts at 193.4° on precipitation, but after recrystallisation melts at 183.4° and has the composition $B_2 \cdot 4HCl \cdot 3AuCl_3$ (Schmidt). The picrate, m.p. 208°, forms glancing yellow needles from boiling alcohol. According to Jorissen,¹ sparteine gives a bulky red precipitate when hydrogen sulphide is passed through a suspension of sulphur in an ethereal solution of the base. A critical review of methods for the estimation of sparteine in galeenical preparations of broom has been published by Guillaume and Proeschel.^{1(a)} The polarographic behaviour has been investigated by Kirkpatrick.^{1(b)}

Constitution. Both nitrogen atoms in sparteine are basic and tertiary,

neither has a methyl group attached to it, and, since the alkaloid is unaffected by reducing agents or permanganate, Wackernagel and Wolfenstein suggested that it was a saturated bicyclic system based on pyridine and pyrrolidine.² The first insight into the constitution of sparteine is due to Moureu and Valeur's investigation of the "exhaustive methylation" of the alkaloid. It forms two monomethiodides, α - (m.p. 240° (*dec.*); $[\alpha]_D - 22.75^\circ$; hydriodide $[\alpha]_D - 17.15^\circ$) and α' - ($[\alpha]_D - 47.2^\circ$; hydriodide $[\alpha]_D - 40.3^\circ$).³ The α -methiodide subsequently prepared by Schöpf and Braun⁴ had m.p. $243-4^\circ$, $[\alpha]_D^{18} - 24.8^\circ$. It yields two methylsparteines (*de-N*-methylsparteines). The α -derivative has m.p. $30-1^\circ$, b.p. $178-9^\circ/11$ mm., $[\alpha]_D - 55.4^\circ$ (M. and V.), $172.5-173^\circ/10$ mm. (S. and B.); $[\alpha]_D - 47.6^\circ$ (S. and B.), whilst the β -isomeride is a liquid (b.p. $180-2^\circ/16.5$ mm., $[\alpha]_D + 9.9^\circ$). Schöpf and Braun obtained, in addition to the α -base, a third methylsparteine and a base, $C_{16}H_{30}ON_2$, which has the composition of a methylsparteine monohydrate, whilst Clemo and Raper got still another methylsparteine (b.p. $135-6^\circ/1$ mm.; $[\alpha]_D - 16.3^\circ$ (EtOH); methiodide, m.p. 247°).⁴ α -*De-N*-methylsparteine by a variety of processes is convertible into *isosparteine*, a saturated, ditertiary base containing no methylimino-group,⁵ and which in turn furnishes two methiodides reconvertible through their methohydroxides into α -*de-N*-methylsparteine.⁶ In the subsequent stages of exhaustive

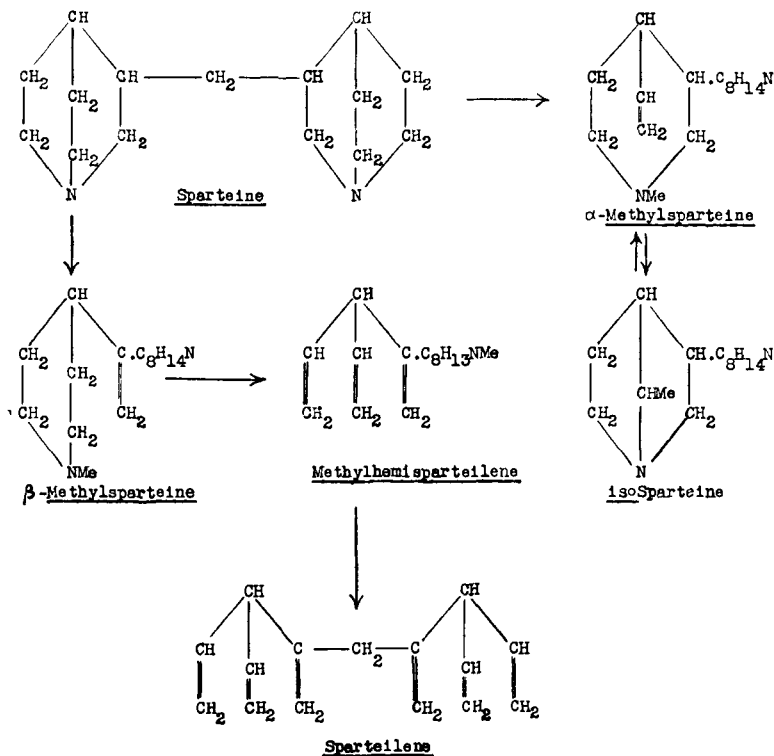

methylation one nitrogen is eliminated as trimethylamine with the production of a mixture, which contains hemisparteilene, $C_{15}H_{23}N$.⁷ A more definite product is obtained by heating tetramethylsparteinum dihydroxide, $C_{15}H_{24}Me_2N(MeOH)_2$, which decomposes into trimethylamine and methylhemisparteilene,⁸ $C_{16}H_{25}N$ (liquid, b.p. $160-1^\circ/16$ mm., $[\alpha]_D + 156.5^\circ$ (EtOH)). Continuing the process with this material there is obtained eventually with the elimination of the second nitrogen atom the hydrocarbon sparteilene, $C_{15}H_{20}$ (b.p. $157-9^\circ/18$ mm., $[\alpha]_D \pm 0^\circ$).⁹ On the basis of these observations Moureu and Valeur suggested the formula given on previous page for sparteine, the alternative α -linkage for the connecting methylene group being left open for consideration. The derivation of the various degradation products referred to above is also shown.

The French authors realised that in certain respects this symmetrical formula, with the two equivalent nitrogen atoms, was difficult to reconcile with certain of the properties and reactions of the alkaloid.¹⁰

The exhaustive methylation of sparteine was reinvestigated by Karrer, Shibata, Wettstein and Jacobowitz.¹¹ At each stage they reduced the unsaturated product formed and so ended up with a pentadecane, $C_{15}H_{32}$ (b.p. $242^\circ/729$ mm., $D_4^{18.7^\circ} 0.7740$, $n_D^{18.7^\circ} 1.43351$). The object of this work was to compare this substance with the pentadecanes theoretically derivable by exhaustive methylation from bases represented by formulæ (I) to (IV), which are based on the assumption that sparteine is derived from lupinine by the addition of a piperidine ring, the lupinine formula being that of Karrer, Canal, Zohner and Widmer.¹²

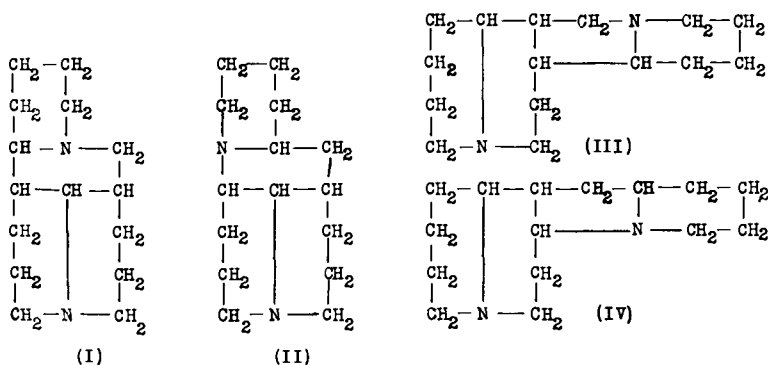

Substances of these formulæ should give rise to the following hydrocarbons:—

- I. 4-Methyl-6-propylundecane. $CH_3 \cdot [CH_2]_2 \cdot CHMe \cdot CH_2 \cdot CHP^{\alpha} \cdot [CH_2]_4 \cdot CH_3$.
 II. and IV. 6-Propyldodecane. $CH_3 \cdot [CH_2]_4 \cdot CHP^{\alpha} \cdot [CH_2]_5 \cdot CH_3$.
 III. 6-Methyl-7-ethyl-dodecane. $CH_3 \cdot [CH_2]_4 \cdot CHMe \cdot CHEt \cdot [CH_2]_4 \cdot CH_3$.

The three hydrocarbons were synthesised, but their physical constants proved to be so similar and so like those of the pentadecane obtained from sparteine that no definite information as to the constitution of the alkaloid could be obtained from them.

By oxidising sparteine sulphate with chromic acid, Willstätter and Marx¹³ obtained *spartyrine*, $C_{15}H_{24}N_2$ (m.p. 153–4°, $[\alpha]_D^{18.5} = 25.96^\circ$), which is one of several dehydrosparteines and contains one ethylenic linkage, and *oxysparteine*, $C_{15}H_{24}ON_2$ (m.p. 87.5°, b.p. 209°/12.5 mm., $[\alpha]_D^{18} = 10.04^\circ$), already prepared by Ahrens.¹⁴ They called attention to the similarity of oxysparteine to lupanine (p. 128) and suggested that the oxygen atom was probably present in a bridge form as in cineole. Galinowsky and Stern have found recently that oxysparteine cannot be catalytically hydrogenated to sparteine.^{14(a)} Schöpf and Braun¹⁵ showed that oxysparteine is converted by hydrogen peroxide into oxysparteine-*N*-oxide (m.p. 220°; picrate, m.p. 221° (*dec.*)). On oxidation of α -de-*N*-methylsparteine with permanganate they obtained a glycol, $C_{16}H_{30}O_2N_2$ (needles, m.p. 200°). Clemo and Raper⁴ also prepared oxysparteine and found it to resemble *isolupanine* (p. 129) in resistance to reduction, and were able to carry out a Hofmann degradation up to the stage of dimethyloxysparteine methiodide, which reacted abnormally, so that it was not possible to eliminate a nitrogen atom. Späth and Galinovsky⁴ (1938), however, succeeded in obtaining a hexahydrohemioxysparteilene, $C_{15}H_{27}ON$, by a special form of this reaction.

Mention may also be made of Winterfeld's use of mercuric acetate, which furnished (*a*) dehydrosparteine, $C_{15}H_{24}N_2$, which was eventually degraded to a hydrocarbon and 2-methylpyrrolidine,¹⁷ and (*b*) α - and β -didehydrosparteines, each of which on catalytic hydrogenation furnished a corresponding *isosparteine*, of which β -*isosparteine* is probably identical with *d*-sparteine. Another dehydrosparteine obtained by Wolffenstein and Reitmann¹⁸ by the oxidation of sparteine with sodium hypobromite is referred to later. Using more drastic conditions of oxidation, Germain¹⁹ obtained oxalic and succinic acids and Karrer and Widmer,²⁰ by exhaustive oxidation with chromic acid, produced γ -aminobutyric acid.

In 1931 Winterfeld and Kneuer²¹ put forward formulæ (V) and (VI) for sparteine based mainly on the following considerations. Lupanine (p. 128) appears to differ from sparteine only in having a carbonyl group replacing a methylene group, and as this base is monoacidic the carbonyl group is probably present as a lactam. Clemo and Leitch²² had shown that *dl*-lupanine could be reduced by heating with hydriodic acid at 220° in sealed tubes to deoxylupanine, which was believed to be *dl*-sparteine, a belief confirmed later when Clemo, Raper and Tenniswood²³ reduced *d*- and *l*-lupanines by this method to *l*- and *d*-sparteines respectively. Winterfeld and Kneuer, however, found that with the same reagents under different conditions β -lupanine, $C_{19}H_{19}N$ (p. 126), is formed along with a by-product giving the pyrrole reaction with pine wood. This reaction could not be confirmed by Clemo and collaborators,²⁴ and the cause of this difference has not been elucidated. As Winterfeld and Kneuer had already found that sparteine could be degraded to α -methylpyrrolidine it seemed that lupanine and sparteine could be represented by formulæ arrived at by combining the formulæ of β -lupanine and α -methylpyrrolidine, and this is done in (V) and (VI).

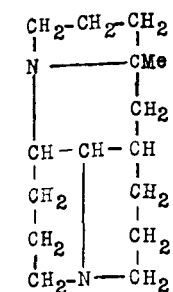

(V)

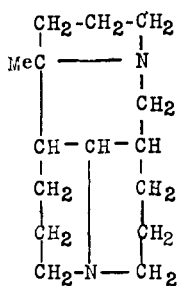

(VI)

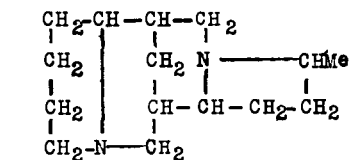

(VII)

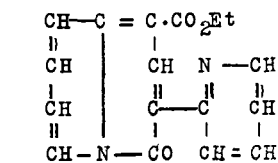

(IX)

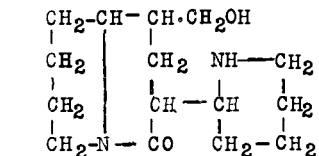

(X)

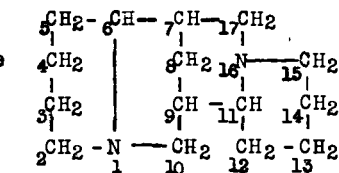

(VIII)

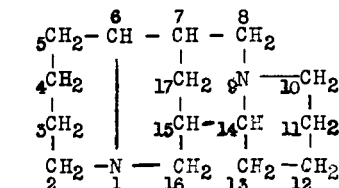

(VIIIa)

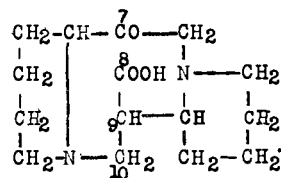

(XI)

In 1933 Ing²⁵ showed that anagryne (p. 140), on catalytic hydrogenation, was converted into *l*-tetrahydroanagryne, C₁₅H₂₄ON₂ (which proved to be identical with *l*-lupanine), whilst on electrolytic reduction it furnished hexahydrodeoxyanagryne, C₁₅H₂₆N₂, identical with *d*-sparteine, with the exception that it had $[\alpha]_D^{19} + 10.9^\circ$, instead of $+ 15.9^\circ$, recorded by Clemo, Raper and Tenniswood. Ing therefore suggested formula (VII) for sparteine based on his proposed formula for anagryne. On this basis the pentadecane (p. 135) obtained by Karrer *et al.*¹¹ from sparteine should be 6 : 8-dimethyltridecane,

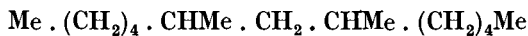

and Schirm and Besendorf¹¹ have synthesised the latter and identified it with the sparteine hydrocarbon. Clemo and Raper²⁶ have modified Ing's formula to (VIII). The latter provides an explanation of the fact that sparteine yields two monomethiodides, which appear to be stereoisomerides, but does not yield a dimethiodide. Examination of a space model of (VIII) shows that if the two octahydropyridocoline systems are both *trans* and if the C₇ - C₉ bridge is *cis* with respect to the hydrogen atoms attached to C⁶ and C¹¹ the system is fairly rigid and the nitrogen atoms are so close to each other that the formation of a dimethiodide is impossible. Couch²⁶ has proposed a new numbering system for the sparteine formula as shown in (VIIIa).

Support for (VIII) has been provided by Clemo, Morgan and Raper's

synthesis of *dl*-oxysparteine (*isolupanine*),²⁶ which is represented by (VIII : CH₂ at 10 replaced by CO). Ethylpyridyl-2-acetate was condensed with ethyl orthoformate to give 1-carbethoxy-4-keto-3-(2'-pyridyl)-pyridocoline (IX), yellow prisms, m.p. 126°. This, on catalytic hydrogenation, gave 1-carbethoxy-4-keto-3-(2'-piperidyl)-octahydropyridocoline, an oil, b.p. 200–210°/1 mm., which, on reduction by sodium in alcohol, gave the corresponding 1-carbinol (X) (*not isolated*), and this with phosphorus pentabromide provided the corresponding 1-bromomethyl derivative (*not isolated*), which, when heated in a sealed tube with anhydrous potassium carbonate, gave *dl*-oxysparteine (VIII : CH₂ at 10 → CO), m.p. 111°, identical with the product formed by the oxidation of deoxylupanine (*dl*-sparteine) with alkaline ferricyanide. The authors point out that this synthesis establishes the ring structure of (VIII) as fundamental for the C₁₅ lupin alkaloids and also for anagryne (p. 140) and aphylline (p. 54), and that in one or other of its stereoisomeric forms it is probably present in matrine (p. 147) and other alkaloids of *Sophora* (p. 148). Winterfeld and Schirm¹⁸ have prepared by the method of Wolfenstein and Reitmann,¹⁸ a dehydrosparteine, C₁₅H₂₄N₂ (m.p. 172–3° [α]_D – 236° (CHCl₃) or – 192° (EtOH); picrate, m.p. 181–2°), which had already been shown to be reduced to a ψ -sparteine (b.p. 325°; [α]_D^{18°} – 49.8°; picrate, m.p. 201°), not identical with any known *isosparteine*, and have oxidised it with nitric acid to succinic acid, and with chromic acid in sulphuric acid, to a keto-acid, C₁₅H₂₄O₃N₂ (dihydrochloride, m.p. 248° (*dec.*); diaurichloride, m.p. 211° (*dec.*). They represent this dehydrosparteine by (VIII) with an ethylenic linkage at either C⁷ – C⁸ or C⁸ – C⁹, so that Wolfenstein's ψ -sparteine must be a stereoisomeride of sparteine. They propose for spartyrine (p. 136) formula (VIII) with an ethylenic linkage at C⁹ – C¹¹, or at C⁶ – C⁷. The keto-acid C₁₅H₂₄O₃N₂ is regarded as (XI) or (XI) with the positions of the carbonyl and carboxyl groups altered thus : CH . COOH and . CH₂ . CO.

d-Sparteine. As already stated *l*-lupanine²³ and *l*-anagryne²⁵ both yield *d*-sparteine on reduction. This base was found in *Sophora pachycarpa* by Orekhov, who continues to use the name "pachycarpine" for it, and with Kabatschnik and Kefeli^{26(a)} has described experiments with "oxypachycarpine," on the results of which he adopts for this substance formula (VIII : with CH₂ at 10 → CO) which makes it identical with oxysparteine. *d*-Sparteine has also been recorded from other plants (Nos. 1, 2, 4, 31, list, pp. 116–8).

At least seven other bases have been mentioned as present in the mother liquors from the manufacture of *l*-sparteine sulphate.²⁷ Valeur found two, sarothamnine and genisteine, of which Winterfeld and Nitzsche²⁷ have confirmed genisteine and have themselves added four more, two, thought to be structural and two, optical isomerides of sparteine, with a fifth substance of higher boiling point.

Sarothamnine, C₁₅H₂₄N₂. This base forms crystalline additive products with solvents, *e.g.*, with chloroform, C₁₅H₂₄N₂ · $\frac{1}{2}$ CHCl₃, m.p. 127°, [α]_D – 38.7°, and with ethyl alcohol, C₁₅H₂₄N₂ · $\frac{1}{2}$ C₂H₅OH, m.p. 99°, [α]_D – 25.6°.

Genisteine, $C_{16}H_{28}N_2$, is a volatile base, m.p. 60.5° , b.p. $139.5-140.5^\circ/5$ mm.; forms a hydrate, B. H_2O , m.p. 117° , $[\alpha]_D - 52.3^\circ$ (EtOH), a picrate, B. $2C_6H_2(NO_2)_3OH$, m.p. 215° , and a platinichloride, B. $H_2PtCl_6 \cdot 2\frac{1}{2}H_2O$.

Retamine, $C_{15}H_{26}ON_2$ (No. 26, table, p. 118). This alkaloid, isolated by Battandier and Malosse,²⁸ is isomeric with oxysparteine and gives colour reactions suggesting relationship to sparteine. It is a strongly alkaline diacidic base, m.p. 168° , $[\alpha]_D + 43.15^\circ$ (EtOH), yields crystalline salts and derivatives of which Ribas, Sanchez and Primo²⁸ have prepared the following: B. HCl, m.p. $272-3^\circ$, picrate, m.p. $165-6^\circ$; acetyl derivative, hygroscopic, m.p. 60° (approx.), phenylurethane, m.p. $190-1^\circ$. It behaves as a tertiary alcohol on oxidation and when heated under pressure with hydriodic acid and red phosphorus forms an isomeride. The same authors suggest for retamine a provisional formula, which is (VIII) of p. 137, with $\cdot C^6H \rightarrow \cdot C^6(OH)$ and they regard retamine as a hydroxy-derivative of an isomeride of sparteine. The hydrochloride is stated to have no action on the frog heart.

Ammodendrine, $C_{12}H_{20}ON_2 \cdot H_2O$ (No. 1, table, p. 116). The base has m.p. $73-4^\circ$, becomes anhydrous at $70-80^\circ$, and then melts at $50-60^\circ$, $[\alpha]_D \pm 0^\circ$. The salts are amorphous and deliquescent except the hydriodide B. HI, which forms a crystalline precipitate, m.p. $218-20^\circ$, from alcohol, and the perchlorate, m.p. $199-200^\circ$. An amorphous *N*-benzoyl derivative was obtained. With methyl iodide ammodendrine behaves as a secondary base, yielding first *N*-methylammodendrine hydriodide (a crystalline precipitate, m.p. $183-5^\circ$, from a mixture of alcohol and acetone), and at the second stage *N*-methylammodendrine methiodide, m.p. $163-5^\circ$. On hydrogenation ammodendrine furnishes a dihydro-base, which is hydrolysed into acetic acid and 2:3'-dipiperidyl, $C_{10}H_{20}N_2$, and must be *dl-N*-acetyl-3- α -piperidylpiperidine. Ammodendrine should therefore be acetyltetrahydroanabasine and is of biological interest as the first recorded occurrence of this type of alkaloid in the Leguminosæ.²⁹

REFERENCES

- (1) *J. Pharm. Chim.*, 1911, [vii], 4, 251. For other special tests, see GRANT, *J. Amer. Pharm. Assoc.*, 1920, 9, 704; COUCH, *Amer. J. Pharm.*, 1925, 97, 38; WAGENAAR, *Pharm. Weekbl.*, 1929, 66, 809; JARETZKY and AXER, *Arch. Pharm.*, 1934, 272, 152. (1a) *Bull. Sci. Pharmacol.*, 1938, 45, 255. (1b) *Quart. J. Pharm.*, 1946, 19, 532. (2) *Ber.*, 1904, 37, 3238; cf. WILLSTÄTTER and MARX, *ibid.*, 1904, 37, 2351, and MOUREU and VALEUR, *Compt. rend.*, 1903, 137, 194. (3) *Compt. rend.*, 1905, 140, 1601, 1645; 1905, 141, 49; *Bull. Soc. Chim.*, 1908, [iv], 3, 674; cf. BAMBERGER, *Annalen*, 1887, 235, 368; SCHOLTZ and PAWLICKI, *Arch. Pharm.*, 1904, 242, 513; SCHOLTZ, 1906, 244, 66; DÜTZMANN and E. MERCK, D.R.P. 421, 387. (4) *Compt. rend.*, 1907, 145, 929; cf. SCHÖFF and BRAUN, *Annalen*, 1928, 465, 97; WINTERFELD and IPSEN, *Arch. Pharm.*, 1928, 266, 308; CLEMO and RAPER, *J. Chem. Soc.*, 1929, 1931; SPÄTH and GALINOVSKY, *Ber.*, 1938, 71, 1282. (5) *Compt. rend.*, 1907, 145, 1184, 1343; 1908, 146, 79; 1911, 152, 386. (6) VALEUR, *ibid.*, 1908, 147, 127; *Bull. Soc. Chim.*, 1909, [iv], 5, 31, 37, 40. (7) *Bull. Soc. Chim.*, 1905, [iii], 33, 1271. (8) *Compt. rend.*, 1907, 145, 815. (9) *Ibid.*, 1912, 154, 161. (10) *Ibid.*, 1912, 154, 309. (11) *Helv. Chim. Acta*, 1930, 13, 1292; cf. SCHIRM and BASENDORF, *Arch. Pharm.*, 1942, 280, 64. (12) *Ibid.*, 1928, 11, 1062. (13) *Ber.*, 1905, 38, 1772;

cf. WACKERNAGEL and WOLFFENSTEIN, *ibid.*, 1904, 37, 3238. (14) *Ibid.*, 1887, 20, 2218; 1891, 24, 1095; 1892, 25, 3607; 1897, 30, 195; 1905, 38, 3268. (14a) *Ber.*, 1944, 77, B., 132. (15) SCHÖPF and BRAUN, *Annalen*, 1928, 465, 97. (16) CLEMO and RAPER, *J. Chem. Soc.*, 1929, 1931. (17) WINTERFELD *et al.*, *Arch. Pharm.*, 1928, 266, 299; 1929, 267, 433; 1930, 268, 372; 1934, 272, 273. (18) *Biochem. Zeit.*, 1927, 186, 269. See also WINTERFELD and SCHIRM, *Arch. Pharm.*, 1938, 276, 544. (19) *Gazzetta*, 1912, 42, [ii], 447; (*Chem. Soc. Abstr.*, 1912, i, 579). (20) *Helv. Chim. Acta*, 1926, 9, 886. (21) *Ber.*, 1931, 64, 150 (with HOLSCHNEIDER), *ibid.*, 2415; cf. WINTERFELD and RAUCH, *Arch. Pharm.*, 1934, 272, 273. (22) *J. Chem. Soc.*, 1928, 1811. (23) *Ibid.*, 1931, 429. (24) *Ber.*, 1931, 64, 1520; cf. however, WINTERFELD and HOLSCHNEIDER, *ibid.*, 1934, 67, 778. (25) *J. Chem. Soc.*, 1933, 504. (26) *Ibid.*, 644; CLEMO, MORGAN and RAPER, *ibid.*, 1936, 1025; cf. WINTERFELD and SCHIRM, *Arch. Pharm.*, 1937, 275, 630; COUCH, *J. Amer. Chem. Soc.*, 1936, 58, 688; see also KING, *Ann. Repts. Chem. Soc.*, 1933, 30, 238. (26a) *C. R. Acad. Sci., U.R.S.S.*, 1941, 31, 335; see also refs. (14), (15) and (16). (27) VALEUR, *Compt. rend.*, 1918, 167, 26, 163; *J. Pharm. Chim.*, 1913, 8, 573; WINTERFELD and NITZSCHE, *Arch. Pharm.*, 1940, 278, 393. (28) *Compt. rend.*, 1897, 125, 360, 450; cf. WUNSCHENDORF and VALIER, *Bull. Sci. Pharmacol.*, 1933, 40, 601, and RIBAS *et al.*, *Anales fis. y quim. Madrid*, 1946, 42, 516. (29) OREKHOV and PROSKURNINA, *Ber.*, 1935, 68, 1807; *Bull. Soc. Chim.*, 1938, [v], 5, 29; ASRATYAN *et al.*, *Farmakol. i. Toksikol.*, 1946, 9, No. 3, 12.

Anagyrene, $C_{15}H_{20}ON_2$ (Nos. 2, 8, 16, 29, 37, 39; list, pp. 116-8). Gerrard's alkaloid, ulexine,¹ from gorse (*Ulex europaeus*) was stated by several workers² to be cytisine, but Klein and Farkass³ were unable to confirm this, and Clemo and Raper⁴ showed that the alkaloid of gorse is anagyrene, sometimes accompanied by a second alkaloid, $C_{15}H_{20}O_5N_2$ (lustrous plates, m.p. 170°). Anagyrene is best known as a constituent of *Anagyris foetida* seeds from which it was isolated by Partheil and Spasski.⁵ The early investigations are due to Klostermann⁶ and Litterscheid.⁷ Its preparation was described by Ing,⁸ who isolated it as the perchlorate, which forms colourless needles, decomposing at 270° (298.5°; Briggs and Russell⁹). The base forms a pale yellow glass, darkening on exposure to light, b.p. 210-5°/4 mm. (Ing), 260-270°/12 mm. (Couch¹⁰); $[\alpha]_D^{25}$ - 165.3° (Ing), - 151.7° (Orekhov *et al.*¹¹), - 168° (Couch), - 146.9° (Briggs and Russell). The hydrochloride B. $HCl \cdot 3H_2O$ has m.p. 235-6° or 295-7° (dry); $[\alpha]_D^{25}$ - 124.2° (Couch) or - 142.5° (Ing). The methiodide, B. MeI, forms colourless needles, m.p. 264° (*dec.*). The mercurichloride occurs in three forms (Litterscheid) but only one, m.p. 221-4°, is usually obtained. The picrate has m.p. 242-4° according to most authors, but Couch records 169.5°. The platinichloride forms ruby-red needles, B. $2HCl \cdot PtCl_4 \cdot 1.5H_2O$, m.p. 250-1°. The aurichloride melts at 167-8°.

Constitution. Anagyrene resembles cystisine in giving a red colour with ferric chloride and in containing a "non-reactive" oxygen atom. Klostermann⁶ showed that it was a ditertiary base and possibly a butylcytisine. Litterscheid⁷ prepared *iso*- and *sec*-butylcytisines, but owing to poor yields comparison with anagyrene could not be made. The same author described anagyrene oxide, $C_{15}O_{20}O_2N_2$ (silky needles, m.p. 195°, acid to litmus), produced by oxidising the base with permanganate and showed that the oxygen atoms were not present as hydroxyl, carbonyl or *N*-oxide. This was probably anagyramide, $C_{15}H_{18}O_2N_2$ (colourless needles, m.p. 201-2°) which was obtained by the action of barium permanganate on

anagyrine and fully investigated by Ing.⁸ It is feebly basic, yields no methiodide, is stable to acid and alkali, but loses carbon dioxide and is reduced when heated with red phosphorus and hydriodic acid at 235–240° to anagyramine, $C_{14}H_{20}ON_2$ (crystals, m.p. 98–9°), which yields a monoacetyl- (m.p. 134–5°) and a nitroso- (plates, m.p. 127–8°) derivative, and is therefore a secondary base. On ozonisation anagyramide furnishes a lactam, $C_{11}H_{16}O_2N_2$ (m.p. 258°), a reaction analogous with the formation of a lactam, $C_7H_{15}ON$, in Späth and Galinovsky's ozonisation of tetrahydrohemicytisylene (p. 144), and therefore suggests the presence of an α -pyridone ring in anagyrine as in cytosine. The loss of carbon dioxide in

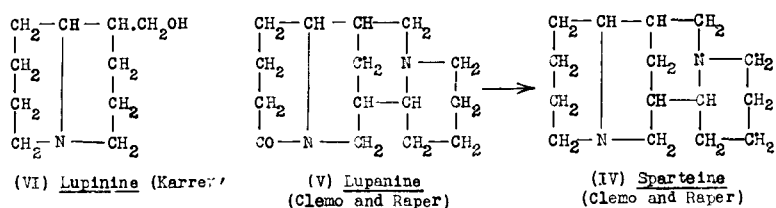
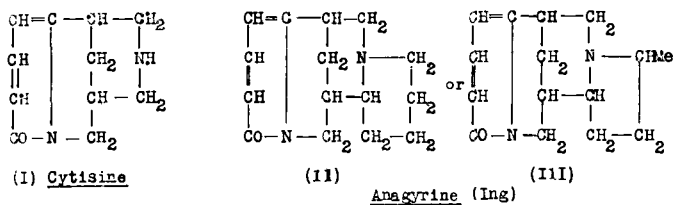

the hydrolysis of anagyramide by hydriodic acid suggests that the second —CO— group in the latter is in a β -position relative to the pyridone ring as in *N*-methyl- β -cytosamide (p. 145). Further, the benzenesulphonyl-derivative of the new lactam loses carbon dioxide on melting, presumably due to the presence of a malonyl residue. These data with others, such as the identification of the hydrogenation products referred to below, indicate that anagyrine and cytosine are simply related, and that a formula for anagyrine may be derived from Ing's representation of cytosine (I) by building into the latter C_4H_9 as a component of a new piperidine (II) or methylpyrrolidine (III) ring.

On exhaustive methylation under carefully controlled conditions, followed by catalytic hydrogenation of the unsaturated product formed at each of the three stages, hexahydroanagryline, $C_{15}H_{23}ON$ (pale yellow oil, b.p. 155–160°/4 mm.), was obtained. This on ozonisation lost C_4H_8 , giving a lactam, $C_{11}H_{21}ON$ (oil; b.p. 140–150°/4 mm.), which on hydrolysis, followed by oxidation with permanganate, gave an oily acid, $C_{11}H_{20}O_4$, the imide of which proved to be α -methyl- α' -*n*-amylglutarimide (cf. Rydon⁸), which may be compared with $\alpha\alpha'$ -dimethylglutaric acid obtained by Späth and Galinovsky in a similar set of reactions applied to cytosine,

From *cytisine* COOH . CHMe . CH₂ . CHMe . COOH

From *anagyryne* COOH . CH(C₅H₁₁) . CH₂ . CHMe . COOH

Ing also found that anagyryne, on catalytic hydrogenation above 80°, yielded a tetrahydro-derivative, C₁₅H₂₄ON₂ (b.p. 186–190°/1 mm., $[\alpha]_D^{20} - 61.45^\circ$ (acetone)), identical with *l*-lupanine (V) (b.p. 186–8°/1 mm.; $[\alpha]_D - 61.0^\circ$ (acetone)), and on electrolytic reduction furnished hexahydro-anagyryne, C₁₅H₂₆N₂ (b.p. 130–5°/1 mm., $[\alpha]_D^{19} + 10.9^\circ$), identical with *d*-sparteine (IV) (b.p. 133–5°/1 mm.; $[\alpha]_D + 15.9^\circ$), with the exception of a difference in the degree of rotation. Galinovsky and Stern¹² have confirmed, by hydrogenation, the reduction of anagyryne to *d*-sparteine, identified by oxidation to *d*-oxysparteine, m.p. 87°, $[\alpha]_D + 10.27^\circ$, which with *l*-oxysparteine (p. 136) gave the *dl*-form, m.p. 112–3° (cf. p. 138). They also found that the catalytic hydrogenation of anagyramide led only to the reduction of the pyridone ring the product being *d*-oxysparteine.

The interesting relationships between the five most important alkaloids in this group, which have been made clear by these investigations, are shown by formulæ (I) to (VI) on p. 141. The synthesis of oxysparteine by Clemo, Morgan and Raper (p. 138) supports formula (II) for anagyryne.

REFERENCES

- (1) GERRARD, *Pharm. J.*, 1886, **17**, 109, 227; 1888, **19**, 1029; 1889, **20**, 1017.
 (2) For bibliography see CLEMO and RAPER.⁴ (3) *Österr. Bot. Zeit.*, 1930, **79**, 107.
 (4) *J. Chem. Soc.*, 1935, 10. (5) *Apoth. Zeit.*, 1895, **10**, 903. (6) *Arch. Pharm.*, 1900, **238**, 227. (7) *Ibid.*, 1900, **238**, 191, 230; cf. GOESSMANN, *ibid.*, 1906, **244**, 20. (8) *J. Chem. Soc.*, 1933, 504; cf. RYDON, *ibid.*, 1936, 1445. (9) *Ibid.*, 1942, 507. (10) *J. Amer. Chem. Soc.*, 1939, **61**, 3327. (11) OREKHOV *et al.*, *Ber.*, 1934, **67**, 1394. (12) *Ber.*, 1944, **77**, 132.

Cytisine (*Ulexine*, *Baptitoxine*, *Sophorine*), C₁₁H₁₄ON₂ (Nos. 2, 3, 7, 8, 29, 30, 32, 34, 38, list, pp. 116–8). The preparation of the alkaloid has been described by Ing.¹ It forms rhombic crystals, m.p. 153°, b.p. 218°/2 mm., $[\alpha]_D^{17} - 119.6^\circ$ (H₂O), is soluble in water, alcohol or chloroform, but nearly insoluble in ether or benzene. It is a strongly alkaline base and forms well-crystallised, deliquescent salts: the hydrochloride, B. HCl . H₂O, colourless prisms; the dihydrochloride, B. 2HCl . 3H₂O, yellowish needles; picrate, m.p. 277°; perchlorate, m.p. 296° (*dec.*); picrolonate, m.p. 270° (*dec.*); aurichloride, B. HAuCl₄, reddish-brown needles, m.p. 220° (*dec.*), sparingly soluble in warm water; and the nitrate, B. HNO₃ . H₂O, needles or leaflets, $[\alpha]_D - 81.5^\circ$. It yields crystalline, mono-acyl derivatives: acetyl, m.p. 208°; benzoyl, m.p. 116°; nitroso, m.p. 174°, indicating the presence of a secondary nitrogen atom.² Cytisine can be nitrated and the aminocytisine formed by reduction can be diazotised (Freund).³ This and the characteristics of dibromocytisine⁴ indicate the presence of an aromatic nucleus.

Constitution. On electrolytic reduction cytisine yields tetrahydrodeoxycytisine, C₁₁H₂₀N₂, an alkaline oil, b.p. 270°, yielding a crystalline hydrochloride, B. HCl, m.p. 282°, $[\alpha]_D - 10.25^\circ$. With phosphorus and hydriodic acid cytisine furnishes ammonia and cytosoline, C₁₁H₁₁ON,

needles, m.p. 199°, which is oxidised by chromic acid to cytisolinic acid, $C_{11}H_9O_3N$, and is reduced by sodium in alcohol to α -cytisolidine, $C_{11}H_{15}N$ (platinichloride, m.p. 216°); β -cytisolidine, produced along with cytisoline, gives a platinichloride, m.p. 234°.⁵ According to Ewins⁶ α -cytisolidine is 6 : 8-dimethyl-1 : 2 : 3 : 4-tetrahydroquinoline and β -cytisolidine is 6 : 8-dimethylquinoline. Späth subsequently showed that cytisoline is 2-hydroxy-6 : 8-dimethylquinoline and synthesised this product.⁷ Ewins first suggested that the cytisine nucleus was formed by the fusion of three rings, benzene, pyridine and pyrazole as in (I), and on this basis with modifications as the result of further experimental work, formulæ were subsequently put forward by Freund and Gauff⁵ (II) and Späth⁷ (III),

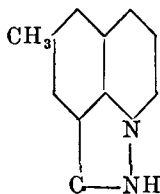

I (Ewins)

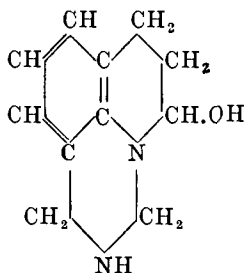

II (Freund and Gauff)

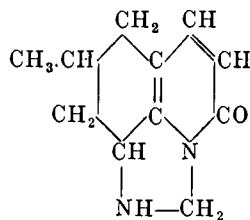

III (Späth)

the latter stating that cytisine gives van de Moer's reaction with ferric chloride and hydrogen peroxide indicating the presence of an α -pyridone ring, that the oxygen atom in cytisine is not present as either a hydroxyl or a normal carbonyl group, and that, as the alkaloid shows marked resistance to reduction, the two ethylenic linkages must be present as a conjugated pair in a single ring.

In 1931 Ing⁸ pointed out that formulæ (II) and (III) do not contain methyl or potential methyl groups in positions 6 and 8 which they occupy in cytisoline. Further, a partially reduced quinoline ought to oxidise easily to a benzenecarboxylic acid and so far the only simple oxidation, products recorded from cytisine were ammonia, oxalic acid and *isovaleric* acid. Distillation of cytisine with zinc dust or soda-lime yields pyrrole and pyridine, but no quinoline. On these grounds Ing suggested that cytisine should be formulated without a quinoline nucleus, and that the reactions which indicate the presence of an aromatic nucleus in the alkaloid can be accounted for by an α -pyridone ring. This α -pyridone nucleus can

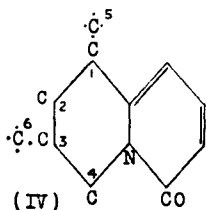

(IV)

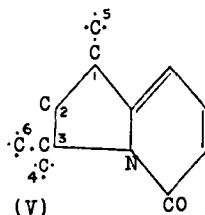

(V)

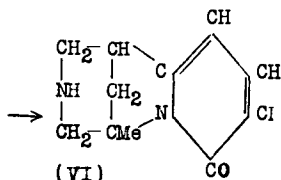

(VI)

be associated with the chain of carbon atoms necessary to produce, on reduction, 6:8-dimethylquinoline, in two ways represented by nuclear structures (IV) and (V), of which (V) would lead to (VI) as the formula which Ing preferred as representing cytosine on this basis.

Partheil⁹ showed that the alkaloid reacts with methyl iodide to give methylcytosine (p. 146), from which an amorphous dimethylcytosine is obtainable, the methiodide of which when boiled with potassium hydroxide solution liberates trimethylamine and a resinous substance, $C_{10}H_{13}O_2N$. On repeating this series of operations, Ing¹ obtained an amorphous de-*N*-dimethylcytosine methiodide, which on conversion to base with silver oxide in methyl alcohol, followed by ebullition in amyl alcohol until trimethylamine ceased to be evolved, yielded a pale yellow, microcrystalline substance, $C_{22}H_{22}O_2N_2$, m.p. 300° . The formation of this bimolecular product was held to be better accounted for by formula (VI), derivable from type (V), than by any similar formula based on type (IV). Späth and Galir ovsky¹⁰ found that in the first stage of exhaustive methylation, as carried out by Partheil and by Ing, polymerisation occurs, but that if conducted in a vacuum at or below 90° , there is produced an unpolymerised de-*N*-dimethylcytosine which was hydrogenated in presence of palladised charcoal to de-*N*-dimethyldihydrocytosine $C_{13}H_{20}ON_2$ (b.p. $150-60^\circ/0.001$ mm.; $[\alpha]_D^{24} - 46.94^\circ$ (MeOH); picrate, m.p. $174-5^\circ$). The next step, carried out under carefully controlled conditions, gave an ammonium base, decomposing at $100-20^\circ/10$ mm. into trimethylamine and dihydrohemicytisylene, $C_{11}H_{13}ON$ (b.p. 140° (bath temp.)/ 0.01 mm., $[\alpha]_D - 1.1^\circ$ (benzene)); the latter, on hydrogenation, gave tetrahydrohemicytisylene, $C_{11}H_{15}ON$ (b.p. $130-40^\circ$ (bath temp.)/ 0.001 mm., $[\alpha]_D - 0.26^\circ$), which, on ozonisation, furnished a lactam, $C_7H_{15}ON$, m.p. $70-5^\circ$, convertible by acid hydrolysis into an acid amide, oxidised by permanganate to a mixture of the fumaroid and malcinoid forms of $\alpha\alpha'$ -dimethylglutaric acid, $COOH-CHMe-CH_2-CHMe-COOH$. This lactam must therefore be represented by formula (VII).

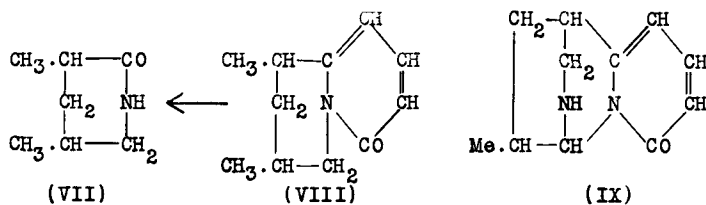

From this (VIII), based on Ing's type formula (IV), is derivable for tetrahydrohemicytisylene, since the latter gives the α -pyridone reaction, but contains no *N*-methylquinolone complex, so that its tertiary nitrogen atom must belong to two rings. This formula is supported by the fact that octahydrohemicytisylene, produced by catalytic hydrogenation of the tetrahydro-base, is oxidised by potassium permanganate to glutaric acid, $COOH-CH_2-CH_2-CH_2-COOH$, representing the chain $-CH-CH_2-CH_2-CH_2-CO-$ in the α -piperidone complex of the

octahydro-base. Glutaric acid is also produced when cytosine is hydrogenated to tetrahydrocytosine and the latter is oxidised by permanganate. From (VIII) Späth and Galinowsky¹⁰ derived five formulæ for cytosine depending upon the way in which the imino-group is fitted into the tetrahydrohemicytisylen formula, and of these three are eliminated by Ing's observation¹¹ that when methylcytosine is oxidised with barium permanganate it is converted into a mixture of two isomeric lactams, $C_{12}H_{14}O_2N_2$, *N*-methyl- α -cytisamide (m.p. 214–5°) and *N*-methyl- β -cytisamide (m.p. 179–80°), each of which can be hydrolysed to the corresponding cytisamic acid, $C_{12}H_{16}O_3N_2$. In these lactams a $—CH_2—NMe—$ group in methylcytosine has been converted into a $—CO—NMe—$ group. Formula (IX) for cytosine would lead to two lactams, which would be geometrical isomerides, and (X) would give rise to two structural isomerides, (XI) and (XII), derived from methylcytosine.

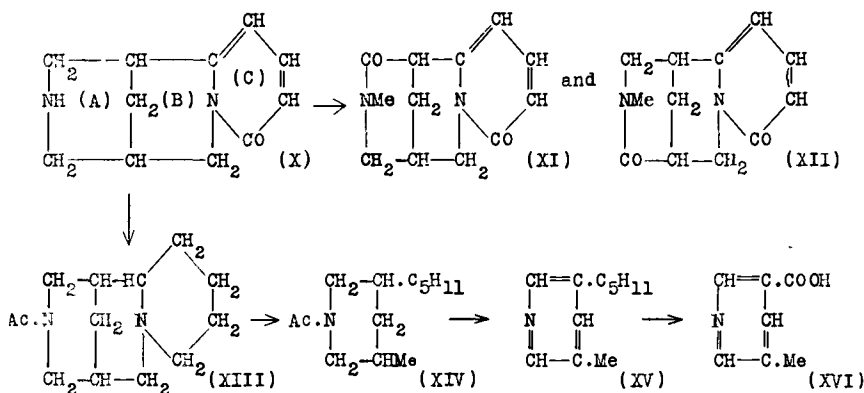

As it is improbable that the two lactams are geometrical isomerides, and as Späth and Galinowsky had already pointed out that a substance represented by formula (IX) should yield methylsuccinic acid on oxidation, formula (X) becomes the most probable for cytosine, and this was confirmed by Späth and Galinowsky's¹² degradation of *N*-acetyltetrahydrodeoxycytosine (XIII) by exhaustive methylation, with reduction at appropriate stages, to *N*-acetyl-3-methyl-5-*n*-amyl-piperidine (XIV), which was then deacetylated and dehydrogenated to the corresponding 3-methyl-5-*n*-amyl-piperidine (XV), and this on oxidation furnished β -methylnicotinic acid (XVI). These results also definitely established the point that ring (A) in cytosine is piperidine and not methylpyrrolidine. In a later paper (1936) Späth and Galinowsky¹² provided further support for formula (X) by showing that tetrahydrohemicytisylen (VIII), when heated with platinum sponge at 270–80°, first loses four atoms of hydrogen from the piperidine ring, giving 8-keto-2 : 4-dimethyl- ψ -quinolizine (4-keto-7 : 9-dimethylpyridocoline), since then synthesised by the same authors¹² (1938), and then undergoes scission and reduction to 3 : 5-dimethyl-2-propyl-pyridine. A further degradation of cytosine starting with cytisic acid was carried out by Lecoq and Polonowski,^{12(a)} which ended with the produc-

tion of what was assumed to be *cis*-octahydropyridocoline, but which agreed in characters with Clemo's synthetic compound now stated to be 1-azadicyclo-[0, 3, 5]-decane or *norlupinane* (B) (p. 126).

Methylcytisine, $C_{12}H_{16}ON_2$. This base, first prepared by Partheil,¹³ was found in the roots of *Caulophyllum thalictroides* L. by Power and Salway,¹⁴ and has since then been frequently observed in other plants (Nos. 2, 8, 30, 33, 37, 38, 41; list, pp. 116-8). It has m.p. 136-7°, $[\alpha]_D^{20}$ - 221° (H₂O). The following salts have been described: hydrochloride, B. 2HCl. H₂O, m.p. 250-5° (*dec.*); hydriodide, m.p. 246° (*dec.*); perchlorate, m.p. 254° (*dec.*); aurichloride, m.p. 206° (*dec.*); picrate, m.p. 230°; picrolonate, m.p. 224-5° (*dec.*); the methiodide occurs in two forms, m.p. 248° and m.p. 267° (276°, Ing).

Calycotomine, $C_{10}H_9(OH)(OMe)_2(NH)$ (Nos. 4, 5; list, p. 117). M.p. 139-141°, $[\alpha]_D^{20}$ + 21° (H₂O). B. HCl, m.p. 193°, $[\alpha]_D^{20}$ + 15° (H₂O). B. HClO₄, m.p. 176-7°. The mercurichloride has m.p. 118-9°, and the picrate, B. C₆H₄O₇N₃. H₂O, m.p. 163-6°, after melting at 99-100° and re-solidifying. The base forms an amorphous nitrosoamine and with methyl iodide furnishes *N*-methylcalycotomine hydriodide, m.p. 228-9°. The dibenzoyl derivative has m.p. 120-2°. The base gives no phenolic reactions, but on demethylation furnishes a product, which could not be isolated but shows a blue fluorescence in solution and gives an intense green colour with ferric chloride. The *dl*-form, isolated as the hydrochloride, m.p. 193°, occurs only in traces.^{14(a)}

Calycotamine, $C_{11}H_{15(17)}O_3N$, occurs with calycotomine but only in traces. The hydrochloride has m.p. 206° and $[\alpha]_D$ + 20° (H₂O). The picrate is an oil; the mercurichloride crystallises in needles.^{14(a)} Two methoxyl groups are present.

Monspessulanine, $C_{15}H_{22}ON_2$ (No. 5; list, p. 117). The base has m.p. 101°, $[\alpha]_D$ - 117° (EtOH), and yields a hydrochloride, m.p. 244°, perchlorate, m.p. 215°, and methiodide, m.p. 247°. It does not give reactions for a carbonyl group and does not acylate. It reduces permanganate and gold chloride. One nitrogen is not basic and is probably in a lactam group. These characteristics link the alkaloid with the lupanine series (p. 128) and it is isomeric with aphyllidine (p. 53). On catalytic hydrogenation, in presence of platinic oxide, it yields a dihydro-derivative, $C_{15}H_{24}ON_2$, m.p. 99°, $[\alpha]_D$ - 10 to - 13°, characterised by a perchlorate, m.p. 224°.¹⁵

REFERENCES

- (1) *J. Chem. Soc.*, 1931, 2200. For an older process, see PARTHEIL, *Ber.*, 1891, 24, 634. For isolation and constants see also ING, *J. Chem. Soc.*, 1933, 504; BRIGGS (with RICKETTS), *ibid.*, 1937, 1795, (with RUSSELL), *ibid.*, 1942, 507, 555. (2) MAASS, *Ber.*, 1908, 41, 1635. (3) *Ibid.*, 1901, 34, 605. (4) PARTHEIL, *Arch. Pharm.*, 1894, 232, 161; LAMIERS, *ibid.*, 1897, 235, 374. (5) FREUND, *Ber.*, 1901, 34, 605; 1904, 37, 16; 1906, 39, 814; *Arch. Pharm.*, 1918, 256, 33. (6) *J. Chem. Soc.*, 1918, 103, 97; see also CHAKRAVARTI *et al.*, *Brit. Chem. Abstr.*, 1934, A, 195; 1936, A, 742. (7) *Monats.*, 1919, 40, 15, 93. (8) *J. Chem. Soc.*, 1931, 2195. (9) *Ber.*, 1891, 24, 635; *Arch. Pharm.*, 1892, 230, 448; 1894, 232, 161. (10) *Ber.*, 1932, 65, 1526; which also quotes a Dissertation by BREUSCHE, Vienna, 1927. (11) *J. Chem. Soc.*, 1932, 2778. (12) *Ber.*, 1933, 66, 1338; 1936, 69, 761; 1938, 71, 721; 1943, 76, 947. (12a)

POLONOVSKI and LECOQ, *Compt. rend.*, 1942, 214, 1912; *Bull. Soc. chim.*, 1945, [v], 12, 83; LECOQ, *ibid.*, 1943, [v], 10, 153, cf. SPÄTH¹² (1943). (13) *Arch. Pharm.*, 1892, 230, 448; cf. BUCHKA and MAGELHAES, *Ber.*, 1891, 24, 674. (14) *J. Chem. Soc.*, 1913, 103, 194. (14a) WHITE, *N. Z. Journ. Sci. Tech.*, 1944, 25, B, 152. (15) *Idem., ibid.*, 1946, 27, B, 339.

Virgiline, $C_{16}H_{26}O_2N_2$ (No. 39^a; list, p. 118). The base melts at 248°, has $[\alpha]_D - 46^\circ$ (EtOH) and forms the following salts: hydrochloride, m.p. 262°; methiodide, m.p. 176°, and picrate, m.p. 188–9°. The nitrogen atoms are tertiary and the base is probably related to sparteine, but contains an inert carbonyl, a hydroxyl and a C–Me group; the monoacetyl derivative has m.p. 174°.

Virgilidine, $C_{10}H_{19}ON$, is isomeric with lupinine, has b.p. 90°/0.01 mm., $[\alpha]_D + 12^\circ$ (EtOH) and $n_D^{17} 1.5128$; the picrate has m.p. 203° and the methiodide, m.p. 256–9°.

Matrine, $C_{15}H_{24}ON_2$ (Nos. 27, 28, 30, 33; list, p. 118). This isomeride of lupanine was isolated by Nagai,¹ and has been investigated principally by Kondo and collaborators.² Matrine exists in four forms; (α) flat prisms or needles, m.p. 77°; (β) rhombs, m.p. 87°; (γ) the freshly distilled base, a liquid, b.p. 223°/6 mm., $D_4^{85} 1.088$; (δ) prisms, m.p. 84°, but only the α -form is usually found. A solution of the β -form in light petroleum deposits a mixture of the α - and δ -forms at 22–4°, whilst the β -form crystallises from a solution of the α -form at 10°. It is soluble in cold water but separates on warming, and is optically active, $[\alpha]_D^{10} + 39.11^\circ$. The following salts have been prepared: hydrobromide, m.p. 272–5°, hydriodide, m.p. 267°, aurichloride, $B. HAuCl_4$, leaflets, m.p. 199°, the platinichloride, $B. H_2PtCl_6$, decomposes at 229–30°. The picrate melts indefinitely and the methiodide occurs in two forms, m.p. 250° and m.p. 304°. The base contains no methylimino-group. The molecular refraction ($n_D^{85.4} = 1.52865$) indicates that it is saturated. The nitrogen atoms are both tertiary, but only one is basic, the other being present as a lactam group, since on hydrolysis by alcoholic potash, potassium matrinatate, $C_{15}H_{25}O_2N_2K$ (leaflets, m.p. 239°), is formed. From an aqueous solution of this salt, ammonium chloride precipitates matrinic acid, $C_{15}H_{26}O_2N_2$, which is a secondary-tertiary base, reconvertible to matrine by heat or by the action of acyl chlorides. With methyl iodide the potassium salt is converted into methyl *N*-methylmatrinatate methiodide (slender silky needles, m.p. 217–9°), which adds on a further molecule of methyl iodide at 100°, the resulting dimethiodide, $C_{15}H_{24}Me_2O_2N_2(CH_3I)_2$, m.p. 145–6°, on treatment with potassium carbonate reverts to the monomethiodide, which is convertible by silver oxide to the methohydroxide. This on distillation at 210–2°/10 mm. loses a molecule of methyl alcohol and reverts to methyl *N*-methylmatrinatate.

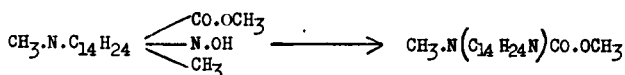

On reduction with sodium in amyl alcohol deoxymatrine ($C_{15}H_{24}N_2$)₂, prisms, m.p. 162°, is produced, which with red phosphorus and hydriodic

acid at 230–60° is reduced to bismatridine ($C_{15}H_{25}N_2$)₂, needles, m.p. 160°. On distillation of matricinic acid hydrochloride with zinc dust, a non-basic substance giving a pyrrole reaction is formed, together with two bases. The first of these is an oil, $C_{10}H_{19}N$, b.p. 87°/20 mm., yielding a crystalline picrate, m.p. 165°, subsequently identified as β -lupinane³ (p. 126). The second, named matridine, $C_{15}H_{26}N_2$, m.p. 76°, furnishes a crystalline aurichloride, $B \cdot 2HAuCl_4$, m.p. 126°. Distillation of potassium matrinatate with soda-lime yields two isomeric bases, α - and β -matrinidines, $C_{12}H_{20}N_2$, and a fraction, b.p. 55–90°/14 mm., which on catalytic hydrogenation yields a more stable product, b.p. 40–70°/6 mm., separable into a secondary base, α -butylpiperidine, and a tertiary base, *nor*lupinane, $C_9H_{17}N$ (p. 124). The recognition of β -lupinane, *nor*lupinane and α -butylpiperidine among the degradation products of potassium matrinatate makes it certain that as in other alkaloids of this group the tertiary nitrogen atom of matrine is a component of a lupinane nucleus.

α -Matrinidine, $C_{12}H_{20}N_2$ (b.p. 130–2°/6 mm.), is a secondary-tertiary base containing an ethylenic linkage and yielding dihydro- α -matrinidine (m.p. 66°, b.p. 122–3°/2 mm.; picrate, m.p. 251° (*dec.*)) on reduction. The latter has been degraded to quinolinic acid (pyridine-2:3-dicarboxylic acid) according to the following scheme, in which the reactions used are indicated in brackets.⁴

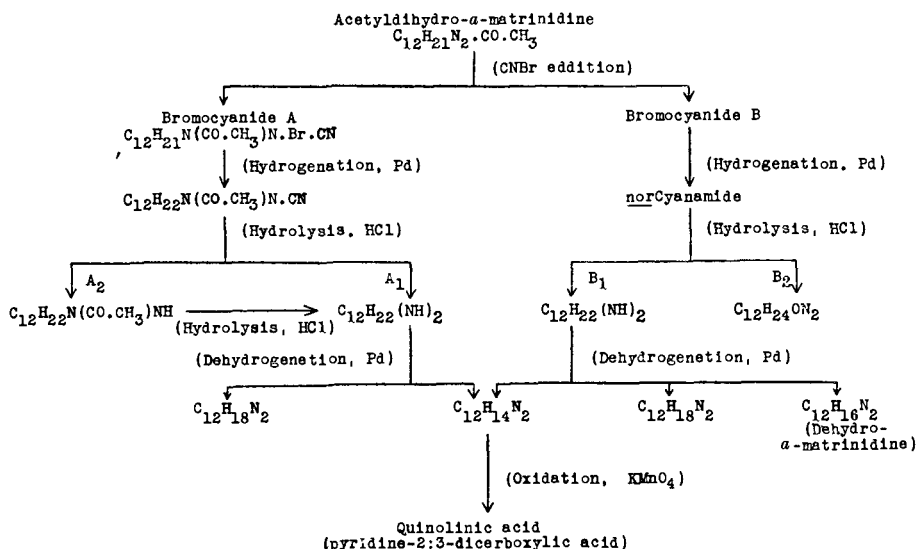

Matrine is isomeric with lupanine (p. 128), and sophocarpine (p. 150); and in common with anagryne (p. 140), sophocarpine and aphylline (p. 54), may be supposed to contain a lactam ring, though it differs from them in the ease with which the lactam group undergoes alkaline hydrolysis with the formation, *e.g.*, of potassium matrinatate, and in the fact that it cannot be reduced to $C_{15}H_{26}N_2$ (sparteine or an isomeride) except by zinc dust distillation. Lupanine and sparteine can be dehydrogenated to the

corresponding dehydro-bases by oxidation with mercuric acetate, whereas matrine requires treatment with platinised asbestos at 280–310° and then yields two bases, octadehydromatrine, C₁₅H₁₆ON₂, and C₁₄H₂₀N₂. The former has m.p. 175–7°, shows a greenish fluorescence, gives the pyrrole pine-shaving reaction, a reddish-violet colour with Ehrlich's reagent and the ferric chloride reaction characteristic of α-pyridones. It reduces gold chloride, and does not react with methyl iodide or with the usual reagents for carbonyl groups. The second substance is a basic oil, b.p. 138°/0.001 mm., and behaves as a monoacidic, ditertiary amine. The picrate has m.p. 142°, the aurichloride, B. H₂AuCl₄, m.p. 118°, and the methiodide, B. MeI, m.p. 129°. The methohydroxide on oxidation with permanganate yields butyric acid, which is not similarly obtainable from matrine methohydroxide, so that in this degradation a propyl side-chain has been produced from the lactam ring of matrine, which may have the structure (A) or (B).



This ring is eliminated in the formation of dihydro-α-matrinidine, which on the basis of the results summarised in the diagram (p. 148), particularly the degradation to quinolinic acid, may be represented by (I), in which the positions of the —NH— and CHMe groups may be interchanged though their relative positions are confirmed by the formation of a benzylidene derivative, m.p. 106–7°, from dihydro-α-matrinidine, assuming that in the formation of α-matrinidine no displacement of a ring occurs. Formulae for matrine may be derived from (I) by the superimposition of the lactam ring (A) or (B). Kondo, Ochiai and Tsuda (1935),⁵ at first preferred (A) for this purpose, but Tsuda (1936),⁵ finding that methyl matrine methiodide (p. 147) on successive treatment with silver oxide and potassium permanganate gave oxalic, succinic and glutaric acids, but no pyruvic acid, concluded that matrine, like lupanine (p. 128) and cytisine (p. 142), must contain an α-piperidone ring, and therefore represents matrine by (II) or (III). An attempt to decide between (II) and (III) by Tsuda and Murakami (1937)⁵ was unsuccessful.

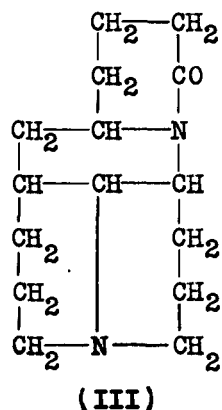
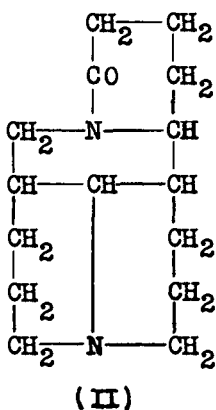
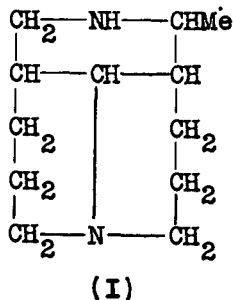

Oxymatrine, $C_{15}H_{24}O_2N_2 \cdot H_2O$ (No. 27; list, p. 118). This base has m.p. $162-3^\circ$ (*dec.*) or 208° (*dry*), $[\alpha]_D^{19} + 47.7^\circ$ (EtOH); yields a picrate, m.p. 215° ; aurichloride, m.p. 207° (*dec.*); hydrobromide, m.p. 215° ; perchlorate, m.p. 240° (*dec.*); and methochloride aurichloride, $B \cdot CH_3Cl \cdot AuCl_3$, m.p. 185° (*dec.*). It contains one tertiary nitrogen atom, and a lactam group. According to Ochiai and Ito⁵ it is matrine-*N*-oxide, and may be prepared by the action of hydrogen peroxide on matrine.

Minor Alkaloids of *Sophora* spp. (items 27-34; list, p. 118). In addition to sparteine (p. 133), cytisine (p. 142), methylecytisine (p. 146), anagyryne (p. 140), matrine (p. 147) and oxymatrine (*see above*) the following minor alkaloids have been recorded in this genus.

Aloperine, $C_{15}H_{24}N_2$. M.p. $73-5^\circ$, $[\alpha]_D + 85.9^\circ$. *Salts*: B, HCl, m.p. $261-3^\circ$, $[\alpha]_D + 92.4^\circ$; B, HAuCl₄, $204-6^\circ$; picrate, m.p. 235° (*dec.*). Contains one :NH group and yields with methyl iodide *N*-methylaloperine methiodide hydriodide, m.p. $247-9^\circ$. The *N*-benzoyl derivative has m.p. $161-2^\circ$.⁶

Sophocarpine, $C_{15}H_{24}ON_2 \cdot H_2O$ (*see also* item 1 (*a*); list, p. 116). M.p. $54-5^\circ$, or $81-2^\circ$ (*dry*), $[\alpha]_D - 29.44^\circ$. *Salts*: B, HCl, m.p. $> 300^\circ$; B, HAuCl₄, m.p. $166-70^\circ$; B₂, H₂PtCl₆, m.p. $207-12^\circ$ (*dec.*); picrate, m.p. $155-7^\circ$; B, MeI, $200-2^\circ$. Electrolytic reduction produces a volatile, crystalline base, $C_{15}H_{26}N_2$, b.p. $153-4^\circ/5$ mm., $[\alpha]_D - 26.2^\circ$ (EtOH). B, MeI, m.p. $> 300^\circ$. Degradation by the Hofmann process was unsuccessful.⁷

Sophoramine, $C_{15}H_{20}ON_2$. M.p. $164-5^\circ$, $[\alpha]_D - 90.8^\circ$. *Salts*: B, HCl, m.p. $247-8^\circ$ (*dec.*); B, HI, m.p. $294-5^\circ$; B, HAuCl₄, m.p. $183-4^\circ$; B₂, H₂PtCl₆, $245-7^\circ$ (*dec.*); picrate, m.p. $229-31^\circ$.⁸

Sophoridine, $C_{15}H_{26}ON_2$. M.p. $109-110^\circ$, $[\alpha]_D - 63.6^\circ$ (H₂O). *Salts*: B, HCl, deliquescent and very soluble. B, HAuCl₄, m.p. $189-90^\circ$; B, MeI, m.p. $234-6^\circ$. Is reduced electrolytically to an oily base, $C_{15}H_{26}N_2$, b.p. $172-3^\circ/4$ mm., $[\alpha]_D - 37.1^\circ$ (EtOH); B, MeI, m.p. $> 300^\circ$. Hofmann degradation attempt unsuccessful.⁹

Sophochryisine. Formula uncertain, $C_{13-15}H_{21-19}O_2N_3$, amorphous, m.p. $284-7^\circ$; $[\alpha]_D^{25} - 113.2^\circ$ (EtOH); picrate, m.p. $> 360^\circ$; picrolonate, m.p. $265.5-7^\circ$ (*dec.*); aurichloride, m.p. $190-2^\circ$ (*dec.*)¹⁰

Minor Alkaloids of *Thermopsis* spp. (items Nos. 36, 37, 38; list, p. 118). In addition to sparteine (p. 133), anagyryne (p. 140), cytisine (p. 142) and methylecytisine (p. 146), the following alkaloids have been recorded in these plants.

Thermopsine, $C_{15}H_{20}ON_2$. M.p. $205-205.5^\circ$, $[\alpha]_D^{20} - 159.6^\circ$ (EtOH). Monoacidic base. *Salts*: B, HI, H₂O, m.p. $306-8^\circ$ (*dec.*); picrate, m.p. $208-9^\circ$; 262° (Manske); B, MeI, m.p. $241-2^\circ$ (*dec.*). Electrolytic reduction yields a base, $C_{15}H_{28}ON_2$, m.p. $112-3^\circ$, $[\alpha]_D + 55.9^\circ$ (MeOH), in which the "indifferent" oxygen of thermopsine has been converted into a hydroxyl group and the "indifferent" *N*-atom into a secondary nitrogen, probably by the opening of a ring, including a :N—CO— group. On catalytic hydrogenation thermopsine gives a tetrahydro-base, m.p. $75-6^\circ$, $[\alpha]_D - 52.2^\circ$ (EtOH), isomeric with matrine and lupanine and in which the

oxygen atom is still "indifferent," though the second nitrogen atom has become basic, *e.g.*, in the dihydriodide, B. 2HI . 3MeOH, m.p. 296–8° (*dec.*). The picrate has m.p. 143–4°, the platinichloride, m.p. 241–2° (*dec.*), and the methiodide, m.p. 261–2°. Thermopsine is not hydrolysed by acids or alkalis, is unsaturated to permanganate and attempts at degradation by the Emde, Hofmann or von Braun procedures proved unsuccessful.¹¹

homo*Thermopsine*, C₁₇H₂₄ON₂. M.p. 224–5°, $[\alpha]_D + 86.9^\circ$ (CHCl₃). Crystallises in small needles (Orekhov *et al.*, 1934).¹¹

Rhombifoline, C₁₅H₂₀O₂N₂. Amorphous. *Salts*: Perchlorate, m.p. 242°; picrate, m.p. 207° (Manske).¹¹

Rhombinine, C₁₆H₂₂O₂N₂ (see also item 18(a), list, p. 118). Amorphous. *Salts*: Perchlorate, m.p. 313°; picrate, m.p. 253° (Manske).¹¹ *Octahydro-rhombinine*, C₁₆H₃₀O₂N₂, has b.p. 140°/0.2 mm. and yields a perchlorate, B, HClO₄, m.p. 213°, $[\alpha]_D - 40.9^\circ$ (H₂O).

REFERENCES

- (1) *J. Pharm. Soc. Japan*, 1899, No. 84; *cf.* PLUGGE, *Arch. Pharm.*, 1895, 233, 441. For more recent records of occurrence and characteristics see refs. (9) and (10). (2) *Ibid.*, 1928, 266, 1. This gives references to the papers published in Japanese journals. (3) WINTERFELD and KNEUER, *Ber.*, 1931, 64, 152. (4) KONDO, OCHIAI, TSUDA and YOSHIDA, *Ber.*, 1935, 68, 570. (5) KONDO (with TSUDA), *ibid.*, 1935, 68, 644; (with OCHIAI and TSUDA), *ibid.*, 1899; *Arch. Pharm.*, 1937, 275, 493; TSUDA, *Ber.*, 1936, 69, 429; TSUDA and MURAKAMI, *J. Pharm. Soc. Japan*, 1937, 57, 68; OCHIAI (with ITO), *Ber.*, 1938, 71, 938; (with NODA), *J. Pharm. Soc. Jap.*, 1938, 58, 174; (with ITO and MARUYAMA), *ibid.*, 1939, 59, 270. (6) *Arch. Pharm.*, 1934, 272, 673; *Ber.*, 1935, 68, 431. (7) *Ibid.*, 1934, 67, 77, 1850; 1935, 68, 429. (8) OREKHOV, *et al.*, *ibid.*, 1933, 66, 948. (9) *Idem.*, *ibid.*, 1933, 66, 948; 1934, 67, 77, 1850; 1935, 68, 429. (10) BRIGGS (with RICKETTS), *J. Chem. Soc.*, 1937, 1795; (with TAYLOR), *ibid.*, 1938, 1206; (with RUSSELL), *ibid.*, 1942, 507, 535. (11) OREKHOV, *et al.*, *Ber.*, 1933, 66, 625; 1934, 67, 1394; 1935, 68, 820; *cf.* MANSKE and MARION, *Can. J. Res.*, 1942, B, 20, 265; 1943, B, 21, 144.

PHARMACOLOGICAL ACTION OF THE LUPINANE ALKALOIDS. None of these alkaloids is of much importance in medicine, though sparteine sulphate is so used, and in Russia the use of galenical preparations of *Thermopsis lanceolata* (No. 37; list, p. 118) as respiratory and circulatory stimulants has been proposed.¹ Several of the plants concerned are known as the cause of fatal poisoning cases notably laburnum (*Cytisus Laburnum*) and Freise² has called attention to "cocobolo" wood, derived from *Apuleia molaris* Benth., as the origin of a chronic poisoning case due to the presence in the wood of a small proportion of cytisine. In this connection special interest attaches to the microchemical detection of cytisine of which a bibliography has been published by Wagenaar.³ Reference has been made already to the "de-bittering" of lupin seeds for use as a feeding-stuff for cattle and for this purpose Makaro and Kondratyeva⁴ have devised a scheme for the preparation of an alkaloid-free lupin flour, the recovered alkaloids being used as an insecticide. This group of alkaloids is attracting some attention in Russia for this purpose and sophocarpine, obtained from *Ammothamnus lehmanni*, has been tried for the destruction of the web mite.⁵

According to Georgadze ⁶ the three sophora alkaloids sophocarpine (*a*), sophocarpidine (*b*) and sophoridine (*c*) only differ in degree and not in character of their pharmacological activity; thus on intravenous injection each causes a rise and then a fall in blood pressure and their activity in this direction is in decreasing order (*a*), (*c*), (*b*). In small doses they stimulate, and in larger doses depress, the isolated heart of either cold- or warm-blooded animals and then their decreasing order of activity is (*c*), (*b*), (*a*).

In spite of the interest displayed in recent years in the natural distribution and the chemistry of anagyrine very little work has been done on its pharmacology as Smith and Wilson ⁷ have pointed out; its vaso-constrictive action has been investigated by Tournade and Raymond-Hamet.⁸

The lupinane group has not attracted chemists as a primary material for modification in the hope of developing substances of possible therapeutic interest. Liberalli ⁹ found lupanine was inactive in avian malaria and Clemo and Swan ¹⁰ state that this is also the case for 11-(ϵ -diethylamino- β -pentyl)aminolupinane. Lupinine *p*-aminobenzoate has been investigated in Russia and shown to possess marked local anæsthetic action.¹¹

Sparteine. This alkaloid closely resembles coniine in action but is less toxic. The lethal dose of the sulphate for the guinea-pig according to Raymond-Hamet ¹² is 63 or 74 mgm. per kilo, depending on the method adopted for assessing the results of toxicity tests. Sparteine appears to exert little action on the central nervous system, but paralyses the motor nerve terminations and the sympathetic ganglia. It also causes greater depression of heart action than coniine and has a depressant effect on the circulation. The inhibitive action of sparteine sulphate in experimental anaphylaxis has been examined by Bertoni,¹³ its antagonism to metrazole by Schnittspahn ¹⁴ and its effects on the autonomic nervous system by Koppányi and Linegar.¹⁵ In stimulant action on the motility of the isolated rabbit uterus Ligon ¹⁶ found lupinine base about one-fifth and lupanine dihydrochloride and trilupine base about one-fifteenth, as effective as sparteine disulphate. The minimal lethal doses (mgm. per kilo.), on intraperitoneal injection into guinea-pigs were: lupanine dihydrochloride, 25–29, lupinine base, 28–30, sparteine sulphate, 42–55, and trilupine base, 200–25. Zipf and Triller ¹⁷ found α -isosparteine as toxic and α -didehydro-sparteine half as toxic as sparteine; both act like sparteine on the isolated frog heart and have a peripheral curare-like action on the muscles of frogs and mice. According to Jack ¹⁸ neither has any contra-fibrillatory action on frog heart though benzyl-lupanol has the same effect as sparteine in this respect and phenyldehydro-sparteine is ten to twenty times as potent as sparteine.

Delourme-Houdé ¹⁹ found that on conversion to quaternary derivatives the capacity of sparteine to intensify and prolong the hypertensive action of adrenaline was increased. Pratesi and Aitieri ²⁰ have investigated the sparteine-like activity of piperidine derivatives of the type, $C_5H_{10}N \cdot CH_2 \cdot CH_2X$ where X is NH_2 , NMe_2 , NEt_2 , $NMePh$ or a second

piperidyl residue ; and Mercier and Mercier ²⁰ have found that large doses of diethylaminoethanol produce sparteine-like effects in dogs.

Cytisine. This base belongs to the same pharmacological group as nicotine.²¹ It is a powerful poison causing nausea, convulsions and death by failure of respiration. The nicotine-like action is shared by *N*-methylcytisine but the latter, according to Scott and Chen,²² who have made a detailed study of its action, is weaker and has about one-fortieth the toxicity of nicotine.

REFERENCES

- (1) VARLAKOV, *Khim. Farm. Prom.*, 1933, 226 ; KALASHNIKOV and KUZNETSOV, *Farm. i. Farmakol.*, 1937, No. 7, 1 ; MASHKOVSKII, *ibid.*, 1941, 4, 105 ; KHALETSKI and FEDOROVA, *Farmatsiya*, 1946, 9, No. 5, 32 ; MAEVSKIL, *Farmikol, i. Toksikol*, 1945, 8, 49. (2) *Samml. Vergiftungsfallen*, 1936, 7, Abt. C, 1-8 (*Chem. Abstr.*, 1938, 32, 4222).
- (3) *Pharm. Weekbl.*, 1930, 67, 205 ; cf. KLEIN and FARKASS, *Österr. Bot. Zeit.*, 1930, 79, 107. (4) *Trudy. Beloruss. Sel'skokhoz. Inst.*, 1939, 10, 47 ; cf. ISAEV, *ibid.*, 1939, 8, 119.
- (5) *Social Sci. Tech. Tashkent*, 1939, 7, 197. (6) *J. Physiol., U.R.S.S.*, 1938, 25, 179.
- (7) *Brit. Med. J.*, 1943, ii, 322. (8) *C. R. Soc. Biol.*, 1942, 136, 667, 732. (9) *Tribuna farm.* (Brazil), 1944, 12, 1. (10) *J. Chem. Soc.*, 1944, 274. (11) MERKULOV, *Bull. Biol. Méd. expil., U.R.S.S.*, 1938, 6, 64 ; NIKITIN, *C. R. Acad. Sci., U.R.S.S.*, 1941, 32, 596 ; PANASCHENKO, *Farmikol, i. Toksikol.*, 1946, 9, 26. (12) *C. R. Soc. Biol.*, 1939, 131, 895. (13) *Giorn. Batteriol.*, 1939, 22, 307. (14) *Arch. exp. Path. Pharm.*, 1941, 197, 252. (15) *J. Pharm. exp. Ther.*, 1941, 72, 23. (16) *Ibid.*, 73, 151 ; LEVY-SOLAL *et al.*, *Presse méd.*, 1946, 24, 349. (17) *Arch. exp. Path. Pharm.*, 1943, 200, 536, 551. (18) *Ibid.*, p. 528. (19) *Compt. rend.*, 1945, 220, 749 ; 221, 60 ; cf. GRAUBNER and KRAUS, *Arch. exp. Path. Pharm.*, 1937, 184, 235. (20) *Boll. sci. facolta. Chim. ind. Bologna*, 1940, 159 ; MERCIER, *C. R. Soc. biol.*, 1946, 140, 191. (21) DALE and LAIDLAW, *J. Pharm. exp. Ther.*, 1912, 3, 205 ; *J. Physiol.*, 1911, 43, 196 ; 1912, 44, xii ; ZACHOWSKI, *Arch. exp. Path. Pharm.*, 1938, 189, 326 ; (with ZIFF), *ibid.*, 1938, 190, 217. (22) *J. Pharm. exp. Ther.*, 1943, 79, 334.

isoQUINOLINE GROUP

ALKALOIDS OF THE CACTACEÆ. Heffter¹ has recorded the presence of alkaloids in a number of cacti, but only those of *Anhalonium* spp. have been fully investigated. Heyl¹ obtained an amorphous base, *pilocereine*, from *Pilocereus sargentianus* Orc., and Ducloux¹ extracted from *Gymnocalycium gibbosum*. Haw., basic material which he regarded as a mixture of the anhalonium bases, anhalonine, lophophorine and mezcaline.

Anhalonium spp. A number of plants known by the name "pellote" and belonging to this genus are used in Mexico to produce intoxication in the course of religious ceremonies. The best-known product of this kind is the flowering heads of *A. Lewinii* Hennings, which have been imported into Europe for use in medicine under the name "mescal or mezcal buttons." The following *Anhalonium* alkaloids are known:—

Hordenine (Anhaline), $C_{10}H_{15}ON$, in *A. fissuratum* Engelm.

Anhalamine, $C_{11}H_{15}O_3N$, in *A. Lewinii*.

Anhalidine (*N*-methylanhalamine), $C_{12}H_{17}O_3N$, in *A. Lewinii*.^{2(b)}

Anhalinine (*O*-methylanhalamine), $C_{12}H_{17}O_3N$, in *A. Lewinii*.^{2(b)}

Mezcaline, $C_{11}H_{17}O_3N$, *N*-methylmezcaline, $C_{12}H_{19}O_3N$,^{2(c)} and

N-acetylmezcaline, $C_{13}H_{19}O_4N$,^{2(c)} in *A. Lewinii*.

Anhalonidine, $C_{12}H_{17}O_3N$, and *O*-methyl-*d*-anhalonidine, in *A. Lewinii*.

Anhalonine, $C_{12}H_{15}O_3N$, in *A. Lewinii* and *A. Jourdanianum* Lem.

Lophophorine, $C_{13}H_{17}O_3N$, in *A. Lewinii*.

Pellotine, $C_{13}H_{19}O_3N$, in *A. Lewinii* and *A. Williamsii* Lem.

Processes for the extraction and separation of the alkaloids are given by Kauder^{2(a)} and Späth and Becke.^{2(b)}

Anhaline, $C_{10}H_{15}ON$, was isolated by Heffter¹ from *A. fissuratum*, and later identified by Späth as hordenine³ (p. 638).

Anhalamine, $C_{11}H_{15}O_3N$, occurs in microscopic needles, m.p. 187–8°. The hydrochloride, $B. HCl \cdot 2H_2O$, forms lustrous leaflets, m.p. 256–8° and the sulphate, $B_2 \cdot H_2SO_4$, colourless prisms; the picrate has m.p. 234–6°. The base contains two methoxyl groups and one hydroxyl group. A dibenzoyl derivative, m.p. 128–9°, and a monobenzoyl derivative, m.p. 167.5°, are formed, the latter but not the former being soluble in alkalis. The methyl ether of anhalamine is identical with *anhalinine*, b.p. 130–40°/0.01 mm., m.p. 61–3°, and the *N*-methyl derivative is *anhalidine*, m.p. 131–3°.

Mezcaline (*Mescaline*), $C_{11}H_{17}O_3N$, is a colourless alkaline oil, b.p. 180–180.5°/12 mm., which absorbs carbon dioxide from the air, forming a crystalline carbonate. The sulphate, $B_2 \cdot H_2SO_4 \cdot 2H_2O$, m.p. 183–6°, forms brilliant prisms; the hydrochloride, m.p. 181°, colourless crystals; picrate, m.p. 216–8°; and the platinumchloride $(B. HCl)_2 \cdot PtCl_4$, m.p.

187–8°, bright yellow needles. The alkaloid contains three methoxyl groups. With methyl iodide in methyl alcohol it forms a methiodide, m.p. 174° and dimethylmezcaline methiodide, pale yellow plates, m.p. 224–5°. *N-Methylmezcaline* has been found in mescal buttons and synthesised.^{2(c)} It has b.p. 130–140°/1 mm. and yields a picrate, m.p. 177.5–178.5°. Späth and Bruck (1938) have recorded *N-acetylmezcaline*, m.p. 93–4°, from the same source.^{2(c)} Benzoylmezcaline forms lustrous needles, m.p. 120°. On oxidation mezcaline yields 3 : 4 : 5-trimethoxybenzoic acid. Wanag and Veinbergs^{3(a)} have condensed mezcaline with phthalic anhydride in presence of acetic acid, to the phthalyl derivative, $(\text{MeO})_3 \cdot \text{C}_6\text{H}_2 \cdot \text{CH}_2 \cdot \text{CH}_2 \cdot \text{N}(\text{CO})_2 \cdot \text{C}_6\text{H}_4$, m.p. 165°, and Hahn and Rumpf^{3(b)} have shown that on demethylation by hydrochloric acid at 130–50°, mezcaline yields the corresponding trihydroxyphenylethylamine, as hydrochloride, m.p. 213.5°, which condenses with pyruvic acid under “physiological conditions” (atmospheric temperature and pH, 7.0) to 6 : 7 : 8-trihydroxy-1-methyl-1 : 2 : 3 : 4 : tetrahydroisoquinoline-1-carboxylic acid (*dec.* 250°), and with other α -ketonic acids to give analogous isoquinoline derivatives.

The alkaloid gives a lemon-yellow coloration with sulphuric acid, passing into violet on warming or on adding a small fragment of sucrose or sodium nitrate. A similar reaction is given by all the alkaloids of this group except hordenine. Microchemical methods for the detection of mezcaline have been described by Rosenthaler⁴ and by Ducloux.⁴

Anhalonidine, $\text{C}_{12}\text{H}_{17}\text{O}_3\text{N}$, crystallises in small octahedra, m.p. 160–1°. The hydrochloride, B. HCl, forms prisms, but the platinum and gold salts are amorphous; the picrate has m.p. 201–8°. The alkaloid contains two methoxyl groups, yields a monobenzoyl derivative, m.p. 189° and with methyl iodide forms *N*-methylanhalonidine hydriodide (pellotine hydriodide), yellow prisms, m.p. 125–130°.

***O*-Methyl-*d*-Anhalonidine**, $\text{C}_{13}\text{H}_{19}\text{O}_3\text{N}$. From a selected fraction of bases in the mother liquors from the working up of “mescal buttons” Späth and Bruck^{2(c)} (1939) isolated this base as the crystalline *d*-tartrate. It is an oil, b.p. 140°/0.05 mm. (bath temp.), $[\alpha]_D^{160} + 20.7^\circ$ (MeOH), characterised by the 2 : 4 : 6-trinitrobenzoyl derivative, m.p. 259–260°, $[\alpha]_D^{45} + 39.7^\circ$ (MeOH) and identified by comparison with the dextro-rotatory component from the resolution of the synthetic *O*-methyl ether of *dl*-anhalonidine, synthesised by Späth.¹¹ The *l*-isomeride had $[\alpha]_D - 20.1^\circ$ (MeOH) and gave a 2 : 4 : 6-trinitrobenzoyl derivative, m.p. 259–260°, $[\alpha]_D^{130} - 43.7^\circ$ (CHCl_3).

Anhalonine, $\text{C}_{12}\text{H}_{15}\text{O}_3\text{N}$, crystallises from light petroleum in needles, m.p. 85.5°, $[\alpha]_D - 56.3^\circ$ (CHCl_3). The hydrochloride, B. HCl, forms colourless prisms, $[\alpha]_D^{170} - 41.9$ (H_2O); the platinumchloride, $(\text{B. HCl})_2 \cdot \text{PtCl}_4$, golden-yellow needles. Anhalonine contains one methoxyl group and a methylenedioxy group. It is a secondary base, forms a nitroso-derivative, and reacts with methyl iodide, forming *N*-methylanhalonine (lophophorine) which in turn gives a methiodide, $\text{C}_{12}\text{H}_{14}\text{O}_3\text{N}(\text{CH}_3) \cdot \text{CH}_3\text{I}$, identical with lophophorine methiodide, m.p. 223° (*dl*-form m.p. 239–241°).

Lophophorine, $C_{13}H_{17}O_3N$, is a colourless syrup, $[\alpha]_D - 47.0^\circ$ ($CHCl_3$), insoluble in water, but readily soluble in organic solvents. The hydrochloride, B. HCl, crystallises in small colourless needles, $[\alpha]_D^{17} - 9.47^\circ$ (H_2O); picrate, m.p. $162-3^\circ$. The base contains one methoxyl group and a methylenedioxy group. Methiodide (*see under anhalonine above*).

Pellotine, $C_{13}H_{19}O_3N$, crystallises from alcohol in tablets, m.p. $111-2^\circ$. The hydrochloride, B. HCl, forms rhombic prisms; the aurichloride melts at $147-8^\circ$ and the picrate at $166-8^\circ$. The alkaloid contains a methylimino group, two methoxyl groups and a phenolic hydroxyl group. The methiodide, B. $CH_3I \cdot H_2O$, crystallises in small prisms, m.p. $198-9^\circ$.

Constitution of the Anhalonium Alkaloids. From Heffter's results it was possible to extend the formulæ assigned to six of the seven anhalonium alkaloids then known as follows:—

Anhalamine, $C_8H_7(OMe)_3(OH)(NH)$	Anhalonine, $C_{11}H_{11}O_2(OMe)(NH)$
Mezcaline, $C_6H_2(OMe)_3(CH_2 \cdot NHMe)(3 : 4 : 5 : 1)$.	Lophophorine, $C_{12}H_{14}O_2N(OMe)$.
Anhalonidine, $C_{10}H_9(OMe)_2(OH)(NH)$.	Pellotine, $C_{10}H_9(OMe)_2(OH)(NMe)$.

Mezcaline. Heffter proved that mezcaline was not identical with the base having the formula shown above, which he synthesised for this purpose,⁵ and it was not until Späth began work on these alkaloids that their relationships were cleared up. In his first paper³ this author showed that anhaline was identical with hordenine (β -*p*-hydroxyphenylethyl-dimethylamine, $HO \cdot C_6H_4 \cdot CH_2 \cdot CH_2 \cdot NMe_2$, p. 633), and described the synthesis of mezcaline by the following series of reactions. Galloyl chloride (3 : 4 : 5-trimethoxybenzoyl chloride) was reduced by Rosenmund's method⁶ to 3 : 4 : 5-trimethoxybenzaldehyde, which was condensed with nitromethane to ω -nitro-3 : 4 : 5-trimethoxystyrene,



This, on reduction with zinc dust and acetic acid, yielded the corresponding oxime, which was further reduced by sodium amalgam to β -3 : 4 : 5-trimethoxyphenylethylamine, $C_6H_2(OMe)_3 \cdot CH_2 \cdot CH_2 \cdot NH_2$, and this proved to be identical with mezcaline (I). Like the latter, it behaves on analysis as if it contained the grouping $-NHMe$ but this had already been disproved by Heffter.⁵ Interest in the remarkable physiological properties attributed to mezcaline has led to many syntheses of this alkaloid and of its isomerides and analogues.⁷

Anhalamine. When mezcaline is condensed with formaldehyde it yields 6 : 7 : 8-trimethoxy-1 : 2 : 3 : 4-tetrahydroisoquinoline and the quaternary iodide obtained from this is identical with dimethylanhalamine methiodide.⁸ It follows that *O*-methylanhalamine must be 6 : 7 : 8-trimethoxy-1 : 2 : 3 : 4-tetrahydroisoquinoline. The free hydroxyl group was shown to be at C⁸ by Späth and Becke,⁹ who found that the product (II : R = Et), formed by *O*-ethylation of anhalamine, gave 4 : 5-dimethoxy-8-ethoxyphthalic acid anhydride, m.p. $106-7^\circ$, on oxidation with potassium permanganate. Anhalamine is therefore 8-hydroxy-6 : 7-dimethoxy-1 : 2 : 3 : 4-tetrahydroisoquinoline (II : R = H). *Anhalidine* is *N*-methylanhalamine and *anhalinine* the *O*-methyl ether (II : R = Me)

of anhalamine.^{2(b)} The structure of anhalamine had already been established by the synthesis of the alkaloid from 5-hydroxy-3:4-dimethoxybenzaldehyde, which was converted into β -5-hydroxy-3:4-dimethoxyphenylethylamine, and the latter condensed with formaldehyde, the hydroxyl group being protected by ethylcarbonation or benzylation up to the last stage.¹⁰

Pellotine and Anhalonidine. The *N*-acetyl derivative of mezcaline (I: $\text{NH}_2 \rightarrow \text{NHAc}$), on treatment with phosphoric oxide, yields 6:7:8-trimethoxy-1-methyl-3:4-dihydroisoquinoline (picrate, m.p. 181–2°), which, on successive catalytic hydrogenation and treatment with methyl sulphate, yields 6:7:8-trimethoxy-1:2-dimethyl-1:2:3:4-tetrahydroisoquinoline identical with *O*-methylpellotine (picrate, m.p. 167–8°), whence it appears that pellotine must be a dimethyl ether of 6:7:8-trihydroxy-1:2-dimethyl-1:2:3:4-tetrahydroisoquinoline. Pellotine and anhalonidine on complete methylation yield the same product, and as anhalonidine is a secondary base and differs from pellotine by containing $-\text{CH}_2$ less, it must be a dimethyl ether of 6:7:8-trihydroxy-1-methyl-1:2:3:4-tetrahydroisoquinoline,¹¹ and pellotine should be *N*-methylanhalonidine.

The position of the free hydroxyl group in these two alkaloids is either C⁶ or C⁸, since Späth has shown that the *ON*-diacetyl derivative of β -5-hydroxy-3:4-dimethoxyphenylethylamine, when heated in toluene solution with phosphoric oxide, yields a product which must be either 6-acetoxy-7:8-dimethoxy-, or 8-acetoxy-6:7-dimethoxy-1-methyl-3:4-dihydroisoquinoline. On reduction with tin and hydrochloric acid it is converted into anhalonidine, which must therefore be 6-hydroxy-7:8-dimethoxy- (or 8-hydroxy-6:7-dimethoxy-)1-methyl-1:2:3:4-tetrahydroisoquinoline. Similarly the methiodide of the acetoxy-compound on reduction yields, by loss of acetic acid and addition of two hydrogen atoms, pellotine, proving the latter to be *N*-methylanhalonidine.¹² The position of the free hydroxyl group was finally shown by Späth¹³ to

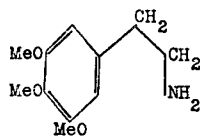

(I) Mezcaline

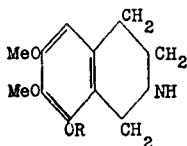

(II) Anhalamine
(R = H)

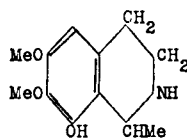

(III) Anhalonidine

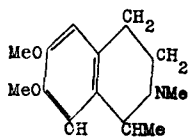

(IV) Pellotine

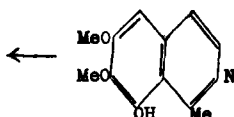

(VI)

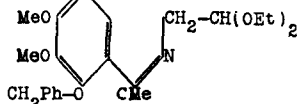

(V)

be at C⁸, as in anhalamine, by converting pelletine into the *O*-ethyl ether, b.p. 130–140°/1 mm., which on oxidation with potassium permanganate yielded 4 : 5-dimethoxy-3-ethoxyphthalic acid, whence pelletine must be (IV), and as pelletine is the *N*-methyl derivative of anhalonidine, the latter must be represented by (III).

This was confirmed by an independent analytical method by Späth and Boschan,¹⁴ and by a synthesis of pelletine by Späth and Becke,¹⁵ starting from the benzyl ether of 2-hydroxy-3 : 4-dimethoxyacetophenone, which was converted by aminoacetal into the Schiff's base (V). This, on treatment with sulphuric acid (73 per cent.), followed by warm water, gave 8-hydroxy-6 : 7-dimethoxy-1-methylisoquinoline (VI), of which the methiodide, m.p. 188–189·5°, on reduction furnishes pelletine (IV). From *dl*-pellotine so formed Späth and Keszler,¹⁶ by a special process of fractionation, isolated *l*-pellotine having $[\alpha]_D^{17} - 15\cdot2^\circ$ (CHCl₃), for which optical homogeneity was not claimed, owing to the ease with which racemisation occurs, slowly in aqueous solution at 15–20°, and rapidly in alkaline solution, but less readily in presence of acid. Natural pelletine is optically inactive, probably due to racemisation during isolation.

Anhalonine and Lophophorine. Späth and Gangl¹⁷ showed that each of these alkaloids contains a methylenedioxy group and that the quaternary iodide prepared from *dl*-anhalonine is identical with lophophorine methiodide so that lophophorine must be *N*-methylanhalonine. Anhalonine was synthesised from 3 : 4-methylenedioxy-5-methoxybenzaldehyde by condensation with nitromethane, reduction of the product to the corresponding β -ethylamine, the acetyl derivative (VII) of which, on treatment with phosphoric anhydride, condensed to 6-methoxy-7 : 8-methylenedioxy-1-methyl-3 : 4-dihydroisoquinoline, m.p. 60–2°. This, on reduction, furnished the corresponding tetrahydroisoquinoline, which proved to be anhalonine (VIII), and on conversion to the quaternary methiodide the latter was found to be lophophorine (IX) methiodide. The possible alternative, 8-methoxy-6 : 7-methylenedioxy-1 : 2-dimethyl-1 : 2 : 3 : 4-tetrahydroisoquinoline, was prepared by Freund's method¹⁷ and the methiodide shown not to be identical with lophophorine methiodide.

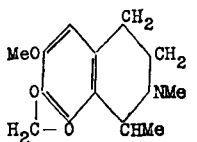
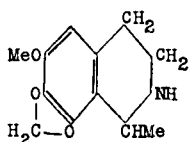
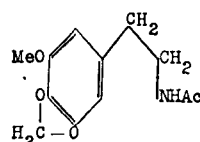
(IX) Lophophorine(VIII) Anhalonine

(VII)

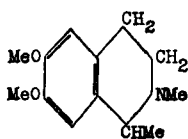
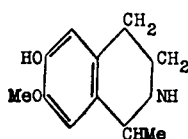
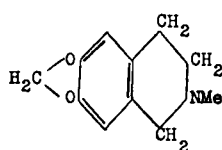
(X) Carnegine(XI) Salsoline(XII) Hydrohydrastinine

Confirmation of this constitution was provided by Späth and Becke,^{2(b)} who identified 5-methoxy-3:4-methylenedioxy-*o*-phthalic acid as an oxidation product of anhalonine. The synthetic *dl*-anhalonine was resolved by crystallisation of the *l*-tartrate from methyl alcohol, into *l*-anhalonine, m.p. 85–6°, $[\alpha]_D^{25} - 56.3^\circ$ (CHCl₃) and its optical antipode. *l*-Anhalonine was methylated by formaldehyde and formic acid to *N*-methyl-*l*-anhalonine, $[\alpha]_D^{25} - 47.0$ (CHCl₃); picrate, m.p. 162–3°, which proved identical with lophophorine.¹⁸

The following alkaloids are included in this section as simple *isoquinoline* bases; only one of them, carnegine, has been obtained from a cactus species (*Cereus*).

Carnegine, C₁₃H₁₉O₂N. From *Carnegia gigantea* (Engelm.) Britt. and Rose (Monimiaceæ), Heyl¹⁹ isolated this base as an alkaline oil, yielding crystalline salts. It was stated to contain two methoxyl groups and to resemble lophophorine in physiological action. These results were confirmed and extended by Späth,²⁰ who showed that carnegine is 6:7-dimethoxy-1:2-dimethyl-1:2:3:4-tetrahydro*isoquinoline* (X) by comparison of the following salts of the two bases: hydrochloride, m.p. 210–1°; picrate, m.p. 212–3° (*dec.*); methiodide, m.p. 210–1° (*vac.*). Späth and Kuffner²¹ subsequently showed that *pectenine*, isolated by Heyl²² from *Cereus pecten aboriginum*, is identical with carnegine.

ALKALOIDS of *Salsola Richteri*. This member of the botanical family Chenopodiaceæ has been shown by Orekhov and Proskurnina²³ to contain three alkaloids of which two are closely related to the typical cactus alkaloids.

Salsoline, C₁₁H₁₅O₂N. The base has m.p. 218–221°. It yields a hydrochloride, B. HCl. 1.5H₂O, m.p. 141–152°; *ON*-dibenzoyl derivative, m.p. 166–8°; *N*-benzoyl derivative, m.p. 172–4°. With diazomethane it furnishes *O*-methylsalsoline, the *l*-form of which was shown to be identical with *salsolidine*, which also occurs in *S. Richteri* in *l*- and *dl*-forms. The *O*-methyl ether on treatment with formaldehyde and formic acid becomes fully methylated to C₁₀H₁₀(OMe)₂(NMe), the product being carnegine (X) (*see above*). On exhaustive methylation, *O*-methylsalsoline yields eventually 3:4-dimethoxy-1:2-divinylbenzene, m.p. 37–9°, which is oxidised by permanganate to metahemipinic acid. The position of the hydroxyl group in salsoline was settled by Späth, Orekhov and Kuffner,²⁴ who synthesised 6-hydroxy-7-methoxy-1-methyl-1:2:3:4-tetrahydro*isoquinoline* (XI), m.p. 223–4°, and showed it to be identical with salsoline. The latter, as isolated from the plant, is a mixture of *d*- and *dl*-forms, from which Proskurnina and Orekhov²³ (1937) isolated, as the *d*-tartrate, the *d*-form, m.p. 215–6°, giving a hydrochloride, m.p. 171–2°, $[\alpha]_D + 40.1^\circ$ (H₂O). The mother-liquors yielded the *l*-form (m.p. 215–6°; B. HCl, m.p. 171–3°, $[\alpha]_D - 39.2^\circ$), convertible by diazomethane into *O*-methyl-*l*-salsoline, identical with *salsolidine*, C₁₂H₁₇O₂N, 2H₂O, which has the following characteristics: m.p. 60–1°, or 71–3° (*dry*); $[\alpha]_D - 52.9^\circ$; hydrochloride, m.p. 233–5°; $[\alpha]_D - 26.5^\circ$; picrate, m.p. 194–5°; picrolonate, m.p. 220–1° and *N*-benzoyl derivative, m.p. 124–5°.

The *dl*-form of this substance, 6:7-dimethoxy-1-methyl-1:2:3:4-tetrahydroisoquinoline, which had already been synthesised by Schöpf and Bayerle,²³ in the course of their biogenetic work on isoquinoline alkaloids, was prepared by Späth and Dengel²³ and resolved into the *d*- and *l*-forms. They recorded for the *dl*-form, m.p. 53–53.5°, and for the *l*-form, m.p. 47.5–48.5°, and $[\alpha]_D^{16} - 59.7^\circ$ (EtOH), which differ somewhat from the figures first recorded for natural *l*-salsolidine. Proskurnina and Orekhov²³ (1939) explained these differences by showing that *d*- and *l*-salsolidine each occurs in two forms, m.p. 41–5° and 71–3° (*dry*) produced respectively by distillation *in vacuo* and crystallisation from water.

The third alkaloid, *salsamine*, has m.p. 155–7° (*dec.*); the hydrochloride, m.p. 255–260° (*dec.*); picrate, m.p. 213–4°; and picrolonate, m.p. 220–1°.

Corypalline, C₁₁H₁₅O₂N (Corydalis spp. Nos. 9, 22; list, p. 170). This phenolic base, m.p. 168°, picrate, m.p. 178°, contains one methoxyl group and on methylation yields 2-methyl-6:7-dimethoxytetrahydroisoquinoline, C₁₂H₁₇O₂N, m.p. 82°, and on ethylation, 2-methyl-6-methoxy-7-ethoxytetrahydroisoquinoline, m.p. 65°, whence the free hydroxyl appears to be at C⁷ and this has been confirmed by the synthesis of corypalline by a method analogous with that used by Späth, Orekhov and Kuffner.²⁴ Corypalline is therefore hydrohydrastinine (XII) with the methylenedioxy group replaced by MeO at C⁶ and .OH at C⁷ (Manske).^{23(a)}

Other simple naturally occurring methyltetrahydroisoquinolines are hydrohydrastinine (XII), (p. 164) found, like corypalline, in Corydalis spp., and hydrocotarnine found in opium (p. 201).

Pharmacology. Interest in the anhalonium alkaloids dates from the investigations of Lewin¹ and Heffter.¹ The general pharmacological actions of mezcaine, anhalonine, anhalonidine and lophophorine show certain qualitative similarities.²⁵ In the frog *mezcaine* depresses the central nervous system. This effect is also observed in mammals; death is due to respiratory paralysis. The effect on the blood pressure varies with the dose and the animal. In the chloralosed dog²⁶ it is mainly depressant; in the decapitated cat²⁷ it has a pressor effect. 3:5-Dimethoxy-4-ethoxyphenylethylamine and 3:4-diethoxy-5-methoxyphenylethylamine have a similar action to mezcaine, but are more toxic.²⁷ A series of methoxyphenylethylamines has been examined by Epstein, Gunn and Virden.²⁸

Anhalonine produces increased reflex excitability in the frog after a phase of paresis (Heffter,¹ 1898). The symptoms in the rabbit are analogous, but the transitory paresis is less marked. The lethal dose of the hydrochloride for rabbits is 0.16–0.2 gm. per kilo. body weight.

Anhalonidine is not so active and resembles pellotine in action. In frogs it produces a type of narcosis or paresis, followed by a phase of increased excitability. Larger doses have a curare action. On mammals the action is slight.

Lophophorine is the most toxic of the group. No preliminary paresis is observed in either the frog or rabbit; 15–20 mg. per kilo. body weight is fatal in rabbits.

Pellotine is a convulsant in the frog and cat. Clerc, Janot and Paris,²⁸ state that the intravenous lethal dose in dogs is 10 mgm./kilo. In chloralosed dogs 5 mgm./kilo slowed the heart and caused a fall in blood pressure; the effects lasted for a few minutes and resembled those due to acetylcholine: they were inhibited by atropine and increased by yohimbine and ergotamine. A few injections of this dose at short intervals produced convulsions and this effect was inhibited by phenobarbitone.

According to Slotta and Müller, mezcaine is excreted in urine in the form of trimethoxyphenylacetic acid.²⁹

The best-known action of "pellote" or "mescal buttons" is the production of visual colour hallucinations. These are usually accompanied by bradycardia, dilatation of the pupil, loss of accurate time sense, nausea, faintness and headache. In the early stages there may also be a certain amount of euphoria. According to Heffter, mezcaine is the substance responsible for these symptoms; neither anhalonidine in equivalent doses nor anhalonine and lophophorine in smaller doses had this effect. Dixon also considered mezcaine the most effective of the alkaloids in this respect, but some doubt has been cast on the purity of his alkaloids.³⁰ Lewin³¹ attributes a certain hallucinating power to anhalonine. For a more detailed survey of the action of mezcaine and a history of mescal Beringer's monograph should be consulted.³² The use of this intoxicant has spread among the Indians in the reservations north of the Mexican border, even to the establishment of a peyote church, and the drug has been stated to have engaged the attention of the Paris police.³³ The production of experimental hallucinations promises to be of use in the analysis of certain personality disorders.³⁴

The pharmacological action of bases from *Cereus coryne* Solm,³⁵ *Pachycereus marginatus*,³⁶ *Trichocereus terschecki*, Britton and Rose,³⁷ and *T. candicans* B. and R.,³⁸ has also been recorded. *T. terschecki* is stated to contain trichocereine (*N*-dimethylmezcaine) and 3:4-dihydroxyphenylethyltrimethylammonium hydroxide. The latter is probably also present in *Cereus coryne*. *T. candicans* is stated to contain hordenine (anhaline) and *p*-hydroxyphenylethyltrimethylammonium hydroxide (candicine).

According to Gvishiani, in experiments on cats and mice *salsoline* resembles papaverine in its effects on blood circulation and hydrastinine in its action on smooth muscle.³⁹ Its use in Russia for the treatment of hypertension has been reported.⁴⁰

REFERENCES

- (1) LEWIN, *Arch. exp. Path. Pharm.*, 1888, 24, 401; 1894, 34, 374; HEFFTER, *ibid.*, 1894, 34, 82; 1898, 40, 385; *Ber.*, 1894, 27, 2975; 1896, 29, 216; 1898, 31, 1193; 1901, 34, 3004; HEYL, *Arch. Pharm.*, 1901, 239, 451; DUCLOUX, *Chem. Zent.*, 1931, i, 1772. Useful summaries of information on the drug and its alkaloids are given by EWELL, *J. Amer. Chem. Soc.*, 1896, 18, 624; and BECCARI, *Arch. Farmacol. sperim.*, 1936, 61, 161 (pharmacognosy and analysis). (2) (a) KAUDER, *Arch. Pharm.*, 1899, 237, 190; (b) SPÄTH and BECKE, *Monats.*, 1935, 66, 327; *Ber.*, 1935, 68, 501, 944; (c) SPÄTH and BRUCK, *ibid.*, 1937, 70, 2446; 1938, 71, 1275; 1939, 72, 384. (3) *Monats.*, 1919, 40, 129; 1921, 42, 263. (3a) *Ber.*, 1942, 75, 1558. (3b) *Ibid.*, 1938, 71, 2141. (4) ROSENTHALER, *Pharm. Zeit.*, 1931, 76, 653; DUCLOUX, *Rev. Farm.*

Buenos Aires, 1931, 74, 87. (5) *Ber.*, 1901, 34, 3004; (with CAPELLMANN), 1905, 38, 3634. (6) *Ibid.*, 1918, 51, 585. (7) SLOTTA (with HELLER), *Ber.*, 1930, 63, 3029; (with SZYSZKA), *J. pr. Chem.*, 1933 [ii], 137, 339; *Ber.*, 1934, 67, 1106; JANSEN, *Rec. trav. Chim.*, 1931, 50, 291, 617; KINDLER (with PESCHKE), *Arch. Pharm.*, 1932, 270, 410; (with BRANDT), *ibid.*, 1935, 273, 478; HAHN (with WASSMUTH), *Ber.*, 1934, 67, 696, 1210; (with RUMPF) (3b); IWAMOTO and HARTUNG, *J. Org. Chem.*, 1944, 9, 513; HEY, *Quart. J. Pharm.*, 1947, 20, 129. (8) SPÄTH, *Monats.*, 1921, 42, 97. (9) *Ber.*, 1934, 67, 2100. (10) SPÄTH and RÖDER, *Monats.*, 1922, 43, 93. (11) SPÄTH, *ibid.*, 1921, 42, 97. (12) SPÄTH, *ibid.*, 1923, 43, 477. (13) *Ber.*, 1932, 65, 1778. (14) *Monats.*, 1933, 63, 141. (15) *Ber.*, 1934, 67, 266. (16) *Ibid.*, 1936, 69, 755. (17) *Monats.*, 1923, 44, 103; FREUND, *Ber.*, 1903, 46, 4258. (18) SPÄTH and KESZTLER, *Ber.*, 1935, 68, 1663. (19) *Arch. Pharm.*, 1928, 266, 668. (20) *Ber.*, 1929, 62, 1021. (21) *Ibid.*, 1929, 62, 2242. (22) *Arch. Pharm.*, 1901, 239, 451. (23) *Ber.*, 1933, 66, 841; 1934, 67, 878; *Bull. Soc. chim.*, 1937, [v], 4, 1265; 1939, [v], 6, 44.; cf. SPÄTH and DENGEL, *Ber.*, 1938, 71, 113, and SCHÖPF and BAYERLE, *Annalen*, 1934, 513, 190. (23a) MANSKE, *Can. J. Res.*, 1937, B, 15, 159. (24) *Ber.*, 1934, 67, 1214. (25) DIXON, *J. Physiol.*, 1899, 25, 12. (26) RAYMOND-HAMET, *Arch. exp. Path. Pharm.*, 1933, 169, 97. (27) GRACE, *J. Pharm. Exp. Ther.*, 1934, 50, 359. (28) *C. R. Soc. biol.*, 1935, 119, 828. (29) SLOTTA and MULLER, *Zeit. physiol. Chem.*, 1936, 238, 14; cf. BERNHEIM and BERNHEIM, *J. Biol. Chem.*, 1938, 123, 317; BLASCHKO, *J. Physiol.*, 1944, 103, 13P. (30) MOGILEWA, *Arch. exp. Path. Pharm.*, 1903, 49, 137. (31) "Gifte und Vergiftungen," Berlin, 1929 p. 724. (32) "Der Meskalinrausch," Berlin, 1927; see also BUCHANAN, *Med. Ann.*, 1931, 12. (33) CRITCHLEY, *Brit. J. Inebr.*, 1931, 28, 99. (34) GUTTMANN, *J. ment. Sci.*, 1936, 82, 203; *Lancet*, 1936, i, 553. (35) RETI, ARNOLT and LUDUEÑA, *Compt. rend. Soc. Biol.*, 1935, 118, 591. (36) ROCA, *An. Inst. biol. Univ. Méc.*, 1931, 2, 137. (37) LUDUEÑA, *Compt. rend. Soc. Biol.*, 1936, 121, 368. (38) *Idem.*, *ibid.*, 1933, 114, 809, 950, 951, 953 (with LEWIS), p. 814; RETI, *ibid.*, p. 811. (39) *J. Physiol.*, U.R.S.S., 1938, 24, 1174. (40) WASTL, *Hahnemannian Month.*, 1946, 81, 243.

ALKALOIDS OF *HYDRASTIS CANADENSIS* L. The rhizomes of this North American plant (Ranunculaceæ) contain three alkaloids, of which one, hydrastine, is, for convenience, dealt with here though the sub-group, phthalideisoquinolines, to which it belongs is typically developed in the botanical order Rhœadales (pp. 169 and 200); the other two, berberine and canadine, are described under Berberis alkaloids (p. 328). The drug is no longer official in the British or United States Pharmacopœia. The British Pharmaceutical Codex states that it contains hydrastine about 2 per cent. and berberine about 2.5 per cent., though lower and higher figures are frequently quoted.¹ A phytochemical investigation of alkaloidal production and distribution in the plant has been made by Gillis and Langenhan.² Processes for the isolation of the total alkaloids and for the separation and purification of hydrastine have been published by Power,³ Schmidt and Wilhelm,⁴ Freund and Will⁵ and Schmidt.⁶ As hydrastine is a potent alkaloid, much attention has been given to its estimation in hydrastis and its galenical preparations. Processes of this kind were published in the British Pharmacopœia of 1914, and the United States Pharmacopœia, 10th Revision, 1926. Assay methods for the liquid and solid extracts are included in the British Pharmaceutical Codex, 1934, and for the crude drug, extracts and tincture, in the United States National Formulary VIII.⁷ A process for the estimation of berberine in Hydrastis tincture has been described by Awe.⁷

Hydrastine, C₂₁H₂₁O₆N. This alkaloid was isolated by Perrins,⁸ and

subsequently investigated by Mahla⁹ and Power.³ The present formula is due to Freund and Will,¹⁰ and Eykman.¹¹ Hydrastine forms colourless, rhombic prisms, m.p. 132°, from alcohol, has a bitter taste, is alkaline to litmus, almost insoluble in water, easily soluble in chloroform (1 in 14 at 25°) or benzene, and less so in alcohol (1 in 170 at 25°) or ether (1 in 175 at 25°). In chloroform it has $[\alpha]_D - 67.8^\circ$, but, according to Carr and Reynolds, the value in dry alcohol is $- 49.8^\circ$, and in 50 per cent. alcohol $+ 115^\circ$.¹² The salts are unstable in water, and generally not well crystallised; the hydrochloride, B. HCl, is a microcrystalline powder m.p. 116°, $[\alpha]_D + 127.3^\circ$ (dil. HCl), obtained by passing hydrogen chloride into a solution of the base in ether; the platinichloride, B₂. H₂PtCl₆, is an amorphous, yellow precipitate, but the picrate, B. C₆H₂(NO₂)₃OH. H₂O, forms yellow needles, m.p. 184°. The acid oxalate and acid tartrate, B. H₂C₄H₄O₆. 4H₂O, crystallise readily from hot water. The alkaloid gives ill-defined metallic derivatives. Hydrastine in sulphuric acid gives with ammonium molybdate an olive-green colour. A solution in dilute sulphuric acid develops a blue fluorescence with an aqueous solution of permanganate. Iodine solution precipitates the characteristic periodide B. HI. I₅, as a dark-brown powder. A series of identification tests is given by Keenan.¹²

Constitution. Hydrastine contains two methoxyl groups and a methylenedioxy-group,¹³ and behaves as a tertiary base. The first insight into the inner structure of the base was obtained when Freund and Will¹⁴ showed that with dilute nitric acid it undergoes hydrolytic oxidation, yielding opianic acid and a new base hydrastinine, C₁₁H₁₃O₃N. This reaction is analogous with the similar hydrolytic oxidation of narcotine (p. 201) to opianic acid and cotarnine and hydrastinine is allied to cotarnine and can be prepared from it.

HYDRASTININE, C₁₁H₁₃O₃N, crystallises from light petroleum in colourless needles, $[\alpha]_D \pm 0^\circ$, m.p. 116–7°, is soluble without colour in non-ionising organic solvents, but dissolves in alcohol and sparingly in water, yielding fluorescent, yellow solutions. It forms salts with mineral acids, losing at the same time a molecule of water. The chloride, C₁₁H₁₂O₂NCl, the salt used in medicine, occurs in pale yellowish needles, has a bitter taste, melts at 212°, is very soluble in water or alcohol, less so in chloroform, or ether. Its aqueous solution shows a blue fluorescence, especially when dilute, is neutral to litmus, and is not precipitated by ammonia solution, but dilute sodium hydroxide solution added drop by drop causes turbidity, which disappears on shaking, and the liquid then deposits crystalline hydrastinine. Bromine water gives, with an aqueous solution of the salt, a yellow precipitate, which is soluble in ammonia solution.¹⁵ The iodide has m.p. 233–4°. A colorimetric method for the estimation of hydrastinine has been described by Steenberg¹⁵ and its polarographic determination is dealt with by Kirkpatrick.¹⁵

Hydrastinine contains a methyl group linked to nitrogen; it reacts with hydroxylamine, forming an oxime, m.p. 145–6°, and with acetic anhydride and benzoyl chloride, forming acetylhydrastinine and benzoyl-

hydrastinine respectively. When treated with caustic alkali it yields *oxyhydrastinine*, $C_{11}H_{11}O_3N$, rosettes of needles, m.p. $97-8^\circ$, b.p. above 350° , and *hydrohydrastinine*, $C_{11}H_{13}O_2N$, m.p. 66° .¹⁶ These reactions and the loss of a molecule of water in forming salts indicate that hydrastinine (1) is a secondary amine; (2) contains an aldehyde group; and (3) has two side-chains between which water is readily eliminated on addition of an acid. Its conversion into oxyhydrastinine and hydrohydrastinine by the action of potassium hydroxide is analogous with the conversion of aromatic aldehydes into a mixture of the corresponding alcohol and acid, and may be represented thus, using Roser's formulation¹⁷ for the base and its salts.

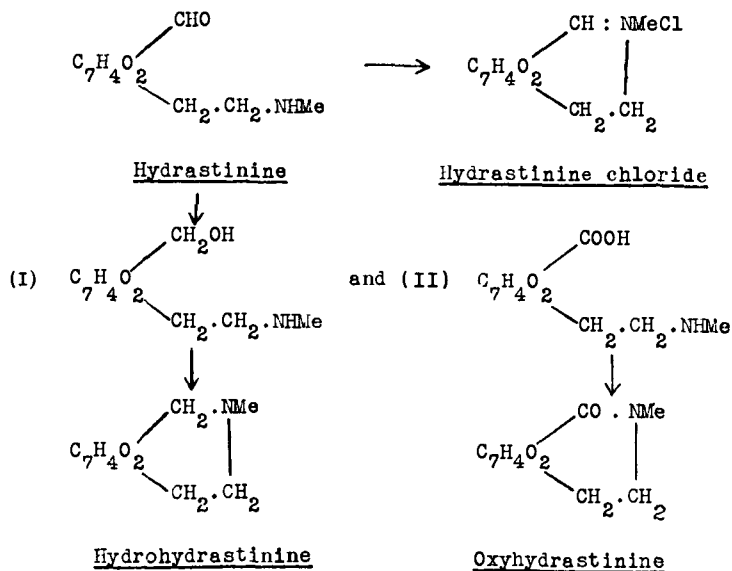

The intermediate products (I) and (II) lose water, forming hydrohydrastinine and oxyhydrastinine respectively.¹⁶ Alkaline permanganate converts oxyhydrastinine into hydrastinic acid (III), $C_{11}H_9O_6N$, needles, m.p. 164° ; this in turn is oxidised by dilute nitric acid to hydrastic acid methylimide (IV), $C_{10}H_7O_4N$, m.p. $227-8^\circ$, which, when warmed with potassium hydroxide solution, furnishes methylamine and hydrastic acid (V).

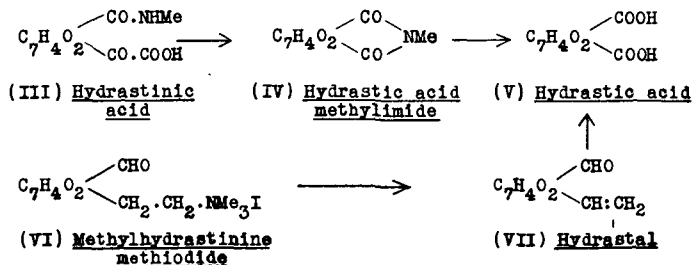

This acid also results from oxidation of the nitrogen-free product of the exhaustive methylation of hydrastinine, which as a secondary amine gives with methyl iodide a mixture of hydrastinine iodide and methylhydrastinine methiodide (VI); the latter, on distillation with alkali, yields an aldehyde, hydrastal (VII). This on oxidation furnishes hydrastic acid (V), $C_9H_6O_6$, needles, m.p. 175° (*dec.*), a dibasic acid, which on melting passes into an anhydride, and when fused with potassium hydroxide furnishes a mixture of protocatechuic acid and catechol. On heating with strong nitric acid, the methylene ether of dinitrocatechol is formed, whilst phosphorus pentachloride converts it into a dichloride (oil), which with water yields *normetahemipinic acid*,



rhombic prisms, forming an anhydride and melting at 247.5° .¹⁸ These observations show that hydrastic acid is 4:5-methylenedioxyphthalic acid.¹⁹ Freund and Lachman¹⁶ formulated these degradation products of hydrastinine thus:—

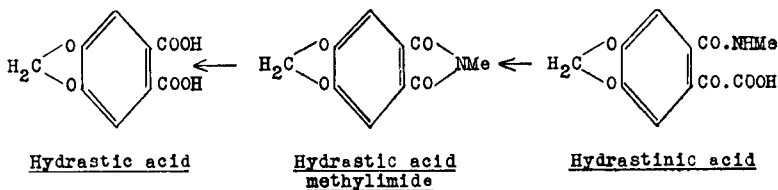

whence the following formulæ are arrived at for hydrohydrastinine, oxyhydrastinine, hydrastinine and hydrastinine chloride, based on those suggested by Roser¹⁷ as a result of his work on the closely allied substance, cotarnine.

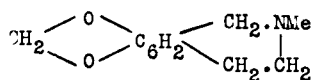

Hydrohydrastinine

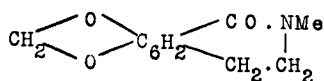

Oxyhydrastinine

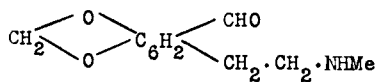

Hydrastinine

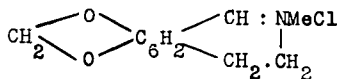

Hydrastinine chloride

This formula for hydrastinine was first confirmed by Fritsch's synthesis²⁰ of this base by condensing piperonal (4:5-methylenedioxybenzaldehyde) with aminoacetal, $NH_2 \cdot CH_2 \cdot CH(OC_2H_5)_2$, and treating the piperonylideneaminoacetal (VIII) so produced with sulphuric acid, thereby converting it into methylenedioxyisoquinoline, the methiodide (IX) of which on reduction furnished hydrohydrastinine (X) as the hydriodide; from this hydrastinine is obtainable by oxidation with

chromic acid²¹ or iodine in presence of potassium acetate.²² The steps in this synthesis may be represented thus:—

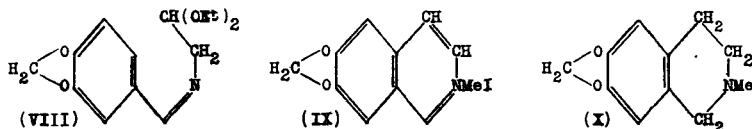

Dobbie and Tinkler²³ suggested that, since hydrastinine in solution in ether or chloroform has an absorption spectrum almost identical with that of hydrohydrastinine, whilst the absorption spectra of its solutions in water or alcohol resemble those of the salts, it may exist in two forms, represented by formula I (solid state or dissolved in ether or chloroform), and II (dissolved in water or alcohol); these conclusions have been confirmed by Steiner.²³ No evidence for the existence of Roser's aldehydic form was obtained.

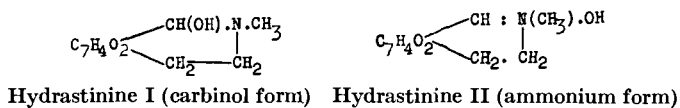

Hydrastinine is used in medicine, and its manufacture by more or less complete synthesis, or from alkaloids such as berberine or narcotine has been investigated. For its preparation from hydrastine the method originally used by Freund and Will,¹⁴ depending on hydrolytic oxidation with dilute nitric acid, is available. Using narcotine, it is necessary to prepare from this, cotarnine by oxidation with nitric acid, reduce the cotarnine to hydrocotarnine, and then convert the latter by Pyman and Remfry's method²⁴ into hydrastinine. With berberine as a starting material, a process has been devised proceeding through benzyltetrahydroberberine, and the various essential steps have been covered by patents.²⁵ Decker has devoted much attention to processes for the preparation of hydrastinine from simpler materials, thus he has shown that formylhomopiperonylamine, $\text{CH}_2 : \text{O}_2 : \text{C}_6\text{H}_3\text{CH}_2 \cdot \text{CH}_2 \cdot \text{NH} \cdot \text{CHO}$, obtained by heating homopiperonylamine formate at $160-70^\circ$, when heated with phosphoric oxide in toluene, yields 6:7-methylenedioxy-3:4-dihydroisoquinoline, which with methyl iodide is converted into hydrastinine iodide.²⁶

The combination of the formulæ for hydrastinine and opianic acid to represent hydrastine, may be made in several ways. Freund, noting that the two products of hydrolysis each contained an aldehyde group, whilst hydrastine itself had none, suggested that combination occurs by condensation between these two groups, and so arrived at formula (III).

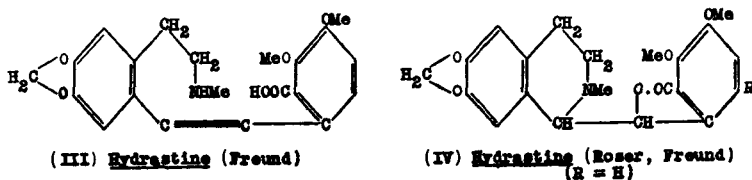

This represents hydrastine as a secondary amine and a free acid, though the alkaloid reacts with alkyl iodides on the whole as a tertiary amine and forms salts with alkalis rather as a lactone than as a free acid. These and other considerations led Freund and Rosenberg²⁸ to suggest the alternative formula (IV), based on Roser's²⁸ formula for narcotine (p. 204).

In 1912 Hope and Robinson,²⁹ by boiling together in alcohol nitromeconin and hydrastinine, obtained a *dl*-nitrohydrastine (IV : R = NO₂), which was converted *via* the hydrazino-derivative to an optically inactive hydrastine, m.p. 137°, assumed to be one of the two *dl*-hydrastines possible, since there are two centres of asymmetry in formula (IV). This substance was further examined by Hope, Pyman, Remfry and Robinson³⁰ and shown to be a mixture, which was resolved at the amino-stage into *dl*-aminohydrastine-a, m.p. 216-7°, and *dl*-aminohydrastine-b, m.p. 196-7°, from which *dl*-hydrastine-a, m.p. 137°; picrate, m.p. 219° (*dec.*), and *dl*-hydrastine-b, m.p. 150-1°, were respectively obtained, the former in good and the latter in poor yield, owing to the formation of a by-product, didehydrohydrastine, C₂₁H₁₉O₆N, colourless matted needles, m.p. 183°, regarded as a phenanthrene derivative. In a later paper Marshall, Pyman and Robinson showed that natural *l*-hydrastine, on boiling with methyl-alcoholic potassium hydroxide, produced an equilibrium mixture by partial conversion into an isomeride of higher lævorotation, - 163°, than that of the natural base, - 68.3°, due to racemisation at one of the asymmetric centres, presumably that in the phthalide group.

The new *l*-hydrastine is considered to be *l*- α -hydrastine and natural hydrastine to be *l*- β -hydrastine, which implies (1) that the latter differs from natural narcotine (*l*- α -narcotine) in stereochemical configuration; (2) that since α -gnoscopine, but not β -gnoscopine, can be resolved, the synthesis of natural hydrastine will involve the deracemisation of hydrastine-b, to *l*- α -hydrastine, which can be epimerised to natural hydrastine (*l*- β -hydrastine) by boiling with methyl-alcoholic potassium hydroxide.

PHARMACOLOGICAL ACTION. In the frog *hydrastine* produces strychnine-like convulsions, which may be succeeded by paralysis when large doses are given. In mammals the bulbar and spinal centres are stimulated, convulsions ensue, and here again large doses cause paralysis. The blood pressure is raised as a result of the central action of the drug; respiration is deepened and accelerated with stimulatory doses. The myocardium is depressed and the uterus contracts. In its earlier stages the action of hydrastine on the central nervous system in mammals shows certain analogies with narcotine and thebaine, but approximates more to thebaine. It appears to be excreted in the urine unchanged. Hydrastine has been used as an internal styptic in uterine hæmorrhage.

Hydrastinine causes little nervous disturbance except in large doses, when it paralyses the nervous system. The pressor effect is greater than that obtained with hydrastine, because of the increased cardiac efficiency and greater peripheral constrictor action induced by moderate doses. The uterus is stimulated to activity by suitable doses, and the main use of *hydrastinine* in medicine is as an oxytocic styptic. When applied to

the eye in 10 per cent. solutions it causes dilatation of the pupil. In the dog some of the drug is excreted in bile as well as in the urine (Bernardbeig and Caujolle).³²

REFERENCES

- (1) For other figures see WASICKY and JOACHIMOWITZ, *Arch. Pharm.*, 1917, 255, 497; CLARK and WINTER, *Trans. Roy. Soc. Canada*, 1926, [iii], 20, III, 307; MARKWELL, *Chem. and Drug.*, 1937, 126, 90; JERMSTAD, *Norsk. farm. Tids.*, 1936, 44, 325, 339; POLACCI and GALOTTI, *Boll. Soc. ital. biol. sper.*, 1942, 17, 652. (2) *J. Amer. Pharm. Assoc.*, 1931, 20, 210, 329; cf. HIROSE and LANGHENHAN, *ibid.*, 1930, 19, 349. (3) *Pharm. J.*, 1884-5, [iii], 15, 297; 1885-6, [iii], 16, 1092. (4) *Arch. Pharm.*, 1888, 226, 329. (5) *Ber.*, 1886, 19, 2797. (6) *Amer. J. Pharm.*, 1919, 91, 270. (7) For other methods and comments see BECKURTS, *Apoth. Zeit.*, 1896, 11, 552; GORDIN and PRESCOTT, *Arch. Pharm.*, 1899, 237, 439; PUCKER, *Pharm. Rev.*, 1908, 26, 132; VAN DER HAAR, *Pharm. Weekbl.*, 1911, 48, 1302; DAVID, *Pharm. Post.*, 1915, 48, 1; DE WAAL, *Pharm. Weekbl.*, 1915, 52, 1423; SCHMIDT, *Amer. J. Pharm.*, 1919, 91, 270; DIETERLE, *Arch. Pharm.*, 1923, 261, 85; RAURICH, *Anal. Fis. Quim.*, 1926, 24, 647, 665, 668; ALBANESE and PEDRONI, *Ann. Chim. Applic.*, 1928, 18, 429; NEUGEBAUER and BRUNNER, *Pharm. Zeit.*, 1933, 78, 1077; 1937, 82, 1212 (microchemical); GREEN, *Bull. Nat. Form. Comm.*, 1942, 10, 288; 1944, 12, 169; COPLEY, *Ibid.*, 1946, 14, 149; BROCHMANN-HANSEN, *Med. fra. Norsk. farm. selsk.*, 1944, 6, 149; 1946, 8, 2; HAMMOND, *Pharm. Arch.*, 1944, 15, 56 (a review); AWE, *Apoth. Zeit.*, 1937, 52, 1359. (8) *Pharm. J.*, 1862, [ii], 3, 546. (9) *Silliman's J.*, 1863, 36, 57. (10) *Ber.*, 1887, 20, 88. (11) *Rec., trav. Chim.*, 1886, 5, 291. (12) *J. Chem. Soc.*, 1910, 97, 1334; cf. FREUND and WILL, *Ber.*, 1886, 19, 2797; KEENAN, *J. Amer. Pharm. Assoc.*, 1948, 37, 41. (13) GAEBEL, *Arch. Pharm.*, 1910, 248, 207. (14) *Ber.*, 1887, 20, 88. (15) See also REICHARD, *Pharm. Zentr.*, 1911, 52, 1253; STENBERG, *Svensk. Farm. Tidskr.*, 1940, 44, 309; KIRKPATRICK, *Quart. J. Pharm.*, 1946, 19, 8. (16) FREUND and WILL, *Ber.*, 1887, 20, 88, 2400; see also FREUND, 1889, 22, 456, 1156; cf. MCGEOGH and STEVENS, *J. Chem. Soc.*, 1934, 1465. (17) *Annalen*, 1888, 249, 172; cf. FREUND, *Ber.*, 1889, 22, 2329; *Annalen*, 1892, 271, 320; (with LACHMAN), *Ber.*, 1889, 22, 2322. (18) Cf. ROSSIN, *Monats.*, 1892, 12, 486. (19) Syntheses of hydrastic acid have been effected by PERKIN and ROBINSON, *J. Chem. Soc.*, 1907, 1086; and STEVENS and ROBERTSON, *ibid.*, 1927, 2790. (20) *Annalen*, 1895, 286, 18. (21) FREUND, *Ber.*, 1887, 20, 2403. (22) German Patent 267,272 (*Chem. Soc. Abstr.*, 1914, [i], 79). (23) *J. Chem. Soc.*, 1904, 85, 1006; cf. STEINER, *Bull. Soc. chim. biol.*, 1924, 6, 231; and HOPE and ROBINSON, *J. Chem. Soc.*, 1911, 99, 2118. (24) *Ibid.*, 1912, 101, 1595; cf. TOPTSCHIEV, *J. Appl. Chim. Russ.*, 1933, 6, 529. (25) FREUND, German Patents, 241,136, 242,217, 242,573, 259,873 (Merck) (*Chem. Soc. Abstr.*, 1912, [i], 383, 487; 1913, [i], 1095); and *Annalen*, 1913, 397, 30. (26) DECKER and collaborators, German Patents, 234,850, 245,523, 267,699 (*Chem. Soc. Abstr.*, 1911, [i], 906; 1914, [i], 198). For other similar syntheses of hydrastinine and its homologues or related substances see DECKER and collaborators, *Ber.*, 1909, 42, 2075; *Annalen*, 1913, 395, 299, 321, 328, 342; PICTET and KAY, *Ber.*, 1909, 42, 1973; FREUND, *ibid.*, 1911, 44, 2356; KAUFMANN and collaborators, *ibid.*, 1913, 46, 2929; 1916, 49, 675; 1917, 50, 1630; E. MERCK, German Patents 279,194, 280,152 (*Chem. Soc. Abstr.*, 1915, [i], 709, 710); ROSENMUND, *Ber. Deut. Pharm. Ges.*, 1919, 29, 200; German Patents 320,840, 336,153 (*Chem. Soc. Abstr.*, 1920, [i], 680; 1921, [i], 587); VON BRAUN, *Ber.*, 1923, 56, 690; Soc. Chem. Ind. Basle; British Patent 191,233 (*Chem. Soc. Abstr.*, 1923, [i], 371); HAWORTH, PERKIN and PINK, *J. Chem. Soc.*, 1925, 127, 1721; KINDLER *et al.*, *Arch. Pharm.*, 1927, 265, 389; 1932, 270, 353; KITASATO, *Acta Phytochim (Jap.)*, 1927, 3, 325; GRYSZKIEWICZ-TROCHIMOWSKI, *Arch. Chem. Farm.*, 1935, 2, 148; TOMITA and SATOMI, *J. Pharm. Soc. Jap.*, 1938, 58, 165; DEY and GOVINDACHARI, *Current Sci. (India)*, 1944, 13, 203. (27) *Ber.*, 1889, 22, 2337. (28) ROSER, *Annalen*, 1889, 254, 357; FREUND and ROSENBERG, *Ber.*, 1890, 23, 404; FREUND, *Annalen*, 1892, 271, 311; SCHMIDT, *Arch. Pharm.*, 1893, 231, 541; RABE and McMILLAN, *Annalen*, 1910, 377; 223. (29) *Proc. Chem. Soc.*, 1912, 28, 17. (30) *J. Chem. Soc.*, 1931, 286. (31) *Ibid.*,

1934, 1315. (32) For pharmacological work on hydrastine and hydrastinine see JOACHIMOGLU and KEESER, *Heftter's Handbuch der Pharmakol.*, 1924, 2, 2, 1120; BAYLE and FABRE, *Compt. rend.*, 1925, 180, 605; BERNARDBEIG and CAUJOLLE, *Compt. rend. Soc. Biol.*, 1935, 119, 1299; WELCH and HENDERSON, *J. Pharm. Exp. Ther.*, 1934, 51, 482.

ALKALOIDS OF THE RHEADALES

The natural order Rhœadales includes the two botanical families Papaveraceæ and Fumariaceæ, which between them yield a great variety of alkaloids belonging to several types, but all, so far as they have been investigated, derivable from isoquinoline. Some of the alkaloids, notably protopine, occur frequently in genera of both families and the alkaloidal types common to both are numerous enough to make it convenient to deal with the alkaloids of both families in one section. In the following distribution list the more important alkaloids are described later, but brief descriptions are given of the minor alkaloids. A considerable number of the alkaloids in this section have been recorded as new and subsequently found to be already known. In such cases the names of the known alkaloids are given in brackets or *vice versâ*, as may be more convenient for the text.

- (1) *Adlumia fungosa* Greene (*A. cirrhosa* Rap). Adlumidine, *d*-adlumine, bicuculline, protopine.¹ According to Schlotterbeck,² α -allo-cryptopine and a base, m.p. 176–7°, are also present.
- (2) *Argemone alba* Lestib. Berberine; base, picrate, m.p. 232–5°.³
- (3) *A. hispida*. Bases, (a) C₁₇H₁₃(₁₅)N(OH)(OMe)₃, m.p. 238°, [α]_D²⁵ –77·5°(CHCl₃), phenolic, benzoyl derivative, m.p. 124–5°.
(b) C₁₇H₁₃N(OMe)₄, m.p. 152·5–153°, [α]_D²⁵ –214·2° (EtOH) or –187·9° (CHCl₃), picrate, m.p. 242·5°; styphnate, m.p. 247–9°; methiodide, m.p. 273–4° (*dec.*); non-phenolic. (c) Amorphous, ether-soluble. (d) Amorphous, ether-insoluble.^{3(a)}
- (3a) *A. mexicana* L. Berberine, protopine (argemonein-).⁴
- (4) *Bocconia arborea* Wats. Chelerythrine, *allo*cryptopine, protopine; Base, P61, C₁₈H₁₀O₃(OMe)₂(NMe), m.p. 210°, isomeric with and closely related to chelerythrine; also three neutral, nitrogenous substances: A, C₂₀H₁₇O₄N, m.p. 302°; B, C₂₀H₁₅O₄N, m.p. 191°; C, C₃₁H₃₃O₅N, m.p. 332°. (Manske.)⁵
- (5) *B. cordata* Willd. Chelerythrine, α -allo-cryptopine, protopine, sanguinarine (?).^{5(a)}
- (6) *B. frutescens* L. Chelerythrine (?), α - and β -allo-cryptopine, protopine.^{5(b)}
- (6a) *B. pearcei* Hecht. Chelerythrine. One per cent. in bark; none in tissues.^{5(c)}
- (6b) *Ceratocapnos* spp. Protopine (Battandier,^{5(b)} 1891).
- (7) *Chelidonium majus* L. This much investigated plant⁶ contains alkaloids of two main types: (a) chelerythrine, chelidonine, α -homochelidonine, oxychelidonine, methoxychelidonine and sanguinarine; (b) α - and β -allo-cryptopine, and protopine. In addition, berberine⁷ and sparteine⁸ have been recorded and a

base, $C_{19}H_{24}ON_2$, m.p. 198–9°, $[\alpha]_D -40.7$, diaurichloride, m.p. 122–4°, phenolic, both nitrogens tertiary.⁹

- (8) *Corydalis ambigua* Cham. and Sch. Corybulbine, corydaline, dehydrocorydaline, protopine. *Bases*:—(I). A quaternary chloride, $C_{20}H_{18}O_4NCl \cdot 2H_2O$; red needles; reducible to a tertiary, tetrahydro-base, $C_{20}H_{21}O_4N$, greyish needles, m.p. 218–9°. (II) Greyish-white needles, m.p. 197–9° (Makoshi).¹⁰

Chou *et al.*¹¹ have isolated thirteen alkaloids of which the following ten appear to be new :

- B $C_{20}H_{23}O_4N$, m.p. 148–9°, $[\alpha]_D \pm 0^\circ$.
 D $C_{19}H_{16}O_4N$, m.p. 204°, $[\alpha]_D^{25^\circ} - 295^\circ$.
 E Silky needles, m.p. 219°.
 F $C_{20}H_{23}O_4N$, m.p. 237°, $[\alpha]_D^{25^\circ} - 250^\circ$: *l*-corypalmine (?).
 H B. HBr, yellow prisms, m.p. 235°, $[\alpha]_D \pm 0^\circ$.
 I M.p. 104°, $[\alpha]_D^{25^\circ} + 112.5^\circ$.
 J $C_{30}H_{36}O_5N_2$, prismatic needles, m.p. 118°; $[\alpha]_D^{25^\circ} + 125^\circ$.
 K $C_{21}H_{25}O_4N$, m.p. 225°, $[\alpha]_D - 250^\circ$.
 L $C_{19}H_{21}O_4N$, m.p. 236°; $[\alpha]_D^{25^\circ} - 325^\circ$.
 M $C_{21}H_{24}O_5N$, m.p. 161°, $[\alpha]_D \pm 0^\circ$ (β -homochelidonine ?).¹¹

According to Huang-Minlon,¹² Makoshi's base¹⁰ (I) is coptisine, while Chou's base, B, is *dl*-tetrahydropalmatine and D and E are *l*- and *dl*-tetrahydrocoptisine respectively.

- (9) *C. aurea* Willd. Huang-Minlon¹² has suggested that Heyl's base, m.p. 148–9°, is *dl*-tetrahydropalmatine. Manske¹³ has recorded the following: aurotensine (*d*- and *dl*-scoulerine), bicucine, bicuculline, capauridine, capaurine, cordrastine, corydaline, α -allocryptopine, protopine, *l*- and *dl*-tetrahydropalmatine, and *bases*: F 24, $C_{16}H_{13}N(OH)(OMe)_3$, m.p. 138°; F 28, $C_{15}H_{12}N(OH)(OMe)_2$, m.p. 135°, F 57 (see *C. montana*); seeds contain corypalline.
- (10) *C. caseana* A. Gray. Bicuculline, caseanine (*l*-tetrahydropalmatine), corypalmine, *l*- and *dl*-isocorypalmine, casealutine (*l*-isocorypalmine), α -allocryptopine, protopine, *l*-scoulerine and *bases*: F 33, $C_{17}H_{15}O_2N(MeO)_2$, m.p. 257°, phenolic; F 35, $C_{17}H_{13}N(OH)(OMe)_3$, m.p. 145°; methyl ether, m.p. 186°.¹⁴
- (11) *C. cheilantheifolia* Hemsl. Berberine, *l*-canadine, *l*-cheilanthifoline, *l*-corypalmine, allocryptopine, protopine, *l*- and *dl*-stylophine and a neutral, nitrogenous substance, $C_{21}H_{18}O_8N_2$, m.p. > 360°, no methoxyl.¹⁵
- (12) *C. claviculata* (L.) DC. Cularine, protopine, *l*- and *dl*-stylophine and *base*, F 52, amorphous, phenolic, methylated to cularine (Manske).¹⁶
- (12a) *C. cornuta* Royle. Protopine, stylophine and two unidentified bases; acetyrnithine is also present.^{16(a)}
- (13) *C. crystallina* Engelm. Bicuculline, capnoidine, protopine.¹⁷
- (14) *C. decumbens* Pers. According to Asahina and Motigase¹⁸ the tubers from which Makoshi¹⁰ isolated dehydrocorydaline and protopine were those of *C. decumbens* and not *C. Vernyi*, as that author

- supposed. Osada²⁰ isolated bulbocapnine, protopine *d*-tetrahydropalmitine, and two *bases*, (a) phenolic, m.p. 205°, and (b) non-phenolic, m.p. 228–230°. A further phenolic base, m.p. 175°, was recorded by Asahina, which Manske suggests may be bicuculline.¹⁸
- (15) *C. lutea* (L.) DC. *isoCorydine* (luteanine), *l-isocorypalmine*, ochrobirine, protopine, *l-stylopine*, *l-tetrahydropalmitine*.²¹
 - (16) *C. micrantha* (Engelm.) Gray. Capauridine, capaurine, protopine, scoulerine, *l-tetrahydropalmitine*: *bases*, F 41, m.p. 177°; F 42, m.p. 239°; F 43, C₁₇H₁₄ON(OMe)₃, m.p. 230° (*dec.*), all phenolic.¹⁷
 - (17) *C. montana* (Engelm.) Britton. Capauridine, capaurimine, capaurine, corydaline, protopine, scoulerine, *dl-tetrahydropalmitine*: *bases*, F 56, C₁₉H₁₅O₂N(OMe)₄, m.p. 207°; F 57, reduction product of a quaternary, amorphous base; C₁₅H₁₂N(OMe)₃, m.p. 129° (Manske²²).
 - (18) *C. nobilis* Pers. Bicuculline, corlumine, *d-isocorypalmine*, corytuberine, cryptopine, protopine, stylopine (tetrahydrocoptisine), *d-* and *dl-tetrahydropalmitine*; *bases*, F 53, C₁₇H₁₇O₄N, m.p. 183°; F 54, C₁₇H₁₇O₃N(OMe)₂, m.p. 143°, phenolic; F 55, m.p. 209°, phenolic.²³
 - (19) *C. ochotensis* Turcz. Aurotensine (*d-* and *dl-scoulerine*), cryptocavine, ochotensimine, ochotensine, protopine: *base* F 49, C₁₈H₂₀O₃N(OMe), m.p. 228° (*dec.*), phenolic. Acetylornithine is also present.²⁴
 - (20) *C. ochroleuca* Koch. Bicuculline, *l-corypalmine*, *l-isocorypalmine*, ochrobirine, protopine, *l-tetrahydropalmitine*: *base*, F 45, C₂₀H₁₉O₈N, m.p. 268° (*dec.*), phenolic, no methoxyl groups; F 46, C₁₁H₉O₂N, 1/2 H₂O, m.p. 227°, not phenolic, contains a dioxymethylene but no methoxyl group.²⁵
 - (21) *C. ophiocarpa* Hook. *l-Adlumine*, berberine, *l-canadine*, *l-corypalmine*, cryptocavine, *α-allo*cryptopine, ophiocarpine, protopine: *base*, F 40, m.p. 196°.²⁶
 - (22) *C. pallida* Pers. Capauridine, capaurimine, capaurine, corypalline, protopine, *d-* and *dl-tetrahydropalmitine*: *base*, F 51, C₁₇H₁₃N(OH)(OMe)₃, m.p. 171°; methylates to *dl-tetrahydropalmitine*.²⁷
 - (23) *C. platycarpa* Makino. Aurotensine (*d-* and *dl-scoulerine*), bicuculline, corybulbine, *isocorydine*, corydaline, *l-isocorypalmine*, protopine, *dl-stylopine* (tetrahydrocoptisine), *l-tetrahydropalmitine*, also a neutral nitrogenous substance, C₆H₉ON, m.p. 172°.²⁸
 - (24) *C. scouleri* HK. *l-Adlumine*, bicuculline, capnoidine, cheilanthifoline, corlumidine, corlumine, cryptopine, *α-allo*cryptopine, protopine, scoulerine.²⁹
 - (25) *C. sempervirens* (L) Pers. *l-Adlumine*, bicuculline, capnoidine, cryptopine, protopine; *base*, F 20, C₁₈H₂₃O₅N, m.p. 221°, no methoxyl.³⁰
 - (26) *C. sibirica* Pers. Bicuculline, cheilanthifoline, corlumine, cryptopine, ochotensine, ochrobirine, protopine, scoulerine. *Bases*: F 15,

- $C_{17}H_{13}O_3N(MeO)_2$, m.p. 212° ; F 16, $C_{16}H_{11}O_3N(MeO)_2$, m.p. 236° .³¹ Acetylornithine is also present.²⁴
- (27) *C. solida* Sm. Bulbocapnine, protopine. *Bases*: (a) m.p. 145° ; (b) m.p. 132° .³²
- (28) *C. ternata* Nakai. *l*-Canadine, *l*-corydine, *isocorydine*, *allocryptopine*, *glaucaine*, protopine, tetrahydrocoptisine.³³
- (29) *C. thalictrifolia* Franch. Adlumidine, *l*-corypalmine, protopine, *d*-stylopine (tetrahydrocoptisine), *d*-thalictrifoline and dehydrothalictrifoline. *Bases*: F 59, $C_{19}H_{20}O_3N(MeO)$, m.p. 176° , solidifying and re-melting at 192 – 200° ; F 60, $C_{19}H_{18}O_2N(MeO)$, m.p. 123° (*dry*), and three amorphous; (1) methylated to $C_{18}H_{15}O_2N(OMe)_2$ m.p. 163° ; (2) methylated to (F 60); (3) methylated to $C_{18}H_{15}O_2N(OMe)_2$, m.p. 167° ,^{33(a)} but not identical with (1).
- (31) *C. tuberosa* DC. (*C. cava* Schwg.). Bulbocapnine,³⁴ α -canadine,³⁵ corybulbine,³⁴ *isocorybulbine*,³⁶ corycavamine,³⁷ corycavidine,³⁸ corycavine,³⁴ corydine,³⁹ corydine,⁴⁰ dehydrocorydaline,⁴¹ *d*-corypalmine,⁴² corytuberine,⁴³ 2 : 9-dihydroxy-3 : 10-dimethoxy-tetrahydroprotuberberine⁴⁴ (scoulerine), *glaucaine*,⁴⁵ hydrohydrastinine,⁴⁶ protopine,⁴⁵ *d*-tetrahydrocolumbamine,⁴⁴ tetrahydrocoptisine, tetrahydropalmatine.⁴² *Bases*: (a) $C_{21}H_{23}O_5N$, m.p. 121° , non-phenolic³⁵; (b) $C_{21}H_{21}O_6N$, m.p. 230° , $[\alpha]_D^{20} - 112.8^\circ$, no methoxyl groups; (c) $C_{18}H_{14}(16)O_5(NMe)(OMe)_2$, m.p. 137.5° , $[\alpha]_D^{20} + 96.8^\circ$ ⁴⁷; (d) $C_{17}H_{13}N(CH_2O)_2$, corydaline type.⁴⁸
- (32) *Dactylicapnos macrocapnos* Hutchinson. *alloCryptopine*, protopine, *l*- and *dl*-stylopine.⁴⁹
- (33) *Dicentra canadensis* Walp. Bulbocapnine, corydine, *isocorydine*, protopine. *Base* F 22, $C_{27}H_{40}O_{10}N_2$, m.p. 237 – 8° , yields a quaternary chloride, $C_{34}H_{30}O_6N_2Cl(OMe)_3$, m.p. 286° .⁵⁰
- (34) *D. chrysantha* Walp. Bicuculline, chrycentrine, cryptocavine, cryptopine, protopine. *Base* F 25, $C_{18}H_{14}O_6(NMe)$, m.p. 230° , phenolic and lactic.⁵¹
- (35) *D. cucullaria* (L) Bernh. Bicuculline, corlumine, cryptopine, α -*allocryptopine*, cularidine, cularine, ochotensine, protopine. Manske was unable to confirm from his specimen the presence of cucullarine recorded by Black *et al.*⁵²
- (36) *D. eximia* (Ker) Torr. *d*-Corydine, cularine, *d*-dicentrine, eximidine, glaucentrine, *d*-glaucaine, protopine. *Bases*: F 21, $C_{16}H_{13}ON(OMe)_4$, m.p. 80° , B. HCl, m.p. 256° ; F 29, $C_{17}H_{13}N(OH)_2(OMe)_2$, m.p. 262° , dimethyl ether, m.p. 177° , B. HCl, m.p. 236 – 7° ; F 30, $C_{16}H_{12}ON(OMe)_2$, m.p. 102° , is probably *N*-demethylcularine.⁵³ Manske has identified his "eximine" as *d*-corydine and that of Eggleston *et al.* as *d*-dicentrine.
- (37) *D. formosa* Walp. *d*-Corydine, corytuberine, cularine, dicentrine glaucentrine, *d*-glaucaine, protopine.⁵⁴
- (38) *D. ochroleuca* Engelm. Bicuculline, cryptopine, protopine.⁵¹
- (39) *D. oregana* Eastwood. Corydine, *l*-corypalmine, α -*allocryptopine*, cularine, dicentrine, glaucentrine, glaucaine, protopine.⁵⁵

- (40) *D. pusilla* Sieb. and Zucc. Dicentrine, protopine.⁵⁶
- (41) *D. spectabilis* L. Protopine only (Manske).⁵¹ Base, m.p. 142–5° and possibly sanguinarine and chelerythrine.⁵⁷
- (42) *Dicranostigma franchetianum* (Prain) Fedde. Chelidonine, protopine, *dl*-stylophine (tetrahydrocoptisine).⁵⁸
Dielytra, see Dicentra.
- (43) *Eschscholtzia californica* Cham. Chelerythrine, α - and β -*allocryptopine*, protopine, sanguinarine. *Bases*: (a) m.p. 242–3°; (b) m.p. 217°.⁵⁹ In roots from Brittany only ionidine, C₁₉H₂₅O₄N₄, m.p. 154–5°.⁶⁰
- (44) *Fumaria officinalis* L. Aurotensine (*d*- and *dl*-scoulerine), cryptocavine, protopine, *l*- and *dl*-sinactine, *dl*-tetrahydrocoptisine. *Bases*: F 37, C₁₉H₁₇O₃N(MeO)₂, m.p. 177°; F 38, C₂₀H₁₈O₅N(OH), m.p. 256°; phenolic, probably a phthalideisoquinoline.⁶¹
- (45) *Glaucium corniculatum* Curt. Protopine.⁶²
- (46) *G. fimbrilligerum*. Chelerythrine, corydine, *allocryptopine*, protopine, sanguinarine.⁶³
- (47) *G. flavum* Crantz. Aurotensine (*l*- and *dl*-scoulerine), *isocorydine* (luteanine), glaucine, protopine. *Base*, F 47, m.p. about 280°. Manske was unable to confirm the presence of chelerythrine or sanguinarine.⁶⁴
- (48) *G. serpierei* Heldr. Aurotensine (*l*- and *dl*-scoulerine), *isocorydine*, glaucine, protopine. *Base*, partly converted to *dl*-sinactine by diazomethane (Manske).⁶⁵
- (49) *Hunnemannia fumariæfolia* Sweet. *allo*Cryptopine, hunnemannine, protopine. *Base*, F 58, C₂₀H₁₅O₃N(MeO)₂, m.p. 174° (Manske).⁶⁶
- (50) *Hypecoum procumbens* L. Protopine (Schmidt).⁶¹
- (50a) *H. erectum* var. *typicum*. Unspecified alkaloids, 0.18 per cent.^{61(a)}
- (51) *Papaver armeniacum*, Armepavine.⁶⁷
- (52) *P. dubium* L. Aporeidine and aporeine.⁶⁸
- (53) *P. floribundum*. Armepavine, floribundine, floripavidine and floripavine.⁶⁹
- (54) *P. hybridum* L. Rhœadine.⁷⁰
- (55) *P. lateritium* L. Amorphous, phenolic bases.⁷¹
- (56) *P. orientale* L. Glaucidine, protopine, thebaine, *isothebaine*; ⁷² oripavine.⁶⁷
- (57) *P. Rhœas* L. Rhœadine.⁷⁰
- (58) *P. somniferum* L. Opium poppy (see list, p. 178).
- (58a). *Petrocapnos* spp. Protopine (Battandier,^{5(b)} 1891).
- (59) *Ræmeria refracta* D.C. Ephedrine, *d*- ψ -ephedrine, *ræmerine*.⁷³
- (60) *Sanguinaria canadensis* L. Chelerythrine, α - and β -*allocryptopine*, protopine, sanguinarine, oxysanguinarine.⁷⁴
- (60a). *Sarcocapnos* spp. Protopine (Battandier,^{5(b)} 1891).
- (61) *Stylophorum diphyllum* Nutt. Chelidonine, protopine, *l*-stylophine. Schlotterbeck and Watkins also recorded diphylline, m.p. 216°, which Manske suggests is *dl*-stylophine (tetrahydrocoptisine), and sanguinarine, which Manske could not confirm.⁷⁵

REFERENCES

- (1) MANSKE, *Can. J. Res.*, 1933, 8, 210. (2) SCHLOTTERBECK, *Amer. Chem. J.*, 1900, 24, 249; (with WATKINS), *Pharm. Archiv.*, 1903, 6, 17. (3) FOOTE, *J. Amer. Pharm. Assoc.*, 1932, 12, 246. (3a) SOINE and GISVOLD, *ibid.*, 1944, 33, 185. (4) SCHLOTTERBECK, *J. Amer. Chem. Soc.*, 1902, 24, 238; SANTOS and ADKILLEN, *ibid.*, 1932, 54, 2923; de ALMEIDA, *Brit. Chem. Abstr.*, 1936, A, 652. (5) MANSKE, *Can. J. Res.*, 1943, B, 21, 140. (5a) ELJKMANN, *Rec. trav. Chim.*, 1884, 3, 12; HOPFGARTNER, *Monats.*, 1898, 19, 179; SCHLOTTERBECK (with MURRILL), *Ber.*, 1900, 33, 2802; (with BLOME), *Pharm. Rev.*, 1905, 23, 310; SCHMIDT, *Arch. Pharm.*, 1901, 239, 401; MOMOYA, *J. Pharm. Soc. Jap.*, 1919, No. 444. (5b) BATTANDIER, *Compt. rend.*, 1891, 114, 1122; 1895, 120, 1276; *J. Pharm. Chim.*, 1891, 24, 350; MILLER, *J. Amer. Pharm. Assoc.*, 1929, 18, 12. (5c) MACCIO, *Arch. pharm. y bioquim. Tucuman Arg.*, 1946, 3, 27. (6) GODEFROY, *J. Pharm.*, 1824, 10, 635; PROBST, *Annalen*, 1839, 29, 123; WILL, *ibid.*, 1840, 35, 113; ELJKMANN, *Rec. trav. Chim.*, 1884, 3, 182; SCHMIDT and SELLE, *Arch. Pharm.*, 1890, 228, 96, 441; WINTGEN, *ibid.*, 1901, 239, 438; SCHMIDT, *ibid.*, p. 395; SCHLOTTERBECK, *Amer. J. Pharm.*, 1902, 74, 584. (7) GADAMER, *Apoth. Zeit.*, 1924, 39, 1569. (8) SPÄTH and KUFFNER, *Ber.*, 1931, 64, 1127. (9) GADAMER and WINTERFELD, *Arch. Pharm.*, 1924, 262, 589. For estimations of alkaloids see NEUGEBAUER and BRUNNE, *Apoth. Zeit.*, 1937, 52, 1038; AWE and NEHRlich, *Sud-deut. Apoth. Zeit.*, 1939, 79, 429. (10) *Arch. Pharm.*, 1908, 246, 381. (11) *Chin. J. Physiol.*, 1928, 2, 203; 1929, 3, 69, 301; 1933, 7, 35; 1934, 8, 155; 1936, 10, 537. (12) HUANG-MINLON, *Ber.*, 1936, 69, 1727; cf. HEYL, *Apoth. Zeit.*, 1910, 25, 137. (13) *Can. J. Res.*, 1933, 9, 436; 1937, 15, 159; 1938, 16, 81; cf. EPPSON, *J. Amer. Pharm. Assoc.*, 1935, 24, 113 (see also Ref. 27). (14) MANSKE and MILLER, *Can. J. Res.*, 1938, B, 16, 153; 1939, B, 17, 94; 1940, 18, 288. (15) *ibid.*,* 1942, B, 20, 57. (16) *Ibid.*, 1940, B, 18, 97. (16a) *Ibid.*, 1946, B, 24, 66. (17) *Ibid.*, 1939, B, 17, 57. (18) *J. Pharm. Soc. Japan*, 1920, No. 463, 766; cf. *Can. J. Res.*, 1933, 8, 142. (19) *Arch. Pharm.*, 1908, 246, 401; cf. SCHMIDT, *ibid.*, p. 575. (20) *J. Pharm. Soc. Japan*, 1927, No. 547, 99, 100, 102, 104. (21) *Can. J. Res.*, 1939, B, 17, 89; 1943, 21, 13. (22) *Ibid.*, 1942, B, 20, 49. (23) *Ibid.*, 1940, B, 18, 288, cf. BIRSMANN, *Inaug. Diss. Dorpat*, 1892 (*Chem. Soc. Abstr.*, 1893, i, 446). (24) *Can. J. Res.*, 1940, B, 18, 75. (25) *Ibid.*, 1939, B, 17, 95. (26) *Ibid.*, 1939, B, 17, 51. (27) *Ibid.*, 1940, B, 18, 80 and ref. (13). (28) *Ibid.*, 1943, B, 21, 13. (29) *Ibid.*, 1936, B, 14, 347; 1940, B, 18, 100. (30) *Ibid.*, 1933, 8, 407; 1938, B, 16, 89. (31) *Ibid.*, 1936, B, 14, 354; 1938, B, 16, 89; 1940, B, 18, 100. (32) HAARS, *Arch. Pharm.*, 1905, 243, 154; HEYL, *Apoth. Zeit.*, 1910, 25, 36. (33) Go, *J. Pharm. Soc. Japan*, 1929, 49, 125; 1930, 50, 122. (33a) MANSKE, *Can. J. Res.*, 1943, B, 21, 111. (34) FREUND and JOSEPHI, *Ber.*, 1892, 25, 2411; *Annalen*, 1893, 277, 1. (35) GADAMER and KNÖRCK, *Apoth. Zeit.*, 1926, 41, 928. (36) GADAMER and ZIEGENBEIN, *Arch. Pharm.*, 1902, 240, 19. (37) *Ibid.*, pp. 23, 83. (38) GADAMER, *ibid.*, 1911, 249, 30. (39) MERCK, *ibid.*, 1893, 231, 131; GADAMER and ZIEGENBEIN, 1902, 240, 94. (40) WACKENRODER, *Berz. Jahrb.*, 1826, 7, 220. (41) SCHMIDT, *Arch. Pharm.*, 1908, 246, 575. (42) SPÄTH, MOSETTIG and TROTHANDL, *Ber.*, 1923, 56, 877, cf. ref. (35). (43) DOBBIE and LAUDER, *J. Chem. Soc.*, 1893, 63, 485. (44) GADAMER, SPÄTH and MOSETTIG, *Arch. Pharm.*, 1927, 265, 675, cf. ref. (35). (45) GADAMER, *ibid.*, 1911, 249, 224. (46) SPÄTH and JULIAN, *Ber.*, 1931, 64, 1131. (47) HAARS, *Arch. Pharm.*, 1905, 243, 154. (48) GADAMER, *Festsch. A. Tschirch*, 1926, 86 (*Chem. Zentr.*, 1927, i, 2558). (49) *Can. J. Res.*, 1943, B, 21, 117. (50) *Ibid.*, 1932, 7, 258; 1938, 16, 81. (51) *Ibid.*, 1937, B, 15, 274. (52) *Ibid.*, MANSKE, 1932, 7, 265; 1938, 16, 81, cf. FISCHER and SOELL, *Pharm. Archiv.*, 1902, 5, 121; BLACK, EGGLESTON, KELLY and TURNER, *J. Agr. Res.*, 1923, 23, 55. (53) MANSKE, *Can. J. Res.*, 1933, 8, 592; 1934, 10, 521; 1938, 16, 81; EGGLESTON, BLACK and KELLY, *J. Agr. Res.*, 1929, 39, 477. (54) *Can. J. Res.*, 1934, 10, 521; cf. HEYL, *Arch. Pharm.*, 1903, 241, 313; ASAHINA, *ibid.*, 1909, 247, 201. (55) *Can. J. Res.*, 1934, 10, 765; 1936, B, 14, 348. (56) ASAHINA,⁵⁴ OSADA, *J. Pharm. Soc. Japan*, 1928, 48, 85. (57) GADAMER, *Apoth. Zeit.*, 1901, 16, 621; DANCKWORTT, *Arch. Pharm.*, 1912, 250, 613; 1922, 260, 94. (58) *Can. J. Res.*,

* In this and later references to *Can. J. Res.* the author is R. H. F. Manske.

1942, B, 20, 53. (59) FISCHER, *Arch. Pharm.*, 1901, 239, 421 (with TWEEDEN) *Pharm. Archiv.*, 1902, 5, 117. (60) BRINDEJONC, *Bull. Soc. Chim.*, 1911, [iv], 9, 97. (61) *Can. J. Res.*, 1938, B, 16, 438; 1940, B, 18, 100; cf. SCHMIDT, *Arch. Pharm.*, 1901, 239, 395. BATTANDIER,^{5(b)} (61a) EFROS, *Farmatsiya*, 1946, 9, No. 5, 22. (62) BATTANDIER, *Compt. rend.*, 1892, 114, 1122, cf. SCHMIDT.⁶¹ (63) KONOVALOVA, JUNUSOV and OREKHOV, *J. Gen. Chem. Russ.*, 1939, 9, 1939 (*Brit. Chem. Phys. Abstr.*, 1940, A iii, 550). (64) MANSKE, *Can. J. Res.*, 1939, B, 17, 399; 1943, B, 21, 13; cf. BATTANDIER, *J. Pharm. Chim.*, 1891, 24, 350; PROBST, *Annalen*, 1839, 31, 250; FISCHER,⁵⁹ GADAMER, *Arch. Pharm.*, 1911, 249, 680. (65) *Can. J. Res.*, 1942, B, 20, 53. (66) With MARION and LEDINGHAM, *J. Amer. Chem. Soc.*, 1942, 64, 1659. (67) JUNUSOV, KONOVALOVA and OREKHOV, *Ber.*, 1935, 68, 2158; *J. Gen. Chem. Russ.*, 1940, 10, 641. (68) PAVESI, *Chem. Soc. Abstr.*, 1905, i, 368; 1907, i, 870. (69) KONOVALOVA, JUNUSOV and OREKHOV, *Ber.*, 1935, 68, 2277. (70) PAVESI, *Chem. Soc. Abstr.*, 1906, ii, 483; cf. HESSE, *Annalen*, 1866, 140, 146, and AWE, *Forst Forschrifte*, 1939, 15, 117. (71) GADAMER and KLEER, *Arch. Pharm.*, 1911, 249, 39. (72) KLEE, *ibid.*, 1914, 252, 211; GADAMER, *ibid.*, p. 274. (73) KONOVALOVA, JUNUSOV and OREKHOV, *Bull. Soc. Chim.*, 1939, [v], 6, 811; see also *Brit. Chem. Physiol. Abstr.*, 1939, Aii, 565; 1940, Aii, 111, 197. (74) KÖNIG and TIETZ, *Arch. Pharm.*, 1893, 231, 145, 175; FISCHER, *ibid.*, 1901, 239, 409; BAUER and HEDINGER, *ibid.*, 1920, 258, 167; SCHLEMMER and GEMPP, *ibid.*, 1938, 276, 506; GREATHOUSE, *Plant Physiol.*, 1939, 14, 377. (75) MANSKE,⁶⁵ cf. SCHLOTTERBECK and WATKINS, *Ber.*, 1902, 35, 7.

ALKALOIDS OF OPIUM

Opium is the sun-dried latex of the unripe capsules of the opium poppy *Papaver somniferum*, L. It is produced in many tropical and sub-tropical countries, but only on a large scale in India, China, Iran, Yugoslavia, Bulgaria, Soviet Russia and Turkey. That used in medicine is mostly the Turkish and European varieties, but Indian and Iranian opiums are imported for extraction of the alkaloids. For various reasons, but mainly as the result of international efforts, centred in the League of Nations, to limit the production of opium and its alkaloids to the quantities required for legitimate use in medicine,¹ much interest has been shown in recent years in the details of the cultivation and utilisation of the opium poppy, apparently in the hope of securing more efficient control of this trade. As examples of this kind of activity reference may be made to the account given by Vrgoč of the production of opium in Macedonia,^{1(a)} Machiguchi's description of opium preparation in Japan,² and information on the modern form of "druggists'" opium produced in the Turkish Government Factory.³ Experiments in the cultivation of the opium poppy and the production of opium have often been made in Northern and Central Europe of which an account has been published by Thoms.⁴ A description of experiments in England about 1821-2 has also appeared.^{4(a)} Recent examples have been described in Denmark, Italy and Rumania,⁵ the results of which show there is no difficulty in producing opium of satisfactory morphine content in the temperate zone, though opium production in the traditional fashion is not likely to be economically possible in such areas.

A good deal of local information has also been published regarding the quality, as measured by morphine and codeine content, of the opium available in some of the producing countries, e.g., India, Iran and Man-

churia.⁶ Opium as prepared for smoking is also receiving the attention of local analysts, and methods of distinguishing between the various forms are being evolved.⁷

More interesting, as regards future developments, are the efforts now being made to dispense with opium as an intermediate in the production of morphine. The early history of experiments in the direct extraction of the alkaloid from poppy capsules and poppy straw has been recounted by Goris⁸ and by Wüest and Frey.⁹

In most European countries the opium poppy is grown either for the production of poppy-seed, to be used as a foodstuff, or, as in England, for the capsules (poppy heads) which are dried and used as domestic remedies. Though cultivation for seed is usually on a small scale in Central Europe, it is widespread and the total production is considerable. The capsules and the straw were usually burnt but in 1933 Kabay,⁹ in Hungary, devised a process for utilising this waste material for the extraction of morphine and other alkaloids. He examined material from Hungarian, Polish and Yugo-Slavian poppies and found the following ranges for content of morphine: straw 0.07 to 0.19, stems 0.01 to 0.03, leaves 0.06 to 0.07, capsules 0.23 to 0.41 per cent.

Wüest and Frey⁹ have pointed out that poppy straw has disadvantages in low yield of morphine and in bulkiness, and prefer poppy heads as a primary material. Many samples of capsules from seven countries were examined by them and found to yield from 0.18 to 0.9 per cent. of morphine, and they conclude that it should be possible to get ripe, dry capsules containing on the average 0.3 to 0.5 per cent. of morphine. Their paper includes a description of a process of analysis, which was found speedy and accurate.

Experiments in the selection of poppies for morphine production have also been made in Germany by Küssner.¹⁰ The yields from capsules of two selections, over two years, were morphine 0.257 to 0.544 per cent. and codeine 0.011 to 0.029 per cent. From seven commercial varieties grown in plots of 50 square metres, the yields in grammes per square metre were: seeds 141 to 200, capsules 65 to 116, morphine 0.123 to 0.471 and non-phenolic bases (codeine, thebaine, papaverine, narcotine, etc.) 0.043 to 0.131.

In the experiments in Australia, described by Barnard and Finnemore,¹¹ the average yield of morphine from capsules of two varieties of poppy, ranged from 0.29 to 0.39 and from 0.26 to 0.30 and from the whole plant from 0.09 to 0.16 and from 0.12 to 0.18 per cent.

For use in medicine, opium is dried, powdered and standardised to a definite content of morphine, which the British Pharmacopœia 1932 places at 10 per cent. (limits: 9.5 and 10.5), and the United States Pharmacopœia (XIII) at not less than 10 or more than 10.5 per cent.

Estimation of Morphine in Opium. The problem of determining with reasonable accuracy the percentage of morphine in opium is of importance for the standardisation of medicinal opium, as a means of fixing the price of crude opium, and of controlling factory operations in the extraction of

opium alkaloids ; it has a special interest in connection with efforts to suppress illegitimate trade in opium and its alkaloids. These varied interests have naturally led to a copious literature on the analysis of opium, which begins with a paper by Guillermond in 1828.¹² In the intervening century two principal methods have been developed due to Dieterich (Helfenberg process)¹³ and to Debourdeaux¹³ (lime-water method). Most of the literature deals with modifications designed to improve one or other of these two methods, but processes new in principle have also been developed, such as that of Mannich.^{14(a)} A useful short and critical summary of modern methods has been published by Griffiths and Whalley.¹⁴ For all ordinary purposes the assay processes described in the British (1932) and United States (XIII) Pharmacopœias and by the Commission of Experts appointed by the Health Organisation of the League of Nations¹⁴ are adequate. A list of references is given to papers published during the last twenty years on the estimation of morphine, arranged under the following heads: 14 (a) opium, 14 (b) galenical preparations of opium, (14 c) poppy plants (poppy straw and poppy-heads), 14 (d) preparations of morphine, 14 (e) biological materials. These five categories overlap to some extent. The lists do not purport to be exhaustive, but they include papers which provide bibliographies, critical comparisons, novel suggestions, or are otherwise likely to be of special interest to research workers.

Estimation of Other Alkaloids in Opium. Of the other alkaloids the most important is codeine, and processes for its estimation in opium have been described by Cęspari,¹⁵ Andrews,¹⁶ and Annett and co-workers ;¹⁷ methods for its assay in admixture with other drugs in tablets and other products are also available.¹⁸ The estimation of papaverine has been described by Issekutz,¹⁹ and of narcotine by Snesarov.²⁰ As to methods for the separation and estimation of two or more of these subsidiary alkaloids, codeine and narcotine have been dealt with by van der Wielen,^{21(a)} narcotine and papaverine by Annett and Bose,^{21(b)} and the bromination of codeine and narceine has been studied by Vaisberg^{21(b)} *et al.* with a view to estimation by this means.

The first scheme for the separation of the six chief alkaloids of opium, *viz.*, morphine, codeine, thebaine, papaverine, narcotine and narceine, is probably that of Plugge.^{21(c)} Much later Kljatschkina investigated for each of these six bases the properties by means of which isolation and estimation could probably be effected and, on the basis of the results, devised a plan for such analyses.^{21(c)} More recently Anneler has published a detailed account of a scheme with the same objective.^{21(c)} Attention had already been given to complex, systematic analyses of this kind, in connection with examination of the mixtures of opium alkaloids, which have long been in use in medicine ; in these at first only morphine and " other alkaloids " ^{21(d)} were determined, but in the more recent schemes provision is made for the estimation of each alkaloid.^{21(e)}

Mention may also be made here of some recent investigations in which comparison of physical properties of the chief opium alkaloids has been

made with a view to devising methods of separation or detection. Levi and Castelli²³ have described the procedure and the results obtained in a chromatographic separation of morphine, codeine, narcotine and papaverine. Kocsis and Hollo²³ have used observation in ultra-violet light to examine the effects of capillary analysis on mixtures of opium alkaloids, and state that only papaverine gives a sufficiently distinctive colour for detection. Csokán²⁴ has recorded extinction curves and tabulated absorption band maxima for the principal opium alkaloids, and Martini²⁵ has provided a review, with photomicrographs of crystals, of the possibilities of identifying these alkaloids by the use of microchemical reagents. The optimal conditions for polarographic determination of each of the chief opium alkaloids and of some derivatives of morphine have been investigated by Kirkpatrick^{25(a)} and a polarographic method for morphine has been developed by Rasmussen, Hahn and Ilver.^{25(a)}

The large scale on which morphine is manufactured has made it possible to conduct investigations on practically unlimited supplies of factory residues, with the result that many alkaloids have been isolated from opium, of which at present twenty-five are known. In the following table, giving their names and formulæ, they have been divided into five groups:—

(1) *Tetrahydroisoquinoline Derivatives.* Hydrocotarnine, $C_{12}H_{15}O_3N$.

(2) *Benzylisoquinoline Derivatives.*

Papaverine, $C_{20}H_{21}O_4N$

Xanthaline, $C_{20}H_{19}O_5N$

dl-Laudanine, $C_{20}H_{25}O_4N$

Laudanidine, $C_{20}H_{25}O_4N$

Codamine, $C_{20}H_{25}O_4N$

Laudanosine, $C_{21}H_{27}O_4N$

Narcotoline, $C_{21}H_{21}O_7N$

l-Narcotine, $C_{22}H_{23}O_7N$

Gnoscopine, $C_{22}H_{23}O_7N$

Oxynarcotine, $C_{22}H_{23}O_8N$

Narceine, $C_{22}H_{27}O_8N$

Xanthaline has been shown to be pavaeraldine (p. 182). The alkaloid *tritopine* is identical with laudanidine, now known to be *l*-laudanine. Gnoscopine is *dl*-narcotine. Merck's *pseudopapaverine* is papaverine.

(3) *Cryptopine type.* Protopine, $C_{20}H_{19}O_5N$. Cryptopine, $C_{21}H_{23}O_5N$.

(4) *Morphine type*

Morphine, $C_{17}H_{19}O_3N$

Codeine, $C_{18}H_{21}O_3N$

Neopine, $C_{18}H_{21}O_3N$

ψ -Morphine, $(C_{17}H_{18}O_3N)_2$

Thebaine, $C_{19}H_{21}O_3N$

Porphyroxine, $C_{19}H_{23}O_4N$

(5) *Alkaloids of Unknown Constitution.*

Aporeine, $C_{18}H_{16}O_2N$

Rhœadine, $C_{21}H_{21}O_6N$

Meconidine, $C_{21}H_{23}O_4N$

Papaveramine, $C_{21}H_{25}O_6N$

Lanthopine, $C_{23}H_{25}O_4N$

The amount of morphine in commercial opium varies from 3 to 25 per cent. In Macedonian and "Turkey" opiums the percentage is usually 15 to 21, and in the Persian drug 10 to 12. Indian opium, as prepared for smoking, may contain 4 to 6 per cent., but as exported for the manu-

facture of alkaloids, the amount may be as high as 12 per cent. The percentage of narcotine varies from 2 to 12 per cent., the Indian and Persian varieties being richest in this alkaloid. Codeine may be present to the extent of 0.5 to 4 per cent., Indian opium being the best source of this alkaloid and "Turkey" opium the poorest. The minor alkaloids are usually found in much smaller quantities: narceine 0.2, thebaine 0.4, papaverine 0.8, and the others each less than 0.1 per cent.

The processes used in the manufacture of morphine are believed to be still based on that described by the Scottish chemist Gregory,²⁶ in 1833, with improvements devised by Anderson.²⁶ A description has been published by Schwyzer,²⁷ who also deals with the manufacture of codeine, narcotine, cotarnine, and the commercially important morphine derivatives, diamorphine (diacetylmorphine), and ethylmorphine (morphine ethyl ether). More recently Barbier^{27(a)} has given an account of processes, based on long experience in the preparation of alkaloids from opium. Kanewska²⁸ has described a process for morphine, narcotine, codeine, thebaine and papaverine, and the same bases are dealt with by Chemnitius,²⁹ with the addition of narceine, by Busse and Busse,³⁰ and by Dott.³¹ It is of interest to note that a number of processes for the extraction and separation of opium alkaloids have been protected by patent in Soviet Russia.³²

Apart from these methods of producing the opium alkaloids of commercial importance, processes for the minor bases have been published by Merck,²⁶ Hesse,³³ Plugge^{21(c)} and Lohmann-Siedler.³⁴

As regards general methods for distinguishing between the alkaloids of opium, mention may be made of the following: Kofler and Kofler's study of the micro-sublimation of these alkaloids and the characters of the micro-sublimates³⁵; the comparison by Maplethorpe and Evers of the picrates of a series of opium bases,³⁶ comparison of the colour reactions of a series of opium alkaloids,³⁷ and their behaviour with specific reagents and precipitants.³⁸

Karrer and Schmid³⁹ have examined the water-soluble constituents in poppy "straw" after extraction of the alkaloids, and have recorded the presence of *p*-hydroxybenzaldehyde, vanillin, *p*-hydroxystyrene, meconin and the following acids: fumaric, *dl*-lactic, benzoic, *p*-hydroxycinnamic, *p*-hydroxybenzoic, 2-hydroxycinchonic, vanillic, phthalic, hemipinic and *m*-hemipinic, with a more highly unsaturated, carboxylic acid "J," b.p. 170–5°/0.02 mm., and three unidentified substances: *Fx*, m.p. 271–2°; *Wx*, m.p. 310° (*dec.*) and *Q*, m.p. 260°; the two latter are free from nitrogen and contain no methoxyl.

REFERENCES

- (1) See, for example, LEAGUE OF NATIONS, PERMANENT CENTRAL OPIUM BOARD. "Pre-War Production and Distribution of Narcotic Drugs and their Raw Materials," Geneva, 1944. "Limitation of the Production of Opium," *Pharm. J.*, 1945, 155, 163. "Opium," J. R. Nicholls, Royal Institute of Chemistry, London, 1938. (1a) *Arch. Pharm.*, 1929, 267, 352. (2) *J. Pharm. Soc. Jap.*, 1926, No. 529, 22. (3) *Pharm. J.*,

1936, 136, 624; cf. LAPINE, 15th Congress Indust. Chem., Brussels, 1936, 111. (4) *Arbeiten. Pharm. Inst. Universität, Berlin*, 1907, 4, 204; 1909, 6, 198; *Ber. deut. pharm. Ges.*, 1923, 33, 25. (4a) *Pharm. J.*, 1948, 160, 151. (5) (Denmark), BAGGESGAARD-RASMUSSEN and SALOMONSEN, *Dansk. Tids. Farm.*, 1936, 10, 1; JESPERSEN, *ibid.*, p. 16. (Italy), ZANDA, *Arch. Farm. Sperim.*, 1939, 67, 29; CORAZZA, *ibid.*, pp. 18, 82. (Rumania), BOTH, *Apoth in Öst.*, 1942, 1, 137 (*Chem. Abstr.*, 1944, 38, 308b). (6) (India), DUNNICLIFFE, *Nature*, 1937, 140, 92; RAKSHIT, *Ind. J. Pharm.*, 1942, 4, 53; *Sci. and Cult.*, 1942, 8, 16. (Iran), NEZAMIE, *Bull. Sci. pharmacol.*, 1940, 47, 29. (Manchuria), ARIMA and IWAKIRI, *Rep. Inst. Sci. Res. Manchoukuo*, 1938, 2, 221; (with YŌSO), 1940, 4, 375. (7) CHAKRAVARTI and MEHRSTRA, *J. Ind. Chem. Soc.*, Indust. News Edit., 1943, 6, 52; RASMDATTA, *Thai. Sci. Bull.*, 1940, 2, Nos. 3-4, p. 129 (*Chem. Abstr.*, 1941, 35, 5254). (8) *Bull. Sci. pharmacol.*, 1938, 45, 265; 1939, 46, 376. (9) *Pharm. Monats.*, 1930, 11, 73 (*Chem. Abstr.*, 1930, 24, 3322; 1931, 25, 2518). *Ber. ung. pharm. Ges.*, 1936, 12, 387; *Hungarian Pat.* 109,788 (*Chem. Abstr.*, 1934, 28, 5182); *British Pat.* 406,107; *German Pat.* 524,964; *U.S. Pat.* 2,009,181. For technical comments on the process see WÜEST and FREY, *Festschrift Barel*, 1936, 556. For comments on the possible results of this extension of the source of supply of morphine see *Lancet*, 1934, 227, 662, and *Münch. Med. Woch.*, Jan. 6, 1939, p. 39. For work in other countries see (for France) HAZARD *et al.*, *Ann. Pharm. franc.*, 1943, 1, 135. COMAR, *ibid.*, 1943, 1, 89 and (for Sweden) TELENUS, *Chem. Abstr.*, 1946, 40, 5883. (10) KUSSNER, *Merck's Jahresh.*, 1940, 54, 29 (*Chem. Abstr.*, 1941, 35, 8203); see also (for France) GUILLAUME and FAURE, *Ann. pharm. franc.*, 1946, 4, 160; (for Holland) VAN ITALLIE, *ibid.*, p. 156. (11) *Repts. Council Sci. Indust. Res.*, Australia, 1941-2, 1942-3, pp. 11; BERENS, *Chem. and Drugg.*, 1943, 139, 196; BARNARD and FINNEMORE, *J. Council Sci. Ind. Res. Aust.*, 1945, 18, 277; LOFTUS HILLS, *ibid.*, p. 286. (12) *J. Pharm. Chim.*, 1828, 14, 436. (13) DIETERICH, *Helfenberger Annalen*, 1888, 76; 1890, 63; DEBOURDEAUX, *Bull. Sci. Pharmacol.*, 1910, 17, 382; *J. Pharm. Chim.*, 1911, [viii] 4, 13, 65, 105. (14) GRIFFITHS and WHALLEY, *Chem. and Ind.*, 1940, 59, 765. An account of the work of the Commission of Experts is given in the *Quarterly Bulletin. Health Organisation, League of Nations*, 1935, 4, 809; 1938, 7, 429. (14a) JERMSTAD, *Ber. Deut. Pharm. Ges.*, 1920, 30, 398; *Norges Apotek. Tids.*, 1940, 48, 215; HOLLMAN, *Pharm. Weekbl.*, 1925, 62, 52; 1926, 63, 1337; EDER, *Festsch. A. Tschirch*, 1926, p. 392; (with MAERKI), *Pharm. Acta Helv.*, 1927, 2, 21; (with STUCKI), *ibid.*, 1932, 7, 259; (with WAECKERLIN), *Compt. rend. XII^e Cong. Int. Pharm.*, 1935, 99; *Quart. J. Pharm.*, 1937, 10, 680; *Pharm. Acta Helv.*, 1940, 15, 227; BOEHM, *Apoth. Zeit.*, 1929, 44, 88; STUBER and KLJATSCHKINA, *Arch. Pharm.*, 1930, 268, 209; 1933, 271, 217; cf. ANGELETTI, *Ann. Chim. Farm.*, 1938, 37; NORILI, *Boll. Chim. Farm.*, 1940, 79, 218; STICH, *Pharm. Zeit.*, 1930, 75, 1233; REIMERS, *Arch. Pharm.*, 1931, 269, 506; *Dansk. Tids. Farm.*, 1930, 4, 237; VAN ARKEL and VAN DER WIELEN, *Pharm. Weekbl.*, 1931, 68, 309; RAKSHIT, *Analyst*, 1931, 56, 711; *Ann. Chim. Anal.*, 1935, [iii], 17, 315; BAGGESGAARD-RASMUSSEN (with REIMERS), *Dansk. Tids. Farm.*, 1931, 5, 21, 145; 1935, 9, 229; 1937, 11, 278; *Pharm. Acta Helv.*, 1932, 7, 249; *Arch. Pharm.*, 1935, 273, 129; (with JACKEROTT and JESPERSEN), *Dansk. Tids. Farm.*, 1934, 8, 185; *Pharm. Acta Helv.*, 1936, 11, 307; (with SCHOU), *Arch. Pharm.*, 1930, 268, 673; BLISS *et al.*, *Amer. J. Pharm.*, 1933, 105, 458; 1935, 107, 193; VAN ITALLIE, *Pharm. Weekbl.*, 1934, 71, 4; LAURENCE and LABARRE, *J. Pharm. Chim.*, 1934, [viii], 20, 353; MANNICH (with HANDKE and BAUMGARTEN), *Arch. Pharm.*, 1935, 273, 97, 199; (with SCHWEDES), *Apoth. Zeit.*, 1913, 28, 82; 1942, 280, 386; cf. NICHOLLS, *Analyst*, 1937, 62, 440; LINDHOLM, *Farm. Notisbl.*, 1946, 55, 150; WALLINGFORD and HOMEYER, *J. Amer. Pharm. Assoc.*, 1936, 25, 402; WINTERFELD, DÖRLE and RAUCH, *Arch. Pharm.*, 1937, 275, 445; cf. MANNICH, *ibid.*, 1941, 279, 388; (14b) KOLTHOFF, *Pharm. Weekbl.*, 1925, 62, 106; cf. HOLLMAN, *ibid.*, 1925, 62, 52; CAINES, *Pharm. J.*, 1927, 118, 751; BAGGESGAARD-RASMUSSEN and REIMERS, *Dansk. Tids. Farm.*, 1931, 5, 21; *Pharm. Acta Helv.*, 1932, 7, 249; *Runge, Apoth. Zeit.*, 1943, 58, 142. (14c) GORIS,^a WÜEST and FREY,^b KLJATSCHKINA, *Khim. Farm. Prom.*, 1934, No. 4, 29; GINSBERG and KRASCHEVSKI, *Prom. Org. Chem.*, 1936, 2, 104; DEBUC and LELIEU, *Compt. rend. Cong. 18, Chim. Indust.*, 1938, p. 95; RASMUSSEN and ILVER, *Dansk. Tids.*

Pharm., 1945, 19, 71; TRAUTNER, *Aust. Chem. Inst. J.*, 1946, 13, 255. (14d) NICHOLLS, *Analyst*, 1922, 47, 506; 1937, 62, 440; BAGGESGAARD-RASMUSSEN and SCHOU, *Arch. Pharm.*, 1930, 268, 673; LAURENCE, *J. Pharm. Chim.*, 1930, [viii], 11, 336; DAVID, *Pharm. Zeit.*, 1931, 76, 706, 748; KLJATSCHKINA and STUBER, *Arch. Pharm.*, 1933, 271, 217; ROZENFELD, *Farm. Zhur.*, 1932, 8-9, 246; VINOGRADOVA, *J. Appl. Chim. Russ.*, 1933, 6, 150; VAN ARKEL, *Pharm. Weekbl.*, 1935, 72, 366; 1937, 74, 1934; GARRETT, *Quart. J. Pharm. Pharmacol.*, 1937, 10, 466; POETHKE, *Arch. Pharm.*, 1940, 279, 109; MATCHELT and LEVINE, *Ind. Eng. Chem. Anal. Edit.*, 1941, 13, 264; ADAMSON and HANDISYDE, *Quart. J. Pharmacol.*, 1946, 19, 350; *Analyst*, 1945, 70, 305. (14e) BALLS, *J. Biol. Chem.*, 1927, 71, 537, 543; (with WOLFF), 1928, 80, 379; KEESER and KEESER, *Arch. exp. Path. Pharm.*, 1928, 127, 230; FLEISCHMANN, *Biochem. Zeit.*, 1929, 208, 392; MAIER, *Arch. exp. Path. Pharm.*, 1931, 161, 163; RISING and LYNN, *J. Amer. Pharm. Assoc.*, 1932, 21, 334; ELLINGER and SEEGER, *Arch. exp. Path. Pharm.*, 1933, 174, 168; KEIL and KLUGE, *ibid.*, 1934, 174, 493; EMERSON, *Proc. Soc. Exp. Biol. Med.*, 1934, 31, 1004; (with MOODEY), *Univ. Calif. Pharmacol. Publ.*, 1939, 1, No. 18, p. 235; DECKERT, *Arch. exp. Path. Pharm.*, 1936, 180, 656; *Zeit. Anal. Chem.*, 1938, 112, 241; WACHSMUTH, *Bull. Soc. chim. biol.*, 1938, 20, 1419; CAHEN and FEUER, *Compt. rend.*, 1939, 208, 1907; FIGHTENBERG, *Compt. rend. soc. biol.*, 1939, 130, 316; SCHIRM, *Apoth. Zeit.*, 1940, 55, 106; TOFT, *Arch. Int. Pharmacodyn.*, 1945, 70, 370 (15) *Pharm. Rev.*, 1904, 22, 348. (16) *Analyst*, 1911, 36, 489. (17) (with SINGH), *ibid.*, 1918, 43, 205; (with SEN), *ibid.*, 1920, 45, 321; (with SANGHI), *ibid.*, 1923, 48, 16. (18) DEMBECK, *Bull. Nat. Formulary Cttee.*, 1941, 9, 119; BROWNLEE, *Pharm. J.*, 1943, 151, 152; CHANDLER, *Analyst*, 1946, 71, 140. (19) *Magyar Gyóg. Társas Ert.*, 1931, 7, 429 (*Chem. Zentr.*, 1931, ii, 3644). (20) *J. Chem. Ind. Moscow*, 1931, 8, 161. (21) (a) *Pharm. Weekbl.*, 1903, 40, 189; *Bull. Sci. pharmacol.*, 1910, 17, 59; (b) *Analyst*, 1923, 48, 53; VAISBERG *et al.*, *Farmatsiya*, 1947, 10, No. 1, 26; (c) PLUGGE, *Arch. Pharm.*, 1887, 225, 343; KLJATSCHKINA, *ibid.*, 1933, 271, 558; ANNELER, *Barell Festschrift*, 1936, 344. (d) BAGGESGAARD-RASMUSSEN and REIMERS, *Dansk. Tijds. Farm.*, 1931, 5, 21. (e) ANNELER, *Arch. Pharm.*, 1920, 258, 130; KLJATSCHKINA and SOROCHINSKAYA, *Farmatsiya*, 1939, No. 5, 8; ADAMSON, HANDISYDE and HODGSON, *Pharm. J.*, 1947, 159, 207. (22) *Anales farm. bioquim.* (Buenos Aytes), 1940, 11, 6. (23) *Zeit. anal. Chem.*, 1943, 124, 35. (24) *Ibid.*, 1942, 124, 344. (25) *Rev. exp. bioquim. Argentina*, 1942, 8, 17. (25a) *Quart. J. Pharm. Pharmacol.*, 1945, 18, 338; RASMUSSEN *et al.*, *Dansk. Tids. Pharm.*, 1945, 19, 41. (26) GREGORY, *Annalen*, 1833, 7, 261; ROBERTSON, *J. Pharm.*, [ii], 19, 158; ANDERSON, *Annalen*, 1853, 86, 180; *cf.* MERCK, *ibid.*, 1836-1839, 18, 79; 21, 202; 24, 46. For an account of this process, as used at the Government Opium Factory, Ghazipore, India, see *Pharmacographia Indica*, 1890, i, 82. (27) "Die Fabrikation der Alkaloide," 1927; see also CHEMNITZ, *Pharm. Zent.*, 1929, 70, 101 and *Pharm. J.*, 1945, [iv], 101, 220. (27a) *Ann. pharm. franc.*, 1947, 5, 121. (28) *J. pr. Chem.*, 1924, [ii], 108, 247. (29) *Pharm. Zent.*, 1927, 68, 307. (30) *Khim. Farm. Prom.*, 1933, 127. (31) Allen's "Commercial Organic Analysis," 5th Edit., London, Vol. VII., p. 671. (32) See, for example, PATZUKOW, *Russ. Pat.* 127; (with BUSCHMARIN and CHITRIN), 18,747; BYLINKIN, 3,381; SCHWARZ, 40,357; KLJATSCHKINA *et al.*, 40,979; 40,980; 53,168; 53,224; BERNSTEIN and BRAUDE, 41,517. (33) *Annalen*, 1870, 153, 47; *Suppl.*, 1872, 8, 262, 272; 1894, 282, 209; *cf.* KAUDER, *Arch. Pharm.*, 1890, 228, 419. (34) Ullmann's "Enzyklopädie tech. Chem.," 2nd edition, 1, 221. (35) *Arch. Pharm.*, 1933, 271, 387; 1934, 272, 537; *Oesterr. Chem. Zeit.*, 1933, 36, 174. (36) *Pharm. J.*, 1925, 115, 137. (37) DAVID, *Pharm. Zeit.*, 1925, 70, 969; FULTON, *J. Lab. Clin. Med.*, 1928, 13, 750; 1928, 14, 13; *Amer. J. Pharm.*, 1937, 109, 219. (38) VAN URK, *Pharm. Weekbl.*, 1927, 64, 371. (39) *Helv. Chim. Acta*, 1945, 28, 722.

BENZYLISOQUINOLINE SUB-GROUP

Papaverine, $C_{20}H_{21}O_4N$. This alkaloid, first obtained by Merck,¹ occurs in the mixture precipitated by ammonia from the mother liquors of opium extract from which morphine and codeine have been separated in Gregory's process, and methods for its isolation from this mixture have been published by Hesse and others.² The alkaloid may be purified by conversion into the acid oxalate, B. $H_2C_2O_4$, m.p. 196° ³ or $201.5-202^\circ$,⁴ which is nearly insoluble in alcohol.

Papaverine crystallises in rhombic prisms or needles, m.p. 147° , $[\alpha]_D \pm 0^\circ$, is insoluble in water, soluble in hot alcohol or chloroform, and slightly so in cold alcohol or ether. It is a weak base for which, according to Wales, there is no satisfactory indicator, though bromophenol-blue has its colour change at the right point for this alkaloid.⁵ The hydrochloride, B. HCl, forms monoclinic plates, m.p. $225-6^\circ$, sparingly soluble in water (1 in 37 at 18°). The picrate forms quadratic plates, m.p. 186° .⁴

Some of the colour reactions formerly ascribed to papaverine were due to cryptopine present as an impurity,³ but the following test is said to be given even by synthetic papaverine. With pure cold sulphuric acid it dissolves to a colourless solution, which becomes rose-red at 110° , darkening to violet at 200° , the colour being discharged on adding water. According to Foster,³ if as little as 0.2 per cent. of cryptopine is present a colour is produced on solution in cold sulphuric acid. Warren⁶ states that Marquis's reagent (sulphuric acid and formaldehyde) gives with papaverine ferricyanide a blue colour, changing to violet, green and brown.

Constitution. Knowledge of the structure of papaverine is principally due to the work of Goldschmiedt and collaborators.⁷ It behaves as a tertiary amine, and gives a methiodide, B. $CH_3I \cdot 4H_2O$, m.p. $60-5^\circ$ or 195° (*dry*). On treatment with hydriodic acid and red phosphorus the alkaloid furnishes four molecular proportions of methyl iodide, and yields papaveroline, $C_{16}H_9(OH)_4N \cdot 2H_2O$, m.p. 260° (*dec.*) (see Kitasato and Robinson⁷). When oxidised with potassium permanganate under varying conditions^{7(a)} it yields papaveraldine and papaverinic acid, and as simpler products of these two substances, 6:7-dimethoxyisoquinoline-carboxylic acid, and *m*-hemipinic, veratric and pyridine-2:3:4-tricarboxylic acids.

Papaveraldine (Xanthaline), $C_{20}H_{19}O_5N$. This substance forms colourless scales, m.p. 210° , yields well-crystallised yellow salts, which are dissociated in water, and reacts as a tertiary base, forming a methiodide, m.p. $133-5^\circ$. It gives an oxime existing in two stereoisomeric forms, and contains four methoxyl groups. The demethylated product, papaveraldoline, $C_{16}H_7ON(OH)_4$, has been prepared by Oberlin.⁸ Miss Dobson and W. H. Perkin have shown that the alkaloid, XANTHALINE, isolated from opium by T. and H. Smith, is identical with papaveraldine.⁹ On reduction with

zinc dust in acetic acid, papaveraldine yields the secondary alcohol, papaverinol, colourless, monoclinic needles, m.p. 137°, which in turn can be converted into papaverine by treatment with hydrogen bromide in acetic acid followed by reduction with zinc dust.¹⁰

In this, the first serious and successful work on the structure of a complex alkaloid, there was naturally at first some confusion between *isoquinoline* and the better-known *quinoline*. The 6 : 7-dimethoxy-*isoquinolinecarboxylic acid* was thought to be a dimethoxycinchoninic acid.¹¹ It was known, however, that *quinoline benzylchloride* on oxidation furnished formylbenzylanthranilic acid, C₆H₄(COOH)—N(C₇H₇)—CHO,¹² whereas various papaverine alkyl halides gave what were presumed to be alkylhemipinisoimides,¹³

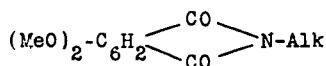

and the supposed dimethoxyquinoline¹¹ from papaverine, on oxidation yielded cinchomeric acid and what was supposed to be hemipinic acid¹³ (3 : 4-dimethoxyphthalic acid), but which proved to be an isomeride, *viz.*, 4 : 5-dimethoxyphthalic acid, and was named *meta*hemipinic acid.¹⁴ These results indicated that the supposed dimethoxyquinoline must be 6 : 7-dimethoxy*isoquinoline*, as shown below :—

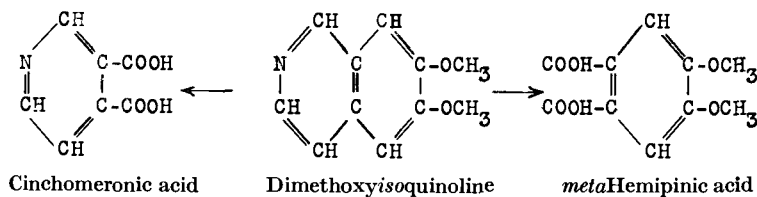

The position in which the veratryl residue is attached to this *isoquinoline* nucleus in papaveraldine and papaverine is determined by the formation of pyridine-2 : 3 : 4-tricarboxylic acid in the oxidation of papaverine by hot permanganate. On the basis of these results, Goldschmiedt assigned the following formula to papaveraldine :—

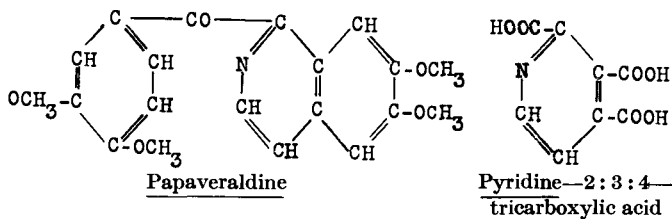

Papaverinic acid, C₁₆H₁₃O₇N · H₂O, crystallises in small tablets, m.p. 233°. It is dibasic, readily forms an anhydride, furnishes an oxime and a phenylhydrazone, contains two methoxyl groups,¹⁵ and on oxidation yields veratric and pyridine-2 : 3 : 4-tricarboxylic acids, and hence is represented by the following formula :—

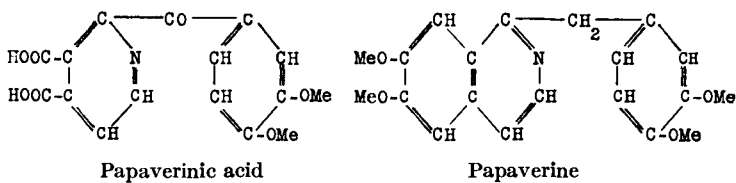

The constitution of papaverine follows from that of papaveraldine, from which it differs in composition by the substitution of $-\text{CH}_2-$ for $-\text{CO}-$.¹⁶ After a first attempt to synthesise papaverine by Fritsch,¹⁷ a complete synthesis was effected by Pictet and Gams,¹⁸ who treated veratrole (*o*-dimethoxybenzene) with acetyl chloride and aluminium chloride, to produce acetoveratrone (4 : 5-dimethoxyacetophenone), the oximino-derivative of which was reduced and the resulting aminoacetoveratrone (I) condensed with *homoveratroyl* chloride (II), yielding *homoveratroylaminoacetoveratrone* (III). This, on reduction of one carbonyl group, gave *homoveratroylhydroxyveratrylamine*,

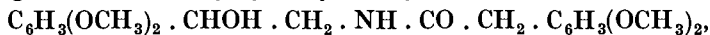

which when boiled with phosphoric oxide in xylene solution lost 2 mols. of water and formed papaverine (IV).¹⁹

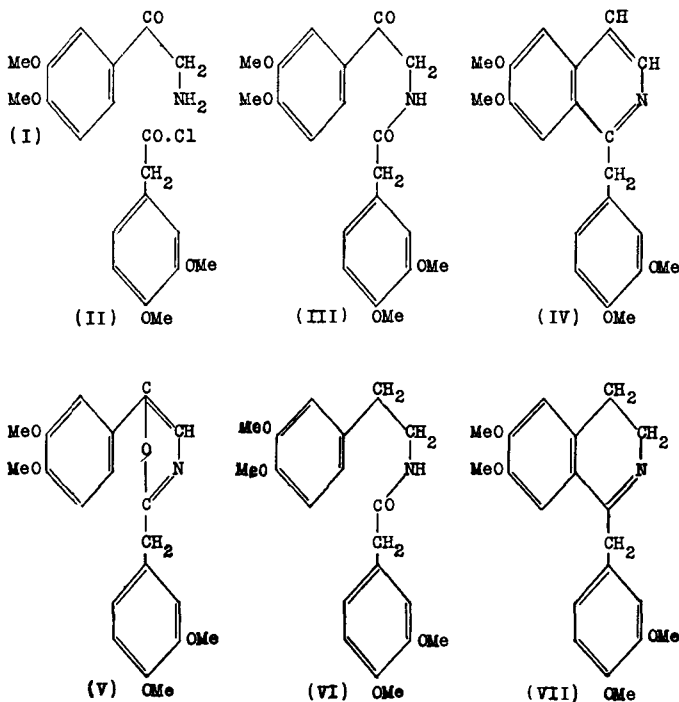

This synthesis depends on intramolecular condensation of an acylamino-alcohol of the type $\text{R}-\text{CH}(\text{OH})-\text{CH}_2-\text{HN}-\text{CO}-\text{R}'$.

Mannich and Walther²⁰ found that the methyl ethers of such alcohols, $R-CH(OMe)-CH_2-NH-CO-R'$, as prepared by Rosenmund's method,²¹ undergo a similar change when boiled in xylene with phosphorus oxychloride; and both they and Rosenmund²² used this method for the synthesis of papaverine and allied substances.

When Pictet and Finkelstein¹⁹ condensed *homoveratrylamine* with *homoveratroyl chloride* and effected ring closure in the product, they obtained 3:4-dihydropapaverine (VII) but were unable to oxidise this to papaverine. This final step was achieved by Späth and Burger²³ by the use of platinised asbestos at 200° in presence of air, and these authors found that tetrahydropapaverine (X) can be dehydrogenated to papaverine under similar conditions.

In an attempted synthesis of papaverine based on Rugheimer's²⁴ preparation of 6:7-dimethoxyisoquinoline from veratrylaminoacetal $(MeO)_2-C_6H_3-NH-CH_2(OEt)_2$, Allen and Buck²⁵ reduced deoxyveratroin oxime, $(MeO)_2-C_6H_3-C(NO_2H)-CH_2-C_6H_3(OMe)_2$, to $\alpha\beta$ -di(3:4-dimethoxy)-phenylethylamine,



but the condensation product between this amine and bromoacetal decomposed in attempts to convert it into papaverine.

In an effort to prepare 1:2-dihydropapaverine, Buck²⁶ dehydrated ω -*homoveratroylaminoacetoveratrone* (III) with phosphoryl chloride, and subjected the product (V) to catalytic reduction, followed by the action of phosphorus pentachloride in the cold. The final product was assumed to be 1:2-dihydropapaverine; but Young and Robinson²⁷ interpret this synthesis differently, and their formulæ (V) and (VI) are given above, the final product being 3:4-dihydropapaverine (VII), which Buck thus prepared for the first time in a crystalline condition, m.p. 97–8°; picrate, m.p. 151°; perchlorate, m.p. 238° (*dec.*).

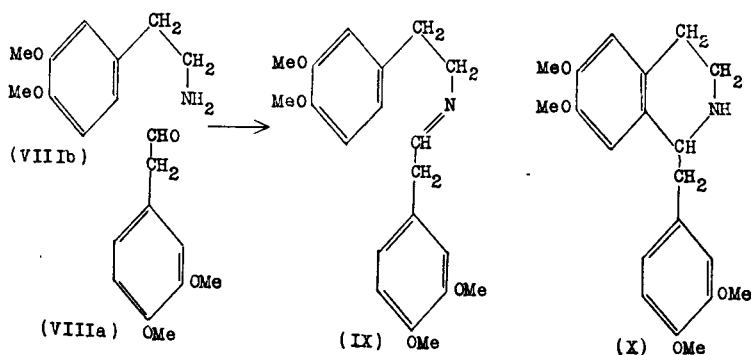

A synthesis of possible biological significance was effected by Späth and Berger,²⁸ who ozonised eugenol methyl ether to 3:4-dimethoxyphenylacetaldehyde (VIIIa), which was then condensed with 3:4-dimethoxyphenylethylamine (VIIb), and the resulting Schiff's base (IX) treated with hot 19 per cent. hydrochloric acid, whereby it was transformed into

dl-tetrahydropapaverine (X) (picrate, m.p. 157–9°); the yield was small owing to the instability of the aldehyde and of the Schiff's base.

Interest is added to this mode of preparation by the observation of Hahn and Schales²⁹ that not only β -phenylethylamines containing a hydroxyl group in the nucleus, but also those with methoxyl or methylenedioxy-groups, condense with phenylacetaldehydes or phenylpyruvic acids to tetrahydroisoquinolines, under conditions which could occur in a plant. The first stage in the condensation, *viz.*, the formation of the *N*-substituted aldehyde ammonia, *e.g.*, $R-CH_2-CH_2-NH-CH(OH)-R'$ or the Schiff's base $R-CH_2-CH_2-N=CHR'$ takes place to greatest advantage at pH 5 and temperature 25°; the second stage, intramolecular condensation to the tetrahydroisoquinoline, only occurs to the extent of 5 per cent.

Other syntheses of products allied to papaverine have been described by Buck, Haworth and Perkin,³⁰ Slotta and Haberlandt,³¹ Kindler,³² Keimatsu³³ and Sugawara.³⁴ Among recent contributions of interest in this connection may be mentioned (1) the study by Bide and Wilkinson³⁵ of the preparation of *homoveratronitrile*, $(MeO)_2C_6H_3 \cdot CH_2 \cdot CN$, and its conversion into *homoveratrylamine* and *homoveratric acid*, two intermediates required for the synthesis of papaverine and (2) the preparation by Clemo and Turnbull³⁶ of a series of 3-methylisoquinolines, substituted in position 1 by Me, Ph, $\cdot CH_2Ph$ or $\cdot CH_2 \cdot C_6H_3(OMe)_2(3:4)$. One member of the series, *viz.*, 7-hydroxy-6-methoxy-1-veratryl-3-methylisoquinoline, $C_{20}H_{21}O_4N$, m.p. 173–4° is isomeric with papaverine. Reference may also be made to the conversion by Pfeiffer, Breitbach and Scholl³⁷ of the natural pigments, brasilin and hæmatoxylin, into alkaloid-like substances, *e.g.*, trimethylbrasilonol oxime, on treatment with alkali, is stated to yield 6 : 7-dimethoxy-1-(2'-hydroxy-4'-methoxyphenyl)-3-methylisoquinoline-2-oxide, m.p. 243°, which is reduced by sulphur dioxide to the corresponding isoquinoline, m.p. 188–9°, yielding a picrate, m.p. 224–5°, a methiodide, m.p. 227–8°, and a 2'-methyl ether, m.p. 110°. A new kind of papaverine analogue is the quinazoline type synthesised by Fetscher and Bogert^{37(a)} of which 6 : 7-dimethoxy-2-benzyl-4-quinazolone, m.p. 269° is an example.

Special Reactions of Papaverine. Papaverine undergoes a number of reactions, which are of interest as providing methods of synthesis for other alkaloids, of which examples will be found under laudanose, laudanine, laudanidine, codamine (pp. 187–195), berberine (p. 331), corydaline (p. 284), and glaucine (p. 311).

Goldschmiedt stated that papaverine, on reduction by tin and hydrochloric acid, yielded tetrahydropapaverine, m.p. 200–1°, together with an amorphous base.³⁸ Freund and Beck by electrolytic reduction of papaveraldine obtained an amorphous isotetrahydropapaverine yielding a crystalline hydriodide.³⁹ On reinvestigating these products, Pyman⁴⁰ found that Goldschmiedt's amorphous base was identical with Freund and Beck's isotetrahydropapaverine, and that the product was a true tetrahydropapaverine, which is also formed by electrolytic reduction of papaverine.²³

Goldschmiedt's supposed tetrahydropapaverine proved to have the composition of a new dihydropapaverine, $C_{20}H_{23}O_4N$, which Pyman named PAVINE, and to which he eventually assigned the formula shown below, on the grounds that (1) it behaves as a secondary base; (2) as it is stable to oxidising and reducing agents the reduced pyridine ring cannot contain a double bond; and (3) the nature of the products formed when the base is degraded by Hofmann's method.

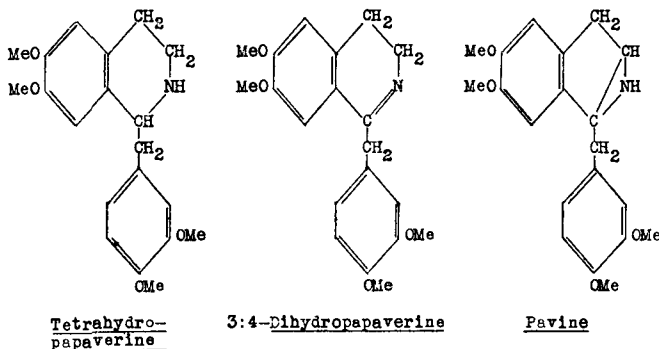

ψ -Papaverine, $C_{21}H_{21}O_4N$. Hesse's alkaloid of this name and formula ⁴¹ was re-examined by Späth and Polgar ⁴² and shown to be papaverine.

Laudanosine, $C_{21}H_{27}O_4N$. This alkaloid occurs in the liquor from which thebaine is precipitated, and can be isolated by Hesse's method.² The crude alkaloid is purified by extraction with small quantities of ether, in which laudanosine is soluble, and finally by precipitation with potassium iodide. The free base crystallises from hot benzene in needles, m.p. 89° , $[\alpha]_D^{15} + 103.23^\circ$ (EtOH), is soluble in alcohol, chloroform, hot benzene or ether (1 in 19.3 at 16°), but insoluble in water or alkalis. The solution in alcohol is alkaline, and the alkaloid and its salts are bitter. The hydriodide, $B \cdot HI \cdot 1/2H_2O$, forms small prisms readily soluble in alcohol, sparingly so in water, and the acid oxalate, $B \cdot H_2C_2O_4 \cdot 3H_2O$, prisms, easily soluble in water. Laudanosine is not coloured by ferric chloride, but with ferric oxide and sulphuric acid, gives a brown colour, changing to green when warmed at 150° . With sulphuric acid alone it gives a rose-red coloration, changing to deep reddish-violet on warming to 150° .

Laudanosine contains four methoxyl groups. By exhaustive methylation it yields trimethylamine and laudanosene (tetramethoxy-*o*-vinylstilbene), $CH_2=CH-C_6H_2(OCH_3)_2-CH=CH-C_6H_3(OCH_3)_2$.⁴³ On oxidation with manganese dioxide and sulphuric acid it furnishes, in addition to the interesting by-product 2:3:6:7-tetramethoxy-9:10-dihydroanthracene, veratraldehyde and 4:5-dimethoxy-2: β -methylaminoethylbenzaldehyde,⁴⁴ subsequently named laudaline, prismatic needles, m.p. $123-4^\circ$. This with acids forms salts of 6:7-dimethoxy-2-methyl-3:4-dihydroisoquinolinium hydroxide, thus behaving similarly to cotarnine and hydrastinine; the chloride, $C_{10}H_{10}(OMe)_2NCl \cdot 3\frac{1}{2}H_2O$, forms primrose needles, m.p. $61-2^\circ$ or 186° (*dec.*, *dry*) from water.

The constitution of laudanosine was determined by Pictet and Athanasescu,⁴⁵ who prepared it by reducing papaverine methochloride with tin and hydrochloric acid and deracemising the *dl*-laudanosine (*N*-methyltetrahydropapaverine) so obtained, by fractional crystallisation of the quinate. Laudanosine must, therefore, be represented by formula (IV) :—

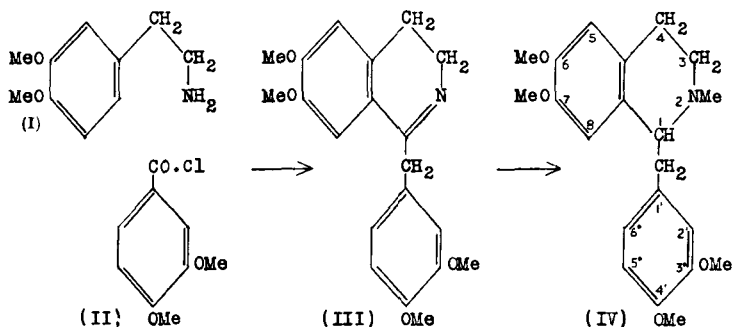

Racemic laudanosine, so prepared, crystallises in needles, m.p. 115°. The hydriodide has m.p. 201-3°; the platinichloride, m.p. 160°, and the picrate, m.p. 174°, are crystalline.

A complete synthesis of laudanosine was effected by Pictet and Finkelstein¹⁹ by the condensation of *homoveratrylamine* (I) with *homoveratroyl chloride* (II), giving *homoveratroylhomoveratrylamine*, which with phosphoric oxide undergoes cyclisation to 3:4-dihydropapaverine (III), which was converted into the methochloride and reduced to laudanosine (IV).

Hydroxylaudanosines. King, l'Ecuyer and Pyman⁴⁶ have shown that papaverinol methochloride prisms, m.p. 211-2° (*corr.*), on catalytic hydrogenation yields two hydroxylaudanosines,



The α -isomeride has m.p. 138°, yields a hydrochloride, m.p. 135° (*approx., dec.*), and a picrate, m.p. 198°. The β -form occurs in minute needles, m.p. 108-9° (*dry*), and yields a picrate, m.p. 178-9°. These substances are of interest since their methiodides and methochlorides on treatment with silver oxide or aqueous sodium hydroxide behave abnormally, breaking up into veratraldehyde and 4:5-dimethoxy-2-vinylbenzyltrimethylamine (oil; picrate, m.p. 158-9°; methiodide, m.p. 197-8°) thus :—

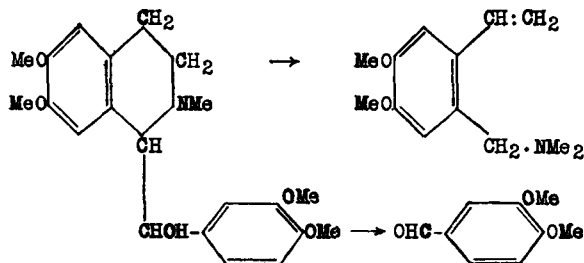

A *dl*-6'-hydroxyaudanosine has been described by Gadamer,⁴⁶ who resolved it into *d*- and *l*-forms, m.p. 188–190·5°, $[\alpha]_D \pm 50^\circ$.

Laudanosoline and *Dehydroaudanosoline*. When audanosine is demethylated it yields laudanosoline, $C_{17}H_{19}O_4N$, first prepared by Oberlin,⁴⁷ and subsequently by Robinson and Kitasato,⁴⁸ and by Schöpf and Thierfelder.⁴⁹ According to the latter authors, the base can be obtained in colourless prisms, m.p. 192–4°, with sintering from 188–190°, by pouring an aqueous solution of the hydrobromide into enough sodium hydroxide solution to make the reaction mixture just alkaline to litmus. The whole is then warmed, boiled for a few minutes and the precipitate rubbed with a glass rod. The hydrochloride, $B \cdot HCl$, forms colourless prisms, m.p. 244°, and in aqueous solution gives a blue-green coloration with ferric chloride. The sulphate, $B_2 \cdot H_2SO_4$, crystallises from dilute sulphuric acid in colourless prisms, softens at 260° and melts at 267° (*dec.*). The hydrobromide, $B \cdot HBr \cdot 3H_2O$, has m.p. 230–2°. The tetrabenzoyl derivative is amorphous, but yields a crystalline hydrochloride, m.p. 190° (*dry*), and picrate, m.p. 212°. ⁴⁸ The tetracetyl derivative is characterised by the picrate, m.p. 178–9° (sintering at 163°), and picrolonate, m.p. 224° (sintering at 220°).⁴⁹ Robinson and Sugasawa⁵⁰ found that laudanosoline (V) was readily oxidisable, but failed to isolate any well-defined oxidation product until they applied tetrachloroquinone (chloranil) in alcohol in presence of potassium acetate, when they obtained a dehydroaudanosoline, which was isolated as the chloride, $C_{17}H_{18}O_4NCl$, H_2O , faintly grey microscopic prisms, m.p. 303–5°, of which a dilute solution in alcohol gives an intensely green colour with ferric chloride, changing to deep reddish-violet on addition of sodium carbonate. The same substance was isolated from solutions of laudanosoline hydrochloride to which sodium carbonate or potassium acetate had been added and the preparation exposed to the air for two months, and it can be obtained by other mild oxidising agencies.⁴⁹

Dehydroaudanosoline yields a normal tetracetyl-derivative (picrolonate, m.p. 207°), when treated with acetic anhydride in pyridine in the cold,⁴⁹ but when acetylated hot it yields two tetracetyl compounds.⁵⁰ One has the formula $C_{16}H_{11}O_4N(Ac)_4$, and crystallises from alcohol in colourless, feathery needles, m.p. 148°, with sintering from 144°. A methyl group has apparently been lost from the parent substance during acetylation. The second product separates from ethyl acetate in pale amber-coloured prisms, m.p. 215°, and has the formula $C_{16}H_9O_4N(Ac)_4$. In this case a methyl group and two hydrogen atoms have been lost.

On treatment with methyl sulphate in an atmosphere of hydrogen, dehydroaudanosoline yields a tetramethoxymethosulphate, m.p. 222–6°, from which the related iodide, $C_{17}H_{13}N(MeI)(OMe)_4$, $3 \cdot 5H_2O$, colourless prisms, m.p. 242–3° (*dec.*) was prepared. The corresponding chloride, m.p. 225° (*dec.*), on heating at 215–25°, is converted into two substances. The first, presumably $C_{17}H_{13}N(OMe)_4$, on treatment with methyl iodide regenerates the methiodide, m.p. 242–3° (*dec.*), described above. The second, $C_{17}H_{11}N(OMe)_4$, crystallises from methyl alcohol in yellow plates, m.p. 201–3°. These two substances evidently stand in the same relation

to each other as the two acetyl derivatives, the first having lost a methyl group and the second a methyl group and two atoms of hydrogen. In each case the simple demethylated product gives a weak indole reaction with Ehrlich's reagent, whereas the demethylated and dehydrogenated substance gives an intense indole reaction with this reagent. Further, the tetracetyl derivative, m.p. 148°, on hydrolysis followed by methylation, yields the methiodide, m.p. 242-3°, described above.

To dehydrolaudanosoline chloride Robinson and Sugawara,⁵⁰ and independently Schöpf and Thierfelder⁴⁹ ascribe formula (VI), which makes it 2 : 3 : 11 : 12-tetrahydroxy-8-methyldibenzotetrahydropyrrocolinium chloride. The primary tetracetyl-derivative, m.p. 148°, is represented by (VII: R = acetyl) and the second acetyl derivative, m.p. 215°, by (VII: R = acetyl) with an ethylenic linkage between carbon atoms 15 and 16. Similarly, the initial tetramethoxy-derivative is to be represented by (VI) with the four hydroxyl groups replaced by methoxyl groups; the primary product formed on heating, by loss of methyl chloride, will be represented by (VII: R = OMe), and the second product, m.p. 201-3°, of the reaction will be represented by (VII: R = OMe), with an ethylenic linkage between C₁₅ and C₁₆.

Proof of formula (VI) for dehydrolaudanosoline salts was provided by a study of its exhaustive methylation, the products at the first and second stages of the application of this process being 5 : 6-dimethoxy-2-(3' : 4'-dimethoxy-6'-vinylphenyl)-1-methyl-dihydroindole (VIII) and 6-dimethyl-amino-3 : 4 : 3' : 4'-tetramethoxy-6'-vinylstilbene (IX) respectively.

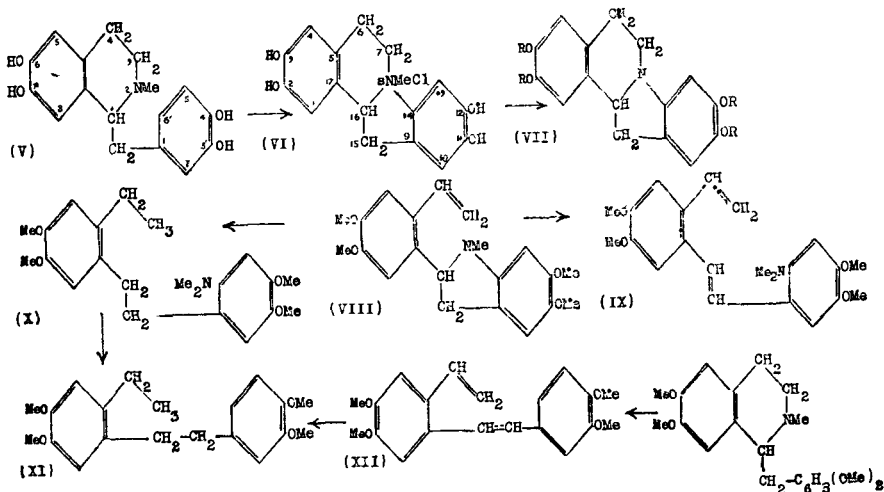

Nitrogen cannot be eliminated from the latter by further methylation, but (VIII) on catalytic hydrogenation has its vinyl group converted into ethyl and the product, on methylation followed by reduction with sodium amalgam,⁵¹ yields 6-dimethylamino-3 : 4 : 3' : 4'-tetramethoxy-6'-ethyl- $\alpha\beta$ -diphenylethane (X), and this, on repetition of the methylation, and reduc-

tion by sodium amalgam, gives trimethylamine and 3 : 4 : 3' : 4'-tetramethoxy-6'-ethyl- $\alpha\beta$ -diphenylethane (XI). This substance was prepared independently by subjecting laudanoline to a two-stage Hofmann degradation, when it furnished tetramethoxyvinylstilbene (laudanoline: XII), which crystallises from warm alcohol in large needles, m.p. 94–5°, and had already been prepared by Decker and Galatty.⁵² On hydrogenation in presence of Adams's platonic catalyst it gave (XI). The foregoing account is based mainly on Robinson and Sugasawa's⁵⁰ paper, but substantially the same ground is covered by Schöpf and Thierfelder,⁴⁹ who give additional details, some of which are referred to above. Among other points dealt with by these authors is the ozonisation of (IX), which gave rise to *m*-opianic acid, *m*-hemipinic acid, 6-dimethylaminoveratraldehyde and 6-dimethylamino-6'-aldehydo-3 : 4 : 3' : 4'-tetramethoxystilbene, $(\text{MeO})_2-\text{C}_6\text{H}_2(\text{NMe})_2-\text{CH} : \text{CH}-\text{C}_6\text{H}_2(\text{CHO})(\text{OMe})_2$, m.p. 144–6°.

In extension of this work, Sugasawa and Yoshihara⁵³ have shown that *dl*-homolaudanosoline (XIII), on oxidation by chloranil in presence of acetic acid, also gives rise to a dehydro-product, which on methylation furnishes 2 : 3 : 11 : 12-tetramethoxy-8-methyl-6 : 7 : 15 : 16-tetrahydro-5 : 18 : 9 : 14-dibenzopyridocolinium salts (XIV).

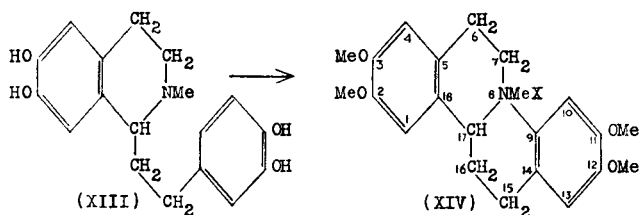

Reference may also be made to the synthesis of various alkylated laudanolinines by Schöpf, Jackh and Perrey,⁵⁴ *e.g.*, laudanoline 6 : 7 : 3'-tribenzyl-4'-methyl ether and laudanoline 4'-methyl ether, to the preparation of the 3' : 7-dimethyl ether⁴⁹ by Schöpf and Thierfelder (1939), and to Robinson and Sugasawa's⁵⁵ synthesis of *protosinomenine* (4' : 7-dimethyl ether of laudanoline).

Laudanine, $\text{C}_{20}\text{H}_{25}\text{O}_4\text{N}$, was isolated by Hesse.⁵⁶ The crude alkaloid is purified by recrystallisation from dilute alcohol for the removal of small quantities of cryptopine, or it may be dissolved in acetic acid and the solution poured into dilute caustic soda, when this impurity is precipitated and laudanine may be recovered from the filtrate by addition of ammonium chloride. It still contains its isomeride laudanidine, which may be separated by repeated crystallisation of the hydrochlorides,⁵⁷ laudanidine accumulating in the aqueous mother liquors. The base crystallises from dilute alcohol, or from a mixture of alcohol and chloroform in rhombic prisms,⁵⁸ m.p. 166°, $[\alpha]_D \pm 0^\circ$. It dissolves in solutions of alkali hydroxides, forming metallic derivatives, which are precipitated by excess of alkali, but is nearly insoluble in solution of ammonia. The salts crystallise well ;

the hydrobromide, B. HBr, $3\text{H}_2\text{O}$, has m.p. $76-7^\circ$; the hydriodide, B. HI, H_2O , is sparingly soluble in water (1 in 500 at 15°); the acid tartrate, B. $\text{C}_4\text{H}_6\text{O}_6 \cdot 3\text{H}_2\text{O}$, forms prisms, m.p. 100° ; the picrate has m.p. $176-7^\circ$. With ferric chloride laudanine gives a green coloration, and with sulphuric acid a faint rose-red colour changing to reddish-violet on warming.

Laudanine contains one hydroxyl and three methoxyl groups, and on oxidation with permanganate furnishes *m*-hemipinic acid (4 : 5-dimethoxyphthalic acid), which implies the presence of a dimethoxyisoquinoline nucleus.⁵⁸ This was made evident by Hesse,⁵⁹ who, on treating laudanine with methyl iodide, obtained laudanine methiodide and a small yield of *dl*-laudanosine, an observation confirmed by Späth,⁶⁰ who also showed that the phenolic hydroxyl group must be present in the benzyl residue, since the *O*-ethylated base yields 4-methoxy-3-ethoxybenzoic acid on oxidation, and similarly ethylcarbonatolaudanine was oxidised to 4-methoxy-3-ethylcarbonatobenzoic acid. On these grounds, Späth⁶⁰ assigned formula (I) to laudanine, and in the following year Späth and Lang⁶¹ synthesised laudanine by condensing β -aminoethyl-3 : 4-dimethoxybenzene with ethylcarbonato *homoisovanilloyl* chloride and submitting the product (II) to cyclisation by means of phosphoric oxide in toluene, giving 1-[ethylcarbonatoisovanillyl]-6 : 7-dimethoxy-3 : 4-dihydroisoquinoline (III). This, on conversion into the methylisoquinolinium chloride, followed by reduction with tin and hydrochloric acid, gave a mixture of laudanine (I) and ethylcarbonatolaudanine (I with $\text{O}-\text{CO}_2\text{Et}$ replacing $-\text{OH}$). A second synthesis of laudanine was effected by Späth and Burger,⁶² who prepared *dl*-laudanosine, by electrolytic reduction of papaverine methosulphate, obtaining a 70 per cent. yield of the racemic base, which was then partially demethylated by heating in a sealed tube with hydrochloric acid (sp. gr. 1.19). On extraction with sodium hydroxide solution, a mixture of phenolic bases was obtained from which laudanine was isolated (*cf.* Schöpf.⁴⁹). On applying the same method to *l*-laudanosine, *l*-laudanine, $[\alpha]_D^{17} - 94.8^\circ$, identical with laudanidine was obtained, while *d*-laudanosine furnished *d*-laudanine, $[\alpha]_D^{17} + 93.5^\circ$. A mixture of *l*- and *d*-laudanine had all the properties of natural laudanine. Natural laudanine has not been deracemised, nor has *l*-laudanine been racemised.⁶² It seems clear therefore that *dl*-laudanine must be regarded as one of the rare instances of the natural occurrence of the racemic form of an alkaloid.

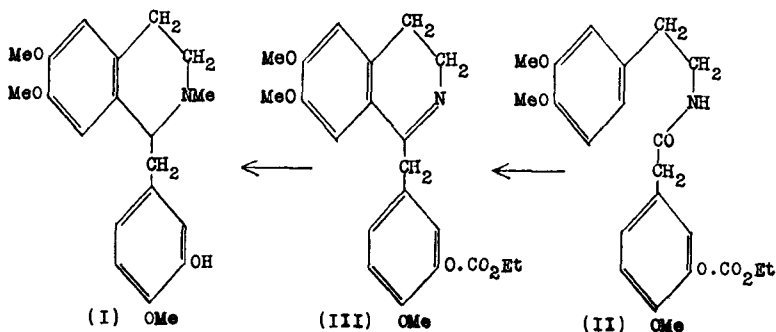

Laudanidine (*l*-laudanine, tritopine), $C_{20}H_{25}O_4N$. As already stated, this alkaloid was obtained from the mother liquors of partially purified laudanine by Hesse,⁵⁷ who suggested that it was a lævorotatory form of that alkaloid. It resembles laudanine in physical properties and gives the same colour reactions. It melts at $184-5^\circ$, and the following specific rotations have been recorded: -87.8° ⁵⁷; -90.6° ; -94.8° ⁶²; -100.6° ⁶³; the second value was given to tritopine, isolated by Kauder,⁶⁴ which Späth and Seka⁶⁵ proved to be laudanidine. The salts of the latter resemble those of laudanine, but the hydrochloride is more soluble in water and is utilised for the separation of the two alkaloids. The acetyl derivative, $C_{20}H_{24}O_4N(C_2H_3O) \cdot H_2O$, has m.p. 98° .⁵⁷

The constitution of laudanidine was determined by Späth and Bernhauer,⁶³ who showed that with diazomethane it yields *l*-laudanosine, m.p. $87-8^\circ$, and, the reversal of this process, *viz.*, partial demethylation of synthetic *l*-laudanosine by Späth and Burger⁶² provided a complete synthesis of *l*-laudanine, which is laudanidine.

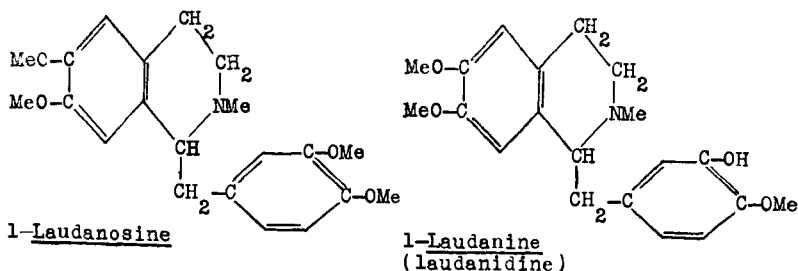

Leithe⁶⁶ has made the interesting observation that α -phenylethylamine (IV), which is lævorotatory, can be converted by a complicated series of reactions into alanine, identical with natural dextrorotatory alanine, which, however, is known to be lævorotatory in configuration, and may be written thus *l*(+)-alanine, whence the initial α -phenylethylamine may be written *l*(-)- α -phenylethylamine. Similar degradation of laudanosine and allied bases has not been effected, but by a careful comparison of the effects of salt formation and of solvent on the sign and magnitude of their observed rotations, it is possible to deduce to which series of simple amino-acids they belong. This comparison is justifiable, since the following formulæ indicate that compounds (V) to (VII) can be regarded as substituted α -phenylethylamines, and the same applies to the natural forms of the following alkaloids, to which Leithe assigns the configurations (*l*) or (*d*) as indicated, their observed rotations being recorded as (+) or (-), *l*(+)-laudanosine, *l*(+)-codamine, *d*(-)-laudanidine:—

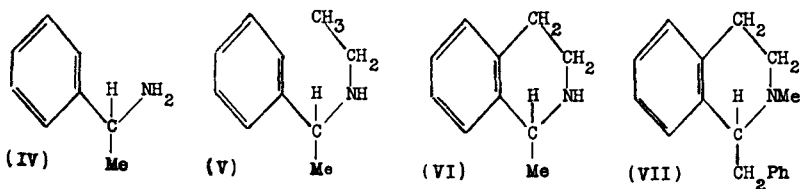

SYNTHETIC ISOMERIDES OF LAUDANINE. In 1903 Pictet and Kramers,⁶⁷ in an attempt to synthesise laudanine, reduced trimethylpapaveroline methochloride (*protopapaverine* methochloride, p. 195) with tin and hydrochloric acid and obtained a base, m.p. 76°, not identical with laudanine, and which was named *isolaudanine*. On repeating this work Späth and Epstein obtained *dl*-codamine and the reactions involved are discussed under codamine below.

In a similar attempt, Decker and Eichler⁶⁸ reduced *N*-methyl*nor*-papaverinium phenolbetaine (VIII) with tin and hydrochloric acid and obtained ψ -laudanine, m.p. 112°, picrate, m.p. 162–3°, which was subsequently investigated by Späth and Epstein,⁶⁹ who showed that on methylation it furnished *dl*-laudanosine and that the ethyl ether on energetic oxidation yielded veratric acid (3:4-dimethoxybenzoic acid) and the methyl ethyl ether of *nor*-*m*-hemipinic acid. This clearly indicated that the free hydroxyl group was in the *isoquinoline* nucleus, and its position was determined by the fact that on mild oxidation 7-methoxy-6-ethoxy-1-keto-2-methyl-1:2:3:4-tetrahydro*isoquinoline*, m.p. 95–6°, was produced, and on this basis these authors assigned formula (IX: R = H R' = CH₃) to ψ -laudanine.

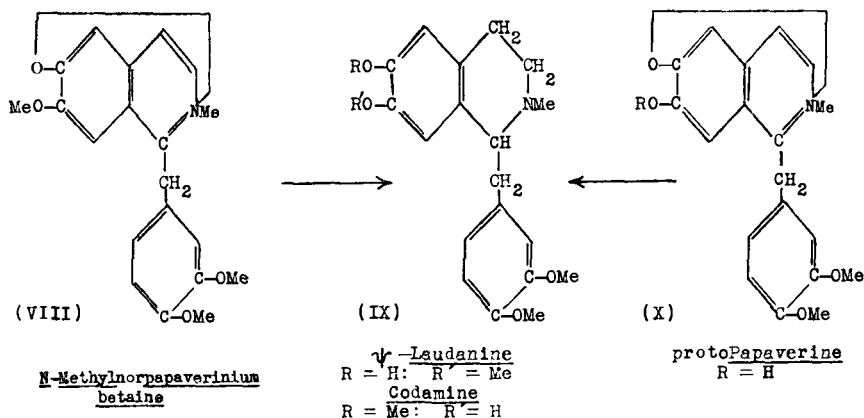

Codamine, C₂₀H₂₅O₄N. The crude alkaloid obtained in Hesse's method of separation² is purified by boiling with dilute sulphuric acid to remove meconidine, and is then regenerated by adding ammonia solution. It crystallises in hexagonal prisms, m.p. 126°⁵⁶; the salts are mostly amorphous, but the hydriodide, B. HI. 1.5H₂O, is crystalline and sparingly soluble in water; the acid tartrate forms colourless needles. Codamine is alkaline, moderately soluble in water, soluble in alcohol and in alkalis. Nitric acid dissolves it, forming a dark-green liquid; a solution in sulphuric acid is colourless, but becomes green and reddish-violet on warming. Aqueous solutions are coloured green by ferric chloride.

Codamine contains one hydroxyl and three methoxyl groups. On methylation it furnishes *d*-laudanosine. The position of the free hydroxyl

group was determined by Späth and Epstein,⁶⁹ who found that codamine ethyl ether on oxidation with potassium permanganate yielded veratric acid, so that the free hydroxyl group must be in the *isoquinoline* nucleus, and therefore in position 6 or 7. When the same oxidising agent is applied under carefully controlled conditions in faintly alkaline solution, the ethyl ether yields 6-methoxy-7-ethoxy-1-keto-2-methyl-1 : 2 : 3 : 4-tetrahydro*isoquinoline*, m.p. 120–1°, which was identified by comparison with the synthetic product, thus establishing formula (IX : R = Me ; R' = C₂H₅) for ethylcodamine, and with the ethoxyl replaced by a hydroxyl group, for codamine (IX : R = Me ; R' = H), so that codamine is ψ -laudanine with the positions of the hydroxyl and methoxyl groups in the *isoquinoline* nucleus interchanged. As a primary material for the synthesis of codamine, Späth and Epstein⁶⁹ used *protopapaverine*, C₁₇H₁₃O₂N(OMe)₂, prepared and so named by Hesse,⁶ and by Pictet and Kramers,⁶⁷ who called it trimethylpapaveroline. It is formed along with other products when papaverine hydrochloride is heated to 235°, a molecule of methyl chloride being evolved. It separates from alcohol in colourless tablets, decomposing at 240° (P. and K.), in yellowish leaflets, decomposing at 260° (H.), or in yellowish crystals, m.p. 279–80° (*dec.*), according to Späth and Epstein. The hydrochloride, B . HCl . 5H₂O, has m.p. 66–7° or 200° (*dry*) ; the acid oxalate, B . H₂C₂O₄ . 5H₂O, forms octahedral yellow crystals, m.p. 138° (*dry*) ; the picrate melts at 206.5°. Sodium and potassium derivatives have been prepared. Späth and Epstein⁶⁹ showed that *protopapaverine* is not a partially demethylated papaverine, since it is not reconverted to papaverine by diazomethane and it contains only two methoxyl groups, the third methyl group of papaverine being now attached to nitrogen. On reduction with tin and hydrochloric acid and treatment of the reduced product with diazomethane, *dl*-laudanosine is formed. On oxidation with permanganate it furnishes veratric acid, so that the veratryl group of papaverine is still intact, and the free hydroxyl group, must be in the *isoquinoline* nucleus. This view is confirmed by the fact that on treatment with diazomethane it yields *N*-methyl*nor*-papaverinium phenolbetaine (VIII), which is one of the by-products in the formation of *protopapaverine* from papaverine hydrochloride. On the basis of this experimental evidence, Späth and Epstein assigned formula (X : R = H) to *protopapaverine*. On treatment with methyl iodide it is converted into 7-hydroxy-6-methoxy-3' : 4'-dimethoxybenzyl-*isoquinoline* methiodide, m.p. 63–4°, which was transformed to the methochloride, m.p. 70–1°, and this, on reduction with tin and hydrochloric acid, yielded *dl*-codamine (IX : R = Me ; R' = H), identified as the picrate, m.p. 187–8°, by its methylation to *dl*-laudanosine and by the oxidation of its ethyl ether to 6-methoxy-7-ethoxy-1-keto-2-methyl-1 : 2 : 3 : 4-tetrahydro*isoquinoline*. Like *dl*-laudanine, *dl*-codamine has not been deracemised.

Armepavine, C₁₈H₁₃(NMe)(OH)(OMe)₂, H₂O. (Items 51, 53 ; list, p. 173.) M.p. 100° (*approx.*) or 148–9° (*dry*), $[\alpha]_D - 118.7^\circ$ (CHCl₃), gives a hydrochloride, m.p. 151–2°, oxalate, m.p. 211–12°, and methiodide,

m.p. 199–200°. Diazomethane converts it into *O*-methylarmepavine, m.p. 63–4°, $[\alpha]_D - 84.48^\circ$ (CHCl_3), which, after boiling with acetic anhydride, is oxidised by nitric acid to anisic acid. With methyl iodide and sodium methoxide in methanol it yields *O*-methylarmepavine methiodide, m.p. 135–6°. This with potassium hydroxide in methanol forms de-*ON*-dimethylarmepavine,

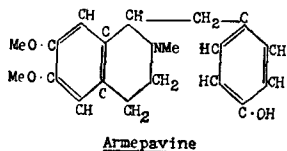

m.p. 86–7°, (B. HCl, m.p. 229–30°) of which the methiodide, m.p. 233–4°, on treatment with alkali decomposes into trimethylamine and α -*p*-anisyl- β -(3 : 4-dimethoxy-6-vinylphenyl)-ethylene, m.p. 79°. The latter is oxidised by permanganate in acetone to anisic and *m*-hemipinic acids. With ethyl sulphate and alkali, armepavine gives *O*-ethylarmepavine, an oil, which permanganate oxidises to *p*-ethoxybenzoic acid. Armepavine is similarly oxidised to *p*-hydroxybenzoic acid and 1-keto-6 : 7-dimethoxy-2-methyl-1 : 2 : 3 : 4-tetrahydroisoquinoline and is therefore 6 : 7-dimethoxy-1-*p*-hydroxybenzyl-2-methyl-1 : 2 : 3 : 4-tetrahydroisoquinoline, *i.e.*, it is laudanosine (p. 187) with MeO. at C^{3'} replaced by H and MeO at C^{4'} changed to HO.⁷⁰

In addition to the foregoing benzylisoquinoline alkaloids all derived from *Papaver* spp, two other members of the group, coclaurine and iso-coclaurine are described in the bisbenzylisoquinoline group (p. 349) with which they are naturally associated.

Pharmacological Action. In the series of opium alkaloids *papaverine* in its general effects stands between morphine and codeine. In comparatively small doses it produces light sleep, which does not become deeper when the dose is raised, but with larger doses reflex irritability is increased and some tetanising action may ensue. It has more tendency to slow the heart than either morphine or codeine and its use as a substitute for quinidine in the treatment of coronary cardiac disease has been discussed.⁷¹ The modern use of papaverine in medicine is due primarily to Pal's observation⁷² of the paralysing action of the alkaloid on the smooth muscle of the intestines and blood vessels. This was confirmed and extended by Macht⁷³ and attributed to the influence of the benzyl group and led to the use of benzyl benzoate and similar esters as spasmolytic drugs, later to the synthesis and pharmacological investigation of many variants on papaverine,⁷⁴ and eventually to the preparation of effective drugs showing considerable divergence⁷⁵ from the structure of papaverine, such as β -diethylaminoethyl fluorene-9-carboxylate hydrochloride

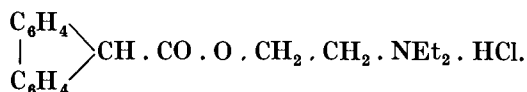

It has been stated already (atropine, p. 112) that there are two types of spasmolytic drug, the neurotropic, typified by atropine, and the musculo-tropic or myotropic to which papaverine belongs. In laboratory work the two types are usually tested against spasm induced by acetylcholine and

barium salts respectively. The trend of recent work has been to search for substances, which will provide both kinds of spasmolytic action and arising, partly out of this development and partly from the occasional use of histamine in the testing of these drugs, a new group of spasmolytic agents has arisen sometimes called anti-histamine drugs (p. 644) which are designed to counteract the effects of histamine liberation.

Though the group of spasmolytic drugs has arisen from knowledge of the structure of three natural alkaloids exerting this action, *viz.*, atropine, papaverine and ephedrine, the literature relating to them is far too voluminous to be dealt with here but an indication of the kind of development that is taking place may be obtained from some results published recently by Loew, Macmillan and Kaiser,⁷⁶ who made a limited comparison of six spasmolytic drugs by determining the minimal dilution of each required to inhibit the spasmogenic effects of histamine, barium and acetylcholine on isolated guinea-pig ileum. The results are summarised in the annexed table.

Reviews of recent work on spasmolytic drugs have been published by Raymond⁷⁷ and by Blicke,⁷⁸ and a detailed account of the action of papaverine and its derivatives, including laudanose and laudanine with numerous references to literature is given by Krueger, Eddy and Sumwalt.⁷⁹

According to Zunz,⁸⁰ the six principal alkaloids of opium

Drug: type and number	Spasm Induced by			
	Histamine	Barium	Acetylcholine	
(a) No. 1	1 : 66,000 —100,000	1 : 33,000 —50,000	1 : 50,000	—66,000
(a) No. 2	1 : 833,000 —1,000,000	1 : 667,000—1,000,000	1 : 25,000,000	—50,000,000
(b) No. 3	1 : 500,000 —667,000	1 : 5,000 —10,000	1 : 100,000,000	—200,000,000
(b) No. 4	1 : 833,000 —1,250,000	1 : 125,000—250,000	1 : 4,000,000	—6,670,000
(c) No. 5	1 : 25,000,000—50,000,000	1 : 66,700 —125,000	1 : 2,500,000	—4,000,000
(c) No. 6	1 : 2,000,000 —3,330,000	1 : 6,670 —8,330	1 : 66,700	—100,000

In this table Type (a) is musculotropic. No. 1 is papaverine hydrochloride; No. 2 is the β -diethylaminoethyl ester of fluorene-9-carboxylic acid hydrochloride. Type (b) is neurotropic. No. 3 is atropine sulphate; No. 4 is the β -diethylaminoethyl ester of diphenylacetic acid hydrochloride. Type (c) is "anti-histamine." No. 5 is β -dimethylaminoethyl benzhydrol ether hydrochloride; No. 6 is *N*-phenyl-*N*-ethyl-*N'*-diethyl ethylenediamine hydrochloride.

arrange themselves in the following descending order as analgesics, the same order being reversed for convulsant action : morphine, papaverine, codeine, narcotine, thebaine, laudanosine. This makes *laudanosine* the most active convulsant of the series. *Laudanosine*⁸¹ and *laudanine*⁸² are stated to resemble thebaine in action, but according to Delphaut and Paret,⁸³ though *laudanosine* is predominantly a convulsant poison, it shows some resemblance to papaverine in its action on the heart and respiration, but is less active as a spasmolytic agent.

REFERENCES

- (1) *Annalen*, 1848, 66, 125; 1849, 72, 50. (2) *Ibid.*, 1870, 153, 47; *ibid.*, *Suppl.*, 1872, 8, 261; (as modified by KAUDER), *Arch. Pharm.*, 1890, 228, 419; for other methods see PLUGGE, *ibid.*, 1887, 225, 343; KANEWSKAJA, *J. pr. Chem.*, 1924, 108, 247. (3) Cf. PICTET and KRAMERS, *Ber.*, 1910, 43, 1329; FOSTER, *Analyst*, 1946, 71, 139. (4) SPÄTH and POLGAR, *ibid.*, 1926, 59, 2787. (5) *J. Ind. Eng. Chem.*, 1926, 18, 390. (6) Cf. HESSE, *J. pr. Chem.*, 1903, 68, 190; PYMAN and REYNOLDS, 1910, 97, 1323 (footnote); WARREN, *J. Amer. Chem. Soc.*, 1915, 37, 2402. For other colour reactions or comments upon them see WAGENAAR, *Pharm. Weekbl.*, 1927, 64, 1085; EKKERT, *Pharm. Zent.*, 1933, 74, 24; KUBLI, *Pharm. Acta Helv.*, 1935, 10, 156; ROZEBOOM, *Pharm. Weekbl.*, 1935, 72, 498; AWE, *Pharm. Zent.*, 1936, 77, 157. (7) *Monats.*, 1883, 4, 704; 1885, 6, 372, 607, 956; 1886, 7, 488; 1887, 8, 510; 1888, 9, 42, 327, 349, 679, 762, 778; 1889, 10, 673, 692; 1898, 19, 324. Papaveroline and derivatives, see KITASATO and ROBINSON, *J. Chem. Soc.*, 1932, 785. (7a) Cf. MENON, *Proc. Ind. Acad. Sci.*, 1944, 19A, 21, for oxidation by selenium dioxide. (8) *Arch. Pharm.*, 1927, 265, 236. (9) *Pharm. J.*, 1893, [iii], 52, 793; DOBSON and PERKIN, *J. Chem. Soc.*, 1911, 99, 135; and MASON and PERKIN, *ibid.*, 1914, 105, 2013. (10) STUHLIK, *Monats.*, 1900, 21, 813; BUCK, PERKIN and STEVENS, *J. Chem. Soc.*, 1925, 127, 1466; cf. GADAMER, *Arch. Pharm.*, 1915, 253, 274. (11) GOLDSCHMIEDT, *Monats.*, 1885, 6, 954; 1886, 7, 485; 1887, 8, 510. (12) CLAUS, *Ber.*, 1883, 16, 1284. (13) GOLDSCHMIEDT, *Monats.*, 1888, 9, 327. (14) GOLDSCHMIEDT and OSTERSETZER, *ibid.*, 1888, 9, 762; ROSSIN, *ibid.*, 1891, 12, 486. (15) Cf. GOLDSCHMIEDT and HÖNIGSCHMID, *Monats.*, 1903, 24, 681. (16) GOLDSCHMIEDT, *ibid.*, 1888, 9, 778; cf. KÖNIGS, *Ber.*, 1899, 32, 3612. (17) *Annalen*, 1903, 329, 37. (18) *Compt. rend.*, 1909, 149, 210. (19) Cf. PICTET and FINKELSTEIN, *Ber.*, 1909, 42, 1979; *Compt. rend.*, 1909, 148, 925. (20) *Arch. Pharm.*, 1927, 265, 1; MANNICH and FALBER, *ibid.*, 1929, 267, 601. (21) *Ber.*, 1913, 46, 1034. (22) (with NOTHNAGEL and RIESENFELDT), *ibid.*, 1927, 60, 392. (23) *Ibid.*, 1927, 60, 704. (24) (with SCHÖN), *ibid.*, 1908, 41, 17; 1909, 42, 2374. (25) *J. Amer. Chem. Soc.*, 1930, 52, 310. (26) *Ibid.*, 1930, 52, 3610. (27) *J. Chem. Soc.*, 1933, 274. (28) *Ber.*, 1930, 63, 2098. (29) *Ibid.*, 1935, 68, 24, 1310; 1936, 69, 622; see, however, SPÄTH (with KUFFNER), *ibid.*, 1935, 68, 496, 1744; (with KUFFNER and KESTZLER), 1936, 69, 378. (30) *J. Chem. Soc.*, 1924, 125, 2176. (31) *Angew. Chem.*, 1933, 46, 766. (32) (with PESCHKE), *Arch. Pharm.*, 1934, 272, 60, 236; (with GEHLHAAR), *ibid.*, 1936, 274, 377. (33) *J. Pharm. Soc. Japan*, 1933, 53, 223 (German text). (34) *Ibid.*, 1935, 55, 58; (with TSUDA), 194; (with KAKEMI), 244 (English text). (35) *J. Soc. Chem. Ind.*, 1945, 64, 84. (36) *J. Chem. Soc.*, 1946, 701. (37) *J. pr. Chem.*, 1940, [ii], 154, 157. (37a) *J. Org. Chem.*, 1939, 4, 71. (38) *Monats.*, 1886, 7, 485; 1898, 19, 324; (39) *Ber.*, 1904, 37, 3321. (40) *J. Chem. Soc.*, 1909, 95, 1610; 1915, 107, 176; cf. PYMAN and REYNOLDS, *ibid.*, 1910, 97, 1320. (41) *J. pr. Chem.*, 1903, [ii], 68, 190. (42) *Ber.*, 1926, 59, 2787. (43) DECKER and GALATTY, *ibid.*, 1909, 42, 1179. (44) PYMAN, *J. Chem. Soc.*, 1909, 95, 1267; (with BHAGWAT and MOORE), *ibid.*, 1931, 443; cf. GADAMER, *Arch. Pharm.*, 1915, 253, 274. (45) *Ber.*, 1900, 33, 2346; cf. PYMAN and REYNOLDS, *J. Chem. Soc.*, 1910, 97, 1323. (46) *J. Chem. Soc.*, 1936, 731; KING and L'ECUYER, *ibid.*, 1937, 427; GADAMER, *Arch. Pharm.*, 1911, 249, 680. (47) *Ibid.*, 1927, 265, 256. (48) *J. Chem. Soc.*, 1932, 785. (49) *Annalen*, 1932, 497, 22; 1939, 537, 143 (cf. THIERFELDER, *Inaug. Diss. Munich*, 1931). (50) *J.*

Chem. Soc., 1932, 789. (51) EMDE, *Arch. Pharm.*, 1912, 391, 88. (52) *Ber.*, 1909, 42, 1179. (53) *J. Chem. Soc.*, 1933, 1583; for further syntheses see *J. Pharm. Soc. Japan*, 1937, 57, 296; *Ber.*, 1938, 71, 1860; *Proc. Imp. Acad. Tokio*, 1941, 17, 102. (54) *Annalen*, 1932, 497, 47, 59. (55) *J. Chem. Soc.*, 1933, 280. (56) *Annalen*, 1870, 153, 47; *Ber.*, 1871, 4, 693. (57) HESSE, *ibid.*, 1894, 282, 209. (58) GOLDSCHMIEDT, *Monats.*, 1892, 13, 691. (59) *J. pr. Chem.*, 1902, [ii], 65, 42. (60) *Monats.*, 1920, 41, 297; cf. DECKER and EICHLER, *Annalen*, 1913, 395, 377; HESS and WELTZIEN, *Ber.*, 1920, 53, 119. (61) *Monats.*, 1921, 42, 273. (62) *Ibid.*, 1926, 47, 733. (63) *Ber.*, 1925, 58, 200. (64) *Arch. Pharm.*, 1890, 228, 419. (65) *Ber.*, 1925, 58, 1272. (66) *Ibid.*, 1930, 63, 1498, 2343; 1931, 64, 2827; 1934, 67, 1261. For the principles involved see FREUDENBERG, *ibid.*, 1914, 47, 2027; WOHL and FREUDENBERG, *ibid.*, 1923, 56, 309; CLOUGH, *J. Chem. Soc.*, 1918, 113, 526. (67) *Arch. Sci. phys. nat.*, 1903, [iv], 15, 121. (68) *Annalen*, 1913, 395, 377; cf. DECKER and DUNANT, *ibid.*, 1908, 358, 288. (69) SPÄTH and EPSTEIN, *Ber.*, 1926, 59, 2791; 1928, 61, 334; cf. SCHÖPF,⁴⁹ (70) KONOVALOVA, JUNUSOV and OREKHOV, *Ber.*, 1935, 68, 2158; *J. Gen. Chem. Russ.*, 1940, 10, 641. (71) KATZ (with LINDNER), *Amer. J. Physiol.*, 1941, 133, 155; (with ELEK), *J. Pharm. exp. Ther.*, 1942, 74, 335; *J. Amer. Med. Assoc.*, 1942, 120, 434; 1943, 122, 196; WEGRIA and NICKERSON, *J. Pharm. exp. Ther.*, 1942, 75, 50; McEACHERN, SMITH and MANNING, *Amer. Heart J.*, 1941, 21, 25. (72) *Zent. Physiol.*, 1902, 16, 68; *Med. Klin.*, 1913, 9, [ii], 1796; POPPER and FRANKE, *Deut. Med. Woch.*, 1912, 38, 1318. (73) *J. Pharm. exp. Ther.*, 1917, 9, 121, 197; 1918, 11, 389, 419. (74) See, for example, KREITMAIR, *Arch. exp. Path. Pharm.*, 1932, 164, 509; (with WOLFES), *Deut. med. Woch.*, 1930, 1703; LANGECKER and STARKENSTEIN, *Klin. Woch.*, 1931, 10, 2257; VON ISSEKUTZ *et al.*, *Arch. exp. Path. Pharm.*, 1932, 164, 158, 173; 1936, 182, 390; EDIT, *Brit. Med. J.*, 1934, i, 812; SAMAAN, *Quart. J. Pharm.*, 1936, 9, 23; BRUCKNER and FODOR, *Ber.*, 1938, 71, 541; KULZ and ROSENMUND, *ibid.*, 1939, 72, 19, 2161. (75) HEILBRON *et al.*, *J. Chem. Soc.*, 1943, 401, 404, 406, 413, 417, 419; LESPAIGNOL, PONTHEU and VANLERENBERGHE, *C. R. Soc. Biol.*, 1944, 138, 528; SHELTON and VAN CAMPEN, U.S. Pat. 2,379,381; BURTNER and CUSIC, *J. Amer. Chem. Soc.*, 1943, 65, 262, 1582; BLICKE (with GRIER), *ibid.*, p. 1725; (with TSAO), *ibid.*, 1944, 66, 1645; LEHMANN, *J. Pharm. exp. Ther.*, 1945, 83, 86; (with YOUNG), *ibid.*, p. 90; (with KNOEFEL), *ibid.*, 1944, 80, 335; (with CHASE and YONKMAN), *ibid.*, 1944, 81, 174; cf. COLEMAN and BYWATERS, *J. Amer. Chem. Soc.*, 1944, 66, 1821, and ROWE, *J. Amer. Pharm. Assoc.*, 1942, 31, 57; RICHARDS, EVERETT and KUETTER, *J. Pharm. exp. Ther.*, 1945, 84, 387; STERN, *Arch. exp. Path. Pharm.*, 1942, 199, 251; cf. GENUIT and KÜBEL, *ibid.*, 1943, 202, 110. (76) *J. Pharm. exp. Ther.*, 1946, 86, 230; for another laboratory comparison see RICHARDS *et al.*⁷⁵ (77) *J. Amer. Pharm. Assoc.*, 1943, 32, 249. (78) *Ann. Rev. Biochem.*, 1944, 13, 549. (79) "The Pharmacology of the Opium Alkaloids," Part 2, p. 1007, laudanone, p. 1042, laudanine, p. 1044. Supplement 165, U.S. Public Health Reports, Washington, 1943. (80) "Elements de Pharmacodynamie spéciale," Paris, Masson & Co., 1932, Tome I, p. 178. (81) BABEL, quoted by PICTET and ATHANASESCU,⁴⁴ also *Rev. Méd. Suisse Roman.* 1899, 19, 657. (82) STARKENSTEIN, *Heffter's Handbuch der Pharmakol.*, 1924, 2, 2, 1007. (83) *C. R. Soc. Biol.*, 1935, 119, 107.

PHTHALIDE/SOQUINOLINE SUB-GROUP

Narcotine, $C_{22}H_{23}O_7N$. This alkaloid, probably found by Derosne in 1803, was first definitely isolated by Robiquet,¹ who gave it the formula, $C_{23}H_{25}O_7N$, which was changed by Matthiessen and Foster² to that now in use. In the extraction of morphine and codeine narcotine remains in the water-insoluble residue, from which it may be extracted by dilute hydrochloric acid, re-precipitated by sodium bicarbonate and recrystallised from boiling alcohol. It crystallises from alcohol in needles, m.p. 176° , $[\alpha]_D - 207.35^\circ$ (EtOH), $[\alpha]_D - 198.0^\circ$ ($CHCl_3$), $+ 50^\circ$ (1 per cent. hydrochloric acid)³; it is nearly insoluble in water, sparingly so in cold 85 per cent. alcohol or ether, readily in benzene, acetone or ethyl acetate; insoluble in cold alkalis or ammonia, but soluble in hot alkalis or "milk of lime." With acids it forms unstable salts that are dissociated by water, and the alkaloid can often be extracted by indifferent solvents from its solutions in dilute acids. The salts are dextrorotatory. The hydrochloride, B. HCl, crystallises with 0.5 to 4.0 H_2O , is very soluble in water, decomposing into basic salts on standing in solution; platinichloride; amorphous; oxalate, B. $H_2C_2O_4$, m.p. 174° , $[\alpha]_D^{20} + 39.5^\circ$ (H_2O); phthalate, B. $C_8H_6O_4$, m.p. 160° , $[\alpha]_D^{22} + 115^\circ$ ($CHCl_3$)^{5(a)}; sesquisulphate,⁴ $B_4 \cdot 3H_2SO_4 \cdot 6H_2O$; picrate, m.p. 175° .⁵

The alkaloid dissolves in sulphuric acid with a greenish colour, changing to red and reddish-violet on warming or long standing. With sulphuric acid containing a trace of nitric acid a deep red colour is produced. According to Labat,⁶ a solution of narcotine in sulphuric acid gives, on warming with gallic acid, a deep blue coloration, due to the liberation of opianic acid. This reaction is also given by hydrastine. Duquenois and Ellert^{6(a)} have described several complex salts of narcotine of which they recommend the silicotungstate for the estimation of the alkaloid.

Constitution. Narcotine is a weak, monoacidic, tertiary base. It contains a methylimino-group and three methoxyl groups, and, when heated in closed tubes with dilute hydrochloric acid, furnishes a series of demethylated derivatives²: dimethylnornarcotine, $C_{19}H_{14}O_4N \cdot OH(OCH_3)_2$, methyl-nornarcotine, $C_{19}H_{14}O_4N(OH)_2 \cdot OCH_3$, nornarcotine, $C_{19}H_{14}O_4N(OH)_3$.

When the alkaloid is heated with water at 150° , or boiled with dilute acids, it is hydrolysed into hydrocotarnine, and opianic acid. Similar decompositions are induced by acid oxidation or acid reduction, thus: (1) dilute nitric acid furnishes opianic acid, $C_{10}H_{10}O_5$, and cotarnine, $C_{12}H_{15}O_4N$; (2) zinc and hydrochloric acid produce meconin, $C_{10}H_{10}O_4$, and hydrocotarnine, $C_{12}H_{15}O_3N$.

Meconin, $C_{10}H_{10}O_4$, was isolated from opium in 1832 by Dublanc, and also occurs in *Hydrastis canadensis*. It crystallises from water in prisms, m.p. 102° , and dissolves in alkaline solutions, forming unstable salts of meconinic acid, $C_{10}H_{12}O_5$, of which it is the lactone. It was

synthesised by Fritsch ⁷ from guaiacol. Edwards, Perkin and Stoyle ⁸ devised a simpler method, based on the condensation of *o*-veratric acid with formaldehyde, and, since opianic acid results from the oxidation of meconin, and hemipinic acid from the further oxidation of opianic acid, this process provides syntheses of these three degradation products.

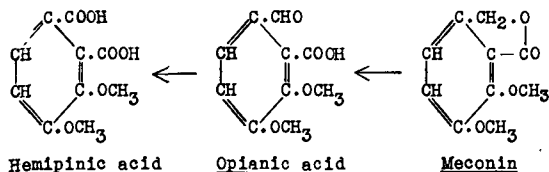

Hydrocotarnine, $\text{C}_{12}\text{H}_{15}\text{O}_3\text{N} \cdot \frac{1}{2}\text{H}_2\text{O}$. This basic hydrolytic product of narcotine occurs in opium.⁹ It crystallises from light petroleum in colourless plates, m.p. $55.5\text{--}56.5^\circ$, and yields well-crystallised salts of which the hydrobromide, B. HBr, m.p. $236\text{--}7^\circ$, is sparingly soluble in water. On oxidation, hydrocotarnine is converted into cotarnine, and on reduction by sodium in alcohol it yields hydrohydrastinine (p. 164) by loss of a methoxyl group.¹⁰

Cotarnine, $\text{C}_{12}\text{H}_{15}\text{O}_4\text{N}$. This base, first obtained by Wohler,¹¹ is conveniently prepared by the action of dilute nitric acid on narcotine.¹² It crystallises in small needles, has m.p. $132\text{--}3^\circ$ (*dec.*), or 125° (*dec.*) when freshly crystallised from benzene, or 100° when dried on a water-bath (Dott),¹³ is readily soluble in alcohol or ether, sparingly in cold water and forms salts with mineral acids, losing a molecule of water: thus the chloride has the composition $\text{C}_{12}\text{H}_{13}\text{O}_3\text{N}, \text{HCl}, 2\text{H}_2\text{O}$, m.p. 197° (*dec.*) or 192° (Dott)¹⁴ and crystallises in pale yellow, silky needles. Specifications for this salt are given in the British Pharmaceutical Codex (1934) and the U.S. National Formulary, VIII. Cotarnine phthalate is also used in medicine. The product used in Great Britain is the acid phthalate, $\text{C}_{12}\text{H}_{13}\text{O}_3\text{N}, \text{C}_8\text{H}_6\text{O}_4, \text{H}_2\text{O}$, m.p. $113\text{--}5^\circ$ or 140° (*dry*); the neutral phthalate has m.p. $102\text{--}5^\circ$. Cotarnine aurichloride forms golden-yellow plates, m.p. $136\text{--}7^\circ$; the picrate crystallises in yellow needles, m.p. 143° . A method of assay for cotarnine has been described by Steenberg.^{14(a)}

Cotarnine contains one methoxyl group, and the presence of a methylenedioxy-group was established by the oxidation of cotarnine by potassium permanganate to cotarnic acid,¹⁵ $\text{C}_8\text{H}_6\text{O}_3(\text{CO}_2\text{H})_2$, plates, m.p. 178° , which still contains the methoxyl group and in which the two carboxyl groups must be in the *ortho*-position to each other, since the acid readily forms an anhydride, m.p. $161\text{--}2^\circ$. With hydriodic acid and red phosphorus at $150\text{--}60^\circ$, cotarnic acid yields gallic acid (3:4:5-trihydroxybenzoic acid).¹⁶ These and other observations show that cotarnic acid is the methyl methylene ether of a 3:4:5-trihydroxyphthalic acid and is therefore a methoxy-derivative of hydrastic acid (p. 164).¹⁶ The relative position of the methoxyl- and methylenedioxy-groups were indicated by Freund and Becker,¹⁷ who showed that when cotarnineanil (II) reacts with methyl iodide it yields cotarnine methine methiodide anil (III), which

with excess of methyl iodide and subsequent warming with dilute hydrochloric acid, is converted into *norcotarnine* methine methiodide (IV) and this, on treatment with alkali, decomposes into *norcotarnone* (V) and trimethylamine. This loss of methyl from a methoxyl group also occurs with the anil of *o*-methoxybenzaldehyde, which on similar treatment yielded *o*-hydroxybenzaldehyde, whence it was argued that in cotarnine the methoxyl group and the aldehyde group, the presence of the latter in cotarnine being indicated by the formation of cotarnine-oxime, m.p. 165–8°, were in the *o*-position to each other.

Cotarnic acid may therefore be represented by (VI), and this was confirmed by Perkin, Robinson and Thomas,¹⁸ who synthesised cotarnic acid, starting from 5 : 6-methylenedioxy-1-hydrindone (VII) which was nitrated in position 7, the nitro-group converted in the usual way to a

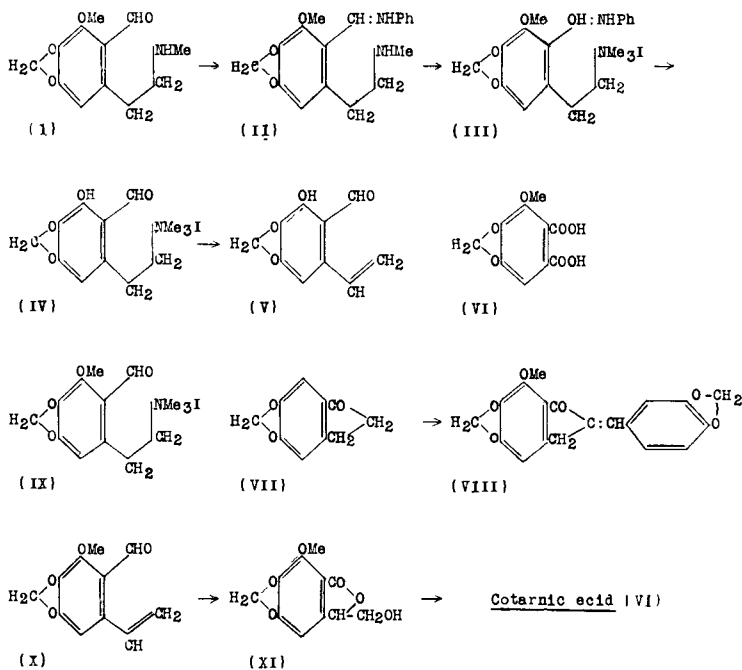

hydroxyl group, the latter methylated, and the condensation product (VIII) with piperonal, oxidised yielding cotarnic acid (VI).

Cotarnine with methyl iodide furnishes cotarnine hydriodide and cotarnine methine methiodide, $C_{11}H_{11}O_4NMe_3I$ (IX), which is decomposed by alkalis into trimethylamine and cotarnone (X), $C_{11}H_{10}O_4$, rhombic plates, m.p. 78°. The latter yields an oxime, m.p. 130–2°, and is oxidised by potassium permanganate to a mixture of cotarnic acid (VI) and cotarnlactone, $C_{11}H_{10}O_6$ (XI), brilliant leaflets, m.p. 154°, which is convertible into the corresponding acid, cotarnonelactone acid, leaflets, m.p. 90–100° (*dec.*). The lactone on further oxidation yields cotarnic acid.¹⁶

The formation of cotarnone from cotarnine methine methiodide by the action of potash (IX—X) led Roser to represent cotarnine and its salts by the following formulæ,¹⁹ the loss of a molecule of water in the formation of cotarnine salts being explained by the production of a partially reduced pyridine ring, which is fully hydrogenated in the reduction of cotarnine to hydrocotarnine. In the reverse process, oxidation of hydrocotarnine to cotarnine, Roser assumed the scission of the ring at the point indicated, with the formation of a hydration product, and oxidation of the latter to cotarnine thus:—

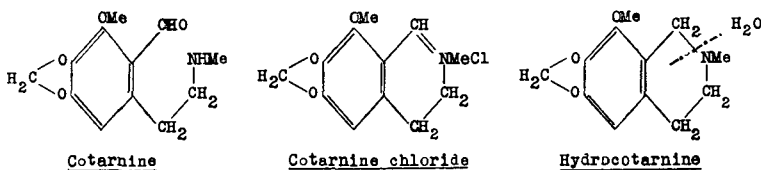
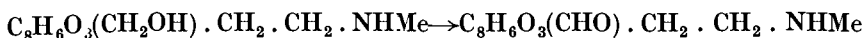

Decker pointed out²⁰ that it was improbable that a secondary amine group and the aldehyde group could co-exist in the same molecule, and suggested that the reactions of cotarnine could be better accounted for by a bicyclic formula. Hantzsch and Kalb²¹ showed that the electrical conductivities of solutions of cotarnine indicated the existence in such solutions of an equilibrium mixture of two or possibly three forms, one having Roser's formula, another Decker's formula (ψ -cotarnine), and a third having the formula of the ammonium base (*see below*) corresponding to that used by Roser for cotarnine salts. Dobbie, Lauder and Tinkler,²² by comparison of the ultra-violet absorption spectra of solutions of cotarnine, found that the solid alkaloid probably possesses the constitution proposed by Decker, whilst in solution in dissociating solvents it possesses, at least in part, the structure assigned by Roser¹⁹ to the salts.

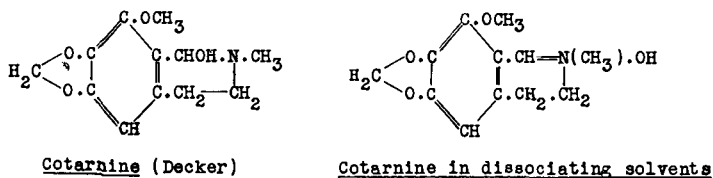

Among other evidence lending support to Decker's formula for cotarnine, may be mentioned the oxidation of cotarnine to apophyllenic acid,²³ [the methylbetaine of cinchomeronic acid (pyridine-3:4-dicarboxylic acid)] which, along with its oxidation to cotarnic acid, implies that cotarnine is an *isoquinoline* derivative. In discussing the large number of condensation reactions with cotarnine which have been described, Hope and Robinson point out that, on the basis of Lapworth's explanation of the Knoevenagel reaction, in a structure, such as the ammonium form of cotarnine (type (c)), the positive ion can unite with the negative residue of

a substance H . X, where X may be any group, such as CN,²⁵ . CH₂ . NO₂,²⁴ CH₂ . C₆H₃(NO₂)₂,²⁴ . CH(CO₂Et)₂,²⁶ CH₂ . COPh,²⁷ to produce a complex of type (d), and this, being unstable, passes into type (e), which represents derivatives of hydrocotarnine.

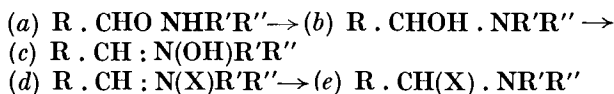

On this basis the formation of 1-alkylhydrocotarnines by the action of Grignard reagents on cotarnine, investigated by Freund and collaborators,²⁸ is represented as taking place in the following way :—

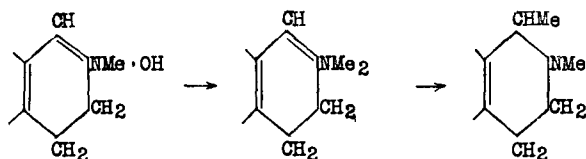

Utilising the formulae assigned to the two products of hydrolysis of narcotine, *viz.*, hydrocotarnine and opianic acid, Roser constructed a formula for the alkaloid¹⁶ which has been confirmed by Perkin and Robinson's synthesis of narcotine from meconin and cotarnine.²⁹

A synthesis of narcotine was attempted by Liebermann,³⁰ who, by condensing opianic acid and hydrocotarnine, in presence of cold 73 per cent. sulphuric acid, obtained *isonarcotine*, distinguished from narcotine by its melting-point, 194°, instead of 176°, and by the fact that it gives a red instead of a green coloration with sulphuric acid. According to Jones, Perkin and Robinson,³⁰ *isonarcotine* is related to narcotine, as shown by the following formulae :—

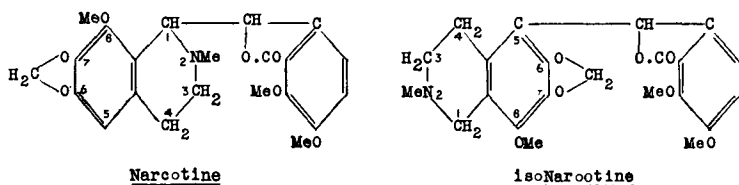

The synthesis of meconin has been referred to already (p. 201). Cotarnine has been synthesised by Salway³¹ from myristicin (I) as a starting-point. This was transformed into β -3-methoxy-4 : 5-methylenedioxyphenylpropionic acid (II), the amide of which was converted by Hofmann's reaction into β -3-methoxy-4 : 5-methylenedioxyphenylethylamine, and the phenylacetyl derivative (III) of this condensed, by heating it in xylene solution with phosphoric oxide, giving rise to the two possible dihydroisoquinoline derivatives. The first of these substances, 8-methoxy-6 : 7-methylenedioxy-1-benzyl-3 : 4-dihydroisoquinoline (IV), on conversion into the methochloride and reduction with tin and hydrochloric acid, gave

1-benzylhydrocotarnine, and this, on oxidation with manganese dioxide and sulphuric acid, yielded cotarnine (V). The second, produced by ring

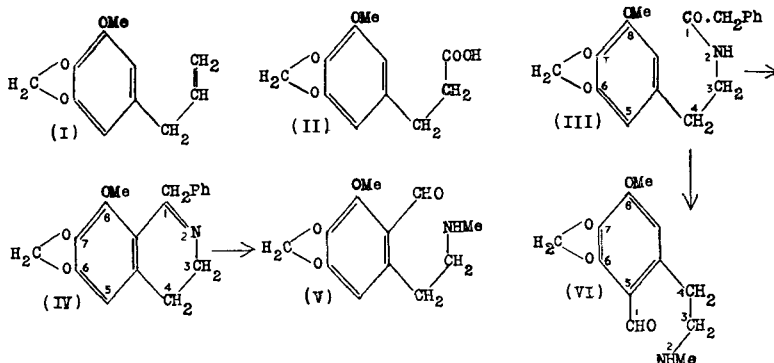

closure at positions 1 and 5 on like treatment, furnished an isomeride, which was named *neocotarnine* (VI), colourless prisms, m.p. 124° (*dec.*).

The syntheses of meconin and cotarnine having been effected, Perkin and Robinson completed this work by condensing these two substances in presence of potassium carbonate or by simply boiling them together in alcoholic solution.²⁹ The product obtained proved to be the alkaloid GNOSCOPINE, an inactive isomeride of narcotine obtained from opium by T. and H. Smith,³² who also showed that this substance is formed when narcotine is boiled in acetic acid solution, and that it gives the same colour reactions as narcotine, and, like this alkaloid, is oxidised to opianic acid and cotarnine. Rabe and MacMillan,³³ found that when narcotine is racemised to gnoscopine, the latter is partly decomposed into *normarceine* (p. 208), cotarnine and meconin. Perkin and Robinson deracemised their synthetic gnoscopine and also natural gnoscopine by crystallisation of the *d*- and *l*-bromocamphorsulphonates. The three isomerides thus obtained had the following characters:—

dl-Narcotine (*gnoscopine*). Colourless needles, m.p. 229° or 232–3° (R. and M.)³³; picrate, yellow prisms, m.p. 188–9°; methiodide, B. CH₃I · 2H₂O, prisms, m.p. 210–2° (*dry*).

d-Narcotine. Colourless needles, m.p. 175°, [α]_D + 199·92° (CHCl₃).

l-Narcotine (natural narcotine). Colourless needles, m.p. 175°, [α]_D – 199·85° (CHCl₃).

Hope and Robinson³⁴ found that nitro- and mono-halogenated meconins condensed even more readily than meconin itself with cotarnine to yield the corresponding substituted gnoscopines, but whilst iodomeconin yielded in this way the iodo-derivative of natural gnoscopine (*α*-gnoscopine), nitromeconin furnished the nitro-derivative of an isomeric base, *β*-gnoscopine, which is a stereoisomeride of the *α*-form yielding the same oxidation products, and, like it, convertible into narceine. *β*-Gnoscopine has not been resolved into optically active forms, but Marshall, Pyman and Robinson³⁵ have shown that natural *l*-narcotine (now more conveniently

named *l*- α -narcotine), when boiled with methyl-alcoholic potash, is partially converted into *l*- β -narcotine, and *d*- α -narcotine is similarly converted into *d*- β -narcotine; a mixture of equal parts of the two β -forms has the characters of β -gnoscopine and shows no depression of melting-point (180°) on admixture with it.

It is considered that in these new forms racemisation or reversible inversion has occurred at the centre of asymmetry in the phthalide group, and that the centre of asymmetry in the *iso*quinoline nucleus is unaffected. The melting-point, 176°, of each new isomeride is depressed by addition of the corresponding α -narcotine and the specific rotation of *l*- β -narcotine, $[\alpha]_{546}$ is -101° (CHCl₃) or $-59\cdot2^\circ$ (N . HCl), that of *l*- α -narcotine, under the same conditions being -246° and $+50\cdot4^\circ$ respectively.

Among interesting transition products of narcotine may be mentioned narceine (described p. 207) and the "tarconines." The latter are derivatives of 6 : 7-methylenedioxy-8-hydroxy*iso*quinoline betaine, and have played some part in the discussion of the constitution of cotarnine.³⁶

Narcotoline, C₂₁H₂₁O₇N. This alkaloid, isolated from opium-poppy capsules by Wrede,³⁷ crystallises from dilute methyl alcohol in rods, m.p. 202° (*dec.*), $[\alpha]_{\text{D}}^{20}$ -189° (CHCl₃) or $+5\cdot8^\circ$ (N/10 . HCl). The acid tartrate, B . C₄H₆O₆ . 0·5H₂O, forms needles, decomposing at 200°. The monoacetyl derivative was isolated as the hydrochloride, C₂₁H₂₀O₇N . Ac . HCl . H₂O, m.p. 230-3° (*dec.*), $[\alpha]_{\text{D}}^{20}$ $+94\cdot8^\circ$ (H₂O). On treatment with diazomethane, narcotoline is converted into narcotine, m.p. 173°, $[\alpha]_{\text{D}}^{20}$ $+47\cdot6^\circ$ (N/10 . HCl). The phenolic hydroxyl group in narcotoline must replace the methoxyl group at C⁸ in narcotine, since narcotoline yields meconin (p. 200) on heating with 20 per cent. acetic acid in sealed tubes at 100-5°.

REFERENCES

- (1) *Ann. Chim. Phys.*, 1817, [ii], 5, 275. (2) *J. Chem. Soc.*, 1863, 16, 342; MATTHIESSEN, *Proc. Roy. Soc.*, 1870, 17, 337. (3) ANNETT, *Analyst*, 1923, 48, 53; *Trans. Chem. Soc.*, 1923, 123, 378; *cf.* PARISELLE, *Compt. rend.*, 1934, 198, 928. (4) DOTT, *Pharm. J.*, 1928, 120, 292, 301. (5) MAPLETHORPE and EVERS, *ibid.*, 1925, 115, 137. (5a) VOLMAR *et al.*, *Compt. rend.*, 1939, 208, 2000. (6) *Bull. Soc. chim.*, 1909, [iv], 5, 742, 743. (6a) *Bull. Soc. chim.*, 1939, [v], 6, 1582. For other colour reactions see REICHARD, *Pharm. Zent.*, 1907, 48, 44. (7) *Annalen*, 1898, 301, 351. (8) *J. Chem. Soc.*, 1925, 127, 195. (9) HESSE, *Annalen*, Suppl., 1872, 8, 326. (10) PYMAN and REMFREY, *J. Chem. Soc.*, 1912, 101, 1595; *cf.* KONDO and NAKAZATO, *J. Pharm. Soc. Japan*, 1924, No. 507, 326; TANAKA, MIDZUNO and OKAMI, *ibid.*, 1930, 89; and TOPTSCHIEV, *J. Appl. Chim. Russ.*, 1933, 6, 529. (11) *Annalen*, 1844, 50, 19. (12) ANDERSON, *ibid.*, 1853, 86, 187; *cf.* ROSER, *ibid.*, 1888, 249, 156. (13) DOTT, *Pharm. J.*, 1907, [iv], 24, 78. (14) *Ibid.*, 1924, 113, 688; 1931, 127, 520. (14a) *Svensk. Farm. Tidskr.*, 1940, 44, 309. (15) ROSER, *Annalen*, 1888, 249, 156; *cf.* FREUND and WULFF, *Ber.*, 1902, 35, 1737; and GAEBEL, *Arch. Pharm.*, 1910, 248, 207. (16) ROSER, *Annalen*, 1889, 254, 334, 359. (17) *Ber.*, 1903, 36, 1521; *cf.* SPÄTH, SCHMID and STERNBERG, *ibid.*, 1934, 67, 2095. (18) *J. Chem. Soc.*, 1909, 95, 1977; for a later synthesis see SPÄTH *et al.*¹⁷ (19) *Annalen*, 1888, 245, 311; 247, 167; 1888, 249, 156, 168; 1889, 254, 334, 359; *cf.* FREUND and BACKER.¹⁷ (20) *J. pr. Chem.*, 1893, [ii], 47, 222. (21) *Ber.*, 1899, 32, 3109; 1900, 33, 2201; *cf.* FREUND and BAMBERG, *ibid.*, 1902, 35, 1739. (22) *J. Chem. Soc.*, 1903, 83, 598; 1904, 85, 121. (23) VONGE.

RICHTEN, *Ber.*, 1880, 13, 1635; *Annalen*, 1881, 210, 79; (synthesis) ROSER, *ibid.*, 1886, 234, 116. (24) *J. Chem. Soc.*, 1911, 99, 1153, 2114. (25) FREUND and PREUSS, *Ber.*, 1900, 33, 380; DECKER, *ibid.*, p. 2273; HANTZSCH, *ibid.*, 1899, 32, 3109; 1900, 33, 2201. (26) LIEBERMANN (with KROFF), *ibid.*, 1904, 37, 211; (with GLAWÉ), p. 2738; KROFF, *ibid.*, p. 2744. (27) HOPE and ROBINSON, *J. Chem. Soc.*, 1913, 103, 361. (28) *Ber.*, 1903, 36, 4257; 1904, 37, 3334; (with REITZ), 1906, 39, 2219; (with BODE), 1909, 42, 1746; (with LEDERER), 1911, 44, 2353. (29) *J. Chem. Soc.*, 1911, 99, 775. (30) *Ber.*, 1896, 29, 183, 2040; *cf.* KERSTEN, 1898, 31, 2098; and JONES, PERKIN and ROBINSON, *J. Chem. Soc.*, 1912, 101, 258. (31) *J. Chem. Soc.*, 1910, 97, 1208; *cf.* DECKER and BECKER, *Annalen*, 1913, 395, 328. For a more recent synthesis see KINDLER and PESCHKE, *Arch. Pharm.*, 1932, 270, 353. (32) *Pharm. J.*, 1878, [iii.] 9, 82; 1893, [iii.] 23, 794. (33) *Ber.*, 1907, 40, 3280; *Annalen*, 1910, 377, 223. (34) *J. Chem. Soc.*, 1914, 105, 2085; see also *ibid.*, 1911, 99, 1153, 2114; 1913, 103, 361; 1914, 105, 1436; GREENWOOD and ROBINSON, 1932, 1370. (35) *Ibid.*, 1934, 1315. (36) JORGENSEN, *Ber.*, 1869, 2, 460; WRIGHT, *J. Chem. Soc.*, 1877, 32, 525; VONGERICHTEN, *Annalen*, 1831, 210, 79; 1882, 212, 165; ROSER, *ibid.*, 1888, 245, 311; 1889, 254, 359. FREUND and LEDERER, *Ber.*, 1911, 44, 2353. (37) *Arch. esp. Path. Pharm.*, 1937, 184, 331.

Narceine, $C_{23}H_{27}O_8N \cdot 3H_2O$. This alkaloid was obtained by Pelletier in 1832, and was subsequently characterised by Couerbe and by Anderson.¹ The latter assigned to it the formula, $C_{23}H_{29}O_9N$, which was accepted until Freund² observed that the base crystallised with 3 mols of water, of which only two are lost at 100°. Anderson's base therefore was $C_{23}H_{27}O_8N \cdot H_2O$.

Narceine remains dissolved in opium extract after the removal of the chief alkaloids and may be isolated as described by Anderson.¹ It is usually prepared from narcotine (*see below*). It forms slender needles or prisms, m.p. 170° or 140–5° (*dry*), $[\alpha]_D \pm 0^\circ$. It dissolves in alkaline liquids, including ammonia, forming metallic derivatives, which crystallise from alcohol on addition of ether with 1 mol. of the solvent, the general formula being $C_{23}H_{26}O_8N \cdot M \cdot C_2H_5OH$, where M represents a monovalent metal. Narceine behaves as a feeble, monoacidic, tertiary base and yields well-crystallised salts. The hydrochloride, B. HCl, crystallises from dilute hydrochloric acid, with $5\frac{1}{2}H_2O$ in the cold, or with $3H_2O$ from hot solutions. If a methyl alcohol solution of hydrogen chloride is used, the salt crystallises with 1 mol. of methyl alcohol, B. HCl. CH_3OH , m.p. 190–2. The picrate has m.p. 195°, and the aurichloride forms reddish-yellow needles, m.p. 130°. Narceine gives a characteristic blood-red colour with chlorine water followed by addition of ammonia. Weak iodine solution colours solid narceine blue; the blue product forms a colourless solution in boiling water and is re-precipitated on cooling.³

The alkaloid can be prepared⁴ by blowing steam through narcotine methochloride previously mixed with the equivalent quantity of sodium hydroxide. The identity of the product, at first called ψ -narceine, with narceine was established by Roser,⁴ and has been confirmed by Addinall and Major.⁴ *homo*Narceine, $C_{24}H_{29}O_8N \cdot 3H_2O$, m.p. 173° (*dec.*) is similarly made from narcotine ethochloride.

Narceine contains three methoxyl and two methyl-groups attached to nitrogen, reacts with phenylhydrazine or hydroxylamine, furnishing phenylhydrazone or oxime anhydrides and esterifies with alcohols in presence of hydrogen chloride. From a study of these reactions, and in

particular the formation of narceine from narcotine, Freund and Frankforter ² represented narceine (III) as produced *via* (II) from narcotine methochloride (I), and this has been confirmed by Freund and Oppenheimer's ⁵ observation that narceine reacts with ethyl nitrite to form an oximino-derivative (IV), which, on exhaustive methylation, gives trimethylamine, hemipinic acid (VI) and 2-cyano-3-methoxy-4:5-methylenedioxy-1-vinylbenzene (V), a substance first obtained by Roser from cotarnine ⁶ and named cotaronitrile.

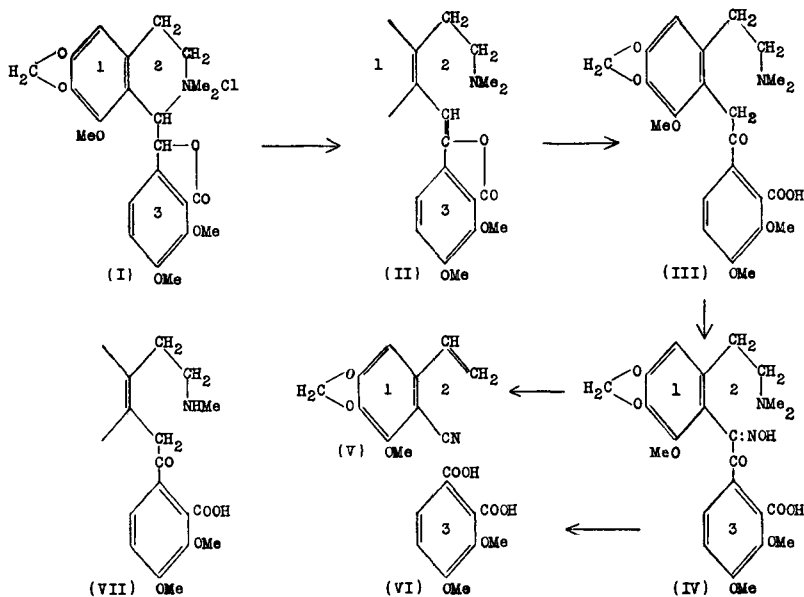

As stated already, on heating in acetic acid solution, *l*-narcotine yields *dl*-narcotine (gnoscopine), and some *nor*narceine (VII), $C_{22}H_{25}O_8N \cdot 3H_2O$ (felted needles, m.p. 146° or 228° (*dry*)). This change is analogous with that of cinchonine into cinchonidine.⁷

REFERENCES

- (1) COUERBE, *Annalen*, 1836, 17, 171; ANDERSON, *ibid.*, 1853, 86, 182. (2) (with FRANKFORTER), *ibid.*, 1893, 277, 20. (3) For other methods of detection see WAGENAAR, *Pharm. Weekbl.*, 1927, 64, 354; ZWIKKER, *ibid.*, 1929, 66, 445. (4) ROSER, *Annalen*, 1888, 247, 167; FREUND and FRANKFORTER, *ibid.*, 1893, 277, 31; FRANKFORTER and KELLER, *Amer. Chem. J.*, 1899, 22, 61; FRERICHS, *Arch. Pharm.*, 1903, 241, 259; HOPE and ROBINSON, *J. Chem. Soc.*, 1914, 105, 2100; RODIONOV, *Bull. Soc. chim.*, 1926, [iv], 39, 305; ADDINALL and MAJOR, *J. Amer. Chem. Soc.*, 1933, 55, 1202. (5) *Ber.*, 1909, 42, 1084; for recent observations on the structure of narceine and the mechanism of its formation from narcotine see ZWIKKER, *Pharm. Weekbl.*, 1929, 66, 461; ADDINALL and MAJOR, *J. Amer. Chem. Soc.*, 1933, 55, 2153. The similar conversion of narcotine *N*-oxide into *N*-hydroxynor-narceine is dealt with by POLONOVSKI and POLONOVSKI, *Compt. rend.*, 1930, 190, 310; *Bull. Soc. chim.*, 1930, [iv], 47, 361, 365. (6) *Annalen*, 1889, 254, 388. (7) RABE, *Ber.*, 1907, 40, 3280.

Oxynarcotine, $C_{22}H_{23}O_8N$. This alkaloid was separated by Mayer,¹ and later by Beckett and Wright,² from crude narceine. It crystallises from hot alcohol in small needles. Its close relationship to narcotine is shown by the formation of cotarnine, $C_{12}H_{15}O_4N$ (p. 201), and hemipinic acid when it is oxidised by ferric chloride; narcotine under these circumstances furnishing cotarnine and opianic acid. Rabe and McMillan³ regard oxynarcotine and *nor*narceine as identical.

REFERENCES

(1) *Proc. Phil. Soc. Glasgow*, 1871. (2) *J. Chem. Soc.*, 1876, 29, 461. (3) *Annalen*, 1910, 377, 223; cf. GADAMER and VAN DER BRUCK, *Arch. Pharm.*, 1923, 261, 117.

In addition to the foregoing five phthalideisoquinoline alkaloids obtained from opium, Manske has isolated from genera of the Rhœadales six more alkaloids definitely assigned to, and three, including base F38 (p. 173), which he considers may belong to this group. Hydrastine, already dealt with (p. 162), is also a phthalideisoquinoline derivative.

Bicuculline, $C_{20}H_{17}O_6N$. (Items 1, 9, 10, 13, 14, 18, 20, 23–26, 34, 35, 38; list, p. 169). This alkaloid exists in two forms, m.p. 177° and m.p. 196°, and has $[\alpha]_D^{25} + 130.5^\circ$ ($CHCl_3$). The hydrochloride has m.p. 259° (*dec.*) and from the methiodide, *N*-methylbicuculline, plates, m.p. 246°, has been prepared. Bicuculline contains no methoxyl groups: it behaves as a lactone and is convertible by alkalis into *bicucine*, which is possibly the corresponding hydroxy-acid (*see below*). It simulates hydrastine in its reactions and differs from that base by CH_4 , indicating that a methylenedioxy group replaces two methoxyl groups, and this view is supported by comparison of the products of oxidative hydrolysis of the two alkaloids. Both yield hydrastinine (p. 163) as the basic product, but while hydrastine provides as the second product, opianic acid,



bicuculline gives 2-carboxy-3 : 4-methylenedioxybenzaldehyde, $C_6H_2(CHO : COOH : -O \cdot CH_2 \cdot O - = 1 : 2 : 3 : 4)$, m.p. 155°.¹ The identity of the latter was established by conversion into 3 : 4-methylenedioxy-*N*-ethylphthalimide, m.p. 130°, and by reduction of the aldehydo-acid to 3 : 4-methylenedioxyphthalide,² m.p. 232–3°. On this basis Manske proposed formula (I; R = H) for bicuculline, which was confirmed by Groenewoud and Robinson's synthesis of the alkaloid (p. 210).

Bicucine, $C_{20}H_{19}O_7N$, H_2O . This alkaloid³ has m.p. 222° (*dec.*) and $[\alpha]_D^{52} - 115.4^\circ$ (N/10, KHO) but in N/HCl it shows mutarotation -145° to -100° , due to the formation of an equilibrium mixture of bicucine and bicuculline. Alkaline permanganate oxidises it to 3 : 4-methylenedioxyphthalic acid, isolated as the ethylimide. In view of its formation from bicuculline by the action of alkali, Manske has suggested for its formula (II) or (III), the former representing it as the *nor*narceine (p. 208) analogue of bicuculline, whilst (III) makes it the hydroxy-acid corresponding to the lactone, bicuculline and is preferred.

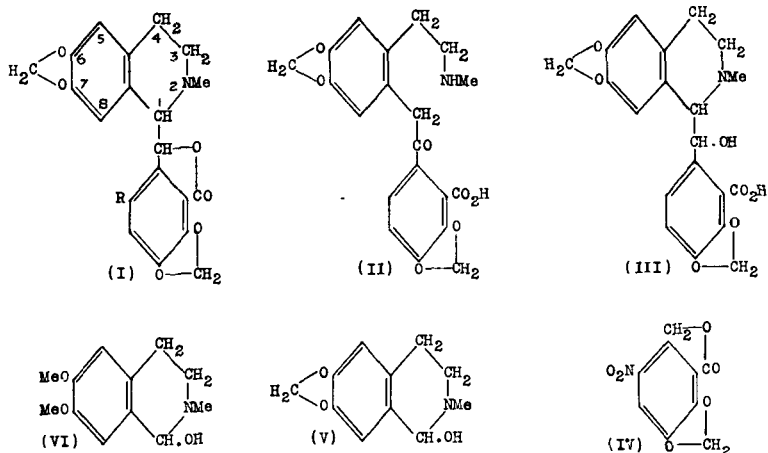

Adlumine and Adlumidine. (Items 1, 21, 24, 25, 29; list, p. 169). From *Adlumia cirrhosa* Rap. Schlotterbeck⁴ isolated two alkaloids, adlumine, $C_{37}H_{34}O_9N(OH)(OMe)_2$, m.p. 188° , $[\alpha]_D + 39.88^\circ$, and adlumidine, $C_{30}H_{29}O_9N$, m.p. 234° . Manske⁵ used these two names for alkaloids isolated from *A. fungosa* Greene, stated to be identical with *A. cirrhosa* Rap., and suggested (I) that Schlotterbeck's adlumine was probably bicuculline with some adlumine and (II) that the two adlumidines are identical.

Adlumine, $C_{21}H_{21}O_6N$. This alkaloid has m.p. 180° , $[\alpha]_D^{22} \pm 42.5^\circ (CHCl_3)$; the *dl*-form has m.p. 175° . Adlumine has two methoxyl groups and a tertiary nitrogen atom. Nitric acid oxidises it to two products: (a) 2-carboxy-3:4-methylenedioxybenzaldehyde (*cf.* bicuculline, p. 209) and (b) Pyman's 4:5-dimethoxy-2 β -methylaminoethylbenzaldehyde,⁶ which was isolated as the carbinol form (VI). On this basis Manske suggested for adlumine formula (I, with $\cdot O \cdot CH_2 \cdot O \cdot$ at 6 and 7 replaced by two methoxyl groups and $R = H$). Adlumine is therefore hydrastine with the positions of the dioxymethylene group and the two methoxyl groups interchanged, or bicuculline with the dioxymethylene group at 6 and 7 replaced by two methoxyl groups.

Adlumidine, $C_{19}H_{15}O_6N$ (items 1, 29; list, p. 169). This alkaloid crystallises in rhombic plates, m.p. 238° ; no methoxyl groups are present.

Synthesis of bicuculline and nitroadlumine. Groenewoud and Robinson⁷ synthesised bicuculline by the general method devised by Hope and Robinson,⁸ the initial products in this case being 6-nitro-3:4-methylenedioxyphthalide (IV) prepared by a new method from *normeconin*, and hydrastinine (V). The condensation product, called nitro- α -bicuculline (the α indicating that the *dl*-product cannot yet be allocated to the α - or β -stereoisomeric series; *cf.* synthesis of hydrastine, p. 167), forms minute yellow needles, sinters at 176° and decomposes at 179° . It was reduced to amino- α -bicuculline (I; $R = NH_2$), yellow prisms, m.p. $203-4^\circ$, the latter

converted to iodo-*x*-bicuculline, prisms, m.p. 208–9°, and this in turn reduced to *x*-bicuculline (I; R = H), which was obtained in colourless elongated plates, m.p. 215°, and behaving like the natural *d*-base with alkalis and with sulphuric acid.

In like manner lodal (VI), on condensation with 6-nitro-3 : 4-methylene-dioxypthalide (IV) yields nitro-*x*-adlumine (I; R = NO₂; .O . CH₂ . O . at C⁶ and C⁷ replaced by 2OMe), which crystallises from chloroform-methyl alcohol in orange, rectangular plates, m.p. 180–1° (*dec.*), and on reduction yields the corresponding amino-derivative, bundles of minute needles, m.p. 218–9°.

Corlumine, C₂₁H₂₁O₆N. (Items 18, 24, 26, 35; list, p. 171). This alkaloid has m.p. 159°, $[\alpha]_D^{25} + 77^\circ$ (CHCl₃) ± 0° (EtOH), and is lævorotatory in acid. It yields on oxidative hydrolysis the same products as adlumine (p. 210) with which it is stereoisomeric but not enantiomorphous.⁹

Corlumidine, C₂₀H₁₉O₆N. (Item 24; list, p. 171), crystallises in prisms, m.p. 236°, $[\alpha]_D^{23} + 80^\circ$, contains one hydroxyl group and on methylation yields corlumine⁹ (*see above*). The free hydroxyl is probably at C⁷ in the isoquinoline nucleus of adlumine, *i.e.*, corlumidine is represented by formula (I) where R = H and the dioxymethylene group at C⁶ and C⁷ is replaced by OMe at C⁶ and OH at C⁷.

Cordrastine, C₁₈H₁₃O₂N(OMe)₄. (Item 9; list, p. 170). Colourless needles, m.p. 196°. Its composition and reactions suggest that it belongs to the phthalideisoquinoline group and is represented by formula (I) (with R = H and the two dioxymethylene groups replaced by four methoxyl groups).¹⁰

Capnoidine, C₁₉H₁₅O₆N. (Items 24, 25; list, p. 171.) M.p. 238°, gives a crystalline hydrochloride, m.p. 244°. It contains no methoxyl groups, is isomeric with adlumine and possibly belongs to the phthalideisoquinoline group.¹¹ See also base F 38 (Item 44; list, p. 173).

Pharmacology. According to Zunz *narcotine* comes between codeine and thebaine in convulsant and analgesic activity and is said generally to resemble codeine in action, but to be less depressant, and is less toxic than either morphine or codeine. Its action on plain muscle resembles that of papaverine. It was at one time used in India for the treatment of malaria but has long been superseded by quinine. It is obtainable in large quantity in working up Indian or Persian opium for morphine and codeine, but though a number of pharmacological investigations¹² have been made, no practical use has been found for it except as a source of cotarnine. The action of *narcotine* is similar to that of narcotine but weaker.¹³

Cotarnine resembles hydrastinine (p. 167) in its pharmacological effects, but its action on the uterus is less marked. It does not constrict the arterioles and appears to have a depressant action on the heart. Magidson and Gorbovizki have shown¹⁴ that the Schiff's bases formed by the condensation of aldehydes with 1-aminomethylanhydrocotarnine have a marked local anæsthetic action but are irritant.

Narceine has been used as a sedative and hypnotic but is believed to

have little action when pure, probably owing to the instability of its salts and the sparing solubility of the free base.

Bicumulline, *bicucine* and *adlumine* have been compared pharmacologically with hydrastine by Welch and Henderson.¹⁵ *Bicumulline* resembles hydrastine in action, but is about 100 times as active as a convulsant. *Bicucine* induces convulsions in rabbits in about the same dose as hydrastine. *Adlumine* is a weaker convulsant than any of the other three but acts more powerfully on the uterus than either *bicumulline* or hydrastine. According to Rice,¹⁶ *corlumine* lies between *bicumulline* and *adlumine* as a convulsant and its action on isolated rabbit intestine and guinea-pig uterus is similar to that of other members of the group. An extensive series of Manske's alkaloids of the Fumariaceæ has been examined by Anderson and Chen,¹⁷ including *adlumidine* and *capnoidine*; all the bases are stated to stimulate isolated guinea-pig or rabbit uterus and *capnoidine* inhibited isolated rabbit intestine. *Capnoidine* was also exceptional in resembling *l-isocorypalmine* (p. 291) in inducing catalepsy in young monkeys. Though *cularine* (p. 313) has not been suggested as a member of either the benzyl- or phthalide_{iso}quinoline group it has been compared pharmacologically by Reynolds¹⁸ with papaverine and hydrastine. As a convulsant, *cularine* was about one-tenth as potent as hydrastine. Like papaverine, and more definitely than hydrastine, a 1 per cent. solution produced anæsthesia of the rabbit cornea. Intravenous injection in the rabbit induced a temporary fall in blood pressure. Unlike hydrastine, it diminished the contractility and tonus of isolated rabbit intestine, but like hydrastine it augmented contraction and tone of isolated guinea-pig or rabbit uterus. In the perfused frog heart *cularine* produced an increase in contractility and tone, while hydrastine decreased contraction but augmented tone.

REFERENCES

- (1) MANSKE, *Can. J. Res.*, 1933, 8, 142. (2) PERKIN and TRIKOJUS, *J. Chem. Soc.*, 1926, 2925; SPÄTH and HOLTER, *Ber.*, 1927, 60, 1891. (3) MANSKE, *Can. J. Res.*, 1933, 9, 436. (4) *Amer. Chem. J.*, 1900, 24, 249; (with WATKINS) *Pharm. Archiv.*, 1903, 6, 27. (5) *Can. J. Res.*, 1933, 8, 210, 404; 1938, B, 16, 89. (6) *J. Chem. Soc.*, 1909, 95, 1266. (7) *Ibid.*, 1936, 199. (8) *Ibid.*, 1911, 99, 1153; 1931, 236. (9) *Can. J. Res.*, 1936, B, 14, 325, 347, 354; 1937, B, 15, 159. (10) *Ibid.*, 1938, B, 16, 81. (11) *Ibid.*, 1933, 8, 407; 1936, B, 14, 347. (12) CHOPRA (with MUKHERJEE and DIKSHIT), *Ind. J. Med. Res.*, 1930, 18, 35; (with KNOWLES), *ibid.*, p. 5; DIKSHIT, *ibid.*, 1932, 19, 765; HAYASHI, *Jap. J. Med. Sci.*, [iv], *Pharmacol.*, 1930, 5, 90; 1932, 6, 203; COOPER and HATCHER, *J. Pharm. exp. Ther.*, 1934, 15, 411. (13) ZIMMERMANN, *Arch. exp. Path. Pharm.*, 1937, 184, 336. (14) *Ber.*, 1935, 68, 656. (15) *J. Pharm. exp. Ther.*, 1934, 51, 482, 492. (16) *Ibid.*, 1938, 63, 329. (17) *Fed. Proc.*, 1946, 5, 163. (18) *J. Pharm. exp. Ther.*, 1940, 69, 112.

MORPHINE SUB-GROUP

Morphine, $C_{17}H_{19}O_3N$. In 1803 Darosne,¹ an apothecary practising in Paris, observed the separation of a crystalline substance, when a syrupy aqueous extract of opium was diluted with water. This crystalline material was probably narcotine, or a mixture of that alkaloid with morphine. Seguin, in 1804, read to the Institute of France a paper in which he described the isolation of morphine, although he did not recognise its basic character. This paper was not published till 1814, and, in the meantime, Sertürner had obtained both morphine and meconic acid from opium, and pointed out that the former was the first member of a new class of substances, "the vegetable alkalis."² The composition of the alkaloid was first determined by Liebig in 1831, who represented it by the formula, $C_{34}H_{36}O_6N_2$, which was reduced by Laurent³ in 1847 to the simple formula now in use.

Morphine crystallises from dilute alcohol in colourless, trimetric prisms containing $1H_2O$, becomes anhydrous at 100° , and then melts at 254° (*dec.*). It is bitter to the taste and sparingly soluble in most solvents. The solubilities given by different observers vary somewhat (*e.g.*, boiling alcohol 1 in 30 to 1 in 36, in cold alcohol 1 in 210 to 1 in 300).⁴ Müller⁴ gives the following figures: water (1 in 3,533), ether (1 in 7,632), benzene (1 in 1,599), chloroform (1 in 1,525), ethyl acetate (1 in 537). According to Florio, the solubility in amyl alcohol is about 1 in 50 at 78° . Müller's figure for solubility in benzene is unusually high, and though Prescott⁵ states that freshly precipitated morphine dissolves in 1,997 parts of benzene, whilst the crystallised alkaloid dissolves in 8,930 parts, the alkaloid is generally stated to be "insoluble" in benzene. Morphine is soluble in limewater (1 in 100 at 25°), or in alkali hydroxide solutions, but less so in ammonia solution (1 in 117, *sp. gr.* 0.97, Duflos). The base is levorotatory, $[\alpha]_D^{23} - 130.9^\circ$ (MeOH), -70° in excess of alkali. It is a monoacidic base, and its salts, which are usually well-crystallised, are neutral to litmus and methyl orange. The average pH of morphine salts is 4.68, and methyl red has been suggested as a suitable indicator for titration of the base.⁶ The salts chiefly used in medicine are the sulphate, hydrochloride and acetate, though the tartrate, bimeconate and others have also been employed. The sulphate, $B_2 \cdot H_2SO_4 \cdot 5H_2O$, forms small silky crystals or cubical masses from water, is soluble in water (1 in 15.5 at 25° , or 1 in 0.7 at 80°), or alcohol (1 in 565 at 25° , or 1 in 240 at 60°). It chars at 250° , but does not melt. It is levorotatory, $[\alpha]_D^{15} - 100.47^\circ + 0.96c$ (H_2O). The hydrochloride, $B \cdot HCl \cdot 3H_2O$, forms colourless silky needles from water, $[\alpha]_D^{15} - 100.67^\circ + 1.14c$ in water (Hesse), or -111.5° at 25° in dry alcohol (Schryver and Lees), is soluble in water (1 in 17.2 at 25° , or 1 in 0.5 at 80°), or alcohol (1 in 42 at 25° , or 1 in 35.5 at 60°). The

hydrobromide, B. $\text{HBr} \cdot 2\text{H}_2\text{O}$, and the hydriodide, B. $\text{HI} \cdot 2\text{H}_2\text{O}$, form long needles. The acetate, B. $\text{CH}_3\text{COOH} \cdot 3\text{H}_2\text{O}$, is a crystalline colourless powder, m.p. 200° (*dec.*), $[\alpha]_{\text{D}} - 77^\circ$ (H_2O), -100.4° (EtOH). It is very soluble in water (1 in 2.25 at 25°), less so in alcohol (1 in 21.6 at 25°), and sparingly so in chloroform (1 in 480 at 25°). The tartrate, $\text{B}_2 \cdot \text{C}_4\text{H}_6\text{O}_6 \cdot 3\text{H}_2\text{O}$, occurs in minute needles and effloresces in air. It is soluble in 11 parts of water and sparingly soluble in alcohol. The picrate has m.p. $163-5^\circ$, and is soluble in 450 parts of water.

Detection. Morphine is at most coloured faintly pink by cold sulphuric acid, but becomes dirty green and then brown on warming. With nitric acid it gives an orange-red coloration. With dilute sulphuric acid and potassium iodate it yields a brown coloration, which darkens on addition of ammonia solution. Sulphuric acid containing a little formaldehyde produces a reddish-violet colour, and sulphuric acid containing selenious acid, blue, changing to green, then brown. Morphine salts in solution, with potassium ferricyanide solution containing a little neutral ferric chloride, give a blue coloration. A few drops of neutral ferric chloride solution added to a solution of a morphine salt produce a blue coloration which disappears on warming or on addition of an acid or alcohol.⁷ For methods of estimation, see p. 176.

apoMorphine, $\text{C}_{17}\text{H}_{17}\text{O}_2\text{N}$. When morphine or its hydrochloride is heated in sealed tubes with hydrochloric acid at 140° , *apomorphine* hydrochloride is formed by the loss of a molecule of water from the parent alkaloid.⁸ Various other methods have been described⁸ of which special interest attaches to that of Small, Faris and Mallonee⁹ for *apocodeine*. *apoMorphine* is separated from any unchanged morphine by adding excess of sodium bicarbonate to the mixture and extracting with ether or chloroform. From the latter it may be crystallised in the absence of oxygen, or it may be isolated as the hydrochloride.

apoMorphine forms colourless prisms from ether with 1 mol. of solvent, but is usually seen as an amorphous white substance which becomes green on exposure to air, a change which occurs even more readily in solution. Unlike morphine, it is readily soluble in chloroform or ether. The hydrochloride, B. $\text{HCl} \cdot \frac{1}{2}\text{H}_2\text{O}$, the salt generally used in medicine, forms minute colourless crystals, which become greenish on exposure to light and air. It is soluble in water (1 in 50 at 25°), or alcohol (1 in 50 at 25°), is neutral to litmus and has $[\alpha]_{\text{D}}^{15^\circ} - 30.5^\circ$ (H_2O). The taste is slightly bitter. When a solution of the hydrochloride is shaken with chloroform, and again after addition of sodium hydroxide, the chloroform is coloured blue and the aqueous layer reddish-violet. These colour changes are due to oxidation products formed in presence of alkali. Such oxidation products may also be present in *apomorphine* hydrochloride, which has been exposed to air and light and are indicated by its forming an immediate green solution in water or a reddish colour in ether when the dry salt is shaken with that solvent. *apoMorphine* gives a crimson tint with nitric acid. With mercuric chloride and sodium acetate in aqueous solution, it produces on boiling a blue colour soluble in amyl alcohol; this reaction is said to be

obtainable with 1 in 100,000 of the alkaloid.¹⁰ When 0.05 gm. of the hydrochloride is shaken with 0.5 per cent. ferrous sulphate solution, the latter becomes blue, then black, the blue colour being restored by alcohol. A colorimetric method of estimation has been described by Cole.¹⁰

On methylation *apomorphine* yields *apo-ψ-CODEINE* (*ψ-apocodeine*, *apocodeine*, *apomorphine methyl ether*), $C_{18}H_{19}O_2N \cdot C_2H_5 \cdot OH$, crystallising in brilliant plates, m.p. $104.5-106.5^\circ$, or $122.5-124.5^\circ$ (*dry*), $[\alpha]_D^{15} - 90^\circ$ (EtOH), which is also produced when codeine or *ψ-codeine* is heated with oxalic acid¹¹ or phosphoric acid.⁹ It stands in the same relation to codeine as *apomorphine* to *morphine*.

ψ-Morphine (*pseudoMorphine*, *oxydimorphine*, *dehydromorphine*, *oxymorphine*), $C_{34}H_{36}O_6N_2 \cdot 3H_2O$. This alkaloid was isolated from opium by Pelletier¹² and later by Hesse.¹³ The formation of a similar substance by the action of mild oxidising agents on *morphine* was observed by Schützenberger,¹⁴ Polstorff¹⁵ and others. The alkaloid is best prepared by gentle oxidation of *morphine* by permanganate or ferricyanide in presence of sodium bicarbonate, but a variety of oxidising agents and mildly alkaline media have been used, e.g., hydrogen peroxide in presence of potassium cuprous cyanide,¹⁶ or potassium persulphate in alkaline solution.¹⁷ The crude alkaloid, precipitated as the reaction proceeds, may be collected, redissolved in sodium hydroxide solution and reprecipitated by the passage of carbon dioxide, and finally purified through the hydrochloride. It forms crusts of minute, colourless needles, becomes anhydrous at 150° , and then has m.p. 327° (*dec.*). It is levorotatory in acid solution ($\alpha = -2.16^\circ$ in N/HCl, $c = 0.85$, $l = 22$ cm.; Bertrand and Meyer, 1909). The optical activity in alkaline solution varies. The base is insoluble in water or ordinary organic solvents, but dissolves to some extent in warm aqueous or alcoholic ammonia, in aqueous alkali hydroxide solutions and in aniline, pyridine or various phenols. The hydrochloride, $B \cdot 2HCl$, crystallises with 2, 4 or $6H_2O$, has $[\alpha]_D - 103.13^\circ$ (dry salt : H_2O) and decomposes about 350° . *ψ-Morphine* gives a dark blue colour with ferric chloride, liberates iodine from iodic acid, gives a green colour with sulphuric acid and formaldehyde and with sulphuric acid and acetic anhydride. The last-mentioned reaction has been used by Drevon¹⁸ as a basis for a colorimetric method of estimation. The suggestion that some conversion of *morphine* into the comparatively inactive *ψ-morphine* may occur during sterilisation by heat,¹⁹ and the possible like transformation in the body lends special interest to methods of detecting and estimating either alkaloid in presence of the other; Ball's method¹⁶ depends on the precipitation of *ψ-morphine* by silicotungstic acid at pH 7.8 and that of Dietzel and Huss¹⁹ on observation of absorption spectra.

Small and Faris²⁰ have prepared the isomeric *ψ-morphines* by the gentle oxidation of α -, β - and γ -*isomorphines* (p. 218). They can all be represented by the formula, $C_{34}H_{36}O_6N_2 \cdot 3H_2O$, and their chief characteristics are as follows :—

α - ψ -isomorphine, m.p. 276°, $[\alpha]_D^{24}$ + 6.2° (N/HCl)

β - ψ -isomorphine, m.p. 272°, $[\alpha]_D^{25}$ - 77.0° (N/HCl)

γ - ψ -isomorphine, m.p. 282-3°, $[\alpha]_D^{24}$ + 44.8° (N/HCl)

(For the constitution of ψ -morphine, see p. 255.)

Codeine, $C_{18}H_{21}O_3N$. This alkaloid was isolated from opium by Robiquet in 1833.²¹ It occurs in opium to the extent of 0.1 to 3 per cent., and is isolated therefrom as the hydrochloride along with morphine hydrochloride in the first stage of Gregory's process.²² It is a methyl ether of morphine and is usually made from the latter by methylation,²³ for which there are numerous patents.²⁴ An extensive series of ethers of morphine and its isomerides, including ethers of the alcoholic hydroxyl group (*heterocodeines*) has been prepared by Faris and Small.²⁴

Properties. Codeine crystallises with $1H_2O$ from water in large translucent, orthorhombic prisms,²⁵ m.p. 155° (*dry*), $[\alpha]_D$ - 137.7° (EtOH) or - 111.5° ($CHCl_3$), and is generally seen in this form, but it separates from dry ether in small anhydrous prisms. Its taste is slightly bitter. Codeine is moderately soluble in water (1 in 120 at 25°, 1 in 59 at 80°), or ammonia solution (1 in 68 at 15.5°), more so in ether (1 in 75 at 15.5° or 50 at 25°), and readily so in alcohol (1 in 2 at 25°, 1 in 0.92 at 60°) or chloroform (1 in 0.5 at 25°). It differs from morphine in being fairly soluble in anisole (1 in 6.5 at 16°) or cold benzene (1 in 13) and in its sparing solubility in aqueous solutions of alkali hydroxides.

Codeine is a strong, monoacidic base, forming salts which are neutral to litmus or methyl orange. The neutral point of the hydrochloride is at pH 4.93, and methyl red is therefore a suitable indicator for the titration of the base.²⁶ The free base and also the sulphate and phosphate are used in medicine. The hydrochloride, $B \cdot HCl \cdot 2H_2O$, forms short needles soluble in water (1 in 28.5 at 15.5°), $[\alpha]_D^{22.5}$ - 108.2° (H_2O), m.p. 264° (*dry salt*); the salt effloresces in air and loses its water completely at 120°. The sulphate, $B_2 \cdot H_2SO_4 \cdot 5H_2O$, forms rhombic prisms, m.p. 278° (*dec.*), $[\alpha]_D^{15}$ - 101.2° (H_2O), which readily lose $2H_2O$ on exposure to air, are completely dehydrated at 100° and regain $3H_2O$ on exposure to air. It is soluble in water (1 in 30 at 25°), sparingly so in alcohol (1 in 1280 at 25°), insoluble in ether. The phosphate, $B \cdot H_3PO_4 \cdot 1, 1\frac{1}{2}$ or $2H_2O$, forms needle-shaped crystals, m.p. 235° (*dec.*), and is soluble in water (1 in 2.5 at 25°), less so in alcohol (1 in 325 at 25°). The picrate crystallises from 50 per cent. alcohol and has m.p. 196-7°. On treatment with sulphoacetic acid,^{26(a)} codeine is converted into 6-acetyl-1-acetodeine,



which occurs in two forms, m.p. 146-7° and 125-126.5°, both having $[\alpha]_D^{20}$ - 207° ($CHCl_3$), and is hydrolysed by sodium ethoxide in alcohol to 1-acetodeine, $CH_3 \cdot CO \cdot C_{16}H_{15}ON(CHOH)(OCH_3) \cdot H_2O$, m.p. 149-150°, $[\alpha]_D^{21}$ - 141°, which forms an oxime, m.p. 100° (*dec.*). On hydrogenation with palladium as catalyst acetodeine yields 1-acetodihydrocodeine and with platinum as the activating agent 1-(1-hydroxyethyl)-dihydrocodeine and 1-ethyl-dihydrocodeine. (For notation see formula XXXV, p. 241.)

Detection. Codeine is distinguished from morphine by the differences

in solubility recorded above, by giving no coloration with ferric chloride solution, and a yellow, not a reddish, solution with nitric acid. A solution of codeine in sulphuric acid, on addition of a drop of ferric chloride solution, or of ammonium molybdate solution, and then gently warmed, develops a bluish-violet colour, changed to red on addition of a drop of dilute nitric acid. Sulphuric acid containing a trace of selenious acid produces a green coloration, changing to blue and back again to green.²⁷ For the detection of morphine in codeine the British Pharmacopœia, 1932, prescribes a special form of the nitrite test and the use of the ferricyanide test for this purpose is discussed by van Giffen.²⁸

"*apoCodeine*," obtained by the action of zinc chloride on codeine is, according to Dott,²⁹ a mixture of chlorocodide, *apomorphine*, amorphous bases and unchanged codeine, but Folkers¹¹ points out that *apocodine* is the name in general use for the methyl ether of *apomorphine*, for which Knorr and Roth suggested the name *ψ-apocodine* (see p. 215).

A number of homologues of codeine have been prepared by the alkylation of morphine; for example, ethylmorphine, which is used in medicine in the form of the hydrochloride, $C_{19}H_{23}O_3N \cdot HCl \cdot 2H_2O$ (colourless, bitter, microcrystalline powder, m.p. 122-5°), and benzylmorphine, $C_{17}H_{18}O_2N(O \cdot CH_2 \cdot C_6H_5)$, also used as the hydrochloride, $B \cdot HCl \cdot H_2O$, a colourless, crystalline powder.

Isomerides of Morphine and Codeine. When morphine is treated with thionyl chloride, phosphorus trichloride or tribromide, the alcoholic hydroxyl group is replaced by the halogen, forming α -chloromorphide and bromomorphide respectively. The former on treatment with concentrated hydrochloric acid is converted into β -chloromorphide. Schöpf and Hirsch have provided evidence that the two are structural isomerides.³⁰ With the same reagents codeine yields a parallel set of compounds, *viz.*, α - and β -chlorocodides, and bromocodide. The chief characteristics of these products may be summarised thus:—

Substance	Formula	M. p.	$[\alpha]_D$	Salts
α -Chloromorphide	$C_{17}H_{18}O_2NCl$	193°	-375.2° (MeOH)	B.HCl, $[\alpha]_D$ -315.3°; B.MeI, m.p. 207°
β -Chloromorphide	$C_{17}H_{18}O_2NCl$	188°	-5° (MeOH)	B.MeI, m.p. 210° (<u>dec</u>)
Bromomorphide	$C_{17}H_{18}O_2NBr$	169-170°	+65.9° (MeOH)	B.MeI, m.p. 200°
α -Chlorocodide	$C_{18}H_{20}O_2NCl$	152-3°	-381.2° (MeOH)	B.MeI, m.p. 168°; $[\alpha]_D$ -215°
β -Chlorocodide	$C_{18}H_{20}O_2NCl$	156-7°	-10° (EtOH)	B.MeI, m.p. indefinite; $[\alpha]_D$ +4.6°
Bromocodide	$C_{18}H_{20}O_2NBr$	162°	+56.5° (EtOH)	-

The three halogenocodides can also be prepared by methylation of the corresponding halogenomorphides. The latter, when boiled with dilute acetic acid, yield a mixture of isomerides of morphine, *viz.*, α -, β - and γ -isomorphines; the last-mentioned isomeride has also been called *neoisomorphine*. In like manner there are formed from the three halogenocodides, α -, β - and γ -isocodeines, which can also be obtained by methylation of the corresponding isomorphines and are better known under the names *isocodeine*, *allo- ψ -codeine* and *ψ -codeine* (*neoisocodeine*) respectively. There are therefore four morphines and four codeines. The four isomerides consist in each case of two stereoisomeric pairs, and the pairs differ from each other in the position of the alcoholic hydroxyl group, this being at 6 (see formulæ, p. 251) in the parent alkaloids and the α -isomerides, and at 8 in the β - and γ -forms. These isomerides in turn give rise to a series of four methylmorphimethines, also existing in two pairs, which are structurally different, and the two members of the first pair are each convertible into a second form by the action of alcoholic potash, α - into β -, and γ - into δ -. The principal facts^{30(a)} about these three series of isomerides are assembled in the table below.

β -Codeine corresponding to β -methylmorphimethine is neopine; that similarly related to the δ -methine is still unknown.

M.p.	Morphine. α -isomorphine.	β -isomorphine. γ -isomorphine.
$[\alpha]_D$	254° 247°	182° 278°
Methylation product	-130.9° -167°	-216° -94°
M.p.	Codeine. <i>iso</i> Codeine.	<i>allo-ψ-Codeine</i> <i>ψ-Codeine</i> .
$[\alpha]_D$	155° 172°	116-117° 181°
Oxidation product	-135° -155°	-235.4° -94°
M.p.	Codeinone.	<i>ψ-Codeinone</i> .
$[\alpha]_D$	187°	174°
Exhaustive methylation product.	-205°	-25°
	3 : 4 : 6-trimethoxyphenanthrene.	3 : 4 : 8-trimethoxyphenanthrene.
Methylation of the isomeric codeines gives the primary methylmorphimethines,	Codeine, α -isomer.	<i>allo-ψ-Codeine</i> , ζ -isomer.
	m.p. . 119°	oil
	$[\alpha]_D$. -214°	$[\alpha]_D$ -178°
		(both stable
		to alkali)
which by action of alcoholic potash yield the secondary methylmorphimethines.	β -isomer,	δ -isomer,
	m.p. . 134°	m.p. . 113°
	$[\alpha]_D$ +438°	$[\alpha]_D$ +284°

Neopine, $C_{18}H_{21}O_3N$. This alkaloid was discovered by T. and H. Smith in the final mother liquors obtained in the extraction of opium alkaloids, and was examined by Dobbie and Lauder,³¹ and later by van Duin, Robinson and Smith,³² who crystallised the base, found it isomeric with codeine and showed that it is β -codeine (p. 251). The base crystallises from light petroleum in needles, m.p. 127-127.5°. In aqueous solution

it is optically inactive, but has $[\alpha]_D^{25} + 18.85^\circ$ in dilute hydrochloric acid or -28.1° (CHCl_3). The salts crystallise well, the hydrobromide being sparingly soluble in water, from which it separates in prismatic crystals, $[\alpha]_D^{20} + 17.32^\circ$ (H_2O), m.p. $282-3^\circ$ (*dec.*).

Neopine contains one methoxyl and one methylimino-group and furnishes an amorphous acetyl derivative, of which the methiodide, $\text{C}_{18}\text{H}_{20}\text{O}_3\text{N}(\text{Ac})(\text{MeI})$, crystallises from methyl alcohol in long glistening needles, m.p. $256-7^\circ$ (*dec.*). On catalytic hydrogenation neopine is converted into dihydrocodeine, $\text{C}_{18}\text{H}_{23}\text{O}_3\text{N} \cdot 2\text{H}_2\text{O}$,³³ m.p. $51-3^\circ$ or $112-3^\circ$ (*dry*), identical with that obtained by the hydrogenation of codeine. Neopine methosulphate is a deliquescent gum. On boiling its aqueous solution, after addition of potassium hydroxide, β -methylmorphimethine is produced. This crystallises from alcohol in rhombohedral prisms, m.p. 135° , and gives a methiodide³⁴ crystallising in glistening needles, m.p. 291° (*dec.*), $[\alpha]_D^{20} + 241.1^\circ$ ($c = 0.506 : \text{MeOH}$) or $+262^\circ$ ($c = 0.3 : \text{EtOH}$, 90%). Neopine, therefore, stands to β -methylmorphimethine in the same relation as codeine does to α -methylmorphimethine (*see table*, p. 218). These observations have been confirmed and extended by Lyndon Small,³² who has shown that neopine on treatment with hydrobromic acid in acetic acid is demethylated and forms 6-acetylneomorphine, $\text{C}_{19}\text{H}_{21}\text{O}_4\text{N}$, $1.5 \text{ H}_2\text{O}$, m.p. $243-51^\circ$ (*dec.*), $[\alpha]_D^{20} + 27.6^\circ$ (EtOH), which with acetic anhydride in pyridine yields diacetylneomorphine, $\text{C}_{21}\text{H}_{23}\text{O}_5\text{N}$, m.p. $127-127.5^\circ$, $[\alpha]_D^{20} + 17.5^\circ$, and is hydrolysed by boiling 2N-caustic soda solution to neomorphine, which separates from chloroform as $\text{C}_{17}\text{H}_{19}\text{O}_3\text{N}$, CHCl_3 , m.p. $\sim 107^\circ$, $[\alpha]_D^{20} - 18.2^\circ$ (CHCl_3), and as solvent-free base, has m.p. $240-1^\circ$ (*dec.*), and gives a bluish-green colour with ferric chloride solution and reddish-violet with Marquis's reagent; the hydrochloride has m.p. $295-8^\circ$ (*dec.*) and $[\alpha]_D^{20} + 22.6^\circ$ (H_2O). 6-Acetylneomorphine on hydrogenation forms 6-acetyldihydromorphine, m.p. 245° , $[\alpha]_D^{20} - 117^\circ$ (EtOH) which on hydrolysis, by hot 3N-sodium hydroxide solution, gave dihydromorphine, characterised by its double melting-point 135° and 207° on slow heating or $155-7^\circ$ when heated rapidly.

Thebaine, $\text{C}_{19}\text{H}_{21}\text{O}_3\text{N}$. This base, which occurs in opium to the extent of 0.1 to 1 per cent., was first obtained by Pelletier and Thiboumery,³⁵ who regarded it as isomeric with morphine, and named it "paramorphine." It was examined by Kane,³⁶ who first called it "thebaine," and by Anderson,³⁷ who described a method of isolation and provided the formula given above. It remains in the mother liquor after the removal of morphine and codeine hydrochlorides in Gregory's process, and in Hesse's method³⁸ of isolating it from this source is obtained as the acid tartrate. This is crystallised from hot water, and the alkaloid regenerated from it is recrystallised from dilute alcohol, from which it separates in leaflets, or from dry alcohol in prisms, m.p. 193° , $[\alpha]_D^{15} - 218.6^\circ$ (EtOH) or -229.5° (CHCl_3). It is readily soluble in alcohol, chloroform or benzene, less so in ether, and almost insoluble in cold water, but sparingly so in ammonia or lime-water. Thebaine behaves as a monoacidic base. The hydrochloride, $\text{B} \cdot \text{HCl} \cdot \text{H}_2\text{O}$, forms large rhombic prisms, $[\alpha]_D - (168.32^\circ - 2.88c)$,

soluble in 15.8 parts of water at 10°. The salicylate is sparingly soluble in water, and may be used for the separation of thebaine from other opium alkaloids.³⁹ The picrate has m.p. 217°. Thebaine gives a blood-red coloration with sulphuric acid, which turns orange-yellow, and eventually olive-green on warming,⁴⁰ and with nitric acid it is at first colourless but becomes yellow in a few minutes.

Porphyroxine, $C_{19}H_{23}O_4N$. In 1837 Merck⁴¹ isolated from opium a product to which he gave this name, and which Hesse⁴² subsequently found to be a mixture of alkaloids, including rhœadine and meconidine. A similar substance was obtained by Dey in 1882, both these preparations having the property of forming purple-coloured solutions with dilute acids. Rakshit⁴³ has examined the material dissolved by ether from an extract obtained by triturating a mixture of Indian opium and lime with water, and has isolated from it a substance to which he assigns the above name and formula. It is described as crystallising from light petroleum in pale yellow or colourless, transparent prisms, m.p. 134–5°, $[\alpha]_D^{32} - 139.9^\circ$ ($CHCl_3$), soluble in water, dilute acids, acetone, chloroform and moderately so in alcohol, benzene, sparingly in ether or light petroleum and almost insoluble in lime water or alkalis. Solutions in dilute acids become red on exposure to air. The alkaloid gives a red colour with sulphuric acid. The salts are mostly crystalline, B. HCl, m.p. 155°, $[\alpha]_D^{32} - 118.8^\circ$ (H_2O), prismatic needles; nitrate, B. HNO_3 , m.p. 122°, feathery tablets, $[\alpha]_D^{32} - 115.4^\circ$ (H_2O); the platinichloride, m.p. 204° (*dec.*), and picrate, B. $C_6H_3O_7N_3$, m.p. 198°, (*dec.*) are crystalline powders.

In a later paper Rakshit⁴⁴ showed that porphyroxine behaves as a tertiary base, yielding a methiodide, m.p. 150–2°, and a methosulphate, m.p. 205° (*dec.*). The presence of a hydroxyl group was indicated by the formation of a monoacetyl derivative, m.p. 125°, $[\alpha]_D - 187.2^\circ$ ($EtOH$), and this group must be non-phenolic as the base is insoluble in alkali. Porphyroxine also forms a crystalline oxime, m.p. 198° (*dec.*), and a semicarbazone, m.p. 244° (*dec.*). It contains one methoxyl group, and the methylmethosulphate, on treatment with potassium hydroxide in methyl alcohol, yields methylporphyroxine, $C_{20}H_{25}O_4N$. The methylmethosulphate, on reduction with sodium amalgam in dilute sulphuric acid, furnishes methyltetrahydroporphyroxine, $C_{20}H_{29}O_4N$, colourless plates, m.p. 150°, but the parent base could not be hydrogenated. On distillation with zinc dust porphyroxine furnishes phenanthrene, ammonia and trimethylamine, and when heated with potassium hydroxide solution (2 per cent.) and hydrogen peroxide, codeine and formic acid are produced; thus:—

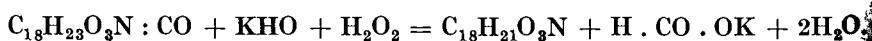

On the basis of these results, Rakshit represents porphyroxine as codeine with a —CO— group as a bridge in the aromatic ring in Pschorr's codeine formula (see p. 234). Machiguchi⁴⁵ isolated from Japanese opium product identical in melting-point and other characteristics with porphyroxine, which on examination proved to be a mixture of codamine, laud

nine and meconidine, and Rajagopalan^{45(a)} was unable to find porphyrroxine in Indian opium and suggested that Rakshit's alkaloid was impure codeine. Bamford found that the porphyrroxine test is not distinctive for Indian opium, and that a substance giving this test also occurs in Turkish opium.⁴⁶

REFERENCES

- (1) *Ann. Chim.*, 1803, 45, 257. (2) *Gilbert's Annalen*, 1817, 55, 56; 57, 192; 1818, 59, 50. For an account of Sertürmer's discovery, see HANZLIK, *J. Amer. Pharm. Assoc.*, 1929, 18, 375. (3) *Ann. Chim. Phys.*, 1847, [iii], 19, 359. (4) *Apoth. Zeit.*, 1903, 18, 257; *cf.*, however, 1 in 6,700 for water found by BAGGESGAARD-RASMUSSEN and REIMERS, *Arch. Pharm.*, 1935, 273, 129. (5) *Pharm. J.*, 1875, [iii], 6, 404. (6) KOLTHOFF, *Biochem. Zeit.*, 1925, 162, 289; *Pharm. J.*, 1927, 118, 126; *cf.* MORTON, *ibid.*, 1926, 116, 567. (7) For other tests for the detection of morphine see OLIVER, *Chem. Soc. Abstr.*, 1915, [ii], 75; EKKERT *Pharm. Zent.*, 1926, 67, 498; 1928, 69, 1, 19, 198; 1929, 70, 165; 1930, 71, 550; SANCHEZ, *J. Pharm. Chim.*, 1937, [viii], 25, 346; WAGENAAR, *Pharm. Weekl.*, 1927, 64, 1119 (microchemical); REIMERS and GOTTLIEB, *Dansk. Tids. Farm.*, 1947, 21, 14. The following relate to biological material: HERRMANN, *Biochem. Zeit.*, 1912, 39, 216; DOVLY, *Analyst*, 1927, 52, 26; BAMFORD, *ibid.*, 1931, 56, 586; PANSE, *Fort. Therap.*, 1932, 8, 629; MUNCH, *J. Amer. Pharm. Assoc.*, 1934, 23, 766, 1185; 1935, 24, 557. (8) MATTHIESSEN and WRIGHT, *Annalen*, 1870, Suppl. 7, 170, 177, 364; MAYER, *Ber.*, 1871, 4, 121; (with WRIGHT), *ibid.*, 1872, 5, 1109; FULTON, *J. Lab. Clinical Med.*, 1928, 13, 750; OPARINA, KARASINA and SMIRNOV, *Khim. Farm. Prom.*, 1934, No. 5, 18 and *Russ. Pat.* 40,981. (9) *J. Org. Chem.*, 1940, 5, 334. (10) GRIMBERT and LECLÈRE, *J. Pharm. Chim.*, 1915, [vii], 11, 23. For other tests see VAN MIKO, *Pharm. Zent.*, 1927, 68, 193; COLE, *J. Roy. Soc. N.S.W.* 1947, 81, 80. (11) KNORR (with ROTH), *Ber.*, 1907, 40, 3356; (with RABE), *ibid.*, 1908, 41, 3050; PSCHORR, JÄCKEL and FECHT, *ibid.*, 1902, 35, 4377; FOLKERS, *J. Amer. Chem. Soc.*, 1936, 58, 1814. (12) *J. Pharm.*, 1835, [ii], 21, 555; *Annalen*, 1835, 16, 27. (13) *Ibid.* 1867, 141, 87; 1884, 222, 234; 1886, 234, 253. (14) *Compt. rend.*, 1858, 46, 598. (15) *Ber.*, 1880, 13, 86; 1886, 19, 1760. (16) BALLS, *J. Biol. Chem.*, 1927, 71, 537, 543; (with WOLFF), *ibid.*, 1928, 80, 403. (17) FULTON, *Amer. J. Pharm.*, 1933, 105, 503. (18) LEULLIER and DREVON, *Bull. Soc. Chim. biol.*, 1932, 14, 521; *J. Pharm. Chim.*, 1935, [viii], 22, 97. (19) *Arch. Pharm.*, 1928, 266, 641; *cf.*, however, STICH, *Pharm. Zeit.*, 1928, 73, 1513. (20) *J. Amer. Chem. Soc.*, 1934, 56, 1930. (21) *Annalen*, 1833, 5, 106. (22) For another process see BYLINKIN, *Russ. Pat.* 3,381, *Brit. Chem. Abstr.*, 1929, B, 538. (23) GRIMAU, *Compt. rend.*, 1881, 92, 1140, 1223; 1881, 93, 67, 217, 591. (24) *E.g.*, Gerinan Patents 39,887, 92,789, 95,644, 96,145, 102,364, 107,225, 108,075, 131,980, 189,843, 214,783, 224,388, 247,380, 418,391; *Russ. Pat.* 20,083 (*Chem. Zent.*, 1931, ii, 3664); 50,438 (*ibid.*, 1938, ii, 953); 191,609 (*ibid.*, 1939, ii, 420); RODIONOV, *Bull. Soc. chim.*, 1926, [iv], 39, 305; other ethers of morphine and its isomerides, see FARIS and SMALL, *J. Org. Chem.*, 1936, 1, 194. (25) For constants of codeine crystals, see KLEY, *Rec. trav. Chim.*, 1903, 22, 367; HEYDRICH, *Zeit. Kryst. Min.*, 1910, 48, 243; WRIGHT, *J. Amer. Chem. Soc.*, 1916, 38, 1647; WHERRY and YANOVSKY, *J. Wash. Acad. Sci.*, 1919, 9, 505. (26) BAGGESGAARD-RASMUSSEN and SCHOU, *Pharm. Zent.*, 1924, 65, 729. (26a) CAUSSE, *Compt. rend.*, 1899, 128, 181; KNOLL and Co., D.R.P. 175,068; KNORR *et al.*, *Ber.*, 1909, 42, 3511; SMALL and MALLONEE, *J. Org. Chem.*, 1940, 5, 286; 1947, 12, 55. (27) Other reactions useful for the detection of codeine are described by WAGENAAR, *Pharm. Weekbl.*, 1927, 64, 671 (microchemical); HEIDUSCHKA and MEISNER, *Arch. Pharm.*, 1927, 265, 455 (microchemical); DE HAAS, *Pharm. Weekbl.*, 1930, 67, 508. (28) *Ibid.*, 1932, 69, 990. (29) *Pharm. J.*, 1891, [iii], 21, 878, 916, 955, 996; *cf.* MATTHIESSEN and BURNSIDE, *Annalen*, 1871, 158, 131; MERCK, *Arch. Pharm.*, 1891, 229, 161; GÖHLICH, *ibid.*, 1893, 231, 235; KNORR and ROTH, *Ber.*, 1907, 40, 3356; J. WIERNIK & Co., *Ger. Pat.* 489,185 (*Chem. Zent.*, 1930, i, 1863). (30) SCHÖPF and HIRSCH, *Annalen*, 1831, 489, 235; SMALL,

FABIS and MALLONEE, *J. Org. Chem.*, 1940, 5, 334. (30a) For a selected bibliography of this subject see GULLAND and ROBINSON, *J. Chem. Soc.*, 1923, 123, 996; and SMALL and LUTZ, Suppl. 108, U.S. Treasury Dept., Public Health Service, Washington, 1932. (31) *J. Chem. Soc.*, 1911, 99, 34. (32) *Ibid.*, 1926, 903; cf. HOMEYER and SHILLONG, *J. Org. Chem.*, 1947, 12, 356; SMALL, *ibid.*, p. 359. (33) Cf. SKITA and FRANK, *Ber.*, 1911, 44, 2865; MANNICH and LÖWENHEIM, *Arch. Pharm.*, 1920, 258, 295. (34) Cf. KNORR (with SMILES), *Ber.*, 1902, 35, 3010; (with HAWTHORNE), *ibid.*, p. 3012. (35) *Annalen*, 1835, 16, 38. (36) *Ibid.*, 1836, 19, 9. (37) *Ibid.*, 1853, 86, 184. (38) *Ibid.*, 1870, 153, 47; cf. KANEWSKAJA, *J. pr. Chem.*, 1924, [ii], 108, 247. (39) PLUGGE, *Rec. trav. Chim.*, 1887, 6, 157. (40) For other methods of detection see REICHARD, *Pharm. Zent.*, 1906, 47, 623; and WAGENAAR, *Pharm. Weekbl.*, 1927, 64, 472. (41) *Annalen*, 1837, 21, 201. (42) *Ibid.*, 1870, 153, 47. (43) *J. Chem. Soc.*, 1919, 115, 455. (44) *Ber.*, 1926, 59, 2473. (45) *J. Pharm. Soc. Japan*, 1926, No. 529, p. 19. (45a) RAJAGOPALAN, *J. Org. Chem.*, 1945, 10, 175. (46) *Analyst*, 1930, 55, 445.

CONSTITUTION OF ALKALOIDS OF THE MORPHINE SUB-GROUP. Morphine has been the subject of investigation almost continuously since its discovery in 1804, with the result that the experimental data available for a discussion of its constitution are too voluminous to permit of a full account being given in a general text-book on alkaloids and it is necessary to confine attention to a few lines of investigation illustrating the more striking peculiarities of the group.

The three alkaloids concerned, morphine, codeine and thebaine, all behave as tertiary bases. Morphine contains two hydroxyl groups of which one is phenolic and the other a secondary alcohol group. On methylation of the phenolic hydroxyl codeine results. On oxidation, codeine is transformed into codeinone by conversion of the secondary alcohol group into a carbonyl group, and when thebaine is boiled with *N*-sulphuric acid for a few minutes, it is hydrolysed into codeinone and methyl sulphate, and in other ways thebaine has been shown to contain two methoxyl groups. That the relationship between the three alkaloids is close may be illustrated by the following slightly extended formulae:—

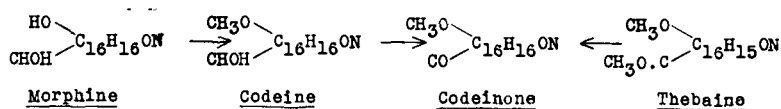

Codeine is therefore a methyl ether of morphine, whilst thebaine is a methyl ether of an enolic form of codeinone. There has been much discussion as to the function of the third or "indifferent" oxygen in the three alkaloids, and its nature has only been disclosed by a study of degradation products.

The three alkaloids all yield characteristic products on treatment with hydrochloric acid. In this way morphine yields *apomorphine*, apparently by loss of water; codeine also yields *apomorphine*, accompanied by other products, but thebaine yields, with dilute hydrochloric acid, *thebenine*, and with strong hydrochloric acid, *morphothebaine*. These two are respectively secondary and tertiary bases, so that in the formation of thebenine a heterocyclic ring has been opened and a tertiary

nitrogen converted into a secondary nitrogen = NCH₃ into —NHCH₃. Further, thebenine and morphothebaine are both isomeric with codeinone, and, as the latter can be converted into thebenine and morphothebaine by the action of hydrochloric acid under appropriate conditions, it seems clear that in the action of hydrochloric acid on thebaine, the latter loses methyl chloride and produces codeinone, which is then by further action of the acid transformed into thebenine and morphothebaine. Since thebaine can be converted into codeinone in various ways,¹ and the latter can be reduced to codeine, it is possible to pass from thebaine to codeine. The relationships thus far established may be summarised thus :—

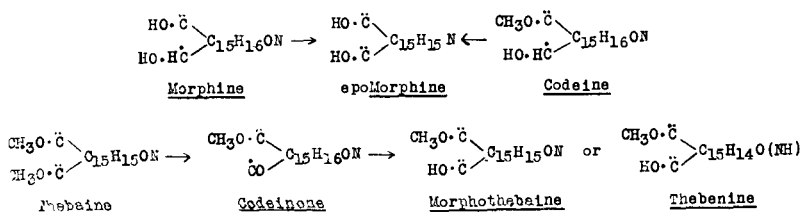

It is known that the third oxygen atom in morphothebaine and thebenine is present as a hydroxyl group ; it must therefore be present in the three parent alkaloids in a form which will permit of ready transformation to this group. The conversion of thebaine into two isomeric bases, one secondary (thebenine) and one tertiary (morphothebaine), each containing one methoxyl group and two hydroxyl groups, is an example of change due to intramolecular migration, common in this group. It is noticeable in the methylmorphimethines, of which six are known.

When α -methylmorphimethine, C₁₉H₂₃O₃N, resulting from the action of boiling sodium hydroxide solution on codeine methiodide, is boiled with acetic anhydride, it is partly converted into the β -isomeride and partly decomposed into ethanoldimethylamine and methylmorphol,² thus :—

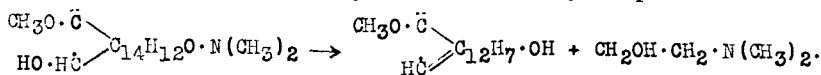

When hydrogen chloride at 180° is used in place of acetic anhydride the demethylated product, morphol, C₁₄H₈(OH)₂ is obtained. Consideration of its reactions led Vongerichten³ to formulate methylmorphol as 3-methoxy-4-hydroxyphenanthrene, identical with the product synthesised by Pschorr and Sumuleanu.⁴

When the Hofmann process of exhaustive methylation is followed and β -methylmorphimethine methohydroxide is heated in water, a decomposition similar to the foregoing takes place with the production of methylmorphenol, trimethylamine and ethylene thus⁵ :—

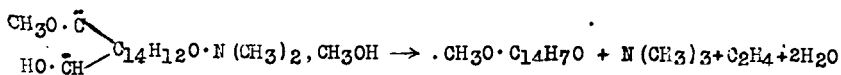

The methyl ether of morphenol thus obtained differs from methylmorphol by two atoms of hydrogen, and contains no hydroxyl group. On fusion

with potash, morphenol is converted into 3 : 4 : 5-trihydroxyphenanthrene,⁶ the constitution of which was established by its conversion into the trimethyl ether, identical with 3 : 4 : 5-trimethoxyphenanthrene, synthesised by Pschorr.⁷ The presence of an ether-oxide linkage in morphenol appears from the fact that on reduction with sodium in alcohol it adds on two atoms of hydrogen, forming morphol,⁸ which contains two phenolic hydroxyl groups, both in one benzene ring, since morphol, but not morphenol, can be oxidised to phthalic acid.⁹ Oxidation of acetylmorphenol with chromic oxide in acetic acid gives rise to a phenanthraquinone, in which the ether-oxide linkage is still intact⁵; positions 9 and 10 in the phenanthrene nucleus of morphenol must therefore be free; this leaves virtually only an oxygen bridge between carbon atoms 4 and 5 to account for the experimental data summarised above and morphenol is, therefore, represented by the formula given on p. 226.

A similar reaction takes place with codeinone, the ketone corresponding to the secondary alcohol codeine. This, with acetic anhydride, yields ethanolmethylamine and the diacetyl derivative of a dihydroxymethoxyphenanthrene, which on replacement of the two acetoxy-groups by methoxyl groups yields methylthebaol,^{10(a)} which Pschorr, Seydel and Stöhrer^{10(b)} had shown to be 3 : 4 : 6-trimethoxyphenanthrene. These are typical cases of a kind of reaction which has proved useful in ascertaining the orientation of the side-chains of the phenanthrene skeleton common to all three alkaloids and their near relatives. The phenanthrene derivatives produced by the degradation of the more important members of the group are recorded in the following table :—

	<u>Alkaloid</u>	<u>Phenanthrene degradation product</u>
Type I.	Morphine } Codeine }	3-Methoxy-4-hydroxyphenanthrene, or 3-methoxy-(4:5)-oxyphenanthrene.
	Thebaine	3:6-Dimethoxy-4-hydroxyphenanthrene.
	<hr/>	
Type II.	spoMorphine	3:4-Dimethoxy-8-vinylphenanthrene. ¹¹
	Morphothebaine	3:4:6-Trimethoxy-8-vinylphenanthrene. ¹²
<hr/>		
Type III.	γ -isoMorphine } ↓ ψ -Codeine } ↓ ψ -Codeinone }	3-Methoxy-4:8-dihydroxyphenanthrene. ¹³
	<hr/>	
	Type IV.	Thebaine

The basic product in these reactions varies with the nature of the initial substance and the character of the degradation process, as the following selected instances show :—

<u>Substance</u>	<u>Degrading Agent</u>	<u>Degradation products</u>	
		(a) <u>Basic.</u>	(b) <u>Neutral.</u>
α - or ϵ -Methylmorphimethine	Acetic anhydride	(a) Ethanol dimethylamine, $\text{HO} \cdot \text{CH}_2 \cdot \text{CH}_2 \cdot \text{N}(\text{CH}_3)_2$.	(b) 3-Methoxy-4-acetoxypheanthrene. ¹⁵
β -Methylmorphimethine	Sodium ethoxide	(a) Dimethylaminoethyl ether, $\text{C}_2\text{H}_5\text{O} \cdot \text{CH}_2 \cdot \text{CH}_2 \cdot \text{N}(\text{CH}_3)_2$.	(b) 3-Methoxy-4-hydroxypheanthrene. ¹⁶
α -Methylmorphimethine methiodide	Hofmann process	(a) Trimethylamine.	(b) 3-Methoxy-(4:5)-oxyphenanthrene. ¹⁷
Codeinone	Acetic anhydride	(a) Ethanol methylamine, $\text{HO} \cdot \text{CH}_2 \cdot \text{CH}_2 \cdot \text{NHCH}_3$.	(b) 3-Methoxy-4:6-diacetoxypheanthrene. ^{10e}
Codeinone methiodide	Alcohol at 160°	(a) Dimethylaminoethyl ether, $\text{C}_2\text{H}_5\text{O} \cdot \text{CH}_2 \cdot \text{CH}_2 \cdot \text{N}(\text{CH}_3)_2$.	(b) 3-Methoxy-4:6-dihydroxypheanthrene. ⁸
γ -Codeinone methiodide	" " "	(a) Dimethylaminoethyl ether, $\text{C}_2\text{H}_5\text{O} \cdot \text{CH}_2 \cdot \text{CH}_2 \cdot \text{N}(\text{CH}_3)_2$.	(b) 3-Methoxy-4:8-dihydroxypheanthrene. ¹⁴
Thebaine	Benzoyl chloride	(a) Ethanol methylamine, $\text{HO} \cdot \text{CH}_2 \cdot \text{CH}_2 \cdot \text{NMe}$.	(b) 3:6-Dimethoxy-4-benzoxypheanthrene. ²⁰

The nature of the basic product formed in these reactions was important in connection with the earliest attempts to devise a constitutional formula for morphine, when it was assumed that the oxygenated basic products, resulted from the hydrolysis of an oxazine ring containing the "indifferent" third oxygen atom of morphine. Knorr, the author of various "oxazine" formulæ for morphine, disposed of it by providing two other explanations. He showed that by the action of hydrogen chloride on α -methylmorphimethane, a mixture of ethanol dimethylamine and tetramethylethylenediamine is obtained, produced, he suggested, from the initial extrusion product, chloroethyl dimethylamine by the action of the alkali used in working up the reaction mixture. Similarly, by the action of sodium ethoxide in alcohol on α -methylmorphimethine or on codeinone methiodide, dimethylaminoethyl ether, accompanied by some dimethylamine in the case of codeinone, is formed, as it is also in the action of alcohol at 160° on the methiodide of either thebaine or codeinone. In these cases Knorr assumed that the initial product is vinyl dimethylamine; which reacts with (1) alcohol, to give dimethylaminoethyl ether; (2) with

acetic acid (in the case of acetic anhydride degradations) to give the hydramine acetate; and (3) with dimethylamine to give tetramethylethylenediamine,²⁰ as shown in the following equations:—

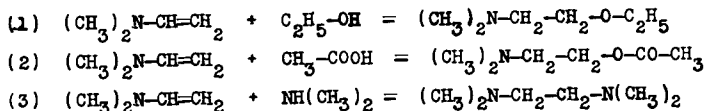

It proved impossible to test the validity of this hypothesis because vinyl dimethylamine could not be prepared.²¹

It follows from the evidence thus obtained that morphine, and consequently codeine and thebaine, must be built up from the complex $-\text{CH}_2-\text{CH}_2-\text{N}-\text{CH}_3$, and a phenanthrene skeleton capable of yielding such derivatives as the following:—

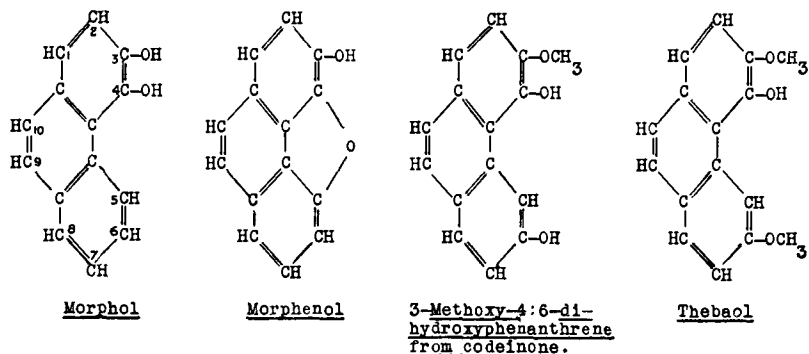

Referring to the table on p. 224, it will be seen that in type I positions 3 and 4 are always occupied by methoxyl or hydroxyl, and in the cases of codeinone methiodide and thebaine position 6 is similarly occupied. There can be little doubt, therefore, that so far as the oxygen atoms are concerned in the alkaloids of type I, the phenolic hydroxyl in morphine is at position 3, the indifferent oxygen forms an oxygen bridge between positions 4 and 5, and the alcoholic hydroxyl is at 6. Codeine differs from morphine in having a methoxyl at 3, and codeinone from codeine by the conversion of a $-\text{CHOH}$ group into $-\text{CO}-$ at 6, whilst thebaine differs from codeinone by the replacement of CO at 6 by $\text{C}-\text{OCH}_3$. Comparing this type with III, it will be seen that γ -isomorphine and ψ -codeine, and consequently ψ -codeinone, which is related to them in the same way as codeinone to morphine and codeine, differ from their isomerides of type I by the wandering of the alcoholic hydroxyl group from position 6 to position 8. In the remaining types II and IV it has been possible to obtain as degradation products substituted vinylphenanthrenes, and thus to secure direct evidence of the point of attachment of the carbon end of the ethanamine chain to the phenanthrene nucleus.

Before discussion of the numerous formulæ that have been suggested

for the three primary bases, morphine, codeine and thebaine, it will be convenient to deal with those now generally accepted for *apomorphine*, *morphothebaine* and *thebenine*, since in these derivatives the protean changes characteristic of the parent alkaloids are no longer possible. To these may be added *isothebaine*, which is of special interest since it is found in *Papaver orientale* (p. 173).

apoMorphine, $C_{17}H_{17}O_2N$. This alkaloid has been described already (p. 214) but the constitutional formula to be assigned to it remains to be dealt with. Though *apomorphine* differs in empirical composition from morphine only by 1 mol. of water, it results from a much more profound change in the morphine nucleus than is implied by that difference. The following particulars are taken mainly from papers by Pschorr *et al.*²² *apoMorphine* contains one methylimino-group, and the presence of two hydroxyl groups is indicated by the formation of a dibenzoyl derivative, colourless prisms, m.p. 156–8°, $[\alpha]_D^{70} + 43.4^\circ$ (CHCl₃), a monomethyl ether (*ψ-apocodeine*, p. 215), and a dimethyl ether, oil, $[\alpha]_D^{50} - 148^\circ$ (EtOH).¹¹ The latter forms a crystalline hydriodide, m.p. 220°, $[\alpha]_D^{150} - 49^\circ$ (EtOH), and a methiodide, m.p. 195°, $[\alpha]_D^{150} - 46^\circ$ (EtOH),¹¹ which, on treatment with alkali, furnishes dimethyl*apomorphimethine*, of which the methiodide, m.p. 242–4°, on boiling for twenty minutes with dilute potassium hydroxide solution, decomposes into trimethylamine and a dimethoxyvinylphenanthrene, $C_{14}H_7(OMe)_2-CH=CH_2$, rhombic tablets, m.p. 80° (picrate, violet needles, m.p. 128°). This, on oxidation with permanganate, gives a 3:4-dimethoxyphenanthrenecarboxylic acid, m.p. 196°, which was

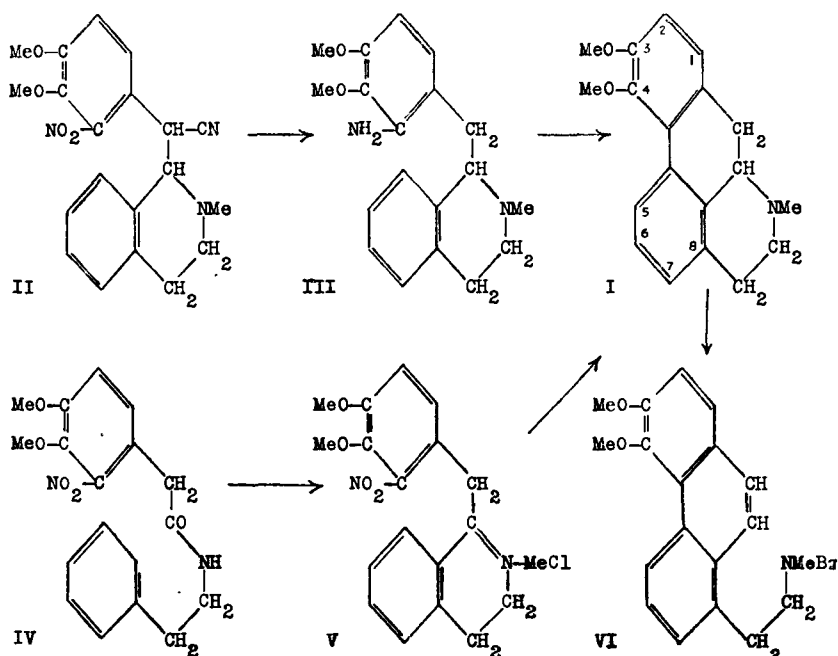

converted by the Curtius method into 3 : 4 : 8-trimethoxyphenanthrene, m.p. 138°, identical with the product synthesised by Pschorr and Busch.²² This leaves no doubt that the neutral product of the Hofmann degradation of *apomorphine* is 3 : 4-dimethoxy-8-vinylphenanthrene,²³ and provides proof of the formula (I : 2 -OMe replaced by 2 -OH groups), suggested for *apomorphine* by Pschorr in 1902.²² In this alkaloid, therefore, the carbon end of the ethanamine chain is attached at carbon atom 8. This formulation of *apomorphine* gave support to the view that the third "indifferent" oxygen of morphine could not form part of an oxazine ring, also involving the ethanamine chain, but was present in a 4 to 5-oxygen bridge as in Vongerichten's morphenol.⁵ Confirmation of this formula was provided by the syntheses in 1929 of *dl-apomorphine* dimethyl ether by Avenarius, Pschorr and Herz,²⁴ and by Späth and Hromatka.²⁵ The former authors condensed 2-nitro-3 : 4-dimethoxyphenylacetonitrile with 1-hydroxy-2-methyl-1 : 2 : 3 : 4-tetrahydroisoquinoline in presence of sodium ethoxide to form the nitrile (II), which, after removal of the cyano-group by hydrolysis and decarboxylation, followed by reduction of the nitro-group, gave 1-(2'-amino-3' : 4'-dimethoxybenzyl)-2-methyltetrahydroisoquinoline (III). This, on diazotisation in presence of copper powder, underwent the Pschorr phenanthrene ring closure to *apomorphine* dimethyl ether (I), which was identified as the methiodide, m.p. 195°, and the methine base hydrochloride, m.p. 220-1°, derived from the latter. Gulland and Virden²⁴ have called attention to various reactions in this synthesis, which are at variance with their experience in syntheses of this type, and which they suggest need further elucidation.

The synthesis by Späth and Hromatka²⁵ was based on the Bischler-Napieralski isoquinoline synthesis, a method already tried without success, for the solution of this particular problem, by Kay and Pictet²⁶ and Gulland, Haworth, Virden and Callow.²⁷ Nitrohomoveratryl- β -phenylethylamide (IV), prepared by Kay and Pictet's method, was treated with phosphoric oxide in boiling toluene, producing a non-basic substance, C₁₈H₁₈O₄N₂, m.p. 124-6°, probably identical with that described by Kay and Pictet²⁶ and the desired product 1-(2'-nitro-3' : 4'-dimethoxybenzyl)-3 : 4-dihydroisoquinoline, m.p. 129°. This, in the form of the methochloride (V), was reduced by tin and hydrochloric acid to the amino-tetrahydro-base, which, on treatment with nitrous acid and copper powder, gave *dl-apomorphine* dimethyl ether (I). As *l-apomorphine* dimethyl ether, obtained from morphine, could not be racemised for comparison with the synthetic product, comparison was made by boiling each with benzoyl chloride to form the scission product (VI), m.p. 164.5-165°, in which there is no asymmetric carbon atom, and which proved to be identical from both sources. A relationship between *apomorphine* and *epistephanine* (p. 361) has been suggested.

Thebenine, C₁₈H₁₉O₃N. This secondary amine, which differs by CH₂ in empirical composition from thebaine, is formed by the action of hot dilute hydrochloric acid on thebaine²⁸ or codeinone,²⁹ but not ψ -codeinone, which does, however, yield triacetylthebenine and ethanolmethylamine

when boiled with acetic anhydride.³⁰ The alkaloid is amorphous, insoluble in ether, sparingly in hot alcohol, insoluble in ammonia, but readily soluble in alkalis, in which it oxidises rapidly. Thebenine dissolves in sulphuric acid, giving a blue solution, which is decolorised on addition of water. The hydrochloride, $B \cdot HCl \cdot 3H_2O$, forms pale yellow crystals, m.p. $231-5^\circ$ (*dec.*), and the sulphate $B_2 \cdot H_2SO_4 \cdot H_2O$, yellow leaflets, m.p. $209-210^\circ$ (*dec.*), sparingly soluble in water. A series of thebenine ethers has been prepared.³¹ Thebenine-8-methyl ether (methebenine) has m.p. $165-7^\circ$, and, according to Pschorr and Massiacu,³² still contains one free hydroxyl group, since it is soluble in alkali, yields a diacetyl derivative (leaflets, m.p. 179°), and can be further *O*-methylated, when the secondary nitrogen has been converted into a quaternary form, as in dimethebeninemethine methiodide, $C_{16}H_{10}(OMe)_3 \cdot NMe_3I$ (needles, m.p. 247°). The latter substance is produced in two stages: methebenine, $C_{19}H_{21}O_3N$, is treated with excess of methyl iodide to produce methebeninemethine methiodide, $C_{16}H_{10}(OMe)_2(OH) \cdot NMe_3I$ (microscopic prisms, m.p. 215°), which is in turn treated in aqueous solution with the calculated quantity of alkali hydroxide and dimethyl sulphate to produce dimethebeninemethine methosulphate, $C_{16}H_{10}(OMe)_3 \cdot NMe_3 \cdot SO_4Me$. This crystallises in colourless needles, m.p. 277° , and is readily converted into the corresponding methiodide by double decomposition with potassium iodide. Either of these quaternary salts on warming in dilute aqueous solution with potassium hydroxide produces trimethylamine and a trimethoxyvinylphenanthrene, m.p. 122.5° , which, on oxidation with permanganate, furnishes a trimethoxyphenanthrenecarboxylic acid, m.p. $219-221^\circ$. This acid, on decarboxylation, gives 3 : 4 : 8-trimethoxyphenanthrene, and thus indicates the positions of the three oxygenated substituents³³ in the phenanthrene nucleus. The original methoxyl group must be at 3, since thebenine is obtainable from codeinone and the latter is known to contain a methoxyl group at 3⁷. Confirmation of the hydroxyl group at 8 is found in the degradation of thebenine ethyl ether (ethebenine) to 3 : 4-dimethoxy-8-ethoxyphenanthrene,³³ m.p. 100° , identical with the synthetic product.³⁴ The position of the vinyl group, representing the original ethanamine chain, is indicated by the fact that the trimethoxyvinylphenanthrene, when boiled in acetic acid, is converted into methebenol,³³ m.p. $133-4^\circ$, first obtained by Freund and Holthof³¹ by treating methebeninemethine methiodide, $C_{16}H_{10}(OMe)_2(OH) \cdot NMe_3I$, with a solution of potassium hydroxide, hydrogen iodide and trimethylamine being eliminated. Thebenol, $C_{17}H_{14}O_3$, m.p. $186-8^\circ$, the phenol corresponding to methebenol, was prepared by Freund³⁵ by the action of caustic soda solution on thebeninemethine methiodide. It gives a monoacetyl derivative and, on distillation with zinc dust, is converted into pyrene, $C_{16}H_{10}$, implying the formation of a ring between C⁴ and C⁵. On the assumption that in the formation of methebenol from 3 : 4 : 8-trimethoxyvinylphenanthrene the vinyl group reacts with the neighbouring hydroxyl group in position 4, formula (VII) was assigned to thebenol,³³ which implies position 5 for the ethanamine chain in thebenine as adopted by Pschorr³³ in his formula

(IX) for this alkaloid. Definite proof of this location was first provided by Gulland and Virden,³⁶ who suggest formula (VIII) for thebenol in view of the ease of formation and stability of six-membered oxide rings. These authors showed that the neutral product formed by the exhaustive methylation of thebenine must be 3 : 4 : 8-trimethoxy-5-vinylphenanthrene, since it furnished on catalytic reduction 3 : 4 : 8-trimethoxy-5-ethylphenanthrene (XII), m.p. 165–6°, identical with this material synthesised for comparison. The synthesis was effected by condensing 2-nitroveratraldehyde and sodium 6-methoxy-3-ethylphenylacetate to *trans*- α -(6'-methoxy-3'-ethylphenyl)-2-nitro-3 : 4-dimethoxycinnamic acid (X), reducing this to the corresponding amine (XI), which by the diazo-reaction in presence of copper powder, cyclised to 3 : 4 : 8-trimethoxy-5-ethylphenanthrene-9-carboxylic acid, which, by elimination of carbon dioxide, gave the required substance (XII).

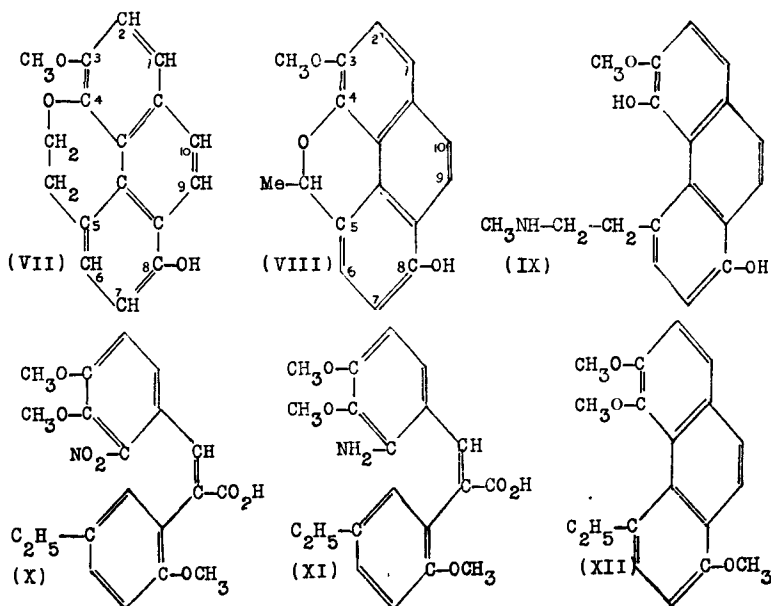

Cook and Thomson^{36(a)} have prepared 1-azapyrene, $C_{15}H_9N$, m.p. 157–9°, which they suggest is identical with thebenidine, $C_{15}H_9N$, m.p. 144–8°, obtained by Vongerichten^{36(a)} along with pyrene by distilling thebenine with zinc dust.

Morphothebaine, $C_{18}H_{19}O_3N$. This tertiary base results from the action of hydrochloric acid on thebaine at 80–90° in closed vessels,³⁷ or in a similar manner from codeinone.²⁹ It forms colourless crystals, which become tinted green or blue when kept, m.p. 197° (*dec.*), $[\alpha]_D^{15} - 130^\circ$ (EtOH). The base furnishes a characteristic acid hydrochloride, $B_2 \cdot 3HCl$, colourless needles, m.p. 254–5°, which is converted by water or alcohol to the normal hydrochloride, $B \cdot HCl$, minute needles, m.p. 256–60°. The

methiodide, B. MeI, crystallises from acetic acid and has m.p. 221–2°. With diazomethane it yields a dimethyl ether, which has not been crystallised, $[\alpha]_D - 184.8^\circ$ (Klee³⁷) or -172.7° (Gulland and Haworth³⁸), but gives a crystalline *d*-acid tartrate, needles, m.p. 208–9° (*dec.*). $[\alpha]_D - 75^\circ$ (H₂O). Morphothebaine is not coloured by sulphuric acid, but with nitric acid it gives a red colour changing to reddish brown. Erdmann's reagent (sulphuric and nitric acids) produces a green colour changing to dirty bluish-violet, and Fröhde's reagent (sulphomolybdic acid) bluish-green changing to dull violet.³⁸ A relationship of morphothebaine to *ψ*-epistephanine (p. 361) has been suggested.

The alkaloid behaves like *apomorphine* when boiled with benzoyl chloride, forming a tribenzoyl derivative, m.p. 184°, in which two benzoyl radicles enter hydroxyl groups, and a third induces scission of a saturated heterocyclic ring.³⁹ The product, on oxidation with chromic acid in acetic acid, yields tribenzoylmorphothebainequinone, isolated as a phenylhydrazone, C₄₅H₃₅O₇N₃, crystallising in red needles, m.p. 227°, and forming with *o*-phenylenediamine an azine, C₄₅H₃₃O₆N₃, m.p. 201°. On hydrolysis with alkali, the two *O*-benzoyl-groups of the tribenzoyl-derivative are removed and *N*-benzoylmorphothebainequinone, C₂₅H₂₁O₆N, brown prisms, m.p. 267°, is obtained, which yields a phenylhydrazone, reddish-brown needles, m.p. 271°, and an azine, C₃₁H₂₅O₄N₃, brownish prisms, m.p. 274–5°. Knorr and Pschorr³⁹ had already shown that the alkaloid on treatment with sodium methoxide and methyl iodide in methyl alcohol at 100° is converted into a methinemethiodide, C₂₂H₂₈O₃NI, m.p. 266–8°, which on treatment with alkali decomposes into a trimethoxyvinylphenanthrene, m.p. 60–1°, yielding on oxidation a trimethoxyphenanthrenecarboxylic acid, m.p. 201°. This acid was shown by Pschorr and Rettberg⁴¹ to yield *via* the Curtius procedure a tetramethoxyphenanthrene, m.p. 108–9°, which in the following year Pschorr and Knöffler⁴² synthesised and showed to be 3 : 4 : 6 : 8-tetramethoxyphenanthrene (XIV), thus confirming formula (XIII) suggested by Pschorr and Halle⁴⁰ in 1907 for morphothebaine, and from which tribenzoylmorphothebaine may be written as (XV). Pschorr and Halle's formula has been confirmed by Gulland and Haworth's synthesis of morphothebaine dimethyl ether,³⁸ effected by the conversion of 2'-nitro-3' : 4'-dimethoxyphenylaceto-β-3-methoxyphenylethylamide (XVI) by the action of phosphorus pentachloride in chloroform at atmospheric temperature into 2'-nitro-6 : 3' : 4'-trimethoxy-1-benzyl-3 : 4-dihydroisoquinoline (XVII), which crystallised from methyl alcohol in faintly yellow prisms, m.p. 121–3°, and yielded a methiodide, yellow needles, m.p. 220° (*dec.*). The latter on reduction with zinc dust and hydrochloric acid was converted into 2'-amino-6 : 3' : 4'-trimethoxy-1-benzyl-2-methyltetrahydroisoquinoline (XVIII) which was transformed into *dl*-morphothebaine methyl ether (XIII : 2 –OH replaced by 2 –OMe) by diazotisation and heating. The *dl*-base is an oil yielding a crystalline hydriodide, colourless needles, m.p. 227° (*dec.*). It was deracemised by crystallisation of the acid *d*-tartrate, the *l*-base hydrogen *d*-tartrate separating first in stellate groups of colourless needles, m.p. 208–9° (*dec.*),

$[\alpha]_D - 74.8^\circ$ from which the oily *l*-base, $[\alpha]_D - 173.5^\circ$ (CHCl_3) was recovered. The methiodide crystallised from alcohol in colourless needles, m.p. 195° , $[\alpha]_D - 87.1^\circ$ (H_2O). The corresponding figures found for the dimethyl ether of *l*-morphothebaine prepared from thebaine were hydrogen *d*-tartrate, m.p. $208-9^\circ$ (*dec.*), $[\alpha]_D - 75^\circ$ (Klee³⁷ gives -74.3°); base $(\alpha)_D - 172.7^\circ$ (Klee gives -184.8°); methiodide, m.p. 195° , $[\alpha]_D - 88.2^\circ$.

The following results were found for the *d*-isomeride isolated from the mother liquors of the *l*-base hydrogen *d*-tartrate and purified by conversion into and crystallisation as the hydrogen *l*-tartrate. Base, oil, $[\alpha]_D + 174.2^\circ$ (CHCl_3); hydrogen *l*-tartrate, m.p. $208-9^\circ$ (*dec.*), $[\alpha]_D + 75.5^\circ$ (H_2O).

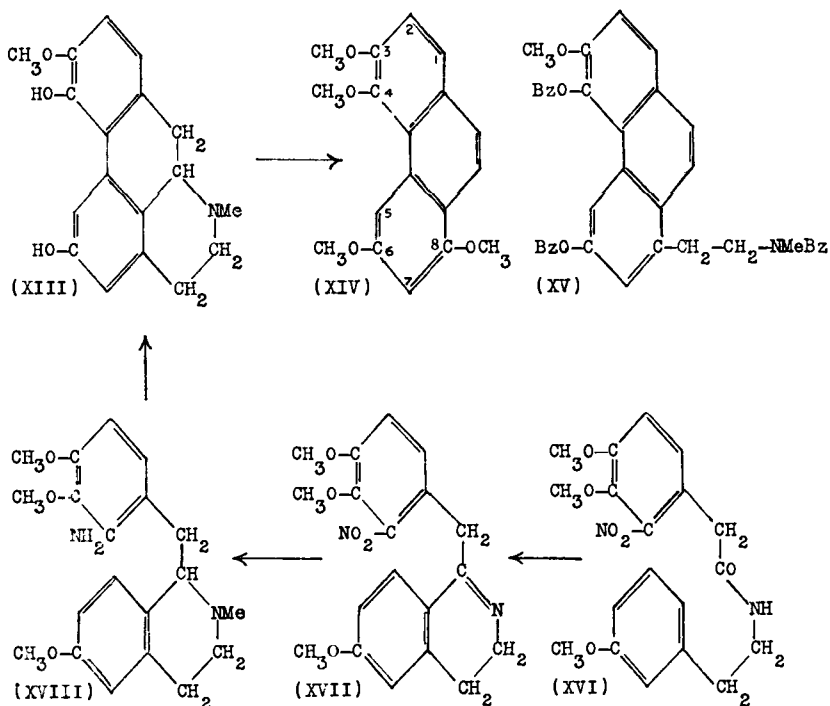

Mechanisms for the change of thebaine into thebenine have been suggested by Freund and Speyer,^{43(a)} Gulland and Robinson^{43(b)} and Schöpf and Borkowsky^{43(c)} and for the conversion of thebaine (or codeinone) into morphothebaine by the same authors and in addition by Gulland and Robinson^{44(a)} and Wieland and Kotake.^{44(b)}

isoThebaine, $\text{C}_{19}\text{H}_{21}\text{O}_3\text{N}$. This alkaloid, like *apomorphine* and *morphothebaine*, belongs to the *aporphine* sub-group (p. 306), but as it is obtained from a *Papaver* sp., viz., *P. orientale*, in which it occurs with thebaine, and is closely related to *morphothebaine*, it is convenient to deal with it in this section, though it is not a *morphine* derivative. It was first obtained as an unnamed phenolic base by *Gadamer* and *Klee* and was

subsequently named *isothebaine* and examined in detail by Klee.³⁷ The base forms highly refractive crystals, m.p. 203–4° [α]_D²⁵ + 285.1° (EtOH). The sulphate, m.p. 120–1° (*dec.*), and the hydrochloride, nitrate and hydrogen-*l*-tartrate are crystalline. The alkaloid is not coloured by sulphuric acid, but turns pale yellow with Erdmann's reagent, and with Fröhde's reagent gives a play of colours in the order blue, green, dark olive-green, and finally pale green. With nitric acid it gives a dark violet colour, which enables traces of it to be detected in presence of thebaine.

*iso*Thebaine is methylated with difficulty by the use of diazomethane in amyl ether, giving *isothebaine* methyl ether, as an oil, [α]_D + 234.5° (CHCl₃) yielding a hydrogen *l*-tartrate, m.p. 226–7° (*dec.*), [α]_D + 143° (H₂O). The alkaloid contains one methylimino-group and two methoxyl groups. When the sodium derivative of *isothebaine* in water is treated with methyl sulphate it is converted into *isothebaine* methyl ether methosulphate, C₂₀H₂₃O₃NMe . SO₄Me, glistening needles, m.p. 237–8°, [α]_D + 158.1° (H₂O), which is decomposed by alkali yielding two methine bases, (*a*) m.p. 104–5°, [α]_D – 283.9° (ether), colourless needles, (*b*) amorphous and optically inactive. The mixture, as produced, reacts with methyl sulphate to form *isothebainemethine* methyl ether dimethosulphate, C₁₉H₁₉O₃NMe₃ . SO₄Me, needles, m.p. 195–6°, which is decomposed by alkali into trimethylamine and a trimethoxyvinylphenanthrene. The latter, on oxidation by potassium permanganate yields a trimethoxyphenanthrenecarboxylic acid, m.p. 170–1°, crystallising in yellowish needles or leaflets, and this on heating in glacial acetic acid at 220° under pressure, is decarboxylated to a trimethoxyphenanthrene, giving a picrate, m.p. 160°, dark red needles, which is regarded as identical with 3 : 4 : 5-trimethoxyphenanthrene picrate,⁷ m.p. 166°. On this assumption, formula (III) was proposed by Klee for *isothebaine* methyl ether, with the suggestion that in *isothebaine* the hydroxyl group might be at 4 or 5, the former being considered the more probable. Attempts were made by Callow, Gulland and Haworth^{38(a)} to confirm this formula by synthesis, as indicated by formulæ (I) to (III), and for this purpose 2'-nitro-3':4'-dimethoxyphenylaceto- β -4-methoxyphenylethylamide (I) was prepared but could not be induced to undergo ring closure to the required substituted dihydroisoquinoline (II), presumably owing to the absence of a *para*-directive substituent at 3, and attempts to provide a suitable substituent were unsuccessful.

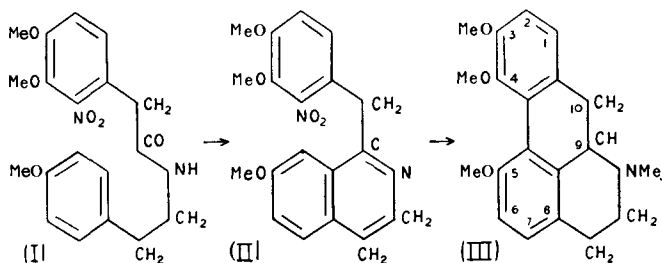

Morphine Formulae. Omitting early attempts to produce constitutional formulae for morphine before the difficulties of the problem were fully realised, the first structure which need be considered is the oxazine formula proposed by Knorr in 1889 and modified in various ways, the last form being (XXII) as suggested in 1903.⁴⁵ This was based on the view that the liberation of such bases as ethanoldimethylamine and ethanoldimethylamine in the degradation of the alkaloids was due to the rupture of an oxygen linkage, and the later assumption²⁰ that the formation of the various simple oxygenated bases produced in these reactions arose from the initial liberation of vinyldimethylamine, which then reacted with the reagents used, or with by-products such as dimethylamine, made it possible to consider other methods of attachment of the ethanamine chain to the phenanthrene nucleus.

In the meantime, Pschorr, Jaeckel and Fecht²² had suggested their pyridine formula in a paper concerned mainly with the constitution of *apomorphine*. They pointed out that their *apomorphine* formula (p. 227) implies, in the formation of *apomorphine* from morphine, constituted on the lines Knorr suggested, the scission of an oxazine ring and its reconstitution as a reduced pyridine ring. Taking this into account, as well as Vongerichten's representation of morphenol (p. 226), in which the third "indifferent" oxygen of morphine is still retained, they proposed to represent morphine by (XXIII), though they recognised the difficulty involved in the hydrolysis of a carbon to carbon linkage, to yield such nitrogen-free products as morphol, along with the basic ethanamine chain resultants. This type of structure has the biological interest of bringing *apomorphine* and morphine into close relationship with the benzylisoquinoline group of opium alkaloids.

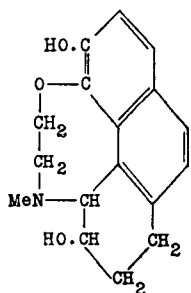

(XXII) Knorr (1903)

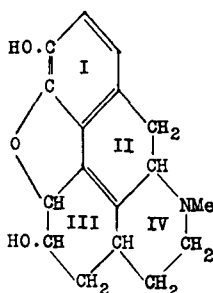

(XXIII) Pschorr (1902)

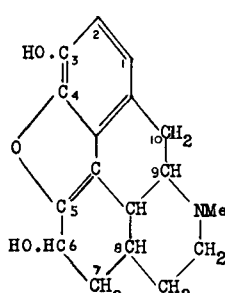

(XXIV) Knorr (1907)

In the following year Ach and Knorr⁴⁶ found that in the oxidation of codeine by chromic acid there is produced a hydroxycodine, $C_{18}H_{21}O_4N$, m.p. $207-8^\circ$, which contains two hydroxyl groups (diacetyl derivative, m.p. $160-1^\circ$) and degrades by Hofmann's method, followed by treatment of the resulting hydroxymethylmorphimethine, $C_{19}H_{23}O_4N$, with acetic anhydride, to ethanoldimethylamine and a diacetyl derivative (m.p. 201°) of a methoxydihydroxyphenanthrene,⁴⁷ indicating that a hydroxyl group

has been inserted, the position of which must be at 9 or 10 in the phenanthrene nucleus, since on oxidation by chromic acid the diacetyl derivative, $C_{19}H_{16}O_5$, loses an acetoxy-group and is converted into methylacetylmorpholquinone, $C_{17}H_{12}O_5$, m.p. 206–9°,⁴⁸ which had already been synthesised by Pschorr and Vogtherr⁴⁹ and shown to be 3-methoxy-4-acetoxy-phenanthrene-9 : 10-quinone. The conclusion was drawn from these results that, as the new hydroxyl group in hydroxycodaine is alcoholic, not phenolic, in character, the two possible positions for it, *viz.*, C⁹ and C¹⁰, must be hydrogenated in codeine. The presumed “hydroxymethylmorphimethine,” which is amorphous, but forms crystals, $C_{19}H_{23}O_4N \cdot (C_2H_5)_2O$, m.p. 50–60°, with 1 mol. of ether, and yields a series of crystalline salts, proved on further investigation to be a ketone⁵⁰ (oxime hydrochloride, m.p. 279°; semicarbazone, m.p. 106–7°; monoacetyl derivative, m.p. 81°), and it was therefore re-named ketodihydromethylmorphimethine. These changes were explained by Pschorr and Einbeck⁵⁰ as due to the formation of a double linkage between C⁹ and C¹⁰ as a result of the opening of the reduced pyridine ring, hence the nitrogen of the ethanamine chain must be attached at C⁹ (or C¹⁰) in codeine. This sequence of changes may be illustrated by the following partial formulæ derived from (XXIII) :—

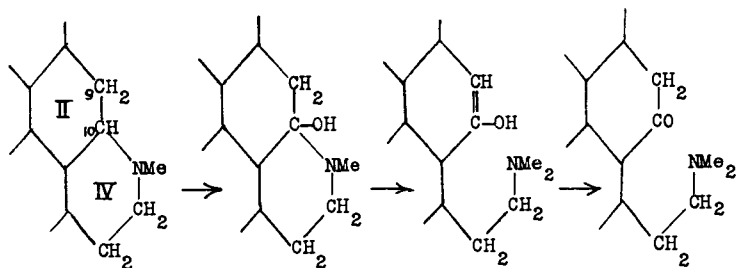

The location of the nitrogen end of the ethanamine chain in the phenanthrene nucleus has been discussed recently by Holmes *et al.*^{49(a)} and experimental work is in progress to obtain more direct evidence on this point.

Knorr and Horlein⁵⁰ at first took the view that a modified form (XXIV) of Pschorr's formula would account more easily for the production of ketodihydromethylmorphimethine from hydroxycodaine (now generally accepted as 9-hydroxycodaine), but in the same year these authors⁵¹ put forward a new constitution for morphine. In dealing with this it will be convenient to use the system of numbering indicated in the general formula (XXV : R = OH or OMe). On this basis carbon atom 15 (the carbon end of the ethanamine chain) is joined to carbon atom 8 in Pschorr's formula (XXIII). Knorr and Horlein pointed out that of the four known morphines, morphine and α -isomorphine yield on methylation codeine and *isocodeine* respectively, and these two codeines oxidise to the same codeinone, which degrades to 3 : 4 : 6-trimethoxyphenanthrene; β - and γ -isomorphines on methylation give *allo- ψ -codeine* and ψ -codeine respec-

tively, and these two codeines oxidise to ψ -codeinone, which degrades to 3 : 4 : 8-trimethoxyphenanthrene. Both codeine and ψ -codeine yield the same deoxycodine⁵² (now distinguished as deoxycodine-A, p. 252), and

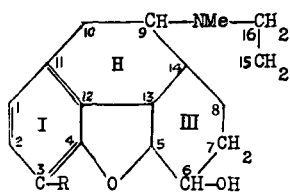

(XXV)

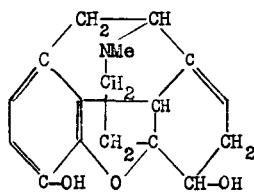

(XXVI) Knorr-Horlein (1907)

this was taken as proof that the sole difference between the two must be in the positions 6 and 8 of the —CHOH group, and in the two codeinones of the —CO—group. To permit of this wandering, positions 6 and 8 must be free from other substituents, and neither can be the point of attachment of the carbon end of the ethanamine chain. Further, as ψ -codeinone and codeinone give the Willstätter reaction with benzenediazonium chloride, and ψ -codeinone, in addition, undergoes the Claisen condensation with aldehydes, it was argued that there must be a methylene group at position 7, the latter being thereby also excluded as a point of attachment. Finally, since in thebenine (IX), in which the cyclic nucleus is completely aromatic, the ethanamine chain is still attached to ring III, points 13 and 14 seemed also to be excluded, which left only 5 as a possible position. Formula (XXVI) is based on these considerations.

Though the Knorr-Horlein formula was generally accepted until 1923, difficulties were frequently encountered in explaining reactions of the morphine alkaloids by it, and in some cases led to suggestions for its modification. Knorr and Horlein adopted an ethylenic linkage at C⁸ to C¹⁴, because (1) positions C⁹ and C¹⁰ must, for the reasons given above, be

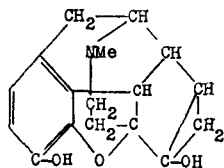
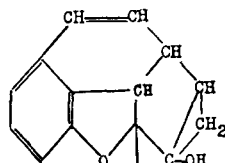
(XXVII) Morphine, von Braun 1914

(XXVIII)

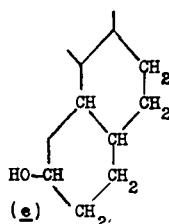
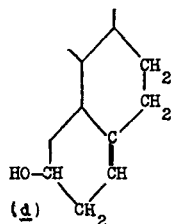
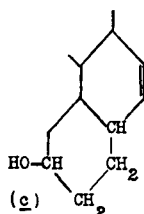
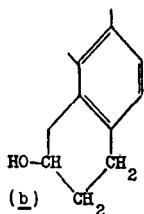
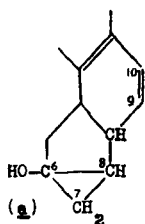

fully hydrogenated, and (2) the shift of this linkage from C⁸-C¹⁴ to C¹⁴-C¹³ provided an explanation of the changes $\alpha \rightarrow \beta$ and $\gamma \rightarrow \delta$ in the methylmorphimethines. Exception was taken to the ethylenic linkage in either of these positions by von Braun,⁵³ on the ground that a double bond in the $\beta\gamma$ -position with respect to a nitrogen generally involves scission of the ring in reaction with cyanogen bromide, whilst in its absence replacement of methyl in the methylimino-group by cyanogen takes place. Applying this method, he concluded that ring III probably contained an ethylenic linkage in thebaine, but not in codeine or morphine, and on this basis suggested formula (XXVII) with a bridge of C⁶-C⁸ for morphine. The salient changes involved in the conversion of morphine to α -methylmorphimethine are shown in partial formula (XXVIII), in which the methoxyl group at 3 and the ethanamine chain, $\cdot\text{CH}_2\cdot\text{CH}_2\cdot\text{NMe}_2$, attached by the carbon end at 5, are omitted for the sake of clearness. von Braun's formula explains a number of typical morphine reactions, particularly the intra-molecular migrations from C⁶ to C⁸, but does not account easily for the reversible change codeine to codeinone,⁵⁴ and fails to explain the reduction products of α - and β -methylmorphimethines.⁵⁵

The latter are represented on the basis of von Braun's formula by the partial formulæ (a) and (b), in which for simplicity the ethanamine chain is omitted. On reduction by sodium in alcohol they both yield the same product, dihydro- β -methylmorphimethine (oil : methiodide, m.p. 263°), in which the ethylenic linkage C⁹ to C¹⁰ has been saturated (d). On catalytic hydrogenation (nickel catalyst), β -methylmorphimethine (b) again yields (d), whilst α -methylmorphimethine (a) gives the isomeric dihydro- α -methylmorphimethine (c), which is identical with the first degradation product of dihydrocodeine methiodide, viz., de-*N*-methyl-dihydrocodeine (oil : perchlorate, m.p. 201°; methiodide, B. MeI. H₂O, m.p. 176° or 223-5° (*dry*)). On complete hydrogenation both isomerides yield the same tetrahydromethylmorphimethine (e) (C₁₉H₂₇O₃N; oil,

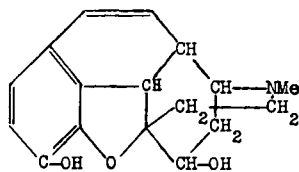

(XXX) Morphine (Freund, 1905)

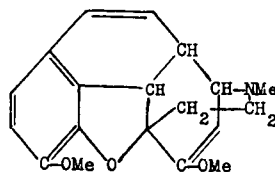

(XXIX) Thebaine (Freund, 1905)

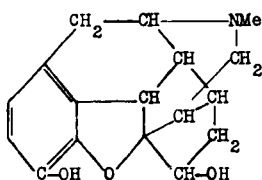

(XXXII) Morphine (Freund, 1916)

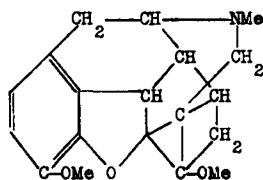

(XXXI) Thebaine (Freund, 1916)

b.p. 230–40°/15 mm.; methiodide, m.p. 220–1°). These results are incompatible with the representation of α - and β -methyl-morphimethines by (a) and (b) respectively, and, as a result of this investigation, von Braun and Cahn⁵⁵ came to the conclusion that morphine must contain an ethylenic linkage at C⁷—C⁸ instead of the bridge C⁶—C⁸ originally suggested by von Braun. In 1905 Freund⁵⁶ suggested formulæ for thebaine (XXIX) and morphine (XXX), based on the results of his study of the action of magnesium phenyl bromide on thebaine. The phenyldihydrothebaine, C₂₅H₂₇O₃N, produced is crystalline, m.p. 60–5°, yields a series of well-crystallised salts, *e.g.*, B . HCl . C₂H₅OH, m.p. 145–7°, methiodide, B . CH₃I, m.p. 230–1°, contains a phenolic hydroxyl group (methyl ether, m.p. 70°; acetyl derivative, m.p. 92°, after sintering from 65°) and behaves as a tertiary base, being degraded in two stages to trimethylamine and phenyldihydrothebenol, C₂₃H₂₀O₃, m.p. 148–9°. The latter contains —CH₂— less than is required by the expected degradation product, due to the formation of a five-membered oxide ring⁵⁶ by interaction of the ethanamine chain residue with the methoxyl group in position 6. In comparison with thebaine, phenyldihydrothebaine is remarkably stable to acids, alkalis, reducing agents and ozone,⁵⁷ and this led Freund and Speyer⁵⁸ to introduce new formulæ in 1916 for thebaine (XXXI) and morphine (XXXII), in which the nitrogen end of the ethanamine chain was linked to carbon atom 9 in accordance with Knorr and Pschorr's results in the degradation of 9-hydroxycodeine,⁵⁰ and ethylenic linkages were avoided in ring III. Though phenyldihydrothebaine is difficult to reduce, it can be hydrogenated in presence of colloidal palladium and then yields phenyltetrahydrothebaimine, C₂₅H₂₉O₃N, leaflets, m.p. 122°, [α]_D²⁰ + 27.6°, which is a secondary base, so that reduction is only effected by rupture of the heterocyclic ring.⁵⁸

A recent study by Small *et al.*⁵⁶ of the action of Grignard reagents on alkaloids of the morphine group, has shown that the reaction involves opening of the oxide ring with the formation of a phenolic hydroxyl group, and insertion of the alkyl or aryl group of the Grignard reagent in ring III and that it only occurs when the alicyclic ethylenic linkage of ring III is at C⁶—C⁷, as in deoxycodine-C, ψ -codeine methyl ether, ψ -codeinone, thebaine, dihydrothebaine, dihydrocodeinone enol acetate and acetyldihydrocodeinone enol acetate. The constitutional problems presented by Freund's phenyldihydrothebaine and the complex character of the products of the action of magnesium methyl iodide on thebaine are fully discussed in the 1939 paper, and in a paper just published (1947)⁵⁶ Small, Sargent and Bralley have shown that phenyldihydrothebaine, C₂₅H₂₇O₃N, as first formed is a mixture of the (+) α - and the (+) δ forms, each of which partly rearranges, under heat treatment, producing the (–) δ - and the (–) α -form respectively. The (+) α - and (–) α -isomers are glassy solids having [α]_D ± 10.0° (EtOH), and the (+) δ - and (–) δ -forms are crystalline solids, m.p. 143°, and have [α]_D ± 131° (acetone). These two pairs of oppositely, optically active isomers parallel those found by Small and Fry for the methyldihydrothebaines, and are similarly

constituted as described above. On Hofmann degradation each isomeride gives rise to an *isomethine*, $C_{26}H_{29}O_3N$, which also arrange themselves in two pairs of equally and oppositely active stereoisomerides. The (+) α - and (-) α -phenyldihydrothebaines give rise to the (+) α - and (-) α -*isomethines*, which have m.p. 101° , and $[\alpha]_D^{20} - 280^\circ$ (EtOH) and $+ 281^\circ$ (EtOH) respectively, *i.e.*, in the change to the *isomethine* the direction of rotation is inverted. Similarly the (+) δ - and (-) δ -forms of phenyldihydrothebaine give rise to a pair of *isomethines*, m.p. $117-9^\circ$ and having $[\alpha]_D^{20} + 153^\circ$ and $- 154^\circ$ (EtOH) respectively, the directions of rotation in this case remaining unchanged. In the formation of the *isomethines* scission occurs between N and C^{16} the NMe_2 group remaining attached to C^9 , while C^{15} and C^{16} remain as a vinyl group attached to C^{13} . (For the normal methine formation in the morphine series, see p. 251.) In the next step of the degradation the (+) α - and the (+) δ -*isomethines* give rise to the (+)-form, while the (-) α -*isomethine* produces the (-)-form of vinylphenyldihydrothebaol, $C_{24}H_{22}O_3$; these two nitrogen-free products have m.p. $149-150^\circ$ and $[\alpha]_D^{20} \pm 47.1^\circ$ (ethyl acetate) and form a racemate, m.p. 149.5° , $[\alpha]_D \pm 0^\circ$.

The phenyldihydrothebaines are resistant to reduction but can be hydrogenated under special conditions, taking up one mole of hydrogen with reductive scission between the N-atom and C^9 , formation of a double bond from C^{14} to C^8 , retention of the ethanamine chain . $CH_2 . CH_2 . NHMe$, at C^{13} , and the elimination of asymmetry at C^9 , so that the (+) α - and (+) δ -phenyldihydrothebaines yield the same (+)-phenyltetrahydrothebainine, $C_{25}H_{29}O_3N$, whilst the (-) α - and (-) δ -forms give the optical antipode; the two phenyltetrahydrothebainines have m.p. 121° and $[\alpha]_D^{20} - 35^\circ$ and $+ 35.5^\circ$ respectively, the direction of rotation being changed in this operation, and form a racemate, m.p. 134° , $[\alpha]_D^{20} \pm 0^\circ$ (acetone).

Since the foregoing summary was prepared a preliminary account of an ingenious explanation of these results, involving a molecular rearrangement of a new type, has been published by Robinson⁵⁶ which cannot be adequately dealt with here and for which the reader must be referred to the original.

In 1917 Faltis,⁶⁹ after making a critical survey of the formulæ up to that time, suggested for morphine and thebaine structures which embodied von Braun's views as to ethylenic linkages in ring III and included an oxygen bridge from C^4 to C^8 in morphine (XXXIV) which was regarded as strained, this condition being enhanced in thebaine (XXXIII) by the

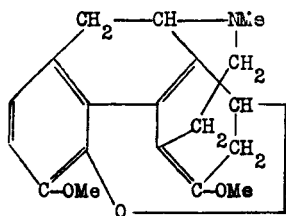

(XXXIII) Thebaine

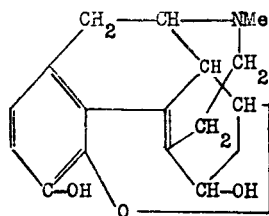

(Faltis, 1917) (XXXIV) Morphine

second ethylenic linkage, and so accounting for the smaller stability of this alkaloid as compared with morphine. This formula is of considerable interest, since it accounts for the C⁶—C⁸ migration in the change, codeine to ψ -codeine, but, apart from the difficulties it introduces in the explanation of a number of typical reactions of these alkaloids, there is strong evidence for the oxygen bridge at C⁴—C⁵, and, in spite of intensive investigation no experimental data have been found to indicate necessity for its replacement.

Among other formulæ which must be mentioned are those of Vis,⁶⁰ which represents morphine as a benzylisoquinoline, Vongerichten,⁶¹ Bucherer,⁶² Gadamer and Klee,⁴³ devised to account for the possible natural formation in *P. orientale* of isothebaine from thebaine, and the vinyl formula of Wieland and Kappelmeier.⁶³

Gulland and Robinson,⁶⁴ having reviewed the evidence available regarding the structure of morphine and codeine, came to the conclusion that the data on which Pschorr's formula was based have been too lightly dismissed, and suggested that the ethanamine chain is associated with the phenanthrene skeleton by the bridge 8—15—13 (a) or 8—15—14 (b), of which they preferred (a).

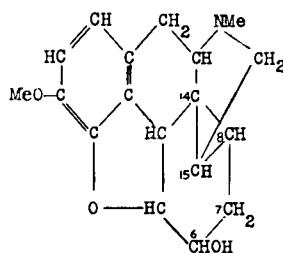
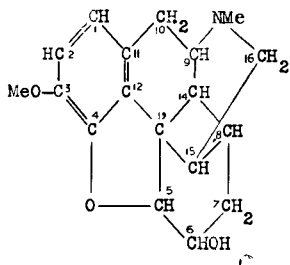

(a) Codeine (Gulland and Robinson, 1923) (b) Codeine (Gulland and Robinson, 1923).

The principal reason adduced for the essential new feature in this formula is that the linkage to carbon atom 13 explains why in morphine and its allies the formation of phenanthrene derivatives and an amino-ethanol derivative always takes place simultaneously. Such a change cannot occur except under conditions which will add a hydrogen atom or a hydroxyl group at position 13. Thus the conversion of α -methylmorphimethine into acetylmethylmorphol and acetoxyethylmorphine is regarded as taking place in the following way:—

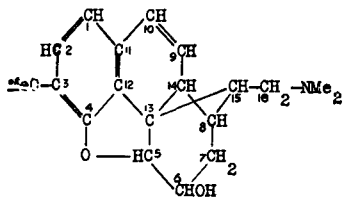

α -Methylmorphimethine
(G. and R.)

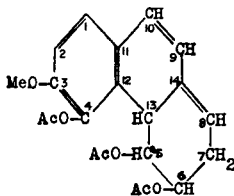

Intermediate product
+
AcO—CH₂—CH₂—NMe₂

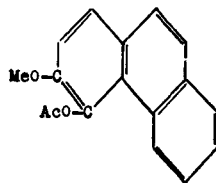

Acetylmethylmorphol

In this formula for codeine the linkage C¹⁵-C⁸ (XXXV = (a) in a different form) was a concession to the view emphasised in Freund and Speyer's 1916 formulæ (XXXI) and (XXXII) that ethylenic linkages do not exist in ring III. In 1925 Gulland and Robinson⁶⁵ re-investigated the hydroxycodoinone formed by the oxidation of thebaine with hydrogen peroxide,⁶⁶ and came to the conclusion that it is a γ -hydroxyketone, the hydroxyl group being at position 14 (XXXVIII), and that it does not contain the group —CO—CH₂—, but that its reduction product dihydrohydroxycodoinone does. This implies the presence of the chain —CO—CH=CH—C(OH)— in 14-hydroxycodoinone, and therefore of —C(OMe)=CH—CH=C in thebaine, and on these data they modified the 1923 formula for codeine to (XXXVI) and of thebaine to (XXXVII).

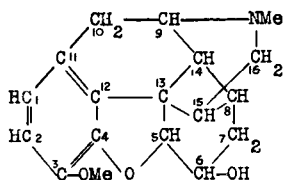

(XXXV) Codeine (Gulland and Robinson, 1923)

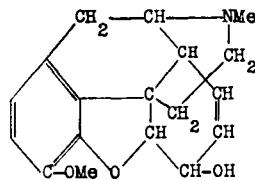

(XXXVI) Codeine (G. and R. 1925)

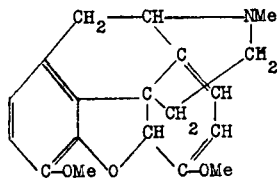

(XXXVII) Thebaine (G. and R. 1925)

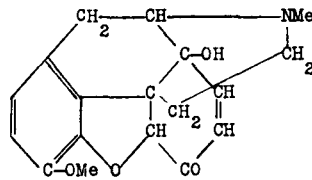

(XXXVIII) Hydroxycodoinone

Formula (XXXVI) contains an ethylenic linkage at C⁷ to C⁸, and in this respect meets von Braun's requirement (p. 237), but is not in accordance with Knorr and Horlein's view (p. 236) that position 7 must be occupied by a —CH₂— group, though Gulland and Robinson⁶⁷ in a discussion of this point make it clear that the evidence for this view is not conclusive. That ring III does contain an ethylenic linkage seems to be clearly established by such observations as (1) the hydrogenation of codeine to dihydrocodeine⁶⁸ (C₁₈H₂₃O₃N · H₂O, m.p. 112-3° (*dry*); monoacetyl derivative, m.p. 120°); (2) the hydrogenation of codeinone to dihydrocodeinone⁶⁹ (p. 245), and (3) the oxidation of codeine in very dilute solution by potassium permanganate to dihydroxydihydrocodeine⁷⁰ (C₁₈H₂₃O₅N; m.p. 208-9°, triacetyl derivative, m.p. 200°). Its location at C⁷ to C⁸, with which Wieland and Kotake⁷⁰ agree, has the advantage that it provides an explanation of the transition, codeine → ψ -codeine, by the analogous transition of geraniol to linalool

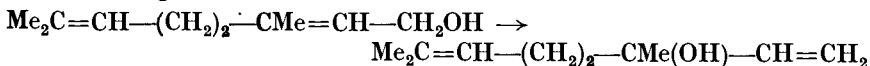

and the difficulty that ψ -codeinone reacts with aldehydes as if it contained the group $-\text{CH}_2-\text{CO}-$, whereas it should contain $=\text{CH}-\text{CH}=\text{CH}-\text{CO}$, is removed by recognising the following system of tautomerides ⁷⁰ :—

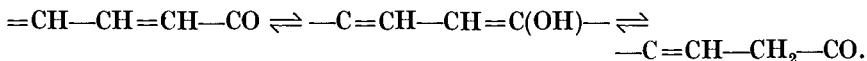

While Wieland and Kotake agree that the ethylenic linkage is at C⁷ to C⁸, they differ in attaching the carbon end of the ethanamine chain at position 5 (formula XXXIX for codeine), and adopt for thebaine a bridge C¹⁵ to C⁶ (XL) in place of Gulland and Robinson's second ethylenic linkage. This device was adopted to account for the difficulty of hydrogenating thebaine beyond dihydrothebaine, which seemed to indicate the presence of only one ethylenic linkage.

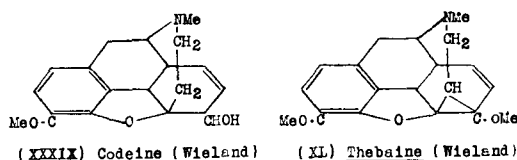

The reduction of thebaine has been repeatedly investigated. Freund, Speyer and Guttmann ⁵⁸ (1920), using spongy platinum in cold *N*-hydrochloric acid, obtained non-phenolic dihydrothebaine. Using colloidal palladium, the product was dihydrothebainone (p. 250). Skita *et al.* ⁸² obtained dihydrothebaine by hydrogenation of thebaine hydrochloride in aqueous solution in presence of colloidal palladium, whereas with colloidal platinum the products were tetrahydrothebaine and dihydrothebainone, the latter being further reduced in aqueous acid solution in presence of colloidal platinum to a dihydrothebainol, different from the usual product of that name. Schöpf and Winterhalder ⁷¹ in their investigation of this reaction, also isolated dihydrothebaine, tetrahydrothebaine and dihydrothebainone and provided explanatory mechanisms for the formation of these substances. Wieland and Kotake ⁷⁰ obtained a 50 to 60 per cent. yield of dihydrothebainone by hydrogenation of thebaine hydrochloride in presence of palladous chloride and gum arabic, but in neutral, alcoholic solution the product was an oil yielding dihydrothebainone on treatment with acids. Small and Browning ⁷² have repeated this experiment and resolved the oil into three crystalline components : (a) dihydrothebainone- Δ -5 : 6-methyl enolate : this is the chief product and had already been suggested by Wieland and Kotake ⁷⁰ as the constitution of their oil, using, however, a bridged-ring formula instead of the ethylenic linkage at C⁵—C⁶.

(b) Tetrahydrothebainone.

(c) Dihydrothebainol-6-methyl ether.

Small and Browning agree with Schöpf and Winterhalder that thebainone methyl enolate (formed by 1 : 6 addition in which the oxygen bridge is ruptured and ethylenic linkages produced at C⁵—C⁶ and C⁷—C⁸) may be the primary intermediate in this reaction since it is hydrogenated

in alcohol in presence of platinic oxide to dihydrothebainone- Δ -5 : 6-methyl enolate, from which it differs only in having an additional ethylenic linkage (C^7-C^8).

The formulæ and chief characteristics of these reduction products are as follows :—

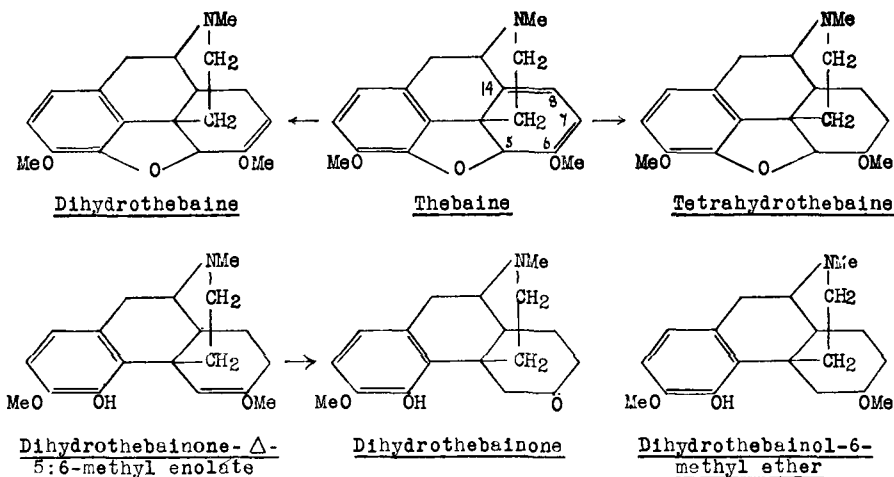

Dihydrothebaine, $C_{19}H_{23}O_3N$, prismatic plates, m.p. $162-3^\circ$, $[\alpha]_D^{20} - 266.8^\circ$ (C_6H_6); picrate, m.p. 235° ; methiodide, m.p. 257° . To be distinguished from phenolic dihydrothebaine, m.p. 154^{931} prepared by reduction of thebaine with sodium in alcohol.

Tetrahydrothebaine, $C_{19}H_{25}O_3N$ (dihydromorphine dimethyl ether), m.p. 83° , $[\alpha]_D^{18} - 152.7^\circ$ (EtOH); B. HCl. $3H_2O$, m.p. $115-6^\circ$; picrate, m.p. 220° ; B. MeI, m.p. $115-6^\circ$, re-melts 212^{71} .

Dihydrothebainone (see p. 250).

Dihydrothebainol (Skita).⁸² $C_{18}H_{25}O_3N$, m.p. 165° ; $[\alpha]_D^{20} - 36.5^\circ$ (EtOH); methiodide, m.p. 273° . To be distinguished from the better-known dihydrothebainol, m.p. $138-142^\circ$, $[\alpha]_D^{28} - 46.2^\circ$, prepared by reducing dihydrothebainone with sodium amalgam (Speyer and Siebert⁵²).

Dihydrothebainone- Δ -5 : 6-methyl enolate, $C_{19}H_{25}O_3N$, m.p. $164-165.5^\circ$, $[\alpha]_D^{25} - 115.7^\circ$ (EtOH). Cold N/HCl converts it into dihydrothebainone hydrochloride.⁷² The isomeric dihydrothebainone- Δ -6 : 7-methyl enolate is formed on catalytic hydrogenation of phenolic dihydrothebaine. It has m.p. $127-8^\circ$, $[\alpha]_D^{27} - 8^\circ$ (EtOH) and yields dihydrothebainone on acid hydrolysis.⁷²

Thebainone methyl enolate. $C_{19}H_{23}O_3N$. This possible intermediate in the hydrogenation of thebaine to dihydrothebainone- Δ -5 : 6-methyl enolate (see above) has m.p. $154-6^\circ$, $[\alpha]_D^{22} + 9.6^\circ$ (EtOH).⁷²

Dihydrothebainol-6-methyl ether. $C_{19}H_{27}O_3N$, m.p. $140.5-142^\circ$, $[\alpha]_D^{21} - 23.4^\circ$ (EtOH); fumarate, m.p. $198-201^\circ$ (dec).⁷²

The 4-methyl ether is a liquid, but all attempts to prepare dimethyl ethers of the two known dihydrothebainols failed; the relationship

between the latter and this new dihydrothebainol-6-methyl ether has not yet been determined.

Schöpf and Winterhalder suggested that in the hydrogenation of thebaine a molecule of hydrogen is first added at C^8-C^{14} producing dihydrothebaine, which under energetic hydrogenation suffers disruption of the oxygen bridge, forming dihydrothebainone. In dihydrothebaine, the chain $.O.CH.C(OMe):CH.$ resembles in certain respects a system of conjugated double linkages and it seems likely that in the formation of dihydrothebainone, addition of hydrogen occurs at the ends of this chain forming the intermediate, which Small and Browning have now isolated, *viz.*, dihydrothebainone-4-5 : 6-methyl enolate.

Most of the dihydrothebainone produced from thebaine is formed under mild conditions of hydrogenation and probably not *viâ* dihydrothebaine, but by way of thebainone methyl enolate and dihydrothebainone-4-5 : 6-methyl enolate as described above.

When addition of hydrogen takes place simultaneously at C^8-C^{14} and C^6-C^7 tetrahydrothebaine is formed and it is argued that formation of the tetrahydro-base supports Gulland and Robinson's formula, since Wieland and Kotake's $C^{15}-C^6$ bridge (XL) would not be reduced under the mild conditions used.

Schöpf⁷¹ has also obtained direct evidence for the location of the carbon end of the ethanamine chain by submitting dihydrocodeinoneoxime to a Beckmann rearrangement. This process, the steps in which are illustrated by partial formulæ for ring III, should provide an aldehyde (XLVc) if the oxime is correctly represented by the Gulland and Robinson formula (XLVb) and a ketone (XLVIc) if it has the structure (XLVIb) required by the Wieland and Kotake formula.

When cold thionyl chloride is allowed to act on dihydrocodeinoneoxime, there is formed a substance (m.p. 196-8°, picrate, m.p. 207-8°; acetyl derivative, m.p. 225°; oxime, m.p. 218-9°), from which the required

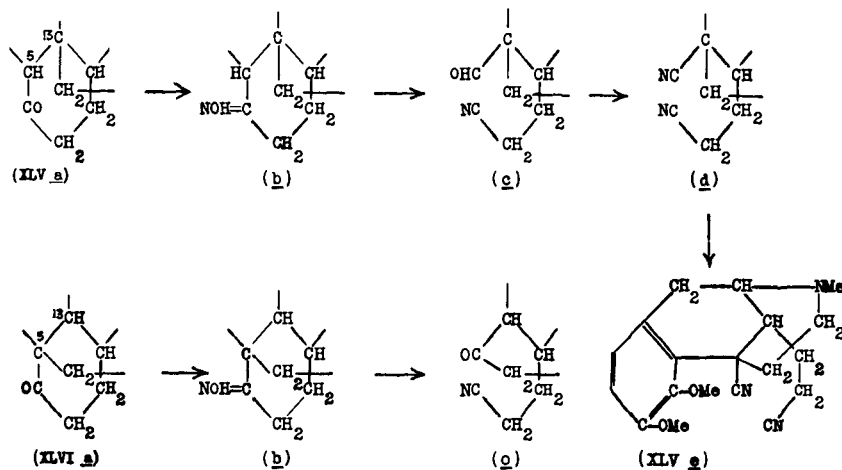

information had to be obtained indirectly. Its oxime methyl ether with cold thionyl chloride yields a dinitrile $C_{19}H_{23}O_2N_3$ (methiodide, m.p. 207° (*dec.*), with sintering from 200°), presumably represented by (XLVd), which, on degradation by the Hofmann method, suffers no loss of carbon atoms, implying that in the dinitrile the nitrogen ring is still intact, as shown in (XLVe), and that in codeine, carbon atom 15 is linked to carbon atom 13, as in the Gulland and Robinson formula. Any attempt to dehydrate a ketoxime derived from (XLVIc) would lead to scission of the heterocyclic ring. The formation of the aldehyde (XLVc) also implies that the oxygen bridge from C^4 must end at C^5 or C^7 , since only under this condition can the Beckmann transformation take place, and of these C^5 is indicated on steric considerations, which rules out the Faltis formula (p. 239).

KETONES OF THE MORPHINE GROUP. As these substances have played an important part in the discussion of constitutional formulae for the morphine group and the allied alkaloids, it is desirable to describe the more important of them.

Codeinone, $C_{18}H_{19}O_3N$. This ketone (XLVII) corresponds to the secondary alcohol codeine and its stereoisomeride *isocodeine*. It may be prepared by oxidising codeine with potassium permanganate in acetone or with potassium dichromate in dilute sulphuric acid and in various other ways.⁷⁴ Codeinone can be reduced to codeine electrolytically or by chemical methods.¹ It crystallises from alcohol in prisms, m.p. $185-6$, $[\alpha]_D^{15} - 205^\circ$ (EtOH). The hydrochloride, B. HCl. H_2O , has m.p. $179-80^\circ$, picrate, m.p. 205° , methiodide, B. $CH_3I \cdot 2H_2O$, m.p. 180° . The oxime, $C_{18}H_{20}O_3N_2 \cdot C_2H_5OH$, has m.p. 212° and $[\alpha]_D^{15} - 499^\circ$ (EtOH). On catalytic hydrogenation, codeinone is reduced to dihydrocodeinone.⁶⁹

Dihydrocodeinone, $C_{18}H_{21}O_3N$. This substance is formed by the hydrogenation of codeinone, oxidation of dihydrocodeine or the methylation of dihydromorphinone but is best prepared by the hydrolysis of dihydrothebaine.⁶⁹ The presence of a $-\text{CO} \cdot \text{CH}_2-$ group is shown by the formation of dianhydro-6-aminopiperonal dihydrocodeinone,⁷⁵ m.p. $270-1.5^\circ$. Dihydrocodeinone is represented by (LIII, p. 246). It has m.p. $197-8^\circ$, yields a hydrochloride, B. HCl. H_2O , m.p. 82° or 125° (*dry, dec.*); methiodide, m.p. $250-5^\circ$; oxime, m.p. 264° , and monoacetyl derivative, m.p. $154-5^\circ$. For the formation of *d*-dihydrocodeinone from sinomenine *via d*-dihydrothebaine, see p. 270.

As the carbonyl group of the morphine ketones is inert towards the Grignard reagent, Small and Rapoport^{75(a)} replaced it by organolithium compounds and with methyl lithium in ether on dihydrocodeinone obtained the corresponding 6-tertiary alcohol, 6-methyldihydrocodeine, $C_{19}H_{25}O_3N$, m.p. 116° , $[\alpha]_D^{20} - 139^\circ$ (EtOH). In this the tertiary 6-hydroxyl group was acetylated by a modified Houben process, giving 6-methyl-6-acetyldihydrocodeine, $C_{21}H_{27}O_4N$, m.p. $124.5-125.5^\circ$, $[\alpha]_D^{20} - 85.1^\circ$ (EtOH) but it could not be replaced by halogen, the product of the action of thionyl chloride being 6-methyldeoxycodine-C, $C_{19}H_{23}O_2N$, m.p. $173-4^\circ$,

$[\alpha]_D^{20} - 242^\circ$ (EtOH). (Cf. deoxycodine-C, formula II, p. 253.) 6-Methyldihydrocodeine could not be demethylated to the corresponding 6-methyldihydromorphine (*see below*) but it was degraded *via* 6-methyldihydro-methylmorphimethine, isolated as the hydrochloride, $C_{20}H_{28}O_3NCl$, m.p. $241-3^\circ$, $[\alpha]_D^{20} - 6.7^\circ$ (EtOH), to the nitrogen-free product, 6-methyl-6-hydroxy-13-vinylhexahydromorphenol, $C_{18}H_{20}O_3$, which sublimes at $100^\circ/0.1$ mm. and has $[\alpha]_D^{20} + 24.4^\circ$ (EtOH).

Dihydromorphinone, $C_{17}H_{19}O_3N$, and derivatives. Dihydromorphinone (LIII; MeO \rightarrow HO) is formed when morphine in solution is treated with relatively large quantities of platinum or palladium catalyst under various conditions.^{75(b)} It melts at $262-3^\circ$ and yields an oxime, m.p. $> 234^\circ$. The hydrochloride is the drug known as "dilaudid." On *O*-methylation dihydromorphinone yields dihydrocodeinone (*see above*), and when dissolved in ether and treated with methyllithium the corresponding tertiary alcohol, 6-methyldihydromorphine, $C_{18}H_{23}O_3N$, m.p. $209-211^\circ$, $[\alpha]_D^{20} - 147^\circ$ (EtOH), is formed. This on methylation with diazomethane gives 6-methyldihydrocodeine as described above (Small and Rapoport^{75(a)}).

Methyldihydromorphinone, $C_{18}H_{21}O_3N$, was prepared by Small, Fitch and Smith⁵⁶ by the action of magnesium methyl iodide on dihydrothebaine, the resulting phenolic methyldihydrothebainone (LI with Me at C⁵ or C⁷, p. 248), m.p. $192-3^\circ$, $[\alpha]_D^{25} - 20.5^\circ$ (EtOH) being converted by the Schöpf process⁸¹ to methyldihydrocodeinone (LIII with Me at C⁵ or C⁷), m.p. $144-144.5^\circ$, $[\alpha]_D^{23} - 146.9^\circ$ (EtOH), which is demethylated by boiling with hydrobromic acid to methyldihydromorphinone, m.p. $243-5^\circ$ (*vac.*), $[\alpha]_D^{24} - 140.7^\circ$ (EtOH) yielding a hydrochloride, m.p. $315-8^\circ$ (*vac. dec.*), $[\alpha]_D^{24} - 104.8^\circ$ (H₂O). The essential intermediate in this process, methyldihydrothebainone, can also be obtained by the action of the Grignard reagent on dihydrocodeinone enol acetate, m.p. $152-153.5^\circ$, itself produced by catalytic rearrangement^{75(a)} of codeine (XXXVI, p. 241) to dihydrocodeinone (LIII), and treatment of the latter with acetic anhydride and sodium acetate. The location, C⁵ or C⁷, of the entering methyl group in these compounds is discussed by Small *et al.*⁵⁶ in the 1938-39 papers.

14-*Hydroxycodine*, $C_{18}H_{19}O_4N$, may be prepared by the action of hydrogen peroxide on thebaine in glacial acetic acid, or by the oxidation of either codeine or thebaine with sodium dichromate.⁶⁶ Certain of its reactions bearing on the constitution of codeine have been mentioned

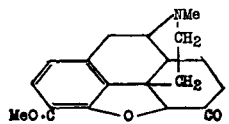
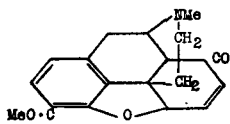
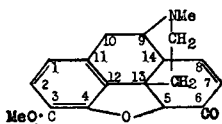

already⁶⁵ (XXXVIII, p. 241). It crystallises in plates, m.p. $275-6^\circ$ (*vac.*), $[\alpha]_D^{25} - 111^\circ$ (dil. acetic acid) and yields a hydrochloride, B. HCl. $2H_2O$,

m.p. 272–4° (*vac.*), $[\alpha]_D^{24}$ – 89° (H_2O), hydriodide B . HI . H_2O , m.p. 255–60° (*vac.*), oxime decomposing at 279–80° and acetyl derivative, m.p. 185°, $[\alpha]_D^{25}$ + 21° (dil. acetic acid). On catalytic hydrogenation it is converted into dihydrohydroxycodeinone (LIII, with .OH at C¹⁴), m.p. 218°, $[\alpha]_D^{25}$ – 97° (dil. acetic acid), of which the hydrochloride, B . HCl, 2.5 H_2O , has m.p. 270–2° (*dec.*) and $[\alpha]_D^{25}$ – 123° (H_2O). The further reduction products of 14-hydroxycodeinone have been investigated by Lutz and Small.⁶⁵

ψ-Codeinone (iso-Codeinone). This isomeride of codeinone is produced by the oxidation of *ψ*-codeine or the stereoisomeric *allo-ψ*-codeine (p. 218).⁷⁶ It crystallises from alcohol, has m.p. 174–5°, $[\alpha]_D^{15}$ – 25° (EtOH), gives a crystalline methiodide, m.p. 220° $[\alpha]_D^{15}$ – 12° (H_2O), and a crystalline semicarbazone, m.p. 180°. In contrast with codeinone, it condenses with benzaldehyde⁶⁷ to form benzylidene-*ψ*-codeinone (oil), of which the methiodide has m.p. 250°. It also forms an amorphous *isonitroso-ψ*-codeinone, which decomposes at 200°. Reference has been made already to the principal reactions of *ψ*-codeinone on the results of which formula (XLVIII) is assigned to it, for which Lutz and Small⁶⁸ have produced confirmatory evidence in the course of their reduction experiments with this substance.

Thebainone and *metaThebainone*, C₁₈H₂₁O₃N. When thebaine is treated with stannous chloride in strong hydrochloric acid, it yields as principal product a substance, which was named thebainone by Pschorr, Pfaff and Herrschmann.⁷⁷ It is produced by hydrolysis of the C—OCH₃ group at position 6 in thebaine, followed by reductive rupture of the C⁴—C⁵ oxygen bridge, and is also obtainable by a similar method from codeinone (Knorr⁷⁷). As the oxygen bridge has been broken, thebainone is a misleading name, but the more appropriate name, *dihydrothebainone*, had already been applied to an isomeric substance obtained by the catalytic hydrogenation of thebaine.⁷⁸ Further, Schöpf has produced evidence for the view that in Pschorr's thebainone the carbon end of the ethanamine chain is not at C¹³ as in thebaine, but at C¹⁴, and on that ground has suggested that the name should be changed to *metathebainone*, the old name thebainone being reserved for an isomeride (*see below*) with the carbon end of the ethanamine chain at C¹³, which, in conjunction with Hirsch, he has also isolated from the complex mixture of products formed by the action of stannous chloride in hydrochloric acid on thebaine, but which was first prepared by Pschorr⁷⁹ during a study of *β*-ethylthiocodide under the name "S-free ketone," and has been re-obtained by that method by Morris and Small⁸⁰ in the course of work on ethylthiocodides.

A further anomaly in nomenclature is *thebainol*, the name applied to the substance formed by the alkaline reduction of *metathebainone*, and which was at first believed to be formed by reduction of the carbonyl group, but which Gulland and Robinson⁸¹ proved to be a ketone. It is isomeric with dihydrothebainone referred to above, and has been re-named *dihyrometathebainone* (Schöpf). The interrelationships of these substances are shown by the following formulæ:—

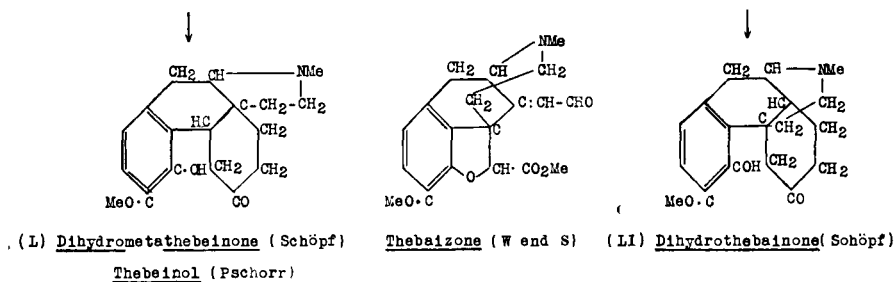
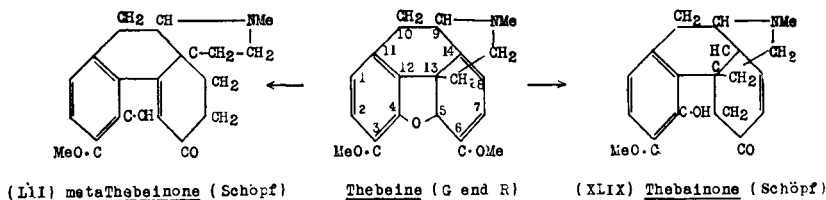

metaThebainone (Schöpf), *Thebainone* (Pschorr), $C_{18}H_{21}O_3N$. This substance is usually prepared from thebaine by the action of stannous chloride in hydrochloric acid at 100° for from fifteen to twenty minutes.⁷⁷ It crystallises with 1.5 mols. of water, has m.p. $88-90^\circ$, or with 1.0 mol. of methyl alcohol, m.p. $115-8^\circ$; has phenolic properties (sodium derivative, orange plates) and gives a picrate, m.p. $250-3^\circ$ (*corr.*), a methiodide, m.p. $255-6^\circ$, an oxime, m.p. $200-1^\circ$ (*corr.*), a semicarbazone, m.p. 227° (*corr.*), and a methyl ether, m.p. 156° (*corr.*). Of the three oxygen atoms in *metathebainone*, one is present as a carbonyl group, one is phenolic and the third occurs in a methoxyl group. Since *metathebainone* is formed by reduction of codeinone, the methoxyl and carbonyl groups must occupy positions 3 and 6 respectively and the hydroxyl group must be located at position 4. As methyl*metathebainone*methine, when boiled with acetic anhydride, gives ethanoldimethylamine and 3:4-dimethoxyphenanthrene (dimethylmorphol), *metathebainone* was at first regarded as represented by (XLIX). This representation⁸¹ did not account for the fact that "thebainol" (L) and dihydrothebainone (LI), both produced by the reduction of "thebainone" and both still retaining the carbonyl group, are isomeric but different substances. Schöpf and Winterhalder found that in the catalytic hydrogenation of thebaine there is produced *epidihydrothebainone*, regarded as epimeric with dihydrothebainone about C^{14} , represented by (LI), since it is assumed to be produced like dihydrothebainone by the mechanism already described (p. 247), and is different from "thebainol" (L). That seemed to imply a structural difference between *metathebainone* (still called thebainone at that time) and the dihydrothebainones, apart from the mere saturation of the ethylenic linkage C^7-C^8 . *metaThebainone* shows marked halochromy in hydrochloric acid solution, due it is assumed to conjugation between the carbonyl group in 6 and an ethylenic linkage, C^5-C^{13} (see LII). This assumption implies a change in

attachment of the carbon end of the ethanamine chain at C¹³, and of the possible new points C¹⁴ is regarded as the most probable. On this basis *metathebainone* is represented by (LII). This representation is in harmony with the fact that Gulland⁷⁵ obtained only a monobenzylidene (m.p. 233°) and a monopiperonylidene (m.p. 176°) derivative from *metathebainone*. Further, Schöpf and Perrey,⁸¹ in applying the method of constructing

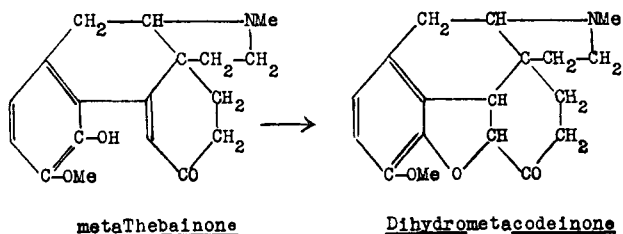

an oxygen bridge from C⁴-C⁵, obtained from *metathebainone* by treating the 1:5-dibromo-derivative with alkali, 1-bromodihydrrometacodeinone, which, on catalytic hydrogenation, furnishes dihydrrometacodeinone (needles, m.p. 196–201°, from methyl alcohol; oxime, m.p. 176–80°). This, on reduction with sodium amalgam, is reconverted to dihydrrometathebainone (L); a series of reactions parallel with those involved in the conversion of dihydrothebainone into dihydrocodeinone (see p. 250).

Thebainol (Pschorr⁷⁷), *Dihydrrometathebainone* (Schöpf⁸¹), C₁₈H₂₃O₃N, is obtained by the reduction of *metathebainone*, with sodium amalgam in dilute alkali. Crystallised from methyl alcohol, it melts at 54–5° and re-melts at 76–8°, but after crystallisation from dry ether it has m.p. 135–6° and $[\alpha]_D^{25} + 67.05^\circ$ (EtOH). The oxime has m.p. 217–8° and $[\alpha]_D^{18} + 104.2^\circ$ (acetic acid, 10%). The benzylidene derivative forms yellow needles, m.p. 100–2°. ⁷⁵ An amorphous dipiperonylidene derivative has been described by Gulland and Robinson.⁸¹ The methyl ether is amorphous, but yields a crystalline methiodide, m.p. 245°. *Thebainol* is represented as (L), produced by saturation of the ethylenic (C⁵-C¹³) linkage in *metathebainone* (LII).

Thebainone (Schöpf), C₁₈H₂₁O₃N. This substance, which must be distinguished from Pschorr's thebainone (*metathebainone* of Schöpf (see p. 248)), is formed, along with the latter in the reduction of thebaine by stannous chloride in hydrochloric acid, and was isolated by Schöpf and Hirsch.⁸¹ Its prior isolation by Pschorr,⁷⁹ as confirmed by Morris and Small,⁸⁰ has been referred to already. It crystallises with 0.5 H₂O, has m.p. 151–2°, yields a hydriodide, m.p. 258–9°, methiodide, m.p. 223°, and an oxime, m.p. 185–6°. On catalytic hydrogenation it yields dihydrothebainone (LI), and can be degraded to 3:4:6-triacetoxypheanthrene, m.p. 165–7°. On this basis formula (XLIX) is assigned to it. The mechanism of the formation of codeinone, thebainone and *metathebainone* from thebaine is discussed by Schöpf and Hirsch.⁸¹

Dihydrothebainone, $C_{18}H_{23}O_3N$, produced by the hydrogenation of thebaine in acetic acid in presence of palladium as catalyst,⁸² has m.p. 138–43°, $[\alpha]_D^{18}$ – 72.5° (Schöpf); gives a hydriodide, m.p. 262–3° (Freund); methiodide, m.p. 116° (Skita) or 150° (Freund); oxime, m.p. 250° or 253–5° (Freund); semicarbazone, m.p. 226–7° (G. and R.); and a piperonylidene derivative, m.p. 174–5°. The methyl ether is amorphous, but gives a crystalline methiodide, m.p. 257–8° (*dec.*).

Since dihydrothebainone is also formed by hydrogenation of thebainone (Schöpf and Hirsch⁸¹), and as Schöpf and Pfeifer⁸¹ have shown that 1 : 5-dibromodihydrothebainone, on treatment with alkali, is converted into 1-bromodihydrocodeinone by formation of the C⁴–C⁵ oxygen bridge,⁸³ and this, on catalytic hydrogenation, yields dihydrocodeinone (LIII, p. 246), the constitution of which has been demonstrated by Schöpf (p. 244), there can be little doubt that dihydrothebainone is represented by (LI). Schöpf and Winterhalder⁸² have also isolated as an oxime (m.p. 228°, $[\alpha]_D^{20}$ – 115.8°) an *epidihydrothebainone*, which is regarded as the C¹⁴ epimeride of dihydrothebainone.

Thebaizone, $C_{19}H_{21}O_5N$. This substance, produced by the action of ozone on thebaine hydrochloride in water, forms pale yellow crystals from ether, has m.p. 125–6° and yields a hydriodide, m.p. 185–7°, a methiodide, B. MeI, m.p. 250–5° (*dec.*) and a semicarbazone, m.p. 202° (*corr.*). On hydrolysis it furnishes thebaizonic acid, $C_{18}H_{19}O_5N$, m.p. ~ 235°, and on oxidation with hydrogen peroxide is converted into thebaizonedicarboxylic acid, $C_{18}H_{19}O_6N$, H_2O , m.p. 189–90° (*dec.*), by simultaneous oxidation of the aldehyde group and hydrolysis of the methyl ester group. On catalytic hydrogenation, the oxygen bridge is ruptured and phenolic *dihydrothebaizone*, $C_{19}H_{23}O_5N$, m.p. ~ 140°, is formed. Thebaizone was first prepared by Pschorr and Einbeck^{83(a)} and the formula assigned (p. 248) is due to Wieland and Small.⁵⁷

METHYLMORPHIMETHINES. The principal characters of these derivatives of the four known morphines⁸⁴ have been given already (p. 218). Below are shown formulæ for the two stereoisomeric pairs of morphines and the three stereoisomeric pairs of methylmorphimethines. β -Methylmorphimethine is also neopinemethine (p. 219), and for that reason the formula of neopine is added.

The stereoisomeric pair, morphine and α -isomorphine, on methylation of the phenolic hydroxyl at C³, give rise to codeine and *isocodeine* respectively, and similarly β - and γ -isomorphines produce ψ -codeine and *allo*- ψ -codeine respectively.

The α - and β -methylmorphimethines cannot be demethylated to morphimethines and the only known member of the latter class is β -morphimethine or, according to Mosettig,^{84(a)} its monoacetyl derivative, m.p. 183–5°, which Vongerichten^{84(a)} obtained by the action of acetic anhydride on morphine methohydroxide. On methylation it yielded β -methylmorphimethine. The latter, on reduction by sodium amalgam in alcohol, gives the dihydro-derivative usually represented by (I) though according to Mosettig the ethylene linkage is as likely to be at C⁹–C¹⁴ as

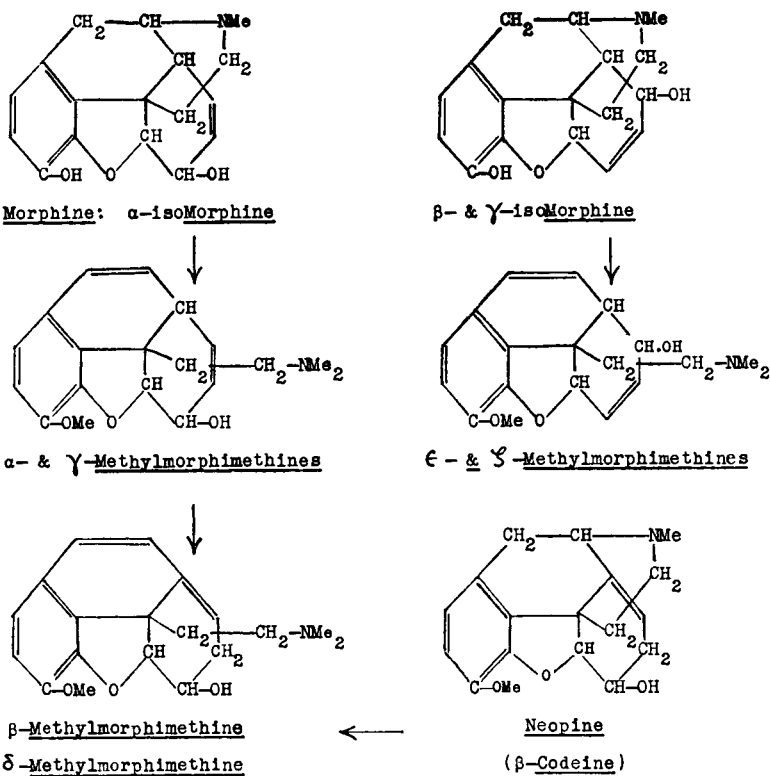

at C⁸—C¹⁴. It has m.p. 86–88.5° and gives a methiodide, m.p. 253–8° (*dec.*). On demethylation by boiling in acetic acid containing hydrogen bromide 6-acetyldihydromorphimethine, m.p. 200–202.5° [α]_D²⁴ + 118.4° (CHCl₃), is produced, which is readily hydrolysed to a dihydromorphimethine, m.p. 174–6°, [α]_D²⁶ + 92.8° (CHCl₃). The latter on methylation yields a new dihydromethylmorphimethine: oil, B. HCl, m.p. 227–30° (*vac.*), [α]_D²⁴ + 47.0° (H₂O) (Mosettig^{84(a)}). The location of the ethylenic linkage

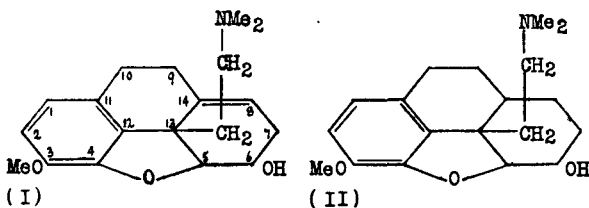

has not been ascertained for this substance but it, like β -dihydromethylmorphimethine, can be hydrogenated catalytically to tetrahydro- α -methylmorphimethine (II) isolated as the hydrochloride, B. HCl, m.p. 229–31° (*vac.*); [α]_D²⁰ – 32.8° (H₂O), in which unsaturation in rings II and III, the source of structural isomerism in the initial products, has disappeared.

This tetrahydro-derivative, on demethylation by boiling in acetic acid containing hydrogen bromide, yields 6-acetyltetrahydro- α -morphimethine, m.p. 240–2° (*vac.*), which is hydrolysed by boiling normal soda solution to tetrahydro- α -morphimethine (II . MeO \rightarrow HO), m.p. 206–8° (*vac.*); B . HCl, m.p. 243–9° (*vac.*), $[\alpha]_{D}^{23} - 29.6^{\circ}$ (H₂O) (Mosettig^{84(a)}).

On catalytic hydrogenation α -methylmorphimethine yields first a dihydro-derivative oil, B . HCl, m.p. 133°, identical with Freund's^{84(b)} de-*N*-methyl-dihydrocodeine, in which the ethylenic linkage at C⁷–C⁸ is saturated and finally the tetrahydro- α -methylmorphimethine (II), described above.

The γ - and δ -methylmorphimethines on catalytic hydrogenation both yield a tetrahydro-derivative, m.p. 115°, $[\alpha]_{D}^{18} - 29.2^{\circ}$ (dilute acetic acid), which may be a stereoisomeride of tetrahydro- α -methylmorphimethine (II).

The ϵ and ζ -methylmorphimethines (formula, p. 251) are catalytically hydrogenated to hexahydro-derivatives by saturation of the two ethylenic linkages and opening of the oxide ring. The one from the ϵ -form has m.p. 155° and that given by the ζ -form, m.p. 174–5° (Speyer and Koulen^{84(b)}).

Deoxycodines, C₁₈H₂₁O₂N. As the name implies, these substances contain one atom of oxygen less than the codeines, *viz.* the oxygen atom at C⁶ in codeine or at C⁸ in ψ -codeine. They are of two types, phenolic as in formula I, or non-phenolic as in formula II, and are distinguished by the letters A, B, C, D. Deoxycodine-A is phenolic (I); the supposed deoxycodine-B has been shown by Small and Morris⁵² (1933) to be an anhydrous form of deoxycodine-A, which is the only representative of the phenolic type. Formula II represents deoxycodine-C, and deoxycodine-D (deoxyneopine), differs from this only in having the ethylenic linkage at C⁸–C¹⁴ instead of at C⁶–C⁷ (Small and Mallon⁵² 1940). They are formed by the reduction of the chlorocodides (p. 217) in various ways, or by the elimination of hydrogen chloride from chlorodihydrocodide, and are themselves reducible to dihydrodeoxycodines of which five, distinguished as A, B, C, D, E, were recorded, until Small and Lutz⁵² (1934) showed that the apparently, well-established dihydrodeoxycodine-A was a mixture in the ratio 1 : 3 of dihydrodeoxycodines B and C, the same mixture being produced by the reduction of α -chlorocodide, deoxycodine-A, or ψ -codeine with sodium in alcohol. Of the four remaining dihydrodeoxycodines, D (formula III) is non-phenolic and B and C are phenolic. The former is represented by IV and C differs from it in having the ethylenic linkage at C⁵–C⁶ instead of at C⁶–C⁷. Dihydrodeoxycodine-E was prepared by Speyer and Sarre⁷⁴ by electrolytic reduction of bromocodine and is of the phenolic type. All the deoxycodines and dihydrodeoxycodines can be reduced to the same tetrahydrodeoxycodine (V) which seems to indicate the same configuration at C¹⁴ throughout the series. This tetrahydro-base is identical with the dehydroxytetrahydrocodeine of Mannich and Löwenheim,⁶⁹ the dihydrothebaccodine of Speyer and Subert⁵² and the dihydrothebainan of Kondo and Ochiai.⁵² It is also produced by the catalytic hydrogenation of β -chlorocodide (p. 217). The clearing-up of the complex and confusing details of the chemistry of

the deoxycodines and deoxymorphines is largely due to Lyndon Small and his collaborators, who have also shown that the α -dihydrodeoxycodine of Freund *et al*⁵² is a bimolecular product and have re-named it bisdihydrodeoxycodine.

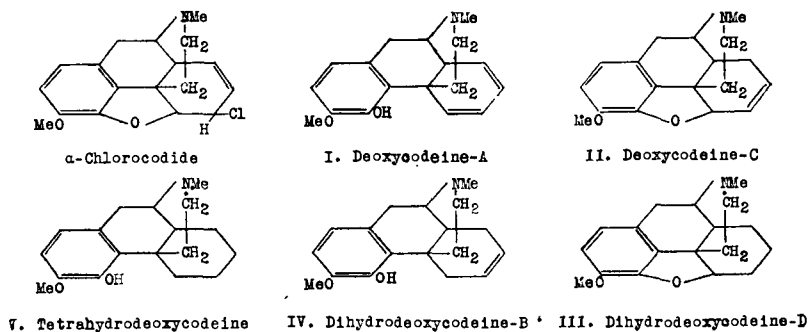

The chief characteristics of these substances are given in the following table:—

Substance	Type	M. p.	$[\alpha]_D$	Salts
Deoxycodine-A ¹	I	-122°	+118.1°	B.HCl, m. p. -270°. $[\alpha]_D +87^\circ$; B.HI, m. p. 265°; B.MeI, m. p. 219-221°
Deoxycodine-C	II	106°	-197.4°	B.HCl; m. p. 114°. $[\alpha]_D -132.7^\circ$ B.HI, m. p. 160.5°. $[\alpha]_D -131.6^\circ$
Deoxycodine-D	II	liquid	-	B.HCl, m. p. 234-5°. $[\alpha]_D^{28^\circ} -12.1^\circ$; B.H ₂ C ₂ O ₄ , m. p. 220-1°
Dihydrodeoxycodine-B ²	IV	128-131°	-106.9°	B.HCl, m. p. 154-6° (de _o); $[\alpha]_D -76.4^\circ$; B.HI, m. p. 255.6°. $[\alpha]_D -79.3^\circ$
Dihydrodeoxycodine-C	IV	109-111°	+5.6°	B.HCl, m. p. 241-2°. $[\alpha]_D +10.8^\circ$; B.HI, 242-3°. $[\alpha]_D +2.2^\circ$ ^D
Dihydrodeoxycodine-D	III	107°	-82.5°	B.HI, m. p. 250-1°; B.MeI, m. p. 256-7°
Dihydrodeoxycodine-E	IV	139°	+58.1°	B.MeI, m. p. 199°; salicylate, m. p. 198°
Tetrahydrodeoxycodine ³	V	145-7°	-32.4°	B.HI, m. p. 241°, $[\alpha]_D -24.2^\circ$; B.MeI, m. p. 263°. $[\alpha]_D -32.3^\circ$

1. There are two hemihydrates, m. p. 124.6° and 151-2°; the anhydrous base has m. p. 159-161°.

2. After sublimation has m. p. 173°.

3. There are two anhydrous forms; unstable, m. p. 124-5° and etable, m. p. 156-7°.

Deoxymorphines, C₁₇H₁₉O₂N. These substances bear the same relation to morphine as the deoxycodines do to codeine. The series is less extensive than the deoxycodines, but each deoxymorphine known can be methylated to the corresponding known deoxycodine (Small *et al.*⁵²), and is represented by the same formula (*see* deoxycodine formulæ, above, with at C³, MeO → OH).

Deoxymorphine-A (I : MeO \rightarrow HO) can be obtained by the electrolytic reduction of α -chloromorphide or bromomorphide, or, along with β -isomorphine, by the reduction of either of these halogenomorphides with zinc-amalgam in 6*N*-hydrochloric acid, but reduction with tin and concentrated hydrochloric acid produces an amorphous base giving a hydrochloride, m.p. 263.5°, $[\alpha]_D^{27}$ -78.1° (H₂O) (cf. Schryver and Lees,⁵² 1900). Deoxymorphine-A has m.p. 260–2°, $[\alpha]_D^{28}$ $+106^\circ$ (10% AcOH) and yields a benzoate, m.p. 240–5°, $[\alpha]_D^{31}$ $+82^\circ$ (EtOH); diazomethane converts it to deoxycodeine-A (p. 253). On hydrogenation in presence of platinum oxide it yields *tetrahydrodeoxymorphine*, C₁₇H₂₃O₂N (V; MeO \rightarrow OH), which can also be prepared by the demethylation of tetrahydrodeoxycodeine (p. 253). This sublimes at 150°/0.3 m.m., has m.p. 241–3°, $[\alpha]_D^{24}$ $-77.5^\circ \pm 5^\circ$ (MeOAc) and yields the following salts: B. HCl, m.p. 260–2°, $[\alpha]_D^{24}$ -47.0° (EtOH); B. HI, m.p. 268–71°; salicylate, m.p. 238–40°; it can be methylated to tetrahydrodeoxycodeine (V, p. 253).

Deoxymorphine-C, C₁₇H₁₉O₂N, 0.5 H₂O (II; MeO \rightarrow HO), is obtained by the action of sodium in methyl alcohol at 140° on chlorodihydromorphide: it has m.p. 189–90°, $[\alpha]_D^{31}$ -155.7° (EtOH) and forms the following salts: B. HCl, 1.5 H₂O, m.p. 240–5°, changing to 291–4° on keeping, $[\alpha]_D^{30}$ -147° (H₂O); B. HI, m.p. 292–4°; B. MeI, 260–4°, $[\alpha]_D^{32}$ -98° (MeOH) and on methylation forms deoxycodeine-C (II). It is hydrogenated, as the base in acetic acid, to a mixture of dihydrodeoxymorphine-D (*see below*) with tetrahydrodeoxymorphine (*see above*), but the latter only is formed when the hydrochloride in water is used.

Deoxymorphine-D, m.p. 254–5° (*vac.*), occurs as a by-product in the preparation of deoxycodeine-D (p. 253) and can be methylated to the latter (Small and Mallonee⁵²).

Dihydrodeoxymorphine-D is obtained by the hydrogenation in presence of palladised barium sulphate of α - or β -chloromorphide, or deoxymorphine-C (*see above*) or by the demethylation of dihydrodeoxycodeine-D (p. 253). It has m.p. 188–9° and $[\alpha]_D^{26}$ -76.8° (MeOH), or as the hemihydrate, m.p. 162–4°, $[\alpha]_D^{28}$ -78.6° (EtOAc). The following specific rotations for salts in water are recorded: B. HCl, -66.8° ; B. HI, -48.4° ; B. MeI, -46.6° . A process for the preparation of this substance has been patented⁸⁵ in which morphine is warmed at 60° with concentrated hydrochloric acid and the resulting dichloro-compound

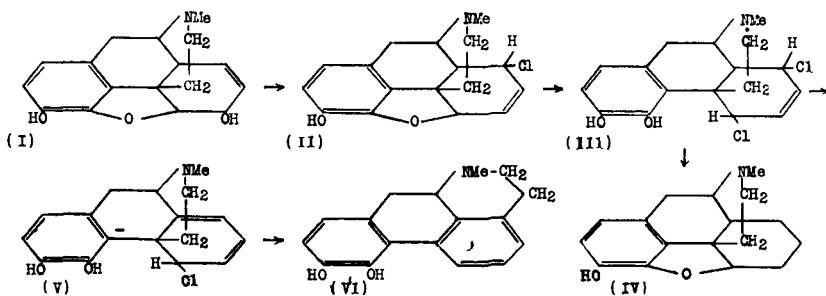

hydrogenated in dilute acid or neutral solution. From information supplied by Dr. Warnat and the results of their own experiments, Small, Faris and Mallonee ⁵² (1940) show that in this process, as indicated by the following formulæ (I to VI), morphine (I) is probably first converted into β -chloromorphine (II), and the latter into dichlorodihydrodeoxymorphine (III), in which ring closure of the oxygen bridge is easily effected to produce dihydrodeoxymorphine (IV). The same authors also suggest that β -chloromorphine (II), and the dichloro-compound (III) are intermediates in the conversion of morphine into *apomorphine* (VI, p. 214), probably *viâ* (V).

ψ -MORPHINE AND ALLIED SUBSTANCES. ψ -Morphine has been described already (p. 215), and mention may now be made of its suggested constitutional relationship to morphine. Goto and Kitasato ⁸⁶ found that, on boiling with acetic anhydride, basic ψ -morphine methiodide, $C_{34}H_{36}O_6N_2 \cdot CH_3I \cdot CH_3OH$, obtained by gentle oxidation of morphine methiodide, yields a substance, m.p. 255°, described as *bis*-2 : 2'-(3 : 4-diacetylmorphol), which, on hydrolysis and methylation, furnishes *bis*-2 : 2'-(3 : 4-dimethylmorphol). On these grounds ψ -morphine is regarded as 2 : 2'-dimorphine, which, using the Gulland and Robinson morphine formula, may be represented as follows :—

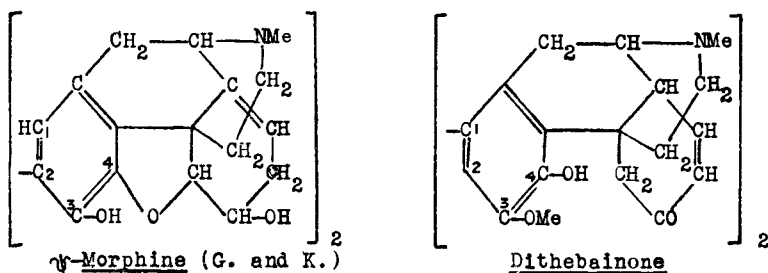

The points of junction are taken as 2 : 2' by analogy with the 2 : 2'-junction in β -dinaphthol. Small and Faris ⁸⁷ have recorded a number of observations on ψ -morphine, for which this formula does not account. In favour of the formula is the fact that 2-bromomorphine cannot be oxidised to a similar bimolecular product. On the other hand, ψ -morphine forms only a monomethyl ether, which is devoid of phenolic character, indicating the presence of only one phenolic hydroxyl group. Further, though the formula is symmetrical, the two nitrogen atoms show different characters ; thus, on methylation, a monomethyl ether methiodide is produced, and a dimethiodide can only be obtained by gentle oxidation of morphine methiodide to the so-called basic ψ -morphine methiodide methohydroxide, convertible to the dimethiodide by dilute hydriodic acid. The same authors have prepared γ - ψ -morphine by similar oxidation of γ -isomorphine, and this product closely resembles ψ -morphine in properties being bimolecular in structure, as indicated by molecular weight determinations, and forming a tetracetyl derivative and a monomethyl ether methiodide. Hydro-

genation of γ - ψ -morphine produces tetrahydro- γ - ψ -morphine, in which the ether oxide linkage in each half of the molecule is still intact, since the same substance is formed by oxidation of dihydro- γ -isomorphine, whose relationship to dihydro- ψ -codeine has been clearly established.⁸⁸ Similarly, ψ -morphine yields tetrahydro- ψ -morphine, identical with that formed by oxidation of dihydromorphine. Bimolecular products have also been obtained by oxidation of (a) heterocodeine (morphine 6-methyl ether) to ψ -heterocodeine (β :6'-dimethyl ether of ψ -morphine), and (b) an equimolecular mixture of morphine and γ -isomorphine, giving morphine- γ -isomorphine.⁸⁷

These bimolecular substances are of interest in connection with the chemistry of disinomenine (p. 271), and Goto and his colleagues have prepared several of them from members of the morphine group of alkaloids. Among these are dimetathebainone⁸⁶ and dithebainone.⁸⁹ The latter is represented as *bis*-1:1'-thebainone ($C_{18}H_{20}O_3N$)₂ (see formula, p. 255), and is formed by the gentle oxidation of thebainone (p. 249). It crystallises in prisms, sinters from 210° and decomposes at 265°, has $[\alpha]_D^{16} - 218.9^\circ$ (CHCl₃) and gives a methiodide ($C_{19}H_{23}O_3NI$)₂, prisms, m.p. 250° (*dec.*), and an amorphous oxime ($C_{18}H_{22}O_3N_2$)₂. On catalytic hydrogenation it furnishes *bis*-1:1'-dihydrothebainone ($C_{18}H_{22}O_3N$)₂, which can also be obtained by oxidation of dihydrothebainone (p. 250) with silver nitrate. It crystallises in prisms, sinters from 210° and decomposes at 258°, and has $[\alpha]_D^{17} - 159.8^\circ$. The optical antipode of this substance is obtained by demethoxylating tetrahydrodisinomenine or by the gentle oxidation of demethoxydihydrosinomenine (p. 268).

In these dithebainone products the *para*-position with reference to the hydroxyl group in ring I is assumed to be the point of junction (see dithebainone formula, p. 255), but an isomeride, *bis*-8:8'-dihydrothebainone, is obtained when thebainone is reduced with sodium amalgam (Goto and Ogawa⁸⁹).

REFERENCES

- (1) ACH and KNORR, *Ber.*, 1903, **36**, 3068; KNORR and HORLEIN, *ibid.*, 1906, **39**, 1409; FREUND, *ibid.*, p. 844; SPEYER, SELIG and HEIL, *Annalen*, 1922, **430**, 1; HILL, *Inaug. Diss. Frankfurt*, 1925; SCHÖPF and HIRSCH, *Annalen*, 1931, **489**, 224. (2) KNORR, *Ber.*, 1889, **22**, 185, 1113; 1894, **27**, 1144; 1904, **37**, 3494. (3) *Ibid.*, 1900, **33**, 1824. For the gradual elucidation of the chemistry of morphol and allied substances see VONGERICHTEN *et al.*, *ibid.*, 1882, **15**, 1484; 1886, **19**, 792; 1896, **29**, 65; 1897, **30**, 2439; 1898, **31**, 51, 2924, 3198; 1899, **32**, 1521; 1900, **33**, 352. (4) *Ibid.*, 1900, **33**, 1810. For later syntheses see SMITH, *J. Chem. Soc.*, 1916, **109**, 568; BARGER, *ibid.*, 1918, **113**, 218; FIESER, *J. Amer. Chem. Soc.*, 1929, **51**, 940; *Ber.*, 1931, **64**, 701. (5) VONGERICHTEN, *ibid.*, 1896, **29**, 67; 1898, **31**, 51; 1900, **33**, 352. For an improved method of preparation see MOSETTIG and MEITZNER, *J. Amer. Chem. Soc.*, 1934, **56**, 2738. (6) VONGERICHTEN and DITTMER, *Ber.*, 1906, **39**, 1718. (7) *Annalen*, 1912, **391**, 40. (8) VONGERICHTEN, *Ber.*, 1898, **31**, 3198. (9) VONGERICHTEN, *ibid.*, 1899, **32**, 1521. (10) (a) KNORR, *ibid.*, 1903, **36**, 3074; (b) *ibid.*, 1902, **35**, 4400; (c) For similar reactions with thebaine see FREUND, *ibid.*, 1895, **28**, 941; 1897, **30**, 1357; PSCHORR and HAAS, *ibid.*, 1906, **39**, 16. (11) PSCHORR (with JAECKEL and FECHT), *ibid.*, 1902, **35**, 4377; (with KARO), *ibid.*, 1906, **39**, 3124. (12) KNORR and PSCHORR, *ibid.*, 1905, **38**, 3153; PSCHORR (with HALLE), 1907, **40**, 2004; (with RETTBERG), *Annalen*, 1910, **373**, 51; (with KNOFFLER), *ibid.*, 1911, **382**, 50. (13) PSCHORR,

DICKHÄUSER and D'AVIS, *Ber.*, 1912, **45**, 2212; KNORR and HORLEIN,⁵¹ (14) FREUND and HOLTHOF, *ibid.*, 1899, **32**, 168; PSCHORR and MASSIACU, *ibid.*, 1904, **37**, 2780; GULLAND and VIRDEN, *J. Chem. Soc.*, 1928, 921. (15) KNORR, *Ber.*, 1889, **22**, 1113; (with BUTLER and HORLEIN), *Annalen*, 1909, **368**, 305. (16) KNORR, *Ber.*, 1904, **37**, 3494. (17) VONGERICHTEN, *ibid.*, 1896, **29**, 65; 1900, **33**, 352. (17a) *J. Biol. Chem.*, 1928, **80**, 403. (18) KNORR, *Ber.*, 1904, **37**, 3499. (19) KNORR, *ibid.*, 1907, **40**, 2032; (with HORLEIN), p. 3341. (20) KNORR, *ibid.*, 1904, **37**, 3494, 3499, 3507. (21) KNORR, *ibid.*, 1905, **38**, 3145 (footnote). (22) (With JAECKEL and FECHT), *ibid.*, 1902, **35**, 4377; (with KARO), 1906, **39**, 3124; (with EINBECK and SPANGENBERG), 1907, **40**, 1980, 1984, 1995, 1998; (with BUSCH), 1907, **40**, 2001. (23) Decomposition of apomorphine by Emde's method, see FALTIS and KRAUS, *Monats.*, 1921, **42**, 377. (24) *Ber.*, 1929, **62**, 321; *cf.* GULLAND and VIRDEN, *J. Chem. Soc.*, 1929, 1794. (25) *Ber.*, 1929, **62**, 325. (26) *J. Chem. Soc.*, 1913, **103**, 947. (27) *Ibid.*, 1929, 1666. (28) FREUND, MICHAELS and GOBEL, *Ber.*, 1897, **30**, 1357. (29) KNORR, *ibid.*, 1903, **36**, 3074. (30) KNORR and HORLEIN, *ibid.*, 1907, **40**, 2032. (31) FREUND and HOLTHOF, *ibid.*, 1899, **32**, 168. (32) *Ibid.*, 1904, **37**, 2780. (33) PSCHORR and LOEWEN, *Annalen*, 1910, **373**, 51. (34) PSCHORR and ZEIDLER, *ibid.*, 1910, **373**, 75. (35) *Ber.*, 1894, **27**, 2961; 1897, **30**, 1357; 1910, **43**, 631. (36) *J. Chem. Soc.*, 1928, 921. (36a) *J. Chem. Soc.*, 1945, 395; VONGERICHTEN, *Ber.*, 1901, **34**, 767. (37) HOWARD, *Ber.*, 1884, **17**, 527; FREUND and HOLTHOF, *ibid.*, 1899, **32**, 168. For preparation see al-o KLEE, *Arch. Pharm.*, 1914, **252**, 211; SCHÖPF and BORKOWSKY, *Annalen*, 1927, **458**, 148 (38) *J. Chem. Soc.*, 1928, 2083. (38a) *Ibid.*, 1929, 1444. (39) KNORR and PSCHORR, *Ber.*, 1905, **38**, 3153. (40) PSCHORR and HALLE, *ibid.*, 1907, **40**, 2004. (41) PSCHORR and REITBERG, *Annalen*, 1910, **373**, 51. (42) *Ibid.*, 1911, **382**, 50. (43) (a) FREUND and SPEYER, *Ber.*, 1916, **49**, 1287; (b) GULLAND and ROBINSON, *J. Chem. Soc.*, 1923, **123**, 130; (c) SCHÖPF and BORKOWSKY, *Annalen*, 1927, **458**, 148; *cf.* GULLAND and VIRDEN,⁵¹ (44) (a) GULLAND and ROBINSON, *Mem. Proc. Manchester Lit. Phil. Soc.*, 1924-25, **69**, 79; (b) WIELAND and KOTAKE, *Annalen*, 1925, **444**, 69. (45) KNORR, *Ber.*, 1889, **22**, 1113; 1899, **32**, 742; 1903, **36**, 3080. (46) *Ibid.*, 1903, **36**, 3068. (47) KNORR and SCHNEIDER, *ibid.*, 1906, **39**, 1414. (48) KNORR and HORLEIN, *ibid.*, 1906, **39**, 3252; *cf.* Ref. (4). (49) *Ibid.*, 1902, **35**, 4412. (49a). (With LEE), *J. Amer. Chem. Soc.*, 1947, **69**, 1996; (with LEE and MOORADIAN), *ibid.*, p. 1998; (with MANN), *ibid.*, p. 2000. (50) PSCHORR and EINBECK, *Ber.*, 1907, **40**, 1980; KNORR and HORLEIN, *ibid.*, p. 2042. (51) *Ibid.*, 1907, **40**, 3341. (52) SCHRYVER and LIES, *J. Chem. Soc.*, 1900, **77**, 1024; KNORR (with HORLEIN), *Ber.*, 1907, **40**, 376, 3341, 4883; (with WALENTIC), *idem*, p. 3860; FREUND, MELBER and SCHLESINGER, *J. pr. Chem.*, 1920, [i], **101**, 1; SPEYER and SIEBERT, *Ber.*, 1921, **54**, 1519; KONDO and OCHIAI, *ibid.*, 1930, **63**, 646. For an excellent resumé of the literature up to 1932 see "Chemistry of the Opium Alkaloids" by SMALL and LUTZ, Supplement No. 103, Public Health Reports, U.S. Govt. Printing Office, Washington, U.S.A., and for later developments the following papers by SMALL and collaborators: Deoxymorphines: SMALL (with MORRIS), *J. Amer. Chem. Soc.*, 1933, **55**, 2874; (with YUEN and EILERS, *idem*, p. 3863. Deoxycodines: (with Cohen), *ibid.*, 1931, **53**, 2214, 2227; 1932, **54**, 802; (with MOSETTIG and COHEN), *idem*, p. 793; (with LUTZ), *ibid.*, 1934, **56**, 1738, 1741; (with LUTZ and WILDER), *idem*, p. 2066; (with YUEN), *ibid.*, 1936, **58**, 192; (with FARIS and MALLONEE), *J. Org. Chem.*, 1940, **5**, 334; (with MALLONEE), *idem*, p. 350. The three stereoisomeric forms of deoxycodine-C are described by GOTO and ARAI, *Annalen*, 1941, **547**, 194. (53) (With KRUBER and AUST), *Ber.*, 1914, **47**, 2312; *cf.* SPEYER and ROSENFELD, *ibid.*, 1925, **58**, 1125. (54) WIELAND and KOTAKE, *Annalen*, 1925, **444**, 82; *cf.*, however, VON BRAUN and CAHN,⁵⁵ (55) *Ibid.*, 1926, **451**, 55. (56) *Ber.*, 1905, **38**, 3234; SMALL *et al.*, *J. Amer. Chem. Soc.*, 1935, **57**, 2651; 1936, **58**, 192, 1457; *J. Org. Chem.*, 1938-39, **3**, 204, 509; 1947, **12**, 839; Brit. Pat. 492,702; 495, 251; U.S. Pat. 2,178,010. For an explanation of these results, see ROBINSON, *Nature*, 1947, **160**, 815. (57) WIELAND and SMALL, *Annalen*, 1928, **467**, 17. (58) *Ber.*, 1916, **49**, 1287. For applications of the formulæ see *J. pr. Chem.*, 1916, [i], **94**, 135; 1920, [ii], **101**, 1; also *Ber.*, 1920, **53**, 2250; 1921, **54**, 1519, 2647, 2976; 1922, **55**, 1329; *Annalen*, 1922, **430**, 1, in which FREUND or SPEYER and collaborators deal mainly with reactions designed to test this and

KNORR's formula. (59) *Arch. Pharm.*, 1917, 255, 85; with HECZKO, *Monats.*, 1923, 43, 255; (with SUPPAN), *Pharm. Monats.*, 1923, 4, 189. (60) *J. pr. Chem.*, 1893, [ii], 47, 584. (61) *Ber.*, 1900, 33, 352. (62) *J. pr. Chem.*, 1907, [ii], 76, 428. (63) *Annalen* 1911, 382, 306. (64) *J. Chem. Soc.*, 1923, 123, 983, 998. The former paper contains a useful selected bibliography of literature on morphine, codeine and thebaine. (65) *Mem. Manchr. Lit. Phil. Soc.*, 1924-25, 69, 79; cf. SCHÖPF and BORKOWSKY, *Annalen*, 1927, 452, 249; LUTZ and SMALL, *J. Org. Chem.*, 1939, 4, 220. (66) FREUND and SPEYER, *J. pr. Chem.*, 1916, [ii], 94, 135; Ger. Pat. 286,431; E. MERCK, Ger. Pat. 411,530. (67) *J. Chem. Soc.*, 1923, 123, 1001; cf. VON BRAUN and CAHN, *Annalen*, 1926, 451, 57; SCHÖPF, *ibid.*, 1927, 452, 212; (with BORKOWSKY), *ibid.*, 1927, 458, 148; LUTZ and SMALL, *J. Amer. Chem. Soc.*, 1935, 57, 2651. (68) OLDENBURG, Ger. Pat. 260,233; SKITA and FRANCK, *Ber.*, 1911, 44, 2862; FREUND, MELBER and SCHLESINGER, *J. pr. Chem.*, 1921, 101, 1; WIELAND and KORALEK, *Annalen*, 1923, 433, 267. (69) MANNICH and LÖWENHEIM, *Arch. Pharm.*, 1920, 258, 295; FREUND *et al.*⁷⁴; SPEYER and SARRE⁷⁴; KNOLL and Co.^{75a}; MERCK and Co., D.R.P. 415,097. (70) CAHN and ROBINSON, *J. Chem. Soc.*, 1926, 908; cf. WIELAND (with KOTAKE), *Annalen*, 1925, 444, 69; *Ber.*, 1925, 58, 2009; (with GARBSCH), *ibid.*, 1926, 59, 2490. (71) *Annalen*, 1927, 452, 211; (with WINTERHALDER), p. 232; SANDERMANN, *Ber.*, 1938, 71, 648; cf. MANNICH, *Arch. Pharm.*, 1916, 254, 349. (72) SMALL and BROWNING, *J. Org. Chem.*, 1938-9, 3, 618. (73) ACH and KNORR, *Ber.*, 1903, 36, 3067; KNORR, *ibid.*, 1906, 39, 1409; (with HORLEIN), *ibid.*, 1907, 40, 4889; FREUND, 1903, 39, 844; MERCK, Ger. Pat. 408,870, 421,217. (74) FREUND, SPEYER and GUTTMANN, *Ber.*, 1920, 53, 2259. For other derivatives of codeinone and their reactions see SPEYER and SARRE, *ibid.*, 1924, 57, 1404, 1409, 1422, 1427; SPEYER and ROSENFELDT, 1925, 58, 1117. (75) GULLAND, *J. Chem. Soc.*, 1928, 703. (75a) *J. Org. Chem.*, 1947, 12, 284. (75b) KNOLL, A.G. Fabr., Ger. Pat. 365,683; 380,919; 607,931; 617,238; 623,821. (76) KNORR and HORLEIN, *Ber.*, 1907, 40, 2032, 3341. (77) *Ibid.*, 1905, 38, 3163; KNORR, *ibid.*, p. 3171. For descriptions see GULLAND and ROBINSON, *J. Chem. Soc.*, 1923, 1003; CAHN, *ibid.*, 1933, 1038; SCHÖPF and BORKOWSKY, *Annalen*, 1927, 458, 148. (78) FREUND, SPEYER and GUTTMANN, *Ber.*, 1920, 53, 2250; SKITA *et al.*, *ibid.*, 1921, 54, 1560. (79) *Annalen*, 1910, 373, 1, 15. (80) *J. Amer. Chem. Soc.*, 1934, 56, 2159. (81) The following papers deal with the constitution of "thebainone": PSCHORR, PFAFF and HERRSCHMANN, *Ber.*, 1905, 38, 3160; GULLAND and ROBINSON, *J. Chem. Soc.*, 1923, 998; CAHN, *ibid.*, 1933, 1038; KONDO and OCHIAI, *Annalen*, 1929, 470, 224; SCHÖPF (with WINTERHALDER), *ibid.*, 1927, 452, 232; (with BORKOWSKY), 1927, 458, 153; (with PFEIFER), 1930, 483, 157; (with PERREY), 1930, 483, 169; (with HIRSCH), 1931, 489, 224. For a study of the reduction products of *metathebainone* see SMALL and MEITZNER, *J. Amer. Chem. Soc.*, 1933, 55, 4602. (82) For papers on dihydrothebainone see FREUND, SPEYER and GUTTMANN, *Ber.*, 1920, 53, 2250; SKITA *et al.*, *ibid.*, 1921, 54, 1560; GULLAND and ROBINSON, *J. Chem. Soc.*, 1923, 998; SCHÖPF (with WINTERHALDER), *Annalen*, 1927, 452, 232; SMALL, FITCH and SMITH, *J. Amer. Chem. Soc.*, 1936, 58, 1457. (83) For another method of oxygen bridge formation in alkaloids of the thebainone type see KONDO and IKAWA, *Ber.*, 1932, 65, 1214. (83a) PSCHORR and EINBECK, *Ber.*, 1907, 40, 3652; FALTIS, *Monats.*, 1922, 43, 382; WIELAND and SMALL.⁵⁷ For other papers on the ozonisation of alkaloids of this group see SPEYER, *Ber.*, 1929, 62, 209; (with POPP), *ibid.*, 1926, 59, 390; (with ROELL), 1930, 63, 539; (with KOULEN), 1931, 65, 2815. (84) For the results of a study of the reduction products of α -, β -, and γ -isomorphines and of ψ -codeine and *allo*- ψ -codeine see SMALL (with LUTZ), *J. Amer. Chem. Soc.*, 1928, 50, 2466; 1932, 54, 4715; 1934, 56, 1741; 1935, 57, 361, 2651; (with FARIS), 1935, 57, 363. (84a) VONGERICHTEN, *Ber.*, 1899, 32, 3278; cf. MOSETTIG, *J. Org. Chem.*, 1940, 5, 401, and VON BRAUN and CAHN, *Annalen*, 1926, 451, 55. (b) FREUND *et al.*, *J. pr. Chem.*, 1920, 101, 1; WIELAND (with KORALEK), *Annalen*, 1923, 433, 267; (with KOTAKE), 1925, 444, 69; SPEYER and KOULEN (*ibid.*, 1924, 438, 34). (85) HOFFMAN-LA ROCHE and Co., B.P. 451,203; 454,747; U.S.P. 2,087,134. (86) GOTO and KITASATO, *Annalen*, 1930, 481, 81. For early papers relating to the chemistry of ψ -morphine see VONGERICHTEN, *ibid.*, 1896, 294, 206; 1897, 297, 213; POLSTORFF, *Ber.*, 1880, 13, 86, 93;

1886, 19, 1760; BERTRAND and MEYER, *Bull. Soc. chim.*, 1909, [iv], 5, 934; *Ann. Chim. Phys.*, 1909, [viii], 17, 501; *Compt. rend.*, 1909, 148, 1681. (87) SMALL and FARIS, *J. Amer. Chem. Soc.*, 1934, 56, 1930. (88) SMALL and LUTZ, *ibid.*, 1934, 56, 1928. (89) GOTO and OGAWA, *Annalen*, 1934, 511, 202. For other compounds of this type see *ibid.*, 1935, 515, 297; *Bull. Chem. Soc. Japan*, 1929, 4, 107; 1935, 10, 252.

Opium Alkaloids of Unknown Constitution

Papaveramine, $C_{21}H_{25}O_6N$. This alkaloid, obtained by Hesse¹ as a by-product in the purification of papaverine, crystallises in prisms, m.p. 128–9°, is a weak base and gives a bluish-violet coloration with sulphuric acid. The hydrochloride is crystalline, the acid oxalate very soluble in water, and the platinichloride, $(B \cdot HCl)_2 \cdot PtCl_4 \cdot 3H_2O$, amorphous.

Lanthopine, $C_{23}H_{25}O_4N$, was obtained by Hesse² in working out his scheme for the isolation of the minor alkaloids of opium. It crystallises in microscopic prisms, m.p. 200° (*dec.*). According to Machiguchi,³ who isolated it from Japanese opium, it has m.p. 141–5°. It is a weak base and possibly phenolic as, although precipitated from solutions of its salts by alkalis, it is soluble in excess and is again precipitated by addition of ammonium chloride. It gives no coloration with ferric chloride, and when pure its solution in sulphuric acid is colourless. The salts tend to gelatinise, but the sulphate crystallises in needles, the acid tartrate forms prisms, and the platinichloride is a crystalline powder $(B \cdot HCl)_2 \cdot PtCl_4 \cdot H_2O$.

Meconidine, $C_{21}H_{23}O_4N$. This alkaloid was prepared by Hesse² and its existence in Japanese opium was confirmed by Machiguchi.³ It is a brownish-yellow, amorphous substance, m.p. 58°, easily soluble in alcohol, most organic solvents and in alkalis. It gives a green solution with sulphuric acid. The salts are amorphous. Meconidine is said to exhibit a slight tetanising action.

REFERENCES

(1) *Jahresb.*, 1886, 1721; *J. pr. Chem.*, 1903, [ii], 68, 190. (2) *Annalen*, 1870, 153, 53; 1872, Suppl. 8, 280. (3) *J. Pharm. Soc. Japan*, 1926, No. 529, 185.

PHARMACOLOGICAL ACTION OF THE MORPHINE GROUP

A characteristic feature of the action of the opium alkaloids is their simultaneous depressing and exciting action on the central nervous system. In this respect there is no clear line of demarcation between the morphine group—morphine, codeine and thebaine—and the papaverine-narcotine group, and as the series is ascended in the order, morphine, papaverine, codeine, narcotine, thebaine, narcotic action diminishes and power of reflex stimulation increases until in thebaine a strychnine-like effect is exhibited.

Morphine. This alkaloid exerts both a depressing and a stimulating action on the central nervous system, the depression affecting the brain especially the sensation of pain and the respiration; the cerebral motor functions are less affected. The stimulant action in the cord is best seen in the cold-blooded animals, when it may develop into tonic convulsions. In higher animals, but rarely in man, there may be some indication of this stimulant action. In cats it may also involve the motor areas, and they

may show an acute maniacal condition. Horses, too, are very restive under morphine. In fish, morphine is a pure convulsant. Man is the most sensitive animal to morphine, and the depressant action is the characteristic effect. The respiration is slowed and deepened, but the respiratory volume is reduced and death is caused by respiratory arrest. The alkaloid has little direct effect on the circulation or on the peripheral muscles and nerves. The passage of food through the alimentary canal is markedly slowed. The pupil is contracted as a result of the central action of the drug until asphyxia sets in, when it becomes widely dilated. Morphine is usually fatal to man in doses of 0.2 to 0.3 gm. Continued use of the drug may lead to increased tolerance and to the danger of addiction.⁵

Numerous derivatives of morphine have been devised for use in medicine including acyl derivatives, of which diacetylmorphine ($C_{17}H_{17}O_3N$, Ac_2 , m.p. 173° , $[\alpha]_D^{25} - 166^\circ$ (MeOH); B.HCl. $2H_2O$, m.p. $231-2^\circ$) is the best known, alkyl and other ethers such as the ethyl- and benzyl-morphines, dihydro- and dihydroketo-compounds such as dihydromorphine, dihydrocodeine, dihydromorphinone, dihydrocodeinone and hydroxydihydrocodeinone, and the deoxy-compounds, *e.g.*, dihydrodeoxymorphine and methyl-dihydrodeoxymorphine.

Vahlen¹ has attributed the characteristic action of morphine to the phenanthrene group, and Bergell and Pschorr² have pointed out that whilst phenanthrene itself has no action on rabbits, the 2-, 3- and 9-hydroxyphenanthrenes cause tetanic convulsions, but no narcotic effect. Loeb and Oldenburg state that, whilst dihydromorphine and dihydrocodeine resemble the parent alkaloids in action, tetrahydrothebaine no longer causes tetanus, and they connect this property with the presence of an ethylenic linkage, supposing that dihydromorphine, but not tetrahydrothebaine, may be reoxidised in the body to the parent base.³ According to von Braun and Kindler, the special properties of morphine and codeine must be associated with the bridged hexamethylene ring, the position of the *N*-atom in relation thereto, and to a less extent the position of the alcoholic hydroxyl group.⁴

These early observations on the correlation of structure and pharmacological action in the morphine group have been greatly extended as a result of chemical, pharmacological and clinical work done under the auspices of the American National Committee on Drug Addiction. In addition to numerous papers, contributed by experts serving this Committee, to chemical and pharmacological journals, two important reports have been published:—

(1) "The Pharmacology of the Opium Alkaloids," by Krueger, Eddy and Sumwalt,⁵ which covers the period 1800 to 1942, and gives a comprehensive survey of pharmacological observations on the alkaloids of opium and their derivatives, with an exhaustive bibliography of over 10,000 titles.

(2) "Studies on Drug Addiction, with special reference to Chemical Structure of Opium Derivatives and Allied Synthetic Substances and their Physiological Action," by Small, Eddy, Mosettig and Himmelsbach.⁶

This second report deals with 125 morphine derivatives and a large number of synthetic substances. The latter have nuclei akin to that of morphine, *viz.*, phenanthrene, phenanthrylene oxide, dibenzofuran, phenanthridine or carbazole, and are provided with side-chains, whose nature and location were suggested by the results of observation of the effects of such groups in morphine. The conclusions arrived at in this notable research cannot be summarised with the brevity necessary for the present purpose, but the mode of work adopted may be illustrated by the following table of pharmacological results recorded for a few of the morphine derivatives investigated. The figures given are doses (milligrammes per kilogramme) necessary to produce the effect named at the head of the column in which they occur. These numerical estimates have the following significance :—

Toxicity. L.D/50, subcutaneously in mice.

Convulsant action. The minimal dose causing convulsions during determination of L.D/50.

General depression. The minimal dose preventing immediate righting of at least 15 out of 20 rats, thirty minutes after intraperitoneal injection.

Analgesia. Intramuscular dose necessary in 4 out of 5 cats, to require an increase of pressure on the tip of the tail to evoke a response.

Exciting effect. The minimal dose inducing signs of exciting action in at least 2 out of 5 cats.

Name of drug	Toxicity	Convulsant Action	General Depression	Analgesia	Exciting Effect	Emetic Action	Respiratory Effect
Morphine	531	531	6.75	0.75	0.57	0.22	0.15
Diacetylmorphine	262	196	1.10	0.43	0.40	(0.3 to 2.11)	0.015
Codeine	241	161	36.1	8.04	8.04	16.0+	1.3
Benzylmorphine	35	35	(a)	7.87	7.87	8.74	(b)
Dihydromorphine	133	(c)	17.7	0.26	1.77	0.17	0.11
Dihydrocodeine	225	168	14.1	7.20	6.45	3.22+	0.9
Dihydromorphinone	84	67	0.88	0.17	0.17	0.08	0.011
Dihydrocodeinone	86	47	4.2	1.28	0.86	2.56+	0.08
Hydroxydihydrocodeinone	426	426	1.34	1.34	0.89	0.89+	0.10
Dihydrodeoxymorphine-D	104	104	0.32	0.08	0.16	(d)	0.012
Dihydroxydeoxycodaine-D	131	65	2.12	1.96	1.96	0.65+	0.08
Thebaine	31	31	-	4.36	4.36	0.87+	-
Thebainone	94	71	-	-	-	-	-
Dihydrothebainone	161	124	-	-	-	-	-

(a) With 20-mgm. dose, three rats had convulsions and two died. Smaller doses did not depress the righting reflex.

(b) Doses up to 20 mgm. had no significant effect on respiratory rate or minute volume.

(c) Convulsions infrequent with fatal doses.

(d) No emetic effect up to 1.0 mgm.

Emetic action. The minimal dose causing a cat to vomit or show signs of nausea.

Respiratory effect. The minimal, effective, depressant dose as measured by Wright and Barbour's method.⁷

The objective of the Committee is to find an analgesic as effective as morphine but without the disadvantageous, secondary effects of the latter and particularly the danger of addiction, which its use involves. In 1941 the Committee issued a report⁸ on the results of their work during 1929-41, in which they call attention to two morphine derivatives in which particular features of the action of morphine have been notably modified, dihydrodeoxymorphine-D^{8(a)} (p. 254) and methyldihydromorphinone^{8(a)} (p. 246). In the latter, analgesic action is stated to have been increased more than narcotic and euphoric effects, emetic action is suppressed and there is a significant decrease in addiction liability and the rate of development of tolerance. It seems therefore that it is possible to vary selectively the individual components of the total pharmacological effect, by chemical modification of the structure of the morphine molecule. *N*-allylmorphine is an example of a large pharmacological change due to a relatively small structural modification; it is stated⁹ to retain the analgesic potency of morphine, but to be antagonistic to morphine in most other respects, such as effect on respiration and on intestinal movement.

These general results have entailed much detailed chemical and pharmacological work on the influence of structural changes on particular items in the pharmacological action of morphine, *e.g.*, its effect on respiration.¹⁰

According to Wright,¹¹ an enzyme occurs in rat, rabbit and man, which hydrolyses diacetylmorphine, the two acetoxy groups being dealt with at different rates. Some evidence was also obtained that the enzyme, which hydrolyses atropine, also catalyses hydrolysis at the 6-acetoxy group in the mono- and di-acetylmorphines. Oberst¹² states that in man diacetylmorphine is completely hydrolysed to morphine, which is excreted mainly in the conjugated form. The action of the enzyme is said to be inhibited by physostigmine¹¹ and several other observations have been made connecting the action of morphine with those (p. 549) of physostigmine, prostigmine, acetylcholine and choline-esterase. It has been found that the analgesic action of morphine is potentiated by prostigmine, especially in addicts.¹³ According to Dastugue,¹⁴ the action of acetylcholine, but not that of barium salts or of nicotine, on leech muscle is sensitised by hydroxydihydrocodeinone, which in this respect is as potent as physostigmine, though it is less potent than the latter in inhibiting the activity of choline-esterase. The sensitising action is not shown towards the action of acetylcholine on frog abdominal muscle or isolated rabbit intestine. It has also been stated that the activity of choline-esterase is inhibited by morphine,¹⁵ and by dihydromorphinone, but most strongly by dihydrodeoxymorphine-D. The degree of inactivation by codeine varies with the source of the enzyme.¹⁶

Apart from the study of drug addiction in its clinical aspects,¹⁷ much

attention has been devoted to the biological and biochemical condition of addicts,¹⁸ and a method has been devised for ascertaining what may be called the "addiction-risk" involved in the medical use of analgesics (Report,⁶ pp. 114-129). It depends on the treatment of addicts, already stabilised to morphine, by the substitution of the experimental drug for morphine, under standardised conditions of observation. In such a comparison of four morphine derivatives, dihydromorphine, dihydrodeoxymorphine-D and dihydrodeoxycodine-D are classed as giving nearly complete, and methyl dihydromorphinone incomplete, addiction satisfaction.¹⁹ The structural changes in morphine, which influence "addiction-risk," have been discussed by Himmelsbach¹⁹ (1941) and the possibility of separating euphoric, analgesic and physical dependence effects of analgesic drugs was dealt with by a symposium in 1943.²⁰

This work on the modification of the morphine molecule and its pharmacological effects has attracted a good deal of attention and several interesting interim summaries and commentaries upon it have been published.²¹

Considerable progress has also been made with the alternative line of work, the search for a synthetic analgesic as effective as morphine and without its disadvantages. The work of the American Committee has shown that it is possible to produce analgesics with a dibenzofuran or carbazole nucleus in place of the phenanthrene or phenanthrylene oxide nucleus of morphine and it is stated⁸ that synthetic products with analgesic potency equal to that of codeine have been prepared. In the 1938 report⁶ moderate analgesic potency was recorded for preparation No. 421, 9-methyl-2-(1-hydroxy-3-diethylamino)-propylcarbazole at 10 mgm. by injection.

In 1943 Dodds, Lawson and Williams,²² having in mind that stilbene derivatives, such as stilboestrol, can replace in medicine the naturally occurring oestrogens, made a similar approach to the problem of finding an effective substitute for morphine, based on $\alpha\beta$ -diphenylethylamine, $\text{Ph} \cdot \text{CHNH}_2 \cdot \text{CH}_2 \cdot \text{Ph}$, of which a series of derivatives was made and put through pharmacological tests for (a) depression of the righting reflex in rats, (b) rise in blood sugar in rabbits, and (c) effects of intramuscular injection in cats. Five preparations survived these screening tests and were tried clinically in patients suffering from pain due to malignant disease and who were receiving morphine at intervals of four hours. The drugs were administered orally in substitution for morphine; $\alpha\beta$ -diphenylethylenediamine, $\text{Ph} \cdot \text{CHNH}_2 \cdot \text{CHNH}_2 \cdot \text{Ph}$, dimethylamino-benzyl phenyl ketone, $\text{Ph} \cdot \text{CHNMe}_2 \cdot \text{CO} \cdot \text{Ph}$, and α -cyclohexyl- β -phenylethylamine, $\text{C}_6\text{H}_{11} \cdot \text{CHNH}_2 \cdot \text{CH}_2 \cdot \text{Ph}$, proved unsuccessful; $\alpha\beta$ -diphenylethylamine, in doses of 200 mgm. at intervals of three hours, relieved pain but induced mental confusion after about one hour. The most promising of the series was β -hydroxy- $\alpha\beta$ -diphenylethylamine, $\text{Ph} \cdot \text{CHOH} \cdot \text{CHNH}_2 \cdot \text{Ph}$, which gave relief of pain without ensuing mental confusion or other undesirable after effects, but further clinical investigation showed that compounds of this series only relieved pain associated with nerve pressure,

and were ineffective on pain due to inflammatory and similar conditions. Albert and Lauriat,²³ who have also conducted clinical trials with this drug suggested that its range of activity might be somewhat wider. This substance, m.p. 163°, B. HCl, m.p. 194–5°, is one of the two externally compensated forms²⁴ of β -hydroxy- $\alpha\beta$ -diphenylethylamine. The other, distinguished as the *iso*-form, m.p. 129° and B. HCl, m.p. 201–2°, is reported by McPhee and Erickson²⁵ to have no analgesic action. The latter authors have prepared a series of diphenylethylamine derivatives of which the most effective analgesics are α -phenyl- β -(3-methoxy-4-hydroxyphenyl)-ethylamine, (MeO)(OH)C₆H₃ · CH₂ · CHNH₂ · Ph, and α -phenyl- β -(4-hydroxyphenyl)- β -hydroxyethylamine, HO · C₆H₄ · CHOH · CHNH₂ · Ph. They exert a prolonged effect at peak activity whereas the effect of morphine diminishes regularly from the peak. The most interesting substance so far found in this series is amidone, 2-dimethylamino-4 : 4-diphenylheptane-5-one, CH₃ · CH(NMe₂) · CH₂ · C(Ph₂) · CO · C₂H₅, used as the hydrochloride, m.p. 231°. It was developed in Germany and is referred to in two official publications, American and British.²⁶ A sample of this material was examined by Scott and Chen,^{26(a)} who found its analgesic potency at least equal to that of morphine. Experiments in dogs showed little or no tolerance, in the addiction sense, and preliminary clinical trials in man indicated that side reactions are not excessive. The chemical reactions by which amidone and *iso*amidone,

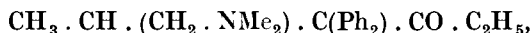

are produced, have been fully investigated by Schultz, Robb and Sprague,^{26(b)} and the pharmacological properties have been compared with those of similar analgesics by Scott, Robbins and Chen^{26(a)} and with a series of homologues and related compounds by Thorpe, Walton and Ofner.^{26(c)} The latter authors have also prepared and examined the *d*- and *l*-forms of amidone. The results indicate that in analgesic activity, taking morphine as equal to 1, *l*-amidone is 2·2, *dl*-amidone 1·3, *d*-amidone less than 0·1 and *iso*amidone, 1. In respiratory depressant activity, again with morphine as 1, *l*-amidone is 2·7 to 3·3, *dl*-amidone, 1·4 to 2·0, *d*-amidone less than 0·1 and *iso*amidone, 0·4 to 0·7.

In 1939 Eisleb and Schaumann²⁷ described the pharmacological action of ethyl 4-phenyl-1-methylpiperidine-4-carboxylate,

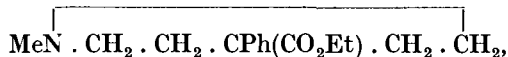

from which it appeared to resemble atropine in spasmolytic action and to be a potent analgesic. The substance has been given a variety of trivial names of which "pethidine" is in common use in Great Britain and "demerol" in the United States. It was found satisfactory in various clinical trials in Germany as a spasmolytic,²⁸ and as an analgesic,²⁹ or both.³⁰ Interest began to be shown in this drug outside Germany in spite of the war, and further pharmacological work on it was done by Duguid and Heathcote,³¹ Gruber, Hart and Gruber,^{31(a)} Yonkman, Noth and Hecht,^{31(b)} and by Way and Ligon.^{31(c)} Yonkman *et al.* also carried out a

clinical trial and found that a dose of 100 mgm., orally or intramuscularly, eight times a day in 118 patients, whose pain would have justified the use of opiates, gave complete relief in 64 per cent., partial relief in 24 per cent. and no relief in 12 per cent. of cases. The analgesic action was greater than that from 1 grain (65 mgm.) of codeine but less than that from $\frac{1}{4}$ to $\frac{1}{3}$ grain (15 to 20 mgm.) of morphine. Other evaluations of pethidine in terms of morphine have been made by Hardy, Wolff and Goodell,³² by Batterman and Himmelsbach and others.³³ Numerous clinical trials with pethidine for the relief of pain due to post-operative, pathological and other conditions have also been conducted in recent years.³⁴ The possibility of addiction arising from the use of this drug has been investigated and seems to be less than with morphine.³⁵ The increasing use of the drug has naturally led to the introduction of methods for its detection,³⁶ and its estimation,³⁷ especially in urine.³⁸ It has also stimulated interest in the synthesis of substances of this type, or developed from it, and to a smaller extent of other types sometimes based on isolated features of the Robinson morphine formula.³⁹ A further outcome of this activity is the renewed attention given to methods for the determination of the pain threshold and the effect of analgesics in raising it, as a means of evaluation for these drugs.⁴⁰

A useful review of information on pethidine has been published by Batterman and Himmelsbach,³³ and an admirable summary of information on synthetic analgesics has been provided by Morrison and Rinderknecht.^{40(a)}

Codeine (morphine methyl ether) resembles morphine in its general effect, but is less toxic and its depressant action less marked and less prolonged, whilst its stimulating action involves not only the spinal cord, but also the lower parts of the brain. In small doses in man it induces sleep, which is not so deep as that caused by morphine, and in large doses it causes restlessness and increased reflex excitability rather than sleep. The respiration is slowed less than by morphine (*cf.* table, p. 261). Cases of addiction for codeine can occur but according to Wolff they are rare.⁴¹ The best known ethers of morphine are ethylmorphine and benzylmorphine (*cf.* table, p. 261), both used to replace morphine or codeine for special purposes.

According to Eddy, as quoted by Small, the analgesic action of neopine, *neomorphine*, 6-acetyl*neomorphine* or 3 : 6-diacetyl*neomorphine* (p. 218) is definitely less than that of morphine and its corresponding analogues. The first two are about half as toxic as codeine and morphine respectively, and the second pair are more toxic than their morphine analogues. None of the four shows the Straub reaction and the convulsant action is less marked.

apoMorphine. This decomposition product of morphine shows some of the morphine effects, but the accent is much more on the excitant than on the depressant action. The medullary excitant action is the most prominent, and in susceptible animals is exercised mainly on the vomiting centre, causing emesis with its concomitant symptoms of nausea, sweating,

etc. In animals where it does not cause vomiting there are other signs of central irritation. Large doses produce convulsions. In addition to its use as an emetic, it has also been found useful in subemetic doses as a sedative in delirium tremens.

Thebaine stands at the other end of the series from morphine and is a convulsant poison rather than a narcotic (see table, p. 261). Hildebrandt⁴² states that it excites the reflexes of cold-blooded animals but in dogs it exerts a narcotic and anti-emetic effect resembling that of morphine rather than that of chloromorphide. The alkaloid is scarcely used in medicine as such, but is a primary material for the preparation of certain of the modern morphine derivatives, such as hydroxydihydrocodeinone and methyldihydromorphinone.

Comprehensive summaries of the pharmacological information available regarding codeine, *apomorphine* and *thebaine* are given in the report already referred to.⁵

Thebenine and *Morphothebaine*. Little pharmacological work seems to have been done on these two degradation products of *thebaine*, but Hildebrandt⁴² records that as compared with *thebaine*, *thebenine* is a much less potent excitant, and that in spite of its resemblance to *apomorphine*, *morphothebaine* is much weaker as an emetic. *Morphothebaine dimethyl ether* (3 : 4 : 6-trimethoxyaporphine), which is related to *bulbocapnine* and to *corydine* (pp. 306, 308), has been examined by Gunn.⁴³ Large doses in mice produce clonic convulsions, followed by central motor paralysis and death from respiratory failure. The symptoms indicate supra-spinal stimulation of the central nervous system. Small doses stimulate respiration in mammals. The alkaloid has a sympathicolytic action resembling that of *ergotoxine* in many ways but differs (a) in having no primary stimulant action on smooth muscle, (b) in paralyzing more readily the peripheral, cardio-accelerator mechanism in the heart, (c) in causing adrenaline-reversal of blood pressure and of action on the uterus of the rabbit but not of the cat, and (d) having a very transient action in the intact animal. The L.D.50 for mice by intraperitoneal injection is 0.11 gm./kilo.

isoThebaine. According to Konson and Saksonov,⁴⁴ this alkaloid stimulates, and later depresses, the central nervous system. Subcutaneous injection induces emesis in dogs and cats. Intravenous injections cause transitory vaso-dilation with inhibited or halted respiration. It raises the tonus and lowers the amplitude of contraction of mouse intestine at a concentration of not less than 40 parts per million.

REFERENCES

- (1) *Arch. exp. Path. Pharm.*, 1902, 47, 368.
- (2) *Zeit. physiol. Chem.*, 1903, 38, 16.
- (3) *Verh. Ges. Deut. Nat. Ärzte*, 1912, [ii], 2, 481.
- (4) *Ber.*, 1916, 49, 2655.
- (5) Supplement No. 165 to *Public Health Reports*, 1943, Washington, U.S.A.
- (6) Supplement No. 138 to *Public Health Reports*, 1938, Washington, U.S.A.
- (7) *J. Pharm. exp. Ther.*, 1937, 61, 422.
- (8) National Research Council, U.S.A. Report of Committee on Drug Addiction, 1929-41 and Collected Reprints.
- (8a) *J. Amer. Med. Assoc.*, 1947, 134, 291; EDDY, *J. Amer. Pharm. Assoc. Pract. Pharm. Edit.*, 1947, 8, 430. For

a clinical study of methyl dihydromorphinone see L. E. LEE, *J. Pharm. exp. Ther.*, 1942, 75, 161, and for pharmacology of dihydrodeoxymorphine-D see Ströckli and Fromherz, *Helv. Physiol. Pharm. Acta*, 1945, 3, 335. (9) ROSS HART, *J. Pharm. exp. Ther.*, 1941, 72, 19; (with McCawley), *ibid.*, 1944, 82, 339; UNNA, *ibid.*, 1943, 79, 27; MAYER and McCawley, *Fed. Proc.*, 1945, 4, 129. For chemical data see VON BRAUN *et al.*, *Ber.*, 1914, 47, 231?; 1916, 49, 750; McCawley, HART and MARSH, *J. Amer. Chem. Soc.*, 1941, 63, 314; WEIJLARD and ERICKSON, *ibid.*, 1942, 64, 869. (10) SUMWALT *et al.*, *J. Pharm. exp. Ther.*, 1941, 73, 229, 246, 258, 274; see also OELKERS, *Arch. exp. Path. Pharm.*, 1940, 194, 296. (11) *Science*, 1940, 92, 244; *J. Pharm. exp. Ther.*, 194?, 75, 328; 1946, 87, 109; MASSART and DUFAYT, *Naturwissenschaften*, 1941, 29, 572. (12) OBERST, *J. Pharm. exp. Ther.*, 1943, 79, 266; also *ibid.*, 1941, 73, 401; 1942, 74, 37 and BERNHEIM and BERNHEIM, *ibid.*, 1944, 81, 374; 1945, 83, 85. (13) SLAUGHTER (with PARSONS and MUNAL), *J. Amer. Med. Assoc.*, 1940, 115, 2058; (with TREADWELL and GALES), *J. Lab. Clin. Med.*, 1943, 28, 1199; ANDREWS, *J. Amer. Med. Assoc.*, 1942, 120, 525; cf. CHIU and CHOU, *Proc. Chin. Physiol. Soc.*, 1943, 1, 125; HIMMELSBACH *et al.*, *J. Pharm. exp. Ther.*, 1942, 76, 50. (14) *C. R. Soc. Biol.*, 1940, 133, 646; (with DODEL and BRESSON), *ibid.*, p. 429; (with GANDOUR), *ibid.*, p. 595. (15) EADIE, *J. Biol. Chem.*, 1941, 138, 597. (16) WRIGHT, *J. Pharm. exp. Ther.*, 1941, 72, 45. (17) See, for example, WILLIAMS, OBERST and BROWN, *U.S. Public Health Reports*, 1946, 61, 1, 37. (18) See, for example, WILLIAMS, *J. Pharm. exp. Ther.*, 1939, 67, 290; HIMMELSBACH, *ibid.*, 1941, 73, 91; ANDREWS and HIMMELSBACH, *ibid.*, 1944, 81, 288; ANDREWS, *Psychosom. Med.*, 1942, 16, 451. (19) HIMMELSBACH, *J. Pharm. exp. Ther.*, 1939, 67, 239; 1941, 71, 42. (20) OBERST, REICHHARD, LEE, CLARK and HIMMELSBACH, *Fed. Proc.*, 1943, 2, 187, 188, 191, 195, 201; see also EDDY, *Amer. J. Med. Sci.*, 1939, 197, 461; and for papers on other special aspects of addiction, HIMMELSBACH, *J. Pharm. exp. Ther.*, 1940, 70, 293; (with ANDREWS), *ibid.*, 1943, 77, 17; 1944, 81, 288; ANDREWS, *J. Clin. Invest.*, 1943, 22, 511, 517. (21) EDDY²⁰; Elit, *J. Amer. Med. Assoc.*, 1941, 117, 453; DODDS, (1946)²²; REGNIER, *Chimiothérapie*, p. 59, Masson *et cie.*, Paris, 1942; TIFENEAU, *Paris Médical*, 1935, p. 59; FOURNEAU, *Chim. et Ind.*, 1938, 39, 1043. (22) *Nature*, 1943, 151, 614; 1944, 154, 514; *Proc. Roy. Soc.*, 1944, B, 132, 119; DODDS, *Brit. Med. Bull.*, 1946, 4, 88; DOWNMAN, *Brit. J. Pharmacol.*, 1947, 2, 207. (23) *Nature*, 1946, 158, 202. (24) READ and STEELE, *J. Chem. Soc.*, 1927, 910. (25) *J. Amer. Chem. Soc.*, 1946, 68, 624. (26) U.S.A. Dept. of Commerce Report, P.B. 981, p. 96-A; B.I.O.S. Final Rept., No. 116, Item 24, pp. 51, 52, 65. (a) *J. Pharm. Exp. Ther.*, 1946, 87, 63; (with ROBBINS), *Science*, 1946, 104, 587. (b) *J. Amer. Chem. Soc.*, 1947, 69, 188, 2454; see also BRODE and HILL, *ibid.*, 1947, 69, 724; *J. Org. Chem.*, 1948, 13, 191; and EASTON, GARDNER and STEVENS, *ibid.*, p. 976, 2941; (with EVANICK), 1948, 70, 76. (c) *Nature*, 1947, 159, 679; 160, 635. (27) *Deut. Med. Woch.*, 1939, 65, 967; SCHLAUMANN, *Arch. exp. Path. Pharm.*, 1940, 196, 104; EISLEB, *Ber.*, 1941, 74, 1433. (28) DIETRICH, *Deut. Med. Woch.*, 1939, 65, 969; KLEIN, *Munch. Med. Woch.*, 1939, 86, 1674. (29) ROSENTHAL, *ibid.*, p. 1079. (30) SCHÄFER, *Deut. Med. Woch.*, 1939, 65, 970. (31) *Quart. J. Pharm.*, 1940, 13, 318; (a) *J. Pharm. exp. Ther.*, 1941, 73, 319; (b) *Ann. int. Med.*, 1944, 21, 7, 17; (c) *J. Amer. Pharm. Assoc.*, 1946, 35, 113; see also BATTERMAN, *Arch. int. Med.*, 1943, 71, 345, and CLARK.²⁰ (32) *J. Clin. Invest.*, 1940, 19, 649, 659. (33) *J. Amer. Med. Assoc.*, 1943, 122, 222; WOOLFE and MACDONALD, *J. Pharm. exp. Ther.*, 1944, 80, 300; CHRISTIE, *Lancet*, 1943, 244, 294. (34) For example, pain arising from pathological conditions: BRANWOOD, *Edin. Med. J.*, 1943, 50, 177; CLIMENKO and BERG, *J. Urol.*, 1943, 59, 255. Post-operative pain: BATTERMAN, *Arch. int. Med.*, 1943, 71, 345; (with MULHOLLAND), *Arch. Surg. Chicago*, 1943, 46, 404. Obstetric pains: GALLEN and PRESCOTT, *Brit. Med. J.*, 1944, i, 176; SNITZER, *ibid.*, p. 179; HORI, *Can. Med. Assoc. J.*, 1944, 51, 509; BARNES, *Brit. Med. J.*, 1947, i, 437. War injuries: CHRISTIE.³³ Neurological cases: FITZGERALD and MCARDLE, *Lancet*, 1943, 244, 296. (35) HIMMELSBACH, *J. Pharm. exp. Ther.*, 1942, 75, 64; 1943, 79, 5; ANDREWS, *ibid.*, 1942, 75, 338; 1942, 76, 89; POLONIO, *Lancet*, 1946, 252, 292. (36) KEENAN, *J. Amer. Pharm. Assoc.*, 1946, 35, 338. (37) MILOS, *Amer. J. Pharm.*, 1945, 117, 343; MUNDELL, *J. Assoc. Off. Agr. Chem.*,

1945, 28, 71. (38) LEHMAN and AITKEN, *J. Lab. Clin. Med.*, 1943, 28, 787; OBERST, *J. Pharmacol. exp. Ther.*, 1943, 79, 10. (39) See, for example, (a) JENSEN and LINDQUIST, *Dansk. Tids. Farm.*, 1943, 17, 173; (b) BERGEL, MORRISON and RINDERKNECHT, *J. Chem. Soc.*, 1944, 265, 267; (with HAWORTH), p. 261; (with HINDLEY), p. 269; (with MACDONALD and WOOLFE), *Brit. J. Pharmacol.*, 1946, 1, 4; GLAZEBROOK and BRANWOOD, *Lancet*, 1945, 249, 528; (c) WALTON and GREEN, *J. Chem. Soc.*, 1945, 315; (d) COOK and REID, *ibid.*, p. 399; BARR and COOK, *ibid.*, p. 438; ANKER, COOK and HEILBRON, *ibid.*, p. 917; ANKER and COOK, 1946, 58; BADGER, COOK and WALKER, *Chem. and Ind.*, 1948, 155; (e) BARLTROP, *J. Chem. Soc.*, 1946, 958; HORNING, *et al.*, *J. Amer. Chem. Soc.*, 1947, 69, 2929; (f) KOELSCH, *J. Amer. Chem. Soc.*, 1943, 65, 2093, 2458-2465. (40) WOLFF *et al.*³²; (with SCHUMACHER), *Science*, 1940, 92, 110; ANDREWS, *J. Clin. Invest.*, 1943, 22, 517; (with WORKMAN), *J. Pharm. exp. Ther.*, 1941, 73, 99; WOOLFE and MACDONALD³³; GLAZEBROOK *et al.*^{39(b)}; DODDS, LAWSON, SIMPSON and WILLIAMS, *J. Physiol.*, 1945, 104, 47; ERCOLI and LEWIS, *J. Pharm. exp. Ther.*, 1945, 84, 301; THORP, *Brit. J. Pharmacol.*, 1946, 1, 113; DAVIES, RAVENTOS and WALPOLE, *ibid.*, p. 255; TOFT, *Acta Pharmacol.*, 1946, 2, 149. (40a) *Jubilee Vol. Dr. E. C. Barends*, 1946, p. 252 (Hoffmann La Roche, Basle); *see also*, LEE, BERGER, ZIERING and HEINEMANN, *ibid.*, p. 264, and *J. Org. Chem.* 1947, 12, 885, 894, 904; FOSTER and CARMAN, *J. Pharm. exp. Ther.*, 1947, 91, 195. (41) *Bull. Health Organisation League of Nations*, 1938, VII, 546. (42) *Arch. exp. Path. Pharm.*, 1911, 65, 54; (with HARNACK), *ibid.*, 1909, 61, 343. (43) *J. Physiol.*, 1941, 100, 64. (44) *Farmakol. i. Toksikol.*, 1946, 9, 14.

ALKALOIDS OF *Sinomenium acutum* Rehd. and Wils. Although this Japanese plant belongs to the Menispermaceæ, it is convenient to deal with it here because its principal alkaloids, sinomenine and disinomenine, belong to the morphine sub-group. Of the other four alkaloids present, *tuduranine* is related to morphothebaine and *isothebaine* and comes into this section in which are also included the two alkaloids of unknown constitution, *acutumine* and *diversine*. The sixth alkaloid, *sinactine*, is *l*-tetrahydrocypiberberine, and is described along with its chemical relatives (p. 338). *Sinomenium acutum* thus contains alkaloids belonging to three different groups, and is typical of the botanical family Menispermaceæ, which includes the alkaloid-bearing genera *Anamirta* (p. 349), *Archangelisia* (p. 329), *Chondrodendron* (p. 363), *Cissampelos* (p. 363), *Cocculus* (p. 350), *Coscium* (p. 329), *Jatrorrhiza* (p. 329), *Menispermium* (p. 350), *Stephania* (p. 361), *Tiliacora* (p. 350) and *Tinospora* (p. 329).

Sinomenine, C₁₉H₂₃O₄N. This alkaloid, first isolated by Ishiwari,¹ has been investigated by Kondo² and by Goto.³ It crystallises in stellate groups of needles and has two melting-points, 161° and 182°. The specific rotation $[\alpha]_D^{26}$ is -70.76° (EtOH). The hydrochloride, B. HCl . 2H₂O, decomposes at 231° and has $[\alpha]_D^{17.7}$ -82.4° (dry salt : H₂O); the aurichloride is amorphous. The alkaloid contains two methoxyl groups and one methylimino-group; it is soluble in alkalis, gives a greenish-blue colour with ferric chloride and forms a monobenzoyl derivative (prisms, m.p. 225°) and a monomethyl ether (needles, m.p. 175°), so that the third oxygen atom is present as a phenolic hydroxyl group. The fourth oxygen is in a carbonyl group (oxime, m.p. 254° (*dec.*); semicarbazone, m.p. 264° (*dec.*)). On catalytic hydrogenation the base is converted into dihydro-sinomenine, C₁₉H₂₅O₄N (needles, m.p. 199°; $[\alpha]_D^{16}$ +170.5°). On distillation with zinc dust, phenanthrene and trimethylamine are produced, and,

according to Goto,³ dibenzoylsinomenol, $C_{30}H_{22}O_6$, m.p. 206° , is formed when the base is heated with benzoic anhydride. When heated with potassium hydroxide solution (66 per cent.), sinomenine yields sinomenol, m.p. 176° , which was at first thought to be 3 : 4-dihydroxy-5 : 6-dimethoxyphenanthrene. On degradation by the Hofmann method, sinomenine methiodide (prisms, m.p. 251°) yields a substance believed to be 3 : 5 : 6-trimethoxy-4-keto-1-vinylphenanthrene, m.p. 310° . These results were expressed by Goto in formula (I) for sinomenine, the nucleus of which is similar to that proposed by Ochiai² (1924). In the same year Kondo and Ochiai⁴ showed that sinomenine and dihydrosinomenine, on reduction with zinc-alumag and hydrochloric acid, were converted into deoxytetrahydrosinomenine, $C_{18}H_{25}O_2N \cdot 0.5H_2O$ (m.p. $150-1^\circ$, $[\alpha]_D^{21} + 48.2^\circ$; B. HI, m.p. $250-1^\circ$), which resembled dihydrothebacoine, prepared by Speyer and Sicbert⁵ by electrolytic reduction of thebainone and for which the following constants are recorded: m.p. $150-1^\circ$, $[\alpha]_D^{24} - 47.22^\circ$, B. HI, m.p. $250-1^\circ$. This substance is now better known as tetrahydrodeoxycodine (p. 253)⁶ and is represented by formula (II). Deoxytetrahydrosinomenine is, therefore, to be regarded as *d*-tetrahydrodeoxycodine.

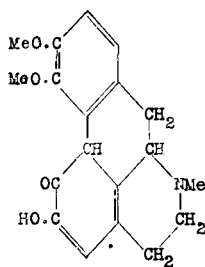

(I) Sinomenine (Goto, 1926)

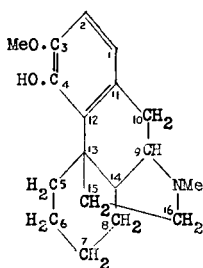

(II)

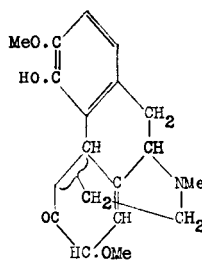

(III) Sinomenine (Kondo 1929)

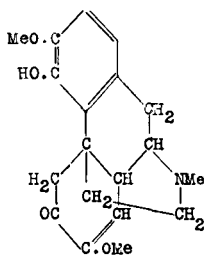

(IV) Sinomenine (Goto 1929)

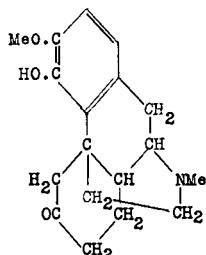

(V)

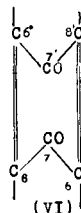

(VI)

The ease with which one methoxyl group is lost in this reduction was at first explained by assuming carbon atom 5 as its point of attachment, but in the following year the same authors⁷ prepared by Pschorr's method 3 : 4 : 6 : 7-tetramethoxyphenanthrene, colourless prisms, m.p. $124-5^\circ$, which proved to be identical with Goto's dimethylsinomenol, and on this

basis the labile methoxyl group was placed at C⁷, the rest of the structure of ring III being left open pending determination of the character of this ring in thebainone, sinomenine being regarded as the *l*-form of a hypothetical *d*-7-methoxythebainone. In a later paper² the same authors still leave open the question of the attachment of the carbon end of the ethanamine chain at C⁵ (Knorr) or C¹³ (Gulland and Robinson), but suggest C⁸-C¹⁴ as the position of the ethylenic linkage (formula III) (instead of the bridge, C¹⁵-C⁸, adopted originally) on the ground that sinomenine has none of the properties of an enolic methyl ether. The similarity of the colour reactions of sinomenine and thebainone, *viz.*, blue with ammoniacal silver solution in acetone and purple (soluble in chloroform) with alkaline solution of potassium ferricyanide, led Goto⁸ to accept this representation of sinomenine in principle, but he preferred to place the ethylenic linkage at C⁷-C⁸, and accepted linkage of C¹⁵-C¹³ for the ethanamine chain (formula IV), which brings the representation of sinomenine into harmony with the current view⁹ of the constitution of thebainone (p. 248).

Since then numerous papers have been published¹⁰ dealing with the reactions of sinomenine and its derivatives, especially by Goto and his collaborators,¹⁰ and the results have disclosed no necessity for the modification of formula (IV). Goto and Sudzuki¹¹ found that, on reduction with sodium amalgam, dihydrosinomenine yields the *d*-form (m.p. 138°, $[\alpha]_D + 59.17^\circ$; semicarbazone, m.p. 235°) of dihydrothebainone¹² (formula V). In this reaction the methoxyl group at 7 is again eliminated, and if the reduction of dihydrosinomenine is effected by the Clemmensen method, the carbonyl group is also removed with the formation of tetrahydrodeoxycodine (II). Goto, Takubo and Mitsui¹⁰ (1931) showed that by the Schöpf and Pfeifer¹⁰ process, *d*-dihydrothebainone, in parallel with the behaviour of its *laxo*-isomeride (p. 250), could be converted into *d*-1-bromodihydrocodeinone, m.p. 206°, $[\alpha]_D^{25} + 161^\circ$ (CHCl₃). The latter on catalytic hydrogenation gave *d*-dihydrocodeinone, m.p. 153°, $[\alpha]_D^{20} + 207.4^\circ$ (CHCl₃), which Goto and Arai¹⁰ (1941) showed could be hydrogenated, in pyridine solution in presence of platinum oxide, to (+) dihydrocodeine, C₁₈H₂₃O₃N, 2H₂O, m.p. 87-8° or 110° (*dry*), $[\alpha]_D^{30} + 146.4^\circ$ (EtOH) and this in turn demethylated to (+) dihydromorphine, m.p. 158-9°, $[\alpha]_D + 151.5^\circ$ (EtOH) giving a hydriodide, m.p. 285°, $[\alpha]_D + 87.9^\circ$ (H₂O).

When sinomenine is heated with hydrochloric acid and the product treated with ammonia solution, *bis*-demethylsinomenylidene, (C₁₈H₂₁O₃N)₂, is formed,¹¹ which crystallises from chloroform, has m.p. > 312°, $[\alpha]_D^{17} + 335.5^\circ$, contains two methoxyl groups and two carbonyl groups (dioxime, m.p. > 315°) and is represented by partial formula (VI), in which it is assumed that the enolic methyl ether group at 7 has been hydrolysed to a carbonyl group, and junction between two residual molecules, effected by two ethylenic linkages formed in each case between the carbonyl group at C⁶ of one residual molecule and the methylene group at C⁸ of the other. In this reaction an intermediate product sinomenine hydrate,¹³ C₁₉H₂₅O₅N (prisms, m.p. 139° or 160°, $[\alpha]_D + 40.8^\circ$), is formed and can be isolated if

the base is liberated with sodium carbonate solution instead of ammonia solution. In the formation of the hydrate the $\dot{C}-OCH_3=CH$ at 7-8 (formula IV) is assumed to pass into $-C(OH)(OCH_3)-CH_2-$. In other cases hydrolysis of the $=\dot{C}-OMe$ group at 7 to a carbonyl group takes place on heating with 2*N*-hydrochloric acid, without formation of a hydrate or subsequent condensation of two residual molecules: thus 1-bromosinomenine is so converted into 1-bromosinomeninone¹⁴ (formula IV, $=\dot{C}(OMe)$ at 7 becoming $-CO-$), which crystallises from chloroform in prisms, m.p. 227°, $[\alpha]_D + 54.52^\circ$, and yields a dioxime, m.p. 189°. Methylsinomenine in like manner furnishes methylsinomeninone,¹⁵ $C_{19}H_{23}O_4N$, m.p. 188°, $[\alpha]_D + 18.65^\circ$. In the other papers quoted¹⁰ examples will be found of degradation of sinomenine derivatives by acetylation or exhaustive methylation and of interconversions between derivatives of codeinone, thebainone and sinomenine.

Abstracts of a series of papers by Goto *et al.*,¹⁰ published in Japan in 1942-44, have become available recently in this country. They deal with the preparation of 7-hydroxycodeinone, 7-hydroxydihydrothebainol and the corresponding (+) derivatives from sinomenine, but chiefly with the reactions of 1-bromosinomenine and its derivatives.

Disinomenine ($C_{19}H_{22}O_4N$)₂ · 2CH₃OH. When sinomenine is gently oxidised it is converted into two bimolecular substances, disinomenine and ψ -disinomenine, of which the former, but not the latter, occurs in *Sinomenium acutum*. Its isolation as "dehydrosinomenine," $C_{19}H_{21}O_4N$, was described by Goto.³ The chief characters of these two bases are as follows:

	Disinomenine.	ψ -Disinomenine.
Melting point	222°	227°
Decomposing point	245°	243°
Crystalline form	Plates	Slender needles
Melting point of hydrochloride	>290°	>290°
Decomposing point of methiodide	263°	268°
Oxime, m.p.	265° (<i>dec.</i>)	>290°
Semicarbazone, m.p.	>290°	>290°
Specific rotation, $[\alpha]_D$	+ 149.8°	- 127.03°
Colour with HCHO-H ₂ SO ₄	Pink	Yellow

The mixture of bases is best obtained by mixing solutions of sinomenine hydrochloride and potassium ferricyanide and adding solution of sodium carbonate. The precipitate is collected, washed with water and dissolved in dilute hydrochloric acid. The mixed hydrochlorides, which crystallise out, are separated by repeated crystallisation from water, the ψ -sinomenine hydrochloride remaining in the mother liquors.

When heated with acetic anhydride in closed vessels at 180°, either base yields in addition to methylethylamine the same tetracetyl-disinomenol, $C_{40}H_{34}O_{12}$, m.p. 253°, from which disinomenol, m.p. >310°, is readily obtained by hydrolysis.¹⁶

Disinomenol is also produced when sinomenol (p. 269) is boiled with a

66 per cent. solution of potassium hydroxide.¹⁷ This similarity in behaviour of the two bimolecular alkaloids is not complete, thus on catalytic hydrogenation they yield distinct tetrahydro-derivatives, which in both cases are dextrorotatory, though ψ -disinomenine itself is lævorotatory and is derived from the lævorotatory alkaloid sinomenine.¹⁸

It is assumed that these alkaloids are formed by junction at C¹, that is, in the *para*-position to the hydroxyl group in ring I, because (1) the diazo-reaction in the two bimolecular alkaloids is much less intense than with sinomenine, and (2) neither of the monobromosinomenines, in which the bromine atom is assumed to be at C¹, can be oxidised to a bimolecular

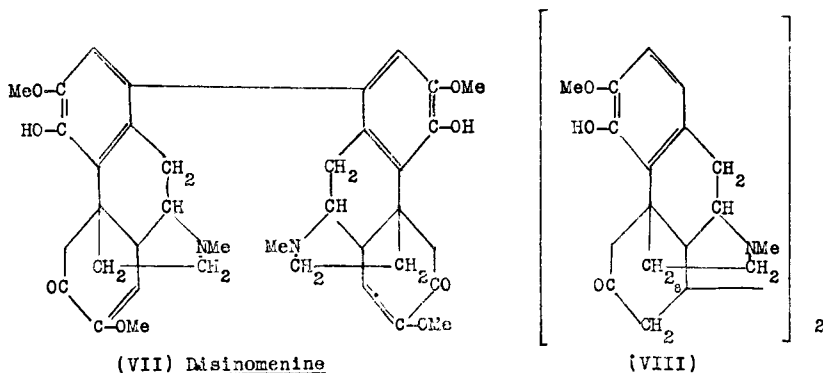

base.¹⁹ Formula (VII) was, therefore, assigned to disinomenine, and it was suggested that in ψ -disinomenine there is probably a different mode of linkage of the ethanamine chain.¹⁷ Mention has been made already of a bimolecular alkaloid of a different type, *viz.*, *bis*-demethylsinomenylidene (p. 270) (partial formula VI), obtainable from sinomenine. A third type is produced by the action of sodium amalgam on sinomenine in dilute sodium hydroxide solution. The substance obtained has the formula $(C_{18}H_{22}O_3N)_2$, m.p. 304°, $[\alpha]_D - 24.45^\circ$, crystallises from alcohol in stout prisms, contains only two methoxyl groups, yields a disemicarbazone, gives a diazo-reaction as intense as that with sinomenine, and resembles sinomenine in its colour reactions with ferric chloride, alkaline potassium ferricyanide and formaldehyde-sulphuric acid. These properties seem to preclude junction in the 1:1'-position, and it is assumed that junction takes place at the 8:8'-position, and the substance is represented as *bis*-8:8'-demethoxydihydrosinomenine (VIII).²⁰ Similar studies have been made of other bimolecular alkaloids of this series, *e.g.*, ψ -morphine (p. 255), dithebaione²¹ (p. 256), *l*- and *d*-*bis*-1:1'-thebenone, 1:1'-dithebaol,²² *l*- and *d*-*bis*-1:1'- β -tetrahydrodeoxycodine.²³ Another type of bimolecular alkaloid of this series, is the 7:7'-methylene*bis*dihydrocodeinone obtained by Rapoport and Small by the action of formaldehyde and dimethylamine on dihydrocodeinone.^{23(a)}

Sinactine, $C_{20}H_{21}O_4N$. See *l*-Tetrahydroepiberberine, p. 338.

Acutumine, $C_{20(21)}H_{27}O_6N$. This base, isolated by Goto and Sudzuki,

crystallises in needles, m.p. 240°, and gives a hydrochloride, $[\alpha]_D + 60 \cdot 2^\circ$, and an aurichloride, m.p. 199–200°. It contains one carbonyl group (semicarbazone, m.p. >290°), probably one carboxyl group, three methoxyl groups, no phenolic hydroxyl group and one methylimino-group. Its absorption spectrum resembles that of narceine.²⁴

Diversine, $C_{20}H_{27}O_5N$ (*Parasinomenine*). This base was obtained by Kondo, Ochiai and Nakajima²⁵ as an amorphous, yellow substance, m.p. 80–93°, $[\alpha]_D^{17^\circ} + 6 \cdot 98^\circ$. It reduces solutions of gold or silver salts. The hydrochloride is amorphous, m.p. 135–140° (*dec.*), as is also the methiodide. The alkaloid contains two methoxyl groups and one methylimino-group, and with benzoic anhydride yields a mixture of mono- and dibenzoyl derivatives. For another diversine, see p. 350.

Tuduranine, $C_{18}H_{19}O_3N$. This member of the aporphine group (p. 306) is the most recent addition to Sinomenium alkaloids and was isolated by Goto²⁶ from the mother liquors of sinomenine. It is crystalline, has m.p. 125° (with softening at 105°), and yields a sparingly soluble hydrochloride, m.p. 286° (*dec.*), $[\alpha]_D^{14 \cdot 5} - 148^\circ$ (dilute MeOH), is freely soluble in alkali, and gives feeble ferric chloride and diazo-colour reactions and a fuchsin-red colour with formaldehyde and sulphuric acid. It behaves as a secondary base and yields a diacetyl derivative, m.p. 170°, $[\alpha]_D^{14^\circ} - 321 \cdot 71^\circ$ (MeOH), which does not form a methiodide, but can be hydrolysed to *N*-acetyl-tuduranine, m.p. 277°, $[\alpha]_D^{18^\circ} - 395 \cdot 24^\circ$, and this can be methylated to *N*-acetyltuduranine methyl ether, m.p. 189°, $[\alpha]_D^{18^\circ} - 400 \cdot 17^\circ$ ($CHCl_3$). With methyl iodide in methyl alcohol, tuduranine is converted into *N*-methyltuduranine methiodide, m.p. 224°. The absorption spectrum of the alkaloid resembles that of morphothcbaine dimethyl ether (p. 231). On degradation by the Hofmann process tuduranine yields a trimethoxyvinylphenanthrene, m.p. 93·5°, or when ethyl iodide is employed a dimethoxyethoxyvinylphenanthrene, m.p. 148°, later corrected to 108°. Goto, Inaba and Nozaki have synthesised 3 : 5 : 6-trimethoxyaporphine, and shown that the *l*-form is identical with *N*-methyltuduranine methyl ether, m.p. 108°, $[\alpha]_D^{12^\circ} - 136 \cdot 9^\circ$ (MeOH).²⁷

Later Goto and Shishido²⁸ prepared *dl*-3-ethoxy-5 : 6-dimethoxy-*N*-ethylnoraporphine ethiodide, m.p. 186–7°, and this, by the Hofmann degradation process, gave the ethiodide of the *de-N*-ethyl base, m.p. 194°, from which the dimethoxyethoxyvinylphenanthrene, m.p. 108°, was obtained, identical with that from natural *l*-tuduranine. The latter is therefore 3-hydroxy-5 : 6-dimethoxy-*N*-noraporphine. A later paper²⁸ (1941) also relating to tuduranine is not yet accessible.

Pharmacology. A good deal of attention has been given in Japan to the pharmacological examination of sinomenine and its derivatives. According to Goto and Takebe, the dextrorotatory derivatives of sinomenine are convulsive poisons, and show neither the sedative nor the analgesic action characteristic of *l*-morphine derivatives. Sinomenine produces in frogs, mice and rabbits increased reflex excitability and respiratory paralysis. In dogs and mice these symptoms are accompanied by a vasodilatation observable in the vessels of the skin and mucosæ. Small

doses stimulate, larger doses stimulate and then paralyse the plain muscle of the intestine and uterus. According to Takaori, diversine has a similar action to sinomenine, but is more toxic. The effects of sinomenine and parasinomenine (diversine) on various aspects of metabolism have been compared with those of quinine, another protoplasmic poison and found, as a rule, to be less active.²⁹

REFERENCES

- (1) *Chem. Soc. Abstr.*, 1921, i, 354. (2) KONDO and OCHIAI, *Annalen*, 1929, 470, 224. (This summarises and extends six papers in *J. Pharm. Soc. Japan*, 1923, No. 497, 511; 1924, No. 503, 8; 1926, No. 538, 1008; 1927, No. 539, 17; 1928, No. 549, 914, 923; cf. TAKAORI, *Deut. med. Woch.*, 1936, 62, 1635.) (3) *Proc. Imp. Acad. Tokyo*, 1926, 2, 7, 167, 414; cf. OCHIAI, *J. Pharm. Soc. Japan*, 1924, No. 503, 8; for similar degradations by acetic anhydride see GOTO, SHISHIDO and TAKUBO, *Annalen*, 1932, 497, 289; GOTO, IIDA and SHISHIDO, *Bull. Chem. Soc. Japan*, 1933, 8, 366. (4) *J. Pharm. Soc. Japan*, 1926, No. 538, 1008; 1929, 49, 556; *Ber.*, 1930, 63, 646; cf. GOTO and MITSUI, *Bull. Chem. Soc. Japan*, 1931, 6, 33. (5) *Ber.*, 1921, 54, 1519. (6) SMALL and COHEN, *J. Amer. Chem. Soc.*, 1931, 53, 2227. (7) *J. Pharm. Soc. Japan*, 1927, No. 539, 17; No. 549, 913, 923. The synthesis was confirmed by GOTO and SUDZUKI, *Bull. Chem. Soc. Japan*, 1929, 4, 163; see also GOTO and SHISHIDO, *ibid.*, 1941, 16, 170. (8) *Ibid.*, 1929, 4, 103; (with SUDZUKI), *ibid.*, p. 244. (9) SCHÖPF and HIRSCH, *Annalen*, 1931, 489, 224. (10) *Bull. Chem. Soc. Japan*, 1929, 4, 195; 1930, 5, 73, 93, 165, 223, 282, 311, 315; 1931, 6, 33, 79, 126, 197, 229; 1932, 7, 273; 1933, 8, 366; 1935, 10, 481, 597; 1942, 17, 113, 304, 393, 439; 1943, 18, 116, 143, 218; 1944, 19, 140; *Ber.*, 1930, 63, 2696; *Annalen*, 1931, 485, 247; 489, 86; 1932, 494, 1; 495, 122; 497, 289; 499, 169; 1933, 501, 304; 503, 277; 507, 296; 1941, 547, 194; see also SCHÖPF and PFLEGER, *ibid.*, 1930, 483, 157; (with HIRSCH), 1932, 492, 213; and OCHIAI and HAKOZAKI, *J. Pharm. Soc. Japan*, 1930, 50, 360. (11) *Bull. Chem. Soc. Japan*, 1929, 4, 244. The results of a sodium amalgam reduction of sinomenine are much more complicated than is here implied, see KONDO and OCHIAI, *J. Pharm. Soc. Japan*, 1926, No. 538, 1008; OCHIAI, *ibid.*, 1929, 49, 556; (with HAKOZAKI), *ibid.*, 1930, 50, 360; GOTO and MITSUI, *Bull. Chem. Soc. Japan*, 1930, 5, 287; GOTO and SHISHIDO, *ibid.*, 1935, 10, 599. (12) FREUND, SPEYER and GUTTMANN, *Ber.*, 1920, 53, 2250. (13) GOTO and SUDZUKI, *Bull. Chem. Soc. Japan*, 1929, 4, 271; GOTO and NAMBO, *ibid.*, 1930, 5, 168. (14) GOTO and NAMBO, *ibid.*, 1930, 5, 73. (15) GOTO, NAMBO and INABA, *ibid.*, p. 223. (16) GOTO and SUDZUKI, *ibid.*, 1929, 4, 107; cf. KONDO and OCHIAI, *J. Pharm. Soc. Japan*, 1927, No. 549, 124. (17) GOTO, *Proc. Imp. Acad. Tokyo*, 1926, 2, 414; see also GOTO and TAKUBO, *Bull. Chem. Soc. Japan*, 1931, 6, 126. (18) GOTO, *ibid.*, 1929, 4, 129. (19) GOTO and NAKAMURA, *ibid.*, 1929, 4, 196. (20) GOTO and SUDZUKI, *ibid.*, 1929, 4, 244; cf. GOTO and INABA, *ibid.*, 1930, 5, 93. (21) GOTO and KITASATA, *Annalen*, 1930, 481, 81; GOTO (with OGAWA), *ibid.*, 1934, 511, 202. (22) GOTO, MICHINAKA and SHISHIDO, *ibid.*, 1935, 515, 297; (with ARAI), *Bull. Chem. Soc. Japan*, 1943, 18, 248. (23) GOTO and SHISHIDO, *Bull. Chem. Soc. Japan*, 1935, 10, 252. (24) *Ibid.*, 1929, 4, 220. (25) *J. Pharm. Soc. Japan*, 1923, No. 497, 511. (26) *Annalen*, 1935, 521, 175. (27) *Ibid.*, 1937, 530, 142. (28) *Ibid.*, 1939, 539, 262; *Bull. Chem. Soc. Japan*, 1941, 16, 329. (29) MORITA, *Fol. pharmacol. Jap.*, 1926, 3, 233; TOKIEDA, *ibid.*, 1927, 5, 85; ISHIKAWA, *Fukuoda Ik. Zasshi*, 1928, 21, 2121; KOIKE, *Fol. pharmacol. Jap.*, 1930, 10, 158; 1936, 21, 347; YAGI, *ibid.*, 1932, 15, No. 1, 85; ARAKAWA, *ibid.*, 1933, 16, No. 2, 182, 194; 17, No. 1, 13; GOTO and TAKEBE, *Proc. Imp. Acad. Tokyo*, 1933, 9, 390; NAKANO, *ibid.*, 1935, 20, 15; TAKAORI, *Deut. med. Woch.*, 1936, 62, 1634; RIN, *Proc. Jap. Pharm. Soc.*, 1938, 12, 194; *Fol. pharmacol. Jap.*, 1938, 25, 140; ITO, *ibid.*, 1940, 30, 197. A summary of results is given by KRUEGER *et al.*, Suppl. No. 165, *Pub. Health Reports*, U.S.A., p. 999.

ALKALOIDS OF OTHER PAPAVER SPP. For the following papaveraceous alkaloids neither constitutional formulæ nor group relation-

ships have been suggested. The numbers in brackets after the names of the alkaloids refer to the numbered list of plants, pp. 169-73.

Rhœadine, $C_{21}H_{21}O_6N$ (Items 54, 57; list, p. 173). This alkaloid was found in the red poppy by Hesse.¹ Its occurrence in opium is doubtful.² The quantity present in the red poppy, as recorded by Hesse and by Pavesi,³ is very small. These workers established the formula $C_{21}H_{21}O_6N$ for rhœadine, and showed that it was a weak base, sparingly soluble in water, most organic solvents and alkaline solutions. Mineral acids dissolve rhœadine forming intensely purple red solutions, but only a small fraction is used up in producing the colour, the rest being converted into a colourless, crystalline substance, *rhœagenine*, a much stronger base, stable to acids, non-volatile, and forming a well-crystallised hydrochloride, hydriodide and nitrate. Rhœadine has also been investigated by Späth, Schmid and Sternberg,⁴ and by Awe,⁵ who describe methods of isolation, the former finding 0.031 per cent. in the petals, and Awe 0.035 per cent. in the green, unripe capsules.

Rhœadine crystallises from a mixture of chloroform and ether, sublimes at $215-25^{\circ}/0.02$ mm., and then melts at $256-57.5^{\circ}$ (*vac.*), and has $[\alpha]_D^{17.5^{\circ}} + 232^{\circ}$ ($CHCl_3$),⁴ According to Awe it has m.p. $272-4^{\circ}$ (Kofler's micro-apparatus), and $[\alpha]_D^{19^{\circ}} + 243^{\circ}$ ($CHCl_3$). A crystalline hydriodide, $B. HI \cdot 2H_2O$, was prepared by the addition of potassium iodide to a solution of the alkaloid in acetic acid. Rhœadine contains one methoxyl group and a dioxyethylene group, but no reactive hydrogen (Zerewitinoff).

Rhœagenine, $C_{20}H_{19}O_6N$. This substance is not isomeric with rhœadine as formerly supposed. It crystallises from methyl alcohol, has m.p. $236-8^{\circ}$ (223° , Hesse; $235-37.5^{\circ}$, Pavesi; $235-6^{\circ}$, Awe), and $[\alpha]_D^{17.5^{\circ}} + 168^{\circ}$ (acetic acid)⁴ or $+ 166^{\circ}$ (acetic acid).⁵ Rhœagenine contains one replaceable hydrogen, no methoxyl group, but still retains the dioxyethylene group. On oxidation with permanganate in a carbon dioxide atmosphere it furnishes 3:4-methylenedioxyphthalic acid, and the methylimide of this acid, as well as a third substance, m.p. $75.7-77.5^{\circ}$. On zinc dust distillation in hydrogen, rhœagenine furnishes *isoquinoline*, and in a two-stage Hofman degradation gives a nitrogen-free product.

Aporeine, $C_{18}H_{16}O_2N$ (Item 52; list, p. 173). This name is derived from *απορεω*, so that *apo* in it has not the usual significance attached to it by chemists. The alkaloid forms greenish-yellow prisms, melts to a fluorescent liquid at $88-9^{\circ}$, decomposes at 225° , can be distilled in hydrogen or carbon dioxide, and is readily soluble in most organic solvents, except hot light petroleum, from which it is best crystallised. It is optically active, $[\alpha]_D^{50} + 75.19^{\circ}$, faintly basic, but gives well-crystallised salts; the acid oxalate crystallises from alcohol in plates, m.p. $89-90^{\circ}$; the hydrobromide forms yellowish-green scales, discolours at 190° , and decomposes above 210° . The hydrochloride separates in glistening plates, m.p. 230° (*dec.*) from water or alcohol, can be sublimed in carbon dioxide at $220-40^{\circ}$, and on exposure to sunlight is converted into a new crystalline base, *aporegenine*, which has not been further characterised. Aporeine gives with formaldehyde a characteristic blue colour turning to black. In a

mixture of nitric and sulphuric acid it develops a violet colour changing to brown and yellow. The alkaloid is said to be a tetanising poison showing a general resemblance to thebaine in action (Pavesi).⁶

Aporeidine (Item 52; list, p. 173) forms rhombic plates, m.p. 176–8°, from alcohol. It is possibly produced by the action of air and light on aporeine.

Petit⁷ recorded the presence in *Papaver orientale* of narcotine, morphine and meconic acid, but subsequent investigators have not confirmed this observation. Gadamer⁸ and Klee found protopine (p. 299), thebaine (p. 219), *isothebaine* (p. 232), glaucidine (p. 311), two phenolic bases and one non-phenolic. Klee⁹ pointed out that during vigorous growth thebaine is almost the only alkaloid in the root, whereas when withering sets in only a little thebaine and a phenolic base are present. It is not surprising, therefore, that in the re-investigation of the air-dried leaves by Konovalova, Junussov and Orekhov,¹⁰ thebaine and the new phenolic base oripavine were found but no *isothebaine*.

Oripavine, $C_{18}H_{21}O_3N$ (Item 56; list, p. 173). This alkaloid was isolated by extracting the dried leaves, moistened with ammonia, with ethylene dichloride. It crystallises from alcohol in colourless needles, has m.p. 200–1°, $[\alpha]_D - 211.8^\circ$ ($CHCl_3$), yields a hydrochloride, m.p. 244–5°, and a methiodide, m.p. 207–8°. The base is soluble in sodium hydroxide solution, giving a crystalline sodium derivative. It contains one hydroxyl, one methoxyl and one methylimino group.

The alkaloids found in *P. floribundum* (Item 53; list, p. 173) by Konovalova, Junussov and Orekhov¹¹ are floripavine, armepavine (p. 195), floripavidine and floribundine; the first pair being phenolic, and the second pair non-phenolic.

Floripavine, $C_{19}H_{21}O_4N$. This crystallises from alcohol in thin needles, has m.p. 200–1°, $[\alpha]_D + 90.5^\circ$ ($CHCl_3$), and gives a hydrochloride, m.p. 235–6°, picrate, m.p. 223–4°, and a methiodide, m.p. 220–1°. The base contains one hydroxyl, two methoxyl groups, and one methylimino-group.

Floripavidine, $C_{21}H_{29}O_5N$. This occurs in the crude mixture of non-phenolic bases, and is separated from floribundine by repeated crystallisation of the mixed hydrochlorides from water. The base crystallises from alcohol in prisms, has m.p. 241–2°, and $[\alpha]_D - 156.25^\circ$ (MeOH); the hydrochloride, m.p. 209–10°, hydriodide, and methiodide, m.p. 228–30°, were prepared. The alkaloid contains no hydroxyl group (Zerewitinoff), but a methoxyl, a dioxymethylene, and a methylimino group are present.

Floribundine, $C_{18}H_{19}O_2N$, crystallises from acetone in prisms, has m.p. 193–5°, $[\alpha]_D - 204.28^\circ$ ($CHCl_3$), and gives a tartrate, m.p. 181–3°, and a methiodide, m.p. 178–80°. One methoxyl and one methylimino-group are present. The mother liquors from floribundine appear to contain a fifth alkaloid, m.p. 200–3°.

Armepavine, $C_{19}H_{23}O_3N$. See p. 195.

REFERENCES

- (1) *Annalen*, Suppl., 1865, 4, 50. (2) HESSE, *ibid.*, 1866, 140, 145; 1869, 149, 35; *Arch. Pharm.*, 1890, [iii], 28, 79. (3) *Atti Ist. bot. Univ. Pavia*, 1906, 9, 45 (*Chem. Zent.*, 1906, i, 690, or *Chem. Soc. Abstr.*, 1906, ii, 483). (4) *Monats.*, 1936, 68, 33; cf.

SPÄTH and ZAJIC, *Ber.*, 1936, **69**, 2448. (5) *Arch. Pharm.*, 1936, **274**, 439; 1941, 116, 279; *Forsch. Fortschritte*, 1939, **15**, 117. (6) *Loc. cit.* and *R. C. Ist Lombardo*, 1905, [ii], **38**, 117; *Gazzetta*, 1907, **37**, [i], 629; 1914, **44**, i, 398 (*Chem. Soc. Abstr.*, 1905, i, 368; 1907, i, 870; 1914, i, 457 (pharmacological) and 719. (7) *J. Pharm.*, 1813, 170. (8) *Arch. Pharm.*, 1911, **249**, 39; 1914, **252**, 274. (9) *Ibid.*, 1914, **252**, 211. (10) *Ber.*, 1935, **68**, 2158. (11) *Ibid.*, 1935, **68**, 2277.

OTHER PAPAVERACEOUS ALKALOIDS

α -NAPHTHAPHENANTHRIDINE SUB-GROUP

This sub-group includes four alkaloids, α -homochelidonine, chelidonine, chelerythrine, and sanguinarine, whose nuclear structure and inter-relationships (formulae I to IV) have been established. Three minor chelidonium alkaloids, oxychelidonine, methoxychelidonine and oxy-sanguinarine, whose association is implied by their names, are included.

α -Homochelidonine, $C_{21}H_{23}O_3N$ (Item 7; list, p. 169), was isolated from *Chelidonium majus* by Schniidd and Selle.¹ It crystallises from ethyl acetate in rhombohedra, m.p. 182°. The salts are amorphous except the aurichloride, which forms reddish-yellow needles from alcohol.

The alkaloid was investigated by Gadamer,² who stated that it was dextrorotatory and contained two methoxyl groups, a methylenedioxy-group, an alcoholic hydroxyl group, and a methylimino-group, and that it resembles chelidonine in its behaviour with acetic anhydride, giving an *O*-acetyl derivative in the cold and a *N*-acetylanhydrohomochelidonine with the boiling reagent. Gadamer³ also showed that on oxidation with mercuric acetate *O*-acetyl- α -homochelidonine is converted into dihydro-chelerythrine, m.p. 160–2° (see below), which on exposure to air is oxidised to chelerythrine (ψ -cyanide, m.p. 258°) just as chelidonine under like conditions passes into ψ -chelerythrine (sanguinarine, p. 280). On the basis of these results, Gadamer suggested that α -homochelidonine differed from chelidonine in the replacement of one methylenedioxy group by two methoxyl groups, and this was confirmed by Späth and Kuffner,⁴ who represent α -homochelidonine by formula (I), chelidonine being (III), and chelerythrine (II).

Chelerythrine, $C_{21}H_{17}O_4N \cdot H_2O$. (Items 4, 5, 6, 7, 43, 46, 60; list, p. 169). This base was isolated by Probst⁵ from the root of *Chelidonium majus*. It was probably first obtained in a pure state by König and Tietz,⁶ from the root of *Sanguinaria canadensis*. A process for the separation and purification of the alkaloids of *Chelidonium majus* roots is given by Schmidt and Selle.¹

Chelerythrine crystallises from alcohol in colourless, prismatic leaflets, m.p. 207°, containing one molecule of alcohol. The alkaloid absorbs carbon dioxide from the air, becoming yellow. The solutions fluoresce blue when the alkaloid is contaminated with its oxidation product, which is formed by mere exposure of solutions to air. The salts, which are quaternary, are intensely yellow. The hydrochloride, $B \cdot HCl \cdot H_2O$, forms citron-yellow needles, and the sulphate, $B \cdot H_2SO_4 \cdot 2H_2O$, golden-yellow needles, sparingly soluble in water; the platinumchloride, $B_2 \cdot H_2PtCl_6$,

golden-yellow needles, and the aurichloride $B. HAuCl_4$, long, silky, brown needles, m.p. 233° (*dec.*). Sulphuric acid dissolves chelerythrine, forming a greenish solution, which slowly becomes dirty yellow. Sulphovanadic acid gives a violet-red tint changing to dark red.

Karrer ⁷ found that chelerythrine reacted with phenylhydrazine as if it contained a carbonyl group, and that on reduction with zinc and

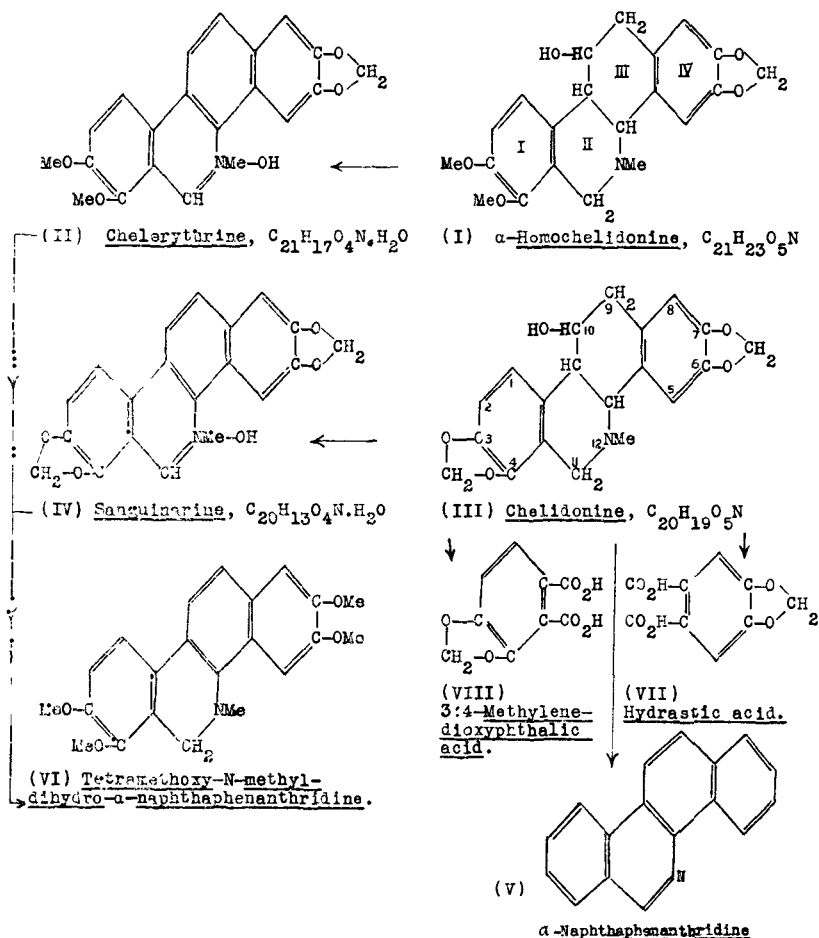

hydrochloric acid, dihydrochelerythrine, m.p. $162-3^\circ$, colourless and non-basic, is produced. With Grignard reagents, α -alkyldihydrochelerythrine are formed analogous with the alkyldihydroberberines (p. 333). Gadamer ³ showed that these reactions, which appear to indicate the presence of a carbonyl group, occur in the same way as with cotarnine and berberine. Two of the oxygen atoms were shown to be present as a methylenedioxy group, and the other two as methoxyl groups.

On these grounds Gadamer regarded chelerythrine as a quaternary base, which on liberation from its salts passed into the carbinol form. In subsequent papers Gadamer suggested that the contradictory observations recorded regarding chelerythrine and sanguinarine were in part due to the difficulty of separating these alkaloids, and in association with Stichel⁶ he prepared Karrer's chelerythrine ψ -cyanide,⁷ $C_{21}H_{18}O_4N-CN$, in a pure state, m.p. 256°. Späth and Kuffner⁴ effected a partial separation of the two alkaloids by crystallisation of the nitrates, and finally obtained pure chelerythrine by crystallisation of the ψ -cyanide, m.p. 260–1°, from acetone. They found that chelerythrine chloride on gentle oxidation by potassium permanganate yielded the methylimide of 3:4-dimethoxyphthalic acid, and on more energetic oxidation, 4:5-dioxymethylene-phthalic acid (hydrastic acid (VII)) was also produced. On distillation with zinc dust chelerythrine chloride furnished α -naphthaphenantridine (1:2-benzphenanthridine) (V).

On the basis of these results they assigned formula (II) to chelerythrine, and this was confirmed by the further observation that dihydrochelerythrine, m.p. 166–7°, on treatment with phloroglucinol and sulphuric acid and subsequent methylation of the dihydric phenolic base so formed, yields tetramethoxy-*N*-methyl-dihydro- α -naphthaphenantridine (VI), m.p. 182–3°, also obtainable from sanguinarine.⁸

Manske has suggested that base, P61 (Item 4; list, p. 169) $C_{18}H_{10}O_3(NMe)(OMe)_2$, m.p. 210°, may be closely related to chelerythrine and is possibly represented by formula (II) with the two methoxyl groups and the dioxymethylene group interchanged in position.

Chelidonine, $C_{20}H_{19}O_5N \cdot H_2O$. (Items 7, 42, 61; list, p. 169). This alkaloid separates with protopine in Schmidt and Selle's process¹ for chelidonium alkaloids, and is isolated by means of its greater solubility in ether, and the sparing solubility of its hydrochloride in hydrochloric acid. The base is purified by crystallisation from acetic acid; it forms monoclinic tablets, m.p. 135–6°, $[\alpha]_D + 115.4^\circ$ (EtOH), is readily soluble in alcohol or ether, but insoluble in water; the hydrochloride B . HCl, and the nitrate, B . HNO₃, are crystalline and sparingly soluble in water. The alkaloid gives a deep crimson colour with strong sulphuric acid and a drop of guaiacol. It is a tertiary base and contains a methylimino-group; the oxygen atoms are present in the form of two methylenedioxy groups and a non-phenolic, hydroxyl group. Gadamer found that on acetylation at a low temperature *O*-acetylchelidonine (two forms, m.p. 161–3°, and m.p. 184–6°; $[\alpha]_D + 110^\circ$) is produced, but at the boiling point of acetic anhydride, *N*-acetylanhydrochelidonine, $C_{22}H_{19}O_5N$, m.p. 152°, $[\alpha]_D \pm 0^\circ$, is formed. This is one among numerous observations made by Gadamer *et al.*⁹ bearing on the constitution of chelidonine. The most interesting of these is the oxidation of *O*-acetylchelidonine with mercuric acetate to a quaternary base, didehydrochelidonine (ψ -cyanide, m.p. 194–6°, $[\alpha]_D + 151-3^\circ$, Gadamer and Winterfeld⁹) whose transformation into dihydro- ψ -chelerythrine, and eventually into ψ -chelerythrine (sanguinarine) is described later.

Gadamer suggested two formulæ of a phenanthrene type for chelidonine in 1919 and 1924, the second formula having a 7-membered heterocyclic ring attached to the phenanthrene nucleus. In a critical review of the chemistry of chelidonine by von Bruchhausen and Bersch,¹⁰ it was pointed out that such formulæ appeared to be excluded by the results of Kling,¹¹ and Schwarz,¹² which unfortunately are not readily accessible. Schwarz in particular showed that Gadamer's chelidoninemethine ($C_{21}H_{22}O_5N$, m.p. 145–6°, $[\alpha]_D - 271.3^\circ$) on oxidation furnished hydrastic acid (VII) and 4 : 5-methylenedioxy-2-dimethylaminobenzoic acid. The latter acid on re-examination by von Bruchhausen and Bersch proved to be 3 : 4-methylenedioxy-2-dimethylaminomethylbenzoic acid, m.p. 191°. These degradation fragments indicated that each methylenedioxy-group is on a different benzene ring.

The same authors, on the basis of this result, but mainly from consideration of the probable close relationship of chelidonine to protopine, proposed formula (III) for chelidonine. This was confirmed by Späth and Kuffner,¹³ who showed that Gadamer's *N*-acetylanhydrochelidonine (*see above*) on oxidation with nitric acid yielded trimellitic acid (benzene-1 : 2 : 4-tricarboxylic acid), and that chelidonine, oxidised by potassium permanganate, furnished hydrastic acid (VII) and 3 : 4-methylenedioxybenzene-1 : 2-dicarboxylic acid (VIII) which Späth and Holter¹⁴ had already prepared by the oxidation of corycavine. Gadamer and Stichel⁹ had shown that sanguinarine on distillation with zinc dust gave rise to a substance, $C_{18}H_{17}N$, m.p. 136°. This, on re-examination by Späth and Kuffner,¹³ proved to have the formula $C_{17}H_{15}N$, and to be identical with Græbe's α -naphthaphenanthridine¹⁵ (V). Perusal of the formulæ (V, VII, VIII) will show that these various degradation products are satisfactorily accounted for by von Bruchhausen and Bersch's formula (III) for chelidonine, which still requires support for the location of the hydroxyl group at C.¹⁰ The nature of the oxidation products indicates that it cannot be in ring I or IV and, mainly on account of the behaviour of chelidonine with acetic anhydride, and the character of the saturated, nitrogen-free substance obtained by Kling in a two-stage Emde degradation of chelidonine, C¹⁰ was selected as the position of this group in agreement with von Bruchhausen and Bersch's view, arrived at chiefly on phylogenetic grounds.

Sanguinarine (*ψ -chelerythrine*), $C_{20}H_{13}O_4N \cdot H_2O$. (Items 7, 46, 60; list, p. 169). This alkaloid was obtained from *Sanguinaria canadensis* roots (blood root) by Dana.¹⁶ Its separation from protopine and especially chelerythrine is difficult, and for details the papers cited should be consulted.¹⁷ It is doubtful whether the alkaloid has been obtained free from chelerythrine, except when prepared by oxidation of chelidonine by mercuric acetate.⁹ The natural alkaloid is said to crystallise from ethyl acetate or alcohol in colourless needles, m.p. 213° (Schmidt, König and Tietz¹⁷); but by removal of associated chelerythrine as the *ψ* -cyanide and fractionation of the residue as the acid *d*-tartrate, Gadamer and Stichel,¹⁷ obtained sanguinarine, which crystallised from ether, melted at 242–3° after being heated at 225–30° for five minutes, or at 266° when

heated more rapidly. Crystallised from alcohol, it had m.p. 195–7°, and is then probably an alcoholate. It is soluble in organic solvents with a bluish-violet fluorescence; the salts are red. The ψ -cyanide is colourless, and has m.p. 238°.

In view of the importance of establishing the relationship of sanguinarine to chelidonine the steps by which the latter alkaloid was converted into ψ -chelerythrine by Gadamer and Winterfeld⁹ may be mentioned. *O*-Acetylchelidonine (p. 279) was oxidised by mercuric acetate to dihydrochelidonine (ψ -cyanide, $C_{21}H_{18}O_3N_2$, m.p. 194–6°), which behaves as a tertiary base, and when boiled in aqueous alcoholic solution is converted into an anhydro-base, dihydro- ψ -chelerythrine, $C_{20}H_{15}O_4N$, which deposits as the reaction proceeds, in crystals, m.p. 187–8°, and is readily oxidised, e.g., by mercuric acetate to ψ -chelerythrine, $C_{20}H_{13}O_4N$, which crystallised from ether, has m.p. 239–42° (*dec.*). The identity of this substance with sanguinarine was established by Gadamer and Stichel.¹⁷ The ψ -cyanide (*cf.* cotarnine ψ -cyanide, p. 204), $C_{21}H_{14}O_4N_2$, crystallises from chloroform on addition of alcohol, has m.p. 237·5–238°, and is colourless. The hydrochloride, $C_{20}H_{13}O_4N \cdot HCl \cdot 3H_2O$, forms long, thin copper-red, or blood-red needles.

The nature of the nucleus in chelidonine and sanguinarine was established by Späth and Kuffner,¹³ who showed that both alkaloids on distillation with zinc dust yielded α -naphthaphenanthridine (V), first prepared by Graebe,¹⁵ and on that basis formula (IV) was suggested for sanguinarine.

The relationship between chelerythrine (II) and sanguinarine (IV) was also established by Späth and Kuffner,⁸ who showed that dihydrochelerythrine (p. 278) and dihydrosanguinarine, $C_{20}H_{15}O_4N$, m.p. 188–9°, prepared from the natural alkaloid, and obviously identical with the dihydro- ψ -chelerythrine of Gadamer and Winterfeld (*see above*), on replacement of the methylenedioxy-groups by methoxyl groups yielded the same substance, *viz.*, tetramethoxy-*N*-methyldihydro- α -naphthaphenanthridine (VI).

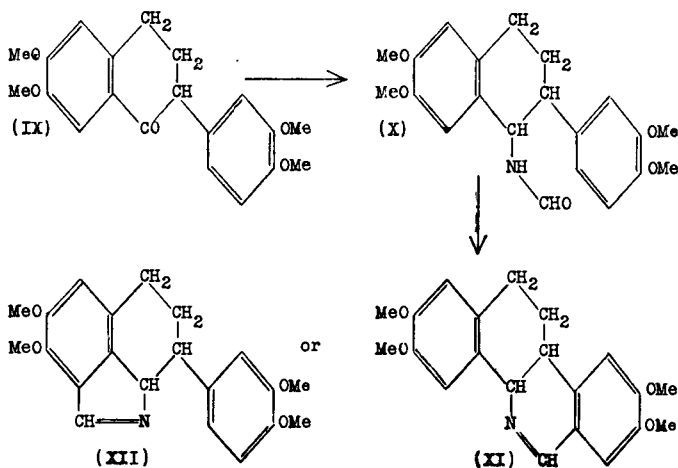

SYNTHETICAL EXPERIMENTS. Richardson, Robinson and Seijo¹⁸ have described the synthesis of a substance which is believed to be tetramethoxytetrahydrobenzphenanthridine (XI). It was obtained by condensing veratraldehyde and acetoveratrone to 3 : 4 : 3' : 4'-tetramethoxychalkone, which by addition of hydrogen cyanide yielded γ -keto- α -cyano- $\alpha\gamma$ -diveratrylpropane, $C_6H_3(OMe)_2 \cdot CH(CN) \cdot CH_2 \cdot CO \cdot C_6H_3(OMe)_2$. This was hydrolysed successively to the corresponding amide and keto-acid, and the latter reduced by Clemmensen's method to $\alpha\gamma$ -diveratrylbutyric acid, $C_6H_3(OMe)_2 \cdot CH(CO_2H) \cdot CH_2 \cdot CH_2 \cdot C_6H_3(OMe)_2$ in which ring closure was effected by treatment with phosphoryl chloride, yielding 1-keto-6 : 7-dimethoxy-2-veratryl-1 : 2 : 3 : 4-tetrahydronaphthalene (IX). The latter, either by direct interaction with formamide or *via* the oxime and amine and treatment with formic acid, was converted into 1-formamido-6 : 7-dimethoxy-2-veratryl-1 : 2 : 3 : 4-tetrahydronaphthalene (X), and in this the second ring closure was made in toluene solution by phosphoryl chloride to (XI) with (XII) as a less likely alternative.

A series of "open" analogues of chelidonine has been prepared by Noller and Kneeland^{18(a)} in the form of tertiary amino-alcohols of the type, $CH_2Ar \cdot NMe \cdot (CH_2)_2 \cdot CHOH \cdot CH_2Ar'$ where Ar and Ar' may be (1) Ph or (2) $C_6H_3 : CH_2O_2$ or (3) $C_6H_3(OMe)_2$. They were made for pharmacological test but none of them showed the spasmolytic action, which led to the suggestion of chelidonine as a substitute for papaverine.

Oxychelidonine, $C_{20}H_{17}O_6N$. (Item 7 ; list, p. 169.) This alkaloid was obtained by Gadamer and Theissen⁹ from residues from the technical extraction of chelidonine, and is one of the products formed when the latter is oxidised with mercuric acetate. It crystallises from a mixture of chloroform and alcohol in slender needles, m.p. $> 285^\circ$, $[\alpha]_D + 102.5^\circ$, yields no salts, contains one methylimino-group and two methylenedioxy groups. It is assumed that a cyclic methylene group near the alcoholic hydroxyl group at C¹⁰ (III, p. 278) has been converted into a carbonyl group which inhibits acylation, but no positive evidence for the presence of a carbonyl group could be obtained. Wintgen's oxychelidonine,¹⁹ $C_{20}H_{19}O_6N \cdot H_2O$, appears to be an amine oxide.

Methoxychelidonine, $C_{21}H_{21}O_6N$. (Item 7 ; list, p. 169.) In a systematic investigation of chelidonine extraction residues, Gadamer and Winterfeld,⁹ isolated this alkaloid. It crystallises from alcohol in prisms, m.p. 221° , $[\alpha]_D + 115.8^\circ$ and gives a crystalline hydrochloride and aurichloride, $B \cdot HAuCl_4$, m.p. $237-8^\circ$. It contains one methoxyl group, two methylenedioxy groups, one hydroxyl group (*O*-acetyl derivative, amorphous, m.p. 147° , $[\alpha]_D + 55.5^\circ$), and a methylimino-group.

Accepting Gadamer and Winterfeld's view that this base is a methoxychelidonine, von Bruchhausen and Bersch¹⁰ suggested that the methoxyl group was probably at C⁵ (III, p. 278).

Oxysanguinarine, $C_{20}H_{13}O_5N$, was isolated by Späth, Schlemmer, Schenck and Gempp²⁰ by chromatographic analysis of blood root alkaloids, and was also prepared by oxidation of sanguinarine nitrate by potassium ferricyanide in alkaline solution. It was purified by crystallisation from

chloroform and sublimation in a high vacuum, and had m.p. 360–1° (*corr.*, *vac.*), $[\alpha]_D \pm 0^\circ$, and is represented by formula (IV) with the change $-\text{NMe} \cdot \text{OH} : \text{CH}-$ into $-\text{NMe} \cdot \text{CO}-$ in ring (II).

Of the papaveraceous plants providing these α -naphthaphenanthridine alkaloids, the most interesting is the celandine, *Chelidonium majus*, which, though obsolete in British and American medical and pharmaceutical practice, still attracts attention elsewhere. Its pharmacognosy has been investigated by Cappenberg and Harms.^{21(a)} A microchemical test for identification of the crude drug has been devised by Ramsted^{21(b)} and both in Germany and Russia processes for estimation of the alkaloidal content of the drug have been published.^{21(c)}

Pharmacological Action. From the foregoing account of the chemistry of these alkaloids, it will be realised that the material available for pharmacological examination may have been of doubtful purity, and it is probable that a careful pharmacological comparison of pure specimens of the four principal alkaloids of the sub-group would yield interesting results. Chelidonine is said to be only slightly toxic. Chelidonine and α -homochelidonine produce some depression of the central nervous system and slight narcosis. They resemble papaverine in their action on muscle and the heart, and produce insensibility of the skin on local application by paralysing the ends of the sensory nerves. Respiration is retarded and deepened. In view of the papaverine-like action on muscle, Hanzlik has suggested the use of chelidonine in asthma and colic.²² According to Greathouse, the immunity of *Sanguinaria canadensis* to root-rot is due to the alkaloids it contains.²³

REFERENCES

- (1) *Arch. Pharm.*, 1890, **228**, 441; *cf.* SCHMIDT, *ibid.*, 1901, **239**, 405, 397. (2) *Ibid.*, 1919, **257**, 298. (3) *Ibid.*, 1920, **258**, 160. (4) *Ber.*, 1931, **64**, 1123. (5) *Annalen*, 1839, **29**, 120; *cf.* WINTGEN, *Arch. Pharm.*, 1901, **239**, 448. (6) *Ibid.*, 1893, **231**, 145, 161; *cf.* BAUER and HEDINGER, *ibid.*, 1920, **258**, 167; and GADAMER and STICHEL, *ibid.*, 1924, **262**, 488; SPÄTH and KUFFNER, *Ber.*, 1931, **64**, 1123. (7) *Ibid.*, 1917, **50**, 212; 1921, **54**, 2071; *Helv. chim. Acta.*, 1923, **6**, 232. (8) *Ber.*, 1931, **64**, 2034. (9) *Arch. Pharm.*, 1919, **257**, 298; 1920, **258**, 148; *ibid.*, 1924, **262**, 249; (with DIETERLE), p. 237; (with WINTERFELD), pp. 452, 589; (with STICHEL), p. 488; (with THEISSEN), p. 578. (10) *Ber.*, 1930, **63**, 2520; 1931, **64**, 947. (11) *Inaug. Diss. Marburg*, 1927. (12) *Ibid.*, 1928. (13) *Ber.*, 1931, **64**, 370. (14) *Ibid.*, 1927, **60**, 1897. (15) *Annalen*, 1904, **335**, 127. (16) *Mag. Pharm.*, 1829, **23**, 125. (17) SCHMIDT, KOENIG and TIETZ, *Arch. Pharm.*, 1893, **231**, 145, 161; SCHMIDT and FISCHER, *ibid.*, 1901, **239**, 409 (bibliography of early literature); BAUER and HEDINGER, *ibid.*, 1920, **258**, 167; GADAMER and STICHEL, *ibid.*, 1924, **262**, 498; KOZNIIEWSKI, *Bull. Acad. Sci. Cracow*, 1910, p. 235. (18) *J. Chem. Soc.*, 1937, 835; *cf.* NOLLER, DENYES, GATES and WASLEY, *J. Amer. Chem. Soc.*, 1937, **59**, 2079; (18a) NOLLER and KNEELAND, *ibid.*, 1946, **68**, 201; *cf.* NOLLER and CASTRO, *ibid.*, p. 203. (19) *Arch. Pharm.*, 1901, **239**, 438. (20) *Ber.*, 1937, **70**, 1677; SCHLEMMER and GEMPP, *Arch. Pharm.*, 1938, **276**, 506. (21a) *Deut. Apoth. Zeit.*, 1939, **54**, 40; (b) *Pharm. Acta Helv.*, 1941, **16**, 15; (c) NEUGEBAUER and BRUNNER, *Pharm. Zeit.*, 1937, **78**, 17; *Apoth. Zeit.*, 1937, **52**, 1038; SCHENK and GRAF, *Arch. Pharm.*, 1937, **275**, 113, 166; RODIONOV and SCHIDLOVSKAJA-OVTSCHINNIKOVA, *J. Appl. Chem. Russ.*, 1943, **16**, 152. (22) MEYER, *Arch. exp. Path. Pharm.*, 1892, **29**, 398; HANZLIK, *J. Pharm. Exp. Ther.*, 1915, **7**, 99; 1921, **17**, 445; 1921, **18**, 63; *J. Amer. Med. Assoc.*, 1920, **75**, 1324; ALKAN, *Arch. Verdau. Kr.*, 1928, **43**, 46; STICKL, *Zeit. Hyg. Infekt. Kr.*, 1928, **108**, 567; KREITMAIR,

Merck's Jahresh., 1936, 50, 104; DANIEL and SCHMALTZ, *Pharm. Zentr.*, 1938, 79, 99; SEEL, STIEDA and PEPLAU, *Hippokrates*, 1939, 10, 1281. (23) *Plant Physiol.*, 1939, 14, 377.

ALKALOIDS OF CORYDALIS AND ALLIED GENERA

The remaining *isoquinoline* alkaloids cannot be pigeon-holed neatly into either botanical or chemical groups. A strictly chemical arrangement separates the considerable number of alkaloids not yet allocated to chemical groups from the alkaloids of known constitution with which they are associated in the plant. A botanical arrangement on the other hand separates closely related alkaloids, thus the *protoberberines* are typically developed in the Ranunculaceæ, Berberidaceæ, Menispermaceæ, Anonaceæ and Rutaceæ, while their tetrahydro-derivatives occur in the Rhœadales, especially in *Corydalis* species. In view of the interest now being shown in the biogenesis of alkaloids and other constituents of plants, it seems desirable to adopt a botanical arrangement and to discuss the alkaloids of *Corydalis* and allied genera separately from those of *Berberis* and its associates (p. 328).

It is convenient to group together under the above heading the alkaloids obtained from the remaining species of the Rhœadales, *viz.*, *Corydalis*, *Dicentra*, *Adlumia* and *Glaucium*, since a number of alkaloids occur in more than one of these genera and apart from the simple *isoquinoline* derivative, *corypalline*, they are divisible into four chemical types of which one, the *bicuculline sub-group*, has been dealt with already (p. 209) along with its relatives, the *phthalideisoquinolines*. The other three types are represented by (a) the tetrahydroprotoberberines (*corydaline sub-group*), (b) the *cryptopine sub-group*, and (c) the *aporphines (bulbocapnine sub-group)*.

The *Corydalis* and *Dicentra* species are distinguished by the number and variety of the alkaloids they contain, and separation and isolation of the latter is a difficult problem. General methods have been devised by Gadamer, Ziegenbein and Wagner,^{1(a)} Gadamer, Späth and Mosettig^{1(b)} and Manske,^{1(c)} but most of the workers on these alkaloids have made contributions to this subject.

TETRAHYDROPROTOBERBERINE SUB-GROUP

Corydaline, $C_{22}H_{27}O_4N$. (Items 8, 9, 31; list. pp. 170-2.) After the discovery of this alkaloid by Wackenroder,² Wicke² analysed well-crystallised salts and adopted the formula $C_{18}H_{19}O_4N$. Birsman³ changed this to $C_{22}H_{25}O_4N$, which Dobbie and Lauder⁴ altered to $C_{22}H_{29}O_4N$, this in turn being modified by Freund and Josephi⁵ to $C_{22}H_{27}O_4N$.

Corydaline crystallises from alcohol in short, six-sided prisms, m.p. 135°, $[\alpha]_D^{20} + 300^\circ$ ($CHCl_3$), is sparingly soluble in cold alcohol, but dissolves readily on warming, is easily soluble in ether or chloroform, insoluble in water or alkalis. Exposed to air, it gradually oxidises to the yellow dehydrocorydaline. It forms well-crystallised salts; the hydriodide, B. HI, forms pale yellow prisms of indefinite melting-point; the nitrate, B. HNO_3 , tablets, m.p. 198°; and the hydrochloride, B. $HCl \cdot 2H_2O$,

columnar crystals, m.p. 206–7°; the aurichloride crystallises from dilute alcoholic hydrochloric acid in orange-coloured needles, m.p. 207°. The platinumchloride occurs in brown crystals, m.p. 227°. The ethyl sulphate, $B \cdot C_2H_5HSO_4 \cdot H_2O$, forms large prisms, m.p. 152.5°, and is characteristic.

Constitution. Corydaline contains four methoxyl groups. Insight into the constitution of the alkaloid has been obtained principally by the study of its oxidation products,⁶ as indicated by the following tabular scheme.

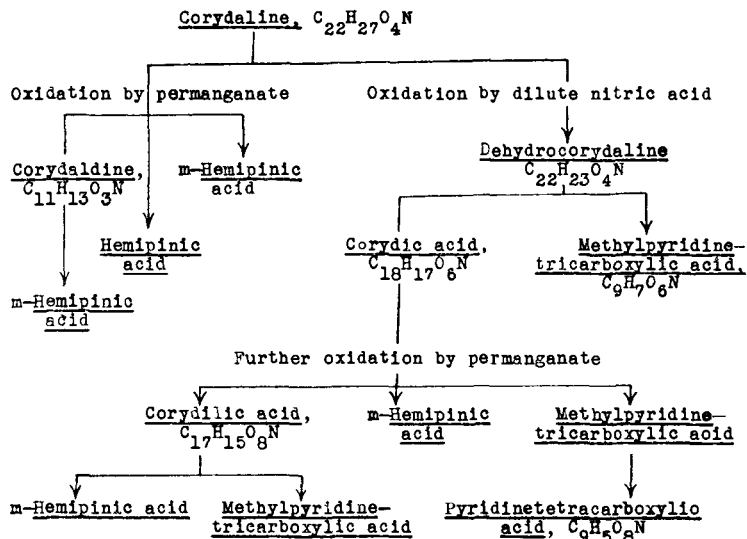

The ultimate products of oxidation are therefore hemipinic acid (3 : 4-dimethoxyphthalic acid), *metahemipinic acid* (4 : 5-dimethoxyphthalic acid) and pyridine-2 : 3 : 4 : 6-tetracarboxylic acid.⁶ The identity of the last-mentioned substance is doubtful, since it was produced by the oxidation of a supposed 2-methylpyridine-3 : 4 : 6-tricarboxylic acid.⁷ The latter has been synthesised by Lawson, Perkin and Robinson⁸ and shown to be different from Dobbie and Lauder's oxidation product. It was largely on the assumed position of the methyl group in this acid that Dobbie and Lauder⁶ based the position of the methyl group in their formula for corydaline. These observations establish the presence of one pyridine and two benzene rings in corydaline, and the study of corydalic and corydaldine provided information as to the way in which these components are built into the molecule of corydaline.

Corydalic acid, $C_{17}H_{15}O_8N \cdot 2H_2O$. This tribasic acid, needles, m.p. 228°, contains two methoxyl groups and on oxidation by potassium permanganate yields methylpyridinetricarboxylic and *metahemipinic acids*. On these grounds, Dobbie and Lauder⁶ assigned to this acid formula (I), which Haars⁹ modified to (II), since it gave a methiodide and appeared to be a tertiary base.

Corydic acid, $C_{18}H_{17}O_6N \cdot 2H_2O$, crystallises in yellow leaflets, m.p. 218° , or with $1H_2O$, m.p. 224° , behaves as a dibasic acid, contains two methoxyl groups and a tertiary nitrogen atom, and is oxidised by permanganate to corydalic acid. Dobbie and Lauder assigned formula (III) to corydic acid, which Haars⁹ modified to (IV), since in his experiments it behaved as a betaine acid and the dimethyl ester iodide had the characters of a quaternary ammonium iodide.

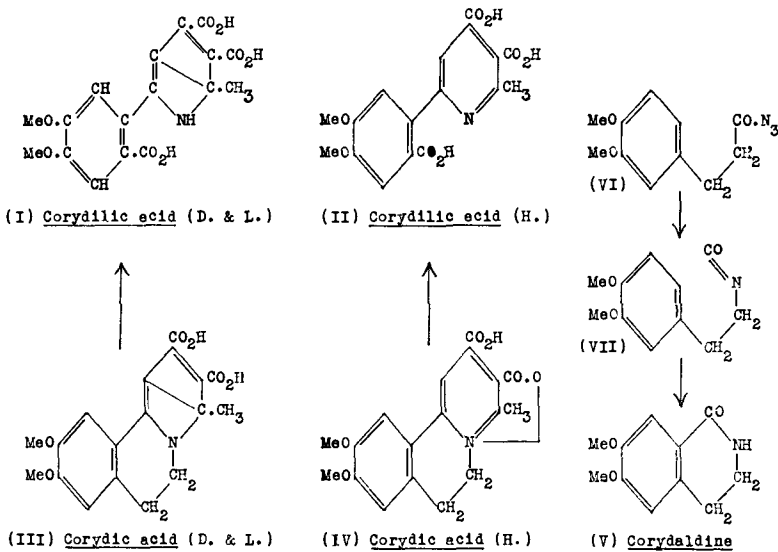

Corydaldine, $C_{11}H_{13}O_3N$, forms prismatic crystals, m.p. 175° , and reacts with nitrous acid, giving nitrosocorydaldine, m.p. 185° , which when warmed with sodium hydroxide solution loses nitrogen and passes into the lactone of hydroxyethylveratric acid. With hydrochloric acid at 150° the latter furnishes a phenol, giving reactions similar to those of the catechol derivative obtained by Perkin in the same way from ω -hydroxyethylpiperonylcarboxylic anhydride, with which it is probably identical. Formula (V) was, therefore, assigned to corydaldine.¹⁰ This formula has been confirmed by a synthesis of the substance by Späth and Dobrowsky,¹¹ who treated *homoveratrylamine* with ethyl chloroformate and effected ring closure in the resulting product by the action of phosphoric oxide in xylene solution. In a later synthesis Mohunta and Rây¹² started from the azide (VI) derived from β -3 : 4-dimethoxyphenylpropionic acid, which on boiling in toluene solution was converted into the *isocyanate* (VII) and this on ring closure yielded corydaldine (V).

Dehydrocorydaline, $C_{22}H_{23}O_4N$. (Items 8, 14, 31; list, pp. 170-2.) This alkaloid is formed by the gentle oxidation of corydaline.¹³ It is a yellowish crystalline powder, m.p. $112-3^\circ$ (*dec.*); the hydrochloride, B. HCl. $4H_2O$, forms yellow leaflets; hydriodide, B. HI. $2H_2O$, small yellow needles; aurichloride, B. HAuCl₄, red-brown needles, m.p. 219° . Like berberine,

it unites with one molecule of chloroform, forming a crystalline compound, m.p. 154°.

Dehydrocorydaline contains four methoxyl groups. On reduction it furnishes two stereoisomerides of corydaline, m.p. 135°, and m.p. 158–9° (163–4° (*vac.*), Späth); the latter (*mesocorydaline*) by crystallisation of the *d*-camphorsulphonate can be partially separated into *d*- and *l*-forms, the *d*-form of which is not identical with natural corydaline.¹⁴ The second isomeride, m.p. 135°, has not been resolved into optically active components, but from the sulphonic acid the *l*-component has been isolated by crystallisation of the brucine salt, and this is taken to indicate that the inactive corydaline, m.p. 135°, is *dl*-corydaline.¹⁵

Dehydrocorydaline exhibits many analogies with berberine; thus both are yellow and both are easily reduced, forming the colourless alkaloids, corydaline and tetrahydroanhydroberberine respectively.

On the basis of the foregoing results and comparisons of the reactions of the base with those of berberine, Dobbie and Lauder⁶ assigned formula (VIII) to dehydrocorydaline, which was slightly modified by Gadamer and Haars.⁶ As a result of work by Späth and Lang¹⁶ and Gadamer and von Bruchhausen¹⁷ the position of the methyl group was changed from C⁸ to C¹³ (IX) in accordance with the newer view of the constitution of corydaline.

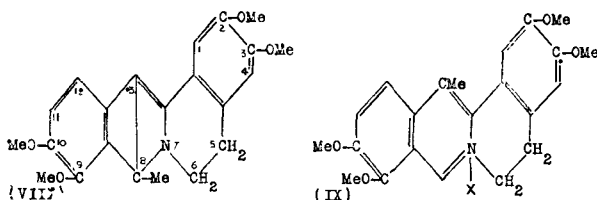

The corresponding formula (X) suggested by Dobbie and Lauder for corydaline, only differs from that of tetrahydroberberine (p. 335) in the substitution of the methoxyl groups at C² and C³ for one methylenedioxy-group and by a methyl group substituted for hydrogen at C⁸, and it is the position of this methyl group, now accepted as being at C¹³, which was the subject of most of the later investigations on the structure of the alkaloid. Späth and Lang¹⁶ pointed out that formula (X) implied that corydaline should be identical with α -methyltetrahydropalmatine (p. 292), but the two forms of the latter synthesised by these authors proved to be different from the two forms of *dl*-corydaline and they proposed two alternative formulae, one of which (XI) was accepted by Gadamer and von Bruchhausen¹⁷ because (1) it accounts equally well for the formation of two optically inactive forms of corydaline by reduction of dehydrocorydaline and (2) explains the simultaneous formation of oxydehydrocorydaline, C₂₂H₂₃O₅N, m.p. 235–6°, and dihydrodehydrocorydaline, C₂₂H₂₅O₄N, when dehydrocorydaline acetate is treated with 30 per cent. sodium hydroxide solution, as occurring in the same fashion as the similar conversion of berberine into oxyberberine and dihydroanhydroberberine. This

formula was approved by Späth and Mosettig¹⁸ after a critical investigation of the degradation of corydaline by the methods of Hofmann and Emde, and confirmed by von Bruchhausen's preparation¹⁹ of *dl*-corydaline, m.p. 135–6° from palmatine-acetone by the action of methyl iodide and reduction of the methylated product. Under these conditions it is the hydrogen atom attached to C¹³ which is reactive, and is replaced by methyl.²⁰ Further evidence in this direction was provided by von

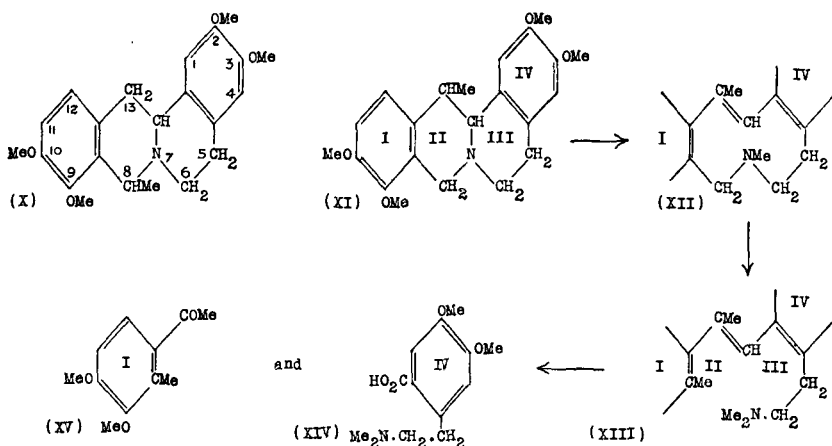

Bruchhausen and Stippler, who converted corydaline methochloride into the anhydro-base (XII), reduced the methosulphate of the latter with sodium amalgam and oxidised the reduction product (XIII) with permanganate to methylacetoveratrone (XV) and with ozone to 4 : 5-dimethoxy-2-dimethylaminoethylbenzoic acid (XIV). This interesting series of reactions supports in general Dobbie and Lauder's view of the structure of the alkaloid, but provides strong evidence for C¹³ as the position of the methyl group.

Confirmatory evidence by a complete synthesis was first provided by the preparation of oxydehydrocorydaline by Koepfli and Perkin¹⁷ from *N*- β -veratrylethyl-3 : 4-dimethoxy- α -methylhomophthalamic acid (XVI); this substance was converted into the methyl ester and ring closure effected by phosphorus oxychloride to (XVII), which on heating at 150–1° underwent the second ring closure to oxydehydrocorydaline (XVIII), identical with Gadamer and von Bruchhausen's product¹⁷

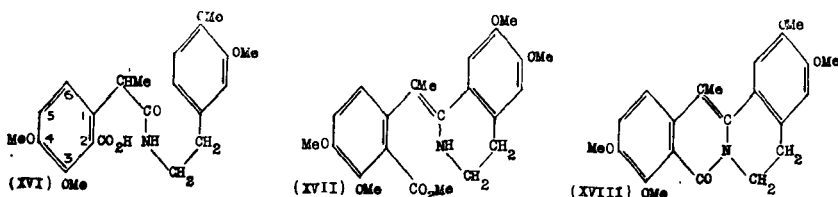

Shortly afterwards Späth and Kruta²¹ taking advantage of the fact that although alkyloxy bases of the type (XIX) condense with formaldehyde to give products of type (XX) and are therefore unsuitable for the synthesis of tetrahydroberberines, the non-alkylated tetrahydropapaverones (XIX: R = R' = OH) condense with formaldehyde at positions 2 or 6 to give products, which on alkylation furnish equal amounts of types (XX, R = R' = OMe) and (XXI, R = R' = OMe).

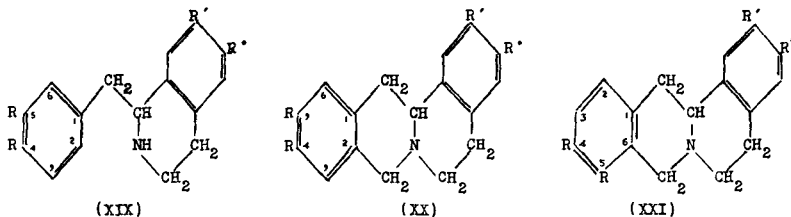

Papaverine was condensed with formaldehyde to methylenepapaverine (XXII), which on successive catalytic and electrolytic hydrogenation yielded two *dl*-methyltetrahydropapaverines (XXIII), which on successive demethylation, condensation with formaldehyde and re-methylation yielded a mixture of bases, from which the two optically inactive corydalines (XXIV), *mesocorydaline*, m.p. 163–4° (*vac.*), and *dl*-corydaline, m.p. 132–3°, identical with the products obtained by the hydrogenation of dehydrocorydaline¹⁵ were isolated. For the conversion of corycavine to corydaline, see p. 304.

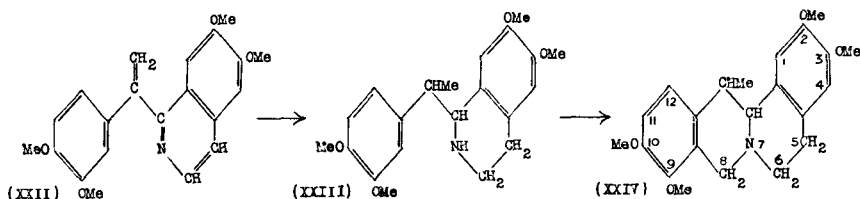

Corybulbine, $C_{21}H_{25}O_4N$. (Items 8, 23, 31; list, p. 170.) This alkaloid isolated from commercial corydaline by Freund and Josephi,²² crystallises from boiling alcohol in colourless needles, m.p. 238°, $[\alpha]_D + 303.3^\circ$ ($CHCl_3$), is slightly soluble in methyl alcohol or ether and readily soluble in chloroform, acetone or hot benzene. The hydrochloride, B.HCl, is slightly soluble in hot water, from which it crystallises in yellowish prismatic crystals, m.p. 245–50° (*dec.*). The platinichloride and aurichloride are amorphous. When treated with iodine, corybulbine is oxidised to dehydrocorybulbine hydriodide, $C_{21}H_{21}O_4N \cdot HI$, m.p. 210–1°. The base is crystalline, has m.p. 175–8°, and on reduction regenerates an optically inactive corybulbine,²³ m.p. 220–2°. On *O*-methylation corybulbine is converted into corydaline, from which it differs in possessing a hydroxyl in place of a methoxyl group, as is shown by the solubility of the alkaloid in alkalis and the formation of acetylcorybulbine, m.p. 160°. Dobbie, Lauder and

Paliatseas²⁴ suggested that the hydroxyl group must be at C² or C³ in the corydaline formula (XXIV) (for constitution *see below*).

isocorybulbine, C₂₁H₂₅O₄N (item 31 ; list, p. 172), first obtained by Gadamer and Ziegenbein,²⁵ was subsequently examined by Bruns.²³ It separates from alcohol in colourless leaflets, m.p. 179–80°, [α]_D + 299·8° (CHCl₃), and closely resembles corybulbine. It contains three methoxyl groups, and on oxidation with iodine yields dehydro*isocorybulbine*; the hydriodide of the latter is reduced by zinc and sulphuric acid to *dl-isocorybulbine*, m.p. 165–7°.

Constitution of Corybulbine and isocorybulbine. Späth and Dobrowsky¹¹ found that on treatment with diazomethane both alkaloids yielded *d*-corydaline so that, as Bruns had already suggested, the only difference between the two must be in the position of the hydroxyl group. The same authors found that the ethyl ethers of the two alkaloids on drastic oxidation yield the methyl ethyl ether of *nor-m*-hemipinic acid, characterised as the ethylimide, m.p. 205°, and identified by comparison with the acid synthesised by a process which leaves no doubt as to its constitution, C₆H₂[(COOH)₂(OMe)(OEt) = 1 : 2 : 4 : 5]. On gentle oxidation corybulbine ethyl ether is converted into 7-methoxy-6-ethoxy-1-keto-1 : 2 : 3 : 4-tetrahydroisoquinoline, whereas *isocorybulbine* ethyl ether yields 6-methoxy-7-ethoxy-1-keto-1 : 2 : 3 : 4-tetrahydroisoquinoline: these substances, which are homologues of corydaline (p. 286), were synthesised for identification. It follows that corybulbine is corydaline (XXIV) with the methoxyl group at C³ replaced by a hydroxyl, whilst in *isocorybulbine* the hydroxyl replaces methoxyl at C². These results were confirmed by independent, but in part similar, investigations by von Bruchhausen²⁶ and by Gadamer.²⁷ Späth and Holter²⁸ subsequently prepared both corybulbine and *isocorybulbine* by partial demethylation of corydaline.

Thalictrifoline, C₁₈H₁₆N(CH₂O₂)(OMe)₂. (Item 29 ; list, p. 172.) M.p. 155°, [α]_D²⁵ + 218° (MeOH). On conversion into and reduction of the quaternary iodide, *dl*-thalictrifoline, m.p. 151°, is formed. On oxidation by permanganate, thalictrifoline yields *m*-hemipinic acid. On demethylation, followed by methylation of the two hydroxyl groups so formed, a stereoisomeride, m.p. 158°, of corydaline is formed, which by the usual process of conversion to the quaternary iodide followed by reduction, is converted into *mesocorydaline*, m.p. 161°. Thalictrifoline is therefore corydaline (XXIV) with the two methoxyl groups at C₉ and C₁₀ replaced by a dioxymethylene group.^{28(a)}

Dehydrothalictrifoline (item 29 ; list, p. 172) was isolated as the quaternary chloride, chocolate-brown, stout prisms, m.p. 271°, which was reduced by zinc in boiling dilute hydrochloric acid to *dl*-thalictrifoline, m.p. 151°, identical with that described above.^{28(a)}

Scoulerine (2 : 9-dihydroxy-3 : 10-dimethoxytetrahydro*protoberberine* C₁₉H₂₁O₄N. This name was suggested by Manske²⁹ for an alkaloid the *d*-form of which was isolated by Knörck²⁹ (No. 31 ; list, p. 172) and subsequently investigated by Gadamer, Späth and Mosettig.³⁰ Later Manske isolated the *l*-form from a number of plants (Nos. 10, 16, 17, 24,

26; list, pp. 170-1). The *l*-form has m.p. 204°, yields a hydrochloride, m.p. 268-9° and a diethyl ether, m.p. 155°. Gadamer *et al.*³⁰ showed that Knörck's *d*-scoulerine contained two methoxyl groups and on methylation yielded *d*-tetrahydropalmatine. The diethyl ether on gentle oxidation gave 6-methoxy-7-ethoxy-1-keto-1 : 2 : 3 : 4-tetrahydroisoquinoline and on drastic oxidation produced a mixture of 5-methoxy-4-ethoxy- and 4-methoxy-3-ethoxy-phthalic acids, both isolated and identified as the ethylimides. These facts are in harmony with the representation of scoulerine by formula (XXV), $R^1 = R^3 = OH$; $R^2 = R^4 = OMe$).

Manske has isolated from several papaveraceous plants an alkaloid *aurotensine* (items 9, 19, 23, 44, 47, 48; list, pp. 170-3) which occurs in rhombic plates, m.p. 128° [α]_D - 69.9° and appears to be an addition compound of *l*- and *dl*-scoulerine (Manske²⁹). Its dimethyl ether (*caseanine* item 10; list, p. 170), m.p. 115-6° (hydrated) or 142° (ex benzene) must be tetrahydropalmatine (p. 292) and *casealutine*, found with caseanine, was shown later by Manske to be *l*-isocorypalmine.

d-Tetrahydrocolumbamine (*isoCorypalmine*; *2-hydroxy-3 : 9 : 10-trimethoxytetrahydroprotoberberine*), C₂₀H₂₃O₄N. (Items 10, 15, 18, 20, 23, 31; list, pp. 170-1.) A minute quantity of this alkaloid isolated by Knörck²⁹ was investigated by Gadamer, Späth and Mosettig.³⁰ It crystallises from methyl alcohol, has m.p. 239-41° (this and the following m.ps. are determined *in vacuo*), is dextrorotatory and contains three methoxyl groups. Its identity was established by its preparation from *d*-canadine (XXVI). The latter was demethylenated³¹ to the 2 : 3-dihydroxy-base, C₁₇H₁₃(OH)₂(OMe)₂N, m.p. 252-3°, and this methylated by means of diazomethane, producing a mixture of the fully methylated base *d*-tetrahydropalmatine (XXVII) with the two partially methylated bases, corypalmine (XXV: $R^2 = \cdot OH$ (*see below*)) and the required substance, m.p. 239-41°, alone or 240-1° mixed with the natural alkaloid, which must therefore be represented by formula (XXV: $R^1 = OH$; $R^2 = R^3 = R^4 = OMe$). *l*-Tetrahydrocolumbamine was similarly prepared from *l*-canadine; it had m.p. 241-2° and the *dl*-form had m.p. 221-2° and mixed m.p. 222-3°, with *dl*-tetrahydrocolumbamine. The *l*- and *dl*-forms of *isocorypalmine* also occur naturally (*see items quoted above*).

It may also be noted that Manske's base F 51 (item 22; list, p. 171) is isomeric with the two corypalmines and like them methylates to tetrahydropalmatine.

d-Corypalmine (*d-tetrahydrojatrorrhizine*; *3-hydroxy-2 : 9 : 10-trimethoxytetrahydroprotoberberine*), C₂₀H₂₃O₄N. (Items 10, 11, 20, 21, 29, 31, 39; list, pp. 170-2.) This alkaloid isolated by Späth, Mosettig and Tröthandl³² forms minute colourless crystals, m.p. 235-6°, [α]_D^{16°} + 280° (CHCl₃), and on methylation with diazomethane yields *d*-tetrahydropalmatine. The position of the hydroxyl group was established by Späth and Mosettig,³³ who treated corypalmine with diazoethane and oxidised the resulting corypalmine ethyl ether with permanganate to 7-methoxy-6-ethoxy-1-keto-1 : 2 : 3 : 4-tetrahydroisoquinoline. As mentioned under tetrahydrocolumbamine (*see above*) in the preparation of the latter alkaloid from

d-canadine (XXVI) there is simultaneously produced *d*-corypalmine,³⁰ m.p. 234–5°. Similarly in the preparation of *l*-tetrahydrocolumbamine from *l*-canadine, *l*-corypalmine, m.p. 235–7°, is also obtained. *dl*-Corypalmine obtained by crystallising an equimolecular mixture of the two forms, has m.p. 215–7°, alone or mixed with *dl*-tetrahydrojatrorrhizine from calumba roots. Though *d*-corypalmine was the form first described the *l*- and *dl*- forms also occur naturally (*see items quoted above*). These facts establish formula (XXV : R² = .OH ; R¹ = R³ = R⁴ = OMe) for corypalmine.

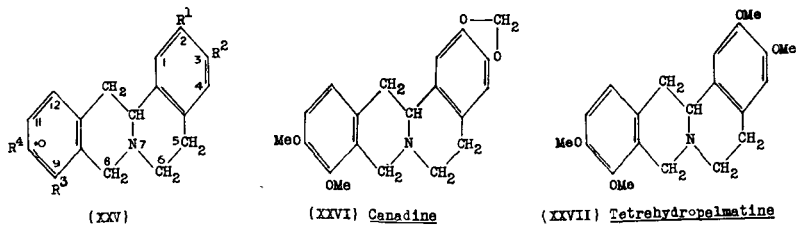

d-Tetrahydropalmatine, C₂₁H₂₅O₄N. (Items 8, 9, 14–18, 20, 22, 23, 31 ; list, pp. 170–2.) This alkaloid was isolated by Späth, Mosettig and Tröthandl.³² It melts at 142°, has $[\alpha]_D^{17} + 292.5^\circ$ (EtOH), and though colourless, develops a yellow tint on exposure to air. The crystals are triboluminescent. The hydrochloride, B . HCl, is sparingly soluble in water. On oxidation with iodine in alcohol at 100°, it yields palmatine iodide. The authors point out that alkaloids melting at temperatures near 142° have been isolated by Haars, Gaebel and Heyl, which may also prove to be *d*-tetrahydropalmatine.³⁴ The base and its *l*- and *dl*-stereoisomerides were prepared by Späth and Mosettig³⁵ by demethylenating *d*-, *l*- and *dl*-canadines, producing the three forms of 2 : 3-dihydroxy-9 : 10-dimethoxy-tetrahydroprotoberberine having m.p. 249–50° (*vac.*), $[\alpha]_D^{13} + 307^\circ$ (EtOH) ; m.p. 249–50° (*vac.*) and m.p. 260–2° (*vac.*, *dec.*) respectively. These on complete *O*-methylation furnished the three forms of tetrahydropalmatine, of which the *d*-isomeride, m.p. 141–2° (*vac.*), $[\alpha]_D^{14} + 288.9^\circ$, proved to be identical with the natural alkaloid. The *l*-form had m.p. 141–2° (*vac.*), $[\alpha]_D - 290.8^\circ$ (EtOH) and the *dl*-form m.p. 147.5–148.5° (*vac.*). The *dl*-base has also been resolved into its components,³⁶ the *d*-base, $[\alpha]_D^{20} + 291^\circ$ (EtOH), separating first as the *d*-hydrogen tartrate, and the *l*-base, $[\alpha]_D - 294^\circ$ (EtOH) being obtained from the mother liquors as *l*-hydrogen tartrate. Tetrahydropalmatine is therefore represented by (XXVII). Späth and Kruta³⁶ prepared *dl*-tetrahydropalmatine by the process described for *meso*- and *dl*-corydalines (p. 289) and by condensing tetrahydropapaveroline with formaldehyde and methylating the product, obtained in poor yield a mixture of *nor*coryalydine (type XX, p. 289) and tetrahydropalmatine.

Haworth, Koepfli and Perkin³⁷ have shown that, like other alkaloids of the *protoberberine* series, tetrahydropalmatine is convertible by the general process (p. 302) into an alkaloid of the *cryptopine* type. The

product, called *cryptopalmatine*, $C_{22}H_{27}O_5N$, crystallises from ether in colourless prisms, m.p. $148-50^\circ$, and like cryptopine gives a characteristic reddish-violet colour with sulphuric acid. A complete synthesis of tetrahydropalmatine by the same authors is described under palmatine (p. 342).

d-Tetrahydrocoptisine, $C_{19}H_{17}O_4N$. (Items 8, 28, 31, 44; list, pp. 170-3.) This alkaloid isolated by Späth and Julian,³⁸ has m.p. $203-4^\circ$ (*vac.*), $[\alpha]_D^{15^\circ} + 310^\circ$ ($CHCl_3$) and is sparingly soluble in alcohol. It contains methylenedioxy- but no methoxyl or methylimino-groups, and on oxidation with iodine in alcohol is converted into a yellow quaternary iodide (coptisine iodide), which can be reduced to *dl*-tetrahydrocoptisine, m.p. $227-8^\circ$, identical with the reduction product of natural coptisine.³⁹ The *dl*-base was resolved by the use of *d*-bromo-camphor- π -sulphonic acid in dilute acetic acid, which separates the *l*-base, m.p. $203-4^\circ$ (*vac.*), $[\alpha]_D^{15^\circ} - 310^\circ$ ($CHCl_3$); from the mother liquors the *d*-base, identical with the natural alkaloid, is obtained after a difficult separation as the *d*-tartrate. It had m.p. $203-4^\circ$ alone or mixed with the natural *d*-base and $[\alpha]_D^{15^\circ} + 310\cdot5^\circ$. It is of interest to note that Haworth and Perkin⁴⁰ in the course of their synthesis of protopine (p. 301) prepared 2 : 3 : 9 : 10-*bismethylenedioxy*-tetrahydroprotuberberine, colourless slender prisms, m.p. 219° , which is no doubt *dl*-tetrahydrocoptisine. The reverse process has been carried out by Späth and Posega,⁴¹ who reduced protopine to the corresponding carbinol base, which on evaporation in solution in hydrochloric acid yielded a quaternary salt from which *dl*-tetrahydrocoptisine was obtained by distillation in a high vacuum. This is a special application of the process by which Perkin⁴² converted the β -modification of tetrahydroanhydroberberine methochloride into tetrahydroanhydroberberine and of which other examples will be found in the cryptopine sub-group (p. 294).

Manske⁴³ has shown that the *stylopine* of Schlotterbeck and Watkins,⁴³ $C_{19}H_{19}O_5N$, m.p. 202° , $[\alpha]_D - 315\cdot2^\circ$ (item 61; list, p. 173), is *l*-tetrahydrocoptisine; he has recorded its presence in three other plants (items 12, 15, 44; list, pp. 170-3) and suggested that *diphylline* (item 61) is *dl*-stylopine, *i.e.*, *dl*-tetrahydrocoptisine. He has also proposed that the name stylopine being simpler than, and having priority over tetrahydrocoptisine, should replace the latter. Each of these names is used in the lists (pp. 169-173), as recorded by the author concerned, in order to avoid confusion.

Other members of this sub-group, usually more closely associated with berberine in distribution, or in structure, or both, and therefore dealt with in the Berberis group, are canadine (p. 336), capaurine (p. 339), cheilanthifoline (p. 339), ophiocarpine (p. 338), sinactine (p. 338), "tetrahydroshobakunine" (p. 340) and tetrahydroworenine (p. 344).

Pharmacological Action. According to Peters,⁴⁴ corydaline, corybulbine and *isocorybulbine* cause narcosis in frogs, followed by paralysis of the spinal cord and weakening of the heart's action. In warm-blooded animals little or no narcosis is produced, the blood pressure falls for a time as a result of damage to the heart and peripheral vaso-dilatation. Corydaline appears to be the most active of the three alkaloids. Anderson and Chen⁴⁵ record the following figures (mgm./kilo) for L.D.50 by intravenous injection

in mice: corydaline 135.5 ± 12.8 ; *l*-isocorypalmine, 132.6 ± 5 ; *d*-, *dl*- and *l*-tetrahydropalmatine, 126.0 ± 4.96 ; 121.5 ± 6.65 ; 110.9 ± 7.88 respectively. All the alkaloids stimulated isolated guinea-pig or rabbit uterus. Corydaline and *l*-isocorypalmine stimulated intestines in weak but inhibited them in strong solution. Fall of blood pressure was induced by all the alkaloids on intravenous injections in etherised cats. There was little difference in the action of the three stereoisomeric forms of tetrahydropalmatine.

REFERENCES

- (1) (a) *Arch. Pharm.*, 1902, 240, 19; (b) *ibid.*, 1927, 265, 675; (c) *Canad. J. Res.*, various papers, 1933-36. (2) WACKENRODER, *Berz. Jahrb.*, 1826, 7, 220; WICKE, *Annalen*, 1866, 137, 274. (3) *Inaug. Diss. Dorpat*, 1888. (4) *J. Chem. Soc.*, 1892, 61, 244. (5) *Annalen*, 1893, 277, 1. Cf. ZIEGENBEIN, *Arch. Pharm.*, 1896, 234, 492; MARTINDALE, *ibid.*, 1898, 236, 214. (6) DOBBIE and LAUDER, *J. Chem. Soc.*, 1902, 81, 145; 1903, 83, 605. Cf. HAARS, *Arch. Pharm.*, 1905, 243, 165. (7) DOBBIE and MARSDEN, *J. Chem. Soc.*, 1897, 71, 665. (8) *Ibid.*, 1924, 125, 632. (9) *Arch. Pharm.*, 1905, 243, 165. (10) DOBBIE and LAUDER, *J. Chem. Soc.*, 1899, 75, 670; cf. PERKIN, *ibid.*, 1890, 57, 1027. (11) *Ber.*, 1925, 58, 1274. (12) *J. Chem. Soc.*, 1934, 1263. (13) SCHMIDT, *Arch. Pharm.*, 1896, 234, 489; HAARS, *ibid.*, 1905, 243, 165. Cf. DOBBIE and MARSDEN, *J. Chem. Soc.*, 1897, 71, 659. (14) GADAMER and WAGNER, *Arch. Pharm.*, 1902, 240, 19. Cf. HAARS, 1905, 243, 165. (15) GADAMER and KLEE, *ibid.*, 1916, 254, 295. (16) *Ber.*, 1921, 54, 3074; cf. GADAMER, *Arch. Pharm.*, 1915, 253, 274; 1916, 254, 295. (17) *Ibid.*, 1921, 259, 246; cf. KOEPLI and PERKIN, *J. Chem. Soc.*, 1928, 2989. (18) *Annalen*, 1923, 433, 138. (19) *Arch. Pharm.*, 1923, 261, 31; (with STIPLER), *ibid.*, 1927, 265, 152. (20) FREUND *et al.*, *Annalen*, 1913, 397, 1; 1915, 409, 188; 1916, 411, 1. (21) *Ber.*, 1929, 62, 1024. (22) *Annalen*, 1893, 277, 1. (23) BRUNS, *Arch. Pharm.*, 1901, 239, 39; 1903, 241, 634. (24) *J. Chem. Soc.*, 1901, 79, 87. (25) *Arch. Pharm.*, 1902, 240, 19. (26) (With SAWAI), *ibid.*, 1925, 263, 602; (with STIPLER), *ibid.*, 1927, 265, 152. (27) (With SAWAI), *ibid.*, 1926, 264, 401. (28) *Ber.*, 1926, 59, 2800. (28a) MANSKE, *Can. J. Res.*, 1936, B, 14, 347, 354; 1938, B, 16, 81, 153; 1939, B, 17, 89; 1940, B, 18, 414; 1943, B, 21, 111. (29) KNÖRCK, *Inaug. Diss. Marburg*, 1926. (30) *Arch. Pharm.*, 1927, 265, 675. (31) SPÄTH and MOSETTIG, *Ber.*, 1927, 60, 383. (32) *Ibid.*, 1923, 56, 877. (33) *Ibid.*, 1925, 58, 2133; cf. SPÄTH and DUSCHINSKY, *ibid.*, 1939. (34) *Arch. Pharm.*, 1905, 243, 162; 1910, 248, 220; 1903, 241, 318. (35) *Ber.*, 1926, 59, 1496. (36) SPÄTH (with LEITHE), *ibid.*, 1930, 63, 3007; (with KRUTA), *Monats.*, 1928, 50, 341. (37) *J. Chem. Soc.*, 1927, 2261. (38) *Ber.*, 1931, 64, 1131. (39) KITASATO, *Proc. Imp. Acad. Tokyo*, 1926, 2, 124. (40) *J. Chem. Soc.*, 1926, 1780; *ibid.*, 1927, 548 (footnote). (41) *Ber.*, 1929, 62, 1029. (42) *J. Chem. Soc.*, 1918, 113, 496. (43) SCHLOTTERBECK and WATKINS, *Ber.*, 1902, 35, 7; MANSKE, *Can. J. Res.*, 1939, B, 17, 89; 1942, B, 20, 53; cf., Go, *J. Pharm. Soc. Jap.*, 1930, 50, 933. (44) *Arch. exp. Path. Pharm.*, 1904, 51, 130; cf. GADAMER, *Arch. Pharm.*, 1905, 243, 150. (45) ANDERSON and CHEN, *Fed. Proc.*, 1946, 5, 163.

Cryptopine Sub-Group

This series of ten alkaloids may appropriately be called the cryptopine sub-group, since the characteristic nuclear structure of the type was first made clear by Perkin's investigation of cryptopine. They are closely related to the protoberberines, with which they are interconvertible by two characteristic reactions, which have been of great value in their investigation. The two alkaloids formerly known as β - and γ -homochelidonines have now been renamed α - and β -allocryptopines respectively to distin-

guish them from homochelidonine (α -homochelidonine) which belongs to the chelidonine sub-group (p. 277).

Cryptopine, $C_{21}H_{23}O_5N$. (Items 18, 24, 25, 26, 34, 35, 38, 58; list, pp. 171-3.) This alkaloid was first obtained as the acid oxalate from thebaine residues by J. Smiles in Messrs. T. and H. Smith's laboratories.¹ According to Pictet and Kramers,² commercial papaverine frequently contains up to 4 per cent. of cryptopine, and to this are due some of the colour reactions ascribed to papaverine and possibly to other alkaloids of opium. It crystallises from alcohol in prisms, m.p. $220-1^\circ$ (*corr.*), $[\alpha]_D \pm 0^\circ$, is soluble in boiling alcohol (1 in 80), but sparingly soluble in ether or benzene. The salts separate as jellies, but can usually be crystallised by warming the liquid. The hydrochloride, B. HCl . 5 (or 6) H_2O , forms gelatinous masses of feathery crystals and is soluble in water or chloroform: the oxalate, B. $H_2C_2O_4$. $4H_2O$, is a characteristic salt and is used for the purification of the alkaloid. The aurichloride forms brownish-yellow needles, m.p. 205° (*dec.*); the platinichloride concentrically arranged needles, m.p. 204° (*dec.*), and the picrate, yellow needles, m.p. $161-3^\circ$.³ With sulphuric acid cryptopine gives a violet colour, changing to green on warming to 150° .

The investigations of Pictet and Kramers² and of Danckwörtt⁴ indicated that cryptopine was a saturated base, contained a methylimino-group, two methoxyl groups, possibly a carbonyl, but no hydroxyl group. No direct evidence of a methylenedioxy group was obtained, but since the alkaloid gave Gaebel's⁵ reaction and a green coloration with sulphuric and gallic acids,⁶ it was assumed that such a group was present. In 1891, Rainy Brown and Perkin⁷ showed that the alkaloid yielded *m*-hemipinic acid on oxidation with permanganate. This remained virtually the only observation bearing on the nuclear structure of the alkaloid up to 1916, when W. H. Perkin began the publication of the results of a long and ingenious investigation of this alkaloid.⁸ In the first paper it is shown that after numerous attempts to obtain evidence of the presence of a piperonyl group by hydrolytic and oxidation experiments, the difficulty was solved by converting cryptopine into the methosulphate, $C_{21}H_{23}O_5N$. Me_2SO_4 , reducing this in acid solution with sodium amalgam to tetrahydromethylcryptopine, $C_{22}H_{29}O_5N$, m.p. 107° , from which acetyl chloride eliminates water yielding anhydrotetrahydromethylcryptopine, $C_{22}H_{27}O_4N$, m.p. 107° . This substance on oxidation with dry potassium permanganate in acetone yielded four products:

- (A) 4 : 5 - Dimethoxy - 2 - β - dimethylaminoethylbenzaldehyde, $(CH_3O)_2 \cdot C_6H_2(CHO) \cdot CH_2 \cdot CH_2 \cdot NMe_2$, which is *N*-methylhydrastinine (p. 165), in which a methylenedioxy group has been replaced by two methoxyl groups.
- (B) 5 : 6-Methylenedioxy-*o*-tolualdehyde, $CH_2 : O_2 : C_6H_2Me \cdot CHO$.¹
- (C) *N*-Formyl-4 : 5-dimethoxy-2- β -methylaminoethylbenzoic acid, $(CH_3O)_2 \cdot C_6H_2(COOH) \cdot CH_2 \cdot CH_2 \cdot NMe \cdot CHO$.
- (D) 5 : 6-Methylenedioxy-*o*-toluic acid.

The formation of (A) and (C) indicates that cryptopine must have in its structure the grouping I, whilst the production of (B) and (D) shows that the alkaloid must also contain the piperonyl ring in the form of grouping II, and from these the structure of anhydrotetrahydromethylcryptopine is represented by formula III :

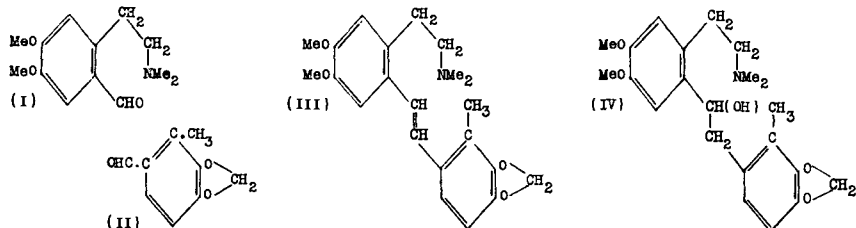

and, as this is formed from tetrahydromethylcryptopine by loss of water, formula IV for the latter is obtained by addition of the elements of water at the ethylenic linkage, and evidence is produced that this change takes place as shown.

Confirmatory evidence up to this point was obtained by treating anhydrotetrahydromethylcryptopine methosulphate with methyl alcoholic potassium hydroxide, which furnished trimethylamine and a non-nitrogenous substance, cryptopidene, $C_{20}H_{20}O_4$, m.p. 124° , which on oxidation with permanganate yielded 5 : 6-methylenedioxy-*o*-tolualdehyde (II) and the corresponding acid, as well as 4 : 5-dimethoxyvinylbenzaldehyde (V) with *m*-opianic and *m*-hemipinic acids, from which the formula of cryptopidene (VI) is built up as follows :

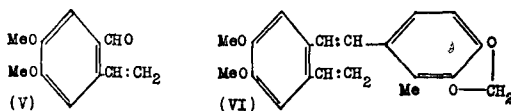

When cryptopine, dissolved in dilute sulphuric acid, is boiled with sodium amalgam, it is reduced to dihydrocryptopine (*cf.* Danckwortt ⁴), $C_{21}H_{25}O_5N$, m.p. $187-8^\circ$, which on treatment with acetyl chloride or phosphoryl chloride yields two isomeric quaternary chlorides (α - and β -) of *isodihydrocryptopine*, $C_{21}H_{24}O_4NCl$. These two quaternary chlorides are isomeric with the two tetrahydroanhydroberberine methochlorides and differ only in the interchange of position between the methylenedioxy and the two methoxy groups. Careful comparison of the two pairs of isomerides and their derivatives shows complete parallelism between the two ; thus the two cryptopine quaternary chlorides yield two anhydrocryptopines, *A*, m.p. 178° , and *B*, m.p. 127° , analogous with the two tetrahydroanhydroberberines (p. 336).

On these and other grounds Perkin represented cryptopine, dihydrocryptopine and *isodihydrocryptopine* chloride by the following formulæ :

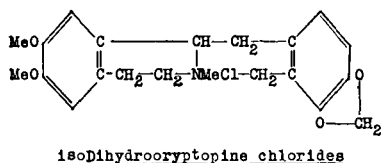
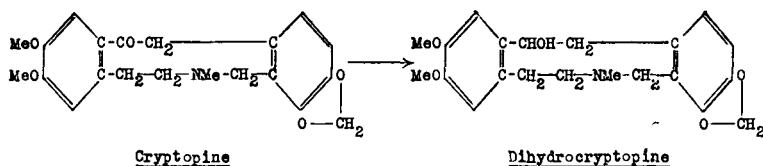

and the formation of the two anhydrodihydrocryptoptines by the following partial formulæ, to which those of the *N*-methylisotetrahydroberberines

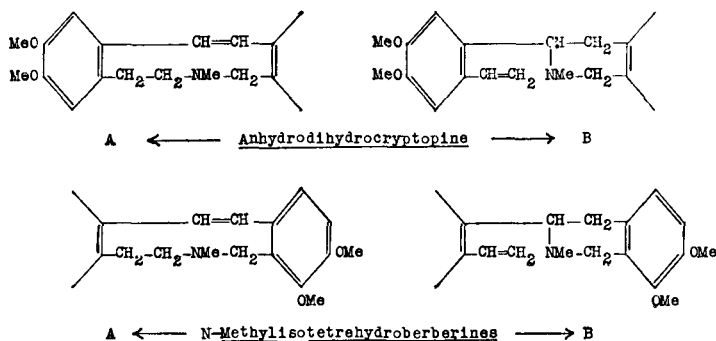

(p. 337) have been added, to illustrate the parallelism between the two series.

This parallelism between the derivatives of berberine and cryptoptine was fully investigated by Perkin in two particularly interesting directions. The formulæ assigned to the two parent alkaloids and to the chlorides of *isocryptoptine* and berberinium, represent cryptoptine as related to an alkaloid isomeric with berberinium hydroxide, which Perkin named *epiberberine*, and which he prepared by de-*N*-methylating *isocryptoptine* chloride, producing dihydroanhydro*epiberberine*, which closely resembles dihydroanhydroberberine, and from which *epiberberine* can be obtained by the action of mild oxidising agents such as iodine or mercuric acetate⁹.

The reverse change, *viz.*, the conversion of berberine derivatives by *N*-methylation into substances constituted similarly to corresponding derivatives of cryptoptine, was achieved by the methylation of dihydroanhydroberberine, to the methochloride, which corresponds to *isocryptoptine* chloride and resembles it closely in character and reactions.¹⁰

From this a number of new substances closely resembling the corresponding cryptoptine derivatives have been prepared.

The synthesis of cryptopine was effected by Haworth and Perkin ¹¹ by a process first used by the same authors in the preparation of α -allo-cryptopine (β -homochelidonine) ¹² (p. 301). 3:4-Methylenedioxyhomophthalic acid was condensed with β -veratrylethylamine to yield *N*- β -veratrylethyl-3:4-methylenedioxyhomophthalimide, which on careful

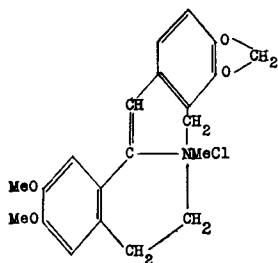
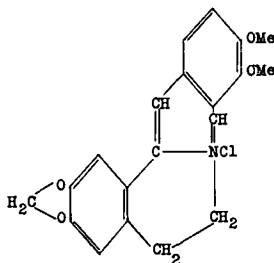
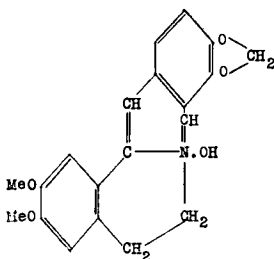
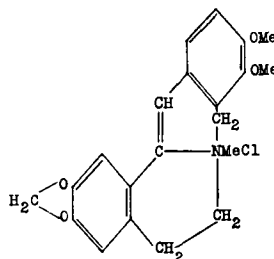
isocryptopine chlorideBerberinium chlorideopiberberinium hydroxideDihydroanhydroberberine methochloride

hydrolysis by sodium hydroxide was converted into the corresponding phthalamic acid (VII), the methyl ester of which undergoes double ring closure to an oxyberberine (p. 332) analogue represented by (VIII), since condensation in the *para*-position to a methoxyl group is far more probable than the like change at the *ortho*-position, and in fact, the substance (VIII) $C_{20}H_{17}O_5N$, m.p. 240° , is identical with oxyepiberberine, prepared from isocryptopine chloride by a general method developed by Perkin ¹³ (cf. oxyberberine, p. 336). Oxyepiberberine on electrolytic reduction yields a colourless base, $C_{20}H_{21}O_4N$, m.p. 170° , which Perkin had already prepared

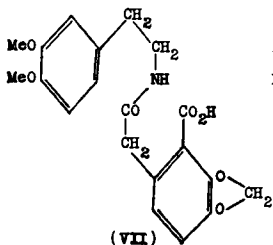

(VII)

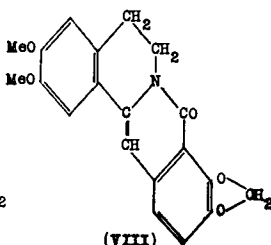

(VIII)

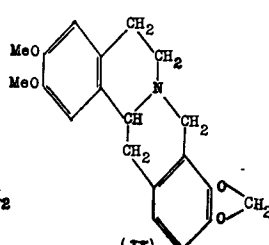

(IX)

from *isocryptopine* chloride and named tetrahydroanhydro*epiberberine* (IX), the *l*-form of which is the alkaloid *sinactine* (p. 338).

The methochloride of (IX) occurs in two forms, identical with the α - and β -forms of *isodihydrocryptopine* chloride (X). The two chlorides were converted into the two anhydrodihydrocryptopines A and B (p. 297). Of these the A base was oxidised by perbenzoic acid to the amine oxide (XI), m.p. 135° (*dec.*), and this on heating with acetic and hydrochloric acids passed into *cryptopine* (XII), m.p. 220–1°, identical in all respects with the natural alkaloid.

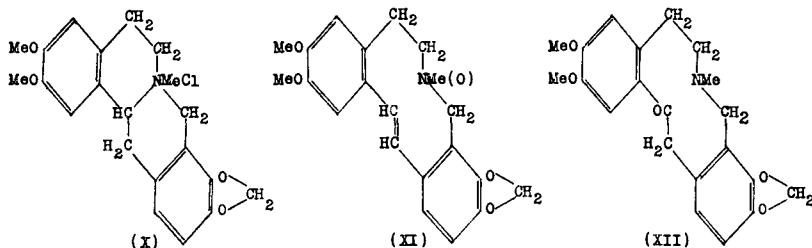

Cryptocavine, $C_{18}H_{15}ON(CH_2O_2)(OMe)_2$. (Items 19, 21, 34, 44; list, pp. 171–3.) M.p. 223°, $[\alpha]_D \pm 0^\circ$. The alkaloid gives the protopine type of colour reaction and is isomeric with *cryptopine*. It was degraded by the method used by Perkin for the latter alkaloid and gave the same final products, *viz.*, 4 : 5-dimethoxy-2- β -dimethylaminoethylbenzaldehyde and 5 : 6-methylenedioxy-*o*-toluic aldehyde (p. 295). From this it is concluded that *cryptocavine* is *cryptopine* (XII) with the two items of the —CO—CH₂ chain in the central 10-membered ring, reversed in position. In the degradation, the —CO—group is reduced to ·CHOH and water is lost. The product, anhydrotetrahydromethyl*cryptocavine* (m.p. 111°; B.HCl, m.p. 258–64°), should on this basis be identical with the corresponding *cryptopine* product, *viz.*, anhydrotetrahydromethyl*cryptopine* (*cf.* formulæ III, IV, p. 296). The two products were not quite identical, possibly due to *cis-trans* isomerism (Manske).^{13(a)}

Protopine (*Macleynine*, *Fumarine*), $C_{20}H_{19}O_5N$. This alkaloid was first isolated by Hesse¹⁴ from opium, but has since been recorded from plants belonging to many genera (items 1, 3a to 50, 56, 58, 60, 61; list, pp. 169–173). The best source is probably *Dicentra spectabilis*.¹⁵

The crude alkaloid is purified by conversion into the sulphate, reprecipitation by ammonia, and crystallisation from chloroform by addition of a little alcohol. It forms monoclinic crystals, m.p. 207°, $[\alpha]_D \pm 0^\circ$, dissolves readily in chloroform (1 in 15), less so in alcohol (1 in 1,000), acetone or ammonia solution. The hydrochloride, B.HCl, forms slightly soluble prisms; the nitrate, B.HNO₃, is suitable for the purification of the alkaloid, being sparingly soluble in water; the platinumchloride, B₂ · H₂PtCl₆, 2 or 4H₂O, forms warty crystals; the aurichloride (m.p. 198°) is a crystalline yellow powder. The base dissolved in acetic acid gives with strong sulphuric acid a blue-violet solution, becoming more intense

and finally changing to red on adding water; sulphovanadic acid gives a reddish-violet colour changing to deep blue. Protopine, according to Danckwortt,¹⁵ contains two methylenedioxy groups and a non-reactive carbonyl group, and differs from cryptopine by the substitution of a second methylenedioxy group for two methoxys. He provisionally represented it as 2-methyl-6:7-methylenedioxy-1-*o*-methylpiperonyl-1:2:3:4-tetrahydroisoquinoline.

These results were to a certain extent confirmed by W. H. Perkin,¹⁶ who found that both alkaloids undergo certain characteristic changes in a similar manner, and that both must be similarly constituted.

Phosphoryl chloride converts protopine into the quaternary salt isoprotopine chloride, $C_{20}H_{18}O_4NCl$, m.p. 215° (*dec.*), which on treatment with potassium hydroxide in methyl alcohol yields anhydroprotopine, $C_{20}H_{17}O_4N$, m.p. $114-5^\circ$,¹⁶ just as cryptopine is convertible into isocryptopine chloride and this into anhydrocryptopine. Similarly, protopine forms protopine methosulphate, $C_{20}H_{19}O_5N \cdot Me_2SO_4$, m.p. 252° ,¹⁵ which is converted by potassium hydroxide in methyl alcohol, into two methylprotopines, α -, m.p. 145° , and γ -, m.p. 112° , corresponding with the two methylcryptopines, α -, m.p. 153° , and γ -, m.p. 110° , respectively.¹⁶

Further, protopine in solution in dilute sulphuric acid is reduced by sodium amalgam to dihydroprotopine, $C_{20}H_{21}O_5N$, $\frac{1}{2}C_2H_5OH$, m.p. 120° , or $151-2^\circ$ (*dry*), which undergoes ring closure with benzoyl chloride or phosphoryl chloride to isodihydroprotopine chloride, $C_{20}H_{20}O_4NCl$ (partial formula IV),¹⁷ which occurs in two forms: α -, m.p. 215° ; β -, m.p. 270° , analogous with the two isodihydrocryptopine chlorides, α -, m.p. 230° (*dec.*); β -, m.p. $>260^\circ$.

These changes take place in the 10-membered ring marked b_1 and b_2 in the formula for protopine, and their character may be illustrated by

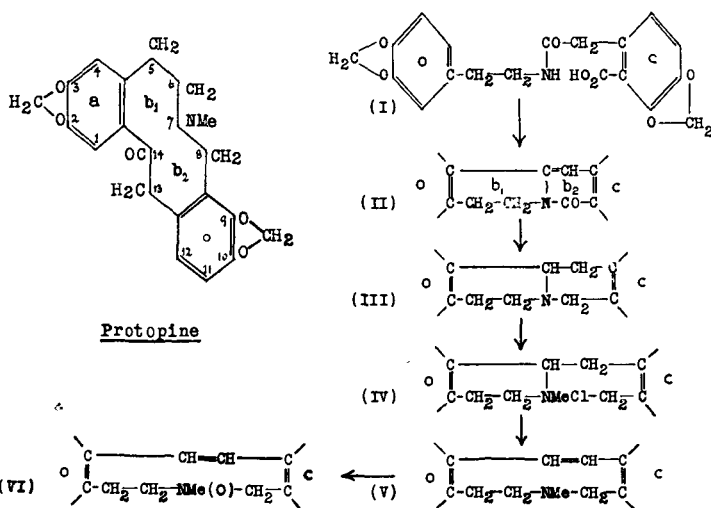

the partial formulæ (I) to (VI) used in the following brief description of Haworth and Perkin's synthesis of protopine.¹⁸

The process used is analogous with that adopted for the synthesis of cryptopine (p. 298). The methyl ester of *N*- β -piperonylethyl-3 : 4-methylenedioxyhomophthalamic acid (I), was treated with phosphoryl chloride and so converted into 2 : 3 : 9 : 10-bismethylenedioxyoxyprotoberberine (II), which was reduced electrolytically to 2 : 3 : 9 : 10-bismethylenedioxytetrahydroprotoberberine (III), of which the methochloride (IV) is identical with isodihydroprotopine chloride, which can be prepared from protopine as already stated above.

This substance under the action of alkali passed into anhydrodihydroprotopine A, C₂₀H₁₉O₄N, m.p. 120° (V), the amine oxide (VI) of which rearranges into protopine by the action of acids.

Ochrobirine, C₂₀H₁₈O₅N(OH), CH₃OH. (Items 15, 20, 26 ; list, p. 171.) The base has m.p. 138–9° or 198° (*dry*), $[\alpha]_D^{21} + 35.9^\circ$ (CHCl₃), and yields a monoacetyl derivative, m.p. 177°. On treatment with zinc-amalgam in dilute acid it changes into an isomeric base, m.p. 238°. As ochrobirine gives colour reactions similar to those of protopine, Manske suggests that it may be 13-hydroxyprotopine, *i.e.*, a hydroxyl in the methylene group contiguous to the carbonyl group.^{18(a)}

α - and β -*allo*Cryptopines (β - and γ -*Homochelidonines*). These alkaloids, now known to be stereoisomerides, have been recorded from a number of plant genera (α -form : items 1, 4, 5, 6, 7, 9, 10, 11, 21, 24, 28, 32, 35, 39, 43, 46, 49, 60 ; β -form : items 6, 7, 43, 60 ; list, p. 169). An exceptional occurrence of β -*allo*cryptopine is that in *Zanthoxylum brachyacanthum* F. Müll (Rutaceæ).¹⁹ The two alkaloids were first separated by Schmidt, Koenig and Tietz²⁰ ; their results were confirmed by Schmidt and Fischer²¹ and by Schmidt and Wintgen,²² who showed that the two were interconvertible physical isomerides.

α -*allo*-Cryptopine, C₂₁H₂₃O₅N, crystallises from acetic ether in monoclinic prisms, m.p. 159–60°, and is readily soluble in chloroform or acetic ether, less so in alcohol. The hydrochloride, B . HCl . 1½H₂O, forms colourless needles, and is readily soluble in water ; the nitrate, hydrobromide and hydriodide are also crystalline ; the platinichloride, B₂ . H₂PtCl₆ . 2½H₂O, is amorphous, but the aurichloride, B . HAuCl₄, m.p. 187°, forms blood-red crystals. The alkaloid dissolves in sulphuric acid, forming a yellow solution changing to violet- and carmine-red. It is a tertiary base, yields two methiodides, m.p. 185° and m.p. 211°, and contains two methoxyl groups.

β -*allo*-Cryptopine, C₂₁H₂₃O₅N. This form crystallises with ½ mol. of alcohol in colourless needles, m.p. 170–1° (*dry*), $[\alpha]_D \pm 0^\circ$. The hydrochloride, B . HCl . 1½H₂O, forms small colourless needles, m.p. 175° (*dec.*), and the aurichloride, B . HAuCl₄, blood-red, warty crystals, m.p. 192° (*dec.*) ; the latter is said to be identical with the aurichloride of the α -form.²¹ The methiodide, B . CH₃I . 2½H₂O, forms yellow prisms ; the alkaloid is a tertiary base and contains two methoxyl groups, a methylenedioxy group and a methylimino group.¹⁹

Constitution. Gadamer²³ found that α -allocryptopine when warmed with phosphoryl chloride passed into dihydroberberine methochloride, $C_{20}H_{19}O_4N \cdot CH_3Cl$, colourless needles, m.p. $200-1^\circ$, a reaction analogous with the conversion of cryptopine into isocryptopine chloride (p. 298). Similarly α -allocryptopine on reduction by sodium amalgam and dilute sulphuric acid gave a dihydrobase, m.p. $167-8^\circ$, which with phosphoryl chloride yielded tetrahydroanhydroberberine methochloride, $C_{21}H_{24}O_4NCl \cdot 3H_2O$, m.p. $249-51^\circ$ (cf. p. 336). These changes Gadamer explained by formula (III) for α -allocryptopine, which it will be seen is that of *epicryptopine*, or cryptopine in which the positions of the methylenedioxy-group and two methoxyl groups have been interchanged. In view of this similarity Gadamer suggested that the names β - and γ -homochelidonine should be replaced by α - and β -allocryptopine respectively.

This formula was confirmed by Haworth and Perkin's¹² synthesis of α -allocryptopine from berberine, the first application of a process, of which examples have been given already in the syntheses of cryptopine (p. 298) and protopine (p. 301) by the same authors. Anhydrotetrahydromethylberberine (I: cf. base (a), p. 346) in dry chloroform was added to a solution of perbenzoic acid in ether cooled below 5° . The amine oxide, $C_{21}H_{23}O_5N$ (II), separated as an oil, which after shaking with sodium hydroxide solution, solidified and was crystallised from water in slender prisms, m.p. 135° . It was dissolved in acetic acid, hydrochloric acid added, the mixture heated in boiling water for an hour and the base precipitated by addition of potassium hydroxide. The precipitate was dissolved in methyl alcohol, ether added, the alcohol washed out with water and the ethereal

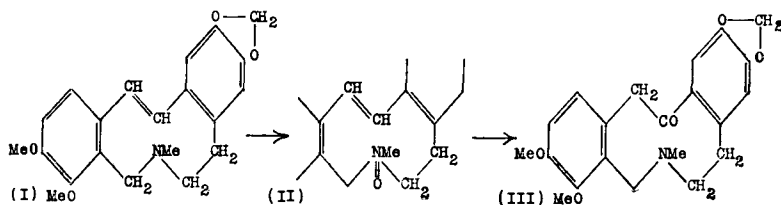

solution dried over potassium carbonate. On concentrating the dry ethereal solution β -homochelidonine (α -allocryptopine) (III) separated; colourless, monoclinic prisms, m.p. $160-1^\circ$, alone or mixed with the natural alkaloid. It gave the colour reactions of α -allocryptopine, yellow changing to violet and bright red with sulphuric acid, yellow changing to violet, blue and green with Frohde's reagent and yellow becoming violet and dirty violet with Erdmann's reagent. The hydrochloride crystallised from alcohol on addition of ether in silky needles, which turned yellow at 170° and decomposed at 190° (approx.); the aurichloride crystallised from alcohol in warts of garnet-red crystals, m.p. $190-2^\circ$ (dec.).

Hunnemannine, $C_{18}H_{18}ON(OH)(OMe)(CH_2O_2)$. (Item 49; list, p. 173.) M.p. 209° . Diazomethane converts the base into α -allocryptopine, m.p. $159-60^\circ$, so that hunnemannine appears to be *O*-demethyl- α -allocryptopine. The ethyl ether has m.p. 168° and on degradation by the method

used by Perkin for cryptopine (p. 295) eventually yields 4-methoxy-3-ethoxy-*o*-toluic acid, m.p. 175°, whence it is concluded that hunnemannine is α -allocryptopine with the methoxyl group at position C⁹ replaced by hydroxyl.^{23(a)}

Corycavine, C₂₁H₂₁O₅N. (Item 31, list; p. 172.) This alkaloid was isolated by Freund and Josephi,²⁴ and was subsequently examined by Gadamer, Ziegenbein and Wagner,²⁵ Gaebel,²⁶ Legerlotz²⁷ and Gadamer and von Bruchhausen.²⁸ It crystallises from hot dry alcohol in rhombic tablets, m.p. 217–8° or 221–2° (in a vacuous tube), $[\alpha]_D \pm 0^\circ$, and is insoluble in water, cold alcohol or alkalis. The hydrochloride, B . HCl, forms needles, m.p. 219°; the hydriodide, B . HI . H₂O, small yellowish needles, m.p. 236°; the platinichloride, (B . HCl)₂ . PtCl₄, yellowish crystals, m.p. 214° (*dec.*); the aurichloride, B . HAuCl₄, has m.p. 178–9° (*dec.*). Corycavine forms a methiodide, rhombic tablets, m.p. 218°; and behaves as a tertiary base containing a methylimino-group. It contains two methylenedioxy groups,²⁶ but no hydroxyl or methoxyl. The alkaloid dissolves in sulphuric acid, giving a dirty green solution changing to reddish violet, and in nitric acid, producing a greenish-yellow colour passing into orange-red.

Corycavamine, C₂₁H₂₁O₃N, was first obtained by Gadamer, Ziegenbein and Wagner²⁵ and can be purified by recrystallisation of the nitrate from boiling water. The free base forms rhombic columns, m.p. 149°, $[\alpha]_D^{20} + 166.6^\circ$ (CHCl₃). The hydrochloride and hydriodide crystallise in needles, but the platinichloride is amorphous. The alkaloid contains two methylenedioxy groups, but no methoxyl. When corycavamine is melted it is converted into corycavine. Both alkaloids give the same colour reactions, yield the same methine base, m.p. 153°, and are believed to be stereoisomeric.

Corycavidine, C₂₂H₂₃O₅N, was isolated by Gadamer.²⁹ It crystallises from hot chloroform with one molecule of the solvent, melts at 212–3°, has $[\alpha]_D^{20} + 203.1^\circ$ (CHCl₃), and yields a crystalline hydrochloride and nitrate, and an amorphous red aurichloride, m.p. 170° (*dec.*). It contains two methoxyl groups, one methylenedioxy-group and a methylimino-group and behaves as a tertiary base on exhaustive methylation. When heated at 209°, it is converted into an inactive modification, m.p. 193–5°. Corycavidine gives with sulphuric acid a yellow colour, becoming grey and finally greenish on warming.

Constitution of Corycavine, Corycavamine and Corycavidine. The constitution of corycavine was first investigated by Gadamer and von Bruchhausen,³⁰ who altered the formulæ, C₂₃H₂₃O₅N and C₂₃H₂₃O₆N, previously suggested for the alkaloid, to C₂₁H₂₁O₅N as now accepted, and thereby made clear its isomerism with corycavamine, and accounted for its formation from the latter by simple fusion. They also showed that on treatment with phosphoryl chloride, corycavine yielded *isocorycavine* chloride, C₂₁H₂₀O₄NCl . 3H₂O, thick, reddish-yellow needles. On reduction the alkaloid furnished dihydrocorycavine, C₂₁H₂₂O₅N, m.p. 205–6°, which like the **unreduced base** is converted by phosphoryl chloride into a

quaternary chloride, *isodihydrocorycavine* chloride, $C_{21}H_{22}O_4NCl$, bright yellow transparent crystals (*cf.* the conversion of cryptopine and dihydro-cryptopine into quaternary chlorides, p. 296). These reactions indicated a protopine-like structure for corycavine. It was also shown that by methods analogous with those mentioned under cryptopine (p. 296), corycavine can be converted into anhydrotetrahydromethylcorycavine, $C_{22}H_{25}O_4N$, needles, m.p. 50–60°, which on oxidation with potassium permanganate yields 2-methyl-3 : 4-methylenedioxyacetophenone (I) and *N*-methylhydrastinine (II) from which the formulæ (III) for anhydrotetrahydromethylcorycavine and (IV) for corycavine can reasonably be built up, though von Bruchhausen³¹ preferred the keto-form (IV) for corycavine to account for the optical activity of the latter and the enolic-form (IV with $\cdot CHMe \cdot CO \rightarrow \cdot CMe : C \cdot OH$) for corycavine. Späth and Holter³² provided an interesting confirmation of this formula for the two alkaloids by distilling *isodihydrocorycavine* iodide, $C_{21}H_{22}O_4NI$, m.p. 296–7°, at 260°/0.01 mm., when two isomeric bases, $C_{20}H_{18}O_4N$, were formed (a) m.p. 140° and (b) m.p. 202–3°. These were separately demethylated and the corresponding phenolic base in each case methylated, whereby they were converted into the optically inactive corydalines (V), (a) into *dl*-mesocorydaline and (b) into *dl*-corydaline (p. 289).

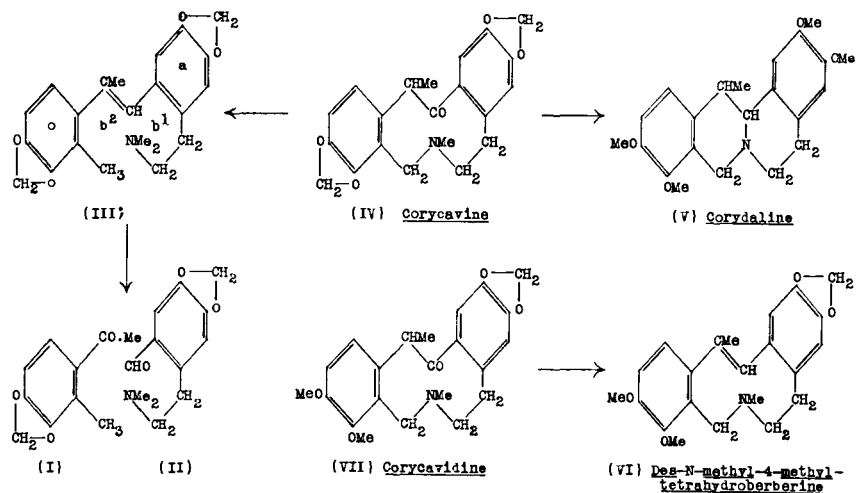

Though probably a member of the cryptopine group, *corycavidine*, according to von Bruchhausen³¹ exhibits anomalous behaviour in certain of the reactions typical of this group. Though it is not converted by acetyl chloride or phosphoryl chloride into a quaternary chloride, its reduction product dihydrocorycavidine, $C_{22}H_{27}O_5N$, needles, m.p. 147–8°, $[\alpha]_D^{20} - 44.3^\circ$ ($CHCl_3$) is so converted into *isodihydrocorycavidine* chloride (isolated as the crystalline mercurichloride). This treated in the usual manner yielded an anhydro-base, which proved to be *de-N*-methyl-4-methyltetrahydroberberine (VI) identical with this product, prepared

by the methods due to Freund and Fleischer³³ for the production of 4-methyl-dihydroberberine, and to Gadamer for the reduction of the latter and subsequent conversion to the anhydro-base (cf. p. 337). von Bruchhausen³¹ also found that corycavidine methosulphate is reduced by sodium amalgam in dilute sulphuric acid to tetrahydromethylcorycavidine, $C_{23}H_{31}O_5N$ (oil: $[\alpha]_D^{20} + 39.9^\circ$ ($CHCl_3$); B. HCl, m.p. 190°), which on evaporation in dilute hydrochloric acid yielded the corresponding anhydro-base, $C_{23}H_{29}O_4N$ (III) with $O \cdot CH_2 \cdot O$ replaced by 2OMe in ring c), oil; B. HCl, m.p. $233-5^\circ$. The latter on oxidation by potassium permanganate in acetone furnished 2-methyl-3:4-dimethoxyacetophenone (as I with 2OMe in place of $\cdot O \cdot CH_2 \cdot O$) and *N*-methylhydrastinine (II). On the basis of these two main reactions and with the support of a number of minor observations von Bruchhausen assigned formula (VII) to corycavidine.

Pharmacology. Though these alkaloids have not been compared pharmacologically as members of the same group, considerable resemblance in action is traceable in the results recorded for those that have been examined. *Cryptopine* depresses the higher centres, and finally causes spinal paralysis in frogs; the heart is also slowed or stopped in diastole. In mammals the drug causes convulsions without increased reflex excitability. Respiration is first stimulated then diminished.³⁴ Beginning with Heathcote,³⁴ more attention seems to have been given to the general pharmacology of cryptopine and especially to its action on smooth muscle, in which respect, according to Heathcote, it resembles papaverine but is much weaker. Mercier, Delphaut and Blache³⁴ have compared the action of cryptopine with those of papaverine and berberine and find that all three alkaloids in sub-lethal doses, show similar effects on arterial blood pressure, respiration and heart; on the intestine, isolated or *in situ*, and on the vegetative nervous system, berberine and cryptopine behave alike, but papaverine shows differences. On the whole cryptopine stands between papaverine and berberine but is in general closer to the latter in action. *Protopine* in small doses has a narcotic action in frogs, while large doses abolish reflex activity and show a curare-like action. At times there is evidence of medullary stimulation. According to Bolm³⁵ large doses (18 to 200 mgm. per kilo) given parenterally to experimental animals induce excitement or convulsions. Small doses slow the heart, lower blood pressure and have a quieting effect. Protopine has an inhibiting action on isolated frog heart, muscle or nerve and a stimulating action on guinea-pig intestine. According to Anderson and Chen,³⁵ the L.D.₅₀ (mgm./kilo) for protopine hydrochloride by intravenous injection in mice is 35.9 ± 1.90 . For cryptopine Delphaut and Blache³⁴ record the m.l.d. of the hydrochloride as 190 mgm./kilo, for subcutaneous injection in guinea pigs.

Peters's results for *corycavine* and *corycavamine* indicate that these two alkaloids produce narcosis in frogs followed by paralysis of the spinal cord, and in mammals increased secretion of tears and saliva and epileptiform convulsions without increase of reflex irritability; they also adversely affect the heart.³⁶

β-Homochelidonine was examined by Meyer³⁷ and von Engel, and the results, as quoted by Schmidt,³⁸ indicate that in frogs *β*-homochelidonine behaves like chelidonine, and that in mammals it causes slight narcosis and a transitory fall in blood pressure, followed by convulsions of the type induced by camphor, slowing of the pulse and, in large doses, paralysis of the vaso-motor centres. It also paralysees the ends of the sensory nerves.³⁹

REFERENCES

- (1) *Pharm. J.*, 1867, [ii], 8, 595; cf. COOK, *ibid.*, 716; and HESSE, *Annalen*, 1872, *Suppl.*, 8, 261; 1874, 176, 200. (2) *Ber.*, 1910, 43, 1329. (3) MAPLETHORPE and EVERS, *Pharm. J.*, 1925, 115, 137; cf. Ref. (2). (4) *Arch. Pharm.*, 1912, 250, 590. (5) *Ibid.*, 1910, 248, 225. (6) LABAT, *Bull. Soc. chim.*, 1909, [iv], 5, 745; for other colour reactions see VAN ITALIE and TOORENBURG, *Pharm. Weekbl.*, 1918, 55, 169. (7) *Proc. Chem. Soc.*, 1891, 7, 166. (8) *J. Chem. Soc.*, 1916, 109, 815-1028; 1919, 115, 713-790. It has become customary to call cryptopine a rare alkaloid, but, according to Dr. H. E. Watt, Indian opium contains 0.3 percent. (*Pharm. J.*, 1918, [iv], 46, 147). (9) *J. Chem. Soc.*, 1918, 113, 492. (10) *Ibid.*, 722. (11) *Ibid.*, 1926, 1769. (12) *Ibid.*, 445. (13) *Ibid.*, 1918, 113, 518. (13a) *J. Amer. Chem. Soc.*, 1940, 62, 2042. (14) *Annalen*, 1872, *Suppl.*, 8, 261; *Ber.*, 1871, 4, 693. (15) DANCKWORT, *Arch. Pharm.*, 1912, 250, 590. This paper includes a bibliography and a résumé of the botanical distribution of protopine. (16) *J. Chem. Soc.*, 1916, 109, 875, 1023. (17) DANCKWORT (*loc. cit.*); GADAMER and KOLLMAR, *Arch. Pharm.*, 1923, 261, 153; OSADA, *J. Pharm. Soc. Japan*, 1927, 547, 100. (18) HAWORTH and PERKIN, *J. Chem. Soc.*, 1926, 1769; for related synthetical experiments, see STEVENS, *ibid.*, 1927, 178; 1935, 663. (18a) *Can. J. Res.*, 1936, B, 14, 354; 1939, B, 17, 89. (19) JOWETT and PYMAN, *J. Chem. Soc.*, 1913, 103, 291. (20) *Arch. Pharm.*, 1893, 231, 136; cf. SCHMIDT and SELLE, *ibid.*, 1890, 228, 441. (21) *Ibid.*, 1901, 239, 409, 421. (22) *Ibid.*, 438. (23) *Ibid.*, 1919, 257, 298; 1920, 258, 148. (23a) MANSKE, MARION and LEDINGHAM, *J. Amer. Chem. Soc.*, 1942, 64, 1659. (24) *Annalen*, 1893, 277, 1. (25) *Arch. Pharm.*, 1896, 234, 528; 1902, 240, 19. (26) *Ibid.*, 1910, 248, 207. (27) *Ibid.*, 1918, 256, 161. (28) *Ibid.*, 1921, 259, 247; 1922, 260, 97. (29) *Ibid.*, 1911, 249, 30. (30) *Ibid.*, 1922, 260, 97. (31) VON BRUCHHAUSEN, *ibid.*, 1925, 263, 584. (32) *Ber.*, 1927, 60, 1891. (33) *Annalen*, 1915, 409, 188. (34) SCHRÖDER, *Arch. exp. Path. Pharm.*, 1883, 17, 140; ZUTZ, *ibid.*, 1897, 38, 408; MUNK, *Diss. Berlin*, 1873; and SIPPEL, *Diss. Marburg*, 1874, quoted by STARKENSTEIN, *Heffer's Handb.*, 1924, 2, 2, 1012; HEATHCOTE, *J. Pharm. Exp. Ther.*, 1925, 25, 35; MERCIER, *et al.*, *Compt. rend. Soc. biol.*, 1938, 127, 554, 1018, 1022; LUDUEÑA, *Rev. Soc. Argent. biol.*, 1938, 14, 339. (35) VON ENGEL, *Arch. exp. Path. Pharm.*, 1890, 27, 49; MEYER, *ibid.*, 1891, 29, 420, 438; BOLM, *ibid.*, 1940, 195, 304; ANDERSON and CHEN, *Fed. Proc.*, 1946, 5, 163. (36) *Arch. exp. Path. Pharm.*, 1904, 51, 130. (37) *Ibid.*, 1892, 29, 397. (38) VON ENGEL, quoted by SCHMIDT, *Arch. Pharm.*, 1893, 231, 143. (39) For other information on cryptopine and protopine, see HALE, *Amer. J. Physiol.*, 1909, 23, 889, 408; MEISSNER, *Biochem. Zeit.*, 1916, 73, 236; LA BARRE, *Arch. int. Pharmacodyn.*, 1924, 28, 429.

Aporphine Sub-Group

Bulbocapnine, C₁₉H₁₉O₄N. (Items 14, 27, 31, 33; list, pp. 170-2.) This alkaloid, first isolated by Freund and Josephi,¹ crystallises from dry alcohol in rhombic needles, m.p. 199°, [α]_D + 237.1° (CHCl₃), is soluble in alkalis (developing a green coloration), and is re-precipitated by carbon dioxide. The hydrochloride forms needles, m.p. 270° (*dec.*); the platini-chloride is crystalline, m.p. 200° and 230° (*dec.*). The methiodide forms brilliant needles, m.p. 257°. The phosphate is the salt used in medicine. The base dissolves in sulphuric acid with an orange-red colour changing slowly to violet, and gives a reddish-brown colour with nitric acid. After

early observations by Gadamer and Zeigenbein,² and Dobbie and Lauder,³ Gadamer and Kuntze⁴ showed that bulbocapnine contained one methoxyl, one hydroxyl and a methylenedioxy-group and on exhaustive methylation yielded trimethylamine and 3 : 4-dimethoxy-5 : 6-methylenedioxy-8-vinylphenanthrene. On these grounds formula (IV) was assigned to it. This was confirmed by Späth, Holter and Posega,⁵ from a study of the oxidation products of bulbocapnine and its derivatives. Bulbocapninemethine methiodide on oxidation by nitric acid yields benzene-1 : 2 : 3 : 4-tetracarboxylic acid, m.p. 233-6°, methyl ester, m.p. 129°, identical with the acid similarly obtained from thebenine. Mild oxidation with permanganate produces oxyhydrastinine, m.p. 96-7° (V), while bulbocapnine methyl ether oxidised by the same reagent furnishes hemipinic acid (3 : 4-dimethoxyphthalic acid) and 2 : 3-methylenedioxy-2' : 3'-dimethoxydiphenyl-5 : 6 : 6'-tricarboxylic acid, m.p. 258-60° (*dec.*) (VI). Bulbocapnine ethyl ether was oxidised to 4-methoxy-3-ethoxy-benzene-1 : 2-dicarboxylic acid (VII), which establishes the relative positions of the hydroxyl and methoxyl groups in the primary base at C⁴ and C³ respectively, positions C¹ and C² being also possible but unlikely. Further confirmation of the formula was provided by Gulland and Haworth's synthesis of bulbocapnine methyl ether.⁶ For this purpose 2'-nitro-3' : 4'-dimethoxyphenylaceto- β -3 : 4-methylenedioxyphenylethylamide (VIII), colourless needles, m.p. 158°, was prepared by condensing β -piperonylethylamine with 2-nitro-3 : 4-dimethoxyphenylacetyl chloride. The amide, on treatment in cold chloroform solution with phosphorus pentachloride, gave 2'-nitro-3' : 4'-dimethoxy-6 : 7-methylenedioxy-1-benzyl-3 : 4-dihydroisoquinoline, pale yellow prisms, m.p. 164°, the methiodide of which on

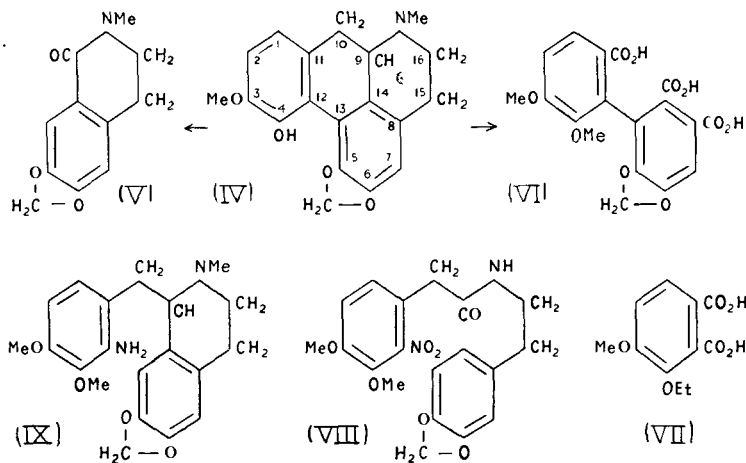

reduction with zinc dust in strongly acid solution gave 2'-amino-3' : 4'-dimethoxy-6 : 7-methylenedioxy-1-benzyl-2-methyltetrahydroisoquinoline (dihydrochloride, glistening prisms, m.p. 231° (*dec.*)) represented by formula (IX), and in this the phenanthrene ring closure was effected by diazotisa-

tion, to produce *dl*-bulbocapnine methyl ether (IV), OH replaced by OMe), yellow rhombs, m.p. 135°, isolated as the hydriodide, colourless prisms, m.p. 250° (*dec.*). This synthetic product was found identical with the *dl*-bulbocapnine methyl ether, prepared by the reduction of dehydrobulbocapnine methyl ether hydriodide, $C_{20}H_{18}O_4NI$, m.p. 228°, as described by Gadamer and Kuntze.⁴ A similar synthesis was effected in the same year by Späth and Hromatka.⁷

Corydine, $C_{20}H_{23}O_4N$. (Items 28, 31, 33, 36, 37, 39, 46; list, pp. 172-3.) This substance, first prepared by Merck,⁸ was examined by Gadamer and collaborators.⁹ It crystallises from alcohol with $\frac{1}{2}C_2H_5OH$, m.p. 124-5°, or 149° (*dry*), $[\alpha]_D^{20} + 204.3^\circ$ ($CHCl_3$). The hydrochloride has m.p. 258° (*dec.*), and the methiodide, m.p. 228-30° (*dec.*). It contains one hydroxyl and three methoxyl groups, and on oxidation with iodine yields dehydrocorydine hydriodide, $C_{20}H_{19}O_4N.HI$. This, on reduction, gives *dl*-corydine, m.p. 165-7°, which on recrystallisation of the acid *d*-tartrate yields *l*-corydine, $[\alpha]_D^{20} - 206.2^\circ$ ($CHCl_3$). Corytuberine (*see below*), on methylation with diazomethane, yields a mixture of corydine and *isocorydine*, so that these two alkaloids are monomethyl ethers of corytuberine.

*iso*Corydine, $C_{20}H_{23}O_4N$, is obtained along with corydine (*see above*) when corytuberine is methylated with diazomethane or methyl sulphate,¹⁰ but also occurs naturally (items 15, 23, 28, 33, 47, 48; list, pp. 171-3). It crystallises in four-sided tablets, m.p. 185°, $[\alpha]_D^{20} + 195.3^\circ$ ($CHCl_3$), and yields a methiodide, m.p. 213-4° (*dec.*), $[\alpha]_D^{20} + 143.3^\circ$.

Corytuberine, $C_{19}H_{21}O_4N.5H_2O$. (Items 18, 31, 37; list, pp. 171-2.) This alkaloid, obtained by Dobbie and Lauder¹¹ from commercial corydaline, crystallises in silky needles, m.p. 240° (*dec.*), $[\alpha]_D^{20} + 282.65^\circ$ (EtOH), is insoluble in benzene or ether, and sparingly in chloroform, but dissolves readily in alkali, the solution darkening in air. The salts are crystalline but unstable. The base forms a crystalline methiodide and contains two methoxyl and two phenolic hydroxyl groups.⁹ On methylation it yields a mixture of corydine and *isocorydine*. On exhaustive methylation corytuberine yields eventually trimethylamine and 3 : 4 : 5 : 6-tetramethoxy-8-vinylphenanthrene, m.p. 69°.

From these results Gadamer¹² assigned to corytuberine formula (X); corydine was regarded as corytuberine with a methoxyl replacing hydroxyl at C⁴, whilst in *isocorydine* a methoxyl group was believed to replace hydroxyl in the alternative position C³. These positions for the hydroxyl groups were shown to need change by Späth and Berger,¹³ who found that corytuberine diethyl ether (amorphous) is oxidised by permanganate to 4-methoxy-3-ethoxyphthalic acid (ethylimide, m.p. 85°). If the ethylation is so conducted as to yield a mixture of the two monoethyl ethers, the product on vigorous oxidation by permanganate yields both 4-methoxy-3-ethoxyphthalic acid and 5-methoxy-4-ethoxybenzene-1 : 2 : 3-tricarboxylic acid (methylimide, m.p. 160°), the constitution of which was established by synthesis. These results indicate for corytuberine formula (XI). It is well-established that corydine and *isocorydine* are different mono-methyl ethers of corytuberine, so that in one the hydroxyl group must be at C⁴,

and in the other at C⁵. To determine which was which Späth and Berger demethylenated bulbocapnine methyl ether (IV, p. 307, HO replaced by MeO) producing the phenolic base (XII), C₁₈H₁₉O₄N · MeOH, m.p. 118–120°. This, on partial methylation, yielded corydine and since (1) methylation must have taken place in ring (D), and (2) corytuberine (XI) on methylation yields corydine, the latter must be represented by formula (XIII); and since the monomethylation of corytuberine also gives rise to isocorydine, this in turn must be represented by formula (XIV).

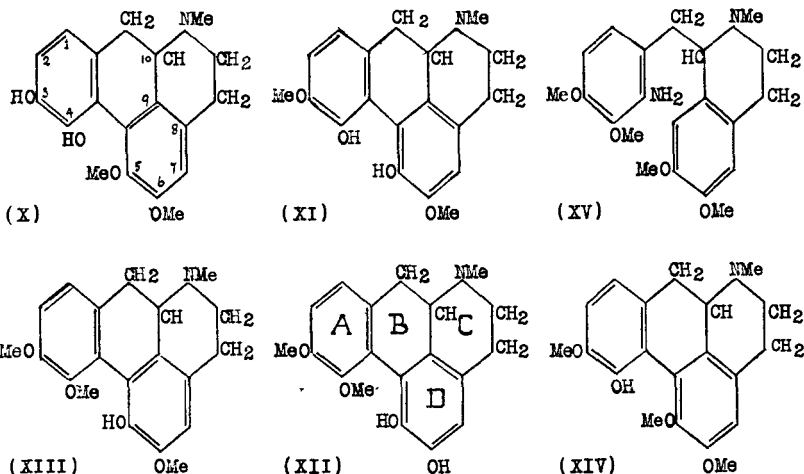

A particularly interesting method for the synthesis of aporphine alkaloids is due to Hope and Robinson,¹⁴ based on the fact that ψ -bases of the cotarnine, hydrastinine and laudaline types can be condensed with *o*-nitrotoluenes to form substituted 1-*o*-nitrobenzyltetrahydroisoquinolines. This method was used by Gadamer¹⁵ for the synthesis of aporphine, the parent base of this group of alkaloids, and by Robinson and Shinoda¹⁶ for the synthesis of a substance, which only differs from corytuberine dimethyl ether (X, 2HO \rightarrow 2MeO) by the replacement of a methoxyl group at C³ by AcNH. The first synthesis of corytuberine dimethyl ether was described by Gulland and Haworth¹⁷ in 1928, and follows the same lines as the bulbocapnine methyl ether synthesis (p. 307), the initial product in this case being 2'-nitro-3':4'-dimethoxyphenylaceto- β -3:4-dimethoxyphenylethylamide (VIII, p. 307, O · CH₂ · O replaced by 2OMe) which was converted by ring closure to the corresponding dihydroisoquinoline and the methiodide of the latter to 2'-amino-6:7:3':4'-tetramethoxy-1-benzyl-2-methyltetrahydroisoquinoline (XV) which on diazotisation (Pschorr reaction) yielded *dl*-corytuberine dimethyl ether (X, above, 2 · OH replaced by 2 · OMe); the latter is an oil, yielding a crystalline hydrochloride and methiodide, m.p. 248° (*dec.*). The base was deracemised by the successive use of *d*- and *l*-tartaric acids. *d*-Corytuberine dimethyl ether *l*-hydrogen tartrate crystallised from alcohol in needles, m.p. 219–222° (*dec.*), $[\alpha] + 149.7^\circ$. The methochloride formed slender

needles, m.p. 243° (*dec.*), $[\alpha]_D + 196^\circ$. These figures are in good agreement with those recorded by Gadamer.¹² The *d*-hydrogen tartrate of the *l*-form also melted at 219–21° (*dec.*), and had $[\alpha]_D - 148.2^\circ$. A similar synthesis was effected by Späth and Hromatka¹⁸ in the same year.

Ecimidine, C₁₇H₁₄ON(OMe)₃. (Item 36; list, p. 172.) A phenolic base, m.p. 133°, yielding a methiodide, m.p. 218° (*dec.*). It is isomeric with corydine and possibly belongs to the aporphine group (Manske).¹⁹

REFERENCES

- (1) *Annalen*, 1893, 277, 10. (2) *Arch. Pharm.*, 1902, 240, 81. (3) *J. Chem. Soc.*, 1903, 83, 612. (4) *Arch. Pharm.*, 1911, 249, 503, 598. (5) *Ber.*, 1928, 61, 322. (6) *J. Chem. Soc.*, 1928, 1132. (7) *Ber.*, 1928, 61, 1334. (8) *Arch. Pharm.*, 1893, 231, 131. (9) *Ibid.*, 1902, 240, 94; 1911, 249, 503, 641, 669. (10) GADAMER, *ibid.*, 1911, 249, 669. (11) *J. Chem. Soc.*, 1893, 63, 485. (12) GADAMER, *Arch. Pharm.*, 1911, 249, 641. (13) *Ber.*, 1931, 64, 2038. (14) *J. Chem. Soc.*, 1911, 99, 2114. (15) (With OBERLIN and SCHOLLER), *Arch. Pharm.*, 1925, 263, 81. (16) *J. Chem. Soc.*, 1926, 1987; *cf.* 1914, 105, 1456. (17) *Ibid.*, 1928, 1834. (18) *Ber.*, 1928, 61, 1692. (19) *Can. J. Res.*, 1933, 8, 592.

Dicentrine, C₂₀H₂₁O₄N. (Items 36, 37, 39, 40; list, pp. 172–3.) This alkaloid crystallises, from ether, alcohol, or ethyl acetate in prisms, m.p. 163–9° $[\alpha]_D + 62.1^\circ$ (CHCl₃), and yields well-crystallised salts. It contains two methoxyl groups and yields a monoacetyl derivative, colourless leaflets, m.p. 202°, which is not hydrolysed even by boiling alcoholic potash.¹ The methiodide, B . CH₃I . H₂O, has m.p. 224°, and according to Manske,² yields a methine base, m.p. 158–9°, the methiodide of which with potassium hydroxide solution decomposes into trimethylamine and a crystalline substance, presumably a substituted phenanthrenyl-ethylene, which polymerises on recrystallisation.

Dicentrine was synthesised by Haworth, Perkin and Rankin from 6'-nitroveratrylhydrohydrastinine³ (I) buff-coloured needles, m.p. 118°, which was reduced to 6'-aminoveratrylhydrohydrastinine (II) (oil: dihydrochloride, prisms, m.p. 250° (*dec.*)), and the latter diazotised in presence of copper powder (Pschorr reaction) to *dl*-dicentrine (III). The synthetic alkaloid forms colourless prisms, m.p. 178–9°; and yields crystalline salts, hydrochloride, m.p. 263–5° (*dec.*); methiodide, m.p. 228–9°; picrate orange prisms, m.p. 188–9°. Like the natural alkaloid it dissolves in sulphuric acid to a colourless solution which soon becomes reddish-violet, and gives green to blue colours with Erdmann's, Fröhde's, and Mandelin's reagents. This synthesis confirms the formula suggested by Gadamer⁴ for dicentrine, from data recorded by Asahina¹ and the similarity of dicentrine to glaucine. The synthetic *dl*-base was subse-

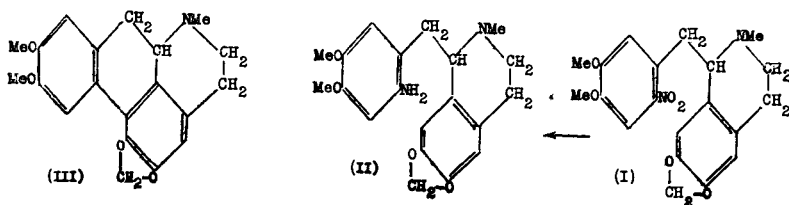

quently deracemised by the same authors ⁵ by the use of *d*- and *l*-tartaric acids to form the respective hydrogen tartrates. The *d*-base crystallised from ether in colourless prisms, m.p. 169° (*corr.*), $[\alpha]_D^{17} + 64.1^\circ$ (CHCl₃); the *l*-base had the same melting-point with $[\alpha]_D^{17} - 63.5^\circ$ (CHCl₃). Osada has shown that dicentrine, on demethylenation, followed by methylation of the phenolic base so formed, produces glaucine ⁶ (*see below*).

REFERENCES

- (1) ASAHINA, *Arch. Pharm.*, 1909, 247, 201. (2) *Canad. J. Res.*, 1933, 8, 592. (3) *J. Chem. Soc.*, 1925, 127, 2018. (4) *Arch. Pharm.*, 1911, 249, 680. (5) *J. Chem. Soc.*, 1926, 29. (6) *J. Pharm. Soc. Japan*, 1928, No. 555, p. 85.

Glaucine, C₂₁H₂₅O₄N. (Items 28, 31, 36, 37, 39, 47, 48; list, pp. 172-3.) This substance was isolated by Probst,¹ but was first prepared in a pure state by R. Fischer.² It crystallises in yellow, rhombic prisms, m.p. 119-120°, $[\alpha]_D + 113.3^\circ$ (EtOH), is readily soluble in alcohol or chloroform and sparingly so in benzene or hot water. The hydrochloride, B . HCl . 3H₂O, forms colourless crystals, and the hydrobromide, B . HBr, pale pink crystals, m.p. 235°. The alkaloid itself is tasteless, but the salts are bitter. Glaucine dissolves in sulphuric acid, forming a colourless liquid which becomes bright blue on standing or violet when warmed. Nitric acid gives a transient green tint; Fröhde's reagent (sulphomolybdic acid in sulphuric acid) yields a green passing into blue. Glaucine behaves as a tertiary base and contains four methoxyl groups. It was synthesised by Gadamer³ by treating a diazotised solution of aminolaudanosine (I) with copper powder, when 'phenanthreno-*N*-methyltetrahydropapaverine,' which proved to be *dl*-glaucine (II), was formed, thus :

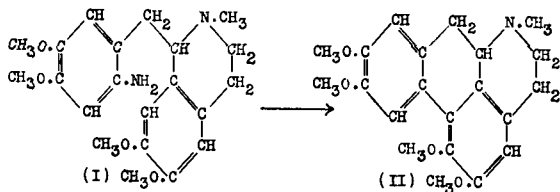

dl-Glaucine has m.p. 137-9°, and on recrystallisation of the *d*- and *l*-hydrogen tartrates furnishes the corresponding salts of *d*- and *l*-glaucine, from which the free bases are obtainable, the *d*-glaucine thus produced being identical with the natural alkaloid.

Unlike most alkaloids of the group, glaucine was assigned a formula ³ without the use of the Hofmann degradation process, but since then this process has been applied to glaucine or its derivatives by a number of workers,⁴ especially in connection with the investigation of boldine (p. 325) and of laurotetanine (p. 320).

Glaucidine (item 56; list, p. 173), composition unknown; m.p. 209-10°,⁵ gives the characteristic colour reactions of glaucine. It is a phenolic base and on methylation gives a product of which the hydrogen tartrate closely resembles that of glaucine.⁵

Glaucetrine, $C_{17}H_{13}N(OH)(OMe)_3$ (items 36, 37, 39; list, p. 172), m.p. 148° , yields a crystalline hydrochloride, m.p. $237-8^\circ$ (*dec.*) and with diazomethane is converted into *d*-glaucine. It is therefore an *O*-demethylglaucine.⁶

REFERENCES

(1) *Annalen*, 1839, 31, 241. (2) *Arch. Pharm.*, 1901, 239, 426. (3) GADAMER, *ibid.*, 1911, 249, 680; cf. PSCHORR, *Ber.*, 1904, 37, 1926. (4) WARNAT, *Ber.*, 1925, 58, 2768; BARGER *et al.*, *J. Chem. Soc.*, 1928, 2919; *Ber.*, 1933, 66, 450. (5) GADAMER, *Arch. Pharm.*, 1914, 252, 211. (6) MANSKE, *Can. J. Res.*, 1933, 8, 592; 1938, B, 16, 81.

Pharmacological action. The alkaloids described above, forming the corydalis section of the aporphine group, are now only a fraction of that group, which includes also *domesticine* (p. 315), *apomorphine* (pp. 214, 227), *morphothebaine* (p. 230), *roemerine* (p. 314), *isothebaine* (p. 232), *tuduranine* (p. 273) and the alkaloids of the Anonaceæ (p. 317) and the Laurales (p. 319). The corydalis section is of special importance as most of the pharmacological work done on the aporphines has been expended on members of that section and especially on bulbocapnine. Peters¹ showed that corytuberine, bulbocapnine and corydine, the only members of the corydalis aporphine alkaloids then known, differed considerably in pharmacological action. Corytuberine, unlike the other two, did not produce narcosis in frogs but induced increased reflex irritability. In warm-blooded animals, corydine produced slight narcosis, corytuberine gave rise to tonic convulsions and a small increase in reflex irritability, while bulbocapnine produced a cataleptic condition, especially in cats. All three alkaloids stimulated the secretion of tears and saliva. Corydine and corytuberine caused emesis, and later workers found that bulbocapnine also produced this effect. Respiration was found to be slowed by bulbocapnine and corydine, but Molitor² later, in the course of a detailed study of special properties of bulbocapnine, found that in non-toxic doses it accelerated respiration, but with lethal doses respiratory failure occurred shortly before heart failure. Corydine slowed the heart through its action on the vagus, but the blood pressure was increased as a consequence of the central action of the drug. Corytuberine also slowed the pulse by vagal action and the blood pressure rose during the convulsions; the respiratory rate was also increased. Later Waud³ showed that *isocorydine* closely resembles bulbocapnine in action, corydine showing a much smaller tendency than *isocorydine* to produce catalepsy. Recent work on bulbocapnine has been concerned mainly with its effects on organs. It appears to reduce intestinal movement,⁴ and to stimulate rabbit uterus *in situ* in small doses but to be inhibitory in medium to large doses.⁵ According to Asakawa,⁶ it induces a moderate hyperglycæmia in rabbits and lowers the glutathione content of the blood and liver and increases it in the spleen.⁶ Some attention has also been given to the mode of action of the alkaloid, which according to Hartog Jager⁷ is on the central nervous system. The catalepsy caused by bulbocapnine has also been investigated. In cats and rats it is antagonised by subsequent

administration of amphetamine, but when the two drugs are given in the reverse order the antagonistic effect is slight.⁸ In monkeys the condition was prolonged by convulsions induced by leptazole, but hypoglycæmic shock produced by injection of insulin had no effect on the catalepsy.⁹ The results of earlier investigations of the catalepsy induced by bulbocapnine have led to the use of the alkaloid in medicine,¹⁰ especially in the treatment of diseases in which involuntary movement is a symptom as in *Paralysis agitans* and St. Vitus' dance.

Glaucine causes slight narcosis in animals, interrupted by epileptiform convulsions. It is also a depressant of the heart and blood vessels and damages striated muscle. According to Iwakawa,¹¹ small doses of *dicentrine* have a narcotic action in frogs and mammals. Larger doses cause convulsions of medullary origin in frogs. The convulsions in mammals arise from centres above the cord. The heart and vasomotor centre are also damaged in mammals, while the respiratory centre is stimulated transiently before being paralysed.

REFERENCES

- (1) *Arch. exp. Path. Pharm.*, 1904, **51**, 130; GADAMER, *Arch. Pharm.*, 1905, **243**, 150. (2) *J. Pharm. exp. Ther.*, 1936, **56**, 85; 1938, **62**, 16. (3) *Ibid.*, 1934, **50**, 100; 1935, **55**, 40. (4) YAMAO and OKUSHIMA, *Jap. J. med. Sci.*, 1941, [iv], **14**, 43; OPPENHEIMER, GLYER and HAMILTON, *Proc. Soc. exp. Biol. Med.*, 1942, **51**, 79; MOLITOR.² (5) AOYAMA, *Mitt. med. Ges. Okayama*, 1939, **51**, 576, 1278; 1938, **50**, 2085; see also FRIEDERICI, *Arch. ges. Physiol.*, 1944, **248**, 51. (6) *Mitt. med. Ges. Okayama*, 1939, **51**, 804, 814, 1019; *Arb. med. Fak. Okayama*, 1939, **6**, 279. (7) *Arch. néerland. Physiol.*, 1938, **23**, 254; see also VEHARA, *Jap. J. med. Sci.*, 1940, [iv], **12**, *Proc.*, 86; DERYATIN, *J. Physiol. U.R.S.S.*, 1940, **29**, 401; WARD and KOLB, *J. Pharm. exp. Ther.*, 1941, **73**, 375; KOK, VAN HARREVELD and WATERMAN, *Acta brev. néerland. Physiol.*, 1938, **8**, 90. (8) SPIEGEL, *J. Pharm. exp. Ther.*, 1938, **63**, 438. (9) KENNEDY, *J. Neurol. Psychiat.*, 1939, **2**, 115; 1940, **3**, 27; OTTAVIANO and PAPPALARDO, *Boll. Soc. ital. biol. sper.*, 1946, **22**, 1082. (10) See, for example, SCHALTENBRAND, *et al.*, *Pflüger's Archiv.*, 1925, **209**, 623, 643, 653, 664; *Klin. Woch.*, 1924, **45**, 2045; FLEISCHHACKER, *Deut. med. Woch.*, 1926, **52**, 352; AMADON and CRAIG, *J. Pharm. exp. Ther.*, 1935, **54**, 334; BRÜCKE, *Arch. exp. Path. Pharm.*, 1935, **179**, 504; 1936, **182**, 324; RAYMOND-HAMET, *Compt. rend.*, 1936, **202**, 357. (11) *Arch. exp. Path. Pharm.*, 1911, **64**, 369; cf. WAUD, *J. Pharm. exp. Ther.*, 1936, **58**, 332.

MINOR CORYDALIS ALKALOIDS. The following four alkaloids have been isolated by Manske from various *Corydalis* species but have not yet been assigned to chemical groups. Cularine has been compared pharmacologically with papaverine and hydrastine, and may prove to be related to one of these alkaloids.

Chrycentrine, $C_{18}H_{15}O_5N$ (item 34; list, p. 172), m.p. 216°, non-phenolic, contains a dioxymethylene, but no methoxyl groups.¹

Cularine, $C_{17}H_{14}ON(OMe)_3$ (items 12, 35, 36, 37, 39; list, pp. 170-2), m.p. 115°, $[\alpha]_D^{25} + 285^\circ$ (MeOH), yields a sparingly soluble acid oxalate, m.p. 245° (*dec.*), and a hydrochloride, m.p. 207°. In *Dicentra eximivia* it is accompanied by a non-phenolic base, F 30, $C_{16}H_{12}ON(OMe)_3$, m.p. 102°, which is probably *N*-demethylcularine. In *Corydalis claviculata* it is associated with one or more *O*-demethylcularines (F 52) of which one, *cularidine*, $C_{17}H_{14}ON(OH)(OMe)_2$ (item 35; list, p. 172), m.p. 157°, has

been isolated from *Dicentra cucullaria*; it yields cularine on methylation with diazomethane.²

Ochotensimine, $C_{20}H_{17}O_2N(OMe)_2$. (Item 19; list, p. 171.) Amorphous, but yields a crystalline methiodide, m.p. 225° (*dec.*), $[\alpha]_D^{22} + 49.2^\circ$ (MeOH), which is identical with the methiodide produced by methylating ochotensine (*see below*) with diazomethane, and treating the product with methyl iodide. Ochotensimine dihydromethine, $C_{23}H_{27}O_4N$, obtained from the methiodide by Emde's method, has m.p. 92° .³

Ochotensine, $C_{20}H_{17}O_2N(OH)(OMe)$. (Items 19, 26; list, p. 171.) Phenolic base, m.p. 252° , $[\alpha]_D + 51.7^\circ$ ($CHCl_3$) or $+ 63.9^\circ$ (N/10, HCl). The *O*-methyl ether is ochotensimine (*see above*).³

Pharmacological Action. As already pointed out, *cularine* shows some resemblance to papaverine and hydrastine in action (p. 196). The M.L.D. (mgm./kilo.) for mice by intravenous injection of *ochotensine* is 10.6 ± 0.54 so that it seems to be the most toxic of the fifteen corydalis alkaloids examined by Anderson and Chen,⁴ who also state that it stimulates isolated guinea-pig or rabbit uterus, inhibits isolated rabbit-intestine and induces a fall in blood pressure on intravenous injection in etherised cats.

Of the ten presumably new but unclassified alkaloids, isolated by Chou from *Corydalis ambigua* (Item 8; list, p. 170), four have been examined pharmacologically by Chen, Anderson and Chou,⁵ who find that alkaloids B and L, given intravenously in sub-lethal doses, produce catalepsy in mice and monkeys and a similar action is shown by L in cats. (Wang and Lu⁶ had already found that B and K resembled bulbocapnine in action.) Alkaloids J and M induce convulsions in lethal, or near lethal, doses in mice. All four have a similar depressant action on the heart in frogs, and in etherised cats they cause a fall in arterial blood pressure. In dilute solution they stimulate isolated rabbit intestine but relax it at higher concentrations. All induce contraction of isolated guinea-pig uterus. The M.L.D. (mgm./kilo.) by intravenous injection in mice are as follows: B, 103; J, 42; L, 150; M, 41.

REFERENCES

- (1) *Can. J. Res.*, 1937, 15, B, 274. (2) *Ibid.*, 1938, 16, B, 81; 1940, 18, B, 97. (3) *Ibid.*, 1936, 14, B, 354; 1938, 16, B, 81; 1940, 18, B, 75. (4) *Fed. Proc.*, 1946, 5, 163. (5) *Chin. J. Physiol.*, 1937, 11, 7. (6) *Ibid.*, 1933, 7, 13.

It is convenient at this point to deal with the remaining alkaloids of the aporphine group, *viz.*, domesticine, roemerine and the alkaloids of the Anonaceæ, Lauraceæ and Monimiaceæ.

Roemerine, $C_{16}H_{12}(NMe)(CH_2O_2)$. (Item 59; list, p. 173.) M.p. $102-3^\circ$, $[\alpha]_D - 77.18^\circ$ (EtOH); B.HCl, m.p. $262-3^\circ$; picrate, m.p. $195-6^\circ$. After a Hofmann degradation of the methiodide, m.p. $215-6^\circ$, the course of which indicated that the alkaloid belonged to the aporphine group, and ended with a methylenedioxyphenanthrene, m.p. $84-5^\circ$, picrate, m.p. $167-8^\circ$, the alkaloid was demethylenated and the dihydroxy-base (*norroemerine*, m.p. $162-4^\circ$) methylated to dimethyl*norroemerine*, m.p.

165–6° (B. HCl, m.p. 242–3°). The methiodide, m.p. 164–7°, of this, on treatment with potassium hydroxide in methyl alcohol, yielded 5:6-pimethoxy-8-vinylphenanthrene, m.p. 86–7°, along with dimethyl-de-*N*-methylnorrœmerine, oil, $[\alpha]_D + 13.55^\circ$ (EtOH); the methiodide, m.p. 278°, of this, on like treatment also yielded 5:6-dimethoxy-8-vinylphenanthrene, whose identity was established by its oxidation by permanganate to 5:6-dimethoxyphenanthrene-8-carboxylic acid. Rœmerine is, therefore, 5:6-methylenedioxy-*N*-methylaporphine, and this constitution has been confirmed by Marion and Grassie's synthesis of the alkaloid.

By a modified Bischler-Napieralsky reaction, 6'-nitrophenylaceto- β -3:4-methylenedioxyphenylethylamide, resulting from the condensation of β -3:4-methylenedioxyphenylethylamine with 2-nitrophenylacetyl chloride, was converted into 6'nitro-1-benzyl-6:7-methylenedioxy-3:4-dihydroisoquinoline. The methiodide of the latter was reduced with zinc and hydrochloric acid to 6'-amino-1-benzyl-2-methyl-6:7-methylenedioxy-1:2:3:4-tetrahydroisoquinoline dihydrochloride, which by the Pschorr ring-closure reaction, produced *dl*-rœmerine (IV, p. 317), m.p. 85–7°. By treatment in succession with *d*- and *l*-tartaric acids, the *dl*-base was resolved into *l*- and *d*-forms. Synthetic *l*-rœmerine is dimorphic, m.p. 85–7° and 102°, and has $[\alpha]_D - 79.9^\circ$ (EtOH), these constants being in good agreement with those of the natural base.

Barger and Weitnauer pointed out that rœmerine is probably identical with *N*-methylanonaine (p. 318); the position of the methylenedioxy group in rœmerine was at that time uncertain.

REFERENCES

KONOVALOVA, JUNUSOV and OREKHOV, *Bull. Soc. Chim.*, 1931, [v], 6, 811, 1479; 1940, [v], 7, 70; cf. BARGER and WEITNAUER, *Helv. Chim. Acta*, 1939, 22, 1041; MARION and GRASSIE, *J. Amer. Chem. Soc.*, 1944, 66, 1290.

Domesticine, C₁₉H₁₉O₄N. This alkaloid, obtained from *Nandina domestica* Thunb. by Kitasato¹ crystallises from ethyl or methyl alcohol, has m.p. 115–7° and $[\alpha]_D + 60.51^\circ$. It is coloured reddish-violet by sulphuric acid, blue by nitric acid vapour, and green by ferric chloride. It contains one methoxyl and a methylenedioxy group. A phenolic hydroxyl group is also present and with diazomethane the base yields a methyl ether, m.p. 139°, $[\alpha]_D + 101.7^\circ$ (CHCl₃) which unlike the parent phenolic base is stable, and does not become coloured on exposure to air. This methyl ether is isomeric with dicentrine (p. 310), and the absorption spectra of the two alkaloids are very similar. It was suggested that domesticine methyl ether was either *isodicentrine* (I) or *epidicentrine* (II), and a decision in favour of the latter was made by Kitasato and Shishido² by the synthesis of *epidicentrine*, the *d*-form of which proved to be identical with domesticine methyl ether. The synthesis was effected by the application of the Pschorr reaction to 6:7-dimethoxy-6'-amino-1-piperonyl-2-methyltetrahydroisoquinoline (III), m.p. 132°. The *dl*-*epidicentrine* obtained had m.p. 142°, yielded a hydrochloride, m.p. 265–70° (*dec.*),

and on deracemisation by the successive use of *d*- and *l*-tartaric acids provided *l*-epidicentrine, m.p. 138–9°, $[\alpha]_D^{18} - 101.81^\circ$ (CHCl₃), and

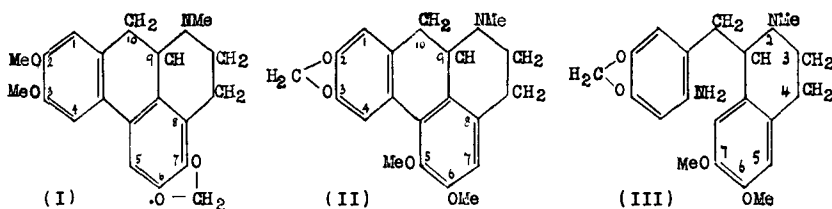

d-epidicentrine, m.p. 139°, $[\alpha]_D^{18} + 102.27^\circ$, the latter being identical with domesticine methyl ether and with the "*nantenine*,"³ m.p. 138.5°, and "*domestine*"⁴ found in *Nandina* fruits. The free hydroxyl group in domesticine is at C⁵ (II), as shown by Shishido's synthesis of domesticine ethyl ether² from 6-methoxy-7-ethoxy-6'-amino-1-piperonyl-2-methyl-tetrahydroisoquinoline (III: MeO at C⁷ replaced by EtO).

Shisido² (1938) has confirmed the identity of the synthetic and natural alkaloids, by showing that the two methyl ethers on degradation by the Hofmann process yield 5:6-dimethoxy-2:3-methylenedioxy-8-vinylphenanthrene, m.p. 142–3°, and the two ethyl ethers the analogous product with ethoxy- replacing the methoxy group at C⁵.

*iso*Domesticine, C₁₉H₁₉O₄N. This base, also isolated by Kitasato, is amorphous, m.p. 85°, but yields a crystalline hydrochloride, more soluble in water than domesticine hydrochloride. It gives the same colour reactions as domesticine, and on methylation yields the same methyl ether ("*domestine*," m.p. 138–9°), but the ethyl ether, m.p. 82°, is different from domesticine ethyl ether, m.p. 126°, implying that the difference between the two alkaloids is due to the difference in position of the hydroxyl group, which is at C⁵ in domesticine, and must be at C⁶ in *isodomesticine*.

The pharmacological action of domesticine has been compared by Tobitani⁵ with that of bulbocapnine (p. 312). Both at first inhibit voluntary movement in the rabbit, induce tremors of the whole body and trismus; convulsions ensue with hypersecretion of various glands. Large doses cause paralysis from the start. The action of both alkaloids is closely related. The range of stimulation is narrower for domesticine and its paralysing action stronger. *Nantenine*, the methyl ether of domesticine, according to Takase and Ohashi,⁶ acts on the central nervous system producing increased reflex action, and on the cardiac muscle causing bradycardia and weakening of heart action leading to fall in blood pressure.

REFERENCES

- (1) *J. Pharm. Soc. Jap.*, 1926, No. 535, 71; No. 536, 80; 1927, No. 544, 80. *Acta Phytochimica*, 1927, 3, 187; 1937, 9, 265; cf. OSADA, *J. Pharm. Soc. Jap.*, 1928, No. 555, 85. (2) *Annalen*, 1937, 527, 176; SHISHIDO, *Bull. Chem. Soc. Jap.*, 1937, 12, 150; 1938, 13, 247. (3) TAKASE and OHASHI, *J. Pharm. Soc. Jap.*, 1926, No. 535, 70. (4) MANIWA, SAKAE and KAN, *ibid.*, 1926, No. 536, 80. (5) *Mitt. med. Ges. Okayama*,

1939, 51, 1447. (6) *J. Pharm. Soc. Jap.*, 1926, No. 535, 70; 1927, No. 541, 37; cf. SHINA, *ibid.*, 1927, No. 544, 79.

ALKALOIDS OF THE ANONACEÆ. This botanical family belongs to the natural order Anonales, which is nearly related to the Laurales, in which are included the families Lauraceæ and Monimiaceæ. It is not surprising, therefore, that the characteristic alkaloids found in these families are of one type, namely derivatives of aporphine.

Alkaloids have been found in four genera of the Anonaceæ. Callan and Tutin¹ found an amorphous alkaloid in *Anona muricata* L., but recently Meyer¹ has isolated and described two crystalline alkaloids, muricine and muricinine, from this species.

Santos² isolated anonaine from *A. reticulata* L., and *A. squamosa* L. (custard apple), while from *A. triloba* L. (*Asimina triloba* Dun.), Lloyd,³ and later Fletcher,³ obtained asiminine, itself amorphous, but yielding crystalline salts. Recently Manske⁴ has isolated from this species the crystalline alkaloid anolobine.

Marañón,⁵ and later Santos and Reyes,⁶ found artabotrine and suaveoline in *Artabotrys suaveolens*, Blume. In one species of the Anonaceæ, *Xylopia macrocarpa* Oliv., berberine has been recorded (p. 329).

Anolobine, $C_{17}H_{15}O_3N$. This alkaloid has m.p. 262° (*dec.*) and $[\alpha]_D^{27} - 22.5^\circ$ ($c = 0.4$: $CHCl_3 + MeOH, 1:1$). The nitrogen is secondary; a dioxymethylene group is present and a phenolic hydroxyl group. The *O*-methyl ether has m.p. 97° , $[\alpha]_D^{27} - 27.9^\circ$ (EtOH) and with methyl iodide gives a mixture of products, from which the quaternary iodide was separated and converted to the methine base, $C_{20}H_{21}O_3N$, m.p. 99° , $[\alpha]_D \pm 0^\circ$. This yielded a sparingly soluble methiodide, decomposed by alkali into trimethylamine and a hydrocarbon, which on oxidation furnished 4-methoxyphthalic acid and an acid m.p. 207° , believed to be 3:4-methylenedioxy-7-methoxyphenanthrene-1-carboxylic acid. On this basis anolobine is regarded as 2-hydroxy-5:6-methylenedioxy-noraporphine (V) (Manske).⁴ Govindachari⁷ has synthesised *dl*-2-methoxy-5:6-methylenedioxy-noraporphine, B. HCl, m.p. 305° , and finds that in the applica-

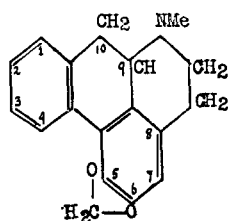

(IV) Roemerine

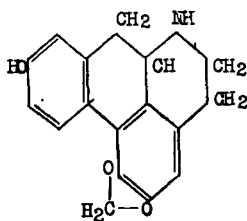

(V) Anolobine

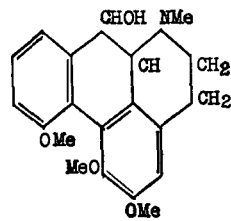

(VI) Artabotrine

tion of the Gadamer⁸ reaction with ethyl chlorocarbonate, $Cl. CO_2Et$, it does not give the same product as Manske's anolobine methyl ether, and concludes that the latter has not the constitution suggested. On the other hand, Marion⁹ has synthesised *dl*-2-methoxy-5:6-methylene-

dioxyaporphine (*ON*-dimethylanolobine) and finds that the methiodide, m.p. 241°, gives a methine base $C_{20}H_{21}O_3N$ (picrate, m.p. 258°) identical with that prepared by Manske from anolobine and concludes that anolobine is 2-hydroxy-5 : 6-methylenedioxy*nor*aporphine (V) as Manske suggested.

Barger and Sargent¹¹ have pointed out that artabotrine (p. 319), may be identical with anolobine methyl ether (V ; HO → MeO).

Anonaine, $C_{17}H_{15}O_2N$, m.p. 122–3°, $[\alpha]_D^{20} - 52^\circ$ ($CHCl_3$), yields a hydrochloride, m.p. 277·5° (*dec.*),² and contains a methylenedioxy-group. The nitrogen is secondary and the base furnishes a neutral nitroso-compound, m.p. 229–30°, a monoacetyl derivative, m.p. 229–30°, and with methyl iodide gives the quaternary iodide, $C_{19}H_{20}O_2NI$, m.p. 217°, decomposed by alkali into the methine base, m.p. 87–90°, of which the methiodide, m.p. 270·5° (*dec.*), yields a methylenedioxyvinylphenanthrene, $C_{17}H_{12}O_2$, m.p. 87°. The latter is oxidised to a methylenedioxyphenanthrenecarboxylic acid, which sublimes at 240° with partial decomposition, and is decarboxylated by heating with copper chromite in quinoline to an oily methylenedioxyphenanthrene, giving a picrate, m.p. 168° (*dec.*). These results indicated that anonaine is probably 5 : 6-methylenedioxy*nor*aporphine and this substance was synthesised by standard methods from *O*-nitrophenylacetyl chloride and *homopiperonylamine*. The *dl*-anonaine hydrochloride obtained had m.p. 285° (*dec.*) and for comparison with the natural product was degraded to the methylenedioxyphenanthrene, which proved to be identical with that obtained from natural *l*-anonaine.

N-methylanonaine, prepared from the natural alkaloid by the action of formaldehyde and formic acid, was isolated as the hydriodide, m.p. 246–7° (*dec.*). *dl-N*-methylanonaine was also synthesised and characterised as the hydriodide, m.p. 244° (*dec.*), and methiodide, m.p. 210–1°. It is regarded as identical with *dl*-roemerine (p. 314), and it may be noted that the melting-point of the Hofmann degradation product of roemerine is very similar to that of anonaine (IV : NMe → NH) (Barger and Weitnauer).¹⁰

Artabotrine, $C_{16}H_{10}(OH)(OMe)_3(NMe)$. After the isolation and preliminary investigation of this alkaloid and the accompanying suaveoline, by Marañón⁵ and by Santos and Reyes,⁶ both alkaloids were investigated by Barger and Sargent.¹¹ Artabotrine forms large, tabular, orthorhombic crystals (crystallographic data are provided¹¹), m.p. 185–6°, $[\alpha]_D^{15} + 194·8^\circ$ ($c = 1·86$; $CHCl_3$) and gives a hydrochloride, m.p. 226–7°, an acetyl derivative, $C_{20}H_{22}O_4N$, Ac, $2H_2O$, m.p. 97–9° or 118–9° (*dry*), and an *O*-methyl ether; the latter is a syrup, $[\alpha]_D^{16} + 182·2^\circ$ ($c = 2·9$; $CHCl_3$), but yields a crystalline methiodide, m.p. 254–5°. Artabotrine methiodide, m.p. 224–5°, when boiled with alcoholic potassium hydroxide yields artabotrinemethine, m.p. 122–3°, $[\alpha]_D^{18} - 183^\circ$ ($c = 1·65$; EtOH). The latter, when refluxed with methyl iodide and then with potassium hydroxide in methyl alcohol, yielded a trimethoxyvinylphenanthrol, $C_{16}H_9O(OMe)_3$, m.p. 115–6°. On treatment with ethyl chlorocarbonate, artabotrine yields an optically inactive substance, $C_{20}H_{22}O_4N(CO_2Et)$, m.p. 109–110°, which with the other reaction products described above, indicates that it is an

aporphine derivative. On oxidation with permanganate, artabotrine forms a monocarboxylic lactone acid, $C_{11}H_{10}O_6$, m.p. 203–4°, containing two methoxyl groups and giving the fluorescein reaction. It is suggested that artabotrine, which is the methyl ether of suaveoline (*see below*) is probably 10-hydroxy-4 : 5 : 6-trimethoxyaporphine (VI). This makes it unique in this series in containing a secondary alcohol group.

Suaveoline, $C_{16}H_{16}(OH)_2(OMe)_2NMe$, m.p. 232°, $[\alpha]_D^{15} + 164^\circ$ ($c = 1.22$; $CHCl_3$), gives a purple colour with ferric chloride and on treatment with nascent diazomethane yields artabotrine methyl ether (*see above*) identified by mixed melting-point of the methiodides. It resembles pukateine (p. 322) in giving Pellagri's reaction,¹² which indicates lack of substitution in the *p*-position to a phenolic hydroxyl, and for that reason the latter group is assumed to be at C⁴, which implies methoxyl at this point in artabotrine. Suaveoline is regarded as probably 4 : 10-dihydroxy-5 : 6-dimethoxyaporphine (VI; OMe at C⁴ → OH).¹¹

Artabotrinine, $C_{16}H_{11}(OMe)(O_2CH_2)NH$. This alkaloid is amorphous, $[\alpha]_D^{85} - 18.9^\circ$ ($c = 2.69$; $CHCl_3$), but forms a crystalline hydrochloride, B. HCl, m.p. 273–4°, and yields a nitroso-compound, hexagonal plates, m.p. 203–4° and a *N*-methyl derivative, $C_{19}H_{19}O_3N$, m.p. 132–3° $[\alpha]_D^{16} - 53.8^\circ$ ($c = 0.424$; EtOH), the methiodide of which has m.p. 223–4°. *N*-methylartabotrinine is isomeric with pukateine methyl ether (p. 322) and laureline (p. 322), contains the same substituents as these alkaloids, but is not identical with either. Assuming that the methylenedioxy group is at C⁵—C⁶ the methoxyl group must be at C², which implies identity of artabotrinine with anobine methyl ether (V; OH → OMe, p. 317).¹¹

Muricine, $C_{16}H_{12}ON(OMe)_3$. Isolated as the hydrobromide, B. HBr, m.p. 242–3°. The base is insoluble in alkali.¹

Muricinine, $C_{16}H_{13}O_2N(OMe)_2$. Isolated as the perchlorate, m.p. 206–8°. The base does not contain a dioxymethylene group, is soluble in alkalis and gives a green colour with ferric chloride.¹

REFERENCES

- (1) *Pharm. J.*, 1911, [iv], 33, 743; MEYER, *Ing. Ned.-Ind.*, 1941, 8, 64 (*Chem. Abstr.*, 1941, 35, 8206). (2) *Philipp. J. Sci.*, 1930, 43, 561; 1931, 44, 409; 1932, 47, 357. *cf.* TRIMURTI, *J. Ind. Inst. Sci.*, 1924, 7, 232. (3) LLOYD, *Arch. Pharm.*, 1887, [iii], 25, 503; FLETCHER, *Amer. J. Pharm.*, 1891, 476. (4) *Can. J. Res.*, 1938, 16, B, 76 (5) *Philipp. J. Sci.*, 1928, 38, 259. (6) With REYES, *Univ. Philipp. Nat. Appl. Sci. Bull.*, 1932, 2, 407. (7) *Curr. Sci.*, 1941, 10, 76; 1942, 11, 238. (8) GADAMER and KNOCH, *Arch. Pharm.*, 1921, 259, 135. (9) *J. Amer. Chem. Soc.*, 1944, 66, 1125. (10) BARGER and WEITNAUER, *Helv. Chim. Acta*, 1939, 22, 1036. (11) *J. Chem. Soc.*, 1939, 991. (12) GADAMER, *Arch. Pharm.*, 1911, 249, 509.

Alkaloids of the Laurales. Well-defined alkaloids have been isolated from three genera of the Lauraceæ—*Actinodaphne*, *Litsea* and *Nectandra* (p. 363) and the presence of alkaloids has been recorded for *Dehaasia*¹ and *Cryptocarya*.² In the Hernandiaceæ there are records of alkaloids in *Cyrocarpus*,² *Hernandia*,¹ and *Illigera*.¹ In the Monimiaceæ the following genera have yielded well-defined alkaloids: *Daphnandra* (p. 326), *Laurelia* and *Pneumus*, and alkaloids have been recorded in

Atherosperma (Atherospermine, $C_{30}H_{40}O_5N_2$, amorphous, from *A. moschata*³) and *Doryphora* (doryphorine, $C_{18}H_{21}O_4N$, m.p. 115–7°, from *D. Sassafras*).⁴ Appleman has also recorded the presence of alkaloids in the leaves of the "Fuerte" variety of "avocado pear" (*Persea gratissima* Gærtn).⁵

REFERENCES

(1) GRESHOFF, *Ber.*, 1890, 23, 3537. (2) BANCROFT, *Aust. J. Pharm.*, 1887, 103, quoted by WEHMER, *Die Pflanzenstoffe*, Jena, 1931. (3) ZEYER, *Vjschr. prakt. Pharm.*, 1861, 10, 504. (4) PETRIE, *Proc. Linn. Soc. N.S.W.*, 1912, 37, 139. (5) *Calif. Avocado Soc. Year Book*, 1944, 37 (*Chem. Abstr.*, 1945, 39, 138).

Laurotetanine, $C_{19}H_{21}O_4N \cdot H_2O$. This alkaloid was first isolated by Greshoff¹ from *Litsea chrysocoma*, who also found it in a number of other Lauraceæ, and subsequently by Filippo² from *L. citrata*, and by Gorter³ from *L. cubeba*.

It crystallises from acetone, m.p. 125°, $[\alpha]_D^{25} + 98.5^\circ$, is colourless, but becomes yellow on exposure to air, behaves as a phenolic base and yields a phenylthiocarbamide, $NHPh \cdot CS \cdot NH \cdot C_{19}H_{20}O_4N$, m.p. 211–2°. The hydrochloride ($6H_2O$), hydrobromide ($6H_2O$), hydriodide ($5H_2O$), sulphate, $B_2 \cdot H_2SO_4$ (12 or $5H_2O$), and the picrate ($1 \cdot 5H_2O$), m.p. 148°, are all crystalline. Dibenzoyllaurotetanine has m.p. 169–70°. With diazomethane the base yields a methyl ether, $C_{20}H_{23}O_4N$ (amorphous, but yielding crystalline salts), and this on treatment with methyl iodide furnishes glaucine methiodide, m.p. 210°.⁴ Gorter³ assumed that the *N*-methylaurotetanine methyl ether which he obtained, $C_{21}H_{25}O_4N \cdot 3H_2O$, m.p. 63°, $[\alpha]_D^{27} + 109^\circ$, was not glaucine (p. 311) but an isomeride, which he named *isoglaucine* and on the ground that laurotetanine, on oxidation with alkaline permanganate, yielded 1:2-dimethoxybenzene-3:4:5-tricarboxylic acid, m.p. 165°, he assigned formula (I) to *isoglaucine* and suggested that the free hydroxyl group in laurotetanine was at C² or C³. The results of Späth⁵ and of Barger⁴ and their collaborators, the former depending mainly on the character of the oxidation products, and the latter on identity of the products of exhaustive methylation, left no doubt that *ON*-dimethylaurotetanine (Gorter's *isoglaucine*) is identical with glaucine, and the recent work of these two groups of authors is concerned with the decision between C²:C³ = OH:OMe or OMe:OH in formula (II). The decision in favour of the first of these alternatives was arrived at by the following contributions. Callow, Gulland and Haworth⁶ synthesised 2:3:6:7- and 3:4:6:7-tetramethoxyaporphines, the former being the substance represented by formula (I) (Gorter's *isoglaucine*), but neither was identical with "*isoglaucine*." Douglas and Gulland⁷ synthesised 3-hydroxy-2:5:6-trimethoxyaporphine, but the synthetic product has not been described in detail. Barger, Eisenbrand, Eisenbrand and Schlittler⁸ synthesised the substance represented by formula (III) and showed that Hofmann degradation of (III) and of *N*-ethylaurotetanine ethyl ether gave rise to the same products, implying that in laurotetanine, the hydroxyl group is at C². The synthesis of (III) was effected by (a) ring closure in 6-nitro-4-methoxy-3-ethoxyphenylacet-

β -3' : 4'-dimethoxyphenylethylamide (IV), m.p. 160°, to 6 : 7-dimethoxy-1-6'-nitro-4'-methoxy-3'-ethoxybenzyl-3 : 4-dihydroisoquinoline, m.p. 174-5°, of which the ethiodide, m.p. 207° (*dec.*), was reduced to the corresponding aminotetrahydroisoquinoline (V), and (b) ring closure in the latter by successive treatment with sodium nitrite, 2*N*-sulphuric acid and

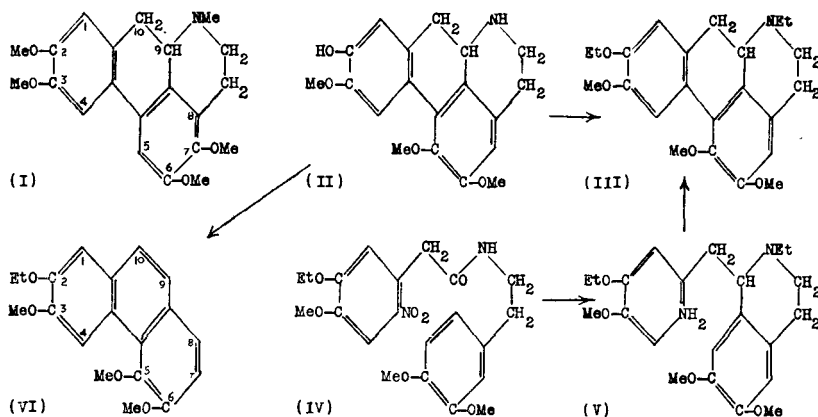

zinc dust and hydrochloric acid, into 3 : 5 : 6-trimethoxy-2-ethoxy-*N*-ethylnoraporphine (III) isolated as the hydriodide, m.p. 205-10° (*dec.*), which is identical with *ON*-diethyl laurotetanine hydriodide. The Hofmann degradation of both products leads to 3 : 5 : 6-trimethoxy-2-ethoxy-8-vinylphenanthrene, m.p. 142°. Späth and Tharrer,⁹ by exhaustive methylation of laurotetanine ethyl ether, obtained a trimethoxyethoxyvinylphenanthrene, m.p. 136-8° (*cf.* Barger *et al.*, *loc. cit.*), which was oxidised to the corresponding acid, m.p. 222-3°, and this on decarboxylation furnished a trimethoxyethoxyphenanthrene, m.p. 114-6°, identical with 3 : 5 : 6-trimethoxy-2-ethoxyphenanthrene (VI) synthesised for comparison. The hydroxy group in laurotetanine, which is ethylated in this group of substances, must therefore be in position 2.

N-Methyl laurotetanine, $C_{20}H_{23}O_4N$. This alkaloid was obtained by Späth and Suominen¹⁰ from *Litsea citrata*. It distils at 205-15° (air-bath temperature) under a pressure of 0.01 mm. and is dextro-rotatory. Diazomethane converts it into glaucine and Hofmann degradation of the ethyl ether yields 3 : 5 : 6-trimethoxy-2-ethoxy-8-vinylphenanthrene, m.p. 140-1°, identical with that obtained from laurotetanine (*see above*). The alkaloid is therefore represented by formula II (NMe replacing NH).

REFERENCES

- (1) *Ber.*, 1890, 23, 3537. (2) *Arch. Pharm.*, 1898, 236, 601. (3) *Bull. Jard. bot. Buitenzorg*, 1921, [iii], 3, 180 (*Chem. Soc. Abstr.*, 1921, [i], 587). (4) BARGER and SILBERSCHMIDT, *J. Chem. Soc.*, 1928, 2919; SILBERSCHMIDT, THESIS, Edinburgh, 1926. (5) SPÄTH and STRAUHAL, *Ber.*, 1928, 61, 2395. (6) *J. Chem. Soc.*, 1929, 658. (7) *Ibid.*, 1931, 2898. (8) *Ber.*, 1933, 66, 450. (9) *Ibid.*, 1933, 66, 583. (10) *Ibid.*, 1933, 66, 1844.

Actinodaphnine, $C_{18}H_{17}O_4N$. This alkaloid, isolated by Krishna and Ghose¹ from *Actinodaphne Hookeri*, Meissn., was investigated by Ghose, Krishna and Schlittler.² It crystallises in needles, m.p. 210–1°, $[\alpha]_D^{20} + 32.77^\circ$ (EtOH), and furnishes crystalline salts: B. HCl, m.p. 280–1° (*dec.*), $[\alpha]_D + 8.75^\circ$ (H_2O); B. HI, m.p. 264–5° (*dec.*), picrate (with $1H_2O$), m.p. 220–2° (*dec.*), and methiodide, m.p. 243–4°. The oxygen atoms are present as dioxymethylene, methoxyl and hydroxyl (methyl ether amorphous), and the presence of = NH is indicated by the formation of a phenylthiocarbamide, m.p. 181°. The constitution of the alkaloid was established by the following additional observations. Actinodaphnine is oxidised by permanganate to methylenedioxyhemimellitic acid (4 : 5-methylenedioxybenzene-1 : 2 : 3-tricarboxylic acid), and *O*-methylactinodaphnine by nitric acid to mellophanic acid (benzene-1 : 2 : 3 : 4-tetracarboxylic acid). *O*-methylactinodaphnine on successive treatment with methyl iodide in acetone, and acetic anhydride (to remove secondary base) yields *N*-acetyl-*O*-methylactinodaphnine, m.p. 222–4°, and dicentrine (I). *N*-methyl-*O*-ethylactinodaphnine, m.p. 198–9°, undergoes normal degradation by Hofmann's method to a substituted 8-vinylphenanthrene, $C_{20}H_{18}O_4$, m.p. 186–7°, and on demethylenation yields the crystalline phenolic base, $C_{17}H_{13}N(OH)_2(OMe)(OEt)$, m.p. 160° (*dec.*), which on exhaustive methylation furnishes 2-ethoxy-3 : 5 : 6-trimethoxy-8-vinylphenanthrene, identical with that obtainable from laurotetanine (III). These experimental data leave no doubt that actinodaphnine is 2-hydroxy-3-methoxy-5 : 6-methylenedioxy-noraporphine (II).

REFERENCES

- (1) *J. Indian Chem. Soc.*, 1932, **9**, 429. (2) *Helv. Chim. Acta*, 1934, **17**, 919.

Laurelia Novæ-Zelandæ. From the bark of this New Zealand tree known locally as "pukatea," Aston¹ isolated three alkaloids which have been further investigated by Barger, Girardet and Schlittler, to whom knowledge of their structure is due.²

Pukateine, $C_{18}H_{17}O_3N$, has m.p. 200°, b.p. 210–15°/2 mm., $[\alpha]_D^{15} - 220^\circ$ (EtOH), is feebly basic and dissolves in alkaline solutions from which it can be regenerated by carbon dioxide. The hydrochloride is crystalline. Alkaline solutions of the alkaloid become green on exposure to air, and such solutions on acidification develop a purple colour extractable by ether. The oxygen atoms are present as a methylenedioxy- and a phenolic hydroxyl group, and the nitrogen atom as a methylimino-group. *O*-methylpukateine crystallises from light petroleum, m.p. 137°, $[\alpha]_D - 261^\circ$ (EtOH), and yields a methiodide, m.p. 240–1°. Acetic anhydride, with pyridine at 100°, gives *O*-acetylpukateine, isolated as the methiodide, m.p. 245°.

Laureline, $C_{19}H_{19}O_3N$. This base crystallises in tablets, m.p. 97°, $[\alpha]_D^{15} - 98.5^\circ$ (EtOH), and yields crystalline salts: B. HCl, m.p. 280°; B. HBr, brownish spangles; B. HNO_3 , m.p. 238–40°; methiodide, m.p. 223°. Laureline is feebly basic and is unstable, a solution in ether

decomposing on exposure to air. It gives a bluish-green colour on warming with sulphuric acid and a vermilion tint with nitric acid. The oxygen atoms are present as a methoxyl and a methylenedioxy-group and the nitrogen as a methylimino-group. Laureline is isomeric but not identical with *O*-methylpukateine.

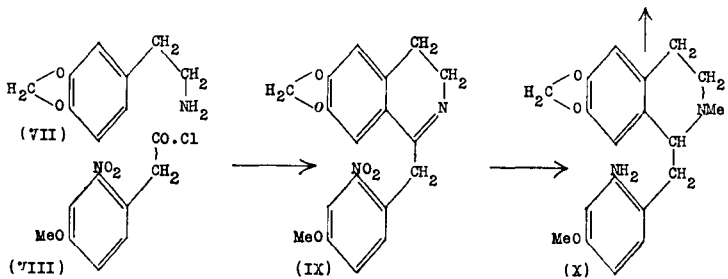
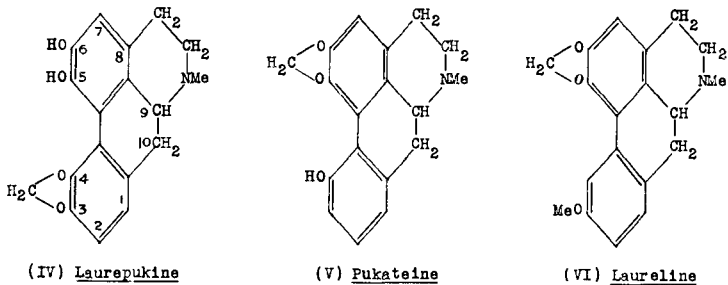
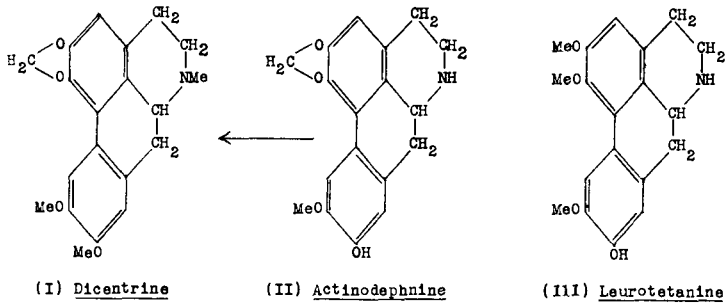

Constitution of Pukateine and Laureline. Methylpukateine and laureline both yield on exhaustive methylation methoxymethylenedioxyvinylphenanthrenes, which can be degraded to methoxymethylenedioxyphenanthrenes; that from methylpukateine was characterised as the picrate, $C_{16}H_{12}O_3 \cdot C_6H_7O_7N_3$, red needles, m.p. 183–4°, and that from laureline had m.p. 132° and gave a picrate, m.p. 172°. On oxidation with permanganate in acetone, laureline yields 4-methoxyphthalic acid, identified as the anil, m.p. 146–7°. Pukateine oxidised by Warnat's method³ with nitric acid yields mellophanic acid (benzene-1 : 2 : 3 : 4-

tetracarboxylic acid) and with permanganate in acetone, hydrastic acid (p. 164), isolated and identified as the ethylimide, m.p. 121°, probably formed from 4:5-methylenedioxybenzene-1:2:3-tricarboxylic acid by loss of one carboxyl group during purification by sublimation. Methylpukateinemethine methiodide on oxidation by permanganate yields 3-methoxyphthalic acid, isolated as the anhydride, m.p. 159°. From these results pukateine was represented by (V) and laureline by (VI), and these formulæ were confirmed by the syntheses of pukateine methyl ether and laureline,² using the Bischler and Napieralski isoquinoline synthesis combined with the Pschorr reaction for the phenanthrene ring closure, of which a number of examples have been given already.

The formulæ (VII) to (X) relate to the preparation of laureline and are identical with those required for methylpukateine except that for the latter the methoxyl group in (VIII, IX, X) is at C³ instead of C⁴. *homo*-Piperonylamine (VII) was condensed with 2-nitro-4-methoxyphenylacetyl chloride (VIII) to give 2-nitro-4-methoxyphenylacetohomopiperonylamide, m.p. 165°, in which ring closure was effected by phosphorus pentoxide in toluene to 2'-nitro-4'-methoxy-6:7-methylenedioxy-1-benzyl-3:4-dihydro-isoquinoline, m.p. 139° (IX), the methiodide of which was reduced to 2'-amino-4'-methoxy-6:7-methylenedioxy-1-benzyl-2-methyltetrahydro-isoquinoline (X) which with Haworth and Gulland's⁴ modification of the Pschorr reaction underwent the second ring closure giving a good yield of *dl*-laureline (VI), which was resolved into optically active components. The *l*-base had m.p. 114°, $[\alpha]_D - 97.7^\circ$ (EtOH), and its identity with laureline was confirmed by its degradation to the vinylphenanthrene, yellow needles, m.p. 158°, identical with that obtained from the natural alkaloid. The *d*-base had m.p. 114° and $[\alpha]_D + 97.6^\circ$ (EtOH). Faltis, Wagner and Adler² have repeated Schlittler's synthesis of laureline² and by a more extensive comparison of the *l*-form with natural laureline have satisfied themselves that the two are identical. They have also prepared the structural isomeride having the methoxyl group at C² instead of C³ as in laureline (VI). This they have named *isolaureline*; the *dl*-form has m.p. 109–10° and forms a hydrochloride, m.p. 238–40°. The *l*-form has m.p. 106–8° and $[\alpha]_D - 35.8^\circ$ (EtOH).

The *dl*-pukateine methyl ether obtained in small yield in the analogous synthesis was isolated as the hydriodide and resolved by the successive use of *d*- and *l*-tartaric acids into the *l*-base, m.p. 136°, $[\alpha]_D^{20} - 252^\circ$ (EtOH), identical with the methyl ether of pukateine, and the *d*-base, m.p. 136°, $[\alpha]_D^{20} + 256.4^\circ$ (EtOH).

Laurepukine, C₁₈H₁₇O₄N. The alkaloid so named by Aston proved to be a mixture of pukateine and laureline, and the name was transferred by Barger and Girardet² to a new third alkaloid. This crystallises in hexagonal tablets, or colourless needles, m.p. 230–1°, $[\alpha]_D - 222^\circ$ (CHCl₃), or -252° (EtOH). The sulphate, B₂ · H₂SO₄ · 6H₂O, m.p. 99–100°, is virtually insoluble in water. The base slowly develops a pale violet colour in sulphuric acid and is coloured orange by nitric acid. Ferric chloride produces a feeble green tint. The oxygen atoms are present in the form of

two hydroxyl groups and a methylenedioxy group, and the nitrogen atom as a methylimino-group. The dimethyl ether, b.p. 200–10°/10 mm., m.p. 134°, $[\alpha]_D - 314^\circ$ (CHCl_3), obtained with difficulty by Gadamer's method,⁵ yields a methiodide, m.p. 249–50°. From a comparison of the absorption spectra,⁶ colour reactions, melting-points and other characteristics of this dimethyl ether with the analogous data for dicentrine (p. 310), bulbocapnine methyl ether (p. 308) and domesticine methyl ether (p. 315), Girardet² concludes that laurepukine is 3 : 4-methylenedioxy-5 : 6-dihydroxyaporphine (IV), though 3 : 4-dihydroxy-6 : 7-methylenedioxyaporphine is not completely excluded.

REFERENCES

(1) ASTON, *J. Chem. Soc.*, 1910, 97, 1381. (2) GIRARDET, *Thèse*, Lausanne, 1931, *Helv. Chim. Acta*, 1931, 14, 504; BARGER and GIRARDET, *ibid.*, 481; SCHLITTLER, *Thèse*, Lausanne, 1932; *Helv. Chim. Acta*, 1932, 15, 394; BARGER and SCHLITTLER, *ibid.*, 381; FALTIS *et al.*, *Ber.* 1944, 77, 686. (3) *Ber.*, 1925, 58, 2773. (4) *J. Chem. Soc.*, 1928, 581. (5) *Arch. Pharm.*, 1911, 249, 641. (6) For absorption spectra of aporphine bases, see KITASATO, *Acta phytochimica* (Jap.), 1927, 3, 175; GIRARDET, *J. Chem. Soc.*, 1931, 2630.

Boldine, $\text{C}_{19}\text{H}_{21}\text{O}_4\text{N}$. This alkaloid was isolated from the Chilean plant *Boldea fragrans*, Gray (*B. chilensis*, Juss.; *Pneumus Boldus*, Molina) by Bourgoin and Verne¹ and was subsequently examined by Merck² and by Warnat.³ It is an amorphous, light-sensitive, bitter substance, which crystallises with solvent, B. CHCl_3 , B. CS_2 , etc., in needles or scales. It has m.p. 161–3°, $[\alpha]_D + 72.7^\circ$ (B. CHCl_3 ; alcohol), and does not yield crystalline salts. With sulphuric acid containing 0.05 per cent. ferrous sulphate it gives a deep-blue and with nitric acid a deep red colour.² It contains two methoxyl and two phenolic hydroxyl groups. With benzoyl chloride it furnishes (Baumann-Schotten method) chiefly a tribenzoyl derivative, needles, m.p. 171°, in which one acyl group is attached to nitrogen, due to scission of a reduced pyridine ring in which the nitrogen atom is tertiary. A dibenzoyl derivative, m.p. 124–7°, is also formed in small quantity. Boldine dimethyl ether (diazomethane process) crystallises in rods, m.p. 117–8° (hydriodide, m.p. 243°; methiodide, m.p. 221°), and by comparison of the two bases and their Hofmann degradation products was shown to be identical with glaucine³ (p. 311), whence boldine must be glaucine with two methoxyl groups replaced by two hydroxyl groups, which, according to Warnat,³ must be in different rings. Their location was determined by Späth and Tharrer,⁴ who found that boldine diethyl ether (diazoethane process) on exhaustive methylation yields trimethylamine and 3 : 5-dimethoxy-2 : 6-diethoxy-8-vinylphenanthrene, m.p. 112–3°, which is oxidised by permanganate in acetone to 3 : 5-dimethoxy-2 : 6-diethoxyphenanthrene-8-carboxylic acid, m.p. 202–3° (*vac.*). The latter on decarboxylation yields 3 : 5-dimethoxy-2 : 6-diethoxyphenanthrene, m.p. 133–4°, identified by comparison with a synthesised specimen. Boldine must therefore be 3 : 5-dimethoxy-2 : 6-dihydroxyaporphine (III; R = .OH). Almost simultaneously Schlittler⁵ confirmed this conclusion by the synthesis of *dl*-boldine diethyl ether starting with

6-nitro-4-methoxy-3-ethoxyphenylacet- β -4'-methoxy-3'-ethoxyphenylethylamide, m.p. 157.5° (I; R = OEt) in which ring closure to

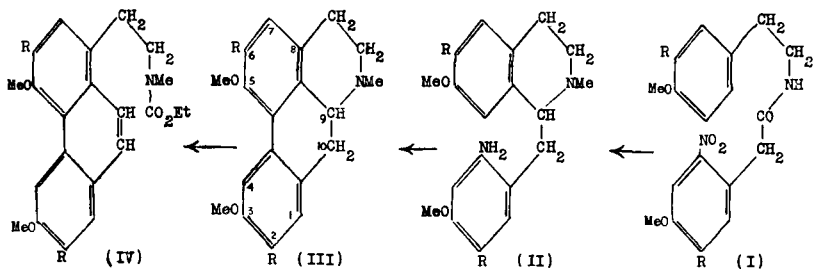

7-methoxy-6-ethoxy-1:6'-nitro-4'-methoxy-3'-ethoxybenzyl-3:4-dihydroisoquinoline, m.p. 163.5°, was effected, and the methiodide, m.p. 188° (*dec.*), of the latter reduced to 7-methoxy-6-ethoxy-1:6'-amino-4'-methoxy-3'-ethoxybenzyl-2-methyltetrahydroisoquinoline (II; R = OEt), which was converted by the Pschorr reaction (diazotisation in presence of copper powder) to 3:5-dimethoxy-2:6-diethoxyaporphine (III; R = OEt). This synthetic *dl*-form being unsuitable for comparison with the diethyl ether of natural boldine, both were treated with ethyl chlorocarbonate⁶ and sodium hydroxide to produce the substance (IV; R = OEt) in which the centre of asymmetry of boldine no longer exists. The two products had m.p. 114–5° alone or mixed. In view of the close relationship of boldine and laurotetanine (p. 320) it is interesting to note that Barger and Silberschmidt⁷ state that a substance resembling boldine accompanies laurotetanine in *Litsea citrata*.

REFERENCES

- (1) *J. Pharm. Chim.*, 1872, **16**, 191. (2) *Merck's Jahresb.*, 1922, **36**, 110. (3) *Ber.* 1925, **58**, 2768; 1926, **59**, 85. (4) *Ibid.*, 1933, **66**, 904. (5) *Ibid.*, 1933, **66**, 988. (6) Cf. GADAMER and KNOCH, *Arch. Pharm.*, 1921, **259**, 135; OSADA, *ibid.*, 1924, **262**, 501. (7) *J. Chem. Soc.*, 1928, 2921.

DAPHNANDRA spp. Bancroft¹ recorded the presence of alkaloids in several *Daphnandra* species, notably *D. repandula* and *D. micrantha*. The latter was examined by Pyman² and shown to contain three alkaloids, daphnandrine, micranthine and daphnoline.

Daphnandrine, C₃₆H₃₈O₆N₂, crystallises, with solvent, from chloroform in colourless needles, m.p. 280° (dried at 100°, *dec.*), [α]_D + 474.7° (dry base: CHCl₃). The hydrochloride, B. 2HCl. 5H₂O, forms colourless prisms, m.p. 282° (*dry, dec.*), [α]_D + 296–314° (H₂O: c = 3.9 to 1.1); the hydrobromide, B. 2HBr. 6H₂O, colourless prisms, m.p. 291° (*dry, dec.*); and the acid oxalate, B. 1½H₂C₂O₄. 5½H₂O, colourless needles, m.p. 225°. The alkaloid is sparingly soluble in nearly all solvents, except boiling chloroform. It contains one methylimino and three methoxyl groups.

Micranthine, C₃₆H₃₂O₆N₂, crystallises, with solvent, from chloroform in colourless needles, m.p. 190–6° (*dec.*), is insoluble in water or ether, sparingly in alcohol or chloroform, and yields a crystalline sulphate,

B. $\text{H}_2\text{SO}_4 \cdot 10\text{H}_2\text{O}$, fine colourless needles, m.p. 312° (*dec.*), from boiling water. No other crystalline salt was obtained. The base contains one — OMe and one = NMe group.

Daphnoline, $\text{C}_{34}\text{H}_{34}\text{O}_6\text{N}_2$, crystallises, with solvent, from alcohol or chloroform in small hexahedra, m.p. $190\text{--}215^\circ$, $[\alpha]_{\text{D}} + 459^\circ$ (dry base; CHCl_3), and is even less soluble than daphnandrine in all ordinary solvents. The hydrochloride, B. $2\text{HCl} \cdot 3\frac{1}{2}\text{H}_2\text{O}$ forms, from alcohol, large colourless double pyramids, m.p. 290° (*dry, dec.*), $[\alpha]_{\text{D}} + 283^\circ$ (hydrated salt; H_2O) and the hydrobromide, B. $2\text{HBr} \cdot 4\text{H}_2\text{O}$, microscopic needles, m.p. 286° (*dec.*), from hot water. Daphnoline is a phenolic base and contains one methylimino and two methoxyl groups.

The three alkaloids give characteristic colour reactions with Fröhde's reagent: daphnandrine, indigo-blue changing to port wine red; micranthine, indigo-blue changing to emerald-green; daphnoline, violet changing to port wine red.

From *D. repandula* Bick and Whalley³ have isolated two new alkaloids, repanduline and repandine, of which the former is also present in *D. Dielsii* Perkins.

Repanduline, $\text{C}_{40}\text{H}_{46}\text{O}_8\text{N}_2$, decomposes slowly at 100° and rapidly at 160° , $[\alpha]_{\text{D}}^{25^\circ} + 443^\circ$ (CHCl_3), behaves as a diacidic base, contains two methoxyl and two methylimino groups and at least one dioxymethylene group. The salts crystallise with difficulty; the hydrochloride decomposes at 218° and the hydrobromide at 240° ; the former has $[\alpha]_{\text{D}} + 372^\circ$ (H_2O).

Repandine, $\text{C}_{38}\text{H}_{42}\text{O}_6\text{N}_2$, m.p. 255° (*dec.*), $[\alpha]_{\text{D}}^{20^\circ} - 78.4^\circ$ (C_6H_6) or -74.6° (CHCl_3), is diacidic and contains three methoxyl and two methylimino- groups but no dioxymethylene group. The hydrobromide and sulphate both decompose $> 200^\circ$ and the hydrochloride has $[\alpha]_{\text{D}}^{20^\circ} - 141^\circ$.

REFERENCES

- (1) *Proc. Roy. Soc. N.S.W.*, 1886, 20, 70. (2) *J. Chem. Soc.*, 1914, 105, 1679.
 (3) *Univ. Queensland Papers, Dept. Chem.*, 1946, 1, No. 28; 1947, 1, No. 30.

PHARMACOLOGY. According to Malcolm,¹ *pukateine hydrochloride* in doses of 0.25 gm. per kilogramme of body weight is a spinal convulsant. In rabbits the convulsions resemble those induced by strychnine. On intravenous injection the blood pressure falls slightly, the heart beats slowly, and death results from respiratory failure. Applied to the tongue, *pukateine* causes numbness. The alkaloid itself is inactive, owing to its insolubility. *Laurotetanine* acts as a tetanising poison in frogs, but is less active than strychnine. Raymond-Hamet² states that *boldine* belongs pharmacologically to the bulbocapnine group (p. 306). It lowers blood pressure and in large doses provokes violent clonic convulsions, the latter being suppressed by the injection of sparteine. *Boldine*, like bulbocapnine, antagonises but does not invert the action of adrenaline in raising blood pressure. These data should be compared with those recorded for aporphine alkaloids of the corydalis group (pp. 306-313).

According to Dale,³ *daphnandrine*, *daphnoline* and *micranthine* all

exhibit the same type of pharmacological action, but daphnandrine is only slightly active. Daphnoline and micranthine produce on hypodermic injection marked local action, causing cedematous infiltration of the subcutaneous tissues and loss of sensibility. They also have a depressant action on the central nervous system, and, when given intravenously, cause vasodilator circulatory depression. Death from large doses is due to respiratory paralysis.

REFERENCES

(1) Quoted by ASTON, *J. Chem. Soc.*, 1910, **97**, 1381. (2) *Compt. rend. Soc. Biol.*, 1936, **121**, 431; cf. BUTTURINI, *Boll. sci. ital. biol. sperim.*, 1940, **15**, 614. (3) Quoted by PYMAN, *J. Chem. Soc.*, 1914, **105**, 1680.

THE BERBERIS AND RELATED ALKALOIDS

Berberine is probably the most widely distributed alkaloid. It and the allied alkaloids palmatine, jatrorrhizine, columbamine and coptisine occur somewhat frequently in the Rhœadales (list, p. 169) as the tetrahydro-derivatives, but, in the botanical families referred to in the distribution list below, the tetrahydro-derivatives are exceptional and the unreduced alkaloids usual. The associated alkaloids include two members of the aporphine group, domesticine and *isodomesticine* (p. 315), one member of the cryptopine group, γ -homochelidonine (p. 294) and two members of the double *isoquinoline* type, *viz.*, berbamine and oxyacanthine (p. 346).

The following list is not exhaustive, but it records the reasonably authenticated occurrences of the berberine type of alkaloid and its associates. Brief descriptions are included in the list, of alkaloids not of sufficient importance to be described fully in the later text.

RANUNCULACEÆ. (1) *Coptis japonica*¹ Mak. Berberine, palmatine, columbamine, coptisine, worenine.

(2) *C. occidentalis*² Salis, *C. Teeta*³ Wall., and *C. trifolia*⁴ Salis. Berberine, "Coptine" (an uncharacterised yellow alkaloid first mentioned by Gross³ for *C. Teeta*).

(3) *Hydrastis canadensis*⁵ L. Berberine, canadine, hydrastine (p. 162).

(4) *Xanthorrhiza apiifolia*⁶ l'Herit. Berberine (Gordin⁴).

(4a) *Thalictrum foliolosum* DC. Berberine and thalictrine.^{4(a)}

BERBERIDACEÆ. In the course of histological investigations of Himalayan *Berberis* spp. Chatterjee^{6(a)} has recorded the presence of alkaloids in the following species: *aristata* DC., *lycium* Royle, *Wallichiana* DC., *Wallichiana* DC. var. *latifolia*, and *vulgaris* L. The alkaloids of *B. insignis* Hook, *B. nepalensis* Spreng and *B. umbellata* Wall, also dealt with in this work, were subsequently characterised (*see below*).

(5) Berberine has been recorded for the following *Berberis* spp.—*B. ætnensis*⁷ Presl., *B. buxifolia*⁸ Lam., *B. Darwinii*⁹ Hook, *B. glauca*¹⁰ DC., *B. nervosa*¹¹ Pursh. and *B. repens*.^{11(a)}

The following *Berberis* spp. contain mixtures of alkaloids :—

- (6) *B. heteropoda* Schrenk. Berberine, palmatine, jatrorrhizine, columbamine, berbamine and oxyacanthine.¹²
- (7) *B. insignis* Hook. Umbellatine.^{12(a)}
- (8) *B. laurina* Billb. (Thunb.). Berberine and possibly hydrastine.¹³
- (9) *B. Thunbergii* DC. var *Maximowiczii*. Berberine, oxyberberine, jatrorrhizine, columbamine, berbamine and oxyacanthine :¹⁴
see also shobakunine and tetrahydroshobakunine (p. 340).
- (10) *B. umbellata* Wall. Umbellatine (Chatterjee, 1944).^{6(a)}
- (11) *B. vulgaris* L. Berberine, berberrubine, palmatine, jatrorrhizine, columbamine, berbamine, oxyacanthine¹⁵ and a base $C_{19}H_{22}ON_2$, hydrochloride, m.p. 256°.
- (12) *Mahonia aquifolium* Nutt. (*Berberis aquifolium* Pursh.) Berberine, berbamine, oxyacanthine, a phenolic base, m.p. 190–3°, and undetermined alkaloids.¹⁶
- (13) *M. nepalensis* DC. (*Berberis nepalensis* Spreng.). Umbellatine, neprotine (Chatterjee, 1944).^{6(a)}
- (14) *M. philippinensis* Nutt. Berberine, jatrorrhizine, shobakunine.¹⁷
- (15) *M. Swaseyi* Fedde. Berberine, berbamine.^{17(a)}
- (16) *M. trifoliata* Fedde. Berberine.^{17(a)}
- (17) *Nandina domestica* Thunb. Berberine, nandinine, domesticine, isodomesticine (p. 315), nantenine,¹⁸ *nandazurine*, $C_{28}H_{18}O_6N_2$, deep blue crystals, m.p. > 350°.
- MENISPERMACEÆ. (18) *Archangelisia flava* L. (Merr).¹⁹ Berberine, jatrorrhizine, columbamine, shobakunine (see p. 340).
- (19) *Coscinium blumeanum* Miers. Berberine, jatrorrhizine, palmatine.²⁰
- (20) *C. fenestratum* Colebr. Berberine.²¹ Two bases, m.p. 205–6° and m.p. 223–4°.^{21(a)}
- (21) *Fibraurea chloroleuca* Miers (*F. tinctoria* Lour.) Palmatine and jatrorrhizine.²⁰
- (22) *Jateorhiza (Jatrorrhiza) palmata* Lam. (Miers). Columbamine, jatrorrhizine, palmatine.²²
- (23) *Sinomenium acutum* Rehd and Wils. Sinaectine (*l*-tetrahydro-epiberberine) and other alkaloids (p. 268).
- Alkaloids of this group have also been recorded in *Tinospora* spp. and *Cocculus* spp. by Beauquesne.²²
- ANONACEÆ. (24) *Cælocline polycarpa* DC. (*Xylopiya polycarpa* Olw.) Berberine.²³
- PAPAVERACEÆ (see list, p. 169).
- RUTACEÆ. (25) *Evodia meliifolia* Benth. Berberine.²⁴
- (26) *Phellodendron amurense* Rupr. Berberine, palmatine.²⁵
- (27) *Toddalia aculeata* Pers. Berberine.²⁴ *Toddaline*, $C_{17}H_{12}O_2(OMe)_2(NMe)$, colourless crystals ex $CHCl_3$, m.p. 269–70°; B. HCl . H_2O , m.p. 205–6°; B. HNO_3 yellow needles, m.p. 239° (*dec.*); picrate, glancing needles, m.p. 237–8°. *Toddalinine*, $C_{17}H_{19}O_3(OMe)(NMe)$, m.p. 180–200° (*dec.*); B. HCl . $2H_2O$, m.p. 283–5°; picrate, m.p. 230–5° (*dec.*).²⁶

- (28) *Zanthoxylum brachyacanthum* F. Müll. *l*- α -Canadine methochloride and γ -homochelidonine.²⁷
- (29) *Zanthoxylum caribæum* Lam. (*Z. Clava Herculis* DC.). Berberine, and *N*-(2-*p*-anisylethyl)-*N*-methylcinnamide, MeO . C₆H₄ . CH₂ . CH₂ . NMe . CO . CH : CHPh, m.p. 76°. ²⁸
- (30) *Zanthoxylum ochroxyylon* DC. α -*Xantherine*, C₂₄H₂₅O₆N, colourless, needles, m.p. 186–7°, turns yellow in air and forms yellow salts. β -*Xantherine*.²⁹
- (31) *Zanthoxylum senegalense* DC. (*Fagara xanthoxyloides*). *Artarine*, C₂₁H₂₃O₄N, amorphous, but yields crystalline yellow salts; B . HCl . 4H₂O needles, m.p. 194°; B₂ . H₂PtCl₆, yellow needles, m.p. > 290°. A second alkaloid forms blood-red needles and yields yellow salts.³⁰

REFERENCES

- (1) MURAYAMA and SHINOZAKI, *J. Pharm. Soc. Japan*, 1926, No. 530, 32; KITASATO, *ibid.*, 1927, No. 542, 48; *Proc. Imp. Acad. Tokyo*, 1926, 2, 124. (2) MOLLET and CHRISTIANSEN, *J. Amer. Pharm. Assoc.*, 1934, 23, 310; ROWE, *ibid.*, 1939, 28, 422. (3) PERRINS, *J. Chem. Soc.*, 1862, 15, 341; GROSS, *Amer. J. Pharm.*, 1873, 14, 193; HOOPER, *Pharm. J.*, 1912, [iv], 34, 482. (4) SCHULTZ, *J. Pharm.*, 1884, [iii], 14, 273; GORDIN, *Arch. Pharm.*, 1902, 240, 146. (4a) VASHISTHA and SIDDIQUI, *J. Ind. Chem. Soc.*, 1941, 18, 641. (5) MAHLA, *Silliman's Amer. J.*, 1862, [2], 33, 43; PERRINS, *J. Chem. Soc.*, 1862, 15, 340. (6) PERRINS, *Pharm. J.*, 1862, 3, 567. (6a) *J. Amer. Pharm. Assoc.*, 1943, 32, 1; 1944, 33, 205, 210; *Science and Culture*, 1942, 7, 619. (7) A. G. PERKIN, *J. Chem. Soc.*, 1897, 71, 1194. (8) ARATA, *Rep. Pharm.*, 1892, 45. (9) CROMWELL, *Biochem. J.*, 1933, 27, 860. (10) SCHILBACH, *Inaug. Diss. Marburg*, 1886 (quoted by WEHMER). (11) NEPPACH, *Amer. J. Pharm.*, 1878, 373. (11a) *J. Pharm. Exp. Ther.*, 1940, 69, 64. (12) OREKHOV, *Arch. Pharm.*, 1933, 271, 323. (12a) *J. Amer. Pharm. Assoc.*, 1941, 30, 247. (13) GURGUEL, COSTA, DA SILVA, *Bull. Assoc. Brasil. Pharm.*, 1934, 15, 11; JANOT and GOUTAREL, *Bull. Sci. Pharmacol.*, 1941, 48, 215. (14) KONDO and TOMITA, *Arch. Pharm.*, 1930, 268, 549. (15) BUCHNER, *Annalen*, 1835, 24, 228; POLEX, *Arch. Pharm.*, 1836, [ii], 6, 263; WACKER, *Vjschr. prakt. Pharm.*, 1861, 10, 545; HESSE, *Ber.*, 1886, 19, 3190; SCHULZ, *J. Amer. Pharm. Assoc.*, 1926, 15, 33; SPÄTH (with KOLBE), *Ber.*, 1925, 58, 2280; (with POLGAR) *Monats.*, 1929, 52, 117; VON BRUCHHAUSEN and SCHULZE, *Arch. Pharm.*, 1929, 267, 617. (16) PARSONS, *Pharm. J.*, 1882–83, [iii], 13, 46; RÜDEL, *Arch. Pharm.*, 1891, 229, 631; POMMEREHNE, *ibid.*, 1895, 233, 127; GORDIN, *ibid.*, 1902, 240, 146; NEUGEBAUER and BRUNNER, *Pharm. Zeit.* 1939, 80, 113, 241; *Deut. Apoth. Zeit.*, 1939, 54, 326. (17) CASTRO, SANTOS and VALENZUELA, *Univ. Philipp. Nat. appl. Sci. Bull.*, 1932, 2, 401. (17a) GREATHOUSE (with WATKINS), *Amer. J. Bot.*, 1938, 25, 743; (with RIGLER) *Plant Physiol.*, 1940, 15, 563. (18) EIJKMAN, *Rec. trav. Chim.*, 1884, 3, 197; KITASATO, *J. Pharm. Soc. Japan*, 1925, No. 522, 1; No. 535, 71; TAKASE and OHASHI, *ibid.*, 1926, No. 535, 70; MANUWA, SAKAI and KAN, *ibid.*, 1926, No. 536, 80; KITASATO and SONE, *Bull. Chem. Soc. Japan*, 1930, 5, 348; PLOUVIER, *Bull. Sci. Pharmacol.*, 1942, 49, 150. (19) SANTOS, *Univ. Philipp. Nat. Appl. Sci. Bull.*, 1931, 1, 153. (20) TOMITA and TANI, *J. Pharm. Soc. Jap.*, 1941, 61, 83. (21) PERRINS, *Pharm. J.*, 1852, 12, 188; STENHOUSE, *J. Chem. Soc.*, 1867, 20, 187; VARIER and PILLAI, *Curr. Sci.*, 1943, 12, 228; CHILD and NATHANIEL, *ibid.*, p. 255 (*Brit. Chem. Physiol. Abstr.*, 1944, A.iii, 156; A.ii, 87); (21a) TIMMIN *et al.*, *Arch. Pharm.*, 1930, 268, 314. (22) GADAMER, *ibid.*, 1902, 240, 450; GORDIN, 1902, 240, 146; GÜNZEL, 1906, 244, 257; FEIST, 1907, 245, 586; SPÄTH and POLGAR, *Monats.*, 1929, 52, 117; SPÄTH and BURGER, *Ber.*, 1926, 59, 1486; BEAUQUESNE, *Bull. Sci. Pharmacol.*, 1938, 45, 7. (23) STENHOUSE, *Annalen*, 1855, 95, 108; 1858, 105, 360. (24) PERKIN and HUMMEL, *J. Chem. Soc.*, 1895, 67, 413. (25) MURAYAMA (with SHINOZAKI), *J. Pharm. Soc. Japan*, 1926, No. 530,

32; (with TAKATA), *ibid.*, 1927, No. 550, 146. (26) DEY and PILLAY, *Arch. Pharm.* 1933, 271, 477; (with DAVID and RAJAMANIKAM), *Ind. J. Med. Res.*, 1935, 22, 765; LOBSTEIN and HESSE, *Bull. Sci. Pharmacol.*, 1931, 38, 157. (27) JOWETT and PYMAN, *J. Chem. Soc.*, 1913, 103, 291, 825. (28) CHEVALIER and PELLETAN, *J. Chim. Med.*, 1826, 2, 314; PERRINS, *J. Chem. Soc.*, 1862, 15, 342; LA FORGE and BARTHEL, *J. Org. Chem.*, 1944, 9, 250. (29) LE PRINCE, *Bull. Sci. Pharmacol.*, 1911, 18, 343. (30) GIACOSA (with MONARI), *Gazzetta*, 1887, 17, 362; (with SOAVE), *ibid.*, 1889, 19, 303; *cf.* PRIESS, *Ber. Deut. Pharm. Ges.*, 1911, 21, 227; THOMS, *Chem. Zeit.*, 1910, 34, 1279; *cf.* THOMS, *ibid.*, 1922, 46, 856; (with THÜMEN), *Ber.*, 1911, 34, 3717.

Berberine, $C_{20}H_{19}O_5N$. (Items 1–6, 8, 9, 11, 12, 14–20, 24–27, 29; list, p. 328, and 2, 3a, 7, 11, 21; list, p. 169.) This alkaloid, first isolated by Chevalier and Pelletan from the bark of *Xanthoxylon Clava Herculis* and named “xanthopicrit,”¹ was obtained independently from barberry root bark (*Berberis vulgaris*) by Buchner and Herberger,² and was examined by Fleitmann.³ The empirical formula was determined by Perrins,⁴ who also identified “xanthopicrit” with berberine. Processes for the preparation of berberine have been described by Lloyd, Schwyzer and others,⁵ and for its purification, *viâ* the acetone compound,⁶ by Gaze.⁷ Methods for the estimation of berberine have been published by Gordin,⁸ Troeger and Linde,⁹ Richter,¹⁰ David,¹¹ Wasicky and Joachimowitz,¹² and Neugebauer and Brunner.¹³ Some attention has been given to the detection of berberine in plant tissues⁸ and Klein and Bartosch¹⁴ have devised microchemical methods for this purpose. Wagenaar¹⁵ has compared various alkaloidal precipitants as microchemical reagents for the alkaloid, while van Zijp¹⁶ has explored the possibilities of berberine as a microchemical reagent for substances with which it forms insoluble derivatives.

Berberine crystallises from water or dilute alcohol in yellow needles with $5.5H_2O$; dried at 100° , the crystals retain $2.5H_2O$, and then become yellowish-brown at 110° , and decompose at 160° (Perkin); from chloroform it forms triclinic tablets containing $1CHCl_3$, m.p. 145° (*dec.* above 150°); the acetone compound,⁷ $B. C_3H_6O$, forms reddish-yellow tablets. Berberine is soluble in cold water (1 in 4.5 at 21°) or alcohol (1 in 100), and readily soluble in the hot liquids; slightly soluble in benzene or chloroform. The aqueous solution is bitter, neutral to litmus and optically inactive. The salts are formed with loss of $1H_2O$; they are mostly of dull yellow colour and crystallise well. The hydrochloride, $C_{20}H_{17}O_4N \cdot HCl \cdot 2H_2O$, occurs in small needles; the hydriodide, $C_{20}H_{17}O_4N \cdot HI$, is sparingly soluble in cold water (1 in 2130); the nitrate forms greenish-yellow needles, and the sulphate slender yellow needles; both are sparingly soluble in cold water, and even less so in dilute solutions of the corresponding acids. The phosphate, $C_{20}H_{17}O_4N \cdot 2H_3PO_4 \cdot 1.5H_2O$, is bright yellow and crystalline.¹⁸ The aurichloride, platinumchloride and carbonate can be crystallised, the first from alcoholic hydrochloric acid. An aqueous solution of berberine gives a precipitate of the nitrate on addition of nitric acid (sp. gr. 1.185). On reduction with sulphuric acid and zinc the aqueous solution becomes colourless by the formation of tetrahydroberberine. Chlorine water, added to berberine hydrochloride in water, gives a reddish coloration.¹⁹

Constitution. Knowledge of the chemistry of berberine is chiefly due to W. H. Perkin, jun.²⁰

The alkaloid contains two methoxyl groups, and is demethylated by hydriodic acid to BERBEROLINE, $C_{18}H_{13}O_4N$ (amorphous). When berberine is oxidised in warm alkaline solution with potassium permanganate a series of degradation products is obtained, of which the following are the more important.

Berberilic acid, $C_{20}H_{19}O_9N$, m.p. $177-82^\circ$, is dibasic, and furnishes a dimethyl ester, m.p. 173° . When heated to about 180° , the acid passes into ANHYDROBERBERILIC ACID, $C_{20}H_{17}O_8N$, colourless needles, m.p. 236° , soluble in alkali carbonate solutions with the formation of berberilates. When ammonium berberilate is dried under reduced pressure, a molecular proportion of ammonia is lost with the formation of the ammonium salt of the anhydro-acid, from which other salts, and the methyl ester, m.p. 178° , have been obtained. Berberilic acid is hydrolysed by hot dilute sulphuric acid to hemipinic acid (I) and ω -aminoethylpiperonylic acid (II), large tabular crystals, m.p. $180-2^\circ$. Berberilic acid is therefore represented by (III).

Berberal, $C_{20}H_{17}O_7N$. This substance, obtained with difficulty from berberine, crystallises in colourless glancing leaflets, m.p. $148-50^\circ$, and on hydrolysis by hot dilute sulphuric acid furnishes (a) ψ -opianic acid (I: CO_2H at C^2 replaced by CHO), the semi-aldehyde of hemipinic acid, and (b) aminoethylpiperonylic anhydride (II: with ring closure between NH_2 and $COOH$), which is *noroxyhydrastinine*, and from which Perkin²¹ prepared oxyhydrastinine (p. 164). These two hydrolytic products can be recombined to form berberal, and Perkin and Robinson²¹ assigned formula (IV) to this substance. When opianic acid (I with CO_2H at C^1 replaced by $-CHO$) is combined with the anhydride of (II), *isoberberal*, needles, m.p. 185° , is produced.

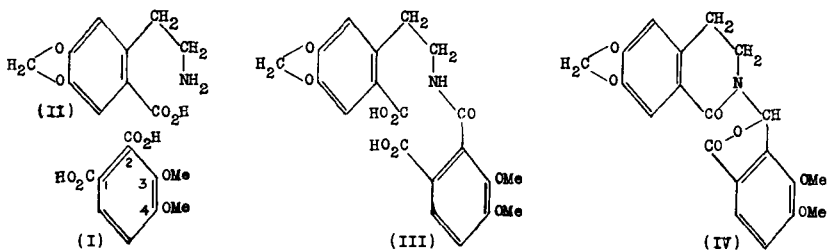

Oxyberberine, $C_{20}H_{17}O_5N$. This, the first product of the action of potassium permanganate on berberine, crystallises from xylene in plates, m.p. $198-200^\circ$. When even traces are dissolved in 50 per cent. sulphuric acid and a drop of nitric acid is added, a brown colour is produced, changing to intense violet. The constitution of oxyberberine is discussed below. From the results of these and other reactions, Perkin assigned a formula to berberine, which was modified by Perkin and Robinson²¹ to (V).

The necessity for at least two formulæ to represent berberine was shown by Gadamer,²² who observed that on adding barium hydroxide to berberine sulphate solution, a brownish-red, strongly alkaline solution of the free base (berberinium hydroxide of Gadamer, V) is obtained, which with excess of sodium hydroxide yields berberinal (supposed aldehyde form of berberine, VI), differing from solid berberine (ammonium form) in being soluble in ether. This furnishes an oxime, m.p. 165°, and on treatment with concentrated sodium hydroxide yields oxyberberine, $C_{20}H_{17}O_5N$, and the so-called dihydroberberine, $C_{20}H_{19}O_4N$, thus behaving

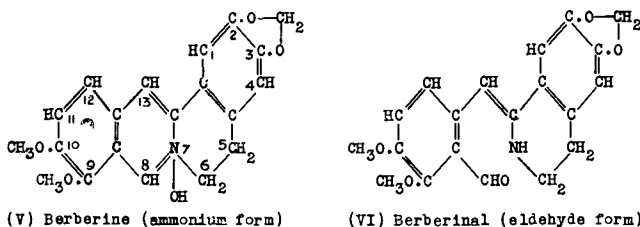

like an aromatic aldehyde. Faltis has suggested²³ that this reaction is in reality analogous with that between quinoline methiodide and alkalis,²⁴ and that the products formed are oxyberberine and tetrahydroberberine (*dl*-canadine). Tinkler²⁵ has, however, observed that ordinary berberine and its salts show the same ultra-violet absorption spectra, whilst Gadamer's "berberinal" shows an absorption spectrum almost identical with that of Freund and Beck's α -methyl-dihydroberberine,²⁶ which would appear to be a derivative of a carbinol form of berberine. Further, the absorption spectrum of the hydro-product formed by the action of alkalis on "berberinal" is similar to that of the supposed "berberinal," and is quite distinct from that of tetrahydroberberine, so that these observations lend no support to Faltis's suggestion. The position, therefore, is that berberine can theoretically exist in three forms, of which two are known, *viz.*, (a) the *ammonium form* (VII), in which berberine exists in solution when the calculated quantity of barium hydroxide is added to an aqueous solution of the sulphate, or when berberineacetone is decomposed by superheated steam, and it is by replacement of the —OH group in this form by acid radicles that berberine salts are formed; and (b) the *carbinol form* (VIII) which represents the ordinary alkaloid first isolated by Gadamer in a pure state, and for which Perkin²⁷ used the name "berberine" and which is, therefore, in this sense synonymous with Gadamer's "berberinal" and Tinkler's "berberinol." The aldehyde, form (VI), has not been obtained. Dihydro- and tetrahydro-berberines on this system of nomenclature then become dihydro- and tetrahydroanhydroberberines.²⁷

By the action of strong alkalis the carbinol form (VIII) is converted into dihydroberberine (IX) and oxyberberine (X).

Bland, Perkin and Robinson²⁸ have shown that oxyberberine is converted by hydrochloric acid into *isooxyberberine* (XI) by the opening of the reduced pyridine ring.

A third form, *neo*oxyberberine (partial formula XII), was obtained by Pyman²⁹ by the oxidation of berberineacetone³⁰ (XIII) with permanganate in acetone solution. The steps in its formation are shown by

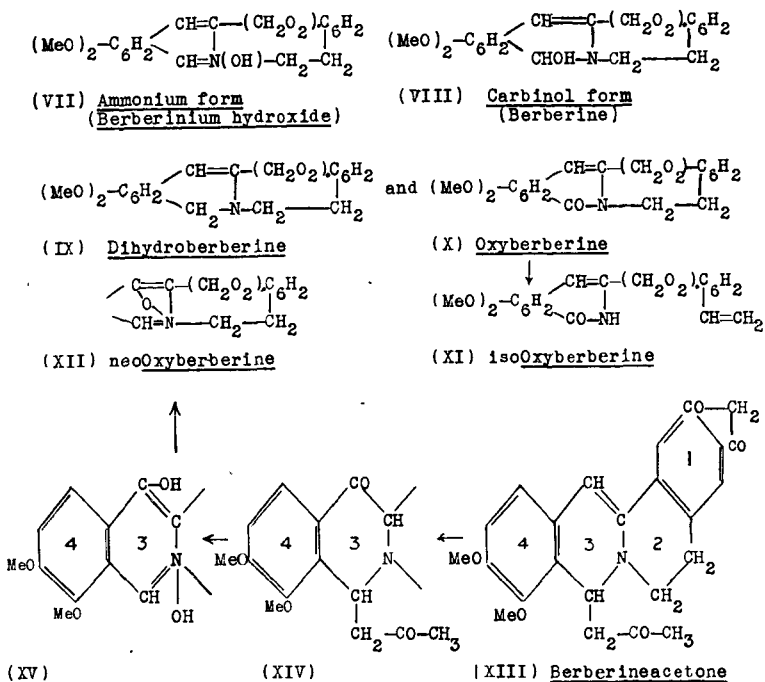

partial formulæ (XIV) and (XV), and (XII) represents it as a phenolbetaine, a view in harmony with its conversion into methoxyberberinium iodide by methyl iodide.

Syntheses of Berberine and Related Substances. In 1911 Pictet and Gams³¹ synthesised two products which they regarded as oxyberberine and berberine. The latter was obtained by heating *homoveratroylhomopiperonylamine* (XVI) in xylene with phosphoric oxide to produce *veratrylmethylenedioxydihydroisoquinoline* (XVII), which was reduced to the tetrahydro-derivative, and the latter treated with methylal and hydrochloric acid, whereby a methylene group was inserted between =NH and C⁶ forming what was supposed to be tetrahydroberberine (XVIII), which was oxidised by iodine in alcohol to berberine. Though comment on the exceptional character of the last stage of this series of reactions was made by the authors themselves and later by Jones and Robinson,³² the identification of the synthetic product with tetrahydroberberine was generally accepted until Buck and Perkin³³ found that in applying this method to the synthesis of tetrahydro*epi*berberine, then recently prepared from cryptopine, they obtained a new substance, tetrahydro-*ψ*-*epi*berberine (XIX) prismatic needles, m.p. 160–1°. Similarly on repeating the Pictet

and Gams synthesis, Haworth, Perkin and Rankin³⁴ obtained not tetrahydroberberine (XVIII), m.p. 169°, but the isomeric tetrahydro- ψ -berberine (XX), C₂₀H₂₁O₄N, m.p. 177°, the final condensation taking place between =NH and C², and not from =NH to C⁶. The ψ -berberines closely resemble the corresponding berberines. The tetrahydro-bases are

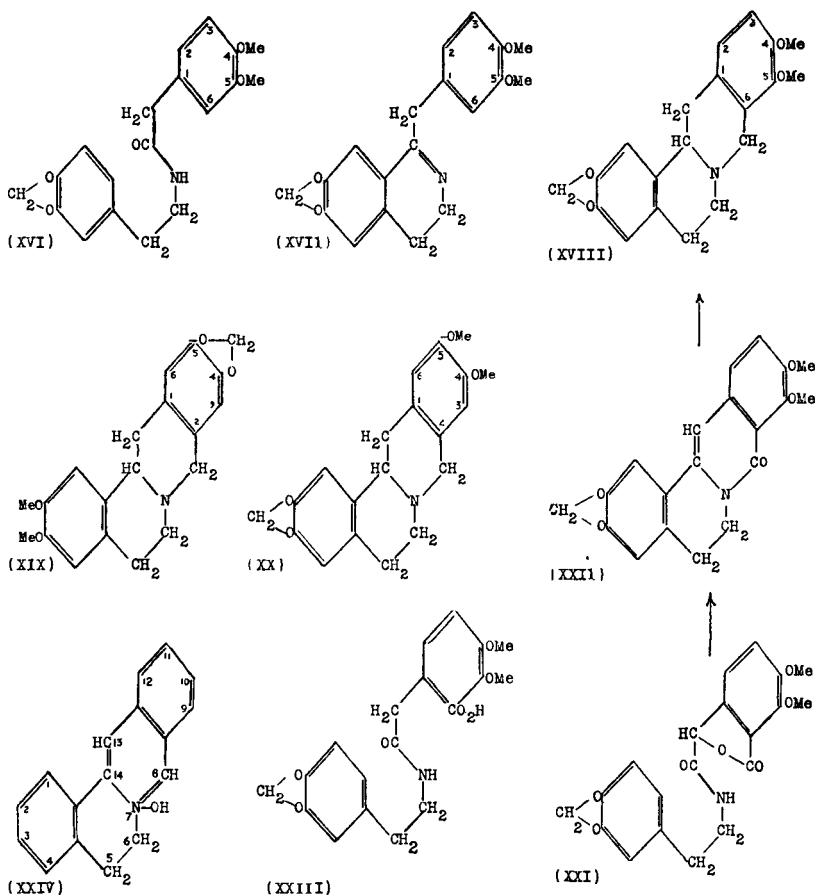

oxidised by iodine in alcohol to the ψ -berberines, which are converted by alkalis to ψ -oxyberberines and dihydro- ψ -berberines.

It should, however, be noted that though Späth and Kruta were unable to condense tetrahydropapaverines with formaldehyde to the berberine type of alkaloid, they found that tetrahydropapaverolines condensed with formaldehyde in both ways, and examples will be found under corydaline (p. 289) and the constitution of palmatine and the related bases (p. 343).

The Pictet and Gams synthesis of oxyberberine also proved on re-investigation³⁴ to be illusory, but several syntheses of this substance

have been described. Perkin, Ray and Robinson³⁵ found that the β -piperonylethylamide of meconincarboxylic acid (XXI), when heated at 100° for several hours with phosphoryl chloride yielded a product, which on reduction with zinc dust in boiling acetic acid formed oxyberberine (XXII), and since the latter can be reduced to tetrahydroberberine³⁶ (XVIII), and this in turn oxidised to berberine, the synthesis of oxyberberine is also a synthesis of berberine.

As one outcome of an investigation into methods for the synthesis of the berberine type of alkaloid by Perkin and his collaborators,³⁷ in the course of which an extensive series of bases related to, or associated with berberine, including the interesting "linear" berberine (*paraberine*), were prepared, Haworth, Perkin and Pink³⁸ devised a general method for such syntheses, of which examples are given under protopine (p. 299) and cryptopine (p. 295), and which was applied by Haworth, Koepfli and Perkin³⁹ to oxyberberine and palmatine (p. 342). For these two alkaloids it involved the preparation of 3:4-dimethoxyhomophthalic anhydride,⁴⁰ which was condensed with β -piperonylethylamine and the resulting phthalamic acid (XXIII), as the methyl ester, boiled with phosphorus oxychloride, which converted it into oxyberberine (XXII).

The nomenclature and numbering of formulæ for berberine and its derivatives is based on the system adopted by Buck, Perkin and Stevens⁴¹ for the parent substance of the series, *protoberberine* (XXIV). Awe⁴¹ has suggested that tetrahydro*protoberberine* should be called "berbine" and used as the basis of a system of names for these alkaloids.

Canadine (*l-Tetrahydroberberine*). $C_{20}H_{21}O_4N$. (Items 3, 28; list, p. 328, and 11, 21, 28, 31; list, p. 170.) In 1873, Hale⁴² obtained indications of a third alkaloid in *Hydrastis canadensis*, which was isolated and named "canadine" by Schmidt and Wilhelm.⁴³ It forms silky needles, m.p. 133–4°, $[\alpha]_D - 299^\circ$ ($CHCl_3$), or -432° (CS_2), insoluble in water, but readily soluble in ether. The hydrochloride, B. HCl, and nitrate, B. HNO₃, are crystalline, levorotatory, and slightly soluble in water. The alkyl halide addition products of canadine exist in two forms, and as shown later, have received much attention from investigators. The α -methiodide, $C_{21}H_{24}O_4NI$, crystallises from hot water in prisms, melts at 220°, and re-melts at 250° (*dec.*), the second m.p. being due to conversion at 230° into the β -methiodide. The latter forms small prisms, m.p. 264° (*dec.*), from water. *l*- α -Canadine methochloride, $C_{21}H_{24}O_4NCl \cdot H_2O$, isolated by Jowett and Pyman from *Zanthoxylum brachycanthum* F. Muell. crystallises from dry alcohol in colourless, prismatic needles, m.p. 262° (*corr.*, *dec.*), $[\alpha]_D - 137.0^\circ$ (H_2O). The *l*- β -canadine methochloride, $C_{21}H_{24}O_4NCl \cdot 6H_2O$, crystallises from water in large, colourless, oblong prisms, m.p. below 100° (air-dry) or 262° (dried at 100°), and has $[\alpha]_D - 153.8^\circ$ (monohydrate, H_2O). Canadine gives an olive-green colour changing to brownish-black with sulphovanadic acid, and a similar colour changing to brownish-red with Fröhde's reagent.

Gadamer⁴⁴ by fractional crystallisation of *dl*-tetrahydroberberine bromocamphorsulphonate, isolated a levorotatory alkaloid identical

with canadine, which is, therefore, to be regarded as *l*-tetrahydroberberine (XVIII).

The isomerism of the quaternary ammonium bases derived from tetrahydroberberine was first investigated by E. Schmidt and pupils,⁴⁵ and later by Voss and Gadamer,⁴⁴ who pointed out that three types of anhydro-base may be expected when an alkoxide of this alkaloid is heated, depending on the fact that the hydroxyl group originally attached to the nitrogen atom may migrate to any one of the three neighbouring carbon atoms (1, 2 and 3 in B), giving rise to carbinol bases, two of which (A and C) may lose the elements of a molecule of water, giving rise to anhydro-bases (E and F) which, however, are not true anhydro-bases of tetrahydroberberine, as Schmidt⁴⁶ had already found, while the C³ carbinol base (D) would not readily lose water.

788

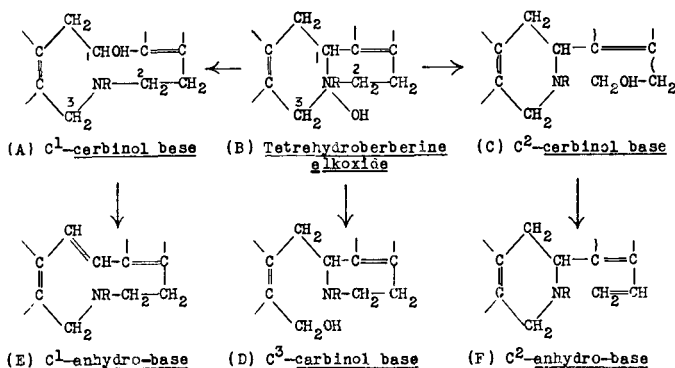

Voss and Gadamer found that when the ethocarbonate of either *dl*-tetrahydroberberine or its *l*-component (*l*-canadine ethohydroxide) was dried to constant weight *in vacuo*, the same optically inactive anhydro-base was formed, and concluded that the latter must be represented by E (R = Et). McDavid, Perkin and Robinson⁴⁷ thought this unlikely, and in giving an account of the exhaustive alkylation of berberine, using in the first stage benzyl chloride, and in the second and third stages methyl iodide (obtaining eventually benzyldimethylamine and the non-nitrogenous compound berberilene) described *N*-benzylisotetrahydroberberine, which they represented by F (R = C₇H₇).

The subject was then fully investigated by Pyman,⁴⁸ who found that the products obtained depended partly on the material started with and partly on the conditions of the experiment. Thus under his conditions, *l*-canadine methohydroxide when dried *in vacuo* gave rise to three anhydro-bases, *a* and *b* optically inactive, and *c* optically active; whilst the methohydroxide of the *dl*-base formed only two, *a* and *b*, but the proportion of *b* formed in this instance was equal to the amount of *b* and *c* together in the case of the *l*-base (canadine). For this and other reasons *b* was regarded as the racemic form of *c* and, like it, is represented by F (R = Me),

whilst E (R = Me) is assigned to base *a*. The whole course of the reaction is explained by Pyman by the following scheme, in which it will be seen that base *a* is liable to conversion into base *b*, which takes place when the drying is conducted at atmospheric pressure, so that under these conditions the *dl*-base gives only anhydro-base *b*, and the *l*-base a mixture of anhydro-bases *b* and *c*, *a* disappearing entirely.

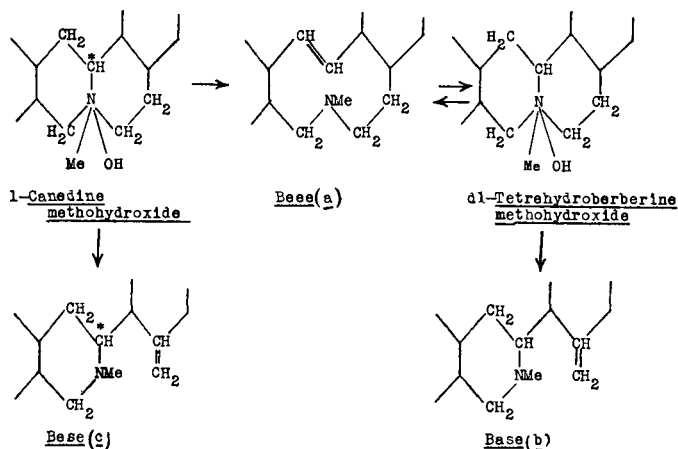

* An asterisk over the asymmetric carbon atom indicates optical activity.

It is of interest in this connection to note that the conversion of tetrahydroberberine into an anhydro-base of type E (p. 337) represents transformation from the berberine to the cryptopine type (p. 295), and that α -canadine methochloride occurs in *Zanthoxylum brachyacanthum* with its cryptopine analogue, γ -homochelidonine (β -allocryptopine, p. 301).

By the method referred to under the benzylisoquinoline alkaloids (p. 193) Leithe⁴⁴ has shown that the configuration of the *l*- and *d*-canadines by reference to *l*(-)- α -phenylethylamine is *l*(-) and *d*(+) respectively.

Ophiocarpine, $C_{17}H_{13}ON(CH_2O_2)(OMe)_2$. (Item 21; list, p. 171.) This base has m.p. 188°, $[\alpha]_D^{24}$ - 284° (CHCl₃), yields a sparingly soluble hydrochloride and a methiodide, m.p. 271° (*dec.*). It contains a methylenedioxy group and on boiling with hydrochloric acid produces a yellow base, which on oxidation with iodine and subsequent reduction is converted into *dl*-canadine (XVIII, p. 335). Ophiocarpine is therefore regarded as 13-hydroxycanadine. In confirmation of that view it is found that the alkaloid yields 6 : 7-methylenedioxy-1-keto-1 : 2 : 3 : 4-tetrahydroisoquinoline (*noroxyhydrastinine*), m.p. 183°, on oxidation by permanganate.⁴⁹

Sinactine, $C_{20}H_{21}O_4N$. (Item 23, list, p. 329, and 44; list, p. 173.) This alkaloid of *Sinomenium acutum* (p. 268) was isolated by Goto and Sudzuki.⁵⁰ It crystallises from alcohol in prisms, m.p. 174°, $[\alpha]_D$ - 312° (CHCl₃), gives a sparingly soluble hydrochloride, m.p. 272° (*dec.*), and a platinichloride, m.p. 245-7°. The oxygen atoms are present in two

methoxyl groups and one dioxymethylene group. On oxidation by iodine in alcohol it forms an iodide; orange-yellow needles, m.p. 300° (*dec.*), which, on treatment with silver chloride in water, furnishes dehydro-sinactine chloride, indistinguishable from *epiberberinium* chloride,⁵¹ and on reduction furnishes *dl*-tetrahydro*epiberberine* (p. 298). Sinactine is, therefore, *l*-tetrahydro*epiberberine*, and this was finally established by Späth and Mosettig,⁵² who transformed cryptopine (p. 295) into *dl*-tetrahydro*epiberberine* and deracemised the latter by the use of *d*- and *l*-tartaric acid in succession, the tartrates being crystallised from methyl alcohol. The optically active bases had m.p. (*vac.*) 178–9°, $[\alpha]_D^{15} \pm 302^\circ$ (CHCl₃). Leithe⁵³ has shown that in configuration natural *l*-sinactine can be referred to the (–) alanine series.

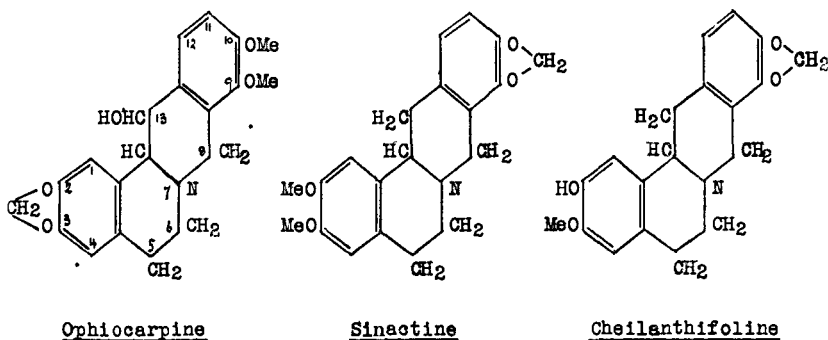

Cheilanthifoline, C₁₇H₁₃N(OH)(OMe)(O₂H₂C). (Items 11, 24 26; list, p. 170.) M.p. 184°, $[\alpha]_D^{20} - 311^\circ$ (MeOH). The *O*-methyl ether has m.p. 177° and is identical with sinactine. The *O*-ethyl ether has m.p. 144° and on oxidation with permanganate furnishes 6-methoxy-7-ethoxy-1-keto-1:2:3:4-tetrahydro*isoquinoline*, m.p. 195°, indicating that the hydroxyl group of the alkaloid is at position 2 in the tetrahydro*protoberberine* nucleus,⁵⁴ *i.e.*, cheilanthifoline is 2-*O*-demethyltetrahydro*epiberberine*.

Capauridine (*dl*-capaurine), C₁₇H₁₂N(OH)(OMe)₄. (Items 9, 16, 17, 22; list, p. 170.) M.p. 208°, $[\alpha]_D \pm 0^\circ$. On methylation with diazomethane it yields *dl*-capaurine *O*-methyl ether, m.p. 142° (*see below*).

Capaurimine, C₁₇H₁₂N(OH)₂(OMe)₃. (Items 17, 22; list, p. 171.) M.p. 212°, $[\alpha]_D^{24} - 287^\circ$ (CHCl₃). Diazomethane converts it to capaurine *O*-methyl ether, m.p. 152° (*see below*). It has been shown recently, (1947),^{54(al)} that the two hydroxyl groups are at C¹ and C⁹.

Capaurine, C₁₇H₁₂N(OH)(OMe)₄. (Items 9, 16, 17, 22; list, p. 170.) M.p. 164°. Yields an *O*-methyl ether, m.p. 152°, which on oxidation by iodine to the quaternary iodide, followed by reduction to the tetrahydro-base forms capauridine methyl ether, m.p. 142°; capauridine must therefore be *dl*-capaurine. Capaurine ethyl ether, C₂₃H₂₉O₅N, m.p. 134°, on oxidation furnishes 3-ethoxy-4:5-dimethoxyphthalic acid. The methyl ether on oxidation by potassium permanganate gives hemipinic acid

(3 : 4-dimethoxyphthalic acid) and 3 : 4 : 5-trimethoxyphthalic acid, while capaurine itself oxidises to hemipinic acid only. Preliminary observations suggested that capaurine belongs to the tetrahydroprotoberberine subgroup and on this basis the free hydroxyl group is placed at C¹ as in (I) (*cf.* narcotoline, p. 204). On oxidation under conditions likely to yield a degradation product of the corydaldine type (p. 286) capaurine methyl ether gave a substance, C₂₂H₂₃O₈N, m.p. 192°. This closely resembles berberal (p. 332) in character and on hydrolysis by dilute hydrochloric acid yields *ψ*-opianic acid (IV) and 6 : 7 : 8-trimethoxy-1-keto-1 : 2 : 3 : 4-tetrahydroisoquinoline (III), m.p. 136–7°. The structure of the latter was proved by its synthesis by two methods. The berberal analogue, C₂₂H₂₃O₈N, is represented by formula (II) (Mauske and Holmes^{54(a)}).

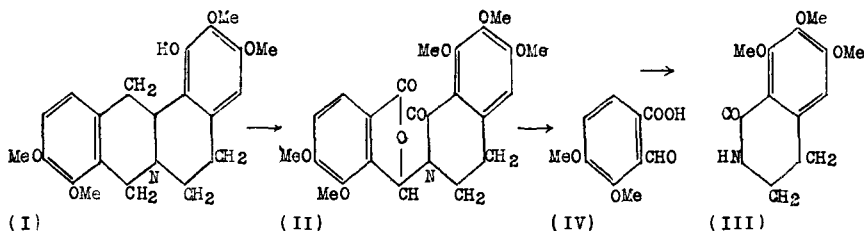

Shobakunine. (Items 9, 14, 18 ; list, p. 329.) According to Tomita and Tani⁵⁵ this product, characterised as the iodide, m.p. 204–6°, is a molecular combination of berberine and palmatine and the so-called *tetrahydroshobakunine* (item 9 ; list, p. 329), m.p. 140–2°, is a similar compound of tetrahydroberberine (p. 336) and tetrahydropalmatine (p. 292).

Thalictrine, C₂₀H₂₇O₄N, 3H₂O. (Item 4a ; list, p. 328.) M.p. 208° or 224–5° (*dry, dec.*), $[\alpha]_{D}^{24} + 308^{\circ}$ (H₂O) or +370° (anhydrous ; H₂O) ; forms salts as a quaternary base ; chloride, C₂₀H₂₆O₃NCl, m.p. 163–5° (*dec.*) ; iodide, m.p. 265° (*dec.*) ; picrate, m.p. 207–8° ; platinichloride, (C₂₀H₂₆O₃NCl)₂, PtCl₄, m.p. 233–4° (*dec.*). The base absorbs carbon dioxide from the air and the presence of the following groups is recorded : (OCH₃)₂, phenolic . OH and NCH₃ . OH ; no CMe is present. Bromine in acetic acid converts the base into tetrabromothalictrine acetate, C₂₂H₂₉O₅NBr₄, orange needles, m.p. 248–50° (*dec.*).⁵⁶

The two following alkaloids of unknown constitution have been recorded for *Berberis* and *Mahonia* species :—

Umbellatine, C₂₁H₂₁O₈N. (Items 7, 10, 13 ; list, p. 329.) The base crystallises from water with 5·5 H₂O, m.p. 205–7° (*dec.*), $[\alpha]_{D} \pm 0^{\circ}$, and yields a nitrate, m.p. 265–7° (*dec.*), sulphate, m.p. 271–3° (*dec.*) and a picrate, m.p. 231° (*dec.*). It contains two methoxyl groups, probably a dioxymethylene group, a methylimino group and possibly four hydroxyls. It yields a methiodide, a methyl ether, m.p. 265°, and on hydrogenation a tetrahydro-derivative, m.p. 213–5° (*dec.*). Its absorption spectrum resembles that of berberine. On oxidation by permanganate it produces hemipinic acid, isolated and identified as the ethylimide, m.p. 90° (Chatterjee).⁵⁷

Neprotine, $C_{19}H_{21}O_6N$. (Item 18; list, p. 329.) Garnet-red crystals, which decompose above 200° , $[\alpha]_D \pm 0^\circ$. The base loses 3.5 mols. and retains 1.0 mol. of water on drying at 100° *in vacuo*. The salts are yellow or orange (Chatterjee).⁵⁸

REFERENCES

- (1) *J. chim. méd.*, 1826, 2, 314. (2) *Annalen, Suppl.*, 1837, 24, 228. (3) *Ibid.*, 1846, 59, 60. (4) *J. Chem. Soc.*, 1862, 15, 339. (5) LLOYD, *Pharm. J.*, 1879-80, [iii], 10, 125; SCHWYZER, "Die Fabrikation der Alkaloide," 1927, p. 97. (6) For details of the constitution of this and similar addition products of berberine, see GADAMER, *Arch. Pharm.*, 1905, 243, 42; PYMAN, *J. Chem. Soc.*, 1911, 99, 1690; ROBINSON and ROBINSON, *ibid.*, 1917, 111, 958. (7) *Zeit. Naturw. Halle*, 1890, 62, 399; *Arch. Pharm.*, 1890, 228, 604; cf. GORDIN and MERRELL, *ibid.*, 1901, 239, 226. (8) GORDIN and PRESCOTT, *ibid.*, 1899, 237, 439; GORDIN, *ibid.*, 1901, 239, 638. Detection of berberine in plants, *ibid.*, 1902, 240, 146; cf. FEIST, *ibid.*, 1918, 256, 1. (9) *Ibid.*, 1900, 238, 6. (10) *Ibid.*, 1914, 252, 192. (11) *Pharm. Post.*, 1915, 48, 1. (12) *Arch. Pharm.*, 1917, 255, 497. (13) *Pharm. Zeit.*, 1936, 81, 1416; *Pharm. Zentr.*, 1937, 78, 17; 1939, 80, 113, 241; *Apoth. Zeit.*, 1937, 52, 1038; cf. AWE, *ibid.*, p. 1359; *Sud-deutsch Apoth. Zeit.*, 1939, 79, 429; see also BROCHMANN-HANSEN, *Pharm. Acta. Helv.*, 1946, 21, 23. (14) *Österr. Bot. Zeit.*, 1928, 77, 1. (15) *Pharm. Weekbl.*, 1930, 67, 77; MARTINI, *Chem. Abstr.*, 1940, 34, 8182; 1942, 36, 6307. (16) *Pharm. Weekbl.*, 1936, 73, 764. (17) GADAMER, *Arch. Pharm.*, 1905, 243, 33. (18) SHEDDEN, *Pharm. J.*, 1900, [iv], 11, 89. (19) For other reactions, see HIRSCHHAUSEN, *Zeit. Anal. Chem.*, 1885, 24, 157. (20) *J. Chem. Soc.*, 1889, 55, 63; 1890, 57, 992; 1910, 97, 305. For earlier work, see WEIDEL, *Ber.*, 1879, 12, 410; SCHMIDT, *ibid.*, 1883, 16, 2589; *Arch. Pharm.*, 1892, 230, 287; LINK, *ibid.*, 291. (21) *J. Chem. Soc.*, 1910, 97, 321; cf. PERKIN, *ibid.*, 1890, 57, 1002. (22) *Arch. Pharm.*, 1901, 239, 648; *Chem. Zeit.*, 1902, 26, 291; *Arch. Pharm.*, 1905, 243, 31. VOSS and GADAMER, *ibid.*, 1910, 248, 43; cf. ROSER, *Chem. Zeit.*, 1902, 26, 385; (23) *Monats.*, 1910, 31, 557. (24) DECKER, *Ber.*, 1903, 36, 2568. (25) *J. Chem. Soc.*, 1911, 99, 1340. (26) *Ber.*, 1904, 37, 4677. (27) *J. Chem. Soc.*, 1918, 113, 503. (28) *Ibid.*, 1912, 101, 262. (29) *Ibid.*, 1911, 99, 1692. (30) GADAMER, *Arch. Pharm.*, 1905, 243, 42. (31) *Compt. rend.*, 1911, 152, 1102; 153, 386; *Ber.*, 1911, 44, 2480. (32) *J. Chem. Soc.*, 1917, 111, 905; cf. SPÄTH and KRUTA, *Monats.*, 1928, 50, 341. (33) *J. Chem. Soc.*, 1924, 125, 1675; cf. BUCK, PERKIN and STEVENS, *ibid.*, 1925, 127, 1462. (34) *Ibid.*, 1924, 125, 1686; cf. BUCK and DAVIS, *J. Amer. Chem. Soc.*, 1930, 52, 660. (35) *J. Chem. Soc.*, 1925, 127, 740; cf. FREUNDLER, *Bull. Soc. chim.*, 1914, [iv], 15, 465. (36) PERKIN, *J. Chem. Soc.*, 1918, 113, 764. (37) *Ibid.*, 1925, 127, 1434, 1444, 1448, 1453; 1926, 32; 1927, 2265, 2275; 1929, 196; see also (a) CHAKRAVARTI *et al.*, *Brit. Chem. Abstr.*, 1933, A, 169; 1934, A, 669; 1935, A, 94, 767; *J. Chem. Soc.*, 1938, 172; (b) STEVENS, *J. Chem. Soc.*, 1935, 663. (38) *Ibid.*, 1925, 127, 1709; cf. SPÄTH, BERGER and KUNTARA, *Ber.*, 1930, 63, 134; LEITHE, *ibid.*, p. 2343; SUGASAWA *et al.*, *Ber.*, 1940, 73, 782. (39) *J. Chem. Soc.*, 1927, 548; cf. SPÄTH and QUIETENSKY, *Ber.*, 1925, 58, 2267. (40) Cf. HAWORTH, PERKIN and STEVENS, *J. Chem. Soc.*, 1926, 1764. (41) *Ibid.*, 1925, 127, 1462; cf. AWE, *Arch. Pharm.*, 1932, 270, 156. (42) *Amer. J. Pharm.*, 1873, 45, 247; cf. LERCHEN, *Jahresb.*, 1878, 144; and BURT, *Pharm. J.*, 1875-76, [iii], 6, 467. (43) *Arch. Pharm.*, 1888, 226, 329. (44) *Ibid.*, 1901, 239, 648; VOSS and GADAMER, *ibid.*, 1910, 248, 43; cf. LEITHE, *Ber.*, 1930, 63, 2343; BERSCH and SEUFERT, *Ber.*, 1937, 70, 1121. (45) *Arch. Pharm.*, 1890, 228, 596, 604. (46) *Ibid.*, 1892, 230, 287, 291. (47) *J. Chem. Soc.*, 1912, 101, 1220. (48) *Ibid.*, 1913, 103, 817; cf. FREUND and FLEISCHER, *Annalen*, 1915, 409, 188. (49) MANSKE, *Can. J. Res.*, 1939, 17, 51; 1942, 20, B, 57. (50) *Bull. Chem. Soc. Jap.*, 1929, 4, 220. (51) GOTO and KITASATO, *J. Chem. Soc.*, 1930, 1234. (52) *Ber.*, 1931, 64, 2048. (53) *Idem.*, p. 2827. (54) MANSKE, *Can. J. Res.*, 1936, 14, B, 347, 354; 1938, 16, B, 438; 1940, 18, B, 100. (54a) *J. Amer. Chem. Soc.*, 1945, 67, 95; 1947, 69, 1800. (55) *J. Pharm. Soc. Jap.*, 1941, 61, 83. (56) VASHISHTA and SIDDQUI, *J. Ind. Chem. Soc.*, 1941, 18, 641. (57) *Ibid.*, 1940, 17, 289; 1942, 19, 238; 385; *J. Amer. Pharm. Assoc.*, 1941, 30, 247. (58) *Ibid.*, 1944, 33, 210; *Sci. and Cult.*, 1942, 7, 619.

Palmatine and Associated Alkaloids. Palmatine, jatrorrhizine (jateorrhizine) and columbamine were first isolated from calumba root (*Jateorrhiza palmata* Lam., Miers) as a result of the work of Günzel¹ followed by that of Feist,² but all three have since been found in other genera. All three are quaternary bases, soluble in water, and methods for their isolation have been described by Günzel,¹ Feist,² and Späth and Polgar,³ usually dependent upon their precipitation as iodides, or their reduction to the tertiary tetrahydro-bases. The latter occur naturally in the Rhœadales and have been described already (p. 284). A method for the separate estimation of the alkaloids of calumba root has been described by Neugebauer and Brunner.^{3(a)}

Palmatine, $C_{21}H_{23}O_5N$. (Items 1, 6, 11, 19, 21, 22, 26; list, p. 328.) The alkaloid is isolated as the iodide, $C_{21}H_{22}O_4NI \cdot 2H_2O$, m.p. 241° (*dec.*), crystallising in orange yellow needles; the chloride, $C_{21}H_{22}O_4NCl \cdot 3H_2O$, has m.p. 205° (*dec.*); the nitrate forms greenish-yellow needles, $C_{21}H_{22}O_4N \cdot NO_3 \cdot 1.5H_2O$, m.p. 239° (*dec.*); the thiocyanate has m.p. 210° (*dec.*), and the perchlorate m.p. 262° (*dec.*). On reduction palmatine iodide is converted into tetrahydropalmatine, $C_{21}H_{25}O_4N$, colourless leaflets, m.p. 144° (p. 292). Palmatine contains four methoxyl groups, resembles berberine in forming addition products with acetone and chloroform, and on oxidation by alkaline permanganate furnishes corydaldine (p. 286) and hemipinic acid (3:4-dimethoxyphthalic acid). On the basis of these results Feist and Sandstede² suggested formula (XXV: R = R' = OMe) for palmatine.

Jatrorrhizine (Jateorrhizine). (Items 6, 9, 11, 14, 18, 19, 21, 22; list, p. 329.) The iodide, $C_{20}H_{20}O_4NI \cdot H_2O$, crystallises in reddish-yellow needles, m.p. $210-2^\circ$; the chloride $C_{20}H_{20}O_4NCl \cdot H_2O$, forms copper-coloured needles, m.p. 206° , and the nitrate golden-yellow needles, m.p. 225° (*dec.*). On *O*-methylation, jatrorrhizine iodide yields palmatine iodide, and on reduction it is converted into *dl*-tetrahydrojatrorrhizine, m.p. $217-8^\circ$, the *d*-form of which is corypalmine and which on *O*-methylation yields tetrahydropalmatine (p. 292).⁴

Columbamine. (Items 1, 6, 9, 11, 18, 22; list, p. 328.) This base probably occurs among the phenolic alkaloids of calumba root,⁴ but it has only been isolated in the form of *dl*-tetrahydrocolumbamine.⁵ $C_{17}H_{13}N(OH)(OMe)_3$, m.p. $223-4^\circ$ (p. 291), which on methylation furnishes *dl*-tetrahydropalmatine.

Constitution. Comparison of the empirical formulæ of the three alkaloids, and the fact that jatrorrhizine and columbamine each stands to palmatine in the relation of a monohydric phenol to its methyl ether, makes it clear that the only difference between jatrorrhizine and columbamine must be in the position of the free hydroxyl group. The method by which this point was settled is described in dealing with the two tetrahydro-derivatives of these alkaloids (p. 291). The constitution of palmatine (XXV: R = R' = Me) is dealt with under tetrahydropalmatine, but it is still necessary to describe the complete synthesis of this alkaloid *via* oxypalmatine (XXVII) and tetrahydropalmatine.

The conversion of tetrahydroberberine into tetrahydropalmatine, first achieved by Späth and Lang,⁶ is described elsewhere (p. 292). By demethylenating berberine sulphate Späth and Quietensky⁷ obtained the dihydric phenolic base (XXV: R = R' = H), which on complete O-methylation yielded palmatine (XXV: R = R' = Me), and on partial methylation gave jatrorrhizine (XXV: R = H; R' = Me), the latter being isolated and identified as *dl*-tetrahydrojatrorrhizine (p. 291). Columbamine is represented by (XXV: R = Me; R' = H). A complete synthesis of palmatine was effected by Haworth, Koepfli and Perkin,⁸ who condensed 3:4-dimethoxyhomophthalic anhydride with β -veratrylethylamine to *N*- β -veratrylethyl-3:4-dimethoxyhomophthalamic acid, the methyl ester (XXVI) of which was converted by treatment with phosphorus oxychloride into oxypalmatine⁹ (XXVII), C₂₁H₂₁O₅N, buff-coloured prisms, m.p. 183°. This behaves like oxyberberine (XXII, p. 335), and on electrolytic reduction yields *dl*-tetrahydropalmatine, m.p. 147°, which on oxidation with iodine in alcohol furnished palmatine (XXV: R = R' = Me) in the form of the iodide, m.p. 241° (*dec.*).

Späth and Kruta¹⁰ have also prepared *dl*-tetrahydropalmatine by the process described for *meso*- and *r*-corydalines (p. 289), and by condensing tetrahydropapaveroline with formaldehyde and methylating the product, obtained in poor yield, a mixture of tetrahydropalmatine and *nor*coryalydine.

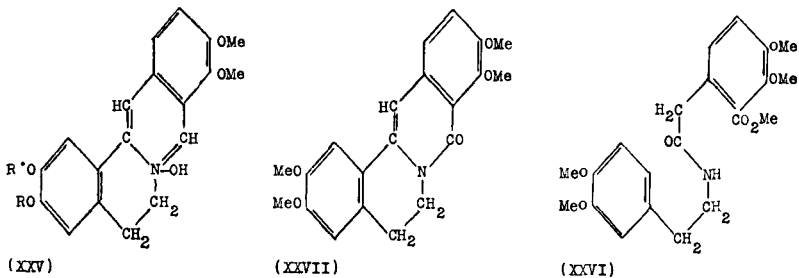

Nandinine, C₁₉H₁₉O₄N. An amorphous product, to which this name was given, was isolated by Eykman¹¹ from the root-bark of *Nandina domestica*. It was obtained in a crystalline condition, m.p. 78°, by Iwakawa,¹² and finally separated into three well-defined phenolic alkaloids, nandinine, domesticine and *isodomesticine* by Kitasato.¹³ Nandinine crystallises from alcohol in leaflets, m.p. 145–6°, [α]_D + 63.2° (EtOH) develops a red colour on exposure to air, and with sulphuric acid gives a yellow colour changing to green and blue. The hydrochloride is crystalline. The base contains one methoxyl group. A phenolic hydroxyl group is also present, and on methylation by diazomethane *d*-canadine is produced.

Frerichs¹⁴ found that berberinium chloride, when fused with carbamide at 200° or heated in a current of carbon dioxide at 190°, was converted into *berberrubine*, C₁₉H₁₅O₄N · 3H₂O, dark red leaflets or needles, m.p. 285°, which regenerated berberinium iodide on treatment with methyl iodide.

On reduction it furnished tetrahydroberberrubine, $C_{19}H_{19}O_4N$, m.p. $167-8^\circ$ which Kitasato deracemised and obtained a *d*-base, m.p. 144° , $[\alpha]_D + 62.9^\circ$, which he regarded as identical with nandinine. Späth and Burger³ showed that berberrubine is a partially demethylated berberine (XXVIII), since the ethyl ether on oxidation furnishes hydrastic acid (4 : 5-methylenedioxyphthalic acid) and 4-methoxy-3-ethoxyphthalic acid. Subsequently Späth and Leithe¹⁵ deracemised *dl*-tetrahydroberberrubine and obtained a *d*-base, differing from nandinine, in having m.p. $195-6^\circ$, $[\alpha]_D^{15} + 303^\circ$ ($CHCl_3$) or $+298^\circ$ (EtOH); the *l*-base had m.p. $195-6^\circ$, $[\alpha]_D - 304^\circ$ ($CHCl_3$). The *dl*-form had m.p. 186° . These results leave Kitasato's identification of nandinine as *d*-tetrahydroberberrubine in doubt.

Coptisine, $C_{19}H_{15}O_5N$. (Items 1 ; list, p. 328, and 8 ; list, p. 170.) This alkaloid was isolated as tetrahydrocoptisine (p. 293) by reducing the mixture of quaternary bases left after removal of berberine as sulphate from the total alkaloids of *Coptis japonica*, and was recovered as the iodide by oxidation of the tetrahydro-derivative with iodine.¹⁶ Coptisine iodide, $C_{19}H_{14}O_4NI$, forms yellow crystals, m.p. $> 280^\circ$; the chloride crystallises in thin orange-yellow prisms, m.p. $280-300^\circ$. Using the process adopted by Späth for the conversion of berberine into palmatine (p. 343), coptisine chloride was converted by demethylenation of both methylenedioxy-groups into the tetrahydric phenolic base, and the latter, on complete methylation, furnished palmatine (XXV : $R = R' = Me$). A reversal of this process was effected by Späth and Posega,¹⁷ who obtained a small yield of tetrahydrocoptisine by demethylating tetrahydropalmatine (p. 292), and methylating the product under special conditions. Coptisine is therefore represented by (XXIX); additional evidence for this formula is given under tetrahydrocoptisine (p. 293).

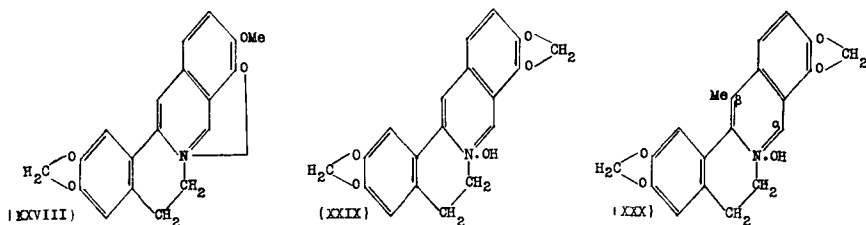

Worenine. This alkaloid, also obtained by Kitasato¹⁸ from *Coptis japonica* was isolated as the tetrahydro-base, $C_{20}H_{19}O_4N$, which crystallises from alcohol in colourless prisms, m.p. $212-3^\circ$, and is oxidised by iodine in alcohol to worenine iodide, yellow crystals from which worenine chloride, thin orange-yellow prisms, m.p. 295° (*dec.*), can be obtained. Tetrahydro-worenine behaves as a tertiary base, contains methylenedioxy- but no methoxyl groups, and its absorption spectrum closely resembles that of tetrahydrocoptisine from which it differs in empirical composition by $.CH_2$. Worenine is, therefore, represented by (XXX), the alternative position (α) for the methyl group being untenable, since α -methyltetrahydrocoptisine obtained by Freund's method^{18(a)} is not identical with

tetrahydroworenine, which is therefore to be regarded as β -methyltetrahydrocoptisine, *i.e.*, worenine stands in the same relation to coptisine (p. 344) as dehydrocorydaline (p. 286) does to palmatine (p. 342).

Pharmacological Action. Berberine is moderately toxic to the larger animals. In the rabbit it causes dyspnoea, cardiac damage, lowered blood pressure and paresis. Hæmorrhages and congestion of the lungs are found post mortem; renal damage has also been reported. It is said that berberine is mostly destroyed in animals but in man considerable amounts appear in the urine after oral administration. The alkaloid has been recommended¹⁹ for the treatment of oriental sore (cutaneous leishmaniasis). The chief use in Western medicine has been on account of its bitter taste, drugs containing berberine, such as barberry bark, being used as bitter tonics and stomachics. Berberine has some bactericidal action,²⁰ and its presence in *Mahonia trifoliata* and *M. Swaseyi* is said to be a factor in the resistance of these plants to a root fungoid disease.²¹ According to Seery and Bieter,²² it has some trypanocidal action, and Brahmachari²³ has used it as an adjunct to quinine in the treatment of malaria.

Canadine is bitter and in small doses causes drowsiness and depression. In large doses it gives rise to transient excitement succeeded by depression and paralysis of the central nervous system. Its injection is followed by violent peristalsis with diarrhœa. It is said to have no effect on the blood pressure. The pharmacological action of *canadine* α - and β -*methochlorides* was examined by Laidlaw,²⁴ who found both to have the curare-like action common to ammonium bases, the β -isomeride being the more active; the relative activities of the four optically active forms are given as $\alpha : d\alpha : l\beta : d\beta = 1 : 9 : 12 : 28$.

Reynolds and Waud²⁵ found that *capaurine* produced paralysis on injection into the lymph sac of frogs, and convulsions when injected into mice or rabbits in doses of 100–200 mgm./kilo. It depressed the activity of the heart, intestine and uterus. The methyl ether caused convulsions in frogs, but otherwise acted like capaurine.

Umbellatine was examined by Gupta and Kahali,²⁶ who found that it killed *Paramœcium* at 1 in 500 and *Leishmania tropica* at 1 in 50,000, but did not inhibit *L. donovani* or *Entamœba histolytica* at 1 in 10,000. It resembles berberine in the nature and range of its pharmacological activity but is more active in producing cardiovascular response and is possibly more potent in the treatment of oriental sore.

According to Biberfeld,²⁷ *palmatine*, *calumbamine* and *jatorrhizine* all paralyse the central nervous system in frogs; palmatine also produces this effect in mammals and differs from the other two in stopping respiration, probably by paralysis of the respiratory centre. All three alkaloids lower the blood pressure on intravenous injection, palmatine being the most active.

REFERENCES

- (1) *Arch. Pharm.*, 1906, 244, 257. For earlier work see GADAMER, *ibid.*, 1902, 240, 450; GORDIN, *idem*, p. 146. (2) *Ibid.*, 1907, 245, 586; (with SANDSTEDE), 1918,

256, 1; (with DSCHU), 1925, 263, 294; (with AWE), 1931, 269, 660; (with AWE and ETZRODT), 1934, 272, 817. (3) *Monats.*, 1927, 52, 117; cf. SPÄTH and BURGER, *Ber.*, 1926, 59, 1486. (3a) *Arch. Pharm.*, 1938, 276, 199. (4) SPÄTH (with BOHM), *Ber.*, 1922, 55, 2985; (with DUSCHINSKY), *ibid.*, 1925, 58, 1939; (with MEINHARD), *ibid.*, 1942, 75, 400; FEIST and DSCHU.² (5) SPÄTH and BURGER, *Ber.*, 1926, 59, 1486. (6) *Ber.*, 1926, 59, 1496; SPÄTH and LANG, *ibid.*, 1921, 54, 3064. (7) *Ibid.*, 1925, 58, 2267; SPÄTH and MOSEFTIG, 1927, 60, 383. (8) *J. Chem. Soc.*, 1927, 548. (9) Cf. RÂY, *J. Ind. Chem. Soc.*, 1927, 4, 403. (10) *Monats.*, 1928, 50, 341. (11) *Rec. Trav. chim.*, 1884, 3, 197. (12) *Mitt. Med. Ges. Tokyo*, 1910, 24, 15. (13) *Acta Phytochimica*, 1927, 3, 177; *J. Pharm. Soc. Jap.*, 1925, No. 522, 1; No. 523, 7. (14) *Arch. Pharm.*, 1910, 248, 276; (with STOEPEL), *ibid.*, 1913, 251, 321. (15) SPÄTH and LEITHE, *Ber.*, 1930, 63, 3007. (16) KITASATO, *Proc. Imp. Acad. Tokyo*, 1926, 2, 124; *Acta Phytochimica*, 1927, 3, 175. (17) *Ber.*, 1929, 62, 1029. (18) *J. Pharm. Soc. Jap.*, 1927, No. 542, 48; *Acta Phytochimica*, 1927, 3, 210. (18a) *Ber.*, 1905, 38, 2653. (19) KARANCHANDAMI, *Ind. Med. Gaz.*, 1927, 62, 558; DAS GUPTA and DIKSHIT, *ibid.*, 1929, 64, 67. For general information on the pharmacology of berberine, see CHOPRA. DIKSHIT and CHOWHAN, *Ind. J. Med. Res.*, 1932, 19, 1193. (20) DICK, *Arch. Surg. Chicago*, 1940, 41, 287. (21) GREATHOUSE and WATKINS, *Amer. J. Bot.*, 1938, 25, 743. (22) *J. Pharmacol. exp. Ther.*, 1940, 69, 64. (23) *Ind. Med. Gaz.*, 1944, 79, 259. (24) *J. Pharmacol. exp. Ther.*, 1913, 4, 461. (25) *Can. J. Res.*, 1944, 22, E, 64. (26) *Ind. J. Med. Res.*, 1944, 32, 53. (27) *Zeit. exp. Path. Pharm.*, 1910, 7, 569 (quoted *Arch. Pharm.*, 1918, 256, 31).

BISBENZYL*iso*QUINOLINE ALKALOIDS

There are now known a considerable number of alkaloids containing two distinct *isoquinoline* nuclei, such as emetine and its congeners (p. 394), and in the morphine sub-group, ψ -morphine, dithebainone (p. 255), disinomenine and its pseudo-isomeride (p. 268). The most important collection of such alkaloids is the bisbenzyl*isoquinoline* or biscoclaurine section of which the following two alkaloids, berbamine and oxyacanthine, are examples, but which is typically developed in the Menispermaceæ.

Berbamine, $C_{37}H_{40}O_6N_2$. This alkaloid, isolated from the root-bark of *Berberis vulgaris* by Hesse,¹ was given the formula $C_{18}H_{19}O_3N$ by Rüdél,² which was accepted until Santos³ altered it to $C_{37}H_{40}O_6N_2$, making it isomeric with oxyacanthine, for which Späth and Kolbe⁴ had already proposed this formula. Berbamine crystallises from alcohol with $4H_2O$ in leaflets, m.p. 156° or 172° (*dry*) or from light petroleum in warty masses, m.p. $197-210^\circ$,² $[\alpha]_D + 108.6^\circ$ ($CHCl_3$). The sulphate and the nitrate are crystalline. The alkaloid gives the same colour reactions as oxyacanthine (*see below*), and being closely related to that alkaloid its constitution is dealt with under oxyacanthine. Berbamine methyl ether, m.p. 182° , $[\alpha]_D + 132^\circ$, occurs in *Stephania cepharantha* as the alkaloid isotetrandrine.

Oxyacanthine, $C_{37}H_{40}O_6N_2$. This alkaloid was isolated by Hesse,¹ and assigned the formula, $C_{19}H_{21}O_3N$, by Rüdél,² which was altered by Späth and Kolbe⁴ to that given above. It crystallises from alcohol in needles, m.p. $208-9^\circ$ ($216-7^\circ$ *in vac.*), $[\alpha]_D + 279^\circ$ ($CHCl_3$) (G. and von B.⁴). The hydrochloride, B. $2HCl$, m.p. $270-1^\circ$ (*vac.*), $[\alpha]_D^{29^\circ} + 188.5^\circ$ (H_2O), is sparingly soluble in dilute hydrochloric acid; the hydrobromide, B. $2HBr$, has m.p. $273-5^\circ$ (*dec., vac.*); the nitrate forms needles, m.p. $195-200^\circ$ (*dec.*), and is sparingly soluble in water. Oxyacanthine dissolves in nitric acid with a yellow colour, is not coloured by sulphuric acid, but on further

addition of nitric acid becomes red. Molybdic acid in sulphuric acid gives a dirty violet tint changing to yellowish-green. It gives a blue colour with a mixture of ferric chloride and potassium ferricyanide.

Oxyacanthine contains three methoxyl groups, and one phenolic hydroxyl group is indicated by the preparation of an *O*-benzoyl derivative, a potassium derivative and a methyl ether (identical with trilobamine methyl ether, p. 357) yielding a hydrochloride, $C_{38}H_{42}O_6N_2 \cdot 2HCl$, m.p. 261° . Oxyacanthine methyl ether dimethiodide, $C_{40}H_{48}O_6N_2I_2$, m.p. $255-60^\circ$, can be degraded by Emde's method in two stages to a nitrogen-free substance, $C_{36}H_{40}O_6$, m.p. $124-5^\circ$, and trimethylamine, suggesting the monocyclic attachment of each nitrogen atom in the form of a methylimino-group (Späth and Kolbe⁴). These results were confirmed by Gadamer and von Bruchhausen,⁴ who added further observations, of which those with acylating agents and with ethyl chloroformate indicated the presence of methyltetrahydroisoquinoline nuclei. These authors suggested that the remaining two oxygen atoms are present as ether linkages. In a further study of the alkaloid, Späth and Pikel⁵ showed that oxyacanthine methyl ether dimethiodide yielded an ammonium base, which when boiled with potassium hydroxide solution produced an optically inactive base, $C_{40}H_{46}O_6N_2$, m.p. $152-3^\circ$. This on oxidation by potassium permanganate gave 2-methoxy-5 : 4'-dicarboxydiphenyl ether, m.p. $313-4^\circ$ (XXXIV : R = Me), the identity of which was established by its synthesis from methyl *p*-bromobenzoate and potassium methyl isovanillate. The facility of degradation by the Emde and Hofmann processes indicates that oxyacanthine probably contains two tetrahydroisoquinoline nuclei. On this basis Späth and Pikel proposed formula (XXXV : R = H) for oxyacanthine, the position assigned to the hydroxyl group being based on the production of *p*-hydroxybenzoic acid, when oxyacanthine is fused with potassium hydroxide and the formation of 2-ethoxydiphenyl ether 5 : 4'-dicarboxylic acid, m.p. $288.5-289.5^\circ$ (XXXIV : R = Et), when oxyacanthine ethyl ether dimethiodide is treated like its methyl analogue (*see above*). This structure explains the formation of an optically inactive base in the first stage of the exhaustive methylation processes by the disappearance of the centres of asymmetry marked *. The main features of this formula were confirmed by von Bruchhausen and Schultze,⁶ who modified slightly the orientation of the methoxyl groups in the two isoquinoline nuclei. von Bruchhausen and Gericke⁷ showed that the methine base, $C_{40}H_{46}O_6N_2$, m.p. 152° (*see above*) formed in the first stage of the Hofmann degradation process with oxyacanthine, is ozonised to the dialdehyde, m.p. 72° corresponding to (XXXIV) and a nitrogen-containing dialdehyde, $C_{25}H_{34}O_6N_2$, needles, m.p. 76° , which is represented by (XXXVI) since its dimethiodide, $C_{27}H_{40}O_6N_2I_2$, m.p. 259° (*dec.*), on treatment with alkali, breaks up into trimethylamine and a nitrogen-free substance, $C_{21}H_{20}O_6$, m.p. 140° , which must be the trimethoxydivinyl-diphenyl ether dialdehyde, m.p. 140° (XXXVII), since on reduction by the Clemmensen method it furnishes 2 : 3 : 2'-trimethoxy-6 : 5'-dimethyl-5 : 4'-diethyldiphenyl ether, m.p. 86.5° (XXXVIII), the constitution of

which has been confirmed by its synthesis by von Bruchhausen, Oberembt and Feldhaus.⁸

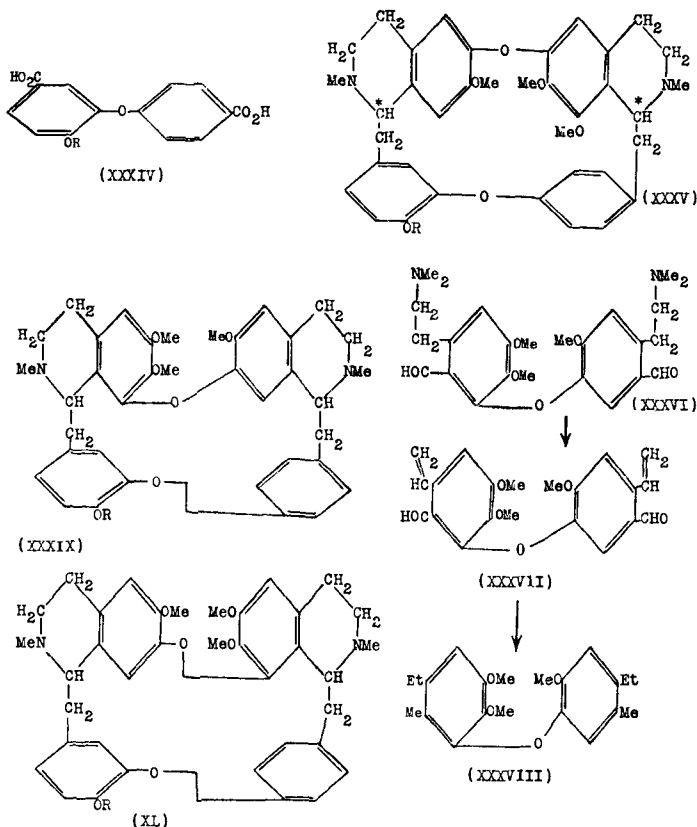

On these data and with the assumption that oxyacanthine is formed by the union of two molecules of *N*-methylcoclaurine (p. 352), oxyacanthine must have one of the two structures (XXXIX : R = H) or (XL : R = H), the other being that of berbamine.⁷ The latter contains three methoxyl groups, a phenolic hydroxyl group (methyl ether, m.p. 182°⁸) and two methylimino-groups, and is isomeric with oxyacanthine. Like the latter, it behaves as a tetrahydroisoquinoline base, and its methine base is oxidised by potassium permanganate to 2-methoxy-5:4'-dicarboxy-diphenyl ether (XXXIV : R = Me).³ According to von Bruchhausen *et al.*,⁸ berbamine methyl ether yields an optically inactive methine base A, m.p. 172°,³ and a crystalline optically active methine base B, m.p. 146–7°, $[\alpha]_D^{20} = 162^\circ$ (CHCl₃). On ozonisation A yields the same products as the corresponding oxyacanthine methine base, *viz.*, the dialdehyde corresponding to (XXXIV) and the nitrogen-containing dialdehyde (XXXVI), and on these grounds it also must be represented like oxyacanthine either by (XXXIX : R = H) or (XL : R = H).

Pharmacological Action. According to Curci,⁹ oxyacanthine in doses of 0.1 to 0.2 gm. produces in rabbits quick and laboured respiration, muscular tremors, clonic convulsions and cessation of respiration before the heart stops. Raymond-Hamet¹⁰ states that oxyacanthine hydrochloride in a dose of 10 mgm. injected into the femoral artery of a dog produced dilation of the blood vessels in the leg and general hypotension.

REFERENCES

(1) *Ber.*, 1886, 19, 3190; cf. POLEX, *Arch. Pharm.*, 1836, [ii], 6, 271; WACKER, *Jahresb.*, 1861, 545. (2) *Arch. Pharm.*, 1891, 229, 631; cf. POMMEREHNE, *ibid.*, 1895, 233, 127; cf. KONDO and TOMITA, *ibid.*, 1930, 268, 551. (3) SANTOS, *Inaug. Diss. Münster*, 1929 (*Chem. Abstr.*, 1930, 24, 1647). (4) *Ber.*, 1925, 58, 2280; cf. GADAMER and VON BRUCHHAUSEN, *Arch. Pharm.*, 1926, 264, 193. (5) *Ber.*, 1929, 62, 2251. (6) *Arch. Pharm.*, 1929, 267, 617. (7) *Ibid.*, 1931, 269, 115. (8) *Annalen*, 1933, 507, 144; VON BRUCHHAUSEN, *Zeit. angew. Chem.*, 1933, 46, 400; cf. KONDO and YANO, *Annalen*, 1932, 497, 90; FALTIS, WRANN, KÜHAS, *ibid.*, 69. (9) Quoted in *Merck's Jahresb.*, 1916, 30, 174. (10) RAYMOND-HAMET, *Compt. rend.*, 1933, 197, 1354; *Compt. rend. Soc. biol.*, 1942, 136, 112.

ALKALOIDS OF THE MENISPERMACEÆ

This is a convenient heading for a section including the chief members of the bisbenzylisoquinoline group of alkaloids. The latter occur chiefly, but not solely, in this botanical family, and two of them, berbamine and oxyacanthine are dealt with above, while a third, phæanthine, is included in this section, though derived from a species of the Anonaceæ, and a more recent addition is magnoline from *Magnolia fuscata* (Magnoliaceæ). Certain plants belonging to the Menispermaceæ, but not containing alkaloids of this type, have been assigned to their appropriate sections, e.g., the calumba root alkaloids (p. 342), and the alkaloids of *Sinomenium acutum* (p. 268), while the curare alkaloids, formerly regarded as all obtained from *Strychnos* spp. (Loganiaceæ), include some members derived from typical menispermaceous alkaloids and are dealt with at the end of this section (p. 371).

The following is a list of the chief plants concerned, with the names of their alkaloidal constituents. Page references are given to the descriptions of the more important alkaloids, but the minor bases are briefly described in the list. Many of the latter are still of unknown constitution and some of them are probably incompletely characterised, e.g., it is noticeable that several have melting-points in the neighbourhood of 217° and specific rotations about +268°. These two constants, with such meagre information as is available regarding botanical origin, suggest that some of these substances may be tetrandrine.

Bebeerine and its allies (p. 363) are also derived from menispermaceous plants, but as their botanical source needs attention in some detail, and in view of their importance as close associates of the curare alkaloids, they are dealt with separately at the end of this section.

(1) *Anamirta paniculata* Colebr. The seed shells are said to contain *menispermine*, C₁₈H₂₄O₂N, m.p. 120°, and an isomeride, *paramenti-*

- spermine*, m.p. 250°, both pharmacologically inactive, the toxicity of the drug being due to the neutral principle, picrotoxin.¹
- (2) *Cocculus diversifolius* DC. (cf. "han-fang-chi," below). *Kukoline*, $C_{16}H_{20}O_3N$, $3H_2O$, m.p. 162°; *diversine*, $C_{16}H_{20}O_4N$, m.p. 144–54°, amorphous.² For another diversine see p. 273.
- (3) *C. laurifolius* DC. *Coclaurine* ³ (p. 352).
- (4) *C. sarmentosus* Diels. *Menisarine* (p. 360), *trilobine*, *isotrilobine*.⁴
- (5) *C. trilobus* DC. *norMenisarine* ⁵ (p. 361), *trilobamine* (p. 357) *trilobine*, *isotrilobine* (p. 358) and an amorphous non-phenolic base.⁶
- (5a) *Magnolia fuscata* (Magnoliaceæ). *Magnoline* (p. 354).
- (6) *Menispermum canadense* L. *Dauricine* ⁷ (p. 353).
- (7) *M. dauricum* DC. *Dauricine* (p. 353) and *tetrandrine* ⁸ (p. 355).
- (8) *Pheanthus ebracteolatus* (Presl.) Merrill. *Pheanthine* ⁹ (p. 356) and uncharacterised bases.
- (9) *Sinomenium acutum* R. and W. (see p. 268).
- (10) *Stephania cepharantha* Hayata (Jap. name "tamasaki-tsuzurafuji.") *Berbamine* (p. 346), *cepharanthine* (p. 357), *O-methylisochondrodendrine* (p. 365), *isotetrandrine* (p. 356) with amorphous, phenolic and non-phenolic bases.¹⁰
- (11) *S. japonica* Miers (see p. 361).
- (12) *S. Sasakii* Hayata (Jap. name "Koto-tsuzurafuji"). *Cepharanthine* (p. 357) and two other bases: (a) $C_{34}H_{28}O_3N_2(OMe)_4$, m.p. 115–7°, $[\alpha]_D^{20} - 57.4^\circ$ ($CHCl_3$); B. $2HCl$, $2H_2O$, m.p. 222–5°; methiodide, m.p. 220°; methine base, $C_{40}H_{44}O_7N_2$, H_2O , m.p. 110–4°; $[\alpha]_D \pm 0^\circ$; B. $2HCl$, m.p. 264°.
- (b) $C_{34}H_{30}O_5N_2(OMe)_2$, phenolic, m.p. 210°, $[\alpha]_D^{20} - 36.7^\circ$ ($CHCl_3$); dimethyl ether, m.p. 160–5°; not identical with (a). (a) and (b) are chemically similar, e.g., in their colour reactions.¹¹
- (13) *S. tetrandra* S. Moore. *Tetrandrine* ¹² (p. 355). One form of "mu-fang-chi" (see below) possibly of this botanical origin contains *menisine* (p. 356) and a tertiary base *menisidine*,¹³ $C_{33}H_{32}O_3N_2(OMe)_3$, m.p. 176°, $[\alpha]_D^{20} + 260^\circ$ ($CHCl_3$), which is also recorded with *tetrandrine* from "shih-chan-chu" provisionally assigned to this species.¹⁴
- (14) *Tiliacora racemosa* Colebr. *Tiliacorine*, $C_{30}H_{27}O_3N(OMe)_2$, m.p. 260–1°, $[\alpha]_D + 105.3^\circ$.¹⁵
- Drugs of Undetermined Botanical Origin*
- (15) *Han-fang-chi*. Alkaloids have been recorded for four samples of this drug:—
- (A) Chen and Chen ¹⁶ found *tetrandrine* (p. 355) in a sample, possibly derived from *Cocculus diversifolius* (see item No. 2 above) or *C. japonicus*.
- (B) Hsü ¹⁷ obtained one phenolic and three non-phenolic bases: *Hanfanchine-A*, $C_{38}H_{42}O_6N_2$, m.p. 218°, $[\alpha]_D^{18} + 268.7^\circ$ ($CHCl_3$), now known to be *tetrandrine*; *hanfanchine-B*, $C_{36}H_{40}O_6N_2$, m.p. 241–2°, $[\alpha]_D^{23.5} + 272.4^\circ$ ($CHCl_3$); *hanfan-*

chine-C, $C_{13}H_{10}O_2(OH)_2(OMe)_2NMe$, $4H_2O$ or $C_{27}H_{23}O_5(OH_4)(OMe)_3(NMe_2)$, $8H_2O$, m.p. $215-7^\circ$ (*dec.*), $[\alpha]_D^{23} - 12.9^\circ$ (H_2O); B. HCl, m.p. $220-2^\circ$ (*dec.*); B. MeI, m.p. $182-4^\circ$. In the third paper (1937) *Stephania tetrandra* is given as the source of this drug.

- (C) Liu, Ma and Li¹⁸ state that a Japanese sample yielded an alkaloid, $C_{19}H_{23}O_4N$, m.p. $160-3^\circ$, $[\alpha]_D^{16} - 66^\circ$, possibly identical with sinomenine (p. 268) and a supply of the drug of Chinese origin furnished an alkaloid, m.p. $215-7^\circ$, $[\alpha]_D + 280.8^\circ$ ($CHCl_3$), which was also obtained from a Chinese sample of "Mo-fang-chi" (*see below*).
- (D) According to Chuang, Hsing, Kao and Chang,¹⁹ the drug of Chinese origin contains tetrandrine (p. 355) and *fangchinoline*, $C_{34}H_{30}O_2N_2(OH)(OMe)_3$, m.p. $237-8^\circ$, $[\alpha]_D^{18} + 255.1^\circ$, which on *O*-methylation yields tetrandrine, and is to be regarded as a demethyltetrandrine.

According to Read,²⁰ the name "han-fang-chi" is applied in China and Japan to *Menispermum dauricum* (p. 350), *Sinomenium acutum* (p. 268) or *Stephania japonica* (p. 361), while "fang-chi" is a native name for *S. tetrandra* in Formosa.

(16) *Mu-fang-chi*.

(A) The alkaloid, m.p. $215-7^\circ$, $[\alpha]_D + 280.8^\circ$ ($CHCl_3$) recorded by Liu *et al.*¹⁸ for "han-fang-chi" was also found by them in "mo-fang-chi."

(B) Two other samples have been dealt with under *Stephania tetrandra* (*see above*), their possible source.^{13, 14}

(C) Chen and Chen²¹ found in a sample believed to be derived from *Cocculus Thunbergii* (which Read²⁰ gives as a synonym for *C. trilobus*) the neutral principle *thunbergin*, $C_{20}H_{14}O_9$, m.p. $277-277.5^\circ$, and *mufangchine*, $C_{14}H_{21}O_{11}N_{14}$, m.p. 231.5° .

(17) *Feng-fan-chi*. From this material King and Shih²² obtained *fangchinine*, m.p. 218° , $[\alpha]_D^{18} + 267^\circ$.

(18) *Chin-Shien-Tiao-Ilu-Iu*. Hsü²³ found five alkaloids in this drug: (A) m.p. $217-8^\circ$; (B) m.p. $238-41^\circ$; (C) phenolic; (D) m.p. 110° ; (E) m.p. $190-5^\circ$ of which (A) and (B) may be identical with the same author's "hanfangchine (A) and (B)" referred to above.

REFERENCES

- (1) PELLETIER and COUERBE. *Annalen*, 1834, 10, 198; *see also* the critical comments by Liebig, *ibid.*, p. 203. (2) OHTA, *Ber. ges. Physiol.*, 1925, 33, 352; for pharmacology *see* OHTA, *Kitasato Arch. exp. Med.*, 1925, 6, 259, 283; RAYMOND-HAMET, *Compt. rend. Soc. biol.*, 1937, 125, 509. (3) GRESHOFF, "Verslag van het onderzoek naar de Plantenstoffen van der Ned.-Ind.," Batavia, 1890; PLUGGE, *Arch. exp. Path. Pharm.*, 1893, 32, 266; KONDO and KONDO, *J. Pharm. Soc. Japan*, 1925, No. 524, 876. (4) KONDO and TOMITA, *J. Pharm. Soc. Jap.*, 1927, 47, 39; 1928, 48, 83; 1930, 50, 91. (5) KONDO and TOMITA, *Ibid.*, 1931, 51, 451. (6) KONDO and NAKASATO, *Ibid.*, 1924, 44, 691; 1926, 46, 41; 1935, 55, 170; *Arch. Pharm.*, 1931, 269, 433. (7) KONDO, NARITA and MURAKAMI, *J. Pharm. Soc. Jap.*, 1941, 61, 117; MANSKE, *Can. J. Res.*, 1943, 21, B, 17. (8) KONDO and NARITA, *J. Pharm. Soc. Jap.*, 1927, No. 542, 40;

1929, 49, 103; (with MURAKAMI), 1941, 61, 117. (9) SANTOS, *Rev. Filip. Med. Farm.*, 1931, 22, No. 9; SULTI, *Thesis Univ. Philipp.*, 1934; for pharmacology see GARCIA, *Phil. J. Sci.*, 1940, 71, 361. (10) KONDO *et al.*, *J. Pharm. Soc. Jap.*, 1938, 58, 276; U.S. Pat. 2,206,407. (11) KONDO and TOMITA, *J. Pharm. Soc. Jap.*, 1939, 59, 207; U.S. Pat. 2,248,241. (12) KONDO and YANO, *J. Pharm. Soc. Jap.*, 1928, 48, 15. (13) CHOU, *Chin. J. Physiol.*, 1935, 9, 267; 1938, 13, 167. (14) CHU, *ibid.*, 1939, 14, 315. (15) VAN ITALIE and STEINHAEUER, *Pharm. Weekbl.*, 1922, 59, 1381. (16) *J. Biol. Chem.*, 1935, 109, 681; cf. KUBOTA, *Folia Pharmacol. Jap.*, 1931, 12, No. 2, 328, 338; 1934, 18, Nos. 2-3, 143, and OHTA.² (17) *J. Chin. Chem. Soc.*, 1935, 3, 260, 365; 1937, 5, 14; 1940, 7, 123. (18) *Pharm. Chem. Res. Rep.* (China), 1935, 1, 13, 29, 37. (19) *Ber.*, 1939, 72, 519. (20) "Chinese Medicinal Plants of the Pen Ts'ao Kang Mu," A.D. 1596, Peiping, 1936. (21) *Chin. J. Physiol.*, 1937, 11, 25; cf. Hsü, *J. Chin. Pharm. Ass.*, 1940, 2, 327. (22) *Bull. Nat. Acad. Peiping*, 1935, 6, 13. (23) *J. Chin. Pharm. Assoc.*, 1936, 1, 327.

In the following descriptions of coclaurine and the chief bisbenzylisoquinoline alkaloids, the numbers in brackets after the names of the alkaloids refer to the numbered items in the foregoing list.

Faltis¹ has made a number of suggestions regarding possible modes of origin of these alkaloids in plants, and useful summaries of information dealing with biological and chemical relationships in the group have been published by King² and by Kondo and Tomita.³

Coclaurine, $C_{17}H_{19}O_3N$. (Item 3; list, p. 350.) This alkaloid was first fully investigated by Kondo.⁴ It crystallises in plates, m.p. 221°, $[\alpha]_D^{20} - 17.01^\circ$, forms a crystalline hydrochloride, m.p. 264°, and a methiodide, m.p. 155°. The hydrochloride gives a violet colour with ferric chloride changing to green on warming. The alkaloid contains one methoxyl, but no methylimino group. Its solubility in alkali indicates the presence of phenolic hydroxyl groups and the formation of a non-basic,

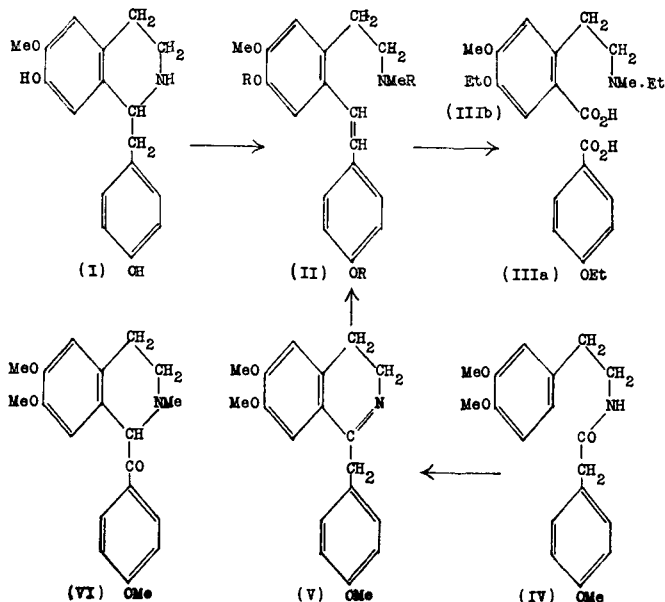

triacetyl derivative, m.p. 174°, and a similar tribenzoyl compound, m.p. 207°, indicates the presence of two such groups and an :NH group. The formula may therefore be extended thus: $C_{16}H_{13}(OCH_3)(OH)_2(NH)$. With diazomethane it yields trimethylcoclaurine, $C_{16}H_{13}(OCH_3)_3(NMe)$, m.p. 202–3°, which is oxidised by potassium permanganate to the keto-derivative (VI), m.p. 147–8°. The corresponding triethylcoclaurine (B. HCl, m.p. 162°) yields a methosulphate, m.p. 122°, from which triethylmethylcoclaurinemethine (II : R = Et) was prepared and oxidised with potassium permanganate, giving *p*-ethoxybenzoic acid (IIIa), and an acid shown to be (IIIb), since it furnished with methyl sulphate and alkali, 4-methoxy-3-ethoxy-6-vinylbenzoic acid, m.p. 165°, which can be hydrogenated to 4-methoxy-3-ethoxy-6-ethylbenzoic acid, m.p. 137.5–138.5°, identified by comparison with the synthetic ester. On this and other confirmatory evidence formula (I) was assigned to coclaurine, and has been confirmed by the synthesis of tetramethylcoclaurimethine (II : R = Me). For this purpose *p*-methoxyphenylaceto- β -3 : 4-dimethoxyphenylethylamide (IV) was converted by phosphorus oxychloride into 1-(4'-methoxybenzyl)-6 : 7-dimethoxy-3 : 4-dihydroisoquinoline (V), which was reduced to the tetrahydroisoquinoline, and this converted into the methosulphate, m.p. 175°, which on treatment with alkali gave tetramethylcoclaurimethine (II : R = Me), m.p. 86°; hydrochloride, m.p. 228.5–229°.

Coclaurine is of special interest since *norcoclaurine* (I : MeO \rightarrow HO) can be regarded as the parent substance from which by ether formation the series of bisbenzylisoquinoline alkaloids can arise. Thus, the dauricine type of alkaloid may be formed by a single ether linkage between the 4'-hydroxyl of one *norcoclaurine* molecule and a hydrogen atom *ortho* to the 4'-hydroxyl of a second molecule.^{1,2,3}

Dauricine, $C_{38}H_{44}O_6N_2$. (Items 6, 7; list, p. 350.) This alkaloid is a bright yellow powder, m.p. 115°, $[\alpha]_D^{11} - 139^\circ$, gives a bluish-brown colour with ferric chloride and contains four methoxyl groups, one hydroxyl group, and two methylimino-groups. The dimethiodide forms needles, m.p. 204°, $[\alpha]_D^{22} - 110^\circ$. Kondo and Narita⁶ at first represented dauricine by the formula $C_{19}H_{23}O_3N$, but finally accepted the double formula and the constitution suggested by Faltis and Frauendorfer.¹ Dauricine is converted by ethyl bromide in presence of alkali into ethyldauricine diethobromide, m.p. 136–9° (*dec.*), which is transformed by boiling alkali into the optically inactive α -ethyldauricineethylmethine, of which the dimethiodide, m.p., 162–5° (*dec.*), can be further degraded to an amorphous, nitrogen-free product, $C_{40}H_{44}O_6$, which is oxidised by potassium permanganate to 2-ethoxy-5 : 4'-dicarboxydiphenyl ether, m.p. 276–7°. Derivatives of this dibasic acid, especially the 2-methoxy compound first obtained by Späth and Píkl⁷ from oxyacanthine (p. 346) and the corresponding 2-methoxydialdehydodiphenyl ether (IX) are typical degradation products in this series of alkaloids. On the basis of the formula, $C_{19}H_{23}O_3N$, Kondo and Narita represented dauricine as the 4'-methyl ether of *N*-methylcoclaurine (*above*). The decision in favour of the Faltis and Frauendorfer formula (VII) was arrived at by the

synthesis ⁸ of α -methyldauricinemethine (VIII), m.p. 127–8°, produced in the first stage of the normal Hofmann degradation. 3 : 4'-Dialdehyde-6-methoxydiphenyl ether (IX) was transformed by hippuric acid, acetic anhydride and sodium acetate into the azlactone, which was converted by treatment with barium hydroxide in boiling aqueous alcohol into

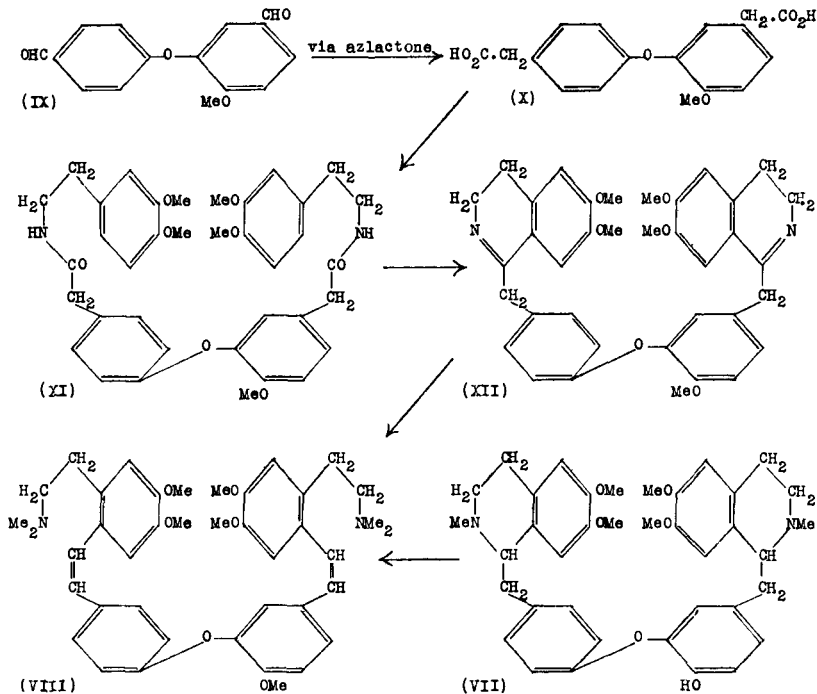

6-methoxy-3 : 4'-di(carboxymethyl)-diphenyl ether (X). This with *homoveratrylamine* gave 6-methoxydiphenyl ether 3 : 4'-diacetidihomoveratrylamide (XI), which by treatment with phosphorus pentachloride was converted into the bisbenzylisoquinoline derivative (XII) and this, on reduction followed by methylation gave α -methyldauricinemethine (VIII) identical with that prepared from dauricine (VII).

Magnoline, $C_{32}H_{25}O(OH)_3(OMe)_2(NMe)_2$. The leaves of the Caucasian tree, *Magnolia fuscata* (Magnoliaceæ), yield 1.5 to 2 per cent. of total alkaloids, of which the fraction, about one-tenth, insoluble in hot benzene, on solution in hot alcohol deposits the phenolic alkaloid magnoline, m.p. 178–9°, $[\alpha]_D - 9.6^\circ$ (pyridine), which yields vitreous salts with the halogen acids but gives a crystalline picrate, m.p. 160–2° (*dec.*) and picrolonate, m.p. 190° (*dec.*). The base is converted by diazomethane into a trimethyl derivative, m.p. 109–110°, which is oxidised by permanganate in acetone to (a) 2-methoxy-5 : 4'-dicarboxydiphenyl ether, identical with Späth's acid ⁷ from oxyacanthine methyl ether (p. 347) and (b), the lactam, 1-keto-6 : 7-dimethoxy-2-methyltetrahydroisoquinoline.^{7(a)} When the

triethyl ether is similarly oxidised analogous products result with ethoxy groups marking the sites of the original phenolic groups, viz., (a) 2-ethoxy-5:4'-dicarboxydiphenyl ether (*cf.* degradation of oxyacanthine, p. 347) and (b) 1-keto-6-methoxy-7-ethoxy-2-methyltetrahydroisoquinoline (*cf.* codamine, p. 195). On the basis of these results Proskurnina and Orekhov ^{7(b)} represent magnoline and the two oxidation products of its trimethyl ether, by the following formulæ, which make magnoline a close relative of dauricine (VII).

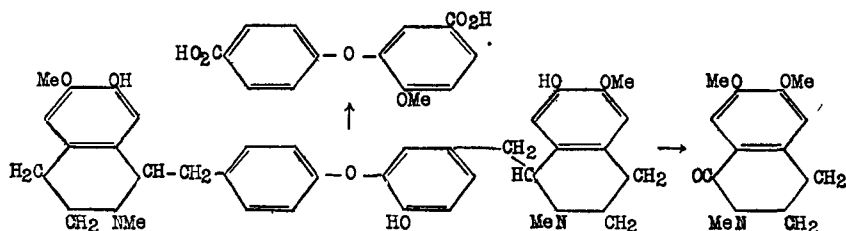

Magnolamine, $C_{32}H_{24}O(OH)_4(OMe)_2(NMe)_2$. This alkaloid occurs in the benzene-soluble portion of the total alkaloids and has been further examined by Proskurnina. ^{7(c)} It has m.p. 117–9°, $[\alpha]_D + 111.6^\circ$ (EtOH), forms a picrate, m.p. 142–5° (*dec.*), a picrolonate, m.p. 163–4° (*dec.*), and a tetramethyl ether, $C_{40}H_{48}O_7N_2$, m.p. 151–2°. The latter, on oxidation by permanganate in acetone, gives (a) 1-keto-6:7-dimethoxy-2-methyltetrahydroisoquinoline, m.p. 124–5° (*cf.* oxidation of magnoline) and (b) magnolaminic acid, $C_{16}H_{14}O_7$, m.p. 280–1°, which on fusion with potash at 250° is hydrolysed to *p*-hydroxybenzoic acid and probably gallic acid. Magnolamine tetraethyl ether, $C_{44}H_{56}O_7N_2$, m.p. 101–3°, on oxidation by permanganate in acetone, gives (c) a neutral product, m.p. 113–4°, (d) an acid, $C_{18}H_{18}O_7$, m.p. 265–7°, forming a dimethyl ester, m.p. 112–3°, and (e) a weakly basic substance, m.p. 120–1°, which proved to be 1-keto-6:7-diethoxy-2-methyltetrahydroisoquinoline. It is suggested that magnolamine is a hydroxymagnolamine, the additional hydroxyl group being located in the hydroxybenzyl portion, of the magnoline molecule, as in the partial formulæ (A) or (B) representing the diphenyl oxide part of the structure (*cf.* magnoline formula, above).

Komissarova finds that the total alkaloids of *Magnolia fuscata* and magnolamine are cardiac depressants at 20 to 1,000 and 10 to 500 parts per million respectively. The differences between the two indicate that the total alkaloids include a component more potent than magnolamine.

Tetrandrine, $C_{38}H_{42}O_6N_2$. (Items 7, 13, 15, 16; list, p. 350.) This alkaloid crystallises from ether or acetone, has m.p. 217°, $[\alpha]_D^{24} + 263.1^\circ$ ($CHCl_3$) and gives a dihydrochloride, m.p. 266° (*dec.*), $[\alpha]_D^{27} + 224.2^\circ$ (H_2O), and a dimethiodide, m.p. 269° (*dec.*). It contains four methoxyl and two methylimino groups, behaves with acetic anhydride as a derivative of

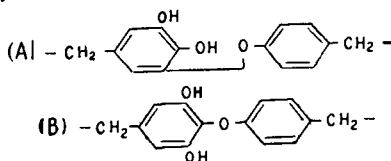

tetrahydroisoquinoline, and furnishes protocatechuic acid and basic products on fusion with potassium hydroxide. The α -methine base, $C_{40}H_{46}O_6N_2$, has m.p. 172° , $[\alpha]_D^{18.5} + 237.6^\circ$, yields a dimethiodide, m.p. 235° (*dec.*), and on ozonisation (Kondo and Yano ⁹) furnishes 2-methoxy-5 : 4'-dialdehydodiphenyl ether and a dialdehydotrimethoxybis-(β -dimethylaminoethyl)-diphenyl ether (Formula XXXVI, p. 348) identical with the two products similarly obtained by von Bruchhausen and Gericke ¹⁰ by the ozonisation of the α -methine bases of the methyl ethers of oxyacanthine and berbamine (p. 347). The optically inactive methine base from methylberbamine melts like that from tetrandrine at 172° , and it has been suggested that tetrandrine is a stereoisomeride of berbamine methyl ether ¹¹ (m.p. 182° , $[\alpha]_D + 132^\circ$), *i.e.*, of the two formulæ (XXXIX) and (XL) given (p. 348), one must represent oxyacanthine methyl ether, and the other tetrandrine and berbamine methyl ether. The specific rotations of the two latter favour the view that the direction of rotation is dextro at one centre of asymmetry in berbamine methyl ether, and at both in tetrandrine.

isoTetrandrine, $C_{38}H_{42}O_6N_2$ (item 10 ; list, p. 350), m.p. 182° , $[\alpha]_D^{17} + 146^\circ$, has been shown to be identical with berbamine methyl ether (p. 346).¹¹

Among other alkaloids closely related to tetrandrine is *fangchinoline* (item 15d ; list, p. 351), a demethyltetrandrine already described (*loc. cit.*).

Phæanthine, $C_{38}H_{42}O_6N_2$. (Item 8 ; list, p. 350.) This alkaloid was isolated by Santos.¹² It has m.p. 210° , $[\alpha]_D^{30} - 278^\circ$ ($CHCl_3$), yields a hydriodide, m.p. 268° , picrate, m.p. 263° , aurichloride, m.p. $170-1^\circ$, and a platinichloride, m.p. 280° (*dec.*), and contains four methoxyl and two methylimino groups. By the Hofmann degradation process it yields an optically inactive methine base A, m.p. 173° , which is oxidised by potassium permanganate in acetone to 2-methoxy-5 : 4'-dicarboxydiphenyl ether (p. 348). A comparison of the properties of phæanthine and tetrandrine by Kondo and Keimatsu ¹³ indicates that these two alkaloids are optical antipodes, so that phæanthine will be represented by either (XXXIX) or (XL) as given on p. 348,¹¹ and of these two formulæ ($R = Me$) one must represent oxyacanthine methyl ether and the other berbamine methyl ether (centres of asymmetry *d*- and *l*-); tetrandrine (centres of asymmetry both *d*-) and phæanthine (centres of asymmetry both *l*-).

Menisine, $C_{38}H_{42}O_6N_2$. (Item 13 ; list, p. 350.) M.p. 152° , $[\alpha]_D^{20} + 290^\circ$ ($CHCl_3$). A tertiary base containing four methoxyl groups. When subjected to Hofmann degradation it yields the same products as tetrandrine, *viz.*, (a) an optically inactive methine base, $C_{40}H_{46}O_6N_2$, m.p. 171° , yielding a dimethiodide, m.p. 257° , (b) a second base giving a methiodide, m.p. 217° , and (c) a substance, $C_{42}H_{54}O_{11}N_2$, forming yellow prisms, m.p. 248° (*dec.*); $[\alpha]_D^{18} + 625^\circ$ (MeOH) and characterised by a methiodide, m.p. 258° (*dec.*), $[\alpha]_D^{18} + 367^\circ$ (H_2O). In the next stage of the Hofmann process trimethylamine is liberated and a nitrogen-free product, $C_{36}H_{32}O_6$, m.p. 221° , is formed.

When heated at 150° for three hours menisine is converted into tetran-drine (Chou ¹⁴).

Trilobamine, $C_{36}H_{38}O_6N_2$. (Item 5 ; list, p. 350.) This phenolic base has m.p. 195°, $[\alpha]_D^{15} + 356.6^\circ$ (dilute acetic acid), forms a dihydriodide, m.p. 264° (*dec.*), and an amorphous dimethyl ether, m.p. 169°, which was eventually shown to be identical with the monomethyl ether of oxyacanthine (p. 347).

When the methine base derived from trilobamine diethyl ether ethiodide is oxidised by permanganate it furnishes 2-ethoxydiphenyl ether 5 : 4'-dicarboxylic acid, identical with that (XXXIV ; p. 348, R = Et) similarly formed from oxyacanthine (p. 347) or dauricine (p. 353) and in the present case derived from the diphenyl ether residue represented by rings (1) and (2) in formula (A) or (B). This fixes the position of one hydroxyl group at OR^3 in (A) or (B); the position of the second is still undetermined but it may well be OR^1 in ring (3) of (A) or ring (4) of (B).¹⁵

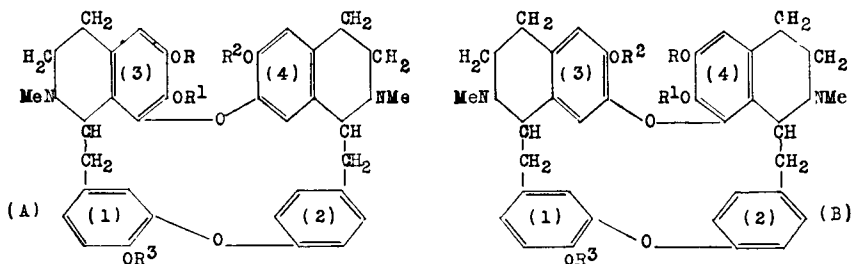

Cepharanthine, $C_{37}H_{38}O_6N_2$, 1.25 C_6H_6 (items 10, 12 ; list, p. 350), is a yellow, amorphous powder, m.p. 103° (*dec.*). When free from solvent it has m.p. 145–155° and $[\alpha]_D^{20} + 277^\circ$ ($CHCl_3$). The salts, including the methiodide, are amorphous. It contains one methylenedioxy group, two methoxys and two methylimino groups.

In the first stage of the Hofmann degradation process two methine bases are formed, *viz.*, cepharanthine- β -methine, $C_{39}H_{42}O_6N_2$, H_2O , m.p. 183–4°, $[\alpha]_D^{27} + 58^\circ$ ($CHCl_3$) and, as chief product, the isomeric cepharanthine- α -methine, $C_{39}H_{42}O_6N_2$, $3H_2O$, m.p. 98–100°, $[\alpha]_D \pm 0^\circ$, which yields a methiodide, m.p. 305–6°. The latter in the second stage of the degradation affords trimethylamine and de-*N*-cepharanthine, $C_{35}H_{30}O_7$, 0.5 MeOH, m.p. about 210° (*dec.*). The α -methine, on oxidation by permanganate, gives 2-methoxy-5 : 4'-dicarboxydiphenyl ether (*cf.* oxyacanthine, p. 347), and on ozonisation, followed by hydrogenation of the primary product, furnishes 2-methoxy-5 : 4'-dialdehydodiphenyl ether, m.p. 77–8° (formula C) and 2-methoxy-2' : 3'-methyleneedioxy-5 : 6'-dialdehydo - 4 : 5' - di - β - dimethylaminoethyldiphenyl ether (formula F) of which the dimethiodide, m.p. 217–20° (*dec.*), is degraded by the Hofmann process to the corresponding divinyl-compound, m.p. 166–8°, and this on hydrogenation followed by a Clemmensen reduction yields 2-methoxy-2' : 3' methyleneedioxy-5 : 6'-dimethyl-4 : 5'-diethyldiphenyl ether (formula G), m.p. 88–9°, the identity of which was established by synthesis, effected

chloride and hydrobromide are crystalline, and sparingly soluble in water. The dimethiodide has m.p. 273° (*dec.*). Trilobine contains two methoxyl and two methylimino-groups; the three inert oxygen atoms are assumed to be present in ether linkages. With dimethyl sulphate and alkali, trilobine furnishes trilobinemethylmethine, $C_{38}H_{40}O_5N_2$, long prisms, m.p. 106°, $[\alpha]_D \pm 0^\circ$, and this on ozonisation yields 2-methoxy-5:4'-dialdehydodiphenyl ether (XIII), m.p. 72-5°, and a complex dialdehyde (XIV), m.p. 124°, of which the dimethiodide, long prisms, m.p. 230° (*dec.*), on Hofmann degradation gives trimethylamine and the *O*-divinyl dialdehyde (XV), m.p. 195° or > 300° (slow heating). The latter is oxidised by

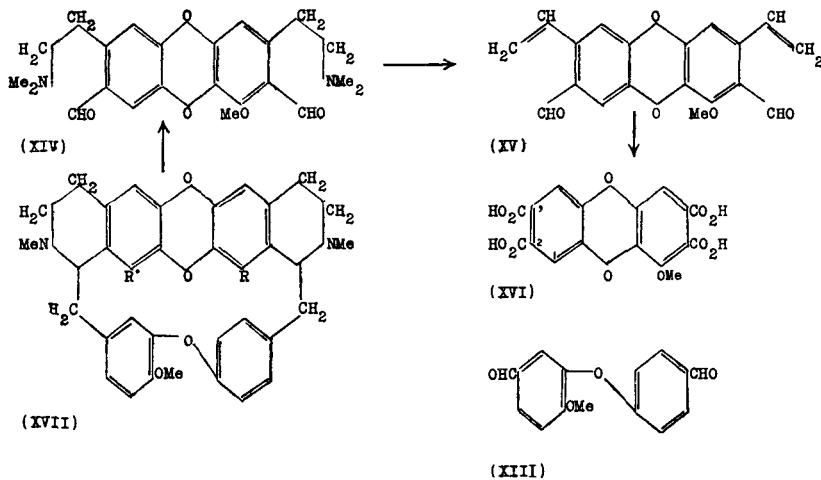

potassium permanganate to a tetracarboxylic acid, $C_{17}H_{10}O_{11}$, m.p. 192-7° (methyl ester, $C_{12}H_8O_2(OMe)(CO_2Me)_4$, m.p. 85°), which on fusion with potassium hydroxide furnishes protocatechuic acid, and is therefore provisionally represented by (XVI). On the basis of these results Kondo and Tomita¹⁷ suggested (XVII: R or R' = OMe) as representing trilobine, and its structural isomeride *isotrilobine* (*see below*), since both alkaloids yield the same degradation products, and the only difference between them must lie in the position of the methoxyl group R or R' in (XVII).

On stereochemical grounds Faltis⁹ proposed formulæ conforming with the general type (XVIII) in which the $-CH_2 \cdot R-$ and CH_2R' groups may each be alternatively

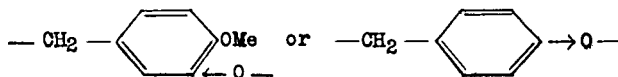

A modified form of (XVIII) has been suggested by Kondo and Tomita.³ The latest form derived from (XVIII) is (XIX) proposed by Faltis *et al.*¹ (1941) in which one methoxyl group has been moved from position α to α' (XVIII).

The adoption of formula (XIX) implies that the intermediate products

(XIV to XVI, p. 359) require revised formulæ and (XVI), for example, becomes (XVI, Faltis, 1941).

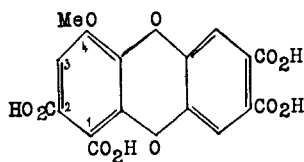

(XVI) (Faltis, 1941)

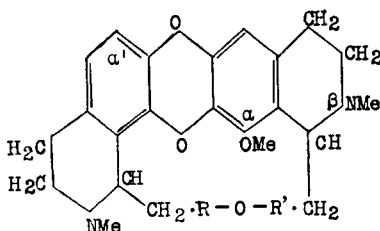

(XVIII)

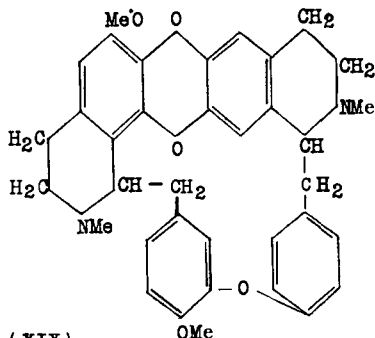

(XIX)

*iso*Trilobine (*Homotrilobine*), $C_{36}H_{36}O_5N_2$. (Items 4, 5; list, p. 350.) This isomeride of trilobine forms stellate clusters of prisms, m.p. 215° , $[\alpha]_D^{19} + 293^\circ$; the dihydrochloride occurs in prisms, m.p. 310° ; the dimethiodide decomposes at 262° . The alkaloid contains two methoxyl and two methylimino-groups, and its reactions indicate its close relationship to trilobine. *iso*Trilobinemethylmethine, $C_{38}H_{40}O_5N_2$, m.p. 115° , $[\alpha]^{20} \pm 0^\circ$, like the trilobine analogue (p. 359), is ozonised to (a) 2-methoxy-5 : 4'-dialdehydodiphenyl ether (XIII) and (b) the diaminodialdehyde (XIV).

The difference between the two alkaloids is assumed to be due to the difference provided for by the alternation of R and R' (XVIII); if one member of the pair so arrived at is trilobine the other should be *iso*-trilobine.¹⁸

Menisarine, $C_{36}H_{34}O_6N_2$. (Item 4; list, p. 350.) This alkaloid crystallises in minute tablets, m.p. 203° (*dec.*), $[\alpha]_D^{12} + 149.4^\circ$ ($CHCl_3$); the hydrochloride, B. HCl. $6H_2O$, forms golden-yellow needles, m.p. 279° (*dec.*), $[\alpha]_D^{16} + 171.5^\circ$; the methiodide, B. $2MeI$, is a yellow crystalline powder, m.p. $269-70^\circ$ (*dec.*). Menisarine contains three methoxyl groups and one methylimino-group. The three remaining oxygen atoms are assumed to occur as ether linkages, the second nitrogen atom to be present in a 3 : 4-dihydroisoquinoline system, and the alkaloid to belong to the trilobine type, since it gives a blue colour with a mixture of nitric and sulphuric acids, and the absorption spectra of trilobine, *isotrilo*bine and dihydromenisarine are similar. The latter, on oxidation by potassium permanganate, yields 2-methoxy-5 : 4'-dicarboxydiphenyl ether (p. 346), and with dimethyl sulphate and alkali is converted into *N*-methyl dihydromenisarinemethylmethine, $C_{39}H_{42}O_6N_2$, colourless prisms, m.p. 112° ,

$[\alpha]_D \pm 0^\circ$, which on further degradation by the Hofmann method yields a nitrogen-free product, m.p. 208° . The methylmethine base, on ozonisation produces (a) 2-methoxy-5:4'-dialdehydodiphenyl ether, and (b) a complex aminoaldehyde, of which the methiodide, $C_{24}H_{30}O_6N_2 \cdot 2MeI \cdot H_2O$, m.p. 224° , is decomposed by boiling alkali to form a nitrogen-free substance, $C_{20}H_{16}O_6 \cdot H_2O$, m.p. $>300^\circ$, which is believed to be a vinylaldehyde of the dioxodiphenylene type (*cf.* XV, p. 359), since it gives a blue colour with a mixture of nitric and sulphuric acids. From these results Kondo and Tomita¹⁹ have suggested that a formula for menisarine is derivable from their modified form of (XVIII) by moving a methoxyl group to α' and the change at β of $-NMe-CH$: to $-N:C$:. The first change conflicts with (XIX) suggested by Faltis *et al.* for trilobine.

norMenisarine, $C_{35}H_{32}O_6N_2$. (Item 5; list, p. 350.) This alkaloid is crystalline, has m.p. 223° , $[\alpha]_D^{21} + 190.3^\circ$, and on methylation with diazomethane yields menisarine, which is therefore the *O*-methyl ether of *normenisarine*.²⁰

Stephania japonica Miers. From the stems of this species, long used as a febrifuge in Japan, Kondo and Sanada²¹ have isolated eight alkaloids:

Metaphanine, $C_{18}H_{29}O_3N$. $[C_{15}H_{19}(OH)(OMe)_2(NMe)]$, m.p. 229° $[\alpha]_D \pm 0^\circ$, monoacetyl derivative, m.p. 150° .

epiStephanine, $C_{19}H_{23}O_3N$. $[C_{15}H_{14}(OMe)_2(CO)(NMe)]$, m.p. 198° , $[\alpha]_D + 195.8^\circ$; methiodide, m.p. 245° , $[\alpha]_D^{12} + 220.95^\circ$; oxime, m.p. 157° ; semicarbazone, m.p. 165° . It has been suggested that deoxydehydro-*epistephanine* methiodide, $C_{20}H_{24}O_2NI$, m.p. 165° (*dec.*), $[\alpha]_D^{23} + 42.28^\circ$ (EtOH) is the enantiomorph of the dimethyl ether of *apomorphine* methiodide, m.p. $190-5^\circ$, $[\alpha]_D^{26} - 42.03^\circ$ (EtOH); *dl*-form, m.p. 214° .

ψ -epiStephanine, $C_{19}H_{21}O_3N$. $[C_{16}H_{11}(OH)(OMe)_2(NMe)]$, m.p. 257° , $[\alpha]_D + 174.55^\circ$. Methyl- *ψ -epistephanine* methiodide, $C_{21}H_{26}O_3NI$, m.p. 221° , $[\alpha]_D^{14} + 118.5^\circ$, is regarded as the optical antipode of dimethylmorphothebaine methiodide, m.p. 187° , $[\alpha]_D^{20} - 110.8^\circ$, and is supposed to differ from *epistephanine* by the substitution of a hydroxyl for a carbonyl group and by different orientation of the oxygenated substituents.

Base VIII, $C_{31}H_{26}O_5N_2$, m.p. $102-3^\circ$, $[\alpha]_D^{27} - 83.33^\circ$; hydrochloride, B. HCl, m.p. $267-8^\circ$.

Stephanoline, $C_{31}H_{42}O_7N_2$. $[C_{27}H_{29}O_2N_2(OH)(OMe)_4]$, m.p. 186° , $[\alpha]_D - 255.4^\circ$; hydrochloride, B. $2HCl \cdot 2H_2O$, m.p. 230° . Phenolic base.

homoStephanoline, $C_{32}H_{44}O_7N_2$, m.p. 232° , $[\alpha]_D - 255.6^\circ$; hydrochloride, m.p. 238° . Phenolic base.

Stephanine, $C_{35}H_{39}O_6N_2$. $[C_{30}H_{25}O_2(OMe)_2(O_2CH_2)(NMe)_2]$, m.p. 157° , $[\alpha]_D^{22} - 91.51^\circ$; dihydrochloride, B. $2HCl \cdot H_2O$, m.p. 280° (*dec.*).

protoStephanine, $C_{21}H_{25}O_4N$, m.p. 75° , $[\alpha]_D + 3.44^\circ$; hydrochloride, m.p. 150° ; aurichloride, m.p. 155° (*dec.*); platinichloride, m.p. 223° (*dec.*); methiodide, m.p. $220-1^\circ$. The oxygen atoms are present as methoxyl groups, and the nitrogen as a methylimino-group.

Pharmacology. A considerable number of menispermaceous plants yielding alkaloids are used as crude drugs in the Far East but the alkaloids so far isolated from them, though pharmacologically active, do not seem

likely to be of practical therapeutic value. According to Horiuchi,²² dauricine (p. 353), epistephanine (p. 361) and insularine (p. 370) produce paralysis and convulsions when given to frogs, mice or rabbits. The heart remains in diastole after cessation of respiration. The emetic action of the three alkaloids is shown strongly in dogs. Tetrandrine (p. 355), which would be expected to resemble berbamine and oxyacanthine in action, has been examined by Chen, Chen, Anderson and Rose,²³ who state that it has a pronounced irritant action on mucous membrane, is slightly antipyretic, produces hyperglycemia in rabbits, induces emesis in pigeons, depresses cardiac activity, reduces blood pressure and depresses the smooth muscle of isolated rabbit intestine and guinea-pig or rabbit uterus. It causes reversal of the polymorphonuclear cells and lymphocytes in rabbits four to six hours after injection. Chen and Chou²⁴ state that menisidine (p. 350) and menisine (p. 356) resemble tetrandrine qualitatively in action. Tsuruta²⁵ found that trilobine produced respiratory paralysis and motor disturbance in frogs, mice and rabbits, reduced blood pressure in the rabbit and in large doses paralysed the heart. Intestinal and uterine contractions were stimulated by small and paralysed by large doses. Motor nerve ends and skeletal muscle were also paralysed.

Of the alkaloids of the han-fang-chi group of drugs (p. 350), Ohta²⁶ states that kukoline is a strong reflex and spasm stimulant and finally causes paralysis and death. Raymond-Hamet²⁶ states that it suppresses the hypotensive action of dihydroxyphenylethanoethylamine.

According to a review by Büchi²⁷ of work done in Japan during the war, promising results have been obtained by the use of the alkaloid cepharanthine (p. 357) in tuberculosis and leprosy.

REFERENCES

- (1) (With FRAUENDORFER), *Ber.*, 1930, **63**, 809; (with HOLZINGER, ITA and SCHWARZ), *ibid.*, 1941, **74**, 79; *Annalen*, 1932, **497**, 69; **499**, 301. (2) *Ann. Repts. Chem. Soc.*, 1933, **30**, 242. (3) *Arch. Pharm.*, 1936, **274**, 65. (4) (With KONDO), *J. Pharm. Soc. Jap.*, 1925, **45**, 876; 1926, **46**, 104; 1928, **48**, 56, 166; 1930, **50**, 63. (5) *J. prakt. Chem.*, 1930, [ii], **126**, 24. (6) *J. Pharm. Soc. Jap.*, 1927, **47**, 40; 1929, **49**, 103; 1930, **50**, 589; *Ber.*, 1930, **63**, 2420. (7) *Ibid.*, 1929, **62**, 2251. (7a) PYMAN, *J. Chem. Soc.*, 1909, **95**, 1272. (7b) *Bull. Soc. Chim.*, 1938, [v], **5**, 1257; *J. Gen. Chem.*, *U.R.S.S.*, 1940, **10**, 707. (7c) *Ibid.*, 1946, **16**, 129. (7d) *Farmakol i Toksikol*, 1945, **8**, 17. (8) KONDO, NARITA and UYEO, *ibid.*, 1935, **68**, 519. (9) *J. Pharm. Soc. Jap.*, 1929, **49**, 51; 1930, **50**, 26; *Annalen*, 1932, **497**, 90; cf. FALTIS, *ibid.*, 1932, **499**, 301. (10) VON BRUCHHAUSEN (with GERICKE), *Arch. Pharm.*, 1931, **269**, 115; (with OBEREMBT and FELDHAUS), *Annalen*, 1933, **507**, 144. (11) KONDO and KEIMATSU, *J. Pharm. Soc. Jap.*, 1935, **55**, 63; with TOMITA.³ (12) *Ber.*, 1932, **65**, 472; cf. FALTIS, *Annalen*, 1932, **497**, 69. (13) KONDO and KEIMATSU, *Ber.*, 1935, **68**, 1503. (14) *Chin. J. Physiol.*, 1938, **13**, 167. (15) KONDO and TOMITA, *Arch. Pharm.*, 1931, **269**, 433; 1936, **274**, 70; *J. Pharm. Soc. Jap.*, 1935, **55**, 104. (16) KONDO, YAMASHITA and KEIMATSU, *J. Pharm. Soc. Jap.*, 1934, **54**, 108; KONDO and KEIMATSU, *ibid.*, 1935, **55**, 25; *Ber.*, 1938, **71**, 2553. (17) KONDO (with NAKAZATO), *J. Pharm. Soc. Jap.*, 1924, **44**, 691; 1926, **46**, 41; (with TOMITA), *ibid.*, 1927, **47**, 39; 1928, **48**, 83; 1930, **50**, 127; *Annalen*, 1932, **497**, 104; for pharmacological action, see TSURUTA, *Folia Pharmacol. Jap.*, 1926, **3**, 280. (18) KONDO¹⁷ and *Arch. Pharm.*, 1936, **274**, 178; cf. FALTIS, *Annalen*, 1932, **499**, 301; *Ber.*, 1941, **74**, 79. (19) *J. Pharm. Soc. Jap.*, 1930, **50**, 91; 1935, **55**, 100; *Arch. Pharm.*, 1936, **274**, 78. (20) KONDO

and TOMITA, *J. Pharm. Soc. Jap.*, 1931, 51, 461; 1935, 55, 170; *Arch. Pharm.*, 1931, 269, 441; 1936, 274, 74. (21) *J. Pharm. Soc. Jap.*, 1924, 44, 5; 1927, 47, 31, 126; 1928, 48, 163; 1931, 51, 55; (with WATANABE), 1938, 58, 46. (22) *Mitt. med. Ges. Tokyo*, 1931, 740. (23) *Chin. J. Physiol.*, 1937, 11, 13. (24) *Ibid.*, 1937, 11, 29; CHOU, LU and WANG, 1937, 12, 163. (25) *Folia Pharmacol. Jap.*, 1926, 3, 280. (26) OHTA, *Kitasato Arch. exp. Med.*, 1925, 6, 259, 283; RAYMOND-HAMET, *Compt. rend. Soc. Biol.*, 1937, 125, 509. (27) *Schweiz. Apoth. Zeit.*, 1945, 83, 198; see also JUNOD, *Med. et Hyg.*, 1946, 4, 1.

Alkaloids of Greenheart, Boxwood and "Pareira brava." In 1843, Maclagan isolated from greenheart bark (bebeeru), (*Nectandra Rodiaei*, Hook) the alkaloids bebeerine and sepeerine; the latter, a yellowish resin for which the names flavobuxine and pelluteine have also been used.¹ Later, Walz² stated that bebeerine was identical with buxine, which Faure³ had obtained from boxwood (*Buxus sempervirens* L.) in 1830. Flückiger⁴ also regarded buxine and bebeerine as identical, and affirmed the identity of the latter with pelosine, which Wiggers⁵ isolated from *Cissampelos Pareira* L., the roots of which have appeared in commerce as "Pareira brava," and which Flückiger had himself prepared from *Chondrodendron tomentosum*, Ruiz and Pav, supposed to be the source of true "Pareira brava," and now of special interest as a source of tube curare (p. 373). Scholtz⁶ confirmed the statement that pelosine and his bebeerine, now known to be derived from pareira root bark, are identical, but regarded buxine as distinct from either. Other alkaloids were isolated from greenheart wood by Maclagan and Gamgee,⁷ and from boxwood by Barbaglia,⁸ but do not appear to have been further investigated. In 1921, Faltis and Neumann⁹ stated that the true source of "Pareira brava" is *Chondrodendron platyphyllum* (St. Hil.) Miers, containing alkaloids different from those of greenheart, and that in consequence the name "bebeerine" should be restricted to alkaloids from greenheart, and that the alkaloids of "pareira brava" should be known as "chondrodendrines." Since the same authors state that commercial bebeerine is made from "pareira brava," this means that bebeerine should be re-named chondodendrine. This suggestion has been adopted in the case of *iso*-bebeerine, which is now generally called *isochondodendrine* or *isochondrodendrine*. These two names arise from the fact that Ruiz and Pavon wrote the generic name *Chondodendron* in mistake for *Chondrodendron* and purists have insisted upon the correction (King,¹⁰ 1935). The name bebeerine persists though Faltis uses chondodendrine, and a new complication has arisen by the identification of Boehm's curine (p. 374) with *l*-bebeerine. Much of the work done in recent years on these alkaloids has been carried out with commercial bebeerine, from which the following alkaloids have from time to time been isolated by the independent work of Scholtz⁶ and Faltis⁹ :—

- (1) *Bebeerine* (Pelosine, α -Bebeerine, Chondrodendrine, Curine).
- (2) *isoChondrodendrine* (*iso*Bebeerine).
- (3) β -*Bebeerine* (β -Chondrodendrine).
- (4) *Bebeerine*.B.
- (5) *Chondrodine*.

The data available regarding the last three probably need revision as suggested by Faltis, Kadiera and Doblhammer.⁹

Chondrodine, $C_{18}H_{21}O_4N$, amorphous, m.p. 218–20°, $[\alpha]_D - 75^\circ$ (EtOH). The hydrochloride, B. HCl, m.p. 274–5°, occurs in yellow leaflets; the picrate, m.p. 193–4°, is a crystalline powder, and the picrolonate, m.p. 185–6°, forms greenish-yellow needles. The alkaloid contains a methoxyl and a methylimino-group, and yields a crystalline dibenzoyl derivative, m.p. 295°. The diethyl ether hydrochloride, m.p. 258°, forms yellow needles (Scholtz,⁶ 1911).

β -**Bebeerine**, $C_{21}H_{23}O_4N$, is amorphous and yields amorphous salts. It has m.p. 124–50°, $[\alpha]_D^{21} + 28.6^\circ$ (EtOH), or -24.7° (pyridine), and its reactions indicate that the formula may be extended to $C_{19}H_{16}O_2(NMe)(OMe)(OH)$.⁹ According to Scholtz⁶ (1913) it has the formula, $C_{18}H_{21}O_3N$, and yields a crystalline methiodide, m.p. 80° (hydrated) or 258–9° (*dry, dec.*). According to Faltis, Kadiera and Doblhammer,⁹ this may be a diastereoisomeride of bebeerine.

Bebeerine-B, $C_{22}H_{23}O_5N$, a yellow powder, m.p. 220° (*dec.*), $[\alpha]_D + 56.7^\circ$. Its reactions indicate the presence of the following groups,

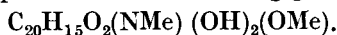

On fusion with potash protocatechuic acid is formed.⁹

Alkaloids of Chondrodendron platyphyllum

The confused state of knowledge referred to above has been clarified, at least as regards the alkaloids of "pareira brava" and the botanical source of this drug, by Dr. H. King,¹⁰ (1940), who has confirmed the statement of Krukoff and Moldenke¹⁰ that genuine "pareira brava" is the root of *Chondrodendron platyphyllum* (St. Hil.) Miers, though some may also be obtained from *C. microphyllum* (Eichl.) Moldenke; these two plants are native to Brazil and authentic samples from both have been examined by King as well as roots of *C. candicans* (Rich ex DC.) Sandwith, from British Guiana and the "pareira brava" root commercially available in England. The results are summarised in the following table, the predominant alkaloid being named first.

Species	Locality	Organ	Alkaloids
<u>Ch. platyphyllum</u>	Rio	Root	<u>d-iso</u> Chondrodendrine, <u>l</u> -bebeerine.
" "	Bahia	Root	<u>l</u> -Bebeerine, <u>d-iso</u> chondrodendrine.
		Stems	<u>l</u> Bebeerine
		Leaves	<u>l</u> Chondrofoline, <u>d-iso</u> chondrodendrine <u>l</u> -bebeerine.
<u>Ch. microphyllum</u>	Bahia	Root	<u>d-iso</u> Chondrodendrine, <u>d</u> -bebeerine.
<u>Ch. candicans</u>	British Guiana	Stem	<u>d-iso</u> Chondrodendrine, <u>d</u> -bebeerine.
<u>Pareira brava</u>			<u>d</u> -Bebeerine, <u>d-iso</u> chondrodendrine. <u>l-iso</u> ococlaurine.

d-**isococlaurine**, $C_{17}H_{19}O_3N$, crystallises from chloroform in clusters of plates, m.p. $216-7^\circ$, yields a crystalline hydrochloride, B. HCl, H_2O , m.p. $175-6^\circ$, $[\alpha]_{5461}^{20} + 23.9^\circ$ (*dry salt*; H_2O) and like coclaurine (p. 352) gives a typical Millon reaction. On boiling in methyl alcohol with potassium hydroxide and methyl iodide it is converted into *O*-methylisococlaurine methiodide, $C_{21}H_{26}O_3NI$, $2H_2O$, m.p. about 113° or 137° (*dry*), which was compared with *O*-methylcoclaurine methiodide, and found to have the same characteristics. The two are regarded as *d*- and *l*-enantiomorphs respectively, of *O*-dimethyl-*N*-methylcoclaurine methiodide. The formation of this compound and the facts that isococlaurine is isomeric with coclaurine (I) and like it does not give a catechol reaction indicates for it formula (II) (King,¹⁰ 1940).

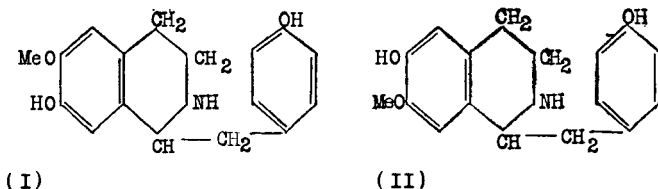

Chondrofoline, $C_{35}H_{36}O_6N_2$, $2H_2O$, crystallises from methyl alcohol in triangular plates, m.p. about 135° , $[\alpha]_{5461}^{20} - 280.6^\circ$ (*dry base*; $N/10$. HCl). It is a phenolic base, contains three methoxyl groups, does not give a Millon reaction, but in methyl alcoholic solution gives a faint, pink-purple colour with ferric chloride. The nitrate forms needles m.p. 225° (*dec.*).

The base boiled in methyl alcoholic solution with methyl iodide and potassium hydroxide, forms a gelatinous methiodide, which was converted by silver chloride into the methochloride. The latter when boiled with 20 per cent. solution of sodium hydroxide, produced a mixture of methine bases, which were separated as the methiodides into *O*-methylbebeerine-methine methiodide B, m.p. 237° (*cf.* p. 375), and a lævrotatory form, m.p. 190° , which proved to be the lævo-enantiomorph of *d*-*O*-methylbebeerinemethine methiodide (form C, p. 375). Chondrofoline therefore belongs to the bebeerine type represented by formula (III). In it $R = H$, the single phenolic hydroxyl is at OR_1 or OR_4 and the remaining groups, OR_2 , OR_3 , OR_4 or alternatively OR_1 , OR_2 , OR_3 are methoxyl groups (King,¹⁰ 1940).

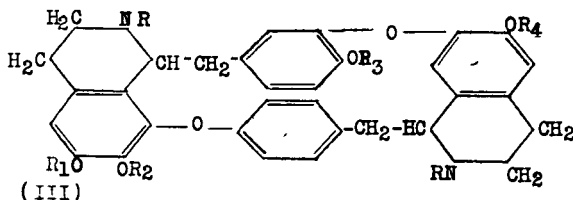

isoChondrodendrine (*isoChondodendrine*, *isoBebeerine*), $C_{36}H_{38}O_6N_2$. This alkaloid, isolated by Faltis⁹ (1912, *cf.* Scholtz,⁶ 1913), was first assigned

the formula $C_{18}H_{19}O_3N$, which was doubled by Faltis, Wrann and Kúhas.¹¹ The alkaloid has been fully characterised by King¹⁰ (1940). It crystallises from methyl alcohol in microscopic needles, m.p. 316° (*dec.*); like bebeerine, it gives a typical Millon reaction. The most characteristic salt is the sulphate $B \cdot H_2SO_4, 15H_2O$, or $B \cdot H_2SO_4, 7H_2O$, after prolonged exposure to air, m.p. $291-2^\circ$ (*dry*; *dec.*) $[\alpha]_{5461}^{20} + 115.6$ (*dry salt*; H_2O) equivalent to $[\alpha]_D + 99.7^\circ$. The hydrochloride, $B \cdot 2HCl$, crystallises in plates or rarely in needles, m.p. 333° (*dec.*) (*cf.* Scholtz,⁶ and Faltis and Neumann⁹). The methiodide, $B \cdot 2MeI, 8H_2O$, separates from methyl alcohol in short prisms, m.p. 287° (*dec.*) or from water in microscopic, double square pyramids; it has $[\alpha]_{5461}^{20} + 64.3^\circ$ (H_2O). Figures somewhat different from the foregoing have been given by Dutcher¹⁰ for the constants of the alkaloid and its salts; he also records for the base $[\alpha]_D^{22} + 120^\circ$ (N/10, HCl) or $+ 50^\circ$ (pyridine). More recently King²⁰ has recorded for the anhydrous sulphate $[\alpha]_{5461}^{19} + 158.9^\circ$ ($c = 0.7$; H_2O) equivalent to $[\alpha]_D^{19} + 137^\circ$ and in good agreement with the value $+ 135^\circ$ recorded by Faltis and Neumann⁹ for a sample of the anhydrous salt. According to Scholtz,⁶ *isochondrodendrine* forms a benzoyl derivative, m.p. 215° . On demethylation by hydrochloric acid, the alkaloid is stated to yield *isobebeeridine*, $C_{34}H_{34}O_6N_2$, microscopic yellow cubes, m.p. 240° , which gives a green colour with ferric chloride.¹²

O-dimethylisochondrodendrine has m.p. $272-3^\circ$, $[\alpha]_D - 36.8^\circ$ (EtOH), and yields a methiodide having m.p. 312° and $[\alpha]_{5461}^{20} + 1.5^\circ$ (*dry salt*; H_2O) according to King,¹⁰ while Faltis and Neumann⁹ give $[\alpha]_D^{16} - 7^\circ$ (50 per cent. EtOH). By the Hofmann method the metho-salt yields two methine bases, $C_{40}H_{46}O_6N_2$, of which the α -form is optically inactive, has m.p. $206-7^\circ$, yields a hydrochloride, m.p. 299° , and is distinguished from the dextrorotatory β -form by giving with sulphuric acid a red colour changing to blue on heating. The β -form has m.p. $167-168.5^\circ$ and $[\alpha]_D + 359^\circ$ (EtOH).⁹ The methiodides of the mixed methine bases when treated with sodium hydroxide in methyl alcohol lose trimethylamine and produce a nitrogen-free product, $C_{18}H_{16}O_3$ but later doubled to $C_{36}H_{32}O_6$, crystallising in monoclinic tablets, m.p. $> 312^\circ$. This, on oxidation with potassium permanganate, furnished an acid, $C_{12}H_5O(OMe)_2(CO_2H)_3$, m.p. $177.5-178^\circ$. Identification of this acid proved difficult, but it was eventually synthesised by Faltis and Fraendorfer¹⁴ and shown to be 2 : 3-dimethoxy-5 : 6 : 4'-tricarboxydiphenyl ether (I), and on this basis a

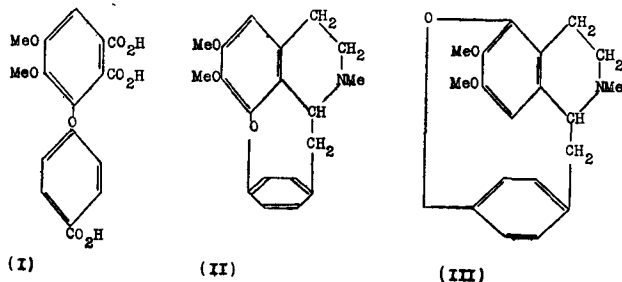

formula for the methyl ether of *isochondrodendrine*, provisionally suggested (Faltis,¹³ cf. Scholtz¹²), was modified to (II) or (III). Doubling of the empirical formula of the alkaloid led to revision, and consideration of the ways in which the two equal halves could be combined to accommodate the experimental evidence led, Faltis, Wrann and Kühas¹¹ to propose formula (IV) for *isochondrodendrine*.

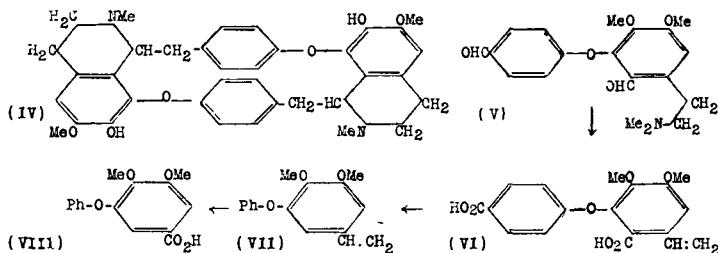

The α -methine base of the alkaloid, on ozonisation¹⁵ followed by hydrogenation of the product, furnishes 2 : 3-dimethoxy-6 : 4'-dialdehydo-5-dimethylaminoethyldiphenyl ether (V), the methochloride of which on oxidation by potassium permanganate and treatment of the product with boiling potassium hydroxide solution gives a 64 per cent. yield of 2 : 3-dimethoxy-6 : 4'-dicarboxy-5-vinyldiphenyl ether (VI), m.p. 192°, indicating that the *isochondrodendrine* molecule is composed of two identical halves (see IV). The dimethoxyvinyldiphenyl ether (VII) produced by the decarboxylation of this acid is oxidised by potassium permanganate to 2 : 3-dimethoxy-5-carboxydiphenyl ether (VIII), m.p. 161°, the constitution of which has been established by the synthesis of its methyl ester, m.p. 69°.¹⁵ King¹⁰ (1940) has pointed out that the positions of the two hydroxyl groups in *isochondrodendrine* are still unsettled, but on the evidence available one, and possibly both, should be adjacent to the ether oxygen atoms as in (IV).

Bebeerine, C₃₆H₃₈O₆N₂. This alkaloid has been described under various names, pelosine, chondrodendrine, chondodendrine and curine (*l*-form) whose origin is described elsewhere (pp. 363 and 374). It crystallises with one molecule of benzene, m.p. 161°, or 213° (solvent-free) or from methyl alcohol, m.p. 214°, and has $[\alpha]_D^{20}$ 298° (EtOH) for the *d*- or *l*-form (Scholtz⁶). Späth *et al.*¹⁶ recorded m.p. 221–221.5° (*vac.*) for both forms and $[\alpha]_D^{20} + 332^\circ$ and -328° for the *d*- and *l*-forms, in pyridine. The *dl*-isomeride has m.p. 299–300°. The hydrochloride, m.p. 271–3°, and dihydrochloride are crystalline. Späth and Kuffner¹⁸ prepared two monomethyl ethers, of which one had m.p. 206–8°, and the dimethyl ether monomethiodide, m.p. 257–8°.

It was clearly established by Scholtz⁶ that the empirical formula, C₁₈H₁₉O₃N, represented the composition of bebeerine, that on this basis the alkaloid contained one hydroxyl, one methoxyl and one methylimino group and that its behaviour with acylating agents indicated the presence of a methyltetrahydroisoquinoline nucleus. These results were confirmed

and extended by Späth *et al.*¹⁶, who developed a provisional formula of the single benzylisoquinoline type. Since 1925, when Späth and Kolbe proposed for oxyacanthine the first bisbenzylisoquinoline formula, other menispermaceous alkaloids had been assigned to that type and in 1933 King¹⁷ suggested that the simple formula, $C_{18}H_{19}O_3N$, then in use for bebeerine should be doubled and that the structure of the alkaloid was probably based on the condensation of two *norcoclaurine* molecules followed by partial methylation. In the following year Späth and Kuffner¹⁸ showed that the nitrogen-free product, $C_{36}H_{40}O_6$, m.p. 186–7° (*cf.* *O*-methylbebeeriline, *below*), obtained by the exhaustive methylation of bebeerine methyl ether under reducing conditions, yielded on oxidation by potassium permanganate 2 : 3-dimethoxy-5 : 6 : 4'-tricarboxydiphenyl ether (III : $R_1 = R_2 = Me$) which had already been obtained in like manner by Faltis and Neumann¹³ from *isochondrodendrine* (p. 366). On this result Späth and Kuffner¹⁸ suggested for bebeerine methyl ether formula (I : $R^1 = R^2 = R^3 = R^4 = Me$). This formula has been confirmed by the results of several independent investigations beginning with King's work on the relationship of bebeerine methochloride to tubocurarine chloride (p. 374). Faltis, Kadiera and Doblhammer⁹ showed that dimethylchondrodendrinemethine (*O*-methylbebeerinemethine, *see below*), on ozonisation, followed by reduction of the product, yields (a) 2 : 3-dimethoxy-6 : 4'-dicarboxy-5-vinyldiphenyl ether (V : $R_1 = R_2 = Me$), identical with that obtained from *isochondrodendrine* (p. 367) and (b) 2 : 6'-dimethoxy-5 : 3'-dicarboxy-4'-vinyldiphenyl ether (VI : $R_3 = R_4 = Me$), which on decarboxylation at C^{3'} and C⁵ followed by oxidation of the vinyl group gave 2 : 6'-dimethoxy-4'-carboxydiphenyl ether, the constitution of which was established by synthesis.

King¹⁰ (1936) showed that the nitrogen-free product (II : R_1 to $R_4 = Me$) from the Hofmann degradation of bebeerine, *viz.*, *O*-methylbebeerilene, $C_{36}H_{32}O_6$, m.p. 198–9°, on oxidation by permanganate yielded two isomeric acids, $C_{17}H_{14}O_9$, 2H₂O, and a third acid, $C_{34}H_{30}O_{16}$. The first of these proved to be the 2 : 3-dimethoxy-5 : 6 : 4'-tricarboxydiphenyl ether (III : $R_1 = R_2 = Me$) of Faltis *et al.* (p. 366), already synthesised by Faltis and Frauendorfer.¹⁴ The second isomeric acid had m.p. 262–4°, contained two methoxyl groups and on decarboxylation gave 2 : 2'-dimethoxydiphenyl ether and was therefore regarded as 2 : 2'-dimethoxy-4 : 5 : 5'-tricarboxydiphenyl ether (IV : $R_3 = R_4 = Me$). The second acid was synthesised by King¹⁰ (1939) and later by a different method by Faltis, Holzinger, Ita and Schwarz,¹⁵ who also confirmed King's results in the formation of these two acids by the oxidation of *O*-methylbebeerilene. The third and more complex acid, $C_{34}H_{30}O_{16}$, crystallises from boiling water in minute needles, m.p. 283–4°, and should have one of the structures indicated by the following linear formulæ (a) or (b) readily derivable from (II) :



These results justified the nuclear structures (I) and (II) assigned to bebeerine methyl ether and its nitrogen-free degradation product respec-

tively, but as both these substances were fully methylated there remained the problem of the orientation of the hydroxyl and methoxyl groups in bebeerine itself. From a study of the Millon reaction King¹⁰ (1937) concluded that in bebeerine one hydroxyl group was at OR₃ (formula I) and this was confirmed later by the preparation of the amorphous *O*-

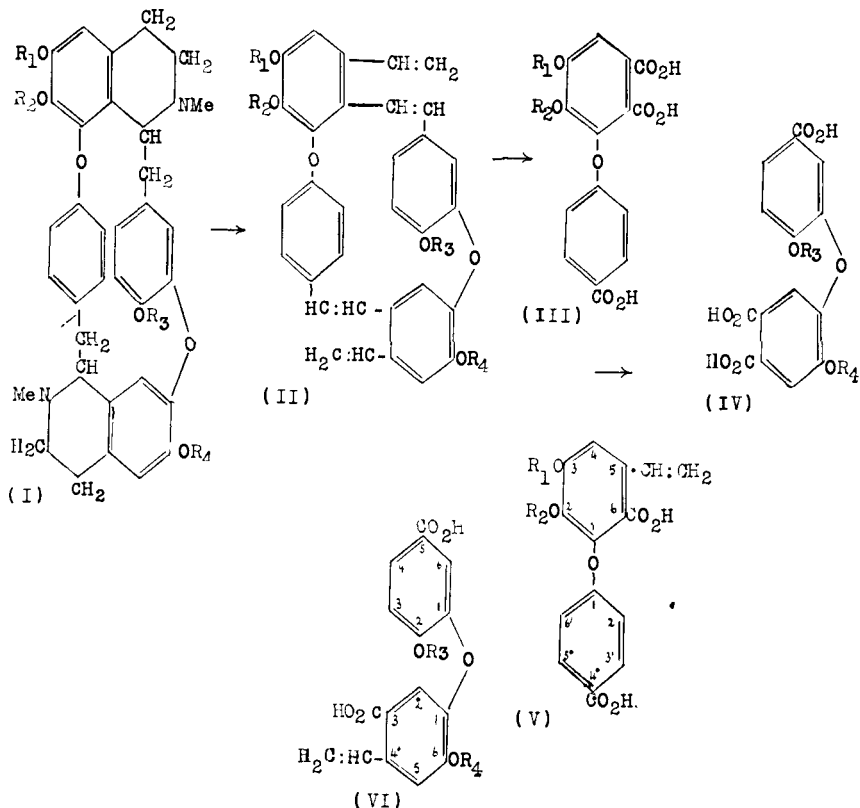

diethylbebeerine, conversion of this in succession to the dimethiodide and dimethochloride and degradation of the latter to *O*-ethylbebeerilene (II), C₃₈H₃₆O₆, m.p. 168–9°, which, like its lower homologue, *O*-methylbebeerilene, was oxidised by permanganate and gave the two analogous ethoxyacids, viz., (c) C₁₈H₁₆O₉, H₂O, m.p. 197° (*dec.*), which by comparison with a synthesised specimen proved to be 3-methoxy-2-ethoxy-5:6:4'-tricarboxyphenyl ether (III: R₂O = EtO; R₁O = MeO), and (d) C₁₈H₁₆O₉, 0.5H₂O, m.p. 255°, also identified with a synthetic specimen as 2-methoxy-2'-ethoxy-4:5:5'-tricarboxyphenyl ether (IV: OR₄ = MeO; OR₃ = EtO).

These results show that bebeerine is represented by (I: R₂ = R₃ = H and R₁ = R₄ = Me). See also curine (*l*-bebeerine), dealt with as a curare alkaloid (p. 374).

Insularine, $C_{37}H_{38}O_6N_2$. An alkaloid obtained by Kondo and Yano¹⁹ from *Cissampelos insularis*, Makino (Japanese "Pareira brava"), along with base B, m.p. 240°, eventually identified as isochondrodendrine methyl ether (p. 366). Insularine, also found in *C. ochiaiana*, Yamamoto, is amorphous, yellow in colour, and yields amorphous salts. The dimethiodide is crystalline, decomposes from 300°, and has $[\alpha]_D^{17} + 27.95^\circ$. Three methoxyl and two methylimino-groups are present; the remaining oxygen atoms are assumed to occur in ether linkages. In 1943 five papers dealing with the degradation products of insularine were published in Japan by Tomita and Uyeo,¹⁹ abstracts of which have become available. The source of the alkaloid is now given as *Cyclea insularis*. Hofman degradation of the methochloride ended with a nitrogen-free product, $C_{36}H_{30}O_6$, m.p. 208°, which hydrogenated to $C_{36}H_{38}O_6$, m.p. 209–11°, and on ozonisation produced formaldehyde and a reaction mixture, which on further oxidation by potassium permanganate yielded three products: (1) 2:3-dimethoxy-4':5:6-tricarbomethoxydiphenyl ether; (2) dimethyl 4-methoxyisophthalate, and (3) insularinic acid, $C_{17}H_{12}O_9$, m.p. 331°, which on sublimation forms an anhydride, $C_{17}H_{10}O_8$, m.p. 326°. Methyl insularinate, m.p. 127–8°, on hydrogenation gave two products, (a) $C_{11}H_{12}O_7$, m.p. 113–4°, which diazomethane converted into 3:4:5-trimethoxyphthalic acid, m.p. 144°, and (b) a substance believed to be methyl hexahydro-toluolate. Insularinic acid heated with hydrogen bromide in acetic acid at 130–5° in a sealed tube and the product hydrogenated, gave a crystalline substance converted by diazomethane into an oil, which on saponification furnished 4-(2:3-dimethoxy-5-carboxyphenoxy)-3-methylbenzoic acid, m.p. 233–5°, identified by comparison with the synthetic product. On the basis of these and other results insularine is assumed to be represented by a formula of the general isochondrodendrine type (p. 379) with a change in the top right corner indicated by the following partial formulæ:

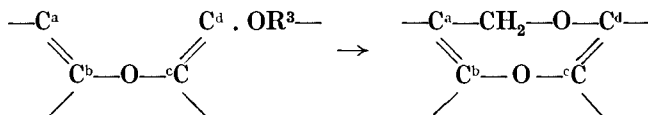

i.e., the $\cdot\text{OR}^3$ group of C^d is replaced by one end of an inserted chain $\text{---CH}_2\text{---O---}$, which now joins C^d to C^a .

REFERENCES

- (1) *Annalen*, 1843, 48, 106. (2) *Jahresb.*, 1860, 548. (3) *Jahresb. Berz.*, 1830, 11, 245. (4) *Pharm. J.*, 1869–70, [ii], 11, 192. (5) *Annalen*, 1840, 33, 81; *cf. Pharmacographia* by FLÜCKIGER and HANBURY, London, 1879, p. 29. (6) *Ber.*, 1896, 29, 2054; *Arch. Pharm.*, 1898, 236, 530; 1899, 237, 199; 1906, 244, 555; 1911, 249, 408; 1913, 251, 136; (with KOCH), 1914, 252, 513. (7) *Pharm. J.*, 1869–70, [ii], 11, 19. (8) *Gazzetta*, 1883, 13, 249; *Ber.*, 1884, 17, 2655. (9) *Monats.*, 1912, 33, 873; (with NEUMANN), *ibid.*, 1921, 42, 311; (with KADIERA and DOBLHAMMER), *Ber.*, 1936, 69, 1271. (10) KING, *J. Chem. Soc.*, 1935, 1381; 1936, 1276; 1937, 1481; 1939, 1157; 1940, 737; *cf. KRUKOFF and MOLDENKE, Brittonia*, 1938, 3, 15; DUTCHER, *J. Amer. Chem. Soc.*, 1946, 68, 419; BRAZIL *et al.*, *Chem. Abstr.*, 1945, 39, 3061. (11) *Annalen*, 1932, 497, 69. (12) SCHOLTZ, *Arch. Pharm.*, 1915, 253, 622. (13) SCHOLTZ

and KOCH, *ibid.*, 1914, 252, 513; FALTIS and NEUMANN, *Monats.*, 1921, 42, 311. (14) FALTIS (with TROLLER), *Ber.*, 1928, 61, 345; (with ZWERINA and ATTIA), *ibid.*, 1929, 62, 1034; (with FRAUENDORFER), *ibid.*, 1930, 63, 806. (15) FALTIS (with DIETRICH, *ibid.*, 1934, 67, 231; (with HOLZINGER, ITA and SCHWARZ), *ibid.*, 1941, 74, 79. (16) *Ibid.*, 1928, 61; 1698. (17) *Chem. Soc. Ann. Rep.*, 1933, 30, 249. (18) *Ber.*, 1934, 67, 55. (19) *J. Pharm. Soc. Japan*, 1927, No. 548, 107; *Arch. Pharm.*, 1936, 274, 76; (with Tomita and Uyeo) *Ber.*, 1937, 70, 1890; *J. Chem. Soc. Jap.*, 1943, 64, 64, 70, 77, 142, 147 (*Chem. Abstr.*, 1947, 41, 3803). (20) *J. Chem. Soc.* 1948, in the press.

ALKALOIDS OF CURARE

Curare, also written urari, ourari, woorari or woorali, is a phonetic rendering of an Amazonian Indian name given to a group of plant extracts prepared for use as arrow-poisons by natives in remote regions of the Orinoco and Amazon valleys. There is an extensive literature¹ recording travellers' descriptions of the preparation of curare, and information regarding the botanical origin of the components of the drug. It is clear that the plants used vary in different districts, and that the belief commonly held until recently that the active components of the drug are derived from various S. American *Strychnos* spp. is not generally true. The chemical evidence indicates that the alkaloids of two varieties of curare are of the type found in menispermaceous plants, and the critical summary of botanical evidence provided by King² (1937) for pot curare supported this view, though it did not exclude the possibility that *Strychnos* spp. might be ingredients in some preparations.

Since 1937 much more evidence has been published regarding menispermaceous plants as sources of the active components of curare. It should be understood that some of the plants used in preparing the drug are now known not to contain curarising components, and evidence by travellers that a particular plant is used, needs to be supplemented by chemical and pharmacological evidence that the plant in question does contain active constituents. After a critical survey of the literature and herbarium material available, Krukoff and Moldenke¹ conclude that there is clear evidence that the following menispermaceous species are used in the preparation of curare:—

Abuta imene (Mart) Eichl.; *A. rufescens* Aubl.

Chondrodendron candicans (L. C. Rich.) Sandw.; *C. iquitatum* Diels;

C. limacifolium (Diels) Mold.; *C. polyanthum* Diels; *C. tomentosum*, Ruiz and Pavon.

Telitoxicum minutiflorum (Diels) Mold.; *T. peruvianum* Mold.

Of these authenticated species, *Chondrodendron candicans* and *C. tomentosum* have been examined by King (pp. 364, 376) and the results of work by Wintersteiner and Dutcher and by King on curares described as made from *C. tomentosum* are given below.

According to Folkers and Unna,^{3(a)} the Peruvian chazuta curare (bamboo type) is made from *C. tomentosum* R. and P., *Annona ambotay* Aubl., *Aristolochia rumicifolia* Mart. and Zucc. and an unidentified plant which is neither a menisperm nor a *Strychnos*. Of these four the first was

markedly active and the third active in large doses. Of four other plants tested at the same time *C. limacifolium* proved inactive, *Telitoxicum minutiflorum* active in large doses, *Elissarrhena grandiflora* active and *Strychnos cogens* Benth. inactive. King² (1948) has shown recently that the stems of *Anomospermum grandiflorum* Eichl. (synonym *Elissarrhena grandiflora*) contain non-quaternary alkaloids and also yield a quaternary fraction exerting a true curare action. In a preliminary study of botanical material collected by Krukoff and Smith^{3(b)} in Brazilian Amazonia, Folkers^(3c) found that out of ten plant species used by the Tecuna Indians three contained curarising components, *Strychnos Castelnæi* Wedd (S. Castelneana Baill.); *S. toxifera* Schomb. and a third *Strychnos* sp., allied to *S. Peckii*, while two, *Chondrodendron limacifolium* and *Telitoxicum minutiflorum* were doubtful. Of twelve other species used by the Javas, nine gave negative results, the active species being *Strychnos Jobertiana* Baill, a second *Strychnos* sp. allied to *S. diaboli* Sandw. and *Capparis sola*, Macbride; the last-named plant is a surprising addition to possible sources of curare, belonging to the botanical family Capparidaceæ. In this connection it is of interest to note that A. J. Henry^{3(d)} of the Sudan Medical Service has recently isolated tetramethylammonium iodide from *Courbonia virgata* A. Brogn., also of this botanical family.

According to Vellard,^{3(d)} a *Strychnos* sp. similar to *S. medeola* is used by the Nambikwaras. Brasil, Campos and Kuhlmann^{3(e)} have mentioned three S. American species of *Strychnos*, viz., *S. diplinerva*, *S. aff. albiflora* Prog and *S. brevifolia* A.D.C., in which, using extracts of the roots in comparison with Tecuna curare, they have found curarising activity by pharmacological tests in rabbits.

There are also on record a number of other observations regarding S. American plants believed to be associated with this drug, e.g., Freise⁴ has given preliminary descriptions of alkaloids isolated from the following species:—

- (a) Undetermined *Strychnos* sp. : old bark; *eurcarine*, $C_{20}H_{23}ON_2$, m.p. 135–144°; 0.13 mgm. per kilo toxic to frogs. Young bark; a base, $C_{23}H_{28}O_4N_2$, resembling vellosine (p. 736).
- (b) *Macoubea guyanensis*. *Macoubeine*, $C_{22}H_{26}O_2N_2$, $4H_2O$, needles, sublimes > 195°, $[\alpha]_D - 55.5^\circ$ (EtOH); 0.05 to 0.1 mgm. per kilo. toxic to various animal species.
- (c) *Trymatococcus amazonicus*. *Base*, m.p. 204°, $[\alpha]_D - 55.6^\circ$.
- (d) *Elissarrhena grandiflora*. *Base*, $C_{22}H_{28}O_4N_2$, H_2O , sublimes at 185°.
- (e) *Elæophora abutifolia*. *Base*, resembling cytisine (p. 142).

By fractionation of an extract of the bark of *Strychnos lethalis* Barb., Carneiro⁵ has obtained two products, *strychnolethaline*, $C_{22}H_{27}O_4N$, and *curaletaline*, $C_{25}H_{31}O_7N$, which he has also isolated from samples of curare.

In view of increasing interest in the medical applications of curare attention is being given to the elimination of inert material and the provision of a more uniform product.⁶ Of primary importance in this

connection is the estimation of the curarising potency of samples of the drug. This has usually been done by biological methods but chemical methods for the estimation of the potent constituents are beginning to be developed.

Three kinds of curare have appeared in European commerce, distinguished by the kind of container in which they are packed.

Para, Tube or Bamboo Curare. This variety was packed in sections of bamboo, but this almost traditional information needs modification since "tube curare" became a commercial article. It is now a viscous, solid or even powdered extract, exported in sealed tins. In view of the relationship established between bebeerine, curine, and tubocurarine, the active alkaloid of this variety of curare, the suggestion was made, first by Späth, Leithe and Ladeck,⁷ and more definitely by King⁸ that its botanical source should be sought among the Brazilian Menispermaceæ, and as shown later the search for the source of the *d*-tubocurarine found in this variety of curare has been narrowed down to *Chondrodendron tomentosum*, or possibly a closely related species liable to be confused with it.

Pot Curare. This was exported in small brown or greyish-brown earthenware pots. It is no longer available commercially, but a specimen collected in 1929 in the Ticuna Indian country between the Rio Iça and the Rio Solimoes on the border between Ecuador and Brazil, was examined pharmacologically by Santesson,⁹ whose results are referred to later. Another specimen from the Amazon region has been examined by King,² whose results indicate that the active alkaloids are of menispermaceous origin, though he pointed out that the bark of *Strychnos Castelnæi* Wedd. contains amorphous, quaternary alkaloid with a strong curare action, so that pot curare may sometimes, or in some districts, be made from this *Strychnos* spp. as suggested by Boehm.⁶

Gourd or Calabash Curare. This type, exported in small gourds, is said to be made from *Strychnos toxifera* Schomb., and this was confirmed by King,¹¹ who isolated from botanically authenticated material collected in British Guiana, an amorphous, quaternary alkaloid indistinguishable from curarine prepared from gourd curare, and Wieland *et al.* have isolated from this species alkaloids which they have also found in this type of curare. Other *Strychnos* spp. from the same territory examined by King contained alkaloids, but not of the curarine type.

Curare was first examined by Roulin and Boussingalt,¹² who isolated a syrupy body, which they named curarine; much later a similar substance was obtained by Buchner,¹³ and in 1865 Preyer¹⁴ announced that he had obtained curarine and its salts in a well-crystallised condition, and by analysis of the platinichloride, ascertained its composition to be $C_{10}H_{35}N$. Sachs¹⁵ was only able to obtain an amorphous alkaloid, to which he assigned the formula $C_{18}H_{35}N$. The work of Boehm¹⁶ explained to some extent these discrepant results; he examined all three varieties and showed that they differed in composition, and that the isolation of the various "curarines" as single substances required special processes.

ALKALOIDS OF PARA, TUBE, OR BAMBOO CURARE. From this variety,

which usually contains quercitol, Boehm isolated the well-crystallised alkaloid *curine*, and the highly toxic but amorphous *paracurarine* or *tubocurarine*. Boehm's process has been improved by King,⁸ who first obtained crystalline tubocurarine chloride.

Curine, *l-Bebeerine* (p. 363), $C_{38}H_{38}O_6N_2$. Boehm¹⁶ assigned to the alkaloid the formula, $C_{18}H_{19}O_3N$, which was doubled by Späth and Kuffner.¹³ The characters, reactions and constitution of the alkaloid are dealt with under bebeerine (p. 367) of which it is the *lævo*-isomeride, but in view of Boehm's pioneer work it is of interest to mention that he made a number of observations bearing on the constitution of curine; he recorded the presence of methoxyl, noted that it must contain a phenolic hydroxyl group and prepared an amorphous *O*-methyl ether. On fusion with potassium hydroxide protocatechuic acid was formed, and on dry distillation, alone or with zinc dust or soda-lime, a product believed to be the methyl ether of *p*-hydroxyquinoline was obtained along with trimethylamine. Boehm also prepared a crystalline curine methiodide, m.p. 252–3°, and converted this into the amorphous ammonium base, which he stated had the characteristic pharmacological action of tubocurarine.

Tubocurarine chloride, $C_{38}H_{41}O_6N_2Cl_2 \cdot 5H_2O$. Though Boehm was successful in obtaining a potent "tubocurarine," he was unable to prepare it or any of its derivatives in a crystalline condition, and this was first achieved by King,⁸ who obtained tubocurarine chloride in microscopic leaflets, m.p. 274–5° (*dec.*), $[\alpha]_{5461}^{20} + 264 \cdot 8^\circ$ (dry salt, H_2O). A saturated aqueous solution gives a weak green colour with ferric chloride. Addition of solid sodium hydrogen carbonate to a saturated aqueous solution of the chloride causes the gradual precipitation of the phenolic betaine as a granular powder. On treatment with methyl iodide in presence of methyl alcoholic potash *O*-dimethyltubocurarine iodide, $C_{40}H_{48}O_6N_2I_2 \cdot 3H_2O$, was obtained, crystallising from water in tablets, m.p. 267° (*dec.*), $[\alpha]_{5461} + 188 \cdot 7^\circ$ (dry salt, H_2O). *d*-Tubocurarine chloride has also been isolated and described by Dutcher.⁸ The recognition of this substance as the active agent in tube curare and the resulting commercial production has made it possible to consider replacement of the biological methods used for estimating the potency of this drug by methods depending on the separation of *d*-tubocurarine chloride from associated alkaloids and its measurement by observation of physical or chemical properties. Foster^{8(a)} has devised two methods, polarimetric and colorimetric, on this basis, which can be used for the estimation of the pure alkaloidal chloride in solutions for injection and are at least of value as a means of rapidly evaluating samples of curare for the manufacture of tubocurarine. Foster and Turner^{8(a)} have also recorded the yields, which varied from 2.26 to 7.35 per cent., obtained by King's process from twelve samples of curare; of two other samples one yielded none and the other provided 1.34 per cent. of a crystalline *lævorotatory* chloride, which on analysis did not seem to be *l*-tubocurarine chloride.

Constitution. Tubocurarine chloride and curine methochloride (*l*-bebeerine methochloride) are isomeric, and though possessing rotations of

different signs, are not enantiomorphous. Their relationship was established by King⁸ in the following way. When *d*-beberine is completely methylated it furnishes amorphous *O*-dimethylbeberine methosalts, of which the methochloride on degradation by Hofmann's method gave a mixture of three methine bases separable as their crystalline methiodides:—

(A) m.p. 234°, $[\alpha] \pm 0^\circ$; (B) m.p. 230° $[\alpha] \pm 0^\circ$; (C) m.p. 190°; $[\alpha]_{5461} + 108^\circ$ (MeOH).

In the second stage of the degradation the three *O*-dimethylbeberine-methine methochlorides gave trimethylamine and a nitrogen-free substance, $C_{36}H_{32}O_6$, m.p. 198–9°, named *O*-dimethylbeberilene.

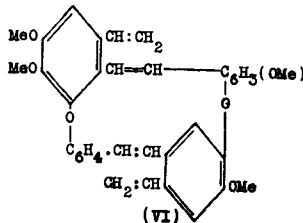
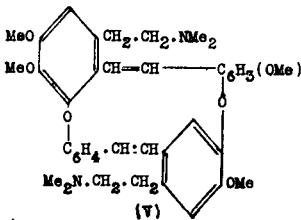
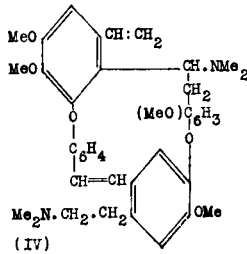
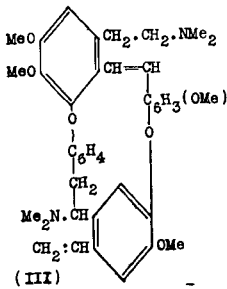
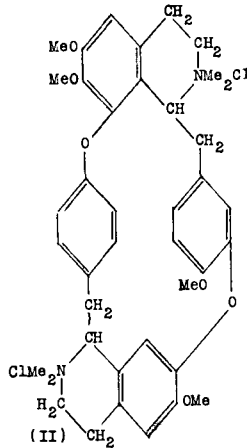
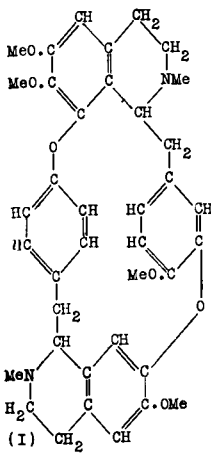

O-dimethyltubocurarine chloride gave in the first stage of the Hofmann degradation a mixture of methine bases separable into four methine methiodides, three of which were identical with the three *O*-dimethylbebeerinemethine methiodides referred to above. The fourth, *l*-*O*-dimethyltubocurarinemethine methiodide (D) occurs in a stable form, aggregates of plates, m.p. 178–80°, and as a less stable form, m.p. 171–2°, $[\alpha]_{5461} - 56.9^\circ$ (MeOH). The mixed *O*-dimethyltubocurarinemethine methochlorides in the second stage of the Hofmann degradation also gave trimethylamine and *O*-dimethylbebeerilene, the characters and constitution of which are dealt with under bebeerine (p. 368). On the basis of formula (I) for *O*-dimethylcurine (*O*-dimethyl-*l*-bebeerine as already discussed), *O*-dimethylbebeerine methochloride and *O*-dimethyltubocurarine chloride will be represented by (II), in which there are two asymmetric carbon atoms adjacent to the nitrogen atoms, so that there will be four optically active forms, two *dextro*- and two *laevo*-. Each of these four active forms can give rise to four different methines depending on which side of the nitrogen atom scission of the heterocyclic ring takes place. In each case there will be three methine bases, two of which being optically active are represented by the condensed formulæ (III and IV), and one inactive base represented by (V). If it be assumed that in *O*-dimethylbebeerine methochloride each centre of asymmetry is dextrorotatory, and that in *O*-dimethyltubocurarine chloride, one centre is *dextro*- and the other *laevo*- rotatory, then the same *d*-methine methiodide, m.p. 190° (C above), can only be produced from both if the dimethiodide derived from (III) or (IV) retains the common *dextro*- centre of asymmetry, and the fourth (D) methine methiodide yielded only by *O*-dimethyltubocurarine chloride must arise from (IV) or (III) in which the *laevo*- centre of asymmetry is preserved. The inactive methine methiodides derived from (V), of which there are two, are probably *cis* and *trans* forms about one or both of the ethylenic linkages. The non-nitrogenous end product of the Hofmann degradation, *O*-dimethylbebeerilene, is represented by (VI, cf. II, p. 369).

Tubocurarine chloride contains, like bebeerine, two phenolic hydroxyl groups. On the basis of the Millon reaction one of these is on the central benzene ring (OR₃ in I, p. 369), and in a paper published since the foregoing account was written, King has shown that *d*-tubocurarine chloride, on conversion into the *O*-diethyl ether and submission of this to a two-stage Hofmann degradation, yields the nitrogen-free *O*-ethylbebeerilene, C₃₈H₃₈O₆, m.p. 167–8°, identical with that obtained from *d*-bebeerine. The distribution of hydroxyl and methoxyl groups in *d*-tubocurarine chloride must therefore be the same as in *d*-bebeerine (I, p. 369, with R₂ = R₃ = H) and as already stated the difference between the two completely methylated alkaloids is due to diastereoisomerism (King, 1939, 1948).⁸

ALKALOIDS OF *Chondrodendron tomentosum*. Dutcher¹⁸ has examined a curare prepared by Indians of the Upper Amazon, in which the only plant used was *Chondrodendron tomentosum*, Ruiz and Pavon. From it he isolated the known alkaloids, *d*-isochondrodendrine (p. 365), *d*-isochondro-

dendrine dimethyl ether (p. 366), *d*-tubocurarine chloride (p. 374), *l*-curine and a new alkaloid, chondrocurine or chondocurine.

d-**Chondocurine** (*d*-chondrocurine), $C_{36}H_{38}O_6N_2$, m.p. 232–4°, $[\alpha]_D^{24} + 200^\circ$ (N/10 HCl) or + 105° (pyridine), yields a hydrochloride, m.p. 280–2°, and a sulphate, B, $H_2SO_4, 4H_2O$, m.p. 263–5° (*dec.*), $[\alpha]_D^{24} + 193^\circ$ (dry salt; H_2O), and in methyl alcohol gives a pink colour with ferric chloride. The hydrochloride in aqueous solution shows a positive Millon reaction after standing a few minutes. The dimethiodide (*d*-chondrocurarine iodide), $C_{38}H_{44}O_6N_2I_2$, m.p. 275 (*dec.*), $[\alpha]_D^{24} + 184^\circ$ (MeOH), is convertible into an amorphous dimethochloride, $[\alpha]_D^{24} + 175$, which is not identical with *d*-tubocurarine chloride. On complete methylation by methyl iodide in presence of potassium hydroxide in methyl alcohol, chondrocurine yields *d*-*O*-dimethylchondrocurine dimethiodide, m.p. 266°, $[\alpha]_D^{24} + 160^\circ$ (H_2O), identical with *d*-*O*-dimethyltubocurarine iodide. Chondrocurine is therefore not identical with the tertiary base corresponding to tubocurarine, but like it belongs to the bebeerine series represented by the general formula (I, p. 369). Its quaternary base *d*-chondrocurarine therefore has the same structure and configuration as tubocurarine, and has one of its two phenolic hydroxyls in the same position as tubocurarine, *i.e.*, OR_3 in the formula (p. 378). The other is either OR_1 or OR_2 , the alternative position in either case being that of the phenolic hydroxyl in tubocurarine.

These results seemed to establish with certainty that the active component of tube curare is derived from *Chondrodendron tomentosum*, but the matter again became doubtful when King¹⁸ reported that in the stems of a carefully authenticated specimen of the plant, collected at Tarapoto in Peru, he had found *l*-curine and *l*-tubocurarine chloride. This is the first recorded natural occurrence of the latter and seems to indicate either that the alkaloidal components of the plant are not constant in character, or that the botanical description of *Chondrodendron tomentosum* covers two species containing the *dextro*- and *laevo*- quaternary alkaloids respectively.

King² has pointed out (1948) that this position is like that obtaining when "pareira brava" sometimes yielded *d*- and sometimes *l*-bebeerine for which an explanation was found in the collection of the drug from two different species, *Chondrodendron microphyllum* and *C. platyphyllum* respectively. The need for a similar botanical investigation of the supposed *C. tomentosum* is emphasised by further results recorded by King, who has examined (1) commercial curare made from the stems of a bush-rope collected along the Madre de Dios river in the Cuzco Province of Peru and (2) stems and leaves of a bush-rope collected at Sisa in Tarapoto and said to be used by the natives to make arrow poison. In both these materials the leaves of the plants used were botanically examined and certified to be indistinguishable from the leaves of *C. tomentosum*. The commercial curare (1) yielded the same alkaloids as Dutcher found in his specimen of curare, and the other material (2) gave *d*-tubocurarine chloride, *l*-bebeerine (curine), *d*-chondrocurine, *d*-isochondrodendrine and a minute quantity of a new alkaloid *d*-*tomentocurine*.

The latter is a microcrystalline powder, m.p. 265° (*efferv.*), $[\alpha]_D^{17} + 210^{\circ}$ (N/10 HCl), gives a Millon reaction and like all the phenolic alkaloids of this group is readily oxidised by nitric acid.

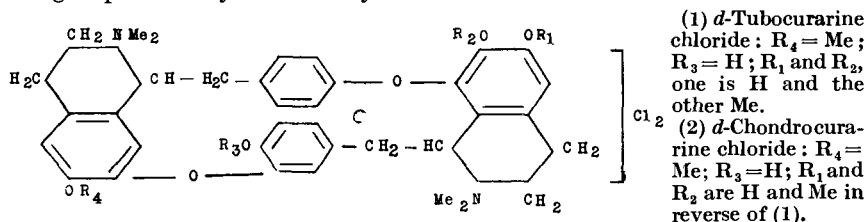

ALKALOIDS OF POT CURARE. This variety of curare is a dark brown, comparatively dry extract. According to Boehm,¹⁶ it contains *protocurine*, colourless hair-like needles, m.p. 306° (*dec.*), a base of low toxicity and yielding crystalline salts. A second alkaloid of similar type is *protocuridine* prisms, m.p. $274-6^{\circ}$, sparingly soluble in all ordinary solvents. The poisonous constituent is *protocurarine*, a red powder, easily soluble in water, and giving characteristic colour reactions with nitric acid and with oxidising agents in sulphuric acid, this latter reaction indicating a *Strychnos* spp. as a possible botanical source.

The specimen examined by King² contained a mixture of alkaloids, which was partially separated by a special process into (a) "non-quaternary" bases, and (b) "quaternary" bases. From the former, which was a mixture of phenolic alkaloids, Boehm's *protocuridine* and a new isomeride of this, *neoprotocuridine*, were isolated.

Protocuridine, $\text{C}_{36}\text{H}_{38}\text{O}_6\text{N}_2$. This base was freed from associated *neoprotocuridine* by crystallisation of the hydrochlorides from water, in which *neoprotocuridine* hydrochloride is sparingly soluble. Protocuridine base was obtained by the addition of sodium bicarbonate to the hydrochloride in water the amorphous precipitate formed, changing into tablets on standing. It was re-crystallised by adding water dropwise to a solution in boiling pyridine when it separated in plates, $\text{C}_{36}\text{H}_{38}\text{O}_6\text{N}_2 \cdot 0.5\text{C}_5\text{H}_5\text{N}$, m.p. 295° . The hydrochloride, $\text{B} \cdot 2\text{HCl} \cdot 6\text{H}_2\text{O}$, crystallises in octahedra, m.p. 295° (*efferv.*), $[\alpha]_{5461}^{20} + 7.6^{\circ}$ (dry salt: H_2O). The sulphate forms pointed tablets, and the platinichloride compact, anisotropic tablets.

Protocuridine contains two phenolic hydroxyl and two methoxyl groups and gives a typical Millon reaction. On methylation it yields *O*-dimethylprotocuridine dimethiodide, $\text{C}_{36}\text{H}_{36}\text{O}_4\text{N}_2$, $(\text{OMe})_2(\text{MeI})_2$, cream-coloured needles, m.p. 318° (*dec.*), which King⁸ (1940) has compared with the dimethiodide of *isochondrodendrine* dimethyl ether (p. 366), m.p. 312° , and finds that they are probably identical. On this basis he suggests for protocuridine a formula (*see* p. 379) of the *isochondrodendrine* type. One phenolic hydroxyl must be at OR_2 ; the site of the second is still unknown.

neoProtocuridine, $\text{C}_{36}\text{H}_{38}\text{O}_6\text{N}_2 \cdot 8\text{H}_2\text{O}$. The base was prepared by mixing an aqueous solution of the hydrochloride, with a saturated solution of sodium bicarbonate. The mixture, on standing, gave a crop of base, which was recrystallised from boiling water, and formed diamond-shaped

leaflets, m.p. 232° (*dec.*). The hydrochloride, B. 2HCl (6 or 7 H₂O), separates from water in microscopic prisms or, when crystallised slowly, in large prisms or plates, and does not melt up to 310°. In very dilute solutions it gives a crystalline nitrate on addition of nitric acid. The sulphate forms rhomb-shaped leaflets, and is optically inactive. *O*-Methylneoprotocuridine methiodide, C₄₀H₄₈O₆N₂I₂, crystallises from boiling water in microscopic rhombs, unmelted at 300°, and yields by the Hofmann degradation process a crystalline methine base whose methiodide is indistinguishable from inactive α -*O*-methylisochondrodendrinemethine methiodide (p. 366). Both are unmelted at 320°, form the characteristic, sparingly soluble nitrate, and give with sulphuric acid the specific colour reaction, cherry-red changing to blue on warming.

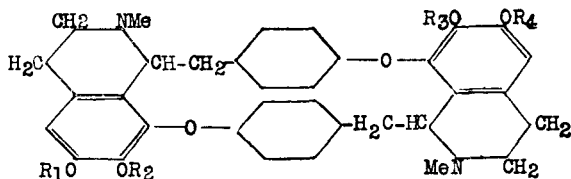

i-isochondrodendrine (R₂ or R₃ = H).

d-Protocuridine (R₂ or R₃ = H).

i-neoprotocuridine (R₁-R₄=H; R₂=R₃=Me)..

The location of the second .OH group
in the first two is uncertain.

*neo*Protocuridine does not show the Millon reaction ; it can therefore be represented by the general *isochondrodendrine* type of formula (*see above*) in which R₁ and R₄ are H and R₂ and R₃ are Me or *vice versa* (*cf.* IV, p. 367).

The "quaternary fraction" of pot curare, after the removal of some *neoprotocuridine*, was separated into a portion salted out by sodium bicarbonate, and a portion not so precipitated. The latter was fractionated on a plan described in the original, the most active product obtained being an amorphous iodide with a paralyzing dose of 1.5 mg. per kilo frog. This iodide was phenolic, gave the Millon reaction, but no strychnine-like reaction with bichromate and sulphuric acid. No crystalline product could be isolated, but on complete methylation certain of the fractions yielded crystalline methiodides as follows :—

- (A) C₂₀H₂₅O₈N₂I₂, anisotropic, spheroidal crystals, m.p. 260° (*dec.*), almost insoluble in all solvents ;
- (B) C₁₈(or C₁₇)H₂₂O₂N₂I, cream-coloured needles, m.p. 318°, which resembles *O*-methylprotocuridine methiodide, and does not depress the melting-point of the latter ;
- (C) Anisotropic nodules, unmelted at 295°, and sparingly soluble,

These results indicate that this specimen of pot curare was of menispermaceous origin.

ALKALOIDS OF GOURD OR CALABASH CURARE. The toxic constituent of this form, as prepared by Boehm,¹⁶ was an amorphous curarine to which the formula $C_{19}H_{26}ON_2$ was assigned. Gourd curare has been investigated in recent years by Wieland *et al.*¹⁹ and by Schmid and Karrer.^{19(a)}

The process of isolation finally adopted by the former authors consists in precipitating as reineckates the water-soluble bases contained in a methyl alcoholic extract of the curare. The mixed reineckates are further purified, by solution in acetone and precipitation with water as often as may be necessary. The product so cleaned represents the bulk of the biological activity of the crude drug; the mother liquors may contain curine (p. 374), which indicates a menisperm as one of the components of such curares. The mixed reineckates are then fractionated chromatographically over alumina and the components isolated as chlorides by the use of silver sulphate and barium chloride in succession. This process has been modified in detail by Schmid and Karrer, who have also found that with their curare, the more soluble reineckate fraction includes less potent quaternary alkaloids.

The material first used by Wieland *et al.* was gourd curare from the middle Orinoco district, near Urbana, in Bolivar State, Venezuela, but in the fourth paper (1941) results are recorded for curares from Colombia and Venezuela, for which more precise details of origin are not available and there is considerable difference in the nature and quantity of the alkaloids in the various samples used. An examination has also been made of the bark of *Strychnos toxifera*, and one of the alkaloids (toxiferine II) it contains has been found in some of the curares examined. In all, ten alkaloids have been obtained and characterised and, with the exception of curine, they are all of quaternary type. They are named toxiferine, dihydrotoxiferine, or calabash-curarine (shortened to C-curarine in practice) according to type, and the variants within the type are distinguished by numbers, or numbers and letters, *e.g.*, toxiferine I, toxiferine IIb.

Calabash curare, probably from the middle Orinoco region, has also been investigated by Karrer and Schmid,^{19(a)} who have isolated eight new alkaloids in addition to Wieland's C-curarine I.

The following three products were obtained by Wieland *et al.* from the early samples of curare from Urbana.

Calabash-curarine I. This alkaloid was first named toxiferine (1937), as it was expected to be found in *Strychnos toxifera* bark; when this bark yielded a different alkaloid, for which the name toxiferine was more appropriate, the name of the curare alkaloid was changed. Crystalline salts have been prepared of which the chloride; $C_{20}H_{23}ON_2Cl$ or $C_{20}H_{21}N_2Cl, H_2O$, colourless needles, m.p. $>350^\circ$, $[\alpha]_D +70-73^\circ$, and the aurichloride, $C_{20}H_{23}ON_2, AuCl_4$, m.p. $223-4^\circ$, have been analysed. Alternative formulæ are quoted for the chloride as it is still uncertain whether a molecule of water is, or is not, present as water of crystallation. If moistened with

ether and dried *in vacuo* the composition is $C_{20}H_{23}ON_2Cl$, but if left *in vacuo* till the weight is constant, it becomes $C_{20}H_{21}N_2Cl$. Dried at 100° the ionic chlorine is largely transformed to combination with carbon. The iodide, $C_{20}H_{23}ON_2I$, m.p. $>320^\circ$, on the contrary, remains unchanged at 150° *in vacuo*. The picrate has m.p. $>300^\circ$. C-curarine I is slowly decomposed in acid media; in strong hydrochloric acid it assumes a deep violet colour, which is discharged on dilution with water. On treatment with potassium hydroxide in methyl alcohol at 150° the chloride is converted into an ether-base, $C_{40}H_{42}ON_4$, m.p. 184° . This yields a dimethiodide, m.p. 300° , not amenable to Hofmann degradation. At 200° the base changes to an isomeride, m.p. $>300^\circ$. It is reduced by sodium in amyl alcohol to a tetrahydride, $C_{40}H_{46}ON_4$, m.p. $105-10^\circ$ (*dec.*) and this or the initial base is catalytically hydrogenated to an octahydride, $C_{40}H_{50}ON_4$, m.p. $90-5^\circ$. C-curarine I chloride is converted by bromine water into C-bromocurarine I chloride $C_{20}H_{20}N_2BrCl$, $2H_2O$, characterised by its high potency and this in turn is transformed by silver oxide and barium hydroxide into the bromo-ether-base, $C_{40}H_{40}ON_4Br_2$, which is inactive. C-nitrocuararine I nitrate, $C_{20}H_{20}O_2N_3$, NO_3 , $0.5H_2O$, obtained by the action of nitric acid on C-curarine I chloride is 20 times as active as the initial curare base.

Karrer and Schmid^{19(a)} found C-curarine I the chief component of their curare and have confirmed and extended Wieland's observations on this substance. C-curarine I chloride yields a crystalline *N*-nitroso-derivative, $C_{20}H_{20}ON_3Cl$, $3H_2O$, and when heated at 300° *in vacuo* ($<10^{-4}$ mm.) loses methyl chloride and forms *nor*-C-curarine I, $C_{19}H_{18}N_2$, obtained finally as a snow-white powder, yielding a crystalline hydrochloride, $B \cdot HCl \cdot H_2O$, m.p. $>300^\circ$, and a picrate, m.p. $>320^\circ$. A methiodide, $B \cdot MeI \cdot H_2O$, and methochloride, $C_{20}H_{21}N_2Cl$, were also prepared and had the same crystalline form as C-curarine I iodide and chloride respectively, gave the same colour reactions as C-curarine chloride and the two chlorides agreed in absorption spectra and in curarising potency. The picrate prepared from *nor*-C-curarine methiodide had m.p. $308-9^\circ$ (*dec.*) and, when used to seed a solution of C-curarine I picrate, induced the latter to crystallise in the same form, small needles, instead of the platelets, m.p. $306-7^\circ$ (*dec.*), previously obtained. In view of the identity of these salts it seems clear that the *nor*-base is formed without further change in the structure of the molecule. As the *nor*-base does not acetylate it is to be regarded as a tertiary amine. Comparison of the neutralisation curves of the hydrochlorides of the *nor*-base, the C-curarine dimeride, quinoline, *iso*quinoline, *py*-tetrahydroquinoline and *py*-tetrahydro*iso*quinoline, indicates that the basic nitrogen of C-curarine is probably a component of a tetrahydro*iso*quinoline or similar system, in which the nitrogen atom is not directly bound to an aromatic nucleus, and is associated with another ring system in such a manner that the second nitrogen atom lies in two rings. As C-curarine forms a nitroso-derivative the nitrogen atom, not associated with the quaternary ammonium group, must be secondary and the results of electrometric titration indicate that it is non-basic, and so resembles

the N-atom in diphenylamine, indole and carbazole. In that connection it is pointed out that C-curarine I chloride in aqueous solution gives, with an aqueous solution of ceric sulphate, an intense blue coloration, which is still visible at an alkaloidal concentration of 10 γ per c.c. This colour reaction is not given by carbazole, yohimbine or strychnine but diphenylamine gives a reddish-violet colour with the reagent. With the carboline colour reaction of Harvey *et al.* (p. 510) C-curarine chloride gives only a yellow colour, but when ferric chloride is replaced by ceric sulphate the colour produced is blue. From these observations it is concluded that one N-atom of C-curarine I belongs to a diphenylamine, carbazole or indole group. The presence of an aromatic ring has already been made evident by Wieland *et al.* (381).

Calabash-curarine II. This alkaloid is best purified through the picrate, m.p. 203–4°. The chloride, C₂₀H₂₅ON₂Cl, or C₂₀H₂₃N₂Cl, H₂O crystallises in long thin needles, decomposing from 220–320°, [α]_D²⁰ + 74.3°. The iodide and perchlorate are crystalline. The chloride is readily brominated and nitrated; the monosubstituted derivatives are much more active than the parent base.

Calabash-curarine III. This isomeride of C-curarine I can be purified *via* the picrate, m.p. 189°, or the β -anthraquinonesulphonate, m.p. 308–310° (*dec.*). The chloride has m.p. 270–4° (*dec.*), [α]_D²⁰ – 936.9° (H₂O).

C-Dihydrotoxiferine I. In the curare from Caracas whose working-up is described in detail in the original, this base was accompanied by C-curarine I. The chloride, C₂₀H₂₃N₂Cl, crystallises in rectangular leaflets or in needles, [α]_D – 610.6° (H₂O). A crystalline sulphate, (C₂₀H₂₃N₂)₂SO₄, 3H₂O, and bromide, C₂₀H₂₃N₂Br, 1.5H₂O, were prepared. The picrate B, C₆H₂O₇N₃, H₂O, has m.p. 183–5°.

C-isoDihydrotoxiferine I. This occurred in many curares accompanied by C-curarine I. The chloride, C₂₀H₂₃N₂Cl, 3H₂O, crystallises in needles, [α]_D²⁰ – 566° (H₂O). A crystalline perchlorate, C₂₀H₂₃N₂ClO₄, and picrate, B, C₆H₂O₇N₃, m.p. 242° (*dec.*) were prepared.

C-Toxiferine II. This base was obtained from curares from Urbana and Caracas, sometimes accompanied by toxiferine II (*see below*), and was isolated by a special method as the chloride, C₂₀H₂₅ON₂Cl, [α]_D + 72.1° (H₂O). The picrate forms hexagonal prisms, m.p. 215° (*dec.*).

ALKALOIDS OF *Strychnos toxifera*. The following alkaloids were obtained from the bark of this species:—

Toxiferine I. This was isolated by the general process as the chloride, C₂₀H₂₃ON₂Cl, 2H₂O, [α]_D²⁰ – 610° (H₂O); the picrate has m.p. 270° (*dec.*).

Toxiferine II. This was also found in curare from Urbana whence it was isolated mixed with C-toxiferine II (*see above*). The chloride could not be crystallised and separation was effected as the picrate, C₂₀H₂₅ON₂, C₆H₂O₇N₃, 2H₂O, m.p. 216°: mixed m.p. with C-toxiferine II picrate, 195°. The picrate loses 1H₂O at 80° *in vacuo* and at 120° *in vacuo* becomes C₂₀H₂₃N₂, C₆H₂O₇N₃, which, as in the case of C-curarine I picrate and chloride, leaves it uncertain whether the base is C₂₀H₂₅ON₂ or C₂₀H₂₃N₂⁺, the + sign indicating this doubt. When the picrate is treated with hydro-

chloric acid the substance obtained is not toxiferine II chloride, but an isomeride, *toxiferine II^a* chloride, which crystallises in rectangular plates, has the composition, $C_{20}H_{25}ON_2Cl$, H_2O , decomposes from $250-74^\circ$, has $[\alpha]_D + 66.6^\circ$ (H_2O) and yields a picrate, m.p. 210° . Toxiferine II^a was found in some curares from Caracas; its occurrence in the drug is regarded as due to the action during extraction, of plant acids on toxiferine II. When toxiferine II^a chloride is absorbed on aluminium oxide it is isomerised to toxiferine II^b chloride, $C_{20}H_{25}ON_2Cl$, crystallising in groups of slender needles, m.p. $240-60^\circ$ (*dec.*), $[\alpha]_D^{20} + 78.4^\circ$ (H_2O). The picrate has m.p. 215° .

As these substances are difficult to isolate and to distinguish, particular importance attaches to their colour reactions and to their relative paralyzing potencies; these and other data for the ten alkaloids are summarised in the table (p. 384), the paralyzing potencies being given in microgrammes (γ) per frog.

Karrer and Schmid^{19(a)} have noted that the dimeride of C-curarine I does not give the characteristic colour reactions of this alkaloid with acids, but still gives that with ceric sulphate and potassium dichromate (p. 384).

The following are the new alkaloids isolated by Schmid and Karrer.^{19(a)} The first four are from the sparingly soluble, and the second four from the soluble, reineckate fractions respectively.

Calebassine. This is isomeric with C-curarine II and is isolated as the picrate, $C_{20}H_{25}ON_2$, $C_6H_2O_7N_3$, m.p. $191-2^\circ$ (*dec.*), which on passage through a Wofatit column charged with chloride ions is converted into the chloride, $C_{20}H_{25}ON_2Cl \cdot H_2O$. This in 2N-sulphuric acid gives a reddish-violet colour with either ceric sulphate or potassium dichromate, and with bromine in water forms a monobromo-derivative (picrate, $C_{20}H_{24}ON_2Br \cdot C_6H_2O_7N_3$) containing a little dibromo-compound. With potassium iodide in water the chloride forms the iodide, B. I. H_2O . Treatment of the chloride with baryta and silver oxide converts it into two dimerides, one, crystalline, $C_{40}H_{46}ON_4 \cdot H_2O$, which darkens at 220° but does not melt and is apparently ditertiary, and the other, amorphous, forming a methiodide, $C_{40}H_{46}ON_4 \cdot (CH_3)_2 \cdot I_2$, from which a picrate, $C_{34}H_{56}O_{15}N_{10}$, m.p. $197-200^\circ$ (*dec.*) was prepared. On hydrogenation in presence of platinum oxide calebassine chloride forms a crystalline dihydride, $C_{20}H_{27}ON_2Cl \cdot \frac{1}{2}H_2O$.

Alkaloid A. This forms a chloride, $[C_{20}H_{23}ON_2]^+Cl^-$, $\frac{1}{2}H_2O$, isomeric with the chlorides of toxiferine, C-curarine I and C-curarine III; the picrate has m.p. 269° (*dec.*). The chloride differs from the isomerides named, in potency, colour reactions and ultra-violet absorption spectrum. The chloride in 2N-sulphuric acid gives a carmine-red colour with potassium dichromate.

Alkaloid B. This was isolated as the chloride, $C_{20}H_{25}ON_2Cl$, which in 2N-sulphuric acid gives a deep, reddish-violet colour with either potassium dichromate or ceric sulphate. The picrate has m.p. $195-6^\circ$.

C-Toxiferine I. Described as the chloride, $C_{20}H_{23}ON_2Cl$, $\frac{1}{2}H_2O$, and picrate, m.p. $\sim 265^\circ$ (*dec.*). Its UV-absorption spectrum is similar to

ALKALOIDS OF GOURD CURARE.

Name of Base	Formula	Potency expressed as γ (0.001 mgm.)	Colour Reactions				Melting point of Picrate
			Conc. HNO ₃	Conc. H ₂ SO ₄	50 per cent. H ₂ SO ₄	H ₂ SO ₄ + K ₂ Cr ₂ O ₇	
C-curarine I . . .	C ₂₁ H ₂₁ N ₂ ⁺	3-4	green	yellow	violet	blue	> 300°
C-curarine III . . .	C ₂₀ H ₂₁ N ₂ ⁺	inactive at 500	bright yellow	yellow-green	yellow-green	blue-violet	189°
Toxiferine I . . .	C ₂₀ H ₂₁ N ₂ ⁺ (H ₂ O)	0.3	brown-green	none	yellowish-red	carminc	270°
C-curarine II . . .	C ₂₀ H ₂₃ N ₂ ⁺ (H ₂ O)	50-100	carminc	none	yellowish-red	carminc	204°
C-dihydrotoxiferine I . . .	C ₂₀ H ₂₃ N ₂ ⁺	1.5	reddish-green	none	yellowish-red	carminc	185°
C-isodihydrotoxiferine I . . .	C ₂₀ H ₂₃ N ₂ ⁺	3-4	brownish-red	violet	none	carminc	242°
Toxiferine II . . .	C ₂₀ H ₂₃ N ₂ ⁺	5 (calc. ex picrate)	—	—	—	—	216°
Toxiferine II ^a . . .	C ₂₀ H ₂₃ N ₂ ⁺ (H ₂ O)	20-30	carminc	none	yellowish-red	carminc	210°
Toxiferine II ^b . . .	C ₂₀ H ₂₃ N ₂ (H ₂ O)	100-150	carminc	none	yellowish-red	carminc	216°
C-toxiferine II . . .	C ₂₀ H ₂₃ N ₂ (H ₂ O)	10	vermillion	none	yellowish-red	carminc	215°

that of alkaloid B and its general colour reactions resemble those of toxiferine, with which they are comparatively tabulated in the original. Dissolved in sulphuric acid, it gives on addition of ferric chloride or potassium hexacyanoferrate an intense blue colour, and with sodium nitrite it produces a reddish-violet colour changing to bluish-violet. No other alkaloid of the calabash curare series gives either of these colour reactions, of which the former recalls the specific reaction for 2 : 3 : 4 : 5-tetrahydro- β -carboline-4-carboxylic acid described by Harvey *et al.* (p. 510). The lethal dose of the chloride for rabbits is 0.008–0.012 mgm./kilo and this high toxicity and other characteristics suggest the possible identity of this alkaloid with toxiferine (p. 384).

The curarising dose, expressed in mgm./kilo for frogs, recorded by Karrer and Schmid for these four alkaloids, is as follows: C-curarine I, 0.1; calebassine, 0.2 to 0.5; alkaloid A, 0.05 to 0.07; alkaloid B, 0.03 to 0.05; C-toxiferine I, 0.005.

The total crude alkaloid from the soluble reineckate fraction had the low curarising potency 25 mgm./kilo frog. It consisted mainly of quaternary alkaloids and nothing crystalline has so far been obtained from the non-quaternary portion.

Fluorocurine, isolated as the picrate, $C_{20}H_{21}ON_2, H_2O, C_6H_5O_7N_3$, m.p. 178°, which was converted to the chloride, $C_{20}H_{23}O_2N_2Cl \cdot \frac{1}{2}H_2O$, a yellow powder, showing greenish-yellow fluorescence in solution in water and giving an intense, but unstable, reddish-violet colour with ceric sulphate in 50 per cent. sulphuric acid. The iodide, $C_{20}H_{23}O_2N_2I \cdot \frac{1}{2}H_2O$, also prepared from the picrate, crystallises in yellow platelets, has $[\alpha]_D + 326^\circ$ (MeOH), contains one methylimino but no methoxyl group, and on hydrogenation absorbs two molecules of hydrogen quickly without loss of yellow colour and then a further 1.4 molecules, becoming colourless and losing its quaternary character. No crystalline hydride has been isolated.

Calebassinine. The picrate, $C_{19}H_{23}O_2N_2, C_6H_5O_7N_3$, crystallises in minute yellow needles, m.p. 260°, and gives an intense carmine colour with ceric sulphate in sulphuric acid but the reaction is negative in the 50 per cent acid. The chloride, $C_{19}H_{23}O_2N_2Cl, \frac{1}{2}H_2O, [\alpha]_D + 63^\circ$ (H_2O) is amorphous, but the iodide, $C_{19}H_{23}O_2N_2I$, crystallises in minute, hygroscopic needles. No methoxyl group is present.

C-Alkaloid UB forms a picrate, $C_{19}H_{23}O_3N_2, C_6H_5O_7N_3$, m.p. 238–240°, which gives an intense, but unstable, carmine colour with ceric sulphate in strong sulphuric acid and is convertible into a crystalline iodide.

C-Alkaloid X obtained in minute quantity as a crystalline chloride, which with nitric acid gives an intense red colour with a violet fluorescence, and orange slowly becoming red, with ceric sulphate in sulphuric acid.

Karrer and Matter^{10(a)} have confirmed the presence of succinic acid as recorded by Boehm,¹⁶ and of protocathechuic acid as found by Wieland, Konz and Sonderhoff¹⁹ and have added thereto, mesaconic acid as a constituent of calabash curare.

ALKALOIDS OF *Erythrina* spp. Observations began to be made about 1935 that extracts of the seeds of *Erythrina* spp. (Leguminosæ) possessed curarising properties.²⁰ In 1937 erythroidine, the first alkaloid of this type, was isolated from *Erythrina americana* Mill. by Folkers and Major and arising from this Folkers and Unna²¹ made a preliminary survey of *Erythrina* spp. for curarising properties, the results of which showed a wide distribution of such properties in this genus, about half of the known species proving active. The relative potencies of the species varied widely. Three types of alkaloid have been found so far by Folkers and co-workers provisionally distinguished as (1) "free," *i.e.*, extractable by immiscible solvents from clean, fat-free plant extracts, which have been rendered alkaline, (2) "liberated," *i.e.*, alkaloids, which are only extractable by the above process after the plant extracts have been subjected to acid hydrolysis and (3) "combined alkaloids" which are not extractable by ordinary methods, contain sulphur and are the sources of group 2 ("liberated alkaloids"). Until this modern research on the genus was started the only *Erythrina* alkaloid known was hypaphorine which has hitherto been included in the indole group, but is now dealt with alongside its natural erythrina associates. It is of interest to note that Deulofeu, Labriola, Hug, Fondovila and Kauffmann²³ (1947) have found in the chief Argentina *Erythrina* spp., *viz.*, *E. crista galli*, in addition to hypaphorine, six of the alkaloids recorded by Folkers *et al.* for other species, *viz.*, the free alkaloids, erythraline, erythramine and erythratine, and the liberated alkaloids, erysodine, erysopine and erysovine.

Hypaphorine, $C_{14}H_{18}O_2N_2 \cdot 2H_2O$, was isolated by Greshoff²² from the seeds of *E. subumbrans* (Hassk) Merr. (*E. hypaphorus* Boerl) and has since been recorded in many *Erythrina* spp.²³ The constants recorded for it by van Romburgh and Barger,²⁴ and by Folkers and Koniuszy²³ (1939) are as follows:—

It forms monoclinic crystals, m.p. 255° (*dry, dec.*) [α]_D + 91·3° (v.R.) or m.p. 236·7° (*dec.*) [α]_D^{27°} + 113·1° (H₂O) (F. and K.) and yields a sparingly soluble nitrate, B. HNO₃, m.p. 215–20°, [α]_D + 94·7° (B.) or m.p. 223·5–224·5° (F. and K.). The hydrochloride has m.p. 231–2° (*dec.*) and [α]_D^{32°} + 89·6° (H₂O) (F. and K.). According to Deulofeu *et al.*²³ (1939) the flavianate crystallises in orange needles or red rhombs, m.p. 235° (*dec.*) and is characteristic.

When heated with potassium hydroxide, hypaphorine yields trimethylamine and indole: it is formed when tryptophan (I) is boiled with methyl iodide in presence of sodium hydroxide in methyl alcohol and the resulting methyl α -dimethylamino- β -3-indolylpropionate methiodide (methyl hypaphorine iodide) (II), m.p. 200·5–201·5° is heated at 100° for a few minutes with sodium hydroxide solution dilute enough to avoid hydrolysis of the hypaphorine (III) as it is formed. According to Cahill and Jackson,²⁴ methyl hypaphorine iodide is completely racemised when heated for 8 hours with methyl iodide and sodium hydroxide in methyl alcohol and *dl*-hypaphorine, m.p. 248–9° (*dec.*) can be recovered from the reaction mixture.

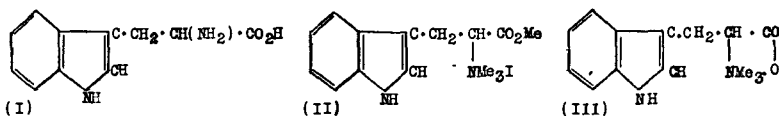

Hypaphorine produces increased reflex irritability and later tetanic convulsions in frogs but has little action on other experimental animals (Plugge).²⁴ The methyl ester iodide (II) has curarising properties (Folkers and Koniuszy,²³ 1939).

Erythroidine, $C_{16}H_{19}O_3N$, as isolated from the seeds of *Erythrina americana* Mill by Folkers and Major,²⁵ was described as having m.p. 94–6°, and yielding a hydrochloride, m.p. 228–9° (*dec.*), $[\alpha]_D^{21} + 109.7^\circ$ (H_2O). It is also obtainable from many other *Erythrina* spp. and was subsequently shown to be a mixture of two stereoisomers, α - and β -erythroidines.^{25(a)}

α -Erythroidine yields the following salts: hydrochloride, m.p. 227–8° (*dec.*), $[\alpha]_D + 118^\circ$; hydrobromide, B. HBr. 0.5 H_2O , m.p. 224° or 220–2° (*dry*); hydriodide, m.p. 210–2°; perchlorate, m.p. 208–208.5° and flavianate, m.p. 216°.

β -Erythroidine is crystalline, m.p. 98.5–99.5°, $[\alpha]_D + 88.8^\circ$ (H_2O) and provides the following salts: B. HCl. 0.5 H_2O , m.p. 229.5–230° (*dec.*), $[\alpha]_D + 95^\circ$ or m.p. 232° (*dry, dec.*), $[\alpha]_D^{25} + 109^\circ$ (*dry; H_2O*); B. HBr, 0.5EtOH, m.p. 227° or 222–4° (*dry*), $[\alpha]_D^{25} + 111.2$ (H_2O); B. HI. H_2O , m.p. 206°, $[\alpha]_D^{25} + 108.1^\circ$ (H_2O); B. $HClO_4$, m.p. 203–203.5°, $[\alpha]_D^{25} + 96.3^\circ$ (H_2O) and flavianate, m.p. 216–216.5°.

Erythroidine, the mixture of α - and β -isomers, on hydrogenation as the hydrochloride, yields tetrahydroerythroidine hydrochloride hemihydrate, m.p. 215–7°, from which tetrahydroerythroidine may be recovered as an oil, b.p. 70–100°/10⁻⁴ to 10⁻⁵ mm.; the hydrobromide has m.p. 224–7° or 215–8° (*dry*).^{25(b)}

β -Erythroidine behaves as a lactone and when one of its salts with an alkali or alkaline earth metal is catalytically hydrogenated under pressure, a mixture of dihydro- β -erythroidines, with two tetrahydro- compounds is produced, from which dihydro- β -erythroidine can be isolated as the hydrobromide. The dihydro- base has m.p. 85–6° (*dec.*), $[\alpha]_D^{25} + 102.5^\circ$ and forms the following salts: B. HCl, m.p. 238° (*dec.*), $[\alpha]_D^{25} + 124.7^\circ$; B. HBr, m.p. 231° (*dec.*), $[\alpha]_D^{25} + 106.0$; B. HI, m.p. 230° (*dec.*), $[\alpha]_D^{25} + 95.5^\circ$, B. $HClO_4$, m.p. 235–6° (*dec.*), $[\alpha]_D^{25} + 102.5$.

β -Erythroidine is converted by sulphuric acid into an *apo*-base; the latter gives an intense purple colour with ferric chloride, which Dietz and Folkers^{25(c)} have made the basis of a spectrophotometric method for the estimation of β -erythroidine.

As β -erythroidine and its hydrides appear to be important curarising agents in the erythrina series it is convenient to tabulate at this stage the threshold curarising potencies of these alkaloids^{25(d)} and to add for comparison the curarising potencies of the other "free" erythrina alkaloids. Similar tables are given later for the "liberated" and "combined" (p. 390) alkaloids.^{25(e)}

Curarising Potencies of "Free" Erythrins Alkaloids

Name of Alkaloid	Potency: mgm./kilo. frog	Name of Alkaloid	Potency mgm./kilo. frog
β -Erythroidine, HCl	3.0	Erythraline, HBr	10
Erythroidine methiodide	200.0	Erythraline, MeI	50
Sodium β -erythroidinate	75.0	Erythramine, HBr	10
Dihydro- β -erythroidine, HCl	0.5	Erythramine, MeI	40
Sodium dihydro- β -erythroidinate	0.6	Dihydroerythramine, HBr	300
α -Tetrahydro- β -erythroidine, HBr	200.0	Erythratine, HBr	75
β -Tetrahydro- β -erythroidine, HBr	0.5	Erythratine, MeI	300
		Dihydroerythratine, HBr	100

In view of the fact that the conversion of tertiary into quaternary bases quite frequently leads to the development of curarising action, it is surprising that in these four alkaloids the methiodides are much less active than the parent bases. On the other hand, hydrogenation in this series may have no effect on activity (*cf.* erythraline and its dihydro-derivative erythramine) or may enhance it (*cf.* β -erythroidine and its dihydride) or may diminish it (*cf.* erythramine and its dihydride).

Erythramine, $C_{18}H_{21}O_3N$. This base occurs in various *Erythrina* species but was first isolated by Folkers and Koniuszy from *E. sandwicensis* and *E. subumbrans* along with hypaphorine. It has m.p. $104-5^\circ$, or $103-4^\circ$ (solvent-free); b.p. $125^\circ/3.9 \times 10^{-4}$ mm., $[\alpha]_D^{29.5^\circ} + 227.6^\circ$ (EtOH). It is isolated as the hydriodide, orange-yellow needles, m.p. 249° (*dec.*), $[\alpha]_D^{25^\circ} + 220^\circ$ (H_2O); the hydrobromide has m.p. 228° , $[\alpha]_D^{26^\circ} + 203.2^\circ$ (H_2O) and the hydrochloride, B. HCl, $0.5H_2O$, m.p. 250° (*dry, dec.*). The oxygen atoms in erythramine are present as one methoxyl and one methylenedioxy group. Neither CMe nor NMe is present and the nitrogen atom is tertiary, a methiodide, m.p. $96-8^\circ$, $[\alpha]_D^{18^\circ} + 176^\circ$ (H_2O) being formed by the action of methyl iodide. Hydrogenation in dilute hydrochloric acid at 2 atmospheres pressure in presence of platinum oxide produces a tertiary dihydro-derivative, m.p. $89-90^\circ$, of which the following salts were prepared: hydriodide, m.p. $214-5^\circ$ (*dec.*), $[\alpha]_D \pm 0^\circ$; hydrobromide, B. HBr. H_2O , m.p. 240° ; methiodide, B. MeI, $0.5H_2O$, m.p. $160-1^\circ$. Erythramine hydrobromide shows curare-like action in the frog at 7 mgm. per kilo.: the methiodide and dihydroerythramine are respectively one-third and one-twentieth as active.²⁶ (For probable constitution see below.)

Erythraline, $C_{18}H_{19}O_3N$. This alkaloid and erythratine were first isolated from *E. glauca* Willd. but have also been obtained from other species of the genus.²⁷ It has m.p. $106-7^\circ$, $[\alpha]_D^{27^\circ} + 211-8^\circ$ (EtOH) and yields the following salts: B. HI, m.p. $252-3^\circ$ (*dec.*), $[\alpha]_D^{23^\circ} + 177^\circ$ (H_2O); B. HBr, m.p. 243° , $[\alpha]_D^{27^\circ} + 216.6^\circ$ (H_2O). The oxygen atoms are present as a methoxyl and a methylenedioxy group. The nitrogen atom is tertiary. The methiodide, m.p. $185-7^\circ$, on oxidation with permanganate yields hydrazic acid methylimide (p. 164). On hydrogenation in very dilute hydrochloric acid and in presence of platinum oxide erythraline absorbs

two molecules of hydrogen producing dihydroerythramine (*see above*). The threshold dose for curare-like action in frogs is the same as that of erythramine, 7–8 mgm. per kilo.

Erythratine, $C_{18}H_{21}O_4N$, $0.5H_2O$, isolated first, along with erythraline from *E. glauca* seeds, and since then found in other *Erythrina* spp.²⁷ has m.p. 170–5°, $[\alpha]_D^{25} + 144.9^\circ$ (EtOH). The hydriodide B . HI has m.p. 242–242.5° and $[\alpha]_D^{25-30} + 109^\circ$ (H_2O); the hydrobromide, B . HBr, melts at 241° and has $[\alpha]_D^{25} + 158.7^\circ$. The methiodide, B . MeI, $0.5H_2O$, has m.p. 121–5°, $[\alpha]_D^{25} + 109.7^\circ$ (H_2O), or when anhydrous, m.p. 135–6°, $[\alpha]_D + 110.4^\circ$ (H_2O) and yields an amorphous methine base, $C_{18}H_{23}O_4N$. On hydrogenation in very dilute hydrobromic acid in presence of platinum oxide erythratine forms dihydroerythratine hydrobromide, m.p. 249°. Like its associates, erythratine has a tertiary nitrogen atom, contains one methoxyl and one methylenedioxy group and no NMe or CMe group, but unlike them it contains an alcoholic, hydroxyl group and yields an *O*-acetyl- and an *O*-benzoyl (dihydrated) derivative, melting at 128–9° and 248–9° respectively.²⁸ The threshold paralysing dose for frogs is one-tenth that of erythraline or erythramine. (For possible constitution see below.)

Constitution of Erythramine, Erythraline and Erythratine. While it is not yet possible to assign a detailed formula to any of these three alkaloids, Folkers, Koniuszy and Shavel²⁸ have been able to suggest a probable tetracyclic nuclear structure common to all of them and based on the following data. All three contain one methoxyl and one methylenedioxy group: erythratine has in addition one alcoholic hydroxyl group. The nitrogen atom in each is tertiary and is common to two rings. None of the three contains either NMe or CMe. Erythramine absorbs one molecule of hydrogen and erythraline two, the product in each case being dihydroerythramine so that erythramine appears to be dihydroerythraline. Erythraline methiodide is oxidised by permanganate in acetone to hydrastic acid methylimide (I). The absorption spectrum of each of the three alkaloids resembles that of 6 : 7-methylenedioxy-1 : 2 : 3 : 4-tetrahydroisoquinoline (II). When either erythraline or erythratine is fused with potassium hydroxide, indole is obtained, but when pure, neither gives indole colour reactions. The skeleton formula suggested is (III) or less probably its linear analogue (Folkers *et al.*^{27, 28}). The methylenedioxy group is definitely in ring 1 and the other substituents and the ethylenic linkage, or linkages, probably in ring 4. It is of interest that formula (III) is of the same type as that assigned to dehydrolaudanosoline (VI, p. 190) and has affinities with the phenanthridine type provisionally suggested for lycorine and tazettine (p. 406).

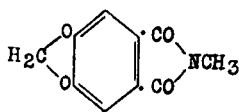

(I)

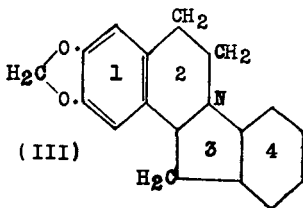

(III)

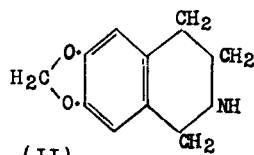

(II)

Liberated Erythrina Alkaloids. Five of these have been described, "erysoccine," *erysodine*, *erysonine*, *erysopine* and *erysovine*, but "erysoccine" proved later to be a mixture of *erysodine* and *erysovine*. Their chief characteristics are summarised in the following table. They are weak bases and contain no NMe or CMe groups. *Erysopine* gives a green colour with ferric chloride indicating that its two phenolic hydroxyl groups are in the *o*-position to each other.²⁹

Liberated Alkaloids of *Erythrina* spp.

Name	Formula	M.p.	$[\alpha]_D$	Minimum paralyzing dose. mgm./kilo.frog
Erysodine	$C_{16}H_{14}N(OMe)_2(OH)$	204-5°	+248°	B.HCl. 10
Erysonine	$C_{16}H_{15}ON(OMe)(OH)$	236-7° (variable)	+285.9°	B.HCl; 100
Erysopine	$C_{16}H_{14}N(OMe)(OH)_2$	241-2°	+265.2°	B.HCl. 4
Erysovine	$C_{16}H_{14}N(OMe)_2(OH)$	179.5°	+232-4°	Na salt. 3

Combined Erythrina Alkaloids. The sources of the "liberated" alkaloids (*see above*) are now known to be, at least in two cases, the sulphur-containing alkaloids *erysothiopine* and *erysothiovine*, which are esters of sulphoacetic acid, $HOOC \cdot CH_2 \cdot SO_2 \cdot OH$, identified as the aniline salt, m.p. 187-9°; with *erysopine* and *erysovine* respectively. The sources of *erysodine* and *erysonine* have not yet been isolated. These combined alkaloids are believed to be sulphonic esters, of the type $HO \cdot OC \cdot CH_2 \cdot SO_2 \cdot O \cdot R$, where R is the alkaloidal residue.³⁰

Combined Alkaloids of *Erythrina* spp.

Name	Formula	M.p.	$[\alpha]_D$	Minimum paralyzing dose mgm./kilo.frog	Corresponding liberated base
Erysothiopine	$C_{16}H_{14}N(OMe)(OH) \cdot O \cdot SO_2 \cdot CH_2 \cdot CO_2H \cdot H_2O$	168-9°	+194°	Na salt. 1	erysopine
Erysothiovine	$C_{16}H_{14}N(OMe)_2 \cdot O \cdot SO_2 \cdot CH_2 \cdot CO_2H \cdot 2H_2O$	187°	+208°	Na salt. 1	erysovine

PHARMACOLOGICAL ACTION. Curare is stated to be almost inert when taken by mouth, owing to poor absorption by intestinal mucous membrane and the rapidity of elimination. Injected hypodermically it is a rapid and potent poison, paralyzing the motor nerve-endings in striped muscle, so that voluntary movements cease and death occurs from respiratory failure.³¹

The drug varies greatly in activity. The following lethal doses (mg. per kilo) have been recorded for rabbits: *pot curare* 0.8 to 10.0, more commonly 2 to 3; *tube curare* 5 to 10; *gourd curare* 1.5 to 8.0.⁹ Boehm¹⁶ gave the

following figures for his "curarines": protocurarine 0.24; tubocurarine 1.0; curarine 0.34. King's tubocurarine chloride produced curare paralysis in frogs at 0.5 mg. per kilo and the isomeric *d*-bebeerine methochloride had about $\frac{1}{40}$ th of that activity; the same author's protocurarine was effective in frogs at 1.5 mg. per kilo. Figures for paralysing doses of the various curare and Erythrina alkaloids isolated in recent years are given in the foregoing chemical sections.

West has shown that curare varies qualitatively in action, some specimens having a "lissive" action, defined as "the selective removal of pathological rigidities without apparent diminution of voluntary power"; and Hartridge and West³² found it possible to control tetany in parathyroidectomised dogs by the use of a curare chosen on this basis.

There has been considerable discussion on this subject^{32(a)} and the difficulty of obtaining supplies of curare and of preparing a uniform and standardised product, suitable for general clinical use, from this extremely variable drug, did not make for rapid progress at first but a number of papers have appeared on the treatment of conditions involving certain types of muscular rigidity.³³ The results were sufficiently promising to arouse interest in the possible therapeutic applications of curare and by 1940 preparations more suitable for extended clinical trial were made available, such as extract of *Chondrodendron tomentosum*, freed from disadvantageous components and biologically standardised,³⁴ *d*-tubocurarine chloride,³⁵ β -erythroidine hydrochloride and more recently dihydro- β -erythroidine hydrochloride. These products have been the subject of clinical trials in spastic-paralytic and dystonic conditions,³⁶ for the control of convulsions in the shock therapy of psychiatric patients³⁷ and more especially as an adjunct to general anaesthetics to produce the muscular relaxation desirable in some surgical operations.³⁸ Curare has also been suggested as a means of diagnosis of *Myasthenia gravis*.³⁹

These developments have naturally led to the investigation of methods of estimating the curarising potency of curare, preparations of tubocurarine chloride and possible synthetic substitutes for the latter. As already stated, chemical methods for curare and its preparations are being developed (p. 374) and work is being done on biological tests.^{40(a)} Investigations are also in progress on the general pharmacology of the drug,^{40(b)} and particularly on its mode of action, and in general on the interactions among acetylcholine, the choline-esterases, curare and physostigmine, the last-named substance and its modern analogues and possible synthetic substitutes (p. 550) having special interest as antidotes to curare. In the latter connexion an unexpected development is the discovery by Halpern, Benda and Bourdon^{40(c)} that the bis-(8-quinolyloxy)-1:5-pentane diethiodide prepared by Bovet, Courvoisier, Ducrot and Horclois⁴³ is not only a potent curarising substance, but also possesses well-marked action of the physostigmine type.

There is already a voluminous literature on the medical use of curare of which several useful reviews have been written.^{40(d)}

Curine is generally stated to be of low toxicity, and not to exhibit

the peripheral action characteristic of curare. It has been examined by Hauschild,⁴¹ who states that it has some curare-like action in frogs, but is primarily a central depressant, death occurring from heart failure. In mice, spasms of the limbs were produced and heart-block, though death was sometimes due to respiratory failure. He concludes that curine acts on the exciting or conducting mechanism of the heart, but not through the central nervous system or the vagus terminations. The action of curine methochloride does not seem to have been determined. Brazil, Seba and Campos⁴¹ have stated that the methochloride of the dimethyl ether of the *l*-bebeerine (curine), obtained from *Chondrodendron platyphyllum*, has a curarising dose 0.0025 to 0.005 mgm. for mice. According to King,² neoprotocuridine hydrochloride produces paralysis in the frog in forty minutes in a dose of 45 mg. per kilo.

It has long been known that quaternary ammonium salts can exert a curare-like action,⁴² and in recent years much attention has been given to the synthesis and pharmacological testing of such products; ⁴³ work on this subject up to 1936 has been reviewed by Ing,⁴³ and more recently a theoretical discussion of the relationship between structure and action in drugs of this type has been provided by Holmes, Jenden and Taylor.^{40(b)} Chase, Lehmann and Yonkmann have compared the action of quaternary salts of quinine with that of β -erythroidine hydrochloride and of dihydro- β -erythroidine hydrobromide. Quinine ethochloride shows marked curariform action of short duration.⁴⁴

An unexpected source of curarising substances has been found by Berger and Bradley⁴⁵ in the α -substituted ethers of glycol, of which they have examined an extensive series. The most promising member of the group is α : β -dihydroxy- γ -(2-methylphenoxy)-propane, m.p. 70–1°, which forms neutral, stable aqueous solutions and has a wide safety margin between paralysing and lethal dose. In non-paralysing doses it antagonises the convulsive action of strychnine, but is less effective against convulsions induced by leptazol (pentamethylenetetrazole). It is under clinical trial⁴⁶ in the hope that it will prove useful in inducing muscular relaxation under light anæsthesia.

REFERENCES

- (1) PERROT and VOGT, "Poisons de Flèches et Poisons d'Épreuve" (Paris, Vigo Frères, 1913), a detailed historical and critical account with a copious bibliography. See also LEWIN, "Die Pfeilgifte" (Leipzig, Barth, 1923); KRUKOFF and MOLDENKE, *Brittonia*, 1938, 3, 6; MCINTYRE, "Curare, History, Nature and Clinical Use," Univ. Chicago Press, 1947. (2) *J. Chem. Soc.*, 1937, 1472; 1948 (*in the press*). (3) (a) *Arch. inter. Pharmacodyn.*, 1939, 61, 370; (b) KRUKOFF and SMITH, *Bull. Torrey Botan. Club*, 1937, 64, 401; (c) *J. Amer. Pharm. Assoc.*, 1938, 27, 689; A. J. HENRY, *Brit. J. Pharmacol.*, 1948 (*in the press*); (d) *Compt. rend.*, 1939, 208, 2104; (e) *O. Hospital*, 1942, 21, 55 (*Chem. Abstr.*, 1944, 38, 2789). (4) *Pharm. Zeit.*, 1933, 78, 852; 1936, 81, 241, 818; 1937, 82, 577. (5) *Compt. rend.*, 1938, 206, 1202; 1939, 208, 382, 1249; *Bull. Soc. chim. biol.*, 1939, 21, 282; cf. BIERRY and GUZON, *Trav. Memb. Soc. biol.*, 1941, 23, 1023; *Compt. rend. fac. sci. Marseille*, 1941, 1, 34 (*Chem. Abstr.*, 1943, 37, 54; 1945, 39, 3069; 1946, 40, 3530); LAPICQUE, *Compt. rend.*, 1939, 208, 384, 857. (6) See, for example, *Nature*, 1946, 158, 743; LAPICQUE, *Compt. rend. Soc. Biol.*, 1940, 133, 224; 1942, 136, 497; *Compt. rend.*, 1942, 215, 398; GOLD, *Trans. Kansas Acad. Sci.*, 1941,

- 44, 221 (*Chem. Abstr.*, 1942, 36, 1441); ROBERTS, HECHT and JACKMAN, *J. Pharmacol. Exp. Ther.*, 1942, 74, 392. (7) *Ber.*, 1928, 61, 1698. (8) *J. Chem. Soc.*, 1935, 1381; 1939, 1157; 1940, 737; 1948, 265; see also DUTCHER, *J. Amer. Chem. Soc.*, 1946, 68, 419. (8a) FOSTER, *Analyst*, 1947, 72, 62; (with TURNER), *Quart. J. Pharm.*, 1947, 20, 228, 412. (9) *Acta Med. Skand.*, 1931, 75, 7; *Skand. Arch. Physiol.*, 1934, 68, 213. (10) *Arch. Pharm.*, 1897, 235, 660. (11) *Nature*, 1935, 135, 469; see also *Kew Bulletin*, 1933, No. 8, 390. (12) *Ann. Chim.*, 1829, [ii], 39, 24. (13) *Jabresb.*, 1861, 767. (14) *Compt. rend.*, 1865, 60, 1346. (15) *Annalen*, 1878, 235, 660. (16) *Abh. Kgl. Sächs. Ges. Wiss.*, 1895, 22, 203; 1896, 24, 23; *Arch. Pharm.*, 1897, 235, 660. (17) *Ber.*, 1934, 67, 55; cf. KING, *Ann. Rept. Chem. Soc.*, 1933, 30, 249. (18) *J. Amer. Chem. Soc.*, 1946, 68, 419; (with WINTERSTEINER), *Science*, 1943, 97, 467; cf. KING, *Nature*, 1946, 158, 515; *J. Chem. Soc.*, 1947, 936. (19) WIELAND (with KONZ and SONDERHOFF), *Annalen*, 1937, 527, 160; (with PISTOR), *ibid.*, 1938, 536, 68; (with PISTOR and BÄHR), *ibid.*, 1941, 547, 140; (with BÄHR and WITKOP), *idem.*, p. 156; cf. WITKOP, *Die Chemie*, 1942, 55, 85; also BOEHRINGER and LIEBRECHT, B.P. 511,186; WIELAND (with KONZ), U.S.P. 2,297,272; D.R.P. 665,511; (with PISTOR), D.R.P. 695,066. (19a) KARRER (with SCHMID), *Helv. Chim. Acta*, 1946, 29, 1853; 1947, 30, 1162, 2081; (with MATTER), *ibid.*, p. 1871. (20) SIMON, *Arch. Farmacol. sperim.*, 1935, 49, 193; LEHMAN, *Proc. Soc. Exp. Biol. Med.*, 1936, 33, 501; CICARDO and HUG, *Compt. rend. Soc. Biol.*, 1937, 126, 154; SANTESSON, *Skand. Arch. Physiol.*, 1938, 80, 361. (21) *J. Amer. Pharm. Assoc.*, 1938, 27, 693; 1939, 28, 1019. (22) *Meded. uit's Lands Plant.*, 1890, 7, 29; 1898, 25, 54. (23) MARANON and SANTOS, *Philippine J. Sci.*, 1932, 48, 563; RAO *et al.*, *Proc. Ind. Acad. Sci.*, 1938, 7, A, 179; cf. CHAKRAVARTI *et al.*, *J. Annamalia Univ.*, 1933, 2, 238; DEULOFEU, HUG and MAZZOCO, *J. Chem. Soc.*, 1939, 1841; (with LABRIOLA), *Anal. Asoc. Quim. Arg.*, 1941, 29, 121; GENTILE and LABRIOLA, *J. Org. Chem.*, 1942, 7, 136; DEULOFEU *et al.*, *ibid.*, 1947, 12, 486; FOLKERS and KONIUSZY, *J. Amer. Chem. Soc.*, 1939, 61, 1232; 1940, 62, 436, 1677; (with SHAVEL), *ibid.*, 1941, 63, 1544. (24) *Proc. K. Akad. Weten. Amst.*, 1911, 13, 1177; *J. Chem. Soc.*, 1911, 99, 2068; CAHILL and JACKSON, *J. Biol. Chem.*, 1938, 126, 29, 627; PLUGGE, *Arch. exp. Path. Pharm.*, 1893, 32, 313. (25) FOLKERS (with MAJOR), *J. Amer. Chem. Soc.*, 1937, 59, 1580. (25a) MERCK & Co., FOLKERS and MAJOR, B.P. 543,187; U.S.P. 2,373,952. (25b) MAJOR and FOLKERS (to MERCK & Co.), U.S.P. 2,280,837. (25c) FOLKERS and KONIUSZY, U.S.P. 2,370,651; DIETZ and FOLKERS, *J. Amer. Pharm. Assoc.*, 1946, 35, 48. (25d) UNNA, KNIAZUK and GRESLIN, *J. Pharmacol. exp. Ther.*, 1944, 80, 39. (25e) UNNA and GRESLIN, *ibid.*, p. 53. (26) FOLKERS (with KONIUSZY), *J. Amer. Chem. Soc.*, 1939, 61, 1232, 3053. (27) *Idem*, *ibid.*, 1940, 62, 436, 1673. (28) FOLKERS (with KONIUSZY and SHAVEL), *ibid.*, 1942, 64, 2146. (29) FOLKERS (with KONIUSZY), *ibid.*, 1940, 62, 1677; (with SHAVEL and KONIUSZY), *ibid.*, 1941, 63, 1544; (with SHAVEL), *ibid.*, 1942, 64, 1892; cf. GENTILE and LABRIOLA.²³ (30) FOLKERS (with KONIUSZY and SHAVEL), *J. Amer. Chem. Soc.*, 1944, 66, 1083. (31) WEST, *Proc. Roy. Soc. Med.*, 1932, 25, 1107; *Lancet*, 1938, 234, 432; *J. Physiol.*, 1938, 91, 437; THORNTON, *ibid.*, 1938, 93, 40. (32) *Brain*, 1931, 54, 312, 508. (32a) See, for example, WEST, COLE, DALE, BURN, HARTRIDGE and others, *Brit. Med. J.*, 1935, i, 123. (33) See, for example, COLE, *Lancet*, 1934, 227, 475, 1130; FLOREY, HARDING and FILDERS, *ibid.*, p. 1036; MITCHELL, *ibid.*, 1935, 228, 262; WEST, *ibid.*, 1934, 227, 1194; 1936, 230, 12; 1938, 234, 432; 1945, 249, 155; *J. Physiol.*, 1938, 91, 437; *Arch. intern. Pharmacodyn.*, 1937, 56, 81; Annotation, *Brit. Med. J.*, 1939, ii, 405. (34) GRIFFITH, *J. Amer. Med. Assoc.*, 1945, 127, 642; cf. Ref. (18); BAIRD and ADAMS, *Proc. Mayo Clinic*, 1944, 19, 200; "New and non-official remedies," *J. Amer. Med. Assoc.*, 1945, 129, 517. (35) MACINTOSH, *Lancet*, 1945, 249, 124; see also WEST³³ (1945). (36) *Brit. Med. J.*, 1939, ii, 405; 1942, ii, 224; BURMAN, *Arch. Neurol. Psychiat.*, 1939, 41, 307; *J. Pharm. exp. Ther.*, 1940, 69, 143; DENHOFF and BRADLEY, *New Eng. J. Med.*, 1942, 226, 411; HARVEY *et al.*, *Trans. Amer. Neur. Ass.*, 1940, 66, 156. (37) BENNETT, *J. Amer. Med. Assoc.*, 1940, 114, 322; *Amer. J. Psychiat.*, 1941, 97, 1040; ROSEN, ZIEGLER and COMINOLE, *J. Amer. Pharm. Assoc.*, 1940, 29, 164; ROSEN and BORENSTEIN, *Psychiat. Quart.*, 1941, 15, 163; HARRIS, PACELLA and HORWITZ, *ibid.*, p. 537; BROWN, ESSEX and MOERSCH, *Proc. Mayo Clinic*, 1941, 16, 264; WILLIAMS,

Ohio State Med. J., 1941, 37, 849; HOBSON and PRESCOTT, *Brit. Med. J.*, 1947, i, 451; DONOVAN, *Lancet*, 1947, 252, 634; RISING and CARROL, *J. Kansas Med. Sci.*, 1946-7, p. 297. (38) GRIFFITH and JOHNSON, *Anæsthesiology*, 1942, 3, 418; DRIPPS and SARGENT, *ibid.*, 1947, 8, 241; CULLEN, *ibid.*, 1944, 5, 166; COLE, *ibid.*, 1945, 6, 48; GRIFFITH, Ref. (34) and *Can. Med. Assoc. J.*, 1945, 52, 391; *Lancet*, 1945, 249, 74; MALLINSON, *ibid.*, p. 75; PRESCOTT, ORGANE and ROWBOTHAM, *ibid.*, 1946, 251, 80; GRAY and HALTON, *Proc. Roy. Soc. Med.*, 1946, 39, 400. (39) BENNETT and CASH, *Trans. Amer. Neur. Ass.*, 1942, 68, 102; *Arch. Neurol. Psych.*, 1943, 49, 537; see also *Lancet*, 1943, 244, 274. (40) (a) CHOU, *Brit. J. Pharmacol.*, 1947, 2, 1; DE JALON, *Quart. J. Pharm.*, 1947, 20, 28; (with WEST), *Nature*, 1947, 159, 841; WEST, *Quart. J. Pharm.*, 1947, 20, 518; SKINNER and YOUNG, *J. Pharm. Exp. Ther.*, 1947, 91, 144; VARNEY, LINEGAR and HOLADAY, *Fed. Proc.*, 1948, 7, 261. (b) See, for example, BRISCOE, *J. Physiol.*, 1938, 93, 194; COWAN, *ibid.*, p. 215; HARRIS and HARRIS, *Proc. Soc. exp. Biol. Med.*, 1941, 46, 419; 1944, 56, 223; MCINTYRE and KING, *Science*, 1943, 97, 69, 516; (with DUNN), *J. Neurophysiol.*, 1945, 3, 297; GROSS and CULLEN, *Anæsthesiology*, 1945, 6, 231; COMROE and DRIPPS, *ibid.*, 1946, 7, 260; HOLMES, JENDEN and TAYLOR, *Nature*, 1947, 159, 86; QUILLIAM and TAYLOR, *ibid.*, 1947, 160, 603; FEATHERSTONE and CROSS, *Amer. J. Physiol.*, 1947, 148, 507; EVERETT, *J. Pharm. exp. Ther.*, 1948, 92, 236; (c) KOPFANYI and VIVINO, *Science*, 1944, 100, 474; BÜLBRING and CHOU, *Brit. J. Pharmacol.*, 1947, 2, 8; LEHMANN, *Jubilee Vol. E. Barrell*, 1946, 314; GRAY and HALTON, *Proc. Roy. Soc. Med.*, 1946, 39, 400; HALPERN, *et al.*, *C. R. Soc. Biol.*, 1947, 141, 979, 981. (d) LANGTON HEWER, *Brit. Med. Bull.*, 1946, 4, 110; SCHLESINGER, *Bull. New York Acad. Med.*, 1946, 22, 520; ROBBINS and LUNDY, *Anæsthesiology*, 1947, 8, 252, 348; Report of a symposium on *d*-tubocurarine chloride, *Brit. Med. J.*, 1947, i, 451; MOERSCH, *Dansk. Tids. Farm.*, 1946, 20, 295. (41) *Arch. exp. Path. Pharm.*, 1934, 174, 742; cf. WEST, *Proc. Roy. Soc. Med.*, 1934-5, 28, 572; BRAZIL *et al.*, *Bol. Inst. Vital. Brazil*, 1945, 5, 79 (*Chem. Abstr.*, 1947, 41, 3872); *J. Amer. Med. Assoc.*, 1947, 133, 882; MARSH, SLEETH and TUCKER, *Fed. Proc.*, 1948, 7, 243 and PELLETIER and MARSH, *ibid.*, p. 248. (42) CRUM BROWN and FRASER, *Trans. Roy. Soc. Edin.*, 1869, 6, 228, 461, 556. (43) See, for example, ING (with COWAN), *J. Physiol.*, 1933, 79, 75; 1934, 82, 432; 1935, 84, 90; (with WRIGHT), *Proc. Roy. Soc.*, 1931, B, 109, 337; 1933, B, 114, 48; (with BARLOW) also PATON and ZAIMIS, *Nature*, 1948, 161, 718; ING, *Physiol. Rev.*, 1936, 16, 527; SIMON, *Arch. int. Pharmacodyn.*, 1934, 47, 75; MAGIDSON and MENSCHIKOV, *Ber.*, 1926, 59, 1209; GLUCKSMANN, D.R.P. 571,294; BOVET, COURVOISIER, DUCROT, HORCLOIS, *Compt. rend.*, 1946, 223, 597; 1947, 224, 1733; BOVET, DEPIERRE and LESTRANGE, *Compt. rend.*, 1947, 225, 74; DEPIERRE, *idem.*, p. 956. (44) *J. Pharm. exp. Ther.*, 1942, 75, 265, 270; CHASE, LEHMAN and RICKARDS, *ibid.*, 1944, 82, 266. See also HARVEY and MASLAND, *ibid.*, 1941, 73, 304; PICK (with UNNA), *ibid.*, 1945, 83, 59; (with RICHARDS), *ibid.*, 1947, 90, 1; MARSH and PELLETIER, *ibid.*, 1948, 92, 127; LENORMANT, *Compt. rend. Soc. Biol.*, 1941, 135, 1050. (45) *Brit. J. Pharmacol.*, 1946, 1, 265; 1947, 2, 241; *Quart. J. Pharm.*, 1947, 20, 94; *Nature*, 1947, 159, 813; *Lancet*, 1947, 252, 97; see also BURKE and LINEGAR, *Fed. Proc.*, 1948, 7, 208. (46) MALLINSON, *Lancet*, 1947, 252, 98.

ALKALOIDS OF IPECACUANHA

The roots of *Cephaelis Ipecacuanha* (Brot) A. Rich constitute the Brazilian ipecacuanha of commerce and also that cultivated in the Federated Malay States, Bengal and Burma. *Carthagenia ipecacuanha* is derived from *Cephaelis acuminata* Karsten collected in Colombia. Emetine, the principal alkaloid of this drug, was first obtained by Pelletier and Magendie¹ in 1817, but was first prepared in a pure state by Paul and Cownley,² who separated from commercial emetine the phenolic base, cephaeline, and later obtained a third alkaloid, psychotrine. To these Pyman³ added emetamine and *O*-methylpsychotrine,

Brazilian roots contain up to 2.5 per cent. of total alkaloids, of which, in the Matto Grosso drug, about 70 per cent. is emetine, whilst Carthagena roots yield about 2 per cent. of alkaloids, of which about half is emetine. From roots yielding 2.7 per cent. of total alkaloids, Carr and Pyman⁴ isolated 1.35 per cent. of emetine and 0.25 per cent. of cephaline. The amount of emetamine varies according to Pyman³ from 0.002 to 0.006 per cent. and of *O*-methylpsychotrine from 0.015 to 0.033 per cent. A detailed account of ipecacuanha and its alkaloids is given by Staub,⁵ and a monograph on the Brazilian drug has been compiled by Addor.⁵

Processes for the extraction of the total alkaloids and isolation of the individual bases will be found in the papers cited above.⁶ Cephaline is too toxic for medical use and is usually converted into emetine by methylation of the phenolic hydroxyl group, and processes have been patented for this purpose, beginning with that of Wellcome, Carr and Pyman in 1913.⁷

A method for the estimation of the total alkaloids and of non-phenolic alkaloids (emetine fraction) is given in the British Pharmacopœia, 1932, Addendum VI, which requires the drug to contain not less than 2 per cent. of alkaloids, of which at least 55 per cent. must be non-phenolic bases, calculated as emetine. The British Pharmacopœia also gives an assay process for emetine in emetine bismuth iodide, the form in which the drug is chiefly used in medicine; it is required to contain not less than 25 and not more than 28 per cent. of emetine. In the United States Pharmacopœia, XIII, both *Cephalis Ipecacuanha* and *C. acuminata* are recognised and must contain not less than 2 per cent. of ether-soluble alkaloids.

Much attention has been given to methods of estimating the alkaloidal contents of the drug and numerous papers on this subject have been published.⁸ Lowdell has used his method to investigate the extent and rate of decomposition of emetine, on exposure of its solution in ether to light. The decomposition products include rubremetine (p. 399) or a similar substance.⁸ Owing to recent Brazilian restrictions on the export of ipecacuanha root, special attention is being given to other sources of supply.⁹ In this connection interest attaches to Melville's record of the differential characters of the Brazilian commercial varieties of the drug, as well as those of Johore, Carthagena and Nicaragua varieties.^{9(a)} According to Chopra and Mukherji,^{9(a)} ipecacuanha grown in India contains 2.1 per cent. of alkaloids of which 1.2 to 1.3 per cent. is emetine and recent analyses by Guha and Mukerji^{9(a)} indicate that roots collected in India from three- to four-year-old plants meet the requirements of the British and United States Pharmacopœias.

Owing to the frequency with which the botanical attribution of ipecacuanha has been changed, and to the considerable number of "substitutes" which have from time to time appeared, it is difficult to summarise briefly the botanical distribution of the ipecacuanha alkaloids, and readers interested in this subject may be referred to Staub⁵ for information and references. Freise¹⁰ states that emetine and the allied bases are to be found in certain Rubiaceae spp. not usually regarded as sources of these alkaloids, and Orzi has stated that the roots of *Bourreria*

verticillata contain about 0.1 per cent. of alkaloids including emetine but not cephaeline. Dultz¹¹ states that Nicaraguan ipecacuanha seed contains 0.03 per cent. of alkaloids. Wagenaar¹² has shown that in ipecacuanha root the alkaloids are located in the peripheral cells just under the cork.

Emetine, $C_{25}H_{40}O_4N_2$. Emetine and its principal salts were systematically characterised by Carr and Pyman.⁴ It is a white amorphous powder, m.p. 74° , $[\alpha]_D - 25.8^\circ$ to -32.7° (50%, EtOH, $c = 1.8$ to 4.1) or -50° ($CHCl_3$), readily soluble in alcohol, ether or chloroform, less so in benzene or light petroleum, and sparingly in water. The hydrochloride, B. $2HCl \cdot 7H_2O$,¹³ separates from hot water in colourless, woolly needles or from cold, saturated solutions in thick transparent prisms, m.p. $235-55^\circ$ (*dry, dec.*),¹⁴ $[\alpha]_D + 11^\circ$ to $+21^\circ$ (H_2O , $c = 1$ to 8), $+53^\circ$ ($CHCl_3$). The hydrobromide B. $2HBr \cdot 4H_2O$ forms slender colourless needles, m.p. $250-60^\circ$, $[\alpha]_D + 12^\circ$ to 15.2° (H_2O , $c = 1.4$ to 3.9) from water. The hydriodide, B. $2HI \cdot 3H_2O$, is sparingly soluble in water, and crystallises from alcohol in colourless needles, m.p. $235-8^\circ$. The nitrate, B. $2HNO_3 \cdot 3H_2O$, forms rosettes of silky needles from alcohol or water, sinters at 188° , and gradually melts up to 245° . The sulphate occurs in white woolly needles, B. $H_2SO_4 \cdot 7H_2O$, m.p. $205-45^\circ$, and is very soluble in water. The platinichloride is amorphous, m.p. $253-65^\circ$. Emetine base gives a dirty greenish-yellow colour with sulphomolybdic acid, but the hydrochloride produces a bright green colour.

Cephaeline, $C_{28}H_{38}O_4N_2$, is best purified by recrystallising from ether, the base regenerated from the hydrochloride or hydrobromide. It forms colourless needles, m.p. $115-6^\circ$ or $120-30^\circ$ (dried at 100°), $[\alpha]_D - 43.4^\circ$ ($CHCl_3$), is readily soluble in chloroform or alcohol, less so in ether, insoluble in water, but soluble in alkali. The hydrochloride, B. $2HCl \cdot 7H_2O$, crystallises from dilute hydrochloric acid in stout prisms, m.p. $245-70^\circ$, $[\alpha]_D + 25^\circ$ to 29.5° (H_2O , $c = 1.7$ to 6.7). An acid hydrochloride, B. $5HCl$, m.p. $84-6^\circ$, separates in fine needles from strongly acid solutions. The hydrobromide, B. $2HBr \cdot 7H_2O$, forms from dilute hydrobromic acid, colourless prisms, m.p. $266-93^\circ$. The sulphate, hydriodide and nitrate are amorphous. Cephaeline gives a dull greenish-blue colour with sulphomolybdic acid in presence of a trace of hydrochloric acid. The base couples with *p*-nitrodiazobenzene, giving a dye which dissolves to a purple colour in aqueous sodium hydroxide.¹⁵

Psychotrine, $C_{28}H_{36}O_4N_2 \cdot 4H_2O$, crystallises best from moist acetone or alcohol; it forms yellowish prisms, showing a pale blue fluorescence. After drying at 100° it sinters at 120° , and flows at 138° . It is sparingly soluble in water, ether, or benzene. The hydriodide, B. $2HI$, separates from dilute hydriodic acid in microscopic yellow needles, m.p. $200-22^\circ$; the nitrate B. $2HNO_3 \cdot H_2O$, m.p. $184-7^\circ$ (dried at 100°), crystallises from water in colourless needles. The sulphate, B. $H_2SO_4 \cdot 3H_2O$, is very soluble in water, but can be crystallised from it in faintly yellow, shining scales, m.p. $214-7^\circ$ (dried at 100°), $[\alpha]_D + 39.2^\circ$ (H_2O , dry salt). The acid oxalate, B. $2H_2C_2O_4 \cdot 4.5H_2O$, forms nearly colourless needles softening

at 130° , and melting up to 145° (*dec.*). Psychotrine can be obtained from *O*-methylpsychotrine by partial demethylation with hydrochloric acid at 170° .¹⁶ It gives a green colour with sulphomolybdic acid, and, like cephaëlin, couples with *p*-nitrodiazobenzene to give a dye soluble in alkali, forming a purple solution.¹⁵

***O*-Methylpsychotrine**, $C_{29}H_{38}O_4N_2$. This alkaloid was isolated by Pyman³ from the non-phenolic portion (emetine fraction) of the total alkaloids by removing the emetine as hydrobromide, regenerating the bases remaining in the mother liquors and converting them into hydrogen oxalates, when these salts of *O*-methylpsychotrine and emetamine crystallise together. The mixture is separated by taking advantage of the fact that methylpsychotrine is removed first by dilute sulphuric acid from a solution of the two bases in chloroform. The alkaloid crystallises from hot, dry ether in prisms, m.p. $123-4^{\circ}$, $[\alpha]_D + 43.2^{\circ}$ (EtOH).¹⁶ Dilute aqueous solutions of the salts are fluorescent. The sulphate, $B \cdot H_2SO_4 \cdot 7H_2O$, separates from water in hard, triboluminescent prisms; it melts at 247° (*dec.*), after drying at $160-70^{\circ}$, and has $[\alpha]_D + 54.1^{\circ}$ (dry salt, H_2O); a monohydrate, $B \cdot H_2SO_4 \cdot H_2O$, is obtained by crystallisation from dry alcohol. The hydrobromide, $B \cdot 2HBr \cdot 4H_2O$, forms pale yellow, silky needles, m.p. $190-200^{\circ}$ (dried *in vacuo*), $[\alpha]_D + 48.0^{\circ}$ (dry salt, H_2O). The hydrogen oxalate, $B \cdot 2H_2C_2O_4 \cdot 3 \cdot 5H_2O$, m.p. $150-62^{\circ}$ (*dec.*), $[\alpha]_D + 45.9^{\circ}$ (dry salt, H_2O), crystallises in rosettes of needles. The picrate, octagonal plates from acetone, melts slowly from $142-75^{\circ}$. The base gives a green colour with Fröhde's reagent.

Emetamine, $C_{29}H_{38}O_4N_2$, crystallises from ethyl acetate in colourless needles, m.p. $153-4^{\circ}$, or, if regenerated from salts into ether, it crystallises (with $0.5Et_2O$) from the dry solvent, and then has m.p. $138-9^{\circ}$ or $142-3^{\circ}$ (*dry*); $[\alpha]_D + 13.6^{\circ}$ (EtOH). It is insoluble in water or alkalis, readily soluble in alcohol, benzene or chloroform, sparingly in ether. The hydrobromide, $B \cdot 2HBr \cdot 7H_2O$, forms glistening, prismatic needles from water, m.p. $210-25^{\circ}$, $[\alpha]_D - 24.3^{\circ}$ to -22.0° (H_2O , $c = 8.04$ to 4.15). The hydrogen oxalate, $B \cdot 2H_2C_2O_4 \cdot 3H_2O$, crystallises in colourless rosettes of needles, m.p. 172° (*dec.*), $[\alpha]_D - 6.1^{\circ}$ (H_2O). The hydrochloride, $B \cdot 2HCl \cdot 8.5H_2O$, separates from hydrochloric acid ($d = 1.16$) in glistening needles, m.p. $77-80^{\circ}$ or $218-23^{\circ}$ (*dry*), $[\alpha]_D - 17.5^{\circ}$ (air-dry salt, H_2O). The hydriodide, microscopic crystals, softens from 208° and froths at 274° ; the nitrate, $B \cdot 2HNO_3 \cdot 2H_2O$, forms prismatic needles, m.p. $165-6^{\circ}$, from water; the picrate separates from acetone in long needles, softening at 147° , and gradually melting up to 173° .¹⁶ The alkaloid contains four methoxyl groups, and both nitrogen atoms are tertiary. On reduction with sodium in alcohol it yields a phenolic and a non-phenolic base, and the latter yields benzoyl*iso*emetine, whence it appears that emetamine differs from emetine in containing two unsaturated linkages.³ It gives an emerald-green colour with Fröhde's reagent.

Two minor alkaloids of ipecacuanha, *ipecamine* and *hydroipecamine*, have been described by Hesse, and are discussed by Pyman.³

Interrelationships of the Ipecacuanha Alkaloids. Examination of the

empirical formulæ of the ipecacuanha alkaloids indicates that they are closely related :—

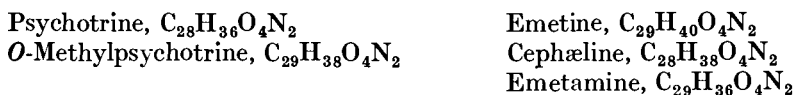

Pyman has shown that psychotrine on treatment with methyl sulphate in presence of sodium amyl oxide is converted into *O*-methylpsychotrine, and Carr and Pyman ⁴ that psychotrine on reduction gives a mixture of cephæline and *iso*cephæline (colourless, diamond-shaped plates, m.p. 159–60°), $[\alpha]_D - 71.8^\circ$ ($CHCl_3$). These are probably stereoisomerides, and on methylation with sodium methyl sulphate in presence of sodium amyl oxide, yield respectively emetine and *iso*emetine,¹⁷ ($C_{29}H_{40}O_4N_2 \cdot H_2O$, plates of radiating needles from ether, m.p. 97–8°, $[\alpha]_D - 47.4^\circ$ ($CHCl_3$), salts dextrorotatory), the two latter being also produced by the reduction of *O*-methylpsychotrine.²⁰ In this operation a third base, $C_{28}H_{38}O_3N_2$, colourless plates, m.p. 126–8°, $[\alpha]_D - 66.2^\circ$ ($CHCl_3$), is formed by loss of a methoxyl group, and is regarded as a demethoxyemetine or a demethoxy-*iso*emetine. These interconversions are mainly brought about by the addition of hydrogen or by methylation of hydroxyl groups, and the interrelationships they imply may be graphically represented thus :—

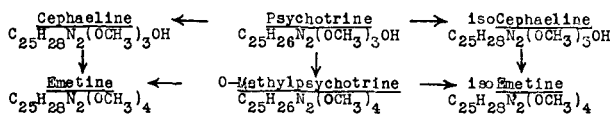

*iso*Emetine is also one of the reduction products of emetamine (Pyman ³) and Ahl and Reichstein ³ have shown that with palladised charcoal at 190–200° emetine is dehydrogenated to emetamine, with 1-methyl-6 : 7-dimethoxyisoquinoline as a by-product. On demethylation emetine and cephæline evolve four and three molecules of methyl chloride (or iodide) respectively, and yield the same phenolic base ⁴ (*noremetine*, *norcephæline*, emetoline, Karrer ¹⁸), $C_{25}H_{32}O_4N_2$, which gives a catechol reaction with ferric chloride. None of the five alkaloids contains a methylimino group, and in each one nitrogen is secondary and the other tertiary,¹⁹ except in emetamine, where both are tertiary.

Methylation of the Alkaloids. When cephæline is treated with methyl sulphate or sodium methyl sulphate under various condition, there is formed in addition to emetine (which was first shown to be the methyl ether of cephæline and partially synthesised in this way by Carr and Pyman in 1913), more or less *N*-methylcephæline (wedge-shaped plates, m.p. 194–5°), and *N*-methylemetine. The latter is also obtained by direct methylation of emetine; it is amorphous, $[\alpha]_D - 52.6^\circ$ ($CHCl_3$), but yields a hydrobromide, $C_{30}H_{42}O_4N_2 \cdot 2HBr \cdot 3H_2O$, m.p. 210–30°, $[\alpha]_D + 5.6^\circ$ (H_2O).

When emetine is fully methylated with methyl iodide, it yields a mixture of α - and β -*N*-methylemetine methiodides, $C_{32}H_{48}O_4N_2I$, melting

at 225–6° and 262° respectively, both of which yield the same *N*-methyl-emetinemethine, $C_{32}H_{46}O_4N_2$ (oxalate, $B \cdot H_2C_2O_4 \cdot 7 \cdot 5H_2O$, hard, brilliant prisms, m.p. 82–3°), so that the methiodides appear to be stereoisomeric.

N-Methylisoemetinemethine, similarly obtained from isoemetine, gives an oxalate, $C_{32}H_{46}O_4N_2 \cdot H_2C_2O_4 \cdot 4H_2O$, crystallising in diamond-shaped prisms, m.p. 133–4° (dried at 100°), $[\alpha]_D + 4 \cdot 2^\circ$ (H_2O), and a methiodide, which crystallises (with 1 mol. of methyl iodide) from water in silky needles, m.p. 178–80°. ²⁰

Oxidation. On gentle oxidation, for example, with iodine (1 mol.) in alcohol, emetine and isoemetine, $C_{29}H_{40}O_4N_2$, are converted into *O*-methylpsychotrine, $C_{29}H_{38}O_4N_2$, whilst more vigorous oxidation of any of these three bases, for example, with four molecular proportions of iodine, or by boiling with ferric chloride yields a new mono-acidic base, RUBREMETINE (dehydroemetine), $C_{29}H_{32}O_4N_2$, isolated as the hydrochloride (rubremetinium chloride ²¹), $B \cdot HCl \cdot 6H_2O$, brilliant scarlet needles, m.p. 127–8° or 166–73° (*dry*). In rubremetine one nitrogen atom is no longer basic, and the second has become quaternary.

Carr and Pyman's observation that on oxidation with potassium permanganate in acetone, emetine yields 6 : 7-dimethoxyisoquinoline-1-carboxylic acid and *meta*hemipinic acid (the latter confirmed by Windaus and Hermanns) ²² constitutes the first definite evidence of the presence of an isoquinoline nucleus in emetine and the allied bases. ²³ In 1927, Späth and Leithe ²⁴ showed that emetine on gentle oxidation with dilute, faintly alkaline solution of potassium permanganate gave 1-keto-6 : 7-dimethoxy-1 : 2 : 3 : 4-tetrahydroisoquinoline (corydaldine, p. 286), and pointed out that unless the oxidation of emetine to 6 : 7-dimethoxyisoquinoline-1-carboxylic acid as observed by Carr and Pyman implied an unusual dehydrogenation, this new observation indicates the presence of a corydaldine complex, and therefore of a second isoquinoline nucleus in emetine. In support of this view it was found that on oxidation of emetine the yield of *m*-hemipiinic acid was 65 per cent. of that calculated for one isoquinoline group, whereas palmatine and papaverine each containing only one isoquinoline group gave only 34 and 25 per cent. respectively, and that further treatment of the by-products in the oxidation of emetine increased the yield to 96 per cent. of the calculated *m*-hemipiinic acid, allowance being made for the ketonic base. The second isoquinoline nucleus thus indicated must contain the secondary nitrogen atom, since *N*-benzoylemetine on oxidation under similar conditions gave 3 : 4-dimethoxy-6- β -benzamidoethylbenzoic acid. In cephaeline the same nucleus probably contains the free hydroxyl group, since cephaeline ethyl ether, on oxidation, gave a mixture of 1-keto-6 : 7-dimethoxy- and 1-keto-7-methoxy-6-ethoxytetrahydroisoquinoline. At the second stage of an Emde degradation emetine produced some trimethylamine (*cf.* Karrer ²¹), indicating the presence of a secondary nitrogen atom, but in the third stage only poor yields of a nitrogen-free product were obtained. On the basis of these observations the partial formula (I) was proposed for emetine by Späth and Leithe. ²⁴

Later in the same year Brindley and Pyman, ¹⁶ proposed formulæ for

all the ipecacuanha alkaloids derived from formula (II), suggested by Robinson in 1925,²⁵ based on a hypothesis as to the possible phytochemical origin of emetine. These authors developed their formulæ in the following way: Formula (II) does not readily afford an explanation of the oxidation of emetine to rubremetine, whereby eight hydrogen atoms are lost, one nitrogen atom becomes non-basic and the other acquires quaternary character, all of which are accounted for by formula (III) for rubremetinium chloride, derivable from formula (IV, R = Me) for emetine. The loss of basicity of one of the nitrogen atoms is thus attributed to amidine formation (double bond N² to C¹²), the quaternary nitrogen atom is accounted for, and of the remaining six vanished hydrogen atoms, one pair is required for the ethylenic linkage C¹ to C⁹, the presence of which is necessary in the formula for *O*-methylpsychotrine, and as the latter is an intermediate product in the formation of rubremetine, this double bond is probably present in the latter, and requires a third double linkage C¹⁰—C¹¹ owing to the formation of the pyridine ring, C. The fourth double bond in rubremetine is assumed to be at C³—C⁴ to account for the resemblance of the oxidation, emetine → rubremetine, to that of tetrahydroberberine → berberine (p. 334), and at the same time to explain why rubremetine cannot be converted into substances analogous with oxyberberine and berberine-acetone.

The methyl group at C¹⁴ (III) instead of at C¹² as in (II) is in agreement with the position of the similar group in corydaline (p. 287).

In view of the interrelationships between the five ipecacuanha alkaloids shown on p. 398, formula (IV: R = Me) for emetine leads to the following formulation of the other ipecacuanha alkaloids. The position of the phenolic hydroxyl group must be the same in cephaeline and psychotrine, and is assumed to be at C⁶. This location appears to be indicated by (1) the results of Späth and Leithe's²⁴ oxidation of cephaeline ethyl ether (p. 399); (2) by the formation of the substance, C₂₀H₂₇O₃NCl₂, obtained by Carr and Pyman⁴ by the oxidation of cephaeline (IV: R = H) with ferric chloride, and whose properties are accounted for by formula (V) in which the *isoquinoline* nucleus containing the phenolic hydroxyl group in ring *A* has disappeared; and (3) the fact that *O*-methylpsychotrine on partial hydrolysis gives a good yield of psychotrine, the single methoxyl group thus preferentially hydrolysed being probably in the *para*-position to the C¹—C⁹ ethylenic linkage assumed to be present in psychotrine, which is the case for the MeO group at C⁶.

The relationship of psychotrine and *O*-methylpsychotrine to the two pairs of stereoisomerides (*a*) cephaeline + *iso*cephaeline, and (*b*) emetine + *iso*emetine respectively, implies that in each of these reductions one ethylenic linkage is saturated and produces one new centre of asymmetry. This ethylenic linkage is assumed to be at C¹ to C⁹, so that on this basis the components of each of the stereoisomeric pairs (*a*) and (*b*) just referred to must be epimeric pairs about C¹.

Fair yields of emetine and *iso*emetine are obtained in the reduction of *O*-methylpsychotrine, but some demethoxyemetine (p. 398) is formed due

to the replacement of one methoxyl group by hydrogen, a change known to occur with methoxyl groups in the *para*-position with respect to a

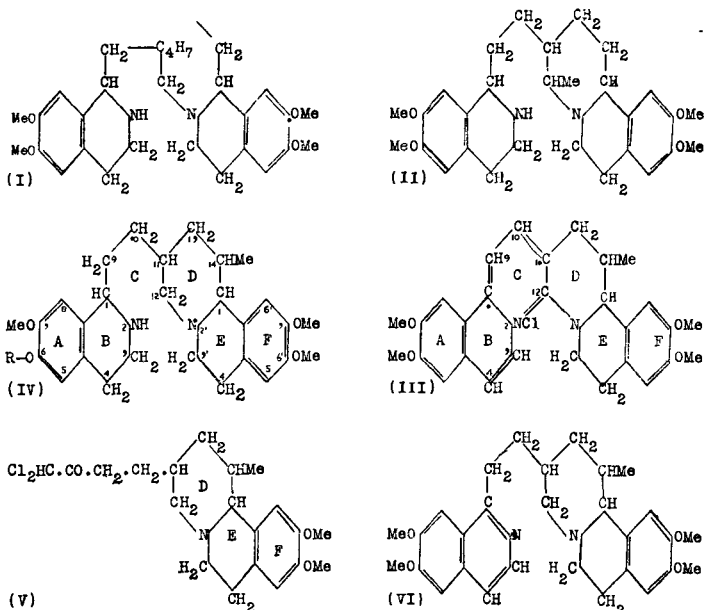

vinyl group; a condition which can be regarded as existing in ring *A* of *O*-methylpsychotrine. The latter is, therefore, represented by (IV) with a double bond at C¹—C⁹ and psychotrine by (IV) with R = H, and a double bond at C¹—C⁹.

Emetamine reduces to *isocemetine* by addition of four atoms of hydrogen, but it seems unlikely that either of its ethylenic linkages occupies position C¹ to C⁹, since it is not found as an intermediate product in the oxidation of *O*-methylpsychotrine to rubremetine, and does not itself yield the latter on oxidation. As it is more feebly basic than *O*-methylpsychotrine, it is assumed that ring *B* of *isoquinoline* nucleus (*A.B.*) is unsaturated as in (VI). Staub,⁵ taking into account the similarity of berberine and rubremetine, and having found that the bromide of the latter is oxidised by permanganate to dioxyrubremetine (dioxyldehydroemetine), C₂₉H₂₈O₆N₂, m.p. >305°, suggested a modified formula for emetine (p. 402) with corresponding changes in the formulæ of the associated alkaloids.

Ahl and Reichstein³ have pointed out that though it is certain that the structure of emetine includes one, and possibly two, 6 : 7-dimethoxy-tetrahydro*isoquinoline* nuclei, the suggestions so far made as to the nature of the rest of the molecule are speculative. They investigated the Hofmann degradation of *N*-acetylemetine, m.p. 97–9°. This forms a monomethide, m.p. 213–6°, from which, by the action of silver oxide and potassium hydroxide, followed by cautious thermal decomposition and reacylation,

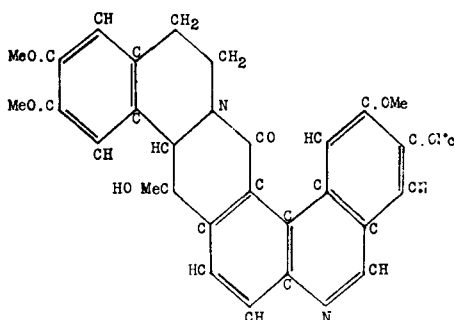
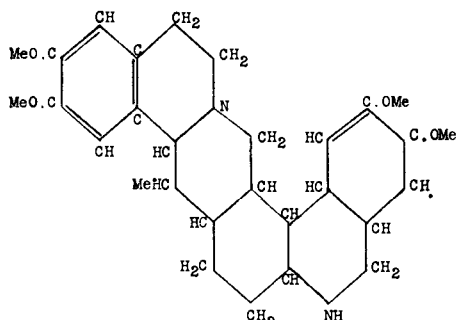
Dioxhydroemetine (Staub)Emetine (Staub)

the amorphous methine base, $C_{32}H_{44}O_5N_2$, was prepared. The methiodide, m.p. $239-40^\circ$, of the latter in the second step of the degradation followed by reacylation, produced a base, characterised as the methoaurichloride, m.p. $111-8^\circ$, and the methiodide, $C_{34}H_{49}O_5N_2I$, m.p. $165-75^\circ$. The latter, in the third stage of the degradation, carried out under strictly controlled conditions, yielded trimethylamine and a neutral substance, $C_{31}H_{39}O_5N$, in which the original secondary nitrogen, marked by its acetyl group, is still present and from which the tertiary nitrogen has disappeared. On oxidation by chromic acid this neutral compound yields *metahemipinic acid*, but with permanganate in acetone under acidic conditions, it also

forms 4 : 5-dimethoxyphthalonimide, $(MeO)_2 \cdot C_6H_2 \cdot CO \cdot NH \cdot CO \cdot CO$, m.p. $269-75^\circ$ (*dec.*), identical with the substance obtained by Hermanns²² in the oxidation of emetine with chromic acid and which was later prepared by Buck²² by the chromic acid oxidation of 6 : 7-dimethoxytetrahydroisoquinoline. These results are considered to be more readily explicable on the basis of the Brindley and Pyman formula than on that of Staub.⁵

The synthetic products allied to emetine prepared by Child and Pyman²⁹ are referred to later. An approach to an analogue of emetine has also been made by King and Robinson.²⁹

Therapeutic Uses of Ipecacuanha Alkaloids. Emetine is used in medicine as an emetic, and in small doses as an expectorant; but for the latter purpose ipecacuanha itself, or one of its galenical preparations, is generally used. Emetine is chiefly of interest as a remedy for amœbic dysentery owing to its direct toxic action on *Entamœba histolytica*, for which purpose it is employed as the hydrochloride for injection, or in one of the insoluble forms, such as emetine bismuth iodide, for oral administration.²⁶ Methods devised by Dobell *et al.*²⁷ have been much used for testing amœbicidal agents *in vitro*, and show that emetine is much more toxic to *Entamœba histolytica* than its stereoisomeride *isoemetine*, or than *N*-methylemetine or *O*-methylpsychotrine, all of which have been tried clinically²⁸ and found inactive. Pyman and his collaborators have synthesised for trial as amœbicides four series²⁹ of substances, of which typical examples are represented by formulæ A, B (and B'), C and D. Representatives of type A

proved inactive *in vitro* at 1 in 5,000, and the best example of types B and B', 9 : 10-dimethoxy-3-phenyl-5 : 6-dihydrobenzglyoxalocoline (B') was active at 1 in 25,000 as compared with emetine, effective at 1 in 500,000.

The harmol derivatives (type C), in which R ranged from ethyl to *n*-dodecyl, proved active *in vitro*, and reached a peak of activity at *O*-nonylharmol, and in a second series in which R was modified by the inclusion of a dialkylamino-residue, activity was further increased and reached a maximum at *O*- λ -di-*n*-butylaminoundecylharmol (type C : R = (C₄H₉)₂N(CH₂)₁₁—).

The remarkable activating influence of the dialkylaminoalkyl side-chain was still shown when the harmol nucleus was replaced by other basic nuclei or even by a simple substituted amino-group, and out of an extensive series of compounds of the general formula (D) $\alpha\kappa$ -tetra-*n*-amyldiamino-*n*-decane proved to be the most active.

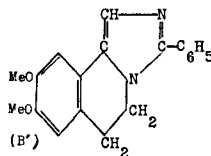
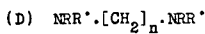
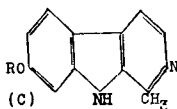
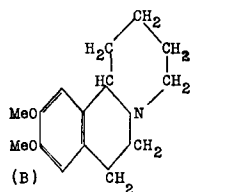
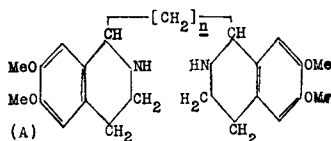

It has been shown by various workers³⁰ that the action of alkaloids on protozoa is influenced in a marked degree by the pH of the medium in which the action is exerted, and at a pH of 6.2 to 6.3 $\alpha\kappa$ -tetra-*n*-amyl-diamino-*n*-decane proved to be 3 to 5 times as active as emetine, and even in presence of blood at least as active. In view of these promising results of *in vitro* tests the synthetic product was tried clinically, but proved not to be sufficiently active to be of practical value. This work is being continued and extended by a team of workers led by Goodwin and Sharp,³¹ who have published two papers dealing (1) with amines which can be regarded, like Pyman's type A, as diamines derivable from the accepted emetine formula and (2) variants on the bis(diamylamino) decane referred to above.

There is a voluminous literature on the subject of amœbicidal agents, which is summarised up to 1932 by Fischl and Schlossberger.³² Recent work includes the clinical comparison by Manson-Bahr of a number of possible substitutes for emetine,³³ the introduction of improved methods for the biological testing of potential amœbicides of which the papers by Jones³⁴ and by Goodwin, Hoare and Sharp³⁵ afford examples, and work

on the pharmacology of emetine and the related alkaloids by Sapeika,³⁶ Kile and Welch³⁷ and by Boyd and Scherf.³⁸

REFERENCES

- (1) *Ann. Chim. Phys.*, 1817, [ii], 4, 172; 1823, [ii], 24, 180. (2) *Pharm. J.*, 1894-95, [iii], 25, 111, 373, 641, 690; 1896, [iv], 2, 321; 1898, [iv], 7, 100. Cf. GLENARD, *Ann. Chim. Phys.*, 1876, [v], 8, 277; and KUNZ-KRAUSE, *Arch. Pharm.*, 1887, 225, 461; 1894, 232, 466. (3) *J. Chem. Soc.*, 1917, 111, 428; see also AHL and REICHSTEIN, *Helv. Chim. Acta*, 1944, 27, 366; BUCK, *J. Amer. Chem. Soc.*, 1934, 56, 1769. (4) *J. Chem. Soc.*, 1914, 105, 1599; cf. HESSE, *Annalen*, 1914, 405, 1. (5) "Ein Jahrhundert chemischer Forschung über Ipecacuanha-Aklaloide," Zurich, 1927; *Helv. Chim. Acta.*, 1927, 10, 826; ADDOR, *Bol. Minist. Agr. Brazil*, 1945, 34, No. 5, p. 1. (6) See also KELLER and BERNHARD, *Arch. Pharm.*, 1925, 263, 401. (7) B.P. 14,677; see also B.P. 17,483, D.R.P. 298,678, B.P. 291,088 (1928), and Russ.P. 20,082 (*Chem. Zent.*, 1931, ii, 3664). (8) FIGDOR, *Amer. J. Pharm.*, 1926, 98, 157, describes a micro-form of Dieterle's process, *Arch. Pharm.*, 1923, 261, 77; BLISS, *J. Assoc. Off. Agric. Chem.*, 1927, 10, 359; LÉGER, *J. Pharm. Chim.*, 1927, [viii], 6, 501 (ipecacuanha extracts); MADSEN, *Dansk. Tids. Farm.*, 1928, 2, 145 (ipecacuanha extracts); BAGGESGAARD-RASMUSSEN, WAEL and CHRISTENSEN, *Dansk. Tids. Farm.*, 1929, 3, 250 (drug and galenical preparations); BAUER and HEBER, *Pharm. Zent.*, 1930, 71, 513; cf. BÜCHI, *Pharm. Zeit.*, 1933, 78, 448; KLYACHKINA and ZILBERG, *Bull. Nauch. Issledov. Khim.-Farm. Inst.*, 1931, 103 (separation of secondary bases from emetine); DAVID, *Pharm. Zeit.*, 1935, 80, 1121; 1936, 81, 806; JERMSTAD, *Norsk. farm. Tids.*, 1936, 44, 358, 388; EVERS and SMITH, *Quart. J. Pharm.*, 1938, 11, 758; DI GANGI and TRUPE, *J. Amer. Pharm. Assoc.*, 1943, 32, 22; WHIPPLE and WOODSIDE, *ibid.*, 1948, 37, 83; LOWDELL, *Pharm. J.*, 1946, 156, 141; 157, 153. (9) See, for example, *Rept. Council Sci. Ind. Res. Aust.*, 1942-3, p. 11. (9a) MELVILLE, *Pharm. J.*, 1946, 157, 89; *Quart J. Pharm.*, 1946, 19, 202; CHOPRA and MUKERJI, *Ind. Med. Gaz.*, 1932, 67, 88; cf. HOOPEP, *Pharm. J.*, 1891, [iii], 22, 591; CÆSAR and LORETZ, *ibid.*, 1892, [iii], 23, 267; GUHA and MUKERJI, *Sci. and Cull.*, 1945, 11, 204; BAL and DATTA, *ibid.*, 10, 448; 1946, 12, 200. (10) FRIESE, *Pharm. Zentr.*, 1935, 36, 223; ORAZI, *Rev. facultad. cienc. quim.*, 1946, 19, 17. (11) *Pharm. Zent.*, 1934, 75, 598. (12) *Pharm. Wechbl.*, 1935, 72, 513. (13) Cf. PAUL and COWNLEY, *Pharm. J.*, 1894, [iii], 25, 373; KELLER, *Arch. Pharm.*, 1911, 249, 519. (14) The melting-points of the ipecacuanha alkaloids and their salts are often indefinite; the first temperature mentioned is usually a sintering-point, and the second the point at which the substance flows or decomposes. (15) PYMAN, *J. Amer. Chem. Soc.*, 1926, 48, 836; cf. PALKIN and WALES, *ibid.*, 1924, 46, 1488; 1925, 47, 2005. (16) BRINDLEY and PYMAN, *J. Chem. Soc.*, 1927, 1067. (17) PYMAN, *ibid.*, 1918, 113, 224. (18) Cf. KARRER, *Ber.*, 1916, 49, 2057; 1917, 50, 582. (19) First observed in emetine by KELLER, *Arch. Pharm.*, 1911, 249, 512. (20) PYMAN, *J. Chem. Soc.*, 1917, 111, 445; 1918, 113, 234. Cf. KARRER, *Ber.*, 1916, 49, 2057; and HESSE, *Annalen*, 1914, 405, 1. (21) CARR and PYMAN, *J. Chem. Soc.*, 1914, 105, 1599; PYMAN, *ibid.*, 1917, 111, 428; cf. KARRER, *Ber.*, 1916, 49, 2057. (22) *Ibid.*, 1914, 47, 1470; HERMANN, *Inaug. Diss. Freiburg i. Br.*, 1915. (23) Cf. DOBBIE and FOX, *J. Chem. Soc.*, 1914, 105, 1642. (24) *Ber.*, 1927, 60, 688. (25) Quoted by BRINDLEY and PYMAN (16). (26) CHOPRA and CHOPRA, *Ind. Med. Gaz.*, 1942, 77, 65; ADAMS, *Trans. Roy. Soc. Trop. Med. Hyg.*, 1945, 38, 237; HARGREAVES, *ibid.*, p. 244; *Lancet*, 1945, ii, 68; DACK and MLOSHOK, *Arch. intern. med.*, 1947, 79, 228. (27) DOBELL (with LAIDLAW), *Parasitology*, 1926, 18, 206; (with LAIDLAW and BISHOP), *ibid.*, 1928, 20, 207; see also BONNIN and ARETAS, *Bull. Soc. Path. Exot.*, 1938, 31, 829; REGNIER et al., *Ann. Pharm. Franc.*, 1944, 2, 49; DE LAMATER and HALLMAN, *Proc. Soc. Exp. Biol. Med.*, 1947, 65, 26; BRACKETT and BLIZNECK, *J. Parasitol.*, 1947, 33, 154. (28) JEPPI and MEAKINS, *Brit. Med. J.*, 1917, ii, 645; Low, *ibid.*, 1915, ii, 715; WENYON and O'CONNOR, *J. Roy. Army Med. Corps*, 1917, 28, 473. (29) CHILD and PYMAN, *J. Chem. Soc.*, 1929, 2010; 1931, 36; COULTHARD, LEVENE and PYMAN, *Biochem. J.*, 1933, 27, 727; 1934, 28, 264; PYMAN, *Chem. and Ind.*, 1937, 56, 789; for other synthetic

work in this direction see SUGASAWA *et al.*, *Proc. Imp. Acad. Tokyo* and KING and ROBINSON, *J. Chem. Soc.*, 1938, 2119. (30) IRIYE, *Nisshin. Igaku*, 1912, 11, No. 9; ACTON, *Lancet*, 1922, i, 126; HENRY and BROWN, *Trans. Roy. Soc. Trop. Med. Hyg.*, 1923-24, 17, 61. (31) (With GOODSON, GORVIN, GOSS, KIRBY, LOCK, NEAL and SOLOMON), *Brit. J. Pharmacol.*, 1948, 3, 49, 62. (32) *Handb. Chemother.*, Teil 1 (Fischer, Leipzig, 1932), pp. 224-56. (33) *Brit. Med. J.*, 1941, ii, 255; see also symposium on amœbiasis, *Trans. Roy. Soc. Trop. Med. Hyg.*, 1947, 41, 55. (34) JONES, *Brit. J. Pharmacol.*, 1947, 2, 217. (35) *Ibid.*, 1948, 3, 44. (36) *S. Afr. J. Med.*, 1937, 2, 10. (37) *Arch. Dermat. Syphilol.*, 1942, 45, 550. (38) *J. Pharm. exp. Ther.*, 1941, 71, 362.

PHENANTHRIDINE GROUP

ALKALOIDS OF THE AMARYLLIDACEÆ

From *Narcissus pseudonarcissus* L. Gerrard¹ isolated the alkaloid narcissine, which was subsequently examined by Ewins.² Twenty years later Morishima³ described a supposed new alkaloid, lycorine from *Lycoris radiata* Herb., and in 1913, Asahina and Sugii⁴ suggested that lycorine and narcissine were identical. This was confirmed by Gorter,⁵ who found the same alkaloid in the following Amaryllidaceous plants: *Amaryllis belladonna* L.; *Clivia miniata* Benth⁶; *Cooperia Drummondii* Herb. (also in *C. pedunculata* by Greathouse and Rigler⁷), *Crinum asiaticum* L.,⁸ *C. giganteum* Andr., *C. pratense* Herb. (also in *C. scabrum*, by Reichert⁹), *Cyrtanthus pallidus* Sims.; *Eucharis grandiflora* Blanck.; *Eurycles sylvestris* Salisb., (also in *E. amboinensis* by Oliveros and Santos¹⁰); *Hymenocallis littoralis* Salisb.; *Sprekelia formosissima* Herb. App.¹¹ (*Ungernia Sewertzovii* Rgl. by Norkina and Orekhov¹²) and (*U. tadshicorum* Uved., by Jurashevski¹³); *Zephyranthes rosea* Lindl and (*Z. texana* by Greathouse and Rigler⁷). The names in brackets in this list are those of species in which lycorine has been recorded by other authors than Gorter.

Lycorine may also be the alkaloid Robecheck¹⁴ found in *Narcissus orientalis*, but *N. poeticus* L., according to Kolle and Gloppe,¹⁵ contains narcipoetine, which may be identical with homolycorine. From *Narcissus tazetta* L. Späth and Kahovec¹⁶ isolated tazettine, to which Kihara¹⁶ has recently added suisenine. Kondo's "base VIII"¹⁷ from *Lycoris radiata* and "ungerine," obtained from *Ungernia Sewertzovii* Rgl. by Orekhov and Norkina,¹² were eventually identified with tazettine. The same authors¹⁶ suggest that sekisanine may also be identical with tazettine. In *Cooperia pedunculata*, Greathouse and Rigler⁷ found a second alkaloid, which may be ψ -lycorine. From *Lycoris radiata* Herb. there have been isolated nine alkaloids, viz., lycorine, lycoramine, lycorenine and tazettine and the minor bases, sekisanine, sekisanoline, ψ -lycorine, homolycorine, and base IX. From *Buphane disticha* Herb. (*Hæmanthus toxicarius* Herb.) Tutin¹⁸ isolated lycorine (narcissine) and three amorphous bases, one of which was named buphanine; the latter has not been characterised but it is converted by potassium hydroxide into a crystalline substance, buphanitine, which has been described.

Lycorine (*Narcissine*), $C_{16}H_{17}O_4N$. The alkaloid crystallises in prisms, m.p. 275° (*dec.*), $[\alpha]_D^{26} - 129^\circ$ (EtOH), and is best purified as the hydrochloride B. HCl. H_2O , needles, m.p. 217° (*dec.*), $[\alpha]_D + 43.0^\circ$; the picrate has m.p. 196° and the perchlorate m.p. 230° (*dec.*). Lycorine contains a methylenedioxy group and two non-phenolic hydroxyl groups (diacetyl derivative, m.p. $215-6^\circ$, $[\alpha]_D + 31.5^\circ$). On oxidation with alkaline permanganate it furnishes hydrastic (4 : 5-methylenedioxyphthalic acid)

and oxalic acids. On these grounds and an assumed resemblance to hydrastine, Gorter ⁵ proposed an *isoquinoline* formula for the alkaloid. Kondo and Tomimura ¹⁹ confirmed Gorter's results but did not accept his formula. Kondo and Uyeo ²⁰ found that lycorine on distillation with zinc dust yielded phenanthridine, thus establishing a relationship with tazettine. In the first stage of the Hofmann degradation of lycorine, the methine base obtained is abnormal, the two hydroxyl groups being eliminated by loss of water. The product obtained is lycorineanhydromethine, $C_{17}H_{15}O_2N$, m.p. 98.5° , $[\alpha]_D \pm 0^\circ$. This on oxidation with permanganate yields two acids, (a) $C_{17}H_{11}O_6N \cdot H_2O$, m.p. 252° (*dec.*), and (b) $C_{16}H_{11}O_5N$, m.p. 288° . The former passes into the second on further oxidation with hydrogen peroxide, indicating that it is an α -keto-carboxylic acid. Acid (b) loses carbon dioxide on fusion and gives a neutral substance, $C_{15}H_{11}O_3N$, m.p. 238° , which was shown to be 6:7-methylenedioxy-*N*-methylphenanthridone (I), by comparison with a synthetic specimen. The position of the carboxyl group in (b) could not be determined by synthetic methods but is probably at C¹ since dihydrolycorineanhydromethine, $C_{17}H_{17}O_2N$, m.p. 87.5° [picrate, m.p. 174° (*dec.*); methiodide, m.p. 236° (*dec.*)] on distillation with zinc dust yields a mixture of phenanthridine, 1-methylphenanthridine and 6:7-methylenedioxyphenanthridine, m.p. 142° [picrate, m.p. 257° (*dec.*)], the identity of the two latter being established by comparison with the synthetic products. These results indicate for lycorineanhydromethine formula (II).

In 1937 ²⁰ a formula of type (III) was put forward for lycorine, but the location of the two hydroxyl groups and of an ethylenic linkage had still to be determined. It seems certain these are in ring B, since the production of hydrastic acid on oxidation precludes the presence of two hydroxyls in rings A or C. In 1938 it was shown that lycorine produces two methiodides, α -, m.p. 247° (*dec.*), $[\alpha]_D^{20} - 46.1^\circ$ (H_2O), and β -B. MeI. H_2O , m.p. 198° (*dec.*) or 281° (*dry, dec.*), $[\alpha]_D^{20} + 128^\circ$ (*dry, H_2O*). Hofmann degradation of either leads to the lycorineanhydromethine, m.p. 98.5° , described above, and this on catalytic hydrogenation gives the dihydrolycorineanhydro-

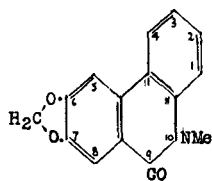

(I)

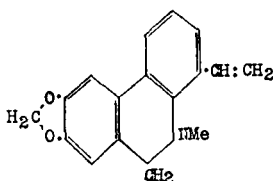

(II)

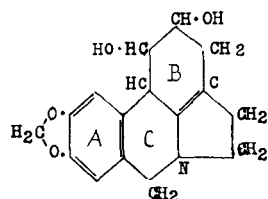

(III)

methine, $C_{17}H_{17}O_2N$, m.p. 87.5° (a) also described already. When the Emde degradation process is applied to the corresponding lycorine α - and β -methochlorides there is formed lycorinedihydroanhydromethine, m.p. $71-71.5^\circ$, [picrate, m.p. $197-8^\circ$, methiodide, m.p. 235° (*dec.*)] which is isomeric with (a) and may be distinguished as (b). On ozonisation (b) produces formaldehyde so that it appears to retain the vinyl group (II)

and on catalytic hydrogenation it yields a hexahydride, $C_{17}H_{23}O_2N$, m.p. $70-72^\circ$, picrate, m.p. $218-21^\circ$. When the Emde degradation process is continued by the reduction of the (*b*)-methochloride with sodium amalgam, there is formed the further methylated, and reduced substance, $C_{18}H_{21}O_2N$, b.p. $165^\circ/0.01$ mm. [picrate, m.p. $147-8^\circ$, methiodide, m.p. $186-7^\circ$] and this by the reduction of its methochloride produces de-*N*-hydroanhydrolycorine, $C_{16}H_{16}O_2$, b.p. $160-70^\circ/0.03$ mm., with elimination of the nitrogen atom. When the lycorineanhydromethine, $C_{17}H_{15}O_2N$, produced in the first stage of the Hofmann process is converted to the methochloride and the latter reduced with sodium amalgam the product is identical with (*b*), viz., lycorinedihydroanhydromethine, $C_{17}H_{17}O_2N$, methyl chloride being eliminated in the reduction process²⁰ (1940). The decision between C_1-C_{11} and $C_{11}-C_{12}$ for the ethylenic linkage was made in favour of the former (III) by a comparison of the absorption spectra of lycorine (III), dihydrolycorine (III; with ring B fully hydrogenated) and their diacetyl derivatives, with that of lycorinedihydroanhydromethine, which indicated that the ethylenic linkage in ring B is not conjugated with a similar linkage in ring A, i.e., it is at C_1 to C_{11} and that in the formation of lycorinedihydroanhydromethine one ethylene linkage in B (formula II) is saturated in preference to that of the vinyl group.

On catalytic hydrogenation lycorine yields dihydrolycorine, $C_{16}H_{19}O_4N$, m.p. 247° , which is oxidised by permanganate to dihydrolycorinone, $C_{16}H_{17}O_5N$, m.p. 246° , and this in turn is oxidised by lead tetracetate to a dialdehyde, isolated as the dioxime, $C_{16}H_{17}O_5N_2$, m.p. 233° (*dec.*). A freshly prepared solution of the dialdehyde is oxidised by peracetic acid to a substance, $C_{16}H_{15}O_6N$, m.p. 245° (*dec.*), believed to be the corresponding aldehydo-acid. This sequence of changes may be represented as below:—

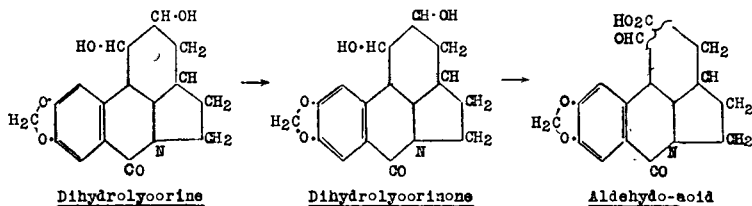

Lycoramine, $C_{17}H_{25}O_3N$. This base was first described as ψ -homolycorine, $C_{19}H_{23}O_4N$ (1932).²² It crystallises from acetone in plates, m.p. $120-1^\circ$, $[\alpha]_D^{27} - 98.15^\circ$ (EtOH), yields a platinumchloride, m.p. 245° (*dec.*), a perchlorate, prisms, m.p. $138-9^\circ$, and a picrate, m.p. $108-9^\circ$. The methiodide forms colourless prisms, m.p. 308° . Lycoramine contains one methylimino-group, one methoxyl group and two non-phenolic hydroxyl groups (diacetyl derivative, m.p. 95°). On oxidation with permanganate it yielded oxalic acid, *m*-methoxyphthalic anhydride, and a neutral substance, $C_{17}H_{23}O_4N$, m.p. 253° , $[\alpha]_D^{18.50} + 73.65^\circ$ ($CHCl_3$) which (*a*) still contains the NMe, OMe, (OH)₂ groups of lycoramine, (*b*) regenerates the parent base on electrolytic reduction, (*c*) yields 1-methylphenanthridine

on distillation with zinc dust, and (d) on oxidation with chromic acid is converted into an α -diketone (V) $C_{17}H_{19}O_4N$, m.p. 220° , $[\alpha]_D^{17} + 275.5^\circ$. This, on oxidation with permanganate in acetone at 0° , yields three acids: $C_{17}H_{21}O_6N$, m.p. $222-3^\circ$ (VI); $C_{16}H_{19}O_5N$, m.p. $119-20^\circ$ (VII), and $C_{13}H_{13}O_6N$, m.p. $261-2^\circ$ (*dec.*) (VIII) which behaves as an *o*-dicarboxylic acid and on decarboxylation yields 6-methoxy-2-methylhydroisocarbostyryl (IX), identified by comparison with the synthetic product. On the basis of these and other results formula (IV) is assigned to lycoramine.²¹

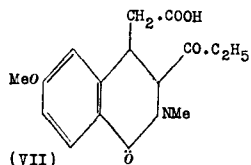
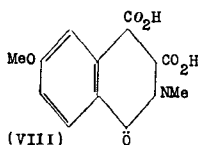
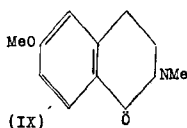
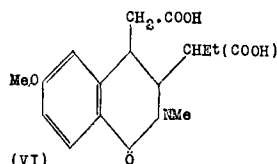
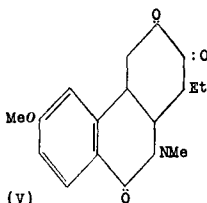
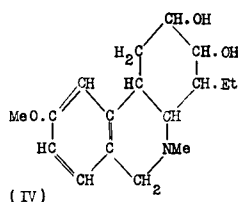

Lycorenine, $C_{18}H_{23}O_4N$. The base crystallises from acetone in rhombic prisms, m.p. $200-2^\circ$, $[\alpha]_D^{22} + 149.3^\circ$. The platinichloride decomposes at 210° , the aurichloride at 116° and the picrate at 162° . Lycorenine contains one methylimino, two methoxyl and two non-phenolic hydroxyl groups; it forms a monoacetyl derivative, m.p. $185-7^\circ$, and with difficulty a diacetyl derivative, m.p. $175-6^\circ$, and behaves as a pseudo-base giving an oxime hydrochloride, which decomposes at 258° . Catalytic hydrogenation converts it into a dihydro-derivative, m.p. $175-7^\circ$, and eventually into deoxytetrahydrolycorenine, $C_{18}H_{25}O_3N$, m.p. $165-8^\circ$, with accompanying compounds, $C_{18}H_{23(25)}O_3N$, m.p. $120-3^\circ$, and $C_{18}H_{27}O_2N$, m.p. $165-7^\circ$. Lycorenine methiodide decomposes at 260° and on treatment with silver hydroxide yields two methine bases, α - and β -, of which the former was isolated as the methiodide, $C_{18}H_{20}O_3NMe_2I$, m.p. 223° (*dec.*); one oxygen atom is lost as water at this step in the degradation, and in the next stage de-*N*-lycorenine, $C_{15}H_{10}O(OMe)_2$, m.p. $114-5^\circ$, is formed, in which the residual oxygen is present as a carbonyl group, possibly due to the conversion of the .CHOH group at C^9 into a .CHO group with the elimination of the nitrogen atom. de-*N*-lycorenine on ozonisation yields

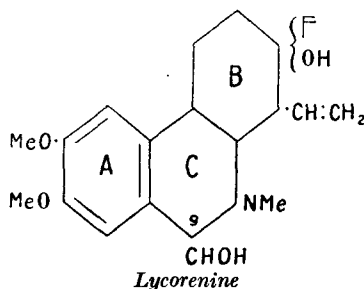

formaldehyde, a dialdehyde, $C_{16}H_{14}O_4$, m.p. $155-7^\circ$, and an aldehydic acid, $C_{16}H_{14}O_5$, m.p. $228-30^\circ$; the latter is further oxidised by permanganate to a dicarboxylic acid, $C_{16}H_{14}O_6$, m.p. $256-7^\circ$, which has been characterised as 3 : 4-dimethoxydiphenyl-6 : 3'-dicarboxylic acid by comparison with a synthesised specimen. On these results the partial formula (p. 409) for lycorine has been suggested in which the position of a hydroxyl group and an ethylenic linkage both assumed to be in ring B have yet to be determined.²²

Tazettine, $C_{18}H_{21}O_5N$. This alkaloid isolated by Späth and Kahovec,¹⁶ has m.p. $210-1^\circ$ (*vac.*), $[\alpha]_D^{16} + 150.4^\circ$ ($CHCl_3$) and yields an *O*-acetyl derivative, m.p. $125-126.5^\circ$. There are also present one methoxyl and one methylenedioxy-group. With sulphuric acid the base produces a brownish-red colour changing to dirty green and brownish-violet on warming. On distillation with zinc dust it yields phenanthridine, $C_{13}H_9N$, m.p. $102-3^\circ$, and on oxidation with permanganate furnishes hydrastic acid (3 : 4-methylenedioxyphthalic acid). From tazettine methiodide, m.p. 220° (*dec., vac.*), the oily methine base, $C_{18}H_{19}O_4N$, b.p. $190-200^\circ/0.01$ mm., $[\alpha]_D^{15} - 40.6^\circ$; picrate, m.p. 171° (*dec., vac.*), was prepared, and on oxidation with potassium permanganate yielded oxalic and benzoic acids. The composition of the methine base is due to the loss of a methoxyl group, which must be accompanied by change in the attachment of a benzene ring, to account for the occurrence of benzoic acid in the oxidation products of the methine base, but not in those of the parent alkaloid. The methine-methiodide on treatment with silver oxide yielded 6-phenylpiperonyl alcohol (XII), $C_{14}H_{12}O_3$, m.p. 101° , which was identified by comparison with a synthetic specimen. The partial formula (X) is suggested for tazettine and (XI) for the methine base, the change from (X) to (XI) being analogous with that taking place in the Hofmann degradation of chelidonine, which also contains a partially hydrogenated phenanthridine ring system.

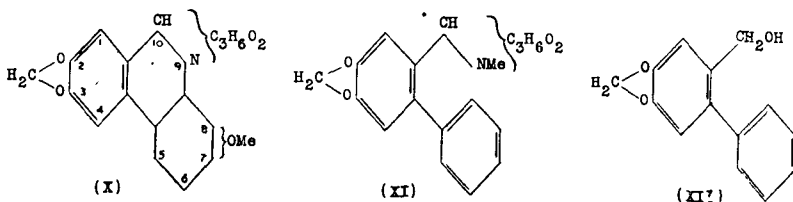

Minor Alkaloids of the Amaryllidaceae. The chief data recorded regarding these alkaloids are summarised in the accompanying table (p. 411):—

Pharmacology. Lycorine was first examined by Morishima² who found it relatively non-toxic to mammals. Given *per os* or subcutaneously to the dog or cat, it causes, in small doses, salivation and in large doses vomiting and diarrhoea. It has no special effect on the blood pressure; death seems to be due to a generalised collapse. Post mortem:—hyperæmia and ecchymoses in the stomach, intestine, pulmonary pleura and endo-

MINOR ALKALOIDS OF THE AMARYLLIDACEÆ.

Name and Formula	Base.		B. HCl.		B. MeI.	Picrate	Derivatives
	M.p.	$[\alpha]_D$	M p.	$[\alpha]_D$	M.p.	M.p.	
Base IX, ²³ C ₁₄ H ₁₁ (NMe)(OMe)(OH) ₂	190°	- 22·4° (MeOH)	234°	—	275°	146°	Diacetyl-, m.p. 275°; methine bases: α -, C ₁₇ H ₂₁ O ₃ N, m.p. 270°; $[\alpha]_D$ - 184·8° (MeOH). β -, m.p. 275°
Buphanitine, ¹⁶ C ₂₃ H ₂₄ O ₆ N ₂ , EtOH	240° (dry)	—	265-8° (dec.)	—	278°	—	—
Crinamine, ⁸ C ₁₆ H ₁₆ O ₃ N (OMe)	193-4°	—	—	—	—	—	—
homoLycorine, ²⁴ C ₁₇ H ₁₅ N(OMe) ₂ (OH) ₂	175°	+ 65·1° (EtOH)	285° (dec.)	+ 86·2°	256°	—	Diacetyl-, m.p. 173° (dec.).
ψ -Lycorine, ²² C ₁₈ H ₁₁ N(MeO)(OH) ₃	245°	- 41·5°	261° (dec.)	—	150°	—	Triacetyl-, m.p. 98-101°.
Sekisanine, ²⁵ C ₁₆ H ₁₆ N(CH ₂ O ₂)(OH) ₂	207-9°	+ 114·6°	211° (dec.)	+ 106·4°	287°	—	Diacetyl-, m.p. 72°. Dihydro-, m.p. 250°, $[\alpha]_D$ - 57·14°.
Sekisanoline, ²⁴ C ₁₇ H ₁₆ ON(CH ₂ O ₂)(OH) ₂	152° (dec.)	- 60·27° (CHCl ₃)	—	—	117-22°	127-33°	Diacetyl-, m.p. 155°.
Suisenine, ¹⁶ C ₁₆ H ₁₃ ON(OMe)(CH ₂ O ₂)(OH)	229°	—	180°	—	—	189°	Benzoyl-, m.p. 196°; Oxidation product, C ₁₂ H ₁₅ O ₄ N, m.p. 244°.

cardium. Laidlaw's² findings in the cat were similar. The apparent sympatholytic effects of lycorine described by Tokumara²⁶ for the rabbit uterus and the vessels of the rabbit's ear were not found by Raymond Hamet²⁷ to extend to blood pressure or renal effects in the chloralosed dog. Sekisanine is described by Morishima as inactive. Buphanine was also examined by Laidlaw¹⁸ and found to produce effects similar to those of hyoscine, the action being weaker and less lasting. It is a mydriatic, paralyses the salivary secretion and the vagus endings in the heart, and causes death by respiratory failure of central origin. Buphanitine is almost inactive. Of the two amorphous bases accompanying buphanine in *Buphane disticha* one is a convulsant poison and the other resembles lycorine and colchicine in action. The toxic effects of extracts of *Buphane disticha* are described by Watt and Breyer Brandwijk.²⁸

REFERENCES

- (1) *Pharm. J.*, 1877, 8, 214. (2) *J. Chem. Soc.*, 1910, 97, 2406. (3) *Arch. exp. Path. Pharm.*, 1897, 40, 221. (4) *Arch. Pharm.*, 1913, 251, 357. (5) *Bull. Jard. Bot. Buitenz.*, 1920, [iii], 1, 352; 1920, [iii], 2, 331. (6) *Cf. MOLLE, Jahresb. Pharm.*, 1903, p. 27. (7) *Amer. J. Bot.*, 1941, 28, 702. (8) TANAKA, *J. Pharm. Soc. Jap.*, 1937, 57, 139. (9) *Arch. Pharm.*, 1938, 226, 328. (10) *Univ. Philipp. Nat. Sci. Bull.*, 1934, 4, 41. (11) *Cf. FRAGNER, Ber.*, 1891, 24, 1498. (12) *Ber.*, 1936, 69, 500 (with SPÄTH and KUFFNER), *ibid.*, p. 2446. (13) *J. Gen. Chem.*, U.S.S.R., 1938, 8, 949. (14) *Pharm. J.*, 1893, p. 183. (15) *Pharm. Zent.*, 1934, 75, 237; according to EHRHARD, *Inaug. Diss. Dorpat*, 1893, this species contains lycorine. (16) *Ber.*, 1934, 67, 1501; *cf. YAMAMOUCHI, J. Pharm. Soc. Jap.*, 1902, 22, 986, and KIHARA, *J. Agric. Chem. Soc. Jap.*, 1939, 15, 128. (17) (With TOMIMURA and ISHIWATARI), *J. Pharm. Soc. Jap.*, 1932, 52, 51; (with SPÄTH and KUFFNER), *Ber.*, 1936, 69, 1086. (18) *J. Chem. Soc.*, 1911, 99, 1240; *cf. LEWIN, Arch. exp. Path. Pharm.*, 1912, 68, 333. (19) *J. Pharm. Soc. Jap.*, 1928, 48, 36; (with KATSURA), *ibid.*, 1934, 54, 194. (20) KONDO (with UYEO), *Ber.*, 1935, 68, 1756; 1937, 70, 1087, 1094; (with KATSURA and UYEO), 1938, 71, 1529; (with KATSURA), 1939, 72, 2083; 1940, 73, 112, 1424; KAMIO, *J. Pharm. Soc. Jap.*, 1937, 57, 839. (21) KONDO and ISHIWATA, *Ber.*, 1937, 70, 2427; *J. Pharm. Soc. Jap.*, 1938, 58, 1, 13 (Japanese text). (22) KONDO (with TOMIMURA and ISHIWATARI), *ibid.*, 1932, 52, 51; (with MITSUHASHI), *ibid.*, 1934, 54, 196; (with IKEDA), *Ber.*, 1940, 73, 867. (23) KONDO, ISHIWATA and OKAYAMA, *J. Pharm. Soc. Jap.*, 1933, 53, 149. (24) KONDO and TOMIMURA, *ibid.*, 1929, 49, 76. (25) *Idem, ibid.*, 1927, 47, 82. (26) *Okayama Igakkahi Zasshi*, 1933, 45, 2536. (27) *Arch. int. Pharmacodyn.*, 1935-6, 52, 129. (28) "Medicinal and Poisonous Plants of S. Africa," 1932, p. 25.

QUINOLINE GROUP

Echinopsine. From *Echinops Ritro* (seeds) and other *Echinops* spp. Greshoff¹ isolated this alkaloid, which Späth and Kolbe² have shown is 1-methyl-4-quinolone. Greshoff also obtained from the same source β -*echinopsine*, m.p. 135°, and *echinopseine*.

REFERENCES

- (1) *Rec. trav. Chim.*, 1900, 19, 360. (2) *Monats.*, 1922, 43, 469.

Dictamnine, $C_{12}H_9O_2N$. This alkaloid was isolated by Thoms¹ from white dittany root (*Dictamnus albus* Linn.) along with trigonelline and choline. It crystallises in prisms, m.p. 132–3°, and yields crystalline salts, B . HCl, m.p. 195°; platinumchloride, m.p. > 250°; aurichloride, m.p. 152°; picrolonate, m.p. 178°; and picrate, m.p. 163°. It was subsequently found in *Skimmia repens*, Nakai by Asahina, Ohta and Inubuse,² who showed that it contained one methoxyl group and was transformed by methyl iodide at 80° into *isodictamnine* (Ib: R = Me), m.p. 188°, which contains no methoxyl group, a change recalling that of α - and γ -alkoxyquinolines to *N*-alkylquinolones.³ With benzoyl chloride and anhydride, it yields *N*-benzoylnordictamnine (Ib: R = Bz), m.p. 165°, from which *nor*-dictamnine (Ib: R = H), m.p. 248°, is obtained by hydrolysis. Dictamnine is oxidised by permanganate in acetone to *dictamnal*, $C_{10}H_6O_2N \cdot OMe$, m.p. 259–60°, and *dictamninc acid*, $C_{10}H_6O_3N \cdot OMe$, m.p. 260° (*dec.*); the latter is converted by hydrochloric acid into 2:4-dihydroxyquinoline and since 4-hydroxy-2-methoxyquinoline-3-carboxylic acid is not identical with dictamninc acid, the latter must be 2-hydroxy-4-methoxyquinoline-3-carboxylic acid. Formula (Ia) was assigned to dictamnine and (Ib: R=Me) to *isodictamnine*. In a later paper Asahina and Inubuse⁴ showed that

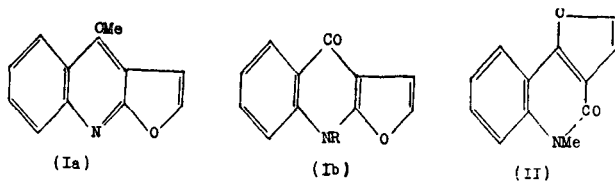

dictamninal was converted by hydrobromic acid in acetic acid into *nor*-*dictamninal*, identical with 2:4-dihydroxyquinoline-3-aldehyde. The latter was synthesised and used to prepare ψ -dictamnine (needles, m.p. 225°), represented by (II). Observations on the pharmacological action of dictamnine have been made by Kovalenko.⁵

REFERENCES

- (1) THOMS, *Ber. deut. Pharm. Ges.*, 1923, 33, 68; (with DAMBERGIS), *Arch. Pharm.*, 1930, 268, 39. (2) *Ber.*, 1930, 63, 2045. (3) KNORR, *ibid.*, 1897, 30, 929, 937. (4) *Ibid.*, 1932, 65, 61. (5) *Farmatsiya*, 1946, 9, No. 5, 20.

Skimmianine, $C_{14}H_{13}O_4N$. This alkaloid was first isolated from the leaves of *Skimmia japonica* Thunb. by Honda,¹ and later from *S. laureola* Hook by Chopra *et al.*^{1(a)} It has also been recorded from *Fagara* spp. (*below*), *Oriza japonica* Thunb. (p. 759) and *Chloroxylon swietenia* D.C. (p. 773). It crystallises in colourless pyramids or pale yellowish rods, m.p. 176°, and yields a picrate, m.p. 195–7° (*dec.*). It was examined by Asahina and Inubuse,² who showed that it contained three methoxyl groups and an unreactive oxygen. It is converted by methyl iodide at 100° into *isoskimmianine*, m.p. 185°, containing two methoxyl groups (*cf.* dictamnine, p. 413). On oxidation by permanganate in acetone, skimmianine yields skimmianal, $C_{10}H_4O_2N(OMe)_3$, m.p. 238°, and the corresponding acid, $C_{10}H_4O_3N(OMe)_3$, m.p. 248°, which is decarboxylated and partially demethylated by hydrochloric acid to 2 : 4-dihydroxy-7 : 8-dimethoxyquinoline, m.p. 250°. Skimmianic acid is therefore represented by formula (III) and skimmianine by (IV).

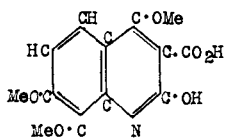

(III)

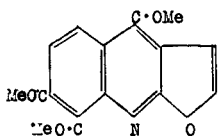

(IV)

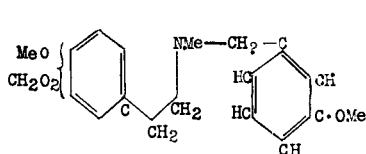

(V)

When treated with alcoholic alkalis the γ -methoxyl group in skimmianine is replaced by the alkyloxy group of the alcohol used.³ The ethoxy-analogue, $C_{15}H_{15}O_4N$, has m.p. 138°, yields a picrate, m.p. 194°, is re-converted to skimmianine by boiling with methyl alcohol, with methyl iodide yields *isoskimmianine*, and is oxidised to the ethoxy-analogues of skimmianal, m.p. 212°, and skimmianic acid, m.p. 225° (I : EtO in 4).

REFERENCES

- (1) *Arch. exp. Path. Pharm.*, 1904, **52**, 83. (1a) CHOPRA *et al.*, *Ind. J. Med. Res.*, 1938, **26**, 481. (2) *Ber.*, 1930, **63**, 2052. (3) BERINZAGHI, DEULOFEU, LABRIOLA and MURUZABAL, *J. Amer. Chem. Soc.*, 1943, **65**, 1357.

The Fagarines. In 1933 Stuckert¹ isolated *cocoberine* (amorphous) from the bark of *Fagara Coco* (Gill), England, and from the leaves of the same plant the following five alkaloids :—

- α -*Fagarine*, $C_{15}H_{13}N(CH_3 \cdot CO \cdot O)(MeO)_2$, m.p. 169°; β -*fagarine*, $C_9H_8N(CH_3 \cdot CO \cdot O)(MeO)$, m.p. 178°; γ -*fagarine*, $C_{15}H_{15}O_3N$, m.p. 139–40°; δ -*fagarine*, m.p. 136°; χ -*fagarine*.

Deulofeu, Labriola and de Langhe² showed that β -fagarine is identical with skimmianine (*above*) which Goto³ had already isolated from *F. manschurica* Honda, and according to Chakravarty⁴ the mature bark of the bael fruit tree, *Aegle marmelos* Correa, contains γ -fagarine.

γ -*Fagarine*. Deulofeu *et al.* changed the formula of γ -fagarine to $C_{13}H_{11}O_3N$, and represented it as a furoquinoline since it is oxidised by permanganate in acetone to 2-hydroxy-4 : x -dimethoxyquinoline-3-alde-

hyde (γ -fagaraldehyde), m.p. 185°, and thence to fagaric acid, m.p. 215°, which in boiling, dilute hydrochloric acid is decarboxylated and partially demethylated to a substance, eventually synthesised by Berinzaghi, Maruzabal, Labriola and Deulofeu,⁵ and shown to be 2 : 4-dihydroxy-8-methoxyquinoline, m.p. 250°. With methyl iodide at 100° γ -fagarine is converted into γ -isofagarine (*cf.* dictamine \rightarrow isodictamine, p. 413). On the basis of these results γ -fagarine is formulated as 8-methoxydictamine (*cf.* Ia, p. 413) and γ -isofagarine as 8-methoxyisodictamine (p. 413, Ib with MeO at C⁸). The ethoxy-analogue of γ -fagarine, EtO in position 4 of the quinoline nucleus, has m.p. 143° and forms a picrate, m.p. 161°.

α -Fagarine, C₁₉H₂₃O₄N, has m.p. 169–170° (*dry*), distils unchanged at 170–5°/0.001 mm. and is optically inactive. It forms a hydrochloride, m.p. 192–3°, a hydrobromide, m.p. 186–8° (*dec.*), a hydriodide, m.p. 190–2° (*dec.*), a methiodide, m.p. 205° (*dec.*), and a picrate, m.p. 208–9°. Two methoxyls, one dioxymethylene group and one methylimino group are present. The base is not hydrogenated, in presence of platinic oxide, with hydrogen at 4 atmospheres pressure, and is unchanged on boiling with either dilute hydrochloric acid or alkali in alcohol. Distilled with soda-lime, it yields methylamine and on oxidation by permanganate under acid conditions it produces formaldehyde and *m*-methoxybenzaldehyde. Provisional formula (V) has been suggested for the alkaloid.⁶

α -Fagarine is identical with fagarine-I on which de Espanes has published a number of pharmacological papers⁷ and Deulofeu *et al.*⁶ have suggested that it should be known in future as fagarine. It is regarded as a possible substitute for quinidine in the treatment of auricular fibrillation,⁷ and arising out of this work *N*-methyl dibenzylamines have been prepared by de Espanes and Weksler⁷ and shown to be active in cardiac fibrillation. A review of the chemistry and pharmacology of the alkaloids of *Fagara coco* has been published by Deulofeu.⁸

REFERENCES

- (1) *Invest. Labor. Quim. biol. Univ. nac. Cordoba*, 1933, 1, 69; DE IPOLA, *ibid.*, p. 94; OLSACHER, *ibid.*, p. 100. (2) *J. Amer. Chem. Soc.*, 1942, 64, 2326. (3) *J. Pharm. Soc. Jap.*, 1941, 61, 91. (4) *J. Ind. Chem. Soc.*, 1944, 21, 401; *cf.* MOOKERJI, *Current Sci.*, 1943, 12, 209. (5) *J. Org. Chem.*, 1945, 10, 181. (6) DEULOFEU (with LABRIOLA, ORIAS, DE ESPANES and TAQUINI), *Science*, 1945, 102, 69; (with LABRIOLA and BERINZAGHI), *J. Org. Chem.*, 1947, 12, 217. (7) *Compt. rend. Soc. Biol.*, 1937, 126, 834; 1938, 127, 118, 233, 510, 512, 579; 128, 309; 1939, 130, 679; (with WEKSLER), *Proc. Soc. Exptl. Biol. Med.*, 1946, 63, 195; SCHERF, *ibid.* 1948, 67, 59, *cf.* VAN DONGEN, *Arch. internat. Pharmacodyn.*, 1941, 66, 41. (8) *Arquiv. facultade nacl. med.* (Rio de Janeiro), 1946, 1, 80; for preparation of α -fagarine see *Bol. Soc. quim. Peru*, 1947, 13, 29.

ALKALOIDS OF CUSPARIA BARK

The presence of alkaloids in angostura or cusparia bark (*Galipea officinalis*) Hancock (*C. trifoliata* Engler) was recorded by Oberlin and Schlagdenhauffen.¹ Körner and Böhringer² isolated from it cusparine, galipine and a third alkaloid, m.p. 180°. The first two were examined by Beckurts, who added "galipidine," "cusparidine"³ and "cuspareine,"⁴

which could not be confirmed by Tröger,⁵ who, however, found a third alkaloid galipoidine, and a fourth, $C_{16}H_{18}O_2N$ (m.p. 186°, yellow, rhombic crystals), which has not been named or further examined. A series of additions to known basic constituents of the bark began with Späth and Papaioanou's⁶ isolation of galipoline, a phenolic base, which yields galipine on *O*-methylation. Examination of the volatile, non-phenolic bases of the bark led to the isolation of quinoline, 2-methylquinoline, 2-*n*-amylquinoline, 4-methoxy-2-*n*-amylquinoline and 2-keto-1-methyl-1 : 2-dihydroquinoline by Späth and Pikel.⁷ In these simple bases and in the alkaloids cusparine, galipine and galipoline, the nucleus is quinoline with H, OH or OMe in position 4, position 2 being either occupied by —CO— or substituted by an alkyl or aralkyl group. In view of the similarity in structure of cusparine and galipine, Späth and Pikel⁷ suggested that both might originate from anthranilic acid, and Schöpf and Lehmann⁸ showed that *o*-aminobenzaldehyde (*M*/200) and acetone (*M*/100) in aqueous solution at pH 12 and 13, when kept for seven days at 25°, give 11 and 86 per cent. respectively of 2-methylquinoline, and in like manner the interaction of *o*-aminobenzaldehyde and hexoylacetic acid produced 2-*n*-amylquinoline-3-carboxylic acid, which could be decarboxylated to 2-*n*-amylquinoline. These syntheses under conditions which could occur in a plant are of special interest in this instance, since methyl anthranilate and an extensive series of ketones occur in plants of the Rutaceæ, though such constituents have not been recorded for *Galipea officinalis*.

Cusparine, $C_{19}H_{17}O_3N$, exists in three forms, colourless needles, m.p. 90–1°, long yellow needles, m.p. 91–2°, and amber-tinted crystals, m.p. 110–22°.⁹ The salts are sparingly soluble in water and readily separated from those of the associated alkaloids; the hydrochloride, B . HCl . 3H₂O, forms needles, m.p. 185–7°; the oxalate, B . H₂C₂O₄ . 1.5H₂O, m.p. 153–8°, sulphur-yellow needles from water; the platinichloride, B₂ . H₂PtCl₆ . 3H₂O m.p. 210°, glancing yellow needles; the aurichloride, B . HCl . AuCl₃, has m.p. 190°. The salts with organic acids on melting yield PYROCUSPARINE, $C_{18}H_{15}O_3N$, needles, m.p. 255° from alcohol.¹⁰ Cusparine contains one methoxyl, but no hydroxyl group. It reacts with methyl iodide as a tertiary base, and the methiodide, yellow prisms, m.p. 190°, gives on treatment with silver oxide, *isocusparine*, m.p. 194°, in which the methyl group of methoxyl in the γ -position of a pyridine ring has migrated to the nitrogen, as also happens in a similar reaction with skimmianine and dictamnine (pp. 413 and 414). The reaction was investigated in detail by Tröger and Müller¹⁰ and is represented thus:—cusparine, $C_{18}H_{14}O_2N(OMe) \rightarrow isocusparine, C_{18}H_{14}O_3(NMe)$. With dilute nitric acid "nitrocusparine," $C_{17}H_{14}O_4N_2 \cdot H_2O$, m.p. 143°, is formed. When heated for several days with nitric acid (sp. gr. 1.075) at 100°, cusparine yields an acid, $C_{10}H_7O_3N \cdot H_2O$, m.p. 271–2°, which is probably a hydroxyquinolinecarboxylic acid.¹¹ On fusion with potassium hydroxide, the alkaloid yields protocathechuic acid. Cusparine gives a cherry-red coloration with sulphuric acid and a deep blue with Fröhde's reagent.

Galipine, $C_{20}H_{21}O_3N$, crystallises from alcohol or ether in prisms,

m.p. 113.5° , and yields crystalline salts, more soluble than those of cusparine. The hydrochloride, $B \cdot HCl \cdot 4H_2O$, forms leaflets, m.p. 165° ; the picrate has m.p. 194° ; the aurichloride, $B \cdot HAuCl_4$, and platinichloride both melt at $174-5^\circ$. The methiodide, $B \cdot CH_3I$, forms yellow needles, m.p. 146° . Galipine contains three methoxyl groups. On oxidation with chromic acid it yields veratric acid and a second acid, $C_{11}H_9O_3N \cdot 2H_2O$, m.p. 194° , which was shown by Späth and Brunner¹² to be 4-methoxyquinoline-2-carboxylic acid. On destructive distillation with zinc dust, galipine yields quinoline.

Galipoidine, $C_{19}H_{15}O_4N$, m.p. 233° , is sparingly soluble in most organic solvents; it forms a platinichloride, $B_2 \cdot H_2PtCl_6 \cdot 2 \cdot 5H_2O$, crystallising in stout yellow prisms and decomposing at 158° , and an abnormal aurichloride, $(B \cdot HCl)_2 \cdot AuCl_3 \cdot 1 \cdot 5H_2O$, m.p. 170° (*dec.*), crystallising in bright yellow needles.⁵

Galipoline, $C_{19}H_{19}O_3N$. A process for the extraction and separation of the angostura bark alkaloids was described by Späth and Eberstaller,¹³ and from the phenolic bases obtained Späth and Papaioanou⁶ isolated this alkaloid. It crystallises from water, has m.p. 193° , contains two methoxyl groups, and on methylation by diazomethane yields galipine.

From a spurious angostura bark, Tröger isolated an unnamed alkaloid, $C_{21}H_{26}O_3N_2$, m.p. 167° , soluble in alkali or acid and giving a crystalline perchlorate and methiodide.¹⁴

Constitution of Cusparine, Galipine and Galipoline. Tröger and Kroseberg⁵ proposed formula (I) for galipine. The substance represented by this formula, synthesised by Späth and Brunner,¹² was found to be different from galipine, and assuming, on good grounds, that the acid $C_{11}H_9O_3N \cdot 2H_2O$, m.p. 194° (*see above*), obtained by Tröger and Kroseberg⁵ to be 4-methoxyquinoline-2-carboxylic acid, they synthesised cusparine by condensing 4-methoxy-2-methylquinoline with piperonal to 4-methoxy-2- β -3':4'-methylenedioxyphenyl- Δ^a -ethinylquinoline (dehydrocusparine), m.p. 186° (II: $-\text{CH}_2-\text{CH}_2-$ replaced by $-\text{CH}=\text{CH}$), which on hydrogenation of the ethinyl group furnished cusparine (II) identical with the

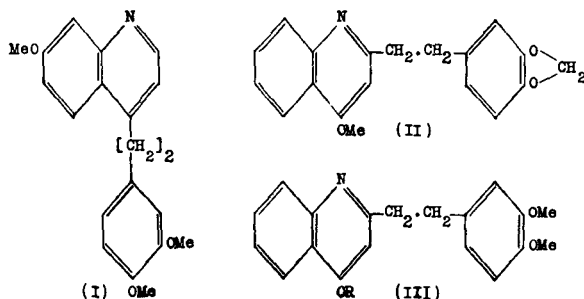

natural alkaloid. In like manner Späth and Eberstaller¹³ synthesised galipine (III: $R = \text{Me}$) by reducing the condensation product of 4-methoxy-2-methylquinoline with 3:4-dimethoxybenzaldehyde.

Galipoline furnishes galipine by methylation of a phenolic hydroxyl group, and the position of this group was determined by the synthesis of galipoline, effected by condensing 4-chloro-2-methylquinoline with 3:4-dimethoxybenzaldehyde, replacing the chlorine by the benzyloxy-group by treatment with sodium benzyl oxide, the resulting 4-benzyloxy-2:3':4'-dimethoxystyrylquinoline being then reduced and the benzyl group removed by hydrolysis, forming galipoline (III: R = H).

A series of quinazolines analogous in constitution with the angostura alkaloids has been prepared by Bogert and collaborators.¹⁵

Cusparia bark is used in medicine as a simple bitter. Raymond-Hamet¹⁶ states that cusparine has sympathicosthenic properties, that is it increases the sensitivity of the sympathetic nervous system to stimulation, e.g., by adrenaline.

REFERENCES

- (1) *J. Pharm. Chim.*, 1877, [iv], 26, 130. (2) *Ber.*, 1883, 16, 2305. (3) *Arch. Pharm.*, 1891, 229, 591; 1895, 233, 410; 1905, 243, 470. (4) *Apoth. Zeit.*, 1903, 18, 697. (5) (With MÜLLER), *Arch. Pharm.*, 1910, 248, 1; 1914, 252, 459; (with RINNE), 1911, 249, 174; (with KROSEBERG), 1912, 250, 494; (with BECK), 1913, 251, 246; (with BÖNICKE), 1920, 258, 250. (6) *Monats.*, 1929, 52, 129. (7) *Ber.*, 1929, 62, 2244; *Monats.*, 1930, 55, 352. (8) *Annalen*, 1932, 497, 1, 7. (9) For description of crystalline form, see MARIA DE ANGELIS, *Atti. Accad. Lincei*, 1921, [v], 30, 328. (10) *Arch. Pharm.*, 1914, 252, 459. (11) TRÖGER and BECKE, *ibid.*, 1913, 251, 246. (12) *Ber.*, 1924, 57, 1243. (13) *Ibid.*, 1924, 57, 1687. (14) *Pharm. Zent.*, 1928, 69, 209. (15) (With MARR), *J. Amer. Chem. Soc.*, 1935, 57, 729; (with PAPA), *ibid.*, 1936, 58, 1701. (16) *Compt. rend.*, 1944, 218, 727; see also PORCHER, *Ann. pharm. franc.*, 1945, 3, 140.

ALKALOIDS OF CINCHONA SPECIES

(Quinolylquinuclidine Sub-group)

This group of natural alkaloids occurs in the various species of the two Rubiaceae genera, *Cinchona* and *Remijia*, indigenous to the eastern slopes of the Andes between latitudes 10° N. and 20° S.

It is over three centuries since cinchona bark came into use in European medicine, and no other natural drug has had so much written about it. There are the stories, sometimes legendary, of its discovery by Europeans,¹ vigorous early discussions of its therapeutic value,² the destruction of the S. American cinchona trees to meet the demand for bark, the labours of botanical explorers in collecting seed for the formation of plantations, the establishment and development of these plantations in Ceylon, India and Java, the competition between them, the gradual emergence of Java as the world's most important source of supply of cinchona bark,³ and the development of the manufacture of quinine sulphate in Europe, the United States and the Tropics.⁴

The disadvantage in war periods of relying on a single source of supply for an essential commodity became evident when Java was invaded by the Japanese in March 1942, the world being thereby deprived of about 90 per cent. of its customary supply of cinchona bark. Quinine was then still considered an indispensable drug for the treatment of malaria and its use had to be restricted to that purpose; stocks of quinidine were similarly reserved for use in cardiac disease.⁵ In efforts to deal with the

shortage, interest was renewed in almost forgotten sources of supply of cinchona bark, such as Ceylon, India, San Thomé and the countries of Central and S. America.^{5(a)} In the Belgian Congo, the Philippine Islands, Soviet Russia and Tanganyika, where experimental plantations of cinchona existed,^{5(b)} exploitation was intensified. Special activity was shown in Central and South America, where exploratory botanical missions from the United States searched for natural stands of cinchona in new or little-known areas and of whose work a preliminary account has been published by Steere.^{5(b)} These missions also established laboratories for the control of quality of bark and so avoided the collection of commercially useless material, one of the troubles experienced by collectors in the early days of S. American cinchona exploitation. Planting on a large scale was also started. In this connection it is of interest to mention that Messrs. Merck & Co., with the co-operation of the Guatemalan Government and the appropriate official department in the United States, began the cultivation of cinchona in Guatemala in 1934, and when the crisis occurred they also became pioneers of cultivation in Costa Rica. A full account of their planting experiments was published^{5(c)} in an interesting illustrated volume issued in the United States in 1944.

Much of the bark collected in S. America was of low alkaloidal content, but proved suitable for the preparation of "totaquina" (p. 420). Among other interesting developments was the discovery by Steere^{5(b)} of large stands of a race of *Remijia pedunculata* on the western slopes of the Andes north of Bucaramanga, the bark of which yielded 3 per cent. of quinine sulphate.^{5(d)}

It will be interesting to see how much of this activity will survive in post-war conditions, especially in competition with new, synthetic, anti-malarial drugs developed during the war and revival of the Java cinchona industry, which is apparently making progress.^{5(e)}

The cinchona alkaloids of practical importance are quinine, quinidine, cinchonine and cinchonidine, but, in addition, over twenty others have been isolated from cinchona and cuprea species. Their names and formulæ are as follows :

Formula	Name
$C_{16}H_{18}ON_2$	Paricine.
$C_{19}H_{22}ON_2$	Cinchonine, cinchonidine, cinchonidine.
$C_{19}H_{24}ON_2$	Cinchotine, cinchamide, cinchonamine.
$C_{19}H_{22}O_2N_2$	Cupreine.
$C_{19}H_{24}O_2N_2$	Quinamine, conquinamine.
$C_{20}H_{24}O_2N_2$	Quinine, quinidine, quinicine, <i>epi</i> quinine, <i>epi</i> quinidine, <i>h</i> -quinine.
$C_{20}H_{26}O_2N_2$	Hydroquinine, hydroquinidine.
$C_{22}H_{26}O_4N_2$	Chairamine, conchairamine, chairamide, conchairamide.
$C_{23}H_{26}O_4N_2$	Cusconine, concusconine, aricine.
$C_{35}H_{44}O_2N_4$	Dicinchonine.
$C_{40}H_{46}O_2N_4$	Diconquinine.

Composition unknown : Javanine, cuscamine, cuscamidine, cusconidine.

Total Alkaloids of Cinchona. The initial planting experiments in the Far East were made with *Cinchona succirubra*. At first the total alkaloids of the bark were used under the name *quinetum*, but in India, when this species began to be replaced by others, such as the Ledger variety of *C. Calisaya* and the cinchona hybrids, as selection for quinine production progressed, "quinetum" was gradually replaced by "cinchona febrifuge," consisting of the residual alkaloids left after removal of quinine.⁶ This variable product⁷ is used as a cheap drug for indigent victims of malaria. The Malaria Commission of the League of Nations has re-defined "quinetum"⁸ as a mixture of equal parts of quinine, cinchonine and cinchonidine, and introduced a new product, "totaquina," which is defined in the British Pharmacopœia 1932 as containing not less than 70 per cent. of crystallisable cinchona alkaloids, of which not less than one-fifth is quinine and in the United States Pharmacopœia XIII as containing not less than 10 per cent. of anhydrous quinine and not less than 70 or more than 80 per cent. of total anhydrous, crystallisable alkaloids.

Totaquina is now being manufactured in Tanganyika,^{5(b), 9} and in Soviet Russia,^{5(b)} cinchona is grown as a biennial crop, the young plants being harvested in the second year of growth and worked up for total alkaloids. The average yield is about 1.25 per cent. of totaquina, which is known locally as "sovchinet."

As the re-introduction of mixtures of cinchona alkaloids for use in medicine has given rise to some discussion, a list of the principal papers on this subject is given.⁹ Several of these provide analyses of locally produced totaquina. Applezweig and Ronzone⁹ have described an ion exchange process for the preparation of totaquina.

Analyses of Cinchona Barks. For galenic preparations, pharmacopœial recognition is usually restricted to barks of cultivated cinchona species known to yield total alkaloids satisfactory in composition; thus, the British Pharmacopœia 1932 prescribes the varieties to be used, and specifies not less than 6 per cent. of total alkaloids, of which at least half must be quinine and cinchonidine, determined by the process prescribed. Numerous other processes have been published and references to the more important of these are given under the following headings¹⁰ :—*identification* of (a) bark, (b) alkaloids; (c) *extraction and separation* of alkaloids; *estimation* of (d) total alkaloids, (e) specific alkaloids by (1) physical methods and (2) chemical methods.

For the separate determination of the four principal components in the total alkaloids, the method in general use is based on the isolation of quinine and cinchonidine as *d*-tartrates, of cinchonine as the base in virtue of its sparing solubility in ether, and of quinidine as the hydriodide. Types of this method have been described by Chick,¹¹ and special modifications designed for use in the analysis of "totaquina" are given in the British Pharmacopœia 1932 and in a special report by the Malaria Commission of the League of Nations.¹² Goodson and Henry¹³ have critically examined this process and shown that, with care, it gives satisfactory

results. Morton¹⁴ and Prideaux and Winfield¹⁵ have investigated the conditions under which cinchona alkaloids can be titrated accurately. Useful analytical data are also provided by the determination of the optical activity of the chief cinchona alkaloids under various conditions by Andrews¹⁶ and the record of optical crystallographic data for many quinine salts by Shaner and Willard.¹⁷

Quinine, $C_{20}H_{24}O_2N_2$. Impure preparations of quinine were probably obtained by Fourcroy in 1792, and by Vauquelin under the name "quina" in 1809. In 1810 a Spanish physician, Dr. Gomes, obtained, by the addition of caustic potash to an alcoholic extract of cinchona bark, a crystalline substance which he named "*Cinchonino*." The basic properties of this material were mentioned by Houtou-Labillardière in Paris to Pelletier and Caventou, who, inspired by the then recent observations of Sertürner on the existence of "organic alkalis" in nature, investigated "*Cinchonino*," and resolved it into two substances, *quinine* and *cinchonine*.¹⁸ The bases were characterised by Pelletier and Dumas,¹⁸ and the composition of quinine was accurately determined by Liebig, Regnault and Strecker, the two latter assigning to it its present formula.

The manufacture of quinine sulphate and other salts is described in detail by Schwyzer, and useful information is also provided by Vetter.¹⁹ The sulphate is the commonest salt and is the form in which quinine is usually isolated from the total alkaloids of the bark and so is the primary material used as a source of the alkaloid for the preparation of other salts and derivatives. The commercial sulphate contains cinchonidine and dihydroquinine, and may be purified by recrystallisation of, (a) the acid sulphate, B. $H_2SO_4 \cdot 7H_2O$, to constant specific rotation $[\alpha]_D^{15} - 216.5^\circ$ (dry salt, $c = M/40$, H_2O), or (b) the dihydrobromide, B. $2HBr \cdot 3H_2O$, which after recrystallisation till pure has $[\alpha]_D^{15} - 189.6^\circ$ (dry salt, $c = M/40$ H_2O).²⁰ Quinine is precipitated as a colourless powder by pouring an aqueous solution of the acid sulphate so purified into excess of ammonia solution with vigorous stirring to prevent co-precipitation of the neutral sulphate. The washed, air-dry powder can be crystallised from boiling benzene, when it separates in needles, containing solvent which is lost on exposure to air, leaving a micro-crystalline powder, m.p. 173.5° (*dry*). When precipitated in presence of ammonia, it is stated to pass gradually into a crystalline, efflorescent trihydrate, B. $3H_2O$, m.p. 57° , which changes to B. $2H_2O$ in air, to B. H_2O when dried over sulphuric acid and becomes anhydrous at 125° and then melts at 172.8° . According to Hesse,²¹ anhydrous quinine is obtained in colourless needles, m.p. 174.4° to 175° , when sodium carbonate is added to quinine sulphate dissolved in warm water, or when the trihydrate is heated during eight days in dilute alcohol at 30° . Anhydrous quinine is sparingly soluble in water (1 in 1,960 at 15° (Hesse), 1 in 1,667 at 20° (Sestini), 1 in 1,750 at 25° (U.S.P. XI), but readily so in alcohol (1 in 0.6 at 25°), ether (1 in 4.5 at 25° , 1 in 188 of pure, dry ether (Treadwell)), chloroform (1 in 1.9 at 25°) or boiling benzene. Ammonia readily forms supersaturated solutions with quinine.²² The alkaloid is levorotatory; the pure base, prepared as described above,

has $[\alpha]_D^{15^\circ} - 284.5^\circ$ (dry base, $c = M/40$ in $N/10$ H_2SO_4)²⁰ or $[\alpha]_D - 158^\circ$ (99 per cent. EtOH, Rabe),²³ $0.894c - 169.38^\circ$ ($c = \text{gm. base in } 100 \text{ c.c. EtOH, Hesse}$),²⁴ or -169° ($c = 1$, EtOH, Emde). The specific rotation of the alkaloid and of its salts varies considerably with the temperature, the solvent and particularly with the pH of the solution.²⁵ Solutions of quinine in certain oxygenated acids, *e.g.*, sulphuric, phosphoric and tartaric, fluoresce blue, but the usual statement that this is not shown by solutions in haloid acids seems not to be strictly true.²⁶

Like other alkaloids of this group, quinine forms molecular compounds with a variety of organic substances. With benzene and toluene it produces compounds of the formulæ $B \cdot C_6H_6$ and $B \cdot C_7H_8$ respectively, with phenol it gives the crystalline product $B \cdot C_6H_5OH$, and similar combinations with polyhydric phenols, ethers, aldehydes and ketones are known. One of the most characteristic of these substances is cupreine-quinine, a combination of the two alkaloids, obtainable from cuprea bark, and at first regarded as a new alkaloid, and named "homoquinine."

Salts. Quinine is a diacidic base forming both "neutral" and "acid" salts. The alkaloid and its salts are intensely bitter. Three sulphates are known. Commercial quinine sulphate, $B_2 \cdot H_2SO_4 \cdot 8H_2O$ (or $7H_2O$), is the "neutral" sulphate and is obtained by neutralising the alkaloid with dilute sulphuric acid and recrystallising from boiling water, from which it separates in bulky masses of colourless, glistening needles, which effloresce and lose their lustre on exposure to dry air, forming the stable dihydrate, $B_2 \cdot H_2SO_4 \cdot 2H_2O$, m.p. 205° , which also results when the salt is exposed over sulphuric acid; at 100° it becomes anhydrous and can be crystallised in this condition from boiling chloroform. The heptahydrate is sparingly soluble in water (1 in 720 at 25° , 1 in 30 at 100°), more soluble in alcohol (1 in 86 at 25° , 1 in 9 at 60°), readily soluble at 50° in a mixture (2 : 1) of chloroform with dry alcohol, and very soluble in dilute acids. The solution in water is scarcely fluorescent, but is markedly so in dilute sulphuric acid. The heptahydrated salt has $[\alpha]_D^{15^\circ} - 166.36^\circ$ in alcohol and the dry salt -247.1° ($c = M/40$, $N/10$ H_2SO_4).²⁰ The acid sulphate, $B \cdot H_2SO_4 \cdot 7H_2O$ (quinine disulphate), forms transparent, orthorhombic crystals, m.p. 160° (*dec.*), $[\alpha]_D^{15^\circ} - 216.1^\circ$ (dry salt, $c = M/40$, H_2O),²⁰ which effloresce in air and turn yellow on exposure to light. It is soluble in water (1 in 8.5 at 25°) or alcohol (1 in 18 at 25°) and sparingly so in ether (1 in 1,770 at 25°) or chloroform (1 in 920 at 25°). The aqueous solution is acid to litmus and markedly fluorescent. The so-called tetrasulphate, $B \cdot 2H_2SO_4 \cdot 7H_2O$, forms colourless prisms, and is very soluble in water, much less so in alcohol.

Quinine hydrochloride, $B \cdot HCl \cdot 2H_2O$, closely resembles the neutral sulphate in appearance, and, like it, effloresces in dry air, m.p. $158-60^\circ$ (dried at 100°), $[\alpha]_D^{17^\circ} - 133.7^\circ$ in water (Oudemans), -155.8° (Tutin), -255.1° (dry salt, $c = M/40$, $N/10$, H_2SO_4),²⁰ soluble in water (1 in 18 at 25°), alcohol (1 in 0.6 at 25°), chloroform (1 in 0.8 at 25°) and sparingly in ether (1 in 240 at 25°). The aqueous solution is neutral to litmus and is not fluorescent except on addition of sulphuric acid. The acid hydro-

chloride, $B \cdot 2HCl$, obtained by treating a solution of the acid sulphate with barium chloride, crystallises in concentrically grouped needles and is very soluble in cold water (1 in 0.75). The hydrobromide, $B \cdot HBr \cdot H_2O$, resembles the hydrochloride, m.p. commences at 152° and ends at 200° , soluble in water (1 in 55 at 15° , Hesse), alcohol (1 in 0.67 at 25°), less so in chloroform or ether. The aqueous solution is neutral and fluoresces only on addition of sulphuric acid. The dihydrobromide, $B \cdot 2HBr \cdot 3H_2O$, crystallises well from water and has $[\alpha]_D^{15} - 189.6^\circ$ (dry salt, $c = M/40$, H_2O).²⁰ Quinine salicylate, $2[B \cdot C_6H_4(OH)(COOH)] \cdot H_2O$, forms colourless needles, m.p. 187° (*dec.*), which slowly become pink in air. It is soluble in water (1 in 77 at 25°), alcohol (1 in 11 at 25°), or chloroform (1 in 37 at 25°). The foregoing are the most important quinine salts used in medicine, but many other salts have been used, *e.g.*, the tannate, formate, valerate, ethylcarbonate, lactate, cacodylate, etc., as well as double salts such as quinine bismuth iodide. Descriptions of many of these salts will be found in the British Pharmaceutical Codex for 1934.

Numerous new salts and additive compounds of cinchona alkaloids, and especially of quinine, have been described, of which only a few can be mentioned as examples: quinine additive compounds with sulph-anilamide,^{26(a)} quinine salts of (+) and (-)-pantothenic acid,^{26(b)} quinine sulphamate and disulphamate,^{26(c)} organo-mercury compounds of quinine and cinchonine such as quinine-monomercuric chloride,^{26(d)} Various salts and combinations of quinine have also been protected by patent, *e.g.*, ascorbates and nicotines.

COMMERCIAL QUININE SALTS. The British Pharmacopœia 1932 provided for a hydrate of the composition $B_2 \cdot H_2SO_4 \cdot 7.5H_2O$, which effloresces on exposure to air. It has been suggested that the stable dihydrate, $B_2 \cdot H_2SO_4 \cdot 2H_2O$, should be substituted. Much discussion has taken place on this point,²⁷ and the dihydrate was adopted in the United States Pharmacopœia (XI). The commercial salts contain small amounts of cinchonidine and hydroquinine, and much attention has been given to devising tests which will ensure that the percentage of cinchonidine is small. For this purpose Pharmacopœias usually rely on some form of the Kerner ammonia test, sometimes supplemented, or more rarely, replaced by, a determination of the optical rotation under clearly defined conditions of temperature, solvent and concentration. Optical methods, based on Oudemans' results in the investigation of the optical rotations of the cinchona alkaloids²⁵ and their salts, have been advocated by Byasson,²⁸ Koppeschaar,²⁹ Davies,³⁰ Léger³¹ and others, and have also been adversely commented on.³² The optical method adopted in the Dutch Pharmacopœia 1926 is convenient and useful in the hands of operators accustomed to the use of a polarimeter, but this Pharmacopœia also gives for the sulphate a stringent form of the Kerner test. Kerner's ammonia test depends on the fact that the neutral sulphates of the two impurities are more soluble in water than quinine sulphate, and that freshly precipitated quinine base is more soluble in dilute ammonia solution than the freshly precipitated impurities. This test has given rise

to much discussion,³³ particularly in its application to other salts, than the neutral sulphate for which it was devised, but the method adopted in the British Pharmacopœia 1932 avoids these difficulties and has proved satisfactory in practice. Critical *résumés* of methods of testing quinine sulphate have been published by Jungfleisch,³⁴ Lenz,³⁵ Hille³⁶ and Reimers and Gottlieb.³⁶ A method of estimating methoxyl-free alkaloids in quinine and quinidine has been devised by Merz and Hoffmann.³⁶

Detection of Quinine. When bromine or chlorine water is added, drop by drop, to a faintly acid solution of a quinine salt until the reagent is present in very slight excess and then excess of ammonia, a characteristic deep green coloration is produced, which is known as the "thalleioquin" reaction, and is said to be given by 1 part of quinine in 20,000 of a solution.³⁷ It is also afforded by quinidine and cupreine, but not by cinchonine or cinchonidine. Much work has been done to explain the formation of the colour and to assign a constitutional formula to "thalleioquin."³⁸ Quinine is more soluble in ether and in ammonia solution than the other cinchona alkaloids, and its oxalate and chromate are less soluble in water. It affords a series of periodides of which that known after its discoverer as "herapathite," $B_4 \cdot 3H_2SO_4 \cdot 2HI \cdot I_4 \cdot 6H_2O$, yields remarkable crystals when prepared under appropriate conditions.³⁹ In the treatment of malarial patients it is frequently necessary to examine blood and urine for one or other of the cinchona alkaloids, usually quinine, and a number of methods have been devised for this purpose.⁴⁰

Quinidine (Conquinine), $C_{20}H_{24}O_2N_2$. This isomeride of quinine is contained in small quantity in most cinchona barks, but especially in *C. pitayensis*, *C. amygdalifolia* and *C. Calisaya*; *Remijia pedunculata* is also a possible source or it may be made by isomerisation of quinine (p. 445). It occurs in the quinine sulphate mother liquors and from the mixture of alkaloids precipitated from these liquors with caustic soda, it may be obtained with cinchonidine by extraction with ether. The cinchonidine is removed as the tartrate, and from the filtrate quinidine is precipitated as the hydriodide. From this it is recovered and recrystallised from boiling alcohol. Commercial quinidine contains cinchonine and may contain as much as 30 per cent. of dihydroquinidine: the former may be eliminated by recrystallisation from boiling alcohol, the cinchonine being removed in the first least soluble fractions. The dihydro-base can then be removed by fractionation as cuprichloride, $B \cdot 2HCl \cdot CuCl_2$, and dihydrochloride, $B \cdot 2HCl$ (Buttle, Henry and Trevan⁴¹), or more simply, by the mercuric acetate process of Thron and Dirscherl.⁴² As criteria of purity the specific rotation and the hydrogen absorption may be used.

Quinidine crystallises from boiling alcohol with 2.5, or from dry alcohol with 1 mol. of the solvent, in prisms, from dry ether with $\frac{1}{3}$ mol. ether in trimetric tablets, and from boiling water with $1\frac{1}{2}H_2O$ in leaflets. Freed from solvents of crystallisation or obtained in anhydrous crystals from benzene it melts at 173.5° and has the following solubilities: water, 1 in 2,000 at 15° ; ether, 1 in 85 at 10° ; alcohol, 1 in 26 of 80 per cent. at 20° ; it is sparingly soluble in chloroform and less so in light

petroleum. The pure alkaloid has $[\alpha]_D^{15} + 334.2^\circ$ (dry base, $c = M/40$, $N/10 \text{ H}_2\text{SO}_4$)⁴¹; $+ 323.8^\circ$ (dry base, $c = 2$ in 1.8 per cent. HCl) has been recorded by Butler and Cretcher⁴³ for quinidine isomerised from pure quinine and $+ 266.7^\circ$ ($c = 2$, EtOH) by Thron and Dirscherl.⁴² The sulphate and the salts of other oxygenated acids show a blue fluorescence, especially in dilute sulphuric acid.

Quinidine is alkaline in solution and behaves as a diacidic base forming two series of salts. The neutral sulphate, $\text{B}_2 \cdot \text{H}_2\text{SO}_4 \cdot 2\text{H}_2\text{O}$, crystallises from hot water in colourless prisms, soluble in water (1 in 98 to 100 at 15° , or 1 in 7 at 100°), more so in alcohol or chloroform, and scarcely in ether. It is dextrorotatory, $[\alpha]_D + 184.17^\circ$ (CHCl_3). The acid sulphate, $\text{B} \cdot \text{H}_2\text{SO}_4 \cdot 4\text{H}_2\text{O}$, forms hair-like, colourless needles, soluble in 8.7 parts of water at 10° : $[\alpha]_D^{15} + 247.8^\circ$ ($c = M/10$, H_2O) or $+ 256.4^\circ$ ($c = M/40$, $N/10 \text{ H}_2\text{SO}_4$). The neutral hydrochloride, $\text{B} \cdot \text{HCl} \cdot \text{H}_2\text{O}$, m.p. $258-9^\circ$ (dry, dec.), $[\alpha]_D^{20} + 200^\circ$ (H_2O), forms asbestos-like prisms, easily soluble in alcohol or hot water, less so in cold water (1 in 62.5 at 10°). The acid hydrochloride, $\text{B} \cdot 2\text{HCl} \cdot \text{H}_2\text{O}$, forms prisms, readily soluble in alcohol, sparingly in water, chloroform or hydrochloric acid. The dihydrobromide, $\text{B} \cdot 2\text{HBr} \cdot 3\text{H}_2\text{O}$, crystallises well from water and has $[\alpha]_D^{15} + 223.0^\circ$ ($c = M/40$, H_2O). The neutral hydriodide, $\text{B} \cdot \text{HI}$, is deposited as a crystalline powder when potassium iodide is added to a neutral aqueous solution of a quinidine salt, and, owing to its sparing solubility in water (1 in 1,250 at 15°) is the form in which quinidine is usually isolated and estimated. Quinidine gives the thalleioquin reaction (p. 424), and is fluorescent in dilute sulphuric acid. Unlike quinine, it is dextrorotatory, gives a sparingly soluble hydriodide and a neutral sulphate soluble in water or chloroform. Monnet has suggested the thiocyanate as a means of estimating quinidine.^{43(a)}

Quinicine (*Quinotoxine*), $\text{C}_{20}\text{H}_{24}\text{O}_2\text{N}_2$. This alkaloid was isolated by Howard⁴⁴ from cinchona bark, but had been prepared previously by Pasteur⁴⁵ by heating quinine acid sulphate, and subsequently by Hesse⁴⁶ in a similar manner from quinidine. It is also formed by heating quinine in dilute acetic acid or water, and the product so obtained was named quinotoxine. The identity of the two was established by von Miller, Rohde and Fussinegger.⁴⁷ The base is a bitter yellow alkaline varnish, $[\alpha]_D + 38.6^\circ$ (CHCl_3),⁴⁸ and is usually purified through the oxalate, $\text{B}_2 \cdot \text{H}_2\text{C}_2\text{O}_4 \cdot 9\text{H}_2\text{O}$, small prisms, m.p. $166-7^\circ$, $[\alpha]_D^{20} + 24^\circ$, which is sparingly soluble in water (1 in 120 approx.), and can be recrystallised from chloroform or alcohol. The lower values, m.p. 149° , $[\alpha]_D + 18.18^\circ$ (alcohol-chloroform 1:2) recorded for this salt are due to the presence of dihydroquinicine (Thron and Dirscherl⁴⁴). The acid tartrate, $\text{B} \cdot \text{C}_4\text{H}_6\text{O}_6$, is also crystalline. The hydrochloride, $\text{B} \cdot \text{HCl}$, crystallises in aggregates, m.p. $179-80^\circ$, or leaflets, m.p. $180-2^\circ$, $[\alpha]_D + 16.26^\circ$ or $+ 13.7^\circ$.⁴⁹ Quinicine *l*-tropate, $\text{B} \cdot \text{C}_9\text{H}_{10}\text{O}_3 \cdot \text{H}_2\text{O}$, crystallises from water in small cream-coloured needles, m.p. $112-3^\circ$ (hydrated) or $116-8^\circ$ (dry), $[\alpha]_D + 8.71^\circ$ (dry salt, $c = 0.997$, EtOH).⁵⁰ The benzoyl-derivative (Thron and Dirscherl⁴⁴) crystallises from benzene or methyl alcohol and has m.p.

118–4°, $[\alpha]_D^{22} + 36^\circ$ ($c = 2$, EtOH). Fränkel and collaborators have prepared an amorphous oxime, reducible to an amorphous amino-derivative, and have also obtained a phenylhydrazone which, although amorphous, yields a crystalline dipicrate, m.p. 130–7° (*dec.*).⁵¹ According to von Miller *et al.*⁴⁷ quinicine yields an isonitroso-compound, m.p. 168–70°, which is crystalline and furnishes crystalline salts and a methiodide.

There is possibility of a partial conversion of quinine into quinicine during the sterilisation of solutions for injection. Howard and Chick found quinine acid sulphate particularly liable to this change when heated under pressure in solution, and measured the extent of the change by observing the fall in optical rotation.⁵² Millar and Dean⁵³ have critically examined various tests suggested for the detection of quinicine and cinchonine and Bachstesz⁵⁴ has utilised the red coloration produced when sodium nitroprusside is added to a solution of quinicine in presence of sodium carbonate. According to de Caro⁵⁴ the minimum lethal dose of quinicine per kilo for white rats is 0.32 gm. compared with 1.25 gm. for quinine. It seems therefore to be less toxic than was formerly supposed, but it has no anti-malarial action.

*epi*Quinine, $C_{20}H_{24}O_2N_2$. This, with its stereoisomeride *epi*quinidine, was isolated by Thron and Dirscherl⁵⁵ from "QUINOIDINE," the mixture of amorphous bases left in quinine factories after the four primary cinchona alkaloids have been extracted. It is still a commercial article used as a cheap febrifuge in malarial territories, though its value as an anti-malarial drug is small. Thron and Dirscherl separated the benzene-soluble fraction of quinoidine by their mercuric acetate process⁴² into vinyl- and non-vinyl-bases. From the former the two *epi*-bases were isolated as the dihydrochlorides and this mixture in turn was separated into its two components by conversion into the dibenzoyl *d*-tartrates, that of *epi*quinine separating first, and the *epi*quinidine salt being recovered from the mother liquor. This process is due to Rabe,⁵⁶ who first prepared these epimerides by isomerisation of quinine and quinidine^{56(a)} and by separating the mixture of isomerides formed by reduction of quinone (p. 444).^{56(b)} *epi*Quinine is an oil, $[\alpha]_D^{22} + 43.3^\circ$ ($c = 0.95$), the dihydrochloride has m.p. 196° (*dec.*), $[\alpha]_D^{21} + 33.3^\circ$ ($c = 0.796$), the hydrobromide, B. HBr. $3H_2O$, m.p. 71–7°, $[\alpha]_D^{20} + 32.9^\circ$ (H_2O), and the dibenzoyl-*d*-tartrate, after crystallisation from acetone, m.p. 159° (*dec.*), $[\alpha]_D^{19} - 22.4^\circ$ ($c = 0.8044$). The *epi*-base on hydrogenation in presence of palladium yields *epi*dihydroquinine, also an oil, $[\alpha]_D^{22} + 31.1^\circ$ ($c = 0.9342$). The specific rotations are for alcohol (99 per cent. or absolute) unless stated otherwise.

*epi*Quinidine, $C_{20}H_{24}O_2N_2$. This alkaloid, isolated from "quinoidine," as described above, crystallises from ether in leaflets and is fluorescent in dilute sulphuric acid. It has m.p. 113°, $[\alpha]_D^{19} + 102.4^\circ$ ($c = 0.8648$, EtOH); the dihydrochloride has m.p. 195–6° (*dec.*), $[\alpha]_D^{20} + 45.5^\circ$ ($c = 0.8012$, EtOH), the hydrobromide, B. HBr. H_2O , m.p. 240°, thiocyanate, m.p. 193°, $[\alpha]_D^{20} + 44.5^\circ$ (H_2O) and the dibenzoyl-*d*-tartrate, B₂. $C_{18}H_{14}O_8$, m.p. 167° (*dec.*), $[\alpha]_D^{21} + 3.7^\circ$ ($c = 0.8068$, alcohol-chloroform 4 : 1). On hydrogenation with palladium as catalyst *epi*quinidine furnishes *epi*-

dihydroquinidine, m.p. 122° , $[\alpha]_D^{22} + 73.1^{\circ}$ ($c = 0.766$, EtOH),⁵⁶ also obtainable by the epimerisation of hydroquinidine (or hydroquinine) or by the reduction of dihydroquinone.

Cinchonine, $C_{19}H_{22}ON_2$. This alkaloid is usually present in cinchona and cuprea barks. One of the best sources is *Cinchona micrantha* bark. It occurs in the crude quinine sulphate mother liquors. The mixed alkaloids recovered from these may be extracted with ether to remove quinidine and cinchonidine and the insoluble residue boiled with successive small quantities of alcohol, from which cinchonine crystallises on cooling. The crude alkaloid is neutralised with dilute sulphuric acid and the sulphate recrystallised from boiling water. Cinchonine so prepared contains quinidine, from which it may be freed by crystallisation from boiling alcohol until it ceases to exhibit fluorescence in dilute sulphuric acid. It will then still contain 10 to 15 per cent. of dihydrocinchonine, which may be removed by reprecipitation as the cuprichloride, $B. 2HCl. CuCl_2$,⁴¹ or by the simpler mercuric acetate process of Thron and Dirscherl.⁴²

Cinchonine separates from alcohol in rhombic prisms, m.p. 264° , $[\alpha]_D^{15} + 263.7^{\circ}$ ($c = M/40$; $N/10 H_2SO_4$). The following figures are probably for cinchonine containing dihydrocinchonine: $+229^{\circ}$ (EtOH), $+234.5^{\circ}$ (alcohol 1 vol., chloroform 2 vols.). It is sparingly soluble in water (1 in 3,810 at 10° , 1 in 3,670 at 20°), more so in alcohol, sp. gr. 0.852 (1 in 140 at 10° , 1 in 125.7 at 20° , 1 in 28 of boiling alcohol), ether sp. gr. 0.7305 (1 in 371 at 10°) or amyl alcohol (1 in 109 at 15° , or 1 in 22 boiling).

It behaves as a diacidic base, and gives two series of salts. The sulphate, $B_2. H_2SO_4. 2H_2O$, forms rhombic crystals, m.p. 200° (*dry, dec.*), readily soluble in 80 per cent. alcohol (1 in 5.8 at 11°), moderately so in water (1 in 65.5 at 13°), $[\alpha]_D + 193.29^{\circ} - 0.374c$ (EtOH) or $+133^{\circ}$ ($CHCl_3$). The acid sulphate, $B. H_2SO_4. 4H_2O$, occurs in octahedral crystals readily soluble in alcohol (1 in 0.9 at 14°), or water (1 in 0.46 at 14°). The hydrochloride, $B. HCl. 2H_2O$, m.p. $217-8^{\circ}$ (*dry*), forms monoclinic crystals, soluble in 22 parts of cold water or 1 part of cold alcohol, $[\alpha]_D^{25} + 133^{\circ}$ ($CHCl_3$) (Rabe). The dihydrobromide, $B. 2HBr$, crystallises from hot water (1 in 1) and the salt made from base purified as described above has $[\alpha]_D^{15} + 143.6^{\circ}$ ($c = M/10, H_2O$) or $+146.2^{\circ}$ ($c = M/40, H_2O$).

Detection. Cinchonine is sparingly soluble in all ordinary solvents, is not fluorescent in dilute sulphuric acid, is dextrorotatory, forms a soluble tartrate and hydriodide and does not give the thalleioquin reaction. Hesse's "homocinchonine" has been shown to be impure cinchonine.⁵⁷

Cinchonidine, $C_{19}H_{22}ON_2$. This alkaloid occurs in most varieties of cinchona bark, but especially in *C. succirubra*.

The ethereal solution of crude quinidine and cinchonidine, obtained as described under cinchonine, is shaken with dilute hydrochloric acid, the excess acid neutralised with ammonia and sodium potassium tartrate added. The base is recovered from the precipitated tartrate by dissolving the latter in dilute acid and pouring the filtered solution in a thin stream, slowly and with constant stirring, into excess of ammonia solution. The crude alkaloid is converted into the neutral sulphate, and this recrystallised

from boiling water (1 : 25). The crystals which separate at 35°, after the third crystallisation are generally free from impurities, and cinchonidine may be regenerated from them as described already.⁵⁸ Commercial cinchonidine generally contains quinine, which may be eliminated by crystallisation from boiling benzene (1 : 30) until the base is no longer fluorescent in dilute sulphuric acid. It then still contains dihydrocinchonidine, which may be eliminated by fractional crystallisation from alcohol (1 : 6), the middle fraction being the best, until the product gives a satisfactory hydrogenation test⁴¹ or mercuric acetate test.⁴²

Cinchonidine crystallises in large trimetric prisms, m.p. 204·5°, and when purified as described has $[\alpha]_D^{15} - 178^\circ$ ($c = M/40$, $N/10$ H_2SO_4). The following figures also on record probably relate to cinchonidine containing dihydrocinchonidine: $-107\cdot9^\circ$ (alcohol-chloroform 1 : 2, Lenz), $-111\cdot0^\circ$ (EtOH, Rabe), $-110\cdot0^\circ$ ($c = 1$, EtOH, Emde). It is sparingly soluble in water (1 in 5,263 at 11·5° (Skraup)); more soluble in alcohol (1 in 16·3 of 97 per cent. alcohol at 13° (Hesse)); or ether (1 in 1,053 of dry ether at 11·5° (Skraup), 1 in 188 of ether, sp. gr. 0·72 at 15° (Hesse)). Cinchonidine is not fluorescent in dilute sulphuric acid solution, and does not give the thalleioquin reaction. It is a diacidic base, and yields two series of salts. The neutral sulphate, $B_2 \cdot H_2SO_4$, m.p. 205° (*dry, dec.*), forms monoclinic prisms with 6 H_2O from cold water, or with 3 H_2O from hot water, and is soluble in alcohol (1 in 72 at 25°), or water (1 in 63 at 25°). The acid sulphate, $B \cdot H_2SO_4 \cdot 5H_2O$, has $[\alpha]_D^{15} - 133\cdot6^\circ$ (dry salt: $c = M/40$, H_2O). The neutral hydrochloride, $B \cdot HCl \cdot H_2O$, m.p. 242° (*dry*), $[\alpha]_D - 117\cdot6^\circ$ (dry salt, $c = 1\cdot214$, H_2O), forms monoclinic double pyramids, or silky prisms with 2 H_2O , from its saturated aqueous solution. The dry salt is moderately soluble in water (1 in 38·5 at 10°), or ether (1 in 325 at 10°), readily in chloroform. The acid hydrochloride, $B \cdot 2HCl \cdot H_2O$, forms large monoclinic prisms easily soluble in water or alcohol. The dihydrobromide, $B \cdot 2HBr \cdot 2H_2O$, crystallises well from water and has $[\alpha]_D^{15} - 114\cdot3^\circ$ (dry salt, $c = M/40$, H_2O). The tartrate, $B_2 \cdot H_2C_4H_4O_6 \cdot 2H_2O$, $[\alpha]_D - 129\cdot6^\circ$ (Oudemans), -132° (Hesse) $-137\cdot7^\circ$ (Koppeschaar), is a crystalline precipitate, sparingly soluble in water (1 in 1,265 at 10°), almost insoluble in sodium potassium tartrate solution, and is the form in which the alkaloid is usually estimated.

Detection. Cinchonidine is distinguished from quinine and quinidine by not being fluorescent in dilute sulphuric acid, and by not giving the thalleioquin reaction and from cinchonine in being levorotatory and more soluble in ether, and in the sparing solubility of its tartrate.

Hesse's "homocinchonidine"⁵⁹ was probably, according to Skraup,⁵⁹ merely an unusually pure cinchonidine.

Cinchotine (*Hydrocinchonine*, more correctly dihydrocinchonine, *Cinchonifine*, ψ -*Cinchonine*), $C_{16}H_{24}ON_2$. This alkaloid occurs in commercial cinchonine to the extent of about 14 per cent.⁶⁰ and may be prepared from this source by the mercuric acetate process,⁴² or more conveniently by the hydrogenation of commercial cinchonine previously freed from quinidine.⁶¹

Cinchotine crystallises from alcohol in prisms, m.p. 267° , and when pure has $[\alpha]_{\text{D}}^{15^{\circ}} + 225.8^{\circ}$ ($c = M/40$, $N/10 \text{ H}_2\text{SO}_4$); other figures recorded are $+150.5^{\circ}$ ($c = 0.31$, EtOH, Emde), $+190^{\circ}$ (Rabe), $+204.5^{\circ}$ (EtOH, Hesse). It is less soluble in chloroform or alcohol (1 in 221.5) than cinchonine. The neutral sulphate, $\text{B}_2 \cdot \text{H}_2\text{SO}_4 \cdot 11\text{H}_2\text{O}$, forms fine needles, m.p. $194.8\text{--}195^{\circ}$ (*dry*), soluble in water (1 in 37.6 at 12°). The hydrochloride, $\text{B} \cdot \text{HCl} \cdot 2\text{H}_2\text{O}$, m.p. 216.5° , $220\text{--}1^{\circ}$ (*dry, dec.*), $[\alpha]_{\text{D}} + 155\text{--}9^{\circ}$ (H_2O), occurs in small needles. The dihydrobromide, $\text{B} \cdot 2\text{HBr}$, has $[\alpha]_{\text{D}}^{15^{\circ}} + 146.2^{\circ}$ ($c = M/40$, H_2O), and forms rhombic crystals from water. The platinichloride, $\text{B}_2 \cdot 2\text{HCl} \cdot \text{PtCl}_4$, occurs in orange-red needles, sparingly soluble in water. On boiling with acetic acid, cinchotine is converted into *dihydrocinchonine*,⁶² a viscous yellow oil, $[\alpha]_{\text{D}}^{23^{\circ}} + 8.8^{\circ}$ in alcohol, which gives a crystalline benzoyl derivative, m.p. $121\text{--}2^{\circ}$, and a phenylhydrazone dipicrate, m.p. 215° (*dec.*), sparingly soluble in alcohol (Rabe⁶³). Emde's dihydrocinchonine,⁶³ according to Rabe, is impure *epidihydrocinchonidine*.

Hydrocinchonidine (*Dihydrocinchonidine, Cinchamidine*), $\text{C}_{19}\text{H}_{24}\text{ON}_2$. This alkaloid was isolated by Forst and Böhringer⁶⁴ from commercial cinchonidine, from which it may be obtained by the mercuric acetate process,⁴² but is more conveniently prepared by the hydrogenation⁶⁵ of pure cinchonidine. It crystallises in six-sided leaflets, m.p. 232° , $[\alpha]_{\text{D}}^{20^{\circ}} - 95.8^{\circ}$ ($c = 0.377$, EtOH : Emde) or -144.6° ($c = M/40$, $N/10 \text{ H}_2\text{SO}_4$), is insoluble in water and only slightly soluble in other solvents except alcohol. The neutral sulphate, $\text{B}_2 \cdot \text{H}_2\text{SO}_4 \cdot 7\text{H}_2\text{O}$, needles soluble in water (1 in 57 at 10°); the acid sulphate, $\text{B} \cdot \text{H}_2\text{SO}_4 \cdot 5\text{H}_2\text{O}$, leaflets, slightly soluble in water, $[\alpha]_{\text{D}}^{15^{\circ}} - 106.8^{\circ}$ (*dry salt*, $c = M/40$, H_2O). The hydrochloride, $\text{B} \cdot \text{HCl} \cdot 2\text{H}_2\text{O}$, m.p. $202\text{--}3^{\circ}$ (*dry*), $[\alpha]_{\text{D}} - 89.4^{\circ}$ ($c = 1.19$, H_2O), six-sided prisms, soluble in water or alcohol. The dihydrobromide, $\text{B} \cdot 2\text{HBr} \cdot 2\text{H}_2\text{O}$, has $[\alpha]_{\text{D}}^{15^{\circ}} - 92.9^{\circ}$ (*dry salt*, $c = M/40$, H_2O).

Hydroquinine (*Dihydroquinine*), $\text{C}_{20}\text{H}_{26}\text{O}_2\text{N}_2 \cdot 2\text{H}_2\text{O}$. This base was isolated by Hesse⁶⁶ from the mother liquors of quinine sulphate manufacture and is present to the extent of 5 to 6 per cent. in commercial sulphate of quinine, from which it is best isolated by the mercuric acetate process.⁴² The demand for hydroquinine as such and as a material for the preparation of hydrocupreine has led to its manufacture from quinine by catalytic hydrogenation.⁶⁷ It crystallises from ether or benzene in needles, m.p. 173.5° (*dry*), $[\alpha]_{\text{D}}^{15^{\circ}} - 235.7^{\circ}$ ($c = M/40$, $N/10 \text{ H}_2\text{SO}_4$) or -142.2° (EtOH), is easily soluble in ether, alcohol, chloroform or acetone. Hydroquinine gives the thalleioquin reaction and a solution in dilute sulphuric acid is fluorescent, but is distinguished from a similar quinine solution by its resistance to permanganate. The neutral sulphate, $\text{B}_2 \cdot \text{H}_2\text{SO}_4 \cdot 6\text{H}_2\text{O}$, occurs in short prisms, sparingly soluble in chloroform and moderately so in water (1 in 348 at 15°), $[\alpha]_{\text{D}}^{15^{\circ}} - 204.6^{\circ}$ (*dry salt*, $c = M/40$, $N/10 \text{ H}_2\text{SO}_4$). The acid sulphate, $\text{B} \cdot \text{H}_2\text{SO}_4 \cdot 3\text{H}_2\text{O}$, forms long needles, easily soluble in water or alcohol. The hydrochloride, $\text{B} \cdot \text{HCl} \cdot 2\text{H}_2\text{O}$, has m.p. $206\text{--}8^{\circ}$ (*dry*), and $[\alpha]_{\text{D}}^{21^{\circ}} - 123.9^{\circ}$ (H_2O). The dihydrobromide, $\text{B} \cdot 2\text{HBr} \cdot 3\text{H}_2\text{O}$, is readily soluble in water (1 in 1) and

has $[\alpha]_D^{15} - 152.5^\circ$ (dry salt, $c = M/40$, H_2O). The alkaloid forms a crystalline benzoyl derivative, m.p. $102-7^\circ$; with methyl iodide it gives a methiodide, B. MeI. MeOH. It readily forms crystalline molecular compounds with cinchonidine, quinidine or cupreine, and by heating its acid sulphate at 140° or by von Miller and Rohde's acetic acid process it is transformed into the isomeric *dihydroquinicine* (dihydroquinotoxine) sulphate, m.p. 174° . On demethylation it furnishes dihydrocupreine (p. 431).

Hydroquinidine (*Dihydroquinidine*), $C_{20}H_{26}O_2N_2 \cdot 2\frac{1}{2}H_2O$. This base occurs in the quinidine of commerce to the extent of 25 to 30 per cent. and was isolated from this source by Forst and Böhringer.⁶⁸ It can be separated from commercial quinidine, after removal of any cinchonine in the latter, by the mercuric acetate process,⁴² but is best prepared by catalytic reduction of quinidine.⁶⁹ It forms thick tablets from ether or long needles from alcohol, m.p. 169.5° , $[\alpha]_D^{15} + 299^\circ$ (dry base, $c = M/40$, $N/10 H_2SO_4$), gives the thalleoquin reaction and is fluorescent in dilute sulphuric acid. The sulphate, $B_2 \cdot H_2SO_4 \cdot 12H_2O$, forms thick, bottle-shaped crystals or fine needles with $2H_2O$, soluble in 92.3 parts of water at 16° ; the hydrochloride, B. HCl, m.p. $273-4^\circ$ (*dec., dry*), $[\alpha]_D^{26} + 183.9^\circ$, occurs in prismatic plates, easily soluble in water; the dihydrobromide, B. $2HBr \cdot 3H_2O$, has $[\alpha]_D^{15} + 200.4^\circ$ (dry salt, $c = M/40$, H_2O); the platinichloride, B. $2HCl \cdot PtCl_4$, forms short, orange-coloured needles. The base can be transformed into dihydroquinicine and on demethylation yields dihydrocupreidine (p. 431).⁶⁹

Cupreine, $C_{19}H_{22}O_2N_2 \cdot 2H_2O$. Cupreine occurs, with quinine, in cuprea bark derived from *Remijia pedunculata*, a plant closely related to, though distinct from, the cinchonas.⁷⁰ Cuprea bark had ceased to be collected commercially, and cupreine had become a museum curiosity, but the bark was again collected during the war, and so cupreine may once more become available. It was prepared by converting the total alkaloids of the bark into neutral sulphates. The product that separated first was the sulphate of HOMOQUININE, a molecular compound of quinine and cupreine, $C_{20}H_{24}O_2N_2 \cdot C_{19}H_{22}O_2N_2 \cdot 4H_2O$. Homoquinine crystallises from ether in needles, plates or prisms, m.p. 177° (*dry*), $[\alpha]_D - 235.6^\circ$ (dil. HCl), becomes anhydrous at 125° , is soluble in chloroform or alcohol, less so in ether. The sulphate, B. B'. $H_2SO_4 \cdot 6H_2O$, forms short hexagonal prisms from hot water; a solution of the sulphate in dilute sulphuric acid poured into excess of sodium hydroxide solution with constant stirring gives a precipitate of quinine, the cupreine remaining in solution, from which it can be recovered as base by the passage of carbon dioxide. Cupreine crystallises in concentrically grouped prisms, becomes anhydrous at 120° , and then melts at 198° , $[\alpha]_D^{17} - 175.5^\circ$ (dry; EtOH). It is sparingly soluble in ether or chloroform, readily in alcohol or solutions of caustic alkalis, but not in ammonia, and gives the thalleoquin reaction. Cupreine is a diacidic base: the neutral sulphate, $B_2 \cdot H_2SO_4$, forms colourless anhydrous needles, m.p. 257° ,⁴⁸ soluble in 813 parts of water at 17° ; the acid sulphate, B. $H_2SO_4 \cdot H_2O$, crystallises in prisms and is soluble in

73.4 parts of water at 17°. On methylation cupreine is converted into quinine, but the latter on demethylation yields a mixture of *apo*-bases (p. 450), which has been called "*apo*quinine" and is also stated to be produced when cupreine is heated with halogen acids.

Hydrocupreine (*Dihydrocupreine*), $C_{19}H_{24}O_2N_2$. This alkaloid does not occur naturally, but can be produced by demethylating dihydroquinine⁷¹ or reducing cupreine.⁷² It crystallises from dilute alcohol in minute needles or from a mixture of chloroform and benzene in warty masses, m.p. 230° (*dec.*) with some sintering at 185–200°, is readily soluble in chloroform, alcohol or hot benzene, and much less so in ethyl acetate, insoluble in light petroleum, $[\alpha]_D^{20} - 155.5^\circ$ (G. and H.),⁷² $[\alpha]_D^{23} - 148.7^\circ$ (H. and J.) in dry alcohol. The hydrochloride, B. HCl, m.p. 280° (*dec.*), $[\alpha]_D^{22.5} - 132.3^\circ$ (H_2O), crystallises in needles; the dihydrobromide, B. 2HBr, 2H₂O, in leaf-like masses of prisms, m.p. 180–90°, and the nitrate, B. HNO₃, in flattened needles, m.p. 220–2°. On methylation the base yields dihydroquinine and a series⁷³ of homologues of hydroquinine has been prepared from it, e.g., (1) *ethylhydrocupreine hydrochloride*, B. HCl, rhombic crystals, m.p. 252–4°, $[\alpha]_D^{21} - 123.6^\circ$ (H_2O); the hydrobromide, m.p. 258–9°; the methiodide, pale yellow plates, m.p. 195–6°, $[\alpha]_D^{21.5} - 113^\circ$. The base itself is a white powder, m.p. 122°, $[\alpha]_D^{20} - 144.3^\circ$ (EtOH), or crystallised from toluene, m.p. 123–8°, $[\alpha]_D^{25} - 136.2^\circ$; (2) *sec-octylhydrocupreine dihydrochloride*, B. 2HCl. 2H₂O, pale yellow sheaves or rosettes of needles, m.p. 190–5°.

On treatment by von Miller and Rohde's process, hydrocupreine is converted into dihydrocupreinotoxine (dihydrocupreicine), and this, too, can be alkylated, giving a series of homologues of dihydroquinine.

Hydrocupreidine (*Dihydrocupreidine*), $C_{19}H_{24}O_2N_2 \cdot xH_2O$. This base, isomeric with the foregoing, is made by demethylating dihydroquinidine, and was first definitely obtained by Heidelberg and Jacobs.⁷⁴ It forms glistening, cream-tinted, hexagonal plates, m.p. 195° (*dec.*), $[\alpha]_D^{19.5} + 227.2^\circ$ ($c = 1.16$, EtOH). The hydrochloride, B. HCl, forms prismatic needles, m.p. 231–3°, $[\alpha]_D^{24} + 194.2^\circ$ ($c = 0.62$, H_2O); the dihydrobromide, B. 2HBr, pale yellow plates, m.p. above 275°; the hydriodide, B. HI. H₂O, pink rhombic plates, m.p. 209–12° (*dry*). The ethyl ether (ethyl-dihydrocupreidine), $C_{19}H_{23}ON_2 \cdot OC_2H_5$, forms slender needles, m.p. 197.5–198°, $[\alpha]_D + 212.8^\circ$ ($c = 1.008$, EtOH), and yields a hydrochloride, B. HCl. 4H₂O, flat needles or narrow plates, m.p. 258–60° (*dry*), $[\alpha]_D^{22} + 183.3^\circ$ ($c = 0.592$, H_2O). Series of higher alkyl ethers have been prepared by Ghosh and Chatterjee,⁷⁵ and by Buttle, Henry, Solomon, Trevan and Gibbs.⁷³

REFERENCES

- (1) ARROT, *Phil. Trans.*, 1737, 40, 81; WEDDELL, "Histoire Naturelle des Quinquinas," Paris, 1849; FLÜCKIGER and HANBURY, "Pharmacographia," London, 1879; SIR CLEMENTS MARKHAM, "Peruvian Bark," London, 1880; "Proceedings of the Celebration of the Three Hundredth Anniversary of the First Recognised Use of Cinchona," Missouri Botanical Garden, St. Louis, U.S.A., 1931. (2) HAGGIS, "Fundamental Errors in the Early History of Cinchona," *Bulletin Hist. Med.*, 1941, 10, 417. (3) CONDAMINE, "Sur l'Arbre de Quinquina," *Mem. de l'Acad. roy. des Sciences*, 1788.

p. 226; J. E. HOWARD, "Nuova Quinologia of Pavon," London, 1860; DYMCK, HOOPER and WARDEN, "Pharmacographia Indica," Vol. II, p. 174, London, 1891; D. HOWARD, *J. Soc. Chem. Ind.*, 1906, 25, 97; VAN GORKOM, "Scheikundige Bijdragen tot de kennis der Java-Kina, 1872-1907," Amsterdam, 1908; WATT, "Cinchona" in "Commercial Products of India," London, 1908; B. HOWARD, "Notes on the Cinchona Industry," Institute of Chemistry, London, 1931; KERBOSCH, *Bull. Colonial Inst.*, Amsterdam, 1939, 3, 36; "Cinchona Culture in Java: its History and Present Situation," *Geneesk. Tijds. Ned. Ind.*, 1931, Afk. 4, Decl. 71; (4) E. SHAW, "Quinine Manufacture in India," Institute of Chemistry, London, 1935. (5) "The Critical Anti-malarial Problem and its Solution," *J. Amer. Med. Assoc.*, 1942, 120, 1043; Restrictions on the use of Quinine or Quinidine, *J. Amer. Pharm. Assoc. (Pharmacy Section)*, 1942, 3, 112; *Chem. and Drugg.*, 1942, Aug. 22, 203, 204; *Pharm. J.*, 1944, 153, 66; 1947, 158, 20, 78. (5a) The following references provide general information on the cultivation of cinchona: *Bulletin of Miscellaneous Information, Kew*, 1931, No. 3; 1932, No. 1; H.M. Stationery Office, London; "The World's Cinchona Bark Industry," *Bull. Imperial Inst.*, 1939, 37, 18; Cinchona Cultivation in the British Empire, *ibid.*, p. 193; WORSLEY, *ibid.*, 1935, 33, 14; BAL, *Indian J. Pharm.*, 1939, 1, 131 (with DATTA), *ibid.*, 1946, 8, 85; WINTERS, LOUSTALOT and CHILDERS, *Plant Physiol.*, 1947, 22, 42, 613; ALLEN, *Pharm. J.*, 1948, 160, 202. The following references describe developments in the countries named: (5b) Belgian Congo, *Pharm. J.*, 1944, 152, 163; 1945, 155, 260; 1947, 158, 135; DENIS, *Meded. Vlaam. Chem. Ver.*, 1945, 7, 151 (*Chem. Abstr.*, 1947, 41, 3261). Central and S. America, STEERE, *Science*, 1945, 101, 177; ANON, *Pharm. J.*, 1944, 152, 163. Bolivia, DE SOUZA, *Chem. Abstr.*, 1947, 41, 3925. Brazil, KRUG and CARVALHO, *Rev. Brazil Farm.*, 1942, 23, 38; WASICKY, *Rev. brasil. quim.*, 1944, 18, 265, 322 (*Chem. Abstr.*, 1945, 39, 1505); *Bol. Oficina sanit. panamericana*, 1945, 24, 159 (*J. Amer. Pharm. Assoc.*, 1945, 34, *Abstr.*, p. 299). Colombia, DE CALDAS *et al.*, *Rev. acad. Columbiana exact. fis. nat.*, 1937, 1, 257, 326; 1938, 2, 67, 377; LITTLE, *ibid.*, 1947, 7, 404; FIGUEROA, *Bol. Inst. Nac. Hig. Sampcr. Martínez*, 1942, 5, 9 (*J. Amer. Pharm. Assoc.*, 1944, 33, *Abstr.*, p. 135); *Pharm. J.*, 1945, 154, 113. Costa Rica, *Pharm. J.*, 1943, 150, 191; 1946, 156, 78. Ecuador, MARTINI and GANDARA, *Bot. Gaz.*, 1943, 107, 184 (*Chem. Abstr.*, 1946, 40, 1633); STEERE, *Bull. Torrey Bot. Club*, 1945, 72, 464 (*Brit. Abstr.*, 1946, A iii, 247); *Pharm. J.*, 1945, 154, 195; 1946, 157, 111. Mexico, SOBERON and PELAEZ, *Ciència (Mex.)*, 1946, 7, 221. Peru, *Pharm. J.*, 1945, 154, 113; 155, 96; 1946, 156, 261; HODGE, *Carib. Forest*, 1946, 7, 79 (*Chem. Abstr.*, 1946, 40, 2932; see also *ibid.*, 1948, 42, 2059). China, HSING, LO and LI, *J. Chem. Eng. Chin.*, 1942, 9, 32 (*Chem. Abstr.*, 1946, 40, 2929). India, *Pharm. J.*, 1944, 153, 202. Philippine Islands, MARANON and BARTLETT, *Nat. Applied Sci. Bull. Phil.*, 1941, 8, 111; SIMPAO, *Rev. Phil. Med. Farm.*, 1941, 32, 80. San Thomé, COSTA, *Noticias farm.*, 1940-41, 7, 173. Soviet Russia, KURSANOV and KRIUKOVA, *Biochimia*, 1939, 4, 562; ALEKSEVA, *Sovet Nauka*, 1940, No. 7, 138; TAMARSKAJA, *J. App. Chem.*, U.R.S.S., 1940, 13, 291; EFIMENKO, *Soviet Plant Ind. Rec.*, 1940, 2, 151; KAPTSIONEL, *Chem. and Drugg.*, 1945, 144, 244. Tanganyika, *J. Trop. Med. Hyg.*, 1942, 45, 126; *Ann. Rept. East African Ind. Res. Board*, 1944; *Repts. E. African Agric. Res. Inst. Amani*, 1942-5, H.M. Stationery Office, London; *Pharm. J.*, 1947, 158, 36. (5c) "History of the Cinchona Project of Merck and Co., Inc. and Experimental Plantations, Inc., 1934-1943," by F. ROSENGARTEN, Jr.; see also "Performance records of individual trees and clones of Cinchona in Guatemala," by J. R. SHUMAN (review in *Science*, 1947, 105, 557). (5d) STEERE ^(b); see also PRO y CASTILLO, *Bol. Soc. Quim. Peru*, 1944, 10, 116; HOCKING, *Science*, 1945, 101, 484. (5e) *Pharm. J.*, 1946, 157, 142; 1947, 158, 191, 305. (6) GAGE, *Trans. Roy. Soc. Trop. Med. & Hyg.*, 1925, 18, 348. (7) HOWARD and CHICK, *Year-book Pharm.*, 1923, p. 639; HOOPER, *ibid.*, 1929, p. 186; GOODSON and HENRY, *Quart. J. Pharm.*, 1930, 3, 238. (8) Cf. GOODSON and HENRY, *ibid.*, 1932, 5, 161. (9) *Malaria Commission, Health Organisation, League of Nations* (1931), *CH/Malaria/Nos. 158 and 167/1*; (1932), *CH/Malaria/No. 188*; *Quart. Bull. Health Org. League of Nations*, 1933, 2, 250; 1934, 3, 825; GIEMSA, *Riv. Malaritol.*, 1933, 12, 70; GROOTHOFF and HENRY, *ibid.*, p. 87; WATTIEZ, *Bull. Inst.*

Roy. Col. Belg., 1933, 4, 852; SABATUCEI, *Scienza farm.*, 1933, 1, 241; EDIT. *Ind. Med. Gaz.*, 1934, 69, 215; FIELD, *Malay Med. J.*, 1934, 9, 26; SLATINEANU, CIUCA *et al.*, *Bull. Soc. Path. Exot.*, 1934, 27, 723; *Asiatic Rev.*, 1939, 35, 777; PÂRVULESCU, CONSTANTINESCO and BOERIU, *Arch. Roum. Path. Exp.*, 1934, 7, 523; BERMOND, *Bull. Sci. Pharmacol.*, 1934, 41, 614; MARAÑÓN, PEREZ and RUSSELL, *Philippine J. Sci.*, 1935, 56, 229; HICKS and CHAND, *Rec. Malaria Survey Ind.*, 1935, 5, 39; EDIT., *E. African Med. J.*, 1944, 21, 289; RAYMOND, *ibid.*, p. 291; 1946, 23, 962; BARANGER and THOMAS, *Biochem. J.*, 1943, 37, 342; CHAYANOV, *Farmatsiya*, 1939, No. 7, p. 19; KAPTSIONEL, Ref. (5b); FIGUEROA, Ref. (5b); YEAGER, REITLER and McDANIEL, *J. Amer. Pharm. Assoc.*, 1946, 35, 337; KNOPPERS and NIEUWENHUIJSE, *Arch. internat. Pharmacodyn.*, 1946, 73, 260; APPELZWEIG, *J. Amer. Chem. Soc.*, 1944, 66, 1990; (with RONZONE), *Ind. Eng. Chem.*, 1946, 38, 576. (10) (a) Identification of Cinchona Bark, WAGG, *Quart. J. Pharm.*, 1938, 11, 443. (b) Identification of Cinchona Alkaloids, KOFLEK and MÜLLER, *Mikrochemie*, 1937, 22, 43; WAGENAAR, *Pharm. Weekbl.*, 1939, 76, 1544; MARTINI, *Mikrochimie ver. Mikrokhim. Acta*, 1940, 28, 235; FULTON, *Ind. Eng. Chem.*, 1941, 13, 848; KEENAN and WARREN, *J. Amer. Pharm. Assoc.*, 1945, 34, 300; SUMERFORD, *Bull. Georgia Acad. Sci.*, 1945, 3, 5; *Bull. Nat. Form. Cttee.*, 1947, 15, 90. (c) Extraction and Separation of Alkaloids, BEGUIN, *Pharm. Acta Helv.*, 1939, 14, 109; ROSENTHALER and JALCINDAG, *ibid.*, 1941, 16, 149; BUCHI (with FUCHS), *ibid.*, 1942, 17, 1; (with GRAETZA), *ibid.*, p. 73; NICHOLS and SHAH, *J. Amer. Pharm. Assoc.*, 1939, 28, 526; HUSA and PACENTA, *ibid.*, 1941, 30, 635; BELCOT and RAPEANU, *Curierul Farm.*, 1940, No. 1, p. 1. *Chromatographic Methods*—HEILBRON *et al.*, B.P. 558,320; KRASNOVA, *J. Appl. Chem.*, U.R.S.S., 1945, 18, 86. (d) Estimation of Total Alkaloids, SELF and CORFIELD, *Pharm. J.*, 1931, 127, 74; *Quart. J. Pharm.*, 1930, 3, 410; ALLPORT and FRIEND, *ibid.*, 1938, 11, 450; STERNON, *Bull. Soc. Chim. Belg.*, 1932, 41, 85; GSTIRNER, *Pharm. Zeit.*, 1933, 78, 706; JERMSTAD, *Norsk. Farm. Tids.*, 1936, 44, 302, 309, 323; WOJAHN, *Apoth. Zeit.*, 1939, 54, 783, 1224; EFIMENKO, *J. Appl. Chem.*, U.R.S.S., 1940, 13, 1405; EDER and RUCKSTUHL, *Pharm. Acta Helv.*, 1943, 18, 396; LJUNGBERG, *Svensk. Farm. Tid.*, 1946, 50, 197, 219, 237; DALMA and RODRIGUEZ, *Arch. farm. bioquim. Tucuman*, 1947, 3, 145 (*Chem. Abstr.*, 1948, 42, 322). (e) Estimation of Specific Alkaloids. (1) *Physical Methods*—KRANTZ, *J. Amer. Pharm. Assoc.*, 1930, 19, 1299. *Spectrophotometric Methods*—FABRE, *Bull. Soc. Chim.*, 1925, [iv], 37, 1304; VAN ARKEL, *Pharm. Weekbl.*, 1938, 75, 485; CAROL, *J. Assoc. Off. Agric. Chem.*, 1942, 25, 524; 1943, 26, 238; cf. LOUSTALOT and PAGAN, *ibid.*, 1947, 30, 153; EFIMENKO, *J. Appl. Chem.*, U.R.S.S., 1940, 13, 1405; STIMSON and REUTER, *J. Amer. Chem. Soc.*, 1946, 68, 1192. (2) *Chemical Methods*—PINXTEREN, *Pharm. Weekbl.*, 1929, 66, 919; VETTER, *Festschrift*, E. C. Barrel, Basle, 1936, p. 541; HERD, *J. Amer. Pharm. Assoc.*, 1942, 31, 9; EDER and RUCKSTUHL, *Pharm. Acta Helv.*, 1943, 18, 396; SCHULEK and KOVACS, *Z. anal. Chem.*, 1941, 121, 21 (Vinyl cinchona alkaloids); ZELIGSON and SIN'KOVSKAYA, *J. Gen. Chem.*, U.R.S.S., 1945, 15, 957; CHRISTENSEN, GOTTLIEB and REIMERS, *Dansk. Tids. Farm.*, 1947, 21, 221, 231. (11) ALLEN'S "Commercial Organic Analysis," 5th edition, vol. 7 (London: J. & A. Churchill; Philadelphia: P. Blakiston's Son & Co. Inc.). (12) *Bull. Health Org. League of Nations*, 1934, 3, 342. (13) *Quart. J. Pharm.*, 1930, 3, 238; 1932, 5, 161. (14) *Pharm. J.*, 1926, 117, 168. (15) *Analyst*, 1930, 55, 561; cf. EVERS, *Year-book Pharm.*, 1921, 327; LIVERSEDGE, *ibid.*, 1922, 425; and PEDERSEN, *Dansk. Tids. Farm.*, 1938, 12, 161. (16) ANDREWS, *Ind. Eng. Chem. [Anal. Edit.]*, 1942, 14, 543; (with WEBB), *ibid.*, 1941, 13, 222. (17) *J. Amer. Chem. Soc.*, 1936, 58, 1977. (18) PELLETIER (with CAVENTOU), *Ann. Chim. Phys.*, 1820 [ii], 15, 291, 1337; (with DUMAS), *ibid.*, 1823, 24, 169. (19) "Die Fabrikation der Alkaloide," Berlin, 1927; VETTER, *Festschrift*, E. C. Barrel, Basle, 1936, p. 542. (20) TUTIN, *Pharm. J.*, 1909, [iv], 29, 600; EMDE, *Helv. Chim. Acta*, 1932, 15, 357; BUTTLE, HENRY and TREVAN, *Biochem. J.*, 1934, 28, 426. (21) *Annalen*, 1890, 258, 135; cf. MALQUORI and COVELLO, *Ann. Chim. Appl.*, 1935, 25, 647. (22) DUNCAN, *Pharm. J.*, 1905, 74, 438. (23) RABE *et al.*, *Annalen*, 1910, 373, 85. (24) HESSE, *ibid.*, 1875, 176, 205. (25) OUDEMANS, *ibid.*, 1876, 182, 44; SCHOORL, *Pharm. Weekbl.*, 1926, 63, 469; LIQUIER, *Compt. rend.*, 1926, 183, 195; LAPP, *ibid.*, 1932, 195, 243; 1933, 196, 970; *Arch. phys. biol.*, 1932, 10, 42;

Bull. Soc. chim., 1935, [v], 2, 1407; DIETZEL and SÖLLNER, *Arch. Pharm.*, 1930, 268, 629; ANDREWS, Ref. 10 (e) (1). (26) RABE and MARSHALL, *Annalen*, 1911, 382, 360; and JETTE and WEST, *Proc. Roy. Soc.*, 1928, A, 121, 299. (26a) STUART, POWELL, ROSE and BIBBINS, *J. Amer. Pharm. Assoc.*, 1939, 28, 90. (26b) GRÜSSNER, GÄTZI-FICHTER and REICHSTEIN, *Helv. Chim. Acta*, 1940, 23, 1276; KUHN and WIELAND, *Ber.*, 1940, 73, B, 971; *ibid.*, 1941, 74, B, 218. (26c) STAHL and KUEVER, *J. Amer. Pharm. Assoc.*, 1942, 31, 154. (26d) RAO and SESHADRI, *Proc. Ind. Acad. Sci.*, 1940, 11, A, 289. (27) See, for example, COWNLEY, *Pharm. J.*, 1876, [iii], 7, 189; SAGE, *ibid.*, 1927, [iv], 65, 264; BEAL and SZALKOVSKI, *J. Amer. Pharm. Assoc.*, 1933, 22, 1219; WALES, *ibid.*, 1934, 23, 793; WARREN, *ibid.*, 1934, 23, 874. (28) *J. Pharm.*, 1884, [v], 7, 291. (29) *Zeit. Anal. Chem.*, 1885, 24, 362. (30) *Pharm. J.*, 1884-85, [iii], 16, 358. (31) *J. Pharm. Chim.*, 1904, [vi], 19, 427. (32) Cf. PAUL, *Pharm. J.*, 1885, [iii], 16, 361; HOOPER, *ibid.*, 1886, [iii], 17, 61; HESSE, *ibid.*, 1887-88, [iii], 18, 517. (33) See, for example, HOWARD, *Pharm. J.*, 1896, [iv], 3, 505; (with CHICK), *ibid.*, 1925, [iv], 61, 125; TUTIN, *ibid.*, 1909, [iv], 29, 600. (34) *J. Pharm.*, 1887, [v], 15, 5. (35) *Zeit. Anal. Chem.*, 1888, 27, 549. (36) *Arch. Pharm.*, 1903, 241, 54; MERZ and HOFFMANN, *ibid.*, 1938, 276, 388; see also ZELIGSON *et al.*, Ref. 10 (e) (2), and REIMERS and GOTTLIEB, *Dansk. Tids. Farm.*, 1947, 21, 45. (37) Cf. HART, *J. Soc. Chem. Ind.*, 1921, 40, 72T; SALOMON, *Ber. Deut. Pharm. Ges.*, 1919, 28, 273; EISENBRAND, *Arch. Pharm.*, 1931, 269, 65. (38) See, for example, FÜHNER, *ibid.*, 1906, 244, 602; COMANDUCCI, *Chem. Soc. Abstr.*, A, 1910, [i], 581; 1911, [i], 317; CHRISTENSEN, *Ber. Deut. Pharm. Ges.*, 1915, 25, 256; 1916, 26, 249; WELLER, *Ber.*, 1921, 54, 230; HARGREAVES, *J. Amer. Pharm. Assoc.*, 1926, 15, 100, 750; 1936, 25, 975; MIKO, *Brit. Chem. Abstr.*, 1928, A, 1146; PAVOLINI, *Boll. Chim. Farm.*, 1931, 70, 795; MONTI and CIRELLI, *Gazzetta*, 1934, 64, 947; 1936, 66, 38; 1937, 67, 621. (39) JØRGENSEN, *J. pr. Chem.*, 1876, [ii], 14, 230; ZIMMERN, *Compt. rend.*, 1926, 182, 1082. (40) ACTON and KING, *Biochem. J.*, 1921, 15, 53; WAGENAAR, *Pharm. Weekbl.*, 1929, 66, 177, 197, 250, 261; 1934, 71, 316; STERKIN and HELFGAT, *Biochem. Zeit.*, 1929, 207, 8; MONNET, *J. Pharm. Chim.*, 1933, [viii], 18, 94; CANALS and PEYROT, *Compt. rend.*, 1934, 198, 746; GREEN, *Ind. Med. Gaz.*, 1929, 64, 614; FIELD and KANDIAH, *Trans. Roy. Soc. Trop. Med. & Hyg.*, 1935, 28, 385; KYKER, WEBB and ANDREWS, *J. Biol. Chem.*, 1941, 139, 551; KELSEY and GEILING, *J. Pharmacol.*, 1942, 75, 183; CORNELL and KAYE, *Milit. Surg.*, 1943, 93, 133; CLAZKO, *U.S. Naval Mil. Bull.*, 1943, 41, 529; BRODIE and UDENFRIED, *J. Biol. Chem.*, 1945, 158, 705; MARSHALL and ROGERS, *Biochem. J.*, 1945, 39, 258. (41) BUTTLE, HENRY and TREVAN, *Biochem. J.*, 1934, 28, 426. (42) *Annalen*, 1935, 515, 252. (43) *J. Amer. Pharm. Assoc.*, 1933, 22, 414. (43a) *J. Pharm. Chim.*, 1935, 22, 112. (44) *J. Chem. Soc.*, 1871, 24, 61; 1872, 25, 101. Confirmed by THRON and DIRSCHERL, *Annalen*, 1935, 521, 48. (45) *Jahresb.*, 1853, p. 473; process improved by VON MILLER and ROHDE, *Ber.*, 1894, 27, 1279; 1895, 28, 1056; cf. HOWARD and CHICK, *Pharm. J.*, 1917, 99, 143. (46) *Annalen*, 1875, 178, 245; 1888, 243, 148. (47) *Ber.*, 1900, 33, 3214; cf. BIDDLE, *ibid.*, 1912, 45, 526; and RABE and McMILLAN, *ibid.*, 1910, 43, 3308. (48) HOWARD and CHICK, *J. Soc. Chem. Ind.*, 1909, 28, 53. (49) HEIDELBERGER and JACOBS, *J. Amer. Chem. Soc.*, 1919, 41, 817. (50) KING and PALMER, *J. Chem. Soc.*, 1922, 121, 2584. (51) *Ber.*, 1925, 58, 544, 554. (52) *Pharm. J.*, 1917, 99, 143; 1923, 111, 93; see also JOHNSON, *J. Amer. Pharm. Assoc.*, 1937, 26, 1227, 1233. (53) *Ibid.*, 1941, 30, 52. (54) BACHSTEZ and DE CARO, *Arch. exp. Path. Pharm.*, 1932, 164, 314. (55) *Annalen*, 1935, 521, 48. (56a) (With KOLBE and HOCHSTÄTTER), *ibid.*, 1932, 492, 242; (with HÖTER), *J. pr. Chem.*, 1939, 154, 66; (56b) *Ber.*, 1908, 41, 67; (with KINDLER), *ibid.*, 1918, 51, 466; 1939, 72, 262; (with HUNTENBERG, SCHULTZE and VOLGER), *ibid.*, 1931, 64, 2498. (57) SKRAUP, *Monats.*, 1899, 20, 579; cf. HESSE, *Annalen*, 1888, 243, 149; 1898, 276, 103. (58) HESSE, *ibid.*, 1880, 205, 196. (59) *Ber.*, 1877, 10, 2156; *Annalen*, 1880, 205, 203; 1883, 243, 148; 1890, 258, 142; cf. SKRAUP, *ibid.*, 1879, 199, 359. (60) HESSE, *Annalen*, 1873, 166, 256; 1898, 300, 46; cf. FORST and BÖHRINGER, *Ber.*, 1881, 14, 486; 1882, 15, 520. (61) HEIDELBERGER and JACOBS, *J. Amer. Chem. Soc.*, 1919, 41, 817. (62) KAUFMANN and HUBER, *Ber.*, 1913, 46, 2913; cf. RABE and KINDLER, *ibid.*, 1918, 51, 1860. (63) *Helv. Chim. Acta*, 1932, 15, 573.

cf. RABE *et al.*, *Annalen*, 1934, 514, 61. (64) *Ber.*, 1881, 14, 1270; HESSE, *ibid.*, 1683; *Annalen*, 1882, 214, 1. (65) SKITA and NORD, *Ber.*, 1912, 45, 3312. (66) *Ibid.*, 1882, 15, 854; *Annalen*, 1887, 241, 257. (67) See, for example, German Patents 251,936, 253,357 (*Chem. Soc. Abstr.*, 1913, [i], 85); 306,939 (*ibid.*, 1918, [i], 546); also SKITA and co-workers, *Ber.*, 1911, 44, 2866; 1912, 45, 3312, 3588; 1916, 49, 1597; KAUFMANN and HUBER, *ibid.*, 1913, 46, 2913; FREUND and BREDEBURG, *Annalen*, 1914, 407, 43; HEIDELBERGER and JACOBS, *J. Amer. Chem. Soc.*, 1919, 41, 817; 1922, 44, 1098. (68) *Ber.*, 1881, 14, 1954; 1882, 15, 520, 1656; cf. HESSE, *ibid.*, 1882, 15, 855, 3010. (69) HEIDELBERGER and JACOBS, *J. Amer. Chem. Soc.*, 1919, 41, 817. (70) PAUL and COWNLEY, *Pharm. J.*, 1881, 12, 497; 1884, [iii], 15, 221, 401; cf. HOWARD and HODGKIN, *ibid.*, 1881, [iii], 12, 528; *J. Chem. Soc.*, 1882, 41, 66; WHIFFEN, *Pharm. J.*, 1881, 12, 497; HESSE, *Annalen*, 1885, 230, 57. (71) HESSE, *ibid.*, 1887, 241, 281; HEIDELBERGER and JACOBS, Ref. 69. (72) GIEMSA and HALBERKANN, *Ber.*, 1918, 51, 1325; KELBER, *ibid.*, 1916, 49, 55. (73) GIEMSA and HALBERKANN, Ref. 72; HEIDELBERGER and JACOBS, *J. Amer. Chem. Soc.*, 1922, 44, 1091; SLOTTA and BEHNISCH, *Ber.*, 1933, 66, 360; 1935, 68, 754; BUTLER, NELSON, RENFREW and CRETCHER, *J. Amer. Chem. Soc.*, 1935, 57, 575; BUTTLE, HENRY, SOLOMON, TREVAN and GIBBS, *Biochem. J.*, 1938, 32, 47. (74) HEIDELBERGER and JACOBS, Ref. 69; cf. FORST and BÖHRINGER, *Ber.*, 1882, 15, 1656. (75) *J. Indian Chem. Soc.*, 1931, 8, 257; 1932, 9, 83.

CONSTITUTION OF THE PRINCIPAL CINCHONA ALKALOIDS

Of the four primary cinchona alkaloids, quinine and quinidine are isomeric and respectively lævo- and dextro-rotatory and the same applies to the other pair, cinchonidine and cinchonine, which in turn differ from the members of the first pair in empirical composition by the residue $-\text{CH}_2\text{O}$ of a methoxyl group, known to be present in quinine and in quinidine. Empirically, quinine may be regarded as methoxycinchonidine and quinidine as methoxycinchonine, and King¹ has shown recently that this is the relationship between the two pairs by (a) converting dihydroquinidine into dihydrocinchonine by removing the methoxyl group of the former, and (b) transforming cupreine, of which quinine is the methyl ether, into cinchonidine by eliminating the phenolic hydroxyl group. The quinidine analogue of cupreine, which has been named cupreidine, is unknown, the base described by Ludwiczakówna, Suszko and Zwierzchowski² under this name, produced by demethylation of quinidine having been shown by Henry and Solomon² to be dihydrocupreidine, due to the presence of dihydroquinidine in the quinidine used, the demethylation products of quinine and quinidine being, not cupreine and cupreidine, but the mixtures of *apo*-bases referred to later (p. 450). Each of the four chief alkaloids on hydrogenation absorbs 1 mol. of hydrogen, forming the naturally occurring alkaloids usually called hydroquinine, etc., but more correctly called dihydroquinine, dihydroquinidine, dihydrocinchonidine and dihydrocinchonine, of which the first two on demethylation furnish dihydrocupreine (also produced by the direct hydrogenation of cupreine), and dihydrocupreidine respectively, neither of which is known to occur naturally.

The two alkaloids which have been most completely investigated are quinine and cinchonine. The scission products of both fall into two classes, *viz.*, derivatives of quinoline and derivatives of a second heterocyclic ring system, formerly referred to as the "second half" of the

molecule, but for which the term quinuclidine was coined by Königs. The proximate decomposition products of this "second half" are distinguished by the occurrence in their names of "loipon" (from *loipos*, a residue) or the prefix "mero" (from *meros*, a part).

OXIDATION OF CINCHONINE AND QUININE. This oxidation proceeds in two well-marked stages. In the first the nuclear structure is preserved and changes occur in side or connecting chains only, whilst in the second scission also takes place and the characteristic products of the two portions of the nuclei appear. Both alkaloids, as already stated, can be hydrogenated to dihydro-derivatives. Similarly, they can each add on a molecule of a halogen, as in the formation of two dibromodihydrocinchonines,³ or a molecule of a haloid acid, as in the formation of the chlorodihydro-bases, each of which exists in two stereoisomeric forms,⁴ e.g., α -chlorodihydroquinine (anhydrous rhombs, m.p. 210° (*dec.*), $[\alpha]_D^{20} - 251.0^\circ$ ($c = 0.5$, $N\text{-HCl}$)) and α' -chlorodihydroquinine (needles, m.p. 194° (*dec.*), $[\alpha]_D^{20} - 168.1^\circ$ ($c = 0.5N\text{-HCl}$)). That these addenda are due to the presence of a vinyl side-chain is clear from the fact that each of the four alkaloids on ozonisation is oxidised to formaldehyde and an aldehyde derived from the alkaloid.⁵ Similarly, each of the four alkaloids on oxidation in the cold with permanganate is converted into formic acid and an alkaloidal substance containing one carboxyl-group. These two reactions in the case of quinine (I) may be represented thus:—

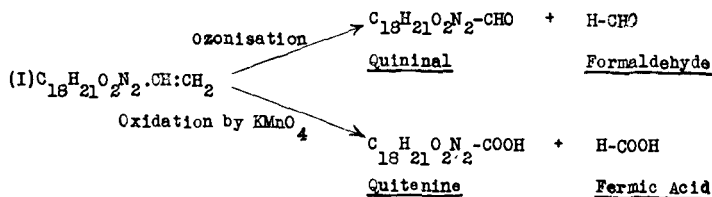

Cinchotenine,⁶ $C_{18}H_{20}O_3N_2 \cdot 3H_2O$, crystallises in needles or leaflets, m.p. 197°, $[\alpha]_D^{26} + 209^\circ$ ($N\text{-H}_2\text{SO}_4$) or $+135.5^\circ$ (H_2O), and is soluble in dilute acids, alkalis or water (1 in 233 at 19°). The base contains two tertiary nitrogen atoms, yields monoacyl derivatives, and forms salts with acids; the aurichloride, $(B \cdot 2HCl) \cdot AuCl_3$, occurs in yellow needles, and the platinichloride, $B \cdot 2HCl \cdot PtCl_4$, in orange-coloured prisms. It is also a carboxylic acid and gives an ethyl ester crystallising in needles, m.p. 213–4°.

The isomeric substance, *cinchotenidine*,⁷ similarly obtained from cinchonidine, crystallises in needles, m.p. 256°, $[\alpha]_D - 201.4^\circ$ or -207° ($N\text{-H}_2\text{SO}_4$), and, like cinchotenine, gives by further oxidation cinchoninic and cincholoiponic acids.

Quitenine, $C_{19}H_{22}O_4N_2 \cdot 4H_2O$, the corresponding quinine product,⁸ forms rhombic prisms from alcohol, m.p. 286° (*dec.*), $[\alpha]_D - 188^\circ$ (H_2O) or -298° ($N\text{-H}_2\text{SO}_4$), slightly soluble in boiling water, insoluble in ether. It gives the thalleoquin reaction, is fluorescent in alcohol or dilute sulphuric acid, and forms salts with acids and with alkalis; the platinichloride

B. $2\text{HCl} \cdot \text{PtCl}_4 \cdot 3\text{H}_2\text{O}$, crystallises in yellow leaflets. The base gives a series of esters and also monoacyl derivatives. Hydriodic acid converts it into quitenol, $\text{C}_{18}\text{H}_{20}\text{O}_4\text{N}_2$, and methyl iodide.

The isomeride *quitenidine*, similarly produced by the oxidation of quinidine,⁹ crystallises in prisms, m.p. 246° , $[\alpha]_{\text{D}}^{23^\circ} + 258^\circ$ ($N\text{-H}_2\text{SO}_4$), and, like quitenine, gives quininic and cincholoiponic acids by further oxidation.

When chromic acid is substituted for permanganate the vinyl group remains unattacked, and the alkaloids each lose two hydrogen atoms, forming the ketones cinchoninone and quinonone respectively. This reaction implies the conversion of a secondary alcohol group into a carbonyl group, and since both cinchonine and cinchonidine yield cinchoninone, and quinine and quinidine, quinonone, this secondary alcohol group must play an important part in differentiating the members of each pair.

Cinchoninone, $\text{C}_{19}\text{H}_{20}\text{ON}_2$, produced by the oxidation of either cinchonine¹⁰ or cinchonidine¹¹ by chromic acid in presence of sulphuric acid forms pale yellow prisms, m.p. $126\text{--}7^\circ$, $[\alpha]_{\text{D}} + 71^\circ$ to $+76^\circ$, is sparingly soluble in light petroleum, easily in ether or chloroform and insoluble in water. The hydrochloride forms minute colourless needles, m.p. $245\text{--}7^\circ$, $[\alpha]_{\text{D}} + 175\cdot9^\circ$. By further oxidation with chromic acid, cinchoninone yields cinchoninic acid and meroquinenine (meroquinene).

Quininone, $\text{C}_{20}\text{H}_{22}\text{ON}_2$, similarly obtained from either quinine¹¹ or quinidine, forms colourless or pale yellow needles or leaflets, m.p. $107\text{--}8^\circ$, $[\alpha]_{\text{D}}^{23^\circ} + 73\cdot8^\circ$, has about the same solubilities as cinchoninone, and yields a hygroscopic, crystalline hydrochloride, m.p. $210\text{--}2^\circ$, $[\alpha]_{\text{D}}^{14^\circ} + 58\cdot7^\circ$. As quinonone is the last stage in Woodward and Doering's synthesis of quinine (p. 462) this group of workers have investigated the quina-ketones in general, and have devised a method for the production of quinonone, by the action of potassium *tert*-butyl oxide on quinine in benzene solution containing benzophenone, which provides yields up to 100 per cent. of the theoretical, and so have made this substance readily available for investigation. When heated for six hours in toluene with 10 moles of sodium *isopropoxide*, quinonone is converted into quinidine and quinine in the proportion 60 to 30 per cent. respectively.

On catalytic hydrogenation it furnishes mainly dihydroquinidine. Benzoyl chloride converts it into the enol benzoate, m.p. $114\text{--}5^\circ$, and on interaction with magnesium alkyl halides it forms alkylquinidines, *e.g.*, methylquinidine, $\text{C}_{21}\text{H}_{26}\text{O}_2\text{N}_2 \cdot 2\text{H}_2\text{O}$, m.p. $105\text{--}12^\circ$, $[\alpha]_{\text{D}}^{25^\circ} + 168^\circ$ (EtOH), and *isobutylquinidine*, m.p. $146\text{--}7^\circ$, $[\alpha]_{\text{D}}^{25^\circ} + 148^\circ$. From these and other data, Woodward, Wendler and Brutschy¹¹ conclude that quinonone has the quinidine configuration (p. 445) and might be called "quinidinone."

On autoxidation by aeration in tertiary butyl alcohol containing potassium *tert*-butyl oxide, quinonone yields quininic acid (98 per cent.) and meroquinenine *tert*-butyl ester, $\text{C}_9\text{H}_{14}\text{N} \cdot \text{CO} \cdot \text{O} \cdot \text{C}_4\text{H}_9$, b.b. $127^\circ/20\text{ mm.}$, $d_4^{30^\circ} 0\cdot9832$, $[\alpha]_{\text{D}}^{29^\circ} + 50\cdot0^\circ$ (EtOH), identified by hydrolysis to meroquinenine (meroquinene) and conversion of this to the better-known ethyl ester (p. 438). (Doering and Chanley.)¹¹

When cinchonine and quinine are oxidised energetically by chromic

acid, instead of these intermediate ketones, the products of the two nuclei are obtained. The following scheme illustrates roughly the relationships of these products to the parent alkaloids. Cinchonidine and quinidine yield respectively the same products as cinchonine and quinine:—

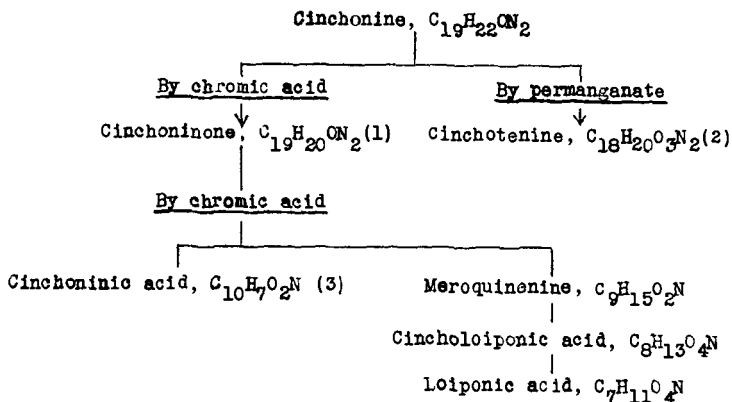

Quinine gives in place of (1) quinone, $C_{20}H_{22}O_2N_2$; in place of (2) quitenine, $C_{19}H_{22}O_4N_2$; and instead of (3) quininic acid, $C_{11}H_9O_3N$, the other products being the same. Cinchoninic and quininic acids are quinoline-4-carboxylic and 6-methoxyquinoline-4-carboxylic acids respectively.

These results indicate that quinine and quinidine differ in structure from cinchonine and cinchonidine in containing a methoxyl group in position 6 in a quinoline nucleus. The identity of the other oxidation products, meroquinenine, cincholoiponic and loiponic acids, in all four cases indicates that the "second half" of the molecule has the same structure in all four alkaloids. Further, this "second half" must be joined to the quinoline nucleus at position 4 by a group capable of conversion into carboxyl.

Meroquinenine, $C_9H_{15}O_2N$ (meroquinene), formed by the oxidation of all four alkaloids and of cinchoninone or quinone and by the hydrolysis of quinenine or cinchenine (p. 439), crystallises from methyl alcohol in needles, m.p. $223-4^\circ$ (*dec.*), $[\alpha]_D + 27.5^\circ$ (H_2O). It gives a nitrosoamine, m.p. 67° , and a monoacetyl derivative, m.p. 110° , and can be esterified; the ethyl ester hydrochloride has m.p. 165° . When oxidised by chromic acid it yields formic and cincholoiponic acids. On reduction with zinc dust and hydriodic acid, it adds on two atoms of hydrogen forming *cincholoipon*, $C_9H_{17}O_2N$, and when heated with hydrochloric acid at $250-60^\circ$ gives 3-ethyl-4-methylpyridine (β -collidine).

Cincholoiponic acid, $C_8H_{13}O_4N \cdot H_2O$, results from oxidation of cinchotenicine, cinchotenidine, quitenine, quitenidine, meroquinenine or cincholoipon, and, according to Skraup, is also formed directly by the oxidation of each of the four parent alkaloids. It crystallises from water in prisms, m.p. 126° or $221-2^\circ$ (*dry*), is insoluble in alcohol or ether, soluble

in water, and dextrorotatory, $[\alpha]_D^{20} + 30.1^\circ$ (H_2O). It furnishes a nitroso-amine, a monoacetyl derivative and a diethyl ester (needles, m.p. 181°). On oxidation with permanganate it produces loiponic acid, $C_7H_{11}O_4N$, and when heated with sulphuric acid, 4-methylpyridine and carbon dioxide. Racemic α - and β -cincholoiponic acids were synthesised by Wohl and Losanitsch,¹² and were resolved into their components by Wohl and Maag¹³ by crystallisation of the brucine salts. Of these, β -*d*-cincholoiponic acid proved to be identical with the acid obtained from cinchonine.

Loiponic acid, $C_7H_{11}O_4N$, obtained in small quantity by Skraup¹⁴ by oxidising cincholoiponic acid with cold permanganate, forms irregular prisms, m.p. 259° (*dec.*), from hot water. It furnishes a diethyl ester, and with acetic anhydride gives acetylloiponic acid anhydride, m.p. 161° . Königs¹⁵ first pointed out the isomerism of loiponic acid with hexahydro-cinchomeronic acid (piperidine-3 : 4-dicarboxylic acid). The latter acid was found to be a mixture of the *cis*- and *trans*-forms, and by treatment with potash was converted wholly into the more stable of these forms. Loiponic acid, on treatment with potash, is also changed into this stable form, and so must be regarded as a labile modification of this acid. From the facts recorded above, the oxidation products of the "second half" of the four alkaloids must be represented by the following formulæ¹⁶ :—

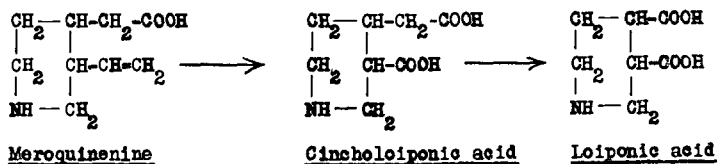

Action of Phosphorus Pentachloride. The oxygen atom in cinchonine and cinchonidine and the second oxygen atom in quinine and quinidine are present as alcoholic hydroxyls, since all four alkaloids yield monoacyl derivatives, are not soluble in alkalis, and on gentle oxidation lose two atoms of hydrogen forming ketones (p. 437). When acted upon by phosphorus pentachloride, this hydroxyl group is replaced by an atom of chlorine, forming cinchoninechloride, $C_{19}H_{21}N_2Cl$ (needles, $[\alpha]_D^{13} + 56^\circ$, m.p. 72°), cinchonidinechloride ($[\alpha]_D^{13} + 78^\circ$, m.p. $108-9^\circ$), quininechloride, $C_{20}H_{23}ON_2Cl$ (minute needles, m.p. 151° , $[\alpha]_D^{15} + 60^\circ$, gives the thalleioquin reaction), and quinidinechloride (crystals, $[\alpha]_D^{15} + 35^\circ$, m.p. $131-2^\circ$) respectively¹⁷; the specific rotations are for approximately 2 per cent. solutions of dry base in 99 per cent. alcohol, and it is noteworthy that they are all dextrorotatory, even in the cases of quinine and cinchonidine.

Action of Alcoholic Potash on the "Chlorides." The products formed in these reactions were the subject of a series of papers by Königs and collaborators published in the period 1880-1900. When cinchonine- or cinchonidine-chloride is heated with alcoholic potash a molecule of hydrogen chloride is split off with the formation of CINCHENINE (*cinchene*), $C_{19}H_{20}N_2$, leaflets, m.p. $123-5^\circ$. Similarly quinine- or quinidine-chloride is converted into QUINENINE (*quinene*), $C_{20}H_{22}ON_2$, crystallising in trimetric prisms,

m.p. 81–2°, and giving the thalleioquin reaction.¹⁸ When heated with phosphoric acid at 175°, cinchenine and quinine undergo hydrolysis (Königs (1894); cf. Livschitz *et al.* (1945))¹⁹ according to the following equations :—

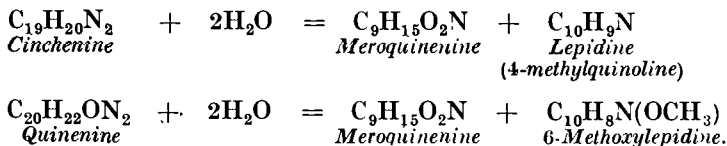

These hydrolyses afford further evidence of the existence in the four alkaloids of a quinoline nucleus and of a second ring system containing a nitrogen atom. The formulæ of the two alkaloids may, therefore, be extended thus: *Cinchonine*, $\text{C}_9\text{H}_6\text{N} \cdot \text{C}_{10}\text{H}_{15}(\text{OH})\text{N}$; *Quinine*, $\text{CH}_3\text{O} \cdot \text{C}_9\text{H}_5\text{N} \cdot \text{C}_{10}\text{H}_{15}(\text{OH})\text{N}$, the complex $\text{C}_{10}\text{H}_{15}(\text{OH})\text{N}$ being the source of meroquinine (1) in the hydrolyses of cinchenine and quinine, and (2) in the oxidation of the parent alkaloids.

Structure of the "Second Half." When cinchenine is heated with haloid acids at 180°, it loses 1 mol. of ammonia, producing a new base, *apocinchenine*, $\text{C}_{19}\text{H}_{19}\text{ON}$, needles, m.p. 209–10°. Similarly, quinine heated with hydrobromic acid at 190° decomposes with the production of methyl bromide, ammonia and *apoquinine*, $\text{C}_{19}\text{H}_{19}\text{O}_2\text{N}$ (crystalline, m.p. 246°). The latter, when fused with zinc ammonium chloride, gives aminoapocinchenine, which, by diazotisation and treatment with alcohol and copper powder, gives *apocinchenine* identical with that obtained from cinchenine.²⁰ *apoQuinine* must, therefore, be a hydroxyapocinchenine.

apoCinchenine furnishes cinchoninic acid on oxidation, so that the changes involved in its formation from cinchonine and quinine must have taken place in the "second half." Comstock and Königs found that it behaves as a phenol, giving ethers when treated with alkyl haloids in presence of alkali. It may, therefore, be assumed that *apocinchenine* contains the quinoline complex with a benzene ring, attached in the 4-position with respect to the nitrogen atom; its formula may, therefore, be written $\text{C}_9\text{H}_6\text{N} \cdot \text{C}_6\text{H}_2(\text{OH}) : \text{C}_4\text{H}_{10}$. The nature of the group C_4H_{10} was arrived at in the following way: *apocinchenine* ethyl ether, m.p. 70°, is oxidised by acid permanganate to *apocincheninic acid ethyl ether*, $\text{C}_{20}\text{H}_{19}\text{O}_3\text{N}$; the latter, when heated with hydrobromic acid, undergoes hydrolysis and loses carbon dioxide, forming *homoapocinchenine*,²¹ $\text{C}_{17}\text{H}_{15}\text{ON}$.

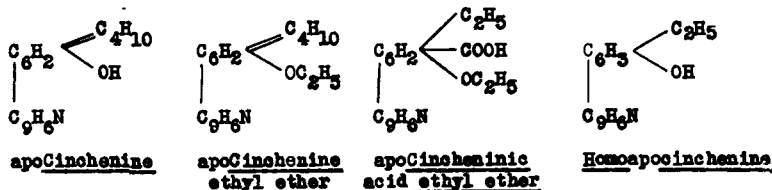

The latter, by a similar series of reactions, yields homoapocincheninic acid ethyl ether; the silver salt of this on heating loses carbon dioxide, giving a quinolyphenetole, which, on dealkylation with hydrobromic acid, yields a quinolyphenol, identical with 4-*o*-hydroxyphenylquinoline.

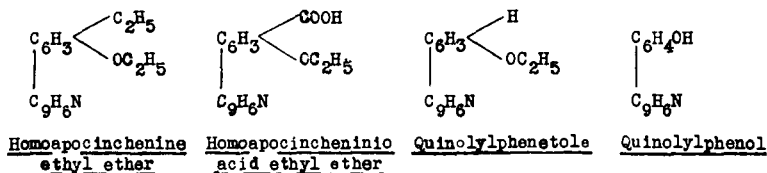

In apocinchenine the hydroxyl group must, therefore, be in the *ortho*-position relative to the point of attachment of the benzene ring to the quinoline nucleus. The relative positions of the two ethyl groups are determined by the fact that apocincheninic acid ethyl ether on oxidation with lead peroxide and sulphuric acid gives the lactone of hydroxyapocincheninic acid ethyl ether (I), which, on oxidation by sodium hypobromite, yields quinolyphenetole-dicarboxylic acid (II).

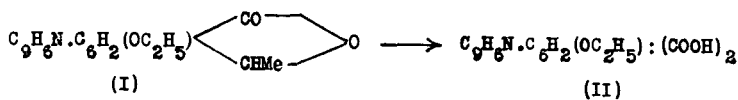

The latter must have its two carboxyl groups in the *ortho*-position to each other, since it readily yields an anhydride and, on fusion with resorcinol, gives a fluorescein. apoCinchenine must, therefore, be represented by one of the formulæ I, II or III, of which Königs considered (II) the most probable, since it best explained the formation of nitroapocinchenine by the action of nitrous acid,²² position 5 (*para* to the HO-group) being then free for the entry of the —NO₂ group. Kenner and Statham²² have, however, proved that (I) is correct by synthesising the 2'-methyl- and 2'-ethyl- ethers of 4-(4': 5'-diethyl)-phenylquinoline and showing that these are identical with methylapocinchenine (oil : picrate, m.p. 200° (*dec.*)) and ethylapocinchenine (m.p. 70–1°, picrate, m.p. 179–80°) respectively.

- (I) C₉H₆N · C₆H₂Et₂ · OH (C₉H₆N : Et : Et : OH = 1 : 4 : 5 : 2)
 (II) C₉H₆N · C₆H₂Et₂ · OH (C₉H₆N : Et : Et : OH = 1 : 3 : 4 : 2)
 (III) C₉H₆N · C₆H₂Et₂ · OH (C₉H₆N : Et : Et : OH = 1 : 5 : 6 : 2)

The facility with which the “second half” of the molecule furnishes benzenoid derivatives recalls the similar behaviour of tropine and ecgonine (Comstock and Königs¹⁷ (1892)) and several formulæ representing cinchonine and quinine, and their isomerides as containing a quinoline ring attached to a bicyclic ring system similar to that of the tropine group have been proposed.²³ The formula now accepted for cinchonine is due

mainly to Königs,²³ and has received ample confirmation from subsequent work, especially of Rabe and his collaborators:—

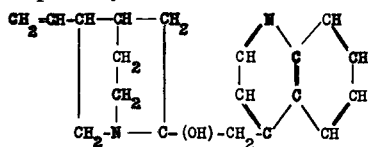

Cinchonine (Königs, 1906)

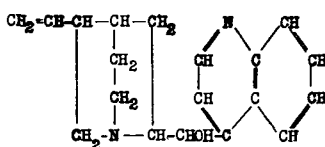

Cinchonine (Rabe, 1908)

Rabe's 1908 formula accounts satisfactorily for the following characteristic reactions of this group of alkaloids. When cinchonine acid sulphate is heated dry, or the base is boiled with various reagents, or with water alone, it is converted into an isomeride, cinchonidine (cinchotoxine) (p. 451), which may also be obtained in like manner from cinchonidine. Quinine and quinidine, under similar treatment, give rise to quinine (quinotoxine) (p. 425), and the reaction also takes place with cupreine and with the dihydrogenated derivatives of all five alkaloids. Cinchonidine and quinine are keto-bases, and contain both a secondary and a tertiary nitrogen atom. When treated with amyl nitrite they form oximino-compounds, which, with phosphorus pentachloride, furnish, in the case of oximino-cinchonidine, cinchoninic acid and meroquininenitrile, and in the case of oximinoquinidine, quininic acid and meroquininenitrile.²⁴ Rabe has also shown that cinchonine and cinchonidine methiodides both yield the same methylcinchonidine (methylcinchotoxine).²⁵ These reactions are readily explicable from the following formulæ, in which Q represents the quinoline residue $-\text{C}_9\text{H}_6\text{N}$, and the * at C⁸ indicates the point at which oximino-substitution takes place²⁶:—

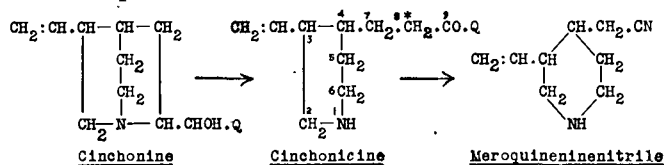

Similarly the ketones cinchoninone and quinone (p. 437) react with nitrous acid, furnishing oximino-derivatives which undergo characteristic decompositions; thus cinchoninone gives cinchoninic acid and an oxime (β -vinyl- α' -quinuclidoneoxime), $\text{C}_9\text{H}_{13}\text{N}:\text{NOH}$, which on hydrolysis by acids yields meroquinine and hydroxylamine. It must be assumed, therefore, that in the formation of these ketones a secondary carbinol group is converted into a .CO. group, so that cinchoninone may be represented by the following formula, where Q represents the quinoline residue²⁷:

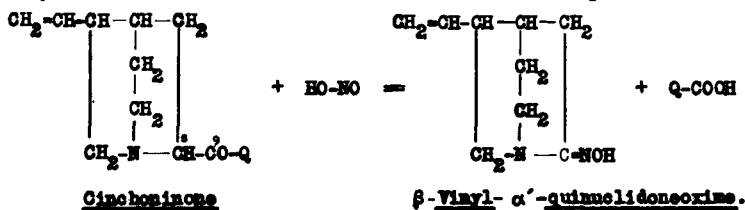

Cinchoninone is also formed by the action of alkali on *N*-bromocinchonine, and, since cinchoninone can be reduced to cinchonine,²⁷ it is possible in this way to reconvert cinchonine into cinchonine and quinicine into quinine.²⁸ On the basis of all these results, Rabe²⁹ developed the following general formula (I) for this group of alkaloids:—

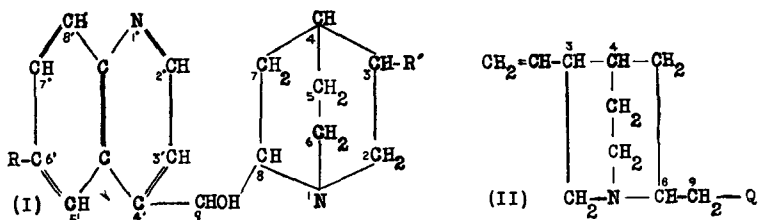

In cinchonine and cinchonidine, R = . H ; R' = . CH : CH₂.

In cupreine, R = . OH ; R' = . CH : CH₂.

In quinine and quinidine, R = . OCH₃ ; R' = . CH : CH₂.

In the dihydro-bases, R' becomes . CH₂ . CH₃.

In the alkylcupreines, R becomes . Oalk (homologues of quinine).

In the alkylhydrocupreines and alkylhydrocupreidines, R becomes Oalk, and R' becomes . CH₂ . CH₃ (homologues of dihydroquinine and dihydroquinidine).

Stereoisomerism in the Cinchona Bases

It was at first common practice to number the four asymmetric carbon atoms indicated in the general formula (I), 1, 2, 3 and 4, but this is now replaced by the more general system introduced by Rabe,³⁰ who suggested the name ruban for (III), which can be regarded as the parent substance of the natural cinchona alkaloids, and rubatoxan (IV) for that of the quinicines (quinatoxines). The formulæ, with notation, for ruban (III) and rubatoxan (IV) are shown below, and the general formula (I) for cinchona bases has been numbered in accordance with that scheme.

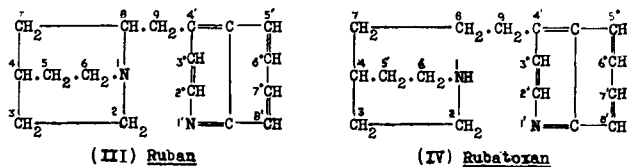

On this basis cinchonine and cinchonidine are named 3-vinylruban-9-ol, quinine and quinidine become 6'-methoxy-3-vinylruban-9-ol, cinchoninone is 3-vinylruban-9-one and quinicine is 6'-methoxy-3-vinylrubatoxan-9-one. The four asymmetric carbon atoms become 3, 4, 8 and 9 respectively.

It has already been shown that both the laevorotatory and dextro-rotatory cinchona alkaloids on degradation yield scission products from the quinuclidine nucleus, which are structurally and optically identical, for example, meroquinine, $[\alpha]_D^{20} + 27.5^\circ$; *d*-β-cincholoiponic acid,

$[\alpha]_D^{20} + 30.1^\circ$; β -vinyl- α' -quinuclidone oxime, $[\alpha]_D^{16} + 112.5^\circ$ to $+ 113.5^\circ$. In all these substances asymmetry at C³ and C⁴ remains, and this is also true of cinchonine and quinine, in which C⁸ and C⁹ are no longer centres of asymmetry. In all the eight principal cinchona alkaloids, therefore, the total effect of carbon atoms C³ and C⁴ must be dextrorotatory. It will be shown later that it is possible to convert the vinyl group of each of the four principal cinchona alkaloids into an ethylidene group ($:C^3H \cdot CH : CH_2 \rightarrow :C^3 : CH \cdot CH_3$) as in α - and β -isoquinine, so that C³ becomes symmetrical. α - and β -isoQuinines have higher lævorotations than quinine, so that presumably C³ in quinine is dextrorotatory. Further, when β -isoquinine is hydrogenated, C³ reverts to its asymmetrical status and produces a mixture of dihydroquinine and *epi*-C³-dihydroquinine. The latter is of higher lævorotation, $[\alpha]_D^{15} - 255.7^\circ$ (M/40, N/10-H₂SO₄) than dihydroquinine, indicating that in the latter C³ is dextrorotatory. Solomon^{30(a)} has shown that β -isoquinotoxine, in which C⁴ is the only centre of asymmetry, is lævorotatory, $[\alpha]_D^{15} - 33.8^\circ$ (M/40, N/10 H₂SO₄).

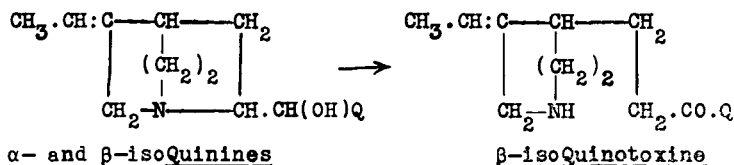

These changes have been experimentally demonstrated only for quinine and quinidine, but in view of the optical identity of the quinuclidine degradation products from the principal cinchona alkaloids, it may be assumed that in all of them the total dextrorotatory effect at C³ and C⁴ is made up of a dextrorotatory effect at C³ exceeding a lævorotatory effect at C⁴.

The directions of rotation at C⁸ and C⁹ have been arrived at from the following considerations. The deoxy-bases (II; p. 443: Q = quinoline residue) obtained from cinchonine and cinchonidine are structurally identical,³¹ but optically different, and since they must be optically identical at C³ and C⁴, and C⁹ is no longer asymmetric, the difference between them (see table, p. 446) must be due to difference in direction of rotation at C⁸, which must therefore be dextrorotatory in cinchonine and lævorotatory in cinchonidine, and this must also be true of quinidine and quinine respectively and of the corresponding dihydro-bases.³² The keto-bases, cinchoninone and quininone, might be expected to exist each in two pairs, since carbon atom 8 is, according to the formula (p. 442), asymmetric, but it is better represented by the tautomeric grouping³³ :—

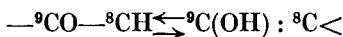

(the evidence for this being that the bases show mutarotation and yield derivatives of the enolic forms), so that in these keto-bases the asymmetry of carbon atoms 8 and 9 virtually disappears, but it becomes evident on reduction, as in the case of dihydrocinchoninone, which on reduction by

aluminium in an alcoholic solution of sodium ethoxide yields dihydrocinchonine (cinchotine, $[\alpha]_D + 190^\circ$), dihydrocinchonidine (cinchamidine, $[\alpha]_D - 98^\circ$), and two new alkaloidal secondary alcohols having $[\alpha]_D + 88.5^\circ$ and $+ 48^\circ$ respectively,³⁴ now known as *epidihydrocinchonine* and *epidihydrocinchonidine* respectively. Using these and other data referred to above, King and Palmer,³⁵ in a discussion of the contribution of each of the four centres of asymmetry, came to the conclusion that the final direction of rotation of the eight principal cinchona alkaloids is made up by dextrorotation at C³ and C⁴, taken together, throughout both series, by lævorotation at C⁸ and C⁹ in the lævorotatory series and by dextrorotation at C⁸ and C⁹ in the dextrorotatory series. Since then Rabe and collaborators³⁶ have shown that when any one of the eight cinchona bases is heated with potassium hydroxide in amyl alcohol it undergoes epimerisation about carbon atoms 8 and 9, yielding an equilibrium mixture of four stereoisomeric secondary alcohols. Thus such treatment of quinine yields a final mixture of the following bases :—

	Quinine	<i>epi</i> Quinine	Quinidine	<i>epi</i> Quinidine
Carbon atom 8	—	—	+	+
Carbon atom 9	—	+	+	—
Carbon atoms 3 and 4	+	+	+	+

This reaction, in the case of quinine, has been investigated in detail by Doering, Cortes and Knox^{36(a)} in a search for a practical method of converting quinine to quinidine. They find that when quinine is refluxed in an atmosphere of nitrogen with the corresponding sodium alcoholate in absolute *n*-butanol, *n*-pentanol, *n*-hexanol or heptanol-2, the amount of quinidine formed increases rapidly to a maximum and then decreases gradually. The reaction does not, as Rabe supposed, lead to a true equilibrium and there are side reactions producing unidentified products, *e.g.*, in *n*-butanol after 24, 36 and 48 hours, the total yields of the four stereoisomerides were 74.5, 67.9 and 52.1 per cent. respectively and the amounts of quinine and quinidine present were 37.7 and 16.6, 22.6 and 16.5, and 14.8 and 12.6 respectively. For the mechanism of this reaction they suggest that the first step is oxidation of quinine to quinone, the asymmetry of the two centres C⁸ and C⁹, concerned in the partial racemisation, being thereby destroyed, and an equilibrium set up between quinone and quinidinone (p. 437) *via* quinenol, : C⁸ = C⁹(OH) . Q. The second step involves reduction of this quinone-quinidinone system to the four stereoisomeric bases. This mechanism is discussed in detail and relevant literature quoted.

A similar mixture results from the reduction of quinone, and an analogous mixture of cinchonine and cinchonidine, each accompanied by its epimeride, results from alkali treatment of cinchonine or cinchonidine or from the reduction of cinchoninone. The characters of the whole series

of bases thus producible from the eight principal cinchona bases are shown in the table below, in which the deoxy-bases have been included to illustrate the effects of the disappearance of asymmetry in the case of carbon atom 9. The constants given are those recorded by Rabe,³⁶ who has also discussed the influence of configuration on basicity in this series.

The last six items in the table relate to ruban and rubanol. Ruban has one asymmetric centre (carbon atom 8 of formula III, p. 443). Ruban-

Substance	[α] _D	Direction of Rotation			Melting-point
		C ⁸ & C ⁹ *	C ⁸	C ⁹	
Quinine	- 158.2°	+	-	-	177°
Deoxyquinine	- 97.7°	+	-	Nil	48°
<i>epi</i> Quinine	+ 43.3°	+	-	+	Oil
Quinidine	+ 243.5°	+	+	+	168°
Deoxyquinidine	+ 211.1°	+	+	Nil	80-82°
<i>epi</i> Quinidine	+ 102.4°	+	+	-	113°
Cinchonidine	- 111°	+	-	-	202°
Deoxycinchonidine	- 29.9°	+	-	Nil	60-62°
<i>epi</i> Cinchonidine	+ 62.8°	+	-	+	103-104°
Cinchonine	+ 224.4°	+	+	+	260°
Deoxycinchonine	+ 179.3°	+	+	Nil	91°
<i>epi</i> Cinchonine	+ 120.3°	+	+	-	82-83°
Dihydroquinine	- 142.5°	+	-	-	168-169°
(+)-Dihydroquinine	+ 143.5°	-	+	+	171.5°
Deoxydihydroquinine	- 77.3°	+	-	Nil	70°
<i>epi</i> Dihydroquinine	+ 32.5°	+	-	+	Oil
Dihydroquinidine	+ 237.5°	+	+	+	168-169°
(-)-Dihydroquinidine	- 237.7°	-	-	-	171°
Deoxydihydroquinidine	+ 167.7°	+	+	Nil	85-87°
<i>epi</i> Dihydroquinidine	+ 73.7°	+	+	-	122°
Dihydrocinchonidine	- 95°	+	-	-	231-232°
Deoxydihydrocinchonidine	- 21.2°	+	-	Nil	52°
<i>epi</i> Dihydrocinchonidine	+ 48.3°	+	-	+	106°
Dihydrocinchonine	+ 200.0°	+	+	+	268-269°
Deoxydihydrocinchonine	+ 143.0°	+	+	Nil	72°
<i>epi</i> Dihydrocinchonine	+ 88.4°	+	+	-	126°
9-Hydroxyruban	+ 132.5°	Nil	+	+	230.5°
" " " "	+ 14.3°	Nil	+	-	118.0°
Ruban	+ 80.5°	Nil	+	Nil	Oil
9-Hydroxyruban	- 14.9°	Nil	-	+	118.0°
" " " "	- 131.8°	Nil	-	-	230.5°
Ruban	- 78.4°	Nil	-	Nil	Oil

* As shown on p. 444, C⁸ and C⁹ taken together as a unit are in total effect dextrorotatory, but C⁸ is dextrorotatory throughout the series and C⁹ is levorotatory.^{30(a)}

9-one furnishes, on reduction, four stereoisomeric rubanols (9-hydroxy-rubans) corresponding to the two dihydro-cinchonines and -cinchonidine*

yielded by dihydrocinchoninone. The rubanols on further reduction ($\text{CHOH} \rightarrow \text{CH}_2$) yield two stereoisomeric rubans, corresponding to the two deoxy-bases, derivable one from the two dihydrocinchonines, and its stereoisomeride, from the two dihydrocinchonidines. If comparison is made of the values of the specific rotations of the ruban-9-one derivatives with those of the dihydrocinchoninone derivatives given in the table, it will be seen that they afford further evidence that the total effect of the centres of asymmetry at C_3 and C_4 (absent in the rubanone derivatives) is dextrorotatory in all the natural cinchona alkaloids.³⁷

The vinyl-free analogues of quinine and quinidine, *viz.*, the 6'-methoxy-ruban-9-ols were also synthesised³⁷ in 1941 by Rabe and Hagen and further details added by Rabe, Schuler and Voss in 1943. 6'-Methoxy-ruban-9-one, m.p. 89° (Prelog *et al.*³⁷ found m.p. $90-1^\circ$ and picrate m.p. $211-211.5^\circ$; the latter was confirmed by Kleiman and Weinhouse³⁷) on hydrogenation in dilute hydrochloric acid in presence of palladium black gave two racemates ($++$) ($--$), m.p. 172° (*dry*) and $(+ -)$ ($- +$), oil. The $(+)$ and $(-)$ signs refer to the direction of rotation at C^8 and C^9 respectively. The two racemates were resolved into two enantiomorphic pairs, for which the following and other data are recorded:—

- (a) $(++)$, B. H_2O , m.p. 187° (*dry*); $[\alpha]_{\text{D}}^{17^\circ} + 173.8^\circ$ (EtOH).
- (b) $(--)$, m.p. 187° ; $[\alpha]_{\text{D}}^{20^\circ} - 173.5^\circ$ (EtOH).
- (c) $(+-)$, oil; $[\alpha]_{\text{D}}^{18^\circ} + 23.5^\circ$ (EtOH).
- (d) $(-+)$, oil; $[\alpha]_{\text{D}}^{14^\circ} - 23.5^\circ$ (EtOH).

Prelog and Zalan^{37(a)} have investigated the spatial distribution about positions C_3 , C_4 and C_8 and have shown that cincholoipon ethyl ester (V), whether prepared from cinchonine or quinine, has $[\alpha]_{\text{D}}^{17^\circ} + 16.7^\circ$ and gives a hydrochloride $[\alpha]_{\text{D}}^{23^\circ} - 9.3^\circ$ (EtOH) or -7.0° (H_2O). The figures found by Kaufman *et al.*^{37(b)} were the reverse of these, *viz.*, -17.2° for the ester and $+5.7^\circ$ for the hydrochloride. The ester was degraded to $(-)$ -3-methyl-4-ethylhexane (VI) in which the C^3 of cincholoipon, and of the cinchona alkaloids, is the only remaining centre of asymmetry. This hydrocarbon belongs to the laevorotatory series, represented by the general formula $\text{CHMe} \cdot \text{C}_2\text{H}_5\text{R}$ where R is an alkyl group with more than two carbon atoms, and can be represented by the conventional projection formula (VII). Cincholoipon was also converted by a series of mild reactions, in which the configuration at C^3 and C^4 was unlikely to be altered, into the optically inactive *cis*-1:2-diethylcyclohexane (VIII), indicating that in cincholoipon and the cinchona alkaloids, the substituents at C^3 and C^4 stand in the *cis*-relation to each other. The dextrorotatory alkaloids cinchonine and quinidine form isomerides (p. 451) in which there is ether formation between the substituents at C^3 and C^8 (see, for example, formula B, p. 449), whereas this type of isomeride is not obtainable from the laevorotatory alkaloids, quinine and cinchonidine. It is assumed, therefore, that in the dextrorotatory bases the substituents at C^3 and C^8 are both in the *endo*-position (X), but in the laevorotatory alkaloids the C^3 substituent is in the *endo*- and the C^8 substituent in the *exo*- position (IX).

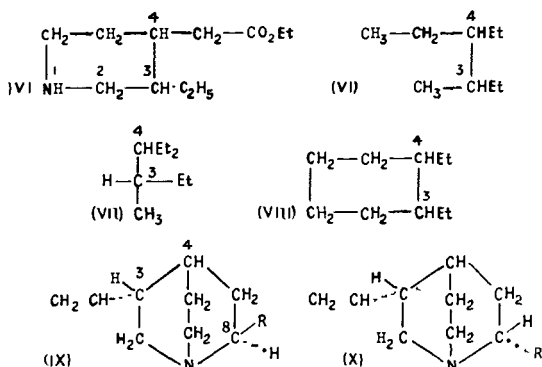

R = Quinolylcarbinol or 6'-methoxyquinolylcarbinol residue, $\text{C}_9\text{H}_9\text{N} \cdot \text{CHOH} \cdot$ or $\text{MeO} \cdot \text{C}_9\text{H}_8\text{N} \cdot \text{CHOH} \cdot$

TRANSFORMATION PRODUCTS OF THE CINCHONA ALKALOIDS

The most important group of structural isomerides of the cinchona alkaloids are the quinicines or quinotoxines (formula F, $\text{CH}_3 \cdot \text{CHOH} \cdot \rightarrow \text{CH}_2 : \text{CH} \cdot$) of which only one, quinicine (p. 425) occurs naturally. Other transformation products have been obtained mainly by three methods: (a) heating the alkaloids with 50 to 70 per cent. sulphuric acid, (b) heating them under pressure with hydrochloric acid (sp. gr. 1.125), or (c) the action of water, alkalis or silver nitrate on the halogen acid addition products (D) of the four cinchona alkaloids containing a vinyl side-chain. The nature of the products of these reactions was first worked out for cinchonine mainly by Skraup³⁸ and his collaborators and by Jungfleisch and Léger.³⁹

One result of all these reactions is the change of the vinyl group to an ethylidene group ($\text{CH}_2 : \text{CH} \cdot \rightarrow \text{CH}_3 \cdot \text{CH} :$) with the formation of the *apo*-bases, e.g., *apocinchonidine* and *β-cinchonidine*, which are the two geometrical isomerides required by the formula (E; Q = quinolyl residue).

In addition to this change, the elements of a molecule of water may be added to the vinyl group with the formation of hydroxydihydro-bases represented by formula (B). This change also appears to occur with all the vinyl-containing alkaloids though neither of the pair of stereoisomerides so produced has been described for cinchonidine.

In the case of the dextrorotatory pair, cinchonine and quinidine, these hydroxydihydro-bases may lose a molecule of water between the two $\cdot \text{CHOH} \cdot$ groups at positions 9 and 10 with the formation of ether oxides,⁴⁰ represented by formula (C) of which there should be a pair of stereoisomerides for each alkaloid. This type of compound has not been obtained from the levorotatory bases, cinchonidine and quinine.

The fourth change is a remarkable one and probably occurs with all four alkaloids, though the characteristic product does not appear to have been observed in the case of cinchonidine. It only occurs in reaction (c). The carbon atom at position 2 is eliminated as formaldehyde.⁴¹ The

products are niquine from quinine and niquidine and isoniquidine from quinidine, which have been proved to be represented by formula (Ga).⁴⁴ This probably also applies to the α - and β -cinchonhydrines derived from cinchonine, though for these formula (Gb) was proposed by Léger³⁹ and they have not been investigated recently (*cf.* Langer⁴³).

The least desirable of the three reactions is (b) as this results in the formation of some chlorodihydro-base and adds to the complexity of the mixture of reaction products.

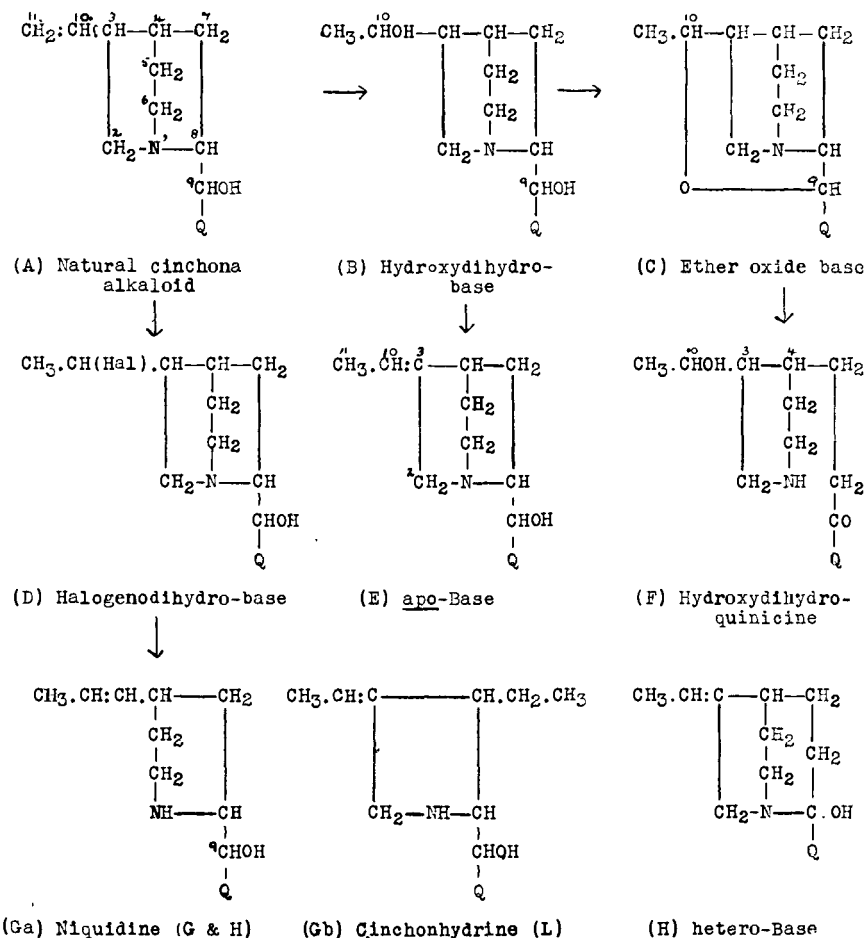

(1) Q may represent quinolyl, 6-hydroxyquinolyl or 6-methoxyquinolyl.

(2) Derivatives of the alkaloids named may also be represented by the formulæ with the following changes:—

(A) Natural dihydro-cinchona alkaloids and their epimerides, $\text{CH}_1 : \text{CH} \cdot \rightarrow \text{CH}_1 \cdot \text{CH}_2 \cdot$

(E) neoapoQuinidine. Ethylenic linkage $\text{C}^{10} - \text{C}^8$ transferred to $\text{C}^8 - \text{C}^2$.

(F) Quinicipines, $\text{CH}_1 \cdot \text{CHOH} \cdot \rightarrow \text{CH}_1 : \text{CH} \cdot$, isoquinicipines, $\text{CH}_1 \cdot \text{CHOH} \rightarrow \text{CH}_1 \cdot \text{CH} :$ and dihydroquinicipines, $\text{CH}_1 \cdot \text{CHOH} \rightarrow \text{CH}_1 \cdot \text{CH}_2 \cdot$

(Ga) Dihydroquinidine and dihydroquinidine, $\text{CH}_1 \cdot \text{CH} : \text{CH} \rightarrow \text{CH}_1 \cdot \text{CH}_1 \cdot \text{CH}_2 \cdot$

In the cases of quinine and quinidine there is an additional complication, except for reaction (c), owing to partial de-methylation of the methoxyl group, thus in the action of sulphuric acid on quinine there may be four products of formula E, *viz.*, the two geometrical isomerides *apo*quinine and *isoapo*quinine (for which Q is 6-hydroxyquinolyl) and their methyl ethers, β -*iso*quinine and α -*iso*quinine respectively (for which Q is 6-methoxyquinolyl).

The results of this additional complication may be illustrated by a comparison of the reaction products in the cases of cinchonine and quinidine.

Type of Product.	Products from Cinchonine	Products from Quinidine
Formula E	<i>apo</i> Cinchonine (<i>allocinchonine</i>) —	<i>apo</i> Quinidine and its methyl ether, <i>neoapo</i> Quinidine and its methyl ether (<i>ne iso</i> quinidine). ψ -Quinidine.
„ B	α - and β -Hydroxydihydrocinchonines.	α - and β -Hydroxydihydro <i>apo</i> quinidines and their methyl ethers, α - and β -hydroxydihydroquinidines.
„ C	α - <i>iso</i> Cinchonine (cinchoniline) β - <i>iso</i> Cinchonine (cinchonigine).	α -, β - and γ - <i>iso</i> Quinidines and <i>isoapo</i> quinidine of which β - <i>iso</i> quinidine is the methyl ether.
„ Ga	α -, β - and γ -Cinchonhydrines.	Niquidine and <i>isoniquidine</i> .

It will be seen from the foregoing that there is no systematic nomenclature for these compounds. Some of them have been isolated by several workers⁴² and with the impression that they were new substances have been given new names,⁴³ and this applies especially to the two *isocinchonines* and dihydrocinchonine. It will be noticed that instead of the two geometrical isomerides required by formula (Ga) there are three cinchonhydrines. The α - and β -forms are well-defined crystalline substances, but the supposed γ -form (see table, p. 452) is amorphous and its authenticity doubtful.³⁹ Formula (E) requires two geometrical isomerides, but quinidine provides three possible claimants for this representation. When one of these *apo*-bases is hydrogenated the ethylidene group $\text{CH}_3 \cdot \text{CH}:$ is converted into an ethyl group and C_3 becomes a centre of asymmetry once more as in the typical cinchona alkaloid (A) and a mixture of epimerides about C_3 is produced. When this process is applied to *apo*quinidine methyl ether, *neoiso*quinidine or ψ -quinidine, the hydrogenated product in each case can be separated into dihydroquinidine and a new substance *epi-C*³-dihydroquinidine. In all three substances therefore one end of the ethylenic linkage must be at C^3 and it is suggested that the unexpected third substance, probably ψ -quinidine, has its ethylenic linkage at $\text{C}^3\text{—C}^2$ instead of at $\text{C}^3\text{—C}^{10}$ (E ; $\overset{11}{\text{C}}\text{H}_3 \cdot \overset{10}{\text{C}}\text{H} : \overset{3}{\text{C}} \rightarrow \overset{11}{\text{C}}\text{H}_3 \cdot \overset{10}{\text{C}}\text{H}_2 \cdot \overset{3}{\text{C}}$).

There is also for the quinidine ether oxide group (formula C) an unexpected third isomeride, possibly due to epimerisation about carbon atoms 9 and 10. These quinidine isomerides are no doubt convertible

like α - and β -isocinchonines into hydroxydihydroquinicines (F) and a study of these products might provide an explanation of this anomalous third isomeride, since the centres of asymmetry would then be reduced to C₃, C₄, C₁₀ of which the configurations at C₃ and C₄ are known (p. 443).

The two niquidines form the expected pair of stereoisomerides required by formula (Ga).⁴⁴ On hydrogenation they both yield the same dihydro-niquidine (Ga; $\text{CH}_3 \cdot \overset{11}{\text{C}} \cdot \overset{10}{\text{C}} \cdot \overset{8}{\text{C}} \cdot \text{H} \rightarrow \text{CH}_3 \cdot \text{CH}_2 \cdot \text{CH}_2$) and this, unlike the normal cinchona alkaloids, but like niquidine itself, cannot be converted into a quinatoxine but when subjected to the usual process for this purpose yields a strongly lævorotatory substance, which is the epimeride about C⁹, viz., *epi*-C⁹-dihydroniquidine. Similarly, when the analogous quinine derivative, dihydroniquine is so treated it is converted into a mixture of stereoisomerides from which dihydroniquidine and *epi*-C⁹-dihydroniquidine have been isolated.

Structural isomerisation of a different type was brought to notice by Rabe, Haeuszler and Hochstätter,⁴⁵ who have shown that the "epicinchonine" of Suszko and Tomanek⁴⁵ is not, as these authors supposed, an epimeride of cinchonine, but is represented by formula (H) and the name, *heterocinchonine* (*h*-cinchonine), has been coined for it. Recently Rabe⁴⁵ (1941) has indicated the existence of *heterodihydrocinchonine* and has recorded the occurrence of *heteroquinine* in "precipitated quinine of commerce." Formula (H) makes these substances derivatives of azadicyclo[3 : 3 : 2]nonane, which it is proposed to call *homoquinuclidine*.

In the following table the characters of the principal isomerides and other transformation products of the cinchona alkaloids are summarised and references are given to the chief papers dealing with them, and upon which the foregoing account is based. The capital letters in brackets printed after the names of the substances refer to the formulæ and explanatory footnote on p. 449.

Name and Formula *	Characters	References
$\text{C}_{19}\text{H}_{22}\text{ON}_2$ α - <i>iso</i> Cinchonine (C) * . . .	Orthorhombic prisms ; m.p. 130·4°, $[\alpha]_{\text{D}} + 53\cdot1^\circ$ } Clinorhombic or orthorhombic crystals ; m.p. 130·7° ; $[\alpha]_{\text{D}}^{17^\circ} - 61\cdot6^\circ$. Needles ; m.p. 216-8°, $[\alpha]_{\text{D}} + 150^\circ$.	Jungfleisch and Léger ³⁹ ; Hesse, <i>Annalen</i> , 1893, 276, 88; Skraup, <i>Monats.</i> , 1901, 22, 1097 ; Lippmann and Fleissner, <i>ibid.</i> , 1893, 14, 371 ; see also, ref. 40.
β - <i>iso</i> Cinchonine (C) . . .		
<i>apo</i> Cinchonine (E) . . .		
Cinchonicine (F †) . . .		
<i>h</i> -Cinchonine (H) . . .	M.p. 179-80° ; $[\alpha]_{\text{D}}^{18^\circ} + 151^\circ$.	Rabe ³⁰ ; Roques, <i>Ann. Chim. Phys.</i> , 1897, [vii], 10, 234 ; von Miller and Rohde, <i>Ber.</i> , 1900, 33, 3214. Suszko ⁴⁶ (1933) ; Rabe, ⁴⁵

* The capital letters in brackets refer to the lettered formulæ (p. 449).

† See notes on formulæ, p. 449.

Name and Formula *	Characters	References
$C_{19}H_{23}ON_2$ <i>apoCinchonidine</i> (E)	Microscopic lamellæ; m.p. 254.7–256.7° (<i>dec.</i>), $[\alpha]_D^{21}$ – 134°.	Hesse, <i>Annalen</i> , 1880, 205, 314; 1888, 243, 149; <i>cf.</i> Paneth, <i>Monats.</i> , 1911, 32, 257.
$C_{19}H_{23}ON_2$ β -Cinchonidine (E)	Needles; m.p. 240–1° (<i>dec.</i>), $[\alpha]_D$ – 126.6° (Léger).	Neumann, <i>ibid.</i> , 1892, 13, 651; Léger, <i>Bull. Soc. Chim.</i> , 1919, [iv.], 25, 571.
$C_{19}H_{24}ON_2$ Dihydrocinchoninicine (dihydrocinchotoxine) (F †)	Oil; $[\alpha]_D$ + 1° (Rabe), + 8.8° (Kaufmann), benzoyl deriv., m.p. 121–2°.	Rabe, <i>Ber.</i> , 1912, 45, 2927; 1918, 51, 1360; Kaufmann, <i>ibid.</i> , 1913, 46, 2913; 1916, 49, 2304.
α -Cinchonhydrine (δ -cinchonine) (Ga)	Needles; m.p. 144.4°; $[\alpha]_D^{19}$ + 139.8°.	Jungfleisch and Léger. ³⁹
β -Cinchonhydrine (Ga)	Prismatic needles; m.p. 155.8°, $[\alpha]_D^{21}$ + 72.16°.	
γ -Cinchonhydrine (Ga)	Amorphous; B. HCl needles, $[\alpha]_D^{21}$ + 122.0° (<i>c</i> = 1 : dil. HCl).	
$C_{19}H_{20}O_2N_2$ <i>apoQuinine</i> (β -isocupreine, Suszko; α -apocupreine, Butler and Cretcher) (E)	Prisms; m.p. 184°; $[\alpha]_D^{20}$ – 214.8°.	Henry and Solomon, <i>J. Chem. Soc.</i> , 1934, 1923; <i>cf.</i> Suszko <i>et al.</i> , <i>Rec. Trav. Chim.</i> , 1933, 52, 839; and Butler and Cretcher, <i>J. Amer. Chem. Soc.</i> , 1935, 57, 1083.
<i>isoapoQuinine</i> (E)	Aggregates of needles; m.p. 275° (<i>dec.</i>); $[\alpha]_D^{15}$ – 261.7°.	Henry, Solomon and Gibbs, <i>J. Chem. Soc.</i> , 1935, 966.
<i>apoQuinidine</i> (E)	Needles or prisms; m.p. 172° or 185–90°; $[\alpha]_D$ + 181.8° or + 208.6° (<i>dry</i>).	
<i>isoapoQuinidine</i> (C)	Hexagonal prisms; m.p. 245°, $[\alpha]_D^{15}$ – 12.6°.	Henry and Solomon (<i>loc. cit.</i>).
<i>neoapoQuinidine</i> (E †)	Prisms, m.p. 260°, $[\alpha]_D^{15}$ + 206.2°.	Henry, Solomon and Gibbs. ^{30(a)}
$C_{19}H_{24}O_2N_2$ α -Hydroxydihydrocinchonine (B)	Flattened prisms; m.p. 252° (<i>dec.</i>), $[\alpha]_D^{18}$ + 182°.	Jungfleisch and Léger ³⁹ ; <i>cf.</i> Widmar, <i>Monats.</i> , 1901, 22, 976.
β -Hydroxydihydrocinchonine (B)	Minute needles; m.p. 273° (<i>dec.</i>), $[\alpha]_D$ + 187.3°.	
Hydroxydihydrocinchonidine (B)	Leaflets; m.p. 242–3° (<i>dec.</i>), $[\alpha]_D^{23}$ – 135° (<i>c</i> = 1, dil. HCl).	Léger (see under β -cinchonidine).
Dihydrocupreicine (F †)	Oil; B. HBr, m.p. 213–5°, $[\alpha]_D^{21.5}$ – 5.4° (water).	Heidelberger and Jacobs, <i>J. Amer. Chem. Soc.</i> , 1922, 44, 1094.

* The capital letters in brackets refer to the lettered formulæ (p. 449).

† See notes on formulæ, p. 449.

Name and Formula *	Characters	References
$C_{19}H_{24}O_2N_2$ Niquidine (Ga)	Stellate groups of needles ; m.p. 172°, $[\alpha]_D^{18} + 301.5^\circ$ (0.1 N. H_2SO_4).	Domanski and Suszko, <i>Bull. Acad. Polon.</i> , 1935, A, 457; Gibbs and Henry, <i>J. Chem. Soc.</i> , 1939, 240, 1294.
isoNiquidine (Ga)	Prisms ; m.p. 163°, $[\alpha]_D^{18}$ + 222.0° (0.1 N. H_2SO_4).	Gibbs and Henry, <i>loc. cit.</i>
Niquine (Ga)	B. H_2O , needles, m.p. 137° (dry), $[\alpha]_D^{15} - 248^\circ$ (0.1 N. H_2SO_4).	Skraup, <i>Monats.</i> , 1893, 14, 428 ; Leger ³² ; Suszko, <i>Bull. Acad. Polon.</i> , 1925, A, 132 ; Reyman and Suszko, <i>ibid.</i> , 1935, A, 360 ; Solomon, <i>J. Chem.</i> <i>Soc.</i> , 1941, 77.
$C_{19}H_{26}O_2N_2$ Dihydronequidine (Ga †)	Needles, m.p. 165°, $[\alpha]_D^{18}$ + 231.6° (0.1 N. H_2SO_4).	Gibbs and Henry, <i>loc. cit.</i>
epi-C ⁹ -Dihydronequidine (Ga †)	Amorphous, $[\alpha]_D^{18} - 140.8^\circ$ (0.1 N. H_2SO_4) ; B ₂ , 3HBr, H_2O , needles, m.p. 240° ; $[\alpha]_D^{18} - 102.8^\circ$ (H_2O).	Gibbs and Henry, <i>loc. cit.</i>
Dihydronequine (Ga †)	Needles, m.p. 85°, $[\alpha]_D^{16}$ - 210.1° (0.1 N. H_2SO_4).	Solomon, <i>loc. cit.</i>
$C_{19}H_{24}O_3N_2$ α -Hydroxydihydroapoquinine (B)	Needles ; m.p. 281-4°, $[\alpha]_D^{15} - 205.4^\circ$ (dil. sulphuric acid).	Henry, Solomon and Gibbs (<i>loc. cit.</i> 1935).
β -Hydroxydihydroapoquinine (B)	Amorphous, m.p. 120° (<i>dec.</i>), $[\alpha]_D^{15} - 205.1^\circ$ (dil. sulphuric acid).	Henry, Solomon and Gibbs, 30(a)
α -Hydroxydihydroapoquinidine (B : Q = 6-Hydroxyquinolyl). β -Hydroxydihydroapoquinidine (B : Q = 6-Hydroxyquinolyl).	Prisms ; m.p. 205°, $[\alpha]_D^{15}$ + 252.6° (0.1 N. H_2SO_4). Prisms, m.p. 190° (<i>dec.</i>) $[\alpha]_D^{20} + 197^\circ$ (<i>c</i> = 0.5 ; EtOH).	Henry, Solomon and Gibbs, <i>J. Chem. Soc.</i> , 1937, 592.
$C_{20}H_{24}O_2N_2$ α -isoQuinine (methyl-isoapo- quinine) 30(a) (E). β -isoQuinine (apoquinine methyl ether), isoquinine, ψ -quinine (E).	Transparent plates ; m.p. 196.5° ; $[\alpha]_D^{18} - 245^\circ$. Colourless needles, m.p. 183-5°, $[\alpha]_D^{15} - 201.9^\circ$.	Böttcher and Horowitz, <i>Monats.</i> , 1911, 32, 793. Henry, Solomon and Gibbs (<i>loc. cit.</i> 1935) ; Suszko <i>et al.</i> , <i>Rec. trav.</i> <i>chim.</i> , 1933, 52, 839, 847.
α -isoQuinidine (C)	Rhombohedra, p.m. 80°, $[\alpha]_D^{15} + 111^\circ$.	Domanski and Suszko, <i>Bull. Inter. Acad. Pol.</i> , 1933, A.123 ; 1935, A.465.
β -isoQuinidine (isoquinidine : iso- apoquinidine methyl ether) (C).	Silky needles ; m.p. 72° or 142° (dry), $[\alpha]_D^{17} - 9.7^\circ$.	Pfannl, <i>Monats.</i> , 1911, 32, 341 ; Konopnicki and Suszko ⁴⁷ ; Henry, Solomon and Gibbs (<i>loc.</i> <i>cit.</i> 1935).

* The capital letters in brackets refer to the lettered formulæ (p. 449).

† See notes on formulæ, p. 449.

Name and Formula *	Characters	References
$C_{20}H_{24}O_2N_2$ <i>apo</i> Quinidine methyl ether (E)	Minute needles; m.p. 180-1°, $[\alpha]_D^{15} + 193.2^\circ$.	Henry, Solomon and Gibbs (<i>loc. cit.</i> , 1935).
γ - <i>iso</i> Quinidine (C)	M.p. 70° $[\alpha]_D^{15} + 51^\circ$.	Domanski and Suszko, <i>Rec. trav. chim.</i> , 1935, 54, 481.
<i>neiso</i> Quinidine = <i>neoapo</i> quinidine methyl ether. (E; Q = 6-methoxy-quinolylyl).	Prisms, m.p. 83°, $[\alpha]_D^{15} + 198.6^\circ$ (0.1 N. H_2SO_4).	Henry, Solomon and Gibbs (<i>loc. cit.</i>).
ψ -Quinidine (E) †	Prisms, m.p. 150-5° (<i>dry</i>), $[\alpha]_D^{15} + 249.4^\circ$ (0.1 N. H_2SO_4).	Henry, Solomon and Gibbs (<i>loc. cit.</i>).
<i>hetero</i> Quinine (H)	M.p. 167°; B ₂ . H_2SO_4 , prismatic needles, m.p. 218° (<i>dec.</i>).	Rabe, <i>Ber.</i> 1941, 74, 725.
β - <i>iso</i> Quinotoxine (F †)	Oil; $[\alpha]_D^{15} - 33.8^\circ$ (0.1 N. H_2SO_4); B. $C_4H_8O_6$, needles, m.p. 192-4°, $[\alpha]_D^{15} - 12^\circ$ (H_2O).	Solomon, <i>J. Chem. Soc.</i> , 1938, 6.
$C_{20}H_{26}O_2N_2$ Dihydroquinidine (dihydroquinotoxine). (F †)	Oil; B ₂ . $H_2SO_4 \cdot 3H_2O$, m.p. 174-6°; $[\alpha]_D^{21.5} - 8.3^\circ$ (H_2O).	Hesse, <i>Annalen</i> , 1887, 241, 273; Rabe, <i>Ber.</i> , 1919, 52, 1842; 1931, 64, 2497; Heidelberger and Jacobs, <i>J. Amer. Chem. Soc.</i> , 1922, 44, 1092.
<i>epi</i> -C ³ -Dihydroquinidine (E †)	M.p. 152° (<i>dry</i>); $[\alpha]_D^{15} + 233.8^\circ$ (0.1 N. H_2SO_4).	Henry, Solomon and Gibbs (<i>loc. cit.</i>).
<i>epi</i> -C ³ -Dihydroquinine (E †)	M.p. 169°. B. 2HBr. $3H_2O$ needles, m.p. 234° (<i>dec.</i>); $[\alpha]_D - 184^\circ$ (H_2O).	Henry, Solomon and Gibbs (<i>loc. cit.</i>).
$C_{20}H_{28}O_3N_2$ α -Hydroxydihydroquinidine = methyl ether of α -hydroxydihydro <i>apo</i> quinidine (B; Q = 6-methoxyquinolylyl).	Prisms, m.p. 145°-50°, $[\alpha]_D + 241.5^\circ$ (0.1 N. H_2SO_4).	Henry, Solomon and Gibbs (<i>loc. cit.</i>).
β -Hydroxydihydroquinidine = <i>allo</i> -quinidine (B: Q = 6-methoxyquinolylyl).	Prisms, m.p. 257°; $[\alpha]_D + 298.5^\circ$ (0.1 N. H_2SO_4).	Henry, Solomon and Gibbs (<i>loc. cit.</i>), cf. Ludwiczak and Suszko, <i>Bull. Acad. Polon.</i> , 1936, A, 276.
α -Hydroxydihydroquinine (B: Q = 6-methoxyquinolylyl).	Needles, m.p. 247-9°, $[\alpha]_D^{15} - 197.5^\circ$ (0.1 N. H_2SO_4).	Henry, Solomon and Gibbs (<i>loc. cit.</i>).

* The capital letters in brackets refer to the lettered formulæ (p. 449).

† See notes on formulæ, p. 449.

SYNTHESES OF CINCHONA ALKALOIDS

The cinchona alkaloids on degradation break down into derivatives of (1) quinoline and (2) quinuclidine and the synthesis of any one of them involves the preparation of each of these two "halves" in a form suitable for combination.

Cinchoninic and Quininic Acids. The "quinoline half" is usually presented in the form of one of these acids, early syntheses of which are due to Pictet and Misner⁴⁶ and Kaufmann and Peyer.⁴⁷

Rabe, Huntenberg, Schultze and Volger⁴⁸ synthesised quinic acid by an improved form of the process used by Knorr⁴⁸ for 4-methylquinoline. Ethyl acetoacetate was condensed with *p*-methoxyaniline and the resulting acetoacet-*p*-methoxyanilide (I) converted into 2-hydroxy-6-methoxy-4-methylquinoline (II) by 90 per cent. sulphuric acid at 100°. The hydroxyl group was replaced by chlorine and the latter by hydrogen, giving 6-methoxy-4-methylquinoline, which was then condensed with benzaldehyde to 6-methoxy-4-styryl-quinoline (III) and the latter oxidised by permanganate to quinic acid (IV). This method has been improved by Ainley and King⁴⁸ and by Campbell *et al.*⁴⁸ and other methods of preparing these two acids have been devised by Halberkann,⁴⁷ Thielpape⁴⁷ and Koelsch.⁴⁷

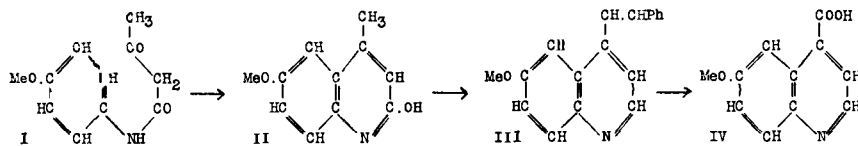

Quinuclidine and its Derivatives. Though quinuclidine is not usually found among the degradation products of the cinchona alkaloids being represented therein by cincholoipon, meroquinenine, and cincholoiponic and loiponic acids (p. 438), a good deal of attention has been given to devising methods of preparing this substance and its derivatives. 3-Ethyl-quinuclidine, which is the "second half" of the dihydro-cinchona bases, was synthesised by Königs and Bernhart,⁴⁹ and quinuclidine itself by Löffler and Stietzel⁴⁹ in 1909 and in 1920 by Meisenheimer, Neresheimer and Schneider,⁵⁰ whose account of its properties, differing considerably from that of Löffler and Stietzel, has been confirmed by more recent workers.

Much interesting work has been done in the last ten years on the bridging of pyrrole and piperidine rings. Early in their work on this subject Clemo and Metcalfe⁵¹ (1937) prepared quinuclidine (V) by the reduction of 3-ketoquinuclidine (IV), the latter resulting from the hydrolysis and decarboxylation of the product (III) of a Dieckmann internal alkylation, applied to ethyl piperidine-1-acetate-4-carboxylate (II), itself made by condensing ethyl piperidine-4-carboxylate (I) with ethyl chloroacetate.

This synthesis came shortly after one by Prelog, Kohlberg, Cerkovnikov, Rězek and Piantanida⁵² (1937) based on a series of reactions which, with modifications and extensions, Prelog and his colleagues have applied to the syntheses of bridged heterocyclic nuclei, of which this is an example. 4-Hydroxymethyltetrahydropyran (VI: R = .OH) is converted *via* the bromo-compound (VI: R = Br) and the nitrile (VI: R = CN) into tetrahydropyran-4-acetic acid of which the ethyl ester (VII) is reduced to 4-(β -hydroxyethyl)-tetrahydropyran (VIII). This is converted by fuming hydrobromic acid into 3-(2-bromoethyl)-1:5-dibromopentane (IX) which with ammonia in methyl alcohol yields quinuclidine (V).

A second synthesis of the same substance was described by Prelog,

Cerkovnikov and Ustricev⁵² (1938) starting from tetrahydropyran-4-propionic acid (A: R = CH₂.CH₂.CO₂H), which was converted by the Curtius-Schmidt method into 4-(2-aminoethyl)-tetrahydropyran (A: R = (CH₂)₂NH₂), and this with fuming hydrobromic acid at 100°

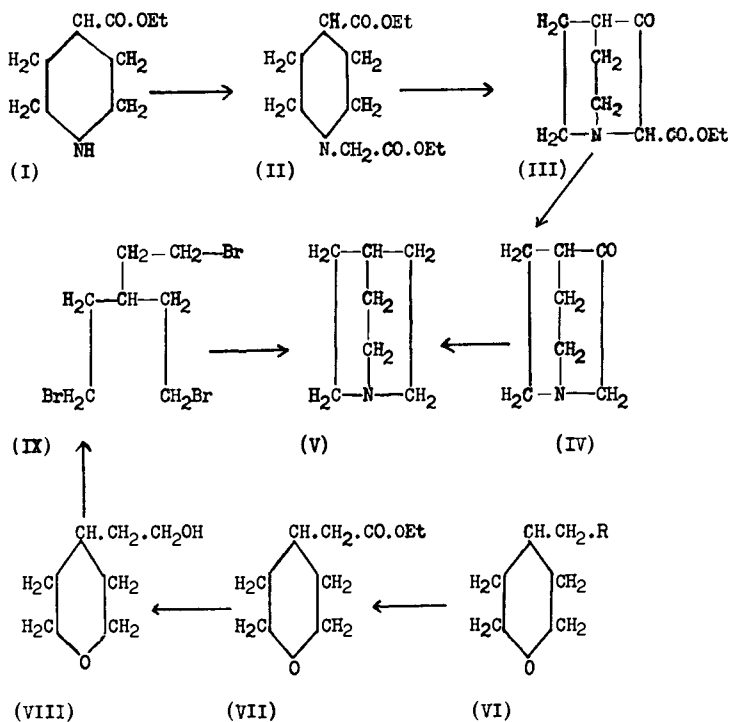

Syntheses of quinuclidine (bicyclo-[2:2:2]aza-1-octane)

yielded 3-(2-aminoethyl)-1:5-dibromopentane (B) convertible by dilute sodium hydroxide solution into quinuclidine (C). The latter crystallises in prisms m.p. 158°, is readily volatile and yields a picrate m.p. 275° (*dec.*), aurichloride m.p. 271°, platinichloride m.p. 238–40° (*dec.*) and ethiodide m.p. 270°.

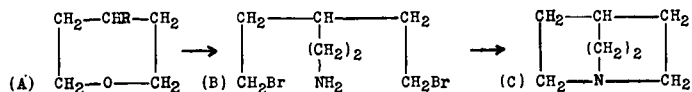

Of more direct interest is the preparation of 3-ethylquinuclidine by this method (Prelog, Šoštarić and Gustak⁵² (1940)). Ethyl tetrahydropyran-4-yl ketone (X: R = tetrahydropyran-4-yl) was condensed with ethyl bromoacetate (XI) to give the hydroxy-acid ester (XII) which was dehydrated by potassium acid sulphate at 90° to ethyl 3-(tetrahydropyran-4-yl)-pentenate (XIII) and this hydrogenated to the corresponding

saturated ester (XIV) and the latter hydrolysed to the acid, which on treatment with sodium azide in sulphuric acid (Curtius-Schmidt reaction) is converted into 1-amino-2-(tetrahydropyranyl-4)-butane (XV). This with fuming hydrobromic acid gives 1-bromo-4-(aminomethyl)-3-(β -bromoethyl) hexane hydrobromide (XVI) which with N/10 sodium hydroxide solution furnishes 3-ethylquinuclidine (XVII). The latter is a

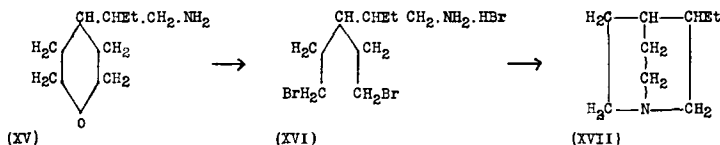
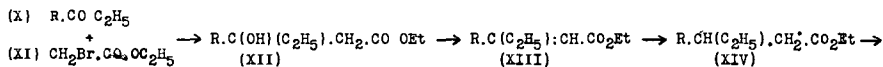

colourless oil, b.p. 78–9°/12 mm., yielding a platinichloride, m.p. 220–3° (*dec.*), aurichloride, $\text{C}_9\text{H}_{17}\text{N} \cdot \text{HCl} \cdot \text{AuCl}_3$, m.p. 178–9°, and picrate, m.p. 153°. The acid tartrate on recrystallisation from water had $[\alpha]_{\text{D}} + 14 \cdot 3^\circ \pm 2 \cdot 0$ ($c = 4 \cdot 76 : \text{H}_2\text{O}$) and did not separate into *d*- and *l*-forms. A partial separation was effected by crystallisation of the α -bromo-*d*-camphor- π -sulphonate, m.p. 188–188·5°, $[\alpha]_{\text{D}} + 76 \cdot 0^\circ \pm 0 \cdot 5$ ($c = 1 \cdot 9 : \text{H}_2\text{O}$), but the base recovered from this was still a partial racemate having as hydrochloride $[\alpha]_{\text{D}} + 37^\circ \pm 4^\circ$ ($c = 0 \cdot 45 : \text{H}_2\text{O}$) as against $+ 72 \cdot 5^\circ$ ($c = 5 : \text{H}_2\text{O}$) recorded by Königs for 3-ethylquinuclidine hydrochloride, prepared from *d*-cincholoipon ethyl ester derived from cinchonine.

Synthesis of the cinchona alkaloid structure has also been attempted by Prelog, Seiwerth, Hahn and Cerkovnikov⁵² (1939). Ethyl tetrahydropyranyl-4- β -propionate was condensed with ethyl cinchoninate to β -(tetrahydropyranyl-4-ethyl)quinolyl-4'-ketone (XVIII: Q = quinolyl). From this ketone the following compounds were prepared: the aminoderivative (XVIIIa); α -tetrahydropyranyl-4- γ -quinoline-4'-propane (XVIIIb), and from the latter the dibromide (XVIIIc), the tetrahydropyran ring being opened by the action of fuming hydrobromic acid. From this dibromide, by the action of ammonia in methyl alcohol, α -piperidyl-4- γ -quinolyl-4'-propane (XVIIId) which is rubatoxin (p. 443) the parent substance of the quinatoxines was obtained.

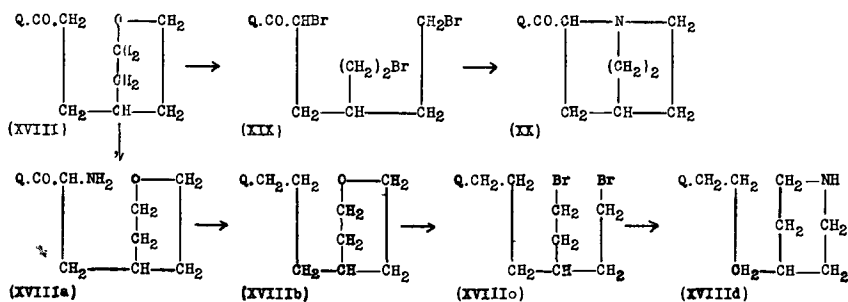

The ketone (XVIII) itself on treatment with fuming hydrobromic acid is converted by the opening of the tetrahydropyran ring into a dibromide, which, with bromine in hydrobromic acid, forms the tribromide (XIX) desired for the final operation, but all attempts to convert this into the rubanone-9 (XX) failed. The ketone (XVIII) and the corresponding carbinol, as well as (XVIIIa) and (XVIII d), proved to be inactive in malaria in canaries. A second approach to the cinchona alkaloid structure was made by Clemo and Hoggarth⁵¹ (1939), who condensed 3-ketoquinuclidine (IV) with quinoline-4-aldehyde to produce 5-keto-6 : 9-rubanene (XXI : Q = quinolylyl). By Rabe's notation for the ruban system (p. 443) this would be 7-keto-8 : 9-rubanene; it was hydrogenated to 5-ketoruban (XXII). This on reduction by aluminium *iso*-propoxide gave ruban-5-ol (XXIII : R = H) and with ethylmagnesium iodide furnished 5-ethylruban-5-ol (XXIII : R = .C₂H₅). The latter was also formed when 5-ethinylruban-5-ol, produced by the condensation of 5-ketoruban with acetylene, was hydrogenated catalytically.⁵¹

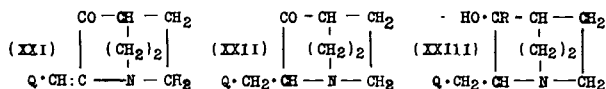

There are a number of other synthetic substances analogous with or approximating to the cinchona alkaloid structure which it is more convenient to deal with in discussing the correlation of chemical structure with pharmacological action in this group (p. 469).

DIHYDRO-CINCHONA BASES. The degradation products of quinuclidine, *viz.*, meroquinenine, cincholoipon and cincholoiponic and loiponic acids can all be regarded as derivatives of 3-ethyl-4-methylpyridine (β -collidine) which is the primary material used by Rabe and his collaborators in forming the quinuclidine nucleus in their syntheses of the dihydro-cinchona alkaloids. It was first prepared by de Coninck⁵³ by distilling cinchonine with alkalis and later by Königs⁵⁴ from meroquinenine, but was first synthesised by Ruzicka and Fornasir,⁵⁵ starting with 2 : 6-dihydroxy-3-ethyl-4-methylpyridine, prepared by the general method of Rogerson and Thorpe,⁵⁶ conversion of this into 2 : 6-dichloro- β -collidine and removal of the chlorine atoms by the action of hydriodic acid. In addition to other and more recent syntheses of β -collidine by Rabe and Jantzen^{57(a)} and Prelog, Komzak and Moor,^{57(a)} a process for 3-vinyl-4-methylpyridine^{57(b)} has been devised by Stevens, Beutel and Chamberlin; new syntheses of *N*-benzoyl-4-piperidinepropionic acid have been effected by Koelsch^{57(b)} and of ethyl 4-piperidyl-propionate by Webb and Corwin,^{57(b)} while reactions with meroquinenine as an objective for further synthetic work have been examined by Robinson and Watt.^{57(c)}

The next stage is the conversion of β -collidine into *d*- and *l*-homocincholoipon and *d*- and *l*-homomeroquinenine, the most promising forms in which the "second half" can be grafted on cinchoninic or quininic acid. Königs and Ottmann⁵⁸ prepared *dl*-homocincholoipon by condensing chloral with β -collidine (I) in presence of zinc chloride and treating the

3-ethyl-4- β -hydroxy- $\gamma\gamma\gamma$ -trichloro-*n*-propylpyridine (II) so formed with alcoholic potash to produce 3-ethylpyridyl-4-acrylic acid (III) which, on reduction by sodium in hot amyl alcohol, gives *homocincholoipon* (IV) (needles, m.p. 225° (*corr.*), aurichloride, leaflets, m.p. 178° (*corr.*)). This process was improved in various ways by Rabe and his collaborators,⁴⁸ who carried it a stage further by de-racemising the mixture of ethyl esters of *dl*-*homocincholoipon* (ethyl β -3-ethyl-4-piperidylpropionate, b.p. 114–7°/3 mm.) by conversion into the *d*-hydrogen tartrates, so obtaining an ester b.p. 112–4°/0.1 mm., $[\alpha]_D^{18} + 19^\circ$, identical with the ethyl (+)-*homocincholoipon* derived from the natural cinchona bases. In a later paper Rabe and Schultze⁵⁹ described the isolation from the mixture of racemic ethyl esters of ethyl (–)-*homocincholoipon* (oil, b.p. 124°/0.1 mm., $[\alpha]_D^{19} - 21.17^\circ$) as the hydrogen *l*-tartrate. Meanwhile, Rabe and Kindler⁶⁰ had found that ethyl *N*-benzoyl-*homocincholoipon*, prepared from *N*-benzoyldihydrocinchonine (*N*-benzoylcinchoticine) by Kaufmann, Rothlin and Brunnschweiler's method,⁶¹ condenses with ethyl cinchoninate in presence of sodium ethoxide to form the β -ketonic ester (V : Q = quinoly), which by hydrolysis with boiling 15 per cent. hydrochloric acid is con-

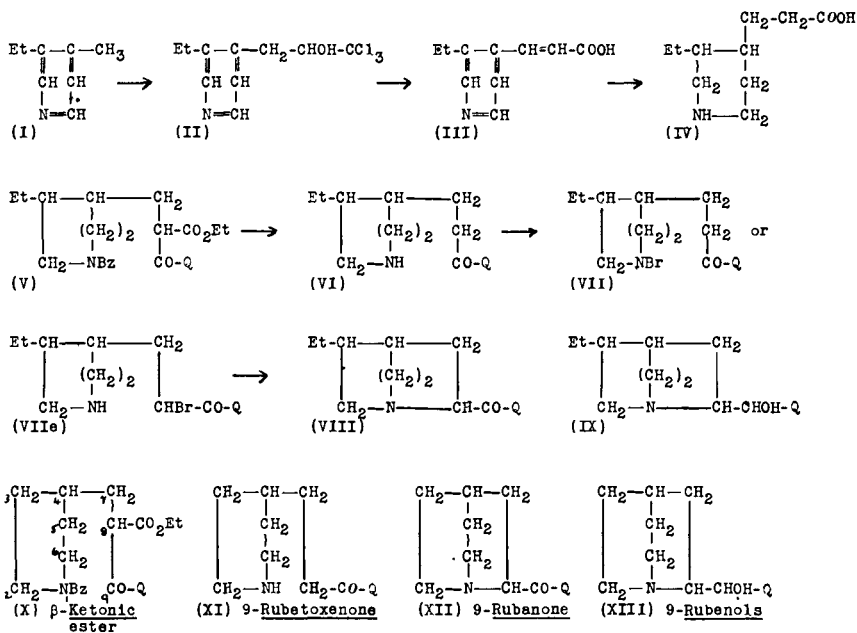

verted into dihydrocinchonine (VI). The latter, by the process described below, yields dihydrocinchoninone,⁶² and this, on reduction with aluminium and sodium hydroxide, furnishes a mixture of four isomerides from which dihydrocinchonine and dihydrocinchonidine were isolated, and subsequently the two isomeric *epi*-bases (p. 445). By a similar method the same authors prepared dihydroquinicine, using ethyl quininate in place

of ethyl cinchoninate,⁶³ and so obtained dihydroquinine and dihydroquinidine, and later on the corresponding *epi*-bases.

Rabe and his collaborators⁶⁴ have also effected the re-conversion of cinchonidine, quinicine and dihydroquinidine into cinchonine, quinine and dihydroquinine respectively, by treating them with sodium hypobromite, forming the *N*-bromo-derivative (VII) or the 8-bromo-derivative (VIIa) as first employed by Kaufmann and Huber⁶² and produced by the action of bromine in hydrobromic acid. Either bromo-derivative is converted by alkali hydroxide into the corresponding quina-ketone (VIII), which is then reduced to the mixture of stereoisomerides of the dihydro-cinchona base (IX) by means of aluminium powder and sodium ethoxide solution. Later it was found that reduction can also be effected by catalytic hydrogenation with palladium in the case of the dihydro-bases, but when the latter process is applied to the vinyl-containing quina-ketones the side-chain is reduced as well as the carbonyl group.⁶⁵

Using the (–)-*homocincholoipon* produced as described, Rabe and Schultze,⁶⁶ by the same sequence of reactions, have produced (–)-dihydroquinone (m.p. 98–9°, $[\alpha]_D^{20} - 70.0^\circ$ (final value; EtOH)), which on hydrogenation in presence of palladium gave a mixture of bases, of which (–)-dihydroquinidine and (+)-dihydroquinine were isolated. The characters of these mirror-image isomerides of dihydroquinidine and dihydroquinine respectively have been given already with the directions of rotation at the centres of asymmetry C³, C⁴, C⁸, C⁹ (see table, p. 446).

Using the same method, Rabe and Riza⁶⁷ have synthesised 9-rubanone, first prepared by Rabe, Kindler and Wagner,⁶⁸ by condensing ethyl *N*-benzoylpiperidylpropionate with ethyl cinchoninate, hydrolysis of the resulting β -ketonic ester (X) to 9-rubatoxanone (XI, yellow crystals, m.p. 30°) and conversion of this into 9-rubanone (XII, yellow needles, m.p. 85–6°) *via* the 8-bromo-derivative (*cf.* formula VIIa). The quina-ketone, like others of its class, becomes in solution a mixture of four ketonol isomerides, and such a solution on hydrogenation furnishes the four 9-rubanols (XIII), particulars of which have already been given in the table (p. 446). Similarly Rabe and Hagen,³⁷ as stated already (p. 447), have prepared the four stereoisomeric 6-methoxy-9-rubanols (XIII; Q = 6-methoxyquinolyl).

The important rôle played by the quinicines (rubatoxanones, quina-toxines) in the syntheses of the dihydrocinchona alkaloids and the possibility that such substances might be used for the preparation of products approaching quinine in therapeutical interest, has led to the production of a large number of quinolyl ketones of various types and the corresponding secondary alcohols, and other derivatives obtainable from them, of which mention may be made of Rubtzov's syntheses of several isomerides of dihydroquinine.⁶⁹

Of special interest in this connection are the quinolylpiperidylcarbinols, of which items have been made by Rubtzov,^{69(a)} and by Sargent *et al.*^{69(a)} The first substance of this type was synthesised by Ainley and King,^{69(a)} *viz.*, 4-(6-methoxyquinolyl)- α -piperidylcarbinol (XIV), C₁₆H₂₄O₂N₂, m.p.

162-3°; dihydrochloride, B . 2HCl, m.p. 231-2° (*dec.*); hydrochloride, B . HCl, m.p. 221° (*dec.*); and the stereoisomeric *iso*-4-(6-methoxyquinoly)- α -piperidylcarbinol, m.p. 187-8°, hydrochloride, m.p. 206-7° (*dec.*), of which the first-named form is the more active in bird malaria.

These two substances only differ from niquidine (p. 453) as formulated (XV) by Gibbs and Henry⁴⁴ by the absence of the unsaturated side-chain CH₃ . CH : CH . , and this investigation has been extended by King and Work^{69(a)} to the preparation of a series of 6-methoxy-4-quinolyldialkylaminomethylcarbinols, Q . CHO . H . CH₂NR₂, and by Work^{69(a)} to the synthesis of compounds related to niquidine, including two preparations of one of the four possible racemates of dihydroniquidine, distinguished as dihydro-*X*-niquidine (XV with . CH : CHMe \rightarrow . CH₂ . CH₂Me). This crystallises as a monohydrate, C₁₉H₂₆O₂N₂ . H₂O, m.p. 98-100°, and was isolated as the hydrobromide B . HBr, m.p. 230-1°. It was prepared, after a preliminary study of possible methods of joining the quinoline and piperidine sections of the niquidine structure, by condensing 5-bromo-1-nitro-3-propylpentane, Br . CH₂ . CH₂ . CHPr . CH₂ . CH₂ . NO₂, with 6-methoxyquinoline-4-aldehyde to give the nitro-carbinol (XVI). The latter could not be crystallised but on catalytic hydrogenation, during which it also cyclised, it gave some dihydro-*X*-niquidine. The latter was also obtained by an alternative method, which like the first gave a very poor yield, by condensing ethyl *N*-benzoyl-4-propylpiperidine-2-carboxylate with quininic acid chloride, using sodium triphenylmethyl as a catalyst. The resulting keto-ester,

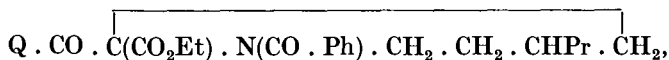

was hydrolysed and decarboxylated and the unstable keto-amine hydrogenated in methyl alcohol with palladised charcoal as catalyst to the

desired product Q . CHO . H . CH . NH . CH₂ . CH₂ . CHPr . CH₂ (XV with CH : CHMe \rightarrow Pr).

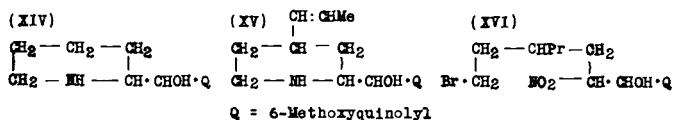

Rabe's general formula (p. 443) for the cinchona alkaloids was published in 1908 and a partial synthesis of quinine was effected by Rabe and Kindler in 1918,⁶⁴ but a complete synthesis of this alkaloid did not become available until 1945 when Woodward and Doering described their ingenious process.

SYNTHESIS OF QUININE. This required a parallel series of operations in which the still unknown substance *homomeroquinine* (3-vinylpiperidine-4-propionic acid) replaced its dihydro-derivative, *homocincholoipon*, for the final condensation with ethyl quininate. The first step was taken by Proštenik and Prelog,^{70(a)} who converted cinchonine to cinchonidine

(cinchotoxine) and the latter to the oxime of the *N*-benzoyl derivative, which was then submitted to a Beckmann transformation by the use of *p*-toluenesulphonyl chloride and alkali as used by Kaufmann *et al.*,^{70(b)} and the resulting amide hydrolysed by alkali to *homomeroquinenine* (*see* VIII, *below*), which was isolated as the ethyl ester, b.p. 102–4°/0.1 mm., $[\alpha]_D^{18} + 42.2^\circ$ (EtOH), giving a *N*-benzoyl derivative, b.p. 190–4°/0.1 mm., and an aurichloride, m.p. 110.5–112° (*dec.*). *homoMeroquinenine* forms tablets, m.p. 211–2° (*dec.*), $[\alpha]_D^{20} + 50.4^\circ$ (H₂O) and yields a dibenzoyl-*d*-tartrate, m.p. 186° (*dec.*). The *N*-benzoyl*homomeroquinenine* ethyl ester was condensed with ethyl quininate in presence of sodium ethoxide at 80–90° and the resulting β -ketonic ester (IX) hydrolysed to quinotoxine, characterised as the dibenzoyl-*d*-tartrate, m.p. 183° (*dec.*), $[\alpha]_D^{20} - 16^\circ$ (EtOH – CHCl₃ = 1 : 2). Since quinotoxine is convertible to quinine (p. 460) this constitutes a partial synthesis of the latter alkaloid. A complete synthesis was achieved by Woodward and Doering,^{70(c)} who started from 7-hydroxy*isoquinoline* (I), m.p. 229.5 to 230.5°, prepared by the method of Fritsch.^{70(d)} This was condensed in methylic alcohol solution with formaldehyde and piperidine to give 7-hydroxy-8-piperidinomethyl-*isoquinoline* (II), m.p. 81.5–82.5°, which was converted to 7-hydroxy-8-methyl-*isoquinoline* (III) by heating for 10 hours at 220° in methyl alcoholic sodium methoxide. The phenolic base was purified by sublimation, and then had m.p. 232–33.5°. It was hydrogenated to the tetrahydro-*isoquinoline* and this acetylated giving *N*-acetyl-7-hydroxy-8-methyl-1 : 2 : 3 : 4-tetrahydro-*isoquinoline*, m.p. 187–98°. On hydrogenation in ethyl alcohol over Raney nickel at 150° and 3,000 lb. pressure, the aromatic ring was fully reduced producing a mixture of stereoisomeric *N*-acetyl-7-hydroxy-8-methyldecahydro-*isoquinolines* (IV) which in solution in acetic acid was oxidised by chromic acid to a mixture of isomeric *N*-acetyl-7-keto-8-methyldecahydro-*isoquinolines* from which[†] the *cis*-isomeride (V) was isolated as the crystalline hydrate, m.p. 80.5 to 82.5°. The black dots in formula V represent hydrogen atoms situated above the plane of the paper.^{70(e)} The *cis-N*-acetyl-7-keto-8-methyldecahydro-*isoquinoline* was rendered anhydrous by evaporation of its solution in benzene and treated in dry alcohol with ethyl nitrite and sodium ethoxide to produce *N*-acetyl-10-oximinodihydro-*homomeroquinenine* ethyl ester (VI) by a type of cleavage reaction, used by Clarke, Lapworth and Wechsler.^{70(f)} The product crystallised in labile, m.p. 96–8°, and stable, m.p. 108.5–109°, forms. On hydrogenation a mixture of stereoisomeric amino-compounds was obtained, a new centre of asymmetry, indicated by an asterisk in (VII), having been produced. The mixture of *N*-acetyl-10-aminodihydro-*homomeroquinenine* ethyl esters was treated with methyl iodide in alcoholic solution over potassium carbonate and the resulting *N*-acetyl-10-trimethyl ammoniumdihydro-*homomeroquinenine* ethyl ester iodide (VII), a colourless, glassy mixture of epimerides, differing in configuration at C*, was heated to 180° with a concentrated solution of sodium hydroxide; it evolved trimethylamine and produced the required *homomeroquinenine* (VIII). This was isolated from the reaction product, by addition of

potassium cyanate, as the uramido-compound, m.p. 165.2–165.8°, which on boiling with N/HCl provided *homomeroquinine* hydrochloride and this on treatment with silver oxide regenerated *dl-cis-homomeroquinine*, m.p. 219–20° (*dec.*). *N*-benzoyl*homomeroquinine* ethyl ester, a colourless, odourless, viscous liquid, was prepared by acid hydrolysis of the

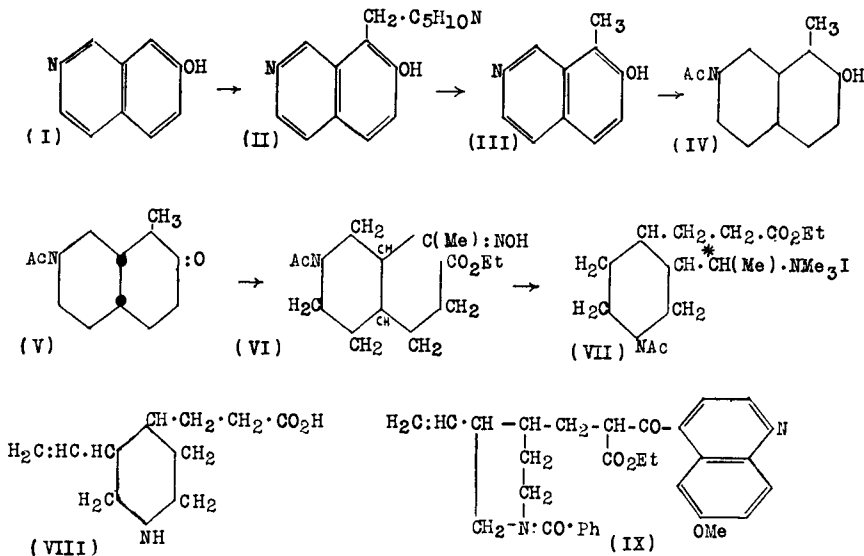

uramido-derivative, followed by esterification of the *homomeroquinine* and *N*-benzylation of the ester, the crude benzoyl derivative being purified by molecular distillation. The final condensation of the *N*-benzoyl derivative with ethyl quininate in presence of sodium ethoxide proceeded smoothly to crude *N*-benzoylquinotoxinecarboxylic acid ethyl ester (IX) which was hydrolysed by boiling with aqueous (1 : 1) hydrochloric acid to crude *dl*-quinotoxine (VI with Et \rightarrow .CH : CH₂ and Q = 6-methoxyquinolyl, p. 459). Although Pasteur^{70(g)} had found that *dl*-tartaric acid could be resolved into *d*- and *l*-forms by the use of natural *d*-quinotoxine (*d*-quinicine), Woodward and Doering found that *dl*-quinotoxine could not be resolved by the use of *d*-tartaric acid, but resolution could be effected by the use of dibenzoyl-*d*- and *l*-tartaric acids. The *d*-quinotoxine so obtained was an oil, with $[\alpha]_D + 43^\circ$ (EtOH), giving a hydrogen *d*-tartrate, m.p. 150–3° (*dry*) and a dibenzoyl-*d*-tartrate, m.p. 185.5–186°. The *l*-quinotoxine had $[\alpha]_D - 43^\circ$ and its dibenzoyl-*l*-tartrate, m.p. 185–6°.

MINOR CINCHONA ALKALOIDS

Quinamine, C₁₉H₂₄O₂N₂. This alkaloid was isolated from *Cinchona succirubra* bark by Hesse^{71(a)} and subsequently found by him in the barks of several cinchona spp. but especially in *C. ledgeriana* bark. It has been examined in detail recently by Henry, Kirby and Shaw.^{71(b)}

The base crystallises in needles, m.p. 185–6°, $[\alpha]_D + 104.5^\circ$ (EtOH)

and contains neither a methoxyl nor a methylimino- group. The hydrochloride, B. HCl . H₂O, has m.p. 166–7°, $[\alpha]_D + 102.8^\circ$ (H₂O), the hydriodide, m.p. 224°, $[\alpha]_D + 84.8^\circ$ (EtOH) and the nitrate, m.p. 186–8°, $[\alpha]_D + 94.9^\circ$ (H₂O). The picrate crystallises from boiling water in small yellow needles, m.p. 175–6°, $[\alpha]_D + 90.0^\circ$ (M/40; acetone). Nitrosoquinamine is amorphous but forms a crystalline picrate, C₁₉H₂₃O₂N₂ . NO . C₆H₃O₇N₃, m.p. 161°, and a crystalline acetyl derivative, C₁₉H₂₂O₂N₂(NO)(CO . CH₃), small yellow cubes, m.p. 137–141°. Quinamine forms a monomethiodide, m.p. 250–1°, $[\alpha]_D + 114.2^\circ$ and a methochloride, m.p. 237–40°, $[\alpha]_D + 111.9^\circ$, and on hydrogenation produces a dihydro- base, m.p. 184–5°, $[\alpha]_D + 119.8^\circ$, yielding a picrate, m.p. 176–8° and a monomethiodide, m.p. 219–25°. When refluxed with acetyl chloride in benzene the alkaloid is converted into amorphous acetyl*apo*quinamine giving a picrate, C₁₉H₂₁ON₂ . CO . CH₃ . C₆H₃O₇N₃, m.p. 143–5°, and yielding on alkaline hydrolysis crystalline *apo*quinamine, C₁₉H₂₂ON₂, m.p. 115–7°, $[\alpha]_D \pm 0^\circ$ (EtOH) or –32.9° (M/40; N/10–H₂SO₄), which forms a hydriodide, m.p. 207–9°, a picrate, m.p. 172–4°, and a methiodide, m.p. 219–20°, and on hydrogenation in alcohol with palladised barium sulphate as catalyst gives rapidly a dihydro-derivative (picrate, m.p. 179–81°) and very slowly a tetrahydro-derivative (picrate, m.p. 175–7°). The formation of nitrosoacetylquinamine and the dehydration to *apo*quinamine in the reactions described above, indicate that in spite of the two replaceable hydrogens found by the Zerewitinoff method, quinamine probably contains three such hydrogens, two as hydroxyl groups and one as a secondary nitrogen. When either quinamine or *apo*quinamine is subjected to prolonged ebullition in dilute acetic acid it is converted into quinamicine, the *apo*-base being apparently first hydrated to quinamine. Quinamicine, like the quinicines (p. 425) in general, could not be crystallised, but a crystalline picrate, C₁₉H₂₄O₂N₂ . C₆H₃O₇N₃, m.p. 203–5°, $[\alpha]_D - 17.46^\circ$ (M/40; acetone), 2:4-dinitrophenylhydrazone, m.p. 239–40° and oxime, m.p. 217–20°, $[\alpha]_D + 82.2^\circ$, were obtained and by the action of methyl iodide, *N*-methylquinamicine methiodide, C₁₉H₂₃O₂N₂ . CH₃ . CH₃I, m.p. 275–6°, $[\alpha]_D - 39.8^\circ$ (EtOH).

Quinamine differs from all the cinchona alkaloids previously examined in not yielding a quinoline derivative on oxidation but instead is oxidised by chromic acid to a vinylquinuclidinecarboxylic acid, C₁₀H₁₅O₂N, m.p. 206–8°, $[\alpha]_D + 57.9^\circ$ (CHCl₃) isolated as a copper salt (C₁₀H₁₄O₂N)₂Cu . H₂O. The acid, on treatment with diazomethane and distillation of the reaction product, is decarboxylated to a base C₉H₁₅N (picrate, m.p. 143–6°) which is assumed to be 3-vinylquinuclidine, since it absorbs one molecule of hydrogen to form 3-ethylquinuclidine, identified as the picrate, m.p. 151–3°, which showed no depression of melting point on admixture with the picrate of 3-ethylquinuclidine prepared by the method of Prelog *et al.*⁵² (1940). Assuming that the central .CHOH group is present in quinamine and is attached to C⁸ of the quinuclidine nucleus as is usual in the cinchona alkaloids, the oxidation acid must be 3-vinylquinuclidine-8-carboxylic acid, and from the data given above the empirical formula of quinamine

may be extended to I (Qn = quinuclidine residue) and assuming that quinamicine is formed just as the quinicines (p. 448) arise from the normal cinchona alkaloids, the formula of quinamicine can be written as II (C_5H_9N = piperidyl residue). (I) $CH_2 : CH \cdot Qn \cdot CHOH \cdot C_9H_8ON$. (II) $CH_2 : CH \cdot C_5H_9N \cdot CH_2 \cdot CH_2 \cdot CO \cdot C_9H_8ON$.

It is also clear from the data given above that in the undetermined residue, C_9H_8ON , the nitrogen atom is secondary and the oxygen is probably present as a hydroxyl group. Evidence as to the structure of this residue was provided by Kirby,^{71(c)} who identified 2 : 3-dimethylindole among the products formed when quinamine is heated with zinc dust at 320° . The alkaloid and its proximate, transformation products all show indole colour reactions and it and the *apo*-base give a positive pine-shaving test when heated with zinc dust. On this basis Kirby has suggested the following formulæ (Qn = quinuclidyl) for quinamine (III) and *apo*-quinamine (IV); that for quinamicine on this basis is obvious from II and the structure now suggested for the residue, C_9H_8ON .

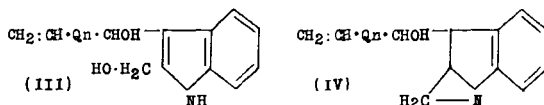

The attachment of the vinylquinuclidylcarbinol residue at C^3 in the indole nucleus is based on the assumption that, like most of the indole alkaloids, quinamine is a tryptamine derivative and the connecting $\cdot CHOH$ group is justified by analogy with the other cinchona alkaloids and the formation of the keto-base quinamicine corresponding to the quinicines (p. 448). The primary carbinol group at C^2 is indicated by the evolution of formaldehyde when quinamine is heated above its melting point and by the formation of small amounts of methyl iodide, when quinamine is subjected to the Herzig-Meyer process for the estimation of methylimino groups, and it accounts for the dehydration to *apo*quinamine by the action of acetyl chloride in which the hydrogen of the NH group must play a part since *N*-nitrosoquinamine can be acetylated without dehydration.

According to Hesse, conquinamine, an isomeride of quinamine (*see table below*) yields, on appropriate treatment, quinamicine and *apo*quinamine. Raymond-Hamet has shown that cinchonamine (*below*) and aricine (*table*, p. 466) give indole colour reactions and in that respect resemble quinamine.⁷⁷

The remaining minor cinchona alkaloids are described in the tables on page 466.

ALKALOIDS OF *Remijia Purdieana*. The bark of *Remijia Purdieana*, a tree related to that yielding cuprea bark, contains a little cinchonine and a series of other alkaloids, for which Hesse⁷² gives a scheme of separation with descriptions.

Cinchonamine, $C_{19}H_{24}ON_2$, first isolated by Arnaud,⁷³ crystallises in triboluminescent,⁷⁴ orthorhombic needles, m.p. 194° , $[\alpha]_D + 121.1^\circ$

Minor Cinchona Alkaloids

Name and Formula	Source	Properties	References
Conquinamine, $C_{19}H_{24}O_2N_2$.	<i>C. succirubra</i> , <i>C. Ledgeriana</i> , etc.	Triclinic crystals, m.p. 121°, $[\alpha]_D + 204.6^\circ$ (EtOH). Crystalline salts.	Hesse, <i>Ber.</i> 1877, 10, 2158; <i>Annalen</i> , 1881, 209, 62; Oudemans, <i>ibid.</i> , p. 38.
Paricine, $C_{16}H_{18}ON_2 \cdot \frac{1}{2}H_2O$.	<i>C. succirubra</i> from Darjeeling.	M.p. 136°, amorphous salts, $[\alpha]_D \pm 0^\circ$.	Hesse, <i>Annalen</i> , 1873, 166, 263; <i>Pharm. J.</i> , 1879, [iii], 9, 993; Howard, <i>ibid.</i> , p. 792.
Dicinchonine (Dicinchonicine), $C_8H_4O_2N_4$.	<i>C. rosulenta</i> and <i>C. succirubra</i> .	Amorphous; m.p. 40°, $[\alpha]_D^{16^\circ} + 65.6^\circ$ (EtOH); B. 2HCl, crystalline.	Hesse, <i>Annalen</i> , 1885, 227, 154.
Diconquinine (Diquinicine), $C_{40}H_{46}O_3N_4$.	"Quinoidine."	Amorphous, dextrorotatory.	Hesse, <i>Ber.</i> , 1877, 10, 2155.
Javanine	<i>C. Calisaya</i> var. <i>Javanica</i> .	Rhombic plates.	Hesse, <i>Ber.</i> , 1877, 10, 2162.

Alkaloids of Cusco Bark (Cinchona Pelletierana, Wedd.)

Name and Formula	Properties	References
Aricine (Quinovatine), $C_{23}H_{26}O_4N_2$.	Prisms, m.p. 188°, $[\alpha]_D - 58.3^\circ$ (EtOH), +14.5° (acid). Oxalate sparingly soluble in water. Green colour with nitric acid.	Pelletier and Corriol, <i>J. Pharm.</i> , 1829, 15, 565; Hesse <i>Annalen</i> , 1873, 166, 259; 1876, 181, 58; 1877, 185, 310; <i>Pharm. J.</i> , 1882, [iii], 12, 517; Howard, <i>J. Chem. Soc.</i> , 1875, 28, 309; Moissan and Landrin, <i>Bull. Soc. Chim.</i> , 1890, [iii], 4, 258.
Cusconine, $C_{23}H_{26}O_4N_2 \cdot 2H_2O$.	Leaflets, m.p. 110° (<i>dry</i>), $[\alpha]_D - 54.3^\circ$ (EtOH).	Leverköhn, <i>Rep. Pharm.</i> , 1829, 33, 357; Hesse, <i>Pharm. J.</i> , 1882, [iii], 12, 507; <i>Annalen</i> , 1877, 185, 301.
Cusconidine . . .	Amorphous.	Hesse, <i>loc. cit.</i>
Cuscamine . . .	Prisms, m.p. 218°.	Hesse, <i>ibid.</i> , 1880, 200, 304.
Cuscamidine . . .	—	

(EtOH). No methoxyl is present. It forms a series of crystalline double chlorides with cadmium, zinc or copper,⁷⁵ does not give the thalleioquin reaction, and solutions of its sulphate are not fluorescent. It is diacidic and forms two series of salts; of which the nitrate, B. HNO₃, crystallises in minute prisms, m.p. 196°, insoluble in water. Cinchonamine hydrochloride, B. HCl, laminæ or B. HCl.H₂O, cubical crystals, has been suggested for use in the estimation of nitrates.⁷⁶ When warmed with strong nitric acid the alkaloid furnishes dinitrocinchonamine. It gives an amorphous, monoacetyl derivative, and forms a methiodide, m.p. 208°, which with silver oxide yields an amorphous methylcinchonamine. Raymond-Hamet found that cinchonamine gives typical indole colour reactions and is probably an indole alkaloid.⁷⁷ This seems to have been

the first indication of the occurrence of this type of alkaloid in a plant closely allied botanically to the cinchonas. The same author showed subsequently ⁷⁷ (1945) that aricine (table, p. 466) also gave indole reactions, but in the meantime definite proof had been provided of the presence of an indole nucleus in quinamine by Kirby ^{71(c)} (p. 465).

Concusconine, $C_{23}H_{26}O_4N_2 \cdot H_2O$, crystallises in monoclinic needles, $[\alpha]_D^{15} + 40.8^\circ$ (Hesse) ⁷² or $+ 19.57^\circ$ (Howard and Chick), ⁷⁶ melts at 144° and re-melts at $206-8^\circ$, is insoluble in water, very sparingly in cold alcohol, easily soluble in ether or chloroform. It dissolves in concentrated sulphuric acid with a bluish-green colour, becoming olive-green on warming. The salts are amorphous. Concusconine contains two methoxyl groups, and forms α - and β -methiodides, which in turn furnish α - and β -methoxyhydroxides, the former crystalline, the latter amorphous.

The chief characters of the remaining bases from this bark are stated in the following table:—

Name and Formula	Crystalline Form	Optical Rotation (α_D^{15})	Colour Reactions
Chairamine, $C_{22}H_{26}O_4N_2 \cdot H_2O$.	Needles or prisms, m.p. 233° (<i>dry</i>).	$+ 100^\circ$ (EtOH).	A solution in acetic acid gives a dark green colour with nitric acid.
Conchairamine, $C_{22}H_{26}O_4N_2 \cdot H_2O$.	Prisms, m.p. 120° (<i>dry</i>).	$+ 68.4^\circ$ at 15° (alcohol).	As above; also sulphuric acid gives a brown colour, becoming green.
Chairamidine, $C_{22}H_{26}O_4N_2 \cdot H_2O$.	Amorphous; m.p. $126-8^\circ$.	$+ 7.3^\circ$ at 15° (alcohol).	Sulphuric acid gives a green colour. Nitric acid colours a solution in hydrochloric acid green.
Conchairamidine, $C_{22}H_{26}O_4N_2 \cdot H_2O$.	Crystalline, m.p. 114° (<i>dry</i>).	$- 60^\circ$ at 15° (alcohol).	Sulphuric acid gives a deep green colour.

REFERENCES

- (1) KING, *J. Chem. Soc.*, 1946, 523. (2) *Rec. trav. Chim.*, 1933, 52, 847; HENRY and SOLOMON, *J. Chem. Soc.*, 1934, p. 1924; cf. THRON and DIRSCHERL, *Annalen*, 1935, 515, 255. (3) COMSTOCK and KÖNIGS, *Ber.*, 1887, 20, 2517; CHRISTENSEN, *J. pr. Chem.*, 1905, 71, 1. (4) GOODSON, *J. Chem. Soc.*, 1934, 1095. (5) SEEKLES, *Rec. trav. Chim.*, 1923, 42, 69. (6) HESSE, *Annalen*, 1875, 176, 232; SKRAUP, *ibid.*, 1879, 197, 381. (7) SKRAUP and VORTMANN, *ibid.*, p. 235; HESSE, *Ber.*, 1881, 14, 1892. (8) KERNER, *Zeit. Chem.*, 1869, p. 593; SKRAUP, *Annalen*, 1879, 199, 348; *Monats.*, 1889, 10, 39; VON BUCHER, *ibid.*, 1893, 14, 598; GOODSON, HENRY and MACFIE, *Biochem. J.* 1930, 24, 874; ANDREWS and CORNATZER, *Elisha Mitchell Sci. Soc.*, 1943, 59, 177. (9) FORST and BÖHRINGER, *Ber.*, 1882, 15, 1659. (10) RABE, *ibid.*, 1907, 40, 3281, 3655. (11) *Annalen*, 1909, 364, 330; RENFREW and CRETCHER, *J. Amer. Chem. Soc.*, 1935, 57, 738; WOODWARD *et al.*, *ibid.*, 1945, 67, 1425; DOERING and CHANLEY, *ibid.*, 1946, 68, 586. (12) *Ber.*, 1907, 40, 4698. (13) *Ibid.*, 1909, 42, 627. (14) *Monats.*, 1896, 17, 377. (15) *Ber.*, 1897, 30, 1326. (16) *Loc. cit.* and KÖNIGS, *ibid.*, 1902, 35, 1357; cf. RABE and PASTERNAK, *ibid.*, 1916, 49, 2753. (17) COMSTOCK and KÖNIGS, *ibid.*, 1880, 13, 286; 1881, 14, 1854; 1884, 17, 1986; 1885, 18, 1219; 1892, 25, 1545; RABE, *Annalen*, 1910, 373, 85; FRÄNKEL *et al.*, *Ber.*, 1923, 56, 433; COHEN and KING, *Proc. Roy. Soc.*, 1938, B, 125, 49; for corresponding bromides see BÖHRINGER, Ger. Pat. 592,540, 592,541. (18) COMSTOCK and KÖNIGS, *Ber.*, 1880, 13, 286; 1881, 14, 108, 1854; 1884, 17, 1984; 1885, 18, 1219. (19) KÖNIGS, *ibid.*, 1894, 27, 900

(with BERNHART and IBELE), *Annalen*, 1906, 347, 143; cf. LIVSCHITZ *et al.*, *J. Gen. Chem. Russ.*, 1945, 15, 324. (20) KÖNIGS, *ibid.*, 1881, 14, 103, 1854; 1885, 18, 1219; 1894, 27, 900; *J. pr. Chem.*, 1900, [ii], 61, 41. (21) COMSTOCK and KÖNIGS, *Ber.*, 1885, 18, 2884; 1887, 20, 2683; 1893, 26, 713. (22) KÖNIGS, *J. pr. Chem.*, 1900, 61, 1; cf. KENNER and STATHAM, *J. Chem. Soc.*, 1935, 299; KENNER, NANDI and GRINDLEY, *Ber.*, 1936, 69, 635. (23) VON MILLER and ROHDE, *Ber.*, 1894, 27, 1187, 1280; 1895, 28, 1056; 1900, 33, 3214; PICTET and WOLFFENSTEIN, *Die Pflanzen Alkaloide*, p. 315; KÖNIGS, *Ber.*, 1899, 32, 3599; 1907, 40, 2873; *Annalen*, 1906, 347, 143; ROHDE and ANTONAZ, *Ber.*, 1907, 40, 2329; RABE, *Annalen*, 1906, 350, 180; *Ber.*, 1908, 41, 62. (24) RABE and collaborators, *Annalen*, 1906, 350, 180; 1911, 382, 365. (25) *Ibid.*, 1909, 365, 366. (26) Cf. ROHDE and ANTONAZ, *Ber.*, 1907, 40, 2329; 1909, 42, 2182. (27) *Ibid.*, 1907, 40, 3655; 1908, 41, 62; *Annalen*, 1909, 364, 330. (28) RABE, *Ber.*, 1911, 44, 2088; 1918, 51, 466; also p. 445 of this book. (29) *Annalen*, 1909, 365, 353; 1910, 373, 85. (30) *Ber.*, 1922, 55, 522; the earlier notation is also due to RABE, *Annalen*, 1910, 373, 85; cf. KAUFMANN and HUBER, *Ber.*, 1913, 46, 2913, who reversed the order. (30a) HENRY, SOLOMON and GIBBS, *J. Chem. Soc.*, 1937, 592; SOLOMON, *ibid.*, 1938, 6. (31) KÖNIGS, *Ber.*, 1896, 29, 372; cf. RABE, *Annalen*, 1910, 373, 85. (32) In the dihydro-deoxybases $\cdot\text{CH}_2\text{:CH}\cdot$ becomes $\text{CH}_2\text{,CH}_2\text{—}$; cf. FREUND and BREDEBURG, *ibid.*, 1914, 407, 43. (33) RABE and co-workers, *ibid.*, 1910, 373, 85; cf. KAUFMANN and HUBER, *Ber.*, 1913, 46, 2913. (34) Ger. Pat. 330,813 (*Chem. Soc. Abstr.*, 1921, [i], 355); cf. KAUFMANN and HUBER³³ and RABE and KINDLER, *Ber.*, 1918, 51, 466. (35) *J. Chem. Soc.*, 1922, 121, 2578. (36) (With IRSCHEK, SUSZKO, MÜLLER, NIELSEN, KOLBE, VON RIEGEN and HOCHSTÄTTER, *Annalen*, 1932, 492, 242; see also *ibid.*, 1910, 373, 85; (with SCHULTZE), *Ber.*, 1933, 66, 120; RABE, *ibid.*, 1943, 76, 251; cf. KAUFMANN and HUBER, *ibid.*, 1913, 46, 2913; and KÖNIGS and HUSEMANN, *ibid.*, 1896, 29, 2185; FIEDZIUSKO and SUSZKO, *Arch. Chem. Farm.*, 1935, 2, 139; SUSZKO and SZELAG, *Bull. Inst. Acad. Pol.*, 1936, A, 403; WOODWARD *et al.*, Ref. 11. (36a) *J. Amer. Chem. Soc.*, 1947, 69, 1700. (37) For 6'-methoxyruban-9-ols see RABE (with KINDLER and WAGNER), *Ber.*, 1922, 55, 532; (with HAGEN), *ibid.*, 1941, 74, 636; (with SCHULER and VOSS), *ibid.*, 1943, 76, 318; cf. PRELOG, SEIWERTH, HEIMBACH-JUHÁSZ, and STERN, *ibid.*, 1941, 74, 647; KLEIMAN and WEINHOUSE, *J. Org. Chem.*, 1945, 10, 562. (37a) *Heb. Chim. Acta*, 1944, 27, 535, 545; cf. KENNER, *Chem. Soc. Ann. Repts.*, 1922, 19, 158; for a synthesis of *dl*-cincholoipon and its ethyl ester, see STORK and McELVAIN, *J. Amer. Chem. Soc.*, 1946, 68, 1053. (37b) (With ZELLER and HUBER), *Ber.*, 1913, 46, 1823. (37c) LEVENE and MARKER, *J. Biol. Chem.*, 1931, 91, 405, 761; 92, 455; see also FREUDENBERG, "Stereochemie," 1932, pp. 679, 727, and E. FISCHER, *Ber.*, 1891, 24, 2683. (38) *Monats.*, 1899, 20, 425 (VON ARLT); 571, 585; 1900, 21, 512, 535, 558; 1901, 22, 171, 191 (HLAVNICKA); 253, 1083, 1097, 1103; 1902, 23, 443 (PECSIS); 455; 1903, 24, 119 (ZWERGER); 311; 1904, 25, 894; see also CORDIER VON LOWENHAUPT, *Monats.*, 1898, 19, 461; and KAAS, *ibid.*, 1904, 25, 1145; 1905, 26, 119; KÖNIGS, ref. 40. (39) *Ann. Chim.*, 1920, [ix], 14, 59 (with a bibliography of the original papers on which the summary is based); *J. Pharm. Chim.*, 1936, [viii], 22, 558, 608; 1938, [viii], 27, 63; *Bull. Soc. Chim.*, 1937, [v], 4, 180; 1938, [v], 5, 183. (40) KÖNIGS, *Annalen*, 1906, 347, 143; cf. RABE and BÖTTCHER, *Ber.*, 1917, 50, 127. (41) SKRAUP, *Monats.*, 1893, 14, 428. (42) SKRAUP, *Monats.*, 1899, 20, 571. (43) JUNGFLEISCH and LÉGER, *Compt. rend.*, 1894, 118, 29; LÉGER, 1919, 169, 797; cf. LANGER, *Monats.*, 1901, 22, 157; CORDIER VON LOWENHAUPT, *ibid.*, 1898, 19, 461; cf. LANGER, *ibid.*, 1901, 22, 151. (44) GIBBS and HENRY, *J. Chem. Soc.*, 1939, 240, 1294; SOLOMON, *ibid.*, 1941, 77; BUTLER, RENFRÉW and CRETCHER, *J. Amer. Chem. Soc.*, 1943, 65, 2038. (45) *Annalen*, 1934, 514, 61; *Ber.*, 1941, 74, 725; cf. SUSZKO and TOMANEK, *Rec. Trav. Chim.*, 1933, 52, 18; LUDWICZKÓWNA and SUSKO, *Arch. Chem. Farm.*, 1935, 2, 196. (46) *Ber.*, 1912, 45, 1800. (47) *Ibid.*, 1912, 45, 1805; cf. KAUFMANN and WIDMER, *ibid.*, 1909, 42, 1999, 3776; 1911, 44, 2052, 2058; 1918, 51, 116; 1922, 55, 614; HALBERKANN, *ibid.*, 1921, 54, 3079, 3090; THIELPAPE, *ibid.*, 1922, 55, 127; 1938, 71, 387; 1939, 72, 1432; KOELSCH, *J. Amer. Chem. Soc.*, 1944, 66, 2019. (48) *Ber.*, 1931, 64, 2487; AINLEY and KING, *Proc. Roy. Soc.*, 1933, B, 125, 60; CAMPBELL, TIPSON, ELDERFIELD, CAMPBELL, CLAPP, GENSLE;

MORRISON and MORGAN, *J. Org. Chem.*, 1946, 11, 803; see also KNORR, *Annalen*, 1886, 236, 69. (49) KÖNIGS, *Ber.*, 1904, 37, 3244; (with BERNHART), *ibid.*, 1905, 38, 3049; LÖFFLER and STIETZEL, *ibid.*, 1909, 42, 124. (50) *Annalen*, 1920, 420, 190. (51) *J. Chem. Soc.*, 1937, 1524, 1989; 1939, 1241; 1941, 476. (52) *Annalen*, 1937, 532, 69, 83; 1938, 535, 37; 1940, 545, 247; *Ber.*, 1939, 72, 1325. (53) *Ann. Chim.*, 1882, [v], 27, 469. (54) *Ber.*, 1894, 27, 1502. (55) *Helv. Chim. Acta*, 1919, 2, 338. (56) *J. Chem. Soc.*, 1905, 87, 1685. (57) (a) RABE and JANTZEN, *Ber.*, 1921, 54, 925; PRELOG and KOMZAK, *ibid.*, 1941, 74, 1705; (with MOOR), *Helv. Chim. Acta*, 1942, 25, 1654; 1943, 26, 846; (b) STEVENS, BEUTEL and CHAMBERLIN, *J. Amer. Chem. Soc.*, 1942, 64, 1093; KOELSCH, *ibid.*, 1943, 65, 2460; WEBB and CORWIN, *ibid.*, 1944, 66, 1456; cf. PRELOG *et al.*, *Helv. Chim. Acta*, 1945, 28, 182; (c) ROBINSON and WATT, *J. Chem. Soc.*, 1934, 1536; (with MATEJKA), *ibid.*, 1932, 2019. (58) *Ber.*, 1921, 54, 1343; (with HOFFMANN), 1925, 58, 194; cf. RABE and KINDLER, 1918, 51, 1360; 1919, 52, 1842. (59) *Ibid.*, 1933, 66, 120. (60) *Ibid.*, 1918, 51, 1360; cf. Ger. Pat. 330,945 (*Chem. Soc. Abstr.*, 1921, [i], 360); and Ger. Pat. 268,830 (*ibid.*, 1914, [i], 575). (61) *Ibid.*, 1916, 49, 2299; cf. Ger. Pat. 313,321 (*Chem. Soc. Abstr.*, 1920, i, 78); for a survey of such reactions see KOELSCH, *J. Org. Chem.*, 1945, 10, 34. (62) KAUFMANN and HUBER, *Ber.*, 1913, 46, 2913. (63) *Ibid.*, 1919, 52, 1842. (64) *Ibid.*, 1911, 44, 2088; 1912, 45, 2163; 1918, 51, 466. (65) RABE *et al.*, *Annalen*, 1932, 492, 252. (66) *Ber.*, 1933, 66, 120. (67) *Annalen*, 1932, 496, 151. (68) *Ber.*, 1922, 55, 532. (69) See, for example, KAUFMANN, PEYER and KUNKLER, *ibid.*, 1912, 45, 3090; cf. REMFY and DECKER, *ibid.*, 1908, 41, 1007; and Ger. Pat. 268,830; 280,970 (*Chem. Soc. Abstr.*, 1914, [i], 575; 1915, [i], 720); KAUFMANN, *Ber.*, 1913, 46, 1823; HOWITZ and KÖPKE, *Annalen*, 1913, 396, 38; RABE and PASTERNAK, *Ber.*, 1913, 46, 1026, 1032; (with KINDLER), *ibid.*, 1917, 50, 144 (cf. Ger. Pat. 330,813, *J. Soc. Chem. Ind.*, 1921, 40, 449A); RUZICKA, *Helv. Chim. Acta*, 1921, 4, 482, 486; KARRER, *Ber.*, 1917, 50, 1499; RUBTZOVA, *J. Gen. Chem. U.R.S.S.*, 1939, 9, 1493; 1943, 13, 593, 702 (*Chem. Abstr.*, 1940, 34, 2850; 1945, 39, 705, 706); KOELSCH, *J. Amer. Chem. Soc.*, 1946, 68, 146. (69a) RUBTZOVA, *J. Gen. Chem. Russ.*, 1946, 16, 461; SARGENT and a team of Workers, *J. Amer. Chem. Soc.*, 1946, 68, 2688-2721 (12 papers); AINLEY and KING, *Proc. Roy. Soc.*, 1938, B, 125, 60; KING and WORK, *J. Chem. Soc.*, 1940, 1307; WORK, *ibid.*, 1946, 194, 197; 1947, 222. (70) (a) PROŠTENIK and PRELOG, *Helv. Chim. Acta*, 1943, 26, 1965; (b) KAUFMANN, ROTHLIN and BRUNTSCHWEILER, *Ber.*, 1916, 49, 2299, 2308; (c) WOODWARD and DOERING, *J. Amer. Chem. Soc.*, 1944, 66, 849; 1945, 67, 860; (d) FRITSCH, *Annalen*, 1895, 286, 10; (e) LINSTAD, *Chem. and Ind.*, 1937, 56, 510; (f) CLARKE, LAPWORTH and WECHSLER, *J. Chem. Soc.*, 1908, 93, 30; (g) PASTEUR, *Compt. rend.*, 1853, 37, 162. (71) (a) *Ber.*, 1872, 5, 265; 1877, 10, 2152; *Annalen*, 1873, 166, 217; 1879, 199, 333; 1881, 207, 288; DE VRIJ, *Pharm. J.*, 1874, 4, 609; HOWARD, *ibid.*, 1875, 5, 1; OUDEMANS, *Annalen*, 1879, 197, 48; (b) *J. Chem. Soc.*, 1945, 524; (c) *Ibid.*, p. 528. (72) *Annalen*, 1877, 185, 296, 323; 1884, 225, 211. (73) *Compt. rend.*, 1881, 93, 593; 1883, 97, 174. (74) TSCHUGAEFF, *Ber.*, 1901, 34, 1824. (75) BOUTROUX and GENVRESSE, *Compt. rend.*, 1897, 125, 467. (76) HOWARD and CHICK, *J. Soc. Chem. Ind.*, 1905, 24, 1281; 1909, 28, 53. (77) *Compt. rend.*, 1941, 212, 135; 1945, 220, 670; 221, 307.

PHARMACOLOGICAL ACTION OF THE CINCHONA ALKALOIDS. The cinchona alkaloids are of special interest as items in chemotherapy because they can be modified in structure in numerous ways and the effects of structural change on pharmacological action, *e.g.*, potency as anti-malarial agents, can be tested biologically in at least a roughly quantitative fashion. Much work has been devoted to the correlation of molecular structure in the group with anti-malarial action, beginning with the work of Grimaux and Arnaud^{1(a)} on homologues of quinine, which was continued and largely extended by Giemsa and his co-workers.^{1(b)}

It should be understood that in the following account the ascription

of anti-malarial activity to a substance does not mean that it is an effective remedy in human malaria; all that is implied is that the substance exhibits anti-malarial activity in tests on the particular infection in the laboratory animals specified, e.g., *Plasmodium relictum* in canaries, *P. gallinaceum* in chicks, *P. lophuræ* in ducklings or *P. knowlesi* in monkeys, a method now in constant use as a screening test.^{2(a)} Curd has produced a useful summary, with an exhaustive bibliography, of the results of biological tests (1914–1942) with the known anti-malarial drugs, in the malaria of man, monkeys and birds, in which infections with nineteen species of *Plasmodium* are dealt with and in addition two species of *Hæmoproteus*, used for testing possible gametocidal action in anti-malarial drugs.^{2(b)}

Since 1886, when the Madras Cinchona Commission, as the result of comparative clinical trials, arranged the four chief cinchona alkaloids in the following descending order of anti-malarial efficiency: (1) quinine and quinidine, (2) cinchonidine, (3) cinchonine, the relative merits of these four alkaloids and their dihydroderivatives have been frequently examined and discussed. Giemsa, Weise and Tropp,^{1(b)} in trials in bird malaria, found that there was little difference in the activity of quinine, dihydroquinine and quinidine, but that cinchonine was definitely inferior. MacGilchrist,³ in a clinical trial in human malaria, placed dihydroquinine first, quinine, quinidine and cinchonine about equal, and cinchonidine inferior. Hegner, Shaw and Manwell³ arrange four of these alkaloids in the following descending order as regards absorption by red blood corpuscles, which they regard as an indication of efficiency against malaria. The figures are partition coefficients (concentration in corpuscles over concentration in serum) for chicken blood. Quinine, 5.0; quinidine, 4.4; cinchonine, 4.3; cinchonidine, 3.8. In 1925 the results of a comparison carried out under the auspices of the British Medical Research Council³ established the practical equivalence of quinidine and quinine.

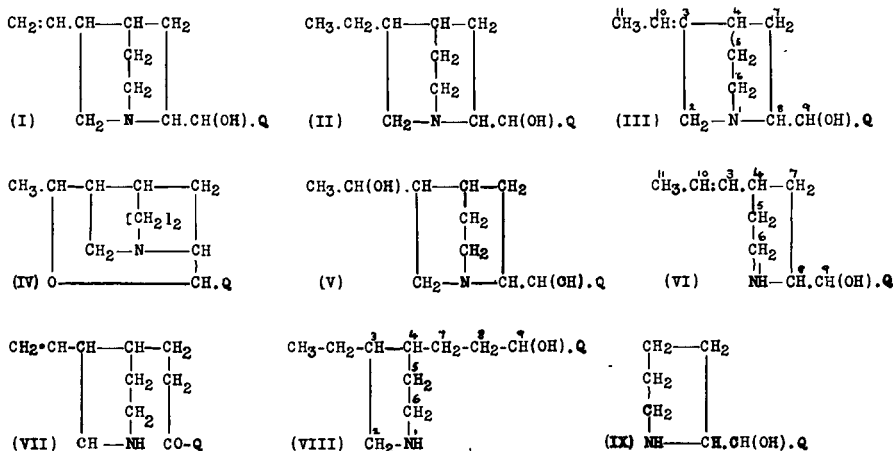

Q may be Quinolylyl, 6-methoxyquinolylyl, or 6-alkoxyquinolylyl, substituted at position 4

QUININE EQUIVALENTS OF CINCHONA BASES AND TRANSFORMATION PRODUCTS.

	Name of Substance and Formula Reference Number					
	I	II	III	IV	V	VI
Q = 6-Methoxyquinolyl in formulæ (p. 449).	Quinidine (0.5) Quinine (1.0)	Dihydroquinidine (0.5-1.0) Dihydroquinine (1-2)	<i>apo</i> Quinidine methyl ether (1.0) α - <i>iso</i> Quinine (0.62). β - <i>iso</i> Quinine (0.69)	α - <i>iso</i> Quinidine (0.065) β - <i>iso</i> Quinidine (0.1) γ - <i>iso</i> Quinidine (inactive)	α -Hydroxydihydroquinine (0.54)	Niquidine (1.45) <i>iso</i> Niquidine (1.05) Niquine (0.86)
Q = 6-Hydroxyquinolyl in formulæ (p. 449).		Dihydrocupreidine (0.68) Dihydrocupreine (0.92).	<i>apo</i> Quinidine (0.4) <i>neoapo</i> Quinidine (0.46). <i>apo</i> Quinine (0.98). <i>isoapo</i> Quinine (0.9).	<i>isoapo</i> Quinidine (0.11)	α -Hydroxydihydro <i>apo</i> quinine (0.076). β -Hydroxydihydro <i>apo</i> quinine (0.036).	Dihydroniqidine * (1.06). Dihydroniqaine * (0.63). * <i>Formula VI</i> with $\text{CH}_3 \cdot \text{CH} : \text{CH} \cdot \dot{\text{C}}\text{H} \rightarrow \text{CH}_3 \cdot \text{CH}_2 \cdot \text{CH}_2 \cdot \dot{\text{C}}\text{H}$
Q = Quinolyl in formulæ (p. 449).	Cinchonidine (0.5). Cinchonine (< 0.2).	Dihydrocinchonidine (< 0.2). Dihydrocinchonine (< 0.2).		Formula VII Quinicines (inactive) (Q = 6-methoxyquinolyl).	Formula VIII Dihydroquinicins (inactive) (Q = 6-methoxyquinolyl).	Formula IX 4-(6-Methoxyquinolyl)- α -piperidylcarbinol (Ainley and King), (0.5).

As found in commerce, the cinchona alkaloids are not necessarily pure; quinidine, for example, may contain up to 30 per cent. of dihydroquinidine. Working with carefully purified specimens of the four chief cinchona alkaloids and their dihydro-derivatives, Buttle, Henry and Trevan⁴ found the results recorded in the table (p. 471) in tests with malaria in canaries. The figures in brackets represent the dose of quinine necessary to produce the same degree of protection as unit dose of the alkaloid named. To the results are also added the data found later by the same authors, with Solomon and Gibbs,⁴ for some of the transformation products (p. 449) of quinine and quinidine. The Roman numeral at the head of each column refers to the type formula on p. 470.

On these results the primary cinchona alkaloids and their dihydro-derivatives arrange themselves in the following descending order of activity: (1) dihydroquinine, (2) quinine, (3) dihydroquinidine, (4) cinchonidine and quinidine, (5) cinchonine, dihydrocinchonidine and dihydrocinchonine.

Since then Seeler, Dusenbery and Malanga³ have shown that when tested against *P. lophuræ* in ducklings, cinchonidine, cinchonine, quinidine and quinine are about equal in activity. On the other hand, Marshall,³ using the same purified alkaloids as Buttle *et al.*, but against *P. gallinaceum* in chicks and a different method of testing, obtained results indicating the following descending order of activity: (1) Dihydroquinine and cinchonine, (2) niquidine, quinidine, dihydroniquidine and cinchonidine, (3) quinine, (4) niquine. Marshall also determined (a) the percentage of alkaloid absorbed from the gut after two hours, (b) the concentration of alkaloid in the red blood corpuscles, and (c) the weight of alkaloid destroyed by 0.5 gramme of chick liver in two hours and found that the anti-malarial activity could in most cases be correlated with factors (a) and (b). The first two factors are much lower, and the third much higher for quinine than for quinidine, and it would be interesting to know whether it is these factors which determine the differences in the relative activities found for quinine and quinidine when tested for anti-malarial activity against different Plasmodium species infecting different animals.

There has been a good deal of discussion⁵ as to the influence of the 6-methoxyl group on activity in the cinchona alkaloids and other anti-malarial drugs and in general it has been held to be better than either hydroxyl or hydrogen at that point, but Marshall's results³ do not support that view, cinchonidine being more active than quinine and cinchonine than quinidine. The two apoquinines (III) as shown in the table are also exceptions, the quinine equivalent in their case being reduced on their methylation to the α - and β -isoquinines. Fournau⁵ has stated that in the case of the quinoline polyamines, the 6-methoxyl group is advantageous but not essential. Judging from the frequency with which 6-methoxyquinoline occurs in the numerous series of polyamines prepared for tests in avian malaria, this opinion seems to be generally accepted though here also there is an exception to be noted. For a series $R \cdot Q \cdot NH[CH_2]_n \cdot NEt_2$ in which R was hydrogen, hydroxyl or an alkoxy

group in position 6 in the quinoline nucleus, Q, and the amino- side-chain was as usual at C⁸. Kritschewsky and Sternberg,⁵ using siskins as test birds, recorded the following changes in the chemotherapeutic index :—

Substituent } —H	—OH	—OCH ₃	—OC ₂ H ₅	—OC ₃ H ₇	—OC ₄ H ₉	—OC ₈ H ₁₇
at C ⁶ in Q. }						
Index .	0	13.3	6	4	1	0

This series is exceptional, not only in showing a fall in the chemotherapeutic index on O-alkylation of the phenolic base but the fall continues as the series is ascended, whereas in general the index rises to a maximum as a homologous series is ascended and then declines. Such investigations among anti-malarial drugs of both the cinchona and the polyamine type have produced anomalous results of another kind. Thus in the series of alkyl ethers of apoquinine (III), C₁₉H₂₂O₂N₂, and dihydrocupreine (II), C₁₉H₂₄O₂N₂, the following quinine equivalents were found ⁴ for the members of two homologous series: (a) apoquinine, C₂₀H₂₄O₂N₂ to C₃₀H₄₄O₂N₂, and (b) dihydrocupreine, C₂₀H₂₆O₂N₂ to C₃₀H₄₆O₂N₂ :—

Series . . .	C ₁₉	C ₂₀	C ₂₁	C ₂₂	C ₂₃	C ₂₄	C ₂₅	C ₂₆	C ₂₇	C ₂₈	C ₂₉	C ₃₀
(a) Odd . . .	0.98	—	1.18	—	1.10	—	1.72	—	1.6	—	1.18	—
Even . . .	—	0.69	—	1.23	—	1.47	—	1.21	—	0.98	—	0.75
(b) Odd . . .	0.92	—	1.05	—	1.87	—	1.50	—	1.43	—	1.6	—
Even . . .	—	1.35	—	1.49	—	1.33	—	1.70	—	1.12	—	1.25

Similarly Magidson *et al.*,⁵ in a series of 6-methoxyquinolines substituted at C⁸ by the chain .NH—[CH₂]_n—NEt₂ found in anti-malarial tests in siskins, the following changes in the chemotherapeutic index :—

Value of n . . .	2	3	4	5	6	7	8	9	10	11
Index (odd) . . .	—	26	—	25	—	34	—	40	—	5
Index (even) . . .	6	—	11	—	13	—	—	—	—	—

Each of these three series has two maxima, one for odd and one for even numbers of carbon atoms. It will be noted that in each the rise in the homologous series is due to the lengthening of an aliphatic chain and it is known that an alternation of some physical constants may occur in a homologous series so constituted. There is a general tendency now to attach greater importance to the physical and biochemical properties of drugs as influencing modes of action, and possibly explaining some of the many anomalies in the pharmacology of structurally related compounds. The cases just cited might provide useful material for a physical and biological investigation on these lines.

According to the table, saturation of the vinyl side-chain in quinine or quinidine (I) → (II) increases activity but reduces it in the case of cinchonidine and has little or no effect on cinchonine.⁴ Addition to the vinyl group of hydrogen chloride, a halogen,^{1(b)} or the elements of a molecule of water (I → V) ⁴ reduces activity. Oxidation of the vinyl group to carboxyl as in quitenine (p. 436) abolishes it, though it is restored on esterification of the carboxyl group,⁴ but not by conversion of the latter to the amide or methylamide.⁷ Work ⁸ found that when the vinyl group is oxidised to .CHO as in the conversion of quinine to quinal, activity is scarcely affected, but reduction of the .CHO group to CH₂OH, as in

quininal to quininol, results in inactivity. Ozonisation of β -isoquinine (III) produces 3-acetyl-6'-methoxyrubanol (III : $\text{CH}_3 \cdot \text{CH} \cdot \rightarrow \text{CH}_3 \cdot \text{CO} \cdot$) which is still active.⁸

The effect of removal of the vinyl group, as in 6'-methoxy-9-rubanol (p. 447) is curious, as the racemate, (+ +) (— —) at C⁸ and C⁹, is active, while the racemate (+ —) (— +) and each of the four components of the two racemates are inactive in malaria in canaries.

The central .CHOH. group in the cinchona alkaloids seems to be essential to anti-malarial activity.^{1(b), 7} Conversion into quinicines [quinatoxines; (I) \rightarrow (VII)] destroys activity and so do such changes as .CHOH. \rightarrow .CHCl. (cinchona chlorides) or .CHOH. \rightarrow .CH₂. (deoxycinchona bases) or .CHOH. \rightarrow .CO. quina-ketones), or acylation of the hydroxyl group except in the case of quinine ethylcarbonate.

The effect of change in the spatial relations at C⁸ and C⁹ is not clear since, as explained above, there is doubt as to the relative activities of the components of the two pairs, quinine and quinidine, and cinchonidine and cinchonine, but *epi*-C⁹-quinine and *epi*-C⁹-quinidine are only slightly active⁴ or, according to Dirscherl and Thron, inactive.⁹ This result supports Neeman's view¹⁰ that for anti-malarial activity the direction of rotation must be the same at C⁸ and C⁹ but that does not explain the inactivity of the (+ +) and (— —) forms of 6-methoxy-9-rubanol as recorded by Rabe and Schuler (p. 447), who also state that the (+ +) form (vinyl-free quinidine) shows the cardiac activity characteristic of quinidine.

Though synthetic compounds, in which basic aliphatic chains or heterocyclic nuclei were associated with a quinoline nucleus through a carbinol group, were prepared by various workers,¹¹ no detailed records of anti-malarial tests of these substances seem to have been published and it was not until 1938 that the quinuclidine nucleus was shown to be unnecessary, by the discovery that niquidine, *isoniquidine* and *niquine*⁴ were all active in malaria in canaries and the subsequent proof¹² that in these substances the quinuclidine nucleus was replaced by piperidine (VI). Thus, scission of the quinuclidine nucleus between positions N¹ and C² and elimination of a CH₂ group produces an active substance (VI), while scission between N¹ and C⁸ and formation of a carbonyl group gives rise to the inactive quinicine (VII). To Ainley and King¹³ belongs the credit of synthesising for the first time a simple form of the typical cinchona alkaloid in which the vinylquinuclidine nucleus is replaced by piperidine, as already described (p. 460). The 4-(6-methoxyquinoly)- α -piperidyl-carbinol (IX), C₁₆H₂₄O₂N₂, and its diastereoisomeride, (the *iso*-form) are active in avian malaria, the first-named form being the more active.

These substances differ structurally from niquidine (VI) by the substitution in the latter of a propylidene chain at C⁴. Ainley and King having already found that *d*- and *l*-dihydroquinicinols (VIII) which are γ -substituted piperidine derivatives, were inactive, it appeared from these two sets of results that the strongly basic centre should not be separated by more than two carbon atoms from the point of attachment to the quinoline nucleus. King and Work¹⁴ therefore prepared a series of

carbinolamines of the type $Q \cdot \text{CHOH} \cdot \text{CH}_2 \cdot \text{NR}^1\text{R}^1$ in which R^1 is an alkyl radical and Q is quinolyl or 6-methoxyquinolyl, or is replaced by naphthyl or methoxynaphthyl. For the four series so made only three substances were active and these all belonged to the 6-methoxyquinolyl series, *viz.*, the dibutyl-, diamyl- and dihexyl-aminomethyl-6-methoxyquinolylcarbinols, the lower and higher homologues in this series being also inactive. In a series of the same type, with the amine group $\cdot \text{NR}^1\text{R}^1$ replaced by NR^1R^2 , *e.g.*, butylhexylaminomethyl-6-methoxy-4-quinolylcarbinol, King and Work¹⁴ (1942) found no active substance.

Work¹⁵ also prepared a series of carbinolamines and polyamines without a quinoline nucleus but, in other respects, conforming in type and range of molecular weight, with quinoline compounds known to possess plasmocidal activity.¹⁶ As none of these were active, it seems clear that the quinoline nucleus in the cinchona alkaloids and in certain synthetic anti-malarials is a potent factor in the production of plasmocidal action. Later the same author made¹⁵ (1942) a series of lepidylamine derivatives of the form $\text{R} \cdot \text{Q} \cdot \text{CH}_2 \cdot \text{NH}[\text{CH}_2]_n \cdot \text{NEt}_2$, which were found to be inactive, in spite of their similarity to the active examples of the type $\text{R} \cdot \text{Q} \cdot \text{NH}[\text{CH}_2]_n \cdot \text{NEt}_2$ prepared by Magidson and Rubtzow.¹⁶ Rubtzow¹⁶ (1939) has also shown that an isomeride of dihydroquinine (II) with the quinuclidine nucleus attached *via* the carbinol group at C^8 in the quinoline nucleus was inactive in an infection of *Plasmodium præcox* in finches.

Derivatives of sulphanylamine and of 4:4'-diaminodiphenylsulphone were tried extensively as anti-malarials during the war. Special methods of testing them were devised,¹⁷ for example by Marshall, Litchfield and White,¹⁷ using ducks infected by *Plasmodium lophurae*, and the technique devised by Coggeshall, Porter and Laird¹⁷ for observing the effect of drugs on exoerythrocytic forms of *P. gallinaceum* by which sulphadiazine appeared to give promising results. The technique of testing anti-malarial drugs is discussed by Tonkin and Hawking.¹⁷

Other novel types of anti-malarials are various diamidines, *e.g.*, 1:11-diamidinoundecane^{17(a)} and 4:4'-diamidinostilbene^{17(b)} and the comparatively simple *p*-tolyl- and *p*-anisyl- guanidine nitrates, which King and Tonkin found to have some retarding action on a sporozoite-induced infection of *P. gallinaceum* in chicks,^{17(c)} a form of activity also found later by Stephen, Tonkin and Walker^{17(d)} for certain tetrahydroacridones. The minimum effective dose (mgm./100g. chick) for a selection of these derivatives of 1:2:3:4-tetrahydroacridone were: 7-methoxy-(12.5); 7-ethoxy- (inactive); 7-chloro- (100); 8-methoxy- (25); 7-methoxy-3-methyl- (inactive); 8-methoxy-3-methyl (50). The corresponding dose for sulphadiazine was 25. Another new type of anti-malarial drug is to be found in the long series of α -phenyl- β -dialkylaminoalcohols prepared by Lutz and a team of collaborators.^{17(e)}

Much work has also been done bearing directly or indirectly on the mode of action of quinine and other anti-malarial drugs. The absorption, distribution and metabolism of quinine has been investigated by various workers¹⁸ of whom Kelsey, Geiling, Oldham and Dearborn¹⁸ (1944)

isolated a well-defined, crystalline metabolite, produced when quinine hydrochloride is incubated with ground rabbit liver at 38° under specified conditions. This substance, $C_{20}H_{24}O_3N_2$, m.p. 247.5°–248.5°, $[\alpha]_D^{25} - 65.5^\circ$ (EtOH) was examined in detail by Mead and Koepfli,¹⁸ who, from its reactions and the resemblance of its absorption spectrum to that of 2-hydroxy-6-methoxy-4-methylquinoline, regard it as *l*-2'-hydroxyquinine (2'-hydroxy-6'-methoxy-3-vinylruban-9-ol). According to P. B. Marshall,¹⁸ this metabolite is inactive in chick malaria, but Kelsey *et al.*¹⁸ (1946) find that at a dosage of 40–70 mgm./kilo./day, it exercises about the same degree of suppression as 15 mgm./kilo./day of quinine, and quote E. K. Marshall for the observation that it has about one-twentieth the activity of quinine in the malaria of ducks.

Of the papers dealing with the mode of action of anti-malarial drugs,¹⁹ Hewitt and Richardson find that quinine, mepacrine and pamaquin produce similar degenerative changes in malarial parasites and suggest that these drugs are directly plasmocidal. Keogh and Shaw¹⁹ have put forward the view that quinine interferes with the life cycle of the parasites by lowering in the red blood corpuscles the amount of calcium required for the growth and reproduction of the plasmodia. The suggestion as to mode of action, which seems to find most favour is inhibition of the enzyme system controlling respiration. Christophers,¹⁹ found that isolated malarial parasites *in vitro* utilise glucose and continue to take up oxygen after the glucose is exhausted and this oxygen uptake is inhibited by anti-malarial drugs, whose potency he states is associated with their basic character and correlated with their pH constant. Christophers and Fulton had already, in 1938,¹⁹ devised methods of using the erythrocytic stage of *P. knowlesi in vitro*, and this technique has made it possible to acquire knowledge of the biochemistry of malaria parasites, as is clear from a symposium on this subject held recently in the United States, at which papers on the enzyme systems^{19(a)} and the chemical and nutritional requirements of the parasites^{19(b)} were dealt with. Interesting observations were made on possible lines of drug antagonism pointing to competition for an enzyme protein^{19(c)} and the method has also been used to study the action of naphthaquinones, one of the new and unexpected sources of anti-malarial drugs, on *P. lophuræ* and *P. knowlesi*, and especially their anti-respiratory effect on these parasites.^{19(d)}

Up to 1939 it was possible to give within reasonable compass an account of the development of synthetic anti-malarial drugs, but with the outbreak of war an intensive campaign²⁰ was started to protect troops fighting in tropical areas from the ravages of malaria. Manufacture of mepacrine was undertaken in this country and the United States, special efforts were made to increase supplies of cinchona bark (p. 418), clinical trials were carried out with quinine, mepacrine and the sulphonamide drugs to determine the most efficient methods for their therapeutic use and work was organised on a huge scale, especially in the United States, for the preparation of new compounds to be tested for anti-malarial action. As a result thousands of new substances have been made and tested, anti-

malarial activity has been discovered in new types of compounds, and much knowledge has been gained regarding the chemotherapy of malaria.²¹ There is already a voluminous literature recording the results of this work and more is still being published. A comprehensive summary of the results obtained in the United States is provided in "A Survey of Anti-malarial Drugs, 1941-1945," edited by F. Y. Wiselogle.²² Volume I, 453 pages, gives a history of the co-operative wartime programme of work and, after other introductory and explanatory matter, deals with biological methods. Volume II, 1,921 pages, in two parts, tabulates for each compound under a survey number (S.N.) its formula, name and, so far as they are recorded, its toxicity and anti-malarial action. References to this valuable and well-arranged publication are given below.

As a practical result there are now at least six synthetic anti-malarial drugs available to malariologists, including the three pre-war drugs, pamaquin, mepacrine and plasmocide.

Quinoline Derivatives

- Chloroquine. 7 - Chloro - 4 - (ω - diethylamino- α -methylbutyl) - aminoquinoline.²³ (Wiselogle, S.N. 7618, Vol. II, p. 1145.)
- Pamaquin. 6-Methoxy-8-(ω -diethylamino- α -methylbutyl)-aminoquinoline.²⁴ (Wiselogle, S.N. 971, Vol. I, p. 409; Vol. II, p. 1191.)
- Pentaquine. 6 - Methoxy - 8 - (ω - isopropylaminoamyl) - aminoquinoline.²⁵ (Wiselogle, S.N. 13276, Vol. II, p. 1183.)
- Plasmocide. 6 - Methoxy - 8 - (ω - diethylaminopropyl) - aminoquinoline.²⁶ (Wiselogle, S.N. 3115, Vol. II, 1179.)

Acridine Derivative

- Mepacrine. 2 - Chloro - 5 - (ω - diethylamino - α - methylbutylamino) - 7-methoxyacridine.²⁷ (Wiselogle, S.N. 390, Vol. II, 1344.)

Guanidine Derivative

- Paludrine. N¹-p-Chlorophenyl-N⁵ isopropylbiguanide.
Cl . Ph—NH—C(: NH) . NH . C(: NH) . NH . CHMe₂.

Since the introduction of pamaquin and mepacrine much chemical and biological work has been done on potential, anti-malarial drugs based on quinoline or acridine and possibilities in these directions are fairly well known. Paludrine is especially interesting as a drug of a new type and its possibilities are in process of clinical exploration. The chemical researches, which led to its discovery are described in a series of papers by Curd and Rose with several collaborators; ²⁸ the biological side of the work is dealt with in a second set of papers ²⁹ by a team of workers, beginning with two by Curd, Davey and Rose detailing the biological methods used, and discussing fully the limits and difficulties met with in devising a standard method of testing and in assessing anti-malarial activity. Parts III to IX are concerned with the pharmacology of, and accounts of clinical trials with, No. 3349, 2-p-chlorophenylguanidino-4- β -diethyl-

aminoethylamino-6-methylpyrimidine, one of the active precursors of paludrine. Papers X to XIV deal with the testing of paludrine (No. 4888) and its N⁶-methyl derivative,

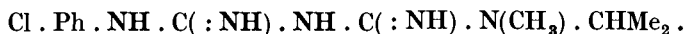

(4430), and refer to the discovery that both these drugs, and especially paludrine, are at least as active schizonticides as quinine or mepacrine, and in addition are active against these forms³⁰ (variously called exo-erythrocytic, cryptozoites, post-sporozoite, etc.) of the malaria parasite, which, in the incubation period, intervene between the sporozoite injected by the bite of the mosquito and the schizonts, or blood-forms, which invade the red-blood corpuscles. These exo-erythrocytic forms have been observed in various types of avian malaria and recently by Shortt and Garnham in monkey malaria,³⁰ and though they have not been observed in human malaria, there is indirect evidence of their existence, and their survival, after clinical cure of malarial attacks by drugs, is now believed to be the cause of the relapses which are so persistent in benign tertian malaria. A drug lethal to either the sporozoites or the exo-erythrocytic forms of all four types of human malaria is the ideal causal prophylactic to be sought for. The results of clinical trials already conducted,³¹ and especially that carried out by the Australian Army Research Station at Cairns under the direction of Dr. N. H. Fairley indicate that paludrine is an advance in that direction. According to Fairley it is, in non-toxic doses, a complete causal prophylactic in malignant tertian malaria, a partial causal prophylactic in benign tertian malaria, and a potent schizonticide for both types. A considerable amount of biochemical and pharmacological work has also been done on paludrine, *e.g.*, on methods of estimation in biological material,³² on the absorption, distribution and excretion of the drug,³³ and on its inhibition of various types of esterase.³⁴ No conclusive evidence as to its mode of action seems to have been obtained, but suggestions on this subject have been made and discussed.³⁵

The cinchona alkaloids, and particularly quinine, have other therapeutic claims in addition to anti-malarial activity, and up to the introduction of the sulphanilamide derivatives as bactericidal agents, the chemotherapy of bacterial diseases was monopolised by quinine derivatives after 1911, when Morgenroth³⁶ began publication of his successful results in the treatment of bacterial infections in animals with such substances, and thereby showed that chemotherapy could provide weapons against bacterial disease, as well as for the protozoal infections, with which up to that time success had been achieved. Morgenroth's studies led to the introduction of the ethyl, *iso*amyl and *iso*octyl ethers of dihydrocupreine (II). Of these the first-named has been used for pneumococcal infections, but is liable to produce optic atrophy. Further work was done by Giemsa and Halberkann,³⁷ and by Jacobs and Heidelberger,³⁸ on the dihydrocupreine series, but it was not until 1935, when Cretcher and his colleagues³⁹ began their studies of *apocupreine* (III) (*apoquinine*) ethers and their possible therapeutic application, that substantial progress was made.

Out of the numerous compounds these investigators made, they eventually selected β -hydroxyethylapoquinine for clinical trial owing to its low toxicity, relatively high bacteriostatic power and lack of deleterious side-effects. The following table summarises the data available on these two points for this drug and its near relatives. The name *apöcupreine* is used by Cretcher for *apoquinine* (p. 452).

Alkoxy-ethers of <i>apo</i> Quinine. Substituent at C ⁶ in Quinolyl Nucleus	Toxicity. Approx. L.D.50 (mice) mgm.	Bacteriostatic Concentration of Drug
C ₂ H ₅ . O	4	1 : 8 × 10 ⁵
HO . C ₂ H ₄ . O	7	1 : 3 × 10 ⁵
(CH ₃) ₂ . CH . O	4	1 : 16 × 10 ⁵
HO . CH ₂ . CH(CH ₃) . O	7	1 : 16 × 10 ⁵
(HO . CH ₂) ₂ . CH . O	9	1 : 3 × 10 ⁵

Bracken *et al.* found that hydroxyethylapoquinine and "sulphapyridine" (α -sulphanilylaminopyridine) gave equal protection to mice against virulent pneumococci, and the use of either chemical enhanced the protective action of the other.⁴⁰ Dawson *et al.*⁴¹ found from the ophthalmoscopic and histological examination of the eyes of dogs that, while massive doses of quinine or the *apoquinine* alkyl ethers (III) caused destruction of the cells of the ganglionic layer, no damage could be detected after similar dosage of β -hydroxyethylapoquinine. Maclachlan and his colleagues⁴² used the drug successfully in a large number of cases of human pneumonia, and no visual disturbance was observed in any patient. Hegner *et al.* found the drug as active as quinine in avian malaria, and less toxic.⁴³ A *résumé* of the literature on "Structure and Anti-pneumococcal Activity in the Cinchona Series" has been published by Renfrew and Cretcher.⁴⁴

None of the quaternary salts of the cinchona alkaloids have given promising results as pneumococcidal agents, but quinine methochloride and ethochloride have received some attention recently as curarising drugs.⁴⁵

The alkyl ethers of dihydrocupreine (II) are known to exhibit local anæsthetic action, which appears to be at a maximum at *isoamyldihydrocupreine*, but local anæsthetic action in this group does not depend on the intact quinuclidine nucleus, since *isoamyldihydrocupreine* (VII) is more potent than *isoamyldihydrocupreine* (II), producing local anæsthesia in the cornea of the rabbit at 1 in 2,000 compared with cocaine at 1 in 50.⁴⁶

Of the other cinchona bases, the dextrorotatory forms cinchonine and quinidine have been used as anti-malarial drugs in cases of idiosyncrasy to quinine, a subject to which Dawson⁴⁷ has given much attention. Quinidine is used to control auricular fibrillation, and its value for this purpose in comparison with dihydroquinidine has been investigated by several workers.⁴⁸ Dawes has recently devised a method of testing

substances for quinidine-like activity by observing their action on the effect of electrical stimulation of isolated rabbit auricle, and has found that many local anæsthetics and spasmolytics exhibit such action. The most promising synthetic substitute is the benzilic ester of piperidino-ethanol, which is 5.4 times as active and has a therapeutic efficiency index three to six times that of quinidine, depending on whether the toxicities are compared in mice by intravenous or intraperitoneal injection. Taking the activity of quinidine as 1, that of quinine is 0.5 and of niquidine 0.35. The King and Work series of carbinol amines, already referred to (p. 474), show quinidine-like action irrespective of whether they are anti-malarial or not, the most active substance being 2- α -naphthyl-2-hydroxyethyl-piperidine hydrochloride, which is 2.8 times as active as quinidine.⁴⁹ MacIntosh and Work⁵⁰ had already shown these substances to be potent local anæsthetics, though they are too irritant for practical use.

α -Fagarine has been suggested as a possible substitute for quinidine in the treatment of auricular fibrillation (p. 414).

Raymond-Hamet⁵¹ has investigated (a) dihydrocinchonidine, (b) cinchonidine, (c) cinchonamine and (d) aricine, especially as regards sympathicolytic action and effect on blood pressure.

REFERENCES

- (1) (a) GRIMAUX and ARNAUD, *Compt. rend.*, 1891, 112, 774, 1364; 1892, 114, 672; 1894, 118, 1303; (b) GIEMSA, *Arch. Schiffs-Trop. Hyg.*, 1926, 30, Beiheft 1, 62; (with WERNER), *ibid.*, 1912, 16, Beiheft 4, 65; *ibid.*, 1914, 18, Beiheft 5, 81; (with WEISE and TROPP), *ibid.*, 1926, 30, 334; (with CESTERLIN), *ibid.*, 1933, 37, Beiheft 4, 6; GIEMSA, *Riv. Malariol.*, 1933, 12, 70. (2) (a) ROEHL, *Arch. Schiffs-Trop. Hyg.*, 1926, 30, Beiheft 3, 11; (b) "The Activity of Drugs in the Malaria of Man, Monkeys and Birds," F. H. S. CURD, *Ann. Trop. Med. Parasit.*, 1943, 37, 115; for other summaries see "Chemotherapy of Malaria," HENRY, *J. Soc. Chem. Ind.*, 1936, 55, 111 T; "A Symposium on Human Malaria with special reference to North America and the Caribbean Region": American Association for the Advancement of Science, 1941, Publication No. 15; "Chemotherapy and Avian Malaria," A. BISHOP, *Parasitology*, 1942, 34, 1; "Chemotherapy of Avian Malaria," MARSHALL, *Physiol. Reviews*, 1942, 22, 190; CARLSON, *J. Amer. Pharm. Assoc.*, 1944, 33, 97. (3) MACGILCHRIST, *Ind. J. Med. Res.*, 1915-6, 3, 51; FLETCHER, *Stud. Inst. Med. Res. Fed. Malay States*, 1923, No. 18; *Bull. Med. Res. Inst.*, F.M.S., 1925, No. 3; MEDICAL RESEARCH COUNCIL OF GREAT BRITAIN, *Special Report Series*, 1925, No. 96; HEGNER, SHAW and MANWELL, *Amer. J. Hyg.*, 1928, 8, 564; SINTON and BIRD, *Ind. J. Med. Res.*, 1929, 16, 725; TO and CHO, *Trop. Dis. Bull.* (Abstr.), 1941, 38, 414; LENTJES, *ibid.*, 1939, 36, 923; SEELER, DUSENBERRY and MALANGA, *J. Pharm. Exp. Ther.*, 1943, 78, 159; HIATT, *ibid.*, 1944, 81, 160; (with QUINN), *ibid.*, 1945, 83, 101; MARSHALL, *ibid.*, 1945, 85, 299; BRATTON, *ibid.*, p. 103. (4) BUTTLE, HENRY and TREVAN, *Biochem. J.*, 1934, 28, 426; (with SOLOMON and GIBBS), *ibid.*, 1938, 32, 47; cf. GOODSON, HENRY and MACFIE, *ibid.*, 1930, 24, 874; see also WORK, ref. 8. (5) FOURNEAU, TREFOUEL, BOVET and BENOIT, *Ann. Inst. Pasteur*, 1931, 46, 514; 1933, 50, 731; see also KRITSCHESKY and STERNBERG, *Zeit. Immunitäts.*, 1933, 80, 438; MAGIDSON and STRUKOW, *Arch. Pharm.*, 1933, 271, 359; CERKOVNIKOV *et al.*, *ibid.*, 1943, 281, 78; *Helv. Chim. Acta.*, 1943, 26, 1180. (6) *Arch. Pharm.*, 1935, 273, 320. (7) COHEN and KING, *Proc. Roy. Soc.*, 1938, 125, B, 49. (8) *J. Chem. Soc.*, 1944, 334. (9) DIRSCHERL and THRON, *Annalen*, 1935, 521, 48; cf. RABE, "Configuration and Basicity," *Ber.*, 1943, 76, 251; for other effects due to optical isomerism see GAUSE *et al.*, *Biol. J.* (Russ.), 1938, 7, 763; CHOPRA *et al.*, *Ind. J. Med. Res.*, 1938, 26, 279, 289. (10) *Nature*,

1944, 154, 550. (11) KAUFMANN, *Ber.*, 1913, 46, 1823; RABE, PASTERNAK and KINDLER, *ibid.*, 1917, 50, 144; KARRER, *ibid.*, p. 1499; see also SCHONHÖFER, "Medizin und Chemie," I, 1933, 208; III, 1938, 62. (12) GIBBS and HENRY, *J. Chem. Soc.*, 1939, 240, 1294; SOLOMON, *ibid.*, 1941, 77. (13) AINLEY and KING, *Proc. Roy. Soc.*, 1938, 125 B, 60. (14) *J. Chem. Soc.*, 1940, 1307; 1942, 401. (15) *Ibid.*, 1940, 1315; 1942, 426. (16) MAGIDSON and RUBTZOW, *J. Gen. Chem. (U.R.S.S.)*, 1937, 7, 1896; RUBTZOW, *ibid.*, 1939, 9, 1493; for other variants see *ibid.*, 1943, 13, 593, 702; 1946, 16, 461; RAJNER *et al.*, *Arch. Pharm.*, 1943, 281, 78. (17) MARSHALL *et al.*, *J. Pharm. Exp. Ther.*, 1942, 75, 89; see also MARSHALL, *ref. 2 (b)*; COGGESHALL *et al.*, *Proc. Soc. Exp. Biol. Med.*, 1944, 57, 286; *J. Amer. Med. Assoc.*, 1945, 128, 7; TONKIN, *ref. 30*; (with HAWKING), *Brit. J. Pharmacol.*, 1947, 2, 221. (a) GLYN-HUGHES, LOURIE and YORKE, *Ann. Trop. Med. Parasit.*, 1938, 32, 103; CHRISTOPHERS and FULTON, *ibid.*, 257; (b) FULTON, *ibid.*, 1940, 34, 53; (c) *J. Chem. Soc.*, 1946, 1063; (d) *ibid.*, 1947, 1034; (e) *J. Org. Chem.*, 1947, 12, 617. (18) KAISER, *Arch. int. Pharmacodyn.*, 1940, 64, 215; HAAG, LARSON and SCHWARTZ, *J. Pharm. Exp. Ther.*, 1943, 79, 136; KELSEY and OLDHAM, *ibid.*, 1943, 79, 77, 81; (with GEILING), *ibid.*, 1943, 78, 314; 1945, 85, 170; (with GEILING and DEARBORN), *ibid.*, 1944, 80, 391; (with CANTRELL and GEILING), *ibid.*, 1944, 82, 349; BURTON and KELSEY, *ibid.*, 1943, 79, 70; CHEN and GEILING, *ibid.*, 1944, 82, 120; MEAD and KOEPLI, *J. Biol. Chem.*, 1944, 154, 507; P. B. MARSHALL, *Nature*, 1945, 156, 505; 155, 730; KELSEY, OLDHAM, CANTRELL and GEILING, *ibid.*, 1946, 157, 440; ANDREWS (with ANDERSON), *J. Pharm. exp. Ther.*, 1943, 78, 346; (with ANDERSON and CORNATZER), 1943, 79, 62; (with CORNATZER), 1944, 82, 3, 261; KYKER, McEWEN and CORNATZER, *Arch. Biochem.*, 1947, 12, 191; WALETZKY and BROWN, *J. Nat. Malaria Soc. (Tallahassee)*, 1943, 2, 53 (*Trop. Dis. Bull.*, 1944, 41, 188); HIATT and QUINN, *J. Pharm. Exp. Ther.*, 1945, 83, 103; DEARBORN and MARSHALL, *ibid.*, 1945, 85, 202; CEITHAM and EVANS, *Arch. biochem.*, 1946, 10, 397. (19) HEWITT and RICHARDSON, *J. Infect. Dis.*, 1943, 73, 1; KEOGH and SHAW, *Austral. J. Exp. Biol. Med. Sci.*, 1944, 22, 139; CHRISTOPHERS, *Trans. Faraday Soc.*, 1943, 39, 333; (with FULTON), *Ann. Trop. Med. Parasit.*, 1938, 32, 43; 1939, 33, 161; COGGESHALL and MAIER, *J. Infect. Dis.*, 1941, 69, 87, 108; (a) EVANS, *Fed. Proc.*, 1946, 5, 390; (b) BALL, *ibid.*, p. 397; (c) HELLERMAN, BOVARNICK and PORTER, *ibid.*, p. 400; *cf.* HAAS, *J. Biol. Chem.*, 1944, 155, 321; (d) WENDEL, *ibid.*, 1943, 148, 21; *Fed. Proc.*, 1946, 5, 406; GINGRICH, *Amer. J. Trop. Med.*, 1947, 27, 147. (20) For special aspects of this campaign see COGGESHALL, *J. Amer. Med. Assoc.*, 1943, 122, 8; *Chem. Eng. News*, 1943, 21, 1152; SHERNDAL, *ibid.*, p. 1154; ELDERFIELD, *ibid.*, 1946, 24, 2598; NAPIER, *New England J. Med.*, 1945, 233, 38. (21) FAIRLEY, *Trans. Roy. Soc. Trop. Med. Hyg.*, 1945, 38, 311; Army Malaria Research Unit, Oxford, *ibid.*, 1945, 38, 128, 133; SHANNON, EARLE, BRODIE, TAGGART, BERLINER *et al.*, *J. Pharm. Exp. Ther.*, 1944, 81, 307; FINDLAY (with MARKSON and HOLDEN), *Ann. Trop. Med. Parasit.*, 1944, 38, 139, 201; (with STEVENSON), *ibid.*, p. 168; for comparisons of anti-malarial drugs, see NAPIER, *New England J. Med.*, 1945, 233, 38; BRIT. MED. RES. COUNCIL, *Brit. Med. J.*, 1944, ii, 664; SAPERO, *J. Amer. Med. Assoc.*, 1946, 132, 623; *Colonial Medical Research Committee Report*, 1946-7, p. 58 (Cmd. 7151, Stationery Office, U.K.); GORDON, DIEUAIDE, MARBLE, CHRISTIANSON and DAHL, *Arch. Intern. Med.*, 1947, 79, 365; COATNEY and CLARK COOPER, *Amer. J. Hyg.*, 1947, 46, 119; (with YOUNG and BURGESS), *ibid.*, p. 132; (with YOUNG and McLENDON), *ibid.*, p. 84; (with YOUNG, BURGESS and SMARR), *ibid.*, p. 105: a review of recent work on antimalarial drugs has been published by BLANCHARD, *Ann. Rev. Biochem.*, 1947, 16, 587. (22) WISELOGLE, "A Survey of Anti-malarial Drugs, 1941-1945," 2 vols., Ann Arbor, Michigan, U.S.A., 1946, Edwards. (23) *J. Amer. Med. Assoc.*, 1946, 130, 1069; SURREY and HAMMER, *J. Amer. Chem. Soc.*, 1946, 68, 118; GOLDSMITH, *J. Malaria Inst. India*, 1946, 6, 311. (24) *Arch. Schiffs-Trop. Hyg.*, 1928, 32, 382; SCHULEMANN, SCHÖNHÖFER and WINGLER, *Klin. Woch.*, 1932, Feb. 27, p. 381; SCHULEMANN, *Proc. Roy. Soc. Med.*, 1931-2, 25, Pt. 1, 897; see also for allied substances, FOURNEAU *et al.*, *ref. 5*; BOVET and DEMANCHE, *Ann. Inst. Pasteur*, 1933, 51, 528; ROBINSON *et al.*, *J. Chem. Soc.*, 1929, 2947, 2952, 2959, 2965; 1930, 1856; 1931, 3089, 3096; 1933, 1467; 1934, 1264, 1267,

1322, 1520, 1524; 1935, 1143, 1421; 1943, 555, 557, 561; BARBER and WRAGG, *ibid.*, 1947, 1331; BOVET *et al.*, *Bull. Soc. path. Exot.*, 1934, 27, 236; MAGIDSON and STRUKHOV, *Arch. Pharm.*, 1933, 271, 359, 569; MAGIDSON, DELEKTORSKAJA and LIPOVITSCH, *ibid.*, 1934, 272, 74; MAGIDSON, MADAJEVA and RUBTZOV, *ibid.*, 1935, 273, 320; CERKOVNIKOV and PRELOG, *Ber.*, 1941, 74, 661; (with STERN), *Helv. Chim. Acta*, 1943, 26, 1180; KRITSCHEVSKI and STERNBERG, *Z. Immunitätsf.*, 1933, 80, 438 (biological); *cf.* SCHULEMANN, *Deut. Med. Woch.*, 1935, 61, 305; SCHÖNHÖFER, *Zeit. Physiol. Chem.*, 1942, 274, 1; DECOURT and SCHNEIDER, *Presse Med.*, 1946, No. 36, 516. (25) LOEB, *J. Amer. Med. Assoc.*, 1946, 132, 321. (26) MARCHOUX, *Bull. Acad. Med. (Paris)*, 1931, [iii], 106, 183; TAREEV *et al.*, *Med. Parasit. Parasitic Dis.* (U.R.S.S.), 1933, 2, 189; LEISERMANN, *ibid.*, p. 210; MILOSLAVSKI, *ibid.*, p. 215. (27) MAUSS and MIETZSCH, *Klin. Woch.*, 1933, 12, 1276; *Angew. Chem.*, 1934, 47, 633; *Ber.*, 1936, 69, 641; see also MAGIDSON and GRIGOROVSKI, *ibid.*, p. 396; FELDMAN and KOPELIOVITCH, *Arch. Pharm.*, 1935, 273, 488; GUHA and MUKHERJER, *J. Ind. Inst. Sci.*, 1946, 28, A, 63; TSCHELINCEV and OSEUROVA, *J. Gen. Chem. Russ.*, 1940, 10, 1978; BACHER *et al.*, *J. Amer. Chem. Soc.*, 1947, 69, 1534; BROWN and HAMMICK, *Nature*, 1947, 159, 612; ALPATOV and NASTUKOVA, *ibid.*, 1946, 158, 838; DROZDOV, *Chem. Abstr.*, 1947, 41, 763; KING, GILCHRIST and TARNOKY, *Biochem. J.*, 1946, 40, Proc. iii; DAWSON, *ibid.*, xli. (28) Parts I, IV, X, *J. Chem. Soc.*, 1946, 343, 362, 729; (with DAVIS), Part II, *ibid.*, p. 351; (with DAVIS, OWEN and TUEY), Parts VI and IX, *ibid.*, pp. 370, 720; (with RAISON), Part V, *ibid.*, p. 366; (with RICHARDSON), Part VII, *ibid.*, p. 378; (with BASFORD), Part VIII, *ibid.*, p. 713; (with LANDQUIST), Part XII, *ibid.*, 1947, 154; CURD and RAISON, Part XIII, *ibid.*, p. 160; see also HULL, LOVELL, OPENSHAW and TODD, Part XI, *ibid.*, p. 41; (with PAYMAN), Part III, *ibid.*, 1946, 357. (29) *Ann. Trop. Med. Parasit.*, 1945, 39; CURD, DAVEY and ROSE, Parts I, II and X, pp. 139, 157, 208; various authors on No. 3349, Parts III to IX; ADAMS, TOWNSEND and KING, Part XI, p. 217; SPINKS and TOTTEY, Part XII, p. 220; ADAMS, MAEGRAITH, KING, TOWNSEND, DAVEY and HAVARD, Parts XIII, XIV, pp. 225, 232: for the pharmacology of paludrine, see also SCHMIDT, HUGHES and SMITH, *J. Pharm. Exp. Ther.*, 1947, 90, 233; CHEN and ANDERSON, *ibid.*, 91, 157; BUTLER, DAVEY and SPINKS, *Brit. J. Pharmacol.*, 1947, 2, 181; for summarised accounts of the discovery of paludrine, see CURD and ROSE, *Chem. and Ind.*, 1946, No. 7, p. 75; No. 8, p. 88, and ROSE, *Endeavour*, 1946, 5, 65; BRADY, *Sci. Prog.*, 1947, 35, 101. (30) JAMES and TATE, *Nature*, 1937, 139, 545; *Parasitology*, 1938, 30, 128; *Trans. Roy. Soc. Trop. Med. Hyg.*, 1937-38, 31, 4; DAVEY, *ibid.*, 1946, 40, 171; (with a selected bibliography); *Nature*, 1944, 153, 110; COGGESHALL *et al.*, ref. 17; SHORTT and GARNHAM, *Nature*, 1948, 161, 126; see also HAWKING, *Nature*, 1948, 161, 175, *Trans. Roy. Soc. Trop. Med. Hyg.*, 1945, 39, 245; 1946, 40, 183; (with TONKIN), *ibid.*, 1947, 41, 407; TONKIN, *Brit. J. Pharmacol.*, 1946, 1, 163; KIKUTH and MUDROW, *Klin. Woch.*, 1937, 16, 1690; *Med. Chem.*, 1942, 4, 44; for a review of the literature on exo-erythrocytic schizogony, see PORTER and HUFF, *Amer. J. Trop. Med.*, 1940, 20, 869. (31) FAIRLEY, *Trans. Roy. Soc. Trop. Med. Hyg.*, 1946, 40, 105; WOODRUFF, *ibid.*, 1947, 41, 263; MAEGRAITH, ADAMS, KING, TOTTEY, RIGBY and SLADEN, *Brit. Med. J.*, 1946, i, 903 and ref. 29. (32) GAGE and ROSE, *Biochem. J.*, 1946, 40, Proc. ii; KING, WOOTTON and GILCHRIST, *Lancet*, 1946, 250, 886. (33) SPINKS, TOTTEY and MAEGRAITH, *Biochem. J.*, 1946, 40, Proc. i. (34) BLASCHKO, CHOU and WAJDA, *Brit. J. Pharmacol.*, 1947, 2, 116. (35) CURD and ROSE, *Nature*, 1946, 158, 707; HAWKING, *ibid.*, 1947, 159, 409; ACHESON, KING and SPENSELY, *ibid.*, p. 53; MARSHALL, *ibid.*, 1947, 160, 463; TONKIN, ref. 30; BLACK, *Trans. Roy. Soc. Trop. Med. Hyg.*, 1946, 40, 163; MADINAVEITA, *Biochem. J.*, 1946, 40, 373; acquired resistance to paludrine, see BISHOP and BIRKETT, *Nature*, 1947, 159, 884 and WILLIAMSON, BERTRAM and LOURIE, *ibid.*, p. 885. (36) MORGENROTH *et al.*, *Berl. Klin. Woch.*, 1911, 48, 1560, 1979; 1916, 53, 794; 1917, 54, 55; *Deut. med. Woch.*, 1914, 40, 538; 1918, 44, 729; *Zeit. Hyg. Infekt.*, 1924, 103, 441; *Biochem. Zeit.*, 1916, 79, 257; see also SCHAEFFER, *ibid.*, 1917, 83, 269, and VON OETTINGEN, "The Therapeutic Agents of the Quinoline Group," New York, 1938. (37) *Ber.*, 1919, 52, 906. (38) *J. Amer. Chem. Soc.*, 1919, 41, 2090; 1920, 42, 1481, 2278; 1922, 44, 1073, 1079; for biological tests,

see BOYD, *Amer. J. Hyg.*, 1926, 6, 173. (39) BUTLER and CRETCHER, *J. Amer. Chem. Soc.*, 1935, 57, 1083; (with NELSON and RENFREW), *ibid.*, p. 575; (with HOSTLER), *ibid.*, 1937, 59, 2354; (with RENFREW and SOUTHER), *ibid.*, p. 227; BUTLER and RENFREW, *ibid.*, 1938, 60, 1473, 1582; 1940, 62, 3304; (with GREEN), *ibid.*, 1939, 61, 1783; RENFREW and CRETCHER, *ibid.*, 1935, 57, 738; (with CLAPP), *ibid.*, 1941, 63, 2169; TIPSON and CRETCHER, *ibid.*, 1942, 64, 1162; (with CLAPP), *ibid.*, 1943, 65, 1092; RENFREW, CARLSON and CRETCHER, *ibid.*, p. 2309; CARLSON and CRETCHER, *ibid.*, 1947, 69, 1952; cf. KAISHI, *Jap. J. Pharmacol. Soc.*, 1943, 32, 28 (*Chem. Abstr.*, 1947, 41, 4582). (40) BRACKEN, JOHNSTON, CRUM, PATRICK, PERMAR and MACLACHLAN, *J. Pharmacol.*, 1940, 68, 259. (41) DAWSON, PERMAR, JOHNSON and MACLACHLAN, *Amer. J. Med. Sci.*, 1937, 193, 543. (42) MACLACHLAN, JOHNSTON, BRACKEN (with PIERCE), *ibid.*, 1941, 201, 367; (with CORRADO and BREAM), *Trans. Assoc. Amer. Phys.*, 1945, 57, 262. (43) HEGNER, WEST, RAY and DOBLER, *Amer. J. Hyg.*, 1941, 33, 101; 34, 132. (44) *Chemical Reviews*, 1942, 30, 49-68; cf. *Chemical and Engineering News*, 1943, 21, 474. (45) HARVEY, *Bull. Johns Hopkins Hosp.*, 1940, 66, 52; (with LANDIS, MASLAND and WIGTON), *Trans. Amer. Neur. Assoc.*, 1940, 66, 154; BENNETT, *Amer. J. Psychiat.*, 1941, 97, 1040; PRESS, *New Eng. J. Med.*, 1942, 227, 475; LEHMAN, CHASE (with YONKMAN), *J. Pharm. Exp. Ther.*, 1942, 75, 265, 270; (with RICKARDS), *ibid.*, 1944, 82, 266; MÖLLER, *Acta Pharmacol. Toxicol.*, 1946, 2, 383. (46) MORGENTHAU, *Ber. deut. Pharm. Ges.*, 1919, 29, 233; see also ALBRICHT, *Arch. Int. Pharmacodyn.*, 1938, 59, 94. (47) DAWSON and GARBADÉ, *J. Pharm. Exp. Ther.*, 1930, 39, 417; *J. Amer. Med. Assoc.*, 1930, 94, 704; DAWSON, *Internat. Clinics*, 1930, 2, Ser. 40, 121; (with NEWMAN), *J. Amer. Med. Assoc.*, 1931, 97, 930; (with SANDERS), *ibid.*, 1932, 99, 1773; SANDERS, *ibid.*, 1931, 97, 850; (with DAWSON and TOMLINSON), *J. Immunol.*, 1933, 24, 173. (48) KIRCHMANN, *Arch. exp. Path. Pharmacol.*, 1939, 192, 639; DE BOER, *Arch. internat. Pharmacodyn.*, 1939, 61, 246; VAN DONGEN and BIJLEMA, *ibid.*, 1939, 63, 90; WEISMAN, *Amer. Heart J.*, 1942, 24, 545; RICHTER, *Zeit. ges. exper. Med.*, 1942, 110, 216; PASTORIUS, *J. Pharmacol. exp. Ther.*, 1939, 66, 27; SCOTT, ANDERSON and CHEN, *ibid.*, 1945, 84, 184; GOLD, MODELL, OTTO and HUNLON, *Fed. Proc.*, 1946, 5, 179; ALEXANDER *et al.*, *J. Pharm. Exp. Ther.*, 1947, 90, 191. (49) DAWES, *Brit. Med. J.*, 1946, i, 43; *Brit. J. Pharmacol.*, 1946, 1, 90. (50) *Quart. J. Pharm.*, 1941, 14, 16. (51) (a) *Compt. rend.*, 1938, 207, 1252; 1944, 218, 425; *C. R. Soc. Biol.*, 1939, 130, 429; (b) *ibid.*, 1943, 137, 134; cf. PROVINCIALI, *Arch. ital. sci. farmacol.*, 1938, 7, 73; (c) *C. R. Soc. Biol.*, 1940, 134, 510; 1941, 135, 263; (d) *Bull. Acad. Med. (Paris)*, 1938, 120, 25.

INDOLE GROUP

Abrine, $C_{12}H_{14}O_2N_2$. This substance is not well named as it is liable to be confused with abrin, the toxic albuminoid product obtained from the same source, jequirity seeds, *Abrus precatorius* L. It was isolated by Ghatak and Kaul,¹ and is stated to melt at 295° ,¹ or at $270-95^\circ$, depending on the rate of heating and to have $[\alpha]_D^{25} + 46^\circ$ (0.5 N/HCl) or $+ 62.4^\circ$ (0.5 N/NaHO).² The following salts have been prepared: ¹ hydrochloride, m.p. 221.5° (*dec.*); nitrate, m.p. 143° (*dec.*); picrate, m.p. 194° (*dec.*), though $186-7^\circ$ has been recorded frequently. Abrine was shown by Hoshino³ to be *d*- α -methylamino- β - β -indolylpropionic acid, $C_8H_6N \cdot CH_2 \cdot CH(NHMe) \cdot CO_2H$, which makes it a close relative of tryptophan, $C_8H_6N \cdot CH_2 \cdot CH(NH_2) \cdot CO_2H$, and hypaphorine (p. 386). This constitution has been confirmed by the syntheses of the *dl*-form by Gordon and Jackson⁴ and Miller and Robson,⁵ who record respectively m.p. 297° and 245° for the melting-point of the synthetic base, and though the m.ps. found for the picrate are in good accord, that for the hydrochloride (M. & R. : $192-3^\circ$) does not agree with Ghatak's figure (*see above*). Cahill and Jackson² have shown that when *d*-abrine and *l*-tryptophan are methylated and the resulting methyl ester methiodides,

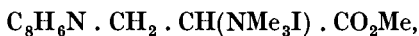

are converted to the corresponding betaines, the product in both cases is hypaphorine, the specific rotations found being $+ 113.7^\circ$, $+ 113.9^\circ$ and $+ 113.4^\circ$ respectively. It follows that abrine, like tryptophan and the natural amino-acids in general, belongs to the *l*-series, and in accordance with the accepted notation⁶ should be described as *l*(+)-abrine. It is of interest to note that as a growth-promoting substance, tried in rats, abrine is less effective than *l*-tryptophan, and more active than *dl*-abrine whence it is suggested that *d*(-)-abrine would probably be inactive, in growth promotion in the rat.⁷

REFERENCES

- (1) GHATAK (with KAUL), *J. Ind. Chem. Soc.*, 1932, **9**, 383; GHATAK, *Bull. Acad. Sci. U.P. India*, 1934, **3**, 295. (2) CAHILL and JACKSON, *J. Biol. Chem.*, 1938, **226**, 29; *cf.* (3). (3) *Proc. Imp. Acad. Tokyo*, 1935, **11**, 227; *Annalen*, 1935, **520**, 31. (4) *J. Biol. Chem.*, 1935, **110**, 151. (5) *J. Chem. Soc.*, 1938, 1910. (6) FREUDENBERG and RHINO, *Ber.*, 1924, **57**, 1547. (7) GORDON, *J. Biol. Chem.*, 1939, **129**, 309; *cf.* CHIN HYU-SUI, *Zeit. physiol. Chem.*, 1938, **257**, 12, 18.

Hypaphorine (α -trimethyl- β -indolepropiobetaine). *See* alkaloids of *Erythrina* spp. (p. 386).

Gramine (*Donaxine*), $C_{11}H_{14}N_2$. This substance was first found in barley mutants by Euler and Hellström,¹ and later in *Arundo donax*

L. by Orekhov and Norkina,² who named it donaxine and characterised it. From the same grass *Madinaveitia*³ isolated a second alkaloid *donaxarine*, and obtained evidence of the presence of a pāenolic base.

Gramine forms flat needles or leaflets, m.p. 138–9°, $[\alpha]_D \pm 0^\circ$, and yields a picrate, m.p. 144–5°, perchlorate, m.p. 150–1°; platinichloride, red needles, m.p. 180–1° (*dec.*) and a methiodide, m.p. 176–7°.² According to *Madinaveitia*,³ gramine on treatment with methyl iodide in methyl alcohol yields trimethylamine, tetramethylammonium iodide and a substance presumed to be 3-hydroxymethylindole. With ethyl iodide in acetone a normal ethiodide, $C_{13}H_{16}N_2I$, m.p. 176°, is formed.

von Euler and Erdtman² first suggested the identity of donaxine and gramine and represented it as 2-dimethylamino-3-methylindole. Wieland and Hsing⁴ found that magnesium-3-indolyl iodide reacted with dimethylaminoacetonitrile to give gramine, identical with the natural alkaloid, which must therefore be 3-dimethylaminomethylindole. It has also been synthesised by Kühn and Stein⁵ by the interaction of indole, formaldehyde and dimethylamine in acetic acid at room temperature. Gramine has been used recently as a primary material for the synthesis of tryptophan⁶ and for the preparation of alkyltryptamines.^{6(a)}

According to Powell and Chen,⁷ gramine, used as the unstable hydrochloride, m.p. 191° (*dec.*), raises the blood pressure in anaesthetised cats in small doses, but lowers it in doses of 30 to 40 mgm. per kilo., with a secondary rise. It reduces the chief effects of adrenaline without reversal. The toxic dose for rats is about 63 mgm./kilo. Supniewski and Serafinowna⁸ state that gramine excites the central nervous system in mammals, but in large doses causes paralysis. At 1 in 25,000 it causes contraction of the isolated uterus.

Donaxarine, $C_{13}H_{16}O_2N_2$, crystallises from acetone, has m.p. 217° $[\alpha]_D \pm 0^\circ$, contains one active hydrogen atom and one methylimino but no methoxyl group: no C-methyl group was found. It gives no colour reaction with the dimethylaminobenzaldehyde or glyoxylic acid reagents, but the vapour gives the pyrrole reaction with pine-wood (*Madinaveitia*³).

REFERENCES

- (1) *Zeit. physiol. Chem.*, 1932, 208, 43; 1933, 217, 23; (with HAGEN) *Ark. Kemi Min. Geol.*, 1934, 11, B, No. 36; (with LÖFGREN), *Zeit. physiol. Chem.*, 1935, 234, 151; (with ERDTMAN), *Ber.*, 1936, 69, 743. (2) *Ibid.*, 1935, 68, 436; *J. Gen. Chem. Russ.*, 1937, 7, 673; VON EULER and ERDTMAN, *Annalen*, 1935, 520, 1; ERDTMAN, *Ber.*, 1936, 69, 2482. (3) MADINAVEITIA, *J. Chem. Soc.*, 1937, 1927; *Nature*, 1937, 139, 27. (4) *Annalen*, 1936, 526, 188. (5) *Ber.*, 1937, 70, 567. (6) ALBERTSON *et al.*, *J. Amer. Chem. Soc.*, 1945, 67, 36; HOWE *et al.*, *ibid.*, p. 38. (6a) SNYDER and KATZ, *ibid.*, 1947, 69, 3140. (7) *Proc. Soc. exp. Biol. Med.*, 1945, 58, 1. (8) *Bull. Acad. Polon.*, 1937, *Classe med.*, 479 (see also *Acta polon. Pharm.*, 1938, 2, 125); MASHKOVSKII, *Chem. Abstr.*, 1944, 38, 4316; RAYMOND-HAMET, *Compt. rend. Soc. Biol.*, 1937, 126, 859; 1939, 130, 1218.

Calycanthine and *Associated Bases*. Calycanthine was isolated from the seeds of *Calycanthus glaucus* Willd by Eccles.¹ From the same source Gordin² obtained *isocalycanthine*, now stated to be a low-melting form

of calycanthine (Manske and Marion²). Späth and Stroh³ later found calycanthine in the seeds of *C. floridus* L., from which, in 1938, Barger, Jacob and Madinaveitia⁴ isolated a second alkaloid, calycanthidine. A third source of calycanthine was discovered by Manske⁵ in *Meratia præcox* Rehd. and Wils., which also contained two other alkaloids, distinguished as α -, m.p. 197–8°, and β -, of which the hydrochloride has m.p. 219–20°; both give Ehrlich's reaction. Manske and Marion² have also found calycanthine in the seeds of *C. occidentalis*, Hook and Arn. All four plants belong to the botanical family Calycanthaceæ.

Calycanthine, $C_{22}H_{26}N_4$. The formula, $C_{11}H_{14}N_2$, adopted by Gordin,³ was doubled by Späth and Stroh³ and altered as now given by Barger, Madinaveitia and Streuli.⁷ The base crystallises in octahedra, m.p. 216°, or after drying at 120° *in vacuo*, 242° (Barger), 243–4° (Gordin) or 245° (Späth); $[\alpha]_D^{18} + 684.3^\circ$ (EtOH). It forms a nitrosoamine, m.p. 175–6° (*dec.*), contains one methylimino group and shows two replaceable hydrogen atoms at 22° in pyridine, and four at 95° (Barger). According to Späth and Stroh it forms a dimethiodide, $C_{22}H_{26}N_4Me_2 \cdot 2MeI$, m.p. 261–2°, but Barger *et al.*, like Gordin, obtained anomalous products on methylation, *viz.* (a) calycanthine dihydriodide, $B \cdot 2HI \cdot H_2O$, m.p. 218–9° or 226–7° (*dry*); (b) calycanthine hydriodide, $B \cdot HI$, m.p. 260°; (c) an oxygenated quaternary salt, $C_{22}H_{26}ON_3I \cdot H_2O$, m.p. 240–2° and (d) an oxygen-free, quaternary salt, $C_{21}H_{22}N_3I$, m.p. 317–8°. The oxygen in (c) does not seem to be present as a methoxyl group. Manske⁸ found that calycanthine was converted by benzoyl chloride into an amorphous substance, which on oxidation with permanganate in acetone yields benzoyl-*N*-methyltryptamine (I : R = CO . Ph), m.p. 202°. The latter is also produced, according to Barger *et al.*,⁷ along with calycanine (*see below*) when the benzylation product is heated with calcium oxide at 300°. The same authors found that calycanthine heated with soda-lime in a closed vessel at 300–20° gave *N*-methyltryptamine (I : R = H), $C_{11}H_{14}N_2$, m.p. 86°, in a yield of 88 per cent. of that required if it forms, or is readily obtainable from, one moiety of the calycanthine molecule, as seems to be agreed by both groups of workers,^{6,7}.

The nature of the second half of the molecule is uncertain. Barger *et al.*⁷ heated the alkaloid with calcium oxide at 305° in a closed tube for 15 hours and identified among the neutral reaction products indole, probably methylindole and either ethyl- or dimethylindole, and in the basic fraction, calycanine (*see below*), *N*-methyltryptamine and a substance, $C_{12}H_{16}N_2$, m.p. 183°, picrate, m.p. 252°, whose reactions and characteristics indicated that it was a methyl-3-carboline, isomeric with harman (p. 490). The products of a similar experiment with soda-lime on benzoylcalycanthine were a substance, $C_{11}H_{11}N$, m.p. 2°, 2-phenylindole and quinoline. Manske and Marion² have recorded the following products from the dehydrogenation of calycanthine by selenium: 3-methyl- and 3-ethylindole, 4-methylquinoline, 3-carboline (*norharman*, p. 491) and calycanine (*see below*).

Both groups of workers have proposed formulæ for calycanthine.

Barger *et al.*⁷ took the view that the alkaloid contains two tryptamine residues, one represented in the degradation products by *N*-methyltryptamine, and the other by methyl-3-carboline, and on this basis proposed formula (II). Manske and Marion,² on the contrary, regard *N*-methyltryptamine and 3-carboline as originating from the same moiety of the molecule, the other half being represented by 4-methylquinoline, and on this conception based formula (III).

Calycanine, $C_{16}H_{10}N_2$ or $C_{21}H_{13(15)}N_3$. This substance was first described by Marion and Manske⁶ as resulting from the dehydrogenation of calycanthine by selenium or distillation of the base with zinc, but was first fully characterised by Barger, Madinaveitia and Streuli,⁷ who obtained it in a number of reactions including the oxidation of calycanthine with chromic acid in acetic acid. It has m.p. $296-7^\circ$, or 310° after sublimation, is a weak but remarkably stable base, contains one reactive hydrogen atom and does not give the Ehrlich colour reaction. Both groups of workers at first assigned to it the formula $C_{16}H_{10}N_2$, but Manske and Marion² changed this to $C_{21}H_{13}N_3$ or $C_{21}H_{15}N_3$. Barger *et al.*⁷ proposed for it formula (IV) and Manske and Marion suggested (V) or (VI) based on their formula (III) for calycanthine. Hargreaves⁹ has made an X-ray examination of crystals of calycanine and obtained evidence which,

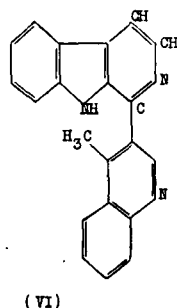
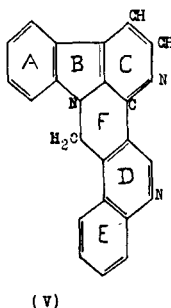
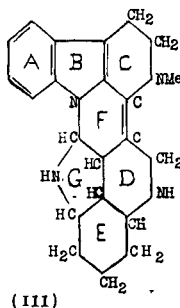
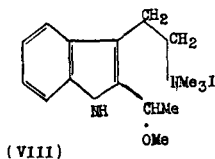
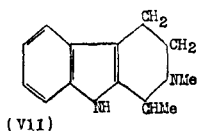
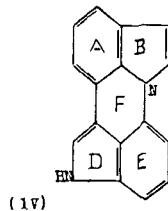
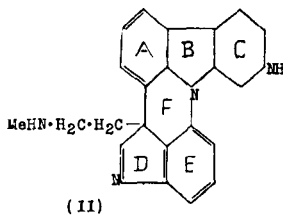
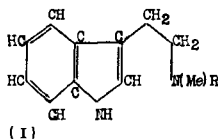

though not conclusive, favours $C_{16}H_{10}N_2$ as the empirical formula. Marion, Manske and Kulka⁶ have recently synthesised the substance represented by formula (VI), and find that it is not identical with calycanine. Molecular weight determinations with calycanine give anomalous results, and in view of the results of the X-ray investigations, they suggest the empirical formula, $C_{16}H_{10}N_2$, with which the combustion results agree,

and consider that calycanine may be represented by a fused carbazole and pyridine nucleus.

Calycanthidine, $C_{13}H_{16}N_2$. The base has m.p. 142° , $[\alpha]_D^{20} - 285^\circ$ (MeOH), and yields the following salts: hydriodide, m.p. 182° ; perchlorate, m.p. 158° ; platinichloride, m.p. $198-200^\circ$; picrate, m.p. 192° ; chromate, m.p. $> 300^\circ$. With methyl iodide it gives a product, m.p. $180-215^\circ$, which, on further treatment with methyl iodide and potassium hydroxide or carbonate in methyl alcohol, gives a salt (A) $MeO \cdot C_{12}H_{23}N \cdot NMe_3I$, m.p. 221° , also obtainable from the base directly by similar treatment. The alkaloid has the composition and character of a *N*-methyltetrahydroharman (VII), and on this basis (A) is represented by (VIII). *dl-N*-methyltetrahydroharman (VII), synthesised by condensing *N*-methyltryptamine (I: R = H) with acetaldehyde, has m.p. 112° , gives a normal methiodide, m.p. $228-9^\circ$, and differs in other respects from calycanthidine. As the latter could not be racemised and the synthetic *dl*-isomeride could not be resolved, precise comparison could not be made (Barger *et al.*⁴).

The statement made by Gordin² (1905) that calycanthine produces symptoms similar to those due to strychnine and acts as a stimulant to the spinal cord and as a cardiac depressant, have in general been confirmed by Cushny,¹⁰ and by McGuigan and von Hess¹¹ for the low-melting form *isocalycanthine* (Manske³). Chen, Powell and Chen¹² state that calycanthine hydrochloride is toxic to rats at 17.2 mgm. per kilo., reduces blood pressure and cardiac contraction in anaesthetised cats, stimulates the isolated intestine and uterus of rabbits, but has only a slight effect on isolated guinea-pig uterus.

REFERENCES

- (1) *Proc. Amer. Pharm. Assoc.*, 1888, 84, 382. (2) *J. Amer. Chem. Soc.*, 1905, 27, 144, 1418; 1909, 31, 1305; 1911, 33, 1626; MANSKE and MARION, *Can. J. Res.*, 1939, 17, B, 298. (3) *Ber.*, 1925, 58, 2131. (4) *Rec. trav. Chim.*, 1938, 57, 548. (5) *J. Amer. Chem. Soc.*, 1929, 51, 1836. (6) *Can. J. Res.*, 1938, 16, B, 432; (with KULKA), *ibid.*, 1946, 24, B, 224. (7) *J. Chem. Soc.*, 1939, 510. (8) *Can. J. Res.*, 1931, 4, 275. (9) *Nature*, 1943, 152, 600. (10) *Arch. int. Pharmacodyn.*, 1905, 15, 487. (11) *J. Pharm. Exp. Ther.*, 1911-12, 3, 441. (12) *J. Amer. Pharm. Assoc.*, 1942, 31, 513; cf. RAYMOND-HAMET, *Compt. rend. Soc. Biol.*, 1941, 135, 111.

ALKALOIDS OF *PEGANUM HARMALA*

The seeds and root of this rutaceous plant contain four alkaloids, harmaline, $C_{13}H_{14}ON_2$, obtained by Goebel,¹ harmine, $C_{13}H_{12}ON_2$, isolated by Fritsche² and harmalol, $C_{12}H_{12}ON_2$, first prepared by O. Fischer.³ From the S. American narcotic drug,⁴ "yage," "caapi" or "ayahuasca," derived from *Banisteria* spp. (Malpighiaceae), viz., *B. caapi*, Spruce,⁵ *B. metallicolor* or *B. lutea*, an alkaloid has been isolated by various workers and named "telepathine,"⁶ "yagine"⁷ or "banisterine"⁸; there is good reason to believe that only one alkaloid is concerned and that it is identical with harmine.^{8,9} The fourth alkaloid is vasicine (peganine), described later (p. 617) under its original source. *Harmala* seeds contain

2.5 to 3 per cent. of alkaloids, of which half to two-thirds is harmaline. A number of processes have been published for the isolation and estimation of the alkaloids.¹⁰

Harmaline, $C_{13}H_{14}ON_2$, crystallises in colourless, or pale yellow, glancing prisms, m.p. 239–40° (*dec.*), $[\alpha]_D \pm 0^\circ$. The hydrochloride, B. HCl. $2H_2O$, occurs in yellow needles; the platinichloride is microcrystalline. Harmaline forms a characteristic mercurichloride and a crystalline acid chromate, which is insoluble in water. Solutions of the salts give with potassium cyanide a precipitate of the hydrocyanide, B. HCN, which reacts as a simple base and forms a hydrochloride, $C_{14}H_{15}ON_3 \cdot HCl$. Harmaline forms an *N*-acetyl derivative, m.p. 204–5°, colourless needles; and with methyl iodide gives *N*-methylharmaline iodide and dimethylharmaline iodide, $C_{15}H_{19}ON_2I$, m.p. 220°; from the former, *N*-methylharmaline, needles, m.p. 162°, can be obtained by the action of baryta. Harmaline contains a methoxyl but no methylimino group and, on demethylation, yields the phenolic base, HARMALOL, $C_{12}H_{12}ON_2 \cdot 3H_2O$, which also occurs in the seeds.¹¹ It crystallises from water in brown needles, m.p. 212° (*dec.*), and is readily soluble in hot water or alkaline liquids. It oxidises in the air.

On reduction harmaline yields tetrahydroharmine, $C_{13}H_{16}ON_2$, m.p. 199°, and on gentle oxidation is converted into harmine.¹²

Harmine, $C_{13}H_{12}ON_2$, crystallises from methyl alcohol in colourless rhombic prisms, m.p. 266°, $[\alpha]_D \pm 0^\circ$. The hydrochloride, m.p. 269.5–270.5° (Chen⁹), nitrate, platinichloride, m.p. 264–6°, acid chromate and oxalate crystallise well. The salts show a deep blue fluorescence in dilute solution. Harmine behaves as a monoacidic base. It gives a methiodide, from which methylharmine, needles, m.p. 209°, may be prepared, and this in turn yields methylharmine methiodide. On demethylation harmine yields the phenolic base HARMOL, $C_{12}H_{10}ON_2$, m.p. 321°.¹³

Constitution of Harmine and Harmaline. Harmaline is a dihydroharmine. Both bases on reduction yield tetrahydroharmine and in both the single oxygen atom is present as methoxyl. Knowledge of the constitution of the two alkaloids is mainly due to the work of O. Fischer and his colleagues, and more recently to the researches of Perkin and Robinson.

On oxidation with chromic acid both alkaloids yield harminic acid,¹⁴ $C_8H_6(COOH)_2N_2$, which has the properties of an *o*-dicarboxylic acid. This when heated *in vacuo* loses in two stages the two carboxyl groups, and furnishes apoHARMINE, $C_8H_8N_2$, m.p. 183°, a secondary base yielding well-crystallised salts (aurichloride, m.p. 240°, picrate, m.p. 247°). With strong nitric acid harmaline gives, in addition to harminic acid, *m*-nitroanisic acid.¹⁵ Harminic acid, on further oxidation by dilute nitric acid, yields isonicotinic acid¹⁶ (pyridine-4-carboxylic acid). There must therefore be present in harmaline a methoxybenzene and a pyridine ring. Further, Perkin and Robinson¹⁷ showed that harmine condenses with benzaldehyde to form benzylideneharmine, $C_{12}H_9ON_2 \cdot CH : CH \cdot C_6H_5$, crystallising from alcohol in pale yellow prisms or needles, m.p. 191–2°, and giving solutions in neutral solvents showing a violet-blue fluorescence.

The formation of such a derivative is typical of substances containing a pyridine ring with a methyl group in the α -position. Harmaline also condenses with benzaldehyde, but the compound formed is benzylidene-diharmaline ($C_{12}H_{11}ON_2 \cdot CH_2$)₂:CH.C₆H₅, insoluble except in boiling pyridine from which it separates in colourless microcrystals, m.p. 245° (*dec.*). This compound resembles that similarly formed with α -methyl-indole. Benzylideneharmaline on oxidation under special conditions furnishes *nor*harminecarboxylic acid, $C_{12}H_9ON_2 \cdot COOH$, and this on decarboxylation yields *nor*harmine, $C_{12}H_{10}ON_2$, colourless needles, m.p. 218°. The changes so far described may be represented as follows :

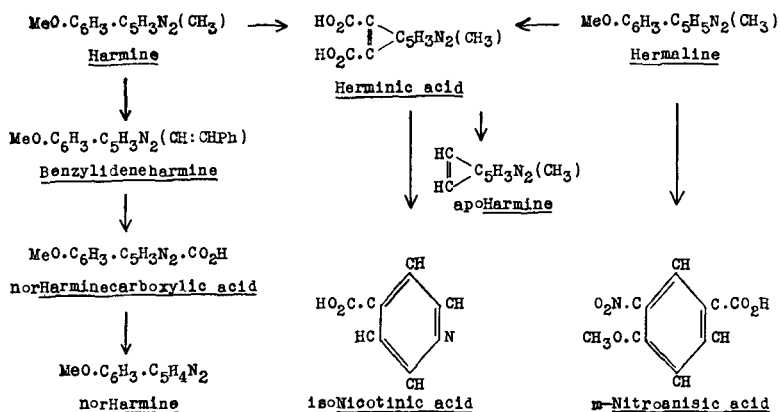

Perkin and Robinson¹⁷ suggested that harmine and harmaline probably had a structure composed of three rings—pyridine, pyrrole and benzene fused together—but the sequence of these rings was in doubt. Fischer's observation that *m*-nitroanisic acid and *isonicotinic* acids are produced on oxidation, indicated that the benzene and pyridine rings occupy terminal positions, but the first definite evidence of the presence and position of the pyrrole nucleus was afforded by Perkin and Robinson's discovery¹⁸ that the base *harman*, $C_{12}H_{10}N_2$ (I), was identical with a base obtained by Hopkins and Cole¹⁹ by the "oxidation" of tryptophan (II) with ferric chloride. *Harman* was prepared by Fischer¹¹ by treating *harmol* with zinc chloride ammonia, so converting it into aminoharman. This, on replacement of the amino-group by hydrogen, yields *harman*, which crystallises from benzene in prisms, m.p. 238°, picrate, m.p. > 250° (*dec.*): aurichloride, m.p. 211–3° (*dec.*). It has not been found in plants yielding harmine or harmaline, but Späth²⁰ has shown that "aribine," $C_{23}H_{20}N_4 \cdot 8H_2O$, obtained by Rieth and Wohler²¹ from the bark of *Arariba rubra* (*Sickingia rubra* Schum; Rubiaceae), and "loturine" found by Hesse²² in *Symplocos racemosa* Roxb. (*Symplocaceae*), are identical with *harman*, while "colloturine," which accompanies "loturine," is probably a form of *harman*.

The formula thus arrived at for *harman* provided confirmation for

the formulæ for harmine and harmaline, already provisionally selected,¹⁸ as shown below.

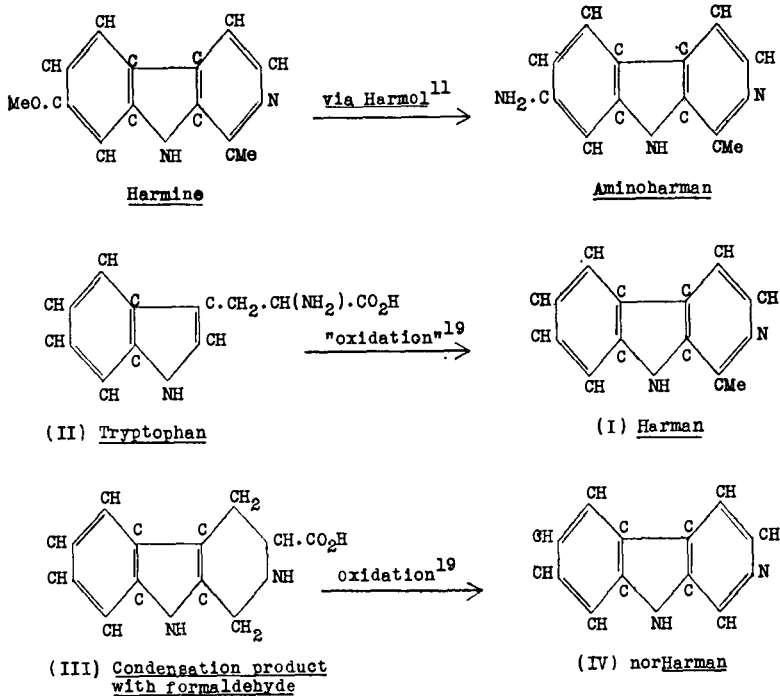

In view of its possible interest as the mode of formation of harman, harmine and harmaline in plants, Kermack, Perkin and Robinson¹⁹ investigated the conversion of tryptophan (II) into harman (I) and *nor*-harman (IV). The latter is produced when tryptophan is condensed with formaldehyde in presence of dilute sulphuric acid and the product (III) oxidised by potassium dichromate. Harman is formed when formaldehyde in this process is replaced by acetaldehyde.

2 : 3 : 4 : 5-Tetrahydroharman, m.p. 179–80°, has been prepared by a number of workers²³ by a modification of this reaction, *viz.*, by the interaction of tryptamine (3- β -aminoethylindole) with acetaldehyde or paraldehyde and Hahn *et al.*²³ have obtained a series of derivatives of tetrahydro*nor*harman by the use of other aldehydes and α -ketonic acids under "biological" conditions of pH and temperature, while Asahina and Osada,²³ by the action of aromatic acid chlorides on the same amine, have prepared a series of amides from which the corresponding substituted dihydro*nor*harmans have been made by effecting ring closure with phosphorus pentoxide in xylene solution.

Since 1921 much work has been done to confirm the formula for harmine and that provisionally assigned to harmaline, both by synthetic methods and by reactions to explore and explain peculiarities in the

behaviour of harmaline and certain of its derivatives. To facilitate reference to the synthetic products, the names pyrindole (V) ^{17, 19} and carboline have been introduced for the skeletal structures of *apoharmane* and *norharman* respectively, and these are shown below, with the notation adopted: thus *apoharmane* (VI) is 8-methyl-7-pyrindole. This pyrindole must not be confused with the synonym for pyrrocoline (p. 21). In the case of carboline two systems of notation have been used. The one adopted here is that of Gulland, Robinson, Scott and Thornley, ^{23a} who suggested that to indicate the position of the pyridine-*N* the Greek letters α , β , γ , δ - should be used in place of the numbers 2, 3, 4, 5. On this basis therefore *norharman* (VII) is 3- (or β)-carboline. It is however still frequently described in the literature as 4-carboline, which belongs to the older notation ¹⁸ still extensively used.

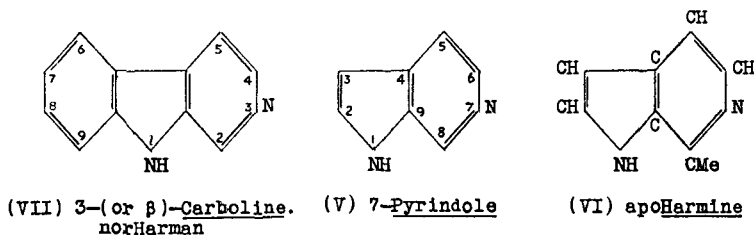

In ordinary methylharmine (p. 489) the methyl group is attached to the nitrogen atom of the pyridine ring (VIII). When it is treated with propyl iodide, and the resulting methylpropylharmine iodide converted to chloride (IX), the latter is not identical with the chloride (X) obtained with the two alkyl reagents applied in the reverse order: the first is *Py-N*-methyl-*ind-N*-propylharmine chloride (IX) and the second is *Py-N*-propyl-*ind-N*-methylharmine chloride (X).²⁴ Iyer and Robinson ²⁵ have shown that when dimethylharmine chloride, m.p. 280–2° (IX or X with $\text{Pr}^\alpha = \text{Me}$) is heated at 290–300°/10 mm. it furnishes a methylharmine (by loss of methyl chloride) crystallising in needles or plates, m.p. 124–5° (*dry*), which differs from *Py-N*-methylharmine (m.p. 209°) and must be *ind-N*-methylharmine (XI), since it furnishes the usual dimethylharmine iodide with methyl iodide.

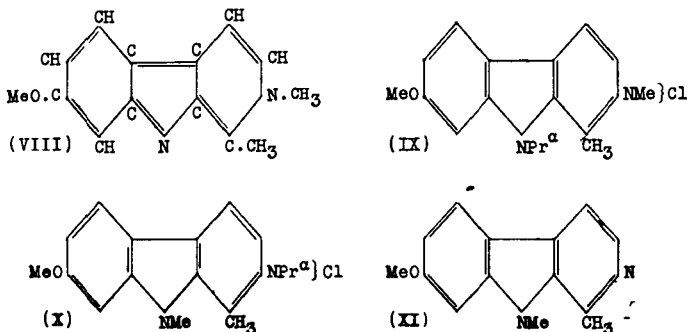

On oxidation with permanganate, methylharmaline is converted into a neutral substance, $C_{13}H_{14}O_2N_2$, m.p. 228° , which, on reduction with sodium and *n*-butyl alcohol yields *N*-methyltetrahydronorharmine (XVII),

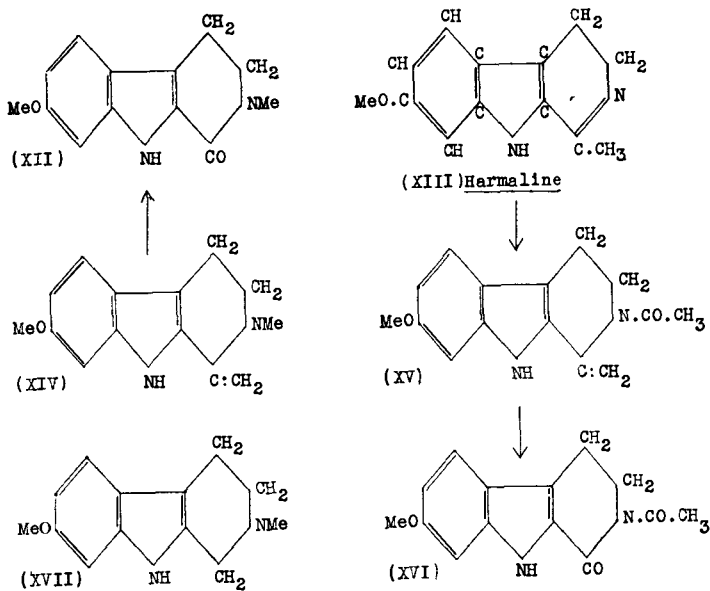

the synthesis of which is described below and about whose constitution there can be no doubt. The neutral substance must therefore be represented by (XII) and harmaline must be 4 : 5-dihydroharmine (XIII).²⁴

The formulæ which would naturally be assigned to acetylharmaline and methylharmaline on this basis are not fully representative of these substances, thus the oxidation of methylharmaline (or harmaline methosulphate) to keto-*N*-methyltetrahydronorharmine (XII) implies that methylharmaline must be represented by (XIV). Similarly, since acetyl-tetrahydroharmine is formed by the catalytic hydrogenation of acetyl-harmaline, the acetyl group must be attached to the pyridine-nitrogen. Further, acetylharmaline, $C_{15}H_{16}O_2N_2$, is oxidised by permanganate to a neutral substance, $C_{14}H_{14}O_3N_2$, m.p. $207-8^\circ$, which is represented by formula (XVI), since on hydrolysis by alkali it furnishes a product, $C_{12}H_{12}O_2N_2$, m.p. 198° , which has been shown by synthesis to be 2-keto-8-methoxytetrahydro- β -carboline (XII, NH replacing NMe²⁶). These facts indicate (XV) as the formula of acetylharmaline, analogous with (XIV) assigned to methylharmaline.²⁷

Apart from the syntheses already quoted as of possible biological interest, mention must be made of a series which are primarily of chemical interest. Kermack, Perkin and Robinson¹⁹ prepared *norharman*, *i.e.*, β -carboline (VII) by warming *N*-methylindole-2-carboxyacetylamide (XVIII) with alcoholic hydrogen chloride, thereby converting it into 2-keto-1-methyl-2 : 3-dihydro- β -carboline (XIX), which on distillation

with zinc dust yielded a product from which *norharman* (VII) was isolated. The process may be represented thus, the methyl group attached to the indole nitrogen being lost in the last stage.

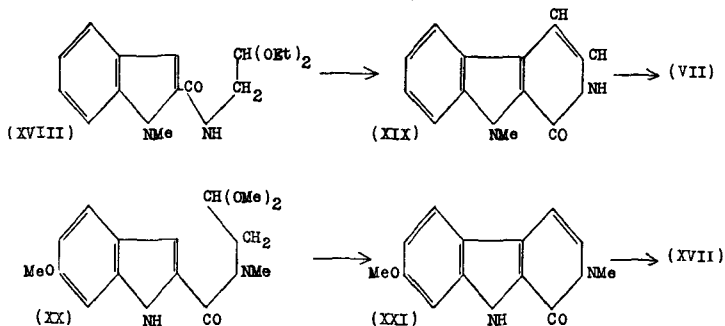

By a similar method the same authors²⁴ have prepared *N*-methyltetrahydro-*norharman* (XVII), starting with 6-methoxyindole-2-carboxylic acid, the acid chloride of which was condensed with methylaminodimethylacetal to give 6-methoxyindole-2-carboxydimethylacetalmethylamide (XX), and this on boiling with alcoholic hydrogen chloride gave 8-methoxy-2-keto-3-methyl-2:3-dihydro- β -carboline (XXI), which on reduction with sodium in *n*-butyl alcohol yielded *N*-methyltetrahydro-*norharman* (XVII). Among other syntheses by the same authors may be mentioned those of *apoharman*²⁸ and *harmaline*.²⁹ The latter is of special interest, being

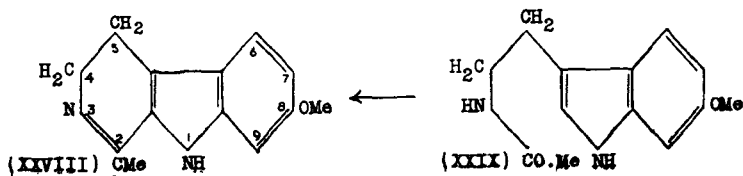
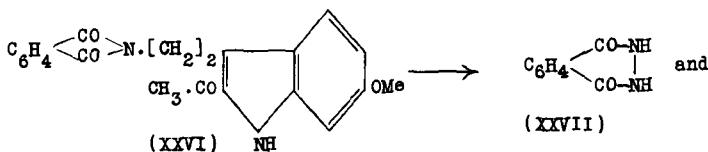
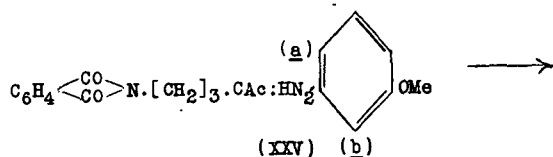
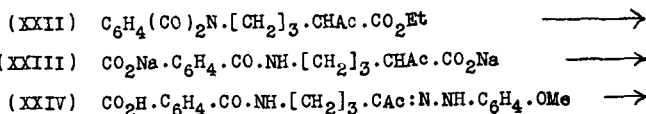

designed to confirm the location of the two hydrogen atoms added to harmine. The method used is as follows:—

Ethyl δ -phthalimido- α -acetylvalerate (XXII) was hydrolysed to sodium δ -*o*-carboxybenzamido- α -acetylvalerate (XXIII), and the latter coupled with *m*-methoxybenzenediazonium chloride in alkaline solution, losing a carboxyl group in the process and forming ζ -*o*-carboxybenzamidohexane- $\beta\gamma$ -dione β -*m*-methoxyphenylhydrazone (XXIV) which was converted by acetic anhydride into the corresponding phthalimide (XXV). A previous investigation had shown that of the two possible positions (a) and (b) for ring closure in this compound, (a) was the favoured site, and on boiling with *n*-butyl alcoholic hydrogen chloride, 6-methoxy 2-acetyl-3- β -phthalimidoethylindole (XXVI) was formed, which with hydrazine hydrate gave insoluble phthalylhydrazide (XXVII) and harmaline (XXVIII).

Of the two other possible formulæ for harmaline with the chain $\text{CH}_2 : \text{C} \cdot \text{NH} \cdot \text{CH}_2 \cdot \text{CH}_2$ — or — $\text{CHMe} \cdot \text{NH} \cdot \text{CH} : \text{CH}$ — in place of — $\text{CMe} : \text{N} \cdot \text{CH}_2 \cdot \text{CH}_2$ — in positions 2 to 5, only the first is consistent with this synthesis, and, as work on methyl- and acetyl-harmaline (p. 493) has shown, this form is assumed with difficulty.

Späth and Lederer³⁰ have published a simplified synthesis of harmaline consisting in treating the acetyl derivative of 6-methoxytryptamine (XXIX) with phosphorus pentoxide in boiling xylene, the harmaline thus produced being converted into harmine by catalytic dehydrogenation at 200°.

By the application to 1 : 2'-pyridylbenztriazole of the Delétra-Ullmann process³¹ of preparing carbazoles by heating arylbenztriazoles, Lawson, Perkin and Robinson³² were able to obtain 2-carboline, but were unable to prepare 3-carbolines, owing to the non-reactivity of 3-halogenopyridines with *o*-phenylenediamine. Späth and Eiter³³ found later that in presence of a little water and copper sulphate, 3-bromopyridine condenses with *o*-phenylenediamine to give N-3-pyridyl-*o*-phenylenediamine (XXX), m.p. 125.5–6°; this with nitrous acid yields the required 1 : 3'-pyridylbenztriazole (XXXI), m.p. 136.5–7°, which on heating at about 350° for eight hours gives 3-carboline (*norharman* XXXII), or on heating with zinc chloride at 320° for 15 minutes produces 3-carboline, 3-anilinopyridine and 5-carboline, m.p. 214–5°.

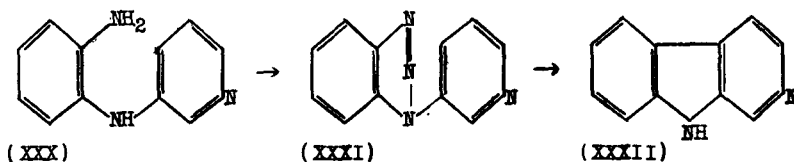

Pruckner and Witkop³⁴ have compared the ultra-violet absorption spectra of a series of alkaloids and alkaloidal nuclei, with special reference to the effects produced by substitution on the harman group leading to yobyrine (p. 505) and its derivatives.

Pharmacology of Harman Derivatives. Medicinal properties have

been ascribed to harmala seeds from the time of Dioscorides. They have long been used as an anthelmintic in India and also as narcotics, and the source of a red dye. Flury ³⁵ and others have shown that harmine and harmaline exhibit anthelmintic action.

Exact knowledge of the pharmacology of the alkaloids is largely due to the work of Gunn and his collaborators. In a summary of his results Gunn ³⁶ states that in large doses harmine causes tremors and clonic convulsions, the latter occurring without marked increase in spinal reflex excitability and not being shown in frogs. With poisonous doses the convulsions are followed for a short time by motor paralysis, due to depressant action on the central nervous system; respiration is paralysed and in mammals there is a fall in temperature. Harmine induces a fall in blood pressure chiefly due to weakening of the cardiac muscle. It arrests the perfused heart in diastole and diminishes the contractions of most forms of smooth muscle with the exception of the uterus, which, particularly in the rabbit, is made to contract powerfully. It is more toxic to most protozoa than quinine. Harmaline (dihydroharmine) is about twice as toxic to most laboratory animals as harmine, but the addition of two atoms of hydrogen affects the degree of activity rather than its pharmacological character, as is also the case for tetrahydroharmine. The minimum lethal doses of the three bases for the rabbit are in the following ratio: harmine : harmaline : tetrahydroharmine = 2 : 1 : 3. The character of the action is still unaltered in tetrahydroharmine, but in changing the ethers, harmine and harmaline, to the respective phenols, harmol and harmalol, the capacity to induce clonic convulsions disappears, and the two phenols cause a progressive paralysis of the central nervous system without initial stimulation. The protozoocidal action is also much reduced. In harmol alkyl ethers (homologues of harmine), the initial stimulant action of harmine diminishes as the weight of the alkyl group increases and at nonylharmol the action is purely depressant. Dilatation of the coronary vessels of the perfused heart shown by tetrahydroharmine is intensified with harmol, and is still more pronounced with the alkylharmols attaining a maximum at amylharmol. The harmala and cinchona groups of alkaloids exhibit much similarity in action in spite of their dissimilarity in chemical constitution, and it is suggested that in cases of this kind the action must be due to a common chemical factor in the tissues concerned.

Raymond-Hamet ³⁶ has made a special study of the vascular action of the harmala alkaloids and certain of their proximate derivatives, including their influence on the pressor and other effects of adrenaline in comparison with that of yobyrine and ketoyobyrine (pp. 505-6).

The possible therapeutic applications of these alkaloids as protozoocidal agents, coronary dilators ³⁷ and ecbolics, and in nervous diseases, for example in the treatment of post-encephalitic conditions, have been discussed by a number of authors. ³⁸ The alkylharmols, referred to above, form part of an extensive series prepared by Coulthard, Levene and Pyman, ³⁹ and tested by these authors for bactericidal properties and by

Coulthard⁴⁰ for amœbocidal action. Each kind of activity increases to a peak as the series is ascended and then diminishes. In the *O-n*-alkyl series the peak is at *O-n*-butylharmol for *Bacillus typhosus*, at *O-n*-amylharmol for *Staphylococcus aureus* and at *O-n*-nonylharmol for *Entamœba histolytica*. In the *O-ω*-diethylaminoalkyl series the peak for *B. typhosus* is at *O-ω*-diethylaminononylharmol. No trypanocidal or anti-malarial action was observed in a selection of the compounds tested.⁴¹

The simpler substance apoharmine according to Flury³⁵ causes increased reflex excitability in the dog. In the frog it produces a like effect which with larger doses goes on to tetanus. Esterification of harmol with methylcarbamic acid induces affinities with the physostigmine type of drug.⁴²

REFERENCES

- (1) *Annalen*, 1841, 38, 363. (2) *Ibid.*, 1847, 64, 365. (3) *Ber.*, 1885, 18, 400; 1889, 22, 637; 1897, 30, 2481; 1914, 47, 99. (4) RUSBY, *J. Amer. Pharm. Assoc.*, 1924, 13, 98; BARRIGA VILLALBA, *Bol. Lab. Samper-Martinez*, Bogota, 1927, October, M. Berthelot Number, pp. 9–35; HOLMES, *Pharm. J.*, 1927, [iv], 65, 111; PERROT and RAYMOND-HAMET, *Compt. rend.*, 1927, 184, 1266; IBERICO, *Chem. Abstr.*, 1942, 36, 1389. In these papers the history of the drug and its botanical origin are discussed. (5) REINBURG, *J. Soc. d'Amer. Paris*, 1921, 13, 25, 197; HILL, quoted by ELGER, *Helv. Chim. Acta*, 1927, 11, 164. (6) ZERDA BAYON, quoted by VILLALBA.⁴ (7) VILLALBA (*loc. cit.*) and *J. Soc. Chem. Ind.*, 1925, 44, 205T. (8) LEWIN, *Arch. exp. Path. Pharm.*, 1928, 129, 133; *Compt. rend.*, 1928, 186, 469. (9) ELGER, *Helv. Chim. Acta*, 1928, 11, 162; WOLFES and RUMPF, *Arch. Pharm.*, 1928, 266, 188; CHEN and CHEN, *Quart. J. Pharm.*, 1939, 12, 30. (10) HASENFRATZ, *Ann. Chim. Phys.*, 1927, [x], 7, 151. For other processes including methods of estimation see ROZENFELD, *Farm. Zhur*, 1930, 183; BOLOTNIKOW, *ibid.*, 1931, 362; BUNTZELMAN, *Bull. Nauch. Issledov Khim. Farm. Inst.*, 1931, 71, and ELGAZIN (JELGASIN), *Khim. Farm. Prom.*, 1932, 128; ISMAILOV and SHRAIBER, *Farmatsiya*, 1939, No. 6, 1. (11) O. FISCHER, *Chem. Soc. Abstr.*, 1901, [i], 405. (12) FISCHER, *Ber.*, 1897, 30, 2482; HASENFRATZ and SUTRA, *Compt. rend.*, 1926, 182, 703; ELGAZIN, *Khim. Farm. Prom.*, 1933, 270; IYER and ROBINSON, *J. Chem. Soc.*, 1934, 1636. (13) FISCHER and TAUBER, *Ber.*, 1885, 18, 403; *cf.* PERKIN and ROBINSON, *J. Chem. Soc.*, 1919, 115, 933. For more recent demethylations of harmine and harmaline see COULTHARD, LEVENE and PYMAN³⁶ and KONOVALOVA and OREKHOV, *Arch. Pharm.*, 1935, 273, 156. (14) FISCHER, *Ber.*, 1897, 30, 2482. (15) FISCHER and BOESLER, *ibid.*, 1912, 45, 1934. (16) FISCHER, ANGERMANN and DIEPOLDER, *ibid.*, 1914, 47, 99. (17) *J. Chem. Soc.*, 1912, 101, 1778; HASENFRATZ and SUTRA, *Compt. rend.*, 1927, 185, 1048. (18) *J. Chem. Soc.*, 1919, 115, 967; *cf.* p. 933, where the genesis of the harmine formula is fully discussed. (19) *J. Physiol.*, 1903, 29, 451; *cf.* KERMAK, PERKIN and ROBINSON, *J. Chem. Soc.*, 1921, 119, 1617; HARVEY and ROBSON, *ibid.*, 1938, 97; (with MILLER, 1941, 153; JACOBS and CRAIG, *J. Biol. Chem.*, 1936, 113, 760; SNYDER *et al.*, *J. Amer. Chem. Soc.*, 1948, 70, 219, 222, 237. (20) *Monats.*, 1919, 40, 351; 1920, 41, 401. (21) *Annalen*, 1861, 120, 247. (22) *Ber.*, 1879, 11, 1542. (23) TATSU, *J. Pharm. Soc. Japan*, 1928, No. 555, 453; AKABORI and SAITO, *Ber.*, 1930, 63, 2245; HAHN *et al.*, *ibid.*, 1934, 67, 2031; *Annalen*, 1935, 520, 107, 123; *Ber.*, 1938, 71, 2163, 2175; *cf.* SCHÖPF and BAYERLE, *Annalen*, 1934, 513, 195; ASAHINA and OSADA, *J. Pharm. Soc. Japan*, 1926, No. 534, 629. (23a) *J. Chem. Soc.*, 1929, 2924. (24) PERKIN and ROBINSON, *ibid.*, 1919, 115, 933; (with KERMAK), 1922, 121, 1877. (25) *Ibid.*, 1934, 1635; *cf.* KONOVALOVA and OREKHOV, *Arch. Pharm.*, 1934, 272, 748. (26) BARRETT, PERKIN and ROBINSON, *ibid.*, 1929, 2942. (27) NISHIKAWA, PERKIN and ROBINSON, *ibid.*, 1924, 125, 657. (28) (With LAWSON), *ibid.*, 1924, 125, 626. (29) (With MANSKE), *ibid.*, 1927, 1. (30) *Ber.*, 1930, 63, 122. (31) *Arch. Sci. phys. nat.*, 1904, [v], 17, 78. (32) *J. Chem. Soc.*, 1924, 625; ROBINSON and THORNLEY, *ibid.*, p. 2169; FREAK and

ROBINSON, *ibid.*, 1938, 2018. (33) *Ber.*, 1940, 73, 719. (34) *Annalen*, 1943, 554, 127. (35) *Arch. exp. Path. Pharm.*, 1910, 64, 105. For later results see SATO, *Folia Pharmacol. Japan*, 1930, 10, 13; KADOYAMA *et al.*, *Tohoku J. Exp. Med.*, 1931, 17, 1, 10, 20, 25, 28; DA COSTA and RAYMOND-HAMET, *Arch. exp. Path. Pharm.*, 1935, 50, 237. (36) *Arch. int. Pharmacodyn.*, 1935, 50, 379. For special contributions see *Trans. Roy. Soc. Edin.*, 1910, 47, [ii], 245; 1912, 48, [i], 83; (with ALLAN) *Quart. J. Pharm.*, 1929, 2, 525; (with Simonart) 1930, 3, 1, 218; (with MACKETH), 1931, 4, 33; 1932, 5, 48; (with HEATHCOTE) 1931, 4, 549; (with ELPHICK), 1932, 5, 87, 56, 63. For other papers on the pharmacology of the harmala bases see KADOYAMA³⁵; LEWIN, *Arch. exp. Path. Pharm.*, 1928, 129, 133; KREITMAIR, *Merck's Jahresb.*, 1929, 42, 9; RAYMOND-HAMET, *Compt. rend.*, 1929, 188, 1519; 1941, 212, 408; 1945, 221, 387; *C. r. Soc. biol.*, 1941, 135, 69, 328; 1944, 138, 410; SETO, *Folia Pharmacol. Jap.*, 1930, 11, 34; SATO, *Tohoku J. Exp. Med.*, 1935, 26, 161; SARGIN and WASSILJEWA, *Bull. Biol. Med. exp., U.R.S.S.*, 1937, 3, 94; AOYAMA, *Mitt. med. Ges. Okayama*, 1939, 51, 576, 1278 (*Chem. Abstr.*, 1942, 36, 6664; 1943, 37, 1185); BEER, *Arch. exp. Path. Pharm.*, 1939, 193, 377, 393; OVEJERO, *Farmacoterap. act.*, 1946, 3, 842 (*Brit. Abstr.*, 1947, A.iii, 406); EUCLIDES (Madrid), 1947, 7, 77 (*Chem. Abstr.*, 1947, 41, 5919). (37) See BRANWELL, CAMPBELL and EVANS, *Lancet*, 1933, 225, 69. (38) See HILL and WORSTER-DROUGHT, *ibid.*, 1929, 217, 647; RUSTIGE, *Deut. med. Woch.*, 1929, 55, 613; PINÉAS, *ibid.*, 1929, 55, 910; FISCHER, *Münch., med. Woch.*, 1929, 76, 451; BERINGER, *Merck's Jahresb.*, 1929, 42, 16; LE GRAND and LAMELIN, *Compt. rend. Soc. Biol.*, 1930, 105, 943; MARINESCO, KREINDLER and SCHEIM, *Arch. exp. Path. Pharm.*, 1930, 154, 301; ROSENBERGER, *Wien. klin. Woch.*, 1930, 43, 207; COOPER and GUNN, *Lancet*, 1931, 221, 901. (39) *Biochem. J.*, 1933, 27, 727. (40) *Ibid.*, 1934, 28, 264. (41) Cf. GUNN and MARSHALL, *Proc. Roy. Soc. Edin.*, 1920, 40, 140; GOODSON, HENRY and MACFIE, *Biochem. J.*, 1930, 24, 888. (42) AESCHLIMANN and REINERT, *J. Pharm. Exp. Ther.*, 1931, 43, 417.

ALKALOIDS OF *EVODIA RUTÆCARPA*

Several species of *Evodia* have been stated to contain berberine, but recent workers have failed to confirm this observation.¹ In the Chinese drug, "Wou-chou-yu," which is the dried fruit of *E. rutæcarpa* Benth. and Hook., Asahina and co-workers found two alkaloids, evodiamine and rutæcarpine,² to which Chen and Chen³ added a third, *wuchuyine*, $C_{13}H_{13}O_2N$, m.p. 237·5°, $[\alpha]_D^{20-50} - 60\cdot8^\circ$. According to Mayeda,⁴ *E. Danielli* Helms. contains no alkaloids.

Evodiamine, $C_{19}H_{17}ON_3$, yellowish leaflets, m.p. 278°, $[\alpha]_D^{15} + 352^\circ$ (+ 251°)³ (acetone) is a weak base, insoluble in dilute acids. When heated in alcohol with hydrochloric acid it absorbs water, being converted into evodiamine hydrate (*isoevodiamine*), $C_{19}H_{19}O_2N_3$, rhombic leaflets, m.p. 146·7°, $[\alpha]_D \pm 0^\circ$, which forms a hydrochloride, $C_{19}H_{17}ON_3 \cdot HCl$, crystallising in plates, m.p. 255·6° or 265·7° (*dry*), and a nitrosoamine, m.p. 120°. Acetic anhydride at 150° reconverts "*isoevodiamine*" to *optically inactive* evodiamine. Evodiamine is decomposed by boiling alcoholic potassium hydroxide into *N*-methylantranilic acid and dihydronorharman.⁶ Evodiamine hydrate undergoes fission under like conditions into carbon dioxide, *N*-methylantranilic acid and a base, $C_{10}H_{12}N_2$, which was at first regarded as 2- β -aminoethylindole, but was eventually shown to be 3- β -aminoethylindole.⁵ When "*isoevodiamine hydrochloride*" is heated *dry* it evolves water and methyl chloride and forms rutæcarpine.⁶

Rutæcarpine, $C_{18}H_{18}ON_3$, crystallises from boiling alcohol in colourless

needles, m.p. $257-8^{\circ}$ ($261-2.5^{\circ}$),³ $[\alpha]_D \pm 0^{\circ}$, and is decomposed by potassium hydroxide in boiling amyl alcohol, yielding anthranilic acid and 3- β -aminoethylindole-2-carboxylic acid, $C_{11}H_{12}O_2N_2$, silky crystals, m.p. 257° . Unlike evodiamine, rutæcarpine yields a monoacetyl and a monobenzoyl derivative melting at $184-6^{\circ}$ and 194° respectively.⁷

To these alkaloids Asahina and Mayeda² assigned formulæ, based on the reactions described, and on the first assumption, referred to above, that 2- β -aminoethylindole was the scission product of evodiamine. Kermack, Perkin and Robinson⁵ pointed out that the evidence did not exclude the possibility that the base produced was in reality 3- β -aminoethylindole, in which case evodiamine and rutæcarpine could be represented by the following formulæ, which would bring them into line with harmine.

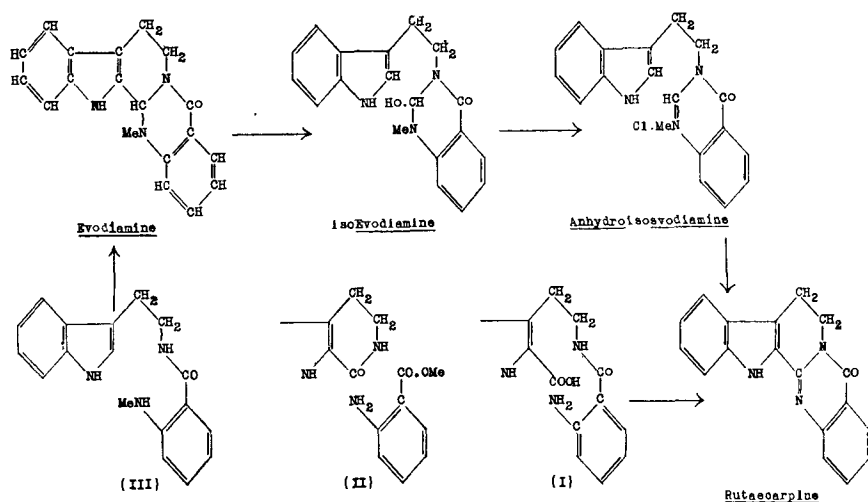

These formulæ explain the scission products of the two alkaloids and the conversion of evodiamine into rutæcarpine, and were accepted by Asahina.⁵ A partial synthesis of rutæcarpine was effected by Asahina, Irie and Ohta,⁸ who prepared the *o*-nitrobenzoyl derivative of 3- β -aminoethylindole-2-carboxylic acid, and reduced this to the corresponding amine (partial formula I), which on warming with phosphorus oxychloride in carbon tetrachloride solution furnished rutæcarpine. This synthesis was completed in 1928 by the same authors by the preparation of 3- β -aminoethylindole-2-carboxylic acid by the action of alcoholic potassium hydroxide on 2-keto-2:3:4:5-tetrahydro-3-carboline. An equally simple synthesis was effected almost simultaneously by Asahina, Manske and Robinson,⁹ who condensed methyl anthranilate with 2-keto-2:3:4:5-tetrahydro-3-carboline (for notation, see p. 492) by the use of phosphorus trichloride (see partial formulæ II). Ohta¹¹ has also synthesised rutæcarpine by heating a mixture of 2-keto-2:3:4:5-tetrahydrocarboline with isatoic anhydride at 195° for 20 minutes.

In the synthesis of evodiamine effected by Asahina and Ohta,¹⁰ *N*-methylanthranilic acid was converted by ethyl chloroformate into *N*-methylisatoic anhydride, which, on treatment with 3- β -aminoethylindole, furnished 3- β -*o*-methylaminobenzoylaminoethylindole (III), and this with ethyl orthoformate at 175–180° gave *dl*-evodiamine, m.p. 278°, convertible by boiling alcoholic hydrogen chloride into *isoevodiamine*, m.p. 147°, as shown above.

In a recent paper, Schöpf and Steuer^{10(a)} describe the synthesis under physiological conditions of rutæcarpine from 4 : 5-dihydro-3-carboline perchlorate and *o*-aminobenzaldehyde.

According to Raymond-Hamet,¹² evodiamine and rutæcarpine on injection induce increased arterial pressure.

REFERENCES

- (1) KLEIN and BARTOSCH, *Österr. Bot. Zeit.*, 1928, 77, 6. (2) (With KASHIWAGI), *J. Pharm. Chém.*, 1916, [vii], 14, 54; (with MAYEDA) *J. Pharm. Soc. Japan*, 1916, No. 416 (*Chem. Soc. Abstr.*, 1921, i, 48). For a more detailed account see *Acta phytochimica*, Tokyo, 1923, 1, 67. (3) *J. Amer. Pharm. Assoc.*, 1933, 22, 716. (4) *J. Pharm. Soc. Japan*, 1935, 55, 90. (5) ASAHINA, *ibid.*, 1924, No. 503, 1; and KERMAK, PERKIN and ROBINSON, *J. Chem. Soc.*, 1921, 119, 1615. (6) ASAHINA and OHTA, *J. Pharm. Soc. Japan*, 1926, No. 530, 30; 1929, 49, 157. (7) (With FUJITA), *ibid.*, 1921, 863. (8) *Ibid.*, 1927, No. 543, 51; 1928, 48, 51; compare ASAHINA and ISHIMASA, *ibid.*, 1926, No. 534, 61. For another synthesis see *ibid.*, 1927, No. 545, 541 (Jap. text). (9) *J. Chem. Soc.*, 1927, 1708; cf. MANSKE and ROBINSON, *ibid.*, p. 240, and SEN and RÁY, *ibid.*, 1926, 646; (10) *Ber.*, 1928, 61, 319, 869; *J. Pharm. Soc. Japan*, 1928, 48, 317 (Jap. text); 10(a) *Annalen*, 1947, 558, 124. (11) *J. Pharm. Soc. Japan*, 1940, 60, 109. (12) *Compt. rend.*, 1945, 220, 749.

ALKALOIDS OF YOHIMBÉ AND QUEBRACHO

Yohimbehe bark, originally believed to be derived from a species of *Tabernæmontana* (Apocynaceæ), but now assigned to *Pausinystalia yohimba*, Pierre (Fam. Rubiaceæ; syn. *Corynanthe yohimbe*, Schum.), a tree native to the Cameroons and French Congo, contains alkaloids on which pioneer work was done by Spiegel.¹ Some of the alkaloids are of uncertain individuality, e.g., Spiegel's "yohimbenine" and the unnamed base described by Danckwörtt and Luy.¹ It is convenient to deal with quebracho alkaloids also in this group, since Fournéau and Page's² identification of quebrachine with yohimbine is generally accepted.³ This involves the inclusion of *Vallesia glabra* as this has one alkaloid, aspidospermine, in common with quebracho. It has also been shown recently that the gelsemium alkaloid, sempervirine, can be isomerised to yobyrine, one of the degradation products of yohimbine, but as most of the gelsemium bases are still of unknown structure it is not thought desirable to deal with this plant in this section. The alkaloids of *Pseudocinchona africana* Chev. (*Corynanthe africana* Br.) are included as one of them, corynantheine is probably a constituent of yohimbé bark, and Janot and Goutarel have stated⁴ that the corynanthidine isolated from this species (1945) is possibly identical with the α -yohimbine of yohimbé bark. The validity of the genus *Pseudocinchona* is still under discussion.⁴ From time to time "yohimbe"

barks have appeared in commerce, which are not derived from *P. yohimba*, Pierre, and have been examined. Among these is *P. macroceras*, Pierre (*Corynanthe macroceras* (K. Sch.), Brandt), which contains inactive alkaloids and little yohimbine⁵ and *Pausinystalia paniculata*, Welw., in which, along with paniculatine, yohimbine is present, according to Raymond-Hamet,^{6(a)} as it is also in *P. trillesii*, Pierre, examined by Dupouy and Beille.^{6(b)} From *Tabernæmontana coronaria* Br. Ratnagiriswaran and Venkatachalan have isolated two alkaloids, *tabernæmontanine*, $C_{20}H_{26}O_3N_2$, m.p. 208–210°, and *coronarine*, $C_{44}H_{56}O_6N_4 \cdot 2.5H_2O$, m.p. 196–8° (*dec.*).^{6(c)}

Processes for the isolation and purification of yohimbine have been described by Thoms,⁷ Feldhoff,⁸ Chemnitzius,⁹ Schwyzer,¹⁰ Raymond-Hamet⁶ and others. Some of these processes have been modified to provide for estimation of the yield of yohimbine, usually as the hydrochloride, from the bark, or to facilitate the identification of this alkaloid in commercial yohimbé bark, which is apt to vary both in quality and in botanical origin.¹¹ According to Witkop¹¹ (1943) modern technical yohimbine hydrochloride may contain a little *isoyohimbine* but no *allo-yohimbine*.

Yohimbine (*Quebrachine*), $C_{21}H_{26}O_3N_2$, crystallises from dilute alcohol in colourless needles, m.p. 234° (Spiegel, Warnat), $[\alpha]_D + 50.9^\circ$ (S); + 56° (EtOH, Fourneau), + 62.2° (EtOH, Witkop), or + 84.1° (pyridine, Hahn³), is readily soluble in alcohol or chloroform, sparingly so in ether. The hydrochloride is crystalline, m.p. 295–300° (*dry, dec.*), 286° (*dec.*, Witkop), $[\alpha]_D^{20} + 105^\circ$ (H_2O); the nitrate, m.p. 269–270°, forms colourless prisms; the thiocyanate separates from hot water in rectangular crystals, m.p. 233–4° (Siedler); the tartrate, $B \cdot 6H_2O$, melts at 213° and remelts at 278° (F). Yohimbine gives a methiodide, $B \cdot CH_3I \cdot H_2O$, m.p. 250°. It contains one methoxyl group and one alcoholic hydroxyl group yielding a sulphuric ester,¹² m.p. 292–5°. On acetylation it furnishes an *O*-acetyl derivative, m.p. 133°, and an *O*:*N*-diacetyl derivative, m.p. 183°; *cf.* Schomer¹¹ (1927).

When yohimbine is heated with potash solution it is converted into potassium yohimbate, from which yohimbic acid (the forms yohimboic and yohimboaic are also used and *noryohimbine*), $C_{20}H_{24}O_3N_2 \cdot H_2O$, is liberated by acetic acid; it crystallises from water in lustrous prisms, m.p. 269° or 299° (*dry, dec.*), $[\alpha]_D + 138.8^\circ$ (pyridine), and, on esterification with methyl alcohol and its homologues, reproduces yohimbine and its homologues, analysis of which by Field¹² confirmed the view that yohimbine is methyl yohimbate, and has the formula assigned to it by Fourneau and Page.²

For the detection and identification of yohimbine, Deniges¹³ uses a microcrystallographic method; the alkaloid in sulphuric acid gives with a minute crystal of potassium dichromate violet streaks, changing to slate-blue and finally green. With nitric acid, the hydrochloride gives a green colour changing to yellow. Other characteristic colour reactions are described by Rossi *et al.*¹⁴ and others, mostly dependent on the coloured products formed by indole derivatives with aldehydes in presence of mineral acids.

Yohimbine and its Isomerides

Name	Crystals and Solvent of Crystallisation	m.p.	$[\alpha]_D$ Py = pyridine A = alcohol	Salts m.p. and $[\alpha]_D$ in Water	Acid Produced on Hydrolysis, m.p. and $[\alpha]_D$	Reference No.
Yohimbine (quebrachine) .	Needles ; —	234–235°	+84 to 108° (Py) +50 to 55° (A)	B. HCl ; 302–303° +103 to +106°	Yohimbic acid, B. H ₂ O, 265–269° ; B (dry), 296–299° +133° to +138° (Py). Ethyl ester : m.p. 190°.	15
<i>meso</i> Yohimbine (<i>iso</i> Yohimbine).	Needles ; —	238–240°	+99 to 108° (Py) +57.1° (A)	B. HCl ; 298–300° +100 to +103.8°	<i>iso</i> Yohimbic acid, B. H ₂ O, 268–269° ; +146° to +147° (Py). Ethyl ester : m.p. 243° (dec.).	16
α -Yohimbine	Polyhedral : MeOH or EtOH + H ₂ O	234–235°	–22° to –28° (A) –9.3° (Py)	B. HCl ; 286° (dec.) +53.6 to +58°	α -Yohimbic acid, 276° (dec.) to 287° (dec.) ; +47.6 to +56.9° (Py). Ethyl ester : 236°, –6.7°	17
β -Yohimbine	Leaflets : H ₂ O or 2MeOH	235–236°	–54° (dry : Py)	B. HCl ; 292° (dec.) +27.7°	β -Yohimbic acid, 257° or 270°, +15.8° (Py).	18
γ -Yohimbine	Leaflets : 3H ₂ O	240° (dec.)	–28.3° (Py)	B. HCl ; 312° (dec.) +37.6°	γ -Yohimbic acid, B. H ₂ O, 252° (dec.) ; +89.5 (Py).	Hahn and Schuch. ¹⁸
δ -Yohimbine	Prisms ; —	254°	–50° (Py)	B. HCl ; 288° (dec.) –18.6°	δ -Yohimbic acid, 253°, +1.6° (Py).	Heinemann. ¹⁹
<i>allo</i> Yohimbine	Leaflets ; 1 or 3 H ₂ O.	B. H ₂ O, 135–140° ; B. 3H ₂ O, 98–99° or 104–105°	–72.7° or –73.6° (Py)	B. HCl ; 275–279° (dec.), +30.3°	<i>allo</i> Yohimbic acid, B. H ₂ O, 248–250°, –79.5° (Py).	19
Yohimbene	Rhombic leaflets	276° (dec.)	+43.7° (Py)	B. HCl. 3H ₂ O ; 234° (dec.), –8.8°	Yohimbenic acid, B. 2H ₂ O, 230° (dec.) –17.1° (Py). Ethyl ester : 250–251°.	20
ψ -Yohimbine	Rhombic ; —	264–265°	+26.6° (Py)	B. HCl ; 258°	—	21
Corynanthine, ex <i>Pseudocinchona africana</i> , Chev.	Hexagonal ; 2H ₂ O	241–242° (dry)	–125° (A) –73° (Py)	B. HCl. 2H ₂ O ; 285°, –64°	Corynanthic acid, B. MeOH, 256–261° or 280° (dry), –58.0° (Py).	22
Paniculatine	B. 1.5, H ₂ O	—	–42° (A)	B. HCl ; +45.95° (H ₂ O)	—	6a

The remaining yohimbé alkaloids are described below: ten of them are isomerides of yohimbine, and for convenience of comparison are dealt with in the table on p. 502.

There is great similarity among the first three alkaloids in this table, and the suggestion has been made that they are identical, though α -yohimbine is lævorotatory and the other two are dextrorotatory. Also ethyl yohimbate has m.p. 190°, whilst ethyl *isoyohimbate* is usually stated to melt at 243°, though Wibaut and van Gastel¹⁶ recorded 202° for the ester monohydrate.

The data given in the table for corynanthine are due to Fourneau and Fiore.²² Raymond-Hamet²² later found that corynanthine on alkaline hydrolysis gave a dextrorotatory acid, which Scholz²² confirmed and identified its methyl ester as yohimbine and suggested that corynanthine is a stereoisomeride of yohimbine. Fourneau and Benoit²² have confirmed that corynanthine on acid hydrolysis gives *l*-corynanthic acid (m.p. 284°, $[\alpha]_D - 85.9^\circ$; pyridine), but on alkaline hydrolysis, even in the cold, some racemisation occurs and the resulting acid is of low lævotation. They also point out that both yohimbine and corynanthine yield yohimbone on dehydrogenation (*cf.*, p. 504) and are probably stereoisomerides.

Raymond-Hamet,⁴ as evidence for the validity of the genus *Pseudo-cinchona*, has shown that the bark of *P. africana* Chev. contains corynanthine and corynantheine (*see below*), but no yohimbine. Janot and Goutarel²² (1943) have recorded that corynanthine on acetylation furnishes a diacetyl derivative, $C_{21}H_{24}O_3N_2, Ac_2$, m.p. 194–5°, $[\alpha]_D - 105^\circ$ (pyridine) and a monoacetyl derivative, $C_{21}H_{25}O_3N_2, Ac(MeOH)$, m.p. 148°, $[\alpha]_D - 60^\circ$ (pyridine). The same authors have compared the ultra-violet absorption spectra of yohimbine, corynanthine, corynantheine and certain of their derivatives and find great similarity in the spectra of yohimbine and corynanthine, the corresponding acids and of acetylcorynanthine; such differences as are found are believed to result from the blocking of a hydroxyl group, *e.g.*, by methylation or acetylation.

The paniculatin mentioned in the foregoing table must not be confused with that found in *Acomitum paniculatum* (p. 674).

In addition to the natural isomerides of yohimbine listed in the foregoing table, several resulting from chemical reactions with yohimbine are known. Witkop¹¹ has described ϵ -yohimbine, $C_{21}H_{26}O_3N_2$, m.p. 203° (*dec.*), $[\alpha]_D^{20} + 29.8^\circ$ (pyridine) produced along with yohimbine, by the esterification with methyl alcohol of the yohimbic acid sulphuric acid ester described by Barger and Field.¹² The same author has called attention to the similarity of δ -yohimbine (*see table*) and the *l*-yohimbine, m.p. 253.4°; B. HCl, $[\alpha]_D^{20} - 27.2^\circ$, which Schomer (1927)¹¹ obtained as a transformation product of yohimbine. Witkop¹¹ has also described α -isoyohimbine, m.p. 304°, $[\alpha]_D^{20} + 53.2^\circ$ (acetic acid) to which the formula $C_{21}H_{24}O_3N_2, 2H_2O$ is assigned. It was produced in a catalytic hydrogenation experiment on apoyohimbine, $C_{21}H_{24}O_2N_2$, which resulted only in the addition of water. It hydrolyses to α -isoyohimbic acid, $C_{20}H_{22}O_2N_2, 1.5H_2O$,

m.p. 238°, and is converted by the action of acetic anhydride and fused sodium acetate into a new *apoyohimbine*, m.p. 230°.

Corynantheine. This alkaloid was found by Karrer and Salamon,²¹ along with ψ -yohimbine (table, p. 502) in residues from yohimbine manufacture, as an amorphous base, yielding a crystalline hydrochloride, $C_{22}H_{28}O_4N_2 \cdot HCl$, m.p. 205°, $[\alpha]_D + 12 \cdot 15^\circ$ (H_2O), soluble in chloroform. It was compared by Raymond-Hamet²³ with the alkaloid which Fourneau had found with corynanthine in *Pseudocinchona africana* (p. 500). The two hydrochlorides had m.p. 200° and $[\alpha]_D^{18} + 7 \cdot 6^\circ$ or $7 \cdot 2^\circ$ (MeOH). Both hydrochlorides were soluble in chloroform and gave blue colours with Fröhde's reagent and with Kiliani's reagent (ferric sulphate in sulphuric acid). Raymond-Hamet's results indicate that the purified hydrochloride has the composition, $C_{22}H_{28}O_3N_2 \cdot HCl \cdot xH_2O$ (x lies between 1 and 2). The alkaloid contains two methoxyl groups, and on alkaline hydrolysis yields corynantheic acid, $C_{21}H_{26}O_3N_2$, which crystallises from methyl alcohol, has $[\alpha]_D^{21} + 7 \cdot 53^\circ$ (MeOH) and contains one methoxyl group. Janot and Goutarel²² have confirmed Raymond-Hamet's results and have obtained crystalline corynantheine, $C_{22}H_{28}O_3N_2$, m.p. 115–6°, $[\alpha]_D^{20} + 28 \cdot 1$ to $28 \cdot 8^\circ$ (MeOH), yielding a hydrochloride, $[\alpha]_D^{20} + 43 \cdot 8^\circ$, and in their 1941 paper state that Raymond-Hamet has also prepared corynantheine hydrochloride, $[\alpha]_D + 40 \cdot 5^\circ$, from *Pseudocinchona pachyceras*.

Corynantheidine, $C_{22}H_{28}O_3N_2$. This isomeride of corynantheine was found by Janot and Goutarel (1944) in the residual, benzene-soluble alkaloids of *Pseudocinchona africana*.²² It was isolated as the picrate, m.p. 252°, $[\alpha]_D^{15} - 152^\circ$ (acetone). The base, $B \cdot COMe_2$, had m.p. 117°, $[\alpha]_D^{15} - 142^\circ$ (MeOH), or -165° (solvent-free, MeOH); $B \cdot HCl \cdot 2H_2O$, m.p. 213°, $[\alpha]_D^{15} - 128^\circ$ (MeOH), styphnate, m.p. 246°, $[\alpha]_D^{15} - 138^\circ$ ($COMe_2$).

Corynanthidine, $C_{21}H_{26}O_3N_2$. This fourth crystalline alkaloid of *Pseudocinchona africana*, and a new isomeride of yohimbine, was also isolated by Janot and Goutarel²² (1945–46), who point out that it resembles Lillig's α -yohimbine (table, p. 502). It has m.p. 243–4°, $[\alpha]_D^{12} - 11 \cdot 5^\circ$ (MeOH) or $-18 \cdot 3^\circ$ (pyridine), forms a hydrochloride, m.p. 288°, $[\alpha]_D^{12} + 57 \cdot 4^\circ$ (H_2O), a picrate, m.p. 231–2°, $[\alpha]_D^{12} + 6^\circ$ (acetone) and a monoacetyl derivative, m.p. 231–2°. On hydrolysis it furnishes corynanthidic acid, m.p. 322–3°, $[\alpha]_D^{12} + 48 \cdot 3^\circ$ (pyridine) and on selenium dehydrogenation yields yobyryne, tetrahydroyobyryne and ketoyobyryne. Oxidation by the Oppenauer process leads to a product different from the yohimbone yielded by yohimbine and corynanthine.

Constitution of Yohimbine and its Isomerides. The yohimbé alkaloids are methyl esters of acids. Yohimbine, yohimbene, *mesoyohimbine* (*isoyohimbine*) and γ -yohimbine (table, p. 502) are hydrolysed to four, distinct, monocarboxylic acids, $C_{20}H_{24}O_3N_2$, each of which on decarboxylation by heating with soda-lime yields "yohimbol,"²⁴ long supposed to be a secondary alcohol, $C_{19}H_{24}ON_2$, but which Witkop¹¹ has shown to be a ketone and has re-named *yohimbone*, $C_{19}H_{22}ON_2$, m.p. 307° (*dec.*),

$[\alpha]_D - 103.9^\circ$ to 105.8° (pyridine); it yields the following salts: B. HCl, m.p. 328° ; picrate, m.p. 171° ; B. MeI, H_2O , m.p. 286° (*dec.*); the 2:4-dinitrophenylhydrazone hydrochloride crystallises from methyl alcohol in needles, m.p. $> 300^\circ$. Witkop made a detailed study of the decarboxylation of yohimbic acid and found that the best yields of yohimbone are obtained under oxidising conditions, e.g., distillation with copper and copper oxide as used by Dewar and King,²⁴ or by the dehydrogenation of the acid, or yohimbine, by the action, under dry conditions, of aluminium phenoxide with cyclohexanone as reagent, and xylene as solvent (Oppenauer process). When the latter process is applied to isoyohimbine or γ -yohimbine, yohimbone is also produced, but yohimbene, or yohimbenic acid, yields a new ketone isomeride, *yohimbenone*, $C_{19}H_{22}ON_2$, m.p. 268° (*dec.*), giving a 2:4-dinitrophenylhydrazone hydrochloride, m.p. 280° (*dec.*). The structural difference between yohimbine and yohimbene appears therefore to remain during the Oppenauer process, but to disappear under distillation with soda-lime at 350° , as the acid from each of these alkaloids then yields yohimbone. The latter, on reduction by aluminium isopropoxide in isopropyl alcohol and xylene, gives the true yohimbol, $C_{19}H_{24}ON_2$, m.p. 243° (*dec.*), $[\alpha]_D^{20} - 63.4^\circ$ (EtOH), characterised as hydrochloride, B. HCl, $0.5H_2O$, m.p. 291° ; $[\alpha]_D^{20} - 51.5^\circ$; (MeOH), methiodide, m.p. 282° , and methochloride, m.p. 259° (*dec.*); it is accompanied by the *trans*-isomeride, *epiyohimbol*, m.p. 258° , $[\alpha]_D - 80.1^\circ$ (MeOH), the proportion of which increases with the duration of the experiment.

*allo*Yohimbine and the corresponding acid yield "*alloyohimbol*," now also known to be a ketone and re-named *alloyohimbone*, $C_{19}H_{22}ON_2$, m.p. 230° (*dec.*), $[\alpha]_D^{18} + 144.6^\circ$ (pyridine); it gives a 2:4-dinitrophenylhydrazone hydrochloride, m.p. 264° (*dec.*). α -Yohimbine and corynanthine yield neither yohimbone nor *alloyohimbone*, and α -isoyohimbic acid is unchanged by the Oppenauer process.

By heating yohimbic acid with thallium hydroxide at $300^\circ/0.1$ mm., Witkop obtained *deoxyyohimbol*, $C_{19}H_{24}N_2$, m.p. 149° , $[\alpha]_D^{20} - 24.8^\circ$ (pyridine). When soda-lime was used at 330° the chief product was tetrahydroyobyrine, $C_{19}H_{20}N_2$, m.p. 167° ; B. HCl, m.p. 236° , a substance first obtained by Mendlik and Wibaut²⁵ by selenium dehydrogenation of any of the four yohimbine isomerides yielding yohimbone. In this reaction it was accompanied by yobyrine and ketoyobyrine. *Yobyrine*, $C_{19}H_{16}N_2$, m.p. $217-8^\circ$, is optically inactive and shows a blue fluorescence in acid solution; the hydrochloride has m.p. 271° (*dec.*) and the picrate, m.p. 239° (*dec.*). Tetrahydroyobyrine is dehydrogenated by platinum black at 280° to 2-(3-isoquinolyl)-3-ethylindole, m.p. 128° , but this process leaves yobyrine unchanged. The latter is hydrogenated, in presence of platinum oxide as catalyst, to *hexahydroyobyrine*, $C_{19}H_{22}N_2$, m.p. 197° . The presence of a reactive methylene group in yobyrine is indicated by its capacity for condensing with aldehydes, e.g., with paraldehyde in presence of sodium ethoxide to give *ethylideneyobyrine*, $C_{21}H_{18}N_2$, m.p. 298° . With chromic acid or selenium dioxide yobyrine is oxidised to *yobyrone*, $C_{16}H_{14}ON_2$,

m.p. 185°. The third product of the selenium dehydrogenation of yohimbine, *viz.*, *ketoyohimbine*, $C_{20}H_{16}ON_2$, has m.p. 330° (*dec.*).

Barger and Field¹² showed that when the sulphuric acid ester of yohimbine is hydrolysed with alkali it yields (a) *yohimbic acid sulphuric ester*, $C_{20}H_{24}O_6N_2S$, $0.5H_2O$, m.p. 289° (*dec.*) of which the hydrochloride has m.p. 308° (*dec.*) and (b) *apoyohimbine*, $C_{21}H_{24}O_2N_2$. The latter crystallised from ethyl alcohol has m.p. 252°, but from methyl alcohol it retains one molecule of solvent and then melts at 187°; the hydrochloride has m.p. 299–300° (*dec.*). Each of these products can be hydrolysed to *apoyohimbic acid*, $C_{20}H_{22}O_2N_2$, m.p. 306° (*dec.*). On esterification with methyl alcohol this acid regenerates some *apoyohimbine*, but also produces an isomeride of *apoyohimbine*, which becomes yellow at 160° and decomposes at 201°; and a substance, m.p. 228°, of uncertain formula which appears to contain an *apoyohimbine*, identical with that, m.p. 230°, formed by the action of acetic anhydride on *α-isoyohimbine* (p. 503). Lead tetracetate oxidises *apoyohimbine* to *tetrahydroyohimbinecarboxylic acid*, $C_{20}H_{20}O_2N_2$, H_2O , m.p. 286° (*dec.*), $[\alpha]_D^{20} + 217.6^\circ$, which, in turn, is oxidised by selenium dioxide in pyridine to *tetrahydroyohimbinecarboxylic acid*, isolated as the hydrochloride, $C_{20}H_{18}O_3N_2$, HCl, 0.5 or $1H_2O$, m.p. 244° (*dec.*).

The empirical relationships of these proximate derivatives of yohimbine may be summarised as follows:—

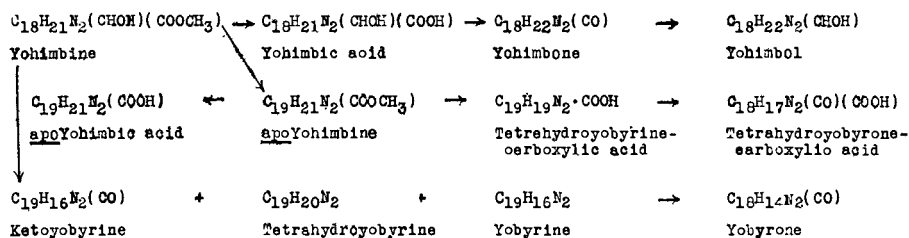

The first indication of the nature of the nuclear structure of yohimbine was secured by Barger and Field,¹² (1915) who, by distilling the alkaloid with soda-lime, obtained a base, $C_{10}H_{12}N$ (m.p. 56°; picrate, m.p. 157°), which was believed to be either an ethyl- or a dimethyl-indole. It was later prepared by Warnat²⁶ from yohimbic and *alloyohimbic* acids, and by Winterstein and Walter,²⁷ but though various isomerides were synthesised for comparison by Warnat and by Mendlik and Wibaut,²⁸ it has not yet been identified. Indications of an indole nucleus were also provided by Warnat's observation²⁹ that *o*-hydroxyphenylcarbimide, an indole-carboxylic acid (m.p. 197–200°) and a dicarboxylic acid, which Späth and Bretschneider³⁰ identified as *N*-oxalyanthranilic acid (I) are formed by the permanganate oxidation of yohimbine. Similarly, Hahn and Just³¹ obtained 6-nitroindazole-3-carboxylic acid (III) by the oxidation of *ON*-diacetylyohimbine with nitric acid with, no doubt, the action of nitrous acid on *o*-aminophenylacetic acid as an intermediate step as shown in (II). More important is the base, $C_{13}H_{12}N_2$, obtained by Warnat³² by the

distillation of yohimbic acid, accompanied by a second base, $C_{12}H_{10}N_2$, according to Winterstein and Walter,²⁸ when yohimbine is distilled with zinc dust, or with steam at 300° in presence of alkali. Barger and Scholz³³ were able to show that the base, $C_{13}H_{12}N_2$, is really $C_{12}H_{10}N_2$, has m.p. 232° , and is harman (p. 490), and that is probably also true of the base $C_{12}H_{10}N_2$ (picrate, m.p. $240-250^\circ$) obtained by Winterstein and Walter. These degradations may be illustrated by the following formulæ:—

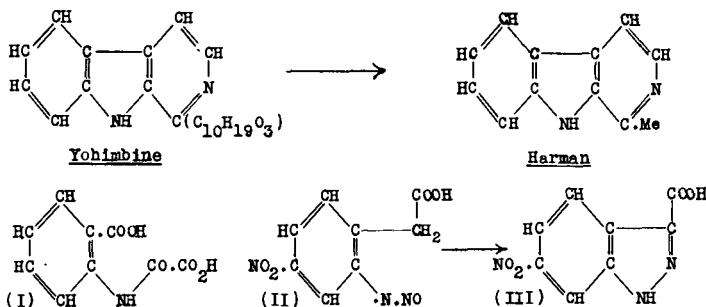

The production of harman accounts for about three-fifths of the molecule of yohimbine. The remainder is represented by other fragments recorded by various workers as products from reactions with yohimbine or its proximate degradation products. They include succinic acid, *o*-toluic acid, *m*-toluic acid, *o*-phthalic acid, 2:3-dimethylbenzoic acid (XIII) and berberonic acid (X), the specific sources of which will be referred to later. Taking these fragments into account, Barger and Scholz³⁴ proposed formula (IVa) for yobyryne, which they regarded as a skeletal structure for yohimbine. Witkop¹¹ has critically reviewed the chemistry of yohimbine and provided new experimental evidence, which necessitates modifications in the formulation of certain of the yohimbine degradation products. He proposes formula (IVb) for yobyryne on the ground that this base behaves as an unreduced substance. The reactivity of the methylene group at C^{14} is regarded as that of an α -substituent in a pyridine ring. The new formula accounts equally well for Scholz's observation³⁵ that yobyryne is oxidised by sodium dichromate in acetic acid to phthalic acid (ex ring E), *o*-toluic acid (ex ring E) and yobyryne. Witkop represents yobyryne as (V), which accounts satisfactorily for Scholz's finding that it is hydrolysed by potassium hydroxide in amyl alcohol, giving as one product an amphoteric acid, m.p. 255° , which Witkop regards as *nor*-harman-3-carboxylic acid (XII with $\cdot COOH$ at C^3). "Tetrahydroisoquinoly]-3-ethylindole (VI), this constitution having been established for it by Scholz,³⁵ who found that it is oxidised by ozone or chromic acid to a substance, $C_{19}H_{20}O_2N_2$, m.p. 154.5° , which, since it is hydrolysed by 10 N-sulphuric acid, to *o*-aminopropiophenone (VIII) and 5:6:7:8-tetrahydroisoquinoline-8-carboxylic acid (IX) and by nitric acid to berberonic acid (X) is represented by (VII). The other important

degradation product of yohimbine, *viz.*, ketoyobyrine, is formulated by Witkop as (XI), which accounts for its hydrolysis by potassium hydroxide to *norharman* (XII) and 2 : 3-dimethylbenzoic acid (XIII) (Mendlik and Wibaut,²⁵ 1931; Barger and Scholz³⁴). In 1935 Scholz³⁵ proposed for yohimbine a formula identical with (XIV), with the exception that the .CHOH group was at C¹⁴. It is placed at C¹⁷ in (XIV) as recent evidence favours that position. The location of the carbomethoxy group in yohimbine is indicated by the formation of 2 : 3-dimethylbenzoic acid (XIII) from ketoyobyrine (XI) and by the work of Hahn, Kappes and Ludwig,³⁶ whose conclusions have however been somewhat modified in detail by Witkop.¹¹ These authors found that yohimbine is dehydrogenated by lead tetracetate to dehydrohydroxyacetylyohimbic acid, C₂₂H₂₄O₅N₂, m.p. 350–5°, [α]_D²⁰ + 391.7° (dilute acetic acid) or, under suitable conditions, to tetrahydroyohimbine (XV), C₂₁H₂₂O₃N₂, m.p. 248–250° (*dec.*), [α]_D²⁰ + 229.4° (dilute acetic acid), which can be hydrolysed to tetrahydroyohimbic acid (XV; Me → H), C₂₀H₂₀O₃N₂ · 2H₂O, m.p. 230–5°, [α]_D²⁰ + 247.4° (dilute acetic acid), and this, on boiling with

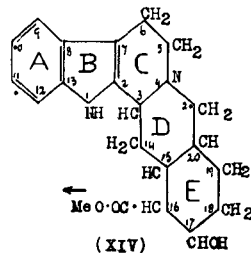
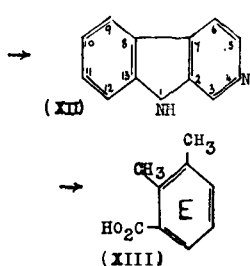
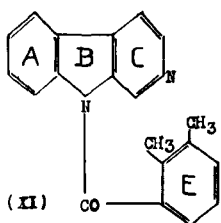
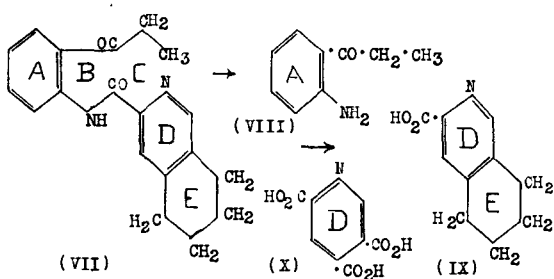
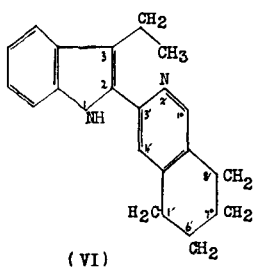
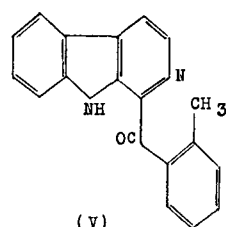
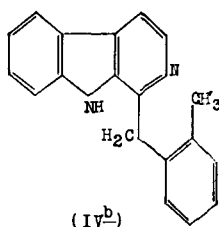
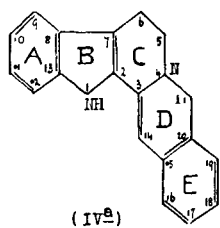

potassium hydroxide in amyl alcohol, gives harman (XVII) and *m*-toluic acid (XVIII).

Witkop¹¹ applied the lead tetracetate process to *apoyohimbine*, $C_{21}H_{24}O_2N_2$, and obtained "tetrahydro*apoyohimbic acid*," $C_{20}H_{20}O_2N_2 \cdot H_2O$, m.p. 286° (*dec.*), $[\alpha]_D + 217.6^\circ$ (EtOH). This is fluorescent in alcohol containing a little mineral acid and yields a hydrochloride, B. HCl, $2H_2O$, m.p. 303° (*dec.*), $[\alpha]_D^{20} + 307.3^\circ$ (EtOH) which also shows a blue fluorescence in alcohol. Pruckner and Witkop³⁷ compared the absorption spectra of yohyrine (IVb) and "tetrahydro*apoyohimbic acid*" with that of the "tetrahydroyohimbic acid" of Hahn *et al.* (*see above*) and found all three so similar that they must be regarded as similarly constituted. Witkop¹¹ therefore proposes to make the following descriptive changes: "Tetrahydroyohimbic acid," $C_{20}H_{20}O_3N_2 \cdot 2H_2O$ (XV, Me \rightarrow H) becomes hexahydroxyyohyrine-carboxylic acid, $C_{20}H_{22}O_3N_2 \cdot H_2O$ (XVI) and "tetrahydro*apoyohimbic acid*," $C_{20}H_{20}O_2N_2 \cdot H_2O$ becomes tetrahydroyohyrinecarboxylic acid (XIX) with unchanged empirical formula. These changes in formulation do not affect the main conclusion reached by Hahn, Kappes and Ludewig that the final formation of harman (XVII) and *m*-toluic acid (XVIII) from yohimbine in this series of operations indicates C¹⁶ as the position of the carbomethoxy group in the parent alkaloid as suggested by Scholz (XIV).

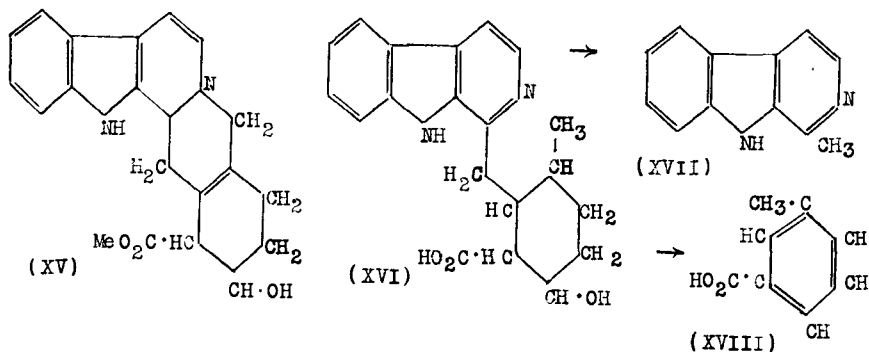

Hahn and Werner³⁷ pointed out that this hydrolysis of "tetrahydroyohimbic acid" to harman and *m*-toluic acid implies that carbon atom 14 appears as the methyl group of harman (XVII), and carbon atom 21 as the methyl group of *m*-toluic acid (XVIII), and that this precludes carbon atom 14 as the site of the hydroxyl group, as suggested by Scholz. They preferred to place it at 17 with 18 or 19 as other possible positions. In support of this view they condensed *m*-hydroxyphenylpyruvic acid with tryptamine hydrochloride and decarboxylated the product to 3-*m*-hydroxybenzyl-3 : 4 : 5 : 6-tetrahydronorharman (XX). This reacts with formaldehyde, forming a product which, on treatment with alkali, gives a hexadecydroyohimbol (XXI). When in this series of operations *m*-hydroxyphenylpyruvic acid is replaced by the *p*-isomeride, the formaldehyde condensation fails, and it is argued that as this is a

synthesis under biological conditions, it probably represents what occurs in the plant, and therefore provides evidence in favour of carbon atom 17 as the location of the hydroxyl group. The views as to the mechanism of the reaction were modified in a later paper by Hahn and Hansel³⁷ describing the synthesis of 5 : 6 : 3 : 14-tetrahydroxybyrine.

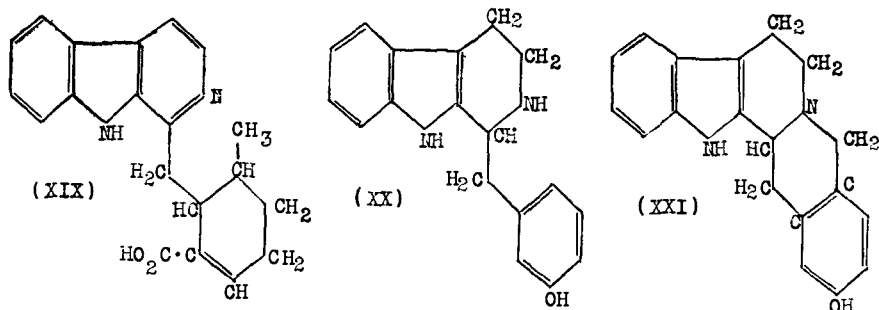

Other contributions to this discussion have been made by Harvey, Miller and Robson,¹⁴ and by Dewar and King,²⁴ and important additional experimental evidence for the location of the .CHOH group at C¹⁷ has been provided by Witkop,¹¹ who explains the improvement in the yield of yohimbone, which occurs when the decarboxylation of yohimbic acid takes place under oxidising conditions, as due to the primary formation of a β -ketocarboxylic acid, which is readily decarboxylated. This may be represented, using part of the yohimbine formula (XIV), as follows :—

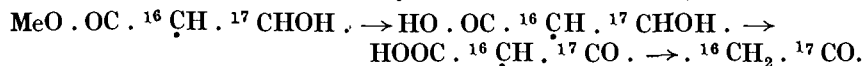

The same author has shown by repetition of the early experiments already referred to (p. 507) that when yohimbine hydrochloride is distilled with zinc dust there is formed in addition to harman (XVII), *p*-cresol, which must originate from ring E of the yohimbine formula (XIV) by inclusion of C²¹ as the methyl group. Witkop's formula for yobyryne (IVb) received prompt confirmation by Clemo and Swan's synthesis³⁸ of this base by condensing *o*-tolylacetic acid with tryptamine to 3-[β -(*o*-tolylacetamido)-ethyl]-indole (XXII), which was cyclised by treatment with phosphoryl chloride and the product dehydrogenated in presence of palladium black at 180°, giving a base, m.p. 216–7°, which proved to be yobyryne. The latter was also obtained by dehydrogenation of 7 : 8-benzo-1 : 2-(2' : 3'-indolo)-3 : 4 : 6 : 9-tetrahydropyridocoline, synthesised by a complex series of reactions. A similar synthesis of yobyryne has been effected by Julian,

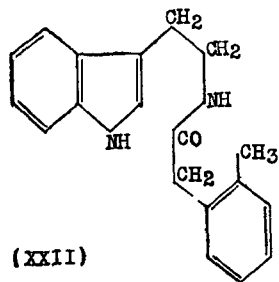

Karpel, Magnani and Meyer,³⁸ who have also shown that the dihydroyobyryne [2-(*o*-methylbenzyl)-4 : 5-dihydro- β -carboline], C₁₉H₁₈N₂, m.p. 178–9°, formed in the penultimate stage of this synthesis undergoes

atmospheric oxidation to yobyronine, which Clemo and Swan also prepared by refluxing their synthetic yobyryne with selenium dioxide in xylene. Julian *et al.* have also synthesised the so-called "tetrahydroyobyryne" (VI) by condensing 3-carboxy-5:6:7:8-tetrahydroisoquinoline with propyllithium to 3-butyryl-5:6:7:8-tetrahydroisoquinoline, $C_9H_{10}N.CO.CH_2.CH_2.CH_3$, which in the Fischer indole synthesis produced "tetrahydroyobyryne," *i.e.*, 2-[3'-(5:6:7:8-tetrahydroisoquinoly)]-3-ethylindole.

The general problem of the mechanism of dehydrogenation in the yohimbine series has been discussed by Janot and Goutarel³⁸ and by Julian, Magnani, Piki and Karpel.³⁸

QUEBRACHO ALKALOIDS. Quebracho, from quebrahacho (axe-breaker), is the name used in Argentina for the barks of several hard-wood trees, distinguished as "blanco," "colorado," "palarosa," etc. The three mentioned all yield alkaloids, but quebracho blanco and palarosa belong to the botanical family Apocynaceæ, are derived from *Aspidosperma quebracho* Schlecht, and are only of interest for the alkaloids they contain, whereas "quebracho colorado" is collected from *Quebrachia (Loxopterygium) Lorentzii* Griseb. (Anacardiaceæ) and though it contains alkaloids (p. 782) is mainly of interest as a source of tanning extract. In this account quebracho bark will be taken to mean the bark of *Aspidosperma quebracho* Schlecht and its varieties. Alkaloids have also been isolated from "payta bark" (*Aspidosperma* sp.) and are known to occur in *A. polyneuron*,³⁹ Müll-Arg. while the bark of *A. quirandy*, Hassler, according to Floriani, contains aspidospermine, aspidosamine and two other alkaloids, *haslerine*, m.p. 237°, and *quirandine*, m.p. 218°, with four more which have not been completely separated.⁴⁰

Floriani has recently examined bark from *Aspidosperma quebracho blanco* Schlecht f. *pendula* Spæg, in which he found the known alkaloids, quebrachine (yohimbine) and aspidospermine, as well as Hesse's aspidosamine, $C_{20}H_{28}O_2N_2$, and a new base, *aspidospermicine*, $C_{17}H_{24}ON$, 1.5H₂O (1938),⁴⁰ Hartmann and Schlittler⁴¹ have shown that the alkaloid "vallesine" from *Vallesia glabra* (Apocynaceæ) is aspidospermine, and this has been confirmed by Deulofeu *et al.*,⁴¹ who have also found it in *V. dichotoma*. Later Schlittler and Rottenberg by chromatographic analysis of the mother liquors of aspidospermine isolated a second alkaloid for which they used the old name *Vallesine* (1948).⁴¹

Quebracho bark was first examined by Fraude,⁴² who isolated aspidospermine, and later by Hesse,⁴³ who obtained quebrachine (yohimbine) and four other bases, aspidosamine, aspidospermatine, m.p. 162°, $[\alpha]_D - 72.3^\circ$, hypoquebrachine and quebrachamine, of which the last has been confirmed by other workers; the first and third, according to Ewins,⁴⁴ are possibly decomposition products of aspidospermine. In the course of an investigation of this alkaloid Ewins isolated two unnamed bases. One of these, m.p. 149–150°, is probably quebrachamine⁴⁵; the other crystallises from ethyl acetate in octahedra, m.p. 176–7°.

Aspidospermine, $C_{22}H_{30}O_2N_2$, crystallises from alcohol in needles, m.p. 208°, b.p. 220°/1–2 mm., $[\alpha]_D^{18} - 99^\circ$ (EtOH), -98° (CHCl₃). It is

feebly basic and does not form crystalline salts. It dissolves unchanged in cold sulphuric acid, but addition of potassium dichromate produces a brown coloration changing to green: perchloric acid gives a rose-red colour and aldehydes such as piperonal or vanillin give a violet colour in presence of hydrochloric or sulphuric acid. The alkaloid contains one methoxyl group, and no evidence of a methylimino group could be got by the Herzig-Meyer method, but the residue from this reaction contains a new base, ASPIDOSINE, $C_{19}H_{26}ON_2$, which crystallises from alcohol in rectangular prisms or plates, m.p. 236–244·5°, $[\alpha]_D - 16^\circ$ (EtOH), and gives intense colour reactions, rose-red with sulphuric acid, greenish-blue with ferric chloride, and deep orange-red with sulphuric followed by nitric acid. The hydriodide, B. III, crystallises from hot water in octahedra, m.p. $> 280^\circ$.

When boiled with dilute hydrochloric acid, aspidospermine evolves one molecule of acetic acid forming DEACETYLASPIDOSPERMINE, $C_{20}H_{28}ON_2$, needles, m.p. 110–1°, b.p. 210°/1–2 mm., $[\alpha]_D + 2\cdot8^\circ$ (EtOH). In sulphuric acid it gives with nitric acid a violet, with potassium dichromate a deep brownish-purple colour, and with ferric chloride a deep magenta tint. The hydriodide, B. 2HI, crystallises from hot dilute hydriodic acid in rectangular prisms, m.p. 235–243°, and is very sparingly soluble in water. The benzoyl derivative forms rhombs, m.p. 186–7° from alcohol, and the dimethiodide, $C_{20}H_{28}ON_2$, 2MeI, octahedra, m.p. 176–7°. On acetylation the deacetyl base is reconverted into aspidospermine. With nitrous acid it forms a nitro-nitroso derivative, $C_{20}H_{26}O_4N_4$, m.p. 155–160° (*dec.*), which boiling hydriodic acid converts into aspidosine (*see above*). On oxidation with chromic acid, aspidospermine yields a new base, $C_{15}H_{24}O_2N_2$, crystallising from ethyl acetate in stout prisms, m.p. 192–3°.

Ewins suggests that deacetylaspidospermine is a secondary-tertiary base, and that aspidospermine is a derivative of a reduced quinoline.

Quebrachamine, $C_{19}H_{26}N_2$. According to Field,⁴⁵ this alkaloid forms rhombohedral leaflets from dry alcohol, has m.p. 147°, $[\alpha]_D - 109\cdot5^\circ$ (acetone), and can be distilled in a high vacuum at about 240–250°. The sulphate, B. $H_2SO_4 \cdot 2H_2O$, forms prisms, sparingly soluble in cold water: the oxalate, B. $H_2C_2O_4$, has m.p. 217°; the picrate occurs in two forms, yellow and red, m.p. 195–6°. The base yields a monomethiodide, m.p. 234°, and a methosulphate, P. Me_2SO_4 , m.p. 235°. On oxidation with nitric acid it gives a small yield of picric acid. Quebrachamine is unaffected by cold sulphuric acid, but develops a blue colour on further addition of a trace of an oxidising agent: it gives colour reactions (a) purple, (b) violet, or (c) blue, with (a) Ehrlich's reagent, (b) vanillin and hydrochloric acid and (c) Hopkins-Adamkiewicz reagent respectively. It behaves as a monoacidic, tertiary base. The second nitrogen atom may be present as an imino-group, while the scarlet picrate and the colour reaction with Ehrlich's reagent may indicate the presence of an indole group.

Vallesine, $C_{20}H_{26}O_2N_2$, m.p. 154–6°, sublimes at 130°/0·05 mm., crystallises from acetone or ether in asbestos-like clusters of needles and has $[\alpha]_D^{24} - 91^\circ \pm 2$ (EtOH). The hydrochloride, B. HCl, has m.p. 247–

251° and the oxalate, B. $\text{H}_2\text{C}_2\text{O}_4$, m.p. 233–4° (*dec.*). The second nitrogen is present as an N-formyl group and is neutral. The base does not give an Ehrlich colour reaction; it contains one methoxyl, one methyl joined to carbon but no methylimino group or replaceable hydrogen (Zerewitinoff). It does not hydrogenate and on hydrolysis by standing in 2N-hydrochloric acid it yields deformylvallesine, $\text{C}_{19}\text{H}_{26}\text{ON}_2$, which closely resembles deacetylaspidospermine, $\text{C}_{20}\text{H}_{28}\text{ON}_2$, in physical constants. It has m.p. 107–8°, $[\alpha]_D^{24} + 7^\circ \pm 2^\circ$, forms a dihydriodide B. 2HI, m.p. > 280°, and on treatment with formylacetic anhydride reconstitutes vallesine. The residues from the crystallisation of deformylvallesine from *n*-pentane on similar treatment with formylacetyl anhydride gave a formyl derivative, m.p. 148–154°, from which a hydrochloride, $\text{C}_{21}\text{H}_{28}\text{O}_2\text{N}_2 \cdot \text{HCl}$, m.p. 245–250° (*dec.*), resembling vallesine hydrochloride, and apparently identical with formyldeacetylaspidospermine hydrochloride, was prepared. Acetyldeformylvallesine had m.p. 208–210° and $[\alpha]_D^{22} - 107^\circ \pm 2^\circ$ (EtOH). It is physically indistinguishable from aspidospermine but satisfactory combustion results could not be obtained. On treatment with benzoyl chloride in benzene deformylvallesine yields a normal benzoyl derivative, $\text{C}_{26}\text{H}_{30}\text{O}_2\text{N}_2$, m.p. 187–190°, and a neutral substance $\text{C}_{26}\text{H}_{34}\text{O}_4\text{N}_2$, m.p. 203–5°, in which deformylvallesine seems to have been benzoylated and also to have absorbed the elements of two molecules of water (1948).⁴¹

PAYTA BARK. From this material Hesse⁴⁶ isolated two alkaloids *paytamine*, $\text{C}_{21}\text{H}_{24}\text{ON}_2$, amorphous and distinguished from its associated base by not being precipitated from solution by potassium iodide, and *paytine*, $\text{C}_{21}\text{H}_{24}\text{ON}_2 \cdot \text{H}_2\text{O}$. The latter crystallises from alcohol, has m.p. 156°, $[\alpha]_D - 149.5^\circ$, and yields a crystalline hydrochloride, B. HCl, prisms from hot water: with perchloric acid it gives a magenta red colour.

Pharmacological Action. Yohimbine lowers blood pressure, increases the depth and frequency of respiratory movements and in toxic doses paralyses respiration, death being due to this cause in mammals, the heart remaining active for some time longer. It possesses local anaesthetic properties and resembles ergotoxine and ergotamine in sympatholytic action.⁴⁷ Though quebrachine has been shown to be identical with yohimbine, differences in pharmacological action have been noted.⁴⁸ The other alkaloids of the group are stated to resemble yohimbine qualitatively in action, but Raymond-Hamet has observed differences in the action of aspidospermine.⁴⁹ According to Edmunds and Gunn,⁵⁰ yohimbine is the most active of the group, closely followed by aspidospermine; quebrachamine and aspidosamine are less potent. Kreitmair⁵¹ found α -yohimbine less toxic than yohimbine, equally potent as a local anaesthetic and similar in action on the genital organs of the dog. Various authors⁵² have stated that yohimbine exerts no oestrogenic activity. Rothlin and Raymond-Hamet⁵³ showed that β -, δ -, *meso*- and *allo*-yohimbines, yohimbene, corynanthine and corynantheine are all to be regarded as true sympatholytic agents and that in this respect corynanthine is more active and much less toxic than yohimbine. Raymond-Hamet also found that

corynanthine is more active on the genital organs of the dog⁵⁴ and that on the rabbit cornea, the local anæsthetic action of yohimbine, cocaine and corynanthine is of the order 2 : 1 : 0.25.⁵⁵ Paris, Janot and Goutarel state that corynantheidine is as effective in sympatholytic action as either corynanthine or corynantheine, and less toxic than the former, the M.L.D. being 0.55g./kg./mouse, against 0.25g./kg./mouse for corynanthine by subcutaneous injection.^{55(a)}

Hesse and Langer⁵⁶ say that as a vasodilator yohimbine is the most potent, followed by β - and α -yohimbines, yohimbene and *alloyohimbine* in descending order. Yohimbine is principally used in veterinary medicine as an aphrodisiac.⁵⁷

The sympatholytic activity of yohimbine, as indicated by its reversal of the action of adrenaline, has attracted much attention from pharmacologists, particularly in regard to effects on blood pressure.⁵⁸ Much work has also been done on the influence of alkaloids of the yohimbine group on other responses to adrenaline.⁵⁹ Yonkman, Stilwell and Jeremias⁶⁰ have pointed out that some of these responses may be lost by the action of sympathetic depressants, such as yohimbine, but may still persist under electrical stimulation; with larger doses of the depressant drug electrical stimulation may also fail to evoke response. These two conditions are spoken of as adrenergic and sympatholytic respectively. Thus in their experiments on cats, anæsthetised by urethane, it was found that yohimbine and ethilyohimbine are adrenergic for the submaxillary salivation effect at doses of 2 to 7 mgm. per kilo. of body weight, and are sympatholytic for the same response at 4 mgm./kilo and 6 mgm./kilo respectively for the two drugs. For sympatholysis of the nictitating membrane response, the necessary doses are yohimbine hydrochloride 28 mgm./kilo or ethilyohimbine hydrochloride 15 mgm./kilo. The ethilyohimbine used in these experiments was the least toxic of a series of yohimbic acid esters tried by Chase, Yonkman and Young⁶¹ in relaxation experiments on arterial muscle contracted by adrenaline or ephedrine. The series included the allyl, allylamine, butyl, phenyl and diethylaminoethyl esters, all of which acted as antisymphathetic agents like yohimbine itself. According to Raymond-Hamet, the diacetylation of corynanthine or yohimbine has little effect on their power to invert hypertension induced by adrenaline. As a vasodilator diacetylyohimbine is about as effective as the parent alkaloid and is less toxic,⁶² but according to Janot, Bovet and Montezin the mono- and diacetyl derivatives are respectively two and five times as potent as the parent base.⁶² Sympatholytic activity is also shown by deoxyyohimbol and by Hahn's synthetic hexahydroyohimbol.⁶³

Witkop¹¹ tested in frogs for curarising action, quaternary derivatives of yohimbine, *apoyohimbine*, yohimbine sulphuric acid ester, deoxyyohimbine, yobyryne, 2-(3'-tetrahydroisoquinoline)-3-ethylindole, harmine and harmaline. The methiodides were usually sparingly soluble and methochlorides proved more suitable for tests. They were either inactive or feebly active, a dose of 500 γ being required in most cases to produce an effect. The most active of the series was 2-(3'-tetrahydro-

isoquinoline)-3-ethylindole methochloride, which at a dose of 200 γ produced complete paralysis. Raymond-Hamet⁶⁴ found that yohimbine methiodide, in doses 50 to 100 times as great as the dose of yohimbine hydrochloride, necessary to produce complete inhibition, hardly affected the hypertension response, but did suppress the renal vasoconstrictive action of moderate doses of adrenaline.

A number of substances having sympatholytic properties have been synthesised and of these several have been submitted to detailed pharmacological investigation, notably 3-diethylaminomethylbenzodioxan⁶⁵ (F883), piperidinomethylbenzodioxan⁶⁶ (F933) and N:N-dibenzyl- β -chloroethylamine.⁶⁷ A comparative study of sympatholytic drugs has been made by King.⁶⁷

REFERENCES

- (1) *Chem. Zeit.*, 1896, 20, 970; 1897, 21, 833; 1899, 23, 59, 81; *Ber.*, 1903, 36, 169; 1904, 37, 1759; 1905, 38, 2825; 1915, 48, 2077, 2084; 1916, 49, 1086; 1926, 59, 2706; cf. DANCKWORTT and LUY, *Arch. Pharm.*, 1924, 262, 81. For a résumé of literature on yohimbé bases see JORIO, *Ann. Chim. Farm.*, 1939, 50. (2) *Bull. Sci. Pharmacol.*, 1914, 21, 7. (3) SPIEGEL, *Ber.*, 1915, 48, 2077, 2084; EWINS, *J. Chem. Soc.*, 1914, 105, 2738; Filippi, *Arch. Farmacol. sperim.*, 1917, 23, 107, 129; HAHN, *Ber.*, 1927, 60, 1681; WARNAT, 1931, 64, 1408. (4) BRANDT, *Arch. Pharm.*, 1922, 260, 49; cf. SMALL and ADAMS, *Pharm. J.*, 1922, [iv], 54, 282, 311; RAYMOND-HAMET, *Rev. bot. appl. agr. trop.*, 1939, 19, 564; *Compt. Rend.*, 1941, 212, 305; JANOT and GOUTAREL, *ibid.*, 1945, 220, 617; *Bull. Soc. Chim.*, 1946, 535. (5) HERZOG, *Ber. Deut. pharm. Ges.*, 1905, 15, 4; *Pharm. Zent.*, 1908, 48, 967, 983; SMALL and ADAMS, *Pharm. J.*, 1922 [iv], 54, 283. (6) (a) *J. Pharm. Chim.*, 1934, [viii], 19, 209; cf. *Bull. Sci. Pharmacol.*, 1926, 32, 21; 1937, 44, 54; (b) *Bull. Soc. Pharm. Bordeaux*, 1906, 45, 203; (c) *Quart. J. Pharm.*, 1939, 12, 174. (7) *Ber. Deut. pharm. Ges.*, 1897, 7, 279; (8) *Pharm. Zeit.*, 1925, 70, 864. (9) *Chem. Zeit.*, 1927, 51, 469. (10) "Die Fabrikation der Alkaloide," 1927, p. 89. (11) See also SCHOMER, *Pharm. Zent.*, 1921, 62, 169; 1922, 63, 385; *Arch. Pharm.*, 1927, 265, 509; BRANDT, *ibid.*, 1922, 260, 49; VOGTHERR and KING, *Pharm. Zeit.*, 1923, 68, 447; WITKOP, *Annalen*, 1943, 554, 83 (with PRUCKNER), *ibid.*, p. 127. (12) BARGER and FIELD, *J. Chem. Soc.*, 1915, 107, 1025; 1923, 123, 1038; FIELD, *ibid.*, 1923, 123, 3004; *Ber.*, 1927, 60, 1009. Series of yohimbic acid esters are also described by WORRALL, *J. Amer. Chem. Soc.*, 1933, 55, 3715; 1935, 57, 900. (13) *Mikrochem.*, 1928, 6, 113; MARTINI, *ibid.*, 1939, 26, 227. (14) *Anal. Farm. Biochim.*, 1932, 3, 51; cf. PESEZ, *J. Pharm. Chim.*, 1935, [viii], 22, 164; SHANER and WILLARD, *Mikrochem.*, 1936, 19, 222; SANCHEZ, *Analyst*, 1939, 64, 688; HARVEY, MILLER and ROBSON, *J. Chem. Soc.*, 1941, 153. (15) SPIEGEL, *Chem. Zeit.*, 1899, 23, 59, 81; *Ber.*, 1903, 36, 169; 1904, 37, 1759; 1905, 38, 2825; FOURNEAU and PAGE, *Bull. Sci. Pharmacol.*, 1914, 21, 7; HAHN, *Ber.*, 1927, 60, 1681; (with BRANDENBERG), *ibid.*, pp. 669, 707; (with JUST), 1932, 65, 715; WARNAT, *ibid.*, 1930, 63, 2959; 1931, 64, 1408. (16) SPIEGEL, *Ber.*, 1915, 48, 2077; 1926, 59, 2706; WARNAT, *ibid.*, 1926, 59, 2388; 1927, 60, 1118; 1931, 64, 1408; HAHN (with BRANDENBERG), *ibid.*, 1927, 60, 669, 709; (with STENNER), 1928, 61, 278; (with SCHUCH), *ibid.*, 1929, 62, 2953; 1930, 63, 1638, 2961; (with JUST), 1932, 65, 715; WIBAUT and VAN GASTEL, *Rec. trav. chim.*, 1936, 54, 85. (17) LILLIG, *Merck's Jahresb.*, 1928, 42, 20; *Ber.*, 1930, 63, 2680; HAHN and SCHUCH, *Ber.*, 1930, 63, 1641, 2961; HEINEMANN, *ibid.*, 1934, 67, 15. (18) HAHN and SCHUCH, *ibid.*, 1930, 63, 1638; HAHN and JUST, *ibid.*, 1932, 65, 714; HEINEMANN, *ibid.*, 1934, 67, 15. (19) WARNAT, *ibid.*, 1926, 59, 2388; 1927, 60, 1118; HAHN (with BRANDENBERG), 1927, 60, 669, 707; (with STENNER), 1928, 61, 278; (with SCHUCH), 1930, 63, 1638; (with JUST), 1932, 65, 714; HEINEMANN, 1934, 67, 15. (20) HAHN (with BRANDENBERG), *ibid.*, 1926, 59, 2189; 1927, 60, 669, 707; (with STENNER), 1928, 61, 278. (21) KÄRRER and SALOMON, *Helv. Chim. Acta*, 1926, 9,

1059; ITO, *Zeit. Kryst. Min.*, 1927, 65, 303; (22) PERROT, *Compt. rend.*, 1909, 148, 1465; FOURNEAU, *ibid.*, p. 1770; 1910, 150, 976; (with FIORE), *Bull. Soc. chim.*, 1911, [iv], 9, 1037; (with BENOIT), *ibid.*, 1945, [v], 12, 934; RAYMOND-HAMET, *Compt. rend.*, 1934, 199, 1658; *Bull. Sci. Pharmacol.*, 1933, 40, 523; 1935, 42, 416; SCHOLZ, *Compt. rend.*, 1935, 200, 1624; WARNAT, *Ber.*, 1927, 60, 1118; HAHN and SCHUCH, *ibid.*, 1930, 63, 1638; JANOT and GOUTAREL, *Compt. rend.*, 1938, 206, 1183; 1943, 217, 71; 1944, 218, 852; 1945, 220, 617; *Bull. Soc. Chim.*, 1941, [v], 8, 625; 1943, [v], 10, 383; 1946, 535. (23) *Compt. rend.*, 1933, 197, 860; *Bull. Sci. Pharmacol.*, 1933, 40, 523; *J. Pharm. Chim.*, 1935, [viii], 22, 306. (24) HAHN (with STEFNER), *Ber.*, 1928, 61, 278; (with SCHUCH), *ibid.*, 1930, 63, 1638, 2961; DEWAR and KING, *Nature*, 1941, 148, 25. (25) MENDLIK and WIBAUT, *Rec. trav. chim.*, 1929, 48, 191; 1931, 50, 91; WIBAUT and VAN GASTEL, *ibid.*, 1935, 54, 85; BARGER and SCHOLZ, *Helv. Chim. Acta*, 1933, 16, 1343. (26) *Ber.*, 1927, 60, 1118. (27) *Helv. Chim. Acta*, 1927, 10, 577. (28) *Rec. trav. chim.*, 1931, 50, 109. (29) *Ber.*, 1926, 59, 2391. (30) *ibid.*, 1930, 63, 2997. (31) *Ibid.*, 1932, 65, 717. (32) *Ibid.*, 1927, 60, 1118. (33) *J. Chem. Soc.*, 1933, 614. (34) *Helv. Chim. Acta*, 1933, 16, 1343. (35) *Ibid.*, 1935, 18, 923. (36) *Ber.*, 1934, 67, 686; cf. MAJIMA and MURAHASHI, *Proc. Imp. Acad. Tokyo*, 1934, 10, 341; cf. BARGER, *Ber.*, 1934, 67, 1124; HAHN, *ibid.*, p. 1211. (37) HAHN and WERNER, *Annalen*, 1935, 520, 123; cf. HAHN and HANSEL, *Ber.*, 1938, 71, 2192; PRUCKNER and WITKOP, *Annalen*, 1943, 554, 127. (38) CLEMO and SWAN, *J. Chem. Soc.*, 1946, 617; see also SCHLITTLER and ALLEMAN, *Helv. Chim. Acta*, 1948, 31, 128; JULIAN *et al.*, *J. Amer. Chem. Soc.*, 1948, 70, 174, 180; JANOT and GOUTAREL, *Int. Cong. Chem.*, London, 1947. (39) FLORIANI, *Ann. Farm. Biochim.*, 1930, 1, 135. (40) *Rev. Cent. Estud. Farm. Biochim.*, 1935, 25, 373, 423; *Rev. Farm.* (Buenos Aires), 1938, 80, 47, 135; (*Chem. Abstr.*, 1938, 32, 4281, 9394); cf. LABRIOLA, *Anal. Asoc. Quim. Arg.*, 1939, 27, 150. (41) *Helv. Chim. Acta*, 1939, 22, 547; SCHLITTLER and ROTTENBERG, *ibid.*, 1948, 31, 446; DEULOFEU, de LANGHE and LABRIOLA, *Rev. Inst. Bact. Dept. Nacl. Arg.*, 1939, 9, 224; (with CARCAMO), *J. Chem. Soc.*, 1940, 1051. (42) *Ber.*, 1878, 11, 2189; 1879, 12, 1560. (43) *Annalen*, 1882, 211, 249. (44) *J. Chem. Soc.*, 1914, 105, 2738. (45) FIELD, *ibid.*, 1924, 125, 1444. (46) *Annalen*, 1870, 154, 287; 1873, 166, 272; 1882, 211, 280. (47) MÜLLER, *Arch. int. Pharmacodyn.*, 1902, 17, 81; RAYMOND-HAMET, *Compt. rend.*, 1925, 180, 2074; *Compt. rend. Soc. Biol.*, 1925, 93, 1274; BARIÉTY and KOHLER, *ibid.*, 1939, 131, 754; WEGER, *ibid.*, 1927, 96, 801; WEINBERG, *J. Pharm. exp. Ther.*, 1933, 47, 79; HAZARD, CHEYMOL and QUINQUAUD, *Ann. physiol. physicochim. biol.*, 1938, 14, 539; *Compt. rend. Soc. Biol.*, 1941, 135, 92; TOURNADE, CHARDON, CALLEJA, *ibid.*, 1941, 135, 444, 446, 544; BULLIARD and DOS GHALI, *Presse méd.*, 1943, 51, 20; DIMITRIJEVIĆ, *Chem. Zentr.*, 1939, i, 4500. (48) NAVARRO, *Rev. Univ. Nacl. Córdoba Arg.*, 1942, 29, 369; cf. HUKUHARA, *Folia Pharmakol. Jap.*, 1940, 29, 79. (49) *Compt. rend.*, 1930, 191, 157. (50) CUSHNY'S "Pharmacology and Therapeutics," 10th edit., 1934, p. 534. (51) *Merck's Jahreshb.*, 1928, 42, 22. (52) VOSS, *Arch. exp. Path. Pharm.*, 1939, 192, 570; BULLIARD and KFOURI, *Compt. rend. Soc. Biol.*, 1943, 137, 666; SULMAN and BLACK, *Endocrinol.*, 1945, 36, 70; cf. FUGO and GROSS, *J. Pharm. exp. Ther.*, 1941, 72, 16. (53) *Arch. int. Pharmacodyn.*, 1935, 50, 241; *Arch. exp. Path. Pharm.*, 1935, 178, 305; *Compt. rend. Soc. Biol.*, 1934, 117, 978; RAYMOND-HAMET, *ibid.*, 1925, 92, 1420; 1931, 108, 1046; 1935, 118, 33; 1936, 121, 1060; 1939, 130, 733; *Bull. Sci. Pharmacol.*, 1940, 47, 33. (54) *Arch. exp. Path. Pharm.*, 1937, 184, 680. (55) *Compt. rend. Soc. Biol.*, 1935, 118, 774. (55a) *Ibid.*, 1945, 139, 663, 665. (56) *Med. Klinik*, 1931, 27, 1536. (57) For method of evaluation see GLASER and KONYA, *Arch. exp. Path. Pharm.*, 1936, 182, 219. (58) TAKESHITA, *Chem. Abstr.*, 1938, 32, 8588; HUTCHINSON, SHAW and WRAGGE, *Austr. J. exp. Biol. Med. Sci.*, 1942, 20, 69; HAZARD *et al.*, *Compt. rend. Soc. Biol.*, 1941, 135, 253; 1942, 136, 397; BARIÉTY and KOHLER, *ibid.*, 1943, 147, 143; YONKMAN (with YOUNG), *J. Pharm. exp. Ther.*, 1939, 66, 40; (with CHASE and LEHMAN), *ibid.*, 1941, 72, 6. (59) YOUNG, *ibid.*, 1935, 54, 164; YONKMAN (with YOUNG), *ibid.*, 1938, 63, 40; (with SACHS), *ibid.*, 1942, 75, 105; TOURNADE, CHARDON and CALLEJA, *Compt. rend. Soc. Biol.*, 1942, 136, 144; RAYMOND-HAMET, *ibid.*, 1942, 136, 170; 1944, 138, 743; HAZARD *et al.*, *ibid.*, 1947, 141, 128. (60) *J. Pharm. exp.*

Ther., 1944, 81, 111. (61) *Proc. Soc. exptl. Biol. Med.*, 1939, 40, 808. (62) *Compt. rend.*, 1943, 216, 614; *Compt. rend. Soc. Biol.*, 1943, 137, 292, 305; cf. JANOT, BOVET and MONTEZIN, *ibid.*, p. 278. (63) RAYMOND-HAMET, *Compt. rend.*, 1943, 217, 303; 1945, 220, 670; *Bull. Acad. Med.*, 1939, [iii], 121, 274; cf. HAHN and WERNER.³⁷ (64) *Compt. rend.*, 1943, 217, 181. (65) FOURNEAU, MADERNI and de LESTRANGE, *J. Pharm. Chim.*, 1933, [viii], 18, 185; for pharmacological tests see, for example, DAELS, *Arch. int. Pharmacodyn.*, 1939, 61, 113; HAZARD *et al.*, *ibid.*, 1939, 62, 30; STERNE, BOVET and LENOIR, *Compt. rend. Soc. Biol.*, 1939, 130, 207. (66) See, for example, BACQ and FREDERICQ, *ibid.*, 1934, 117, 806; ROSS, *Amer. J. Physiol.*, 1936, 116, 574; WIERZUCHOWSKI, *Arch. int. Pharmacodyn.*, 1938, 59, 1; MOISSET, *ibid.*, p. 482; HAZARD and MOISSET, *ibid.*, p. 457; SHEEN, *ibid.*, p. 242; and *Ann. Physiol. Physicochim. biol.*, 1938, 14, 621; MORRISON and LISSAK, *Amer. J. Physiol.*, 1938, 123, 404; KATZ and FRIEBERG, *ibid.*, 1939, 127, 29; HILL and MEYER, *ibid.*, 1939, 126, 305; LOMBROSO, *Compt. rend. Soc. Biol.*, 1940, 133, 551; HAZARD and VAILLE, *ibid.*, 1943, 137, 716; BRUNAUD and GERMAIN, *ibid.*, 1944, 138, 840, 842, 861, 862. (67) NICKERSON and GOODMAN, *J. Pharm. Exp. Ther.*, 1947, 89, 167; NICKERSON *et al.*, *Fed. Proc.*, 1946, 5, 195; KING, *ibid.*, 1947, 6, 345.

ALKALOIDS OF ERGOT

Ergot consists of the mycelia of *Claviceps purpurea*, a fungus which occurs on grasses and cereal crops, especially on rye. Wenzell¹ prepared from it two basic products, ergotine and ecboline. A crystalline alkaloid, ergotinine, was first obtained by Tanret, who also isolated from the mother liquors "amorphous ergotinine." Tanret's² crystalline ergotinine is probably identical with "picrosclerotine" (Dragendorff and Pedwyssozki)³ and with "secaline" (Jacobi).⁴ Kobert⁵ showed that ergotinine was physiologically inactive, whilst the amorphous alkaloid, which he called cornutine, was active. The latter was described in detail for the first time by Barger and Carr,⁶ who named it ergotoxine, and almost simultaneously by Kraft,⁷ who called it hydroergotinine, since it was assumed to be converted into ergotinine by loss of water. Subsequently, owing to a scarcity of ergot arising out of the first world war, Spiro and Stoll⁸ examined ergot of Central European origin and found that it gave a new alkaloidal pair, ergotamine and ergotaminine, not present in the ergot of international trade derived from Spain and Russia. In 1930 Smith and Timmis⁹ isolated from Spanish ergot a fifth alkaloid, ψ -ergotinine, which was isomeric with and convertible into ergotoxine.

In 1935, as the result of clinical experiments by Moir¹⁰ on the action of aqueous extracts of ergot, a third active alkaloid was isolated as ergometrine by Dudley and Moir,¹¹ as ergotocine by Kharasch and Legault,¹² as ergobasine by Stoll and Burckhardt,¹³ and as ergostetrine by Thompson.¹⁴ Still another name, ergonovine, is adopted in the United States Pharmacopœia XIII. Comparison of specimens left no doubt that only one alkaloid is involved,¹⁵ for which, in this account, the name ergometrine, accepted in the British Pharmacopœia, 1932, is used. Its inactive ergotinine analogue was isolated from ergot by Smith and Timmis¹⁶ and named ergometrinine. The same authors¹⁷ added ergosine and its ergotinine analogue, ergosinine, in 1937. A further alkaloid, *ergomonamine*, $C_{16}H_{19}O_4N$, was isolated by Holden and Diver.¹⁸ It has m.p. 132–132.5°, yields a picrate, m.p. 163–4°, and differs from other ergot alkaloids in not

giving indole colour reactions. Stoll and Burckhardt¹⁹ in 1937 described an additional pair of alkaloids, ergocristine and ergocristinine, the latter proving later to be identical with ergotinine. Further progress was reported by Stoll and Hofmann,¹⁹ in 1943, with the isolation of two new alkaloids, ergokryptine and ergokryptinine, and the re-characterisation of ergotoxine and ψ -ergotinine under the names ergocornine and ergocorninine. By these changes in terminology proposed by Stoll and Hofmann the historic names ergotoxine and ergotinine, would no longer be used for pure substances but kept as group names. These proposals have been commented upon adversely by Foster¹⁹ and by Foster, Smith and Timmis,¹⁹ who emphasise that the re-naming of well-known alkaloids, which had been obtained pure, or substantially pure, many years earlier, is unnecessary and likely to cause confusion. Two other alkaloidal products need mention. Ergoclavine, isolated by Kussner,²⁰ has been shown by Smith and Timmis¹⁷ to be an equimolecular mixture of ergosine and ergosinine, and sensibamine²¹ has been found by Stoll²¹ to be a similar complex of ergotamine and ergotaminine. Useful résumés of work on the alkaloids of ergot have been given by several authors,²² of which that by Stoll is of special interest as dealing with recent developments in the pharmacology of these alkaloids.

There are also present in ergot of rye a considerable number of simple bases and amino-acids, probably formed, at least in part, by the fungus from the proteins of the host plant.²³ They include *p*-hydroxy- β -phenylethylamine (tyramine),^{23(a)} ergothioneine (thiohistidine betaine),²⁴ 4- β -aminoethylglyoxaline (histamine),²⁵ secaleaminosulphonic acid, $\text{NH}_2 \cdot \text{C}_{15}\text{H}_{26}\text{O}_{15} \cdot \text{SO}_3\text{H}$ (ergotic acid),²⁶ δ -guanidylbutylamine (agmatine),²⁷ putrescine, cadaverine, *iso*amylamine,²⁸ trimethylamine, choline, acetylcholine,²⁹ betaine, clavine,³⁰ (shown by Barger and Dale to be a mixture of leucine and aspartic acid³¹), tyrosine, histidine and tryptophan.³² Holden and Diver have also obtained a crystalline potassium salt, $\text{C}_7\text{H}_9\text{O}_{11}\text{NK}$.¹⁸

The ergot of commerce is usually collected from rye crops, but ergots from other botanical sources are occasionally available and have attracted considerable attention during the war.³³ Attempts have also been made to cultivate ergot on host crops, and Stoll's description (1945) indicates that this can be achieved successfully.^{33(a)} The commercial separation of ergot sclerotia from grain crops by hand is a laborious operation and labour-saving methods are being investigated.^{33(b)}

Ergot and its galenical preparations are apt to deteriorate on storage and the conditions necessary to minimise this have been investigated.³⁴ Attention has also been given to methods for complete extraction of the active alkaloids from the drug in making galenical preparations such as the liquid extract.³⁵

Poisoning by ergot still occurs occasionally in countries where rye is extensively used as a food grain or where ergotised grain is liable to be fed to cattle and methods for its detection have been devised,³⁶ but interest in the analysis of ergot centres chiefly on the estimation of the active alkaloids in the crude drug or its preparations. The methods used may

be wholly chemical, and usually based on colour reactions, such as the blue colour produced with all the ergot alkaloids by dimethylamino-benzaldehyde,³⁷ or combinations of chemical with physical or biological methods,³⁸ or wholly biological,³⁹ based on the cock's comb test, as was specified in the United States Pharmacopœia XII, or on the uterus contraction test devised by Broom and Clark.³⁹ The earlier papers are concerned either with estimation of the total alkaloids or with the determination of ergotoxine or ergotamine. Since 1935 special attention has been given to the separation and estimation of ergotoxine (with ergotinine) and ergometrine (with ergometrinine), and also to the estimation of ergometrine in presence of ergometrinine.⁴⁰ Biological methods are available for estimating the pharmacologically active bases, ergotoxine, or ergotamine, and ergometrine in the alkaloidal fractions obtained.⁴¹

Figures varying from 0.1 to 0.4 per cent. have been recorded for total alkaloids in ergot.⁴² Von Békésy^{33(a)} has found 0.7 per cent. in a cultivated ergot and has directed attention to the importance of selection in such experiments. The British Pharmacopœia, 1932, 6th Addendum, requires "prepared ergot" to contain 0.2 per cent. of total alkaloids, calculated as ergotoxine, of which not less than 15 per cent. must be water-soluble alkaloids, calculated as ergometrine. In the United States Pharmacopœia XII, the potency of ergot was defined as one gramme to be equivalent in biological action to 0.5 milligramme of the standard ergotoxine ethanesulphonate, but ergot is not official in U.S.P. XIII.

For detailed information on ergot the late Professor G. Barger's monograph (1931) should be consulted.⁴³

Chief Characteristics of the Ergot Alkaloids. There are six pairs of ergot alkaloids; the members of each pair are interconvertible and appear to be related to each other in the same way, constituting two series which may be called the ergotoxine and ergotinine series after the first pair discovered. Each pair consists of a levorotatory and physiologically potent member (ergotoxine series) and a strongly dextrorotatory, but physiologically weak member (ergotinine series). Members of each series are in some cases difficult to distinguish from each other, except by careful comparison of crystalline form, ease of crystallisation, solubility and specific rotation in more than one solvent. Members of each pair have a tendency to crystallise together, and Köfler¹⁷ has described the crystalline forms of such mixtures, of which "ergoclavine" and "sensibamine" are examples. There is a general tendency in the ergotoxine type to form additive compounds, thus they all crystallise with solvent and the addendum is usually only removable with difficulty. The ergotinine type usually crystallises without solvent. The potent alkaloids are also unstable, particularly in solution, on exposure to light, and they show mutarotation. These contrasts in chemical, physical and pharmacological behaviour are associated with comparatively small differences in structure or configuration in the two types and both show even more striking similarities in physical and chemical characteristics. Thus the members of each pair yield the same products of hydrolysis one of which is lysergic

acid. It will be shown later that this acid is a constant product of hydrolysis throughout the six pairs of alkaloids and that the "ergotoxine" bases are derived from this acid and the "ergotinine" bases from its isomeride *isolysergic acid*. To these two acids is ascribed their property of giving the same group of indole colour reactions, *viz.*, (a) a deep blue colour, with dimethylaminobenzaldehyde,⁴⁴ (b) a purplish-blue colour when a drop of sulphuric acid is added to a solution of one of the alkaloids in glacial acetic acid containing a trace of ferric chloride, (c) a blue colour with glyoxylic acid in presence of sulphuric acid, and (d) a yellow colour with nitric acid containing a trace of sodium nitrite. These colour reactions are also given by lysergic and *isolysergic acids*, and their amides, *isoergine* and *ergine*. The alkaloids also give similar absorption spectra, *viz.*, a peak at A 3,180 and a less pronounced inflexion with a maximum at A 2,420, the former, but not the latter, being also shown by *ergine*. Salts of the alkaloids show a blue fluorescence in aqueous solution.

The following is a list of the known alkaloids, with their specific rotations, as recorded by Smith and Timmis,⁴⁵ or by Stoll, Burckhardt and Hofmann.¹⁹

Ergotoxine Series	Specific Rotation [‡]	Ergotinine Series	Specific Rotation [‡]	Formulae
Ergotoxine	- 226°	Ergotinine	+ 466°	}
		ψ -Ergotinine	+ 513°	
Ergotamine	- 192°	Ergotaminine	+ 462°	C ₃₃ H ₃₅ O ₅ N ₅
Ergosine	- 193°	Ergosinine	+ 522°	C ₃₀ H ₃₇ O ₅ N ₅
Ergoeristine ^{19, 21}	- 217°	Ergoeristinine	+ 460°	C ₃₅ H ₃₉ O ₅ N ₅
Ergocornine	- 226°	Ergocorninine	+ 512°	C ₃₁ H ₃₉ O ₅ N ₅
Ergokryptine	- 226°	Ergokryptinine	+ 508°	C ₃₂ H ₄₁ O ₅ N ₅
Ergometrine	- 16° (pyridine as solvent)	Ergometrinine	+ 520°	C ₁₉ H ₂₃ O ₂ N ₃

[‡] [α]₅₄₆₁ for solution in chloroform, unless stated otherwise.

Isolation of Ergot Alkaloids. In the papers already quoted (refs. 6 to 19) the processes used for the isolation of the total alkaloids and the separation of the component bases are given; to those may be added references to methods by other authors.⁴⁶ There are also numerous patented processes, some of which are quoted in the following special sections.

ERGOTOXINE AND THE ERGOTININES. Ergotoxine and ergotinine were first described in detail by Barger and Carr,⁶ who assigned to ergotoxine the formula, C₃₅H₄₁O₆N₅ (C, 66.9; H, 6.6; N, 11.2), and to ergotinine, C₃₅H₃₉O₅N₅ (C, 68.9; H, 6.5; N, 11.5). There has been no difficulty about the empirical formula of ergotinine. The analyses quoted by Smith and Timmis⁹ (C, 69.05; H 6.5; N 11.9) confirm this formula, which is also supported by the work of Soltys,⁴⁷ and by Stoll and Hofmann,¹⁹

who identify ergotinine with ergocristinine, to which this formula was assigned by Stoll and Burckhardt.¹⁹ Identity of ergotinine and ergocristinine being accepted, it is pertinent to point out that the name ergotinine has priority over ergocristinine.

The formula for ergotoxine has presented more difficulty. This alkaloid was first obtained crystalline by Smith and Timmis,⁴⁷ who did not suggest a formula, but stated that it appeared to be isomeric with ψ -ergotinine for which they quoted analyses (C, 66.6; H, 6.7; N, 11.8), and for ergotoxine (N, 11.8 to 12.0). They added that these results required a modification of the formula, $C_{35}H_{41}O_6N_5$, for ergotoxine, a suggestion also made by Soltys.⁴⁷ The formula, $C_{31}H_{39}O_5N_5$ (C, 66.27; H, 7.0; N, 12.47), which Stoll and Hofmann propose for ergocornine and ergocorninine accommodates the analytical figures Smith and Timmis got for ψ -ergotinine, though the nitrogen figure is rather low. Here also the name ψ -ergotinine has priority over ergocorninine.

As regards ergotoxine, the analytical results and the physical constants found by Smith and Timmis for their crystalline ergotoxine are in close agreement with those recorded by Stoll and Hofmann for their ergocornine, and Foster has shown that the analytical data for ergotoxine ethanesulphonate, prepared from ergotoxine purified by Stoll and Hofmann's method, differed but little from those prescribed by the British Pharmacopœia, *e.g.*, specific rotation $+124^\circ$ as compared with the official requirement of $[\alpha]_D +119-122^\circ$.

The objections raised by Foster,¹⁹ and by Foster, Smith and Timmis¹⁹ to the adoption of the new name ergocornine for what is still essentially ergotoxine, have been referred to already. In cases of this kind the objections are usually somewhat academic, but in this instance there are the real practical difficulties, that the substance has been named ergotoxine in chemical, pharmaceutical, pharmacological and medical literature for nearly forty years, much of the work on the structure of the ergot alkaloids has been published under this name, and ergotoxine ethanesulphonate, of specified quality, has become a standard for biological and colorimetric assays of ergot preparations. The British Pharmacopœia, 1932, with the First Addendum thereto, includes a monograph on this salt, and another has been adopted by the Health Organisation of the League of Nations.⁴⁷ In view of this it seems necessary to describe ergotoxine, ergotinine and ψ -ergotinine in the following account, as well as their respective equivalents, ergocornine, ergocristinine and ergocorninine, in case both sets of names come into use just as, unfortunately, the three names ergometrine, ergonovine and ergobasine are already in use for another ergot alkaloid.

Ergotoxine (Hydroergotinine). The alkaloid separates from benzene in rhombic crystals (for description, see Köfler²¹) containing 21 per cent. of the solvent and having $[\alpha]_{546}^{19^\circ} -179^\circ$ ($c = 1$, $CHCl_3$) or -226° (solvent-free base): heated from 170° it softens at 180° and melts at $190-200^\circ$. Ergotoxine phosphate, $B \cdot H_3PO_4 \cdot H_2O$, crystallises in needles, m.p. $186-7^\circ$. The methanesulphonate, $B \cdot CH_3 \cdot SO_3H$, m.p. 214° (*corr.*), and

the ethanesulphonate,⁴⁸ $B \cdot C_2H_5 \cdot SO_3H$, m.p. 209° (*corr. dec.*), also form clusters of needles from alcohol: the latter is official in the British Pharmacopœia, 1932. The hydrochloride, $B \cdot HCl$, forms diamond-shaped plates, m.p. 205°; the hydrobromide, $B \cdot HBr$, acicular prisms, m.p. 208°; and the acid oxalate, $B \cdot H_2C_2O_4$, minute prisms, m.p. 179°. The statement that ergotoxine is convertible into ergotinine by boiling with methyl alcohol (Kraft⁷) or by treatment with acetic anhydride (Barger and Carr⁶) needs revision; the product of this action should be ψ -ergotinine.

Ergotinine, $C_{35}H_{39}O_5N_5$ (ergocristinine), crystallises from dilute acetone in long, stout prisms (descriptions of this and other forms are given by Köfler²¹), m.p. 229° (*corr., dec.*) [α]_D + 365°, [α]₅₄₆₁ + 459° ($c = 0.35$, $CHCl_3$). The statement that it is convertible into ergotoxine by boiling with ethyl alcohol containing phosphoric acid, or on standing in solution in acetic acid (Kraft⁷) or lactic acid,⁴⁹ needs revision: the product should be ergocristine.

ψ -Ergotinine crystallises from alcohol in thin needles, has m.p. 239° (*dec.*) and [α]₅₄₆₁¹⁹ + 513° ($c = 1$, $CHCl_3$). It is transformed into ergotoxine phosphate when boiled with ethyl alcohol containing phosphoric acid.⁹

Ergotamine and **Ergotaminine**, $C_{33}H_{35}O_5N_5$. Stoll has published⁸ (1945) an interesting and exhaustive monograph on ergotamine, on which the following description is based. It is stated that there are two strains of ergot, one yielding alkaloids of the ergotoxine group and another providing ergotamine. In normal times commercial ergot comes mainly from Spain and Russia and is of the former type. In Hungary and Bulgaria both types occur. Another source of supply is the ergot collected from tall fescue grass in New Zealand (Smith and Timmis⁴⁷), which also contains ergometrine (Foster and Grant⁴⁷).

Ergotamine crystallises from a variety of solvents but always with the solvent, *e.g.*, from aqueous acetone, which is recommended as a medium, it separates in rectangular plates, $B \cdot 2H_2O \cdot 2C_3H_6O$, decomposes at 180° and has, for solvent free base, [α]_D²⁰ - 160° and [α]₅₄₆₁²⁰ - 192° ($c = 1$; $CHCl_3$) or [α]_D²⁰ - 12.7° and [α]₅₄₆₁²⁰ - 8.6° ($c = 1$; pyridine). Köfler⁵⁰ has described crystals of the alkaloid with various solvents. Ergotamine is a weak, monoacidic base. The following salts have been described: $B \cdot HCl$, m.p. 212° (*dec.*); $B \cdot HBr$, m.p. 213° (*dec.*); $B_2 \cdot H_2SO_4$, m.p. 205° (*dec.*); $B \cdot H_3PO_4$, EtOH, m.p. 200° (*dec.*). The methanesulphonate melts at 210° (*dec.*) and the ethanesulphonate at 207° (*dec.*). The tartrate crystallises from methyl alcohol in thick, rhombic tablets, $B_2 \cdot C_4H_6O_8 \cdot 2MeOH$, m.p. 203° (*dec.*). This salt is official in the U.S. Pharmacopœia XIII and is assigned m.p. 177-184° with [α]_D²⁰ - 150° in chloroform for the base recovered from a specified quantity of the salt by the method directed.⁵¹

Ergotamine, like ergotoxine, is unstable, especially in aqueous solutions of its salts exposed to light; the rate of deterioration for both alkaloids has been measured by Wokes and Elphick.⁵²

Ergotaminine. This base is sparingly soluble in most organic solvents

and does not retain solvent of crystallation. It can be crystallised from boiling methyl alcohol (1 in 1,500) and forms thin, rhombic plates, m.p. 241–3° (*dec.*), $[\alpha]_{\text{D}}^{20} + 369^{\circ}$ ($c = 0.5$; CHCl_3) or $+ 397^{\circ}$ ($c = 0.5$; pyridine) or $[\alpha]_{5461}^{20} + 462^{\circ}$ and $+ 497^{\circ}$ in chloroform and pyridine respectively for (c) = 0.5. It does not form crystalline salts.

Ergosine and Ergosinine, $\text{C}_{30}\text{H}_{37}\text{O}_5\text{N}_5$. This pair of alkaloids was isolated by Smith and Timmis.¹⁷

Ergosine is prepared by boiling ergosinine with phosphoric acid in a mixture of alcohol and acetone, or with potassium hydroxide in diluted alcohol, mixtures of the two alkaloids being formed and requiring special methods of separation; it crystallises from ethyl acetate in prisms, m.p. 228° (*dec.*), $[\alpha]_{\text{D}}^{20} - 161^{\circ}$; $[\alpha]_{5461}^{20} - 193^{\circ}$ ($c = 1$; CHCl_3) or $+ 24^{\circ}$ ($c = 1$, acetone). The hydrochloride, B. HCl . COMe₂, separates from acetone in diamond-shaped plates, m.p. 235° (*dec.*). The hydrobromide, B. HBr . COMe₂, forms needles from acetone, darkens at 200° and decomposes at 230°. The nitrate, B. HNO₃ . COMe₂, crystallises in needles from acetone, darkens at 185° and decomposes at 215°.

Ergosinine crystallises readily from various solvents in prisms, m.p. 228° (*dec.*), or from methyl alcohol in needles, B. 0.5MeOH, m.p. 220° (*dec.*); the solvent-free base has $[\alpha]_{\text{D}}^{20} + 420^{\circ}$; $[\alpha]_{5461}^{20} + 522^{\circ}$ ($c = 1$, CHCl_3) or $+ 475^{\circ}$ ($c = 1$, acetone); the hydrochloride is amorphous, darkens at 200° and decomposes at 206°.

Ergocristine and Ergocristinine, $\text{C}_{35}\text{H}_{39}\text{O}_5\text{N}_5$. From the double compound of these two alkaloids, m.p. 172–5° (*dec.*), $[\alpha]_{\text{D}}^{20} + 105^{\circ}$ ($c = 0.92$; CHCl_3), Stoll and Burckhardt¹⁹ isolated *ergocristine*, as the hydrochloride, which crystallised from alcohol on addition of ether in long tablets, m.p. 205° (*dec.*), $[\alpha]_{\text{D}}^{20} + 105.7^{\circ}$ ($c = 0.2$; EtOH). The base crystallises from acetone in prisms with 1 mol. of solvent, and has m.p. 160–175° (*dec.*) and $[\alpha]_{\text{D}}^{20} - 183^{\circ}$ or $[\alpha]_{5461}^{20} - 217^{\circ}$ ($c = 1$; CHCl_3). Stoll and Hofmann¹⁹ have isolated ergocristine from commercial ergotoxine (p. 518) as the di-(*p*-toluoyl)-*l*-tartrate, B₂, $\text{C}_{20}\text{H}_{18}\text{O}_8$, m.p. 191° (*dec.*) $[\alpha]_{\text{D}}^{20} + 58^{\circ}$ ($c = 0.2$; EtOH). The phosphate has m.p. 195° (*dec.*), ethanesulphonate, m.p. 207° (*dec.*) and tartrate, m.p. 185–190° (*dec.*). On boiling in methyl alcohol ergocristine is changed into the dextrorotatory isomeride *ergocristinine* (ergotinine), m.p. 226° (*dec.*), $[\alpha]_{\text{D}}^{20} + 366^{\circ}$ or $[\alpha]_{5461}^{20} + 460^{\circ}$ ($c = 1$; CHCl_3), which is reconverted to ergocristine by boiling with phosphoric acid (1 per cent.) in alcohol.

Ergokryptine and Ergokryptinine, $\text{C}_{32}\text{H}_{41}\text{O}_5\text{N}_5$. Ergokryptine was isolated as the di-(*p*-toluoyl)-hydrogen-*l*-tartrate from commercial ergotoxine (Stoll and Hofmann,¹⁹ 1943). The base crystallises from boiling benzene in prisms, m.p. 212° (*dec.*), $[\alpha]_{\text{D}}^{20} - 187^{\circ}$ or $[\alpha]_{5461}^{20} - 226^{\circ}$ ($c = 1$; CHCl_3). The following m.p.'s are recorded for its salts: hydrochloride, 208° (*dec.*); phosphate, 198–200° (*dec.*); tartrate, 209° (*dec.*); ethanesulphonate, 204° (*dec.*). The di-(*p*-toluoyl)-hydrogen-*l*-tartrate, B. $\text{C}_{20}\text{H}_{18}\text{O}_8$, forms long needles, m.p. 186° (*dec.*), from boiling methyl alcohol and has $[\alpha]_{\text{D}}^{20} + 103^{\circ}$ ($c = 0.2$; EtOH). Ergokryptine is converted by boiling in methyl alcohol into its ergotinine analogue, *ergokryptinine*.

which crystallises from boiling methyl alcohol in needles, m.p. 240–2° (*dec.*), $[\alpha]_{\text{D}}^{20} + 408^\circ$ or $[\alpha]_{5461}^{20} + 508^\circ$ ($c = 1$; CHCl_3).

Ergocornine and **Ergocorninine**, $\text{C}_{31}\text{H}_{39}\text{O}_5\text{N}_5$. Ergocornine was prepared by fractional crystallisation of the di-(*p*-toluoyl)-*l*-tartrates of commercial ergotamine by Stoll and Hofmann¹⁹ (1943). It crystallises from methyl alcohol (1 in 20) in polyhedra, melts at 182–4° (*dec.*) and has $[\alpha]_{\text{D}}^{20} - 188^\circ$ or $[\alpha]_{5461}^{20} - 226^\circ$ ($c = 1$; CHCl_3). The following melting points are recorded for its salts: hydrochloride, B. HCl, 223° (*dec.*); hydrobromide, B. HBr, 225° (*dec.*); phosphate, 190–5°; ethanesulphonate, 209° (*dec.*). The di-(*p*-toluoyl)-hydrogen *l*-tartrate, B. $\text{C}_{26}\text{H}_{18}\text{O}_8$, melts at 180–1° (*dec.*) and has $[\alpha]_{\text{D}}^{20} + 103^\circ$ ($c = 0.2$; EtOH).

Ergocorninine formed from ergocornine on standing in aqueous alcoholic potash crystallises best from boiling alcohol (1 in 15) in massive prisms, m.p. 228° (*dec.*), and has $[\alpha]_{\text{D}}^{20} + 409^\circ$ or $[\alpha]_{5461}^{20} + 512^\circ$ ($c = 1$; CHCl_3).

Ergometrine and **Ergometrinine**, $\text{C}_{19}\text{H}_{23}\text{O}_2\text{N}_3$. The isolation of these alkaloids has been referred to already (p. 517). A method for the preparation of ergometrine has been described by Dudley,⁵³ and the following characters are mainly those given by that author:—

Ergometrine crystallises, with solvent, from benzene in needles or from methyl ethyl ketone in prisms; both forms have m.p. 162–3° (*dec.*). From ethyl acetate it crystallises at –4° in thin, solvent-free plates, m.p. 160–1° (*dec.*), and at atmospheric temperature on concentration *in vacuo* in diamond-shaped plates, B. 0.5EtAc, m.p. 130–2° (*dec.*), from which the combined solvent is not removed at 100° *in vacuo*. By crystallisation from acetone, Grant and Smith⁵⁴ obtained a second form in long needles, m.p. 212° (*dec.*), which appears to be the more stable, since the form, m.p. 162–3°, tends to pass into it on keeping. Ergometrine has $[\alpha]_{\text{D}} - 44^\circ$ (CHCl_3); $+42.2^\circ$ or $[\alpha]_{5461} + 62.6^\circ$ ($c = 1.7$, EtOH) or $[\alpha]_{5461}^{20} - 16^\circ$ ($c = 1$, pyridine).⁵⁵ The hydrochloride forms needles, m.p. 245–6° (*dec.*), $[\alpha]_{\text{D}}^{25} + 63.0^\circ$ ($c = 0.87$, H_2O); the hydrobromide, needles, m.p. 236–7° (*dec.*), and the oxalate, needles, m.p. 193° (*dec.*), $[\alpha]_{\text{D}} + 55.4^\circ$ ($c = 0.59$, H_2O). Ergonovine (ergometrine) maleate is official in the United States Pharmacopœia XIII with the standard $[\alpha]_{\text{D}}^{25} + 48^\circ$ to 57° ($c = 1$; H_2O). The picrate exists in two interconvertible forms: fine yellow needles (hydrated), m.p. 148° (*dec.*), and ruby-red prismatic columns (anhydrous), which decompose suddenly at 188–9°. On hydrogenation the base yields dihydroergometrine, m.p. 225–230° (*dec.*).⁵⁶

*Ergometrinine*¹⁶ crystallises from acetone in short, stout prisms, m.p. 195–7° (*dec.*), $[\alpha]_{\text{D}}^{20} + 414^\circ$ (CHCl_3), $[\alpha]_{5461}^{20} + 520^\circ$ ($c = 1$, CHCl_3) or $+413^\circ$ ($c = 0.7$, MeOH). The hydrochloride, B. HCl, H_2O , forms small needles, m.p. 175–180° (*dec.*); the hydrobromide, B. HBr, H_2O ; crystallises from aqueous acetone on addition of ether, in needles, m.p. indefinite (180–190°); the nitrate, B. HNO_3 , forms stout prisms, m.p. 235° (*dec.*), $[\alpha]_{\text{D}}^{20} + 282^\circ$ ($c = 0.98$, H_2O), from aqueous methyl alcohol on addition of ether, and the perchlorate, needles which discolour at 210° and decom-

pose at 225°. Ergometrine and ergometrinine are interconvertible by the methods referred to under ergotoxine.⁵⁷

Constitution of the Ergot Alkaloids. Ergotoxine and ergotinine, according to Soltys,⁴⁷ owe their amphoteric character to a weakened carboxyl group. No methoxyl group is present in either, or in ergotamine and ergotaminine, but each of the four contains one methylimino group. Each on boiling with dilute alkali liberates one molecular proportion of ammonia, probably derived in the case of ergotoxine from the *isobutyrylformamide* (dimethylpyruvamide), which Barger and Ewins⁵⁸ detected in that alkaloid. Soltys also found evidence of the presence of four replaceable hydrogen atoms in each of the four alkaloids, and on oxidation each yielded with permanganate benzoic acid and with nitric acid *p*-nitrobenzoic acid.⁵⁹ In the same year Smith and Timmis showed that each of the four alkaloids is hydrolysed by potassium hydroxide in alcohol to ammonia and ergine, $C_{14}H_{12}N(NMe) \cdot CO_2NH_2$ (see below),⁶⁰ which proved to be the amide of lysergic acid, $C_{14}H_{12}N(NMe) \cdot CO_2H$ (see below), which Jacobs and Craig⁶¹ later obtained by more energetic alkaline hydrolysis of ergotinine. The formation of ergine accounts for about half the molecule of each of these four ergot alkaloids, and the differences between the two pairs must be due to differences in structure between the remaining halves, the nature of which is now known from a study of their hydrolytic products. Jacobs and Craig⁶² found that ergotinine on alkaline hydrolysis yielded dimethylpyruvic acid and a dipeptide, $C_{14}H_{18}O_3N_2$, m.p. 252° (dec.), which, on acid hydrolysis, appeared as *d*-proline (pyrrolidine-2-carboxylic acid) and *l*-phenylalanine (β -phenyl- α -aminopropionic acid), $C_6H_5 \cdot CH_2 \cdot CH(NH_2) \cdot COOH$. Ergotinine is therefore regarded as made up from the fragments, *d*-proline and *l*-phenylalanine in a peptide linkage with dimethylpyruvic and lysergic acids and possibly ammonia. The same authors⁶³ from similar evidence concluded that ergotamine and ergotaminine differ from ergotoxine and ergotinine in yielding pyruvic in place of dimethylpyruvic acid.

For the third pair of alkaloids, ergosine and ergosinine, the latter was shown by Smith and Timmis¹⁷ to yield lysergic acid (or its amide, ergine), pyruvic acid and *l*-leucine, while on distillation under reduced pressure it furnished a product, $C_{11}H_{18}O_2N_2$, m.p. 148°, $[\alpha]_{5461}^{20} + 105^\circ$ ($c = 1, H_2O$), which must be *l*-leucyl-*d*-prolinelactam (3 : 6-diketo-5-*isobutyl*-1 : 2-trimethylenepiperazine), since it gave *l*-leucine and *d*-proline on acid hydrolysis. As ergosine and ergosinine are interconvertible, it is safe to assume that ergosine yields the same hydrolytic products as ergosinine, with the exception that, as explained later, the basic hydrolytic product may be lysergic or *isolysergic* acid, depending on the primary material and the conditions of hydrolysis.

Of the fourth pair, ergometrine was found by Jacobs and Craig⁶⁴ to yield lysergic acid and *d*- β -aminopropyl alcohol (*l*-(+)- β -aminopropyl alcohol), and the same products were obtained by Smith and Timmis¹⁶ from its isomeride, ergometrinine. This pair of alkaloids must therefore be hydroxyisopropylamides of lysergic acid. The first member of each

of the remaining pairs of alkaloids, ergocristine—ergocristinine, ergokryptine—ergokryptinine, ergocornine—ergocorninine, have been hydrolysed by Stoll, Hofmann and Becker¹⁹ and the products identified, with the result that these six alkaloids are shown also to be derivatives of lysergic, or *isolysergic* acid, and the differences between the pairs to lie in differences in the amino-acids of the residual portions of the molecules, the hydrolytic products of which for the whole series of ergot alkaloidal pairs are shown in the following summary, in which ergotoxine and ergotinine are placed with their presumed equivalents, ergocornine and ergocristinine respectively, for the reasons already given. The names of the substances actually hydrolysed to give these results are marked with an asterisk :—

Ergocornine * (ergotoxine)—ergocorninine (ψ -ergotinine). Dimethylpyruvic acid, *d*-proline, *l*-valine¹⁹ (1943).

Ergocristine *—ergocristinine (ergotinine *). Dimethylpyruvic acid, *d*-proline, *l*-phenylalanine.^{19, 62}

Ergokryptine *—ergokryptinine. Dimethylpyruvic acid, *d*-proline, *l*-leucine.¹⁹

Ergotamine *—ergotaminine. Pyruvic acid, *d*-proline, *l*-phenylalanine.^{62, 63}

Ergosine—ergosinine.* Pyruvic acid, *d*-proline, *l*-leucine.¹⁷

Ergometrine *—ergometrinine.* *l*-(+)- β -aminopropyl alcohol.^{16, 62, 64}

This summary shows that of the six pairs of ergot alkaloids the first five are peptides divisible into two sub-groups, which differ mainly in having either dimethylpyruvic or pyruvic acid as a characteristic hydrolytic product. The sixth pair, ergometrine—ergometrinine, are acid amides

According to Stoll (1945),^{33(a)} when ergocornine is treated with one molecule of sodium hydroxide it is hydrolysed to lysergic acid amide and the polypeptide.

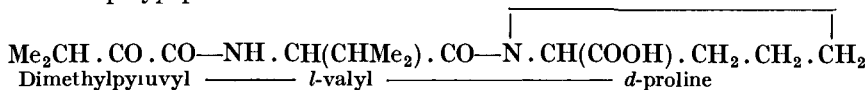

Synthetic experiments have established the constitution of the polypeptide and the succession of the amino-acids, proline being always at the distal end and the second amino-acid in the middle.

Ergine and *isoErgine*, C₁₆H₁₇ON₃. Ergine, first obtained by Smith and Timmis,⁶⁰ crystallises from methyl alcohol in prisms, B. MeOH, m.p. 135° (*dec.*), or from aqueous acetone in colourless plates, B. 2H₂O, m.p. 115° (*dec.*). It has $[\alpha]_{540}^{20} + 514^\circ$ ($c = 1$, acetone) or $+ 598^\circ$ ($c = 1.5$, CHCl₃). Ergine is alkaline in reaction and yields well-defined salts, B. HCl, plates, m.p. 255–260° (*dec.*); B. HBr, prisms, m.p. 260° (*dec.*), and B. HClO₄, slender needles, m.p. 225° (*dec.*). It gives the same colour reactions as the ergot alkaloids (p. 520) and still retains one methylimino-group. On hydrolysis by alkali it yields 1 mol. each of ammonia and lysergic acid, C₁₆H₁₆O₂N₂. Impressed by the high dextrorotation of ergine, Smith and Timmis⁶⁵ applied to this base the methods used in the isomerisation of dextrorotatory ergot alkaloids to the laevorotatory iso-

merides (ergotinine to ergotoxine type) and so converted it into *isoergine*, prisms from methyl alcohol, m.p. 242° (*dec.*), $[\alpha]_{5461}^{20^\circ} + 25^\circ$, $[\alpha]_{\text{D}}^{20^\circ} + 10^\circ$ ($c = 0.5$, pyridine). The hydrochloride, B. HCl · H₂O, forms needles, m.p. 269° (*dec.*, *dry*). On boiling with alcoholic alkali there is rapid interconversion of ergine and *isoergine*, but under special conditions the latter can be hydrolysed to lysergic acid (*see below*).

The Lysergic Acids, C₁₄H₁₂N(NMe) · CO₂H. Lysergic acid, first obtained by Jacobs and Craig,⁶¹ crystallises in plates, m.p. 238° (*dec.*), $[\alpha]_{\text{D}}^{20^\circ} + 40^\circ$ (pyridine), and yields a hydrochloride, m.p. 208–210°, and acid sulphate, m.p. 220°. It gives indole reactions similar to those of the ergot alkaloids (p. 520). On reduction it yields dihydrolysergic acid, m.p. 336° (*dec.*), $[\alpha]_{\text{D}}^{20^\circ} - 88^\circ$ ($c = 0.5$, pyridine),⁶⁶ subsequently obtained from ergotamine or ergotoxine by hydrogenation followed by hydrolysis⁶⁷ and named α -dihydrolysergic acid, whilst the isomeride, similarly obtained from ergotaminine, was called γ -dihydrolysergic acid, m.p. 300–330°, $[\alpha]_{\text{D}}^{25^\circ} + 32^\circ$ (pyridine).⁶⁷ Smith and Timmis⁶⁵ found that lysergic acid, $[\alpha]_{5461}^{20^\circ} + 55^\circ$ ($c = 0.5$, pyridine), on boiling in aqueous solution, was converted into *isolysergic acid*, C₁₆H₁₆O₂N₂ · 2H₂O, m.p. 218° (*dec.*), $[\alpha]_{5461}^{20^\circ} + 368^\circ$, $[\alpha]_{\text{D}}^{20^\circ} + 281^\circ$ ($c = 1$, dry : pyridine), which yields a nitrate, needles, m.p. 185° (*dec.*), and a methyl ester, slender rods, m.p. 174° (*dec.*), $[\alpha]_{5461}^{20^\circ} + 236^\circ$ ($c = 0.5$, CHCl₃), and is reconverted into lysergic acid on treatment with alkali. It appears, therefore, that lysergic acid and *isoergine* belong to the ergotoxine series, and *isolysergic acid* and ergine to the ergotinine series. The same authors prepared *dl*-lysergic acid by heating the *d*-form in dilute barium hydroxide solution at 150° in an atmosphere of nitrogen. It crystallised in leaflets, m.p. 250° (*dec.*).

Stoll and his collaborators⁶⁸ have separated the *dl*-form of *isolysergic acid* into the hydrazides of the *d*- and *l*-forms and converted the latter into the corresponding lysergic acid hydrazides. When hydrazine reacts with a member of either the ergotoxine (lævorotatory) or ergotinine (dextrorotatory) series, *dl*-*isolysergic acid hydrazide*, m.p. 240° (*dec.*), hexagonal plates from alcohol, is produced. This forms a salt with di-*p*-toluoyl-*l*-tartaric acid which, from the boiling methyl alcohol, used as a solvent, deposits *d*-*isolysergic acid hydrazide hydrogen di-p*-toluoyl-*l*-tartrate, $[\alpha]_{\text{D}}^{20^\circ} + 238^\circ$ ($c = 0.4$; EtOH 50 per cent.). From this, *d*-*isolysergic acid hydrazide*, plates or prisms, m.p. 204° (*dec.*), $[\alpha]_{\text{D}}^{20^\circ} + 452^\circ$ ($c = 0.8$; pyridine), can be recovered. From the mother liquor of the *d*-form, the stereoisomeric *l*-*isolysergic hydrazide*, m.p. 204° (*dec.*), $[\alpha]_{\text{D}}^{20^\circ} - 454^\circ$ ($c = 0.7$; pyridine), can be regenerated. From this pair of stereoisomerides the corresponding pair of lysergic acid hydrazides can be prepared by the action of potassium hydroxide in aqueous alcohol. Thus *l*-*isolysergic acid hydrazide* yields *l*-lysergic acid hydrazide, long needles or prisms, m.p. 218° (*dec.*), $[\alpha]_{\text{D}}^{20^\circ} - 11^\circ$ ($c = 1$; pyridine) and in like manner *d*-*isolysergic acid hydrazide* furnishes *d*-lysergic acid hydrazide, m.p. 218° (*dec.*), $[\alpha]_{\text{D}}^{20^\circ} + 11^\circ$ ($c = 1$; pyridine). *dl*-Lysergic acid hydrazide similarly prepared from *dl*-*isolysergic acid hydrazide* separates from hot alcohol in long needles, m.p. 220°.

These hydrazides on treatment with nitrous acid are converted into azides, which with appropriate amino-alcohols, furnish ergometrine and its isomerides and analogues. The four pairs of stereoisomeric "ergometrines" and "ergometrinines" in the following list have been prepared in this way with *l*-(+)- β -aminopropyl alcohol or its *d*-(-)-isomeride.

No.	Name	m.p. (dec.)	$[\alpha]_D^{20}$	Activity on rabbit uterus
1	<i>d</i> -Lysergic- <i>l</i> -(+)- β -propanolamide * . . .	162°	+ 90°	1·0
	(<i>d</i> -ergometrine)			
2	<i>l</i> -Lysergic- <i>d</i> -(-)- β -propanolamide . . .	162°	- 89°	0·0
	(<i>l</i> -ergometrine)			
3	<i>d</i> -Lysergic- <i>d</i> -(-)- β -propanolamide . . .	220°	- 11°	1·0
4	<i>l</i> -Lysergic- <i>l</i> -(+)- β -propanolamide . . .	220°	+ 10°	—
5	<i>d</i> -isoLysergic- <i>l</i> -(+)- β -propanolamide . . .	196°	+ 414°	—
	(<i>d</i> -ergometrinine)			
6	<i>l</i> -isoLysergic- <i>d</i> -(-)- β -propanolamide . . .	196°	- 415°	—
	(<i>l</i> -ergometrinine)			
7	<i>d</i> -isoLysergic- <i>d</i> -(-)- β -propanolamide . . .	195°	+ 353°	—
8	<i>l</i> -isoLysergic- <i>l</i> -(+)- β -propanolamide . . .	195°	- 351°	—
9	<i>d</i> -Lysergicethanolamide	95°	- 10°	0·3
10	<i>d</i> -Lysergic-(+)- β -butanolamide	172°	- 45°	1·3
11	<i>d</i> -Lysergic- <i>l</i> -(+)- δ -methyl- β -pentanolamide . . .	130°	- 38°	0·3
12	<i>d</i> -Lysergic- <i>d</i> -norephedride	230° †	+ 14°	0·05
13	<i>d</i> -Lysergic- <i>l</i> -norephedride	130°	- 17°	1·0
14	<i>l</i> -Lysergic- <i>l</i> -norephedride	230° †	- 16°	0·0

* The propanolamine obtained by hydrolysis of ergometrine and ergometrinine is dextrorotatory, but belongs to the *l*-series and appears to be fully described as *l*-(+)- β -aminopropyl alcohol.

† Melting point of hydrochloride: the bases are amorphous.

In the fifth column of this table are recorded activities on the rabbit uterus *in situ* in relation to that of ergometrine taken as unity, (a) illustrating the effect of stereoisomerism, derivatives of *l*-lysergic acid being inactive, (b) of three homologues (Nos. 9–11) of ergometrine, indicating the existence of a peak of activity in the homologous series, and (c) of three lysergic acid derivatives of *d*- or *l*-norephedrine (Nos. 12–14) showing that aliphatic amino-alcohols are not essential to this type of activity in the group and also illustrating the effect of stereoisomerism on activity. As an example of the necessity for caution in drawing conclusions from the results of biological experiments it may be pointed out that *d*-lysergic-(+)- β -butanolamide (No. 10) has proved at least as active in clinical trials as ergometrine itself, thus confirming the high activity found in the pharmacological tests, but *d*-lysergic-*l*-norephedride (No. 13), which also ranked as high as ergometrine in these pharmacological experiments, was inferior to it in clinical trials.

Several formulæ for the lysergic acids have been proposed by Jacobs and Craig and their collaborators.⁶⁹ The tetracyclic nucleus was suggested in 1935. Its present form is shown by formula (2) and is based mainly on the following considerations:—

The occurrence of two optically active forms of each of the acids, lysergic and *isolysergic*, implies the existence in each of one centre of asymmetry (C⁸).

The free 2-position in the pyrrole ring (B) explains the indole colour reactions given by these acids and the parent alkaloids.

Rings (C) and (D) account for the production of quinoline, when the tribasic acid, C₁₄H₉O₈N, m.p. >350°, obtained by the oxidation of ergotinine⁵⁹ with nitric acid, is distilled with soda-lime.⁷⁰

The formation of 1-methyl-5-aminonaphthalene⁷⁰ when dihydro-lysergic acid is fused with potassium hydroxide requires rings (A) and (C).

The presence of an indole nucleus (rings (A) and (B)) is established by the formation of 3:4-dimethylindole, m.p. 115-7°, picrate, m.p. 185-7°, by decarboxylation of an indole acid obtained when dihydrolysergic acid is fused with potassium hydroxide.⁷¹

Since both acids yield dihydro-derivatives there must be a readily reducible ethylenic linkage, the position of which must be conjugate with the indole nucleus to satisfy the character of the absorption spectra (Jacobs, Craig and Rothen⁷¹) and must account for the fact that lysergic acid is a weaker base than its isomeride, implying that in the former the ethylenic linkage is nearer the :NMe group, which is met by placing it at C⁵-C¹⁰ for lysergic acid and at C⁹-C¹⁰ for *isolysergic* acid.⁷²

The carboxyl group, and therefore the centre of asymmetry, was first placed at C⁷, but of the four possible positions that at C⁸ is now considered

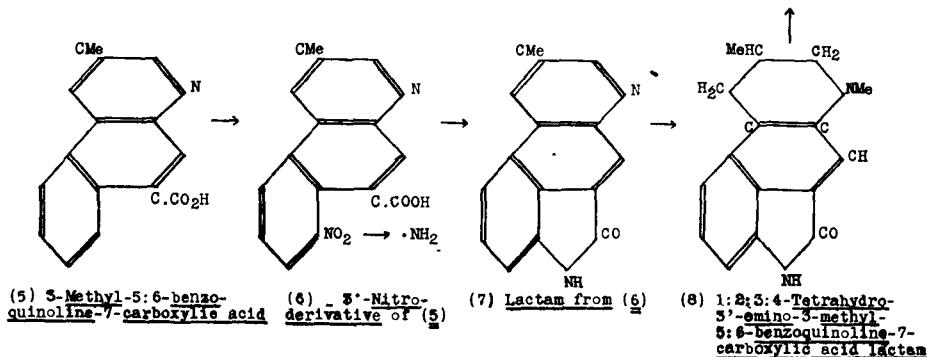
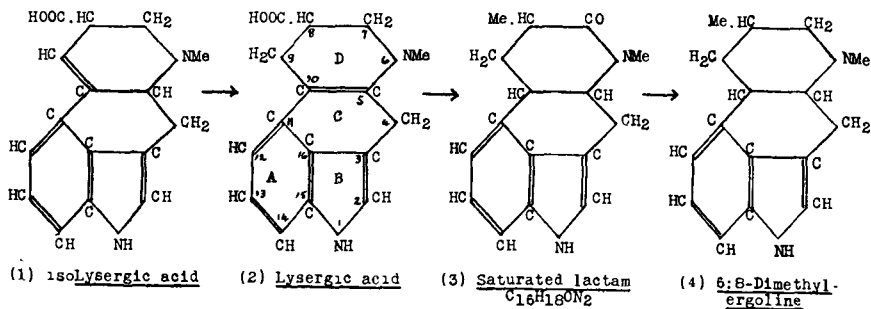

the most likely, C⁹ being occupied by the ethylenic linkage in *isolysergic acid*, while C⁴ would give a tryptophan character to the structure, which is not shown by either acid, and of C⁷ and C⁸, the latter is favoured by the dissociation constants and the β -amino-acid character⁶⁹ of the change from lysergic acid (2) to the lactam (3).

Jacobs *et al.*⁷³ have synthesised tetracyclic products of these types, of which the most interesting is *ergoline*, C₁₄H₁₆N₂, m.p. 175–183°, which may be regarded as the parent base for lysergic and *isolysergic acids*. Recently (1942) it has been shown⁷³ that dihydrolysergic acid can be degraded to 6 : 8-dimethylergoline (4). *dl*-Lysergic acid, m.p. 252° (*dec.*), with sodium in butyl alcohol gives *dl*-dihydrolysergic acid, which on heating at 350° under 25 mm. yields as a sublimate the unsaturated *dl*-lactam, C₁₆H₁₆ON₂, m.p. 313–6°. This is hydrogenated to the saturated lactam (3), C₁₆H₁₈ON₂, existing in two forms, m.p. 332–6° and 310–5°, and reducible by sodium in butyl alcohol, probably to 7-hydroxy-6 : 8-dimethylergoline, which when heated to sublimation at 200°/0.2 mm. yields *dl*-dehydro-6 : 8-dimethylergoline, C₁₆H₁₈N₂, m.p. 182–6°, convertible by hydrogenation into *dl*-6 : 8-dimethylergoline, C₁₆H₂₀N₂, (4) found in two crystalline forms, m.p. 227–9°. This work repeated with α -dihydrolysergic acid as a starting point, yielded an optically active 6 : 8-dimethylergoline, m.p. 246–8°, [α]_D²⁰ – 49° (*c* = 0.286 ; CHCl₃).

Synthesis of 6 : 8-dimethylergoline for comparison with the degradation product was effected by converting 3-amino-1-naphthoic acid by the Darzens and Meyer form of the Skraup reaction,⁷³ in which the $\alpha\gamma$ -diethyl ether of β -methylglycerol is used in place of glycerol, into 3-methyl-5 : 6-benzoquinoline-7-carboxylic acid (5) which was nitrated in the 3'-position and the nitro-derivative (6) reduced to the lactam (7) and this in turn converted *viâ* the methiodide to the methochloride. The latter on catalytic hydrogenation gave 1 : 2 : 3 : 4-tetrahydro-3'-amino-1 : 3-dimethyl-5 : 6-benzoquinoline-7-carboxylic acid lactam (8) and this on reduction by sodium in butyl alcohol gave a mixture of products from which *dl*-6 : 8-dimethylergoline (4) was isolated as the hydrochloride, m.p. 222–3° (Jacobs and Gould 1939).⁷³

Further evidence for this formulation of lysergic acid is provided by the synthesis of *dl*-dihydrolysergic acid by Uhle and Jacobs.⁷³ They converted cyanoacetal, (EtO)₂.CH.CH₂.CN, b.p. 99°/14 mm., D₂₀²⁰ 0.9496, into the sodium derivative of cyanomonaldehyde, (CHO)₂ : C(CN)Na, and condensed the latter with 3-aminonaphthostyryl to produce 2-cyano-2-formylethyliden-3-aminonaphthostyryl (I), m.p. 290–2°, which, on fusion with zinc chloride, and hydrolysis of the reaction product with hydrochloric acid, gave 3'-amino-5 : 6-benzoquinoline-3 : 7-dicarboxylic acid lactam (II). This does not melt up to 360°, but yields a methyl ester, crystallising in golden-yellow needles, m.p. 300–1°, and a methochloride, m.p. > 360°. The latter proved difficult to hydrogenate to the 1 : 2 : 3 : 4-tetrahydro-derivative, but the reaction was eventually effected in hot dilute hydrochloric acid in presence of platinum black. The tetrahydro-lactam-acid was isolated *viâ* the copper salt and regenerated

from this as golden-yellow needles, m.p. 230–5° (*dec.*). On reduction with sodium in boiling butanol it gave *dl*-dihydrolysergic acid (III), subliming at 200–230° under a pressure 10⁻⁴ mm., and giving a methyl ester, m.p.

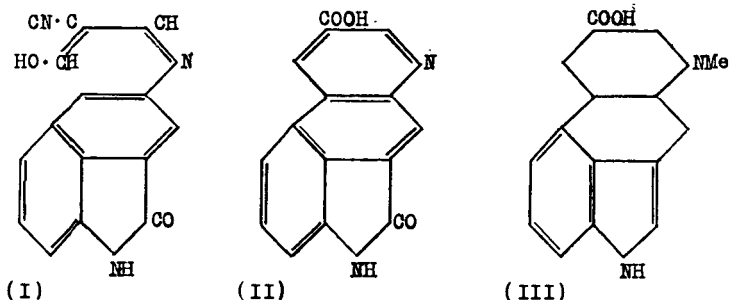

145–175°, and in these and other characteristics agreeing with *dl*-dihydrolysergic acid, derived from *dl*-lysergic acid. Jacobs and Craig⁷⁴ have also provided evidence for the view that the dimethylpyruvic and pyruvic acids, formed in the hydrolysis of the ergotamine and ergotamine types are derived from α -hydroxyvaline, Me₂CH · C(OH)(NH₂)(COOH), and α -hydroxyalanine, Me · C(OH)(NH₂)(COOH), residues, respectively, and on this basis have proposed the following formula for these alkaloids. Stoll and Hofmann's recent results (p. 523) involve change of the name, ergotamine to ergocristine for this formula, as it is the latter which yields phenylalanine on hydrolysis. For convenience of comparison the formula of ergometrine, now the most important ergot alkaloid, is added.

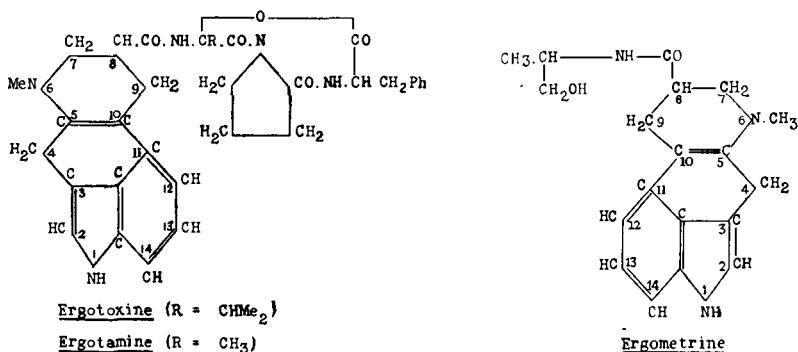

Recently Hofmann^{74(a)} has found that when the azide hydrochlorides of the lysergic and *isolysergic* acids, or of their dihydro-derivatives, are boiled in dilute hydrochloric acid, a Curtius reaction occurs and the carboxyl is replaced by an amino-group. In this way he has prepared the following amines. They melt with decomposition and the specific rotations are for pyridine as solvent :—

6-Methyl-8-aminoergolen, C₁₅H₁₇N₃, m.p. 253°, [α]_D²⁰ + 96°; ex lysergic acid.

6-Methyl-8-aminoisergolen, C₁₅H₁₇N₃, m.p. 198°, [α]_D²⁰ + 249°; ex *isolysergic* acid.

These two are represented by formulæ (2) and (1) respectively in the

set on p. 529, with in each case the COOH group at C⁸ replaced by NH₂.
6-Methyl-8-aminoergoline, C₁₅H₁₉N₃, m.p. 243°, [α]_D^{20°} - 117°, ex dihydrolysergic acid.

6-Methyl-8-aminoisoergoline (I),
C₁₅H₁₉N₃, m.p. 275-280°, [α]_D^{20°} - 66° } ex dihydroiso-
6-Methyl-8-aminoisoergoline (II),
C₁₅H₁₉N₃, m.p. 203°, [α]_D^{20°} + 29° } lysergic acids I
and II (p. 533).

A homologous series of urethanes of lysergic and isoerysergic acids has been prepared by Troxler ^{74(b)} by boiling the respective azides in benzene and addition of the appropriate alcohol. They have the general formula R.NH.CO.O.R', where R is the 6-methylergolenyl residue and R' is an alkyl group, methyl to butyl. The two methyl derivatives are (6-methylergolenyl-8)-carbamic acid methyl ester, C₁₇H₁₉O₂N₃, m.p. 236-7° (*dec.*), [α]_D^{20°} + 50° (pyridine) and (6-methylisoergolenyl-8)-carbamic acid methyl ester, C₁₇H₁₉O₂N₃, m.p. 180° (*dec.*), [α]_D^{20°} + 346° (pyridine).

These urethanes and the amino-compounds described above do not isomerise or racemise like the lysergic acids and the ergot alkaloids, which is taken to indicate that the carboxyl group at C⁸ is an important factor in this reaction.

Dihydro-derivatives of Ergot Alkaloids. (1) *Lævorotatory Series.* Though Jacobs and Craig ⁷⁵ succeeded in obtaining the well-defined products α- and γ-, dihydrolysergic acids, by the reduction of lysergic acid with sodium in amyl alcohol (1934), or by hydrolysis of the hydrogenation products of ergotamine and ergotamine and of ergotinine, ergotaminine and ergine (1936), and they as well as Kharasch ⁷⁶ had obtained dihydroergometrine (1936), Stoll and Hofmann ⁷⁷ first succeeded in preparing well-defined dihydro-derivatives of the lævorotatory and pharmacologically active ergot alkaloids, using dioxan as a solvent with palladium black as catalyst at a temperature of 60-70° and a pressure of 30-40 atmospheres (1943). The dihydro-derivatives crystallise well, form crystalline salts and on hydrolysis yield the α-dihydrolysergic acid of Jacobs and Craig, which is re-named (-)-dihydro-d-lysergic acid. The principal characteristics of these dihydro-compounds are given in the following table:—

Name	Formula	M.p. (<i>dec.</i>)	[α] _D ^{20°} (pyridine)	Salts or Derivatives
Dihydroergotamine .	C ₂₈ H ₃₇ O ₅ N ₅	239°	- 64°	B. HCl, m.p. 220-5°; B. CH ₃ .SO ₃ H, m.p. 230-5°; B ₂ .C ₄ H ₄ O ₆ , m.p. 210-5°
Dihydroergosine .	C ₂₈ H ₃₉ O ₅ N ₅	212°	- 52°	—
Dihydroergocristine .	C ₂₅ H ₄₁ O ₅ N ₅	180°	- 56°	—
Dihydroergokryptine .	C ₂₂ H ₄₃ O ₅ N ₅	235°	- 41°	—
Dihydroergocornine .	C ₃₁ H ₄₁ O ₅ N ₅	187°	- 48°	—
(-)-Dihydro-d-lysergic acid.	C ₁₆ H ₁₉ O ₂ N ₂	> 300°	- 122°	Hydrazide, C ₁₆ H ₁₉ ON ₂ , m.p. 247° (<i>dec.</i>), [α] _D ^{20°} - 123° (pyridine).
Dihydroergometrine .	C ₁₉ H ₂₅ O ₂ N ₃	230°	- 145°	—

(2) *Dextrorotatory Series.* Using palladium or platinum oxide as catalyst, in glacial acetic acid, with hydrogen at a pressure of 10-25 atmospheres,

Stoll, Hofmann and Petrzilka (1946) ⁷⁷ have also succeeded in obtaining dihydro-derivatives of this series (ergotinine type) of ergot alkaloids. Each of these bases yields two dihydro-derivatives, distinguished as isomerides I and II. Their chief characteristics are summarised in the following table :—

Name	Formula	Isomeride I		Isomeride II	
		M.p. (dec)	$[\alpha]_D^{20}$ (pyridine)	M.p. (dec)	$[\alpha]_D^{20}$ (pyridine)
Dihydroergotaminine	$C_{33}H_{37}O_5N_5$	236°	+97°	206°	-7°
Dihydroergosinine	$C_{30}H_{39}O_5N_5$	234°	+108°	223°	+3°
Dihydroergocristinine	$C_{35}H_{41}O_5N_5$	248°	+109°	175°	+13°
Dihydroergokryptinine	$C_{32}H_{43}O_5N_5$	268°	+126°	226°	+26°
Dihydroergocorninine	$C_{31}H_{41}O_5N_5$	264°	+147°	180°	+32°
Dihydroergometrinine	$C_{19}H_{25}O_2N_3$	211°	+8°	212°	+45°

The dihydro-bases of type (I) yield on treatment with hydrazine the expected (—)-dihydro-*d-isolysergic acid* (I) hydrazide, but on hydrolysis with alkali the reduced *isolysergic acid* residue is irreversibly isomerised to the dihydrolysergic acid residue and the product obtained is (—)-dihydro-*d-lysergic acid* (cf. p. 532).

The second type, dihydro-bases (II), hydrolyses with alkali or with hydrazine to (+)-dihydro-*d-isolysergic acid* (II), which is probably identical with the γ -dihydrolysergic acid of Jacobs and Craig. The principal characters of the dihydro-lysergic and *isolysergic acids* and their derivatives are summarised in the following table :—

Name	Formula	Dihydroisolysergic acids				Dihydrolysergic acid	
		I*		II		M.p.	$[\alpha]_D^{20}$
		M.p.	$[\alpha]_D^{20}$	M.p.	$[\alpha]_D^{20}$		
Acid	$C_{16}H_{18}O_2N_2$	280°	-86°	310°	+17°	318°	-122°
Hydrazide	$C_{16}H_{20}ON_4$	227°	-23°	260°	+56°	247°	-123°
Azide	—	—	-48°	—	—	—	-79°
Amide	$C_{16}H_{19}ON_3$	275°	0°	307°	+17°	276°	-131°
Methyl Ester	$C_{17}H_{20}O_2N_2$	190°	-82°	—	—	187°	-96°

* This acid crystallises with a molecule of water, which is not lost at 135-140° in a high vacuum.

Pharmacological Action. Certain of the simple amines and amino-acids found in ergot are pharmacologically active and have some influence on

the total activity of the crude drug and its galenical preparations, but the specific effects are associated with the alkaloids proper. These form a series of pairs of isomeric amides, one member of each pair being derived from lysergic acid and the other from *isolysergic acid*. The lysergic acid derivatives, typified by ergotoxine, are lævorotatory and highly active pharmacologically, while those of *isolysergic acid*, typified by ergotinine, are strongly dextrorotatory and though they may have the same kind of action as their lævorotatory isomerides, are always less potent.

White ⁷⁸ has shown that the lysergic acids themselves exhibit weakly some, but not all, of the types of activity characteristic of the alkaloids of higher molecular weight. Both acids produce a slight transitory cyanosis of the cockscomb and cause ataxia and delayed miosis in the cat and also relax the isolated rabbit intestine. On the whole, lysergic acid appeared more active than the isomeride.

The simple amides of these two acids, *isoergine* (lysergic acid amide) and *ergine* (*isolysergic acid amide*) also induce in some degree the same type of pharmacological effect as the more complex ergot alkaloids. In the cat both amides produced some of the "sham rage" symptoms, so commonly seen with the larger ergot alkaloids and intracardially in monkeys, *ergine* and *isoergine* produced drowsiness, jerkiness and difficulty in maintaining sustained movement. In the fowl, intravenously, 1.2 mgm. per kilo of either amide caused cyanosis of the comb. Both reduce the contraction of the isolated rabbit intestine and have little or no sympatholytic activity, but show an oxytocic effect on the isolated guinea-pig uterus in concentrations of 1 to 50,000 to 1 to 100,000. In contrast, *ergosine*, a typical lævorotatory ergot alkaloid, may be active on the guinea-pig uterus in concentrations down to 1 : 6,000,000, while *ergosinine*, its dextrorotatory isomeride, is only active in concentrations of the order of 1 : 125,000 to 1 : 250,000. It is only among the alkaloids larger than *ergometrine* that a true sympatholytic activity is observed.

White's observations on the pharmacological activity of the lysergic acids and their simple amides are of practical, therapeutic interest in view of the possibility of preparing from natural supplies of these acids, partially synthetic oxytocic substances of which a first series by Stoll and Hofmann ⁶⁸ has been described (p. 528), including *d*-lysergic-(+)- β -butanolamide, already the subject of promising clinical trials.⁷⁹

Of the typical ergot alkaloids, six pairs (table, p. 526) are now known. The first five pairs are more complex in structure than the sixth pair, *ergometrine* and *ergometrinine*.

Of these twelve alkaloids, three are of practical, therapeutic importance, *viz.*, *ergotoxine*, *ergotamine* and *ergometrine*, and round them a vast pharmacological and clinical literature has accumulated, but for the present purpose it is sufficient to mention the results of comparisons which have been made between the chief types of pharmacological action exerted by *ergometrine* and the longer-known ergot alkaloids *ergotoxine* and *ergotamine*.

Brown and Dale ⁸⁰ have shown that *ergometrine (a)* produces central

excitation with general sympathetic stimulation, but with only a trace of paralysing action on motor sympathetic effects; (b) causes cyanosis of the cockscomb, but has a much smaller tendency to produce gangrene than ergotoxine and its congeners; (c) exerts a pressor action much less marked than that of the ergotoxine group and is less toxic; and (d) as its most characteristic action produces a long, persistent rhythm of powerful contractions in a uterus normally quiescent as in the early puerperium. In a discussion of oxytocic drugs Chassar-Moir⁸¹ points out that ergometrine acts more quickly than the alkaloids of the ergotoxine group, is more certain in action when given orally, that there is little difference in the duration of the action, and that ergometrine is less toxic and its use involves no risk of puerperal gangrene.

The ergotoxine group of ergot alkaloids all exert pressor action, produce gangrene of the cockscomb, reverse the action of adrenaline on plain and especially uterine muscle, and induce contraction of the puerperal uterus. It is for this last purpose that ergotoxine and ergotamine are chiefly used in medicine. Considerable use is also made of ergotamine for its central action in migraine. Earlier comparisons⁸² did not suggest any differences in pharmacological action between the two alkaloids, but more recent work has shown that ergotamine is less toxic to mice and that its sympathicolytic and hyperpyretic activities are less than those of ergotoxine.

In the series of papers already referred to, White⁷⁸ has recorded for various animals the action of doses of the newer alkaloids, ergosine and ergocristine, likely to produce toxic symptoms. The ergotoxine ethanesulphonate used for comparison in these experiments was of ergocornine quality (p. 524) and free from ergocristine. The effects, in the fowl, for example, are like those induced by ergotoxine or ergotamine,⁸² and ergosine had a similar but less powerful action, while ergometrinine in ten times the dose used for ergosine was virtually inactive. Like all the bases of the ergotoxine group ergosine produces a fall in rectal temperature in mice but a tendency towards a rise in this factor in rabbits, though here the response is variable in kind and degree. In this respect ergosine is inactive in mice like all the alkaloids of the ergotinine type tried, and is much less potent than ergosine in rabbits. In the pithed cat ergosine and ergocristine have a pressor action, and the adrenaline response of the perfused cat hind limb is reversed by both alkaloids and is reduced by ergosine. Ergosine and ergosine both lower the activity of isolated rabbit intestine, the former being the more active, as it is also in its effect on the adrenaline response. In action on isolated guinea-pig intestine, ergosine, like ergometrine and *isoergine*, causes contraction, but ergocristine, like ergosine, ergometrinine, ergine, the two lysergic acids and ergotoxine, relaxes the intestine. Taking the sympathicolytic activity of ergotoxine as 1, the relative potencies of other ergot alkaloids are approximately as follows: ergotamine, 0.8; ergosine, 1.9; ergosine, 0.033; ergocristine, 0.75. On isolated guinea-pig uterus ergosine, ergosine, ergocristine, ergometrine, *isoergine* and ergine all show oxytocic activity,

as do also ergosine, ergometrine, ergometrinine, ergotoxine and ergotamine on rabbit uterus *in situ*.

Stoll ^{33(a)} (1945) has pointed out that the polypeptide ergot alkaloids have two main types of activity :—

(1) Action on smooth muscle (uterus, blood vessels, intestine, etc.).

(2) Inhibiting action on the sympathetic functions of the vegetative system.

Ergometrine and its homologues exert only the first type of activity. The principal results of hydrogenation of any of the ergot alkaloids are to lower toxicity and to reduce greatly the action on the musculature. Dihydroergometrine and its homologues are almost inactive substances and the dihydro-derivatives of the polypeptide bases, ergotamine, ergocornine, etc., exert only the second type of action uncomplicated by action on smooth muscle. The effects on toxicity are shown in the following table. The figures are for L.D.50, in mgms./kilo. by intravenous injection in rabbits :—

Ergotamine	.	.	3.55	Dihydroergotamine.	.	25.00
Ergocornine	.	.	1.17	Dihydroergocornine	.	35.00
Ergocristine	.	.	2.15	Dihydroergocristine	.	27.00
Ergokryptine	.	.	1.05	Dihydroergokryptine	.	20.50

The effect of hydrogenation is markedly displayed by the method adopted by Rothlin and Brügger ⁴¹ to estimate the relative activities of four ergot alkaloids and their dihydro-derivatives in inhibiting the action of adrenaline on the isolated seminal vesicles of the guinea-pig. Using ergotamine as standard (activity = 1) their results for action on isolated rabbit uterus (R) and on guinea-pig seminal vesicles (S) are as follows :—

	R	S		R	S
Ergotamine .	1.0	1.0	Dihydroergotamine.	2.25	7.0
Ergocornine.	0.5	2.0	Dihydroergocornine	2.5	25.0
Ergocristine.	1.0	4.0	Dihydroergocristine	3.6	35.0
Ergokryptine	1.5	4.0	Dihydroergokryptine	5.0	35.0

This simplification in the range of activity in the dihydro-bases provides possible new therapeutical applications, and clinical trials on these lines are now in progress, particularly with dihydroergotamine. ^{82(a)}

Ergothioneine is under investigation as a possible remedy for thyrotoxicosis. ^{82(b)}

As cases of ergotism still occur in man and animals, mention may be made of the recent investigation by Fitzhugh, Nelson and Calvery ⁸³ of the effects of long-continued feeding of known percentages of ergot in the diet of rats ; one of the numerous symptoms of chronic toxicity recorded is retardation of growth in the early stages, this effect being increased with diets low in protein.

Useful general articles on the pharmacology of the ergot alkaloids have been published by Nelson and Calvery, ⁸⁴ White, ^{22, 78} and Barger, ⁸⁵ and monographs on ergotamine and the alkaloids of ergot by Stoll (1945). ^{8, 22}

REFERENCES

- (1) *Amer. J. Pharm.*, 1864, **36**, 198; (2) *Compt. rend.*, 1875, **81**, 896; 1878, **86**, 888. (3) *Arch. exp. Path. Pharm.*, 1876, **6**, 153. (4) *Ibid.*, 1897, **39**, 104. (5) *Ibid.*, 1884, **18**, 316. (6) *Chem. News*, 1906, **94**, 89; *J. Chem. Soc.*, 1907, **91**, 337; BARGER and DALE, *Biochem. J.*, 1907, **2**, 240. (7) *Arch. Pharm.*, 1906, **244**, 336. (8) *Verh. Schweiz. Nat. Ges.*, 1920, p. 190; STOLL, *Schweiz. Apoth. Zeit.*, 1922, **60**, 341, 358, 374; *Helv. Chim. Acta*, 1945, **28**, 1283. (9) *J. Chem. Soc.*, 1931, 1888. (10) *Brit. Med. J.*, 1932, **i**, 1119. (11) *Ibid.*, 1935, **i**, 520, 798; *Science*, 1935, **81**, 559. (12) *Ibid.*, 1935, **81**, 388; *J. Amer. Chem. Soc.*, 1935, **57**, 956, 1140. (13) *Compt. rend.*, 1935, **200**, 1680; *Science*, 1935, **82**, 415; *Münch. med. Woch.*, 1937, **84**, 322. (14) *Science*, 1935, **81**, 636, 82, 62; *J. Amer. Pharm. Assoc.*, 1932, **21**, 853, 1135, **22**, 736; 1935, **24**, 24, 185, 748; 1937, **26**, 805. (15) KHARASCH, KING, STOLL and THOMPSON, *Nature*, 1936, **137**, 403; for details see STOLL and BURCKHARDT, *Schweiz med. Woch.*, 1936, **66**, 353. (16) *J. Chem. Soc.*, 1936, 1166, 1440. (17) *Ibid.*, 1937, 396; for description of crystals see KÖFLER, *Arch. Pharm.*, 1938, **276**, **40**, 61. (18) *Quart. J. Pharm.*, 1936, **9**, 230. (19) *Zeit. Physiol. Chem.*, 1937, **250**, **1**; 1938, **251**, 287; STOLL and HOFMANN, *Helv. Chim. Acta*, 1943, **26**, 1570; (with BECKER), *ibid.*, 1602; FOSTER, *Analyst*, 1945, **70**, 132; (with SMITH and TIMNIS), *Pharm. J.*, 1946, **157**, 43. (20) *Arch. Pharm.*, 1934, **272**, 503; *Zeit. angew. Chem.*, 1937, **50**, 34. (21) "CHINOIN" and E. WOLF, B.P., 388, 529; STOLL, *Schweiz. med. Woch.*, 1935, **65**, 1077; cf. Chem. Fabr. vorm Sandoz, B.P., 453, 531; KÖFLER, *Arch. Pharm.*, 1937, **275**, 455. (22) BARGER, *Analyst*, 1937, **62**, 340; KÜSSNER, *Angew. Chem.*, 1937, **50**, 34; KÖFLER, *Merck's Jahresh.*, 1937, **51**, 19; WHITE, *Edin. Med. J.*, 1940, **47**, 789; JACOBS, *Univ. Penna. Bicent. Cong.*, 1941, **27**; CUNNINGHAM, *New Zealand Journ. Sci. Tech.*, 1941, **23A**, 138; STOLL, *Experientia*, 1945, **1**, 250; K. E. SHARP, *Pharm. J.*, 1946, **156**, 349. (23) KIESEL, *Zeit. physiol. Chem.*, 1924, **135**, 61; HOLTZ and MÜLLER, *Arch. exp. Path. Pharm.*, 1925, **105**, 27. (23a) BARGER, *J. Chem. Soc.*, 1909, **95**, 1125, 1720; ROSENMUND, *Ber.*, 1909, **42**, 4778. (24) TANRET, *Compt. rend.*, 1909, **149**, 222; BARGER and EWINS, *J. Chem. Soc.*, 1911, **99**, 2336; PIRIE, *Biochem. J.*, 1933, **27**, 202; HARRINGTON and OVERHOFF, *ibid.*, 1933, **27**, 338; AKABORI, *Ber.*, 1933, **66**, 151; NEWTON, BENEDICT and DAKIN, *J. Biol. Chem.*, 1927, **72**, 367; EAGLES and JOHNSON, *J. Amer. Chem. Soc.*, 1927, **49**, 575; 1928, **50**, 1386; HUNTER, *Biochem. J.*, 1928, **22**, 4; BEHRE, *ibid.*, 1932, **26**, 458. (25) BARGER and DALE, *J. Chem. Soc.*, 1910, **97**, 2592; KUTSCHER, *Zentr. Physiol.*, 1910, **24**, 163; WINDAUS and VOGT, *Ber.*, 1907, **40**, 3691; 1911, **44**, 1721; PYMAN, *J. Chem. Soc.*, 1911, **99**, 668. (26) KOBERT, *Arch. exp. Path. Pharm.*, 1885, **18**, 316; KRAFT, *Arch. Pharm.*, 1906, **244**, 336; VAHLEN, *Arch. exp. Path. Pharm.*, 1908, **60**, 42. (27) ENGELAND and KUTSCHER, *Zentr. Physiol.*, 1910, **24**, 479, 589; cf. KOSSEL, *Zeit. Physiol. Chem.*, 1910, **66**, 257; 1910, **68**, 170. (28) BARGER and DALE, *Proc. Physiol. Soc. J. Physiol.*, 1909, **38**, lxxvii-lxxix. (29) EWINS, *Biochem. J.*, 1914, **8**, 44, 366. (30) VAHLEN, *Arch. exp. Path. Pharm.*, 1906, **55**, 136; 1908, **60**, 42. (31) BARGER and DALE, *Biochem. J.*, 1907, **2**, 240; cf. VAN SLYKE, *J. Pharm. exp. Ther.*, 1909, **1**, 265. (32) FRÄNKEL and RAINER, *Biochem. Zeit.*, 1916, **74**, 167. (33) HASSALL, *New Zealand J. Sci. Tech.*, 1944, **25B**, 169; FOSTER and GRANT, *Analyst*, 1944, **69**, 271 (ergot from New Zealand grasses); STUHR, CHRISTENSEN and WONG, *J. Amer. Pharm. Assoc.*, 1931, **20**, 794; 1943, **32**, 241 (ergot from various Oregon grasses); SCHWARTING and HINER, *ibid.*, 1945, **34**, 11 (ergot from rye and wheat). (33a) JARETZKY, *Arch. Pharm.*, 1935, **273**, 348; VON BÉKÉSY, *Zent. f. Bakt.*, 1938, **99**, Abt. 2, 321; *Biochem. Zeit.*, 1939, **302**, (3-4), 187; 1940, **303**, 368; *Ber. ungar. pharm. Ges.*, 1943, **19**, 424 (*Chem. Abstr.*, 1946, **40**, 6211); THOMAS and RAMAKRISHNAN, *Madras Agric. J.*, 1942, **30**, 411; HYNES, *Pharm. J.*, 1941, **147**, 172; MELVILLE, *ibid.*, 179; NEILL, *N.Z. Journ. Sci. Tech.*, 1941, **23**, 130A; HECHT, *Pharm. Acta Heb.*, 1944, **19**, 112, 317; cf. STOLL and BRACK, *idem*, p. 118; STOLL²²; MUKERJI and DEY, *Current Sci.*, 1943, **12**, 87; 1944, **13**, 128; SAHA and BHATTACHARJEE, *Nature*, 1945, **156**, 363; BALDACCI, *Farmaco Sci. e. tec.*, 1946, **1**, 110, 187 (*Chem. Abstr.*, 1946, **40**, 6550, 6668); LEWIS, U.S.P. 2,402,902. (33b) PLANTE and SUNDERLAND, *J. Phys. Chem.*, 1944, **48**, 203; *J. Council Sci. Indust. Res. Australia*, 1943, **16**, 28. (34) CHRISTENSEN and REESE, *J. Amer. Pharm. Assoc.*, 1939, **28**, 343; REESE, *ibid.*, 1944, **33**, 315; HERSANT and LINNELL, *Pharm. J.*, 1938, **131**, 3; WOKES, *Quart. J.*

Pharm., 1929, 2, 384; SMELT, *ibid.*, 1933, 6, 399; CORRAN and RYMILL, *ibid.*, 1935, 8, 337; SWANSON *et al.*, *J. Amer. Pharm. Assoc.*, 1932, 21, 229, 320, 1003; SWOAP *et al.*, *ibid.*, 1933, 22, 8; STUART and BIBBINS, *ibid.*, 1934, 23, 1104; SCHOUB and TONNESEN, *Dansk. Tids. Farm.*, 1940, 14, 49; DEY, BOSE and MUKERJI, *Current Sci.*, 1942, 11, 432. (35) LINNELL and RANDLE, *Pharm. J.*, 1927, 119, 423; WOKES and ELPHICK, *Quart. J. Pharm.*, 1930, 3, 539; DAGLISH and WOKES, *ibid.*, 1939, 12, 133, 152; CORRAN and RYMILL, *ibid.*, 1935, 8, 337; HAMPSHIRE and PARTRIDGE, *ibid.*, 1941, 14, 116; MILLER, *J. Assoc. Off. Agric. Chem.*, 1939, 22, 719. (36) OKOLOV, *Zeit. Unters. Lebensmitt.*, 1929, 37, 63, 72; KLUGE, *ibid.*, 1934, 68, 645; CHERTOK and BERESOVSKA, *Probl. Nutrit. Kharkov*, 1934, 3, 21; CUNNINGHAM *et al.*, *New Zealand J. Sci. Tech.*, 1944, 26A, 121, 125. (37) VAN OETTEL, *Arch. exp. Path. Pharm.*, 1930, 149, 218; VAN PINXTEREN, *Pharm. Weekbl.*, 1931, 68, 1151; 1934, 71, 1230; OTTEN, *ibid.*, 1937, 74, 510; SMITH, *Publ. Hlth. Rep. U.S.A.*, 1930, 45, 1466; STEVENS, *J. Amer. Pharm. Assoc.*, 1933, 22, 99, 940; ALLPORT and COCKING, *Pharm. J.*, 1932, 129, 235; GLYCART, *J. Off. Agric. Chem.*, 1933, 16, 387; 1935, 18, 540; 1937, 20, 566; 1938, 21, 538; SCHULEK and VASTAGH, *Dansk. Tids. Farm.*, 1939, 13, 101; JORGENSEN, *ibid.*, 1944, 18, 181; KOPET and DILLE, *J. Amer. Pharm. Assoc.*, 1942, 31, 109; MOLNAR, *Pharm. Acta. Helv.*, 1944, 19, 270; BROWNLEE, *Quart. J. Pharm.*, 1945, 18, 172. Qualitative colour reactions—see Evers, *Pharm. J.*, 1927, 118, 721; VAN URK, *Pharm. Weekbl.*, 1929, 66, 473; FAIRBAIRN, *Pharm. J.*, 1943, 150, 94; MCGILLIVRAY and METCALF, *New Zealand J. Sci. Tech.*, 1943, 25B, 115, 119, 123; VON BÉKÉSY, *Ber. ungar. pharm. Ges.*, 1943, 19, 404 (*Chem. Abstr.*, 1946, 40, 6756). (38) HARMSMA, *Pharm. Weekbl.*, 1928, 65, 1114; SCHLEMMER (with SCHMITT), *Arch. Pharm.*, 1932, 270, 15; SCHLEMMER, WIRTH and PETERS, *ibid.*, 1936, 274, 16; SMITH and STOHLMANN, *J. Pharm. exp. Ther.*, 1930, 40, 77; SMITH, *J. Amer. Pharm. Assoc.*, 1934, 23, 25; WOKES and CROCKER, *Quart. J. Pharm.*, 1931, 4, 420; ALLPORT and CREWS, *ibid.*, 1935, 8, 447; VON BÉKÉSY, *Biochem. Zeit.*, 1939, 302, 187; 1940, 308, 368; KÖFLER, *Angew. Chem.*, 1939, 52, 251. (39) BROOM and CLARK, *J. Pharm. exp. Ther.*, 1923, 22, 59; *cf.* BURN and ELLIS, *Pharm. J.*, 1927, 118, 384; SWANSON, *J. Amer. Pharm. Assoc.*, 1929, 18, 1127; (with POWELL, STEVENS and STUART), *ibid.*, 1932, 21, 229, 320; VON ISSEKUTZ *et al.*, *Arch. exp. Path. Pharm.*, 1928, 128, 165, 173; PATTIE and NELSON, *J. Pharm. exp. Ther.*, 1929, 36, 85; THOMPSON, *J. Amer. Pharm. Assoc.*, 1930, 19, 221, 436, 705; 1937, 26, 805; McCLOSKEY *et al.*, *ibid.*, p. 844; CROSBIE, *ibid.*, 1934, 23, 1110; BERG, *ibid.*, 1936, 25, 32. (40) HAMPSHIRE and PAGE, *Quart. J. Pharm.*, 1936, 9, 60; 1938, 11, 57; TRABUCCI, *Boll. Soc. ital. Biol. sper.*, 1937, 12, 232; ALLPORT and PORTER, *Quart. J. Pharm.*, 1938, 11, 96; ALLPORT and JONES, *ibid.*, 1941, 14, 106; STEVENS, *J. Amer. Pharm. Assoc.*, 1938, 27, 100; SCHOUB, AAGE and BENNEKOU, *Dansk. Tids. Farm.*, 1938, 12, 257; TONNESEN (with SCHOUB), *ibid.*, pp. 268, 272, 279; 1940, 14, 33, 45, 49; (with JORGENSEN), *ibid.*, 1940, 14, 134; DAGLISH and WOKES, *Quart. J. Pharm.*, 1939, 12, 451; SMITH, *J. Amer. Pharm. Assoc.*, 1940, 29, 385; 1947, 36, 321; SCHUMACHER, *Deut. Apoth. Zeit.*, 1940, 55, 312; GROVE, *J. Amer. Pharm. Assoc.*, 1941, 30, 260; *J. Assoc. Off. Agric. Chem.*, 1942, 25, 813; 1944, 27, 342; KNUDSEN and GROVE, *Ind. Eng. Chem.*, 1942, 14, 556; GROVE and VOS, *J. Amer. Pharm. Assoc.*, 1945, 34, 256; MCGILLIVRAY and METCALF, *New Zealand J. Sci. Tech.*, 1943, 25B, 119, 123; BACHINSKY and ALLMARK, *Can. Chem. Process Ind.*, 1946, 30, 83 (*Chem. Abstr.*, 1947, 41, 1387). (41) KUSSNER and SIECKMANN, *Munch. med. Woch.*, 1936, 83, 725; SWANSON, HARGREAVES and CHEN, *J. Amer. Pharm. Assoc.*, 1935, 24, 835; DE BEER and TULLAR, *J. Pharm. exp. Ther.*, 1941, 71, 256; POWELL, REAGAN, STEVENS and SWANSON, *J. Amer. Pharm. Assoc.*, 1941, 30, 255; VOS, *ibid.*, 1943, 32, 188; BRÜGGER, *Helv. Physiol. Pharm. Acta*, 1945, 3, 117; (with ROTHLIN), *ibid.*, p. 519; ROTHLIN, *Helv. Chim. Acta*, 1946, 29, 1290. (42) YOUNGKEN, FISCHER and ROGERS, *J. Amer. Pharm. Assoc.*, 1942, 31, 136; WESTON and TAYLOR, *J. Agric. Sci.*, 1942, 32, 437; FOSTER and GRANT, *Analyst*, 1944, 69, 271; STOLL, *Mitt. Naturf. Ges. Bern.*, 1942, 45 (*Chem. Abstr.*, 1947, 41, 6671). (43) "Ergot and Ergotism," GURNEY and JACKSON: London and Edinburgh, 1931. (44) VAN URK, *Pharm. Weekbl.*, 1929, 66, 473; *cf.* M. I. SMITH, *U.S. Public Health Reports*, 1930, 1460. (45) *J. Chem. Soc.*, 1936, 1440; 1937, 396. (46) FORST, *Arch. exp. Path. Pharm.*, 1926, 114, 125; 117, 232; 1936, 181, 180; HEROLD, *Chim. et Ind.*, 1933, 29, 1017.

(47) SMITH and TIMMIS, *J. Chem. Soc.*, 1930, 1390 ; cf. SOLTYS, *Ber.*, 1932, 65, 553 ; FOSTER and GRANT, *Analyst*, 1944, 69, 271 ; *Bull. Health Organ. League of Nations*, 1945-6, 12, 146. (48) WELLCOME FOUNDATION and G. M. TIMMIS, B.P., 286,582 ; cf. FOSTER.¹⁹ (49) RAYMOND-HAMET, *Bull. Soc. Chim. biol.*, 1926, 8, 765. (50) *Arch. Pharm.*, 1936, 274, 398 ; 1938, 276, 61 ; cf. BRASSEUR, *Bull. Soc. Chim. biol.*, 1935, 17, 1462. (51) Cf. BEESLEY and FOSTER, *Analyst*, 1945, 70, 374. (52) *Quart. J. Pharm.*, 1930, 3, 59 ; 1931, 4, 101. (53) *Pharm. J.*, 1935, 134, 709 ; *Proc. Roy. Soc.*, 1935, B, 118, 478 ; *J. Amer. Chem. Soc.*, 1935, 57, 2009. (54) *Nature*, 1936, 137, 154. (55) SMITH and TIMMIS, *J. Chem. Soc.*, 1936, 1440. (56) JACOBS and CRAIG, *J. Biol. Chem.*, 1936, 113, 767. (57) WELLCOME FOUNDATION and TIMMIS, B.P. 445,324-5. (58) *J. Chem. Soc.*, 1910, 97, 284. (59) Compare JACOBS, *J. Biol. Chem.*, 1932, 97, 739 ; (60) *J. Chem. Soc.*, 1932, 763, 1543 ; 1934, 674. (61) *J. Biol. Chem.*, 1934, 104, 547. (62) *Ibid.*, 1935, 108, 595 ; 110, 521 ; *J. Amer. Chem. Soc.*, 1935, 57, 383, 960. (63) *Science*, 1935, 81, 256 ; *J. Org. Chem.*, 1936, 1, 245. (64) *Science*, 1935, 82, 16 ; *J. Biol. Chem.*, 1935, 110, 521. (65) *J. Chem. Soc.*, 1936, 1440 ; description of crystals, BRASSEUR, *Chem. Zent.*, 1935, ii, 3897. (66) *J. Biol. Chem.*, 1934, 106, 393 ; 1935, 111, 455 ; *Science*, 1936, 83, 166. (67) *J. Biol. Chem.*, 1936, 115, 227 ; cf. 1935, 108, 595. (68) *Zeit. physiol. Chem.*, 1937, 250, 7 ; 1938, 251, 155 ; *Helv. Chim. Acta*, 1943, 26, 922, 929, 944 (clinical results : JAHNKE, *Zbl. Gynäk.*, 1942, 66, 1071). (69) JACOBS and CRAIG, *J. Biol. Chem.*, 1935, 111, 455 ; *Science*, 1936, 83, 38 ; *J. Biol. Chem.*, 1936, 113, 759, 767 ; 115, 227 ; *J. Amer. Chem. Soc.*, 1938, 60, 1701 ; CRAIG, SHEDLOWSKY, GOULD and JACOBS, *J. Biol. Chem.*, 1938, 125, 289. (70) JACOBS, *J. Biol. Chem.*, 1932, 97, 739 ; *Science*, 1936, 83, 38. (71) *J. Biol. Chem.*, 1935, 111, 455 ; 1939, 128, 715 ; JACOBS, CRAIG and ROTHEN, *Science*, 1936, 83, 166 ; cf. KHARASCH and LEGAULT, *ibid.*, p. 388. (72) CRAIG, SHEDLOWSKY *et al.*⁶⁹ ; cf. HIXON and JOHNS, *J. Amer. Chem. Soc.*, 1927, 49, 1786, but see also ADAMS and MAHAN, *ibid.*, 1942, 64, 2588 ; and KOELSCH, *J. Org. Chem.*, 1943, 8, 295. (73) *Science*, 1937, 85, 248 ; *J. Biol. Chem.*, 1937, 120, 141 ; 1938, 126, 67 ; 1939, 130, 399 ; 1942, 145, 487 ; DARZEN and MEYER, *Comp. rend. Acad. Sci.*, 1934, 198, 1428 ; UHLE and JACOBS, *J. Org. Chem.*, 1945, 10, 76. (74) JACOBS and CRAIG, *J. Biol. Chem.*, 1938, 126, 419 ; cf. TURNER, *Ann. Repts. Chem. Soc.*, 1935, 32, 345 ; 1936, 33, 374. (74a) HOFMANN, *Helv. Chim. Acta*, 1947, 30, 44. (74b) TROXLER, *ibid.*, p. 163. (75) *J. Biol. Chem.*, 1934, 106, 393 ; 1936, 113, 767 ; 1936, 115, 227. (76) KHARASCH and ELI LILLY and Co., U.S.P. 2,086,559. (77) *Helv. Chim. Acta*, 1943, 26, 2070 ; 1946, 29, 635 ; ROTHLIN, *Helv. Physiol. Pharmacol. Acta*, 1944, 2, C48 and ref. (41). (78) *Quart. J. Pharm. Pharmacol.*, 1943, 16, 344 ; 1944, 17, 1, 95. (79) TOLLEFSON, *West J. Surg. Obst. Gyn.*, 1944, 52, 383 ; KIRCHOF, RACELY, WILSON and DAVID, *idem*, p. 197 ; TRITSCH and SCHNEIDER, *Amer. J. Obstet. Gynec.*, 1945, 50, 434 ; FARBER, *ibid.*, 1946, 51, 859. (80) *Proc. Roy. Soc.*, 1935, B, 118, 446 ; cf. ROTHLIN, *Compt. rend. Soc. Biol.*, 1935, 119, 1304 ; *Schweiz. Med. Woch.*, 1938, 69, 71. (81) *Proc. Roy. Soc. Med.*, 1935, 28, 1654 ; *Brit. Med. J.*, 1936, ii, 243, 799 ; *J. Obstet. Gyn.*, 1943, 50, 94 ; *idem.*, 1944, 51, 247 ; cf. BICKERS, *Amer. J. Obstet. Gyn.*, 1943, 46, 238. (82) DALE and SPIRO, *Arch. exp. Path. Pharm.*, 1922, 95, 337 ; cf. *Brit. Med. J.*, 1922, ii, 1173 ; BURN and ELLIS, *Pharm. J.*, 1927, 118, 384. (82a) HORTON, PETERS and BLUMENTHAL, *Proc. Staff Meet. Mayo Clinic*, 1945, 20, 241 ; SPÜHLER, *Schweiz. Med. Woch.*, 1946, 76, 1259 ; DANNENBERG, *Perm. Found. Med. Bull.*, 1946, 4, 96 ; ORTH and RITCHIE, *J. Pharm. Exp. Ther.*, 1947, 90, 166 ; KIRCHOF, DAVID, PHATAK and RACELY, *J. Amer. Pharm. Assoc.*, 1947, 36, 145 ; BLUNTSCHLI, *S. Afr. Med. J.* 1947, 21, 21. (82b) LAWSON and RIMINGTON, *Lancet*, 1947, 252, 586, 906 ; ASTWOOD and STANLEY, *ibid.*, p. 905. (83) *J. Pharm. Exp. Ther.*, 1944, 82, 364 ; cf. ANDERSON and WELLS, *Proc. Soc. Biol. Med.*, 1948, 67, 53. (84) *Physiological Reviews*, 1938, 18, 297. (85) Heffter's *Handb. exper. Pharmacol., Ergänzungswerk*, Band VI, 1938, p. 84.

ALKALOIDS OF CALABAR BEAN

The seeds of *Physostigma venenosum*, Balf., have long been used in West Africa as an ordeal poison. From them Jobst and Hesse,¹ isolated

physostigmine in an amorphous condition. Vee first obtained the alkaloid crystalline and named it eserine.² The "calabarine" subsequently obtained by Harnack and Witkowski³ consists of decomposition products. The second well-defined base to be isolated was eseridine⁴ and the third cseramine.⁵ The next addition was isophysostigmine, isolated by Ogui.⁶ Salway⁷ in 1911 obtained a fifth alkaloid, physovenine, and four years later Polonovski and Nitzberg isolated a new base, geneserine.⁸ A method for the assay of Calabar beans for ether-soluble alkaloids has been published by Salway.⁹ The alkaloidal content varies from 0.05 to 0.3 per cent.

Physostigmine (*Eserine*), $C_{15}H_{21}O_2N_3$. The alkaloid is best prepared in the laboratory by Salway's process.⁷ Methods of manufacture are described by Chemnitius¹⁰ and by Schwyzer.¹⁰

Physostigmine crystallises in two forms, m.p. 86–7° and m.p. 105–6°, the latter being the more stable. It dissolves easily in alcohol, ether or chloroform; the solutions are alkaline and laevorotatory, $[\alpha]_D -75.8^\circ$ ($CHCl_3$); -120° (C_6H_6). The hydrobromide, $B. 2HBr$, forms colourless needles, m.p. 224–6°. The salicylate occurs in colourless, acicular crystals, m.p. 186–7°. The sulphate, $B_2 \cdot H_2SO_4$, is a microcrystalline deliquescent powder, m.p. 145°; the aurichloride, $B. 2HAuCl_4$, yellow leaflets, m.p. 163–5°, and the platinichloride, $B. H_2PtCl_6$, orange-yellow needles, m.p. 180°. The mercuric iodide derivative, $B. HI \cdot HgI_2$, crystallises in small prisms, m.p. 170°, the benzoate forms prisms, m.p. 115–6°, and the picrate, yellow feathery needles, m.p. 114°. The colourless salts, such as the sulphate and salicylate used in medicine, are apt to become red on exposure to light and air.

Physostigmine dissolves in nitric acid to a yellow solution, which on warming becomes red and on evaporation to dryness leaves a green residue. A neutral solution of the sulphate gives with dilute solution of sodium hydroxide a white precipitate, which gradually becomes pink and dissolves in excess of the alkali, forming a reddish solution, which eventually becomes yellowish-green.¹¹

Johnson has described a method for the estimation of physostigmine in the salicylate; for the determination of minute amounts of the alkaloid Ellis, Plachte and Straus have devised processes depending on (a) inhibition of serum choline-esterase by the alkaloid, or (b) measurement of the colour intensity produced by the conversion of physostigmine to rubreserine in an alkaline medium.^{11(a)}

Constitution. Physostigmine behaves as a monoacidic, tertiary base. On treatment with alkali it is converted into ESEROLINE, $C_{13}H_{18}ON_2$, methylamine and carbon dioxide, these two by-products being derived from a urethane group in the parent alkaloid.¹² With sodium ethoxide the products are eseroline and methylurethane, whilst if the alkaloid be heated at its melting-point, methylcarbimide, $CONHMe$, is evolved. Eseroline can be reconverted to physostigmine by the action of methylcarbimide in ether in presence of sodium and, using other carbimides, homologues of physostigmine have been prepared.¹³ Eseroline forms colourless needles, m.p. 129°, $[\alpha]_D -107^\circ$ (EtOH), and, like physostigmine

behaves as a monoacidic tertiary base; it contains two methylimino groups.¹⁴ On exposure to air it undergoes oxidation to RUBRESERINE, $C_{13}H_{16}O_2N_2 \cdot H_2O$, crystallising from water in deep red needles, m.p. 152° (*dry*), and under certain conditions to ESERINE BLUE, $C_{17}H_{23}O_2N_3$, which appears to be a combination of eseroline with one of the degradation products resulting from the oxidation (Salway¹²); the final product is "eserine brown." Methods of preparing these various breakdown products of physostigmine have been described by Ellis,¹² who has also compared the absorption spectra of rubreserine, adrenochrome (oxidation product of adrenaline) and 2-iodoadrenochrome, and suggests that rubreserine, like adrenochrome, contains a 2 : 3-dihydroindole-5 : 6-quinone group. Massart, Vandendriessche and Dufait¹² have shown that indophenol oxidase attacks eseroline at pH 7.3, two atoms of oxygen being used per molecule of eseroline, with the production of rubreserine.

Eseroline yields a series of alkyl ethers of which the ethyl ether, eserethole, oil, b.p. $308-310^\circ$, $[\alpha]_D - 81^\circ$, picrate, m.p. 133° , is the most interesting. When eseroline methiodide is heated at 200° in an atmosphere of carbon dioxide it is converted into physostigmol, $C_{10}H_{11}ON$, colourless needles, m.p. 103° , which still contains a methylimino group and the phenolic hydroxyl group of eseroline (Straus¹²). In like manner eserethole methiodide, when heated in a high vacuum at $180-220^\circ$, furnishes physostigmol ethyl ether, $C_{12}H_{15}ON$, lustrous plates, m.p. 86° ; picrate, m.p. 95° .¹⁵ This substance has been synthesised by Stedman¹⁵ by condensing *p*-ethoxyphenylmethylhydrazine with α -ketoglutaric acid to form 5-ethoxy-2-carboxy-1-methylindole-3-acetic acid (I). This, on decarboxylation, yielded 5-ethoxy-1 : 3-dimethylindole (II), which proved to be identical with physostigmol ethyl ether, and so established the validity of the formula (III) for physostigmol proposed by Straus¹² and settled the position of the phenolic hydroxyl group in this substance and in eseroline.

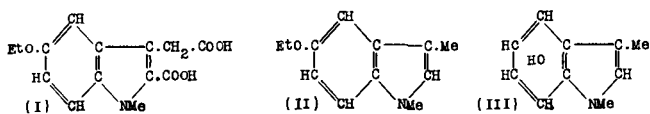

Another synthesis of physostigmol ethyl ether was effected by Keimatsu and Suganuma,¹⁶ and confirmation of the physostigmol formula was provided by the synthesis of dihydrophysostigmol methyl ether by Späth and Brunner.¹⁷ Based upon the Straus formula (III) for physostigmol, several formulæ¹⁸ for eseroline and physostigmine were put forward before the position of the hydroxyl group and the location of the methyl group in the β -position of the indole ring in physostigmol were thus demonstrated. The most interesting of these is the group of formulæ suggested by M. and M. Polonovski,¹⁸ based mainly on a study of the reduction and exhaustive methylation of eserethole. They found that this was reduced by zinc and hydrochloric acid to the secondary base, dihydro-eserethole (oil : oxalate, needles, m.p. 204°), which must be formed by

the scission of a heterocyclic ring.¹⁹ Further, when eserethole methiodide is treated with alkali, eseretholemethine, prisms, m.p. 89°, $[\alpha]_D + 10^\circ$, is formed. This is reconverted to eserethole methiodide by hydriodic acid, and with methyl iodide furnishes a quaternary methiodide, m.p. 100°, $[\alpha]_D - 11.8^\circ$, which is decomposed by alkali giving trimethylamine and a new base etheseroline, $C_{12}H_{12}N \cdot OEt$, prisms, m.p. 48°, $[\alpha]_D - 98^\circ$ (EtOH). The formation of these substances was explained (1924) by the following formulæ²⁰ :—

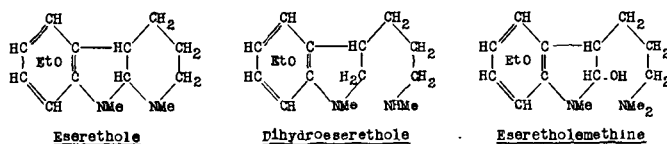

To develop the formula of physostigmol into that of eseroline it is necessary to add on a residue, C_3H_7N , in which the nitrogen atom is basic and tertiary (Salway) and is present as $=NMe$ (Straus), whence the residue may be expanded to $-CH_2-CH_2-NMe$, which implies a pyrroline ring. The formula now generally accepted for eseroline (IV) and that for physostigmine (V) deducible from it, were proposed by Robinson,²¹ and the additional evidence for them provided by Barger and Stedman²¹ may be summarised as follows :—

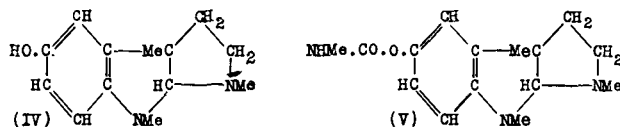

The formation of dihydroeserethole by reduction of eserethole is readily accounted for by the opening of the pyrrolidine ring. It was shown by Barger and Stedman²² that the reversion of eseretholemethine to eserethole methiodide by hydriodic acid is analogous with the behaviour of Brunner's alkylene indolines.²³ For this reason M. and M. Polonovski²⁴ reinvestigated the formation of eseretholemethine and showed that it was produced by tautomeric change from methyleseretholinium hydroxide and not by loss of water. These changes may be represented by the formulæ shown on p. 543.

The indolinol character of eseretholemethine is indicated by the fact that the methiodide on treatment with picric acid yields a diquaternary picrate (m.p. 170°) with the loss of the hydroxyl group. More definite proof is afforded by the oxidation of eseretholemethine with ammoniacal silver nitrate or potassium ferricyanide, when a dehydroeseretholemethine (oxyeseretholemethine of Polonovski), picrate, m.p. 199°, is produced which is assumed to have formula (VI), since on exhaustive methylation it yields trimethylamine and an unsaturated product (deep-red picrate, m.p. 103°), which absorbs two atoms of hydrogen, forming 5-ethoxy-1 : 3-dimethyl-3-ethyl-2-indolinone (VII), colourless cubes, m.p. 68°. The

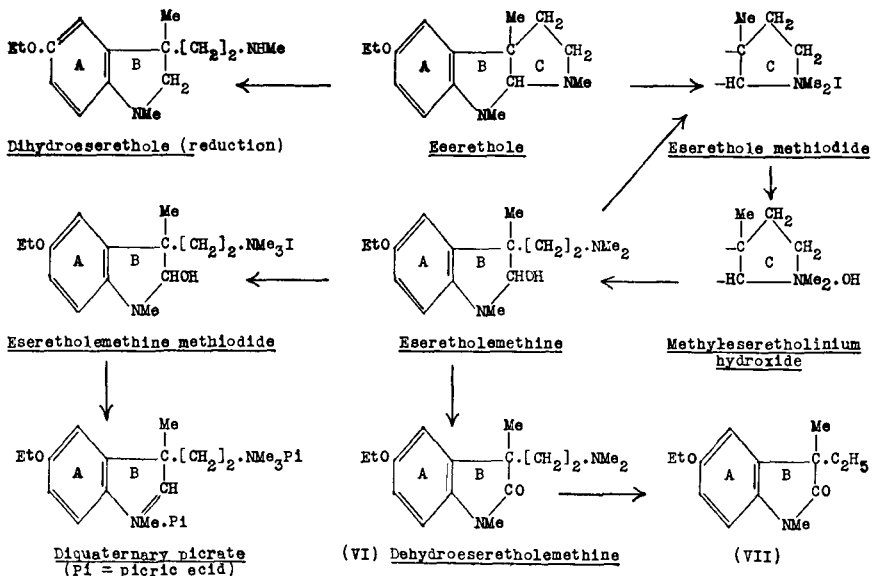

formula (IV) for eseroline, and therefore of (V) for physostigmine, have been definitely established by the syntheses effected by three groups of workers.

King and Robinson,²⁵ in continuation of researches²⁶ on the synthesis of indolines, prepared dehydroesermetholemethine (VI: MeO replacing EtO) by the following series of reactions: the *p*-methoxyphenylhydrazone of γ -phenoxypropylacetone was converted by boiling alcoholic sulphuric acid into the indole (VIII), which with methyl iodide under pressure at 120° gave 5-methoxy-1:2:3-trimethyl-3- β -phenoxyethylindoleninium iodide (IX), convertible by cold, aqueous sodium hydroxide into the methylene-indoline (X). This in turn was oxidised by potassium permanganate to the indolinone (XI), which, on treatment with fuming hydrobromic acid, gave (XII), and this, on re-methylation at 5 and replacement of the bromine atom by a dimethylamino-group, gave *dl*-dehydroesermetholemethine (XIII), which in the form of a quaternary salt was resolved into *d*- and *l*-components, each of which gave a methopicate, m.p. 132-3°, but the *l*-base methopicate, on admixture with the corresponding quaternary salt obtained by the degradation of physostig-

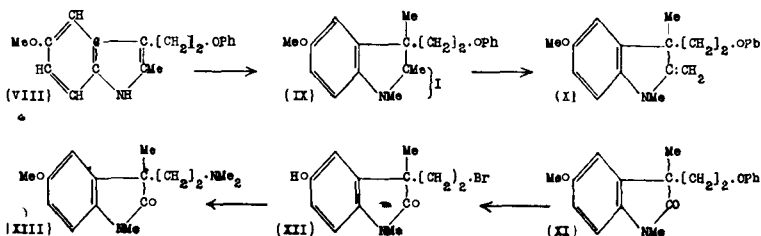

mine, showed no change in melting-point, whilst the *d*-base methopiecrate on similar admixture showed a rise of melting-point to 193–4°, identical with that of the synthetic *dl*-base methopiecrate.

Robinson and Suginome²⁶ had already achieved the synthesis of the complete ring system of physostigmine by the preparation of *dl*-noreserethole. For this purpose phthaloyl- γ -bromobutylimide, $\text{CH}_3\text{—CHBr—CH}_2\text{—CH}_2\text{—N}=(\text{CO})_2\text{—C}_6\text{H}_4$, was condensed with ethyl sodioacetoacetate to ethyl δ -phthalimido- α -acetyl- β -methylvalerate (XIV), which, on coupling in alkaline solution with *p*-ethoxybenzenediazonium chloride, lost the acetyl group and formed ethyl δ -phthalimido- α -keto- β -methylvalerate *p*-ethoxyphenylhydrazone (XV). The latter underwent ring closure on treatment with hydrogen chloride in alcohol, to ethyl 5-ethoxy-3-methyl-3- β -phthalimidoethylindolenine-2-carboxylate (XVI), in which the replacement of the carbethoxy-group by a hydrogen atom proved troublesome, but was achieved by hydrolysis to the dicarboxylic acid (XVII), which, when heated in boiling xylene, gave as chief product *NN'*-phthaloyldinoreserethole (XIX) the desired base 5-ethoxy-3-methyl-3-(β -phthalimidoethyl)-indolenine (XVIII) being formed only in small amount. In a subsequent paper by King, Iguori and Robinson²⁶ this difficulty was avoided by applying the indolenine synthesis to γ -phthalimido- α -methylbutaldehyde and *p*-ethoxyphenylhydrazine and so obtaining (XVIII) directly. The transformation of the latter to *noreserethole* (XXI) was accomplished by treating the methosulphate (XX) with hydrazine in alcohol to eliminate the phthalic acid residue as phthalylhydrazide; ring closure then took place on addition of hydrochloric acid to the filtrate,

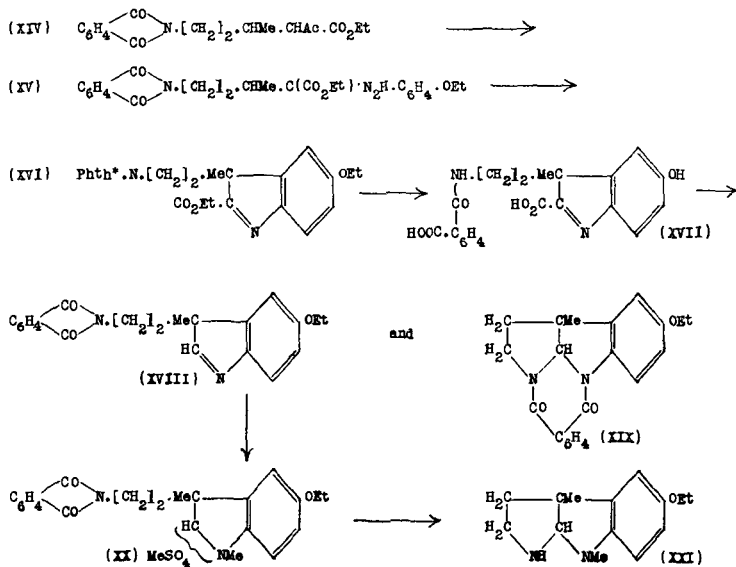

*Phth = phthalyl residue

with the formation of *dl*-noreserethole (XXI). The latter is a strongly basic syrup giving a hydrochloride, bluish-grey needles, m.p. 191–2°, a platinichloride, yellowish-brown prisms, m.p. > 185° (*dec.*), and a picrate, reddish-orange prisms, m.p. 180–1°.

The same authors subsequently devised another method of completing the tricyclic physostigmine system.²⁷ 5-Methoxy-1:3-dimethyl-3- β -bromoethyl-2-indolinone (XXII), already used as an intermediate in the synthesis of dehydroesermetholemethine (p. 543), was converted *via* the phthalimido-derivative into the corresponding ethylamine (XXIII), which was cyclised by phosphoric oxide in boiling xylene to the amidine (XXIV), and this on catalytic hydrogenation gave *dl*-noresermethole (XXV), a basic red oil giving a picronate, m.p. 227° (*dec.*), and yielding on methylation the quaternary base isolated as *dl*-esermethole methopicrate (XXVI), which occurs in two forms, m.p. 190° and m.p. 183–4°; a mixture of the two forms melts at 183–4°, and admixture of each form with *l*-esermethole methopicrate (m.p. 194°) prepared from physostigmine lowers the melting-point of the latter to that of the added component.²⁸

dl-norEserethole (XXV: MeO \rightarrow EtO), unlike *noresermethole*, on treatment with methyl *p*-toluenesulphonate, undergoes mono-*N*-alkylation and furnishes *dl*-eserethole (XXVII: .MeO \rightarrow EtO.), identified as the methopicrate, m.p. 184–6° (King, Robinson and Sugimoto²⁶). As this substance, like various analogues in this series, contains two asymmetric carbon atoms, efforts have been made to resolve the synthetic *dl*-base, which has been obtained crystalline by King, Liguori and Robinson.²⁸ It forms rectangular plates, m.p. 79–80°, and furnishes a dimorphic picrate, m.p. 139–140° and 150–1°. As explained below, this variety of *dl*-eserethole should be distinguished as *dl*-eserethole-*b*.

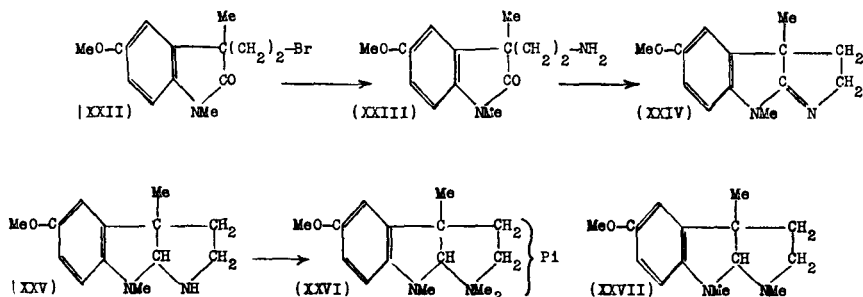

In the course of work²⁹ on the tricyclic system of physostigmine, Hoshino and Kobayashi started with 5-ethoxyindolyl- β -ethylamine, which was treated with magnesium ethyl iodide and the product heated with methyl iodide in benzene. From the resulting mixture a supposed *dl*-dinoreserethole (XXVIII) was isolated. It had m.p. 35–9°, b.p. 145–150°/1 mm.; gave a picrate, m.p. 170–1°, and on treatment with methyl iodide was presumed to yield *dl*-dinoreserethole hydriodide and *dl*-methyleserethole.³⁰ m.p. 80–1°, b.p. 184–5°/4 mm., which gave a methopicrate,

m.p. 174–5°, and was represented by (XXIX). After a direct comparison of specimens, King and Robinson³¹ believed this substance might be a *dl*-eserethole. Kobayashi³⁰ later provided evidence that the substance, C₁₅H₂₂ON₂, was not (XXIX) but 5-ethoxy-3-methyl-3-dimethylaminoindolenine, and this was subsequently confirmed by its synthesis in 1939 by a new method.



Hoshino and Kobayashi (1935) have also described the resolution of *dl*-eserethole by crystallising the mixed *d*-hydrogen tartrates from alcohol, when *d*-eserethole *d*-hydrogen tartrate [m.p. 173–4°, $[\alpha]_D^{25} + 115^\circ$ (H₂O)] separated first. The base recovered from the mother liquors yielded with *l*-tartaric acid, *l*-base *l*-hydrogen tartrate (m.p. 173–4°, $[\alpha]_D^{25} - 115^\circ$). The active picrates had m.p. 135–6° and the *dl*-picrate m.p. 152°.

Still another method of building up the tricyclic system of physostigmine, simpler than any of the foregoing, has been devised by Julian and Pikel, and applied to the preparation among others of the following products: *dl*-deoxynereseroline,³² *dl*-deoxyeseroline,³³ *dl*-eserethole,³⁴ *l*-eseroline and physostigmine.³⁵ The following process was used for *dl*-eserethole.

p- α -Bromopropiono-*N*-methylphenetidide (XXXII) on treatment with aluminium chloride yielded 5-hydroxy-1:3 dimethyloxindole (XXXIII), the ethyl ether of which, with chloroacetonitrile in presence of sodium ethoxide, gave 5-ethoxy-1:3-dimethyloxindolyl-3-acetonitrile (XXXIV), which on catalytic hydrogenation furnished the corresponding amino-compound (XXXV) convertible by the action of methyl iodide on its benzylidene derivative into the 1:3-dimethyl-3- β -methylaminoethylloxindole (XXXVI), which is reduced by sodium in alcohol to *dl*-eserethole (XXXVII), which is reduced by sodium in alcohol to *dl*-eserethole (XXXVIII), which is reduced by sodium in alcohol to *dl*-eserethole (XXXIX).

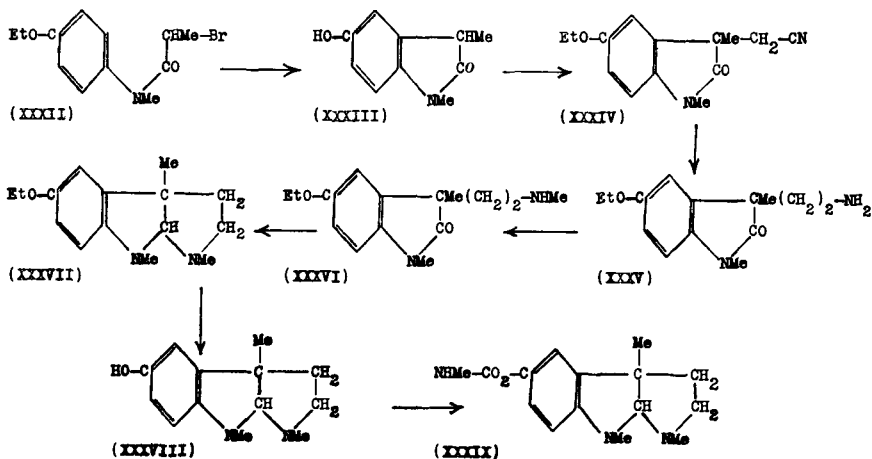

(XXXVII). The latter crystallises from a well-cooled solution in ether and light petroleum, has m.p. 38°, b.p. 181–3°/12 mm., and yields an orange-yellow picrate, m.p. 155°. The product of action of methyl iodide upon the new base gave a yellow dipicrate, m.p. 169–171°, which on recrystallisation from alcohol passed into the red monopicrate, m.p. 191°. This synthetic base King and Robinson³¹ suggest should be called *dl*-eserethole-*a* and they regard it and *dl*-eserethole-*b* (p. 545) as possibly related to each other as *cis-cis* and *cis-trans* isomerides. Julian and Pikel³⁵ were unable to resolve *dl*-eserethole, but they succeeded with *dl*-5-ethoxy-1 : 3-dimethyl-oxindolyethylmethylamine (XXXVI) by the successive application of *d*-camphorsulphonic acid (which removes the *d*-amine, $[\alpha]_D^{28} + 30^\circ$ (EtOH); picrate, m.p. 175°) and *d*-tartaric acid, which isolates the *l*-base ($[\alpha]_D^{28} - 30^\circ$ (EtOH); picrate, m.p. 175°). The latter, on reduction by sodium in alcohol, furnished *l*-eserethole, $[\alpha]_D^{28} - 81.6^\circ$, *d*-hydrogen tartrate, m.p. 168°, picrate, m.p. 135°, agreeing with *l* eserethole (p. 541), prepared from physostigmine. The *l*-eserethole so obtained was de-alkylated by the action of aluminium chloride suspended in light petroleum to *l*-eseroline (XXXVIII), m.p. 128°, identical with the product obtained from physostigmine (XXXIX), and, as the latter had already been synthesised from *l*-eseroline by Polonovski and Nitzberg,¹³ the work of the American authors constituted the first complete synthesis of physostigmine.

Geneserine, $C_{15}H_{21}O_3N_3$, was obtained by Polonovski and Nitzberg³⁶ by extracting calabar beans previously soaked in 2 per cent. sodium hydroxide solution with ether. It forms orthogonal crystals, m.p. 128–9°, $[\alpha]_D - 175^\circ$ (EtOH), -188° (dil. H_2SO_4), is a weak base, does not give crystalline salts with mineral acids, but yields a salicylate, m.p. 89–90°, picrate, m.p. 175°, and a methiodide, m.p. 215°. At 160° it evolves methylcarbimide and is decomposed by sodium in alcohol, furnishing GENESEROLINE, $C_{13}H_{18}O_2N_2$, which is analogous with eseroline (p. 540) and, like it, yields methyl and ethyl ethers, e.g., the ethyl ether, geneserethole, is obtained by the action of ethyl bromide on geneseroline in presence of sodium ethoxide. Geneserine differs from physostigmine by one atom of oxygen, shows parallelism in its reactions and is reduced to physostigmine by zinc dust and acetic acid in alcohol, whilst physostigmine can be oxidised by hydrogen peroxide to geneserine. On these grounds Polonovski³⁷ regards it as an amine oxide of physostigmine, and has also produced evidence for the existence of a tautomeride, distinguished by its greater power of decolourising methylene blue. There is ground for the view that geneserine and eseridine (*see below*) are identical.

Eseramine, $C_{16}H_{25}O_3N_4$, was first obtained by Ehrenberg,³⁸ and its occurrence in Calabar beans was confirmed by Salway.³⁹ It forms colourless needles, m.p. 245° (*dec.*) and is sparingly soluble in ether, chloroform or benzene, but readily in hot alcohol.

*iso***Physostigmine**, $C_{15}H_{21}O_2N_3$, obtained by Ogui⁴⁰ is insoluble in ether and furnishes a crystalline sulphate, m.p. 200–2°. Salway was unable to confirm its occurrence in Calabar beans.³⁹

Eseridine, $C_{14}H_{23}O_3N_3$, was obtained by Böhringer and Söhne,⁴¹ and

subsequently examined by Eber.⁴² It is stated to melt at 132° and to be converted into physostigmine when heated with dilute mineral acids. Salway³⁹ was unable to obtain evidence of its presence in Calabar beans. It has been stated that generine and eseridine are identical.⁴³

Physovenine, $C_{14}H_{18}O_3N_2$, was obtained by Salway³⁹ from the mother liquors left after the separation of eseramine. It crystallises from a mixture of benzene and light petroleum in small, colourless prisms, m.p. 123°. Its salts are dissociated by water. With barium hydroxide physovenine liberates carbon dioxide and assumes a deep red colour, and, owing to the similarity of this behaviour with that of physostigmine, Salway suggested that physovenine may be an intermediate product in the formation of eseroline from physostigmine.

Pharmacological Action. The action of physostigmine on the parasympathetic nervous system was early recognised. In 1873 its potentiating effect on the stimulation of such nerves was observed, for example, on the cardiac vagus.⁴⁴ Its antagonistic effect on the action of curare (p. 391) was noted in 1900, and in the light of more recent knowledge of the mode of action of both drugs the nature of this antagonism is being investigated in detail.⁴⁵

The explanation of the action of physostigmine began with the discovery of the parasympathetic action of acetylcholine by Hunt and Taveau and Dale,⁴⁶ and the observation by Loewi⁴⁷ that on stimulation of the frog's cardiac vagus, a substance having the properties of acetylcholine was liberated. Loewi and Navratil⁴⁷ later suggested that the action of physostigmine on the heart was due to the inhibition of the destruction of acetylcholine by an esterase normally present there. Engelhart and Loewi⁴⁸ and Matthes⁴⁹ showed that the normal destruction of acetylcholine was largely enzymic in character and specifically inhibited by physostigmine.

Feldberg and Gaddum⁵⁰ proved that acetylcholine was involved as the transmitter of the nervous impulse in the autonomic ganglia. Later papers by Dale *et al*⁵¹ showed that acetylcholine functions as the transmitter of the voluntary nervous impulse in mammalian muscle and the possible intervention of analogous mechanisms in the central nervous system has become apparent.⁵² This work has been reviewed, especially in its clinical aspects, by Fraser.^{52(a)} The results have led to much research on the details of such actions, *e.g.*, on the distribution, specificity and purification of the choline-esterases,^{53(a)} methods of estimating the activity of these enzymes^{53(b)} and study of the interaction of enzyme, substrate and alkaloid.^{53(c)} It should be added that this essentially chemical hypothesis does not tell the whole story of this physiological problem, and an interesting account of an electrical explanation of transmission has been given recently by Eccles,^{53(d)} and Cunliffe, Barnes and Beutner^{53(d)} have called attention to the electrogenic properties of acetylcholine.

Ellis, Krayer and Plachte⁵⁴ have shown that the degradation products of physostigmine, eseroline and eserine-brown do not inhibit choline-esterase, but rubreserine and eserine-blue are inhibitors *in vitro*, having

about 1 per cent. of the potency of physostigmine, and also show the same types of activity as the parent alkaloid in other directions.

The three items in the reactions described above have all been varied in experimental investigations. Hawkins and Gunter⁵⁵ have used benzoylcholine and acetyl- β -methylcholine as substrates, in addition to acetylcholine, and have employed specific choline-esterase as well as the non-specific type (*pseudo*-choline-esterase).^{55(a)} Prelog, Junász, Režek and Stern^{55(b)} have prepared the sulphur analogue of acetylcholine chloride, *viz.* dimethyl- β -acetoxylethylsulphonium chloride and shown that it closely resembles acetylcholine in its behaviour with choline-esterase, but is less active pharmacologically and acceleration of fission by the enzyme is less. Zeller^{55(c)} has dealt with types of choline-esterase and their inhibition by various chemotherapeutic and pharmaceutical substances, Vincent and Beaujard^{55(d)} have shown that many alkaloids exert this inhibiting action though none is as potent as physostigmine, and Wright^{55(e)} has found effective inhibitors for the choline-esterase of human blood in phenanthrenedialkylamino-alcohols of the type $\text{Ar} \cdot \text{CHOH} \cdot \text{CH}_2 \cdot \text{NAlk}_2$. According to Scheiner,^{55(f)} β -naphthylquinoline methiodide is twice as active in this respect as physostigmine and about equal to prostigmine (*see below*). Probably the most interesting addition to inhibitors of choline-esterase is diisopropyl fluorophosphonate, on which there is now a considerable pharmacological literature. It is one of a series of toxic inhalants of the type $(\text{RO})_2\text{POF}$, prepared by a team of chemists led by McCombie and Saunders,⁵⁶ and tested biologically by a group of workers directed by Adrian.^{56(a)} In the most potent items so far described, R is *cyclohexyl*, or an unsubstituted, secondary, alkyl radical, such as *isopropyl* or *secbutyl*. Their miotic action was noticed owing to their effect on the eyes of the chemists working with them and this led to their examination for physostigmine-like properties. They were found to be potent inhibitors of choline-esterase *in vitro*, the more active of them causing inhibition at a concentration of 10^{-11} M. Inhibition by them, unlike that due to physostigmine, is progressive and irreversible and takes place with ordinary esterases as well as with choline-esterase.

The miotic effect induced by physostigmine lends itself to investigation of the interrelation of chemical constitution and pharmacological action, and Stedman has devoted much attention to this subject. Eseroline is devoid of miotic activity, so that the latter action in physostigmine must be mainly due to the fact that it is a methylurethane, and, since activity only becomes evident in the urethanes of phenolic bases or phenols with a basic side-chain, a basic nucleus for the urethanes appears also to be essential.

In the series $\text{NHR} \cdot \text{CO} \cdot \text{O} \cdot \text{C}_6\text{H}_4 \cdot \text{NMe}_2$ all the members tried in which R is a methyl group were active, but when R is ethyl or hydrogen, miotic action is reduced or may even disappear, thus the *p*- and *m*-dimethylaminophenyl esters of ethylcarbamic acid ($\text{R} = \text{C}_2\text{H}_5$) are inactive but the *o*-ester is active, indicating that activity is also influenced by the position and nature of the basic group. When the tertiary basic

group in this series becomes quaternary, the activity of the *m* series increases, whilst that of the *o*- and *p*-isomerides disappears. In the series of urethanes derived from the isomeric hydroxybenzyl dimethylamines similar relations are exhibited; miotic activity is shown by the methyl—but not by the ethyl—or phenyl—urethanes, and in the methyl series the order of activity is as follows for the position of the side-chain: *ortho*- >, *para*- >, *meta*-. Conversion into the quaternary bases increased the activity of the *ortho*-compound, diminished that of the *meta*- and abolished activity in the *para*-derivative.⁵⁷ One of the substances made by E. and E. Stedman,⁵⁸ the methylurethane of α -*m*-hydroxyphenylethyldimethylamine (XL: "miotine") had miotic activity of the same order as physostigmine, and was examined along with similar products by White and Stedman⁵⁹ and shown to be qualitatively identical with physostigmine as a parasympathetic stimulant. Stedman and Stedman⁶⁰ also found that the miotic urethanes in general inhibited the action of liver esterase, though the relative inhibitory activities did not always run parallel with miotic action in the same series. In view of the differences sometimes observed in the action of stereoisomerides, it is of interest to note that Easson and Stedman⁶¹ found *l* "miotine" more active than the *d*-form when applied to isolated rabbit intestine. A more extensive comparison of *d*- and *l*-miotines by White and Stedman⁶² confirmed this as regards general toxicity and physiological action.

A further development of this subject is due to Aeschlimann and Reinert,⁶³ who found that in the series represented by (XLI) the dimethylcarbamic ester (XLI: R = Me) and the methylphenylcarbamic ester (XLI: R = Ph) were at least as active as physostigmine in stimulating peristalsis. The miotic activity of the dimethylcarbamic ester (prostigmine, neostigmine) is similar to that of physostigmine, that of the methylphenylcarbamic ester being weak.

Recently Aeschlimann and Stempel⁶³ have prepared a series of analogues of prostigmine in which R of (XLI) is a substituted phenyl group. These have been submitted to a wide range of pharmacological tests in comparison with prostigmine. Several of them showed curare-like action in the frog rectus, and this type of action has been further investigated by Lehmann⁶³ in another series of inhibitors of choline-esterase of which the most potent curarising agent was (2-hydroxy-3-cyclohexylbenzyl)-methylpiperidinium bromide dimethylcarbamate. These substances are more effective after muscle tension is augmented by prostigmine or physostigmine than on normal muscle: the reverse is true of curare.

R. D. Haworth *et al.*⁶⁴ have prepared series of compounds related to "miotine" and to "prostigmine," and have used them to investigate the correlation of structure with toxicity in the two series.

Physostigmine can be regarded as the methylcarbamate of a *p*-aminophenol, with an alkyl chain substituent in the *o*-position relative to the amino-group. Stevens and Beutel,⁶⁵ with this in mind, have prepared substances of the type p -R₁R₂N · CO · O · C₆H₃R · NMe₃X, where R is an alkyl radical, *e.g.*, isopropyl, in either the *o* or *m*-position relative to the

cf. FÜHNER, *Biochem. Zeit.*, 1918, 92, 347; MASSART *et al.*, *Enzymologia*, 1939, 7, 339. (13) POLONOVSKI and NITZBERG, *Bull. Soc. Chim.*, 1916, [iv], 19, 27, 46. (14) STRAUS, ref. (12). Cf, however, HERZIG and LIEB, *Monats.*, 1918, 39, 285. (15) STEDMAN, *J. Chem. Soc.*, 1924, 125, 1373. (16) *J. Pharm. Soc. Japan*, 1928, No. 554, 348. (17) SPÄTH and BRUNNER, *Ber.*, 1925, 58, 518. (18) STRAUS ref. (12); M. and M. POLONOVSKI, *Compt. rend.*, 1923, 176, 1480, 1813, 1896; 177, 127; 1924, 178, 2078; 179, 57, 178, 334; 1925, 180, 73; *Bull. Soc. chim.*, 1923, [iv], 33, 970, 977; 1924, [iv], 35, 1492. (19) *Loc. cit.* and *ibid.*, 1918, [iv], 23, 335, 357. (20) *Ibid.*, 1918, [iv], 23, 335, 357; *Compt. rend.*, 1923, 176, 1480, 1896; 177, 127; 1924, 178, 2078. (21) Quoted by STEDMAN and BARGER, *J. Chem. Soc.*, 1925, 127, 247. (22) *Ibid.*, 1923, 123, 762. (23) BRUNNER, *Ber.*, 1905, 38, 1359. (24) *Compt. rend.*, 1924, 178, 2078; 179, 57; 1925, 180, 73; *Bull. Soc. chim.*, 1925, [iv], 37, 744. (25) *J. Chem. Soc.*, 1932, 326. (26) ROBINSON (with SUGINOME), *ibid.*, 1932, 298, 304; (with BOYD-BARRETT), *ibid.*, p. 317; BOYD-BARRETT, *ibid.*, p. 321; KING, ROBINSON and SUGINOME, *ibid.*, 1933, 1472; KING, LIGUORI and ROBINSON, *ibid.*, 1933, 1475. (27) *Ibid.*, 1932, 1433; 1933, 270; (with SUGINOME), 1933, 1472; KING, LIGUORI and ROBINSON, *ibid.*, 1934, 1416. (28) *Ibid.*, 1934, 1416. (29) HOSHINO (with TAMURA), *Proc. Imp. Acad. Tokyo*, 1932, 8, 171; (with KOBAYASHI), *ibid.*, 1934, 10, 99, 564; 1935, 11, 416; (with KOBAYASHI and SHIMODAIRA) 1935, 11, 192; (with TAMURA), *Annalen*, 1932, 500, 35; (with KOBAYASHI and KOTAKE), *ibid.*, 1935, 516, 76, 81; (with SHIMODAIRA), 1935, 520, 11, 19. (30) HOSHINO, KOBAYASHI and KOTAKE, *ibid.*, 1935, 516, 81; KOBAYASHI, *ibid.*, 1938, 536, 143; 1939, 539, 213. (31) *J. Chem. Soc.*, 1935, 757. (32) (With BOGGESS), *J. Amer. Chem. Soc.*, 1934, 56, 1797. (33) *Ibid.*, 1935, 57, 539. (34) *Ibid.*, 1935, 57, 563. (35) *Ibid.*, 1935, 57, 755. (36) *Bull. Soc. chim.*, 1915, [iv], 17, 244. (37) *Ibid.*, 1917, [iv], 21, 191; 1918, [iv], 23, 335, 356; (with DESGREZ), *Compt. rend.*, 1938, 207, 685; see also *Atti. X. Cong. internat. chim.*, 1939, 3, 303, 306. (38) *Verh. Ges. Deut. Nat. Aerzte*, 1893, 11, 102. (39) *J. Chem. Soc.*, 1911, 99, 2148. (40) *Apoth. Zeit.*, 1904, 19, 891. (41) *Pharm. Post.*, 1888, 21, 663. (42) *Pharm. Zeit.*, 1892, 37, 483. (43) *Merck's Berichte*, 1926, 40, 37. (44) ARNSTEIN and SUSTSCHINSKY, *cit. ROSSBACH and FRÜHLICH*, "Pharmakologische Untersuchungen," Würzburg, 1873, 1, 3. (45) PAL, *Zbl. Physiol.*, 1900, 14, 255; COWAN, *Journ. Physiol.*, 1938, 93, 215; FEGLER and KOWARZYK, *Compt. rend. Soc. Biol.*, 1938, 127, 1149; ECCLES, KATZ and KUFFLER, *J. Neurophysiol.*, 1942, 5, 211. (46) HUNT and TAVEAU, *J. Pharm. Exp. Ther.*, 1910, 1, 303; DALE, *ibid.*, 1914-15, 6, 147. (47) *Pfuger's Archiv.*, 1921, 189, 230; (with NAVRATIL), *ibid.*, 1926, 214, 689. (48) *Arch. exp. Path. Pharm.*, 1930, 150, 1. (49) *J. Physiol.*, 1930, 70, 338. (50) *J. Physiol.*, 1934, 81, 305. (51) (With FELDBERG), *ibid.*, 1934, 81, 320; (with FELDBERG and VOGT), *ibid.*, 1936, 86, 353; (with BROWN and FELDBERG), *ibid.*, 1936, 87, 394. (52) HENDERSON and WILSON, *Quart. J. Exp. Physiol.*, 1936, 26, 83; SCHWEIZER and WRIGHT, *J. Physiol.*, 1937, 89, 165, 384. (52a) *Brit. Med. J.*, 1938, i, 1249, 1293, 1349. (53a) STEDMAN, STEDMAN and EASSON, *Biochem. J.*, 1932, 26, 2056; GLICK, *J. Biol. Chem.*, 1938, 125, 729; *J. Gen. Physiol.*, 1938, 21, 289, 431; SANZ, *Helv. physiol. pharmacol. Acta*, 1944, 2, C. 29; STRELITZ, *Biochem. J.*, 1944, 38, 86; BADER, SCHUTZ and STACEY, *Nature*, 1944, 154, 183; AUGUSTINSSON, *ibid.*, 1946, 157, 587; *Biochem. J.*, 1946, 40, 343; HAWKINS and MENDEL, *J. Cell. Comp. Physiol.*, 1946, 27, 69; BODANSKY, *Ann. New York Acad. Sci.*, 1946, 47, 521; CHAUDURI, *Ann. Biochem. Exp. Med.*, 1946, 6, 91; ELLIS, *J. Pharm. Exp. Ther.*, 1947, 91, 370. (53b) EASSON and STEDMAN, *Proc. Roy. Soc.*, 1936, B, 121, 142; RINKEL and PIJOAN, *J. Pharm. exp. Ther.*, 1938, 64, 228; SACK and ZELLER, *Science*, 1943, 97, 449; KRAYER, GOLDSTEIN and PLACHTE, *J. Pharm. exp. Ther.*, 1944, 80, 8. (53c) EADIE, *J. Biol. Chem.*, 1941, 138, 597; 1942, 146, 85; ELLIS *et al.* 11(a); STRAUS, GOLDSTEIN and PLACHTE, *J. Gen. Physiol.*, 1943, 26, 559; CANTONI and LOEWI, *J. Pharm. exp. Ther.*, 1944, 81, 67. (53d) ECCLES, *Nature*, 1945, 156, 680; with numerous references; CUNLIFFE, BARNES and BEUTNER, *ibid.*, 1947, 159, 307. (54) *J. Pharm. Exp. Ther.*, 1943, 79, 809. (55) *Biochem. J.*, 1946, 40, 192. (55a) MENDEL and RUDNEY, *ibid.*, 1943, 37, 59. (55b) *Helv. Chim. Acta*, 1942, 25, 907. (55c) *Verh. Ver. Schweiz Physiol.*, 1942, 21, 43; *Helv. Chim. Acta*, 1942, 25, 216, 1099 (with BISSEGGER), *ibid.*, 1943, 26, 1619; cf. BODANSKY (53a). (55d) *Ann. pharm. franc.*, 1945, 3, 22. (55e) *J. Pharm. Exp. Ther.*, 1946, 87, 109. (55f) *C. R. Soc. biol.*, 1946, 140, 34. (56) *Nature*, 1946,

157, 287; SAUNDERS, *Chem. and Ind.*, 1947, 117. (56a) *Nature*, 1946, 158, 625; cf. MACKWORTH and WEBB, quoted by DIXON and NEEDHAM, *ibid.*, p. 433. (57) STEDMAN, *Biochem. J.*, 1926, 20, 719; 1929, 23, 17. (58) *J. Chem. Soc.*, 1929, 609; 1931, 1126. (59) *J. Pharm. exp. Ther.*, 1931, 41, 259. (60) *Biochem. J.*, 1931, 25, 1147. (61) *Ibid.*, 1933, 27, 1257. (62) *J. Pharm. exp. Ther.*, 1937, 60, 198. (63) *J. Pharm. exp. Ther.*, 1931, 43, 413; AESCHLIMANN, *Chem. and Ind.*, 1935, 54 139 T; (with STEMPPEL), *Barell Jubilee Vol.*, 1946, 306; LEHMANN, *ibid.*, p. 314; see also MIES, *Arch. exp. Path. Pharm.*, 1938, 190, 658; FRIEND and KRAYER, *J. Pharm. exp. Ther.*, 1941, 72, 15; PERLOW, *ibid.*, 1939, 66, 66. For notes on clinical uses of drugs of the physostigmine type see *Lancet*, 1938, i, 1119; *Brit. Med. Journ.*, 1941, ii, 732; 1942, ii, 431; and for a general account of these drugs, BARGER, *Pharm. J.*, 1938, Oct. 29, p. 437. (64) (With LAMBERTON and WOODCOCK, *J. Chem. Soc.*, 1947, 182; (with DAVIES, JONES and LAMBERTON), *ibid.*, p. 191. (65) *J. Amer. Chem. Soc.*, 1941, 63, 308; GARDNER and STEVENS, *ibid.*, 1947, 69, 3086; CHAIKIN, *ibid.*, 1947, 69, 1266. (66) *Lancet*, 1934, i, 1200. (67) *Ibid.*, 1935, i, 432. (68) MINOFF, DODD and RIVEN, *J. Amer. Med. Assoc.*, 1939, 113, 553; *Science*, 1938, 87, 348; THOMPSON and TICE, *J. Pharm. exp. Ther.*, 1941, 73, 455. (69) COMROE, TODD, GAMMON, LEOPOLD, KOELLE, BODANSKY and GILMAN, *Amer. J. Med. Sci.*, 1946, 212, 641; GADDUM and WILSON, *Nature*, 1946, 159, 680.

ALKALOIDS OF STRYCHNOS SPECIES

Strychnine and brucine occur most abundantly in nux-vomica seeds (*Strychnos Nux-vomica*, L.) and Ignatius beans (*S. Ignatii*, Berg.). Both drugs contain from 2 to 3 per cent. of alkaloids, of which about one-half is strychnine in the former and two-thirds in the latter, the rest being mainly brucine. A third alkaloid vomicine is present in nux-vomica seeds,¹ and a fourth, strychnicine, in nux-vomica leaves.² A fifth alkaloid, struxine, was isolated from deteriorated nux-vomica seeds by Schaefer,³ and in 1931 Warnat⁴ added α -colubrine, β -colubrine and pseudostrychnine, found in the residues of strychnine manufacture. The alkaloids of other *Strychnos* species are shown in the following list⁵ :—

- S. aculeata* Sol. (W. Africa). Traces of brucine in fruit (Hébert, *J. Pharm. Chim.*, 1908, [vi], 27, 151).
- S. Castelnæi* Wedd. (Brit. Guiana). See curare (p. 372).
- S. cinnamomifolia* Thwaites (Ceylon, India). Strychnine and brucine (Short, *Year-book Pharm.*, 1924, 646).
- S. colubrina* L. (East Indies). Brucine and strychnine (Pelletier and Caventou, *Ann. Chim. Phys.*, 1818, [ii], 8, 323; 1819, 10, 142; 1819, 12, 113).
- S. Henningsii* (S. Africa). Two crystalline alkaloids: (1) $C_{25}H_{28}O_5N_2$, m.p. 280.5–282°, $[\alpha]_D^{20} - 80^\circ$ (EtOH); contains one methoxyl, but no methylimino group and is possibly phenolic; (2) $C_{24}H_{30}O_5N_2$, m.p. 214.5–215°, contains two methoxyl groups and gives a violet coloration with Frohde's reagent. The alkaloids are possibly mono- and di-methoxy derivatives of the same parent base. Amorphous alkaloids are also present and possibly a third crystalline base (Rindl, *S. Afr. J. Sci.*, 1929, 26, 50; *Trans. Roy. Soc. S. Africa*, 1931, 20, 59; (with Sapiro), *ibid.*, 1936, 23, 361).
- S. ligustrina* Bl. (East Indies). Seeds 0.6 to 1.5 per cent., nearly all brucine; stem bark 2.2 per cent. of which 0.5 per cent. is strychnine.

- Rowaan (*Ph. Weekbl.*, 1941, **78**, 1125 ; cf. Greenish, *Year-book Pharm.*, 1879, **2**, 1013).
- S. lucida* (West Australia). Seeds : strychnine, 0.84 per cent. ; brucine, 1.5 per cent (Watson, *J. Roy. Soc. W. Aust.*, 1940-1, **27**, 117).
- S. Rheedei* (India). Brucine.
- S. Tieute* Lesch. (Java). "Upas tree." Strychnine with traces of brucine (Pelletier and Caventou, *Ann. Chim. Phys.*, 1824, [ii], **26**, 44 ; van Boorsma, *Bull. Inst. Bot. Buit.*, 1902, No. 14, 3, 7).
- S. Toxicifera* Schomb (Guiana). See curare (p. 372).
- S. Vacacoua* Baill. (Madagascar). Bakankosine, $C_{16}H_{23}O_8N \cdot H_2O$, an alkaloidal glucoside ; colourless crystals from alcohol ; m.p. 157° and 200° , $[\alpha]_D - 205.2^\circ$. Hydrolysed by acids to *d*-glucose and the aglycone, $C_{10}H_{13}O_3N$. Non-toxic (Bourquelot and Hérissé, *Compt. rend.*, 1907, **144**, 575 ; 1908, **147**, 750 ; *J. Pharm. Chim.*, 1907, [vi], **25**, 417 ; 1906, [vi], **28**, 433 ; *Arch. Pharm.*, 1909, **247**, 857).
- S. potatorum* Linn. and *S. nux-blanda*, Hil. The seeds are stated not to yield alkaloids (*British Pharm. Codex*, 1934, p. 675) and this is also true of *S. spinosa* grown in Florida (Lofgren and Kinsley, *J. Amer. Pharm. Assoc.*, 1942, **31**, 295). The Chinese drug "fan-mu-pieh," reported by Jeng-Hung-Chu to contain strychnine and brucine (*J. Chin. Pharm. Assoc.*, 1940, **2**, 246) is listed in Read's "Chinese Medicinal Plants" as nux-vomica.

Isolation and Estimation of Strychnine. The British Pharmacopœia, 1932, specified for the official nux-vomica a content of strychnine not less than 1.2 per cent. This pharmacopœia prescribes a process for the estimation of strychnine, depending on extraction of the total alkaloids, and oxidation of the brucine by nitric acid under defined conditions, the unaltered strychnine being then isolated and estimated.⁶ A method for the estimation of strychnine in the total alkaloids, depending on the sparing solubility of strychnine ferrocyanide in water, was devised by Dunstan and Short⁷ and has again received attention recently, particularly in regard to conditions necessary to ensure complete precipitation. For the isolation of strychnine from biological material, Fabre and Oficjalski^{8(a)} have applied their process of electro dialysis, and chromatographic methods have been described by Bjorling, by Brownlee and by Christensen.^{8(b)} For the estimation of isolated strychnine, Rasmussen⁹ has used a method based on the colour developed by the alkaloid with ammonium vanadate in sulphuric acid, and Allen and Allport⁷ have described a process based on the colour reaction of nitrites with "reduced strychnine" (Denigès). Strychnine is frequently used in medicine in association with other alkaloids and special methods have been devised for its estimation in such cases.¹⁰ Appropriate methods are also available for its isolation and estimation in toxicological investigations,¹¹ and for its assay in vermin killers and poisoned baits.¹²

Strychnine, $C_{21}H_{23}O_3N_2$. This alkaloid was discovered by Pelletier and Caventou in 1817, and was investigated by Regnault,¹³ who provided

the formula given above. For the extraction of strychnine and brucine on a laboratory scale the finely ground *Strychnos* seeds may be mixed with slaked lime and made into a stiff paste with water. This is dried at 100°, powdered, and exhausted with boiling chloroform. From this the alkaloids are removed by agitation with dilute sulphuric acid, which is then filtered, excess of ammonia added, and the precipitate extracted with 25 per cent. alcohol, which dissolves the brucine and leaves most of the strychnine undissolved. The latter is purified by recrystallisation from alcohol, in which brucine is more soluble. For operation on a larger scale processes have been devised by Watson and Sen,¹⁴ Schwyzer¹⁵ and Volek.¹⁶

Strychnine crystallises in colourless rhombs, m.p. 268–290°, dependent on the rate of heating, $[\alpha]_D - 109.9^\circ$ (EtOH, 80 per cent.) – 139.3° (CHCl₃).⁴ According to Loebisch and Schoop, it distils unchanged at 270°/5 mm. The base is slightly soluble in water (1 in 6,400 at 25°, 1 in 3,000 at 80°) or ether (1 in 5,500 at 25°), more so in 90 per cent. alcohol (1 in 110 at 25° or 1 in 28 at 60°), or benzene (1 in 150 at 25°), readily so in chloroform (1 in 6 at 25°). The aqueous solution is alkaline and has a bitter taste, even in a solution containing 1 part in 700,000. It behaves as a monoacidic base; the salts crystallise well.

Strychnine nitrate, B. HNO₃, occurs in colourless shining needles, soluble in water (1 in 42 at 25°), alcohol (1 in 120 at 25°), or chloroform (1 in 156 at 25°); lævorotatory. The sulphate, B₂. H₂SO₄. 5H₂O, forms colourless prismatic crystals, m.p. 200° (*dry*), and is soluble in water (1 in 31 at 25°), or alcohol (1 in 65 at 25°), less so in chloroform (1 in 325 at 25°). The hydrochloride, B. HCl. 2H₂O, forms colourless, efflorescent, trimetric prisms, soluble in cold water (1 in 35) or alcohol (1 in 80). The aurichloride, B. HAuCl₄, crystallises from alcohol in orange-yellow needles. The hydriodide, B. HI. H₂O, is sparingly soluble in water, as is also the periodide, B. HI. I₂, reddish-brown prisms from alcohol. The dichromate, B. H₂Cr₂O₇, is slightly soluble in cold water (1 in 1,815 at 18°) and crystallises from boiling water in orange-yellow needles. The tetrachloriodide, B. HICl₄, is a pale yellow, crystalline powder, m.p. 91° (*dec.*). The benzylidene derivative crystallises in pale lemon yellow leaflets, m.p. 235–7°, and on solution in sulphuric acid (60 per cent.) gives a deep blue coloration with potassium dichromate. *Strychnine N-oxide*, C₂₁H₂₂O₃N₂, m.p. 210–2°, the preparation of which has been improved by Oesterlin,¹⁷ has been the subject of several investigations into its reactions, as have also the N-oxides of three derivatives of strychnine, described later, *viz.*, *isostrychnine N-oxide*, which is amorphous but yields a crystalline perchlorate, m.p. 149–150°, *strychninic acid N-oxide*, C₂₁H₂₄O₄N₂, m.p. 232–4°, and *neostrychnine oxide*, C₂₁H₂₂O₃N₂. 3H₂O, m.p. 179–180°.

Strychnine is not coloured by sulphuric acid, even on warming. With nitric acid it gives a yellowish coloration, and the residue left on evaporating the liquid at 100° gives a reddish-purple colour with ammonia. A fragment of the alkaloid in a drop of sulphuric acid gives, with a crystal of potassium dichromate, manganese dioxide, ceric oxide or potassium permanganate stirred in it, a series of colours, beginning with blue, which gradually passes

through violet and red to yellow.¹⁸ The only other alkaloids which resemble strychnine in this respect are "curarine" and gelsemine. Certain other alkaloids give a somewhat similar colour reaction, but most of these are also coloured by sulphuric acid alone. Brucine gives a deep red colour when oxidised, *e.g.*, with nitric acid, and this is apt to obscure the colour change produced by strychnine, so that if brucine is present it should first be eliminated. Organic matter also masks the reaction, and may be removed by warming with sulphuric acid and recovering the strychnine by adding water and ammonia and shaking out with chloroform.¹⁹ Sulphuric acid containing ammonium vanadate gives with strychnine a deep bluish-violet colour, changing to purple and finally to red.²⁰

Owing to its use as a vermin-killer and to its importance in toxicology, a great deal of attention has been given to methods for the isolation of strychnine from biological materials and the detection of minute quantities. For critical reviews of such methods see Ainsworth Mitchell,²¹ Steyn,¹¹ Ward and Munch.²² A microchemical method for the differentiation of strychnine and brucine has been described by Martini.²¹

Brucine, $C_{23}H_{26}O_4N_2$. Brucine was first obtained in 1819 by Pelletier and Caventou from *Strychnos Nux-vomica* bark, then supposed to be derived from *Brucea ferruginea*. Its composition was determined by Regnault.¹³

Preparation. The mother liquors from strychnine manufacture are concentrated and the alkaloids precipitated as neutral oxalates. The precipitate is dried and extracted with dry alcohol in which the strychnine salt is the more soluble. The less soluble salt dissolved in water is decolorised with charcoal, the alkaloid regenerated with ammonia and purified by crystallisation as the sulphate. According to Saunders, pure brucine may be obtained by slow crystallisation from a solution of the pure hydrochloride in alcoholic ammonia.²³ A method of separation depending on the greater solubility in water of strychnine hydriodide was employed by Shenstone,²⁴ whilst others have made use of the sparing solubility of strychnine chromate for the removal of small quantities of this alkaloid from brucine. For a large scale process see Schwyzer.¹⁵

Brucine crystallises from water or aqueous alcohol in monoclinic prisms containing $4H_2O$, m.p. 105° or 178° (*dry*), $[\alpha]_D - 119^\circ$ to -127° ($CHCl_3$) or -80.1° ($EtOH$). The alkaloid is slightly soluble in cold water (1 in 320), more so in boiling water (1 in 150), very soluble in alcohol, chloroform, or amyl alcohol, sparingly soluble in ether (1 in 134).

Brucine is a monoacidic base; the salts crystallise well and are readily soluble in water. The hydrochloride, B. HCl, forms needles, the hydriodide, B. HI, leaflets, sparingly soluble in water and the sulphate, $B_2 \cdot H_2SO_4 \cdot 7H_2O$, long needles.

Brucine is easily distinguished from strychnine by not giving the characteristic play of colours when oxidised with chromic acid in sulphuric acid and by affording an intense red colour with nitric acid, which may be distinguished from that given by morphine by cautiously adding stannous

chloride, when, in the case of brucine, the red colour changes to violet. A series of other colour reactions has been described by François.²⁵

REFERENCES

- (1) WIELAND and OERTEL, *Annalen*, 1929, **469**, 193. (2) VAN BOORSMA, *Bull. Inst. bot. Buitenz*, 1902, No. xiv., p. 3. (3) *J. Amer. Pharm. Assoc.*, 1914, **3**, 1677. (4) *Helv. Chim. Acta*, 1931, **14**, 997. (5) For a more comprehensive list see WEHMER, "Die Pflanzenstoffe," Vol. II., Jena, 1931. (6) VAN DER WIELEN (with LE COULTRE), *Pharm. Weekbl.*, 1939, **75**, 1329; (with GROEN), *ibid.*, 1939, **76**, 3; EDER and RUCKSTUHL, *Pharm. Acta Helv.*, 1944, **19**, 23. (7) *Pharm. J.*, 1883, [iii], **14**, 292; GADREAU, *J. Pharm. Chim.*, 1927, [viii], **6**, 145; KOLTHOFF and LINGANE, *J. Amer. Pharm. Assoc.*, 1934, **23**, 302. ALLEN and ALLPORT, *Quart. J. Pharm.*, 1940, **13**, 252. (8a) *J. Pharm. Chim.*, 1938, [viii], **28**, 369; (8b) *Svensk. Farm. Tids.*, 1944, **48**, 137; BROWNLEE, *Quart. J. Pharm.*, 1945, **18**, 163; CHRISTENSEN, *Dansk. Tids. Pharm.*, 1944, **18**, 105. (9) *Dansk. Tids. Farm.*, 1942, **16**, 11. (10) HADDOCK and EVERS, *Quart. J. Pharm.*, 1931, **4**, 314; EVERS and SMITH, *ibid.*, 1936, **9**, 397; cf. HALSTROM, *Dansk. Tids. Pharm.*, 1935, **9**, 181; REIMERS, *ibid.*, 1940, **14**, 65; see also GARRATT, *Analyst*, 1937, **62**, 538; MURRAY, *J. Assoc. Off. Agric. Chem.*, 1937, **20**, 638; HERD, *J. Amer. Pharm. Assoc.*, 1942, **31**, 9; BROWNLEE, *Pharm. J.*, 1944, **152**, 148; VAN DER WIELEN and GROEN.⁶ (11) PORTNOW, *Pharm. Zent.*, 1929, **70**, 661; KOLL, *Arch. exp. Path. Pharm.*, 1931, **162**, 307, 320; PRIESTLEY, *J. Pharm. Exp. Ther.*, 1930, **38**, 241; NUNN, *Pharm. J.*, 1932, **128**, 145; STEYN, *Onderstepoort J.*, 1935, **5**, 139; 1938, **10**, 411; NAIDU and VENKATRAO, *Analyst*, 1945, **70**, 8; LABAT and KERCONOU, *Bull. biol. pharm.*, 1937, p. 457; TOFT, *Acta Pharmacol. Toxicol.*, 1946, **2**, 156; (with IPSEN), *ibid.*, p. 167. (12) FRANÇOIS and SEGUIN, *J. Pharm. Chim.*, 1928, [viii], **7**, 331; ELMORE, *J. Assoc. Off. Agric. Chem.*, 1926, **9**, 224; WARD and CRABTREE, *J. Amer. Pharm. Assoc.*, 1942, **31**, 113. (13) *Annalen*, 1838, **26**, 17; cf. NICHOLSON and ABEL, *J. Chem. Soc.*, 1850, **2**, 241. (14) *J. Indian Chem. Soc.*, 1926, **3**, 397. (15) "Die Fabrikation der Alkaloide," Berlin, 1927. (16) VOLCK, U.S. Pat. 1,548,566 (*Brit. Chem. Abstr.*, 1925, **B**, 828). (17) PICTET and MATTISSON, *Ber.*, 1905, **38**, 2782; POLONOVSKI, *Bull. Soc. Chim.*, 1927, [iv], **39**, 1147; OESTERLIN, *Ber.*, 1943, **76**, 224; (with IMUDSKY), *ibid.*, p. 574. (17a) LEUCHS and SCHULTE, *ibid.*, p. 1038; (with RUCK), *ibid.*, 1940, **73**, 731. (17b) *J. Chem. Soc.*, 1932, 773. (18) MARCHAND, *J. Pharm.*, [iii], **4**, 200. (19) For other interfering substances, see MAMELI, *Chem. Soc. Abstr.*, 1915, [ii], 113. (20) GUERIN, *J. Pharm. Chim.*, 1914, [vii], **9**, 595; cf. POF and O'DAY, *J. Amer. Pharm. Assoc.*, 1930, **19**, 1292. (21) "Allen's Organic Analysis," 5th edition, Vol. vii, pp. 777-799; MARTINI, *Mikrochemie*, 1937, **23**, 164; and for recent microchemical methods, see DENIGES, *Bull. Trav. Soc. Pharm. Bordeaux*, 1937, **75**, 5; KLEIBS, *Farmat. i Farmakol.*, 1937, **1**, 16 (*Chem. Abstr.*, 1939, **33**, 5991); BERISSO, *Anales Assoc. Quim. Argentina*, 1942, **30**, 44. (22) WARD and MUNCH, *J. Amer. Pharm. Assoc.*, 1930, **19**, 954. (23) *J. Amer. Chem. Soc.*, 1928, **50**, 1231. (24) *J. Chem. Soc.*, 1881, **39**, 456. (25) *Bull. Soc. Pharm. Bordeaux*, 1930, **68**, 156.

*pseudo*Strychnine (*ψ*-Strychnine), C₂₁H₂₂O₃N₂. This alkaloid and the two colubrines described below, were isolated by Warnat¹ from the mother liquors of strychnine manufacture. It can also be prepared by the oxidation of strychnine with air or ozone and has been the subject of investigation by Leuchs *et al.*,² Blount and Robinson,³ and Kotake *et al.*⁴ The base forms a crystalline powder, m.p. 266-8°, and in alcohol has $[\alpha]_D^{25}$ - 43.8° or in chloroform - 86° (W), - 129° (L) or - 113° (K). It gives the same play of colours with sulphuric acid and potassium dichromate as strychnine, but is a weaker base and less toxic. It forms a series of crystalline salts: B . HCl . 2H₂O, $[\alpha]_D^{19}$ + 3.9° (H₂O); B . HNO₃, $[\alpha]_D$ + 7.6° (EtOH); B . HClO₄, prismatic needles; and ferrichloride,

$C_{21}H_{23}O_2N_2Cl_4Fe$, orange-red plates, m.p. $284-5^\circ$ (*dec.*) from acetic acid. The nitroso-derivative, $C_{21}H_{21}O_4N_3$, has m.p. $292-4^\circ$ and $[\alpha]_D^{19} + 223.8^\circ$ ($CHCl_3$).

On solution in hot methyl or ethyl alcohol, ψ -strychnine is converted into *O*-methyl- ψ -strychnine, $C_{22}H_{24}O_3N_2$, m.p. $198-200^\circ$, $[\alpha]_D^{25} - 70.1^\circ$ ($CHCl_3$) and *O*-ethyl- ψ -strychnine, $C_{23}H_{26}O_3N_2$, m.p. $224-5^\circ$, $[\alpha]_D^{28} - 56.8^\circ$ ($CHCl_3$) respectively. These ethers are formed by the replacement of a molecule of water by a molecule of the alcohol, which is not lost on drying at 110° , but hydrolysis of either ether to ψ -strychnine occurs on solution in cold dilute acids.¹

With methyl iodide, the methyl ether formed what appeared to be a normal methiodide, $C_{23}H_{27}O_3N_2I$, m.p. 216° (*dec.*), giving on treatment with potash in boiling methyl alcohol a base, $C_{23}H_{26}O_3N_2$, m.p. $174-5^\circ$ (*dec.*) regarded as des-N : O-dimethyl- ψ -strychninium hydroxide. The latter was hydrolysed by boiling dilute hydrochloric acid to N(*b*)-methylchano- ψ -strychnine, $C_{22}H_{24}O_3N_2$, m.p. $270-1^\circ$ (*dec.*), giving a perchlorate, blackening at 250° and exploding at 290° , and a characteristic dibenzylidene derivative, lemon-yellow prisms, m.p. $284-5^\circ$ (*dec.*), while its dihydro-derivative, $C_{22}H_{26}O_3N_2$, m.p. $296-7^\circ$, furnishes a monobenzylidene derivative, m.p. $264-6^\circ$.³

(For explanation of the symbol N(*b*) and the term *chano* see pp. 561 and 576 and the strychnine formulæ, p. 574.)

Leuchs,² on the contrary, finding that the methiodide, $C_{23}H_{27}O_3N_2I$, contains no methoxyl group suggested that the methyl ether methiodide first formed suffered transfer of the *O*-methyl group to N(*b*) thus : $C(O.Me) \cdot N(b) \rightarrow :CO \ N(b)Me$, the N-methyl base, $C_{22}H_{24}O_3N_2$, so produced becoming available as the methiodide as isolated. Part of the original *pseudostrychnine* methyl ether methiodide was also believed to undergo hydrolysis thus :—

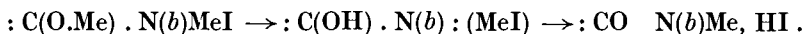

and to become obtainable eventually as the hydriodide of the same N-methyl base, $C_{22}H_{24}O_3N_2$, the evidence for this being that on conversion of this, by the action of methyl sulphate, into the quaternary base, the latter can be isolated as the perchlorate, m.p. $285-293^\circ$ (*dec.*), identical with the perchlorate prepared from the methiodide, $C_{23}H_{27}O_3N_2I$.

The constants and characters assigned by Leuchs to the base, $C_{22}H_{24}O_3N_2$, indicate its identity with Blount and Robinson's N(*b*)-methylchano-*pseudostrychnine* (*see above*). On reduction in acid solution with zinc dust ψ -strychnine is converted into strychnine. On the basis of these results Blount and Robinson³ suggested that ψ -strychnine is a hydroxystrychnine and contains a group $=C(OH)-N=$, the alkyl derivatives being ethers $=C(OR)-N=$ and the nitrosoamine $=CO \ NO-N=$. This view makes the alkaloid analogous with the carbinol bases, berberine and cotarnine, but, unlike them, it furnishes normal instead of anhydro-salts. It is a tertiary alcohol, since the group $=NH-CHOH-$ is usually easily oxidised to $=N-CO-$, whereas ψ -strychnine is stable to potassium

ferricyanide, cannot be oxidised to a cyclic amide, and its methylation product hydrolyses to a keto- and not an aldehydo-amine. The hydroxyl group is situated on a carbon atom contiguous to N(b) of the strychnine formula (p. 574) in a group $-\text{CH}_2-\text{C}(\text{OH})-\text{N}(b)=$. Evidence confirming that view has been provided by Prelog and Kocór; it implies C² (formula XXVII p. 582) as the position of the hydroxyl group.³

Under the action of alkali, according to Kotake, Sakan and Kusumoto,⁴ ψ -strychnine yields tryptamine, and N-methylchano- ψ -strychnine produces N-methyltryptamine.

Leuchs attributes the occurrence of ψ -strychnine in mother liquors from the manufacture of strychnine, to atmospheric oxidation of the latter and has described the preparation of ψ -strychnine by the action of air on strychnine in presence of cupric hydroxide and solution of ammonia. In this process there are formed as by-products, *strychnone*, $\text{C}_{21}\text{H}_{20}\text{O}_3\text{N}_2$, m.p. $\sim 268^\circ$ (*dec.*), $[\alpha] - 667^\circ/d$ (CHCl_3) and ψ -*strychnone*, $\text{C}_{21}\text{H}_{20}\text{O}_4\text{N}_2$, m.p. $315-7^\circ$ (*dec.*), $[\alpha] + 33\cdot3^\circ/d$ (CHCl_3). In the former the :¹N(b) - ⁹CH₂- group (I, p. 574) has been converted to :N(b) . CO . (Leuchs and Räck).²

ψ -Strychnine condenses with malonic acid to give strychnine-9-acetic acid, $\text{C}_{23}\text{H}_{24}\text{O}_4\text{N}_2$, $3\text{H}_2\text{O}$, m.p. $270-2^\circ$ (*dec.*), $[\alpha]_{\text{D}}^{20} - 54^\circ/d$ (H_2O) or $-75^\circ/d$ (acetic acid) which on heating is decarboxylated to 9-methylstrychnine, $\text{C}_{22}\text{H}_{24}\text{O}_2\text{N}_2$, $2\text{H}_2\text{O}$. The latter resinifies on drying, sinters above 95° and decomposes at $105-8^\circ$ (Leuchs *et al.*,² 1943).

Dihydro- ψ -strychnine, $\text{C}_{21}\text{H}_{24}\text{O}_3\text{N}_2$, m.p. $240-3^\circ$ (*vac.*), $[\alpha]_{\text{D}} + 38\cdot7/d$ (CHCl_3), forms a methyl ether, m.p. $\sim 209^\circ$ (*vac.*) and a benzylidene derivative, m.p. $209-215^\circ$ (Leuchs and Räck,² 1940). Unlike ψ -strychnine, the dihydro-derivative can be converted, *either* by boiling with acetic anhydride or by condensation with malonic acid, into the corresponding 9-acetic acid, in this case dihydrostrychnine-9-acetic acid, $\text{C}_{23}\text{H}_{26}\text{O}_4\text{N}_2$, m.p. $300-3^\circ$ (*vac. dec.*), $[\alpha]_{\text{D}}^{20} + 43\cdot0^\circ$ (H_2O) (Leuchs *et al.*,² 1942).

Strychnine-9-acetic acid yields a typical yellow benzylidene derivative, m.p. $285-8^\circ$, but dihydrostrychnine-9-acetic acid forms a colourless compound, isolated as the perchlorate, $\text{C}_{30}\text{H}_{30}\text{O}_4\text{N}_2$, H_2O , HClO_4 , m.p. $205-225^\circ$ (*dec.*), which may be an *isobenzylidene* derivative, though it gives a transient blue colour with sulphuric acid and potassium dichromate.

ψ -**Brucine**, $\text{C}_{23}\text{H}_{26}\text{O}_5\text{N}_2$. This substance was prepared by Leuchs and Tessmar⁵ by the aerial oxidation of brucine in Fehling's solution and is thus an analogue of the similarly prepared ψ -strychnine (*see above*). It has m.p. $258-263^\circ$, and $[\alpha]_{\text{D}}^{20} - 100^\circ$ (CHCl_3) and yields a methyl ether, m.p. $\sim 100^\circ$, a benzylidene derivative, m.p. 165° (*dec.*), a N-nitroso-compound, m.p. 248° (*dec.*), and a dihydro-derivative, m.p. $258-260^\circ$ (*dec.*), $[\alpha]_{\text{D}}^{20} + 29^\circ/d$ (CHCl_3). Its reactions have been investigated in detail by Leuchs and his collaborators⁵ on the same lines as their study of ψ -strychnine, with results which are largely parallel. It is sometimes called 9-hydroxybrucine, but this location of the hydroxyl group has not been fully established.

α -**Colubrine**, $\text{C}_{22}\text{H}_{24}\text{O}_3\text{N}_2$. $4\text{H}_2\text{O}$. This alkaloid crystallises from hot dilute alcohol. The anhydrous base has m.p. 184° , $[\alpha]_{\text{D}}^{19} - 76\cdot5^\circ$ (EtOH),

80 per cent.). The hydrochloride, $B \cdot HCl \cdot 3H_2O$, forms long leaflets, $[\alpha]_D - 3.1^\circ$ (EtOH, 80 per cent.), and the sulphate, $B_2 \cdot H_2SO_4 \cdot 10H_2O$, glancing leaflets. On oxidation with alkaline permanganate α -colubrine yields *N*-oxalyl-4-methoxyanthranilic acid (dimethyl ester, m.p. 163°), whence the alkaloid is assumed to contain the structure (I) corresponding with (III) and (IV) in strychnine and brucine respectively.¹

β -Colubrine, $C_{22}H_{24}O_3N_2$, crystallises from dilute alcohol, has m.p. 222° , $[\alpha]_D^{19} - 107.7^\circ$ (EtOH, 80 per cent.), and yields a crystalline hydrochloride, $B \cdot HCl \cdot H_2O$, $[\alpha]_D - 32.7^\circ$ (H_2O), and sulphate, $B_2 \cdot H_2SO_4 \cdot 9H_2O$, crystallising in long prisms. On oxidation with alkaline permanganate β -colubrine yields *N*-oxalyl-5-methoxyanthranilic acid, identified as the dimethyl ester, m.p. 176° , presumably derived from structure II.

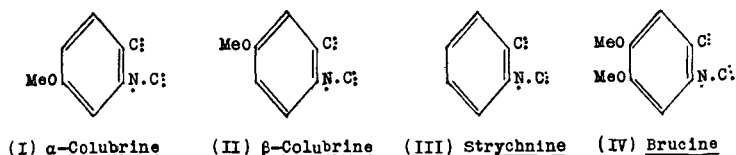

It is not certain that the rest of the molecule in these two alkaloids is identical in structure with that in strychnine and brucine.

Struxine, $C_{21}H_{30}O_4N_2$, obtained by Schaefer⁶ from deteriorated nux-vomica seeds in about 0.1 per cent. yield, is regarded as a decomposition product of strychnine or brucine. It forms rhombic crystals from alcohol, is colourless, but becomes yellow on exposure to light and chars at 250° . It yields normal and acid salts, the latter only from excess of acid. With sulphuric acid it gives no coloration, but addition of potassium dichromate produces a yellow colour changing to green.

Strychnicine. This alkaloid, isolated from nux-vomica leaves grown in Java,⁷ forms needles, m.p. 240° (*dec.*), and is characterised by the following colour reaction. When sodium hydroxide solution is added drop by drop to a solution of a salt of the alkaloid in water, the precipitate formed dissolves on addition of more alkali, forming an orange-coloured liquid which develops a violet colour on addition of hydrochloric acid. Strychnicine is scarcely poisonous, but is said to produce tetanus in frogs.

REFERENCES

- (1) *Helv. Chim. Acta*, 1931, 14, 997. (2) LEUCHS, *Ber.*, 1937, 70, 1543, 2455; 1938, 71, 660; 1940, 73, 1392; 1944, 77, 675; (with GRUNOW and TESSMAR), 1937, 70, 1701; (with RÄCK), *ibid.*, 1940, 73, 731, 811; (with GUNDERMANN), 1942, 75, 168; (with FLAMMERFELD, VILLAIN and SCHÖNE), 1943, 76, 1065. See also PAUSACKER and ROBINSON, *J. Chem. Soc.*, 1947, 1557. (3) *J. Chem. Soc.*, 1932, 2305; 1934, 595; PRELOG and KOCÓR, *Helv. Chim. Acta*, 1947, 30, 359. (4) *Sci. Pap. Inst. Phys. Chem. Res. Tokyo*, 1939, 35, 415. (5) LEUCHS (with TESSMAR), *Ber.*, 1937, 70, 2369; 1939, 72, 965; 1940, 73, 1892; (with SEEGER), 1939, 72, 495; (with LOUIS), 1939, 72, 1483, 1588; (with BOIT), 1940, 73, 99, 885, 1392; (with TEUBER), 1942, 75, 920; (with HWANG), 1942, 75, 168; (with TUSCHEN and MANGELBERG), 1944, 77, 403. (6) *J. Amer. Pharm. Assoc.*, 1914, 3, 1677. (7) VAN BOORSMA, *Bull. Inst. bot. Buitenz.*, 1902, No. xiv, p. 3.

CONSTITUTION OF STRYCHNINE AND BRUCINE. Though strychnine is not the most complex of alkaloids when judged merely by its molecular weight, its compact structure and lack of detachable fringes made the determination of its structure a difficult problem on which much labour and ingenuity have been expended and over 200 papers published. The results of this work are voluminous, interesting and important, but it is impossible to condense them into a complete account of the chemistry of these alkaloids within such space as can be spared in this volume. It is hoped that the following account mentions as many of the constitutionally important substances and reactions as are necessary to make clear the processes by which constitutional formulæ for these alkaloids have been developed. The workers on strychnine and brucine have been comparatively few. Valuable pioneer work was done by Hanssen and by Tafel, and in recent years the investigation has occupied three teams of workers, that of Leuchs since 1908, that of Perkin and Robinson beginning in 1909, and that of Wieland since 1929. These authors have had the foresight to include the words strychnine, brucine or Strychnos in the titles of all their papers, so that readers who desire fuller information than can be given here will have no difficulty in compiling a bibliography of the most important contributions to the constitutional chemistry of the two alkaloids by consulting the entries under the names of the six authors and three subjects mentioned above in the excellent periodical indexes issued by the British or American abstract journals. Readers may also be referred to Sir Robert Robinson's Bakerian lecture (1931) on "The Molecular Structure of Strychnine and Brucine" ¹ for a critical review of the principal reactions and theoretical data upon which formulæ for these two alkaloids can be constructed and the conditions such formulæ must fulfil, and to the paper (1946) by the same author with Briggs and Openshaw,¹ which brings these views up to that date.

Strychninic Acids (Strychnic Acids). Although strychnine contains two atoms of nitrogen, it behaves as a monoacidic base. Warmed with a solution of sodium ethoxide it takes up a molecule of water,² forming strychninic acid, $C_{21}H_{24}O_3N_2$, which crystallises in minute needles, m.p. 215° , is soluble in water and forms salts with mineral acids, but when warmed with excess of the latter reverts to strychnine. Strychninic acid forms a nitrosoamine, dissolves in alkaline solutions to form unstable salts, undergoes indirect esterification, and with methyl iodide yields methylstrychninic acid methiodide. These reactions indicate that it is an iminocarboxylic acid produced by the hydration of a lactam group in strychnine thus:—

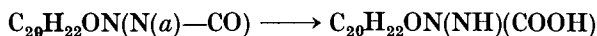

The nitrogen atom included in the lactam group is non-basic and is conveniently distinguished as N(a), the second and basic nitrogen being written N(b).

In the conversion of strychnine to strychninic acid, Tafel ² pointed out that a second acid is formed, identical with Gal and Etard's ³ "dihydrostrychnine" and now known as *isostrychninic acid*. The preparation of

the latter has been improved by Oesterlin and Imoudsky,³ who agree with Tafel² that it crystallises as a monohydrate, $C_{21}H_{24}O_3N_2 \cdot H_2O$, m.p. 247–8°. Leuchs and Schulte³ give m.p. 245–8° (*vac. dec.*) and $[\alpha]_D^{20} - 151^\circ/d$ (N/NaOH). The acid forms a N-nitroso derivative, m.p. 243°, which is isomerised by hydrogen chloride in alcohol to a C-nitrosoisostrychninic acid, decomposing at 238–240°. Oesterlin was unable to effect condensation of the acid with *o*-toluenesulphonyl chloride, but according to Leuchs and Schulte³ it yields an *O*-acetylisostrychninic acid, $C_{23}H_{26}O_4N_2 \cdot 5H_2O$, m.p. 180–5° (*dry*) with acetic anhydride, though Siddiqui³ states that the product is an acetylisostrychnine, m.p. 196°. Oesterlin³ coupled the acid with various diazonium salts. The derivative so formed with diazobenzenesulphonic acid, occurs in orange-red needles, m.p. 310° (*dec.*), and on reduction by stannous chloride in hydrochloric acid yields aminoisostrychninic acid, $C_{21}H_{25}O_3N_3$, decomposing at 240–5°. The formation of this azo-derivative is made the basis of a method for the detection and estimation of small amounts of isostrychninic acid in strychninic acid. *iso*Strychninic acid is not convertible into isostrychnine by any of the ordinary methods (Oxford, Perkin and Robinson³), but the reverse process is feasible, and according to Bacovescu and Pictet⁴ isostrychnine (prismatic needles from benzene, m.p. 223–4°, $[\alpha]_D + 24.1^\circ$ to $+ 25.1^\circ$ [EtOH]) is formed when strychnine is heated in water at 160–180°, or better with ammonia and methyl alcohol, and this with sodium ethoxide in alcohol yields isostrychninic acid. *iso*Strychnine, unlike strychnine, contains a hydroxyl group and yields an acetyl derivative, m.p. 133–4° (Oxford *et al.*³) but which Leuchs and Schulte (1942)³ describe as amorphous, and yielding a crystalline perchlorate, m.p. 206°. According to the same authors, isostrychnine forms with benzaldehyde a derivative, which is abnormal in being colourless, and is named *isobenzylidene*-strychnine. It is amorphous, has $[\alpha]_D^{20} - 655^\circ/d$ ($CHCl_3$), and can be isolated as the crystalline sulphate, $C_{28}H_{26}O_2N_2 \cdot H_2SO_4 \cdot 5H_2O$, or perchlorate, m.p. 60–70° or 160–170° (*dry*).

When strychnine is treated with hydrogen bromide and red phosphorus in boiling acetic acid, it is converted into a complex bromodeoxyisostrychnine hydrobromide, $(C_{21}H_{21}ON_2Br)_x$, which is hydrolysed by boiling N-sulphuric acid to isostrychnine (*see above*), now distinguished as I, and isostrychnine-II, m.p. 218–9°, $[\alpha]_D^{20} - 258^\circ$ (EtOH), which with acetic anhydride gives the acetyl derivative of isostrychnine-I (*see above*).

A similar study of the action of hydrogen bromide on brucine and the resulting derivative of *isobrucine* is in progress (Leuchs and Schulte, 1942).³

Strychnine combines with methyl iodide, forming a methiodide, which on successive treatment with silver sulphate and baryta gives methylstrychnine,⁴ also formed when strychninic acid methiodide is treated with silver oxide.⁵ Methylstrychnine, $C_{22}H_{26}O_3N_2 \cdot 2H_2O$, crystallises in long prisms, is soluble in water, gives the characteristic colour reactions of strychnine, and though not bitter, still exerts a physiological action like that of strychnine. It behaves as a secondary amine, and gives a meth-

iodide, which on heating with silver sulphate and barium hydroxide yields dimethylstrychnine, $C_{23}H_{28}O_3N_2 \cdot 6H_2O$.⁵ This base is also produced from strychninic acid by conversion of the latter into the corresponding methiodide, which in presence of caustic soda and methyl iodide furnishes *N*-methylstrychninic acid methiodide: this readily loses a molecule of hydrogen iodide when warmed with silver oxide, forming the corresponding betaine of *N*-methylstrychninic acid, usually called dimethylstrychnine. The latter with nitrous acid yields nitrosodimethylstrychnine which resembles nitrosodimethylaniline in giving dyes by condensation with benzaldehyde, etc. Such behaviour is also characteristic of *N*-methyltetrahydroquinoline, whence Tafel suggested that this base is the nucleus of the strychnine molecule.⁶

In like manner *isostrychninic acid* furnishes methyl*isostrychnine*, $C_{22}H_{26}O_3N_2 \cdot 7H_2O$ (needles from water), and dimethyl*isostrychnine*, $C_{23}H_{28}O_3N_2 \cdot 3H_2O$ (microscopic needles, from water).

The formation of this series of alkylation products may be represented by the following scheme:—

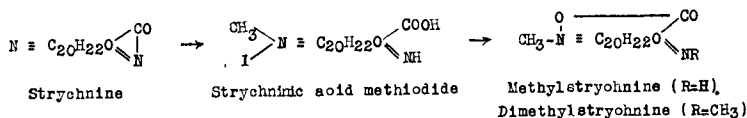

Reduction Products. The more important results of the reduction of strychnine and *isostrychnine* are summarised in the following scheme:—

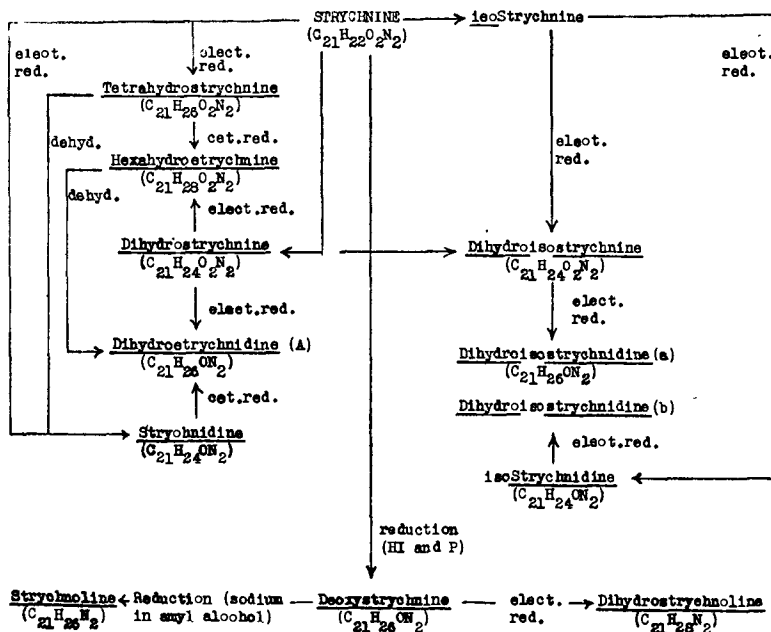

Deoxystrychnine, $C_{21}H_{26}ON_2 \cdot 3H_2O$, is formed when strychnine is boiled with hydriodic acid and phosphorus for eighteen hours; it melts at 75° or 172° (*dry*). When heated with sodium methoxide in alcohol it is converted into deoxystrychninic acid, $C_{21}H_{25}O_2N_2 \cdot H_2O$, which forms colourless, microscopic needles and yields a crystalline nitrosoamine. Deoxystrychnine gives with sulphuric acid and potassium dichromate a bluish-violet coloration changing to brown, whilst the corresponding acid gives an intensely red colour with the same reagents. It is clear from the above that the lactam group is still present in deoxystrychnine, and that it is the second oxygen atom which has been eliminated. When deoxystrychnine is further reduced ⁷ with sodium in amyl alcohol *strychnoline*, $C_{21}H_{26}N_2$, colourless needles, m.p. $175-8^\circ$, from dilute alcohol, is produced; whilst *dihydrostrychnoline*, $C_{21}H_{28}N_2$, colourless prisms, m.p. 129° , b.p. $267-270^\circ/16$ mm., $[\alpha]_D^{20} + 10.5^\circ$ ($CHCl_3$), is formed when deoxystrychnine is reduced electrolytically. The relationship of these products to strychnine may be represented thus:—

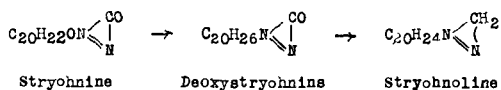

Strychnidine, $C_{21}H_{24}ON_2$. This base, formed by electrolytic reduction of strychnine (Tafel ⁷; Clemo, Perkin and Robinson ⁸) crystallises from alcohol in stellate groups of needles, m.p. 250.5° (*dec.*) with some sintering at 246° , b.p. $290-5^\circ/14$ mm., $[\alpha]_D^{20} - 8.28^\circ$ ($CHCl_3$). In acid solution it gives an intensely red coloration with oxidising agents. Strychnidine yields a yellow azo-compound with diazobenzene chloride, but does not form a benzylidene derivative. Both nitrogen atoms are basic and it gives two series of salts; the dihydrochloride, B. $2HCl$, forms colourless needles and is converted into the monohydrochloride by crystallisation from water.

Tetrahydrostrychnine, $C_{21}H_{26}O_2N_2 \cdot H_2O$. This substance, also formed by the electrolytic reduction of strychnine,⁸ crystallises from alcohol in prisms, m.p. 202° , gives colour reactions of the strychnidine type, and yields both neutral and acid salts; the hydrochloride, B. HCl , occurs in small needles readily soluble in water and the dihydriodide, B. $2HI \cdot 2H_2O$, in pyramidal crystals. The base yields an amorphous nitrosoamine, the hydrochloride of which crystallises from warm water in lustrous, yellowish prisms. It also furnishes a crystalline monoacetyl derivative, and on heating with hydrochloric acid or phosphorus oxychloride is dehydrated to strychnidine.

Strychnine, strychnidine and tetrahydrostrychnine are all converted into dihydro-derivatives on catalytic hydrogenation, indicating the presence of one ethylenic linkage in these substances, and dihydrostrychnine in turn yields on electrolytic reduction dihydrostrychnidine and hexahydrostrychnine. The formation of this group of reduction products from strychnine may be represented thus:—

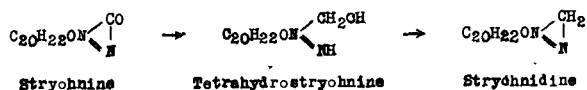

The results so far recorded indicate that strychnine contains one ethylenic linkage, that one of the nitrogen atoms is basic and tertiary (N(b)), that the second nitrogen atom is not basic and occurs in a cyclic amide group (=N—CO—), that the cyclic amide group can be reduced to the form (—CH₂OH NH=) as in tetrahydrostrychnine or (—CH₂—N=) as in strychnidine or strychnoline. Further, since strychnine forms a benzylidene derivative, it must contain an activated methylene group, and, as the only other oxygen atom is not present as a carbonyl group, activation must be due to the cyclic amide group and a heterocyclic ring in strychnine must contain the group =N(a)—CO—CH₂. There remains to be dealt with the second oxygen atom,⁹ which is eliminated in the formation of deoxystrychnine, but is still retained in strychnidine. This oxygen in strychnine, and all the derivatives which retain it, is inert towards the usual reagents for carbonyl and hydroxyl groups, indicating its possible presence in a cyclic ether linkage.

Clemo and Raper⁹ have hydrogenated strychnine under drastic conditions (Raney nickel; temp. 220°; pressure 150 atm.). The chief product is base "D," C₂₁H₂₆O₂N₂, m.p. 252°, which forms an acetyl derivative, m.p. 194°, possibly indicating a secondary alcohol, gives strychnine colour reactions and on electrolytic reduction yields a base, C₂₁H₂₈ON₂, m.p. 217°, containing one active hydrogen (Zerewitinoff) and giving colour reactions of the strychnidine type. The characters of "D" indicate that the :N(a).CO. system remains intact, that :N(b). is still tertiary, but that the cyclic ether linkage has been opened producing a primary or secondary carbinol group.

OXIDATION PRODUCTS. The evidence for the existence of a benzene ring in strychnine has been summarised by Robinson.¹ Claus and Glassner¹⁰ prepared a dinitrostrychnine hydrate, C₂₁H₂₂O₃N₂(NO₂)₂, which was examined by Tafel,⁷ and more recently by Siddiqui,⁷ who has shown it to be dinitrostrychninic acid. Tafel also obtained a series of nitrated degradation products, including dinitrostrycholcarboxylic acid, referred to later. Picric acid was obtained by Shenstone¹¹ and 3:5-dinitrobenzoic acid by Menon, Perkin and Robinson¹² by the action of hot dilute nitric acid on the alkaloid, degradations which Robinson¹ represents as occurring in the following manner:—

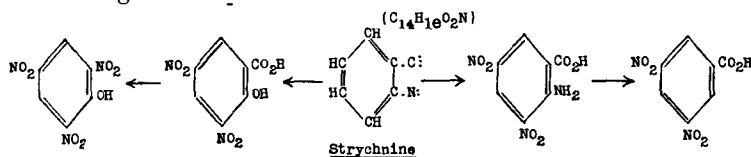

Strychnine can also be halogenated¹³ and sulphonated,¹⁴ and among its high temperature decomposition products indole and carbazole have been recognised.¹⁵

In the following groups of oxidation products it is the benzene ring which is first destroyed. Hanssen¹⁶ showed in 1884 that brucine, on oxidation with chromic acid, furnished an acid, C₁₆H₁₈O₄N₂, later corrected

to $C_{16}H_{20}O_4N_2$, which he subsequently obtained by the same method from strychnine, and pointed out that both alkaloids must contain the nucleus $C_{16}H_{18}O_2N_2$, that the differences, C_5H_4 and $C_7H_8O_2$, between this nucleus and strychnine and brucine, might represent phenyl and dimethoxyphenyl groups respectively, in the two alkaloids and that brucine is probably a dimethoxystrychnine. Subsequently Hanssen showed that cacotheline (see below) was oxidised by bromine to an acid, $C_{19}H_{24}O_7N_2$, later changed to $C_{19}H_{26}O_6N_2$, which in turn was oxidised by chromic acid to the C_{16} acid referred to above. Hanssen's investigations and conclusions have been confirmed and extended by Leuchs and by Wieland and the relationships of these products to brucine and strychnine may now be represented by the following scheme:—

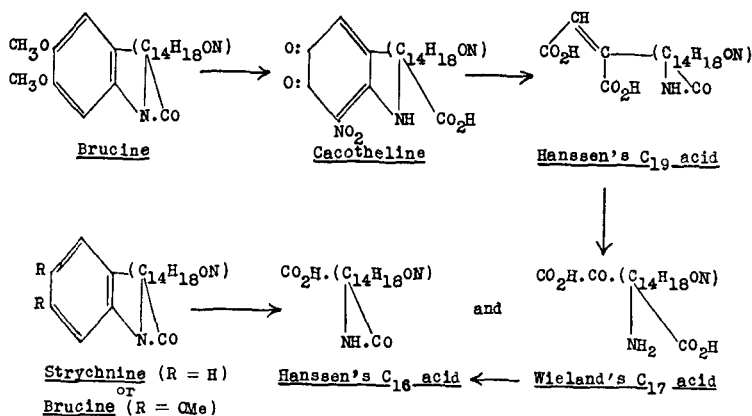

Cacotheline (Bidemethylnitrobrucinehydrate nitrate). This substance was first obtained by Gerhardt,¹⁷ and later on was prepared by Strecker¹⁸ and others, but its nature was first ascertained by Moufang and Tafel¹⁹ and its constitution determined by Leuchs and collaborators.²⁰ It is the nitrate of a base, $C_{21}H_{21}O_7N_3$, crystallises in yellow tablets and is dextro-rotatory in alkaline solution. From such a solution the free base can be isolated by neutralisation with acetic acid. It crystallises in yellow leaflets containing 2 mols. of water, becomes anhydrous at 105° and explodes on further heating. It furnishes with acids three sets of differently coloured salts, and yields an oxime, $C_{21}H_{22}O_7N_4 \cdot 2H_2O$, yellow needles; which on reduction gives a diaminophenol, of which the trihydrobromide, $C_{21}H_{24}O_3N_4 \cdot 3HBr$, forms colourless needles or leaflets. The methyl ester hydrochloride, $C_{20}H_{20}O_5N_3 \cdot COOCH_3 \cdot HCl \cdot H_2O$, crystallises in reddish-brown needles. Cacotheline base forms a methosulphate, $C_{21}H_{21}O_7N_3 \cdot Me_2SO_4$, crystallising in reddish-brown leaflets.

Hanssen's Acid, $C_{19}H_{22}O_6N_2 \cdot 2H_2O$. Hanssen's preparation of this acid by the action of bromine on cacotheline²¹ was confirmed by Leuchs, Mildbrand and Leuchs²² and by Cortese.²³ The acid crystallises in colourless prisms or plates, $[\alpha]_D^{14} - 37.0^\circ$ (as sodium salt in water). The salts with acids crystallise well; the nitrate has $[\alpha]_D^{20} - 30.0^\circ$ (H_2O).

The acid yields a methyl ester (hydrochloride, slender needles ; methiodide, pale yellow prisms) and a dimethyl ester, crystallising in colourless prisms and yielding a methiodide, $C_{21}H_{26}O_6N_2 \cdot CH_3I$, which forms hexagonal plates. The silver salt is converted by methyl iodide in methyl alcohol into the betaine, $C_{20}H_{24}O_6N_2$, colourless prisms, $[\alpha]_D^{25} - 5.6^\circ$ (H_2O). On reduction with sodium amalgam the acid adds on two atoms of hydrogen ; the resulting amorphous acid yields a crystalline dimethyl ester, $C_{21}H_{28}O_6N_2$, colourless prisms, m.p. $143-7^\circ$ (*dec.*). On hydrogenation in presence of platinic oxide as catalyst 2 mols. of hydrogen are absorbed to form the acid, $C_{19}H_{26}O_6N_2$, colourless prisms, $[\alpha]_D + 17.7^\circ$ (H_2O).²³ On oxidation with chromic acid the C_{19} acid is converted into Wieland's C_{17} acid and Hanssen's C_{16} acid.²³

Wieland's C_{17} Acid. In 1929 Wieland and Münster²⁴ showed that brucine, on oxidation with chromic acid, yielded two acids : (a) $C_{17}H_{22}O_6N_2 \cdot 5H_2O$ and (b) Hanssen's C_{16} acid. Cortese²³ found subsequently that strychnine and Hanssen's C_{19} acid also yielded these two acids on oxidation with chromic acid, while Leuchs²⁵ also obtained the C_{17} acid less directly from strychnine and from brucine, and drew the conclusion from this and other observations that brucine must be *o*-dimethoxystrychnine. The C_{17} acid separates from hot water in hexahedral crystals, darkens at $250-280^\circ$, m.p. $> 345^\circ$, and has $[\alpha]_D^{24} + 49.2^\circ$ (H_2O). On catalytic hydrogenation it yields an acid, $C_{17}H_{22}O_5N_2 \cdot 3H_2O$, m.p. $224-7^\circ$, by absorption of a molecule of hydrogen and loss of a molecule of water, with formation of a lactam group. The semicarbazone has m.p. above 300° . On oxidation with chromic acid or hydrogen peroxide the C_{17} acid is converted into Hanssen's C_{16} acid.

Hanssen's C_{16} Acid, $C_{16}H_{20}O_4N_2 \cdot 2$ or $4H_2O$. This acid, obtained by the oxidation of either strychnine or brucine and certain of their derivatives as described above, forms cubical or bipyramidal crystals, m.p. 311° (*dec.*), $[\alpha]_D^{24} - 116.3^\circ$ (H_2O), and yields a dihydro-derivative, $C_{16}H_{22}O_4N_2$, m.p. $292-4^\circ$ (*dec.*), $[\alpha]_D^{28} - 6.01^\circ$ (H_2O), identical with the product obtained by the direct oxidation of dihydrobrucine with chromic acid. Diazomethane converts the acid into the methylbetaine, $C_{17}H_{22}O_4N_2$, m.p. $250-2^\circ$ (*dec.*), $[\alpha]_D^{23} - 92.6^\circ$, which loses carbon dioxide on heating and is probably a β -betaine.^{24, 25}

These substances can be regarded as derived from strychnine (or brucine) by the loss of carbon atoms of the benzene ring, and Leuchs and Wegener²⁶ have suggested they should be named as derivatives of hypothetical bases *nucine* and *nucidine*, arising from strychnine and strychnidine in the following way :—

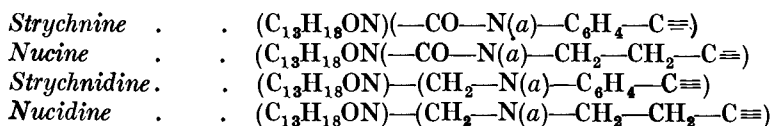

The following is an example of the application of this system of nomenclature. Strychnidine (p. 564) is oxidised by chromic acid to 2 : 3-diketo-

nucidine, $C_{17}H_{20}O_3N_2$, m.p. $267-9^\circ$, $[\alpha]_D^{17} + 55.6^\circ$ (H_2O), which is reduced by zinc and hydrochloric acid to 2-keto-3-hydroxynucidine, m.p. $252-4^\circ$, and is oxidised by hydrogen peroxide to carboxyaponucidine, isolated as

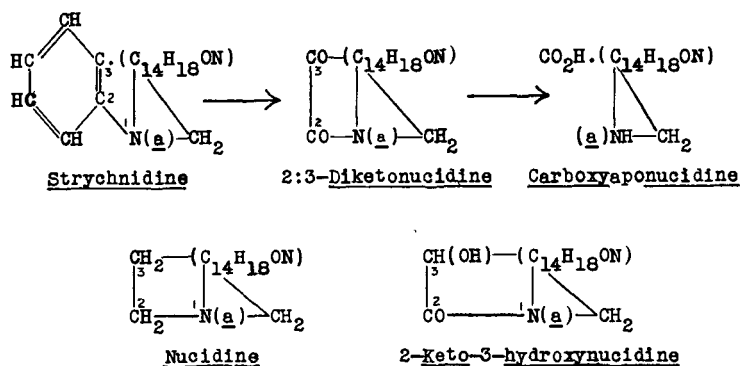

the perchlorate, $C_{16}H_{22}O_3N_2 \cdot 2HClO_4 \cdot H_2O$, in which the original benzene ring is now represented only by a carboxyl group, and which on decarboxylation yields aponucidine, $C_{15}H_{22}ON_2$, m.p. $123-4^\circ$ (*dry*).²⁷

Dinitrostrycholcarboxylic Acid, $C_{10}H_5O_8N_3$. This important degradation product of strychnine, prepared, along with other nitrated products of the alkaloid, by Tafel,²⁸ by treating strychnine first with dilute and finally with concentrated nitric acid, crystallises from alcohol in needles, loses solvent of crystallisation at 110° and melts at 300° . On reduction with tin and hydrochloric acid it gives diaminostrycholcarboxylic acid, $C_{10}H_9O_4N_3$, indicating the presence of two nitro-groups, and when heated with water in sealed tubes at $200-210^\circ$ loses one carboxyl group forming dinitrostrychol, $C_9H_5O_6N_3$, slender needles, m.p. 282° (*dec.*). The remaining oxygen atoms were long supposed to be present as hydroxyl groups and dinitrostrychol up to 1930 had been regarded as a dinitrodihydroxyquinoline or isoquinoline.²⁹ Menon, Perkin and Robinson³⁰ found that dinitrostrycholcarboxylic acid could be esterified by alcohol and a mineral acid catalyst to a substance at first regarded as ethyl dinitro-*O*-ethylstrycholcarboxylate. This, on application of the Curtius reactions gave a urethane regarded as $C_9H_2N(NO_2)_2(OH)(OEt)-NH-CO_2Et$, which was converted by boiling nitric acid into picric acid, and on hydrolysis by sulphuric acid, followed by oxidation by permanganate in acid solution yielded 5:7-dinitroisatin (V). The conclusion was drawn that dinitrostrychol must be either 2:3-dihydroxy-6:8-dinitroquinoline-4-carboxylic acid or 3:4-dihydroxy-6:8-dinitroquinoline-2-carboxylic acid, either of which could yield dinitroisatin (V) and picric acid. It was already known that dinitrostrycholcarboxylic acid, on further treatment with nitric acid, has its presumed single carboxyl group²⁸ replaced by a nitro-group yielding trinitrostrychol. Menon and Robinson³¹ found that the latter yields a methyl ester, which, by the Curtius degradation process, yields a urethane identical with that obtained by nitration of the urethane produced in like

manner from dinitrostrychol. The latter must therefore still contain a carboxyl group distinguished by unusual stability. On this basis and bearing in mind its ready degradation to 5 : 7-dinitroisatin, dinitrostrychol-carboxylic acid must be 5 : 7-dinitroindole-2 : 3-dicarboxylic acid (I) and dinitrostrychol probably 5 : 7-dinitroindole-2-carboxylic acid (II). The latter conclusion was confirmed by Menon and Robinson,³² who prepared 5 : 7-dinitro-2-indolylurethane (III) from dinitrostrychol, hydrolysed it to 5 : 7-dinitro-2-aminoindole and converted this to 5 : 7-dinitroisatin-3-oxime (IV), a substance obtainable by the action of hydroxylamine on dinitroisatin (V) and which can be hydrolysed to the latter. Further proof was provided by Hill and Robinson's³³ synthesis of dinitrostrycholamide (5 : 7-dinitroindole-2-carboxamide) (VI), identical with the amide obtained from dinitrostrychol (II).

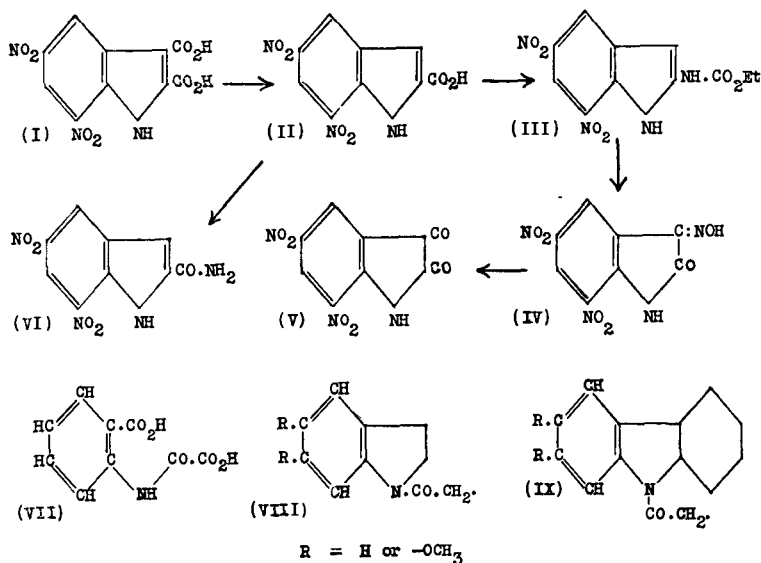

While this work was in progress Späth and Bretschneider showed that strychnine, on oxidation with permanganate in alkaline solution, furnished *N*-oxalylanthranilic acid (VII), brucine yielding oxalyl-4 : 5-dimethoxyanthranilic acid, the latter observation providing confirmation of the evidence previously adduced that the two methoxy-groups in brucine are in the *ortho*-position relative to each other as indicated by Lions, Perkin and Robinson.³⁴ The results so far considered indicate the presence in brucine and strychnine of the complex (VIII), which can be extended to (IX) if account is taken of the readiness with which carbazole can be obtained from strychnine and brucine and certain of their derivatives by decomposition with alkali³⁵ at temperatures ranging from 200° to 400°.

Knowledge of the structure of the rest of the molecule is mainly due to the results of the exhaustive study by Leuchs and his pupils of the oxidation

products of strychnine and brucine. The following scheme represents the course of the primary oxidation of the two alkaloids by permanganate in acetone solution, followed by reduction and hydrolysis of the initial products. Some of the substances have been re-examined recently by Holmes *et al.* and by Prelog *et al.*³⁶

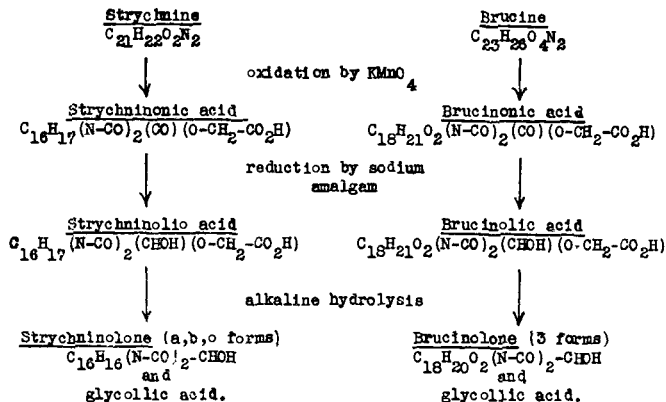

Strychninonic acid, $C_{21}H_{20}O_6N_2 \cdot 2H_2O$, obtained by Leuchs³⁶ in 1908, crystallises from hot water in colourless prisms, m.p. 265–7° (*corr.*, *dry*), $[\alpha]_D^{20} - 43.3^\circ$, yields a monoethyl ester, m.p. 209–210° (*corr.*), and an oxime, m.p. 268–271° (*dec.*). It shows no basic properties whence it is assumed that both nitrogen atoms are present in the form of =N—CO— groups, and in confirmation of this the acid absorbs 2 mols. of water when heated with dilute hydrochloric acid, forming a dihydrate, $C_{21}H_{24}O_8N_2 \cdot H_2O$, rectangular prisms, m.p. 235–240°.

Strychninolic acid, $C_{21}H_{22}O_6N_2$, obtained by reduction of strychninonic acid with sodium amalgam, forms long prisms, m.p. 238°, and yields an acetyl derivative, needles, m.p. 281° (*corr.*).

Strychninolone, $C_{16}H_{18}O_3N_2$, is formed when strychninolic acid is kept for several hours in *N*-sodium hydroxide solution, glycollic acid being also produced. It crystallises from alcohol in glistening prisms, m.p. 228–231°, $[\alpha]_D^{20} - 112.4^\circ$, yields an acetyl derivative, $C_{21}H_{20}O_4N_2$, m.p. 241–3° (*dec.*), and with hydrochloric acid at 100° forms two monohydrates, $C_{16}H_{20}O_4N_2$, which have the properties of amino-acids, and result from the separate hydrolysis of two =N—CO— groups. The dihydro-base has m.p. 268–270° and $[\alpha]_D - 12^\circ$ (acetic acid). This *a*-form of strychninolone passes into the isomeric *b*-form on longer contact with alkali. Strychninolone-*b*, $C_{16}H_{18}O_3N_2 \cdot H_2O$, crystallises in prisms, m.p. 228–230° (*dry*), $[\alpha]_D^{20} - 37^\circ$ (acetic acid). On reduction it furnishes a mixture of the *a*- and *c*-forms of dihydrostrychninolone (Prelog),³⁶ and not dihydrostrychninolone-*b* as Leuchs, Diels and Dornov³⁷ supposed. On prolonged action of alkali or when ammonia in methyl alcohol is used, a third form is produced, strychninolone-*c*; it forms hexagonal prisms, m.p. 251–2°, $[\alpha]_D^{18} - 176.1^\circ$ (acetic acid); the acetyl derivative has m.p. 256–7° and

$[\alpha]_D^{17} - 231.3^\circ$ (acetic acid) and the dihydro-derivative, m.p. $227-9^\circ$ and $[\alpha]_D - 88^\circ$ (acetic acid).³⁷

Brucinolone, $C_{21}H_{22}O_5N_2$. This substance is produced from brucine, in the same way as strychninolone (*see above*) from strychnine, *via brucinonic acid*, $(MeO)_2(C_{16}H_{15})(N-CO)_2(CO)(O-CH_2-CO_2H)$, (colourless prisms, with $1H_2O$, m.p. $173-183^\circ$ (*corr.*) or 266° (*dry, corr., dec.*), $[\alpha]_D^{20} - 48.5^\circ$) and its reduction product *brucinolic acid*, $C_{23}H_{26}O_8N_2$, m.p. $250-1^\circ$ (*corr., dec.*), $[\alpha]_D^{20} - 22^\circ$, which in alkali decomposes into glycollic acid and a mixture of brucinolone-*a* and brucinolone-*b*. The *a*-form has not been isolated, but its existence is known by the formation of brucinolonic acid (*a*) on further oxidation and the dihydro-derivative, m.p. $285-290^\circ$ (*dec.*), has been prepared by Prelog.³⁶ Brucinolone-*b* is obtained from the crude mixture by purification through the hydrate or the acetyl derivative (m.p. $253-4^\circ$) and then has m.p. 270° , $[\alpha]_D^{20} - 37^\circ$. On reduction it gives a mixture of (*a*) and (*c*) dihydrobrucinolones (Prelog,³⁶ *cf.* Leuchs, Diels and Dornov³⁷). Potassium hydroxide in alcohol converts it into brucinolone-*c* (*cryptobrucinolone*), which has m.p. $190-2^\circ$, $[\alpha]_D - 151.1^\circ$ (acetic acid), yields an acetyl derivative, prisms (m.p. $272-4^\circ$, $[\alpha]_D - 199.5^\circ$), and is reducible to dihydrobrucinolone-*c*, m.p. 180° , $[\alpha]_D - 78^\circ$ (acetic acid).³⁸

The formation of strychninolone and brucinolone was first explained by Fawcett, Perkin and Robinson,²⁹ who suggested that the loss of glycollic acid from brucinolic acid must be due to the change, indicated by (*a*):—

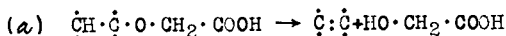

and that this implies the rearrangement (*b*) during the formation of brucinonic acid from brucine, or strychninonic acid from strychnine.

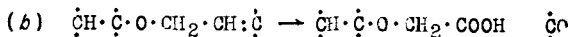

Robinson¹ has pointed out that the formation of dihydrostrychninonic acid, $C_{21}H_{22}O_6N_2$, rectangular plates, m.p. 315° , $[\alpha]_D^{20} + 4.3^\circ$, as a by-product in the oxidation of strychnine by permanganate, can be explained if certain assumptions are made, *e.g.*, the change represented thus:—

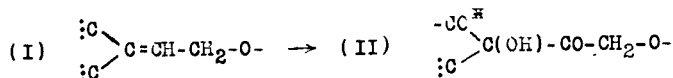

would give a product (II) which could undergo hydrolytic fission to dihydrostrychninonic acid. In this system the CO* group must be that formed in association with N(*b*) as N(*a*)—CO is known to be joined to a methylene group. The existence of this system assumed to explain the formation of the dihydro-acid implies the presence in strychnine of the group

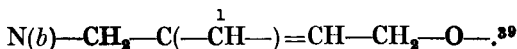

When acetylbrucinolone-*b* is oxidised with permanganate in acetone, acetylbrucinolonic acid, $C_{23}H_{24}O_9N_2$, is formed, which on acid hydrolysis produces acetic acid (from the acetoxy-group), malonic acid and a new base *curbine*, $C_{18}H_{20}O_5N_2$, crystallising in slender needles, m.p. 322° , and giving a red colour with nitric acid. The change involved in the degradation of brucinolone-*b* to curbine is explained in the following way:—

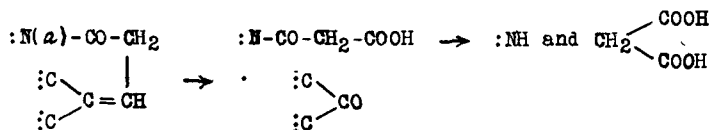

The nitrogen atom in this system must be N(a), since its associated —CO— is followed by —CH₂— and the double bond concerned must be that formed in the conversion of brucinonic acid to brucinolone.⁴⁰ The whole change of groups in the conversion of acetylbrucinolone (I) through acetylbrucinolonic acid (II) to curbine may therefore be represented by the following extended formulæ, in which the index figures above the symbols correspond with the items in the graphic formulæ (V) and (VI) on p. 574; the unit in square brackets is the eliminated malonic acid.

(I)

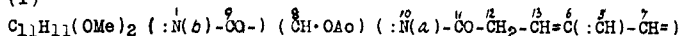

(II)

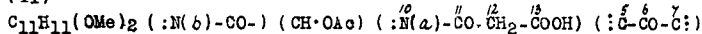

(III)

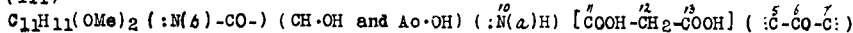

The three brucinolones are structural isomerides, but as brucinolone-*a* has not been isolated, the corresponding degradation of acetylstrychninolone-*a* may be given. In this case the final product corresponding to curbine is an amino-acid, $C_{17}H_{15}O_4N_2$ (needles or prisms, m.p. 280° (*dec.*)), together with oxalic acid. Here it is assumed that the system initially present changes as follows⁴¹:—

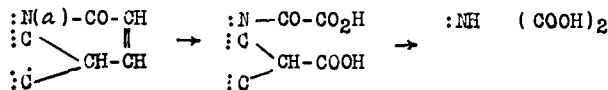

From the foregoing it appears that strychninolone-*a* and brucinolone-*b* must contain the systems (IV) and (V) respectively attached to N(a):—

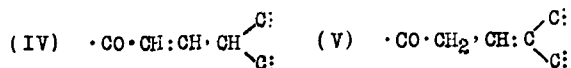

and, having regard to the formation of these ketones from strychnine and brucine, these two must be derived from the system (VI) in the two parent alkaloids:—

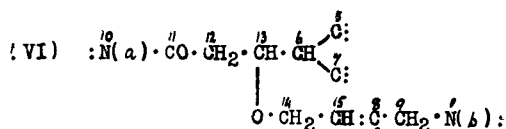

The first formulæ for strychnine and brucine were suggested by Perkin and Robinson in 1910⁴² and were modified by these authors and their collaborators, as further knowledge accumulated from the protean transformations to which the two alkaloids have been subjected.⁴³ Formula (I) indicates the views current up to 1939. Robinson and Leuchs were both in agreement as to the main features of the structure to be assigned to both alkaloids, but there was still discussion as to whether the $\cdot \text{CH}_2 \cdot \text{CH}_2 \cdot$ chain, which begins at N(b) in ring D, has its second terminal at carbon atom 4, as suggested by Menon and Robinson,⁴⁴ at carbon atom 3, as adopted by Leuchs,⁴⁵ or at carbon atom 5, proposed by Blount and Robinson,^{46, 47} as a possible alternative to C⁴. The latter authors have pointed out that strychnine does not behave as a dihydroindole, as is implied by the adoption of C³ as the second terminal. Therefore one of the carbon atoms, α or β in the indole nucleus, *i.e.*, C⁴ or C⁵ in formula I, must be attached by a carbon chain to N(b) and selection of C⁴ has the advantage of providing the required tryptophan nucleus. The most probable position for the second terminal was therefore C⁴, but this could not be reconciled with the results of the action of bromine water on 2 : 3-diketonusidine, as recorded by Leuchs.⁴⁵ This substance is produced by the oxidation of strychnidine or brucidine^{45(a)} with chromic acid and would be represented by (II) if the second terminal of the $\cdot \text{CH}_2 \cdot \text{CH}_2 \cdot$ chain is at C⁴. When 2 : 3-diketonusidine (p. 568) is treated with bromine water at 0° it forms, according to Leuchs, bromo-2 : 3-diketonusidine hydrate, isolated as the perchlorate, C₁₇H₂₁O₄N₂Br · HClO₄, [α]_D^{21°} + 98°/d. Leuchs assumed that the $\cdot \text{CH}_2 \cdot \text{CH}_2 \cdot$ chain in strychnine and brucine had its second terminal at C³ and that carbon atom 4 had a free hydrogen in the parent alkaloids, and in 2 : 3-diketonusidine, which was replaced by a bromine atom in this reaction. On repeating the bromination experiment, Holmes and Robinson⁴⁴ found that bromine was absorbed but were unable to isolate any well-defined reaction product. In their repetition of the experiment Leuchs and Grunow⁴⁵ confirmed the original experimental data but gave a new interpretation of the results, which did not involve bromine substitution at C⁴ in 2 : 3-diketonusidine. Though this change of view provides no positive evidence for C⁴ as the second terminal of the $\cdot \text{CH}_2 \cdot \text{CH}_2 \cdot$ chain, it eliminates the chief objection to it and left the Menon and Robinson formula (IIIA) as giving the best all-round explanation of the reactions of brucine and strychnine up to that time.

In the following account of some reactions and derivatives of the two alkaloids the Leuchs variation (IIIB ; note the different system of numbering adopted) is sometimes used for the convenience of readers, who may need to consult original papers in which it appears, but there is no difficulty in making the simple transfer $\overset{1}{\text{N}}(\text{b}) \cdot \text{CH}_2 \cdot \text{CH}_2 \cdot \text{C}^3$ to $\overset{1}{\text{N}}(\text{b}) \cdot \text{CH}_2 \cdot \text{CH}_2 \cdot \text{C}^4$

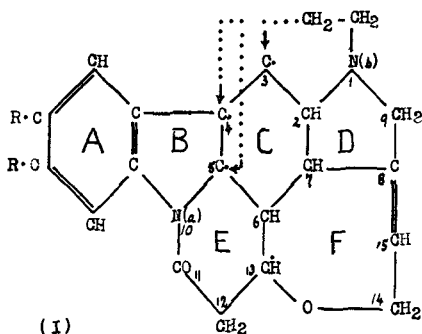

(I),
Strychnine, R=H; Brucine, R=OMe

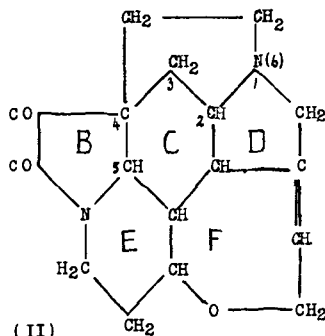

(II)
2:3-Diketonoucidine

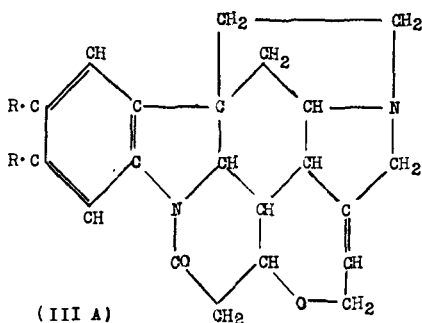

(III A)
Strychnine, R=H (Menon and Robinson)

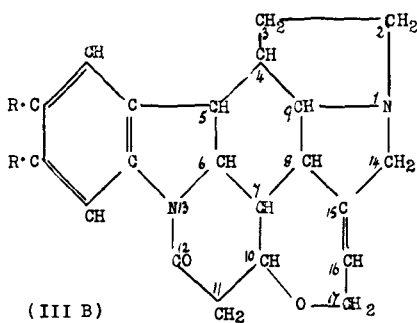

(III B)
Strychnine, R=H (Leuchs)

in such formulæ. The changes which take place in the conversion, already described (p. 572), of brucine into brucinolone and curbine are illustrated by partial formulæ (IV) to (VI) based on the Leuchs modification (IIIB), which is also used in formulæ (VII) to (IX), showing the structure and interrelationships of the Hanssen and Wieland series of acids, C_{19} , C_{17} and C_{16} , obtained by the oxidation of strychnine or brucine (p. 566). It will be observed that the chain N(a) to N(b), referred to on p. 573, the evidence

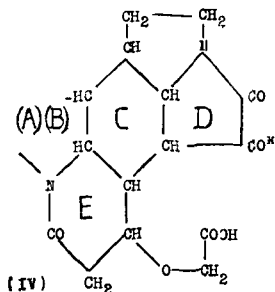

Brucinonic acid
Brucinolic acid $CO^M \rightarrow CH \cdot OH$

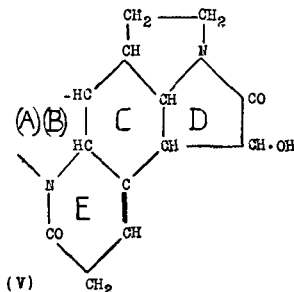

Brucinolone

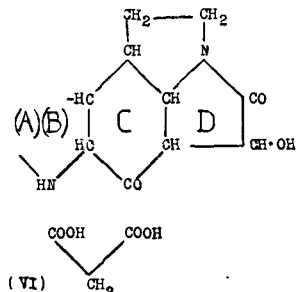

Curbine and Malonic acid

for which in strychnine and brucine was summarised by Robinson,¹ forms the branched chain of carbon atoms 10, 11, 12, 13-0-14, 15, 6, 7, 8, 9 in formula (I).

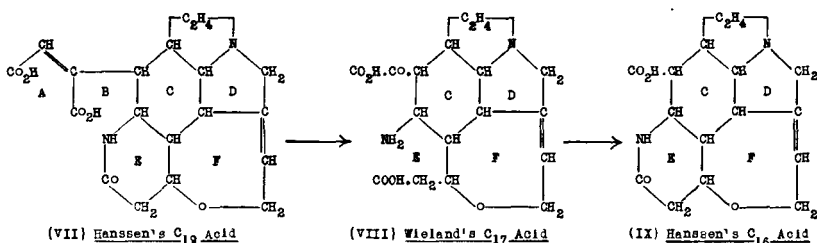

Of the reactions of strychnine and brucine which have been studied in detail since the stage of formula (I)* was reached, the most difficult and the most interesting are the attempts at Hofmann degradation.⁴⁸ When *N(b)*-alkylstrychnidinium salts are heated with an alkali hydroxide in methyl alcohol, the usual Hofmann elimination does not occur and there is formed a methoxyalkyldihydro*neo*strychnidine, which on boiling with dilute acid reconstitutes a quaternary alkyl*neo*strychnidinium salt and this, in the case of the chloride, on heating loses alkyl chloride and forms *neo*strychnidine (XI, *a* or *b*), m.p. 203–4°. In a strictly analogous manner strychnine methosulphate can be converted into *neo*strychnine,^{48(a)} and in the brucine series, *neobrucine*, m.p. 225–6°, and *neobrucidine*, m.p. 198–9°, have been prepared.⁴⁹ On catalytic hydrogenation the *neo*-bases yield the same dihydro-bases as the parent alkaloids, so that their isomerism must be due to a change in position of the ethylenic linkage of strychnine and brucine and this change is illustrated by strychnidine (X) and *neo*strychnidine, the new position of the ethylenic linkage being placed at C⁷—⁸C (XI*a*), whilst Leuchs⁵⁰ prefers to place it at C²—C⁷ (XI*b*). The arguments for (XI*a*) have been fully stated by Reynolds and Robinson.⁵¹ An important substance, needing consideration in this connection, is methoxymethyldihydro*neo*strychnine, C₂₃H₂₈O₃N₂, m.p. 141–3°, formed by the action of sodium methoxide in methyl alcohol on methylstrychnine and represented by (XII). This, when heated with dilute sulphuric acid, loses methyl alcohol and the solution, after neutralisation and addition of sodium iodide, yields methyl*neo*strychninium iodide, m.p. 325° (*dec.*), convertible by the action of silver chloride to the corresponding chloride, C₂₁H₂₂O₂N(NMe)Cl . MeOH, m.p. 289–290°, which on heating yields *neo*strychnine, C₂₁H₂₂O₂N₂, m.p. 228–9° (XIV).⁵² The latter still retains the :N(*a*)—CO—CH₂— group of strychnine, since it yields a benzylidene derivative, m.p. 158–9°. It hydrogenates catalytically with more difficulty than strychnine to the same product, dihydrostrychnine, C₂₁H₂₄O₂N₂ . 2H₂O, m.p. 220–2° (*dry*). On electrolytic reduction it yields two products, analogous, but not identical, with those afforded by strychn-

* The formulæ of strychnine and its derivatives, especially the *neo*-bases, are at present under revision (see *Addendum*, p. 582).

nine (p. 563), *viz.* *neostrychnidine* and *tetrahydroneostrychnine*, $C_{21}H_{26}O_2N_2$, m.p. 167–8°, and a third product, *hexahydrostrychnine*, $C_{21}H_{28}O_2N_2$, m.p. 197–9°, identical with that similarly obtained from *strychnine*.

On oxidation with *perbenzoic acid*, *methoxymethyl-dihydro-neostrychnine* (XII) is converted into a *keto-amide*, which has been named *methoxymethylchano-dihydrostrychnone* (XIII), $C_{23}H_{28}O_5N_2$, m.p. 198–9° (*dry*). It is neutral and therefore contains the groups: $N(a)-CO-$ and $:N(b)-CO-$ and forms a *monoxime* and a *p-nitrophenylhydrazone*.⁵³ (see also *Addendum*, p. 582). The particle *chano* is employed to denote ring-opening by a real or imaginary process of isomeric change.⁵⁴ Briggs and Robinson⁵³ point

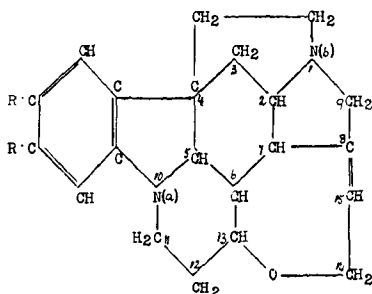

(X) *Strychnidine*. R = H
Brucidine. R = OMe

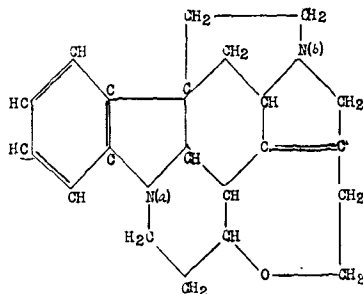

(XIa) *neostrychnidine* (Robinson)

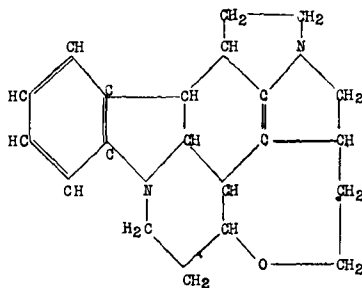

(XIb) *neostrychnidine* (Leuchs)

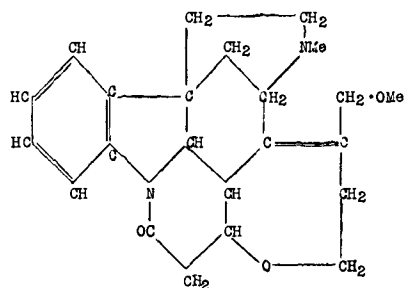

(XII) *Methoxymethyl-dihydro-neostrychnine*

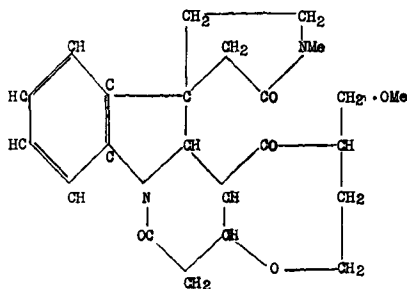

(XIII) *Methoxymethylchano-dihydrostrychnone*

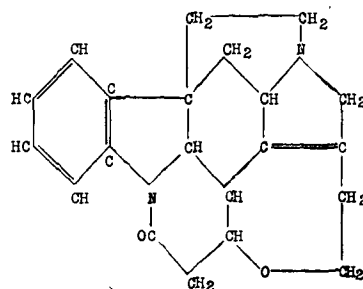

(XIV) *neostrychnine*

out that the formation of a keto-amide in this reaction confirms the occurrence of the group $\cdot \dot{C}=\dot{C}-\dot{C}H-N(b)$: in the *neo*-bases (cf. Leuchs⁵⁰). This difficulty in the application of the Hofmann process led to attempts to effect degradation by the use of the Emde method⁵⁵ on strychninium⁵⁶ and strychnidinium⁵⁷ salts. In both cases complex mixtures of products were obtained. From the mixture resulting from the action of sodium amalgam, in hot water in presence of carbon dioxide, on strychnidine methosulphate there were obtained :—

- (1) Methylstrychnidinium salts.
- (2) Methyl*neo*strychnidinium salts, due to migration of the ethylenic linkage (see p. 575).
- (3) Hydroxydihydro-N(b)-methylchanodihydroneostrychnidine- θ , $C_{22}H_{30}O_2N_2$, m.p. 235–6°, which is a hydrate of (4) and convertible into it by the action of phosphoryl chloride.
- (4) N(b)-Methylchanodihydroneostrychnidine- θ , $C_{22}H_{28}ON_2$, m.p. 142–3°, *des*-base-A identical with (b) in the next series (see below). It contains one double bond and on catalytic hydrogenation yields N(b)-methylidihydrochanodihydroneostrychnidine-A, m.p. 177°, isomeric with (5).
- (5) N(b)-Methylidihydrochanodihydrostrychnidine- θ , $C_{22}H_{30}ON_2$, m.p. 192–3°.

Finally, it was thought that the reaction might be simplified by the use of the Hofmann process on methylidihydrostrychnidinium salts and Achmatowicz and Robinson⁵⁸ started with dihydrostrychnidine-A which was converted into methylidihydrostrychnidinium-A and this used as the hydrogen carbonate or hydroxide (XVI) for thermal decomposition, which produced the following mixture of compounds :—

- (a) Dihydrostrychnidine-A, $C_{21}H_{26}ON_2$, m.p. 214–5°.
- (b) A *des*-base, $C_{22}H_{28}ON_2$, m.p. 143–4°, *des*-base-A, identical with (4) from the Emde degradation of a methylstrychnidinium salt (see above). Formula (XV) for *des*-base-A has been modified recently ; the ethylenic linkage is now placed at $C^{15}-C^8$ instead of at C^7-C^8 (see *Addendum*, p. 582).
- (c) Methoxymethyltetrahydrostrychnidine, $C_{23}H_{32}O_2N_2$, m.p. 220°, previously obtained,⁴⁸ by the electrolytic reduction of the methoxymethylidihydroneostrychnidine, which results from the digestion of strychnidine methosulphate in methyl-alcoholic potash.
- (d) Hydroxymethyltetrahydrostrychnidine hydrate, $C_{22}H_{30}O_2N_2 \cdot H_2O$, m.p. 158–9°, of which (c) is the methyl ether.
- (e) A *des*-base, $C_{22}H_{28}ON_2$, m.p. 196–7° ; anhydromethylstrychnidinium-D hydroxide or *des*-base-D.

The most interesting of these products are the two *des*-bases of which *des*-base-A is represented by (XV). The second, (e) or *des*-base-D, on

subjection to conditions for catalytic hydrogenation in acetic acid, undergoes internal alkylation and yields two isomerides, the methyl-dihydrostrychnidinium acetates, distinguished as A and D. The D-form, $C_{24}H_{32}O_3N_2$, has m.p. $307-8^\circ$, and is convertible into the iodide, $C_{22}H_{29}ON_2I \cdot H_2O$, m.p. $325-7^\circ$, and the chloride, $C_{22}H_{29}ON_2Cl \cdot H_2O$, m.p. $318-9^\circ$. The latter on digestion with sodium methoxide in methyl alcohol regenerates *des*-base-D, and on thermal decomposition produces dihydrostrychnidine-D, $C_{21}H_{26}ON_2$, m.p. $198-200^\circ$, which may be a stereoisomeride of dihydrostrychnidine-A (of which the methoxyhydroxide is represented by (XVI)) or have the structure (XVII).⁵⁹

Methyl-dihydrostrychnidinium-A acetate is produced in much smaller amount in the "hydrogenation" (internal alkylation) reaction and was isolated as the iodide, m.p. $345-350^\circ$, and converted to the chloride, which on treatment with sodium methoxide gave methoxymethyltetrahydrostrychnidine (*c* in the above list) with some *des*-base-D, and on thermal decomposition yielded dihydrostrychnidine-A. These and other reactions of *des*-base-D are regarded as best accounted for by formula (XVIII).⁴⁴

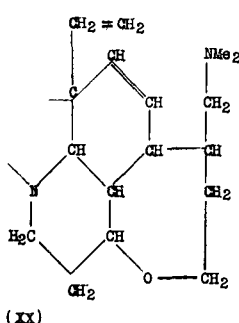
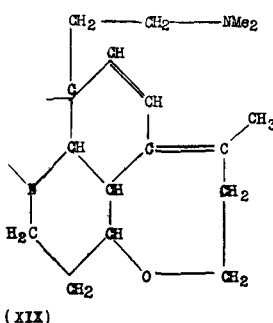
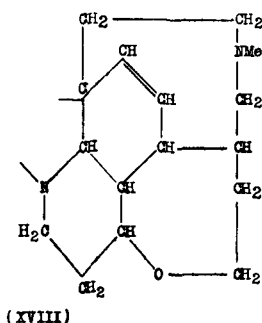
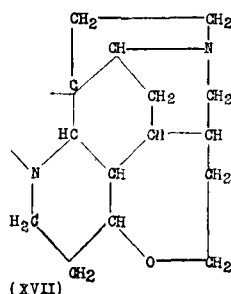
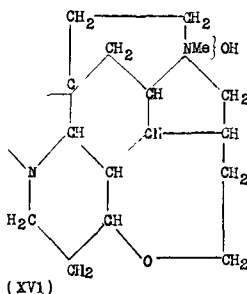
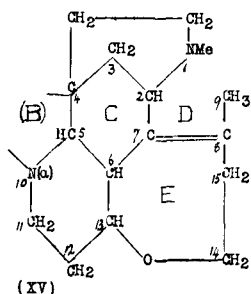

The further degradation of the two *des*-bases (items (b) and (e), p. 577) has been investigated by Achmatowicz⁶⁰ with results which are summarised in diagram A, by-products being omitted for the sake of simplicity.

Both *des*-bases yield mono- and di-metho-salts, and the latter on digestion with sodium methoxide in methyl alcohol give the better yield

DIAGRAM A

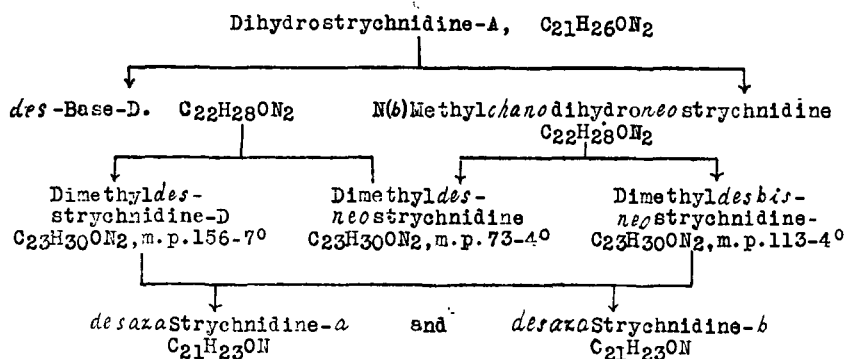

of the degradation products, the dimethyl desstrychnidines. All three of the latter contain $N(b)Me_2$ and form tetrahydro-derivatives, indicating the presence of two ethylenic linkages. Dimethyl des neostrychnidine and dimethyl des bis neostrychnidine yield the same tetrahydro-derivative on hydrogenation, indicating that at least one of the two ethylenic linkages occupies a different position in the two bases. In dimethyl des neostrychnidine one of ethylenic linkages is capable of migration since the methochloride of this base on treatment with sodium methoxide is converted into dimethyl des bis neostrychnidine, the *bis* indicating that one ethylenic linkage has undergone two migrations from the strychnidine position, i.e., from $C^{15}-C^8$ to C^7-C^2 ; the second double bond for this base is placed by Achmatowicz at C^3-C^4 , but according to Holmes and Robinson,⁴⁴ the positions of the two double bonds are not yet deducible but may form one of the following three arrangements:—

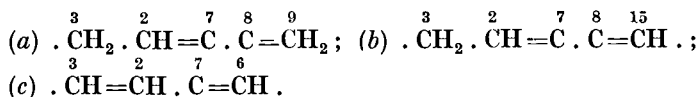

For dimethyl des neostrychnidine the Achmatowicz formula has been slightly modified to (XIX) by Holmes and Robinson. The third substance, dimethyl des strychnidine-D yields both a dihydro- and a tetrahydro-derivative and, unlike *des-base-D*, from which it is derived, does not undergo internal alkylation when subjected to the "hydrogenation" process in acid solution: it is represented by (XX).

In the final stage, when the dimethochloride of either dimethyl des bis neostrychnidine or that of dimethyl des strychnidine-D is heated with sodium methoxide in alcohol $N(b)$ is eliminated as trimethylamine and there is formed a mixture of the two *desazastrychnidines*, *a* and *b*, of which the first is amorphous but yields a crystalline methiodide, m.p. 154-5°, and the second is crystalline, m.p. 109-110°, giving a methiodide, m.p. 105-6°. Each yields a hexahydro-derivative, which may be a mixture of stereoisomerides, and the difference between the forms *a*- and *b*- is probably the result of dissimilar distribution of the three ethylenic linkages thus indi-

cated as present. Holmes and Robinson⁴⁴ give the four arrangements, *a, b, e*; *a, b, d*; *a, c, f*; and *a, c, g* (see skeletal formula XXI) as those available for the positions of the three double bonds in the two isomerides.

Briggs, Openshaw and Robinson¹ have suggested that the three ethylenic linkages are at *a, b* and *e* (see *Addendum*, p. 582).

A similar Hofmann degradation of dihydrobrucidine, ending in *desaza*-brucidine, $C_{23}H_{27}O_3N$, m.p. $133-4^\circ$, has been described.

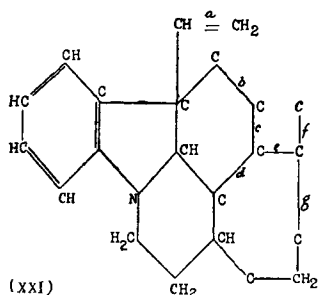

The change of strychnine to *isostrychnine* (p. 562) involves the appearance of a hydroxyl group, apparently in place of the ether-oxide linkage, and the ethylenic linkage is still present, though possibly not in the same position as in strychnine (Robinson⁶⁵). Various methods of meeting these requirements have been suggested,⁴⁶ including that of Huisgen and Wieland, based on a comparison of the action of hydrogen bromide on vomicine, strychnine and brucine as a result of which *isostrychnine* is regarded as an analogue of *isovomicine* and represented by partial formula (XXII), the changes in the conversion of strychnine to *isostrychnine* taking place in rings E and F (formula I, p. 574, cf. vomicine to *isovomicine*, p. 587). Similarly Huisgen and Wieland have shown that the scission of ring F by halogen acids to form deoxybases takes place in the same way with all three alkaloids. The deoxystrychnine, $C_{21}H_{22}ON_2$, so formed has m.p. 198° , and on ozonisation yields

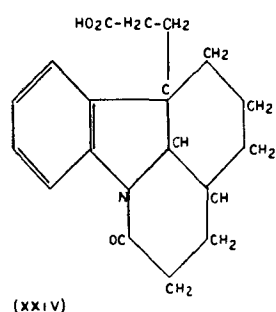
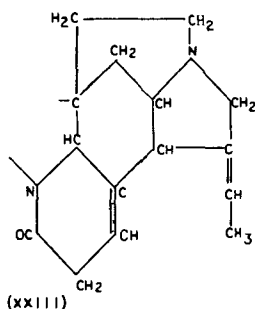
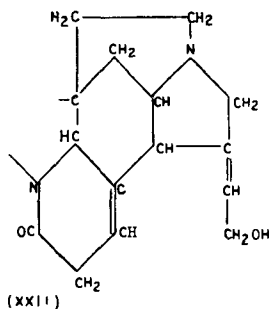

acetaldehyde. It is identical with the deoxy*isostrychnine*, m.p. $195-7^\circ$, of Leuchs and Schulte,³ obtained by the dehalogenation of bromodeoxy*isostrychnine* hydrobromide, by the action of zinc dust in acetic and hydrobromic acids, and as the analogue of deoxyvomicine may be represented by partial formula (XXIII). (Compare deoxyvomicines-(*a*) and -(*b*) (p. 590).) According to Leuchs and Schulte,³ the "deoxystrychnine" of Tafel⁷ (p. 564) is to be regarded as a tetrahydrodeoxystrychnine identical with the product, $C_{21}H_{26}ON_2$, m.p. $175-6^\circ$, obtained by the catalytic hydrogenation of either the bromodeoxy*isostrychnine* hydrobromide, or the deoxy*isostrychnine* referred to above.

A final proof that brucine is *o*-dimethoxystrychnine has been provided by Leuchs and Overberg,⁶⁵ who found that strychnidine (X) in presence of an unusually active platinum oxide catalyst can be reduced to octahydrostrychnidine, isolated as the perchlorate, $C_{21}H_{32}ON_2 \cdot 2HClO_4$, $[\alpha]_D^{20} + 16.7^\circ/d$. Brucidine in like manner can be hydrogenated to dihydrobrucidine, and then by elimination of the two methoxyl groups on further reduction yields the same octahydrostrychnidine, indicating that brucine is stereochemically identical with *o*-dimethoxystrychnine.

Clemo, Perkin and Robinson⁴⁸ have recorded the production of indole and carbazole when methylstrychnine is heated with caustic potash, and more recently a series of simple bases has been obtained by the alkaline degradation of strychnine. Of these, tryptamine (β -3-indolyethylamine), 3-ethylindole, indole and 4-methyl-3-ethylpyridine have been identified, and a fifth purified as the picrate, $C_{10}H_{11}N \cdot C_6H_3O_7N_3$, m.p. 192° , has been described by Clemo and by Siddiqui,⁶² but has not been identified.^{62(a)} Tryptamine is to be expected as the Robinson formula includes the tryptamine skeleton.⁶³

Other investigations of interest are the studies of the isomeric dihydroderivatives of brucine and strychnine and their reactions, carried out by Leuchs and his collaborators,⁶⁶ investigation of the red *o*-quinone (isolated as the perchlorate, $C_{21}H_{20}O_4N_2 \cdot HClO_4$) formed in the well-known test for brucine with nitric acid,⁶⁷ and the examination of the transformation products of oximinobrucine by Wieland *et al.*⁶⁸

The synthetical experiments started by Openshaw and Robinson⁶³ have for their immediate objective the preparation of one of the possible degradation products of strychnine, and a beginning has been made by the preparation of the lactam of hexahydrocarbazole-1:11- $\beta\beta'$ -dipropionic acid (XXIV), which reproduces a portion of the strychnine molecule as represented in Robinson's formula (IIIa, p. 574), and in sulphuric acid gives a purple colour with a trace of potassium dichromate (Otto reaction).

The same authors,⁶³ by a modification of the process of preparation, obtained a mixture of the original product, m.p. 271° ; now distinguished as isomeride-A, with a stereoisomeride, m.p. 232° (isomeride-B). The latter, like A, gives the Otto reaction and was converted *via* the hydrazide, into the lactam of 11- β -aminoethylhexahydrocarbazole-1- β -propionic acid-B, b.p. $220^\circ/0.2$ mm. (XXIV, with $\cdot CH_2 \cdot COOH \rightarrow \cdot CH_2 \cdot NH_2$), which forms a hydrogen *d*-tartrate, m.p. $201-3^\circ$, and is converted by long-continued heating with methyl iodide in methyl alcohol, into the lactam of 11- β -dimethylaminoethylhexahydrocarbazole-1- β -propionic acid-B methiodide, $C_{20}H_{29}ON_2 \cdot I \cdot H_2O$ (XXIV, with $\cdot CH_2 \cdot COOH \rightarrow \cdot CH_2 \cdot NMe_2 \cdot MeI$). This was transformed into the quaternary *d*-bromocamphorsulphonate, m.p. 265° , but no resolution has yet been effected. The lactam of 3-carboxyhexahydrocarbazole-1:11- $\beta\beta'$ -dipropionic acid (XXIV, with a carboxyl group at C³), $C_{19}H_{21}O_5N$, m.p. $257-8^\circ$, has also been prepared. The same authors, with Holmes,⁶³ have synthesised the lactam of 11-ethylhexahydrocarbazole-1- β -propionic acid, $C_{17}H_{21}ON$, m.p. $106.8-107.5^\circ$, of which (XXIV) is a carboxy-derivative.

Addendum. Few papers on the Strychnos alkaloids were published during the war, but at its close a discussion arose, mainly concerning the 5-membered ring containing N(b) in the Robinson formula (XXV). In 1945 Prelog and Szpilfogel⁶⁹ suggested for strychnine formula (XXVI), in which this ring, marked E in (XXVII), is 6- instead of 5-membered and G has 5 components in place of 6 as in (XXV). This is stated to represent a strain-free model and to have the advantage that it contains in E and G the skeleton of β -collidine and so accounts better than (XXV) for Clemo's⁶² record of this base among the products of the alkaline degradation of strychnine. In later papers the same authors⁶⁹ give the results of a chemical and spectrographic study of the degradation of dihydrostrychninone, $C_{19}H_{18}O_3N_2$, m.p. 318° , $[\alpha]_D^{25} - 49^\circ$ ($CHCl_3$), the results of which are regarded as indicating that ring E is more than 5-membered. In a comment on this formula Robinson⁷⁰ pointed out that it contains $N(b)(CH_2)_3$ and cannot provide an explanation of the properties of *pseudostrychnine* (hydroxystrychnine, p. 557). Prelog and Kocór⁶⁹ subsequently showed that *pseudostrychnine* is oxidised by permanganate to a hydroxystrychninonic acid, $C_{21}H_{20}O_7N_2$, m.p. $274-6^\circ$ (*dec.*), $[\alpha]_D^{17} - 39^\circ$ (N/10 NaHO), which supports Robinson's views as to the constitution of this alkaloid. Robinson also stated that formula (XXVI) does not afford a satisfactory basis for an explanation of the formation and transformations of methoxymethyldihydrochanostrychnone (p. 576) or of dihydrostrychnidine-D and suggested that if new evidence is found that ring E is 6-membered the formula worth serious consideration is (XXVII). A detailed comparison of formulæ (XXV) and (XXVII) was made by Briggs, Openshaw and Robinson¹ (1946), especially in regard to their explanatory possibilities.

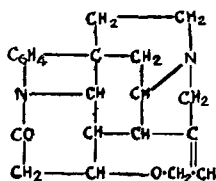

(XXV)

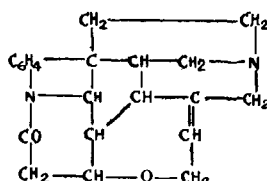

(XXVI)

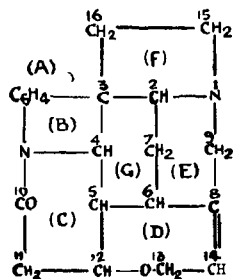

(XXVII)

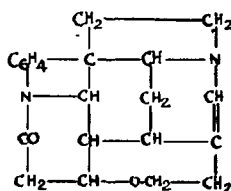

(XXVIII)

It is pointed out that experimental evidence is now available covering the whole of the strychnine molecule except the group (C₃H₄), which in the (XXV) formula is constituted by the items at C², C³ and C⁷. It is also

known that the structure includes : N(b)CH $\begin{matrix} \diagup C \\ \diagdown C \end{matrix}$ because *pseudostrychnine*

is a tertiary alcohol. These conditions limit choice among possible structures, of which six others considered, offer no advantage over (XXV) or (XXVII). Dissection of (XXVII) and of the formula for cinchonine (p. 443) into possible phyto-chemical units, on the lines suggested by Robinson ⁷¹ in 1917, discloses a close structural similarity in the two alkaloids, and this is even more striking in another strychnine formula suggested somewhat later by Robinson ⁷² but which is now regarded as unnecessary in view of further developments. Reference has already been made to the difference in opinion regarding the location of the double bond in the *neo*-bases (p. 575). It was found ¹ (1946) that these substances couple with diazonium salts in dilute aqueous acid, forming products which are neutral and appear to be arylhydrazones. The reaction was represented as follows :—

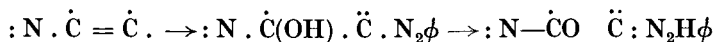

and appears to be analogous with the characteristic oxidation of the *neo*-bases to keto-amides by the addition of two oxygen atoms, as in the oxidation, described by Briggs and Robinson,⁵³ of methoxymethyldihydro-*neostrychnine* (a) to the neutral ketone, methoxymethyl*chanodihydrostrychnone* (b) in almost theoretical yield by perbenzoic acid. The two processes may be represented by partial formulæ of the units concerned thus :—

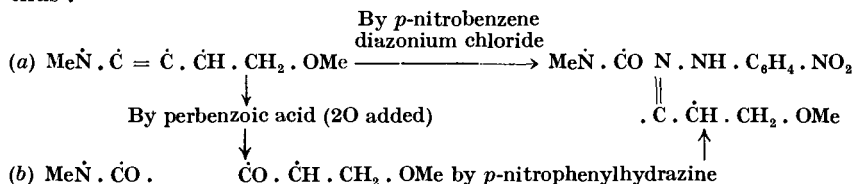

The product of the coupling of (a) with *p*-nitrobenzenediazonium chloride is identical with the *p*-nitrophenylhydrazone of (b). The oxidation of *neostrychnidine* to *strychnidone* by permanganate ⁴⁸ (1932) and of *neobrucidine* to *brucidone* ⁴⁹ (1927) are probably analogous, and it is now found that by the action of *p*-nitrobenzenediazonium chloride, *neostrychnine* is converted into *strychnone p*-nitrophenylhydrazone.

This location of the double bond in the *neo*-bases in juxtaposition to N(b) was at first considered to favour formula (XXV) rather than (XXVII) for strychnine. In (XXVII) a double bond could be inserted at C²—C⁷, C⁸—C⁹ or C¹⁵—C¹⁶, and the possibilities of each position were discussed in detail. In the meantime Chakravarti and Robinson ⁷³ found that *brucine* and *strychnine* can be converted easily into *neobrucine* and *neostrychnine*

respectively by refluxing their solutions in xylene with Raney nickel under carefully controlled conditions, and the same authors have stated in a preliminary announcement ⁷⁴ that the action of bromine on *neostrychnine* in cold acid solution converts it into oxodihydro*neostrychnine*, $C_{21}H_{22}O_3N_2$, now renamed oxodihydro*allostrychnine*, which has been recognised as an aldehyde formed by the molecular rearrangement : $N \cdot CH=C : \rightarrow : N-C(CHO) :$. This is taken to imply that the unsaturation in the *neo*-bases lies between C⁸ and C⁹ (XXVII), *i.e.*, in the change from strychnine to *neostrychnine* (XXVIII) the ethylenic linkage moves one step nearer N(*b*).

Three new papers bearing on the structure of strychnine have become available too late for inclusion in this summary of recent work. Woodward, Brehm and Nelson ⁶⁹ have compared the ultra-violet absorption spectra of strychnine and Leuchs's strychnone (p. 559) and used the results for a discussion of the relationship of the two alkaloids. Prelog and Kathriner have investigated the oxidation of strychnine, ψ -strychnine and brucine by permanganate in weakly acid solution ⁷⁵ and Bailey and Robinson ⁷⁶ from a study of the brucones have confirmed the conclusion of Woodward *et al.* that Leuchs's strychnone is a true indole derivative. Mention must also be made of a paper by Clemo and King ⁷⁷ on new reduction products of strychnine, of which a preliminary account has been published with a summary of the ensuing discussion.

REFERENCES

- (1) *Proc. Roy. Soc.*, 1931, A, 130, 431; (with BRIGGS and OPENSHAW), *J. Chem. Soc.*, 1946, 903. (2) LOEBISCH and SCHOOP, *Monats.*, 1886, 7, 83; TAFEL, *Annalen*, 1891, 264, 50; 1898, 301, 285. (3) GAL and ETARD, *Bull. Soc. chim.*, 1879, [ii], 31, 98; *cf.* TAFEL, *loc. cit.*; OXFORD, PERKIN and ROBINSON, *J. Chem. Soc.*, 1927, 2391; SIDDIQUI, *J. Ind. Chem. Soc.*, 1940, 17, 152; OESTERLIN and IMOUDSKY, *Ber.*, 1943, 76, 172, 374; LEUCHS and SCHULTE, *ibid.*, 1942, 75, 573, 1522; 1943, 76, 1038. (4) *Ber.*, 1905, 38, 2787. *J.* LEUCHS and NITSCHKE, *ibid.*, 1922, 55, 3171; OXFORD, PERKIN and ROBINSON, *J. Chem. Soc.*, 1927, 2391. (5) TAFEL, *ref.* (2), and *Ber.*, 1890, 23, 2732. (6) Compare BLOUNT, PERKIN and PLANT, *J. Chem. Soc.*, 1929, 1975. (7) TAFEL, *Annalen*, 1892, 268, 229; 1898, 301, 285; *cf.* SIDDIQUI, *Proc. Ind. Acad. Sci.*, 1940, 11, A. 268; *J. Ind. Chem. Soc.*, 1940, 17, 152, 233; (with BASHEV and ALI), *ibid.*, 1944, 21, 285. (8) SKITA and FRANCK, *Ber.*, 1911, 44, 2862; CLEMO, PERKIN and ROBINSON, *J. Chem. Soc.*, 1927, 1589; OXFORD, PERKIN and ROBINSON, *ibid.*, p. 2389; LEUCHS, *Ber.*, 1944, 77, 675. (9) PERKIN and ROBINSON, *ibid.*, 1929, 964; CLEMO and RAPER, *ibid.*, 1946, 891. (10) *Ber.*, 1881, 14, 773. (11) *J. Chem. Soc.*, 1885, 47, 139. (12) *Ibid.*, 1930, 842. (13) MINUNNI and ORTOLEVA, *Gazzetta*, 1900, 30, 1, 39. (14) LEUCHS *et al.*, *Ber.*, 1908, 41, 4393; 1909, 42, 2681; 1912, 45, 3686. *Cf.* STOEHR, *ibid.*, 1885, 18, 3430 and LOEBISCH and SCHOOP, *Monats.*, 1885, 6, 844. (15) See, for example, CLEMO, PERKIN and ROBINSON, *J. Chem. Soc.*, 1927, 1597. (16) *Ber.*, 1884, 17, 2266, 2849; 1885, 18, 777, 1917. (17) OESTERLIN, *ibid.*, 1943, 76, 224, 574. (18) *Annalen*, 1854, 91, 76. (19) *Ibid.*, 1899, 304, 24; *cf.* CLAUS (with RÖHRE), *Ber.*, 1881, 14, 765; with GLASSNER, *ibid.*, 773. (20) *Ibid.*, 1918, 51, 1375; 1922, 55, 724; 1929, 62, 1929; (with F. LEUCHS), 1910, 43, 1042; (with ANDERSON), 1911, 44, 2136, 3040; (with OSTERBERG and KAEHRN), 1922, 55, 564; (with HEMPEL), 1923, 56, 1775. (21) *Ibid.*, 1887, 20, 451. (22) *Ibid.*, 1922, 55, 2403. For further work on this reaction and on the C₁₉ acid see LEUCHS, *ibid.*, 1925, 58, 1729; 1929, 62, 1929; (with TAUBE), 1924, 57, 1092; (with BENDER and WEGENER), 1928, 61, 2849; (with HOFFMANN), 1929, 62, 1258 and 2308; 1930, 63, 439; (with KRÖHNKE), 1929, 62, 2598; (with

LOUIS), 1939, 72, 490. (23) *Annalen*, 1929, 476, 280; see also WIELAND and GUMBLICH, *ibid.*, 1930, 482, 52. (24) *Ibid.*, 1929, 469, 216; 1930, 480, 89. (25) (With KRÖHNKE), *Ber.*, 1929, 62, 2176; 1930, 63, 1045; (with HOFFMANN), *ibid.*, 1929, 62, 2303 and 1930, 63, 439; (with GRUNOW), 1937, 70, 257; (with BEYER), *ibid.*, 628. (26) *Ibid.*, 1930, 63, 2215. (27) LEUCHS (with KRÖHNKE), *ibid.*, 1930, 63, 1045; 1931, 64, 455; (with OVERBERG), 1931, 64, 1007; LEUCHS, 1938, 71, 1525; (with LOUIS), 1939, 72, 2076. (28) *Annalen*, 1898, 301, 285; LEUCHS and KRÖHNKE, *Ber.*, 1929, 62, 2176; SIDDIQUI. (29) Compare ASHLEY, PERKIN and ROBINSON, *J. Chem. Soc.*, 1930, 382; FAWCETT, PERKIN and ROBINSON, *ibid.*, 1928, 3082. (30) *Ibid.*, 1930, 830. (31) *Ibid.*, 1931, 773. (32) *Ibid.*, 1932, 780. (33) *Ibid.*, 1933, 486. (34) *Ber.*, 1930, 63, 2997; cf. LEUCHS, *ibid.*, 1931, 64, 461; LIONS, PERKIN and ROBINSON, *J. Chem. Soc.*, 1925, 127, 1158. (35) See, for example, CLEMO, PERKIN and ROBINSON, *ibid.*, 1927, 1625. (36) *Ber.*, 1908, 41, 1711; (with SCHNEIDER), 1909, 42, 2494; (with REICH), 1910, 43, 2417; (with DIELS), 1936, 69, 47; HOLMES, OPENSHAW and ROBINSON, *J. Chem. Soc.*, 1946, 908; PRELOG and SZPILFOGEL, *Helv. Chim. Acta*, 1945, 28, 1669; (with BATTEGAY), *ibid.*, 1947, 30, 366. (37) LEUCHS (with SCHNEIDER), *Ber.*, 1909, 42, 2494; (with REICH), 1910, 43, 2417; (with SCHWAEBEL), 1914, 47, 1552; 1915, 48, 1009; (with BENDIXSOHN), 1919, 52, 1442; (with NITSCHKE), 1922, 55, 3738; (with DIELS and DORNOV), 1935, 68, 106; cf. KOTAKE and MITSUWA, *Bull. Chem. Soc. Jap.*, 1936, 11, 231; *J. Chem. Soc. Jap.*, 1938, 59, 146; LEUCHS, *Ber.*, 1937, 70, 2031. (38) LEUCHS, *Ber.*, 1908, 41, 1711; 1938, 71, 2237; (with WEBER), 1909, 42, 770, 3703; (with BREWSTER), 1912, 45, 201; (with PEIRCE), 1912, 45, 2653, 3412; (with RAUCH), 1914, 47, 370; (with HELLRIEGEL and HEERING), 1921, 54, 2177; (with GLADKORN), 1923, 56, 1780; (with BAUR), 1932, 65, 1230; (with DORNOV), 1935, 68, 1785. (39) Cf. LEUCHS, *ibid.*, 1932, 65, 1230. (40) LEUCHS (with BREWSTER), *ibid.*, 1912, 45, 201; (with PEIRCE), 1912, 45, 2653; (with RAUCH), 1914, 47, 370; (with GLADKORN and HELLRIEGEL), 1923, 56, 2472; (with DORNOV), 1935, 68, 1785. (41) (With SCHWAEBEL), *ibid.*, 1914, 47, 1552; 1915, 48, 1009; (with NITSCHKE), 1922, 55, 3738; (with DIELS and DORNOV), 1935, 68, 106. (42) *J. Chem. Soc.*, 1910, 97, 309. (43) FAWCETT, PERKIN and ROBINSON, *ibid.*, 1928, 3082; PERKIN and ROBINSON, *ibid.*, 1929, 964; MENON, PERKIN and ROBINSON, *ibid.*, 1930, 830; ROBINSON, *Proc. Roy. Soc.*, 1931, A, 130, 431; MENON and ROBINSON, *J. Chem. Soc.*, 1931, 773; ACHMATOWICZ, PERKIN and ROBINSON, *ibid.*, 1932, 486. See also, especially for isostrychnine, OLIVERI-MANDALA (and COMELLA), *Gazzetta*, 1923, 53, 619; 1924, 54, 516; CIUSA (with SCAGLIARINI), 1924, 54, 202; 1928, 58, 774. (44) MENON and ROBINSON, *J. Chem. Soc.*, 1932, 780; HOLMES and ROBINSON, *ibid.*, 1939, 603; cf. LEUCHS, *Ber.*, 1939, 72, 1588. (45) *Ber.*, 1932, 65, 1230; (with GRUNOW), 1939, 72, 679; (a) (with KRÖHNKE), 1930, 63, 1045; (with WEGENER), *ibid.*, 2215; (with OVERBERG), *ibid.*, 1931, 64, 1007. (46) BLOUNT and ROBINSON, *J. Chem. Soc.*, 1932, 2305; cf. KOTAKE and MITSUWA, *Annalen*, 1933, 505, 203; *Sci. Papers Inst. Phys. Chem. Res. Tokyo*, 1934, 24, 119, with reply by ROBINSON, *J. Chem. Soc.*, 1934, 1490. (47) *Ann. Rev. Biochem.*, 1933, 2, 447; (with ACHMATOWICZ), *J. Chem. Soc.*, 1934, 582; (with REYNOLDS), 1934, 592; 1935, 935. (48) PERKIN and ROBINSON (with CLEMO), *ibid.*, 1927, 1589; (with ACHMATOWICZ), 1932, 486; (a) (with ACHMATOWICZ and CLEMO), 1932, 767. (49) (With GULLAND), *ibid.*, 1927, 1627; (with ACHMATOWICZ), 1932, 775. (50) (With BEYER), *Ber.*, 1935, 68, 292; cf. KOTAKE and YOKOYAMA, *Sci. Papers, Inst. Phys. Chem. Res. Tokyo*, 1937, 31, 321. (51) *J. Chem. Soc.*, 1935, 936. (52) PERKIN, ROBINSON, ACHMATOWICZ and CLEMO, *ibid.*, 1932, 767; see also ref. (73). (53) BRIGGS and ROBINSON, *ibid.*, 1934, 590. (54) BLOUNT and ROBINSON, *ibid.*, 1932, 2306. (55) *Annalen*, 1912, 391, 88. (56) PERKIN, ROBINSON and SMITH, *J. Chem. Soc.*, 1932, 1239. (57) *Idem, ibid.*, 1934, 574; see also ref. (44). (58) *Ibid.*, 1934, 581. (59) *Idem, ibid.*, 1938, 1467. (60) *Ibid.*, 1938, 1472; (with DYBOWSKI), p. 1483. (61) ACHMATOWICZ, LEWI and ROBINSON, *ibid.*, 1935, 1685; ACHMATOWICZ and DYBOWSKI, *ibid.*, 1938, 1488. (62) KOTAKE, *Proc. Imp. Acad. Tokyo*, 1936, 12, 99; (with MORI and MITSUWA), *Sci. Papers Inst. Phys. Chem. Res. Tokyo*, 1937, 31, 129; CLEMO, *J. Chem. Soc.* 1936, 1695; (with METCALFE), *ibid.*, 1937, 1518; SIDDIQUI, *J. Ind. Chem. Soc.*, 1930, 16, 396; PRELOG and METZLER, *Helv. Chim. Acta*, 1946, 29, 1168. (63) OPENSHAW and ROBINSON, *J. Chem. Soc.*, 1937, 942; 1946, 912; (with HOLMES), 1946, 910; see also LIONS,

Proc. Roy. Soc., N.S.W., 1938, **71**, 192. (64) ROBINSON, *Ann. Rev. Biochem.*, 1933, **2**, 447; see also ref. (3) and WIELAND (with JENNEN), *Annalen*, 1940, **545**, 99; (with THIEL), *ibid.*, 1942, **550**, 287; (with HUISGEN), *ibid.*, 1943, **555**, 9. (65) *Ber.*, 1933, **66**, 951. (66) (With DORNOV), *ibid.*, 1935, **68**, 2234; 1936, **69**, 1838; (with HÖHNE), *ibid.*, p. 2525; (with GRUNOW), 1937, **70**, 257; (with BEYER), *ibid.*, p. 629; (with STEINBORN), 1938, **71**, 1577. (67) LEUCHS, SEEGER and JAEGER, *ibid.*, 1938, **71**, 2023. (68) (With MAHLERWEIN), *Annalen*, 1937, **527**, 141; (with WILLE), *ibid.*, 1937, **531**, 268. (69) *Experientia*, 1945, **1**, 197; *Helv. Chem. Acta*, 1945, **28**, 1669; (with KOCOR), *ibid.*, 1947, **30**, 359; 1948, **31**, 237; see also WOODWARD, BREHM and NELSON, *J. Amer. Chem. Soc.*, 1947, **69**, 2250. (70) *Experientia*, 1946, **2**, 28; *Nature*, 1946, **157**, 438. (71) *J. Chem. Soc.*, 1917, **111**, 885. (72) *Nature*, 1947, **159**, 263. (73) CHAKRAVARTI and ROBINSON, *J. Chem. Soc.*, 1947, **78**. (74) *Nature*, 1947, **160**, 18; see also *Chem. and Ind.*, 1946, 264. For full paper see ROBINSON, PAUSACKER and CHAKRAVARTI, *J. Chem. Soc.*, 1947, 1554. (75) *Helv. Chim. Acta*, 1948, **31**, 505. (76) *Nature*, 1948, **161**, 433. (77) *Chem. and Ind.*, 1948, 156.

Vomicine,* $C_{22}H_{24}O_4N_2$.¹ This alkaloid, obtained from residues of strychnine manufacture, forms colourless needles from 80 per cent. alcohol, or hexagonal prisms from acetone, has m.p. 282°, $[\alpha]_D^{25} + 80.4^\circ$ (EtOH), is a weak, monoacidic base giving salts which are acid in reaction. The hydrochloride, B. HCl . 3H₂O, has m.p. 245° (*dec.*), and, like the hydrobromide, hydriodide, sulphate and nitrate, is sparingly soluble in water. The acetyl derivative has m.p. 204–5° (Part XXVII). A dihydro-derivative, m.p. 290°, is formed by catalytic hydrogenation. The alkaloid gives a stable red colour with chromic acid in sulphuric acid, and with nitric acid a brown to orange-yellow tint develops slowly. Boiled with potassium hydroxide in methyl alcohol an intensely green colour is produced, which, on careful addition of hydrochloric acid, followed by a few drops of ferric chloride solution, changes to amethyst (Part VI). It contains no methoxyl, or methylenedioxy-group, and does not react with carbonyl group reagents. It has one replaceable hydrogen (Part XII), probably as a tertiary hydroxyl group,² contains an aromatic ring, since it can be brominated and nitrated (Part X), resembles strychnine and brucine in furnishing an *isonitroso*-derivative and a benzylidene derivative (yellow, triangular leaflets, m.p. 280° (*dec.*)), indicating the presence of a reactive methylene group. It does not react with methyl iodide, but yields an addition product with methyl sulphate which, on crystallisation from hot water, loses 1 mol. of methyl alcohol and forms vomicine methosulphate, m.p. 272° (Parts I and XXII).

CONSTITUTION. The fact that vomicine occurs naturally with strychnine suggests probable similarity of structure, and this is borne out by the parallelism of the reactions and derivatives of the two alkaloids, vomicinic acid, deoxyvomicine and vomicidine, for example, being formed in the same way and being analogous with the strychnine derivatives, strychninic acid, deoxystrychnine and strychnidine respectively. The two nitrogen atoms, like those of strychnine, are distinguished as N(*a*) (lactam nitrogen) and N(*b*) (basic nitrogen). As evidence for the structure of strychnine has been given already, the discussion of the constitution of vomicine is

* See note under reference (1).

mostly concerned with the differences between the two alkaloids and comparison of their analogous derivatives, and for this purpose it is convenient to have at this stage the formula for (I) vomicine and partial formulæ for (II) *isovomicine* and (III) *deoxyvomicine*, on which most of the results of experimental work have been explained. It should however be noted that a new formula for vomicine has been developed recently and is briefly referred to in an addendum (p. 595). Two points should be noted about the :N(CH₂)₂O group: (1) it is said to be the source

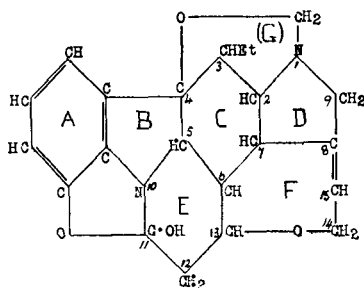

(I) Vomicine (Wieland) 1937

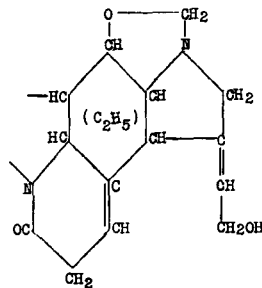

(II) *isovomicine* (1943)

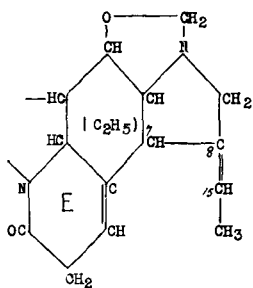

(III) *Deoxyvomicine-(b)*

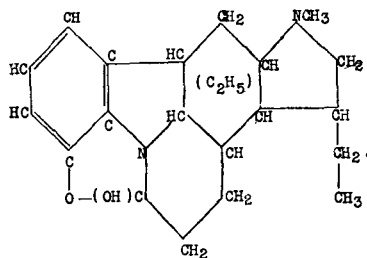

(IV) Base C₂₂H₃₀O₂N₂ (1943)

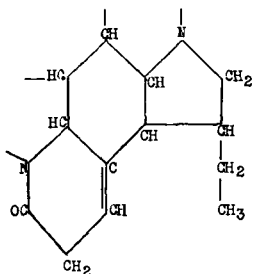

(V) Dihydrodeoxyvomicine

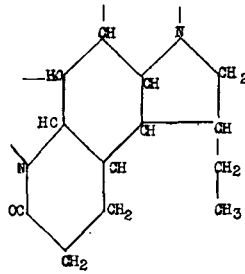

(VI) Tetrahydrodeoxyvomicine

of the molecule of methyl iodide formed when vomicine is subjected to a methylimino determination; (2) the position of the second terminal of the :N(CH₂)₂O— chain is at C⁴ in (I) and at C³ in (II) and (III). Since

1937 (the date of formula I) this terminal has also been placed at C⁵ and C⁷ (Part XXVII). Similarly the ethyl group shown at C³ in formula I has also been placed more recently at C⁴ (Part XXVII).

isoVomicine, C₂₂H₂₄O₄N₂ (Parts XXV and XXVII). When vomicine is boiled with hydrogen bromide and phosphorus in acetic acid, a reversible reaction, vomicine \rightleftharpoons *isovomicine* occurs. *isoVomicine* has m.p. 256° and $[\alpha]_D + 260.3^\circ$ (CHCl₃): it contains two hydroxyl groups and forms a mono- and a di-acetyl derivative, melting at 191–2° and 173° respectively; the lactam group is still present. On catalytic hydrogenation, *isovomicine*, unlike vomicine, does not yield simply a dihydro-derivative, but gives a mixture of products including a base, C₂₂H₃₀O₂N₂, (IV), m.p. 210°, also obtained by the hydrogenation of deoxyvomicine (Parts I and XV). In the formation of deoxyvomicine (*see below*) by the action of hydriodic acid and phosphorus in acetic acid on vomicine, there is simultaneously obtained an iodo-compound, C₂₂H₂₅O₃N₂I, m.p. 223° (*dec.*), (Part XXIII), which is also produced when *isovomicine* is subjected to this reaction, though in this case no deoxyvomicine is formed directly, but is obtained by the action of zinc dust and acetic acid on the mother liquors from which the iodo-compound has separated. If in place of hydrogen iodide and phosphorus in acetic acid there is used for this reaction potassium iodide, phosphorus and phosphoric acid,² *isovomicine* gives a 20 per cent. yield of the colourless variety of deoxyvomicine, while vomicine, which gave a 60 per cent. yield of yellow deoxyvomicine under the former conditions, now produces a new isomeride, *neodeoxyvomicine* (p. 591). No well-defined product has been obtained by the oxidation of *isovomicine* with chromic acid. On electrolytic reduction it furnishes *isovomicidine*, C₂₂H₂₆O₃N₂, as a faintly pink, crystalline powder, m.p. 290° (*dec.*). On the basis of these results and its relationship to deoxyvomicine (III), formula (II) was assigned to *isovomicine* and (IV) to the base, C₂₂H₃₀O₂N₂, as a reduction product of both *isovomicine* and deoxyvomicine (Part XXIX).

Vomicinic Acid, C₂₂H₂₆O₅N₂. Vomicine, like strychnine, contains a lactam group, and, on hydrolysis by potassium hydroxide in methyl alcohol, yields vomicinic acid, which, in presence of alkali, autoxidises rapidly, but can be isolated if the hydrolysis is conducted in an atmosphere of nitrogen. The acid crystallises from dilute alcohol (20 per cent.) in colourless needles, sinters at 164° and melts at 282°; the latter is the melting-point of vomicine, which is no doubt re-formed from the acid by loss of water. The acid yields a nitrosoamine, orange-yellow prisms, m.p. 190° (*dec.*). Vomicinic acid furnishes dyes when treated with oxidising agents in presence of dilute acid. This explains the ferric chloride colour reaction referred to above, and all vomicine derivatives retaining the lactam group give a colour reaction of this type when the lactam group is opened and the product subjected to oxidation in acid; bromovomicine and bromodihydrovomicine are exceptional, the formation of a dye in these cases being inhibited by the *p*-orientation of the substituent bromine atom in relation to the —NH— group (Part VI). Vomicinic acid cannot

be esterified by ordinary methods, but yields the following series of products on treatment with methyl iodide (Part VII) :—

(1) *N(a)*-Methylvomicinic acid, $C_{21}H_{24}O_3N(\cdot COOH)(: N(a)CH_3)$, m.p. 255° (*dec.*), $[\alpha]_D^{20} + 20.7^\circ$ (EtOH), and its methyl ester, m.p. 266° (*dec.*), $[\alpha]_D^{20} + 38.6^\circ$ (EtOH).

(2) *O* : *N(a)*-Dimethylvomicinic acid,

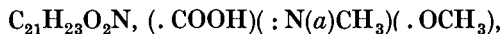

m.p. $242-4^\circ$ (with loss of water at 170°), $[\alpha]_D^{25} + 48.4^\circ$, and its methyl ester, m.p. $214-6^\circ$, $[\alpha]_D^{20} + 61.7^\circ$ (EtOH).

(3) $C_{21}H_{23}O_2(\cdot CO \cdot O)(: N(a)CH_3)(\cdot OCH_3)(: N(b)CH_3)$. This *betaine* results when *O* : *N(a)*-dimethylvomicinic acid methyl ester methiodide, m.p. 210° , is converted by silver oxide into the quaternary methohydroxide and the latter is heated, a molecule of methyl alcohol being lost. It has m.p. $195-8^\circ$, $[\alpha]_D + 14.2^\circ$ (EtOH) and gives a methiodide, which with silver oxide regenerates the betaine. The most interesting feature of this series of compounds is the appearance of a methoxyl group in *O* : *N*-dimethylvomicinic acid ; this, it is assumed, is due to the methylation of a phenolic hydroxyl group and is taken to indicate the existence of a benzoxazoline group in vomicine, scission occurring in the conversion of the base into vomicinic acid (*see* partial formulæ below). Methyl *O* : *N*-dimethylvomicinate can be hydrogenated to the dihydro-base, $C_{25}H_{34}O_5N_2$, prisms, m.p. $183-5^\circ$, and therefore contains the ethylenic linkage characteristic of the Strychnos alkaloids.

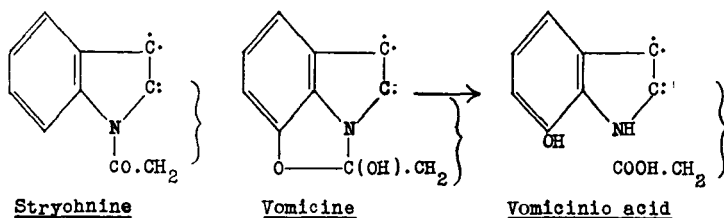

*iso*Vomicine and the proximate derivatives of vomicine, still containing the lactam group, yield, on alkaline hydrolysis, analogues of vomicinic acid, which in some cases are assumed to be formed, as the preparations give the characteristic vomicinic acid colour reaction ; *see*, for example, alkaline hydrolysis of *isovomicine* and *neodeoxyvomicine* (Part XXVII).

REDUCTION PRODUCTS OF VOMICINE. The following list includes the principal types of substances formed by the action of various reducing agents on vomicine directly, or at one or two removes. They range in degree of structural change from the simple dihydro-derivative to the base, $C_{22}H_{30}O_2N_2$ (formula IV), in which both oxido-rings have been opened and reduced to residues and the original ethylenic linkage of vomicine has been saturated, though the special lactam group of vomicine is taken as still intact.

Vomicine, $C_{22}H_{24}O_4N_2$.
 Deoxyvomicine, $C_{22}H_{24}O_3N_2$.
 Dihydrovomicine, $C_{22}H_{26}O_4N_2$.
 Dihydrodeoxyvomicine, $C_{22}H_{26}O_3N_2$.
 Iododihydrodeoxyvomicine, $C_{22}H_{25}O_3N_2I$.
 Vomicidine, $C_{22}H_{26}O_3N_2$.
 Dihydrovomicidine, $C_{22}H_{28}O_3N_2$.
 Base, $C_{22}H_{30}O_2N_2$.

Deoxyvomicines, $C_{22}H_{24}O_3N_2$ (Ref. 1, Parts I, XXVII, XXIX). Three isomerides are known, which may for convenience of reference and description be distinguished as (a), (b) and (c), though (a) is usually called "yellow," (b) is spoken of as "colourless," and (c) is named *neodeoxyvomicine*. Deoxyvomicine-(a), or the yellow isomeride, is formed by the action of hydrogen iodide and phosphorus in acetic acid on vomicine (I). It has m.p. 211° , $[\alpha]_D^{22^\circ} + 242^\circ$ ($CHCl_3$), still contains the lactam group of vomicine and two ethylenic linkages. In a variety of ways, *e.g.*, by distillation *in vacuo*, or prolonged boiling in solvents, it is transformed into deoxyvomicine-(b), the colourless form, which has m.p. 207° and $[\alpha]_D^{20^\circ} + 209^\circ$ ($CHCl_3$). Both isomerides on catalytic hydrogenation produce a mixture of hydro-derivatives of which one component, a base, $C_{22}H_{30}O_2N_2$, m.p. 211° , $[\alpha]_D^{21^\circ} + 73^\circ$ ($CHCl_3$), is common to both (Part XIV). This base, represented by (IV), is also produced by the hydrogenation of *isovomicine* (II). On ozonisation both deoxyvomicines yield acetaldehyde, but this is produced more quickly and in larger quantity from the (b)- than the (a)-form. The second ethylenic linkage in ring E (formula III) is placed in the $\beta\gamma$ -position to the $-CO-$ group because deoxyvomicine-(b) contains a reactive methylene group giving a benzylidene derivative, m.p. $198-9^\circ$. Under the experimental conditions used for this reaction deoxyvomicine-(a) isomerises to the (b)-form and so gives the same derivative.

Both deoxyvomicines combine with hydrogen iodide to form iododihydrodeoxyvomicines, $C_{22}H_{25}O_3N_2I$. That from deoxyvomicine-(a) is identical with the by-product formed in the conversion of vomicine into deoxyvomicine-(a) by the action of hydriodic acid: it can only be isolated as the hydriodide, $C_{22}H_{25}O_3N_2I \cdot HI \cdot H_2O$, m.p. 214° (*dec.*), and all attempts to isolate the free *iodo*-base result in de-iodination and the formation of deoxyvomicine-(a). Reduction of this hydriodide, under special conditions, by zinc dust in cold hydriodic acid, provides dihydrodeoxyvomicine-II, $C_{22}H_{26}O_3N_2$, m.p. 168° , $[\alpha]_D^{20^\circ} + 345^\circ$ ($CHCl_3$), giving a hydrochloride, m.p. 235° (*dec.*). The iododihydro-base resulting from the addition of hydrogen iodide to deoxyvomicine-(b) is identical with the product of the action of hydriodic acid on *isovomicine*; it has m.p. 220° and is also the iodine analogue of the bromodihydrodeoxyvomicine, $C_{22}H_{25}O_3N_2Br$, m.p. 243° (*dec.*), obtained by the action of hydrogen bromide on dihydrovomicine (Part XXV). Both the iodo- and bromo-compounds can be dehalogenated by reduction and yield the same dihydrodeoxyvomicine-I, $C_{22}H_{26}O_3N_2$, m.p. 209° , $[\alpha]_D^{22^\circ} + 243^\circ$ ($CHCl_3$). This gives a benzylidene

derivative, m.p. 222°, and on catalytic hydrogenation forms two tetrahydrodeoxyvomocines, $C_{22}H_{28}O_3N_2$, A and B. Of these A has m.p. 246–7°, and $[\alpha]_D^{21} + 210^\circ$ ($CHCl_3$), gives a methiodide, m.p. 222° (*dec.*), and a colourless, benzylidene derivative, m.p. 247°, and can be electrolytically reduced to tetrahydrodeoxyvomocidine-A, $C_{22}H_{30}O_2N_2$, m.p. 250–1° (*dec.*).

The B-isomeride has m.p. 185–6° and $[\alpha]_D + 270^\circ$ ($CHCl_3$) and is reduced electrolytically to tetrahydrodeoxyvomocidine-B, m.p. $\sim 200^\circ$.

In considering these interrelationships with reference to formulæ (I to III) it should be remembered, as already pointed out, the second terminal of the $-O-CH_2-$ group is not necessarily at C^4 as shown in (I) or at C^3 as in (II) and (III), and similarly the location of the C_2H_5 group shown at C^3 in (I) is doubtful. In the action of hydrogen iodide on vomicine (I) ring F appears to be opened with the formation of a hydroxyl group at C^{14} and an ethylenic linkage at C^6-C^{13} , as in *isovomicine* (II). Under more drastic conditions, hydrogen iodide is added at the ethylenic linkage, C^8-C^{15} , resulting in the formation of the two iododihydrodeoxyvomocines, which are regarded as epimerides about C^8 . The loss of hydrogen iodide from these may occur in the direction C^8 to C^7 , believed to give rise to deoxyvomicine-(a), or C^8 to C^{15} to form deoxyvomicine-(b) (formula III); the deoxyvomocines are therefore to be regarded as derivatives of *isovomicine*. The two dihydrodeoxyvomocines (V) are also regarded as epimerides while the two tetrahydrodeoxyvomocines (VI) originating from a single dihydrodeoxyvomocine-I are believed to owe their isomerism to *cis* and *trans* arrangements about the junction of the *homo-* and *hetero-*cyclic rings (Part XXIX). Tetrahydrodeoxyvomocidine, the final stage in this series of reactions, differs from the tetrahydrodeoxyvomocines (VI) by the replacement of the lactam $-CO-$ by $-CH_2-$.

*neo*Deoxyvomocine, the third isomeride, is produced when vomicine is heated under reflux with potassium iodide and phosphoric acid in presence of phosphorus. It crystallises from alcohol in prisms, m.p. 312° (*dec.*), retains the lactam group and the ethylenic linkage of vomicine and gives a dihydro-derivative, m.p. 321°, but cannot be acetylated.

Vomicidine, $C_{22}H_{26}O_3N_2$, obtained by the electrolytic reduction of vomicine, crystallises from alcohol in needles or plates, m.p. 284° (*dec.*), yields an acetyl derivative, m.p. 229–230° (*dec.*), and a benzoyl derivative, m.p. 208–9°, and gives a blue-violet colour with oxidising agents in acid solution. It is a phenolic base (Part VIII), and good yields of the *methyl ether* (needles, m.p. 295° (*dec.*)) are obtained by the use of methyl iodide or sulphate in presence of alkali in at atmosphere of nitrogen. *Vomicidine* itself or the methyl ether, on heating with methyl iodide in alcohol, yields the methyl ether methiodide (m.p. $> 300^\circ$, with sintering at 280°). With methyl iodide in a sealed tube at 100° *vomicidine* gives a dimethiodide, and this, on treatment with diazomethane, is converted to the phenolbetaine, $C_{23}H_{28}O_3N_2$, which melts at 246° and then solidifies, being converted into *vomicidine methyl ether*. The phenolbetaine with hydriodic acid yields *vomicidine-N(a)* methiodide hydriodide, and this with diazomethane yields the corresponding methyl ether methiodide. *Vomicidine* no longer

contains the lactam group, but it still retains the ethylenic linkage, and on hydrogenation yields some dihydrovomocidine, m.p. 296–8°, which is best prepared by electrolytic reduction of dihydrovomocine.

The conversion of vomocine to vomocidine is analogous with the reduction of strychnine to strychnidine, with the difference that the oxazoline ring in vomocine is opened with the formation of a phenolic hydroxyl group. The nitrogen atom (*a*) thereby becomes basic and vomocidine, like strychnidine and brucidine, is readily oxidised to dyes; thus it and the derivatives described above, except the phenolbetaine and the dimethiodide, give blue-violet colours on addition of ferric chloride to their solutions in dilute acid (Part XIV). Vomocidine and the derivatives described above may be represented by the following partial formulæ:—

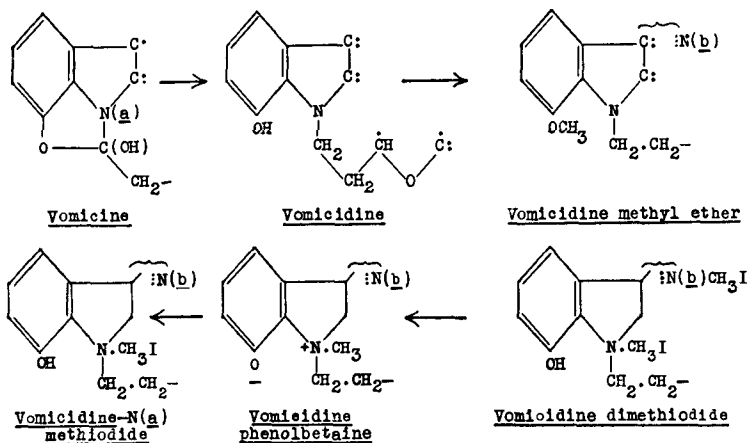

Analogues of vomocidine are produced by the electrolytic reduction of proximate derivatives of vomocine, still containing the lactam group, e.g., *iso*Vomocine, $\text{C}_{22}\text{H}_{24}\text{O}_4\text{N}_2 \rightarrow$ *isovomocidine*, $\text{C}_{22}\text{H}_{26}\text{O}_3\text{N}_2$, m.p. 290° (*dec.*) (Part XXVII).

oxyvomocine, $\text{C}_{22}\text{H}_{24}\text{O}_3\text{N}_2 \rightarrow$ deoxyvomocidine, $\text{C}_{22}\text{H}_{26}\text{O}_2\text{N}_2$, (amorph.) B. MeI. $2\text{H}_2\text{O}$, m.p. 175° (Part XXIII).

Dihydrodeoxyvomocine, $\text{C}_{22}\text{H}_{26}\text{O}_3\text{N}_2 \rightarrow$ dihydrodeoxyvomocidine, $\text{C}_{22}\text{H}_{28}\text{O}_2\text{N}_2$, m.p. 264° (*dec.*) (Part XXIV).

Exhaustive Methylation. (Parts I, XXII, XXVIII.) This process applied to vomocine has developed difficulties like those met with in the case of strychnine (p. 575). The Emde process used with vomocine metho-sulphate, $\text{C}_{22}\text{H}_{24}\text{O}_4\text{N}_2 \cdot \text{MeHSO}_4$, m.p. 272° (*dec.*), produced two methyl-vomocines, I and II, $\text{C}_{23}\text{H}_{28}\text{O}_4\text{N}_2$.

I has m.p. 232.5°, $[\alpha]_D + 156.5^\circ$; B. MeI, m.p. 244–5°.

II has m.p. 240.0°, $[\alpha]_D + 126.0^\circ$; B. MeI, m.p. 206° (*dec.*).

Each contains a methoxyl and a methylimino group and gives a dihydro-derivative. The chief difference between them seems to be that although each can be demethylated by heating with hydrobromic acid, (I) yields

the hydroxy-derivative, $C_{22}H_{26}O_4N_2$, m.p. 272° , but (II) also adds on a molecule of the halogen acid to give $C_{22}H_{27}O_4N_2Br$, m.p. $> 300^\circ$.

In the next stage each methylvomicine yields a dimethylvomicine, $C_{24}H_{32}O_4N_2$.

I has m.p. 92° and B. MeI, m.p. 261° .

II has m.p. 184° and B. MeI, m.p. 290° (*dec.*).

Dimethylvomicine-I methiodide with potash in methyl alcohol at $110-120^\circ$ yields some trimethylamine, but is chiefly converted into an isomeride, $C_{25}H_{35}O_4N_2I$, m.p. 278° (*dec.*). The lactam ring remains intact in both the methyl- and dimethyl-vomicines. Three of these products have been reduced electrolytically giving methylvomicidine-I, $C_{23}H_{30}O_3N_2$, m.p. 230° (*dec.*); dimethylvomicidine-I, $C_{24}H_{34}O_3N_2$, m.p. 236° (*dec.*) and dimethylvomicidine-II, m.p. 236° (*dec.*).

The changes occurring in the two stages from vomicine to dimethylvomicine are represented by the following partial formulæ. The difference between the two methylvomicines is presumed to be due to a change in position of the ethylenic linkage, which in methylvomicine-I is thought to be as in formula (III) with $CHOH \rightarrow CHOMe$ and in methylvomicine-II as in formula (II).

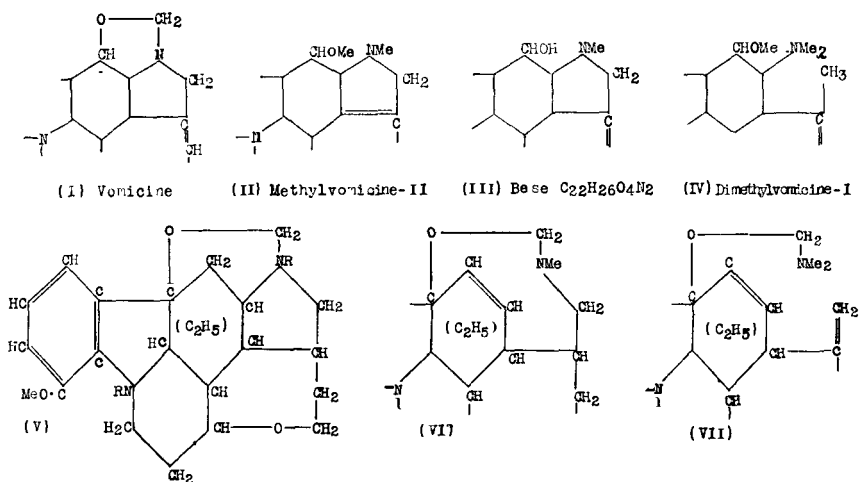

Achmatowicz and Racinski³ have also essayed a degradation of this type, starting with dihydrovomicidine, $C_{22}H_{28}O_3N_2$, and using the procedure adopted with dihydrostrychnidine (p. 577). Dihydrovomicidine dimethochloride, on treatment with potassium methoxide in methyl alcohol at 185° , gave *O*-methyl-dihydrovomicidine-A, $C_{23}H_{30}O_3N_2$, m.p. $216-7^\circ$; which contains a methoxyl but no methylimino-group. This base gives a series of quaternary salts ($V : R = MeX$) of which the dimetho-carbonate, m.p. $160-5^\circ$ (*dec.*), on heating at 230° produced *O*-methyl-*N*(*b*)-methyl-*des*-dihydrovomicidine, $C_{24}H_{32}O_3N_2$, m.p. $191-2^\circ$, which contains a methoxyl and a methylimino group and an ethylenic linkage and is

represented by partial formula (VI). On boiling with diluted sulphuric acid the substance reverts in part to *O*-methyl-dihydrovomicidine-A and is in part converted into an isomeride, *O*-methyl-dihydrovomicidine-D, m.p. 198–201°, which in structure and mode of formation is the analogue of methyl-dihydrostrychnidine-D (p. 578). The dimethocarbonate, m.p. 176–8° (*dec.*), of (VI) on heating at 230° reverts in part to (VI) but also provides some *O*-methyl-*N*(*b*)-dimethyl-desvomicidine, m.p. 121–121·5°, (VII), which can be hydrogenated to the dihydro-base, m.p. 140–1° at room temperature, while at 70° tetrahydro-*O*-methyl-*N*(*b*)-dimethyl-desvomicidine, an oil giving a methiodide, m.p. 175–8°, is formed.

Oxidation of Vomicine. On oxidation with chromic acid, vomicine yields three acids (Parts I, IX, XII and XXIII):—

(1) $C_{16}H_{20}O_3N_2 \cdot 3H_2O$, m.p. 304° (*dec.*), after sintering at 285°, acid to litmus, decolourises permanganate; absorbs 2 mols. of hydrogen in presence of platinum oxide as a catalyst.

(2) $C_{17}H_{22}O_5N_2 \cdot 3H_2O$. This, the chief oxidation product, crystallises from water in thick transparent prisms, m.p. 307–310° (*dec.*), $[\alpha]_D^{19} - 90\cdot6^\circ$ (H_2O). It decolourises permanganate and, on heating at 120°, becomes anhydrous and loses carbon dioxide, forming a base, $C_{16}H_{22}O_3N_2$, m.p. 302–310°, ($[\alpha]_D^{23} - 86\cdot2^\circ$ ($c = 0\cdot9$, H_2O)). It is alkaline to litmus and decolourises permanganate. On catalytic hydrogenation the acid, $C_{17}H_{22}O_5N_2$, is converted into the dihydro-acid, $C_{17}H_{24}O_5N_2 \cdot 4H_2O$, m.p. 264° (*dec.*), but there is formed, along with this by decarboxylation and further reduction, a base, $C_{16}H_{26}O_2N_2$, m.p. 201–2°, $[\alpha]_D^{14} + 17\cdot8^\circ$ (EtOH), which is also produced by hydrogenation of the base, $C_{16}H_{22}O_3N_2$ (*see above*). This can be distilled in a high vacuum, is relatively stable to permanganate and is strongly alkaline. It yields a monobenzoyl derivative, m.p. 158° (*dec.*), and a methiodide, which sinters at 124°, swells at 240–250° and froths at 295°. It is probable that in the conversion of the base $C_{16}H_{22}O_3N_2$ into $C_{16}H_{26}O_2N_2$, the ethylenic linkage is first saturated and then the ether-oxide ring is opened, the sequence of changes being the same as in the reduction of deoxyvomicine, $C_{22}H_{24}O_3N_2$, to the base $C_{22}H_{28}O_2N_2$ and of strychnine, $C_{21}H_{22}O_2N_2$, to deoxystrychnine, $C_{21}H_{26}ON_2$.

(3) The third acid to which the formula, $C_{17}H_{22}O_7N_2$, was first ascribed (Part I, 1929) has now been shown to have the formula, $C_{16}H_{20}O_6N_2 \cdot 5H_2O$, (Part XXIII). It has m.p. 266–8°, $[\alpha]_D^{20} - 80\cdot6^\circ$ (H_2O), and is decarboxylated at 200° to a base, $C_{15}H_{20}O_4N_2$, m.p. 264–6°, $[\alpha]_D^{18} - 51\cdot3^\circ$ ($CHCl_3$), which contains a methylimino-group and one active hydrogen and does not form a methiodide.

Oxidation of Vomicidine (Parts XVIII, XX, XXVI). The chief product of the oxidation of vomicidine by chromic acid is a dibasic acid, $C_{16}H_{24}O_7N_2 \cdot 2H_2O$, m.p. 219–220° (*dec.*), which with diazomethane gives a dimethyl ester, $C_{21}H_{28}O_7N_2$, m.p. 235–6° (*dec.*). The latter on catalytic hydrogenation absorbs three molecules of hydrogen giving a substance, $C_{21}H_{32}O_6N_2$, m.p. 136°. The C_{19} acid yields formic and oxalic acids when heated with alkali at 120° and with dilute hydrochloric acid in sealed tubes at 155° loses two molecules of carbon dioxide and one of carbon monoxide,

forming a base, $C_{16}H_{24}O_2N_2$, m.p. 146° . The acid is represented by formula (VIII) and the base by (IX): the second terminal of the :N.CH₂.O group, as already stated, is uncertain. Of the various reactions recorded for the base (Parts XVIII and XXVI) the most interesting is its dehydrogenation by palladium at 230° to *vomipyrine*, $C_{15}H_{16}N_2$, m.p. $105-6^\circ$, which gives the pyrrole reaction, yields a yellow hydrochloride, m.p. 240° , and forms a dihydro-derivative giving a hydrochloride, m.p. 221° (*dec.*). Vomipyrine was originally represented as 7:11-diethyl-5:6-pyrroloquinoline (X) but neither this, which was later named *isovomipyrine*, nor 8:11-diethyl-5:6-pyrroloquinoline proved, on synthesis, to be identical with vomipyrine. Comparison of the absorption spectra of a series of pyrroloquinolines and other tricyclic bases with that of vomipyrine, indicated that the latter is a pyrroloquinoline though the location of its substituents was still uncertain (Part XXI). Robinson and Stephen⁴ have now shown that vomipyrine is ind-N-methyl-5-*isopropyl*-7:8-pyrroloquinoline.

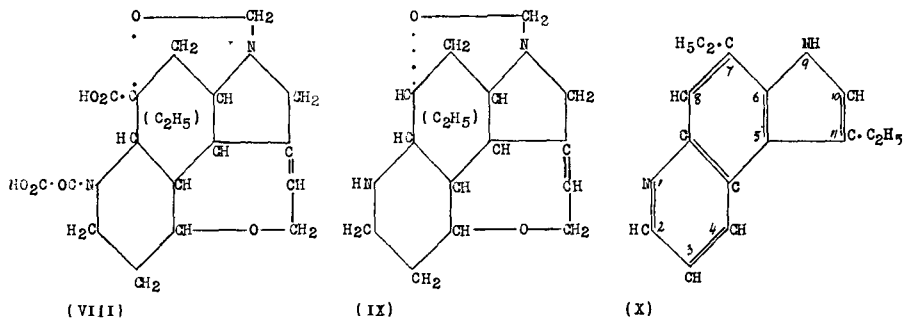

Addendum. Bailey and Robinson⁵ state that the acid (p. 594),



obtained by Wieland *et al.* (Parts I and IX) by the oxidation of vomicine with chromic acid, as described above, is also produced by the chromic acid oxidation of N-methyl-*sec*- ψ -strychnine,⁶ or the corresponding derivative of ψ -brucine. This observation indicates that vomicine is an *ar*-hydroxyl derivative of N-methyl-*sec*-*pseudostrychnine* and its relation to strychnine, and to the acid $C_{17}H_{22}O_5N_2 \cdot 3H_2O$, can be represented by the following partial formulæ based on the second line of the strychnine formula (XXVII; p. 582), the rest of the formula being the same for both alkaloids.

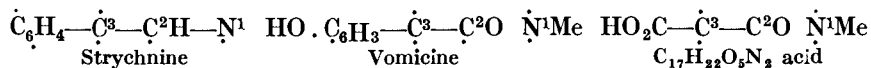

REFERENCES

(1) The chemistry of vomicine is dealt with in a series of papers by Wieland and collaborators published in *Liebig's Annalen*. These parts are referred to in the text of the article where necessary. Part I (with OERTEL), 1929, 469, 193; VI, VII, VIII (with CALVET and MOYER), 1931, 491, 107, 117, 129; IX, X (with HÖLSCHER and

CORTESE), *ibid.*, pp. 133, 149; XII (with HÖLSCHER), 1932, 500, 70; XIV (with HÖLSCHER and BOSE), 1933, 507, 69; XV (with VABVOGLIS), *ibid.*, p. 82; XVII (with KIMMIG), 1937, 527, 151; XVIII (with HORNER), 1937, 528, 73; XIX (with WILLA), 1937, 531, 268; XX (with HORNER), 1938, 536, 89; XXI, HORNER, 1939, 540, 73; XXII (with MÜLLER), 1940, 545, 59; XXIII (with SCHMAUSS), *ibid.*, p. 72; XXIV (with JENNEN), *ibid.*, p. 86; XXV (with JENNEN and MÜLLER), *ibid.*, p. 99; XXVI (with HORNER), *ibid.*, p. 112; XXVII (with THIEL), 1942, 550, 287; XXVIII (with WEISSKOPF), 1943, 555, 1; XXIX (with HUISGEN), *ibid.*, 1943, 555, 9; XXX, *idem*, 1944, 556, 157. (2) MIESCHER and BILLETER, *Helv. Chim. Acta*, 1939, 22, 601. (3) *Rocz. Chim.*, 1938, 18, 333 (*Brit. Chem. Abstr.*, 1939, A ii, 291). (4) *Nature*, 1948, 162, 177; *cf. J. Chem. Soc.*, 1946, 903. (5) *Nature*, 1948, 161, 433; *Chem. and Ind.*, 1943, 157. (6) LEUCHS, *Ber.*, 1937, 70, 2455.

Pharmacological Action of Strychnos Alkaloids. Strychnine is highly toxic; in poisonous doses it acts principally on the spinal cord, causing excessive reflex irritability, which results in convulsions (tetanus) in which all the muscles of the body are involved. The respiratory muscles are affected and, as a general rule, in the mammal after two or three convulsions respiration fails. With large doses death may occur almost immediately from asphyxia resulting from paralysis of the central nervous system. The terminations of the motor nerves are paralysed in the same way as by curare. In small quantities strychnine slows the heart and raises the blood pressure, and, with poisonous doses, the blood pressure is very high, due to the increased activity of the vasomotor centre. A good deal of pharmacological work is being done on strychnine, *e.g.*, on its toxicity in the toad,¹ the frog² and the guinea-pig,³ on the effect of hydrogen ion concentration of the gastric juice on the absorption of the alkaloid in the stomach of the dog or cat,⁴ and on the action of the alkaloid on various organs⁵ and tissues.⁶ Mention may also be made of the attempts to prepare anti-bodies to strychnine.⁷ In medicine strychnine is chiefly used as a tonic because of its bitter taste, and to a certain extent because of its local action on the digestive organs, and its use in this way has been reviewed by Anderson,⁸ who in his experimental investigation found that it stimulates the fasting stomach to active contraction, hastens the emptying time after a test meal and increases the volume and acidity of the gastric juice. He found no evidence that parenteral administration led to any improvement in the condition of the patient. It is also employed in various forms of paralysis for its stimulant action on the central nervous system. It has been used as a remedy in chronic alcoholism. Its principal use is probably as a vermin killer.

Brucine closely resembles strychnine in action, but is much less poisonous and it also has a more marked curare-like action on the nerve-endings in voluntary muscle.

Of the other *Strychnos* alkaloids vomicine has been investigated by Ruickoldt,⁹ who finds that in mice and rabbits it causes clonic convulsions, due to stimulation above the level of the anterior corpore quadragemina. Convulsions can be elicited after intravenous, but not after subcutaneous, injections. The toxicity is low; twelve times the convulsive dose does not cause death. No special action is exerted on blood

pressure or respiration. Experimental animals become tolerant to large doses, so that the alkaloid is probably rapidly decomposed in the body. Injection of vomicine in rabbits produces hyperglycæmia, which is inhibited by ergotamine and prevented by adrenalectomy. Vomicine therefore appears to act by inducing adrenal activity by central sympathetic stimulation.

α - and β -Colubrines are bitter and in toxicity stand between brucine and strychnine, the minimum lethal doses (mg. per kilo) of the four alkaloids as salts by intravenous injection in mice are as follows : strychnine, 0.75 ; α -colubrine, 1.5 ; β -colubrine, 6.6 ; brucine, 33. ψ -Strychnine is not bitter and is even less toxic, the m.l.d. being 100 mg. under the same conditions (Warnat¹⁰). Strychnicine is also of low toxicity, but is stated to produce tetanus in frogs.

Little pharmacological use has been made of the large number of brucine and strychnine derivatives produced in the course of the constitutional investigations referred to above, though in a few instances examinations for toxicity and convulsant action have been made. Tafel,¹¹ in his early papers, recorded that methylstrychnine, strychninic and *isostrychninic* acids, deoxystrychnine and strychnidine, are all convulsant and poisonous. According to Lewin,¹² methylstrychnine shows a curare-like action in the frog. Babel¹³ found that in strychnine *N*-oxide the convulsive action was weakened and the paralysing effect increased in comparison with strychnine ; the *N*-oxide is also less toxic. Wiki¹⁴ found *isostrychnine* about one-thirtieth as toxic as strychnine. Among degradation products Leuchs¹⁵ found brucinonic and strychninonic acids were not poisonous.

Among other spinal convulsants are laurotetanine, gelsemine, thebaine and the doubtful alkaloid "calabarine," of which thebaine is stated to lie between strychnine and brucine in activity. There is no obvious common chemical relationship among these substances apart from their basic character. Other instances of absence of correlation in physiological action of the strychnine type, among closely related substances, are quoted by Clemo, Perkin and Robinson.¹⁶ *neo*Strychnine is about one-fiftieth as active as strychnine, being about equal to brucine or strychnidine, whilst *neostrychnidine* is about twice as active as *neostrychnine*.¹⁷

A comparative investigation has been made by Amanu *et al.*¹⁸ of strychnine and some of its derivatives for toxicity, taking strychnine nitrate as standard and equal to 1. The following results were obtained :—

Strychnine *N*-oxide, 10 ; *isostrychnine*, 20 to 30 ; methylstrychnine, 100 ; strychnine methosulphate, 30 ; strychninic acid, 25 to 30 ; *isostrychninic* acid, 30 to 35. Rats, mice, rabbits, cats, dogs and frogs were used, and the figures are comparative lethal doses for mammals.

An investigation of the elimination of strychnine has been made by Hazelton and Fortunato.¹⁹

REFERENCES

- (1) LAMBRUSCHINI, *Rev. Soc. argent. biol.*, 1938, 14, 353 ; PENHOS, *ibid.*, 1944, 20, 109 (*Brit. Chem. Abstr.*, 1938, A iii, 1038 ; 1945, A iii, 789). (2) MESHCHERKAYA-

but can be accommodated in type (II). The large lactone ring of (II) explains the failure to regenerate carpaine from carpamic acid. Since carpamic acid is not oxidised by chromic acid to a keto-acid, and is not, like the pyrrolidylpropanols,⁷ converted into a ketone when heated with formaldehyde, it should be represented as a tertiary instead of a secondary alcohol. As azelaic acid is the largest fragment produced on oxidation, a chain of seven methylene groups is essential, and (III) is regarded as the best method of meeting this condition as well as providing for a :CMe. and a tertiary alcohol group, though (IV) has been considered as an unlikely alternative. The attachment of the side-chain in the α -position is in harmony with the failure of carpamic acid to give a colour reaction with isatin.⁸ Moreover, when carpamic acid is heated with hydriodic acid and red phosphorus at 320°, nitrogen is eliminated and a hydrocarbon, C₁₄H₂₈ or C₁₄H₃₀, is formed, which contains one :CMe. group instead of the two which should be formed by the opening of a β -substituted pyrrolidine ring. Similarly exhaustive methylation of carpaine, followed by hydrogenation, leads in two stages to a lactone hydrolysed to an acid, C₁₄H₂₈O₃, also containing one :CMe. group.

A second basic substance isolated from papaw seed and named "carpamine" has been shown to be benzylthiourea.⁹

Pharmacological Action. Carpaine has been investigated by several workers.¹⁰ It is essentially a heart poison, though not of the cardiac glucoside type. It lowers the pulse frequency and depresses the central nervous system. Five milligrammes per kilogramme body weight is said to be toxic to rabbits. According to To and Kyu, it is a potent amoebicide.

REFERENCES

- (1) *Meded. uit's Lands. Plant.*, 1890, No. 7, p. 5.
- (2) *Merck's Report*, 1891, p.30.
- (3) *Arch. Pharm.*, 1893, 231, 184; 1897, 235, 332.
- (4) *J. Chem. Soc.*, 1910, 97, 466.
- (5) (a) (With GIRARDET), *Helv. Chim. Acta*, 1933, 16, 90; (b) (with WORK), *J. Chem. Soc.*, 1937, 711; see also (with URUSHIBARA), *ibid.*, p. 714; (with SHORT), *ibid.*, p. 715; (with HART SMITH), *ibid.*, p. 718.
- (6) *Ber. Deut. Pharm. Ges.*, 1914, 24, 123.
- (7) HESS, *Ber.*, 1913, 46, 4107.
- (8) GRASSMANN and VON ARNIM, *Annalen*, 1935, 519, 192.
- (9) PANSE and PARANJPE, *Proc. Ind. Acad. Sci.*, 1943, A, 18, 140.
- (10) ALCOCK and MEYER, *Arch. Physiol.*, 1903, 225; KAKOWSKI, *Arch. int. Pharmacodyn*, 1905, 15, 84; TU, *Folia Pharmacol. Jap.*, 1925, 1, 32; KYU, *ibid.*, 1930, 10, 333; To and KYU, *Jap. J. Med. Sci.*, 1934, 8, No. 1, 52.

PYRROLIZIDINE GROUP

The Senecio Alkaloids. The botanical family Compositæ, until comparatively recently, was singularly free from recorded occurrences of alkaloids. That has been changed since the joint work of Watt¹ and Cushny² proved that a liver disease of farm animals in S. Africa was caused by the alkaloids present in a Senecio species. Now, alkaloids of the same type, which are beginning to be called "hepatotoxic" alkaloids, have been isolated from many *Senecio* spp., including the noxious weeds "groundsel" and "ragwort," common everywhere. Similar alkaloids have also been found in two genera, *Heliotropium* and *Trichodesma*, of the Boraginaceæ and in several species of *Crotalaria* (Leguminosæ). The known alkaloids of the group and their recorded botanical distribution are given in alphabetical order in the following list. Brief descriptions of the less clearly defined alkaloids of the group are included in the list, but those alkaloids which have been fully named and characterised are described separately later as indicated by page references.

- AUREINE. *S. aureus*.³ Subsequently identified with senecionine.⁴
CAMPESTRINE, C₁₃H₁₉O₃N, m.p. 93°, and a second base, m.p. 215°. *S. campestris* var. *maritima*.⁵
CARTHAMOIDINE (p. 614). *S. carthamoides*.
DICROTALINE (p. 603). *Crotalaria dura*, Wood and Evans, and *C. globifera*, E. Mey.⁶
FUCHSISENECIONINE, C₁₂H₂₁O₃N · B. HCl, m.p. 225–7°, and a second base, C₉H₁₅O₂N. *S. Fuchsii*.^{6(a)}
GRAMINIFOLINE, C₁₈H₂₃O₅N, m.p. 236°. *S. graminifolius*, Jacq.⁷
GRANTIANINE (p. 603). *Crotalaria grantiana*.⁸
HASTACINE (p. 603). *Cacalia hastata*.^{8(a)}
HELIOTRINE (p. 603). *Heliotropium lasiocarpum*, F. and M.⁹
HIERACIFOLINE (p. 603) and a second base, C₂₀H₁₇O₆N, m.p. 237°. *Erechtites hieracifolia* (L), Raf. (Compositæ).¹⁰
INTEGERRIMINE (p. 603). *S. integerrimus* Nutt.¹¹
ISATIDINE (p. 603). *S. isatideus*⁵ D.C.; *S. retrorsus*¹² D.C. *S. scleratus* Schw.²¹
JACOBINE (p. 603). *S. cineraria*,⁵ *S. crucifolia*,⁵ *S. Jacobæa*¹³ L.
JACODINE (p. 604). *S. aquaticus*,^{4, 5} *S. cineraria*,^{4, 5} *S. Jacobæa*^{4, 5} L.
JACONINE (p. 604). *S. Jacobæa*⁴ L.
LASIOCARPINE (p. 604). *Heliotropium lasiocarpum* F. and M.⁹
LONGILOBINE (p. 604). *S. longilobus*.¹¹
MIKANOIDINE, C₂₁H₂₉O₆N, amorphous, hydrolysed to (a) *mikanecine*, C₈H₁₅O₂N, picrate, m.p. 186°, possibly a *dihydroretronecine* (p. 607) and (b) *mikanecic acid*, C₁₃H₁₆O₅, m.p. 240°. *S. mikanoides* (Walp) Otto (Manske³).
MONOCROTALINE (p. 604). *Crotalaria retusa* and *C. spectabilis*.¹⁴
OTHOSENINE (p. 604). *S. othonnæ*.¹⁵

- PLATYPHYLLINE (p. 604). *S. adnatus* D.C.,¹⁶ *S. hygrophilus*²⁰ Dyer and Sm., *S. platyphyllus* D.C.¹⁷
- PTEROPHINE (p. 605). *S. ilicifolius*¹⁸ Thunb.; *S. pterophorus* D.C.¹⁸
- RETORSINE (p. 605). *S. glaberrimus*,⁵ *S. graminifolius*,⁷ *S. ilicifolius* Thunb.,⁷ *S. isatideus* D.C.,⁵ *S. latifolius*,²⁶ *S. pterophorus*,⁷ *S. retrorsus* (Manske)¹³, *S. venosus*.⁵
- RIDDELLINE (p. 605). *S. Riddellii*.¹⁹
- ROSMARININE (p. 605). *S. brachypodus* D.C.,²⁰ *S. hygrophilus* Dyer and Sm.,²⁰ *S. pauciligulatus*²⁰ Dyer and Sm., *S. rosmarinifolius*,²⁰ *S. sceleratus* Schw.²¹ In *S. hygrophilus* it may be replaced by an isomeride, C₁₈H₂₇O₆N, m.p. 175–6°, [α]_D^{25°} – 62·4° (MeOH).²⁰
- SCELERATINE (p. 605). *S. sceleratus* Schw.²¹
- SENECIFOLIDINE (p. 606) and SENECIFOLINE. *S. latifolius*.¹
- SENECIONINE (p. 606). *S. aureus*,⁴ ¹¹ *S. ilicifolius* Thunb. (de Waal),²⁰ *S. integerrimus*,¹¹ *S. pseudoarnica*,¹¹ *S. squalidus*,²² *S. viscosus*,⁵ *S. vulgaris*.²³
- SENECIPHYLLINE (p. 606). *S. platyphyllus*,¹⁷, ²⁴ *S. spartioides*,¹¹ *S. stenocephalus* (1937).¹⁷
- SILVASENECINE, C₁₈H₂₁O₄N, or C₁₃H₂₁O₃N, and a base, C₁₃H₂₁O₄N, giving a crystalline hydrochloride. *S. silvaticus* L.⁵, ^{6(a)}
- SPARTIOIDINE, C₁₈H₂₃O₅N, m.p. 178°, giving a methiodide, m.p. 239°. *S. spartioides*.¹¹
- SQUALIDINE (p. 606). *S. squalidus*.²²
- TRACHELANTAMINE and TRACHELANTINE (pp. 606–7). *Trachelanthus korolkovi*.²⁴
- TRICHODESMINE (p. 607). *Trichodesma incanum* D.C.²⁵

In addition the following Senecio spp. have been recorded as containing unnamed alkaloids:—

- S. brasiliensis*. Alkaloid, C₁₈H₂₅O₅N, m.p. 232–4° (*dec.*), [α]_D^{20°} – 66·8° (CHCl₃); methiodide, m.p. 243° (*dec.*), [α]_D^{20°} – 43·4° (MeOH); picrate, m.p. 189·5°; aurichloride, m.p. 182°. The base is hydrolysed by baryta to retronecine (p. 607) and a dextrorotatory acid, C₁₀H₁₆O₅, m.p. 141–2°.⁴⁷
- S. crucifolius* L. Base. C₁₈H₂₇O₅N, m.p. 222°.⁵
- S. paludosus* L. Possibly two bases.⁵
- S. saracenicus*. Two bases: (a) C₈H₁₃ON; crystalline picrate and methiodide. (b) C₁₃H₂₁O₃N; crystalline aurichloride.⁵

Of the alkaloids described in the following paragraphs nearly all have been shown to undergo alkaline hydrolysis to an acid and an amino-alcohol. These hydrolytic products have been conveniently grouped together as *necic acids* and *necines* respectively, and the *necines* have proved much the more attractive to investigators. Of these twenty-five alkaloids, sixteen yield the same necine, retronecine, two yield a second necine, heliotridine, and two more a third, platynecine. As these three necines are closely related they are discussed together later. Of the five remaining

neenes one, senecifoline, is probably retronecine, but the other four are each characteristic of a single alkaloid.

The necic acids have received little attention from investigators, but when more is known about them they may prove to be less variable in character than appears to be the case at present. Those acids which have merely been characterised are described briefly under the appropriate alkaloids, but the few that have been more fully examined are described together later.

Dicrotaline, $C_{14}H_{19}O_5N$, m.p. 170° (*dec.*), is unstable and decomposes on keeping. B. HCl, m.p. $258-60^\circ$ (*dec.*), $[\alpha]_D^{20} + 25.7^\circ$ (H_2O); picrate, m.p. $238-240^\circ$ (*dec.*). On alkaline hydrolysis the base produces retronecine (p. 607) and the dibasic *dicrotalic acid*, $C_8H_{10}O_5$, m.p. 109° .⁶

Grantianine, $C_{18}H_{23}O_7N$, m.p. $204-5^\circ$ (*dec.*), $[\alpha]_D^{27} + 50.6^\circ$ ($CHCl_3$), forms a hydrochloride, m.p. $221-2^\circ$ (*dec.*), picrate, m.p. $225-8^\circ$ (*dec.*) and a methiodide, m.p. $242-3^\circ$. It hydrogenates without cleavage to *tetrahydrograntianine*, m.p. 242.5° (*vac.*), yielding a picrate, m.p. $156-7^\circ$ (*dec.*), and is hydrolysed by potassium hydroxide in methyl alcohol, to retronecine (p. 607) and *grantianinic acid*, possibly $C_{10}H_{14}O_7$, but not yet isolated in a pure state.⁸

Hastacine, $C_{18}H_{27}O_5N$, m.p. $170-1^\circ$, $[\alpha]_D - 72.34^\circ$, is hydrolysed by boiling, dilute, alcoholic potash to *hastanecinic acid*, $C_8H_{13}(OH)(CO_2H)$, m.p. $148-9^\circ$, $[\alpha]_D + 4.6^\circ$ and *hastanecine*, an aminoglycol, $C_8H_{15}O_2N$, m.p. $113-4^\circ$, $[\alpha]_D - 9.07^\circ$. The alkaloid is stated to have spasmolytic properties.^{8(a)}

Heliotrine, $C_{16}H_{27}O_5N$, m.p. $125-6^\circ$, $[\alpha]_D - 75^\circ$ ($CHCl_3$), yields a methiodide, m.p. $108-111^\circ$, and contains one methoxyl group, two hydroxyl groups and a tertiary nitrogen atom. On alkaline hydrolysis it forms heliotridine (p. 607) and *heliotric acid* (p. 613). In presence of platonic oxide it absorbs two molecules of hydrogen and affords, as scission products, heliotric acid and hydroxyheliotridane⁹ (p. 607).

Hieracifoline, $C_{18}H_{25}O_5N$, m.p. 227° , $[\alpha]_D^{26} - 89.7^\circ$ ($CHCl_3$). On alkaline hydrolysis it yields retronecine (p. 607) and *hieracinecic acid*, $C_{10}H_{16}O_5$, m.p. 132° , described as dibasic.¹⁰

Integerrimine, $C_{18}H_{25}O_5N$, m.p. $172-172.5^\circ$, $[\alpha]_D^{28} + 4.3^\circ$ (MeOH). The hydrolytic products are retronecine (p. 607) and *integerrinecic acid*, $C_{10}H_{16}O_5$, m.p. 151° .¹¹

Isatidine, $C_{18}H_{25}O_7N \cdot 2H_2O$, crystallises in rhombic prisms: $a : b : c = 0.692 : 1 : 0.432$. M.p. 145° (*dec.*), $[\alpha]_D^{22} - 8.25^\circ$ (H_2O). Absorbs four molecules of hydrogen to form *octahydroanhydroisatidine*, later re-named hexahydrodeoxyisatidine, $C_{18}H_{31}O_6N$, which melts at $115-120^\circ$, re-melts at $183-4^\circ$, forms a hydrochloride, m.p. 218° (*dec.*), $[\alpha]_D^{20} - 52.5^\circ$ (H_2O), and on hydrolysis by barium hydroxide in water yields as the basic product *tetrahydroisatinecine*, $C_8H_{17}O_3N$, m.p. 174.5° , $[\alpha]_D^{20} - 88^\circ$ (H_2O). The parent alkaloid, isatidine, on hydrolysis by baryta, yields isatinecine (p. 612) and two acid products, isatinecic acid and isatinecic monolactonic acid¹² (p. 613).

Jacobine, $C_{18}H_{25}O_6N$, m.p. 219° , $[\alpha]_D^{17} - 46.8^\circ$ ($CHCl_3$), forms a nitrate,

m.p. 234°, $[\alpha]_D^{17}$ - 28.6° (H₂O), a picrate, m.p. 180°, which is soluble in water, and a methiodide, m.p. 255°. The base contains two active hydrogen atoms, and on hydrolysis furnishes retronecine (p. 607) and *jaconecic acid*, C₁₀H₁₆O₆, which has m.p. 182°, $[\alpha]_D^{15}$ + 31.7°, and contains three C-methyl groups.¹³

Jacodine, C₁₈H₂₅O₅N, m.p. 217°, $[\alpha]_D^{17}$ - 109.6° (CHCl₃) yields a nitrate, m.p. 215°, $[\alpha]_D^{17}$ - 77.4° (H₂O), and a picrate, m.p. 171°. The hydrolytic products are retronecine (p. 607) and an *acid*, C₁₀H₁₆O₅, m.p. 136-7° (Barger and Blackie 4).

Jaconine, C₁₈H₂₅O₈N · H₂O, m.p. 146°, b.p. 180°/0.01 mm. (Barger and Blackie 4).

Lasiocarpine, C₂₁H₃₃O₇N, m.p. 94-95.5°, $[\alpha]_D$ - 4° (EtOH). On alkaline hydrolysis it furnishes heliotridine (p. 607) and angelic acid, CH₃ · CH : C(CH₃) · CO₂H, and on hydrogenolysis the products are (a) *lasiocarpic acid*, C₉H₁₆O₅, m.p. 95-7°, $[\alpha]_D$ + 10.6° (EtOH), which is unsaturated and contains one methoxyl and two hydroxyl groups, and (b) a *base*, C₁₃H₂₃O₂N, b.p. 123-5°/8 mm., $[\alpha]_D$ + 3.8° (EtOH), which gives a picrate, m.p. 157-9°, and is hydrolysed to hydroxyheliotridane (p. 607) and methylethylacetic acid. Lasiocarpine is regarded as *angelyllasiocarpylheliotridine*, both hydroxyl groups in heliotridine being esterified.⁹

Longilobine, C₁₈H₂₃O₅N, m.p. 217-8° (*dec.*), $[\alpha]_D^{25}$ - 79.2° (EtOH), gives a methiodide, m.p. 249° (*dec.*), and on alkaline hydrolysis yields retronecine (p. 607) and *longinecic acid*, C₁₀H₁₄O₅, m.p. 126-9°.¹¹

Monocrotaline, C₁₆H₂₃O₆N, m.p. 197-8° (*dec.*), $[\alpha]_D^{26}$ - 55.7° (CHCl₃), forms a hydrochloride, m.p. 184° (*dec.*), $[\alpha]_D^{28}$ - 38.4° (H₂O), and a methiodide, B · MeI · 3MeOH, m.p. 205° (*dec.*), $[\alpha]_D^{28}$ + 23.4° (MeOH). In boiling aqueous barium hydroxide solution the alkaloid is hydrolysed to retronecine (p. 607) and *monocrotic acid* (p. 612), and on hydrogenation in presence of platinum oxide in acetic acid the scission products are (a) retronecanol (p. 607) and (b) *monocrotalic acid*¹⁴ (p. 612).

Othosenine (otosenine), C₁₉H₂₇O₇N, m.p. 221-2°, forms a picrate, m.p. 233-5°. On hydrolysis with barium hydroxide solution it furnishes an acid, C₁₀H₁₆O₆, m.p. 180-2°, possibly identical with *jaconecic acid* (*see above*); the basic hydrolytic product was apparently decomposed in this process. On acid hydrolysis othosenine yielded a substance, C₁₀H₁₃O₄Cl, m.p. 111-3°, and *othonecine*, C₉H₁₅O₃N, isolated as the hydrochloride, m.p. 146-8°. Othonecine contains one hydroxyl, one carbonyl and one methylimino group but no methoxyl, and is regarded as probably a derivative of N-methylpyrrolidine. On hydrogenation it is converted into a *reduced product*, C₉H₁₇O₂N, b.p. 105-7°, characterised by a picrate, m.p. 231.5°, and an oxime, C₉H₁₈O₂N₂, m.p. 179-181°.¹⁵

Platyphylline, C₁₈H₂₇O₅N. The constants recorded by Orekhov¹⁷ are generally lower than those found by de Waal,¹⁶ which are given in brackets: base, m.p. 124-5° (129°), $[\alpha]_D$ - 45.09° (-56.4°) (CHCl₃); perchlorate, m.p. 222-3° (*dec.*) (244-5°); picrate, m.p. 199-200°, picrolonate, m.p. 205-6° (*dec.*), aurichloride, m.p. 200-1° (*dec.*) and a methiodide, m.p. 216-7°, $[\alpha]_D$ - 31.27° (EtOH). Platyphylline contains one hydroxyl

group but no methoxyl or methylimino group, and on hydrolysis yields platynecine (p. 607) and *platynecic acid*, $C_{10}H_{14}O_4$, m.p. 154–5°, and now known to be identical with senecic acid lactone (p. 613).

Pterophine, $C_{18}H_{23}O_5N$, m.p. 227–8° (*dec.*), $[\alpha]_D^{18} - 88.5^\circ$ ($CHCl_3$), yields a nitrate, m.p. 208° (*dec.*), $[\alpha]_D^{20} - 69.9^\circ$ (H_2O), a picrate, m.p. 190°, and a methiodide, m.p. 260° (*dec.*), and on alkaline hydrolysis forms retronecine p. (607) and *pterophenic lactone*, $C_{10}H_{16}O_6$, m.p. 166.5°, $[\alpha]_D - 17.7^\circ$ (H_2O), which is stated to contain one lactone group and no free carboxyl group, and to exhibit a “dualism,” one form being probably identical with seneciophyllic acid, $C_{10}H_{14}O_4$ (*see below*).¹⁸

Retrorsine, $C_{18}H_{25}O_6N$, m.p. 214–5°, $[\alpha]_D^{18} - 17.6^\circ$ (EtOH), gives a nitrate, B. HNO_3 , 0.5 EtOH, n.p. 145°, a monophenylcarbamate, m.p. 200–2°, a perbromide hydrobromide, $C_{18}H_{25}O_6NBr_2 \cdot HBr$, and a methiodide, m.p. 266° (*dec.*). On alkaline hydrolysis, retrorsine yields retronecine (p. 607) and *retronecic acid*, $C_{10}H_{16}O_6$, m.p. 177°, $[\alpha]_D - 11.36^\circ$ (EtOH), a dihydroxydicarboxylic acid, which on heating with anhydrous oxalic acid is converted into the lactone acid, $C_{10}H_{14}O_5$, m.p. 181–3°, obtained by Manske from potassium retronecate formed in the hydrolysis of retrorsine by potassium hydroxide in alcohol. On catalytic hydrogenation retrorsine absorbs two molecules of hydrogen and furnishes retronecanol (p. 607) and retronecic acid.²⁶

Riddelline, $C_{18}H_{23}O_6N$, m.p. 197–8° (*dec.*), $[\alpha]_D^{25} - 109.5^\circ$ ($CHCl_3$), forms a hydrochloride, m.p. 225–6° (*dec.*), $[\alpha]_D^{25} - 80.6^\circ$ (H_2O), and a methiodide, m.p. 260–2° (*dec.*), and is hydrolysed by boiling aqueous barium hydroxide solution to retronecine (p. 607) and *riddelliac acid*, $C_{10}H_{14}O_6 \cdot H_2O$, m.p. 62° or 102–3° (*dry*), $[\alpha]_D^{22} - 2.65^\circ$ (*dry*: EtOH): the latter is a dibasic acid and possibly contains a lactone group also. On hydrogenation the acid yields a mixture, but the dimethyl ester, b.p. 144–5°/1 mm., $[\alpha]_D^{32} - 2.84^\circ$ (EtOH), is reduced to dimethyl dihydro-riddellate, b.p. 146–7°/1 mm., $[\alpha]_D^{32} - 15.3^\circ$. When riddelline is hydrogenated in presence of Raney nickel the product is *tetrahydro-riddelline*, $C_{18}H_{27}O_6N$, m.p. 205°, $[\alpha]_D^{31} - 9.5^\circ$, which on alkaline hydrolysis yields retronecanol (p. 607) and riddelliac acid.¹⁹

Rosmarinine, $C_{18}H_{27}O_6N$, m.p. 209°, $[\alpha]_D^{24} - 94^\circ$ (EtOH), forms a nitrate, m.p. 218° (*dec.*), $[\alpha]_D^{20} - 91.5^\circ$ (H_2O), and a methiodide, m.p. 251°, and on hydrolysis yields senecic acid (p. 613) and rosmarininecine (p. 612). It absorbs one molecule of hydrogen and the product on hydrolysis furnishes *rosmarininecine* and dihydro-senecic acid (p. 613).²⁰

Sceleratine, $C_{18}H_{27}O_7N \cdot H_2O$, m.p. 178°, $[\alpha]_D^{21} + 54^\circ$ (EtOH), forms a nitrate, m.p. 250–5° (*dec.*), $[\alpha]_D^{24} - 10^\circ$ (H_2O), hydrochloride, m.p. 290° (*dec.*), aurichloride, m.p. 184–6° (*dec.*), picrate m.p. 216° (*dec.*), and methiodide, m.p. 254° (*dec.*). The products of alkaline hydrolysis are retronecine (p. 607) and *sceleranecic acid*, $C_{10}H_{14}O_5$, m.p. 156°, $[\alpha]_D^{24} - 9.3^\circ$, which behaves as a dilactone and is also produced in a more stable form, m.p. 213°. On catalytic hydrogenation with platinum oxide as catalyst in N-hydrochloric acid, hydrolysis occurs and sceleranecic acid is again formed, but retronecine is replaced by retronecanol (p. 607).²¹

Senecifolidine, $C_{18}H_{25}O_7N$, m.p. 212° (*dec.*), $[\alpha]_D^{20} - 13.9^\circ$ (EtOH), gives a nitrate (B. HNO_3)₂ EtOH, m.p. 145° , $[\alpha]_D - 24.35^\circ$, and an aurichloride crystallising in hair-like needles.¹

Senecifoline, $C_{18}H_{27}O_8N$, m.p. $194-5^\circ$, $[\alpha]_D + 28.13^\circ$ (EtOH), forms a nitrate, m.p. 240° (*dec.*), $[\alpha]_D - 15.8^\circ$ (H_2O), hydrochloride, m.p. 260° (*dec.*), $[\alpha]_D - 20^\circ$, and aurichloride, B. $HAuCl_4 \cdot EtOH$, m.p. 220° (*dry*). On hydrolysis by alkali senecifoline produces *senecifolic acid*, $C_{10}H_{16}O_6$, m.p. $198-9^\circ$, $[\alpha]_D + 28.36^\circ$ (EtOH), and *senecifolinine*, $C_8H_{11}O_2N$.¹ The latter is amorphous but yields crystalline salts (hydrochloride, m.p. 168° , $[\alpha]_D - 12.6^\circ$, and aurichloride, m.p. 150°)¹; it may prove to be identical with retronecine (p. 607), as suggested by Barger *et al.*²⁶

Senecionine, $C_{18}H_{25}O_5N$, m.p. 232° , $[\alpha]_D - 54.6^\circ$ ($CHCl_3$), sublimes at $130-140^\circ/0.2$ mm. The nitrate has m.p. 214° , $[\alpha]_D - 34.2^\circ$ (H_2O); the picrate, m.p. 191° , the aurichloride, m.p. 186° , and the methiodide, m.p. 249° . The hydrolytic products are retronecine (p. 607) and *senecic acid*.²²

Seneciphylline, $C_{18}H_{23}O_5N$, m.p. $217-8^\circ$, $[\alpha]_D - 134.2^\circ$ ($CHCl_3$), forms a perchlorate, which decomposes from $220-245^\circ$, a picrate, m.p. $182-3^\circ$, a methiodide, m.p. $231-2^\circ$ (*dec.*), and an aurichloride, m.p. $162-3^\circ$ (*dec.*). It contains one hydroxyl group but no methoxyl or methylimino group. The nitrogen is tertiary. On hydrolysis seneciphylline yields retronecine (p. 607) and *seneciphyllic acid*, $C_{10}H_{14}O_5$, m.p. $140-1^\circ$, $[\alpha]_D \pm 0^\circ$ (Orekhov *et al.*)¹⁷

Squalidine, $C_{18}H_{25}O_5N$, m.p. 169° , $[\alpha]_D^{16} - 26.9^\circ$ ($CHCl_3$); the nitrate has m.p. 204° and $[\alpha]_D^{16} - 8.65^\circ$ (H_2O); the picrate melts at 203° . The hydrolytic products are retronecine (p. 607) and *squalinecic acid*, $C_{10}H_{14}O_4$, m.p. 129° ; the latter is probably related to senecic acid (p. 613) and like the latter contains three C-alkyl groups (Barger and Blackie).²²

Trachelantamine, $C_{15}H_{27}O_4N$, m.p. $92-3^\circ$, $[\alpha]_D - 18.14^\circ$, yields a picrate, m.p. $155-6^\circ$, and is hydrolysed by alkali into *trachelantic acid*, $C_7H_{14}O_4$, m.p. $93-5^\circ$, and *trachelantamidine*, $C_8H_{15}ON$, b.p. $114-5^\circ/3$ mm., $[\alpha]_D - 12.94^\circ$, characterised as hydrochloride, m.p. $110-2^\circ$, picrate, m.p. 174° , and picrolonate, m.p. 182° . This substance is isomeric with hydroxyheliotridane (p. 607) and retronecanol (p. 607), which are both convertible into the oxygen-free base heliotridane, $C_8H_{15}N$. In a parallel series of reactions, trachelantamidine yields on treatment with thionyl chloride, chloro*pseudoheliotridane*, $C_8H_{14}NCl$, b.p. $86-8^\circ/8$ mm., $[\alpha]_D - 16.5^\circ$ (no solvent), picrate, m.p. 180° , which on alkaline reduction followed by hydrogenation forms *pseudoheliotridane*, $C_8H_{15}N$, b.p. $159-160^\circ$, $[\alpha]_D - 8.25^\circ$ (no solvent), giving a picrate, m.p. $232-3^\circ$, picrolonate, m.p. $162-3^\circ$, aurichloride, m.p. $183-4^\circ$, and methiodide, m.p. $>275^\circ$. This in the first stage of a Hofmann degradation produces de-N-methyl-*pseudoheliotridane*, $C_9N_{17}N$, b.p. $158-160^\circ$, $[\alpha]_D - 64^\circ$ (no solvent), picrate, m.p. 127° . This on hydrogenation furnishes the saturated base, $C_9H_{10}N$, b.p. $165-7^\circ$, $[\alpha]_D - 11^\circ$ (no solvent), which forms a picrate, m.p. $158-9^\circ$. When this dihydride is passed over platinised asbestos at $300-320^\circ$ it produces a pyrrole derivative, $C_9H_{15}N$, b.p. $189-191^\circ$, $[\alpha]_D - 5^\circ$ (no solvent).

In a more recent paper Menschikov assigns to trachelantamidine formula (VI, p. 611), which makes it structurally identical with *isoretronecanol* (p. 609). He also provides experimental evidence for the view that trachelantic acid is 2-methyl-3:4-dihydroxypentane-3-carboxylic acid, $\text{Me}_2\text{CH} \cdot \text{C}(\text{OH})(\text{CO}_2\text{H}) \cdot \text{CHOH} \cdot \text{CH}_3$, and trachelantamine becomes $\text{C}_7\text{H}_{12}\text{N} \cdot \text{CH}_2\text{O} \cdot \text{OC} \cdot \text{C}(\text{OH})\text{Pr}^\beta \cdot \text{CHOH} \cdot \text{CH}_3$, $\text{C}_7\text{H}_{12}\text{N}$ being the pyrrolizidine residue²⁴ (1947).

Trachelantine, $\text{C}_{15}\text{H}_{25}\text{O}_5\text{N}$, m.p. 166–7°, $[\alpha]_{\text{D}} - 22.5^\circ$, contains two hydroxyl groups, and is hydrolysed by alkalis to *trachelantidine*, $\text{C}_8\text{H}_{13}\text{O}_2\text{N}$, characterised as the hydrochloride, m.p. 107–8°, and *trachelantic acid* (see above).

Trichodesmine, $\text{C}_{18}\text{H}_{27}\text{O}_6\text{N}$, m.p. 160–1° (*dec.*), $[\alpha]_{\text{D}} + 38^\circ$ (EtOH), gives a methiodide, m.p. 202° (*dec.*), and on alkaline hydrolysis yields retronecine (p. 607) and *dl*-lactic acid with *isobutyl methyl ketone*, the latter probably arising from a β -ketonic acid first formed.²⁵

The Necines. The most important of these substances and their near derivatives are the following:—

RETRENECINE, $\text{C}_8\text{H}_{13}\text{O}_2\text{N}$, m.p. 121–2°, $[\alpha]_{\text{D}} + 50.2^\circ$ (EtOH), forms a hydrochloride, m.p. 164°, $[\alpha]_{\text{D}}^{15^\circ} - 16^\circ$, picrate, m.p. 142°, and aurichloride, m.p. 146°; the monobenzoyl derivative gives a hydrochloride, m.p. 151°, and a methochloride, m.p. 128°; diacetylretronecine distils at 125° in a high vacuum and forms a picrate, m.p. 146°, and a methiodide, m.p. 118–120°. Retronecine absorbs two molecules of hydrogen producing retronecanol.

Retronecanol, $\text{C}_8\text{H}_{15}\text{ON}$, b.p. 140/30 mm., m.p. 95–6°, $[\alpha]_{\text{D}}^{28^\circ} - 91.1^\circ$ (EtOH), forms a hydrochloride, m.p. 210° (*dec.*), a methiodide, m.p. 193° (*dec.*), $[\alpha]_{\text{D}}^{27^\circ} - 52.8^\circ$ (MeOH), and a picrate, m.p. 210°; the monoacetyl derivative gives a picrate, m.p. 176°, and a methiodide, m.p. 207–8° (Manske,¹³ Barger *et al.*,²⁶ Adams and Rogers¹⁴).

HELIOTRIDINE, $\text{C}_8\text{H}_{13}\text{O}_2\text{N}$, m.p. 116.5–118°, $[\alpha]_{\text{D}} + 31^\circ$ (MeOH), forms a hydrochloride, m.p. 122–4°, and a dibenzoyl derivative hydrochloride, m.p. 180°. The latter on hydrogenation is converted into the non-crystalline hydroxyheliotridane benzoate.

Hydroxyheliotridane, $\text{C}_8\text{H}_{15}\text{ON}$. This substance stands in the same relation to heliotridine as retronecanol does to retronecine. It has b.p. 126–8/12 mm., m.p. 60–5°, $[\alpha]_{\text{D}} - 14.5^\circ$ (H_2O), and forms a methiodide, m.p. 296°, and a picrate, m.p. 196° (*dec.*). The single oxygen is present as a hydroxyl group (Menschikov, 1935).⁹

PLATYNECINE, $\text{C}_8\text{H}_{15}\text{O}_2\text{N}$, m.p. 148°, $[\alpha]_{\text{D}} - 56.8^\circ$ (CHCl_3), forms a picrate, m.p. 189°, aurichloride, m.p. 209–210° (*dec.*), and methiodide, m.p. 202–3°; the hydrochloride is crystalline but hygroscopic; two active hydrogen atoms are present and both mono- and di-benzoyl derivatives have been prepared; the mono-compound has m.p. 119–120° and $[\alpha]_{\text{D}} - 87.9^\circ$ (EtOH); the di-derivative is an oil, but yields a crystalline hydrochloride, m.p. 228–230°. Adams and Rogers³¹ by hydrogenating retronecine, in presence of Raney nickel, have prepared platynecine, having $[\alpha]_{\text{D}}^{30^\circ} - 57.7^\circ$ (CHCl_3) and otherwise identical with the hydrolytic product of platyphylline. Sulphuric acid at 100° converts platynecine to

anhydroplatynecine, $C_8H_{13}ON$, b.p. 194–5°/750 mm., $[\alpha]_D - 25.2^\circ$, which forms a picrate, m.p. 265–270° (*dec.*), picrolonate, m.p. 226–7° (*dec.*), and methiodide, 211–3°; it contains no active hydrogen and is not catalytically hydrogenated.^{16, 17, 27}

Constitution. The first contribution to knowledge of the structure of the necines was made by Menschikov (1933),⁹ who found that heliotridine is converted by thionyl chloride into an unstable dichloro-derivative, which on catalytic hydrogenation forms *chloroheliotridane*, $C_8H_{14}NCl$, b.p. 84–5°/10 mm., $[\alpha]_D - 133.5^\circ$, and this with sodium ethoxide in boiling alcohol yields *heliotridene*, $C_8H_{13}N$, b.p. 165–6°, picrate, m.p. 224–5° (*dec.*), which on hydrogenation furnishes *l*-heliotridane, $C_8H_{15}N$, b.p. 168.5°, $[\alpha]_D - 99.5^\circ$, picrate, m.p. 236° (*dec.*), picrolonate, m.p. 152–3°, aurichloride, m.p. 199–200°. These two oxygen-free bases have been prepared from other sources, *e.g.*, hydroxyheliotridane by Menschikov (1935),⁹ retronecanol by Konovalova and Orekhov,²² and later by Adams and Rogers,²⁷ and from platynecine with more difficulty by Konovalova, Orekhov and Tiedebel (1938).¹⁷ Where they were obtained in sufficient quantity for detailed comparison, the constants found are in good agreement, except that heliotridene shows great variation in rotatory power: the extremes recorded by Menschikov are -10° and -160° , while Adams and Rogers found $[\alpha]_D^{34} + 38^\circ$, against -149.8° , recorded by Konovalova and Orekhov²² for heliotridene ex retronecanol. Smaller variations also occur in the rotations recorded for heliotridane.

The exhaustive methylation of heliotridane was investigated by Menschikov,²⁸ who obtained at the first stage *de-N-methylheliotridane*, $C_9H_{17}N$, b.p. 163°, $[\alpha]_D - 36^\circ$, picrate, m.p. 119–120°, which was converted to the dihydro-derivative, $C_9H_{19}N$, b.p. 165°, $[\alpha]_D - 1.5^\circ$, picrate, m.p. 125–6°, and the latter dehydrogenated over platinised asbestos at 270–5° to a base, $C_9H_{15}N$, b.p. 189–191°, $[\alpha]_D \pm 0^\circ$, giving a strong pyrrole reaction. This base was reduced by zinc and hydrochloric acid to the pyrroline base, $C_9H_{17}N$, b.p. 165–6°, and this hydrogenated to *dl*-dihydro-*de-N*-methylheliotridane, b.p. 163.5–4°; picrate, m.p. 114–5° (*cf.* the *l*-form described above), which at the second stage of the Hofmann process followed by hydrogenation gave *dl*-tetrahydro-*de-N*-dimethylheliotridane (b.p. 180–1°, platinichloride, m.p. 133–4°, picrolonate, m.p. 93–94.5°), which proved to be identical with δ -dimethylamino- γ -methylheptane, already obtained in the Hofmann degradation of 1-methyl-2-*sec*-butylpyrrolidine.²⁹ As neither the latter, nor its isomerides, in which the *sec*-butyl radical is replaced by *n*-butyl or *isobutyl*-, is identical with *dl*-dihydro-*de-N*-methylheliotridane,³⁰ Menschikov suggested that the latter must be 1 : 3-dimethyl-2-*n*-propylpyrrolidine (I) which could arise from 1-methylpyrrolizidine (II) representing heliotridane. In support of that view it was found that 2-*sec*butylpyrrolidine (III), on treatment with sodium hypobromite at -5° , yielded a bromo-amine which, when heated with sulphuric acid, was converted into *dl*-heliotridane (1937)²⁸ characterised by its picrate, m.p. 236°. The accuracy of this view was settled by Adams and Rogers,³¹ who synthesised 1 : 3-dimethyl-2-*n*-propylpyrrolidine

(I) of which one form (picrate, m.p. 116°) is identical with *dl*-dihydro-de-N-methylheliotridane and the other (picrate, m.p. 126°) is diastereoisomeric with, and convertible into, it by, dehydrogenation to the corresponding pyrrole and hydrogenation of the latter in presence of copper chromite as catalyst.

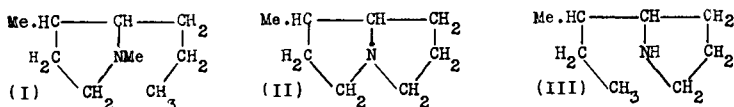

A complete synthesis of *dl*-heliotridane has been effected by Prelog and Zalan,³² using Prelog's general method for the synthesis of dicyclic amines, the proximate, primary material in this case being 1 : 7-dibromo-4-amino-3-methylheptane hydrobromide,

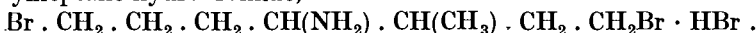

which on treatment with dilute alkali gives *dl*-heliotridane (II). As the latter contains two asymmetric carbon atoms, two diastereoisomeric racemates might be produced in this reaction but only one was formed. It had density and refractive index in general agreement with those recorded for *l*-heliotridane, as were also the melting points of characteristic derivatives. Density D_4^{20} 0.902, refractive index n_D^{20} 1.4638 (*cf.* with Adams and Rogers,³¹ D_4^{25} 0.935, n_D^{20} 1.4641), picrate, m.p. 234–6° (literature 232–6°), picrolonate, m.p. 162–3°, aurichloride, m.p. 200–1° (Konovalova and Orekhov give for these two constants 152–3° and 199–200° respectively).

The nature of the nucleus in the group of necines having thus been definitely established, Adams and his co-workers turned attention to the location of the hydroxyl groups and the position of the ethylenic linkage in retronecine. After discussion of the former problem in a series of papers,³³ consideration of the differences in reactivity of the two hydroxyl groups in retronecine and of the relative basic strengths of retronecine and its derivatives, led to the proposal of formula (IV), with a primary carbinol group at C¹, a secondary carbinol group, at first placed at either C⁶ or C⁷, but eventually shown to be at C⁷, and an ethylenic linkage at either C¹—C⁸ or C¹—C² and later proved to be in the latter position. Experimental proof of the nature of the hydroxyl groups was provided in the following way (Adams and Hamlin)³³ :—

Platynecine, C₈H₁₅O₂N, prepared by the hydrogenation of retronecine, C₈H₁₃O₂N, was converted to the monobenzoylechloroplatynecine, ClHC · C₆H₁₀N · CH₂ · O · Bz, m.p. 72–3°, $[\alpha]_D^{29}$ – 14.5°, of Konovalova and Orekhov,¹⁷ and this hydrogenated in alcohol with Raney nickel as catalyst, producing *isoretronecanol benzoate*, m.p. 56–7°, $[\alpha]_D^{28}$ – 60.8°, which was hydrolysed to *isoretronecanol* (VI), m.p. 39–40°, $[\alpha]_D^{27}$ – 78.2°, picrate, m.p. 194–5° (*dec.*). This on oxidation by chromic acid in acetic acid produced 1-carboxypyrrolizidine (VII), m.p. 228–9° (*dec.*), $[\alpha]_D^{29}$ – 65.8°, which gives a picrate, m.p. 220–1° (*dec.*), and with diazomethane forms the methyl betaine characterised by its picrate, m.p. 194–5° (*dec.*), and aurichloride, m.p. 224–5° (*dec.*).

Evidence that the second hydroxyl is in a secondary alcohol group was found in the oxidation of retronecanol, $C_8H_{15}ON$, (VIII) by aluminium *tert*-butyloxyde in presence of cyclohexanone, to *retronecanone*, $C_8H_{13}ON$, b.p. $95-6^\circ/15$ mm., $[\alpha]_D^{30} - 96.7^\circ$, which forms a semicarbazone, m.p. $209-210^\circ$ (*dec.*), an oxime, m.p. $167-8^\circ$, $[\alpha]_D^{26} - 76.0^\circ$, and a picrate, m.p. 195° (*dec.*).

Evidence for the location of the secondary alcohol group at C⁷ was provided by the synthesis of *l*-retronecanone by Adams and Leonard.³⁴ Starting from ethyl 3-methylpyrrolidine-2-carboxylate (X), synthesised by a complex series of reactions, similar to those used by Fischer and Zemplén,³⁵ for the preparation of proline (pyrrolidine-2-carboxylic acid), Adams and Leonard combined this ester with ethyl acrylate to form ethyl β -N-(3-methyl-2-carbethoxypyrrolidyl)-propionate (XI) which was cyclised. The crude product containing the resulting keto-ester was hydrolysed and decarboxylated, by heating with hydrochloric acid, to 1-methyl-7-ketopyrrolizidine (IX). The series of reactions was repeated, using the *l*-form of β -methyl- δ -*m*-nitrobenzoylaminovaleric acid, one of the intermediates used in the synthesis of ethyl 3-methylpyrrolidine-2-carboxylate (X) to get an *l*-form of 1-methyl-7-ketopyrrolizidine. It was thus possible to compare derivatives of (a) *dl*-1-methyl-7-ketopyrrolizidine, (b) *l*-1-methyl-7-ketopyrrolizidine, and (c) *l*-retronecanone, of which (b) and (c) proved to be identical, as shown in the following table:—

Specimen	b p	[α]	Oxime				Picrate
			m p	[α] _D	Picrate, m p	Picrolonate, m p	m p
(a)	96.5-98°/18 mm.	—	128-130°	nil.	—	—	189-190°
(b)	—	—	166-7°	- 77.3°	188-190°	209-211°	—
(c)	95-6°/15 mm. .	- 96.7°	167-8°	- 76.0°	188-190°	209-210°	195°

In view of the identity, so proved, of 1-methyl-7-ketopyrrolizidine (IX) with retronecanone, it follows that the carbonyl group in the latter must be at C⁷, and that this must also be the position of the secondary carbinol group in retronecine (IV), retronecanol (VIII), deoxyretronecine (XII) and platynecine (V), and also in heliotridine and hydroxyheliotridane, which Adams regards as stereoisomers of retronecine and retronecanol respectively.

The position of the ethylenic linkage at C¹ to C⁸ or C¹ to C² has been dealt with by Adams and Mahan.³⁶ When monocrotaline is catalytically hydrogenated until one molecule of hydrogen has been absorbed,²⁷ the normal basic hydrolytic product retronecanol (VIII) is replaced by deoxyretronecine (XII), $C_8H_{13}ON$, m.p. $77-8^\circ$, which forms a hydrochloride, m.p. $182-3^\circ$, $[\alpha]_D^{24} - 15.9^\circ$ (H₂O), and a picrate, m.p. $157-8^\circ$, and on further hydrogenation yields retronecanol (VIII) from which it differs by retaining the ethylenic linkage of the retronecine residue in monocrotaline. With thionyl chloride deoxyretronecine hydrochloride is

converted into chloro*isoheliotridene*, b.p. 59.5–60.5°/4.5 mm.; $[\alpha]_D^{32} + 50.1$, which is reduced by chromous chloride in hydrochloric acid to *isoheliotridene* (XIII), b.p. 73°/30 mm., $[\alpha]_D^{28} - 45.8^\circ$, picrate, m.p. 198.5–

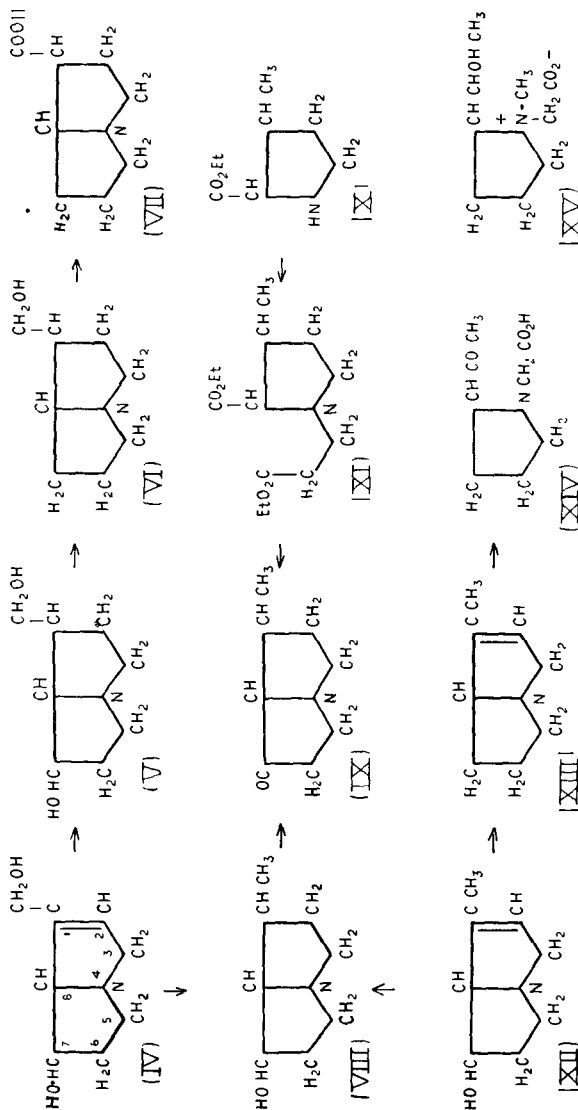

199.5°. This still retains the initial ethylenic linkage and can be hydrogenated to heliotridane (II). The hydrochloride in water is oxidised by ozone to 2-acetylpyrrolidinoacetic acid (XIV) hydrochloride, m.p. 180–1°, $[\alpha]_D^{27} - 4.4^\circ$ (MeOH). In this the presence of the .CO.CH₃ group is shown by a positive iodoform reaction and the formation of a 2 : 4-dinitro-

PYRROLIZIDINE GROUP

phenylhydrazone, m.p. 199–201° (*dec.*); the hydrochloride on hydrogenation furnishes the related hydroxy-acid, 2- α -hydroxyethylpyrrolidinoacetic acid, m.p. 186.5–187.5°, $[\alpha]_D^{28} - 63.5^\circ$ (H₂O), which with diazomethane forms the betaine (XV), itself an oil, but yielding a crystalline hydrochloride, m.p. 176–7°. The hydroxy-acid as hydrochloride, in acetic anhydride at 100°, is converted into the lactone, characterised by the picrate, m.p. 169–170°, and a methiodide, m.p. 242–3°. These results clearly indicate the C¹—C² position for the ethylenic linkage in retronecine, as shown in formula (IV).

Rosmarinecine, C₈H₁₅O₃N, derived from rosmarinine (p. 605), has m.p. 171–2°, $[\alpha]_D^{25} - 118.5^\circ$ (MeOH), gives a picrate, m.p. 175°, and a methiodide, m.p. 195°. It is not hydrogenated in presence of Adams's platinic oxide, and Richardson and Warren suggest that the third hydroxyl group is at C² (V : CH₂ → CHO at C²), which makes it a hydroxyplatynecine, a suggestion of some biological interest as platyphylline, one of the sources of platynecine, occurs with rosmarinine, by which it seems sometimes to be replaced. Senecic acid is the acid component in both alkaloids and occurs free in the plant.²⁰

Isatidine (p. 603) does not seem to be a derivative of 1-methylpyrrolizidine: its basic hydrolytic product, *isatinecine*, C₈H₁₃O₃N, has m.p. 212–5°, $[\alpha]_D^{20} + 22.4^\circ$ (H₂O): it has two ethylenic linkages, no methylimino- or methyl to carbon group, does not behave as a tertiary base, and gives well-marked pyrrole reactions. On these grounds it has been suggested that it is a partially reduced pyrrole with a side-chain .CH(:CH₂).CH₂.CH₃ at C². (De Waal, 1941.)¹²

The Necic Acids. There appears to be much more variety among the necic acids than among the necines, possibly because so little is known about them. Most of them are described briefly under their appropriate alkaloids, but there are at least four which need more detailed description.

Monocrotaline on alkaline hydrolysis yields retronecine and *monocrotic acid*, C₇H₁₂O₃, b.p. 145–6°/18 mm., $[\alpha]_D \pm 0^\circ$, which forms a *p*-bromophenacyl ester, m.p. 78°, and a methyl ester, b.p. 94–6°/18 mm., characterised by a 2:4-dinitrophenylhydrazone, m.p. 95–6° (*see below*). The acid gives the iodoform reaction and is oxidised by sodium hypobromite to a mixture of *dl*- and *meso*- $\alpha\alpha'$ -dimethylsuccinic acids (I). These and other reactions show that monocrotic acid is $\alpha\beta$ -dimethylævulic acid (II)^{14, 37} and this has been confirmed by comparison with a synthetic specimen of the acid. The methyl ester of the synthetic acid forms a mixture of 2:4-dinitrophenylhydrazones, m.p. 108–9° and 121–2°, into which the analogous product, m.p. 95–6°, first made from methyl monocrotate (*see above*), has also been separated.

When monocrotaline is hydrogenolysed the acid scission product is *monocrotalic acid*, C₈H₁₂O₅, m.p. 181–2°, $[\alpha]_D^{28} - 5.33^\circ$ (H₂O), which provides a methyl ester, m.p. 79–80°, $[\alpha]_D^{30} - 16.2^\circ$ (EtOH), containing one active H atom and a *p*-bromophenacyl ester, m.p. 162–3°. It is a lactonic acid, which on boiling with sodium hydroxide solution loses carbon dioxide and produces $\alpha\beta$ -dimethylævulic acid (monocrotic acid, II).

This fact limits the range of structural formulæ, which might be proposed for crotalic acid, but does not simplify the problem of selection. Three formulæ have been considered of which the first and second were eliminated after exploratory synthetic work and the remaining proposal (III) is now under investigation.^{37, 38}

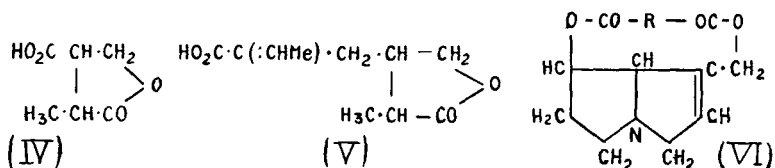
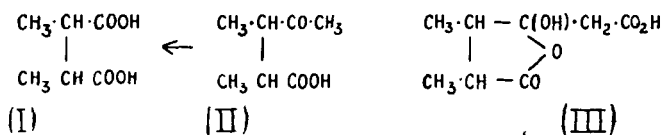

On hydrolysis by boiling aqueous solution of barium hydroxide, isatidine (p. 603) yields two acid products. *Isatinecic acid*, $\text{C}_{10}\text{H}_{16}\text{O}_6$, m.p. 148.5°, $[\alpha]_{\text{D}}^{20} + 86^\circ$ (H_2O), which appears to contain one ethylenic linkage, one carboxyl group and one "per-carboxyl" group ($\text{R} \cdot \text{CO} \cdot \text{O} \cdot \text{O}$), the evidence for the latter being the liberation of iodine from neutral or alkaline potassium iodide solution. The second product is *isatinecic monolactonic acid*, $\text{C}_{10}\text{H}_{14}\text{O}_5$, m.p. 197-8°, $[\alpha]_{\text{D}}^{20} + 108.8^\circ$, which contains one carboxyl and one lactone group, the latter being produced, it is suggested, by lactonisation of the per-carboxyl group of isatinecic acid during prolonged heating in the hydrolysis of isatidine.

The name *isatinecic acid* has also been used for an acid, $\text{C}_{10}\text{H}_{16}\text{O}_6$, m.p. 181.5°, formed when isatidine is hydrolysed by potassium hydroxide in boiling alcohol.¹²

The acid product from the hydrolysis of platyphylline (p. 604), rosmarinine (p. 605), or senecionine (p. 606) is the same and, depending on the procedure adopted, may be isolated as *senecic acid lactone* or *senecic acid*.²⁰ The latter has the formula $\text{C}_{10}\text{H}_{16}\text{O}_5$, m.p. 151°, $[\alpha]_{\text{D}}^{25} + 11.8^\circ$ (EtOH), and appears to be a dicarboxylic acid with a hydroxyl group in the γ -position to one or both of the carboxyls, so that the acid passes readily into the *lactone acid*, $\text{C}_{10}\text{H}_{14}\text{O}_4$, m.p. 156°, $[\alpha]_{\text{D}}^{25} + 38.9^\circ$ (EtOH), which has sometimes been described as the acid (Barger and Blackie).²² The lactone acid contains three C—Me groups and an ethylenic linkage. It forms a dihydro-derivative, $\text{C}_{10}\text{H}_{16}\text{O}_4$, m.p. 106°, and on oxidation with nitric acid yields an acid, $\text{C}_6\text{H}_8\text{O}_4$, m.p. 142°, which Manske⁴ suggests may be the methylparaconic acid (IV) derivable from (V) suggested as a possible representation of senecic acid lactone.

No connection appears to have been traced between the Senecio alkaloids and the senecioic acid ($\beta\beta$ -dimethylacrylic acid) found by Asahina in *Senecio Kaempferi*.³⁹

The acid product from heliotrine (p. 603), *heliotric acid*, $\text{C}_8\text{H}_{16}\text{O}_4$,

m.p. 92.5–94.5°, $[\alpha]_D - 12^\circ$ (H₂O), is described as monobasic and containing one hydroxyl and one methoxyl group. It is oxidised by lead peroxide in dilute phosphoric acid to 2-methyl-4-methoxy-3-pentanone, b.p. 144–5°, $[\alpha]_D + 22.5^\circ$, giving an oxime, m.p. 108–9°, and a semicarbazone, m.p. 146–7°, whose constitution was established by its reactions. On this basis heliotric acid is believed to be 2-methyl-3-hydroxy-4-methoxy-pentane-3-carboxylic acid, CH₃ . CHMe . C(OH)(COOH) . CHOMe . CH₃.⁴⁰

On the evidence available there is no reason to doubt that the “necyl-necines” or parent alkaloids of this group are constituted normally, in which case (VI; p. 613) probably represents a typical retronecine ester.

Toxicology. Senecio species are no longer used in modern medicine,⁵ and practical interest in them arises from the fact that they produce disease in farm animals kept in pastures infested with them. Poisoning cases in human beings have also occurred through the presence of Senecio seed in food-grains, where the latter have been grown as crops in fields infested by these noxious weeds. The resultant disease is variously named in Canada, New Zealand, South Africa, Norway and elsewhere, but it has one common feature, liver necrosis. Since the definite association of this disease with Senecio alkaloids by Cushny² and Watt,¹ numerous poisoning cases, especially in animals, have been recorded,⁴¹ and many toxicity trials have been made with single Senecio species.⁴² More recently much detailed pharmacological work has been done by K. K. Chen⁴³ and his colleagues on the various Senecio alkaloids. The alkaloids vary in degree of toxicity and in details of pharmacological action, but the characteristic effect of the group is the production of liver necrosis, which is usually central, but may be predominantly periportal as with pterophine and carthamoidiine. The latter alkaloid was isolated from *Senecio carthamoides* by Adams but has not yet been described chemically. Chen, Harris and Rose⁴³ (1940) have noted that platyphylline, which seems to be less prone to cause liver necrosis than its allies, has an atropine-like action on the eye and the intestine, and Goldenhershel⁴⁴ has made a detailed study of the alkaloid as a possible substitute for atropine and concludes that at least as an antispasmodic in diseases of abdominal organs it has advantages over atropine. It appears to be generally agreed among the Russian workers that as a parasympathetic drug atropine is from 20 to 30 times more potent than platyphylline.

Trachelantamine, according to Syrneva,⁴⁴ has a weak atropine-like action and also produces local anaesthesia. Its hydrolytic product, trachelantamidine, which is structurally identical with isoretronecanol, yields a *p*-aminobenzoyl derivative of which the crystalline hydrochloride, m.p. 230–2°, is said to be as potent a local anaesthetic as cocaine hydrochloride. The chloro-*ψ*-heliotridane (p. 606) formed by the action of thionyl chloride on trachelantamidine reacts with 6-methoxy-8-aminoquinoline to form 6-methoxy-8-(*pseudoheliotridylamino*)-quinoline,

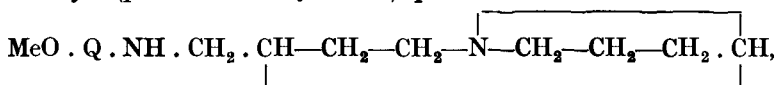

which as the dihydrochloride, m.p. 180–2° (*dec.*), was tried in malaria in finches and found to have a chemotherapeutic index 5 to 6 less than that of plasmoquin.

A detailed study has been made of the pharmacology and toxic effects of *Senecio Riddellii* and its alkaloid by Rosenfeld and Beath.⁴⁵

Attention has been called recently to *Amsinckia intermedia* as causing liver necrosis in swine, horses and cattle. Like *Heliotropium* and *Tri-chodesma*, it belongs to the Boraginaceæ.⁴⁶

REFERENCES

- (1) *J. Chem. Soc.*, 1909, 95, 466; *Bull. Imp. Inst.*, 1911, 9, 346. (2) *Proc. Roy. Soc.*, 1911, B, 84, 188; *cf. J. S. Afr. Med. Res.*, 1920, 18, 346. (3) MANSKE, *Can. J. Res.*, 1936, 14, 6; *cf. KELLY and LYNN, J. Amer. Pharm. Assoc.*, 1931, 20, 755. (4) BARGER and BLACKIE, *J. Chem. Soc.*, 1937, 584; MANSKE,¹¹ (5) BLACKIE, *Pharm. J.*, 1937, 138, 102. (6) MARAIS, *Onderstepoort J.*, 1944, 20, 61. (6a) MÜLLER, "Heil- und Gewürz-pflanzen," 1924 (*Chem. Zentr.*, 1925, ii, 1049). (7) DE WAAL, *Onderstepoort J.*, 1941, 16, 149–165. (8) ADAMS, CARMACK and ROGERS, *J. Amer. Chem. Soc.*, 1942, 64, 571. (8a) KONOVALOVA and MENSCHIKOV, *J. Gen. Chem., U.R.S.S.*, 1945, 15, 328. (9) MENSCHIKOV, *Ber.*, 1932, 65, 974; 1933, 66, 875; 1935, 68, 1051; (with SCHDANOWITSCH), 1936, 69, 1110. (10) MANSKE, *J. Can. Res.*, 1939, B, 17, 8. (11) *Idem, ibid.*, p. 1. (12) DE WAAL, *Onderstepoort J.*, 1939, 12, 155; 1940, 14, 433; 1941, 16, 149. (13) MANSKE, *Can. J. Res.*, 1931, 5, 651; HOSKING and BRANDT, *New Zealand J. Sci. Tech.*, 1936, 14, 638; BARGER and BLACKIE.⁴ (14) ADAMS and ROGERS, *J. Amer. Chem. Soc.*, 1939, 61, 2815; *cf. NEAL, RUSOFF and AHMANN, ibid.*, 1935, 57, 2560. (15) ZDANOVICH and MENSCHIKOV, *J. Gen. Chem., U.R.S.S.*, 1941, 11, 835, *cf. KONOVALOVA* (with GUREWITSCH and OREKHOV), *Bull. Acad. Sci. U.R.S.S. Ser. Chim.*; 1936, 961. (16) DE WAAL and TIEDT, *Onderstepoort J.*, 1940, 15, 251; RICHARDSON and WARREN, *J. Chem. Soc.*, 1943, 452. (17) OREKHOV and TIEDEBEL, *Ber.*, 1935, 68, 650; (with KONOVALOVA), *ibid.*, p. 1186, and *J. Gen. Chem. U.R.S.S.*, 1938, 8, 273 (*Chem. Abstr.*, 1938, 32, 5403); *Bull. Soc. Chim.*, 1937, [v], 4, 2037. (18) *Onderstepoort J.*, 1941, 16, 158. (19) MANSKE¹¹; ADAMS *et al.*, *J. Amer. Chem. Soc.*, 1942, 64, 2760. (20) RICHARDSON and WARREN¹⁶; DE WAAL and TIEDT, *Onderstepoort J.*, 1940, 15, 241; DE WAAL, *ibid.*, 1941, 16, 156. (21) DE WAAL and PRETORIUS, *Onderstepoort J.*, 1941, 17, 181. (22) BARGER and BLACKIE, *J. Chem. Soc.*, 1936, 743; *cf. KONOVALOVA and OREKHOV, Bull. Soc. Chim.*, 1937 [v], 4, 1285. (23) GRANDVAL and LAJOUX, *Compt rend.*, 1895, 120, 1120; MANSKE, *Can. J. Res.*, 1936, 14, B, 6; BARGER and BLACKIE.²² (24) MENSCHIKOV (with BORODINA), *J. Gen. Chem., U.R.S.S.*, 1941, 11, 209; 1945, 15, 225; MENSCHIKOV, *ibid.*, 1947, 17, 343; (with GUREWITSCH), *idem*, p. 1714. (25) MENSCHIKOV and RUBINSTEIN, *Ber.*, 1935, 68, 2039; KONOVALOVA and OREKHOV (1937).¹⁵ (26) MANSKE, *Can. J. Res.*, 1931, 5, 651; 1936, B, 14, 6; BARGER, SESHADRI, WATT and YABUTA, *J. Chem. Soc.*, 1935, 11. (27) ADAMS and ROGERS, *J. Amer. Chem. Soc.*, 1941, 63, 537. (28) *Ber.*, 1935, 68, 1555; *Bull. Acad. Sci. U.R.S.S. Ser. Chem.*, 1937, 1035. (29) *J. Gen. Chem. Russ.*, 1937, 7, 1632. (30) (With SCHDANOWITSCH), *Ber.*, 1936, 69, 1799. (31) *J. Amer. Chem. Soc.*, 1941, 63, 228. (32) *Helv. Chim. Acta*, 1944, 27, 531; *cf. Ber.*, 1939, 72, 1101; *Annalen*, 1940, 545, 230; CLEMO and MELROSE, *J. Chem. Soc.*, 1942, 424, and GALINOWSKY and REICHARD, *Ber.*, 1944, 77, 138. (33) (With ROGERS), *J. Amer. Chem. Soc.*, 1941, 63, 537; (with CARMACK and MAHAN), 1942, 64, 2593; (with HAMLIN), 1942, 64, 2597. (34) *ibid.*, 1944, 66, 257. (35) *Ber.*, 1909, 42, 2989. (36) *J. Amer. Chem. Soc.*, 1943, 65, 2009. (37) ADAMS (with ROGERS and SPRULES), *ibid.*, 1939, 61, 2819; (with ROGERS and LONG), *ibid.*, 2822; (with LONG), *ibid.*, 1940, 62, 2289. (38) (With WILKINSON), *ibid.*, 1943, 65, 2203. (39) *Arch. Pharm.*, 1918, 251, 355. (40) MENSCHIKOV, *J. Gen. Chem., U.R.S.S.*, 1939, 9, 1851 (*Brit. Chem. Abstracts*, 1940, A ii, 152). (41) *Nature*, Dec. 16th, 1920, p. 508; *Lancet*, Oct. 23rd, 1920, p. 848; Nov. 27th, 1089; Dec. 18th, 1266. Useful accounts of the causative plants and of the disease as it occurs in S. Africa are given by WATT and

BREYER-BRANDWIJK, "Medicinal and Poisonous Plants of S. Africa," 1932, p. 198; STEYN, *Onderstepoort J.*, 1937, 9, 116, and "The Toxicology of Plants in S. Africa," 1934, p. 457. See also KHAYAT and GILDER, *Trans. Roy. Soc. Trop. Med.*, 1947, 41, 119. (42) See, for example, WATT and BREYER-BRANDWIJK⁴¹; STEYN and VAN DER WALT, *Onderstepoort J.*, 1941, 16, 119. (43) (With HARRIS and SCHULZE), *J. Pharm. Exp. Ther.*, 1940, 68, 123; (with HARRIS and ROSE), platyphylline, seneciophylline and lasiocarpine, *ibid.*, p. 130; 1943, 78, 372; (with HARRIS and ANDERSON), integerrimine, jacobine, longilobine, senecionine, spartioidine, *ibid.* 1942, 75, 69; monocrotaline and retronecine, *ibid.*, p. 78; isatidine, pterophine, scleratine., *ibid.* 83,; riddelline, *ibid.*, 1943, 78, 372; carthamoidine, *ibid.*, 1943, 79, 133; 1946, 87, 382; general (with ROSE, FINK and HARRIS), *ibid.*, 1945, 83, 265. (44) *Klinicheskaya*, 1943, 31, 56 (*Amer. Rev. Soviet Med.*, 1943, 1, 155); BABSKY, *Compt. rend. Acad. Sci., U.R.S.S.*, 1940, 27, 83; KOVYREV, *Byull. Ekspit. Biol. Med.*, 1941, 11, 92 (*Chem. Abstr.*, 1944, 38, 5597); SYRNEVA, *Farmakol i Toksikol.*, 1946, 9, 15, 45 (*Chem. Abstr.*, 1947, 41, 6987); quoted by MENSCHIKOV and GUREWITSCH,²⁴ (1947). (45) *Amer. J. Clin. Path.*, 1945, 15, 407; *J. Amer. Pharm. Assoc.*, 1947, 36, 331. (46) McCULLOCH, *Science*, 1940, 91, 95; GROVES, *Wash. Agric. Exp. Stat. Bulln.*, 1941, 410, 35. (47) NOVELLI and de VARELA, *Anal. Asoc. Quim. Arg.*, 1945, 33, 176 (*Brit. Abstr.*, 1947, A ii., 219).

QUINAZOLINE GROUP

Vasicine (*Peganine*), $C_{11}H_{12}ON_2$. This alkaloid was isolated from the leaves of *Adhatoda vasica* Nees (*Acanthaceae*) by Hooper,¹ and was again prepared by Sen and Ghose.² It was subsequently obtained by Merck from *Peganum Harmala* (p. 488), and was investigated by Späth and Nikawitz³ under the name "peganine." According to Pallares, the water-soluble red pigment found in the bark of "Sangre de drago," on hydrolysis by acid furnishes *l*-peganine.^{3(a)} Vasicine has m.p. 198° (*dec.*) or $211-12^\circ$ (*vac.*), $[\alpha]_D \pm 0^\circ$, and yields crystalline salts; hydrochloride, B. HCl. $2H_2O$, m.p. 208° (*dry*); hydriodide, B. HI. $2H_2O$, m.p. 195° (*dry*); picrate, m.p. 199° (*dec.*); and methiodide, m.p. 187° .

Constitution. Ghose⁴ suggested that vasicine is probably either 2-propyl-(or 2-isopropyl)-4-hydroxyquinazoline on the following grounds: (1) it was converted by phosphorus pentachloride and oxychloride into deoxychlorovasicine, $C_{11}H_{11}N_2Cl$ (greenish platelets, m.p. $136-7^\circ$), which on reduction furnished a base, $C_{11}H_{12}N_2 \cdot 0.5H_2O$, m.p. $87-8^\circ$; B. HCl, m.p. $255-6^\circ$, subsequently named deoxyvasicine (p. 618); (2) it was oxidised by potassium permanganate to 4-hydroxyquinazoline; (3) on fusion with potassium hydroxide it yielded acetic and *o*-aminobenzoic acids. De and Rây⁵ prepared 2-propyl- and 2-isopropyl-4-hydroxyquinazolines and found that neither was identical with vasicine, and a reinvestigation by Ghose, Krishna, Narang and Rây⁶ showed that the permanganate oxidation product was 4-quinazolone (I). With acetic anhydride vasicine gives an anomalous acetyl derivative, $C_{13}H_{12}ON_2$, m.p. 165° (subsequently shown by Späth *et al.* to be *N*-acetylpegadiene; the normal *O*-acetylvasicine has m.p. 122°). On the basis of these results the Indian authors suggested formula (II) for vasicine and formula (III) for *isovasicine*, m.p. 164° , an isomeride stated to be produced by the action of alkali on the natural alkaloid. In their investigation of peganine Späth and Nikawitz³ came to the conclusion that their experimental data were best accounted for by formula (IV). The chief new reaction concerned is the formation from vasicine by oxidation with potassium permanganate of 4-keto-3:4-dihydroquinazolyl-3-acetic acid (V), of which the methyl ester (m.p. 152°) is hydrolysed by potassium hydroxide solution to *o*-aminobenzoic and aminoacetic acids, the latter being isolated in the form of its benzoyl-derivative (hippuric acid).

The substance represented by formula (IV), *viz.*, 4-hydroxy-3-allyl-3:4-dihydroquinazoline, m.p. 130° , was synthesised by Reynolds and Robinson,⁷ and proved to be different from vasicine. Späth and Kuffner⁸ established the identity of the degradation product (V), upon which formula (IV) for vasicine was chiefly based by synthesis from isatoic anhydride, which, on treatment with glycine ester hydrochloride and sodium methoxide, gave the substituted hippuric acid (VI), and this, on heating with

formic acid gave (V). Narang and Rây⁹ then proposed for consideration two formulæ (VII) and (VIII), of which (VII) was preferred, and at the same time apparently accepted the identity of vasicine and peganine, of

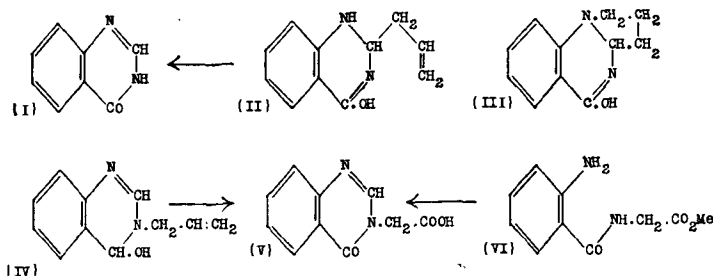

which they had previously expressed doubt.¹⁰ Formulæ of the types (II), (IV) and (VII) were rendered untenable by the work of Hanford, Liang and Adams,¹¹ who showed that reduction of 3-allyl-3 : 4-dihydroquinazoline (IX) (which is not identical with deoxyvasicine as it should be if vasicine were (IV)) or of its ketoderivative (IX : CO at 4) gave 3-allyl-1 : 2 : 3 : 4-tetrahydroquinazoline (reduction of the linkage $N^1=C^2$ in IX), which is not identical with dihydrodeoxyvasicine, $C_{11}H_{14}N_2$, m.p. 69–70°; picrate, m.p. 185°, prepared by reduction of vasicine with sodium and amyl alcohol. Dihydrodeoxyvasicine proved to be identical with “deoxytetrahydropeganine” previously prepared in this manner by Späth and Nikawitz³ from peganine.

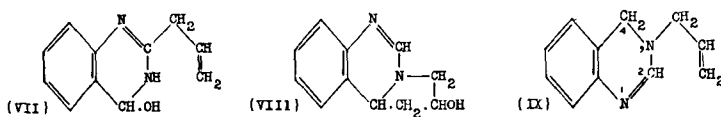

The American authors suggested (X) or (XI), already considered by Späth and Nikawitz³ for vasicine, and support for a formula of type (XI) was provided by Späth, Kuffner and Platzer,¹² who, by condensing *o*-nitrobenzyl chloride with methyl γ -aminobutyrate to *o*-nitrobenzylpyrrolidone (XII), reduction of this to the amino-compound (XII : $NO_2 \rightarrow NH_2$) and ring-closure in presence of phosphoryl chloride obtained the base Δ^9 -pegene (XIII), m.p. 99–100°, identical with the product formed by the reduction of deoxychloropeganine. The same substance (XIII) was synthesised independently by Hanford and Adams,¹³ who identified it with Ghose's deoxyvasicine, $C_{11}H_{12}N_2$ (m.p. 96.5–97.5° (*dry*); picrate, m.p. 205–6°, *cf.* p. 617). Morris, Hanford and Adams¹³ then showed that in vasicine the hydroxyl group was probably at α instead of β as shown in (XI), and the proof of this constitution for the alkaloid was provided by Späth, Kuffner and Platzer,¹⁴ who found that 1-*o*-amino-benzylpyrrolidine was identical with deoxyhexahydrovasicine and synthesised vasicine by the following method.¹⁵ Methyl γ -phthalimidobutyrate (XIV) was hydrolysed to the acid and converted by bromination followed

by hydrolysis into γ -phthalimido- α -hydroxybutyric acid (XV). This was freed from its phthalic acid residue and the methyl ester of the resulting γ -amino- α -hydroxybutyric acid (XVI) condensed with *o*-nitrobenzyl

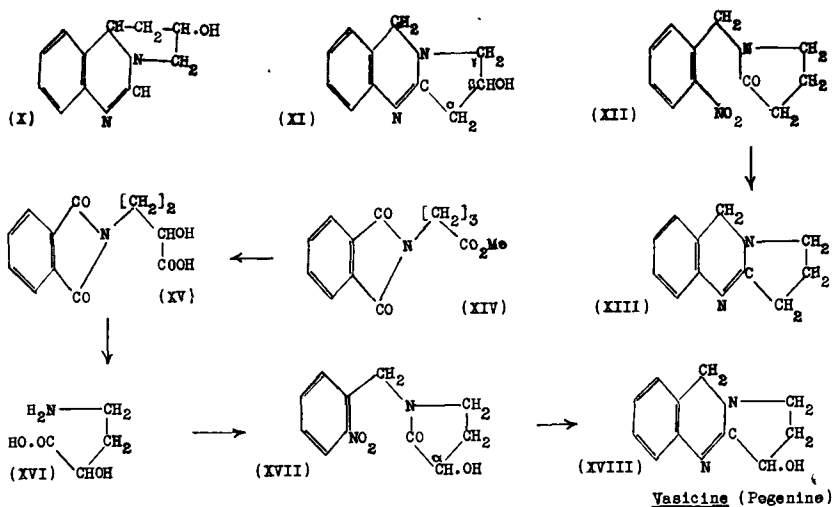

chloride to 3-hydroxy-1-*o*-nitrobenzylpyrrolidone (XVII), which, on reduction by tin and hydrogen chloride in acetic acid, gives, through the corresponding amino-compound, vasicine (XVIII), m.p. 211–2° (peganine, 3-hydroxy- Δ^9 -pegene). Späth, Kuffner and Platzer¹⁶ resolved vasicine by crystallisation of the *d*- and *l*-tartrates in succession into *l*-vasicine, m.p. 211–2° (*vac.*), after softening at 197–200°, $[\alpha]_{\text{D}}^{24} - 159^\circ, -189^\circ, -203^\circ$ ($c = 1.04, 2.01, 2.66$; CHCl_3), or $+31.4^\circ$ ($c = 1.94$; HCl). The *d*-form showed like variation of $[\alpha]_{\text{D}}$; both forms racemised on repeated sublimation *in vacuo*, or when heated with hydrochloric acid (5 per cent.) at 100°. Later the same authors¹⁷ effected a simpler synthesis of vasicine by condensing *o*-aminobenzylamine with α -hydroxy-butylolactone. Though Hooper's original vasicine was slightly dextrorotatory as the sulphate, all the later preparations from *Adhatoda vasica* or *Peganum Harmala* had been optically inactive, but Späth and Keszler¹⁸ were able to prepare *l*-vasicine from the fresh leaves of the former plant and Rosenfeld and Kolesnikow¹⁹ isolated the same form from the flowers and stems of *Peganum Harmala*. Finally reference must be made to Schöpf and Oechler's²⁰ synthesis of deoxyvasicine under conditions which might occur naturally, and based on the observation that under suitable conditions *o*-aminobenzaldehyde, primary bases and formaldehyde give 4-hydroxy-3-alkyltetrahydroquinazolines, which react as ψ -bases of 3-alkyl-1:2-dihydroquinazol-3-inium salts, which in turn yield 4-hydroxy-3-alkyl-3:4-dihydroquinazolines. *o*-Aminobenzaldehyde with γ -aminobutyraldehyde (used as the diethyl-acetal) in a citrate buffer solution (pH 4.8–5.0) at 30° for four days probably produces 4-hydroxy-2:3-cyclo pntanotetrahydroquinazoline, since addi-

tion of picric acid leads to precipitation of 2 : 3-cyclopentano-1 : 2-dihydroquinazol-3-inium (XIX) picrate, m.p. 168–170°. If, however, the reaction mixture is treated with palladium-black and hydrogen, prior to the addition of picric acid, deoxyvasicine (Δ^9 -pegene, XIII) is obtained, due to a shift of two hydrogen atoms. It is suggested that under natural conditions *o*-aminobenzaldehyde might arise from tryptophan, and the unknown aminohydroxybutyraldehyde (XX) required for a corresponding biogenesis of vasicine from hydroxyornithine (XXI).

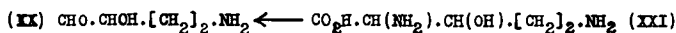
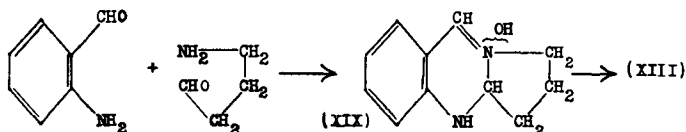

Mention should also be made of a number of other papers relating to syntheses of products allied to vasicine or to discussions on reactions bearing on the constitution of the latter.²¹

The crude drug, *Adhatoda vasica*, is used in India as a remedy for asthma. According to Chopra,²² vasicine produces broncho-dilation and might be used clinically as an expectorant. A detailed pharmacological examination of peganine in comparison with harmine has been made by Tutaev and Makarova.²³

REFERENCES

- (1) *Pharm. J.*, 1888, [iii], 18, 841. (2) *J. Ind. Chem. Soc.*, 1924, 1, 315. (3) *Ber.*, 1934, 67, 45; SPÄTH and KUFFNER, *ibid.*, p. 868. (3a) *Arch Bioquim.*, 1946, 10, 235 (*Chem. Abstr.*, 1946, 40, 6487). (4) *J. Ind. Chem. Soc.*, 1927, 4, 1. (5) *Ibid.*, 1927, 4, 541. (6) *J. Chem. Soc.*, 1932, 2740; *Current Sci.*, 1935, 4, 158; cf. MORRIS, HANFORD and ADAMS, *J. Amer. Chem. Soc.*, 1935, 57, 921, 951. (7) *Nature*, 1934, 134, 142; *J. Chem. Soc.*, 1936, 196. (8) SPÄTH and KUFFNER, *Ber.*, 1934, 67, 1494. (9) *Chem. and Ind.*, 1934, 53, 698; cf. *J. Chem. Soc.*, 1935, 1277. (10) *Current Sci.*, 1934, 2, 388. (11) *J. Amer. Chem. Soc.*, 1934, 56, 2780. (12) *Ber.*, 1935, 68, 497; for a second synthesis see *ibid.*, 1936, 69, 255. (13) *J. Amer. Chem. Soc.*, 1935, 57, 921; MORRIS, HANFORD and ADAMS, *ibid.*, p. 951. (14) *Ber.*, 1935, 68, 935. (15) *Ibid.*, 1935, 68, 699. (16) *Ibid.*, p. 1384. (17) *Ibid.*, 1936, 69, 255. (18) *Ibid.*, p. 384. (19) *Ibid.*, 1936, 69, 2022; cf. SPÄTH and ZAJIC, *ibid.*, p. 2449. (20) *Annalen*, 1936, 523, 1; cf. *ibid.*, 1935, 518, 127. (21) SPÄTH (with PLATZER), *Ber.*, 1935, 68, 2221; 1936, 69, 387; (with KUFFNER and LINTNER), *ibid.*, 1936, 69, 2052; (with KUFFNER), *ibid.*, 1938, 71, 1657; RÂY, NARANG and JUNEJA, *Current Sci.*, 1935, 3, 352, 552; *J. Chem. Soc.*, 1935, 1277; BERI, NARANG and RÂY, *J. Ind. Chem. Soc.*, 1935, 12, 395; NARANG and RÂY, *J. Chem. Soc.*, 1936, 686, 1570; KONEK, *Math. naturw. Anz. Ung. Akad. Wiss.*, 1936, 54, 452; AHMED, NARANG and RÂY, *J. Ind. Chem. Soc.*, 1938, 15, 152. (22) CHOPRA, *Ind. Med. Gaz.*, 1925, 60, 854. (23) *Trans. Ukrain. Inst. Exp. Pharm.*, 1938, 1, 32.

GLYOXALINE GROUP

ALKALOIDS OF *PILOCARPUS* SPP. (JABORANDI)

JABORANDI leaves were first used in medicine in 1874 by Dr. Coutinho, of Pernambuco, by whom the drug was sent to Europe. Holmes showed that up to 1893 jaborandi was obtained from *P. Jaborandi* Holmes and not as had been supposed from *P. pennatifolius* Lem. Since 1896 the place of these species has been taken by the leaves of *P. microphyllus* Stapf. The leaves of *P. Selloanus* Engler and *P. trachylophus* Holmes have also appeared on the market from time to time.

Pilocarpine, the chief alkaloid of the drug, was isolated by Hardy¹ and independently by Gerrard,² who obtained several of its salts crystalline. Harnack and Meyer³ isolated a second alkaloid, jaborine, which is a mixture of the various alkaloids of the drug (Jowett⁴), and in 1885 the same authors⁵ obtained pilocarpidine, the existence of which Jowett⁴ confirmed, though it does not occur in present-day jaborandi. In 1897 a third alkaloid was isolated by Petit and Polonovski⁶ from the leaves of *P. microphyllus* and named "pilocarpidine" [β -pilocarpine (Brühl), isopilocarpine (Jowett)], apparently under the impression that it was identical with Harnack and Meyer's base. A fourth alkaloid, pilosine, was obtained by Pyman. Petit and Polonovski have stated that *P. spicatus* leaves contain ψ -pilocarpine and ψ -jaborine. According to Imbesi,⁸ *P. pennatifolius* leaves grown in Sicily contain less alkaloid than the Brazilian drug.

The principal facts relating to the alkaloidal constituents of the leaves of *Pilocarpus* spp. are shown in the following table.

Name of Plant	Commercial Name	Constituents	Amount of Total Alkaloid per cent.	Amount of Crystalline Pilocarpine Nitrate obtained per cent.
<i>P. Jaborandi</i> (Holmes).	Pernambuco jaborandi.	Pilocarpine isopilocarpine (?) pilocarpidine	0.72 ⁷	0.67
<i>P. pennatifolius</i> (Lemaire).	Paraguay jaborandi	Pilocarpine isopilocarpine	0.2-0.3	—
<i>P. microphyllus</i> (Stapf).	Maranhão jaborandi	Pilocarpine isopilocarpine pilosine	0.76-0.78 ⁶	0.45 ⁷
<i>P. racemosus</i>	Guadeloupe jaborandi	Pilocarpine	—	0.12 ⁹
<i>P. trachylophus</i> (Holmes).	Ceara jaborandi	Not known	0.4 ⁷	—
<i>P. spicatus</i> (St. Hilaire).	Aracati jaborandi	ψ -Pilocarpine ψ -Jaborine	0.16 ⁷	—

The extraction of alkaloids from jaborandi has been dealt with by Würtzen,¹⁰ and the estimation of pilocarpine in the drug and its preparations by Jowett¹¹ and by Bourcet¹¹ and more recently by Taran⁸ and by Shupe.¹¹ Elvidge has devised a colorimetric method based on Ekkert's test,^{11(a)} and a polarographic study has been made by Kirkpatrick.^{11(b)} The two first-named authors depend on the isolation of pilocarpine nitrate, which is also the basis of the process of manufacture described by Chenmitius.¹²

Pilocarpine, $C_{11}H_{16}O_2N_2$. The base is a colourless oil, b.p. $260^\circ/5$ mm. (partially isomerised to *isopilocarpine* on distillation), $[\alpha]_D + 100.5^\circ$ ($CHCl_3$), but has been crystallised, m.p. 34° ; it is freely soluble in water, alcohol or chloroform, but almost insoluble in ether. The salts with acids crystallise well; the nitrate, B. HNO_3 , forms well-defined prisms, m.p. 178° , $[\alpha]_D + 82.9^\circ$ (H_2O), and dissolves in 6.4 parts of water at 20° or 146 parts of alcohol (95 per cent.) at 15° ; the hydrochloride, B. HCl , prisms, m.p. $204-5^\circ$, $[\alpha]_D + 91.74^\circ$. The hydrobromide forms small prisms, m.p. 185° , $[\alpha]_D + 77.05^\circ$; the aurichloride, B. $HAuCl_4 \cdot H_2O$, small lemon-yellow needles, m.p. $124-5^\circ$; and the picrate, needles, m.p. $161-2^\circ$.

Pilocarpine dissolves in dilute soda solution, and the rotation is thereby reduced, due to the formation of the sodium salt of pilocarpic acid, $C_{11}H_{16}O_3N_2$, of which pilocarpine is the lactone. Amorphous barium and copper salts have been prepared. Pilocarpine in dilute sulphuric acid gives with hydrogen peroxide, followed by potassium dichromate, a bluish-violet colour soluble in benzene.¹³ For the identification of the alkaloid Wagenaar¹⁴ recommends precipitation with gold chloride solution.

isoPilocarpine, $C_{11}H_{16}O_2N_2$. When pilocarpine is heated alone, or a solution in alcoholic soda is boiled, it is converted into an isomeride, *isopilocarpine*. The latter is found in the leaves of *P. microphyllus*, and, according to Jowett, may occur in the pilocarpine nitrate of commerce. It is a colourless, viscid oil, b.p. $261^\circ/10$ mm., $[\alpha]_D + 42.8^\circ$; the nitrate crystallises from water in prisms, m.p. 159° , $[\alpha]_D + 35.68^\circ$; the hydrochloride, (B. HCl)₂ · H_2O , has m.p. 127° or 159° (*dry*), and the aurichloride, B. $HAuCl_4$, forms lemon-yellow needles, m.p. $158-9^\circ$. When *isopilocarpine* is dissolved in water and a molecular proportion of soda added, the rotation falls to zero, due to the formation of sodium *isopilocarpate*.

Constitution of Pilocarpine and isoPilocarpine. Though numerous interesting observations have been made on these two alkaloids by M. and M. Polonovski,¹⁵ knowledge of their constitution is due principally to the work of Jowett⁴ and of Pinner.¹⁶

isoPilocarpine, on oxidation with permanganate, yields a mixture of acids separable by fractional distillation of the ethyl esters into pilopic acid, $C_7H_{10}O_4$, silky plates, m.p. 104° , $[\alpha]_D + 36.1^\circ$, and *homopilopic acid*, $C_8H_{12}O_4$, a thick, colourless oil, b.p. $235-7^\circ/20$ mm., $[\alpha]_D + 45.4^\circ$. Pilopic acid gives with cold barium hydroxide solution, a salt of the composition $(C_7H_9O_4)_2 \cdot Ba$, but with the boiling solution a barium salt of a hydroxydibasic acid is formed, $C_7H_{10}O_5 \cdot Ba$. Pilopic acid must therefore be a

lactic acid, yielding on hydrolysis a hydroxy-dibasic acid, $C_7H_{12}O_5$. On potash fusion it is converted into *n*-butyric acid. With cold baryta water *homopilop* acid furnishes a microcrystalline barium salt of the formula $(C_8H_{11}O_4)_2Ba$, and with boiling baryta water the salt of a dibasic hydroxy-acid, $C_8H_{12}O_5Ba$. It is therefore also a lactic acid. When fused with potassium hydroxide it furnishes α -ethyltricarballic acid, $COOH \cdot CH(C_2H_5) \cdot CH(COOH) \cdot CH_2 \cdot COOH$, which could be formed from one of the three isomeric hydroxy-acids of the following formulæ :—

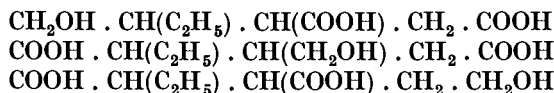

homoPilop acid is very stable, and is probably therefore the γ -lactic acid of one of these three hydroxy-acids. Further, pilop acid seems to be produced from its higher homologue by loss of carbon dioxide and oxidation of the contiguous carbon atom. Of the four γ -lactic acids derivable from these three hydroxy-acids only two (I and II) answer these conditions,

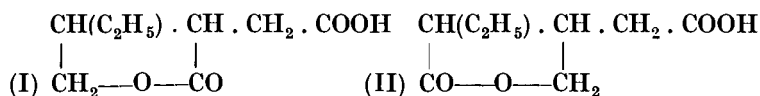

and these lead to the following possible formulæ for pilop acid :—

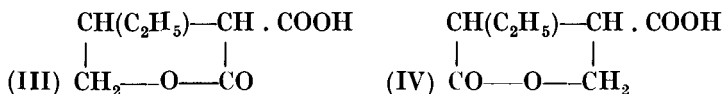

As a substance of formula (III) should lose carbon dioxide on heating, whereas pilop acid is stable even at 200° , it seemed probable that *homoPilop* acid is represented by (II) and pilop acid by (IV). Jowett also showed that pilocarpine, like *isopilop*carpine, yields *homopilop* acid when oxidised by permanganate.¹⁶ In the oxidation of the two alkaloids the two nitrogen atoms are eliminated as ammonia and methylamine.

From these and other experimental results Pinner and Schwarz¹⁷ suggested that pilocarpine could be represented by formula (V), and subsequently Jowett confirmed this by the preparation of a series of disubstituted glyoxalines from *isopilop*carpine by distillation with soda-lime,¹⁸ although he pointed out that the reactions of the alkaloid were

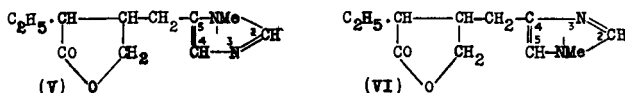

equally well accounted for by formula (VI), since it was then impossible to decide whether the dialkylglyoxalines produced on distillation with soda-lime were 1 : 4- or 1 : 5-derivatives.

The settlement of this point proved difficult, but the dimethylglyoxaline obtained by Jowett from *isopilop*carpine was finally shown by Pyman¹⁹ to be the 1 : 5-isomeride (b.p. $224-5^\circ$; aurichloride, m.p.

218–9°), since its nitro-derivative (VII), on reduction with stannous chloride, yielded as one product *dl*-*N*-methylalanine (VIII), whereas the isomeric dimethyl-glyoxaline (b.p. 198–9°; aurichloride, m.p. 137–8°) yielded a nitro-compound (IX), which on similar reduction furnished

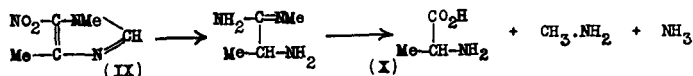
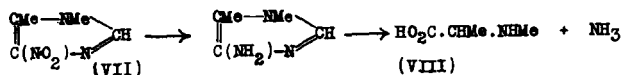

among other products *dl*-alanine (X) and must be the 1 : 4-isomeride. A further proof was provided by Burtles, Pyman and Roylance,²⁰ who, by the condensation of α -methylaminopropionacetal (XI) with thiocyanic acid, obtained 2-thiol-1 : 5-dimethylglyoxaline (XII), which, on oxidation with nitric acid, furnishes 1 : 5-dimethylglyoxaline (XIII), identified as the picrate, m.p. 167–8°, and aurichloride, m.p. 218–9°.

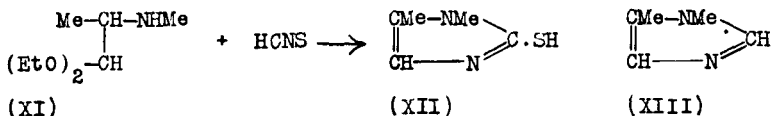

There are two asymmetric carbon atoms in the pilopyl residue, and the relationship between pilocarpine and *isopilocarpine* was assumed by Jowett²¹ to be stereochemical, whilst Pinner²² took the view that they might be structural isomerides dependent on the point of attachment of the pilopyl residue to the glyoxaline ring. Definite experimental evidence in favour of Jowett's view was provided by Langenbeck,²³ who showed (1) that the two alkaloids yielded different methiodides (examined as the methochloroplatinates, m.p. 223–4° and 224–5°, mixed m.p. 210°), whereas it is assumed 4- or 5-substituted glyoxalines should yield the same methiodide,¹⁹ and (2) that on ozonisation the two alkaloids yielded two different, well-defined methylamides, *viz.*, *homopilocarpic acid methylamide*, m.p. 104°, $[\alpha]_{546}^{15} + 147\cdot0^\circ$, and *homoisopilocarpic acid methylamide*, m.p. 53°, $[\alpha]_{546}^{15} + 104\cdot9^\circ$ respectively. This evidence seemed to indicate clearly that the difference between the two alkaloids is due to stereoisomerism in the pilopic acid residue. This view has been confirmed by a series of syntheses by Russian chemists,²⁴ which may be summarised thus: Diethyl formyl-ethylsuccinate (I: R = Et) was reduced by aluminium in wet ether to the ethylitamalates (II), which on heating gave a mixture of ethyl ethyl-paraconates (III) (ethyl pilopates or ethyl 2-keto-3-ethyltetrahydrofuran-4-carboxylates), separable into two racemic mixtures:—

(A) A liquid ester, $\text{C}_9\text{H}_{14}\text{O}_4$, b.p. 276–276·5°/751 mm., which hydrolysed to an acid, m.p. 87·5–88·0°, b.p. 184–5°/7·5 mm., separable by crystallisation of the strychnine salt into two acids, m.p. 105·5°, having $[\alpha]_{\text{D}}^{22} - 58\cdot06^\circ$ and $+ 58\cdot92^\circ$ respectively, the latter being identical with an acid obtainable from Jowett's pilopic acid (III: R = H), m.p. 104°,

$[\alpha]_D + 36.1^\circ$ (due to partial racemisation) by crystallisation of the strychnine salt, and, since it is obtained from *isopilocarpine*, is re-named *isopilopinic acid*. Independent syntheses of *dl-isopilopinic acid* have been effected by Welch.²⁵

(B) The second mixture of esters is solid, m.p. 48.5–49°, b.p. 283°/751 mm., and on hydrolysis yields a racemic acid, m.p. 90–1°, which, on heating at 180°, passes into the racemic *isopilopinic acid*, m.p. 87.5–88°, just as pilocarpine changes into *isopilocarpine* on heating. This labile acid was resolved by N. A. and V. A. Preobrashenski^{24(b)} into acids having m.p. 121.2–122.2°, $[\alpha]_D^{18^\circ} + 54.6^\circ$, and m.p. 120–121.8°, $[\alpha]_D^{18.5} - 54.0^\circ$ for *d*- and *l*-pilopinic acids respectively (III: R = H). The same authors with A. M. Poljakova^{24(c)} converted synthetic *dl*-pilopinic acid into *dl-homopilopinic acid* by conversion into the acid chloride (IV), reduction of the latter to the aldehyde, and finally to pilopyl alcohol (V), which was transformed *via* the chloride, iodide and nitrile to *dl-homopilopinic acid* (VI), m.p. 100–1°. For the conversion of *d*-pilopinic acid (III: R = H) into *d-homopilopinic acid*^{24(d)} (VI) an alternative method was used, *viz.*, treatment of *d*-pilopoyl chloride (IV) with diazomethane to form *d*-pilopoyl diazomethyl ketone (VIII), which, on treatment with sodium hyposulphite and silver oxide in water, gave *d-homopilopinic acid* (VI).

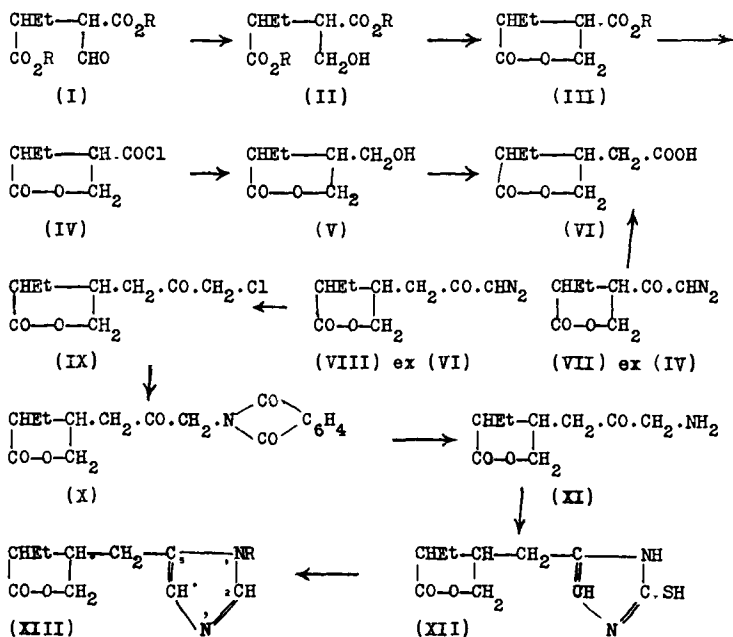

(XIII) Pilocarpidine R = H; Pilocarpine and isopilocarpine R = Me

The construction of *d*-pilocarpine was effected^{24(e)} by converting *d-homopilopoyl chloride* (VI: CO₂H → COCl) into diazomethyl *d-homopilopoyl ketone* (VIII), transformation of the latter by the action of hydro-

chloric acid into *d*-homopilopyl chloromethyl ketone (IX), m.p. 86–7°, $[\alpha]_D^{17} + 115.35^\circ$ (CHCl_3), which, with potassium phthalimide in boiling alcohol, yielded phthalimidomethyl *d*-homopilopyl ketone (X), m.p. 157–158.5°, $[\alpha]_D^{16} + 66.7^\circ$ (tetrachloroethane). The latter, on hydrolysis by hydrochloric acid gave aminomethyl *d*-homopilopyl ketone (XI) (hydrochloride, m.p. 179–181°, $[\alpha]_D^{17.95} + 90^\circ$), which, with potassium thiocyanate, yielded 2-thiol-5-*d*-homopilopyl glyoxaline (XII), m.p. 207–208.5° (*dec.*), $[\alpha]_D^{14} + 122.96^\circ$ (MeOH), and this, on oxidation with ferric chloride, furnished pilocarpidine (XIII: R = H) (nitrate, m.p. 132.5–133°, $[\alpha]_D^{19} + 71.78^\circ$ (H_2O)), which on methylation furnished pilocarpine (XIII: R = Me), isolated as the nitrate, m.p. 175.5–176.5°, $[\alpha]_D^{21} + 82.64^\circ$ (H_2O). The results of other syntheses effected by the general methods outlined above are given in the following table with reference numbers:—

Synthetic Product	Characters of Nitrate		Starting Material	Characters	
	m p	$[\alpha]_D$		b p or m p	$[\alpha]_D$
<i>iso</i> Pilocarpidine 24(f) . . .	112–113.5° (<i>dec</i>)	+ 27.63°	<i>d</i> -homoisopilopic acid.	b p 160.8°/0.01 mm	50.98°
<i>iso</i> Pilocarpine 24(f) . . .	158–158.5°	+ 55.62°		m p 74.2°	—
<i>dl</i> - <i>iso</i> Pilocarpidine 24(h) . . .	114–115°	—	<i>dl</i> -homoisopilopic acid 24(g)	m p 100–101°	—
<i>dl</i> - <i>iso</i> Pilocarpine 24(h) . . .	134–135°	—		m p 106–107°, 24(i)	—
<i>dl</i> -Pilocarpidine 24(i) . . .	123–129°	—	<i>dl</i> homopilopic acid 24(c)	m p 100–101°	—
<i>dl</i> -Pilocarpine 24(i) . . .	135–136°	—		m p 106–107°, 24(i)	—

In a general account of this work published by Preobrashenski, Poljakowa and Preobrashenski,²⁴⁽ⁱ⁾ the additional information is given that the results of an investigation based on the principles outlined by Freudenberg and Kuhn show that *isopilocarpine* is to be regarded as a *cis* and *pilocarpine* as a *trans* form. A technical method for the synthesis of *pilocarpine* is also described. More recently N. A. and V. A. Preobrashenski^{24(j)} have applied these methods, starting with *d*-pilopyl chloride to the synthesis of *d*-*norpilocarpidine*, isolated as the nitrate, m.p. 145–6°, and N. A. Preobrashenski with Kuleshowa^{24(k)} have in like manner synthesised a series of *pilocarpine* analogues such as *N*-*dl*-homoisopilopylimidazole (picrate, m.p. 133–4°), *N*-*dl*-isopilopylimidazole (picrate, m.p. 143–4°) and 2-*dl*-pilopylpyrimidazole (picrate, m.p. 167–8°).

Independent syntheses of *homo*- and *homoisopilopic* acids and of *dl*-pilocarpidine and *dl*-*isopilocarpidine* have been published by Dey.²⁵

Pilocarpidine, $\text{C}_{10}\text{H}_{14}\text{O}_2\text{N}_2$. This alkaloid was obtained by Harnack²⁶ from *P. Jaborandi*, and later by Merck from the mother liquors from crystallisation of *pilocarpine* nitrate. It does not occur in the leaves of *P. microphyllus* (Jowett,²⁷). The free base is a viscid oil, $[\alpha]_D + 81.3^\circ$ (less in presence of alkali). The salts crystallise well; the nitrate, B. HNO_3 , in colourless prisms, m.p. 137°, $[\alpha]_D^{15} + 73.2^\circ$. The aurichloride, unlike that of *pilocarpine*, is very soluble in water, but crystallises from acetic acid, m.p. 124–5°. The platinichloride, $(\text{B} \cdot \text{HCl})_2\text{PtCl}_4 \cdot 4\text{H}_2\text{O}$, forms yellow needles, m.p. 187° (*dry*). The picrate, unlike the corresponding salts of *pilocarpine* and *isopilocarpine*, is an oil. Burtles, Pyman and

Since pilosine can be recovered unchanged after boiling for a short time with dilute alkali, it is regarded as allied stereochemically to *isopilocarpine* rather than *pilocarpine*.

The foregoing formula has been confirmed by the synthesis of pilosinine by Poljakova and V. A. and N. A. Preobrashenski,²⁹ who followed the process used for the synthesis of *pilocarpine* and the allied alkaloids (see p. 625), starting with diethyl formylsuccinate to produce *pilosinic acid*,

$$\text{CH}_2 \cdot \text{O} \cdot \text{OC} \cdot \text{CH}_2 \cdot \text{CH} \cdot \text{CO}_2\text{H}, \text{ m.p. } 64.5^\circ \text{ (cf. pilopic acid (III) p. 625),}$$

which was converted *via* the chloride to *homopilosinic acid*,

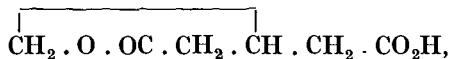

m.p. 86.5–87.5° (cf. *homopilopic acid* (VI)), from which *pilosinidine*, isolated as the nitrate, m.p. 117–8°, was prepared *via* aminomethyl *homopilosinyl ketone* and 2-thiolpilosinidine, m.p. 202.5–203° (cf. preparation of *pilocarpidine* (p. 625)) and methylated to pilosinine. Quite recently Natradze and Michlina^{29(a)} have described the synthesis of *isopropylpilosinine* starting from *isopropylsuccinic acid*, $\text{COOH} \cdot \text{CHPr}^s \cdot \text{CH}_2 \cdot \text{COOH}$, and proceeding *via* diethyl formylisopropylsuccinate (cf. (I), p. 625) on the lines indicated above.

ψ -*Pilocarpine* and ψ -*Jaborine* are optically inactive alkaloids obtained by Petit and Polonovsky³⁰ from *P. spicatus* (Aracati jaborandi). The former is a colourless syrup giving a nitrate, small needles, m.p. 142°; and a hydrochloride, prisms, m.p. 198–9°. ψ -*Jaborine* is also amorphous; its nitrate forms lamellæ, m.p. 158°, and the hydrochloride, small hard prisms, m.p. 222°.

Pharmacological Action of Jaborandi Alkaloids. *Pilocarpine* belongs to the group of alkaloidal excitants of the parasympathetic nerve-endings, and is thus allied in action to physostigmine, arecoline, muscarine and certain derivatives of choline. It causes increased secretion by the salivary, lachrymal, gastric and other glands, the solids of the secretions being increased as well as the fluids, though to a less extent; this action is inhibited by atropine.³¹ The plain muscle of most organs is contracted or brought into rhythmical activity after *pilocarpine*. The heart may be slowed by the action of the drug, but in some cases it is accelerated, and at the same time there is a rise in blood pressure. The respiratory centre is not directly affected by small doses. Vasomotor paralysis with subsequent dyspnoea is rather an early symptom. Death is generally due to the peripheral action of the drug on the circulation and respiration.

Pilocarpine is being less used in medicine as a diaphoretic in dropsy and similar diseases because of its depressant action on the heart. It has also been employed as a substitute for physostigmine to contract the pupil and reduce intraocular pressure. It has been used as an antidote to atropine, but it does not antagonise the action of atropine in the central nervous system.

isopilocarpine and *pilocarpidine* are stated to have the same general action as *pilocarpine*, but are much weaker, *pilocarpidine* being the least

active of the three. Pilocarpic acid is inactive.³² Pilocarpine, *anhydropilocarpine* and pilosinine all exhibit a weak pilocarpine action. *neopilocarpine* does not resemble pilocarpine in action.³³

Apart from the group of substituted glyoxalines allied to pilocarpine described by Pyman and examined pharmacologically by Laidlaw,³³ few attempts have been made to synthesise possible replacements for this alkaloid, but it is of interest to record that the pilocarpine analogue, α -acetyl- α -4(5)glyoxalinylmethylbutyrolactone, synthesised by Tschelincev and Fisch³⁴ has no pilocarpine-like action. There is an old observation by Schulz³⁵ that 1-ethyl-2-methylglyoxaline exerts in part the pharmacological action characteristic of the atropine group and more recently Herwick and Koppanyi³⁶ have called attention to two atropine-like activities exerted by pilocarpine under certain conditions.

REFERENCES

- (1) *Bull. Soc. chim.*, 1875, [ii], 24, 497; (with CALMELS), *Compt. rend.*, 1886, 102, 1116, 1251, 1562; 103, 277; 1887, 105, 68. (2) *Pharm. J.*, 1875, [iii], 5, 865, 965; 1877, 7, 255. (3) *Annalen*, 1880, 204, 67. (4) *J. Chem. Soc.*, 1900, 77, 474, 851; 1901, 79, 581, 1331. (5) *Chem. Zent.*, 1885, 628. (6) *J. Pharm.*, 1897, [vi], 5, 369, 370, 430, 475; 6, 8. (7) PAUL and COWNLEY, *Pharm. J.*, 1896, [iv], 3, 1. (8) EVANS, *Analytical Notes*, 1906, p. 21; 1908, p. 20; 1909, p. 35; cf. CARR and REYNOLDS, *Pharm. J.*, 1908, (iv.), 26, 542; IMBESI, *Arch. farm. sperim.*, 1938, 65, 113; TARAN, *Farmaskaya*, 1940, No. 5, 26. (9) JOWETT and PYMAN, *J. Chem. Soc.*, 1912, 28, 268. (10) *Dansk. Tids. Farm.*, 1939, 13, 160. (11) JOWETT, *Year-book Pharm.*, 1899, 36, 435; BOURCET, *Ann. Falsif.*, 1929, 21, 23; SCHUPE, *J. Assoc. Offic. Agric. Chem.*, 1941, 24, 757. (11a) *Quart. J. Pharm.*, 1947, 20, 234, 413. (11b) *Ibid.*, 1946, 19, 532. (12) *J. pr. Chem.*, 1928, 118, 20. (13) ROSENTHALER, *Schweiz. Apoth. Zeit.*, 1924, 62, 124, 142. (14) *Pharm. Weekbl.*, 1930, 67, 285. (15) *Bull. Soc. chim.*, 1922, [iv], 31, 1027, 1185, 1201, 1204. (16) *J. Chem. Soc.*, 1903, 83, 438; cf. PINNER and collaborators, *Ber.*, 1900, 33, 1424, 2357; 1901, 34, 727; 1902, 35, 204, 2443; 1905, 38, 2560. (17) *Ber.*, 1902, 35, 2441. (18) *J. Chem. Soc.*, 1903, 83, 442; (with POTTER, *ibid.*, p. 464. (19) *Ibid.*, 1922, 121, 2616; cf. 1901, 97, 1820. (20) *Ibid.*, 1925, 127, 581. (21) *Ibid.*, 1903, 83, 438; 1905, 87, 794; cf. M. and M. POLONOWSKI, *Bull. Soc. chim.*, 1922, [iv], 31, 1314. (22) *Ber.*, 1905, 38, 1510. (23) *Ibid.*, 1924, 57, 2072; 1932, 65, 842; *J. pr. Chem.*, 1928, [ii], 119, 77. (24) TSCHITSCHIBABIN and PREBRASHENSKI, *Ber.*, 1930, 63, 460; PREBRASHENSKI *et al.*, (b) 1935, 68, 847; (c) *ibid.*, p. 844; (d) *ibid.*, p. 850; (e) N. A. PREBRASHENSKI, WOMPE, V. A. PREBRASHENSKI (with SCHTSCHUKINA), *ibid.*, 1933, 66, 1536; (f) *ibid.*, 1187; (g) PREBRASHENSKI, POLJAKOWA and PREBRASHENSKI, *ibid.*, 1934, 67, 710; (h) *ibid.*, 1936, 69, 1314; (i) *ibid.*, p. 1835; *Bull. Acad. Sci. U.R.S.S.*, 1936, 983; FREUDENBERG and KUHN, *Ber.*, 1931, 64, 703; (j) *J. Gen. Chem. U.R.S.S.*, 1945, 15, 672; (k) *ibid.*, 237. (25) WELCH, *J. Chem. Soc.*, 1931, 1370; DEY, *ibid.*, 1937, 1057. (26) *Annalen*, 1887, 238, 230. (27) *J. Chem. Soc.*, 1900, 77, 474; cf. PYMAN, *ibid.*, 1912, 101, 2260. (28) *Ber.*, 1925, 58, 513; see also PAULY and ARAUNER, *J. pr. Chem.*, 1928, 118, 33. (29) *J. Chem. Soc.*, 1912, 101, 2260; cf. LÉGER and ROQUES, *Compt. rend.*, 1912, 155, 1088; 1913, 156, 1687; POLJAKOWA *et al.*, *J. Gen. Chem. U.R.S.S.*, 1939, 9, 1402. (29a) *Ibid.*, 1947, 17, 1718. (30) PETIT and POLONOVSKY, *J. Pharm.*, 1897, [vi], 5, 369. (31) HOLLANDER, *Gastroenterology*, 1944, 2, 201. (32) MARSHALL, *J. Physiol.*, 1904, 31, 123. (33) BURN, quoted by Burtles, Pyman and Roynance, *J. Chem. Soc.*, 1925, 127, 581; see also for the pharmacological action of other substituted glyoxalines allied to pilocarpine in structure, LAIDLAW, quoted by PYMAN, *ibid.*, 1912, 101, 530; and for a description of the group of alkaloids affecting parasympathetic nerves consult HENDERSON and ROEPKE, *Physiol. Reviews*, 1937, 17, 373. (34) *J. Gen. Chem. U.R.S.S.*, 1941, 11, 459. (35) *Arch. exp. Path. Pharm.*, 1881, 13, 304; 1883, 16, 256. (36) *J. Pharm. Exp. Ther. Proc.*, 1941, 72, 20.

ALKALOIDAL AMINES

REFERENCE has been made already to the association with alkaloids in plants of comparatively simple amines and amino-acids. Some of these substances, *e.g.*, acetylcholine and *isoamylamine*, are physiologically active, and there would be some justification for including them in a work on plant alkaloids, and this also applies to such substances as arginine, choline, betaine and other compounds of this type, but they are better dealt with as a separate class of simple basic constituents of plants. Special reference may be made to *galegine*, $C_6H_{13}N_3$, isolated by Tanret¹ from the seeds of *Galega officinalis* and regarded by him as a 3-methylpyrrolidine derivative, but which was shown by Barger and White² to be a guanidine derivative of the following constitution: $Me_2C : CH . CH_2 . NH . C(: NH) . NH_2$.

REFERENCES

- (1) *Compt. rend.*, 1914, 158, 1182, 1426; *Bull. Soc. chim.*, 1924, [iv], 35, 404.
- (2) *Biochem. J.*, 1923, 17, 827; see also SPÄTH (with PROKOPF), *Ber.*, 1924, 57, 474; (with SPITZY), *ibid.*, 1925, 58, 2273; and the following papers, mainly pharmacological, MULLER, *Zeit. Biol.*, 1925, 83, 239; (with REINWEISS), *Arch. exp. Path. Pharm.*, 1927, 125, 212; SIMONNET and TANRET, *Compt. rend.*, 1927, 184, 1600; 185, 1616.

Spherophysine, $C_{10}H_{22}N_4$. This base was obtained by Rubinshtein and Menshikov¹ from the Central Asian plant, *Sphaerophysa salsula*. It is strongly basic and hygroscopic and is isolated as the carbonate, m.p. 192–3°. The dibenzoate, m.p. 149–150°, and the dipicrate, m.p. 154–5°, are stable in air. The base is hydrogenated to a dihydro-derivative of which the carbonate has m.p. 193–4°, the dibenzoate, m.p. 146–7°, and the dipicrate, m.p. 154–5°. On steam distillation over barium hydroxide spherophysine yields carbamide and a diamine, $C_9H_{20}N_2$, b.p. 105–6°/10 mm., which gives a dihydrochloride, m.p. 262° (*dec.*) and a dipicrate, m.p. 180–1°, and on reduction furnishes a dihydride, $C_9H_{22}N_2$, b.p. 95–6°/10 mm., giving a dipicrate, m.p. 171–2°, and a dihydrochloride, m.p. 296° (*dec.*). The latter, on dry distillation, furnishes 1-*isoamylpyrrolidine*, b.p. 166–7°, characterised as the picrate, m.p. 145–6°, platinumchloride, m.p. 168–9°, and aurichloride, m.p. 157–8°, and which is also formed by the action of 50 per cent. hydrobromic acid on the nitroso-derivative of the diamine, $C_9H_{22}N_2$. With 5 per cent. hydrochloric acid this nitroso-amine yields 1-hydroxy-4-(*isoamylamino*)-butane. These reactions indicate that the saturated amine, $C_9H_{22}N_2$, is *isoamylputrescine*,



The dibenzoyl derivative, m.p. 98–9°, of the latter on controlled, alkaline hydrolysis yields a mixture of two monobenzoyl*isoamylputrescines*, separated as the hydrochlorides, of which (A), m.p. 92–3°, on treatment with nitrous acid followed by acid hydrolysis gives *isoamyl-*

putrescine. This is taken to indicate that in (A) the benzoyl group is on the primary amino-group and that it must be on the central nitrogen atom in the second hydrochloride (B), m.p. 191–2°. When the latter, $\text{Me}_2\text{CH} \cdot [\text{CH}_2]_2 \cdot \text{NBz}[\text{CH}_2]_4 \cdot \text{NH}_2 \cdot \text{HCl}$ is refluxed with diazomethane and the benzoyl group removed by hydrolysis, there is produced dihydrospherophysine, which is therefore represented as



Similar treatment of the first hydrochloride (A), m.p. 92–3°, yields *isodihydrospherophysine benzoate*, characterised as the carbonate, m.p. 122°, and hydrochloride, m.p. 125–6°, and yielding on hydrolysis *isodihydrospherophysine*, of which the carbonate has m.p. 167° and the dipicrate, m.p. 146–7°.

The unsaturated diamine, $\text{C}_9\text{H}_{20}\text{N}_2$, from the hydrolysis of spherophysine, on oxidation with permanganate yields the ketoaldehyde, $\text{Me}_2\text{CH} \cdot \text{CO} \cdot \text{CHO}$ (dioxime, m.p. 95–6°, and osazone, m.p. 113–4°) and putrescine, $\text{NH}_2[\text{CH}_2]_4\text{NH}_2$, which indicates that this unsaturated diamine is $\text{Me}_2\text{CH} \cdot \text{CH} : \text{CH} \cdot \text{NH}[\text{CH}_2]_4 \cdot \text{NH}_2$.

REFERENCE

- (1) *J. Gen. Chem.* (Russ.), 1944, 14, 161, 172.

Phenylalkylamines. Several phenylalkylamines and their derivatives have been recorded as occurring in plants. White¹ found β -phenylethylamine in many species of acacia and has suggested that this was also the base Leprince² found in mistletoe. *N*-methyl- β -phenylethylamine has been isolated from *Arthrophytum leptocladum* M. Pop, by Jurashevski,³ tyramine (*p*-hydroxyphenylethylamine) was obtained from American mistletoe (*Phoradendron* spp.) by Crawford⁴ and 2 : 4-dihydroxyphenylethylamine occurs in broom (*Cytisus scoparius*; table, p. 117). Recently Buelow and Gisvold⁵ have identified 3 : 4-dihydroxyphenylethylamine in the roots of *Hermodium alipes* S. Watson (Nyctaginaceae), and La Forge and Barthel⁶ have isolated from the bark of southern prickly ash (*Zanthoxylum carolinianum* = *Zanthoxylum Clava Herculis* Lam = *Fagara carolinianum*, cf. table, p. 330), a new substance of this type, viz., *N*-(2-*p*-anisylethyl)-*N*-methylecinnamide,



m.p. 76°. This species is also of interest as an early source of berberine (p. 330), and more recently of an insecticide, and of asarinin⁷ (xanthoxylin-S), closely allied to sesamin and like the latter possessing the remarkable property of reinforcing the insecticidal action of pyrethrum.

N-methyltyrosine (β -*p*-hydroxyphenyl- α -methylaminopropionic acid) under the names angeline, andirine, geoffroyine, surinamine and rhatanine has been isolated from *Ferreira spectabilis*, *Andira retusa*, *A. inermis*, *Geoffroea surinamensis* and *Krameria triandra*.⁸

Halostachine, $\text{C}_9\text{H}_{13}\text{ON}$. This base was isolated from *Halostachis caspica*, also given as *Halostachys caspica* (Chenopodiaceae), where it is

accompanied by an amino-acid, $C_5H_{11}O_2N$, m.p. 297° , $[\alpha]_D \pm 0^\circ$, yielding a hydrochloride, m.p. $234-5^\circ$, and a picrate, m.p. $184-6^\circ$. Halostachine has m.p. $43-5^\circ$; the hydrochloride has m.p. $113-4^\circ$ and the methiodide m.p. $230-1^\circ$: the N-methyl derivative, b.p. $125-7^\circ/20$ mm., $[\alpha]_D - 65^\circ$, is converted by thionyl chloride into a chloride hydrochloride, $C_{10}H_{14}NCl \cdot HCl$, m.p. $202-3^\circ$, which on reduction by sodium amalgam yields a base $C_{10}H_{15}N$, b.p. $203-5^\circ$, giving a picrate, m.p. $133-4^\circ$. Halostachine itself is oxidised by permanganate to benzoic acid, and with thionyl chloride produces the chloride hydrochloride, $C_9H_{12}NCl \cdot HCl$, m.p. $168-9^\circ$. These data are due to Menschikov and Rubinshtein,⁹ who assign to the base the formula $C_6H_5 \cdot CHOH \cdot CH_2 \cdot NHMe$ (cf. ephedrine (p. 636)). In a paper which has just become available, Menschikov and Borodina⁹ describe a synthesis of the *dl*-base of this formula and its resolution into *d*- and *l*-forms, of which the latter yields an acid tartrate, $[\alpha]_D - 18.73^\circ$, and a hydrochloride, $[\alpha]_D - 52.46^\circ$, and is identified as *l*-halostachine.⁹ According to Syrneva,¹⁰ the pharmacological action is similar to that of ephedrine.

REFERENCES

- (1) *New Zealand J. Sci. Tech.*, 1943-4, 25B, 139. (2) *Compt. rend.*, 1907, 145, 940. (3) *J. Gen. Chem. U.R.S.S.*, 1939, 9, 595; 1941, 11, 157, 207. (4) *J. Biol. Chem.*, 1914, 19, 303; 1916, 24, 169. (5) *J. Amer. Pharm. Assoc.*, 1944, 33, 270. (6) *J. Org. Chem.*, 1944, 9, 250. (7) LA FORGE, HALLER and SULLIVAN, *ibid.*, 1942, 7, 185, 187; *J. Amer. Chem. Soc.*, 1942, 64, 187. (8) HILLER-BOMBIEN, *Arch. Pharm.*, 1892, 230, 513; BLAU, *Zeit. Physiol. Chem.*, 1908, 58, 153. Constitution, see GOLDSCHMIEDT, *Monats.*, 1912, 33, 1379; 1913, 34, 659; FRIEDMANN and GUTHMANN, *Biochem. Zeit.*, 1910, 27, 491; JOHNSON and NICOLET, *Amer. Chem. J.*, 1912, 47, 459. Recent syntheses: KANEVSKAJA, *J. pr. Chem.*, 1929 [ii], 124, 48; DEULOFEU and MENDWELZUA, *Ber.*, 1935, 68, 783. (9) *J. Gen. Chem. U.R.S.S.*, 1943, 13, 801 (*Chem. Abstr.*, 1945, 39, 1172); (with BORODINA), *ibid.*, 1947, 17, 1569 (*Chem. Abstr.*, 1948, 42, 2245). (10) *Farmakol i Toksikol*, 1941, 4, 105 (*Chem. Abstr.*, 1944, 38, 1029).

Damascenine, $C_{10}H_{13}O_3N$. From the seeds of *Nigella damascena* L., Schneider isolated a crystalline alkaloid, damascenine, $C_{10}H_{15}O_3N$,¹ which was re-examined by Pommerehne,² who assigned to it the formula $C_9H_{11}O_3N$, and stated that by the action of alkalis it was converted into an isomeride, damascenic acid. Subsequently, Keller named an alkaloid of the formula, $C_{10}H_{13}O_3N$, which he obtained from the seeds of *Nigella aristata* (*N. arvensis*), "methyl-damascenine," since it could also be obtained by treating silver damasceninate with methyl iodide.³ Ewins confirmed Schneider's results and synthesised damascenine.⁴ According to Ewins, Pommerehne's "damascenine" was a mixture of damascenine with damascenic acid, whilst Keller's methyl-damascenine is Schneider's damascenine. Ewins describes a method of isolating the alkaloid and obtained a yield of 0.32 per cent. from the seeds.

It forms a crystalline mass, m.p. $24-6^\circ$, b.p. $154^\circ/15$ mm. or $270^\circ/750$ mm., and is soluble in most organic solvents, the solutions showing a blue fluorescence. The salts crystallise well, and the forms of certain of them have been described.⁵ The hydrochloride, $B \cdot HCl \cdot H_2O$, forms triclinic crystals, m.p. 122° or 156° (*dry*); the nitrate has m.p. $94-5^\circ$;

the picrate crystallises in lemon-yellow rhombic plates, m.p. 158–9°. On hydrolysis with acids or alkalis, damascenine yields methyl alcohol and damascenic acid, $C_9H_{11}O_3N$, a monobasic acid, which with boiling hydriodic acid yields methyl iodide and 2-methylamino-3-hydroxybenzoic acid. Damascenic acid is therefore 2-methylamino-3-methoxybenzoic acid and damascenine the corresponding methyl ester.⁴

Ewins has synthesised both substances from *m*-methoxybenzoic acid, which on nitration gave 2-nitro-3-methoxybenzoic acid, and this, on reduction and treatment with methyl iodide, yielded damascenic acid, which, by esterification with methyl alcohol, furnished damascenine. Kaufmann and Rothlen found that the additive product of 8-methoxyquinoline and methyl sulphate, on oxidation with permanganate, yields formyldamascenic acid, $MeO \cdot C_6H_3(NMe \cdot CHO) \cdot COOH$, which can be transformed into damascenic acid by warming with dilute hydrochloric acid.⁶

REFERENCES

(1) *Pharm. Zent.*, 1890, 31, 173. (2) *Arch. Pharm.*, 1900, 238, 531. (3) *Ibid.*, 1904, 242, 299; 1908, 246, 1. (4) *J. Chem. Soc.*, 1912, 101, 544. (5) SCHWANTKE, *Zeit. Kryst. Min.*, 1909, 46, 73. (6) *Ber.*, 1916, 49, 578; for synthesis of damascenine analogues see RODIONOV and FEDOROVA, *Bull. Acad. Sci., U.R.S.S.*, 1937, 501.

Hordenine (*Anhaline*), $C_{10}H_{15}ON$, was isolated by Léger¹ from barley malt germs, and has since been found in barley and other grass embryos² and in Anhalonium spp. (p. 154). Its development during the germination of barley has been studied by Raoul³ and methods of estimation⁴ have been described. The base forms colourless prisms, m.p. 117–8°, b.p. 173–4°/11 mm., and sublimes at 140–150°. It is alkaline in reaction, liberates ammonia from its salts, behaves as a monoacidic, tertiary base and forms well-crystallised salts: hydrochloride, m.p. 176·5–177·5°; sulphate, m.p. 209–211°; picrate, m.p. 139–140°; picrolonate, m.p. 219–220°; methiodide, m.p. 229–230°, reineckate, $B \cdot (C_4H_6N_6ScR) \cdot 5H_2O$, m.p. 176–8°. On exhaustive methylation hordenine yields trimethylamine and *p*-vinylanisole, $MeO \cdot C_6H_4 \cdot CH : CH_2$. The *O*-acetyl derivative is oxidised by potassium permanganate to *p*-acetoxybenzoic acid. On these data Léger¹ suggested that hordenine is *p*-hydroxy- β -phenylethyl-dimethylamine,⁵ and this was confirmed by Barger's⁶ synthesis of the base, starting with phenylethyl alcohol:—

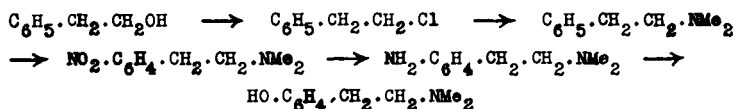

Since then other syntheses have been effected⁷ of hordenine and its homologues and derivatives.

According to Camus,⁸ hordenine is of low toxicity, but in large doses it causes death by arrest of respiration. It is less active than adrenaline but analogous in its action,⁹ resembling ephedrine rather than adrenaline.

Barger and Dale¹⁰ found that the methiodide had a marked nicotine-

like action and according to Raymond-Hamet¹¹ this effect is also shown by hordenine itself and is not suppressed by the introduction of a second hydroxyl group as in β -(3 : 4-dihydroxyphenyl)ethyl dimethylamine (oxyhordenine). Stedman¹² states that the methylcarbamido-derivative shows mitotic activity. Schweitzer and Wright¹³ found that the hydrochloride and methiodide of the dimethylcarbamate ester of hordenine have anticholine-esterase action *in vitro* and similar action on the response of muscle to motor-nerve stimulation; the hydrochloride produces effects qualitatively similar to those of physostigmine but quantitatively 50–100 times less potent. Removal of the anticholine-esterase grouping from this ester hydrochloride abolishes this central stimulant action, hordenine being a central depressant.

REFERENCES

- (1) *Compt. rend.*, 1906, 142, 108; 143, 234, 916; 1907, 144, 208, 488; cf. TORQUATI, *Chem. Soc. Abstr.*, 1911, [ii], 253; GÄBEL, *Arch. Pharm.*, 1906, 244, 435; and HASHITANI, *Chem. Soc. Abstr.*, 1920, [i], 360. (2) REILHES, *Compt. rend. Soc. Biol.*, 1936, 122, 852; cf. HASHITANI, *J. Tokio. Chem. Soc.*, 1920, 41, 545. (3) RAOUL, *Ann. Ferm.*, 1937, 3, 385; *Compt. rend.*, 1934, 199, 425; *Rev. cytol. cytophysiol. veg.*, 1939, 4, 92 (*Chem. Abstr.*, 1942, 36, 5957). (4) JANOT and FAUDEMAY, *Bull. Sci. Pharmacol.*, 1932, 39, 288; ARNOLT, *Anal. Assoc. quim. Arg.*, 1936, 24, 19B; GONNARD, *Bull. Soc. Chim. Biol.*, 1939, 21, 617; PEDINELLI, *Ann. Chim. Applic.*, 1941, 31, 410; *Boll. Sci. facolta Chim. Ind. Bologna*, 1941, 37. (5) Cf. GÄBEL, *Arch. Pharm.*, 1906, 244, 435. (6) *J. Chem. Soc.*, 1909, 95, 2193. (7) ROSENMUND, *Ber.*, 1910, 43, 306; VOS WINCKEL, *ibid.*, 1912, 45, 1004; EHRlich and PISTSCHIMUKA, *ibid.*, 2428; SPÄTH and SOBEL, *Monats.*, 1920, 41, 77; KINDLER *et al.*, *Annalen*, 1923, 431, 187; *Arch. Pharm.*, 1927, 265, 389; VON BRAUN *et al.*, *Ber.*, 1912, 45, 2504; 1914, 47, 492; 1924, 57, 913. (8) *Compt. rend.*, 1906, 142, 110, 237, 350. (9) RIETSCHEL, *Arch. exp. Path. Pharm.*, 1937, 186, 387; *Klin. Woch.*, 1937, 16, 714. (10) BARGER and DALE, *J. Physiol.*, 1910, 41, 19. (11) *Compt. rend.*, 1939, 209, 67; see also BROOM and WAYNE, *J. Pharm. Exp. Ther.*, 1946, 86, 83. (12) *Biochem. J.*, 1926, 20, 719. (13) *J. Physiol.*, 1938, 92, 422; cf. *ibid.*, 1937, 90, 310.

ALKALOIDS OF EPHEDRA SPP.

Ephedrine was discovered by Nagai in 1887 but it remained little more than a chemical curiosity until Chen and Schmidt¹ called attention to its therapeutic possibilities, since when a voluminous literature has accumulated on its sources, chemistry, pharmacology and clinical applications. The chief source of supply was at first the Chinese plant "Ma-Huang." According to Read,² "Ma-Huang" is a group name for various species of Ephedra, but the material principally used in China and exported thence under this name is *Ephedra sinica* Stapf. (*E. flava* Porter Smith, *E. Mahuang* Liu). Prior to 1927 *E. sinica* was confused with *E. vulgaris* Rich. var. *helvetica* Hooker and Thomson, now known to be *E. helvetica* C. A. Meyer, found in Europe. *E. vulgaris* Rich is now referred to *E. distachya* Linn., which occurs both in Europe and in Asia. The other important Chinese species is *E. equisetina* Bunge, but the drug is mainly derived from *E. sinica* Stapf. with occasional supplies of *E. equisetina* Bunge, or mixtures of these. Numerous analyses of "Ma-Huang" have been recorded, and Read *et al.*,³ in particular, have investigated (1) the variation in alkaloidal content of the principal Chinese species with the

season, environment and other conditions, and (2) the distribution of alkaloid in the various organs of the plants.

Owing to the disturbed state of China in recent years, supplies of Ephedra from that quarter have diminished and for some time were replaced by a drug of Spanish origin and later, as Spain also became involved in civil war, by supplies from India, where attention has been given to the five indigenous species *E. intermedia* Schrenk and Mayer, *E. gerardiana* Wall, *E. nebrodensis* Tineo, *E. pachyclada* Boiss. and *E. foliata* Boiss., of which the first three are of commercial importance.⁴

The world war made all these sources of supply difficult of access and stimulated interest in the possibilities of local production. Examination of a number of American species of ephedra had already shown them to be devoid of alkaloids,⁵ except for the S. American species *E. andina*, in which Chávezt⁵ found ephedrine, and in the United States attention has been given to the experimental cultivation of imported species, notably *E. sinica* and *E. gerardiana*; ^{5(a)} a Moroccan type, *E. alenda*, was found to contain only ψ -ephedrine (Sievers ^{5(a)}). In Australia experimental cultivation of the Indian species *E. gerardiana*, *E. intermedia* and *E. nebrodensis* has been tried and preliminary yields of 1.35, 1.05 and 0.98 per cent. of total alkaloids respectively have been recorded.⁶ In Russia, *E. equisetina* and *E. intermedia* are available and are considered to be worth exploitation.⁷ In Italy various local species have been found to contain mainly ψ -ephedrine and that in small amount, but better results are recorded for two species already referred to and which are available in Sardinia, viz. *E. vulgaris* Rich and *E. nebrodensis*.⁸

To avoid the difficulty of variation in alkaloidal content liable to occur in commercial Ephedra a proposal has been made in India⁹ for the manufacture of a standardised extract representing 5 per cent. of the weight of the crude drug and containing 18 to 20 per cent. of the total alkaloids. Both in India and China experimental extraction of ephedrine has been started.¹⁰

The demand for ephedrine is now being met to an increasing extent by the synthetic product.

Ephedrine also occurs in the leaves of the yew tree (*Taxus baccata*)¹¹ and in *Sida rhombifolia* Linn,¹² whilst Stockman's "cathine" from *Catha edulis* Forsk has been shown by Wolfes¹³ to be *d-nor-ψ*-ephedrine. Ghosh, Chopra and Dutt¹⁴ state that the bark of *Moringa pterygosperma* Gaertn. contains two alkaloids similar to ephedrine in pharmacological action. The more active of the two, *moringinine*, is amorphous; the other is a liquid but yields a crystalline hydrochloride, C₇H₉N · HCl, m.p. 254.4°, $[\alpha]_D^{20} + 1.8^\circ$, a picrate, m.p. 195°, and an aurichloride, m.p. 170.8°.

Nagai's ephedrine¹⁵ was obtained from "Ma-Huang" and the same alkaloid, together with its stereoisomeride *pseudoephedrine* (ψ -ephedrine), was isolated by Merck¹⁶ from the European species, *E. helvetica* C. A. Meyer. From commercial "Ma-Huang" Smith¹⁷ prepared two additional bases, *l-N*-methylephedrine and *nor-d-ψ*-ephedrine. Nagai and Kanao¹⁸ added two more, viz., *d-N*-methyl- ψ -ephedrine and *l-norephedrine*, and

Chen, Stuart and Chen¹⁸ isolated *benzylmethylamine* (B . HCl, m.p. 180·5° ; aurichloride, m.p. 139–140°), while Chou and Mei¹⁸ obtained a volatile base, *ephedrine*, C₈H₁₈O₃N₂ [m.p. 76° or 87° (*dry*); B . HCl, m.p. 90° ; picrate, m.p. 190°]. From the European species Wolfes¹⁹ has also isolated *l-N*-methylephedrine and *l-norephedrine*, and from *E. monostachya*, Spehr¹⁹ obtained a base C₁₃H₁₉ON, monoclinic prisms, m.p. 112°, which is said to be physiologically inactive, and is generally known as “ephedrine, Spehr.”

The total alkaloidal content of *Ephedra* varies widely, being influenced by the species collected and the seasonal and environmental conditions, as has been shown by Read³ and by Chopra⁴ and their colleagues. For specially collected material yields as high as 2·56 per cent., of which 1·8 per cent. is ephedrine, have been recorded, but about 1 per cent. of total alkaloids is not usually exceeded in the commercial product.

For commercial *Ephedra* the British Pharmaceutical Codex, 1934, specifies a total alkaloidal content of not less than 1·25 per cent. when assayed by the method therein prescribed. The proportion of *l*-ephedrine is generally about 70 per cent. Methods of assay for total alkaloids are described by Feng and Read³ and by Krishna and Ghose,⁴ who discuss the various difficulties involved and comments on these and other methods have been made by various workers.²⁰ Conditions affecting the results of such assays have also been discussed by T'ang and Wang,²¹ and Brownlee²² has shown that chloroform is not a suitable medium for the assay since it converts ephedrine quickly and ψ -ephedrine slowly to the hydrochloride.

For the assay of ephedrine in the total alkaloids a colorimetric method based on the biuret reaction was used by Feng and Read³ and is described in detail by Feng.²³ Krishna and Ghose⁴ separated ephedrine and ψ -ephedrine by treating the dry mixed hydrochlorides with dry chloroform in which the ephedrine salt is virtually insoluble and the ψ -ephedrine salt soluble.²⁴

For the estimation of ephedrine in its salts or simple solutions, titration methods and a Kjeldahl estimation have been described by various authors.²⁵ The formation of iodoform from ephedrine has been proposed as a method of estimation by Sanchez,²⁶ and biological methods have been used by several authors.²⁷

Useful summaries of work on ephedrine, ψ -ephedrine and their derivatives have been published by three workers in this field.²⁸

Ephedrine, C₁₀H₁₅ON. The base occurs in commerce in the anhydrous form, m.p. 38·1°, or as a hemihydrate,²⁹ m.p. 40°, b.p. 225° or 152–3°/25 mm., $[\alpha]_D^{20} - 6·3^\circ$ (EtOH), or +11·2° (H₂O : Emde). The hydrochloride, B . HCl, forms colourless needles, m.p. 217–8° or 220–1° (*corr.*), $[\alpha]_D^{20} - 34^\circ$ (H₂O) (values ranging from –32·5° to –38·6° have been recorded, but recent figures are, as a rule, near to 34°). The hydrobromide, B . HBr, has m.p. 205° ; the sulphate, B₂ . H₂SO₄, forms hexagonal plates, m.p. 243°, $[\alpha]_D^{22} - 30^\circ$, is sparingly soluble in alcohol, but readily so in water ; the oxalate, B₂ . H₂C₂O₄ forms prismatic needles, m.p. 249° (*dec.*), and is sparingly soluble in cold water. The aurichloride, m.p. 128–131°,

and the platinichloride, m.p. 186° (*dec.*), form yellow needles. The nitrosoamine has m.p. 92°, and the dibenzoyl derivative m.p. 134°.

On boiling with 25 per cent. hydrochloric acid ephedrine is partially converted into ψ -ephedrine. This change is reversible, an equilibrium mixture of the two bases being formed, though according to Mitchell³⁰ the commercially desirable conversion of ψ -ephedrine into *l*-ephedrine is effected with more difficulty than the reverse process. Mitchell also states that when ephedrine is heated with acetic anhydride at 70° for ten minutes it is converted into O-acetylephedrine, C₁₂H₁₇O₂N · 2H₂O, m.p. 52° or 87° (*dry*), $[\alpha]_D^{20} + 5^\circ$ (EtOH) or $+ 7^\circ$ (*dry*, EtOH), from which neither a well-defined hydrochloride nor hydrobromide could be obtained. Welsh,^{30(a)} on the contrary, regards this substance as N-acetyl-*l*-ephedrine and finds that it forms with hydrochloric acid an adduct, C₁₂H₁₇O₂N · HCl, m.p. 106–7° (variable with rate of heating), $[\alpha]_D^{20} + 5.6^\circ$ (EtOH, 50 per cent.), which is acid in solution and in which the acid can be titrated directly and quantitatively. N-acetyl-*dl*-ephedrine, similarly prepared, has m.p. 77–78.5° and yields a hydrochloride, which melts slowly from 100° to about 180°. The latter, on standing in acetone solution containing hydrochloric acid, is converted into O-acetyl-*dl*-ephedrine hydrochloride, m.p. 201–201.5° (*dec.*), of which a 2 per cent. solution has pH 5.0. On treatment with alkali in excess it regenerates the N-acetyl derivative. The O-acetyl derivative can also be obtained by heating N-acetyl-*dl*-ephedrine hydrochloride for 70 minutes at 110° or by refluxing *dl*-ephedrine hydrochloride with a mixture of acetic anhydride and acetyl chloride. It has not been possible to prepare O-acetyl-*l*-ephedrine hydrochloride by any of these methods, owing apparently to the difficulty of inducing it to crystallise. When N-acetyl-*l*-ephedrine is heated at 110° it yields about 52 per cent. of O-acetyl-*d*- ψ -ephedrine hydrochloride (*see* ψ -ephedrine, *below*). The mixed bases obtained by alkaline hydrolysis of the crude product of this re-arrangement had $[\alpha]_D^{20} + 29.7^\circ$ (H₂O) as hydrochlorides, corresponding to about 66 per cent. of ψ -ephedrine hydrochloride and 34 per cent. of *l*-ephedrine hydrochloride, calculated from the specific rotations of these two salts. Hydrolysis of N-acetyl-*l*-ephedrine by refluxing with dilute hydrochloric acid produces *d*- ψ -ephedrine and *l*-ephedrine hydrochlorides in the proportion 62 to 38; the inversion is stated to take place during the shift of the acetyl group from N to O and not by the action of the acid on *l*-ephedrine.

Re-arrangement between amino-ester and hydroxy-amide forms in derivatives of amino-alcohols are not uncommon and the mechanism of this interchange in one series has been discussed by Phillips and Baltzly.^{30(b)}

With potassium ferricyanide and sodium hydroxide solution ephedrine forms benzaldehyde. A solution of the hydrochloride gives with copper sulphate and sodium hydroxide solutions, a purple coloration extractable by ether, leaving the aqueous layer blue. A solution of ephedrine base in chloroform on standing is partially converted into ephedrine hydrochloride.³⁰

Much attention has been given to devising tests for (a) the identification of ephedrine,³¹ (b) means of distinction between ephedrine and ψ -ephedrine^{31(a)} and (c) the recognition of the *dl*-form of ephedrine.^{31(b)} Ephedrine, according to Kirkpatrick,^{31(c)} is polarographically inactive.

ψ -Ephedrine, $C_{10}H_{15}ON$, crystallises from ether in rhombs, m.p. 118–9°, $[\alpha]_D^{20} + 51.2^\circ$ (EtOH), and, unlike ephedrine, is sparingly soluble in water. The hydrochloride, B. HCl, crystallises in colourless, slender needles, m.p. 181–2°, $[\alpha]_D^{20} + 62.05^\circ$ (H_2O), and, unlike the ephedrine salt, is soluble in chloroform. The sulphate forms prisms, $[\alpha]_D + 52.5^\circ$; the oxalate, m.p. 218° (*dec.*), unlike that of ephedrine, is readily soluble in water; the aurichloride has m.p. 126.5–127.5°. Nitroso- ψ -ephedrine has m.p. 86°, and dibenzoyl- ψ -ephedrine melts at 119–120°. By Mitchell's³⁰ process *d*- ψ -ephedrine yields an acetyl derivative, m.p. 103.5–104°, $[\alpha]_D^{20} + 110.4^\circ$ (EtOH, 50 per cent.), which Welsh^{30(a)} has shown to be the N-acetyl compound (*cf.* ephedrine above). The hydrochloride has m.p. about 180° with some sintering at 175° (m.p. variable with rate of heating) and $[\alpha]_D + 93.3^\circ$ (EtOH, 50 per cent.). On heating at 110° the N-acetyl hydrochloride is converted into *O*-acetyl-*d*- ψ -ephedrine hydrochloride, m.p. 179.5–181° (variable with rate of heating) and $[\alpha]_D + 98.6^\circ$ (H_2O). In contrast to the effect on N-acetyl-*l*-ephedrine (*see above*) of acid hydrolysis, the N- and O-acetyl- ψ -ephedrines produce only the original amino-alcohol, *d*- ψ -ephedrine, on boiling with dilute hydrochloric acid. Identification tests for ψ -ephedrine and means of distinction from ephedrine have been devised by various authors.^{31(a)}

***l*-norEphedrine**, $C_9H_{13}ON$, was isolated by Kanao¹⁵ from Ma-Huang and by Wolfes¹⁹ from European Ephedra. It forms a crystalline mass, m.p. 51°, b.p. 167–8°/22 mm., and yields a hydrochloride, m.p. 173° (*corr.*), $[\alpha]_D^{20} - 33.14^\circ$ (H_2O), hydrogen *l*-tartrate, m.p. 160° (*approx.*), with some sintering at 130°, $[\alpha]_D^{33} - 34.64^\circ$ (H_2O); platinichloride, m.p. 221° (*dec.*); aurichloride, m.p. 188°, *p*-nitrobenzoyl derivative, m.p. 175–6°. The base synthesised by Nagai and Kanao³² had $[\alpha]_D^{20} - 14.56^\circ$ (EtOH).

***nor-d*- ψ -Ephedrine**, $C_9H_{13}ON$, was first isolated by Smith¹⁷ from Ma-Huang, and later by Wolfes¹³ from *Catha edulis*, and was synthesised by Nagai and Kanao.³² It crystallises in plates, m.p. 77–8° (*corr.*), has $[\alpha]_{5461}^{20} + 37.9^\circ$ (MeOH), yields a sulphate, $B_2 \cdot H_2SO_4$, hexagonal plates, m.p. 295° (*corr.*, *dec.*), $[\alpha]_{5461}^{20} + 48.7^\circ$ (H_2O), hydrochloride, prisms, m.p. 178–9° (*corr.*), $[\alpha]_D^{24} + 42.1^\circ$ (H_2O), $[\alpha]_{5461}^{15} + 53.4^\circ$ (H_2O), oxalate, needles, m.p. 235°, and hydrogen tartrate, m.p. 149–151° (*dry, corr.*), $[\alpha]_{5461}^{20} + 49.5^\circ$ (H_2O). The dibenzoyl derivative has m.p. 156–7° (*corr.*), $[\alpha]_{5461}^{20} + 32.8^\circ$ (MeOH), and on partial hydrolysis yields *N*-benzoyl-*nor-d*- ψ -ephedrine, m.p. 132° (*corr.*), $[\alpha]_{5461}^{20} + 67.2^\circ$ (MeOH), which, in contact with hydrogen chloride in acetone, is converted into *O*-benzoyl-*nor-d*- ψ -ephedrine hydrochloride, needles, m.p. 244–5° (*corr.*), $[\alpha]_{5461}^{20} - 37.6^\circ$ (H_2O), but which regenerates the *N*-benzoyl derivative on recovery of the base with sodium hydroxide solution. Similar migrations of the acyl group in this type of alkaloid have been recorded by Nagai and Kanao.³³

Gibson and Levin ³⁴ have called attention to *nor-d-ψ*-ephedrine as a useful base for the resolution of externally compensated acids.

N-Methylephedrine, C₁₁H₁₇ON, was isolated by Smith ¹⁷ (1927) from Ma-Huang, and later by Wolfes ¹⁹ from European Ephedra. It crystallises in stout needles, m.p. 87–8° (*corr.*), b.p. 137–9°/14 mm., [α]_D – 29.2° (MeOH); gives a hydrochloride, B . HCl, m.p. 188–9°, 192° (Wolfes), [α]_D²⁰ – 29.8° (H₂O); picrate, m.p. 144°; methiodide, m.p. 212–3°, [α]_D – 21.8° (H₂O); oxalate, m.p. 187°; aurichloride, m.p. 128–9°. The base was first prepared by Nagai in 1892 ¹⁵ and examined in greater detail by Nagai and Kanao (1929).³²

d-N-Methyl-*ψ*-ephedrine, C₁₁H₁₇ON, was isolated by Nagai and Kanao ¹⁵ (1928) from Ma-Huang, and was subsequently synthesised by them.³² It was first prepared by methylation of *ψ*-ephedrine by Emde,³⁵ and more recently by Smith ¹⁷ (1927). The base crystallises in needles, m.p. 30°, b.p. 145°/24 mm., [α]_D²¹ + 48.1° (MeOH); gives a hydrochloride, [α]_D²³ + 58.11° (H₂O); aurichloride, yellow plates, m.p. 126–7°; hydrogen tartrate, B . C₄H₆O₆ . 2H₂O, m.p. 84° (*corr.*) or 152° (*dry, corr.*); picrate, m.p. 152–3° (*corr.*); and methiodide, m.p. 216–7° (205°, Emde), [α]_D + 42.3° (H₂O).

Constitution of Ephedrine and ψ-Ephedrine. The first clue to the structure of these bases was given by Ladenburg and Oelschägel,³⁶ who prepared from *ψ*-ephedrine, a nitrosoamine and a dibenzoyl derivative, and showed that on oxidation, under certain conditions, benzoic acid was produced with methylamine. These authors suggested the formula (I), Ph . CHOH . CHMe . NHMe, now accepted for the alkaloid. Miller ³⁷ found that ephedrine also gives a dibenzoyl derivative, m.p. 115–6°, and can be exhaustively methylated to the quaternary hydroxide, which, on boiling in aqueous solution, gave trimethylamine and an oil, C₉H₁₀O, b.p. 205–210° (*see below*). Miller suggested for ephedrine the formula (II), Ph . CH₂ . CH(NHMe) . CH₂OH, which makes it a structural isomeride of *ψ*-ephedrine (I). Schmidt and Emde ³⁸ confirmed and extended these observations, and Emde ³⁸ suggested (1907) that the two bases were stereoisomerides of the formula (III), Ph . CH(NHMe) . CHMe . OH, this being preferred to (I) because of the ease with which the carbon-nitrogen linkage is broken, due, it was assumed, to its proximity to the double bonds of the benzene nucleus. The view that the two bases are stereoisomerides is supported by the ease with which ephedrine can be isomerised to *ψ*-ephedrine by acylation (Calliess,³⁹ Nagai and Kanao ³³) or by boiling with hydrochloric acid (25 per cent.), the change under the latter conditions being reversible.³⁹ Support for formula (I) was finally provided by Schmidt and Bümmling,³⁹ who found that when the hydrochloride of either base is distilled in carbon dioxide, methylamine hydrochloride and propiophenone are produced :

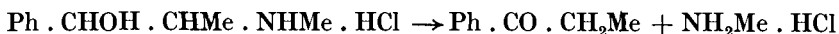

and by Rabe's observation ⁴⁰ that the product, C₉H₁₀O, formed, with methylamine, by the decomposition of the ammonium base of ephedrine

is α -phenylpropylene $\alpha\beta$ -oxide (IV) $\text{Ph} \cdot \overline{\text{CH} \cdot \text{O}} \cdot \text{CHMe}$, b.p. 204° , $[\alpha]_{\text{D}}^{16} + 65.84^\circ$. Subsequent work by various authors⁴⁰ provided additional support for formula (I), which was finally proved by syntheses of both alkaloids.

Attempts had been made from 1904 onwards⁴¹ to synthesise ephedrine or ephedrine-like substances, but it was not until 1920 that two substances now generally accepted as optically inactive forms of ephedrine and ψ -ephedrine were obtained by Eberhard.⁴² The process used was the reduction of α -methylaminopropiophenone by (a) sodium amalgam and dilute hydrochloric acid and (b) hydrogen in presence of palladised charcoal:

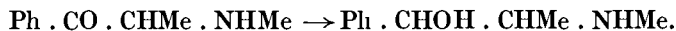

Two products were obtained, (A) m.p. 76° , giving a hydrochloride, m.p. 187° , and an aurichloride, m.p. 115° , and (B) m.p. 114° , forming a hydrochloride, m.p. 158 – 161° , and an aurichloride, m.p. 115 – 6° . These characteristics indicate that (A) and (B) are racemic forms of ephedrine and ψ -ephedrine respectively.

Fourneau and Puyal⁴³ (1922) converted propenylbenzene, obtained by dehydration of phenylethylcarbinol, into the bromohydrin, which on treatment with methylamine yielded an ephedrine, m.p. 60° , giving a hydrochloride, m.p. 190° , and an acetyl derivative, presumed to be acetyl- ψ -ephedrine, m.p. 176° , from which hydrochloric acid produced a hydrochloride, m.p. 175° , regarded as *dl*- ψ -ephedrine hydrochloride, giving a base, m.p. 117° . The base, m.p. 60° , initially produced in this reaction was later shown by Fourneau and Kanao⁴¹ to be identical with Emde's *isoephedrine* (formula III). Fourneau and Benoit⁴¹ have recently investigated the action of methylamine on (1) the mixture of *cis*- and *trans*-forms of phenylpropylene oxide (IV) formed by oxidising propenylbenzene with perbenzoic acid, (2) the *d*-phenylpropylene oxide, obtained by exhaustive methylation of *l*-ephedrine, and (3) the *l*-form of the oxide similarly obtained from *d*-ephedrine. The products of these three reactions are:—

(1) *dl*-*isoephedrine*, m.p. 59 – 60° , B.HCl, m.p. 190 – 1° ; picrate, m.p. 146° ; *dl*-ephedrine and ψ -ephedrine, with possibly some ψ -*isoephedrine*.

(2) *l*-ephedrine and *d*-*isoephedrine*, m.p. 51 – 2° , giving a hydrochloride, m.p. 169° , $[\alpha]_{\text{D}}^{20} + 36^\circ$, and a picrate, m.p. 140° .

(3) *d*-ephedrine and *l*-*isoephedrine*, characterised as the hydrochloride, m.p. 167 – 8° , $[\alpha]_{\text{D}}^{20} - 36^\circ$.

In the meantime, Späth and Göhring⁴⁴ had effected another synthesis of both inactive bases, and resolved each of the latter into the two possible optically active forms. This synthesis was effected by the stages represented by the following five equations, which need no descriptive explanation; the original paper should be consulted for a full discussion of the reactions involved.

- (a) $\text{CH}_3 \cdot \text{CH}_2 \cdot \text{CHO} + \text{Br}_2 \rightarrow \text{CH}_3 \cdot \text{CHBr} \cdot \text{CHO} + \text{HBr}$
 (b) $\text{CH}_3 \cdot \text{CHBr} \cdot \text{CHO} + \text{HBr} + \text{MeOH} \rightarrow \text{CH}_3 \cdot \text{CHBr} \cdot \text{CHBr} \cdot \text{OMe} + \text{H}_2\text{O}$
 (c) $\text{CH}_3 \cdot \text{CHBr} \cdot \text{CHBr} \cdot \text{OMe} + \text{Ph} \cdot \text{MgBr} \rightarrow \text{CH}_3 \cdot \text{CHBr} \cdot \text{CHPh} \cdot \text{OMe} + \text{MgBr}_2$
 (d) $\text{CH}_3 \cdot \text{CHBr} \cdot \text{CHPh} \cdot \text{OMe} + \text{NH}_2\text{Me} \rightarrow \text{CH}_3 \cdot \text{CH}(\text{NH}_2\text{MeBr}) \cdot \text{CHPh} \cdot \text{OMe}$
 (e) $\text{CH}_3 \cdot \text{CH}(\text{NHMe}) \cdot \text{CHPh} \cdot \text{OMe} + \text{HBr} \rightarrow \text{CH}_3 \cdot \text{CH}(\text{NHMe}) \cdot \text{CH}(\text{OH}) \cdot \text{Ph} + \text{CH}_3\text{Br}$

The first product in the Späth and Göhring synthesis is *dl*- ψ -ephedrine, m.p. 118–9°, which was resolved, by crystallisation of the *d*-tartrate and *l*-tartrate in succession, into *l*- and *d*-components, the latter being identical with natural ψ -ephedrine (p. 638), m.p. 118–118.7°, $[\alpha]_D^{22.5^\circ} + 52.9^\circ$ (EtOH); B. HCl, m.p. 182.5–183.5°, $[\alpha]_D^{20^\circ} + 62.8^\circ$ (H₂O). The *l*- ψ -ephedrine had identical constants, but with $[\alpha]_D - 52.5^\circ$. The *d*- and *l*-forms were isomerised into *l*- and *d*-ephedrines respectively, the former being identical with natural ephedrine (p. 636) and having m.p. 39–40°; B. HCl, m.p. 217.3–217.8°, $[\alpha]_D^{20^\circ} - 34.5^\circ$ (H₂O), and the *d*-form having identical constants except for B. HCl, $[\alpha]_D^{20^\circ} + 35.8^\circ$. Of numerous subsequent syntheses of ephedrine⁴⁵ mention may be made of that described independently in 1929 by Manske and Johnson⁴⁵ and by Skita and Keil,⁴⁶ which depends on the catalytic hydrogenation of an equimolecular mixture of α -phenylpropane- $\alpha\beta$ -dione (A) and methylamine in alcohol, β -methylimino- α -phenylpropane- α -one (B) being formed intermediately and reduced to *dl*-ephedrine (C) with a little *dl*- ψ -ephedrine.



The *dl*-ephedrine was resolved into its components by the use of *d*- and *l*-mandelic acids. In 1921 Neuberg and Hirsch⁴⁷ showed that benzaldehyde was reduced by yeast, fermenting in sucrose or glucose solution to benzyl alcohol and a phenylpropanolone, which proved to be *l*-Ph. CHOH. CO. CH₃. This can be simultaneously, or consecutively, condensed with methylamine and then converted to *l*-ephedrine by reduction, e.g., with aluminium amalgam in moist ether, or by hydrogen in presence of platinum oxide as catalyst (Knoll, Hildebrandt and Klavehn⁴⁵).

It is definitely established⁴⁸ by the interconversion of (–)-ephedrine (I) and (+)- ψ -ephedrine (II), and by the reduction of both these bases to (+)-deoxyephedrine (III) (B. HCl, m.p. 172°, $[\alpha]_D^{15^\circ} + 19.14^\circ$ (H₂O); B. HAuCl₄, m.p. 126°),⁴⁹ that the contribution of C^(a) is (–) in (–)-ephedrine and (+) in (+)- ψ -ephedrine, and that of C^(b) is (+) in both bases.

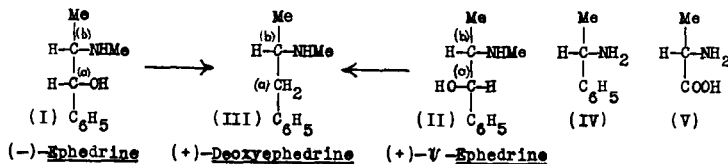

It has also been shown by Freudenberg,⁵⁰ and by Leithe,⁵¹ that the configuration about C^(a) is correlated with that of (–)-mandelic acid in (–)-ephedrine and with (+)-mandelic acid in (+)- ψ -ephedrine. The configuration about C^(b) has been investigated by Leithe,⁵¹ and by Freudenberg and Nikolai,⁵² who agree in representing the distribution about this

centre of asymmetry by formulæ (I) and (II) for ephedrine and ψ -ephedrine, Leithe referring both to *l*-($-$)- α -phenylethylamine⁵³ (IV) and Freudenberg and Nikolai correlating both with the natural amino-acid *l*-($+$)-alanine (V).⁵⁴ The crystal structures of the double tartrates of ψ -cocaine with ephedrine and N-methylephedrine have been investigated by Brückl,⁵⁴ and of the hydrohalide salts of *d*-, *l*- and *dl*-forms of ephedrine, ψ -ephedrine and N-methylephedrine by Gossner and Neff,⁵⁴ with special reference to the crystallographic relationships of *d*-, *l*- and *dl*-forms.

Pharmacological Action. When ephedrine first became available in 1887 it was of interest mainly as a mydriatic and its later widespread use dates from 1924, when Chen and Schmidt⁵⁵ recorded its similarity to adrenaline in pharmacological action. In 1910 Barger and Dale⁵⁶ introduced the term sympathomimetic amines to describe substances exhibiting this type of action, which includes the production of a rise in arterial blood pressure, dilatation of the pupil, contraction of the plain muscle of the orbit, a flow of saliva and tears not readily abolished by atropine, inhibition of the tone and rhythm of the muscular walls of the mammalian intestine and of the cat's urinary bladder. At the same time these authors prepared and examined pharmacologically a series of aliphatic and cyclic amines, the latter chiefly derivatives of phenylethylamine, and from the results drew certain conclusions regarding the kind of molecular structure associated with sympathomimetic action. Since then there has been an almost continuous output of papers dealing with the synthesis and pharmacological action of possible sympathomimetic chemicals. One result of this activity has been to extend the range of therapeutic application of drugs of this type as Gold⁵⁷ has pointed out in a recent review of their clinical uses. Adrenaline is probably still the best all-round drug of this type when action of short duration is required, but ephedrine and a number of the synthetic drugs are especially useful in particular directions and for these purposes can replace adrenaline. The action of ephedrine, unlike that of adrenaline, is not potentiated by cocaine⁵⁸ nor reversed by sympatholytic drugs such as ergotoxine.⁵⁹ The pressor and vaso-constrictor activity is slower and less than that of adrenaline, but is more persistent and, being more stable to metabolic conditions, ephedrine can be given by mouth, whereas adrenaline has to be used by injection. It stimulates the respiratory centre, increasing the depth of respiration; reinforces heart action and dilates the bronchi, more especially when they are in spasm, hence its use in bronchial asthma. It contracts the uterus and dilates the pupil. Large doses may cause hyperglycemia. Ephedrine also has some analeptic action,⁶⁰ due to its central nervous stimulation, which is the basis for its use in the treatment of depression by drugs and for the relief of narcolepsy, though for this purpose its derivatives, deoxyephedrine (methedrine)⁶¹ and *dl*-deoxynorephedrine (amphetamine);

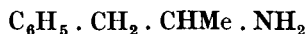

seem to have advantages and the latter⁶² has received particular attention in this respect.

According to Chen, Wu and Henriksen,⁶³ the stereoisomerides of ephedrine resemble it qualitatively in pharmacological action but differ in degree of activity in particular directions. The mydriatic activities of *l*-ephedrine and *d-ψ*-ephedrine are greater than those of *d*-ephedrine and *l-ψ*-ephedrine respectively and the same is true for their pressor action in pithed cats, *l*-ephedrine being three times as potent as the *d*-form and *d-ψ*-ephedrine seven times as active as *l-ψ*-ephedrine. Swanson, Scott, Lee and Chen⁶³ find that in near relatives of ephedrine the *l*-isomeride is more active than the *d*-form, *e.g.*, the ratios of pressor activity for the *l*- and *d*-forms are for deoxyephedrine, 1 : 0.707 ; for deoxynorephedrine ($C_6H_5 \cdot CH_2 \cdot CHMe \cdot NH_2$), 1 : 0.712 ; for *isodeoxynorephedrine*s ($C_6H_5 \cdot CHMe \cdot CH_2 \cdot NH_2$), used as *l*-mandelates, 0.850 : 0.677, and for the *norephedrine*s, ($C_6H_5 \cdot CHOH \cdot CHMe \cdot NH_2$), also used as *l*-mandelates, 1 : 0.678, while the *l*-mandelates of *l*- and *d-ψ*-*norephedrine*s have 1 : 0.869. Among other relatives of ephedrine Schaumann has shown that there are considerable differences in potency in particular directions between ephedrine and its mono- and di-hydroxy-derivatives.⁶⁴ *l*-N-methylephedrine seems on the whole to be somewhat less active than ephedrine ;⁶⁵ it is said to have no central nervous action and its bronchial dilation effect to be slower but equal to that of the parent base in duration and potency. *l*-N-ethylephedrine is stated to have about the same toxicity and effect on the bronchioles as ephedrine, to exert less action on the cardiovascular system, to show minimal central nervous stimulation, but to have a greater effect than ephedrine on uterine and intestinal muscle.⁶⁶ Ephedrine, according to Schultz,⁶⁷ exerts some local anæsthetic action and this property seems to be greatly developed in the *l*-, *d*- and *dl*-forms of cinnamylephedrine, which Schultz and Barbour⁶⁷ state are about ten times as active as cocaine as surface anæsthetics tested on the rabbit's cornea, and twenty times as potent as procaine when tested by the human intradermal wheal method. One per cent. solutions caused local necrosis and more dilute solutions produced local erythema lasting 12 to 24 hours. The drug also relaxes spasm induced by barium chloride or acetylcholine in the intestine, and by pituitary extract in the uterus ; in action it is said to resemble papaverine rather than ephedrine.

In a monograph on ephedrine Gaddum⁶⁸ has reviewed the differences in the action of adrenaline and ephedrine and has suggested that the latter has the same relation to adrenaline as physostigmine has to acetylcholine, that is, ephedrine inhibits the action of an enzyme system, which normally destroys adrenaline, or the substance closely resembling it, produced by adrenergic nerves.

As already stated, the number of substances made by chemists for pharmacological examination as possible sympathomimetic amines is enormous and the literature voluminous. Fortunately the latter has been reviewed from time to time, and most recently in the symposium⁶⁷ in which Hartung dealt with the correlation of structure and pharmacological action in β -phenylethylamine derivatives, which includes the more impor-

tant members of the group. In the same symposium Beyer and Morrison describe the systems which, in the course of animal metabolism, may play a part in the deamination of amines resulting in their conversion into inactive substances, *e.g.*, the change of phenylethylamine into phenylacetaldehyde by the action of amine oxidase (tyraminase). An extensive series of amines has been subjected *in vitro* to the action of such systems under appropriate conditions and the rates of deamination found for the amines show good correlation with the pressor activity, duration of action, efficacy when administered orally, and proportion excreted unchanged in *in vivo* experiments. The structural features in derivatives of phenylethylamine, which seem to promote resistance to deamination by such systems are stated and discussed. The results of a recent investigation of ten amines in similar fashion by Snyder, Goetze and Oberst have confirmed Beyer's observations.⁶⁹ Randall and Hitchings,⁷⁰ using the phenoloxidase system, tyrosinase, on a series of phenylethylamine derivatives, including secondary, tertiary and quaternary compounds, the 2-, 3- and 4-mono-hydroxyphenylethylamines, and the 2 : 3- and 3 : 4-dihydroxyphenylethylamines, found that where oxidation did occur, the results indicated that susceptibility to attack by tyrosinase and the ability to act as pressor agents appeared to depend primarily on different molecular configurations.

Useful comparisons, over a range of pharmacological factors, of various well-known, sympathomimetic amines have been made by Gunn, Tainter and other workers,⁷¹ which serve to indicate lines for the development of special activity. Most of the drugs of this group produced recently are still of the phenylalkylamine type, but divergence in structure is in progress, for example, in derivatives of pyridylalkylamines,⁷² tetrahydroisoquinolines,⁷³ naphthylalkylamines,⁷⁴ indanamines,⁷⁵ indolyethylamines,⁷⁶ furfurylalkylamines,⁷⁷ iminazoles, of which 2-naphthyl-1'-methyliminazoline is an interesting item,⁷⁸ α -thienylalkylamines⁷⁷ and open-chain amines,⁷⁹ such as 2-methylaminoheptane and 2-aminoheptane, and various amidines.⁸⁰

Much attention has been given to development of drugs with improved bronchodilator action. Diverging from the phenylalkylamine type there is emerging a group of "anti-histamine" drugs, so-called because they are intended to counteract the allergic and other effects believed to be due to the liberation of histamine, and are tested in the laboratory against the effects of histamine administered by "atomisation" or by injection. A summary of the French work on this subject has been published by Bovet and Walthert,⁸¹ from which it appears that two effective drugs are N-benzyl-N-dimethylaminoethyl-aniline and N-*p*-methoxy benzyl-N-dimethylaminoethyl-2-aminopyridine; of the latter 0.1 mgm. per kilo of body weight is stated to protect guinea-pigs against the effects of histamine injected intravenously. Much work has also been done in the United States on this subject, and among the drugs developed are alkamine benzhydryl ethers of the type $C_6H_5 \cdot CH(OR) \cdot C_6H_5$ in which R may be, for example, dimethylaminoethyl or β -piperidinoethyl.⁸² Alkyloxy-

diaminotriazines of the type $C(NH_2) : N \cdot CR : N \cdot C(NH_2) : N$ where R may be an alkyloxy, cycloalkyloxy, aryloxy, amino- or substituted amino-group,⁸³ are stated to be less effective.

Anti-histamine drugs, on which there is an extensive literature and of which several are already in practical use, are not only bronchodilators, but counteract other effects of histamine and so belong to the group of spasmolytics, but typical spasmolytics such as atropine, papaverine and pethidine appear to be much less active against bronchiole spasm induced by histamine.⁸⁴ Anti-histamine action is also characteristic of certain esters of polynuclear carboxylic acids of which diethylaminoethyl 9 : 10-dihydroanthracenecarboxylate is an example. It exerts a bronchodilator effect and protects sensitised guinea-pigs against a lethal dose of antigen.⁸⁵ 2-Aminoindane and its N-benzyl and N-methyl derivatives are stated to be more potent bronchodilators than ephedrine when tested by bronchial perfusion of isolated rabbit lung, and similar action is also ascribed to 2-aminoindan-1-ol and 1-aminoindan-2-ol and certain of their alkyl derivatives. These indanamine compounds given intravenously to dogs have little or no effect on blood pressure.⁷⁵

REFERENCES

- (1) *Proc. Soc. Exp. Biol. Med.*, 1924, 21, 351. (2) See especially "Chinese Medicinal Plants : EPHEDRA, Part II.—Botany of Mahuang" (*Flora sinensis*, Series B, Vol. XXIV, No. 1, 1930); "Chinese Medicinal Plants from the Pen Ts'ao Kang Mu, A.D. 1596," published by the *Peking Nat. Hist. Bull.*, 1936. For other contributions to the botany and pharmacognosy of "Ma-huang," see HOLMES, *Pharm. J.*, 1926, 117, 643; STAFF, *Kew Bulletin*, 1927, 133; FARWELL, *J. Amer. Pharm. Assoc.*, 1927, 16, 135; READ and LIU, *ibid.*, 1928, 17, 339; 1929, 18, 328; LIU, *China J.*, 1927, 7, 81; SHORT, *Quart. J. Pharm.*, 1928, 1, 182; SMALL, *ibid.*, 1928, 1, 163; GILG and SCHÜRHOFF, *Arch. Pharm.*, 1930, 268, 233. (3) (With FENG), *Chin. J. Physiol.*, 1927, 1, 297; 1928, 2, 87, 337; *J. Amer. Pharm. Assoc.*, 1927, 16, 1034; cf. TARLÉ, *J. Chin. Chem. Soc.*, 1935, 3, 377, and CHRISTENSEN and HINER, *J. Amer. Pharm. Assoc.*, 1936, 25, 969. (4) *Ind. J. Med. Res.*, 1928, 16, 889; 1931, 19, 177; cf. KRISHNA and GHOSE, *Arch. Pharm.*, 1930, 268, 636; *Indian For. Rec.*, 1931, 16, Part II., 1; *J. Soc. Chem. Ind.*, 1929, 48, 671; READ and FENG, *J. Amer. Pharm. Assoc.*, 1928, 17, 1189; QAZILBASH, *Pharm. J.*, 1947, 158, 9; ANON., *Chem. and Drugg.*, 1939, 130, 70; ARINO, *Farmacog. Madrid*, 1943, 2, 101. (5) NIELSEN, MCCAUSLAND and SPRUTH, *J. Amer. Pharm. Assoc.*, 1927, 16, 288; 1928, 17, 427; TERRY, *ibid.*, 1927, 16, 397; BEASLEY and HARRIS, *ibid.*, 1942, 31, 171; READ and FENG, *Proc. Soc. Exper. Biol. Med.*, 1927, 24, 819; cf. GROFF and CLARK, *Univ. Calif. Publ. Bot.*, 1928, 14, 247, and CHÁVEZ, *Bol. Soc. Quím. Peru*, 1937, 3, 198 (*Chem. Abstr.*, 1938, 32, 6326). (5a) LE BLANC and HUME, *S. Dakota Agr. Exp. Stat. Ann. Rept.*, 1938, 40; HINER, *ibid.*, 1940, 16 (*Chem. Abstr.*, 1941, 35, 1181; 1942, 36, 5320); CHRISTENSEN and HINER, *J. Amer. Pharm. Assoc.*, 1939, 28, 199; SIEVERS, *J. Amer. Pharm. Assoc.*, 1938, 27, 1221 (cf. PERRONET and CHATIN, *J. Pharm. Chim.*, 1942, [ix], 2, 19, and BLACK and KELLY, *Amer. J. Pharm.*, 1927, 99, 748). (6) *Reports Council Sci. and Ind. Aust.*, 1941-2, 1942-3, p. 11. (7) MASSAGETOV, *Farmat i Farmakol*, 1938, p. 17 (*Chem. Abstr.*, 1940, 34, 6765). (8) ALBERTI, *Boll. Chim. Farm.*, 1939, 78, 477; MULAS and SALIS, *Arch. Ist., Biochim. Ital.*, 1939, 11, 315; CARBONI, *Ricerca Sci.*, 1940, 11, 754; *Ann. Chim. Appl.*, 1941, 31, 278, 281, 457; LA FLORESTA, *Arch. Farm. sperim.*, 1939, 68, 66; 1940, 69, 41; *Boll. Soc. Ital. Biol. sperim.*, 1940, 15, 501, 503; SIMON, *Chem. Abstr.*, 1943, 37, 4582. (9) GHOSE and KRISHNA, *J. Ind. Chem. Soc.*, 1943, 6, 142. (10) *Nature*, 1944, 153, 201; 1946,

157, 524; MARSHALL, *Pharm. J.*, 1947, 158, 334. (11) GULLAND and VIRDEN, *J. Chem. Soc.*, 1931, 2148. (12) GHOSH and DUTT, *J. Ind. Chem. Soc.*, 1930, 7, 825. (13) *Arch. Pharm.*, 1930, 268, 87. (14) *Ind. J. Med. Res.*, 1935, 22, 785; CHOPRA and DE, *Ind. Med. Gaz.*, 1932, 67, 128. (15) *J. Pharm. Soc. Japan*, 1892, No. 120, 109; No. 121, 181; No. 127, 832; 1928, 48, 101; *Annalen*, 1929, 470, 157; KANAO, *Ber.*, 1930, 63, 95. (16) *Merck's Jahreshb.*, 1888, 1; 1893, 13. (17) *J. Chem. Soc.*, 1927, 2056; 1928, 51; 1929, 2755; cf. NAGAI and KANAO, *J. Pharm. Soc. Japan*, 1928, 48, 101. (18) CHEN, STUART and CHEN, *J. Amer. Pharm. Assoc.*, 1931, 20, 339; CHOU and MEI, *Chin. J. Physiol.*, 1934, 8, 161. (19) *Arch. Pharm.*, 1930, 268, 327; SPEHR, *Pharm. Zeit. Russ.*, 1892, 31, 65. (20) For other methods and comparisons of methods, see WILLIAMS, *J. Amer. Pharm. Assoc.*, 1928, 17, 430; Hsu, *ibid.*, 1930, 19, 817; HAYDEN and JORDAN, *ibid.*, 1933, 22, 616; PAUL and GLYCART, *J. Assoc. Off. Agric. Chem.*, 1929, 12, 290; PEYER and GSTIRNER, *Pharm. Zeit.*, 1931, 76, 1440; RYBILL and MACDONALD, *Quart. J. Pharm.*, 1937, 10, 463. (21) *J. Pharm. Soc. China*, 1943, 1, 27 (*Brit. Abstr.*, 1944, B iii, 237), cf. MONNET and DURAND, *J. Pharm. Chim.*, 1938, [viii], 28, 145. (22) *Pharm. J.*, 1944, 153, 178. (23) *Chin. J. Physiol.*, 1927, 1, 397; see also CHEN, *J. Amer. Pharm. Assoc.*, 1929, 18, 110. (24) Cf. JACKEROTT, *Dansk. Tids. Farm.*, 1939, 13, 53; 1942, 16, 134. (25) MORAW, *J. Amer. Pharm. Assoc.*, 1928, 17, 431; *Amer. Pharm. Assoc. Lab. Bull. Natl. Form. Comm.*, U.S.A., 1939, 7, 337; ROSEN, *ibid.*, 1940, 8, 353; GRANT, *J. Assoc. Off. Agric. Chem.*, 1940, 23, 790; WELSH, *ibid.*, 1947, 36, 467; HILTY, *J. Amer. Pharm. Assoc.*, 1944, 33, 28; WELSH, *ibid.*, p. 96; 1947, 36, 373; SCHOEN, *ibid.*, p. 116. (26) SANCHEZ, *J. Pharm. Chim.*, 1935, [viii], 22, 489; cf. FOURMENT and ROQUES, *Bull. Sci. Pharmacol.*, 1937, 44, 372. (27) READ and FENG,³ (1927); PITTENGER, *J. Amer. Pharm. Assoc.*, 1928, 17, 634; GITHENS, *ibid.*, 1933, 22, 391. (28) CHEN and KAO, *ibid.*, 1926, 15, 625; EMDE, *Arch. Pharm.*, 1930, 268, 83; READ, *Trans. Far-East. Assoc. Trop. Med.*, 1927, 2, 537. (29) MOORE and TABERN, *J. Amer. Pharm. Assoc.*, 1935, 24, 211; cf. *J. Amer. Med. Assoc.*, 1935, 104, 1707; READ, *Chin. Med. J.*, 1937, 51, 69; cf. EMDE, *Helv. Chim. Acta*, 1929, 12, 370; and JAROWSKI and HARTUNG, *J. Org. Chem.*, 1943, 8, 564. (30) *J. Chem. Soc.*, 1940, 1153. (30a) WELSH, *J. Amer. Chem. Soc.*, 1947, 69, 128. For early papers on acetylation of ephedrines see NAGAI, *J. Pharm. Soc. Jap.*, 1927, No. 127, p. 832; SCHMIDT and CALLIESS, *Arch. Pharm.*, 1912, 250, 154; SCHMIDT, *ibid.*, 1914, 252, 111. (30b) *J. Amer. Chem. Soc.*, 1947, 69, 200. (31) TSIANG and BROWN, *J. Amer. Pharm. Assoc.*, 1927, 16, 294; SIVADJIAN, *J. Pharm. Chim.*, 1930, [viii], 12, 266; 1931 [viii], 14, 61; cf. HARTUNG, CROSSLEY and MUNCH, *ibid.*, 1931, [viii], 13, 474; PESEZ, *ibid.*, 1938 [viii], 27, 120; SANCHEZ²⁶; (a) CHEN, *J. Amer. Pharm. Assoc.*, 1929, 18, 110; FENG and READ, *ibid.*, 1933, 22, 1241; FOURMENT and ROQUES²⁶; (b) CHEN, *loc. cit.*; ROSENTHALER, *Zeit. Anal. Chem.*, 1931, 86, 61; PARIS, *Pharm. Weekbl.*, 1936, 73, 1526; (c) *Quart. J. Pharm.*, 1946, 19, 534. (32) *Annalen*, 1929, 470, 157. (33) *J. Pharm. Soc. Japan*, 1927, No. 540, 20; 1928, 48, 145; *Annalen*, 1929, 470, 157. (34) *J. Chem. Soc.*, 1929, 2754. (35) *Arch. Pharm.*, 1906, 244, 246. (36) *Ber.*, 1889, 22, 1823. (37) *Arch. Pharm.*, 1902, 240, 481. (38) SCHMIDT, *ibid.*, 1906, 244, 239, 241; EMDE, *ibid.*, 1907, 245, 662; 1909, 247, 54; cf. GADAMER, *ibid.*, 1908, 246, 566. (39) FLAECHEER, *ibid.*, 1904, 242, 380; SCHMIDT, *ibid.*, 1906, 244, 239; 1908, 246, 210; (with BÜMMING), 1909, 247, 141; GADAMER, *ibid.*, 1908, 246, 566; CALLIESS, *Apothl. Zeit.*, 1910, 25, 677. (40) *Ber.*, 1911, 44, 824; cf. SCHMIDT, *Arch. Pharm.*, 1911, 249, 305; 1914, 252, 89; 1915, 253, 52; EBERHARD, *ibid.*, 1915, 253, 62; OGATA, *J. Pharm. Soc. Japan*, 1919, No. 451, 751; also DAVIES, *J. Chem. Soc.*, 1932, 1580; MCKENZIE, LUIS and MITCHELL, *Ber.*, 1932, 65, 798. (41) See, for example, SCHMIDT, *Arch. Pharm.*, 1908, 247, 141; (with FLAECHEER), *ibid.*, 1905, 243, 73; (with CALLIESS), *Apoth. Zeit.*, 1911, 26, 368. FOURNEAU, *J. Pharm. Chim.*, 1904, [vi], 20, 481; 1907, [vi], 25, 593. For a critical survey of this early work see FOURNEAU (with KANAO), *Bull. Soc. Chim.*, 1924, [iv], 35, 614; (with BENOIT), *ibid.*, 1945, [v], 12, 987. (42) *Arch. Pharm.*, 1915, 253, 62; 1917, 255, 140; 1920, 258, 97. (43) *Anal. Fis. Quim.*, 1922, 20, 394; cf. FOURNEAU, *J. Pharm. Chim.*, 1904, [vi], 20, 481; 1907, 25, 593. (44) *Monats.*, 1920, 41, 319; *Ber.*, 1925, 58, 197. (45) FOURNEAU (with KANAO), *Bull. Soc. Chim.*, 1924, [iv], 35, 614, critical *résumé* with bibliography; (with NICOLITICH), *ibid.*, 1928, [iv], 43, 1282; (with TORRES), *Anal. Fis. Quim.*, 1925, 23, 450; SPÄTH

and KOLLER, *Ber.*, 1925, 58, 1268; BOSSERT and BRODE, *J. Amer. Chem. Soc.*, 1934, 56, 165; MANSKE and JOHNSON, *J. Amer. Pharm. Assoc.*, 1928, 17, 1199; *J. Amer. Chem. Soc.*, 1929, 51, 580, 1906, 2269; KANAO, *J. Pharm. Soc. Japan*, 1927, No. 540, 17; NAGAI and KANAO, *Annalen*, 1929, 470, 157; cf. SPÄTH and BRETSCHNEIDER, *Ber.*, 1928, 61, 327; KNOLL, HILDERRANDT and KLAVEHN, B.P. 360,334; cf. U.S.P. 1,956,950; VON FODOR, *Ber.*, 1943, 76, 126 (norephedrine); COUTURIER, *Compt. rend.*, 1938, 207, 345; STEVENS, *J. Amer. Chem. Soc.*, 1938, 60, 3089; SAH, *Ber.*, 1938, 71, 2300. (46) SKITA (with KEIL), *Ber.*, 1929, 62, 1142; (with BAESLER), *ibid.*, 1933, 66, 858; (with MEINER), *ibid.*, pp. 974, 1400. (47) NEUBERG and HIRSCH, *Biochem. Zeit.*, 1921, 115, 282. (48) EMDE, *Helv. Chim. Acta*, 1929, 12, 365, 377, 384, 399; (with SPANHAUSER), *ibid.*, 1930, 13, 3; *Arch. Pharm.*, 1930, 268, 90. (49) SCHMIDT, *Arch. Pharm.*, 1914, 252, 120; 1915, 253, 52. (50) (With SCHOEFFEL and BRAUN), *J. Amer. Chem. Soc.*, 1932, 54, 234; (with NIKOLAI), *Annalen*, 1934, 510, 223. (51) *Ber.*, 1932, 65, 660. (52) *Ibid.*, 1931, 64, 2827. (53) FREUDENBERG and RHINO, *ibid.*, 1924, 57, 1547. (54) BRÜCKL, *Zeit. Kryst.*, 1932, 81, 219; GOSSNER and NEFF, *ibid.*, 1933, 85, 370; 86, 32; 1934, 89, 417; 1936, 93, 488; *Neues. Jahrb. Min.*, 1935, 69, 347. (55) *J. Pharm. Exp. Ther.*, 1924, 24, 339. (56) *J. Physiol.*, 1910, 41, 19. (57) *Ind. Eng. Chem.*, 1945, 37, No. 2. Symposium on sympathomimetic agents: GOLD; clinical uses; SCHOLZ, imidazole derivatives; HARTUNG, β -phenylethylamine derivatives; TAINTER, pharmacological methods and objectives; BEYER and MORRISON, deamination of sympathomimetic amines; GRAHAM, CARTLAND and WOODRUFF phenylpropyl- and phenylisopropyl-amines. (58) EDS, *Proc. Soc. Exp. Biol. Med.* 1927, 24, 551; CHEN, *J. Pharm. exp. Ther.*, 1928, 33, 229; TAINTER, *ibid.*, 1929, 36, 569; RAYMOND-HAMET, *Arch. exp. Path. Pharm.*, 1931, 160, 1. (59) NAGEL, *Arch. exp. Path. Pharm.*, 1925, 110, 129; KREITMAIR, *ibid.*, 1927, 120, 189; RAYMOND-HAMET, *Compt. rend. Soc. Biol.*, 1927, 97, 618. (60) KOLL and ERGANG, *Arch. exp. Path. Pharm.*, 1942, 199, 577; HAZLETON, *J. Amer. Pharm. Assoc.*, 1944, 33, 65; TAINTER, WHITSELL and DILLE, *J. Pharm. exp. Ther.*, 1939, 67, 56. (61) HAUSCHILD, *Arch. exp. Path. Pharm.*, 1938, 190, 177; 1939, 191, 465; IVY and GOETZL, *War Medicine* (Chicago), 1943, 3, 60; use, as a pressor substance in surgery, see DODD and PRESCOTT, *Brit. Med. J.*, 1943, i, 345; BURN, *Brit. Med. Bull.*, 1946, 4, 95; measurement of analeptic activity, see GOODWIN and MARSHALL, *J. Pharm. exp. Ther.*, 1945, 84, 12; review of literature, HALEY, *J. Amer. Pharm. Assoc.*, 1947, 36, 161, 301. (62) GOLD⁵⁷; DAVIDOFF and REIFENSTEIN, *Am. J. Psychiatry*, 1939, 95, 945; DAVIES, GUTTMANN, TREVAN, RICHTER, RUDOLF, STRÖM-OLSEN, *Proc. Roy. Soc. Med.*, 1939, 32, 391; *New and Non-Official Remedies, U.S.A.*, 1945, 278; WARREN and WERNER, *J. Pharm. exp. Ther.*, 1945, 85, 119; NEWMAN, *ibid.*, 1947, 89, 106. (63) READ *et al.*, *Chin. J. Physiol.*, 1928, 2, 97, 435; 1929, 3, 81, 95; CHOPRA *et al.*, *Ind. J. Med. Res.*, 1931, 19, 177; CHEN, *Arch. Int. Med.*, 1927, 39, 404; (with WU and HENRIKSEN), *J. Pharm. exp. Ther.*, 1929, 36, 363; (with SWANSON, SCOTT and LEE), *ibid.*, 1943, 79, 329; (with SWANSON and STELDT), *ibid.*, 1945, 85, 70; EMILSSON, *Acta Physiol. Scand.*, 1942, 3, 275; BADGER, *Nature*, 1947, 159, 194; STEDMAN, *ibid.*, p. 195. (64) *Arch. exp. Path. Pharm.*, 1931, 160, 127; *Med. u. Chem.*, 1936, 3, 383; cf. KIESE, GARAN and KRAUTWOLD, *Klin. Woch.*, 1938, 17, 967. (65) PAK and READ, *Quart. J. Pharm.*, 1936, 9, 235, 256; for action of methiodide see LEE, VAN ARENDONK and CHEN, *J. Pharm. exp. Ther.*, 1936, 56, 466. (66) BECKER, WARREN, MARSH, THOMPSON and SHELTON, *ibid.*, 1942, 75, 289; HARTUNG,⁵⁷ (67) *Anæsthesiology*, 1940, 1, 69; *J. Pharm. exp. Ther.*, 1940, 70, 283; (with BARBOUR), *ibid.*, 1942, 76, 295; WELSH and KEENAN, *J. Amer. Pharm. Assoc.*, 1941, 30, 123; see also EIDEBENZ, *Arch. Pharm.*, 1942, 280, 49. (68) *Brit. Med. J.*, 1938, i, 713; (with KWIAKOWSKI), *J. Physiol.*, 1938, 94, 87; 1939, 96, 385; (with K. and JANG, *ibid.*, p. 104, cf. GRAHAM and GURD, *J. Pharm. exp. Ther.*, 1941, 72, 48. (69) *Ibid.*, 1946, 86, 145. (70) *Ibid.*, 1944, 80, 77; cf. DULIERE and RAPER, *Biochem. J.*, 1930, 24, 239; ALLES, BLOHM and SAUNDERS, *J. Biol. Chem.*, 1942, 144, 757. (71) HAUSCHILD, *Arch. exp. Path. Pharm.*, 1938, 190, 177; 1939, 191, 465; *Klin. Woch.*, 1941, 20, 863; CRISMON and TAINTER, *J. Pharm. exp. Ther.*, 1938, 64, 190; 1939, 66, 146; TAINTER, *J. Amer. Med. Assoc.*, 1941, 116, 2769; GUNN, *Brit. Med. J.*, 1939, ii, 155, 214; WARREN and WERNER, *J. Pharm. exp. Ther.*, 1946, 86, 280, 284; REICHERT and SCHMIEDER, *Arch. exp. Path. Pharm.*, 1941, 198, 121.

(72) WALTER, HUNT and FOSBINDER, *J. Amer. Chem. Soc.*, 1941, **63**, 2771; HUNT and FOSBINDER, *J. Pharm. exp. Ther.*, 1942, **75**, 299; LEE, DINWIDDIE and CHEN, *ibid.*, 1947, **89**, 83; NIEMANN and HAYS, *J. Amer. Chem. Soc.*, 1942, **64**, 2288; BURRUS and POWELL, *ibid.*, 1945, **67**, 1468; RIEGEL and WITTCOFF, *ibid.*, 1946, **68**, 1913. (73) BUCK, *ibid.*, 1934, **56**, 1769, 1771; (with IDE), *ibid.*, 1938, **60**, 2101; 1940, **62**, 425; HJORT (with de BEER and FASSETT), *J. Pharm. exp. Ther.*, 1938, **62**, 165; **63**, 432; 1940, **68**, 69, 73; FASSETT and HJORT, *ibid.*, 1938, **63**, 253. (74) RAJAGOPALAN and VENKARTACHALAM, *Curr. Sci.*, 1944, **13**, 232. (75) LEVIN, GRAHAM and KOLLOFF, *J. Org. Chem.*, 1944, **9**, 380. (76) RAYMOND-HAMET, *C. R. Soc. Biol.*, 1941, **135**, 1320. (77) ALLES and FEIGEN, *J. Pharm. exp. Ther.*, 1941, **72**, 265. (78) SCHOLZ⁵⁷; EMERSON *J. Pharm. exp. Ther.*, 1944, **82**, 42; CRAVER, CHASE and YONKMANN, *ibid.*, p. 275; YONKMANN, RENNICK and SCHWERMA, *ibid.*, 1945, **84**, 197; HILD, *Schweiz. Med. Woch.*, 1941, **71**, 557. (79) AHLQUIST, *J. Amer. Pharm. Assoc.*, 1943, **32**, 151; *J. Pharm. exp. Ther.*, 1944, **81**, 235; 1945, **85**, 283; SWANSON and CERN, *ibid.*, 1946, **88**, 10; FELLOWS, *ibid.*, 1947, **90**, 351; GAKENHEIMER and HARTUNG, *J. Org. Chem.*, 1944, **9**, 85; ROHRMANN and SHONLE, *J. Amer. Chem. Soc.*, 1944, **66**, 1516; DUNKER and HARTUNG, *J. Amer. Pharm. Assoc.*, 1941, **30**, 619 (Review). (80) FASTIER, *Nature*, 1944, **154**, 429; GOODWIN and MARSHALL, *J. Pharm. exp. Ther.*, 1945, **84**, 16. (81) *Ann. Pharm. Franc.*, 1944, **2**, 43; BOVET, DE LESTRANGE and FOURNEAU, *C. R. Soc. Biol.*, 1939, **130**, 1192. (82) LOEW (with KAISER and MOORE), *J. Pharm. exp. Ther.*, 1945, **83**, 120; (with MACMILLAN and KAISER), *ibid.*, 1946, **86**, 229; ELLIS, *Fed. Proc.*, 1946, **35**, 30; ELIAS and MCGAVACK, *Proc. Soc. exp. Biol. Med.*, 1946, **61**, 133. (83) LOEW, KAISER and ANDERSON, *J. Pharm. exp. Ther.*, 1946, **86**, 7. (84) LOEW, KAISER and MOORE, *ibid.*, 1946, **86**, 1; FEINBERG, *J. Amer. Med. Assoc.*, 1916 **132**, 702. (85) LEHMANN (with KNOEFEL), *ibid.*, 1944, **80**, 335; (with YOUNG), 1945, **83**, 90; BURTNER and CUSIC, *J. Amer. Chem. Soc.*, 1943, **65**, 262, 1582.

ALKALOIDS OF BRASSICA SPP.

Sinapine, $C_{16}H_{25}O_6N$, was isolated as a thiocyanate from black mustard seeds (*Brassica nigra*) by Henry and Garot.¹ Will and Laubenheimer² first noted that sinapine occurs in white mustard seed in the form of the alkaloidal glucoside SINALBINE, $C_{30}H_{42}O_{15}N_2S_2$, which, on hydrolysis by the enzyme myrosin, also present in the seed, furnished dextrose, *p*-hydroxybenzylthiocarbimide and sinapine sulphate.³ Owing to its instability sinapine is unknown in the free state. The thiocyanate can be recrystallised from water and converted into the acid sulphate by treatment with sulphuric acid.

Sinapine acid sulphate, $C_{16}H_{24}O_5N \cdot HSO_4 \cdot 3H_2O$, crystallises in leaflets, m.p. 127° (188°, *dry*). The thiocyanate, $C_{16}H_{24}O_5N \cdot SCN \cdot H_2O$, forms pale yellow needles, m.p. 178°: iodide, m.p. 185–6°. When the thiocyanate is warmed with alkalis there is formed choline and sinapic acid, $C_{11}H_{12}O_5$ ⁴; the acid was investigated by Remsen and Coale,⁵ and by Gadamer.³ It crystallises in prisms, m.p. 191–2°, contains two methoxyl groups and a carboxyl group and furnishes a monoacetyl derivative. With methyl iodide in presence of alkalis, it yields methyl methylsinapate, $C_8H_4(OMe)_3 \cdot CO_2Me$, which by partial hydrolysis with alcoholic potash forms methylsinapic acid, and from the latter there is formed by oxidation trimethylgallic acid. Acetylsinapic acid, on oxidation by permanganate yields syringic acid (3:5-dimethoxy-4-hydroxybenzoic acid). Gadamer³ proposed the following formulæ for sinapic acid and sinapine, the latter being the choline ester of sinapic acid:

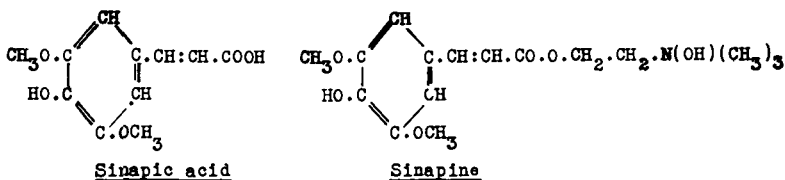

This was confirmed by Späth's synthesis⁶ of sinapine iodide by the following method. Syringic acid was converted into carbethoxysyringic acid, and this through the acid chloride into the aldehyde,



This on heating with malonic and acetic acids yielded 4-carbethoxy-3:5-dimethoxybenzylidenemalonic acid,



which on distillation *in vacuo* furnished carbethoxysinapic acid,



from which sinapic acid was obtained by hydrolysis with sodium hydroxide *in vacuo*. Esterification of the acid with choline could not be carried out but dimethylaminoethanol with acetylsinapoylchloride gave the corresponding acetyl ester,

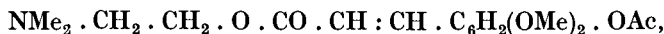

from which the acetyl group was readily eliminated yielding a product, which on treatment with methyl iodide was converted into sinapine iodide, $\text{NMe}_3\text{I} \cdot \text{CH}_2 \cdot \text{CH}_2 \cdot \text{O} \cdot \text{CO} \cdot \text{CH} : \text{CH} \cdot \text{C}_6\text{H}_2(\text{OMe})_2 \cdot \text{OH}$, identical with that obtainable from the natural alkaloid.

REFERENCES

- (1) *J. Pharm.*, 1825, 20, 63. (2) *Annalen*, 1879, 199, 162. (3) GADAMER, *Arch. Pharm.*, 1897, 235, 44, 81, 570; *Ber.*, 1897, 30, 2322, 2327, 2330. (4) VON BABO and HIRSCHBRUNN, *Annalen*, 1852, 84, 10. (5) *Amer. Chem. J.*, 1884, 6, 52. (6) *Monats.*, 1920, 41, 271.

ALKALOIDS OF CHEIRANTHUS AND ERYSIMUM SPP.

Cheiroline. In 1898 Reeb obtained from wallflower leaves and seeds two substances, cheiranthin and cheirinine. The former was described as a glucoside, having a digitalis-like action, whilst cheirinine was given the formula $\text{C}_{18}\text{H}_{35}\text{O}_{17}\text{N}_3$, and was stated to resemble quinine in pharmacological action.¹ In 1908 Wagner² obtained from the seeds cheiroline, $\text{C}_9\text{H}_{16}\text{O}_7\text{N}_2\text{S}_2$, colourless prisms, m.p. 47–8°, which when warmed with mercuric oxide and water yields cheirole, $\text{C}_9\text{H}_{20}\text{O}_9\text{N}_2$, colourless needles, m.p. 172.5°. Schneider³ showed that Wagner's cheiroline should be represented by the formula $\text{C}_5\text{H}_9\text{O}_2\text{NS}_2$, and proved that the substance was identical with methyl- γ -thiocarbimidopropylsulphone, $\text{CH}_3 \cdot \text{SO}_2 \cdot (\text{CH}_2)_3 \cdot \text{NCS}$. Cheiroline appears to exist in wallflower seed as a glucoside. It has also been obtained from the seeds of *Erysimum*

*aureum*⁴ and *E. arkansanum*,³ whilst Schneider and Kaufmann have obtained from *Erysimum perowskianum*,⁵ *erysoline*, $C_6H_{11}O_2NS_2$, which occurs as a glucoside and which they have shown by synthesis to be methyl- δ -thiocarbimidobutylsulphone, $CH_3 \cdot SO_2 \cdot (CH_2)_4 \cdot NCS$.

REFERENCES

- (1) *Arch. exp. Path. Pharm.*, 1898, **41**, 302; 1899, **43**, 130; cf. SÜSSENGUTH, *Chem. Zeit.*, 1944, **ii**, 451; DUMENOVA, *Chem. Abstr.*, 1946, **40**, 6683. (2) *Chem. Zeit.*, 1908, **32**, 76. (3) *Ber.*, 1908, **41**, 4466; 1909, **42**, 3416; 1912, **45**, 2954; *Annalen*, 1910, **375**, 207. (4) Cf. SCHLAGDENHAUFFEN and REEB, *Compt. rend.*, 1900, **131**, 753. (5) *Annalen*, 1912, **392**, 1.

ALKALOIDS OF *COLCHICUM AUTUMNALE*

Colchicine, $C_{22}H_{25}O_6N$, was obtained from the seeds and corms of the autumn crocus, *Colchicum autumnale* L. (Liliaceæ), by Pelletier and Caventou,¹ and has since been found in other *Colchicum* spp. and in numerous Liliaceous spp.² In *Gloriosa superba*³ it occurs with two other alkaloids: (a) $C_{15}H_{17}O_4N$ or $C_{33}H_{38}O_9N_2$, leaflets, m.p. 177–8°, and (b) $C_{23}H_{27}O_6N$, needles, m.p. 276°, which may be a methylcolchicine. Oberlin⁴ found that colchiceine, $C_{21}H_{23}O_6N$, of which colchicine is a methyl ether, occurs with colchicine, but according to Zeisel⁵ is probably formed during extraction. Liptak states that the alkaloids are located chiefly in the endosperm and the third layer of the seed-coat.⁶ A process for manufacture has been published by Chemnitius.⁷ A method for the estimation of colchicine is given in the British Pharmacopœia, 1932, a minimum alkaloidal content of 0.25 per cent. in the corm and 0.3 per cent. in the seed being required. For a discussion of methods see Grier,⁸ and Saifert,^{8(a)} and for other processes Coll and Preioni,⁹ Rosenthaler,¹⁰ Self and Corfield¹¹ and Boyland and Mawson.¹¹ According to Niemann¹² colchicum flowers contain 0.8 per cent. of colchicine.

Commercial colchicine usually consists of yellow flakes or powder, or crystals containing chloroform of crystallisation. It can be crystallised from water¹³ as a trihydrate, or from ethyl acetate (Clewer *et al.*³) forming soft, pale yellow needles, m.p. 155–7°, $[\alpha]_D^{16.5} - 120.8^\circ$ ($CHCl_3$)³ or -429° (H_2O). The pure alkaloid is more easily obtained by chromatographic fractionation (Ashley and Harris¹³). From benzene it crystallises with 1 mol. of solvent and has m.p. 140°. According to Merck,¹³ the base forms two crystalline compounds with chloroform, B. $CHCl_3$ and B. $2CHCl_3$, which decompose at 100° or in water at 50°. It is miscible in all proportions with aqueous alcohol or chloroform but is less soluble in water or dry alcohol. Colchicine is feebly basic and its salts decompose in water; the aurichloride has m.p. 209°. The alkaloid forms a yellow solution in sulphuric acid, which turns greenish-blue, then red on addition of a drop of nitric acid. A solution in chloroform gives no colour with ferric chloride in the same solvent, but under these conditions colchiceine gives a green colour. A solution of colchicine in dry alcohol produces a garnet colour with ferric chloride; an aqueous solution gives no colour with this reagent in the cold but becomes reddish-brown on warming.

According to Grewe,¹³ colchicine on exposure to ultra-violet light changes to an isomeride, needles, m.p. 220°, which he has named lumicolchicine.

Constitution. Zeisel⁵ showed that with hot dilute hydrochloric acid colchicine lost 1 mol. of methyl alcohol, giving rise to colchiceine, $C_{21}H_{23}O_6N$ (p. 655). With stronger acid colchiceine gave a molecule of acetic acid and a new base, trimethylcolchicine acid, $C_{19}H_{21}O_5N \cdot 2H_2O$, m.p. 159° (*dec.*), which forms salts both with bases and acids, contains three methoxyl groups, and on demethylation yields colchicine acid, $C_{16}H_{15}O_5N$. These changes indicate the presence in colchicine of a labile methoxyl group, three more resistant methoxyl groups and an acetyl group; removal of the latter leaves a substance, which behaves as a primary amine. The labile methoxyl group was assumed by Zeisel⁵ to be a carbomethoxyl group, and he represented colchicine by the extended linear formula $(MeO)_3(C_{15}H_9)(CO \cdot OMe)(NHAc)$ and colchiceine as the corresponding carboxylic acid. Windaus¹⁴ showed that colchiceine behaved as an aldehydic- or keto-enolic substance and not as an acid, and that trimethylcolchicine acid yields a dibenzoyl derivative, $(CH_3O)_3 \cdot C_{16}H_9O \cdot (OBz)(NHBz)$, m.p. 298° (*dec.*), which, on treatment with potassium hydroxide solution, forms *N*-benzoyltrimethylcolchicine acid, m.p. 253–4°, and this, unlike the dibenzoate, gives a dark green colour with ferric chloride. The corresponding dibenzenesulphonyl derivative exists in two stereoisomeric forms, both yielding the same *N*-benzenesulphonyl-derivative on careful hydrolysis and implying the presence of an oxymethylene group and that colchicine is the methyl ether of the oxymethylene compound, colchiceine. On the other hand, colchiceine may be an *o*-hydroxyaldehyde, since on treatment with iodine in presence of alkali it is converted into *N*-acetyliodocolchinol, $C_{20}H_{22}O_5NI$, apparently by the replacement of an aldehyde group by iodine, though this may correspond with the conversion of oxymethylene camphor into monobromocamphor by bromine in presence of alkali.¹⁵ Though the hydroxy-aldehyde formulation is preferred,¹⁶ it is adopted in a modified form to account for the labile character of this methyl ether group in colchicine, and the failure to give aldehydic reactions. The action of iodine in converting colchiceine (I) into *N*-acetyliodocolchinol (III) is represented thus:—

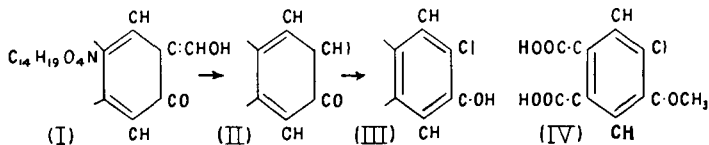

The methyl ether of *N*-acetyliodocolchinol (III; C.OH → C.OMe) is oxidised by hot permanganate solution to 4-iodo-5-methoxyphthalic acid¹⁶ (IV). The latter is unchanged when the substituents are interchanged in position (as required by the more recent results of Barton, Cook and Loudon described below), so these observations imply the presence of a benzene ring in *N*-acetyliodocolchinol, with iodine as a

substituent at C⁴ or C⁵ and hydroxyl at C⁵ or C⁴. This represents ring C in the colchicine formula ultimately adopted by Windaus.

A second benzene ring is indicated by the fact that colchicine, colchicine and trimethylcolchicinic acid are all oxidised by hot permanganate to 3 : 4 : 5-trimethoxyphthalic acid. This represents ring A in the Windaus formula.

If the NH₂ group is eliminated first, as in the fusion of colchicine with potassium hydroxide, and the product is oxidised with permanganate, terephthalic and trimellitic (benzene 1 : 2 : 4-tricarboxylic) acids are formed, which should come from a third benzene ring.

The foregoing results imply either an anthracene or a phenanthrene nucleus. Decision between the two was arrived at by deacetylating *N*-acetylcolchicinol methyl ether, (MeO)₄(C₁₅H₉)(NHAc), to the corresponding primary amine, of which the quaternary ammonium hydroxide, when heated *in vacuo*, decomposed into trimethylamine, and a substance, C₁₉H₂₀O₄. The latter, subsequently prepared by Cook *et al.* in a simpler fashion (p. 653) and named *deaminocolchicinol methyl ether*, forms tablets, m.p. 111°, contains four methoxyl groups, and, on demethylation and distillation with zinc dust, yields a hydrocarbon, C₁₅H₁₂, shown to be 9-methylphenanthrene, m.p. 91–2°,¹⁷ synthesised for this purpose. From these data formula (V) was suggested for *N*-acetylcolchicinol methyl ether. Position 9 is indicated for the nitrogen side-chain, since *N*-acetylido-colchicinol methyl ether (V with I at C⁶ or C⁷), on reduction with zinc dust, followed by chromic acid oxidation, yields 4-methoxy-*o*-phthalimide (Windaus,¹⁴ 1919). In colchicine ring C has the structure shown in (I), whence (VI) was proposed for the alkaloid, and from this (VII) follows for colchicine itself with the substituents at C⁶ and C⁷ possibly interchanged in (VI) and (VII).

The location of a methoxyl group at position 4 in ring A was proved indirectly by Windaus,¹⁶ whence it follows that the three vicinal methoxy groups in that ring must occupy positions 2-, 3- and 4-. The positions of all four methoxyl groups in colchicine were later clearly settled by Barton, Cook and Loudon¹⁸ (p. 653).

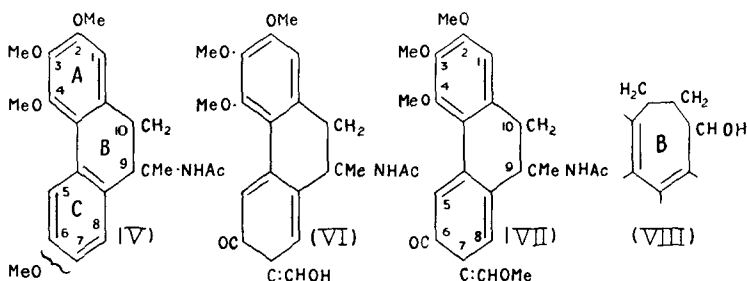

The presence of a methylene group at C¹⁰ is indicated by the chromic acid oxidation of colchicine to oxycolchicine, C₂₂H₂₃O₇N, yellow prisms, m.p. 266–8°⁵ (VII; CH₂ → CO at C¹⁰).

For the synthesis of phenanthrene derivatives which may be regarded as an approach to colchicine as formulated by Windaus, see Windaus and Eichel,¹⁷ Sharp,¹⁹ and Grewe.^{19(a)}

Windaus's formula seemed to be supported on the whole by the results Bursian obtained in the investigation of the hydrogenation of colchicine and colchiceine and his study of the absorption spectra of these alkaloids²⁰; the same is true of Schuhler's results of work on the spectral and physico-chemical properties of colchicine,²¹ while the structure of ring C was confirmed by Grewe's synthetical proof¹⁶ of the formation of 4-iodo-5-methoxyphthalic acid (p. 651). Further work, and especially that of J. W. Cook and his colleagues, has shown that revision of the formula is necessary. Cohen, Cook and Roe²² found that when colchinal methyl ether (V with NHAc \rightarrow NH₂), is treated with nitrous acid, a laevorotatory alcohol, C₁₉H₂₂O₅, m.p. 115.5–116.5°, is formed, which should be a tertiary carbinol related to 9:10-dihydrophenanthrene. It is too stable for such a constitution and its ultra-violet absorption curve shows that it is not a phenanthrene derivative. The authors point out that though rings A and C of the Windaus formula seem to be reasonably well established the evidence for ring B, *viz.* the formation of 9-methylphenanthrene from deaminocolchinal methyl ether, might well be due to intramolecular change induced by the drastic process of demethylation, followed by zinc distillation, and if such a change occurs they suggest ring B might be seven-membered, which would make the new alcohol, a secondary carbinol (partial formula VIII), and seemed to present no difficulty in accounting for the salient points in colchicine chemistry. It then became of interest to synthesise deaminocolchinal methyl ether (p. 652) which Windaus¹⁶ regarded as either 2:3:4-6 or -7-tetramethoxy-9-methylphenanthrene, and which Cook, Graham *et al.*,²³ prepared in a simple fashion by the action of phosphorus pentoxide on *N*-acetylcolchinal methyl ether. In this reaction acetamide is eliminated and there is also formed a third product,¹⁸ *isodeaminocolchinal methyl ether*, m.p. 100–1°, which is obtained in better yield by the dehydration of the alcohol, C₁₉H₂₂O₅ (VIII), referred to above. Neither deaminocolchinal methyl ether nor its isomeride forms a picrate and each absorbs a molecule of hydrogen producing the same dihydride, C₁₉H₂₂O₄, m.p. 96–7°. These properties are not those of a phenanthrene derivative. Three tetramethoxy-9-methylphenanthenes, *viz.* 2:3:4-5, -6, and -7 were synthesised by Buchanan, Cook and Loudon²⁴ and the -5 and -7 isomerides, which were simultaneously formed in the appropriate Pschorr reaction, were definitely orientated by Barton, Cook and Loudon.¹⁸ Deaminocolchinal methyl ether proved not to be identical with either 2:3:4:6- or 2:3:4:7-tetramethoxy-9-methylphenanthrene, and as identity with one of these isomerides is a fundamental point for the Windaus formula for colchinal methyl ether (V; NHAc \rightarrow NH₂) becomes untenable. Barton Cook and Loudon also showed that deaminocolchinal methyl ether is oxidised by sodium dichromate in acetic acid to two substances: (a) 2:3:4:7-tetramethoxyphenanthraquinone (IX; R = H) which settles the positions of the four methoxyl groups in *N*-acetylcolchinal

methyl ether, of the phenolic hydroxyl group in ring C of *N*-acetylcolchicol, and of the methoxyl substituents in colchicine itself so that the positions of the substituents at C⁶ and C⁷ in the Windaus colchicine formula (VII) have to be interchanged. The second oxidation product (b) appears to be $\alpha\beta$ -unsaturated ketone, C₁₉H₁₈O₅, m.p. 109–111°.

These results the authors consider cannot be accounted for on the basis of a 6-membered ring B and the adoption of a 5- or 7-membered ring B introduces a difficulty in explaining the formation of 2 : 3 : 4 : 7-tetramethoxyphenanthraquinone in the oxidation of deaminocolchicol methyl ether. There is, however, a precedent in Weitzenböck's oxidation of 4 : 5 : 6 : 7-dibenzo- $\Delta^{1:4:6}$ -cycloheptatriene-1-aldehyde²⁵ (X) to phenanthraquinone, for representing the $\alpha\beta$ -unsaturated ketone as 9 : 12 : 13 : 14-tetramethoxy-3 : 4 : 5 : 6-dibenz- $\Delta^{1:3:5}$ -cycloheptatriene-7-one (XI : CH₂ at C⁷ → CO), using the system of numbering adopted by Kenner and Turner.²⁶

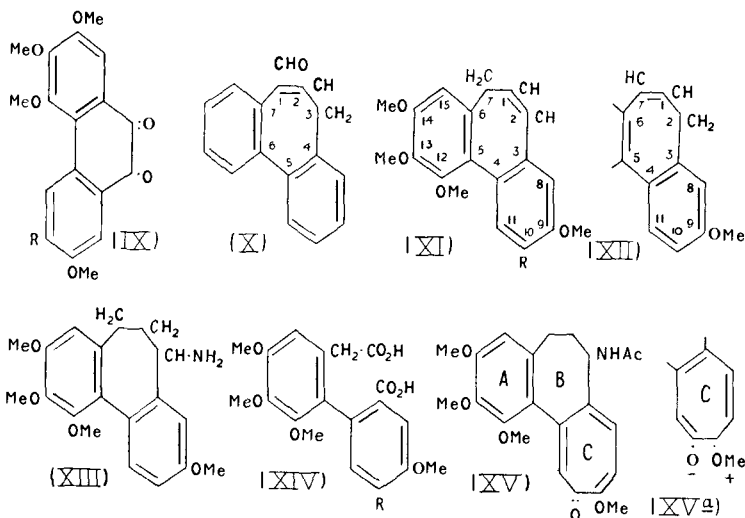

On oxidation by osmium tetroxide in ether, deaminocolchicol methyl ether produced a glycol, C₁₉H₂₂O₆, *cis*-1 : 2-dihydroxy-9 : 12 : 13 : 14-tetramethoxy-3 : 4 : 5 : 6-dibenz- $\Delta^{3:5}$ -cycloheptadiene, m.p. 165–6°, which on scission by lead tetra-acetate in benzene yielded, possibly *via* the intermediate dialdehyde, 2 : 3 : 4 : 7-tetramethoxy-10-phenanthraldehyde, m.p. 130–1°. The latter gave an oxime, m.p. 169–170°, and was oxidised by permanganate in acetone to the corresponding acid, m.p. 198–201°, of which the methyl ester had m.p. 101–3°, both being identified by mixed melting-points with synthetic specimens. In a parallel series of operations, *isodeaminocolchicol* methyl ether gave 2 : 3 : 4 : 7-tetramethoxy-9-phenanthraldehyde.

These results indicate that deaminocolchicol methyl ether is 9 : 12 : 13 : 14-tetramethoxy-3 : 4 : 5 : 6-dibenz- $\Delta^{1:3:5}$ -cycloheptatriene (XI;

R = H) and *isodeaminocolcholinol methyl ether* is 9:12:13:14-tetramethoxy-3:4:5:6-dibenz- $\Delta^{3:5:7}$ -cycloheptatriene (XII). On this basis and assuming absence of nuclear change during the first step of the Hofmann process, colcholinol methyl ether must be represented by (XIII). Windaus's conversion of deaminocolcholinol methyl ether into 9-methylphenanthrene has been paralleled by the production of the same hydrocarbon from 3:4:5:6-dibenzcyclohepta-1:3:5-triene. This is the unsubstituted nucleus in formula (XI) proposed for deaminocolcholinol methyl ether, and the synthetic product resembles the latter in its behaviour towards oxidising and reducing agents and in other respects (Cook, Dickson and Loudon).²⁷

Support for this formulation has also been provided by Tarbell, Frank and Fanta,²⁸ who found that deaminoiodocolcholinol methyl ether (XI; R = I), $C_{19}H_{19}O_4I$, m.p. 175–6°, was oxidised by permanganate in acetone, to two products (a) a dark red substance, $C_{18}H_{15}O_6I$, m.p. 213°, probably 6-iodo-2:3:4:7-tetramethoxyphenanthraquinone (IX; R = I) and (b) a dibasic acid, $C_{19}H_{19}O_8I$, m.p. 264–5° (XIV; R = I), which was hydrogenated to $C_{19}H_{20}O_8$, m.p. 243–5°. The iodo-acid dimethyl ester (XIV; R = I and $2CO_2H \rightarrow 2CO_2Me$) when boiled with sodium methoxide in benzene gave a phenanthrol, m.p. 194–195.5°, with OMe at positions 2:3:4:7, CO_2Me at 10, OH at 9 and I at 6.

Cook²⁷ has suggested that colchicine itself may contain the 7-membered ring B and Dewar²⁹ has proposed for the alkaloid formula (XV) with (XVa) as a resonance form, mainly on the ground that the third ring (C) in colchicine resembles in some of its reactions, stipitatic acid and presents similar difficulty in interpretation of experimental results.

Cook²⁷ has pointed out that Dewar's 7-membered ring C receives some support from Meyer and Reichstein's observation that colchicine is oxidised by periodic acid to a monocarboxylic acid, $C_{21}H_{23}O_8N$, m.p. 238–9° (*dec.*), $[\alpha]_D^{16} - 410.4^\circ$ (MeOH, 60 per cent.), giving a crystalline silver salt, m.p. 205–8° (*dec.*), and a methyl ester, m.p. 98–100°, $[\alpha]_D^{16} - 341^\circ$ (acetone). Dewar's formula has also been invoked by Šantavý²⁹ to explain the formation of *colchic acid*, $C_{21}H_{23}O_6N$, m.p. 262–6°, when colchicine, or Sorkin's *isocolchicine* (*see below*), is refluxed with sodium methoxide in methyl alcohol, colchicine remaining unchanged under like treatment. Arnstein, Tarbell, Huang and Scott²⁹ also support this formulation to explain the formation of an aldehydic substance in the oxidation of hexahydrocolchicine, $C_{21}C_{29}O_6N$, m.p. 205.5–6°, which they regard as a glycol (diacetate, m.p. 167°).

Colchiceine (*Acetyltrimethylcolchicinic acid*), $C_{21}H_{23}O_6N \cdot 0.5H_2O$, may be prepared by heating colchicine with dilute sulphuric or hydrochloric acid. It crystallises in colourless needles, m.p. 172° (*dry*), $[\alpha]_D - 253^\circ$ ($CHCl_3$), is readily soluble in alcohol or chloroform, sparingly so in water, and neutral in reaction. Its solutions in alkalis or acids are yellow. The base gives a dark-green coloration with ferric chloride. According to Sorkin,³⁰ colchiceine on treatment with diazomethane produces a mixture of colchicine and *isocolchicine*. The latter has m.p. 225° and $[\alpha]_D - 307^\circ$

(CHCl₃) gives a yellow solution in water and hydrolyses to colchicine. The constitution of colchicine is discussed above.

Pharmacological Action. Colchicine and colchicine exert much the same type of action but the former is the more active and the more toxic. Even on hypodermic administration it acts slowly. The chief toxic symptoms in man are vomiting and diarrhœa. It has no important direct action on the heart, but is, among other things, a capillary poison. Large doses cause an ascending paralysis of the central nervous system and vasomotor and respiratory paralysis. Galenical preparations of the crude drug and colchicine itself, generally as the salicylate, are used in the treatment of gout, for empirical reasons based on clinical experience. Up-to-date pharmacology has been unable to furnish any adequate reason for its use. For more detailed information the papers by Dixon and Malden,³¹ Fühner³² and Lipps, Beck and Jacobson³³ should be consulted. Renewed interest has been shown in colchicine in the last few years owing to its action in inhibiting cell-division. Dixon and Malden³¹ observed that it caused a transient fall in the number of leucocytes followed by considerable leucocytosis, and that it appears to stimulate karyokinesis in bone marrow. The latter view has been modified by the results of later work,³⁴ which indicate that cell-division is arrested half-way and it is the accumulation of partially divided cells which gives the appearance of stimulated cell-division. Amoroso's observation³⁵ that the alkaloid induces regression of tumours in mice and is effective in treating spontaneous tumours in dogs, led to further investigation of the effect of the alkaloid on cell-division in normal and malignant cells and on the metabolism of tumours.³⁶ The results indicate that the inhibition of cell-division by the alkaloid is not specific for tumour cells and the quantity required to interfere effectively with the growth of a transplanted tumour approaches the lethal dose for the host.

Lettré and Fernholz³⁷ have tested a series of colchicine derivatives, including a group of alkylcolchicines, on experimentally induced tumours; all proved to be less potent than the parent alkaloid. *N*-Acetyl- β -*p*-anisyl-(3 : 4 : 5-trimethoxyphenyl)-propylamine,

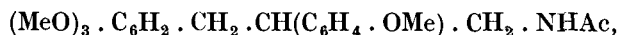

prepared by Cook and Engel,³⁶ was tested by Brues³⁶ on mitosis in the liver of the rat and reported as giving in 10 mgm. dose a completely abnormal, nuclear picture, which was slightly modified at a dose of 1 mgm. Two other interesting structural approximations to the Windaus formula for colchicine were prepared by Meyer and Reichstein,³⁷ *viz.* 7-hydroxymethylene-8-ketotetrahydrophenanthrene and its 6-hydroxymethylene-5-keto isomeride and the methyl ether of each. These were tested by Heitz on *Vicia faba* and found to have no colchicine action, but that does not preclude the possibility that a more sensitive test would not reveal some activity.

Much of the biological work with colchicine in recent years has lain in its use to detect and measure certain types of cellular activity, and in the study of the effects it produces when applied to growing plants.

Bastenie and Zylberszac,³⁸ in a general article on the former subject, point out that colchicine (1) brings into mitosis all cells which are in "karyokinetic imminence" but which normally would slowly and successively reach mitosis, and (2) stops them at this stage. This has made possible a technique which picks out cell multiplication and can be used for detecting many types of hormonal stimulation, *e.g.*, the action of follicular hormone and other oestrogens.³⁹

There is a voluminous literature, chiefly of botanical interest, dealing with the effects of the application of colchicine to plants of economic importance such as tobacco,⁴⁰ cotton,⁴¹ wheat and rice.⁴²

In addition to colchicine a considerable variety of chemicals has been found showing activity of this type. Lettré and Fernholz³⁷ dealt with a series of substituted arylalkylamines among which α -phenyl- β -*p*-anisyl-ethylamine was the simplest active substance. Shmuk and Gusseva⁴³ found acenaphthene the most active of a group of aromatic hydrocarbons and their halogen derivatives, while Simonet and Guinochet⁴⁴ noted differences in the type of action shown by colchicine and halogenated benzenes and Gavaudan *et al.*⁴⁴ have observed other abnormalities and have discussed the influence of chemical structure and physical properties in cyclic hydrocarbons on such action.

A comprehensive bibliography of colchicine has been published by Eigsti.⁴⁵

REFERENCES

- (1) *Ann. Chim. Phys.*, 1820, [ii], 14, 82. (2) ALBO, *Arch. Sci. phys. nat.*, 1901, [iv], 12, 227; PERROT, *Compt. rend.*, 1936, 202, 1088; KLEIN and POLLAUFG, *Osterr. Bot. Zeit.*, 1929, 78, 251; GLOTOV, *C. R. Acad. Sci. U.R.S.S.*, 1934, 24, 502; TARAN, *Farmatsiya*, 1940, Nos. 9, 10, p. 38. (3) CLEWER, GREEN and TUTIN, *J. Chem. Soc.*, 1915, 107, 835; PARTHASARATHY, *Curr. Sci.*, 1941, 10, 446. (4) *Monats.*, 1888, 9, 870. (5) *Ibid.*, 1883, 4, 162; 1886, 7, 557; 1888, 9, 1, 865; 1913, 34, 1181, 1327, 1339. (6) *Ber. ungar. pharm. Ges.*, 1927, 3, 346. (7) *J. pr. Chem.*, 1928, 118, 29. (8) *Yearbook Pharm.*, 1923, 611; (8a) SEIBERT, *Deut. Apoth. Zeit.*, 1943, 58, 71; see also GILLET, *Ann. pharm. franc.*, 1944, 2, 152. (9) *Rev. Farm.*, 1930, 72, 187; see also KIRKPATRICK, *Quart. J. Pharm.*, 1946, 19, 533 (polarographic). (10) *Pharm. Zeit.*, 1931, 76, 288. (11) *Pharm. J.*, 1932, 129, 236; BOYLAND and MAWSON, *Biochem. J.*, 1938, 32, 1204. (12) *Pharm. Acta Helv.*, 1933, 8, 92. (13) MERCK, *Pharm. Zent.*, 1916, 57, 619; ASHLEY and HARRIS, *J. Chem. Soc.*, 1944, 677; MÜHLEMANN and TOBLER, *Pharm. Acta Helv.*, 1946, 21, 34; GREWE, *Naturw.*, 1946, 33, 187. (14) *S. B. Heidelberg, Akad. Wiss.*, 1910, 1; 1911, 1; 1914, 18; 1919, 16. (15) CLAISEN, *Annalen*, 1894, 281, 345; cf. BRÜHL, *Ber.*, 1904, 37, 2156. (16) WINDAUS, *Annalen*, 1924, 439, 59; GREWE, *Ber.*, 1938, 71, 245; cf. ŠANTAVÝ, *C. R. Soc. biol.*, 1946, 140, 932. (17) WINDAUS (with EICKEL), *Ber.*, 1924, 57, 1871; (with JENSEN and SCHRAMME), *ibid.*, p. 1875. (18) *J. Chem. Soc.*, 1945, 176. (19) SHARP, *ibid.*, 1936, 1234. (19a) *Ber.*, 1939, 72, 426. (20) *Ber.*, 1938, 71, 245. (21) *Compt. rend.*, 1940, 210, 490. (22) *J. Chem. Soc.*, 1940, 194. (23) *Ibid.*, 1944, 322. (24) *Ibid.*, 1944, 325. (25) *Monats.*, 1913, 34, 199. (26) *J. Chem. Soc.*, 1911, 99, 2104; KENNER, *ibid.*, 1913, 103, 613; cf. TAURINS, *J. pr. Chem.*, 1939, 153, 192. (27) *Chem. and Ind.*, 1945, 403; *J. Chem. Soc.*, 1947, 746. (28) *J. Amer. Chem. Soc.*, 1946, 68, 502. (29) *Nature*, 1945, 155, 141; see also pp. 50, 479, and COOK, p. 479; ŠANTAVÝ, *C. R. Soc. Biol.*, 1946, 140, 932; *Helv. Chim. Acta*, 1948, 31, 821; ARNSTEIN *et al.*, *J. Amer. Chem. Soc.*, 1948, 70, 1669. (30) *Helv. Chim. Acta*, 1946, 29, 246; see also STEINEGGER and LEVAN, *Hereditas*, 1947, 33, 385. (31) *J. Physiol.*, 1908, 37, 50. (32) *Arch. exp. Path. Pharm.*, 1910, 63, 857; 1918, 72, 228; *Heffter's Handb. exp. Pharm.*, 1920, 2, 498.

(33) LIPPS, *Arch. exp. Path. Pharm.*, 1920, 85, 235; BECK, *ibid.*, 1932, 165, 208; JACOBSON, *Compt. rend. Soc. Biol.*, 1925, 93, 1178; TALBOTT, *Bull. New York Acad. Med.*, 1942, 18, 318. (34) DUSTIN, *Bull. Acad. roy. Med. Belg.*, 1934, 14, 487; LITS, *Compt. rend. Soc. Biol.*, 1934, 115, 1421; LUDFORD, *Arch. exp. Zellforsch.*, 1936, 18, 411. (35) *Nature*, 1935, 135, 266; *Vet. J.*, 1935, 91, 88. (36) BRUES and COHEN, *Biochem. J.*, 1936, 30, 1363; BRUES, quoted by Cook and Engel, *J. Chem. Soc.*, 1940, 198; BOYLAND and BOYLAND, *Biochem. J.*, 1937, 31, 454; 1941, 35, 1283; PEYRON, LAFAY and KOBOZIEFF, *Bull. Assoc. franc. Cancer*, 1936, 25, 874; PEYRON, LAFAY and POUMEAUX-DELILE, *Compt. rend. Acad. Sci.*, 1937, 205, 378; CLEARKIN, *J. Path. Bact.*, 1937, 44, 469; OUGHTERSON, TENNANT and HIRSCHFELD, *Proc. Soc. exp. Biol. Med.*, 1937, 36, 661; *Rep. Imp. Cancer Res. Fund.*, 1945-6, quoted in *Nature*, 1946, 157, 669; LUDFORD, *J. Nat. Cancer Inst.*, 1946, 6, 89; LETTRÉ *et al.*, *Zeit. physiol. Chem.*, 1944, 281, 58, 133, 139; DUSTIN, *Nature*, 1947, 159, 794; LEHMANN, *Experientia*, 1947, 3, 223. (37) LETTRÉ and FERNHOLZ, *Zeit. Physiol. Chem.*, 1943, 278, 175 (*Brit. Chem. and Physiol. Abstr.*, 1944, Aii, 48; Aiii, 92); (with ALBRECHT), *Naturwiss.*, 1941, 29, 390; *Chem. Zeit.*, 1943, 67, 52; MEYER and REICHSTEIN, *Pharm. Acta Helv.*, 1944, 19, 127. (38) *Arch. Intern. Méd. exp.*, 1938, 13, 183. (39) MCPHAIL and WILBUR, *J. Pharm. exp. Ther.*, 1943, 78, 304; BARBER and CALLAN, *Proc. Roy. Soc. B.*, 1943, 131, 258; BASTENIE and ZYLBERSZAC, *Compt. rend. Soc. Biol.*, 1937, 126, 446, 891; ALLEN, SMITH and GARDNER, *Endocrinology*, 1937, 21, 412; *Amer. J. Anat.*, 1937, 61, 321. (40) BRADLEY and GOODSPEED, *Proc. Nat. Acad. Sci., U.S.A.*, 1943, 29, 295; DUSSBAU, HITIER and FARDY, *Compt. rend.*, 1943, 217, 704; BADENHUIZEN, *Nature*, 1941, 147, 577. (41) STEPHENS, *Trop. Agric.*, 1940, 17, 23; HARLAND, *ibid.*, p. 53. (42) SINNOTT, BLAKESLEE and FRANKLIN, *Genetics*, 1941, 26, 168; DERMAN, *ibid.*, p. 147; (with BAIN), *ibid.*, p. 147; TANG and LOO, *Science*, 1940, 91, 222; NEWCOMER, *ibid.*, 1945, 101, 677; see also "Action and Use of Colchicine in the Production of Polyploid Plants," J. L. FYFE, Imperial Bureau of Plant Breeding and Genetics, Cambridge, 1939. (43) SHMUK (with GUSSEVA), *Compt. rend. Acad. Sci., U.R.S.S.*, 1939, 22, 441; (with KOSTOV), *ibid.*, 1939, 23, 263. (44) *Compt. rend.*, 1939, 208, 1667; cf. GAVAUDAN, GAVAUDAN and DURAND, *C. R. Soc. Biol.*, 1939, 130, 432, 1234, 1443; 1940, 133, 348; *Compt. rend.*, 1939, 208, 593. (45) *Lloydia*, 1947, 10, 65.

ALKALOID OF *AMANITA MUSCARIA*

Muscarine was isolated from fly agaric (*Amanita muscaria* L.) by Schmiedeberg and Koppe¹ as a deliquescent syrupy base with a characteristic pharmacological action, arresting the frog's heart in diastole and being antagonised by atropine. Further examination by Harnack,² showed that this preparation contained choline, which was eliminated as far as possible as the aurichloride, $C_5H_{14}ON \cdot AuCl_4$, leaving a more soluble aurichloride, $C_5H_{14}O_2N \cdot AuCl_4$. To the alkaloidal chloride Harnack and Schmiedeberg assigned the formula, $(CH_3)_3NCl \cdot CH_2 \cdot CH(OH)_2$, which is that of a hydrate of the aldehyde corresponding to choline.

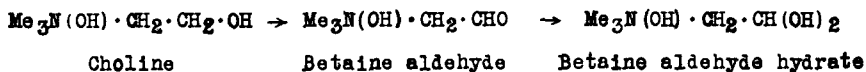

This view was supported by the observation that choline on treatment with nitric acid yielded a product having a pharmacological action similar to that of muscarine as known up to that time.³ Comparison of the "natural" and "artificial" products by Böhm⁴ showed that the former was much more active than the latter and that its action was antagonised by atropine, whilst the "artificial muscarine" had a curare-like action on the atropinised frog. Later, Nothnagel⁵ investigated the action of

nitric acid on choline and isolated "artificial muscarine" and a choline nitrous ester, $(\text{CH}_3)_3\text{NCl} \cdot \text{CH}_2 \cdot \text{CH}_2 \cdot \text{ONO}$, produced in this reaction, but the results of Ewins's⁶ investigation showed that "artificial muscarine" (now also called synthetic muscarine, choline-muscarine, pseudo-muscarine) is choline nitrous ester, and Dale,⁷ working with Ewins's material, found that it had the pharmacological properties attributed to "artificial muscarine." Several other attempts were made⁸ by the synthesis of bases having the formula $\text{C}_5\text{H}_{14}\text{O}_2\text{NCl}$, and in other ways to clear up the question but without success. Finally, King⁹ isolated from fly agaric a base with, in higher degree, the pharmacological action characteristic of Schmiedeberg's preparation. The process used is complicated and for details the reader is referred to the original paper. The mixture of choline and muscarine finally obtained is fractionated as aurichlorides, the more soluble muscarine aurichloride being eventually obtained by crystallisation from dilute hydrochloric acid containing a little gold chloride as glistening leaflets with a gold content of 38.2 per cent. corresponding to a molecular weight of about 210 for the base. The yield was 0.12 gm. from 25.5 kg. of fresh fungus. Of the pure muscarine chloride made from this aurichloride, only $\frac{1}{500}$ mg. was required to stop the frog's heart in diastole, as against $\frac{1}{20}$ to $\frac{1}{30}$ mg. recorded by Schmiedeberg and Harnack. King's results were extended by Kögl, Duisberg and Erxleben,¹⁰ who used a different method for the concentration and isolation of the alkaloid. Muscarine chloride, $\text{C}_8\text{H}_{18}\text{O}_2\text{NCl}$, has $[\alpha]_{\text{D}}^{20} + 1.57^\circ$ (H_2O): the aurichloride, $\text{C}_8\text{H}_{18}\text{O}_2\text{N} \cdot \text{AuCl}_4$ forms bright yellow leaflets, m.p. 115–7°, and *O*-benzoylmuscarine platinichloride, $\text{C}_{30}\text{H}_{44}\text{O}_6\text{N}_2 \cdot \text{PtCl}_6$, crystallises from dilute hydrochloric acid and has m.p. 256–7°. The same authors found that muscarine is unaffected by dilute alkali in presence of nitrogen, is not hydrogenated in presence of platinum oxide at room temperature and is stable in air at pH 9.8 but not at pH 4.0. It gives the Angelo-Rimini and Schiff reactions for aldehydes. The chloride on distillation with silver oxide furnishes trimethylamine, an unidentified volatile substance, m.p. 70°, and *d*- α -dihydroxy-*n*-valeric acid, m.p. 72°, $[\alpha]_{\text{D}}^{20} + 18.0^\circ$ (H_2O), identified by direct comparison with the synthetic *l*-isomeride.¹¹ The formation of a carboxyl group in this Hofmann degradation is believed to be due to oxidation of an aldehyde group by the silver oxide. Muscarine is therefore considered to be either $\text{C}_2\text{H}_5 \cdot \text{CHOH} \cdot \text{CH}(\text{NMe}_3\text{OH}) \cdot \text{CHO}$ or $\text{C}_2\text{H}_5 \cdot \text{CH}(\text{NMe}_3\text{OH}) \cdot \text{CHOH} \cdot \text{CHO}$, the former being preferred on account of its serine-like structure and its stability to alkalis.

Quaternary salts of the substances represented by these formulæ have been prepared by Kögl, Veldstra and van der Laan¹¹ as well as of the next lower homologues, the substituted butyraldehydes, and the methyl ethers of both series. Their pharmacological activities were negligible in comparison with that of muscarine, but as six stereoisomeric forms may be produced in each synthesis, the inactivity may be due to stereoisomerism, just as in the case of threonine (α -amino- β -hydroxybutyric acid) where West and Carter¹¹ found that only the *d*(–) form is

active as a growth-promoting substance. Fourneau and Chantalou¹¹ point out that such disparity in activity among stereoisomerides is unusual and that as the synthetic substance does not restore the colour to sulphited fuchsine, while muscarine does, there may be a structural difference between the two. Fourneau, Bovet, Bovet and Montezin¹¹ have described a series

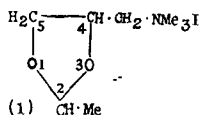

of aminoacetals of which one has an intense muscarine-like action, *viz.* 4-dimethylaminomethyl-2-methyl-1:3-dioxolan methiodide (I). This substance is isomeric with muscarine, and its lower homologue (I with CHMe at 2 replaced by CH₂) which is isomeric with acetylcholine is also an active parasympathetic agent. Pfeiffer¹¹ has discussed the nature and spatial relationships of the prosthetic groups required for maximal muscarinic action.

In addition to natural muscarine and the so-called "choline-muscarine" referred to above, two other products have been given names suggesting relationship to muscarine, *viz.* (1) *isomuscarine*, Me₃N(OH)·CHOH·CH₂OH prepared by Bode⁸ and shown to be toxic, but distinct from muscarine in type of action, and (2) *anhydromuscarine* (betaine aldehyde) made first by Berlin erblau¹² and later by Fischer¹³ and which, according to Voet¹³ possesses nicotine and curare-like properties.

Other products of pharmacological interest in this connection are dealt with by Hunt and Renshaw,¹⁴ by Lee, van Arendonk and Chen,¹⁵ by Bender, Sprites and Sprinson,¹⁶ by Morrison,¹⁷ and by Work¹⁸. It should be noted that *Amanita* spp. also contain toxins, on which a considerable amount of work has been done, especially with *A. phalloides*.¹⁹

REFERENCES

- (1) *Das Muscarin*, Leipzig, 1869. Cf. *Jahresb.*, 1870, p. 875. (2) *Arch. exp. Path. Pharm.*, 1875, 4, 168. (3) HARNACK and SCHMIEDEBERG, *ibid.*, 1876, 6, 101. (4) *Ibid.*, 1885, 19, 60. Cf. MEYER, *Ber.*, 1893, 26, 801; HONDA, *Arch. exp. Path. Pharm.*, 1911, 65, 454. HONDA obtained two uncharacterised alkaloids, α - and β -myketosines as well as muscarine from fly agaric. (5) *Ber.*, 1893, 26, 801; *Arch. Pharm.*, 1894, 232, 286. (6) *Biochem. J.*, 1914, 8, 209. Cf. WEINHAGEN, *J. Amer. Chem. Soc.*, 1920, 42, 1670. (7) *J. Physiol.*, 1914, 48, xxiv. (8) See, for example, SCHMIDT and BODE, *Annalen*, 1892, 267, 249, 268; EWINS, *Biochem. J.*, 1914, 8, 366; (pharmacological) DALE, *J. Pharm. exp. Ther.*, 1914, 6, 147; SCALBA, *Atti. R. Accad. Lincei*, 1922, [v], 31, ii, 518; GUTH, *Monats.*, 1925, 45, 631. (9) *J. Chem. Soc.*, 1922, 121, 1743. (10) *Annalen*, 1931, 489, 156. (11) *Ibid.*, 1942, 552, 1; WEST and CARTER, *J. Biol. Chem.*, 1937-8, 122, 611; J. P. FOURNEAU (with CHANTALOU), *Bull. Soc. Chim.*, 1945, [v], 12, 845; E. FOURNEAU (with BOVET, BOVET and MONTEZIN), *Bull. Soc. Chim. biol.*, 1944, 26, 134; 1945, 26, 516; see also *Ann. pharm. franc.*, 1945, 3, 114; 1946, 4, 166, 172; PFEIFFER, *Science*, 1948, 107, 94. (12) *Ber.*, 1884, 17, 1139. (13) *Ibid.*, 1893, 26, 464; 1894, 27, 165; cf. VOET, *Arch. int. Pharmacodyn.*, 1929, 36, 205. GLAUSE, *Diss. Berne*, 1884, p. 17; MEYER, *Arch. exp. Path. Pharm.*, 1893, 32, 111. (14) *J. Pharm. Exp. Ther.*, 1929, 37, 193. (15) *Ibid.*, 1936, 56, 466. (16) BENDER, SPRITES and SPRINSON, *ibid.*, 1943, 77, 107. (17) *Ibid.*, 1943, 79, 1. (18) WORK, *J. Chem. Soc.*, 1941, 190. (19) IMHAÜSER, *Arch. exp. Path. Pharm.*, 1929, 145, 120; 1931, 162, 506; RAAB, *Zeit. physiol. Chem.*, 1932, 207, 157; 1933, 216, 224; RENZ, *ibid.*, 1934, 230, 245; BENET and MAREK, *Compt. rend.*, 1936, 202, 1219; WIELAND (with LYNEN), *Annalen*, 1937, 533, 93; (with WITKOP), 1940, 543, 171; (with HALLERMAYER and ZILG), 1941, 543, 1; BEAUVILLAIN, BOILOU and DRONNE, *C. R. Soc. Biol.*, 1942, 136, 396.

STEROIDAL ALKALOID GROUP

ALKALOIDS OF *SOLANUM* SPP.

Among the well-known *Solanum* species that have been chemically examined are *S. nigrum*, *S. tuberosum* (potato) and *S. lycopersicum* (tomato). From these and other species¹ an alkaloidal glucoside, which was first prepared by Desfosses,² has been obtained. This substance has been named "solanine," but it is not certain that all the plants recorded as containing solanine contain the same solanine or that the alkaloid has been obtained in a pure state in each case.

Firbas stated that at least two of these alkaloidal glucosides occur in young potato shoots, solanine and solaneine, and that these may be accompanied by solanidine, a basic decomposition product of solanine.³ Solaneine was later shown to be a mixture of solanine and solanidine.

Solanine, $C_{45}H_{73}O_{15}N$. Various empirical formulæ for this alkaloid have been published by Firbas,³ Wittman,⁴ Cazeneuve and Breteau,⁵ Davis,⁶ Colombano,⁷ Zemplen and Gerecs⁸ and Oddo and Caronna,¹⁰ but with the final settlement of the formula of solanidine as $C_{27}H_{43}ON$ by Schöpf and Herrmann,¹⁷ there seems little doubt about the general acceptance of the formula given above for the parent alkaloid. Solanine is not a readily accessible alkaloid and much remains to be done in clearing up its detailed chemistry, *e.g.*, the composition of its acetyl derivative, referred to below. The alkaloid crystallises with water in slender needles, melts at 285° (*dec.*) after drying at 100° , but shows marked shrinkage at 235° , which no doubt accounts for the great variation (235 to 285°) in melting point recorded. It has $[\alpha]_D^{20} - 42.16^{\circ}$ (dil. HCl)⁴ or $- 59.45^{\circ}$ (pyridine),⁸ and is sparingly soluble in water (1 in 8,000), readily soluble in hot alcohol, but almost insoluble in ether or chloroform; it has a bitter taste and is hardly alkaline to litmus. The salts are amorphous, but according to Heiduschka and Sieger,⁴ the hydrochloride is crystalline, m.p. 212° (*dec.*). Solanine is unaffected by alkalis, but when warmed with acids is hydrolysed into *solanidine* and a mixture of the sugars, dextrose, rhamnose and galactose.⁹ Zemplen and Gerecs state that acetylsolanine, m.p. $204-5^{\circ}$, $[\alpha]_D^{20} - 34.96^{\circ}$, the formula of which needs revision, to conform with the new formula for solanine, is hydrolysed in acetic acid solution by hydrobromic acid to an acetylated rhamnosidogalactose and an acetylated solanidine glucoside, m.p. $115-120^{\circ}$ (*dec.*), $[\alpha]_D^{20} - 8.01^{\circ}$ (EtOH). This, on further hydrolysis, yields solanidine and dextrose. The conclusion is drawn that the sequence of components in solanine is solanidine—dextrose—galactose—rhamnose. On repeating this work, Oddo and Caronna¹⁰ found that acetylsolanine acetate in chloroform is hydrolysed by a mixture of acetic and hydrobromic acids to (a) rhamnose tetraacetate, m.p. 90° ; (b) an acetylsolanidine glucosegalactoside hydro-

bromide ; and (c) an acetylsolanidine glucoside. As the second of these products is hydrolysed by alcoholic potash to solanidineglucoside and galactose, the sequence arrived at is the same as that suggested by Zemplén and Gerecs, though the experimental results of the two groups of investigators differ considerably in detail. Heiduschka and Philippi¹¹ state that acetylsolanine is hydrolysed by boiling hydrochloric acid to solanidine hydrochloride.

Solanine is toxic and, as occasional cases of poisoning by potatoes are usually attributed to its presence, methods for its detection are of some importance. This subject has been dealt with recently by Rooke, Bushill, Lampitt and Jackson,¹² who have investigated (a) processes for the complete extraction of solanine and solanidine, for which they recommend that devised by Pfankuch,¹³ (b) methods of estimation for which they found two procedures useful, *viz.*, that of Pfankuch, which estimates solanine and solanidine together and depends on measurement of the purple colour formed by these alkaloids with sulphuric acid and formaldehyde, and that of Connor,¹⁴ which estimates solanine only and depends on determination of the reducing power of the alkaloidal glucoside before and after acid hydrolysis under standard conditions. The same authors have applied these methods to an investigation of the distribution of solanine and solanidine in the potato plant, and the effects on the alkaloidal content of potatoes, induced by sprouting, normal growth, storage under varying conditions, etc. Other methods of identification^{15(a)} and estimation^{15(b)} have been described by various authors.

The name solanine should be sufficient to indicate that the substance referred to is the glucosidal alkaloid first isolated from potatoes. The use of such forms as "T-solanine," "solanine-t" and "solanine tuberosum" is confusing, as is also the proposed substitution of "solatubine" for solanine.

Solaneine, isolated by Firbas³ and examined by Davis,⁶ has been shown by Soltys¹⁶ to be a mixture of solanine and solanidine.

Solanidine, $C_{27}H_{43}ON$. This hydrolytic product of solanine was first obtained by Firbas.³ The empirical formula assigned to it has varied, but the one given above, due to Schöpf and Herrmann,¹⁷ is now generally accepted. Solanidine crystallises from alcohol in needles, m.p. 219° ($[\alpha]_D^{21} - 28.5^\circ$, EtOH); the hydrochloride, B.HCl, forms rhombic prisms, m.p. 345° (*dec.*), but the platinichloride is amorphous. The alkaloid yields a methiodide, m.p. 280° (*dec.*), and a monoacetyl derivative, m.p. 206–8°, due to the presence of a secondary carbinol group. When solanidine hydrochloride is heated, a molecule of water is eliminated and solanidene, $C_{27}H_{41}N$, m.p. 167°, is formed.¹⁷ The latter, according to Bergel and Wagner, is identical¹⁸ with *solanthrene*, or better, *solanthrine*, m.p. 170°, $[\alpha]_D^{17} - 92.3^\circ$ ($CHCl_3$),¹⁶ which Dieterle and Schaffnit¹⁹ found in potato shoots, and which can be produced from solanidine in various ways,²⁰ and is formed with solanidine in the acid hydrolysis of solanine.¹⁸ It contains two ethylenic linkages and on hydrogenation yields tetrahydro-solanthrine (solanidane), $C_{27}H_{45}N$, m.p. 164°, $[\alpha]_D^{17} + 30.4^\circ$ ($CHCl_3$).

Solanidine contains at least three :CMe groups,¹⁷ and since it yields dihydrosolanidine, m.p. 219–220°, must contain one ethylenic linkage.¹⁸ When solanidine is heated with copper powder at 160–300°/11 mm., it is converted into solanidone, $\text{C}_{27}\text{H}_{41}\text{ON}$, m.p. 218°, which yields an oxime, m.p. 228°, and condenses with benzaldehyde or amyl nitrite to give compounds indicating the existence in solanidone of the group $\text{—CH}_2\text{—CO—CH}_2\text{—}$ and therefore in solanidine of $\text{—CH}_2\text{—CHOH—CH}_2\text{—}$.¹⁷

Dieterle and Rochelmeyer²⁰ found that selenium at 320° converts solanidine into phenanthrene, chrysene and pyridine with other products, and Soltys and Wallenfels,¹⁶ impressed by the fact that solanidine, like certain of the sterols, gave a sparingly soluble digitonide dehydrogenated solanidene (solanthrene) with selenium, and obtained Diels's hydrocarbon, $\text{C}_{18}\text{H}_{16}$, m.p. 126–7°, now known to be γ -methyl-1 : 2-cyclopentenophenanthrene and a characteristic dehydrogenation product of the sterols (Fieser¹⁶). This hydrocarbon was subsequently obtained from solanidine itself by Craig and Jacobs.^{16(a)} Using this new fact and the experimental data summarised above, the former authors proposed formula (I) for solanidine. The lupinane structure for rings (E) and (F) was suggested because of its resistance to degradation, which is also characteristic of the heterocyclic $\text{C}_7\text{H}_{15}\text{N}$ residue of solanidine. Clemo, Morgan and Raper²¹ have pointed out that a substance represented by (I) would be unlikely to extrude the lupinane nucleus on selenium dehydrogenation, and on this and other grounds propose the modified formula (II), pointing out that a similar methylidopyrrole structure has been suggested for heliotrine (p. 603).

Experimental evidence in support of these formulæ so far as rings *a*, *b*, *c* and *d* are concerned has been provided by Rochelmeyer *et al.*²⁰ who have shown (1938–9) that solanidone (solanideneone, solatubenone (*see above*)) has the carbonyl group at C^3 and is an $\alpha\beta$ -unsaturated ketone, the ethylenic linkage having wandered from the $\beta\gamma$ ($\text{C}^5\text{—C}^6$) position in solanidine to the ($\text{C}^5\text{—C}^4$) position during the formation of the ketone, a change parallel with that occurring in the typical sterol, cholesterol, on conversion to cholestenone.

The reduction products of solanidine and certain of its derivatives have been investigated by Rochelmeyer (1938–9),²⁰ and more recently by Prelog and Szpilfogel,^{20(a)} with the result that all four stereoisomeric dihydrosolanidines and the two corresponding solanidanones have been prepared, emphasising the stereochemical and steroidal similarity of solanidine and cholesterol. Catalytic hydrogenation of solanidine in acetic acid in presence of platinic oxide gave the known dihydrosolanidine (*see above*), now named solanidan-3(β)-ol. This on oxidation by aluminium isopropoxide in acetone and benzene gave solanidan-3-one, which on hydrogenation in acetic acid, in presence of platinic oxide, is re-converted to solanidan-3(β)-ol, but with the addition of hydrogen bromide to the reaction mixture²⁰ gives a solanidanol acetate, m.p. 190°, $[\alpha]_D^{17} + 18.0^\circ$ (CHCl_3). The latter on hydrolysis by potassium hydroxide in methyl alcohol yields the second dihydrosolanidine, solanidan-8(α)-ol. Proof that

the two are epimeric is provided by the application of Plattner and Fürst's ^{20(b)} process to solanidan-3(β)-ol, which it converts into solanidan-3(α)-ol.

The third and fourth isomerides, *viz.*, the two *allosolanidanols*, were prepared from solanidone (Δ^4 -solutubenone of Rochelmeyer; Δ^4 -solaniden-3-one), already described (p. 663), by hydrogenation with platinised Raney nickel in an alkaline medium. The reaction product yielded *allosolanidan-3(α)-ol* and *allosolanidan-3(β)-ol*. It probably also included the two solanidanols since the uncrystallisable residue on epimerisation by sodium in boiling xylene followed by precipitation with digitonin, yielded some solanidan-3(β)-ol.

The 3(α)- and 3(β)-solanidanols on treatment with boric anhydride produced the same Δ^2 (or Δ^3)-solanidene, which was hydrogenated to solanidane.¹⁶ Similarly the two *allosolanidanols* gave the same Δ^2 - (or Δ^3)-*allosolanidene*, reducible to *allosolanidane*. The chief characteristics of these ten substances and their interrelationships are summarised in the following table:—

No.	Name and Formula	M.p.	[α] _D (CHCl ₃)	Acetyl derivatives		Notes
				M.p.	[α] _D	
Dihydrosolanidines, C ₂₇ H ₄₅ ON						
1	Solanidan-3(β)-ol	220°	+28.2°	196°	+16.5°	Ex No.5 by hydrogenation.
2	Solanidan-3(α)-ol	211-2°	+31.9°	174-6°	+21.9°	
3	<i>allo</i> Solaniden-3(β)-ol	216-7°	+27.9°	140-1°	+31.4°	Ex No.6 by hydrogenation.
4	<i>allo</i> Solanidan-3(α)-ol	212-4°	+34.5°	140-1°	+45.2°	
5	Solanidan-3-one, C ₂₇ H ₄₃ ON	210-2°	+45.8°	-	-	Ex No.1 by oxidation.
6	Δ^4 -Solanidene-3-one, C ₂₇ H ₄₁ ON	213-6°	+89.0°	-	-	Ex solanidine by oxidation.
7	Δ^2 -(or Δ^3)-Solanidene, C ₂₇ H ₄₃ N	165°	+67.9°	-	-	Ex Nos.1 & 2 by loss of water.
8	Δ^2 -(or Δ^3)- <i>allo</i> Solanidene, C ₂₇ H ₄₃ N	145-6°	+34.0°	-	-	Ex Nos.3 & 4 by loss of water.
9	Solanidane, C ₂₇ H ₄₅ N	161-2°	+33.1°	-	-	Ex No.7 by hydrogenation.
10	<i>allo</i> Solanidane, C ₂₇ H ₄₅ N	140-2°	+34.8°	-	-	Ex No.8 by hydrogenation.

According to Rochelmeyer,²⁰ (1939) in the formation of Δ^4 -solaniden-3-one (solanidone, Δ^4 -solutubenone), C₂₇H₄₁ON, the ethylenic linkage of solanidine moves from C⁵—C⁶ to C⁴—C⁵, and in the reduction of this substance by sodium in alcohol only the carbonyl group is reduced, two isomerides of solanidine, C₂₇H₄₃ON being formed, *viz.* the *cis*- (m.p. 204°, [α]_D + 91.5°) and *trans*- (m.p. 169°, [α]_D + 116.4°) forms of Δ^4 -solaniden-3-ol (Δ^4 -solutubenol, Rochelmeyer).

There still remains for consideration the nature of the heterocyclic portion of the molecule, *viz.*, rings *e* and *f* in formulæ (I) and (II). In 1942

Rochelmeyer,²⁰ after oxidation experiments on acetylsolanidine with chromic acid, concluded that the heterocyclic residue could not be attached to the homocyclic portion of the molecule at one point only as in formula (II). The first positive evidence as to the nature of the heterocyclic residue was provided by Prelog and Szpilfogel,^{20(a)} who investigated

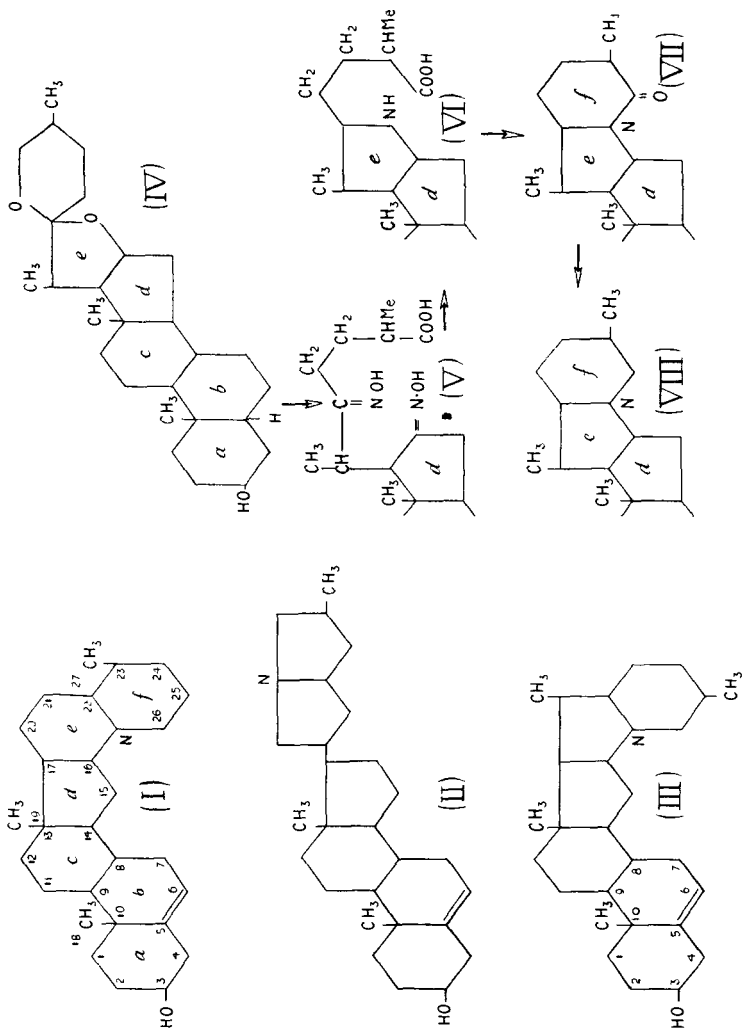

especially the basic products formed in the selenium dehydrogenation of solanidine and found 5-methyl-2-ethylpyridine, which was identified by comparison with a synthetic specimen. Jacobs and Craig had already obtained this base by the selenium dehydrogenation of veratrum alkalines (p. 708) and they subsequently and independently obtained it from solanidine.^{16(a)} As the formation of this base is difficult to account for by

either formula I or II, Prelog and Szpilfogel proposed the new formula (III) for solanidine, which is supported by the conversion of sarsasapogenin (IV) to the stereochemically corresponding dihydrosolanidine, *viz.* *allosolanidan-3-(β)-ol*, by Uhle and Jacobs.^{20(c)} These authors started with the known sarsasapogenic acid dioxime (partial formula V) which was hydrogenated in methyl alcohol-acetic acid solution, with platinum oxide as catalyst, to the amino-acid (VI), $C_{27}H_{45}O_3N$, m.p. 143°, $[\alpha]_D^{25} + 25.0^\circ$ (EtOH). The latter on melting forms the lactam (VII), $C_{27}H_{43}O_2N$, m.p. 200–2°, $[\alpha]_D^{28} + 17.0^\circ$ (EtOH), and this on hydrogenation produces one of the forms of dihydrosolanidine (partial formula (VIII); complete formula III with ethylenic linkage C^5-C^6 hydrogenated), *viz.*, *allosolanidan-3(β)-ol*, m.p. 216–8°, $[\alpha]_D^{28} + 27.3^\circ$ (CHCl₃) (*cf.* item 3, table, p. 664).

Solasonine (solanine-*s*), $C_{45}H_{73}O_{16}N$. This alkaloid was first isolated by Oddo *et al.*²³ from the tubers of *Solanum sodomaeum* and was named solanine-*s* to distinguish it from the solanine of potatoes. The name solasonine was suggested by Rochelmeyer.²² The alkaloid "solancarpine," isolated by Saiyed and Kanga,²⁴ and also by Gupta and Dutt,²⁴ from *S. xanthocarpus* S. and W., has been shown by Briggs,²⁵ and by Rochelmeyer²² (1939) to be solasonine. Similarly the alkaloid "purapurine," prepared by Levi from *S. aviculare*,²⁶ has been identified by Bell and Briggs²⁵ with solasonine.

The alkaloid has undergone changes in empirical formula, and that now given is provided by Briggs, Newbold and Stace,²⁵ after a further investigation and a critical review of published work on this subject.

Solasonine crystallises from 80 per cent. alcohol with 4.5 H₂O and then melts at 245–250° (*dec.*), or from methyl alcohol in crystals with 0.5 H₂O, m.p. 275–280°, $[\alpha]_D^{25} - 53^\circ$ to -68.7° (EtOH): the picrate has m.p. 199–201°, the picrolonate, m.p. 230–1°; the hydrochloride forms microscopic scales, m.p. > 265°. The acetyl derivative melts at 135–8° and on hydrolysis, by 70 per cent. hydrobromic acid in acetic acid, is stated to yield (*a*) diacetylramnose, m.p. 75°, (*b*) acetobromosolanidine-*s* and (*c*) an acetylsolanidine-*s*-glucose galactose, m.p. 170°, after discoloration at 140°, which is hydrolysed by potassium hydroxide in alcohol to solanidine-*s*-glucoside and galactose. The names of these hydrolytic products are those given by Oddo and Caronna,¹⁰ and "solanidine-*s*" should be replaced by solasodine. The formulæ originally assigned to these products need alteration to conform with the new formula for solasonine, but in their review of this work Briggs *et al.* (1942) agree that Oddo's results justify the conclusion that the sequence in the gluco-alkaloid is similar to that in solanine (p. 661) and may be stated as

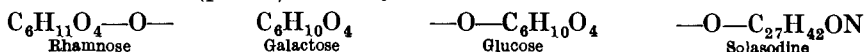

and not with two molecules of solasodine, one at each end, as proposed by the Italian workers.

Solasodine (solanidine-*s*), $C_{27}H_{43}O_2N \cdot H_2O$. This formula was first used by Rochelmeyer²² (1939) and was confirmed by Briggs, Newbold and Stace.²⁵ The alkaloid results from the acid hydrolysis, usually in

alcohol, of salasonine (*see above*) along with glucose, galactose and rhamnose. It crystallises from dilute alcohol or dioxan, in nacreous scales, m.p. 197–8°, though this constant has been raised once to 200·5–202·5°, $[\alpha]_D^{25} - 97\cdot1^\circ$ (MeOH)²⁵ or $-92\cdot4^\circ$ (C₆H₆).²² The following salts have been prepared: picrate, m.p. 144°; picrolonate, m.p. 234°; hydrochloride, m.p. 314°, $[\alpha]_D^{24} - 70^\circ$ (MeOH); hydriodide, m.p. 293°; tartrate, m.p. 222°; oxalate, m.p. 248°. Solasodine contains two active hydrogen atoms, assumed to be present as hydroxyl groups but only monoacyl derivatives are formed, e.g., monoacetylsolasodine, C₂₉H₄₅O₃N, m.p. 195°, and 3 : 5-dinitrobenzoyl-solasodine, m.p. 191·5–193°. Rochelmeyer found that solasodine gives Rosenheim's colour reaction with trichloroacetic acid, forms a sparingly soluble digitonide, and on selenium dehydrogenation yields Diels's hydrocarbon, γ -methylcyclopentenophenanthrene, so it must belong to the

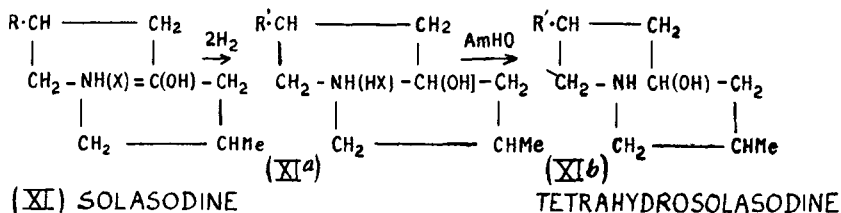
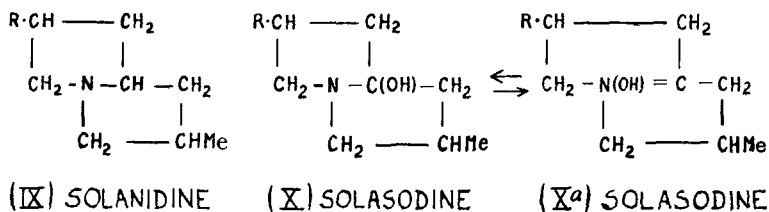

steroid group and one of the hydroxyl groups should be in position 3 and should be the one acylated, since the monoacetyl derivative does not precipitate with digitonin. With methyl and ethyl iodides solasodine forms only the hydriodide, described as quaternary; with acetic acid and sodium nitrite it produces with loss of water the quaternary nitrite, C₂₇H₄₁ON. HNO₂, m.p. 260·5–262·5° (*dec.*), which on treatment with hot, dilute, ammonia solution regenerates solasodine. This nitrite was first prepared by Oddo and Caronna, who called it "azosolanidine-s" and regarded its formation as an indication of a secondary amine group in solasodine²⁷ (1936). Briggs, Newbold and Stace²⁵ suggest that the behaviour of the solasodine nitrogen atom is due to its association with the second hydroxyl group of solasodine, either as a carbinol amine (X : R = steroid residue) or more probably as a quaternary hydroxide (Xa : R = steroid residue). This suggestion makes solasodine the quaternary hydroxide of solanidine as formulated (IX) by Clemo, Morgan and Raper. In this connection it is

pointed out that, like solanidine, solasodine is converted either by heating with copper powder or by treatment with aluminium *tert*-butoxide in benzene-acetone, into the corresponding ketone, in this case solasodenone, $C_{27}H_{41}O_2N$, m.p. $184-5^\circ$, $[\alpha]_D \pm 0^\circ$, which does not precipitate with digitonin or give the Rosenheim colour test. This reaction involves the change $-\overset{3}{\text{CHOH}}- \rightarrow -\overset{3}{\text{CO}}-$ and the transfer of the ethylenic linkage, C^5-C^6 , to C^4-C^5 as in cholesterol to cholestenone, and the ultra-violet absorption curve is in accord with these assumptions.²² Similarly, solasodine is dehydrated by heating with hydrochloric acid in methyl or ethyl alcohol to solasodiene, $C_{27}H_{41}ON$, m.p. $169.5-170.5^\circ$, $[\alpha]_D^{25^\circ} - 86.9^\circ$ (CHCl_3), which is also produced along with solasodine in the acid hydrolysis of solasonine. The second ethylenic linkage formed in this reaction is placed at C^3-C^4 being conjugated with the primary double bond, in a different ring, positions in accord with a maximum at $2,340\text{A.}$, $\log \epsilon 4.34$, observed in the ultra-violet absorption spectrum by Rochelmeyer,²² who named this substance solanosodine (1939). It gives the Rosenheim colour reaction, contains one active hydrogen atom (Zerewitinoff) and forms a hexahydro-derivative, $C_{27}H_{47}ON$, m.p. $184-6^\circ$, $[\alpha]_D^{25^\circ} - 18^\circ$, on hydrogenation in acetic acid, under pressure in presence of platinic oxide.

Under similar conditions, but with palladised charcoal as catalyst, solasodine forms a dihydro-derivative, $C_{27}H_{45}O_2N$, m.p. $208.5-210.5^\circ$, $[\alpha]_D^{25^\circ} - 63.5^\circ$ (CHCl_3), and in presence of platinic oxide, a tetrahydro-derivative, $C_{27}H_{47}O_2N$, which is dimorphic, m.p. 292.5° , and $285-291^\circ$, $[\alpha]_D^{18^\circ} - 4.94^\circ$ (CHCl_3).

The salts of solasodine, except in the case of the nitrite already referred to, are formed without loss of water and in their formation, as well as in the production of hexahydrosolasodiene (dihydrochanosolasodane) and tetrahydrosolasodine (dihydrochanosolasodanol) it is suggested that solasodine acts as the carbinol-amine (X) hydrogenation, *e.g.*, taking place as in (XI) to (XIb), where R is the unsaturated, and R' the saturated sterol residue, *i.e.*, the ethylenic linkage is saturated first (R to R' in XI to XIa) and scission of the bridge between the two rings takes place by what is described as a kind of Emde degradation.

Colour Reactions. Rochelmeyer (1939)²² has provided a list of colour reactions given by solasodine and solasodiene (solanosodine), with reagents usually applied to the sterols, and Briggs *et al.*²⁵ have found that when concentrated sulphuric acid (1 mil) is carefully added to a solution of solasonine or solasodine in hot alcohol (1 mil) a characteristic, intense, greenish-yellow fluorescence is produced, a reaction which is not given by solanine or solanidine. They have also found that intense colours are formed when solasonine or solasodine is mixed with resorcinol, or one of a variety of aldehydes, and boiled with concentrated hydrochloric acid. Colours are also produced with this test by cholesterol, digitonin, jacobine carbazole, pyrrole, or nicotine, the most intense colours being formed with *p*-hydroxybenzaldehyde or anisaldehyde.

Solauricine, $C_{45}H_{73}O_{16}N$. From an alcoholic extract of the dried

berries of *Solanum auriculatum*, Anderson and Briggs²⁵ isolated a glucosidal alkaloid of this formula, which was at first assumed to be solasonine. It yielded on acid hydrolysis an aglycone resembling solasodine. On further investigation, Bell, Briggs and Carroll²⁵ came to the conclusion that this gluco-alkaloid and its aglycone are new compounds showing a remarkable similarity in physical and chemical characters to solasonine and solasodine, with which they are respectively isomeric. They named the gluco-alkaloid solauricine and the aglycone *solauricidine*, and showed that the latter is not a dimorphic form of solasodine.

When the juice of the fresh berries of the same plant was examined it yielded a gluco-alkaloid, m.p. 269–270° (*dec.*), which appeared to be solauricine, m.p. 270° (*dec.*), but on hydrolysis it furnished a crude aglycone, m.p. 219–220°, which, after a long series of recrystallisations from a variety of solvents, gave a fraction of pure solasodine, m.p. 199.5–202°, and another of pure solauricidine, m.p. 213–7°.

The major difference between the two gluco-alkaloids and also between the two aglycones, lies in their melting-points and those of their derivatives. For convenience of comparison these are summarised in the following table, which includes mixed melting-points to illustrate the difficulty met with in this series, that a mixture of two distinct members of the group may not show depression of melting-point.

Derivative	Solasoanine	Solauricine	Mixture	Notes
	M. p.	M. p.	M. p.	
Glucosalkaloid	276°	270°	272°	Solasodine has
Picrate	197°	185°	184°	[α] _D -80.4° as
Picrolonate	231°	232°	-	base, -70.5° as
Aglycone	198° *	219° †	208-211° †	hydrochloride;
Hydrochloride	314.5-315°	313-313.5°	313.5-314°	solauricidine
Hydroxide	288°	285°	286°	has [α] -89.9° as
Picrate	144°	141°	142°	base and -68.2°
Picrolonate	232°	234°	232°	as hydrochloride.
Tartrate	220°	222°	221°	
Oxalate	245-6°	238°	239°	
Acetyl derivative	195° *	197-203° *	-	
O-Nitrobenzoyl *	222°	220°	-	
Dihydro-	208.5-210.5°	221.5-227.5°	-	

* These are melting-points; all others in the table are melting-points with decomposition.

This table shows that the similarity of the two aglycones is most marked in their salts, but they do not appear to be dimorphic forms giving identical salts, for the melting-points of the bases are unchanged after sublimation, the rotations of the two bases in solution are different, though those of the two hydrochlorides are identical within the limits of experimental error, and all attempts at interconversion of the two bases

have been unsuccessful. A further complication lies in the observation that both solasodine and solauricidine occur in dimorphic forms, and that the optical, axial angles of each respective dimorphic form obtained from solasodine or solauricidine are indistinguishable. No difference in chemical reactivity has yet been traced between the two aglycones. The glucosidic moiety of solauricine has been shown by Briggs and Carroll²⁵ to yield glucose, galactose and rhamnose on hydrolysis and is therefore assumed to be the same in constitution as that of solanine and solasonine.

Solanocapsine, $C_{26}H_{44}O_2N_2 \cdot H_2O$. The presence of an alkaloid in the berries of *Solanum pseudocapsicum* L. was noted by Breyer-Brandwyk,²⁹ and this material, on investigation by Barger and Fraenkel-Conrat,³⁰ yielded solanocapsine, $C_{26}H_{44}O_2N_2$, and solanocapsidine, $C_{26}H_{42}O_4N_2$. The crude alkaloidal mixture, after hydrolysis gave indications of the presence of a carbohydrate, so that a gluco-alkaloid may also be present. Solanocapsine crystallises from 50 per cent. alcohol in flat prisms, m.p. 222°, $[\alpha]_D + 25.5^\circ$, and yields a dihydrochloride, $B \cdot 2HCl \cdot H_2O$, needles, m.p. $> 280^\circ$, a sulphate, $B \cdot H_2SO_4$, flat prisms, m.p. 324°, and a picrate,

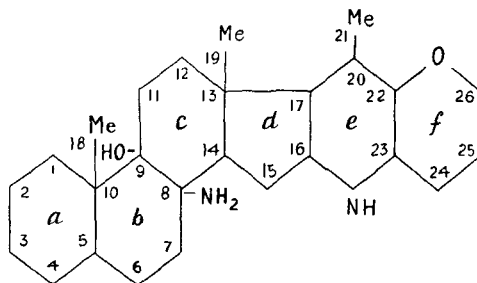

Solanocapsine

m.p. 194°. The alkaloid contains no methoxyl or methylinino group; three CMe groups are present, and three active hydrogens are detectable at atmospheric temperature and four at 95°, one of which is due to a hydroxyl group, one to an imino group and two to an amino group, as indicated by other reactions of the alkaloid. With potassium hydroxide in methyl alcohol solanocapsine is converted into an *apo*-base, $C_{26}H_{42}ON_2$ (amorphous), due to elimination of a tertiary hydroxyl group with a neighbouring hydrogen atom. This *apo*-base with nitrous acid yields a nitroso-compound, $C_{26}H_{40}O_2N \cdot NO$, m.p. 194°, also produced in like manner from the parent alkaloid, the original hydroxyl group being eliminated as water, with the formation of a double bond and the amino-group replaced by a new hydroxyl group. Solanocapsine yields a diacetyl derivative (amorphous), m.p. 150–160°, which is neutral and in which the hydroxyl is not acylated. The alkaloid condenses with acetone to the compound $C_{29}H_{48}O_2N_2$, m.p. 233°, decomposed by acetic anhydride into *N*-acetylsolanocapsine, m.p. 238°, and acetone. The nitroso-compound (*see above*), on oxidation with potassium permanganate in acetone or pyridine, forms a neutral substance, m.p. 218°, and an acid, $C_{15}H_{24}O(NH)(CO_2H)_2$, m.p. 226–7°. Solanocapsine does not yield a sparingly soluble digitonide.

The second alkaloid SOLANOCAPSIDINE, $C_{26}H_{44}O_4N_2$, m.p. 305° (approx.), is amorphous. It was used for a selenium dehydrogenation experiment and yielded Diels's hydrocarbon, γ -methylcyclopentenophenanthrene (picrate, m.p. 117°) and a mixture of bases from which 2-methyl-5-ethylpyridine (picrate, m.p. 162°) and 4-methyl-2-ethylpyridine (picrate, m.p. 125°) were isolated.

On the assumption that the two alkaloids may have a similar structure and, with that reservation, applying the result of the selenium dehydrogenation experiment to the case of solanocapsine, the authors suggest that the annexed formula (p. 670) accounts for all the reactions of this alkaloid so far observed.

Solangustine, $C_{33}H_{53}O_7N \cdot H_2O$. This alkaloid was isolated by Tutin and Clewer²⁸ from *Solanum angustifolium*. It separates from hot amyl alcohol in pale yellow crusts of microscopic crystals, m.p. 235° (dec.), and is only readily soluble in pyridine. It contains no methoxyl group and the acetyl derivative is amorphous. The sulphate, $B_2 \cdot H_2SO_4 \cdot 3H_2O$, forms needles, m.p. above 325° , and is only soluble, and that sparingly, in boiling acetic acid. On hydrolysis solangustine yields 1 mol. each of dextrose and solangustidine, $C_{27}H_{43}O_2N$. The latter is amorphous, but yields well-crystallised salts. The hydrochloride, $B \cdot HCl$, forms lustrous plates, m.p. above 325° , from boiling alcohol containing hydrochloric acid. The nitrate, $B \cdot HNO_3$, separates in colourless leaflets, m.p. 290° (dec.), from alcohol. The picrate, yellow needles, has m.p. 250° . The monoacetyl derivative crystallises from ethyl acetate in needles, m.p. 256° .

Other Solanum spp. From *Solanum grandiflorum* var. *pulverulentum*, Freire³¹ isolated a toxic alkaloid grandiflorine. *S. melongena*, the egg-plant, yielded to Yoshimura³² trigonelline, β -amino-4-ethylglyoxaline and choline. In *S. dulcamara* Masson³³ found an amorphous gluco-alkaloid *solaceine*, which yielded solanidine on hydrolysis, whilst Davis⁶ records the presence of solanine and solanidine. Anderson found an alkaloid in the fruit.³⁴ Little and McMurray³⁵ recorded alkaloids in *S. carolinense* L., and Sciuchetti *et al.*^{35(a)} found 0.03 per cent. of alkaloids in the leaves and tops of *S. triflorum* Nutt., but none in the fruits.

Pharmacological Action. The "solanines" are stated to resemble the saponins in action and are described as protoplasmic poisons and potent hæmolytics. Their effects are usually only met with in cases of poisoning by potatoes, which from faulty cultivation or storage or some other cause contain more than the usual traces of solanine, but in quite a number of cases of mass potato poisoning the effects, while severe, have not proved fatal. The symptoms of solanine poisoning are headache, nausea, emesis and gastritis. With sufficiently large doses parenchymatous nephritis and hæmoglobinuria, and even central nervous paralysis and cardiac arrest, may ensue. It is also a local irritant. Solangustine appears to be relatively inactive.³⁶ According to Watt, Heimann and Epstein,³⁷ solanocapsine induces marked local irritation on intravenous injection; its systemic action is wholly intracardiac, the effects being mainly on the sinus and large doses disturbing conduction and disorganising the action

of the heart. Kussner has prepared a series of aminoacyl esters of aglycones of natural cardiac glucosides. They behave like alkaloids, form salts and are said to be less easily hydrolysed than the natural glucosides. They have been tested pharmacologically by Kreitmair, whose results indicate that the diethylaminoacetyl ester of strophanthidin-k is a promising cardiac drug.^{37(a)} For accounts of poisoning ascribed to solanine in potatoes and other *Solanum* spp. see Rost,³⁸ Lewin³⁹ and Pohl.⁴⁰

REFERENCES

- (1) For an extended list of *Solanum* spp. and their alkaloidal contents see WEHMER, "Die Pflanzenstoffe." For *S. villosum* see GUTH, *J. Amer. Pharm. Assoc.*, 1938, 27, 217. (2) *Jahresb.*, 1820, 2, 114. (3) *Monats.*, 1889, 10, 541. (4) *Ibid.*, 1905, 26, 445. Cf. HEIDUSCHKA and SIEGER, *Arch. Pharm.*, 1917, 255, 18. (5) *Compt. rend.*, 1899, 128, 887. (6) *Pharm. J.*, 1902, [iv], 15, 160. (7) *Gazzetta*, 1908, 38, [i], 19; 1912 42, [ii], 101. (8) *Ber.*, 1928, 61, 2294; cf. ODDO, *ibid.*, 1929, 62, 267. (9) ZWENGER and KIND, *Annalen*, 1859, 109, 244; SCHULZ, *Zeit. Zuckerind. Böhm.*, 1900, 25, 89; ZEISEL and WITTMANN, *Ber.*, 1903, 36, 3554; VOTOČEK and VONDRÁČEK, *ibid.*, p. 4372; and HEIDUSCHKA and SIEGER.⁴ (10) *Ibid.*, 1934, 67, 446. (11) *Ibid.*, 1935, 68, 669, (12) *J. Soc. Chem. Ind.*, 1943, 62, 20, 48; cf. LAMPITT and GOLDENBERG, *Chem. and Ind.*, 1940, 59, 748; ROCHELMMEYER, *Chem. Zent.*, 1944, ii, 1188 and WOLF and DUGGAR, *J. Agric. Res.*, 1946, 73, 1; STREET *et al.*, *Ann. appl. Biol.*, 1946, 33, 1. (13) *Biochem. Zeit.*, 1937, 295, 44; cf. BRETON, *Ann. pharm. franc.*, 1945, 3, 69. (14) *Plant. Physiol.*, 1937, 12, 79. (15a) ALBERTI, *Zeit. Unters. Lebens.*, 1932, 64, 260; WILLMOTT, *Analyst*, 1933, 58, 431; FISCHER and THIELE, *Österr. Bot. Zeit.*, 1930, 78, 325 (*Chem. Zentr.*, 1930, ii, 2164; cf. *Monats.*, 1930, 56, 282); *Pharm. Zent.*, 1931, 72, 545; *Arch. Pharm.*, 1937, 275, 521. (15b) BÖMER and MATTIS, *Zeit. Unters. Lebens.*, 1923, 45, 288; 1924, 47, 97; GRIEBEL, *ibid.*, 1924, 47, 436; VALENTIN, *Pharm. Zent.*, 1933, 74, 611; VON FELLEBERG, *Mitt. Lebens. Hyg.*, 1940, 31, 85 (*Brit. Abstr.*, 1946, C. 43). (16) *Ber.*, 1933, 66, 762; (with WALLENFELS), *ibid.*, 1936, 69, 811. For a full account of work on Diels's hydrocarbon see FIESER, "The Chemistry of Natural Products related to Phenanthrene," New York, 1937, pp. 159-166. (16a) *J. Biol. Chem.*, 1943, 149, 451; *Science*, 1943, 97, 122. (17) SCHÖPF and HERRMANN, *Ber.*, 1933, 66, 298. (18) BERGEL and WAGNER, *ibid.*, 1933, 66, 1093. (19) *Arch. Pharm.*, 1932, 270, 550. (20) DIETERLE and ROCHELMMEYER, *ibid.*, 1935, 273 532, 539; ROCHELMMEYER, *ibid.*, 1936, 274, 543; (with GEYER and SHAH), *Ber.*, 1938, 71, 226. (20a) *Helv. Chim. Acta*, 1942, 25, 1306; 1944, 27, 390. (20b) *Ibid.*, 1943, 26, 2269. (20c) *J. Biol. Chem.*, 1945, 160, 243. (21) *J. Chem. Soc.*, 1936, 1299. (22) *Arch. Pharm.*, 1937, 275, 336; 1939, 277, 329. (23) *Gazzetta*, 1905, 35, [i], 27; 1906, 36, [i], 310; 1911, 41, [i], 490; 1914, 44, [i], 680, 690; [ii], 181, 191; *Ber.*, 1936, 69, 283; see also ROMEO, *ibid.*, 1905, 35, [ii], 579; SOLDAINI, *Boll. chim. Farm.*, 1905, 44, 769. (24) *Proc. Ind. Acad. Sci.*, 1936, 4A, 255; cf. PENDSE and DUTT, *Ind. J. Med. Res.*, 1932, 20, 663; GUPTA and DUTT, *J. Ind. Chem. Soc.*, 1938, 15, 95; MANJUNATH and SHADAKSHARASWAMY, *J. Mysore Univ.*, 1942, 3B, 117. (25) BRIGGS, *J. Amer. Chem. Soc.*, 1937, 59, 2467; *Nature*, 1939, 144, 247; (with ANDERSON), *J. Chem. Soc.*, 1937, 1036; (with BELL), *ibid.*, 1942, 1; (with NEWBOLD and STACE), *idem.*, p. 3; (with BELL and CARROLL), *idem.*, p. 12; (with CARROLL), *idem.*, p. 17. (26) *J. Soc. Chem. Ind.*, 1930, 49, 395. (27) ODDO, *Gazzetta*, 1911, 41, [i], 534; 1914, 44, [ii], 191; (with CARONNA), *Ber.*, 1936, 69, 283. (28) *J. Chem. Soc.*, 1914, 105, 164. (29) *Bull. Sci. Pharmacol.*, 1929, 36, 541. (30) *J. Chem. Soc.*, 1936, 1537. (31) *Compt. rend.*, 1887 105, 1074. (32) *J. Chem. Soc. Japan*, 1921, 42, 16. (33) *Bull. Sci. Pharmacol.*, 1912, 19, 283. (34) *Chem. News*, 1911, 104, 2; cf. WELLS and REEDER, *ibid.*, 1907, 96, 199. (35) *Pharm. Arch.*, 1940, 11, 23. (35a) (With McMURRAY and WALLER) *J. Amer. Pharm. Assoc.*, 1944, 33, 300, 303. (36) DALE, quoted by TUTIN and CLEWER, *J. Chem. Soc.*, 1914, 105, 564. (37) *Quart. J. Pharm.*, 1932, 5, 649. (37a) *Merck's Jahresb.*, 1939'53, 45, 52. (38) STARKENSTEIN, ROST and POHL, "Toxikologie" (Berlin, 1929), p. 122. (39) LEWIN, "Gifte und Vergiftungen," p. 820. (40) POHL, *Heffter's Handb. d. Pharmakol.*, 1924, II, 2, 1294.

THE ACONITE ALKALOIDS

The alkaloids of *Aconitum* spp. are mainly of two kinds : (a) *aconitines* which are diacyl esters of a series of polyhydric, amino-alcohols (aconines) and are highly toxic, and (b) the *atisines*, which are amino-alcohols and like the aconines of low toxicity. There is still doubt as to the identity of one of the "aconitines," viz. japaconitine, for which Majima *et al.*¹ confirmed the characters recorded by Dunstan and Read,² but regard it as identical with aconitine, a view previously taken by Mandelin,³ Lübbe⁴ and Freund and Beck,⁵ but not by Paul and Kingzett,⁶ who discovered japaconitine, or by Wright, Luff and Menke,⁷ Dunstan and Read,² and Makoshi.⁸ Schulze and Liebner,⁹ regard the two alkaloids as isomerides yielding the same pyraconitine (p. 675). There can be little doubt that the two alkaloids are isomeric, but as their identity cannot be regarded as established, a description of japaconitine is given below, and in the following list, aconitine, except in the case of *A. Napellus*, means aconitine as defined by Majima.¹

Aconitine is also stated to occur in Portuguese aconite (*A. Napellus* Linn., sub-species *lusitanicum*),¹⁰ and it may also be present in an unidentified aconite from the Chumbi Valley, Tibet¹³ (*cf. A. Ludlowii*, below).

Aconite roots marketed in India are apt to be from mixed species and botanical verification of such material is desirable.¹²

- Aconitum anthora*, L. Anthonine, soluble in ether, dextrorotatory; ψ -anthonine, insoluble in ether: both amorphous and of low toxicity.¹¹
- A. Balfourii*, Stapf.¹² (India). Pseudoaconitine¹³ (p. 682).
- A. calliantum*, Koidzumi (Japan). Hypaconitine (p. 681), mesaconitine (p. 680), traces of aconitine.¹⁴
- A. chasmanthum*, Stapf.¹² (Indian). Indaconitine¹⁵ (p. 684).
- A. columbianum*. Unspecified alkaloids of low toxicity.¹⁶
- A. deinorrhizum*, Stapf.¹² Pseudoaconitine.¹³
- A. Fauriei*, Léviellé and Vaniot (Japan) = *A. chinense* (Sieboldt). Aconitine, mesaconitine.¹⁴
- A. grossedentatum*, Nakai (Japan). Aconitine, hypaconitine, mesaconitine.¹⁴
- A. hakusanense*, Nakai (Japan). Aconitine, hypaconitine, mesaconitine.¹⁴
- A. heterophyllum*, Wall. Atisine (p. 687).
- A. ibukiense*, Nakai (Japan). Aconitine, hypaconitine, mesaconitine.¹⁴
- A. kamtschaticum*, Willd. and Reichb. (Japan). Hypaconitine, mesaconitine.¹⁴
- A. lucidusculum*, Nakai (Japan). Lucidusculine,¹⁷ (p. 690).
- A. Ludlowii*, Exell. (Tibet). Uncharacterised alkaloids.^{17(a)}
- A. lycocotnum*, L. Lycaconitine and myocotnine (p. 686).
- A. Majimai*, Nakai. Aconitine, mesaconitine.¹⁴
- A. mandschuricum*, Nakai (China). Mesaconitine.¹⁴
- A. mokchangense*, Nakai (Korea). Aconitine, mesaconitine.¹⁴
- A. Napellus*, L. Aconitine (*see below*), benzaconine, aconine, neopelline.¹⁸
- Freudenberg and Rogers¹⁹ have also found in "commercial amor-

- phous aconitine" napelline, neoline, *l*-sparteine and *l*-ephedrine (1937).
- A. palmatum*, Don. Palmatisine, non-toxic,¹² m.p. 285°, B. HBr, m.p. 245° (*corr.*).
- A. paniculatum*, Lam. Paniculatine, C₂₉H₃₅O₇N, small rhombic prisms, m.p. 263°.²⁰
- A. ponticum*. Pontaconitine, uncharacterised (Rosenthaler, 1942).^{20(a)}
- A. sachalinense*, Fr. Schmidt (Saghalien). Jesaconitine, aconitine¹⁴ (traces), kobusine.
- A. senanense*, Nakai (Japan). Hypaconitine, traces of aconitine.¹⁴
- A. septentrionale*, Koelle. Lappaconitine, septentrionaline and cynoactonine²¹ (p. 686).
- A. spicatum*, Stapf.¹² Bikhaconitine (p. 685).
- A. Staerckianum*, Reichenbach. Aconitine (?), neopelline.²²
- A. subcuneatum*, Nakai (Japan). Aconitine, jesaconitine (p. 679).¹⁴
- A. talassicum* (Central Asia). Talatisine, talatisamine, talatisidine and isotalatisidine (p. 689).⁵⁰
- A. tianschanicum*, Fedtsch. Aconitine.⁵⁰
- A. tortuosum*, Willd. (Japan). Aconitine, hypaconitine, mesaconitine (traces).¹⁴
- A. Zuccarini*, Nakai (Japan). Aconitine, mesaconitine, hypaconitine (traces).¹⁴

Aconitine, C₃₄H₄₇O₁₁N. After early indications of the presence of alkaloids in *A. Napellus* L. by Geiger and Hesse,²³ and by von Planta,²⁴ crystalline aconitine was probably first prepared in 1860 by Groves.²⁵ The alkaloid was investigated by Wright *et al.*,²⁶ and later on by Dunstan *et al.* and by Freund and co-workers.²⁷

Aconite root is now but little used in medicine. The United States Pharmacopœia XI recognised both aconite root and aconitine and required the former to conform with a specified, biological test in guinea-pigs. Neither was recognised in U.S.P. XII. A considerable number of processes for the estimation of alkaloids in aconite have been published.²⁸ The British Pharmacopœia, 1948, in which aconite root is official, requires it to contain 0.5 per cent of alkaloids and provides a chemical assay method. A number of biological methods have been suggested,²⁹ but a joint investigation by Broom, Burn, Gaddum, Trevan and Underhill has shown that the biological test in mice is attended with difficulties owing to variation in susceptibility of different colonies of mice.³⁰ Kirkpatrick found aconitine polarographically inactive. It has been stated that tincture of aconite should be adjusted to a pH 2.0 to 3.0 to ensure stability.³¹ There has been discussion³² regarding the empirical formula for aconitine, but C₃₄H₄₇O₁₁N is now generally accepted.

The alkaloid has m.p. 202–3°, $[\alpha]_D + 14.61^\circ$ or $+ 18.7^\circ$ (CHCl₃) (Majima), crystallises in rhombic prisms (a : b : c = 0.54492 : 1 : 0.38917), is soluble in chloroform or benzene, less so in ether or dry alcohol, and almost insoluble in water or light petroleum. The salts are levorotatory;

the hydrobromide, B. $\text{HBr} \cdot 2\frac{1}{2}\text{H}_2\text{O}$, forms hexagonal tablets from water; it sinters at 160° and melts at 200° or at $206-7^\circ$ if dried at $115-120^\circ$, or from alcohol and ether in minute needles with $\frac{1}{2}\text{H}_2\text{O}$, m.p. $206-7^\circ$; this salt has $[\alpha]_{\text{D}} - 30.8^\circ$ (-27.7° , H_2O ; Majima); the hydriodide, m.p. 226° , is sparingly soluble in water; the hydrochloride, B. $\text{HCl} \cdot 3.5\text{H}_2\text{O}$, has m.p. 149° ($165-6^\circ$ or $194-5^\circ$ (dry), Majima) and $[\alpha]_{\text{D}} - 30.9^\circ$ (H_2O); the aurichloride, B. $\text{HCl} \cdot \text{AuCl}_3 \cdot 3\text{H}_2\text{O}$, m.p. 136.5° or 152° (dried at 115°), crystallises in golden-yellow needles, and, according to Jowett,³⁴ exists in three forms: α - m.p. 135° (dec.); β - m.p. 152° ; γ - m.p. 176° after sintering at 154° . The perchlorate has m.p. $215-222^\circ$, $[\alpha]_{\text{D}} - 18.9^\circ$ (Majima¹⁴).

Aconitine produces an intense tingling sensation when a drop of a solution, 1 in 10,000, is applied to the tip of the tongue. It also gives a characteristic unstable, crystalline precipitate when a few drops of potassium permanganate solution are added to a solution of the alkaloid in dilute acetic acid. The formation of acetic acid when the alkaloid is heated dry, or of benzoic acid when it is hydrolysed by alkali, have also been suggested as identification tests. For the recognition of minute quantities a biological test is probably the best procedure.³⁵

Aconitine contains four methoxyl groups and three hydroxyl groups (triacetyl derivative, m.p. $207-8^\circ$).³⁶ On hydrolysis by water under pressure, or by boiling with dilute acid, it loses 1 mol. of acetic acid and forms benzoyleaconine, whilst hydrolysis by alkalis eliminates both acetic and benzoic acids and yields aconine.

Benzoyleaconine (benzaconine, isaconitine, picraconitine), $\text{C}_{32}\text{H}_{45}\text{O}_{10}\text{N}$, m.p. 130° , $[\alpha]_{\text{D}} + 5.6^\circ$, is amorphous, but yields crystalline, laevorotatory salts, B. HBr , m.p. 273° , colourless prisms; B. HI , m.p. $204-5^\circ$; B. HCl , two forms, m.p. 217° and m.p. 270° , $[\alpha]_{\text{D}} - 20.7^\circ$ (H_2O). On acetylation it furnishes a tetracetyl derivative, which is not identical with triacetylaconitine (Dunstan and Carr).³⁶

Aconine, $\text{C}_{25}\text{H}_{41}\text{O}_9\text{N}$, m.p. 132° , $[\alpha]_{\text{D}} + 23^\circ$ (H_2O), is amorphous, and yields hygroscopic salts, which crystallise with difficulty. The hydrobromide, B. $\text{HBr} \cdot 1.5\text{H}_2\text{O}$, has m.p. 225° (dry); the hydrochloride, B. $\text{HCl} \cdot 2\text{H}_2\text{O}$, m.p. $175-6^\circ$, $[\alpha]_{\text{D}} - 7.7^\circ$ (H_2O); the aurichloride is amorphous. Pentacetylaconine ("tetracetylaconine") is crystalline and has m.p. $231-2^\circ$ (Majima³⁷). Aconine contains four methoxyl groups, and in it Jacobs and Elderfield³⁷ demonstrated the presence of an ethylimino group.

The acetyl group in aconitine may be eliminated in two other ways: (a) by heating aconitine in sealed tubes with methyl alcohol, when *methylbenzoyleaconine*,³⁸ m.p. $210-1^\circ$, is formed, or (b) by heating the alkaloid at its melting-point, when *pyraconitine*, $\text{C}_{32}\text{H}_{43}\text{O}_9\text{N}$, m.p. 167.5° (171° , Schulze),³⁹ $[\alpha]_{\text{D}}^{20} - 112.2^\circ$ (EtOH), is formed. The latter yields crystalline, laevorotatory salts, and on hydrolysis by alkalis affords benzoic acid and *pyraconine*, $\text{C}_{25}\text{H}_{39}\text{O}_8\text{N}$, amorphous, $[\alpha]_{\text{D}} - 91^\circ$ (H_2O), but yields a crystalline hydrochloride, B. $\text{HCl} \cdot 2.5\text{H}_2\text{O}$, m.p. 154° (135° , Schulze), $[\alpha]_{\text{D}} - 102^\circ$ (H_2O) (-124.6° , Schulze).³⁹

Some progress has been made in determining the structure of the alkaloid and much work has been expended in oxidation experiments, the results of which are reviewed in recent papers by Jacobs, with Craig and Elderfield,⁴⁰ and which may be summarised as follows for the oxidising agents used :—

Chromic Acid. On oxidising *aconine*, $C_{19}H_{19}(OH)_5(OMe)_4(NEt)$, with this reagent Schulze³² (1906, 1908) obtained, along with methylamine and acetaldehyde, two products (a) $C_{24}H_{35}O_8N = C_{21}H_{22}ON(OH)_4(OMe)_3$, basic, yielding a hydrochloride, $B \cdot HCl \cdot 3H_2O$, m.p. 213° or 220° (*dry, dec.*), $[\alpha]_D^{20} + 54 \cdot 4^\circ$ (H_2O), a tetracetyl derivative, m.p. 223° (*dec.*) and a methiodide, needles, m.p. 222° (*dec.*). This substance was later identified by Jacobs and Craig⁴⁰ (1940) as the basic hydrolytic product of aconitoline (*see below*). (b) $C_{24}H_{33}O_9N$, amphoteric and possibly the amino-acid corresponding to the amino-alcohol (a); it yields a hydrochloride, $B \cdot HCl \cdot 0 \cdot 5H_2O$, m.p. $> 250^\circ$, a barium salt, $B_2 \cdot Ba \cdot 10H_2O$, and a methyl ester hydrochloride, m.p. $215-220^\circ$.

Using chromic acid with *aconitine*, $[C_{19}H_{19}(OAc)(OBz)(OH)_3(OMe)_4(NEt)]$, Lawson⁴¹ obtained *aconitoline*, $C_{30}H_{37}O_9N$, prisms, m.p. 220° , hydrolysed by sodium ethoxide in alcohol to benzoic acid and a base, $C_{23}H_{33}O_8N$, volatile in a high vacuum and yielding a hydrochloride, $B \cdot HCl \cdot 3H_2O$, m.p. 222° , and a diacetyl derivative, m.p. 239° . According to Jacobs and Craig,⁴⁰ aconitoline has the formula $C_{33}H_{41}O_{10}N$ and is hydrolysed by alkali to a base yielding a methiodide, $C_{25}H_{38}O_8NI$, m.p. $222-5^\circ$, identical with Schulze's substance (a) methiodide (*see above*).

Majima and Tamura⁴¹ obtained by the use of chromic acid on aconitine, *aconitinone*, $C_{34}H_{45}O_{11}N$, m.p. about 150° (*dec.*), which retains four methoxyl groups, slowly loses a molecule of methyl alcohol forming *demethanolaconitinone*, $C_{33}H_{41}O_{10}N$, m.p. 220° (*dec.*), $[\alpha]_D^{20} + 69 \cdot 28^\circ$ ($CHCl_3$), $[B \cdot HAuCl_4]$, m.p. 177° , picrate, m.p. $197-8^\circ$ (*dec.*), which is hydrolysed by alcoholic potash to *demethanolaconinone*, $C_{24}H_{35}O_8N$, $[B \cdot HCl \cdot 3H_2O]$, m.p. 224° (*d'c.*). At 219° demethanolaconitinone loses acetic acid and forms *pyrodemethanolaconitinone*, $C_{31}H_{37}O_8N$, amorphous, m.p. $115-130^\circ$ $[B \cdot HAuCl_4]$, m.p. 196° (*dec.*); $B \cdot HClO_4 \cdot H_2O$, m.p. 257° (*dec.*). On oxidation with nitric acid demethanolaconitinone yields the nitronitroso-compound, $C_{31}H_{35}O_{13}N_3$, described later (p. 677).

Potassium Permanganate. In the action of this agent on aconitine the best-known products are acetaldehyde, believed to result from the dealkylation of the ethylimino group,³⁷ and *oxonitine*. Since its discovery by Carr,⁴² the latter has been repeatedly investigated,⁴² and for it Jacobs, Elderfield and Craig⁴⁰ have tentatively suggested that Späth and Galinowsky's⁴² formula,

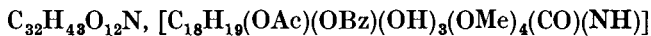

may have to be replaced by $C_{33}H_{43}O_{12}N$. Oxonitine crystallises from boiling acetic acid on addition of acetone in prisms, m.p. $279-282^\circ$ (*dec.*), $[\alpha]_D^{26} - 45^\circ$ ($c = 0 \cdot 965$; $CHCl_3$), absorbs 3 mols. of hydrogen forming hexahydroxonitine, $C_{33}H_{49}O_{12}N$, m.p. 258° , and on pyrolysis at $280-5^\circ$

loses acetic acid and forms pyroxonitine, $C_{31}H_{39}O_{10}N$, m.p. 180° , $[\alpha]_D - 127^\circ$ (MeOH), which hydrogenates to the hexahydro-derivative, $C_{31}H_{45}O_{10}N$, m.p. $160-3^\circ$. Alkaline hydrolysis deacylates oxonitine to oxonine, $C_{24}H_{37}O_{10}N \cdot 4H_2O [C_{19}H_{19}(OH)_5(OMe)_4(CO)(NH)]$, m.p. 175° . Pentacetyloxonine, m.p. 246° (*dec.*), $[\alpha]_D^{20} - 77.1^\circ$ ($CHCl_3$), can be obtained by direct oxidation of pentacetylaconine (Tamura ⁴²). Pyroxonitine on alkaline hydrolysis yields pyroxonine, $C_{24}H_{35}O_9N$, m.p. 264° (*dec.*).

When oxonitine is digested with hydrogen chloride, 6 per cent., in methyl alcohol at 100° , it loses carbon dioxide and is converted into a base, $C_{31}H_{45}O_{10}N$ or $C_{32}H_{47}O_{10}N$, m.p. 250° , which contains one methylimino and five methoxyl groups.

Brady ⁴² found that in the oxidation of aconitine by permanganate there was formed a second product, $C_{21}H_{29}O_9N$, m.p. 272° . Jacobs, Elderfield and Craig ⁴² have also recorded the formation in this reaction of oxoaconitine, $C_{33}H_{43}O_{12}N$, or possibly $C_{34}H_{45}O_{12}N$, m.p. 261° , $[\alpha]_D - 98^\circ$ ($CHCl_3$).

Nitric Acid. The most interesting product of this action was first obtained by Brady ⁴² by the use of fuming nitric acid on aconitine. It was described as a nitrosodicarboxylic acid, $C_{22}H_{26}O_{11}N_2$, m.p. 205° . Suginome ⁴³ obtained the same substance by the oxidation of mesaconitine or oxonitine, but assigned to it the formula $C_{31}H_{33}O_{13}N_3$. It melted at 205° , resolidified and then re-melted at 282° and had $[\alpha]_D^{24} - 33.2^\circ$. Lawson ⁴¹ described three products of this kind, (a) $C_{29}H_{33}O_{13}N_3$, m.p. 186° , from aconitoline (p. 676), and (b) $C_{31}H_{35}O_{13}N_3$, m.p. 268° (*dec.*), with (c) $C_{31}H_{35}O_{14}N_3$, m.p. 263° , both from aconitine under different conditions. Jacobs and Craig ⁴⁰ point out that though no deep-seated action takes place in this oxidation several groups are involved simultaneously, mixtures of reaction products are probably formed, which are not easily separated and completely characterised, so that some confusion in results was to be expected. They are convinced that aconitine, oxoaconitine (*above*), oxonitine (p. 676) and aconitoline on oxidation by nitric acid all yield the same product, a *nitronitroso*-compound, $C_{31}H_{35}O_{13}N_3$, which crystallises in four-sided prisms, m.p. 278° (*dec.*), $[\alpha]_D^{25} - 31^\circ$ (EtAc), or in wedge-shaped forms, melting to a resin at $180-200^\circ$, re-solidifying on continued heating and re-melting at $277-9^\circ$. It is insoluble in sodium carbonate solutions and is not an acid but may be a lactone or a $:CH_2 \cdot NO_2$ derivative. It is apparently formed from oxonitine or oxoaconitine by oxidative removal of a molecule of hydrogen and introduction of a nitro group by replacement of a methoxyl group. Thus, Jacobs and Craig ⁴⁰ were able to isolate in this oxidation of oxoaconitine, an intermediate product, $C_{33}H_{38}O_{13}N_2$, in stout, colourless prisms, m.p. $180-190^\circ$, $[\alpha]_D^{25} + 11.5^\circ$ (EtAc), giving a practically negative Liebermann nitroso-test. Oxonitine provided a similar intermediate product, $C_{32}H_{36}O_{13}N_2$ or $C_{33}H_{38}O_{13}N_2$, needles, m.p. $288-9^\circ$ (*dec.*), $[\alpha]_D^{25} + 14^\circ$ (EtAc), giving no Liebermann test. This nitration stage appears to be followed by a complicated oxidative cleavage of a cyclic amide group with nitrosation of a liberated secondary basic group, ending in the formation of the *nitronitroso*-compound, $C_{31}H_{35}O_{13}N_3$.

According to Suginome⁴³ the latter, which he calls nitronitrosoaconitinic acid, is represented by the extended formula



(*cf.* Lawson⁴¹), and on hydrolysis by barium hydroxide in alcohol yields nitronitrosoaconitinic acid, $\text{C}_{22}\text{H}_{27}\text{O}_{11}\text{N}_3$, m.p. 298° (*dec.*), $[\alpha]_{\text{D}}^{20} - 36.6^\circ$ (acetone). Lawson's analogous hydrolytic product of his nitronitroso-compound, m.p. 268° , has the formula $\text{C}_{22}\text{H}_{29}\text{O}_{11}\text{N}_3$, sinters at 186° and melts at 201° .

Lawson⁴¹ found that aconitine was converted by nitrous acid into a substance, $\text{C}_{31}\text{H}_{40}\text{O}_{12}\text{N}_2$, crystallising in small, colourless prisms, m.p. 276° (*dec.*). Jacobs and Craig⁴⁰ confirmed this observation but prefer the formula $\text{C}_{34}\text{H}_{44}\text{O}_{13}\text{N}_2$. Nitric acid converts this nitroso-derivative into the nitronitroso-compound, $\text{C}_{31}\text{H}_{35}\text{O}_{13}\text{N}_3$, described above.

Freudenberg⁴⁴ has obtained one nitrogen-free product, $\text{C}_{19}\text{H}_{24}\text{O}$, b.p. $215-220^\circ$, by the distillation of aconitine or "amorphous aconitine" with barium hydroxide or zinc dust. He suggests that the fundamental hydrocarbon, $\text{C}_{20}\text{H}_{30}$, may contain two five-membered and four six-membered rings, which will include nine secondary carbon atoms.

Neopelline, $\text{C}_{28}\text{H}_{33}\text{O}_5(\text{OMe})_3(\text{NMe}) \cdot 3\text{H}_2\text{O}$, was isolated from "amorphous aconitine" by Schulze and Berger.¹⁸ It is amorphous, and on alkaline hydrolysis furnishes acetic and benzoic acids with *neoline*, $\text{C}_{23}\text{H}_{39}\text{O}_6\text{N}$, amorphous, but yielding a crystalline hydrobromide, needles, m.p. $210-5^\circ$ (*dec.*), $[\alpha]_{\text{D}}^{28} - 4.31^\circ$, and an acetyl derivative, the aurichloride of which has m.p. 145° , with some sintering at 124° . Freudenberg and Rogers¹⁹ state that neoline occurs in "commercial amorphous aconitine," has the formula $\text{C}_{24}\text{H}_{41}\text{O}_6\text{N}$, crystallises in prisms, m.p. $153-4^\circ$; $[\alpha]_{\text{D}}^{23} + 9.7^\circ$ (EtOH), and yields a hydrobromide, m.p. 214° , $[\alpha]_{\text{D}} + 2.1^\circ$. Suginome and Shimanouti¹⁴ have suggested that neoline may have the formula $\text{C}_{23}\text{H}_{37}\text{O}_6\text{N}$ or $\text{C}_{24}\text{H}_{39}\text{O}_6\text{N}$, and neopelline $\text{C}_{32}\text{H}_{43}\text{O}_8\text{N}$ or $\text{C}_{33}\text{H}_{45}\text{O}_8\text{N}$.

Napelline, $\text{C}_{22}\text{H}_{33}\text{O}_3\text{N}$. Isolated by Freudenberg and Rogers¹⁹ (1937), from residual bases of *A. Napellus*, forms rectangular plates and yields a crystalline hydrobromide, B. HBr, m.p. 229° (*dec.*), $[\alpha]_{\text{D}}^{23} - 42.7^\circ$ (H_2O); hydriodide, B. HI, m.p. $181-5^\circ$ (*dec.*); and hydrochloride m.p. $220-2^\circ$ (*dec.*), $[\alpha]_{\text{D}} - 93.9^\circ$ (H_2O). The same authors¹⁹ (1938) have shown that napelline on selenium dehydrogenation yields a hydrocarbon, $\text{C}_{17}\text{H}_{16}$ (*cf.* atisine, p. 688).

Jacobs and Craig,¹⁹ who have re-examined napelline, state that the base distils at 0.1μ and bath temperature $140-150^\circ$, has m.p. $85-8^\circ$, contains three replaceable hydrogens, and a methylimino but no methoxyl group. The hydrobromide absorbs a molecule of hydrogen to form dihydronapelline, m.p. $145-160^\circ$, of which the hydrobromide has m.p. $256-8^\circ$. They were unable to confirm the formation of the hydrocarbon, $\text{C}_{17}\text{H}_{16}$, by selenium dehydrogenation as observed by Freudenberg and Rogers, but did obtain an alkylphenanthrene, $\text{C}_{18}\text{H}_{18}$, m.p. $76-9^\circ$, picrate, m.p. $182-4^\circ$, and a second substance, picrate, m.p. $142-6^\circ$,

possibly a dimethyl- or ethyl-phenanthrene. They also obtained a base, $C_{17}H_{17}N$, yielding a picrate, m.p. $233-7^\circ$ (cf. atisine, p. 688).

Japaconitine, $C_{34}H_{49}O_{11}N$. The possible identity of japaconitine with aconitine has been referred to already. The following description is based on Dunstan and Read's² account and their view that the two alkaloids are distinct is supported by the difference in crystalline form recorded by Pope⁴⁵ and by Schwankte.⁴⁶

Japaconitine forms rosettes of needles, m.p. 204.5° (*corr.*), $[\alpha]_D + 20.26^\circ$ ($CHCl_3$); the hydrochloride, $B.HCl.3H_2O$, occurs in rosettes of hexagonal plates, m.p. $149-150^\circ$, $[\alpha]_D - 23.8^\circ$ (H_2O); the hydrobromide, rosettes of hexagonal plates, $B.HBr.4H_2O$, m.p. $172-3^\circ$; the nitrate, $B.HNO_3$, minute rosettes, m.p. $173-7^\circ$ (from water), or 194° (from alcohol and ether), and the thiocyanate, $B.HCNS$, lustrous needles, m.p. $190-2^\circ$. The aurichloride, $B.HAuCl_4$, occurs in two forms: α -golden-yellow rosettes, m.p. 231° , and β -yellow prisms m.p. $154-160^\circ$. Japaconitine and its salts cause, even in very dilute solution, an intense tingling when applied to the tip of the tongue. It contains four methoxyl groups, combines with methyl iodide, forming a methiodide, m.p. $224-5^\circ$, which, on treatment with dilute potash, produces methyljapaconitine, $C_{34}H_{49}O_{11}NCH_3$; needles, m.p. 206° . Acetyl chloride in the cold converts the alkaloid into triacetyljapaconitine, m.p. 166° . On hydrolysis the base furnishes one molecular proportion of acetic acid and *japbenzaconine* (benzoyljapaconine), $C_{32}H_{47}O_{10}N$, m.p. 183° , $[\alpha]_D + 40.16^\circ$ (EtOH), which on alkaline hydrolysis yields benzoic acid and *japaconine*, amorphous, m.p. $99-100^\circ$, $[\alpha]_D + 10.8^\circ$ (H_2O), of which the hydrobromide crystallises in triangular plates, m.p. 221° . When heated at its melting-point japaconitine forms *pyrojapaconitine*, $C_{32}H_{45}O_9N$, m.p. $167-8^\circ$, $[\alpha]_D - 65.8^\circ$ (EtOH) (which, according to Schulze and Liebner,¹⁰ is identical with pyraconitine). The pyrojapaconine, $C_{25}H_{41}O_8N$, produced by the hydrolysis of pyrojapaconitine, is amorphous, has m.p. $123-8^\circ$ and $[\alpha]_D - 73.9^\circ$.

Jesaconitine, $C_{35}H_{49}O_{12}N$, first obtained by Makoshi,⁸ and later by Majima and Morio,¹⁴ is amorphous, m.p. $128-131^\circ$, but yields a crystalline perchlorate, prisms, m.p. $230-2^\circ$ (*dec.*), $[\alpha]_D - 16.7^\circ$ (MeOH); aurichloride, prisms, m.p. $208-9^\circ$ (*dec.*); and perbromide, m.p. $181-2^\circ$ (*dec.*). On boiling with dilute sulphuric acid it loses acetic acid and yields *jesanisaconine* (*p*-anisoylaconine), $C_{33}H_{47}O_{11}N$, of which the hydrochloride, $B.HCl.3H_2O$ is crystalline, m.p. $209-210^\circ$ (*dry, dec.*), $[\alpha]_D^{20} - 19.2^\circ$ (H_2O). On alkaline hydrolysis jesaconitine yields acetic and *p*-anisic acids and *aconine* (cf. p. 675) isolated as the hydrochloride, $C_{25}H_{41}O_8N.HCl.2H_2O$, m.p. $169-170^\circ$, $[\alpha]_D^{21} - 2.6^\circ$ (H_2O), and yielding a pentacetyl derivative, m.p. $241-2^\circ$ (*dec.*), $[\alpha]_D^{13} - 33.7^\circ$ ($CHCl_3$). When heated dry jesaconitine yields *pyrojesaconitine* isolated as the crystalline perchlorate, prisms, m.p. $271-2^\circ$, $[\alpha]_D^{18} - 27.4^\circ$ (MeOH). On oxidation (Majima and Tamura³⁷) with permanganate jesaconitine yields acetaldehyde (taken to imply the presence of an ethylimino group), while triacetyljesaconitine, m.p. 232° (*dec.*), yields triacetyljesoxonitine, $C_{30}H_{49}O_{10}N$, m.p. 235° (*dec.*), $[\alpha]_D^{17.8} - 41.45^\circ$ ($CHCl_3$), which, on hydrolysis and re-acetylation, furnishes

pentacetyloxonine (Tamura ⁴²). Jesaconitine appears therefore to be acetyl-*p*-anisoylaconine and its formula may be written :—

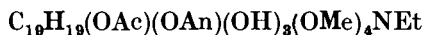

where An = *p*-anisoyl.

Kobusine, $C_{20}H_{27}O_2N$, obtained by Suginome and Shimanouti ¹⁴ from the precipitation liquids of crude jesaconitine from *A. sachalinense*, Fr. Schmidt, crystallises in the rhombic-bisphenoidal system (a : b : c = 1.0736 : 1 : 0.9811), is not toxic and has m.p. 268°, $[\alpha]_D^{22} + 83.6^\circ$ (CHCl₃). It yields crystalline salts, B . HBr . H₂O, m.p. 288° (*dec.*), $[\alpha]_D^{18} + 40.68^\circ$ (H₂O); B . HCl . 1.5H₂O, m.p. 300° (*dec.*), $[\alpha]_D^{21} + 41.4^\circ$ (H₂O); B . HClO₄, m.p. 220° (*dec.*), platinichloride, m.p. 262° (*dec.*), picrate, m.p. 277°, and methiodide, m.p. 287° (*dec.*). The alkaloid cannot be hydrolysed. No methylimino or methoxyl group is present and it does not react with diazomethane or reagents for carbonyl. It forms a diacetyl derivative, m.p. 139–140°, contains two ethylenic linkages one of which terminates at a nitrogen atom since catalytic hydrogenation followed by acetylation yields a triacetyltetrahydrokobusine, m.p. 183–4° (*dec.*).

Mesaconitine, $C_{33}H_{45}O_{11}N$, crystallises from boiling methyl alcohol in prisms, m.p. 208–9°, $[\alpha]_D^{17} + 25.7^\circ$ (CHCl₃). The hydrobromide, B . HBr . 3.5H₂O, has m.p. 172–3° (*dry, dec.*), $[\alpha]_D - 24.8^\circ$. The perchlorate forms prisms, m.p. 217–225° (*dec.*), $[\alpha]_D - 14.8^\circ$, and the aurichloride, yellow prisms, m.p. 224–6° (*dec.*). The alkaloid yields a triacetyl derivative, contains four methoxyl groups and one methylimino group, and is hydrolysed by boiling dilute sulphuric acid to *benzmesaconine*, $C_{31}H_{43}O_{10}N$, of which the hydrochloride, B . HCl . H₂O, forms prisms, m.p. 255–7° (*dec.*), $[\alpha]_D^{24} - 24.0^\circ$, and the hydrobromide, B . HBr . 3H₂O, has m.p. 245–6°, $[\alpha]_D^{24} - 21.8^\circ$ (H₂O). Hydrolysis with alcoholic potash converts mesaconitine into *mesaconine*, characterised as the acetyl (probably pentacetyl) derivative, prisms, m.p. 228–9° (*dec.*), $[\alpha]_D - 19.1^\circ$. When heated dry mesaconitine loses 1 mol. of acetic acid and is converted into *pyromesaconitine*, $C_{31}H_{41}O_9N$, which is amorphous, but yields crystalline salts (B . HBr . 0.25H₂O, m.p. 215° (*dec.*), $[\alpha]_D^{17} - 37.8^\circ$; aurichloride, m.p. 180–1° (*dec.*); and perchlorate, m.p. 285–7°) accompanied by some *γ*-*pyromesaconitine*, $C_{31}H_{41}O_9N$, prisms, m.p. 169–170° (*dec.*), $[\alpha]_D - 107^\circ$ (EtOH), of which the hydrobromide, B . HBr . 2H₂O, m.p. 240–1°, $[\alpha]_D^{14} - 102^\circ$ (H₂O), is more soluble in alcohol than *pyromesaconitine* hydrobromide and is recovered from the mother liquors by addition of ether. On oxidation with permanganate in acetone mesaconitine yields formaldehyde, presumed to come from a methylimino group, and *oxonitine*, m.p. 282° (*dec.*), $[\alpha]_D^{20} - 41.7^\circ$ (CHCl₃), identical with that obtained from aconitine. Triacetylmesaconitine on oxidation furnishes triacetyloxonitine, which melts at 178° and re-melts at 235° (*dec.*) and has $[\alpha]_D^{17.9} - 50.8^\circ$ (CHCl₃). Diacetylpyromesaconitine, in like manner, gives diacetylpyroxonitine (Tamura ⁴²), which on alkaline hydrolysis yields *pyroxonine*, $C_{25}H_{33}O_6N$, needles, m.p. 270° (*dec.*), identical with that obtainable from aconitine *via* pyraconitine. The formula of mesaconitine can be extended

to $C_{19}H_{19}(OMe)_4(OH)_3(OAc)(OBz)(NMe)$ in which the undetermined residue, $C_{10}H_{19}$, must be identical with that of aconitine, from which mesaconitine only differs in containing a methylimino in place of an ethylimino group (Majima, with Morio¹⁴; with Tamura³⁷).

Majima and Tamura,⁴¹ by mild chromic acid oxidation of mesaconitine, obtained *mesaconitinone*, $C_{33}H_{43}O_{11}N$, m.p. 173° (*dec.*), $[\alpha]_D^{20} - 35^\circ$ ($CHCl_3$), which yields an aurichloride, $B.HAuCl_4$, m.p. 226° (*dec.*), a diacetyl-derivative, m.p. 215° (*dec.*), a semicarbazone, m.p. 214° (*dec.*), and reacts with isoamyl nitrite to form *oximinomesaconitinone*, m.p. 236° (*dec.*), $[\alpha]_D^{30-50} - 98.9^\circ$, convertible by nitrogen trioxide in chloroform to nitro-mesaconitinone, m.p. 215° (*dec.*), $[\alpha]_D^{30-50} - 41.4^\circ$ ($CHCl_3$), which is oxidised by nitric acid to the nitronitroso-compound, $C_{31}H_{33(or\ 35)}O_{13}N_3$, m.p. 282° (*dec.*), $[\alpha]_D^{14} - 31.94^\circ$, already described as a degradation product of aconitine (p. 677).

Mesaconitinone on acid hydrolysis loses a molecule of acetic acid to form benzmesaconinone, $C_{31}H_{41}O_{10}N$, and when heated at 175/15 mm. in hydrogen loses water and methyl alcohol forming demethanolanhydromesaconitinone, $C_{32}H_{37}O_9N$, m.p. 194° , $[\alpha]_D^{20} + 26.24^\circ$ ($CHCl_3$), which can be deprived of its acetyl and benzoyl radicals to yield demethanolmesaconinone, $C_{23}H_{33}O_8N$, m.p. $250-2^\circ$ (*dec.*), $[\alpha]_D^{21} + 76.5^\circ$.

On the basis of these results the authors suggest that mesaconitine contains the group $.CH_2.CH(OH).CH_2.C(OMe).CH_2.NMe$.

Hypaconitine, $C_{33}H_{45}O_{10}N$, crystallises from methyl alcohol in prisms, m.p. $197-8^\circ$ (*dec.*), $[\alpha]_D^{17} + 22.7^\circ$ ($CHCl_3$), yields a hydrobromide, $B.HBr.2.5H_2O$, m.p. $178-9^\circ$ (*dry, dec.*), $[\alpha]_D - 18.4^\circ$ to -20.5° (H_2O); a perchlorate, m.p. $178-180^\circ$ (*dec.*), $[\alpha]_D - 11.2^\circ$ (EtOH), and an aurichloride, $B.HAuCl_4$, prisms, m.p. $243-5^\circ$ (*dec.*). The alkaloid contains four methoxyl groups and one methylimino group and is hydrolysed by boiling dilute sulphuric acid into acetic acid and *benzhypaconine*, $C_{31}H_{43}O_9N$. The latter is amorphous, but yields a crystalline hydrochloride, $B.HCl.3.5H_2O$, m.p. $242-4^\circ$ (*dry, dec.*), $[\alpha]_D^{13} - 6.5^\circ$ (H_2O). On hydrolysis by water in a closed vessel at $160-170^\circ$ hypaconitine yields acetic acid, benzoic acid and *hypaconine*; the latter is characterised by its tetracetyl derivative, $C_{24}H_{35}O_4NaC_4$, prismatic crystals, m.p. $182-4^\circ$ (*dec.*). Hypaconitine on dry heating yields *pyrohypaconitine*, $C_{31}H_{41}O_8N$, m.p. $119-120^\circ$, $[\alpha]_D^{13} + 21.7^\circ$ ($CHCl_3$), and on oxidation with permanganate in acetone yields formaldehyde and *hypoxonitine*, m.p. $267-8^\circ$ (*dec.*), $[\alpha]_D^{15} - 63.1^\circ$ ($CHCl_3$), for which the formula¹⁴ assigned in 1929, *viz.*, $C_{24}H_{29}O_9N$, probably needs adjustment as in the case of oxonitine (p. 676). On this basis it contains three methoxyl groups, but no methylimino group.

The formula of hypaconitine may therefore be extended as follows: $C_{19}H_{20}(NMe)(OMe)_4(OH)_2(OAc)(OBz)$ (Majima, with Morio¹⁴; with Tamura³⁷). Unlike aconitine and mesaconitine, hypaconitine is scarcely affected by chromic or nitric acid and the latter does not yield a crystalline oxidation product with hypoxonitine (Majima and Tamura⁴¹).

Pseudaconitine, $C_{36}H_{51}O_{12}N$, occurs in *Aconitum deinorrhizum* Stapf, and *A. Balfourii* Stapf,¹² and is obtainable from "Nepaul Aconite Roots." It was isolated by Wright and Luff,⁴⁷ and has been further examined by Dunstan and Carr,⁴⁸ Freund and Niederhofheim,⁴⁹ E. Schmidt⁴⁵ and Henry and Sharp.¹³ The alkaloid crystallises from hot alcohol in colourless rhombs, m.p. 212–3°, $[\alpha]_D^{20} + 17.06^\circ$ (EtOH) or $+ 22.75^\circ$ ($CHCl_3$). The salts are laevorotatory in solution; the hydrochloride, B. HCl . 4H₂O, forms twinned triangular prisms, m.p. 179–182°, $[\alpha]_D^{20} - 18.1^\circ$ (H₂O), and is very soluble in water; the hydrobromide, B. HBr . 3H₂O, forms rosettes of triangular prisms, m.p. 199°, $[\alpha]_D^{20} - 18.5^\circ$ (H₂O); the hydriodide B. HI . H₂O, truncated prisms, m.p. 230°; the nitrate, B. HNO₃ . H₂O, triangular prisms, m.p. 198°, $[\alpha]_D^{18} - 17.95^\circ$ (H₂O); the aurichloride, B. HAuCl₄, golden-yellow needles, m.p. 233°: the perchlorate has m.p. 239° and the picrate m.p. 196°. Pseudaconitine, like aconitine, causes an intense tingling when even a very dilute solution is applied to the tip of the tongue. It also yields a crystalline permanganate which is more stable and somewhat more soluble in water than that of aconitine. On heating neutral solutions of its salts in water at 135° pseudaconitine undergoes partial hydrolysis into acetic acid and *veratroylpseudaconine*, $C_{34}H_{49}O_{11}N \cdot H_2O$, irregular crystals, m.p. 199°, $[\alpha]_D - 38.15^\circ$ (EtOH); B. HBr . 3H₂O, large prisms; B. HNO₃, rosettes of rhombic prisms, m.p. 232°; aurichloride, B. HAuCl₄, amorphous. On alkaline hydrolysis veratroylpseudaconine yields veratric acid and *pseudaconine*, $C_{25}H_{41}O_8N$, which is amorphous, but crystallises with solvents; with acetone it forms large colourless prisms, B. C₃H₆O, m.p. 93–4°, $[\alpha]_D^{20} + 38.7^\circ$ (H₂O), and with alcohol, crystals, B. C₂H₅OH, m.p. 94–5°, $[\alpha]_D + 39.11^\circ$ (H₂O). The solvent-free base yields a tetracetyl derivative, colourless needles, m.p. 228°, $[\alpha]_D^{20} - 8.1^\circ$. Pseudaconitine contains six methoxyl groups, two being in the veratroyl radical. On treatment with acetyl chloride it yields a diacetyl derivative, colourless needles, m.p. 229° (*dec.*), $[\alpha]_D + 24.0^\circ$ ($CHCl_3$). According to Konovalova and Orekhov,⁵⁰ an ethylimino group is present. On these data the empirical formula of pseudaconitine may be extended thus:

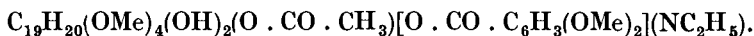

When pseudaconitine is heated under pressure with methyl alcohol the acetyl group is replaced by a methyl group producing *veratroylmethylpseudaconine*, $C_{31}H_{51}O_{11}N$, colourless prisms, m.p. 206–7°, $[\alpha]_D + 29.8^\circ$ (EtOH). A similar replacement takes place with tetracetylpsudaconine; an acetyl group is also eliminated when pseudaconitine is heated *in vacuo*, at 220°, with the formation of *pyropseudaconitine*, $C_{34}H_{47}O_{10}N$, colourless needles, m.p. 132–5°, $[\alpha]_D^{16} + 175.2^\circ$ (EtOH). Sharp,⁵¹ points out that this elimination cannot be due (a) to interaction between the acetyl group and a contiguous hydroxyl group as has been suggested by Schulze and Liebner⁵² for aconitine, since pyropseudaconitine still retains the two hydroxyl groups of the parent base, or (b) to absorption of a hydrogen atom from a neighbouring carbon atom with the formation of a double

bond, since no evidence of unsaturation in the product could be obtained, but must be due to a third possibility; (c) interaction of the acetyl group with hydrogen attached to a more remote carbon atom, with the formation of a bridge, thus:—

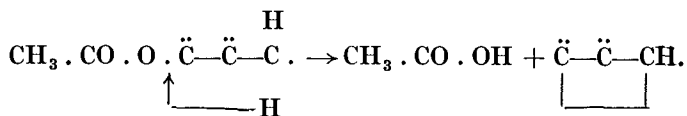

Sharp also found that pyropseudaconitine, when boiled with acetic anhydride, yields *triacetyldemethylpyropseudaconitine*, $\text{C}_{39}\text{H}_{51}\text{O}_{13}\text{N}$, colourless prisms, m.p. 228° , $[\alpha]_{\text{D}}^{20} + 28.4^\circ$ (CHCl_3), formed by acetylation of the two hydroxyl groups and replacement of a methoxyl by an acetoxy group.

The oxidation products of pseudaconitine have been investigated by Henry and Sharp.¹³ With chromic acid it yields a weakly basic substance, $\text{C}_{34}\text{H}_{45}\text{O}_{11}\text{N}$, prisms, m.p. 255° (*dec.*), $[\alpha]_{\text{D}}^{20} + 67.95^\circ$, which forms unstable but crystalline salts: B. HCl, needles, m.p. 180° , $[\alpha]_{\text{D}}^{20} + 39.5^\circ$ (EtOH); picrate, m.p. $229\text{--}230^\circ$. It contains one methoxyl group less than pseudaconitine, and on hydrolysis yields acetic and veratric acids and a crystalline substance, $\text{C}_{23}\text{H}_{35}\text{O}_7\text{N}$, m.p. $175\text{--}7^\circ$.

When oxidised by nitric acid pseudaconitine provides two products: (1) a bright yellow, granular powder, $\text{C}_{34}\text{H}_{45}\text{O}_{17}\text{N}_3$, which decomposes at 195° , contains a nitrosoamino group, and on hydrolysis yields acetic and 6-nitroveratric acids, with intractable, amorphous products, and (2) a substance, $\text{C}_{33}\text{H}_{40}\text{O}_{16}\text{N}_4$, crystallising in faintly yellow prisms, which blacken at 260° and decompose at 270° . It contains one acetyl group, a nitrosoamino group, two nitro groups, five methoxyl groups, but no alkylimino group. On hydrolysis it furnishes acetic and 6-nitroveratric acids and a substance, $\text{C}_{22}\text{H}_{31}\text{O}_{10}\text{N}_3$, crystallising with solvents in needles, melting at $85\text{--}115^\circ$, depending on the solvent present, or at 215° , solvent-free, $[\alpha]_{\text{D}}^{20} + 30.9^\circ$ (EtOH). With sodium methoxide in methyl alcohol it is converted into the crystalline sodium salt, $\text{C}_{22}\text{H}_{32}\text{O}_{11}\text{N}_3\text{Na}$, of the corresponding acid, which gives a pyrrole pine-shaving test on heating. This hydrolytic product still contains the nitrosoamino group and one nitro group. With acetyl chloride the original oxidation product furnishes a substance, $\text{C}_{37}\text{H}_{45}\text{O}_{17}\text{N}_2$, colourless, small prisms, m.p. $227\text{--}230^\circ$, in which the nitroso group has been replaced by an acetyl group and two hydroxyl groups acetylated.

Jacobs and Craig⁴⁰ have suggested that in accordance with their suggestions for changes in the formulæ of oxidation products of aconitine, the formula of the chromic acid oxidation product of pseudaconitine should be $\text{C}_{35}\text{H}_{45}\text{O}_{11}\text{N}$, instead of $\text{C}_{34}\text{H}_{45}\text{O}_{11}\text{N}$, to bring it into line with that proposed for aconitoline, and the nitric acid product (b) should be $\text{C}_{33}\text{H}_{38}\text{O}_{16}\text{N}_4$, in place of $\text{C}_{33}\text{H}_{40}\text{O}_{16}\text{N}_4$. Though these proposals still need confirmation, it is of interest to use them in the following comparative and admittedly speculative, extended formulæ:—

ACONITINE.	$C_{18}H_{19}(\text{NEt})(\text{CHOH})(\text{OH})_3(\text{OMe})_4(\text{OAc})(\text{OBz}).$	$C_{34}H_{47}O_{11}N$
<i>Aconitoline.</i>	$C_{18}H_{17}(\text{NEt})(\text{CO})(\text{OH})_3(\text{OMe})_3(\text{OAc})(\text{OBz}).$	$C_{32}H_{41}O_{10}N$
<i>Nitronitroso</i> <i>cpd.</i>	$C_{18}H_{17}(N \cdot \text{NO})(\text{CO})(\text{OH})_3(\text{OMe})_3(\text{OAc})(\text{OBz}^* \cdot \text{NO}_2).$	$C_{31}H_{35}O_{13}N_3$
PSEUDAACONITINE.	$C_{18}H_{19}(\text{NEt})(\text{CHOH})(\text{OH})(\text{OMe})_4(\text{OAc})(\text{OVe}).$	$C_{36}H_{51}O_{12}N$
<i>Chromic acid</i> <i>product.</i>	$C_{18}H_{16}(\text{NEt})(\text{CO})(\text{OH})(\text{OMe})_3(\text{OAc})(\text{OVe}).$	$C_{35}H_{45}O_{11}N$
<i>Nitric acid</i> <i>product.</i>	$C_{18}H_{17}(\text{NO}_2)(N \cdot \text{NO})(\text{CO})(\text{OH})(\text{OMe})_3(\text{OAc})(\text{OVe}^* \cdot \text{NO}_2).$	$C_{33}H_{36}O_{16}N_4$

* Benzoyl (Bz) or veratroyl (Ve) nitrated.

α -Pseudoaconitine, $C_{36}H_{51}O_{12}N$. This isomeride of pseudoaconitine was isolated by Marion and Edwards ^{12(a)} from a benzene extract of "Nepaul Aconite Root." It crystallises from methyl alcohol in diamond-shaped prisms, m.p. 205–6° (*dec.*), $[\alpha]_D^{25} + 24.7^\circ$ (CHCl_3), and yields a crystalline perchlorate, which sinters at 233° and melts at 246° (*dec.*), and a hydriodide, clusters of needles, m.p. 220–220.5°. When heated in neutral solution in a sealed vessel at 135° for three hours the alkaloid is hydrolysed to acetic acid and α -veratroylpseudoaconine, which has also been isolated from the primary benzene extract, and is presumably a natural constituent of the particular specimen of "Nepaul Aconite Root," from which the extract was made. α -Veratroylpseudoaconine, $C_{34}H_{49}O_{11}N$, forms flat needles, m.p. 209–211°, $[\alpha]_D + 55^\circ$ (CHCl_3) and yields a perchlorate, B. HClO_4 , m.p. 232–3° (*dec.*), a hydrobromide, m.p. 246–7° (*dec.*), and a hydriodide, m.p. 246° (*dec.*).

On boiling with potassium hydroxide in methyl alcohol, α -pseudoaconitine yields the same products as pseudoaconitine, *viz.*, acetic acid, veratric acid and pseudoaconine. The same authors found that pseudoaconine, $C_{25}H_{41}O_8N$, on boiling with 10/*N*-sulphuric acid, loses one methyl group and the elements of methyl alcohol, yielding des-*O*-methyldemethoxydehydropseudoaconine, $C_{23}H_{35}O_7N$, which crystallises from methyl alcohol with one molecule of solvent, in needles, m.p. 133° (*dec.*) with some sintering at 127° and has $[\alpha]_D + 17.9^\circ$ (MeOH). The authors consider that in pseudoaconitine and α -pseudoaconitine, the acetyl group occupies the same position, but that the veratroyl radical esterifies a different hydroxyl group in the two alkaloids.

Indaconitine, $C_{34}H_{47}O_{10}N$, isolated by Dunstan and Andrews ¹⁵ from *A. chasmanthum* Stapf, crystallises in rosettes of needles or hexagonal prisms, m.p. 202–3°, $[\alpha]_D + 18.3^\circ$ (EtOH) and yields crystalline salts: hydrobromide, hexagonal prisms, m.p. 183–7° (*dry*), $[\alpha]_D - 17.3^\circ$, from water, or in crystals, m.p. 217–8° from alcohol and ether: the aurichloride, B. HAuCl_4 , forms rosettes of yellow needles, m.p. 147–152°, with sintering at 142°. The alkaloid isolated from this plant by Bauer and Radjhan ¹⁶ differs chiefly in not yielding crystalline salts. Like aconitine, indaconitine causes an intense tingling when even a very dilute solution is applied to the tip of the tongue, and gives a crystalline precipitate with permanganate, but the crystals are smaller. It contains four methoxyl groups. When indaconitine sulphate in aqueous solution is heated in a sealed tube it undergoes hydrolysis, yielding 1 mol. each of acetic acid and *benzoylpseud-*

aconine (indbenzaconine), a colourless varnish, m.p. 130–3°, $[\alpha]_D + 33.6^\circ$ (EtOH), yielding well-crystallised salts: the hydrobromide,



m.p. 247° (*dry*), forms rosettes; the hydrochloride, needles or octahedra, m.p. 242–4° (*dry*), $[\alpha]_D - 8.0^\circ$ (H₂O), and the aurichloride orange-coloured rosettes, m.p. 180–2° from alcohol. On alkaline hydrolysis indaconitine forms acetic and benzoic acids, and *pseudaconine*, C₂₅H₄₁O₈N (see p. 682).

When indaconitine is heated dry it loses 1 mol. of acetic acid and furnishes α -*pyroindaconitine*, C₃₂H₄₃O₈N, amorphous, m.p. 130–3°, $[\alpha]_D + 91.9^\circ$ (EtOH), of which the crystalline hydrobromide has m.p. 194–8° (*dry*), $[\alpha]_D + 54.7^\circ$ (H₂O). Indaconitine hydrochloride, heated at 165–170° yields an isomeric β -*pyroindaconitine*, also amorphous, but giving a crystalline hydrobromide, needles, m.p. 248–250°, $[\alpha]_D + 27.6^\circ$.

Bikhaconitine, C₃₆H₅₁O₁₁N · H₂O, isolated by Dunstan and Andrews⁵³ from *A. spicatum* roots, crystallises from ether in button-shaped masses, m.p. 118–123°, or, better with 1H₂O from alcohol, on addition of water, in colourless granules, m.p. 113–6° (*dry*), $[\alpha]_D^{20^\circ} + 12.21^\circ$ (EtOH). The salts crystallise well; the hydrobromide, B · HBr · 5H₂O, has m.p. 173–5° (*dry*), $[\alpha]_D^{20^\circ} - 12.42^\circ$; the hydrochloride, B · HCl · 5H₂O, m.p. 159–161° (*dry*), $[\alpha]_D^{20^\circ} - 8.86^\circ$; the aurichloride, B · HCl · AuCl₃, m.p. 232–3°. Bikhaconitine and its salts, even in very dilute solution, excite the tingling sensation characteristic of the aconitines when applied to the tip of the tongue. It contains six methoxyl groups, of which two are in a veratroyl radical. When an aqueous solution of bikhaconitine sulphate is heated at 130°, hydrolysis takes place with the formation of 1 mol. each of acetic acid and *veratroylbikhaconine*, C₃₄H₄₉O₁₀N, m.p. 120–5°, $[\alpha]_D^{20^\circ} + 29.9^\circ$, which is amorphous and is best purified by regeneration from the recrystallised aurichloride, B · HCl · AuCl₃, which forms clusters of orange-yellow prisms with 2C₂H₅OH or 5H₂O, m.p. 145–8° (*dry*), from alcohol. The hydriodide, m.p. 189–190° (*dry*), forms rosettes of needles from water.

On alkaline hydrolysis veratroylbikhaconine yields 1 mol. each of veratric acid and *bikhaconine*, C₂₅H₄₁O₇N. The latter is amorphous, $[\alpha]_D^{22^\circ} + 33.85^\circ$, and differs from its analogues, *aconine* (p. 675), *japaconine* (p. 679) and *pseudaconine* (p. 682) in being soluble in ether and in yielding readily crystallisable salts: the hydrobromide, B · HBr, m.p. 145–150° (*dry*), forms tetragonal prisms; the nitrate, B · HNO₃ · 2H₂O, m.p. 125–8°, $[\alpha]_D^{20^\circ} + 15.38^\circ$, tetragonal prisms with acicular or pyramidal ends and the aurichloride, B · HCl · AuCl₃ · 3H₂O, m.p. 129–132°, or 187–8° (*dry*), glistening, rhombic plates.

When heated at 180° bikhaconitine loses 1 mol. of acetic acid and forms *pyrobikhaconitine*, C₃₄H₄₇O₉N, a colourless varnish yielding amorphous salts; the aurichloride has m.p. 115–123°.

Aconitum septentrionale. In 1896 Rosendahl⁵⁴ isolated from this plant three alkaloids, which were re-examined by Schulze and Ulfert⁵⁵ and by Weidemann,⁵⁶ whose results differ in some points.

Lappaconitine, $C_{32}H_{44}O_8N_2$,⁵⁵ or $C_{32}H_{42}O_9N_2$,⁵⁶ crystallises in hexagonal tablets, m.p. 213·5–214·5°,⁵⁵ 223°,⁵⁶ $[\alpha]_D + 22\cdot3^\circ$ (C_6H_6),⁵⁵ + 27·0° ($CHCl_3$).⁵⁶ No crystalline salts have been prepared. The alkaloid contains two methoxyl groups and a methylimino group according to Schulze and Ulfert, whilst Weidemann found three methoxyl groups. On boiling with dilute sulphuric acid in a current of hydrogen the alkaloid is hydrolysed into acetic acid and *picrolappaconitine*⁵⁵ (anthranoyllappaconine) $C_{30}H_{42}O_7N_2$, which crystallises in rhombic tablets, $[\alpha]_D^{25} + 22\cdot07^\circ$ (C_6H_6). The platinum-chloride, $B. H_2PtCl_6 \cdot 4H_2O$, forms brownish needles or leaflets, m.p. 300–310° (*dec.*). On alkaline hydrolysis lappaconitine yields *lappaconine*, $C_{23}H_{37}O_6N \cdot 1\cdot5H_2O$ ⁵⁵ or $C_{23}H_{35}O_7N \cdot 2H_2O$,⁵⁶ which is crystalline, m.p. 96°,⁵⁵ 93°,⁵⁶ $[\alpha]_D^{25} + 16\cdot29^\circ$,⁵⁵ + 22·41°,⁵⁶ strongly alkaline and yields well crystallised salts; hydrochloride, $B. HCl$, m.p. 246–7°,⁵⁵ 240°⁵⁶; aurichloride,⁵⁵ $B. HAuCl_4 \cdot H_2O$, m.p. 126–7°. The acid hydrolytic products of lappaconitine, according to Schulze and Ulfert are anthranilic and acetic acids, whilst Weidemann, who used cold alkali, obtained only one acid, *viz.*, acetylanthranilic acid (lappaconitic acid) which implies that only one —OH group is engaged with an acyl group in lappaconitine. These results, conflicting though they are, agree in showing that lappaconitine is distinct from lycaconitine, the alkaloid of *Aconitum lycoctonum*, a plant with which *A. septentrionale* is liable to be confused.⁵⁷

Septentrionaline, $C_{33}H_{46}O_9N_2$,⁵⁶ is amorphous, m.p. 131°, $[\alpha]_D^{19\cdot5} + 32\cdot7^\circ$ (EtOH). Weidemann states that it contains four methoxyl groups, and on hydrolysis by alkalis yields (1) a crystalline acid, $C_8H_9O_2N$, m.p. 125–6°, which on further treatment with alkali yields anthranilic acid, $C_7H_7O_2N$, and must be a near relative of the latter; and (2) a basic amorphous product, $C_{25}H_{39}O_7N$, m.p. 89°, $[\alpha]_D^{19\cdot5} + 29\cdot55^\circ$ (EtOH), which yields a crystalline hydrochloride.

Cynoctonine, $C_{36}H_{55}O_{13}N_2$, is amorphous and dextrorotatory.

Aconitum lycoctonum.⁵⁷ From the roots of this species Hübschmann isolated the amorphous alkaloids acolyctine and lycoctonine.⁵⁸ Dragendorff and Spohn showed⁵⁹ that Hübschmann's alkaloids were probably decomposition products of *lycaconitine*, $C_{27}H_{34}O_6N_2 \cdot 2H_2O$, which they isolated along with *myoconitine*, $C_{27}H_{30}O_8N_2 \cdot 5H_2O$. These results have been considerably extended by Schulze and Bierling,⁶⁰ and more recently by Marion and Manske,⁶⁰ for lycoctonine.

Lycaconitine, $C_{36}H_{46}O_{10}N_2$, $[\alpha]_D^{20} + 42\cdot5^\circ$ (EtOH), is amorphous, weakly basic, and has yielded no crystalline derivatives. On hydrolysis by water or dilute hydrochloric acid it yields succinic acid and anthranoyl-lycoctonine (*see below*), whilst alkalis hydrolyse it to lycoctonic acid (succinyl-anthranilic acid, $COOH \cdot C_6H_4 \cdot NH \cdot CO \cdot CH_2 \cdot CH_2 \cdot COOH$), m.p. 179°, and *lycoctonine*, for which Marion and Manske⁶⁰ propose the new empirical formula, $C_{29}H_{33}O_5N \cdot H_2O$, in place of $C_{25}H_{39}O_7N \cdot H_2O$, and provide new melting-points for the base and its salts: base, m.p. 139°, after sintering at 120°; $B. HCl$, m.p. 145° (*dec.*); $B. HBr$., m.p. > 360°; perchlorate, m.p. 215°; picrate, m.p. 154°; methiodide, m.p. 188°. Schulze and Bierling recorded $[\alpha]_D^{20} + 49\cdot64^\circ$ (EtOH) for the base. Lycoctonine contains one

methylimino and, on the basis of the new formula, three methoxyl groups. According to Schulze and Bierling two hydroxyl groups are present.

Lycoctonine is also the basic, hydrolytic product of some delphinium alkaloids (pp. 694-6).

Anthranoylylcoctonine, $C_{32}H_{44}O_8N_2$, is crystalline, m.p. 154-5°, and yields a crystalline perchlorate, $B \cdot 2HClO_4$, m.p. > 235°. On hydrolysis by alkalis the base yields lycoctonine and anthranilic acid; it is probably Dragendorff's "lycaconine."

Myoctonine, $(C_{36}H_{42}O_{10}N_2)_2$, $[\alpha]_D^{20} + 44.7^\circ$ (EtOH), is amorphous; on hydrolysis it furnishes the same products as lyaconitine.

A third unnamed base distinguished by giving an insoluble thiocyanate is present; on hydrolysis by alkalis it also yields lycoctonine and lycoctonic acid.

Atisine, $C_{22}H_{33}O_2N$. After its discovery in *A. heterophyllum* roots by Broughton,⁶¹ atisine was investigated by Wasowicz,⁶² who prepared several crystalline salts. The formula, $C_{22}H_{31}O_2N$, was suggested by Wright⁶³ and confirmed by Jowett,⁶⁴ but was altered by Lawson and Topps⁶⁵ to $C_{22}H_{33}O_2N$, which has now been confirmed by Jacobs and Craig^{66(a)} in a critical revision of previous work. Atisine is a colourless varnish which can be sublimed in a molecular still at 140° (bath temp.) under 0.1 μ and then forms an opaque film, m.p. 57-60°. It is unstable in solution, especially in alkali. The salts crystallise well; B. HCl, m.p. 311-2° (*dec.*), $[\alpha]_D^{25} + 28^\circ$ (H₂O); B. HBr, m.p. 273°; $[\alpha]_D + 24.3^\circ$; B. HI, m.p. 279° (*dec.*), $[\alpha]_D + 27.4^\circ$; the aurichloride is amorphous; the platinichloride is a crystalline powder. A methyl to carbon and an ethylimino group are present, but Lawson and Topps's dioxymethylene group could not be confirmed and the formation of diacetylatisine hydrochloride, m.p. 241-3° (*dec.*), indicates the presence of two hydroxyl groups.

Atisine appears to suffer an unusual change when subjected to the action of alcoholic alkali. According to Jowett, a hydrate, $C_{22}H_{33}O_3N$, is formed, while Lawson and Topps regarded the product as a demethylatisine, $C_{21}H_{31}O_2N$, m.p. 147°; B. HCl, m.p. 278° (*dec.*). Jacobs and Craig find that by the mild action of potash in methyl alcohol, atisine is first converted into *isoatisine*, m.p. 150-1°, $[\alpha]_D^{25} - 16.5^\circ$ (PhMe); B. HCl, m.p. 295-9° (*dec.*), $[\alpha]_D^{25} - 4^\circ$ (H₂O).^{66(b)} On more drastic treatment with the same reagent atisine, and *isoatisine*, are converted into a mixture of dihydro-derivatives of which one form, $C_{22}H_{35}O_2N$, m.p. 149-151°, $[\alpha]_D^{27} - 44^\circ$ (PhMe); B. HCl, m.p. 259° (*dec.*); $[\alpha]_D^{27} - 16^\circ$ (H₂O) has been isolated.^{66(a)} Dihydroatisine is not obtainable by direct hydrogenation of atisine, but on catalytic hydrogenation it absorbs one molecule of hydrogen to give a mixture of tetrahydroatisines, also obtainable by the direct hydrogenation of atisine or *isoatisine*, and from which one form, $C_{22}H_{37}O_2N$, m.p. 171-4°, $[\alpha]_D^{25} - 33^\circ$ (PhMe), or -23° (CHCl₃), or -11° (Pyr) has been isolated.^{66(a), (b)}

Both Lawson and Topps⁶⁵ and Jacobs and Craig^{66(a)} have investigated the dehydrogenation of atisine by selenium. The results are not imme-

diately reconcilable and the more important may be set out for convenience of comparison as follows :—

Products	Lawson and Topps	Jacobs and Craig
Bases	$C_{20}H_{29}ON$, picrate, m.p. 242-3° (<i>dec.</i>), B . HCl, m.p. 265°. * $C_{17}H_{17}N$, picrate, m.p. 206° (<i>cf.</i> napelline, p. 678).	$C_{20}H_{27}ON$, picrate, m.p. indefinite. $C_{21}H_{31}ON$, m.p. 180-190°. $C_{16}H_{15}ON$, m.p. 258-261°. $C_{20}H_{29}N$, picrate, m.p. 210-213°. $C_{16}H_{15}N$, tertiary, m.p. 83-5°, picrate, m.p. 221-3°; B . MeI; m.p. 233-5°.
Neutral substance	$C_{19}H_{27}O_2N$, m.p. 240°, b.p. > 220/1 mm.	—
Hydrocarbons	† $C_{17}H_{16}$, m.p. 41°; picrate, m.p. 129°. Viscous, brown oil, b.p. 170- 200/1 mm.	1-Methylphenanthrene, † $C_{17}H_{16}$, m.p. 41-3°, picrate, m.p. 129-131°. † $C_{18}H_{18}$, picrate, m.p. 163-6°.

* From "demethylatisine."

† From "demethylatisine" and from atisine: has the characters of a phenanthrene derivative.

‡ Absorption spectrum characteristic of a phenanthrene derivative.

The $C_{17}H_{16}$ hydrocarbon, m.p. 41-3°, obtained by both groups of workers, has been submitted to detailed physical and chemical examination by Craig and Jacobs,^{66(e)} who concluded that it was either 1-methyl-6-ethyl- or 1-ethyl-6-methyl-phenanthrene. The former substance has been synthesised by Huebner and Jacobs^{66(f)} and found to be identical with the atisine hydrocarbon. The same authors have also shown that while atisine is mostly recovered unchanged, under conditions of mild oxidation with permanganate, *iso*atisine is converted into *oxoiso*atisine, $C_{22}H_{33}O_3N$, m.p. 250-260°, $[\alpha]_D^{30} - 39^\circ$ ($CHCl_3$), presumably by saturation of one of the two ethylene linkages of atisine and *iso*atisine, thus :—

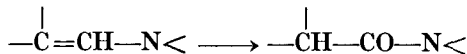

since *oxoiso*atisine forms only a dihydro-derivative, $C_{22}H_{35}O_3N$, m.p. 219-223°, $[\alpha]_D^{25} - 38^\circ$ ($CHCl_3$), and reacts with only one equivalent of perbenzoic acid. With bromine it forms a bromo-derivative, $C_{22}H_{33}O_3NBr$, m.p. 172-5°, $[\alpha]_D^{30} - 73^\circ$ (EtOH), while *iso*atisine forms a dibromide hydrobromide, $C_{22}H_{33}O_2NBr_2$, HBr, m.p. 212-5° (*dec.*) and dihydro-*oxoiso*atisine is unaffected by this reagent. The change from atisine to *iso*atisine must involve one or both of the double bonds, since both yield the same tetrahydro-derivative. One of the bonds involved must be that adjacent to the nitrogen atom as *iso*atisine is a weaker base than atisine. The latter on treatment in benzene solution with Raney nickel catalyst on alumina for ten hours yielded a base, $C_{20}H_{29}ON$, m.p. 145-150°, giving a hydrochloride, m.p. 230-5°, $[\alpha]_D^{25} + 31^\circ$ (H_2O), and a picrate, m.p. 254-6°. Twenty grams of the pale brown resin of the total alkaloid of

A. heterophyllum, in which atisine was the chief alkaloid, after standing four years, yielded 8 grams of isoatisine, due to isomerisation, with heteratisine, 0.4 gm., and atisine hydrochloride, 0.35 gm.^{66(d)}

Jacobs and Craig^{66(c)} found two other alkaloids in the mother liquors accumulated during the isolation of atisine from *A. heterophyllum*.

Heteratisine, $C_{22}H_{33}O_5N$, crystallises in prisms, has m.p. $262-7^\circ$ (*dec.*), $[\alpha]_D^{27} + 40^\circ$ (MeOH), forms a hydrochloride, m.p. $265-270^\circ$ (*dec.*), contains one methoxyl and one methylimino group, two active hydrogens and a lactone ring, opened by alkali and re-formed on acidification. In a later paper^{66(d)} the same authors describe the isolation of BENZOYLHETERATISINE, $C_{29}H_{37}O_6N$, m.p. $213-4^\circ$, $[\alpha]_D^{25} + 73^\circ$ (EtOH), which yields a hydrochloride, m.p. $218-221^\circ$ (*dec.*), and is hydrolysed to benzoic acid and heteratisine; the latter they suggest may not exist naturally in the plant but may be produced from benzoylheteratisine during extraction.

Hetisine, $C_{20}H_{27}O_3N$, crystallises with solvent; it effervesces at 145° , m.p. $253-6^\circ$, sublimes at $190-210^\circ/0.1$ mm. (bath temp.), $[\alpha]_D^{25} + 13.7^\circ$ (EtOH). The hydrochloride changes at 320° , ceases to be doubly refractive at $328-335^\circ$, and has $[\alpha]_D^{25} + 12.7^\circ$ (EtOH). The base is stable to alkali, contains three active hydrogen atoms and yields a dihydro-derivative, which melts at $136-9^\circ$, re-melts at $250-5^\circ$, and yields a hydrochloride, m.p. 333° (*dec.*). The methiodide, m.p. $>300^\circ$, on decomposition by silver oxide and subsequent pyrolysis, yields desmethylhetisine, $C_{21}H_{29}O_3N$, m.p. $122-4^\circ$, giving a hydrochloride, m.p. $303-5^\circ$, a methiodide, m.p. $246-250^\circ$, and a methochloride, $C_{22}H_{32}O_3NCl$, m.p. $285-290^\circ$. The latter, in the next stage of the Hofmann degradation, reverts to desmethylhetisine hydrochloride, $C_{21}H_{30}O_3NCl$, which was hydrogenated to the dihydro-derivative hydrochloride, which volatilises at $315-8^\circ$, and the latter converted to the methiodide, $C_{22}H_{34}O_3NI$, m.p. $249-251^\circ$, but here also reversion occurred on attempting to continue the Hofmann degradation. Dihydrohetisine also proved useless for this purpose, as the products would not crystallise. On selenium dehydrogenation hetisine yields three basic products: (a) $C_{18}H_{17}N$, (b) $C_{18}H_{15(17)}N$ and (c) $C_{19}H_{25(27)}N$, isolated as picrates, melting at $225-230^\circ$ (*dec.*), $235-245^\circ$ (*dec.*) and $320-5^\circ$ respectively, and of which (a) and (b) may be identical.

Two neutral fractions were also obtained: (d) $C_{34}H_{58(60)}$, b.p. 260° , $n_D^{26} 1.4805$, and (e) pimanthrene, $C_{16}H_{14}$, identical with the hydrocarbon obtained from staphisine (Jacobs and Huebner).^{66(c)(h)}

Konovalova and Orékhov⁵⁰ isolated the following four alkaloids from the roots of *A. talassicum*, M. Pop.

Talatisine, $C_{20}H_{29}O_3N$. $[C_{19}H_{28}(NMe)(OH)_3]$, m.p. 246° , $[\alpha]_D + 37.7^\circ$ (EtOH), contains a methylimino and three hydroxyl groups and yields the following salts: B. HCl, m.p. $256-7^\circ$; B. HI, m.p. 265° (*dec.*); B. HClO₄, m.p. 222° (*dec.*); picrate, m.p. $247-250^\circ$ (*dec.*). The triacetyl-derivative has m.p. $213-4^\circ$ and gives a perchlorate, m.p. $165-6^\circ$, and a methiodide, m.p. $253-4^\circ$. Thionyl chloride converts the alkaloid into the trichloride, $C_{19}H_{28}Cl_3NMe$, m.p. $175-6^\circ$, $[\alpha]_D + 8.6^\circ$ (MeOH). Dihydro-talatisine melts at $262-3^\circ$ and yields a picrate, m.p. $230-1^\circ$.

Talatisamine, $C_{16}H_{24}(NH)(OH)(OMe)_3$, melts at 137–141° and its hydrochloride at 195–6°. It is optically inactive.

Talatisidine, $C_{19}H_{23}(NEt)(OH)_3(OMe)_2$, melts at 220–1°, $[\alpha]_D - 20^\circ$ ($COMe_2$); three salts have been prepared. B. HCl, m.p. 186–9°; B. $HClO_4$, m.p. 218–220°, picrate, m.p. 161–4° (*dec.*).

*iso*Talatisidine, isomeric with talatisidine, has m.p. 139–140° $[\alpha]_D \pm 0^\circ$.

Lucidusculine, $C_{24}H_{37}O_4N$, isolated by Majima and Morio¹⁷ from *A. lucidusculum*, crystallises in leaflets, has m.p. 170–1° and $[\alpha]_D - 95.5^\circ$ ($CHCl_3$). The salts crystallise well, B. $HBr \cdot 1.5H_2O$, m.p. 248–250° (*dec.*); $[\alpha]_D^{26^\circ} - 62.7^\circ$ (H_2O); B. $HCl \cdot 3.5H_2O$, m.p. 98–115° or 245–265° (*dry, dec.*); perchlorate, m.p. 260–5° (*dec.*), $[\alpha]_D^{15^\circ} - 70.3^\circ$ (EtOH); picrate, m.p. 173–6°; methiodide, m.p. 197°, $[\alpha]_D^{15^\circ} - 65.0^\circ$ (EtOH). On alkaline hydrolysis it furnishes acetic acid and *luciculine*, $C_{22}H_{35}O_3N \cdot H_2O$, m.p. 115–7°, $[\alpha]_D^{11.6^\circ} - 11.4^\circ$ (EtOH); of which the hydrochloride, B. $HCl \cdot 1.5H_2O$, has m.p. 198–203°, $[\alpha]_D - 9.4^\circ$ (H_2O). Lucidusculine yields a monoacetyl derivative, m.p. 153–7°, $[\alpha]_D^{35^\circ} - 76.0^\circ$ ($CHCl_3$). A methylimino but no methoxyl group is present. The authors suggest that lucidusculine is related to atisine (*see above*).

Pharmacology. Aconitine is highly toxic. The lethal doses per kilo body-weight on subcutaneous injection are, for frogs 0.05–0.14 mg., guinea-pigs 0.012 mg. and for rabbits 0.014 mg., as recorded by Cash and Dunstan,⁶⁷ but figures differing considerably from these have been recorded by later workers in some cases.⁶⁷ Toxic doses produce respiratory paralysis and a direct toxic action on the heart which often terminates in ventricular fibrillation. In addition it causes smarting and tingling of the skin and later reduces cutaneous sensitivity: the prickling in the throat and skin are very characteristic symptoms. The body temperature is often reduced.⁶⁸ All the aconitines show a similar type of action differing in degree. Japaconitine⁶⁹ and indaconitine⁷⁰ are rather more active than aconitine; pseudaconitine⁶⁹ is most active and bikhaconitine⁷⁰ occupies an intermediate position between the last two in most of the animals so far investigated. The action of jesaconitine⁷¹ and of mesaconitine⁷² is qualitatively similar to that of japaconitine. According to Hildebrandt⁷³ lycaconitine and myoconitine resemble aconitine in action but are much weaker, and that also appears to be true of lappaconitine.⁷⁴ Atisine resembles aconine and is relatively non-toxic. Raymond-Hamet has made some interesting observations on its effect on blood pressure alone and after administration of adrenaline.⁷⁵

The loss of the acetyl group with the production of pyraconitine, or its replacement by a methyl group as in methylbenzoylaconine leads to loss of the characteristic toxic action of aconitine. In methylbenzoylaconine the curare-like action characteristic of the aconines begins to be shown.⁷⁶ Aconine behaves as a cardiac stimulant and is antagonistic to aconitine in a much greater degree than is benzoylaconine.⁶⁷

REFERENCES

- (1) MAJIMA (with SUGINOME and MORIO), *Ber.*, 1924, 57, 1456; (with SUGINOME), *ibid.*, p. 1467; (with MORIO), *Annalen*, 1929, 476, 203; cf. HENBY, *Chem. Soc. Ann. Rep.*, 1927, 24, 189. (2) *J. Chem. Soc.*, 1900, 77, 49. (3) *Arch. Pharm.*, 1885, 23, 162;

- (4) *Chem. Zent.*, 1890, ii, 148. (5) *Ber.*, 1894, 27, 720. (6) *Pharm. J.*, 1877, [iii], 8, 173. (7) *J. Chem. Soc.*, 1879, 35, 387. (8) *Arch. Pharm.*, 1909, 247, 243. (9) *Ibid.*, 1913, 251, 453. (10) COSTA and VALE, *Noticias farm* (Portugal), 1940, 6, 127 (*Chem. Abstr.*, 1940, 34, 6763). (11) GORIS and MÉTIN, *Compt. rend.*, 1925, 180, 968, 1132, 1282; GORIS, 1937, 205, 1007. (12) *Bull. Imp. Inst.*, 1906, 4, 38; DATTA, GUPTA and BAL, *Ind. Pharm.*, 1945, 1, 6. (12a) MARION and EDWARDS, *J. Amer. Chem. Soc.*, 1946, 68, 2565. (13) HENRY and SHARP, *J. Chem. Soc.*, 1928, 1105. (14) MAJIMA (with SUGINOME and MORIO), *Ber.*, 1924, 57, 1461, 1472; (with MORIO), *Annalen*, 1929, 476, 171, 194, 203; MORIO, *ibid.*, p. 181; SUGINOME and SHIMANOUTI, *ibid.*, 1940, 545, 220; HURUTA, *Jap. J. Med. Sci.*, [vii], 1940, 3, 191. (15) DUNSTAN and ANDREWS, *J. Chem. Soc.*, 1905, 87, 1620; BAUER and RADJHAN, *Pharm. Zent.*, 1931, 72, 145. (16) BEATH, *J. Amer. Pharm. Assoc.*, 1926, 15, 265. (17) MAJIMA and MORIO, *Proc. Imp. Acad. Tokyo*, 1931, 7, 351; *Ber.*, 1932, 65, 599. (17a) RITCHIE, *Pharm. J.*, 1945, 154, 166. (18) SCHULZE and BERGER, *Arch. Pharm.*, 1924, 262, 553. (19) FREUDENBERG and ROGERS, *J. Amer. Chem. Soc.*, 1936, 58, 533; 1937, 59, 2572; *Ber.*, 1936, 69, 1962; *Science*, 1938, 87, 139; JACOBS and CRAIG, *J. Biol. Chem.*, 1942, 143, 611. (20) BRIMNER, *Schweiz. Apoth. Zeit.*, 1922, 60, 357. (20a) ROSENTHALER, *Pharm. Acta Helv.*, 1942, 17, 194. (21) WEIDEMANN, *Arch. exp. Path. Pharm.*, 1922, 95, 166; see also JERMSTAD, *Chem. Zent.*, 1944, ii, 1198. (22) SCHULZE and BERGER, *Arch. Pharm.*, 1927, 256, 524. (23) *Annalen*, 1833, 7, 276. (24) *Ibid.*, 1850, 74, 257. (25) *Pharm. J.*, 1860, [ii], 8, 121. (26) *J. Chem. Soc.*, 1875, 29, 1265; 1877, 31, 143; 1878, 33, 151, 318; 1879, 35, 387. (27) For a good historical account of the early investigations, see SCHULZE, *Arch. Pharm.*, 1906, 244, 136. (28) See, for example, CORNWELL and JONES, *Pharm. J.*, 1926, 117, 197; VAN BRONKHORST, *Pharm. Weekbl.*, 1935, 72, 1058; GSTIRNER, *Pharm. Zent.*, 1932, 73, 465; BAKER and JORDAN, *J. Amer. Pharm. Assoc.*, 1936, 25, 291; LECOQ, *J. Pharm. Chim.*, 1938 [viii], 28, 321. ROCHE LYNCH *et al.*, *Analyst*, 1942, 67, 289; EDER and RUCKSTUHL, *Pharm. Acta Helv.*, 1944, 19, 53. (29) See, for example, SWANSON and HARGREAVES, *J. Amer. Pharm. Assoc.*, 1927, 16, 296; 1923, 12, 957; 1924, 13, 1108; JAUREGUI, *ibid.*, 1927, 16, 1045; MUNCH *et al.*, *ibid.*, 1929, 18, 17, 986, 993; BRANDT, *Arch. exp. Path. Pharm.*, 1930, 156, 203; DYER, *Quart. J. Pharm.*, 1930, 3, 626; GORIS, *Bull. Sci. Pharmacol.*, 1931, 38, 677; PULEWKA and GREVENER, *ibid.*, 1934, 177, 74; FREUDWEILER, *Pharm. Acta Helv.*, 1935, 10, 51; CHRISTENSEN and NELSEN, *J. Amer. Pharm. Assoc.*, 1940, 29, 97; HOPPE and MOLLETT, *ibid.*, 1943, 32, 215. (30) *Quart. J. Pharm.*, 1932, 5, 33. (31) CARR and KRANTZ, *J. Amer. Pharm. Assoc.*, 1934, 23, 50; BAKER, *ibid.*, p. 974. (32) See WRIGHT and LUFF²⁶; JURGENS, *Inaug. Diss. Dorpat*, 1885; DUNSTAN and co-workers, *J. Chem. Soc.*, 1891, 59, 271; 1892, 61, 385; FREUND and BECK, *Ber.*, 1894, 27, 433; SCHULZE, *Apoth. Zeit.*, 1904, 18, 783; 1905, 20, 368; *Arch. Pharm.*, 1906, 244, 136, 165; 1908, 246, 281; DUNSTAN and HENRY, *J. Chem. Soc.*, 1905, 87, 1653. (33) TUTTON, *ibid.*, 1891, 59, 233; cf. WATANABE, *Annalen*, 1929, 476, 211. (34) *J. Chem. Soc.*, 1893, 63, 994. (35) For other tests see WAGENAAR, *Pharm. Weekbl.*, 1930, 67, 165; MUNCII and PRATT, *J. Amer. Pharm. Assoc.*, 1934, 23, 968; VILANIL, *Crón. Méd.*, 1934, 510; SA, MAH, HOO, *Sci. Rep. Tsing Hua Univ.*, 1934, 2, 245 (*Brit. Chem. Abstr.*, 1934, A, 1017); GIRARD *et al.*, *J. Pharm. Chim.*, 1942, [ix], 2, 156; see also DENIGES, *Compt. rend.*, 1944, 219, 659. (36) DUNSTAN and CARR, *J. Chem. Soc.*, 1895, 67, 459; cf. SCHULZE³² (1906). (37) *J. Amer. Chem. Soc.*, 1936, 58, 1059; cf. FREUDENBERG, *Ber.*, 1936, 69, 1962; MAJIMA and TAMURA, *Annalen*, 1936, 526, 116. (38) DUNSTAN, TICKLE and JACKSON, *Proc. Chem. Soc.*, 1896, p. 59; SCHULZE, *Arch. Pharm.*, 1906, 244, 165. (39) SCHULZE and LIEBNER, *Arch. Pharm.*, 1913, 251, 453; 1916, 254, 567; DUNSTAN and CARR, *J. Chem. Soc.*, 1894, 65, 178. (40) JACOBS and CRAIG, *J. Biol. Chem.*, 1940, 136, 323; (with ELDERFIELD), *ibid.*, 1939, 128, 439. (41) LAWSON, *J. Chem. Soc.*, 1936, 80; MAJIMA and TAMURA, *Annalen*, 1940, 545, 1. (42) CARR, *J. Chem. Soc.*, 1912, 101, 2241; BRADY, *ibid.*, 1913, 103, 1821; BARGER and FIELD, *ibid.*, 1915, 107, 281; MAJIMA and SUGINOME, *Ber.*, 1925, 58, 2047; SPÄTH *et al.*, *ibid.*, 1930, 63, 2994; 1931, 64, 2201; HENRY and SHARP, *J. Chem. Soc.*, 1931, 581; MAJIMA, SUGINOME and SHIMANUKI, *Ber.*, 1932, 65, 595; MAJIMA and TAMURA,³⁷ TAMURA, *Annalen*, 1937, 533, 183; JACOBS, ELDERFIELD and CRAIG, *J. Biol. Chem.*, 1939, 128, 439; cf. JACOBS and ELDERFIELD, *J. Amer. Chem. Soc.*, 1936, 58, 1059. (43) SUGINOME, *Annalen*,

1937, 533, 172. (44) *Ber.*, 1936, 69, 1962; (with ROGERS), 1937, 70, 349. (45) POPE, *J. Chem. Soc.*, 1900, 77, 49. (46) SCHMIDT and SCHWANTKE, *Arch. Pharm.*, 1909, 247, 242; cf. WATANABE, quoted by MAJIMA and MORIO, *Annalen*, 1929, 476, 203. (47) *J. Chem. Soc.*, 1878, 33, 151. (48) *Ibid.*, 1897, 71, 350. (49) *Ber.*, 1896, 29, 852. (50) KONOVALOVA and ORÉKHOV, *Bull. Soc. Chim.*, 1940, [v], 7, 95; *J. Gen. Chem. U.R.S.S.*, 1940, 10, 745. (51) *J. Chem. Soc.*, 1928, 3094. (52) *Arch. Pharm.*, 1913, 251, 453; 1916, 254, 567. (53) *J. Chem. Soc.*, 1905, 87, 1636. (54) *J. Pharm.*, 1896, [vi], 4, 262. (55) *Arch. Pharm.*, 1922, 260, 230. (56) *Arch. exp. Path. Pharm.*, 1922, 95, 166. (57) On the authority of Dr. O. Stapf, Carr has suggested that the *A. septentrionale* Koelle, used by Rosendahl (and by Schulze and Weidemann), was probably the true *A. lycoctonum* L., whilst the *A. lycoctonum* referred to on p. 686 is really *A. vulparia* Reichb. (58) *Jahresh.*, 1866, p. 483. (59) *Pharm. Zeit. Russland*, 1884, 23, 313. (60) *Arch. Pharm.*, 1913, 251, 8, with a bibliography and critical résumé of early work; MARION and MANSKE, *Can. J. Res.*, 1946, 24B, 1. (61) Blue Book, "Cinchona Cultivation in East India," 1877, p. 133. (62) *Arch. Pharm.*, 1879, 214, 193. (63) *Yearbook Pharm.*, 1879, 422. (64) *J. Chem. Soc.*, 1896, 69, 1578; cf. GORIS,¹¹ (65) *Ibid.*, 1937, 1640; cf. CHANDRASENA, *ibid.*, 1933, 740. (66) JACOBS and CRAIG, *J. Biol. Chem.* (a) 1942, 143, 589; (b) 1943, 147, 567; (c) 1942, 143, 605; (d) 1943, 147, 571; (e) 1944, 152, 651; (f) 1947, 170, 203; (g) *idem.*, p. 515; (h) *idem.*, p. 189. (67) *Proc. Roy. Soc.*, 1898, 62, 338; cf. MUNCH and GITTINGER, *J. Amer. Pharm. Assoc.*, 1929, 18, 17; CHEN, ANDERSON and BROWN ROBBINS, *Quart. J. Pharm.*, 1938, 11, 84. (68) For special papers on the action of aconitine, see CORONEDI, "Tossicologia dell'aconito e dei suoi alcaloidi," Florence, 1925; EKERFORS, *Compt. rend. Soc. Biol.*, 1928, 98, 795, 797. (69) CASH and DUNSTAN, *Proc. Roy. Soc.*, 1901, 68, 379. (70) *Idem*, *ibid.*, 1905, 76, 468. (71) BERNI, *Arch. Farm. sperim.*, 1930, 50, 110. (72) BENIGNI, *Boll. Soc. ital. biol. sperim.*, 1929, 4, 399. (73) Quoted by SCHULZE and BIERLING, *Arch. Pharm.*, 1913, 251, 48; for a recent pharmacological report on *A. lycoctonum* see RAYMOND-HAMET, *C. R. Soc. biol.*, 1943, 137, 675. (74) ROSENDAHL, quoted by BOEHM,⁶⁶ (75) CASH, quoted by JOWETT, *J. Chem. Soc.*, 1896, 69, 1525; see also RAYMOND-HAMET, *Compt. rend. Soc. Biol.*, 1938, 128, 479; *Compt. rend.*, 1942, 215, 247. (76) CASH and DUNSTAN, *Proc. Roy. Soc.*, 1901, 68, 384.

INTERRELATIONSHIP OF THE ACONITUM AND DELPHINIUM ALKALOIDS. The two genera *Aconitum* and *Delphinium* belong to the sub-order Ranunculaceæ. The botanical similarity thus indicated does not necessarily indicate similarity in alkaloidal components for *Hydrastis canadensis* belongs to the same sub-order, but its alkaloids have little in common with those of the aconites and larkspurs. This related botanical origin may, however, be regarded as one item in the accumulated evidence, that these two sets of alkaloids have the same type of structure, which justifies Craig and Jacobs, who have provided most of the evidence, in dealing with them as one group named "the aconite alkaloids." Similarity in structure is clearly indicated by the following points. The basic, hydrolytic product, lycoctonine, is common to one aconite and some delphinium alkaloids. *iso*Talatisidine is the hydrolytic base of condelphine and occurs as such in *A. talassicum*. Atisine and staphisine have both been shown to produce alkylphenanthrenes in pyrolytic experiments. There is a close parallelism in the nuclear and peripheral structure of delphinine,

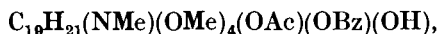

and aconitine, $C_{10}H_{19}(NEt)(OMe)_4(OAc)(OBz)(OH)_3$, and in their reactions.

Craig, Michaelis, Granick and Jacobs¹ have recently studied the ultra-violet absorption spectra of a series of items in this group of alkaloids,

viz. (a) the naturally occurring alkamines, atisine and heteratisine, and the derived bases dihydroatisine, tetrahydroatisine and *iso*atisine, and (b) the hydrolytic alkamines, aconine and delphonine, and certain derivatives of the latter, *viz.*, the methochloride and methoxyhydroxide, *N*-methyl-delphonine, pyrodelphonine and α -oxodelphonine. Based on these results and the structural data accumulated from their previous work, they suggest the annexed formula as an example of a possible type of nucleus for these alkaloids. This assumes relationship of these alkaloids to the diterpenes, as indicated by the formation of pimanthrene (1:7-dimethyl-phenanthrene) from staphisine (p. 699) and from hetisine (p. 689).²

While the hydrolytic alkamines, aconine and delphonine, cannot be hydrogenated and have therefore been regarded as saturated, their ultra-violet absorption spectra as bases in solution and in common with those of heteratisine and tetrahydroatisine, show a strong absorption within the range 2,200 to 2,600 Å, indicating unsaturation. With the bases in acid solution there is a reduction in intensity and a shift in the position of the absorption. It is assumed that these results arise from association of points of unsaturation with the nitrogen atom. A similar range of absorption is shown by *N*-methylpyrrole, as base in solution, but in this case there is no shift in position on acidification.

Delphonine shows an unusually high basic dissociation constant, and that of aconine is only a little less. In the case of tertiary vinyl cyclic amines, which prove to be unexpectedly strong bases, Adams and Mahan³ suggested that they exist in solution as equilibrium mixtures consisting of the tertiary unsaturated base and a quaternary arrangement in which the double bond has moved to the nitrogen, which may be represented thus:—

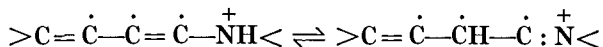

The assumption of these conjugated double bonds makes possible a tetracyclic nucleus which accords with the suggestion previously made by the authors that these alkaloids might be structurally related to the diterpenes.² It may also be noted that one of the nitric acid oxidation products of pseudoaconitine has been recorded as unexpectedly giving a pyrrole reaction on destructive distillation.⁴

REFERENCES

- (1) *J. Biol. Chem.*, 1944, **154**, 293. (2) CRAIG and JACOBS, *ibid.*, 1944, **152**, 645; JACOBS and HUERNER, *ibid.*, 1947, **170**, 189. (3) ADAMS and MAHAN, *J. Amer. Chem. Soc.*, 1942, **64**, 2588. (4) HENRY and SHARP, *J. Chem. Soc.*, 1928, 1105.

ALKALOIDS OF *DELPHINIUM* SPP.

Delphinium spp., of which the larkspur is a familiar example, have often been the cause of poisoning in cattle and a few have been used as

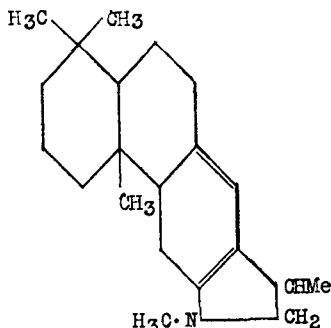

insecticides. This has led to the examination of some species but only to establish the source of toxicity and in such cases there is little more recorded than the presence and percentage of alkaloids, as for example in *D. Andersonii*,¹ *D. barbeyi*² (1919), *D. crassifolium*,^{3(a)} *D. chinense*,³ *D. formosum*,³ *D. geyeri*,⁴ *D. glaucescens*,² *D. glaucum*,⁴ *D. hybridum*,³ *D. rhinante*,³ *D. subalpinum*.²

More work has been done on the alkaloids of *D. bicolor*, Nutt, *D. Menziesii*, D.C., *D. scopulorum*, Gr. and *D. Nelsonii*,⁴ Gr. which, according to G. Heyl⁴ (1903), contain a mixture of alkaloids, having pharmacological properties akin to those of curare (Lohmann⁴) and hence named "delphocurarine." From this material he isolated a crystalline alkaloid, $C_{23}H_{33}O_7N$, m.p. 184–5°, which contained methoxyl (18 per cent.).

Delphinium ajacis L. From the seed of this species Keller and Volker⁵ isolated two crystalline alkaloids which they named ajacine and ajaconine. Their work was reviewed by Hunter,⁵ who reported the presence of four alkaloids, viz., ajacine, ajaconine and new alkaloids ajacinine and ajacinoidine (amorphous). Goodson⁶ described ajacine in detail (1944) and later reported the isolation of ajaconine and three more bases distinguished as B, C and D. According to Hunter, lycoctonine (p. 686) is probably also present.

Ajacine, $C_{34}H_{46}O_9N_2 \cdot 2H_2O$. According to Goodson, the base crystallises from 70 per cent. alcohol in needles, m.p. 154°, $[\alpha]_D^{22} + 49.5^\circ$ (EtOH) or $+30.8^\circ$ (N/5—HCl), and contains one ethylimino, two hydroxyl and four methoxyl groups. On alkaline hydrolysis it yields lycoctonine, $C_{25}H_{39}O_7N \cdot H_2O$ (cf. Manske's formula, p. 686), and acetylanthranilic acid, $C_9H_9O_3N$. On acid hydrolysis ajacine furnishes acetic acid and anthranoyllycoctonine, $C_{32}H_{44}O_8N_2$ (p. 687). Ajacine is therefore acetyl-anthranoyllycoctonine, which brings it into close relationship with lycanotine (p. 686).

Ajaconine, $C_{21}H_{31}O_3N$ (Hunter) or $C_{22}H_{33}O_3N$ (Goodson), has m.p. 172°, $[\alpha]_D^{18} - 119^\circ$ (EtOH) (G) or $[\alpha]_D^{17} - 133^\circ$ (CHCl₃) (H), forms a sulphate, B. $H_2SO_4 \cdot 7H_2O$, m.p. 113° or 231° (dry, dec.), $[\alpha]_D^{23} + 5.5^\circ$ (H₂O), an acid oxalate, B. $H_2C_2O_4$, m.p. 234–5°, an amorphous picrate, m.p. 95–8°, and a methiodide, m.p. 134°. Ajaconine is an N-methyl base, contains no methoxyl groups and absorbs one molecule of hydrogen in presence of palladium-black.

Ajacinine, $C_{22}H_{35}O_6N$, m.p. 210–1°, $[\alpha]_D^{17} + 52^\circ$ (CHCl₃), forms a hydriodide, m.p. 169–170°, and an acid oxalate, B. $H_2C_2O_4$, m.p. 195° (dec.); the hydrobromide, m.p. 154–160°, and picrate, m.p. 99–103°, have not been crystallised.

Ajacinoidine, $C_{38}H_{56}O_{12}N_2$, is amorphous, m.p. 120–6°, $[\alpha]_D^{16} + 46^\circ$ (CHCl₃), and gives an amorphous picrate, m.p. 125–80°.

Base B, $C_{19}H_{22}O_3(MeO)_3(NEt)(AcO)$, m.p. 195°, $[\alpha]_D^{17} + 34^\circ$ (EtOH) or $+0.5$ (N/5 HCl), forms an aurichloride, B. $HAuCl_4 \cdot 3H_2O$, m.p. 205°. The substituents are as shown in the extended formula. On hydrolysis it yields acetic acid and base C (see below).

Base C, $C_{19}H_{23}O_4(OMe)_3(NEt)$, m.p. 206°, $[\alpha]_D^{18} + 57^\circ$ (EtOH) or

+ 36.4° (N/5HCl), forms an aurichloride, B . HAuCl₄ . H₂O, m.p. 169° (*dec.*) or 171° (*dry*). The known substituents are as shown in the extended formula.

Base D, C₄₄H₅₄O₈N(NMe)(OMe)₃, m.p. 97°, [α]_D¹⁵ + 59.3° (EtOH), yields a hydriodide, C₄₃H₆₆O₁₂N₂ . HI . 2H₂O, m.p. 213°, [α]_D¹⁵ + 32.4° (N/5KHO in EtOH). The substituents known are stated in the extended formula.

D. Brownii, Rydb. From this species Manske ⁷ prepared an alkaloida product which could not be crystallised or converted into crystalline salts, but on alkaline hydrolysis yielded methylsuccinic acid (fine prisms, m.p. 112°), anthranilic acid and a crystalline base, m.p. 120–1°, [α]_D²² + 52.2° (MeOH), later identified with lycoctonine by comparison with a specimen of the latter prepared from *Aconitum lycoctonum*.

Delphinium confusum, Pop. From this Russian species Rabinovich and Konovalova ⁸ isolated the following alkaloid :—

Condolphine, C₂₅H₃₉O₆N. [C₁₉H₂₃(Ac)(OH)₂(OMe)₂(NEt)]. The base has m.p. 156–8°, [α]_D + 26.8°, yields a perchlorate, m.p. 209–210°, an oxalate, m.p. 160–2° (*dec.*), [α]_D – 23.55°, and a methiodide, m.p. 203–5° (*dec.*). The diacetyl derivative has m.p. 130–4°. On alkaline hydrolysis condolphine furnishes the corresponding amino-alcohol, C₂₃H₃₇O₅N . H₂O, which, after purification through the oxalate, had m.p. 114–7° or 140–2° (*dry*) and proved to be identical with *isotalatisidine*, one of the alkaloids of *Aconitum talassicum* (p. 690). This, with the occurrence of a lycoctonine derivative in *D. ajacis*, *D. elatum* (pp. 694, 696) and *D. Brownii* (p. 695), forms the second case of the occurrence of the same alkaloid structure in the two Ranunculaceae genera, *Aconitum* and *Delphinium*.

D. consolidida, L. From this species Keller ⁵ isolated three alkaloids of which one (Base "A") was well defined. Markwood ⁹ obtained three crystalline alkaloids of which delcosine was probably Keller's base A, and Cionga and Iliescu ¹⁰ have added to Markwood's observations, but failed to obtain his third base. This work has recently been critically revised by Marion and Edwards, ^{10(a)} who have isolated from the seeds six alkaloids of which two, delcosine and delsoline, were already known; another, consolidine, may be Markwood's "third base," and the remaining three are new records for this species, *viz.* delsonine, lycoctonine and anthranoylycoctonine. They have also altered the empirical formulæ of the alkaloids delcosine and delsoline.

Delcosine, C₂₂H₃₇O₆N, m.p. 203–4°, [α]_D²⁵ + 56.8° (CHCl₃), perchlorate, m.p. 217–8°, [α]_D + 32.0° (MeOH); hydrobromide, B . HBr . 2MeOH, m.p. 103° (*dec.*); hydrochloride, B . HCl . 2MeOH, m.p. 89°. The base is stable to alkali and when refluxed with acetyl chloride, forms a triacetyl derivative, m.p. 203° (*dec.*), and a compound, C₂₂H₃₃O₅NAc, m.p. 157–161°. Delcosine contains three hydroxyl and three methoxyl groups and absorbs one molecule of bromine to form a perbromide. Cionga and Iliescu ¹⁰ reported both delcosine and delsoline as lævorotatory.

Delsoline, C₂₅H₄₃O₇N. Contains four methoxyl groups, has m.p.

213–6.5°, $[\alpha]_D^{28}$ + 51.7° (CHCl₃), and yields a perchlorate, m.p. 192.5–193.5°, $[\alpha]_D^{27}$ + 28.1° (MeOH), and a hydrobromide, which crystallises with solvent, m.p. 83°. The base is stable to potassium hydroxide in alcohol.

Delsonine is amorphous and is isomerised to *isodelsonine*, m.p. 108–111°, by boiling with potassium hydroxide in alcohol. The following crystalline salts of delsonine were prepared: perchlorate, C₂₄H₄₁O₆N · HClO₄, m.p. 216° (*dec.*), $[\alpha]_D^{32}$ + 23° (MeOH); hydriodide, B. HI, m.p. 202°. The base contains at least four methoxyl groups.

Consolidine, C₃₃H₄₉O₉N, has m.p. 153–7°, $[\alpha]_D$ + 64° (MeOH), contains three methoxyl groups and is hydrolysed by alcoholic alkali to benzoic acid and a new base *consoline*, which has not been crystallised as such or as perchlorate.

The *anthranoylylcoctonine* obtained could not be crystallised. It has $[\alpha]_D^{24}$ + 54° (MeOH) and formed a crystalline perchlorate, C₂₇H₃₈O₆N₂ · HClO₄, m.p. 207°, $[\alpha]_D$ + 29.3° (MeOH), and a hydriodide, B. HI, m.p. 183°, $[\alpha]_D$ + 33° (MeOH). It yields lycoctonine and anthranilic acid on alkaline hydrolysis and appears to be isomeric, rather than identical, with Goodson's anthranoylylcoctonine (p. 697).

D. elatum, L. Of the three alkaloids noted by Keller³ in the seeds of this species, one, unnamed, was crystalline, had the formula C₃₃H₅₁O₈N and m.p. 218°. According to Goodson,¹² the seeds yield 1.7 per cent. of alkaloids from which three bases were isolated:—

Delpheline, C₂₅H₃₉O₆N. The yield of this base was 0.18 per cent. It crystallises in prisms, m.p. 227°, $[\alpha]_D^{20}$ – 25.8° (CHCl₃), contains one ethylimino, one hydroxyl, one methylenedioxy and three methoxyl groups, and yields a hydrochloride, B. HCl · H₂O, m.p. 219° (*dec.*), $[\alpha]_D^{20}$ – 42.8° (H₂O), and a nitrate, B. HNO₃, m.p. 191–3°, $[\alpha]_D^{22}$ – 41.2° (H₂O). It is a weak base and the salts tend to lose acid on drying. The monoacetyl derivative has m.p. 125°. $[\alpha]_D^{20}$ – 34.5° (EtOH).

Delatine, C₁₉H₂₅O₃N · H₂O. Yield as crude hydrochloride, 0.125 per cent. The hydrated base crystallises in prisms, m.p. 148°, $[\alpha]_D^{23}$ + 13.5° (H₂O). The anhydrous base melts at 261–4°. It contains neither methoxyl nor ethylimino groups. The hydrochloride B. HCl has m.p. 274–7° and $[\alpha]_D^{18}$ + 13.4° (H₂O).

Methyllycaconitine, C₃₇H₄₈O₁₀N₂, was isolated as the crystalline hydriodide, B. HI · 2H₂O, m.p. 201° (*dec.*), of which the crude yield was 0.8 per cent. The free base is amorphous and after drying at 70° to 105° *in vacuo* has m.p. 128° and $[\alpha]_D^{22}$ + 49.1 (EtOH). On hydrolysis in alcoholic sodium hydroxide it yields *l*-methylsuccinylanthranilic acid, C₁₀H₁₁ON(CO₂H)₂, m.p. 155°, $[\alpha]_D^{24}$ – 7.0° (EtOH), and LYCOCTONINE,* C₂₅H₃₉O₇N · H₂O, m.p. 143°, $[\alpha]_D^{20}$ + 53.2° (EtOH), apparently identical with the basic hydrolytic product of lycaconitine (p. 686) from which methyllycaconitine differs in yielding methylsuccinic acid in place of succinic acid on hydrolysis. This established for the first time similarity in constitution between alkaloids of the two closely related Ranunculaceae

* Formula is doubtful in view of Manske's alteration of the lycoctonine formula (p. 686).

genera, Aconitum and Delphinium. Further examples are given under *D. ajacis*, *D. Brownii* and *D. confusum* (p. 695). On acid hydrolysis, methyllycaconitine yields *l*-methylsuccinic acid and anthranoyllycoctonine, $C_{32}H_{44}O_8N_2$, m.p. 172° , $[\alpha]_D^{24} + 32.4^\circ$ ($c = 2$; $N/5$ HCl), similarly obtained from lycaconitine and ajacine.

D. occidentale. According to Couch,¹³ this species yields the following alkaloid:—

Deltaline, $C_{21}H_{33}O_6N$, m.p. $180-1^\circ$, $[\alpha]_D^{24} - 27.8^\circ$ (EtOH), yielding an aurichloride, $B \cdot HAuCl_4 \cdot 3H_2O$, m.p. $120-5^\circ$, and an amorphous triacetyl derivative, m.p. $270-2^\circ$. The alkaloid contains two methoxyl groups and is isomeric with Markwood's delcosine.

Delphinium sp. From an unidentified species of delphinium the following alkaloid was isolated by Rabinovitch and Konovalova.⁸

Delphamine. The extended formula, $C_{20}H_{23}(OH)_4(OMe)_3(NEt)$, is proposed and the similarity of this to formulæ for some aconite alkaloids is pointed out. The base is crystalline, has m.p. $196-200^\circ$, $[\alpha]_D + 66.6^\circ$, yields an acid tartrate, m.p. 160° (*dec.*), a nitrate, m.p. 160° (*dec.*), $[\alpha]_D + 33.5^\circ$, and a methiodide, m.p. 180° (*dec.*). It is stable to alkali and furnishes a diacetyl derivative, m.p. $118-121.5^\circ$, $[\alpha]_D + 28.8^\circ$, two hydroxyl groups remaining unacylated. It contains one ethylimino group, identified by the production of acetaldehyde on oxidation by acid permanganate.

Delphinium Staphisagria L. From the seeds of this species, the oil of which is used as a pediculicide, Brandes isolated delphinine in 1819, and this and other alkaloidal components were subsequently examined by various workers including Marquis,¹⁴ Kara-Stojanov,¹⁵ Ahrens,¹⁶ Keller,¹⁷ Walz¹⁸ and most recently by Jacobs and Craig.¹⁹

Delphinine, $C_{34}H_{47}O_9N$ (Walz) or $C_{33}H_{45}O_9N$ (J. and C.). The alkaloid crystallises in rhombs,²⁰ or six-sided plates,¹⁹ m.p. $198-200^\circ$, $[\alpha]_D^{25} + 25^\circ$ (EtOH), shows mutarotation in alcoholic solution, and forms an acid oxalate, $B \cdot H_2C_2O_4$, m.p. 168° (*dry*), a hydrochloride, $B \cdot HCl$, m.p. $208-210^\circ$, and a monobenzoyl derivative, m.p. $171-3^\circ$. On alkaline hydrolysis it yields one molecule each of acetic and benzoic acids. The basic, hydrolytic product of this action is DELPHONINE, $C_{24}H_{39}O_7N$, which is amorphous, but can be distilled at a bath temperature of 140° and a pressure of 0.001 to 0.0001 mm. The brittle, possibly semi-crystalline resin so obtained, has m.p. $76-8^\circ$ and $[\alpha]_D^{24} + 37.5$ (EtOH).

On hydrogenation, delphinine forms hexahydrodelphinine, $C_{33}H_{51}O_9N$, m.p. $192-3^\circ$, by reduction of the benzoyl radical, hexahydrobenzoic acid replacing benzoic acid as a product of hydrolysis.

Delphinine contains one hydroxyl, one methylimino and four methoxyl groups, which with the acetoxy and benzoyloxy groups accounts for all the oxygen atoms of the alkaloid.

In their study of its oxidation by permanganate in acetone, Jacobs and Craig obtained two isomerides, $C_{33}H_{43}O_{10}N$, the α - and β -oxodelphinines of which the former predominates and is probably identical with Keller's substance X 214¹⁷. It has m.p. $218-221^\circ$, $[\alpha]_D^{20} - 62^\circ$ (AcOH). The β -form has m.p. $228-9^\circ$, $[\alpha]_D^{20} + 31^\circ$ (AcOH). Both substances retain

the acetyl and benzoyl groups and four methoxyl groups, but in neither can the *N*-methyl group be detected.

When delphinine is heated in methyl alcohol, acetic acid is liberated and methylbenzoyldelphonine, $C_{32}H_{45}O_8N$, formed. This has m.p. $173-5^\circ$, $[\alpha]_D^{25} + 27^\circ$ (EtOH), and on oxidation with permanganate in acetone in presence of acetic acid, is converted into methylbenzoyl- α -oxodelphinine, $C_{32}H_{43}O_9N$, which melts at $221-3^\circ$, solidifies and re-melts at $236-7^\circ$ and has $[\alpha]_D^{25} - 41.5^\circ$ (MeOH). This product is also formed by the action of hydrogen chloride (3 per cent.) in methyl alcohol on α -oxodelphinine (*see above*). This replacement of an acetyl by a methyl group also occurs, though less readily, when β -oxodelphinine is heated at 100° in methyl alcohol with hydrogen chloride (4 per cent.), the product being methylbenzoyl- β -oxodelphonine, $C_{32}H_{43}O_9N$, m.p. $182-5^\circ$, $[\alpha]_D^{25} + 27^\circ$ (MeOH). This kind of reaction was first recorded for aconitine (p. 675) and it serves to emphasise the parallelism in reactivity, and probably therefore in structure, which exists between aconitine and delphinine and possibly between the whole range of aconite and larkspur alkaloids.

Another example of this is the loss of acetic acid when delphinine is heated in hydrogen at $200-215^\circ$. Just as aconitine is so converted into pyraconitine so delphinine yields pyrodelphinine, $C_{31}H_{41}O_7N$, m.p. $208-212^\circ$, and similarly α -oxodelphinine, $C_{33}H_{43}O_{10}N$, under like treatment loses acetic acid and yields pyro- α -oxodelphinine, $C_{31}H_{39}O_8N$, which crystallises from methyl alcohol in needles, m.p. $248-250^\circ$, after sintering at 238° . This, on hydrogenation, forms a hexahydro-derivative, m.p. $183-5^\circ$, presumably by saturation of the benzoyl radical, which therefore leaves unexplained the mechanism by which acetic acid is lost in this pyrolytic reaction (*cf.* pyropseudaconitine, p. 683).

With nitrous acid at 100° , delphinine, $C_{33}H_{45}O_9N$, yields a nitroso-derivative, $C_{33}H_{44}O_{10}N_2$, m.p. $240-1^\circ$, but is chiefly converted into hydroxydelphinine, $C_{33}H_{45}O_{10}N$, m.p. $180-2^\circ$ (*dec.*), $[\alpha]_D^{20} + 7^\circ$ (EtOH). This is oxidised by permanganate to a third or γ -oxodelphinine, $C_{33}H_{43}O_{10}N$, m.p. $226-9^\circ$, $[\alpha]_D^{20} + 40^\circ$ (AcOH), which, like the α - and β -forms, can replace its acetyl by a methyl group forming methylbenzoyl- γ -delphonine, m.p. $184-8^\circ$, $[\alpha]_D^{20} + 5^\circ$ (MeOH), closely resembling methylbenzoyl- β -delphonine except in specific rotation.

The action of hydrochloric and nitric acids on delphinine and certain of its derivatives has also been investigated (Jacobs and Craig,¹⁹ 1940).

Addendum. In an important paper received too late for incorporation in the foregoing account and of which only a brief summary can be given, Jacobs and Huebner^{19(a)} have used α -oxodelphinine (I) as a primary material for further investigations on the nuclear structure of delphinine and the changes it undergoes are shown in the accompanying diagram. It is pyrolysed to pyro- α -oxodelphinine (II), which is isomerised by hydrochloric acid in methyl alcohol to isopyrooxodelphinine, $C_{31}H_{39}O_8N$ (III), m.p. $292-6^\circ$, $[\alpha]_D^{25} - 13^\circ$ (pyridine), and there is also formed in this reaction the chloro-compound, $C_{29}H_{33}O_6NCl_2$, already described by Jacobs and Craig¹⁹ (1940) and which is now represented by (IV). When this chloro-

compound is refluxed with acetic acid and sodium acetate it forms a diacetyl derivative, $C_{33}H_{39}O_{10}N$, which sinters $>235^\circ$ and finally resinifies at $275-280^\circ$ and is represented by (VIII). When the chloro-compound is refluxed with zinc dust in acetic acid, a substance, $C_{31}H_{37}O_8N$, is formed, which sinters $>230^\circ$ and finally melts and decomposes at $243-8^\circ$. It is represented by (V) and its octahydride, $C_{31}H_{45}O_8N$, m.p. 187° , named hexahydrobenzoyloxodedelphonine acetate, by (VI). The latter on alkaline hydrolysis yields acetic and hexahydrobenzoic acids with oxo-dedelphonine, $C_{22}H_{33}O_6N$, m.p. $306-312^\circ$ after sintering at 292° , to which (VII) is assigned.

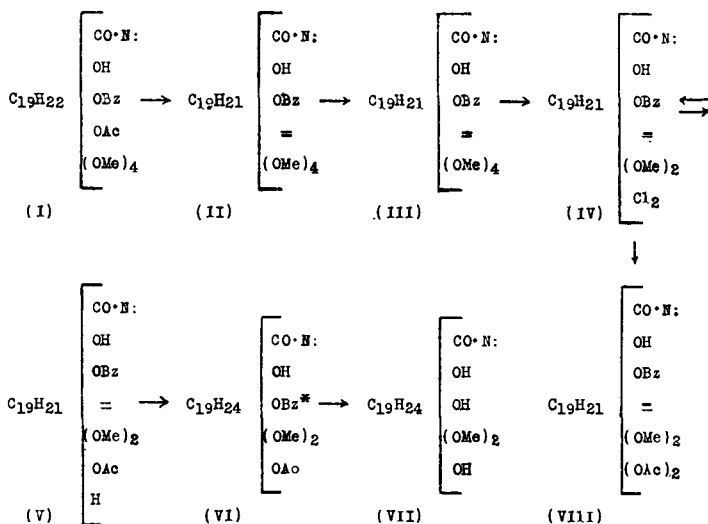

* in this the benzoyl group is reduced to hexahydrobenzoyl.

Hexahydrobenzoyloxodedelphonine acetate (VI) was dehydrogenated by selenium at 330° and gave as chief product a hydrocarbon, $C_{17}H_{24}$, b.p. $90^\circ/0.02$ mm., whose composition, ultra-violet absorption spectrum and chemical properties, so far as examined, indicate that it may be a bicyclopentenobenzene and therefore in a different category from the phenanthrene hydrocarbons yielded by the atisine group of bases.

Staphisine, $C_{22}H_{31}ON$ or $C_{42}H_{60}ON_2$. This alkaloid was isolated by Jacobs and Craig¹⁹ (1941) by a chromatographic method from delphinine mother liquors. It has m.p. $205-8^\circ$, after sintering from 170° , $[\alpha]_D^{25} - 159^\circ$ (C_6H_6), and gives a hydrochloride, m.p. 256° (*dec.*), hydrobromide, m.p. $255-8^\circ$, and a nitrate, m.p. $236-243^\circ$. With methyl iodide at 100° it furnishes $C_{44}H_{60}ON_2 \cdot MeI$, m.p. 255° (*dec.*), and on further methylation, $C_{22}H_{31}ON \cdot MeI$, m.p. 250° (*dec.*). Staphisine contains a methylimino but no methoxyl group. On hydrogenation it gives a product, $C_{44}H_{64}ON_2$, m.p. $205-9^\circ$ to $252-4^\circ$. On dehydrogenation by selenium at 340° in nitrogen a series of hydrocarbons is produced of which the most interesting

are a hydrocarbon, $C_{16}H_{14}$, later (1944) proved to be identical with pimanthrene (1:7-dimethylphenanthrene), and a hydrocarbon, $C_{19}H_{20}$, m.p. 70–2°, forming a picrate, m.p. 143–4°, subsequently shown by Huebner and Jacobs to be a methylretene, *viz.*, 1:3-dimethyl-7-isopropylphenanthrene, by comparison with a synthetic specimen, m.p. 73–6°, picrate, m.p. 145–6°. The possibility that staphisine should be represented by the doubled formula, $C_{42}H_{60}ON_2$, *i.e.*, by loss of a molecule of water between two molecules, $C_{21}H_{31}ON$, is also discussed in this paper.

The following three alkaloids described by early workers on *D. staphisagria* are not well characterised: DELPHISINE,¹⁵ m.p. 189°; said to resemble and to be isomeric with delphinine. DELPHINOIDINE,¹⁵ $C_{25}H_{42}O_4N$, amorphous. STAPHISAGROINE,¹⁶ $C_{40}H_{46}O_7N_2$, amorphous, m.p. 275–7°.

Pharmacological Action. Delphinine resembles aconitine in its action. In cases of poisoning death is due to respiratory paralysis accompanied by cardiac and vasomotor damage. It also has an irritant action on the skin. Detailed accounts of the pharmacology of various species of Delphinium and their alkaloids are given by Boehm²¹ and by Lewin²² and cases of larkspur poisoning are described by Jakobsen,²³ Markwood⁸ and Marsh, Clawson and Marsh.²⁴ According to Williams, the insecticidal properties of *D. ajacis* seeds are due to the oil and not to the alkaloids.²⁵ Kuder²⁶ has published a general article on the botany, horticulture and chemistry of the larkspurs.

REFERENCES

- (1) MILLER, *J. Amer. Pharm. Assoc.*, 1923, 12, 492. (2) BEATH, *J. Amer. Pharm. Assoc.*, 1918, 7, 955; *Wyoming Agric. Exp. Stat. Bull.*, 1919, No. 120, p. 55. (3) KELLER, *Arch. Pharm.*, 1925, 263, 274. (3a) EFROS, *Farmatsiya*, 1946, 9, 22. (4) F. W. HEYL, HEPNER and LOY, *J. Amer. Chem. Soc.*, 1913, 35, 880; G. HEYL, *Südd. Apoth. Zeit.*, 1903, 43, Nos. 28–30 (*Chem. Soc. Abstr.*, 1903, i, 650); LOHMANN, *Pfluger's Archiv.*, 1902, 92, 398. (5) KELLER, *Arch. Pharm.*, 1910, 248, 468; (with VÖLKER), *ibid.*, 1913, 251, 207; *cf.* HUNTER, *Pharm. J.*, 1943, 152, 82, 95; *Quart. J. Pharm.*, 1944, 17, 302. (6) GOODSON, *J. Chem. Soc.*, 1944, 108; 1945, 245. (7) *Canad. J. Res.*, 1938, B, 16, 57; 1946, B, 24, 1. (8) *J. Gen. Chem., U.R.S.S.*, 1942, 12, 321, 329. (9) *J. Amer. Pharm. Assoc.*, 1924, 13, 696; 1931, 20, 454. (10) *Ber.*, 1941, 74, 1031. (10a) *J. Amer. Chem. Soc.*, 1947, 69, 2010. (11) *J. Lab. Clin. Med.*, 1924, 9, 326. (12) *J. Chem. Soc.*, 1943, 139; 1944, 665. (13) *J. Amer. Chem. Soc.*, 1936, 58, 684. (14) *Ann. Chim. Phys.*, 1833, 52, 352. (15) *Pharm. Zeit. Russ.*, 1890, 29, 641 (*J. Chem. Soc. (Abstr.)*, 1891, 60, 842). (16) *Ber.*, 1899, 32, 1581, 1669. (17) *Arch. Pharm.*, 1910, 248, 648; (with SMECHEL), 1925, 263, 274. (18) *Ibid.*, 1922, 260, 9. (19) *J. Biol. Chem.*, 1939, 127, 361; 128, 431; 1940, 136, 303; 1941, 141, 67; 1944, 152, 645; 154, 293; HUEBNER and JACOBS, *ibid.*, 1947, 169, 211. (19a) *Ibid.*, 1947, 170, 209. (20) MARKWOOD, *J. Amer. Pharm. Assoc.*, 1927, 16, 928, gives crystal measurements; for ultra-violet absorption spectrum *see* BRUSTIER and VIGNES, *Bull. Soc. Chim.*, 1945, [v], 12, 37. (21) HEFFTER, "Handbuch der Exper. Pharmakol." 1920, 2, Pt. I, p. 314; FISCHER and HUBER, *Helv. Phys. Pharmacol. Acta*, 1944, 2, C. 38. (22) "Gifte und vergiftungen," p. 598. (23) *Norsk. Mag. Laegevidensk.*, 1935, 96, 725. (24) *Exp. Sta. Rec. (U.S.A.)*, 1916, 35, 770. (25) *Amer. J. Pharm.*, 1914, 86, 414; *cf.* JARETZKY and JANICKI, *Arch. Pharm.*, 1940, 278, 156. (26) *J. Chem. Education*, 1947, 24, 418.

THE VERATRUM ALKALOIDS

This group of alkaloids is obtained from three Liliaceous plants, *sabadilla* or *cevadilla* seeds (*Schoenocaulon officinale*, A. Gray) and the rhizomes of

Veratrum album L. and *V. viride* Ait, known respectively as white or European hellebore, and green or American hellebore, though they have nothing to do with the true hellebores (p. 774). Each of these drugs yields a series of alkaloids, of which some have been thoroughly characterised and are now the subject of active structural investigation; their names are printed in italics in the following lists. Others described by the early investigators¹ have not been dealt with recently; their names are printed in ordinary type.

SABADILLA SEEDS. *Cevadine*, $C_{32}H_{49}O_9N$; *cevadilline*, $C_{34}H_{53}O_8N$; *cevine* (sabadinine), $C_{27}H_{43}O_8N$; *sabadine*, $C_{29}H_{51}O_8N$; *veratridine*, $C_{36}H_{51}O_{11}N$.

WHITE HELLEBORE. *Jervine*, $C_{27}H_{39}O_3N$; *rubijervine*, $C_{27}H_{43}O_2N$; *isorubijervine*,² $C_{27}H_{43}O_2N$; *pseudojervine*, $C_{33}H_{49}O_8N$; *protoveratridine*³, $C_{32}H_{51}O_9N$; *protoveratrine*,³ $C_{39}H_{61}O_{13}N$; *germerine*,⁴ $C_{37}H_{59}O_{11}N$; *germine*, $C_{27}H_{43}O_3N$.

GREEN HELLEBORE. *Jervine*, $C_{27}H_{39}O_3N$; *rubijervine*, $C_{27}H_{43}O_2N$; *pseudojervine*, $C_{33}H_{49}O_8N$; *protoveratridine*,⁵ $C_{32}H_{51}O_9N$; *germine*,⁵ $C_{27}H_{43}O_3N$; *veratrosine*,⁶ $C_{33}H_{49}O_7N$; *veratramine*,⁷ $C_{27}H_{39}O_2N$; *veratridine*, $C_{36}H_{51}O_{11}N$; *cevadine*, $C_{32}H_{49}O_9N$.

Two unnamed alkaloids have also been described. One was obtained by Bredemann⁸ in work on the alkaloids of white hellebore; it occurred in the mother liquors from protoveratrine crystallisation and formed spherical aggregates of needles, m.p. 239–241°. The other was isolated by Jacobs and Craig⁷ during a chromatographic analysis of residual, benzene-soluble alkaloids of green hellebore. It is represented by the formula $C_{27}H_{41(39)}O_4N$, crystallises in six-sided platelets or flat needles, sinters about 130°, effervesces at 170–5°, and on further heating solidifies and finally melts at 272–4°; it has $[\alpha]_D^{30} - 78^\circ$ (MeOH).

Commercial "veratrine" is a mixture of alkaloids prepared from sabadilla seeds and consists largely of cevadine and veratridine with some cevine. Its manufacture has been described by Schwyzer.⁹ "Crystalline veratrine" was first isolated by G. Merck.¹ Wright and Luff introduced the name cevadine to distinguish this alkaloid from the commercial amorphous mixture known as "veratrine."

Jervine has also been recorded from other *Veratrum* spp., e.g., *V. nigrum*, *V. lobelianum*¹⁰ and *V. grandiflorum*⁷ and veratrine-like alkaloids in *Zygadenus* spp. (p. 779).

The well-authenticated veratrum alkaloids are of three types:—

(1) *Esters of veratrum alkamines*. Cevadine, germerine, protoveratridine, protoveratrine, veratridine.

(2) *Glucosides of veratrum alkamines*. Pseudojervine, veratrosine.

(3) *Veratrum alkamines*. These may occur naturally as such, or in the form of the esters, or glucosides of types (1) and (2). Cevine, germine, jervine, protoverine, rubijervine, isorubijervine, veratramine. They are all, so far, C_{27} compounds.

Although medical interest in these drugs has declined, all three species have received considerable attention as insecticides. For this reason

chemical¹¹ and biological^{11(a)} methods of assaying the drugs for alkaloidal content, and particularly means of ascertaining their insecticidal efficiency,¹² have become of practical importance, as well as methods of ensuring standardisation and stability of preparations.¹³

Sabadilla Seeds. Processes for the isolation of the total alkaloids and separation of the components have been published¹ by Wright and Luff, by Bosetti and by G. Merck. The more modern methods used by Poethke,⁴ Saito,⁷ Seiferle *et al.*,⁵ Jacobs and Craig,⁷ and others for the alkaloids of white and green hellebores (*see below*) could no doubt also be used to advantage for sabadilla seed. A test for galenical preparations of sabadilla has been devised by Ramstad depending on the presence of chelidonic acid in the seed.^{13(a)}

Cevadine, $C_{32}H_{49}O_9N$ (crystallised veratrine), was first isolated in a crystalline condition from sabadilla seeds by G. Merck,¹ who called it veratrine, and was subsequently obtained by Schmidt and Koppen,¹⁴ and by Wright and Luff,¹ whose name "cevadine" has been generally adopted, though Ahrens¹⁵ suggested that it should be called "crystallised veratrine." The yield of total alkaloids from the seeds is said to be from 6 to 7 gm. per kilo, of which 0.8 to 0.9 gm. may be obtained as crystalline cevadine, 0.5 to 0.6 as veratridine and 0.2 to 0.3 as sabadilline.

The alkaloid crystallises in rhombic prisms with 2 mols. of alcohol,¹⁶ which it loses at 130–140°, m.p. 205° (*dry*), $[\alpha]_D^{17} + 12.5^\circ$ (EtOH), $+ 6.4^\circ$ (pyridine), $+ 1.25^\circ$ (acetone),¹⁷ dissolves readily in hot alcohol, but is insoluble in water, and sparingly soluble in ether. The hydrochloride, B. HCl, crystallises in needles; the aurichloride, B. HAuCl₄, in brilliant yellow needles, m.p. 182° (*dec.*); the picrate blackens at 225°; the mercurichloride, B. HCl.HgCl₂, forms silvery scales, m.p. 172° (*dec.*). Cevadine gives no coloration with hydrochloric acid. With sulphuric acid it becomes yellow, with a green fluorescence, then orange and slowly crimson. Mixed with sugar and then moistened with sulphuric acid, a deep green colour, changing to blue, is produced.

Cevadine contains neither a methoxyl nor a methylimino group; it yields crystalline benzoyl and *o*-nitrobenzoyl derivatives, m.p. 255° and 236° respectively, and a methiodide, which decomposes at 210–2°, and is converted by silver oxide into cevadinemethylhydroxide.¹⁸ When warmed with alcoholic soda, cevadine undergoes hydrolysis into cevine and angelic and tiglic acids.¹⁶ When hydrogen chloride is passed into cevadine in alcohol, ethyl'tiglate and cevine are formed.¹⁹

CEVINE, $C_{27}H_{43}O_8N \cdot 3.5H_2O$, was first prepared by Wright and Luff,¹ but was obtained crystalline by Freund and Schwarz.¹⁶ It forms triclinic prisms, sinters at 155–160°, melts at 195–200°, $[\alpha]_D - 17.52^\circ$ (EtOH), reduces Fehling's solution, and with alcoholic potash forms a characteristic crystalline potassium derivative. The hydrochloride, B. HCl, crystallises in needles, m.p. 247°; the aurichloride has m.p. 162° (*dec.*); the methiodide, B. CH₃I. 2H₂O, is crystalline and melts at 257° (*dec.*), and from it a base, $C_{28}H_{45}O_8N \cdot H_2O$, m.p. 277°, may be prepared, which Jacobs and Craig²⁰ (1938) regard as a phenolic (or enolic) betaine. Dibenzoylcevaine,

m.p. 195–6°, crystallises in large tablets; diacetylcevine has m.p. 190°, and di-(*o*-nitrobenzoyl)-cevine, m.p. 175°, $[\alpha]_D - 54.7^\circ$ (EtOH).¹⁷ Cevine, like its isomeride *germine*, contains eight replaceable hydrogen atoms. On oxidation by hydrogen peroxide it forms cevine oxide,²¹ $C_{27}H_{43}O_9N$.

Blount²² has shown that cevine on dehydrogenation by selenium at 270–330° gives rise to the two following products:—

Cevanthrol, $C_{17}H_{16}O$, crystallises from benzene in plates, m.p. 197–8°, behaves as a phenol and gives an acetyl derivative, m.p. 138–9°. X-ray analysis (Blount and Crowfoot²²) indicates that it is a phenanthrene derivative, with a hydroxyl group, possibly at C³.

Cevanthridine. Craig and Jacobs²³ propose for this substance the formula $C_{25}H_{27}N$, in place of $C_{23}H_{25}N$ adopted by Blount. It has m.p. 207°, yields a hydrochloride, m.p. 245° after darkening from 230°, a picrate, m.p. 230–240°, and a methiodide, m.p. 254–6° (B) or 268–270° (C and J). With hydrogen in acetic acid in presence of platinum oxide it forms a tetrahydro-derivative, m.p. 158–9°, giving a hydrochloride (decomp. 280–295°), an acetyl derivative, m.p. 206–7°, and a *p*-bromobenzoyltetrahydrocevanthridine, m.p. 107–113°. An X-ray examination²² indicates that cevanthridine may have a condensed ring structure with a fourth benzene ring fused on at C⁷—C⁸ or C²—C³. Craig and Jacobs²² found that the ultra-violet absorption curve of tetrahydrocevanthridine is very similar to that of a $C_{17}H_{16}$ hydrocarbon produced in the selenium dehydrogenation of cevine.

Jacobs and Craig²⁴ have made an extended study of the selenium dehydrogenation products of cevine and in addition to cevanthrol and cevanthridine have obtained the following thirteen substances: *Bases*, β -picoline, 5-methyl-2-ethylpyridine, 5-methyl-2-hydroxyethylpyridine, base, C_8H_9ON (picrate, m.p. 151–2°), base, $C_9H_{13}N$ (picrate, m.p. 150–1°), base, $C_{20}H_{19}N$, m.p. 233–5° (methiodide, m.p. 285–290°), base, $C_{26}H_{25}N$, m.p. 229–230° (methiodide, m.p. 295° (*dec.*)).

Hydrocarbons, 4:5-benzohydrindene; $C_{17}H_{16}$, m.p. 167–9° (picrate, m.p. 127–9°); $C_{18}H_{18}$, m.p. 116–8°; $C_{19}H_{20}$, m.p. 185–8°; $C_{24}H_{30}$, m.p. 108–110°.

Oxygenated substance, $C_{23}H_{24}O$, m.p. 181–7°.

Comparisons of the ultra-violet absorption spectra of the four hydrocarbons have been made with those of a series of condensed ring hydrocarbons and it is tentatively concluded that they may be derivatives of either *cyclopentenophenanthrene* or *cyclopentenofluorene*.²⁵ All four hydrocarbons give a colour reaction in the Vanscheidt test.²⁶

On oxidation with chromic acid in dilute sulphuric acid,²⁷ cevine produces an acid fraction, which on heating at 180° gives a good yield of *decevinic acid*, $C_{14}H_{14}O_6$, m.p. 273–8° (*dec.*), $[\alpha]_D^{25} + 47.6^\circ$ (pyridine). This with diazomethane gives a dimethyl derivative, $C_{16}H_{18}O_6$, m.p. 165–6°, which under controlled conditions is hydrolysed by alkali to a monomethyl derivative (A), $C_{15}H_{16}O_6$, m.p. 128°. An isomeric monomethyl derivative (B), in which it is the other point that is methylated, is obtained by methylating acetyldecevinic acid, $C_{16}H_{16}O_7$, m.p. 169–171°.

to acetyldecevinic methyl ester, $C_{17}H_{18}O_7$, m.p. 182–3°, and refluxing this in methyl alcohol to produce monomethyl derivative B. $C_{15}H_{16}O_6$, m.p. 242–5°. Neither the dimethyl nor the monomethyl derivative (A) can be acetylated, so that one of the two points for alkylation is also a point for acylation. On catalytic hydrogenation decevinic acid is reduced to a lactone acid, $C_{14}H_{20}O_4$, m.p. 237–9°, giving a monomethyl ester, m.p. 127–8°. When decevinic acid is allowed to stand with two equivalents of alkali, it loses carbon dioxide and forms an acid, $C_{13}H_{16}O_5$, m.p. 150–5° (*dec.*), which is dibasic, gives no colour with ferric chloride and when distilled or heated with alkali yields a ketolactone, $C_{12}H_{16}O_3$, m.p. 165–8°, $[\alpha]_D^{25} - 50^\circ$ ($CHCl_3$), giving an oxime, m.p. 194–5°. When decevinic acid is heated with sulphur at 300°, it is converted into 2-hydroxy-1:8-naphthoic anhydride.

Fractionation of the methyl esters of the crude fraction of oxidation acids, provided evidence of the presence of five acids including probably methylsuccinic acid with some succinic acid. A tetramethyl ester, $C_{14}H_{22}O_8$, m.p. 65–6°, $[\alpha]_D^{25} + 22.0^\circ$ (MeOH), gave on hydrolysis a *hexanetetracarboxylic acid*, m.p. 170–5°, which on distillation at 230°/0.2 mm. gave the dianhydride, $C_{10}H_{10}O_6$, m.p. 154–160° (*dec.*), $[\alpha]_D^{25} + 67^\circ$ (acetone), and a ketomonoanhydride, $C_9H_{10}O_4$, m.p. 115–8°, $[\alpha]_D^{25} + 128^\circ$ (acetone). For this acid the formula $[HOOC \cdot \dot{C}Me \cdot CH_2 \cdot COOH]_2$ was suggested, but it has recently been found that identity with the *meso*-, *dl*-, or *l*-form of the acid of this formula, synthesised for comparison as the methyl esters, could not be established (Heubner and Jacobs, 1947).²⁷

An acid, $C_{11}H_{16}O_8$, m.p. 145–8°, possibly a heptanetetracarboxylic acid, is also present. There was also obtained a viscous trimethyl ester, $C_{17}H_{24}O_8$, hydrolysed to an acid, $C_{14}H_{18}O_8$, which was not isolated, but on sublimation yielded decevinic acid and is therefore regarded as the precursor of that acid (*see above*) for which it is not yet possible to suggest a formula. Two basic products were also isolated from the original oxidation mixture; they both behave as lactams and may be a methylpyrrolidone, C_5H_9ON , m.p. 58°, and a methylpiperidone, $C_6H_{11}ON$, m.p. 34–7°.

Veratridine (amorphous veratrine), $C_{36}H_{51}O_{11}N$. This alkaloid, probably identical with Schmidt and Koppen's "water-soluble amorphous veratrine"²⁸ and with the amorphous veratrinines of Wright and Luff¹ and G. Merck,¹ was named veratridine by Bosetti.¹ Its isolation from commercial "veratrine" has been described by Blount.²² It is a colourless powder, m.p. 160–180°, $[\alpha]_D^{20} + 8.0^\circ$ (EtOH). The sulphate, B. $H_2SO_4 \cdot 9H_2O$, forms colourless, silky needles, which resinify on drying in air. The nitrate is sparingly soluble in water. The alkaloid remains colourless in hydrochloric acid, becomes orange-red, and finally crimson with a blue fluorescence in sulphuric acid; mixed with sugar and moistened with sulphuric acid it changes in succession to green, blue and dirty purple. On hydrolysis by alkalis in alcohol it yields veratric acid and "verine," whose identity with cevine was established by Blount,¹⁹ who also made the necessary alteration of the formula of veratridine from $C_{37}H_{53}O_{11}N$ to $C_{36}H_{51}O_{11}N$.

Cevadilline (*Sabadilline*), $C_{84}H_{53}O_8N$, is the amorphous residue, insoluble in ether, obtained in the purification of cevadine. When warmed with alcoholic soda, tiglic acid and *cevilline*, $C_{29}H_{47}O_7N$, are formed (Wright and Luff.¹)

Sabadine, $C_{29}H_{51}O_8N$, isolated by E. Merck,¹ crystallises from ether in needles, m.p. 238–240° (*dec.*). The hydrochloride, B. HCl . 2H₂O, has m.p. 282–4° (*dec.*), the nitrate, B. HNO₃, is sparingly soluble in water, and the aurichloride, B. HAuCl₄, forms golden-yellow needles.

Sabadinine, also obtained by E. Merck,¹ was shown by Hess and Mohr to be *cevine*.²⁹

White and Green Hellebores. The contradictory information recorded regarding the alkaloids of these drugs since Pelletier and Caventou isolated "veratrine" in 1820, was reviewed by Wright and Luff,¹ who also described methods for the isolation of the various alkaloids, which have been modified or added to by Salzberger,³ Bredemann,⁸ Saito, Suginome and Takaoka,³⁰ and more recently by Poethke,⁴ who has estimated and made a special study of the distribution of the various alkaloids in the organs of white hellebore grown in Bavaria and Jugoslavia.⁴ From this material he isolated jervine, rubijervine, protoveratrine and a new alkaloid germerine. Protoveratridine is not, as Salzberger suggested, a decomposition product of protoveratrine, but is produced from germerine during extraction by Salzberger's method. ψ -Jervine was found in the rhizomes, but in no other organs of the plant as collected in Upper Bavaria. Christensen and McLean¹¹ have described a biological method for the assay of green hellebore, and additions to the known alkaloids of that species have been made by Seiferle *et al.*⁵ and by Jacobs and Craig.^{6,7} A detailed account of an extraction of white hellebore has been published by Manceau *et al.*^{11(b)}

Jervine, $C_{27}H_{39}O_3N$, was first obtained by Wright and Luff¹ (1879). They assigned to it the formula $C_{26}H_{37}O_3N \cdot 2H_2O$, which was altered to that given above by Jacobs and Craig.³¹ It crystallises in stellate groups of prisms, m.p. 243–244.5° (W. and L.), 241° (Bredemann), 244–6° (J. and C.), $[\alpha]_D^{25} - 147^\circ$ (EtOH). The hydrochloride, B. HCl . 2H₂O, has m.p. 308° (W. and L.) or 330–4° (*dec.*) with a change in crystalline form at 280° (J. and C.); the hydriodide has m.p. 302–5°; the nitrate and aurichloride are both crystalline and the picrate melts at 274–284° (Seiferle⁵). Jervine dissolves in sulphuric acid to a yellow solution, which becomes green on warming or on standing. Jacobs and Heubner³¹ state that with jervine and *iso*-jervine (p. 707) two active hydrogens are found at atmospheric temperature, due to a hydroxyl group and a secondary nitrogen, and at 95° two more are recorded and doubtfully attributed to "hindered" hydroxyl groups. Jervine yields a nitroso-derivative, m.p. 251–2° (*dec.*), a *N*-acetyl derivative, m.p. 161–2°, and, with boiling acetic anhydride, a diacetyl derivative, m.p. 176–7°. On treatment with aluminium *tert*-butoxide it is converted into Δ^4 -jervone, $C_{27}H_{37}O_3N$, m.p. 193–4°, $[\alpha]_D^{28} + 28.3^\circ$ (EtOH), which yields an oxime, m.p. 287–9°, and is reduced by aluminium *isopropoxide* to Δ^4 -jervine, $C_{27}H_{39}O_3N \cdot H_2O$. This melts over the range 203–211°, and gives a deep reddish-purple colour with trichloroacetic acid; its ultra-

violet absorption curve indicates that the isomerisation has not greatly disturbed the chromophorically active feature of the jervine molecule, nor the $\Delta^{\alpha\beta}$ -ketonic type of absorption. The hydroxyl group of jervine is believed to be at C³ and it is considered that Δ^4 -jervine may be a mixture of 3- α and 3- β epimerides, but as it does not give a sparingly soluble digitonide separation was not attempted. The absorption spectrum of Δ^4 -jervone is similar to those of Δ^4 -solanidone (p. 663) and rubijervone (p. 708), but Δ^4 -jervone is more strongly absorbent and its formation is taken to indicate a 3-hydroxy- Δ^5 -structure for jervine. On hydrogenation in alcohol, in presence of platinum oxide, jervine yields dihydrojervine, $C_{27}H_{41}O_3N$, which crystallises solvent-free from acetone with m.p. 248–251°, $[\alpha]_D^{26}$ – 82° (EtOH), forms a *N*-acetyl derivative, $C_{29}H_{43}O_4N$, which melts at 157–9° and re-melts at 256–9°, and a diacetyl derivative, m.p. 210–2°. A tetrahydrojervine, m.p. 216–221°, $[\alpha]_D^{28}$ – 18° (EtOH), is formed when either jervine or its dihydro-derivative is hydrogenated in acetic acid: its *N*-acetyl derivative has m.p. 266–9° and the ultra-violet absorption spectrum indicates that the carbonyl group is still present though no oxime could be prepared. Jervine, on reduction by sodium in butanol produces a so-called tetrahydrojervine, which is in reality α -dihydrojervinol, $C_{27}H_{43}O_3N$, m.p. 223–5°, $[\alpha]_D^{27}$ – 107° (EtOH). When dihydrojervine is similarly reduced, β -dihydrojervinol, m.p. 286–9°, $[\alpha]_D^{28}$ – 4° (EtOH), is formed, and this in turn can be hydrogenated in acetic acid to tetrahydrojervinol, $C_{27}H_{45}O_3N$, m.p. 293–6°, $[\alpha]_D^{28}$ + 48·5° (EtOH), which is also obtained when tetrahydrojervine is reduced by sodium in butanol. In these reactions it is thought that the Δ^5 -double bond has been saturated in dihydrojervine, and that the carbonyl group is reduced in the formation of the jervinols.

*iso*Jervine proved resistant to hydrogenation and in acetic acid only a trace of a product, $C_{27}H_{45}O_2N$ (hexahydrodeoxy*iso*jervine), m.p. 163–5° or 218–220° (*solvent-free*), $[\alpha]_D^{26}$ + 26° (*solvent-free*; EtOH), could be obtained; in this reaction the double bonds seem to have been saturated and the oxygen atom of the carbonyl or hydroxyl group lost; the substance may equally well have the formula $C_{27}H_{47}O_2N$. On reduction with sodium in butanol *iso*jervine yields dihydro*iso*jervinol, $C_{27}H_{43}O_3N \cdot H_2O$, m.p. 135–140°, $[\alpha]_D^{25}$ + 84° (*dry*; EtOH). *iso*Jervine changes rapidly in alkaline solution. On acetylation, *N*-acetyl*iso*jervine, m.p. 202–3°, is formed and on further treatment, *N*-acetyl*iso*jervine diacetate (triacetyl*iso*jervine), $C_{33}H_{45}O_6N$, m.p. 192–3°.

A formula is tentatively suggested for jervine, based on the formula for sapogenin (IV, p. 665) with the following changes: CO at C¹², ethylenic linkages, Δ^5 and Δ^7 , and the oxygen of the six-membered heterocyclic ring at the extreme right changed to NH. Alternative structures for the side-chain are also discussed, especially in relation to the isomerisation of jervine to *iso*jervine (p. 707).

On selenium dehydrogenation at 340° jervine, like cevine, yields three types of products.³²

Bases. 5-Methyl-2-ethylpyridine.

$C_8H_{11}ON$, m.p. 145–7°, possibly 5-methyl-2-ethyl-3-hydroxypyridine.

Hydrocarbons. $C_{14}H_{14}$, m.p. 87–9°, possibly a methyl-4 : 5-benzohydrindene.

$C_{20}H_{22}$, m.p. 79°; $C_{24}H_{30}$, m.p. 100–1°; $C_{21}H_{24}$, m.p. 70–81°. These three hydrocarbons have absorption spectra curves very similar to that provided by the $C_{17}H_{16}$ hydrocarbon from cevine (p. 703) and like it give the Vanschiedt colour test; ²⁶ they are provisionally regarded as homologues of a tetracyclic fluorene, possibly a cyclopentenofluorene.

$C_{20}H_{16}$, m.p. 125–7°; $C_{22}H_{20}$, m.p. 154–5°. This pair appears to be pentacyclic. Both hydrocarbons give a modified Vanschiedt test. Their absorption curves are quite unlike those characteristic of the cevine hydrocarbons, the difference being due probably to the additional, aromatic ring and in confirmation of this, their absorption curves are strikingly similar to that of 1 : 2-benzofluorene, of which they may be homologues.

Pseudojervine, $C_{33}H_{49}O_8N$, was first obtained by Wright and Luff,¹ and later by Salzberger.³ It crystallises from alcohol in hexagonal tablets, m.p. 300–7° (*dec.*), and has $[\alpha]_D^{20} - 139^\circ$ ($CHCl_3$).⁴ It dissolves with a green colour in sulphuric acid. The hydrochloride, $B.HCl \cdot 2H_2O$, m.p. 254–6° (*corr., dec.*), and sulphate are crystalline, but the aurichloride is amorphous. The formula, $C_{33}H_{49}O_8N$, is due to Poethke,⁴ who further found that the alkaloid is a secondary base, giving a nitroso-derivative, m.p. 261°, and contains five replaceable hydrogen atoms. Jacobs and Craig⁶ confirmed this formula and showed that on boiling with dilute hydrochloric acid pseudojervine is hydrolysed to *d*-glucose and an isomeride of jervine, which has been named *isojervine*. The latter crystallises with solvent, *e.g.*, $C_{27}H_{39}O_3N \cdot CHCl_3$, softens 135–150°, or $B.EtOH$, m.p. 114–6° (*dec.*). The acetone-form, $B.C_3H_6O$, has m.p. 110–4°, $[\alpha]_D^{30} - 32^\circ$ ($EtOH$). Jervine (p. 705) is converted into *isojervine* on standing for a short time in methyl alcohol saturated with hydrogen chloride, and this isomerisation no doubt occurs in the acid hydrolysis of pseudojervine. Dihydropseudojervine on hydrolysis yields glucose and dihydrojervine.

Veratrosine, $C_{33}H_{49}O_7N$, accompanies pseudojervine in *V. viride*. It has m.p. 242–3° (*dec.*), $[\alpha]_D^{25} - 53 \cdot 0^\circ$ ($EtOH + CHCl_3$), and on hydrolysis by boiling, dilute hydrochloric acid furnishes *d*-glucose and veratramine.⁶

Veratramine, $C_{27}H_{39}O_2N$, occurs naturally in *V. viride* and *V. grandiflorum*⁷ and is also formed by the hydrolysis of veratrosine.⁶ It has m.p. 209–210·5°, $[\alpha]_D^{27} - 68^\circ$ ($MeOH$), and yields a dihydro-derivative, m.p. 198–200°, and a triacetyl-derivative, m.p. 204–6°, which on controlled hydrolysis leaves a *N*-acetyl derivative, m.p. 177–180°. According to Saito, veratramine on treatment with methyl iodide in methyl alcohol in presence of sodium carbonate, yields *N*-methylveratramine methiodide, m.p. 268° (*dec.*), from which the methochloride, m.p. 277°, can be prepared.

Rubijervine, $C_{27}H_{43}O_2N$, first obtained by Wright and Luff¹ and subsequently prepared by Salzberger³ and by Bredemann⁸ has been re-examined recently by Jacobs and Craig,² who have replaced Wright and Luff's formula, $C_{26}H_{43}O_2N$, by that given above. The alkaloid

crystallises from alcohol in needles, m.p. 240–2°, $[\alpha]_D^{25} + 19.0^\circ$ (EtOH). It was shown by Poethke ⁴ to be a tertiary base, probably containing both oxygen atoms as hydroxyl groups. The hydrobromide has m.p. 265–270° and the hydriodide, m.p. 293–6°. The diacetyl derivative melts at 160–3°. On hydrogenation rubijervine yields a dihydro-derivative, m.p. 222°, from which a diacetyl derivative, $C_{31}H_{49}O_4N$, m.p. 216–9°, was prepared.³³ The alkaloid dissolves in sulphuric acid with a yellow colour passing into reddish-brown. Warmed with hydrochloric acid, it gives a reddish-violet coloration. It does not yield an acetyl compound.

On selenium dehydrogenation at 340° rubijervine yields 5-methyl-2-ethylpyridine, and a relatively large fraction of a hydrocarbon, $C_{18}H_{16}$, m.p. 74–7°, which gives a picrate, m.p. 131–2°, and a *sym*-trinitrobenzene additive compound, m.p. 144–5°. This hydrocarbon is regarded as an isomeride of Diels's methylcyclopentenophenanthrene, the characteristic dehydrogenation product of the sterols, because of the close similarity of its ultra-violet absorption curve to that of 1 : 2-cyclopentenophenanthrene and its resemblance to α -methyl-1 : 2-cyclopentenophenanthrene which has m.p. 76–7° and forms a trinitrobenzene derivative, m.p. 143–4°. A third product of the action is a phenol, $C_{18}H_{16}O$, m.p. 136–8°, which may be a hydroxyl derivative of the $C_{18}H_{16}$ hydrocarbon. The probability that the $C_{18}H_{16}$ hydrocarbon is a cyclopentenophenanthrene brings rubijervine into relationship with solanidine, which yields Diels's hydrocarbon on dehydrogenation and has been assigned a structure of the normal sterol type. Rubijervine should therefore undergo sterol reactions and it has been found that, like solanidine,³⁴ it can be converted, by either the Sexton or the Oppenauer process,³⁵ to the corresponding ketone, rubijervone, $C_{27}H_{41}O_2N$, m.p. 205–9°, $[\alpha]_D^{30} + 100^\circ$ (EtOH), yielding an oxime, m.p. 160°, re-melting at 247–254°.³⁶ The ketone is reduced by sodium *isopropyl* oxide to the corresponding epimeric alcohols,³⁷ from which in solution in ether there separated the sparingly soluble *epiallorubijervine*, $C_{27}H_{43}O_2N$, m.p. 228–231°, $[\alpha]_D^{26} + 63^\circ$ (EtOH). From the remaining mixture the digitonide was precipitated and from it was recovered the epimeride, *allorubijervine*, $C_{27}H_{43}O_2N \cdot H_2O$, m.p. 176–8°, $[\alpha]_D^{25} + 40^\circ$ (EtOH). The mixture and both epimerides gave Rosenheim's colour reaction with trichloroacetic acid.³⁸ Comparative surface film studies have also been made with rubijervine, *isorubijervine* (*see below*), diacetylrubijervine and solanidine, and the results indicate that solanidine has approximately the same molecular dimensions as rubijervine.³⁹

isoRubijervine, $C_{27}H_{43}O_2N$. This alkaloid was found by Jacobs and Craig, accompanying rubijervine, in working up the benzene-soluble fraction of the alkaloids of *Veratrum album*,² and was later isolated from *V. viride*.³⁸ It crystallises with solvent, from hot alcohol, by rapid cooling, in needles, and then melts at 218°, or slowly in anhydrous prisms, with m.p. 241–4°, $[\alpha]_D^{25} + 9.4^\circ$ (EtOH). The dihydro-derivative has m.p. 244°. The hydrobromide sinters above 275° and slowly resinifies at 290–5°. It precipitates with digitonin and can be dehydrogenated by either the Sexton or the Oppenauer process³⁵ to the corresponding ketone. *iso*-

rubijervone, $C_{27}H_{41}O_2N$, m.p. $> 250^\circ$, $[\alpha]_D^{27^\circ} + 111^\circ$, which yields an oxime, m.p. $250-4^\circ$ (*dec.*), and is reduced by aluminium isopropoxide to the corresponding epimeric alcohols.³⁸ From the digitonide prepared from the mixture *alloisorubijervine*, m.p. $250-1^\circ$, $[\alpha]_D^{25^\circ} + 63^\circ$ ($CHCl_3$), was recovered. Like the mixture of epimerides it gives the Rosenheim colour reaction with trichloroacetic acid.

The selenium-dehydrogenation products of *isorubijervine* have not yet been fully examined, but the two structurally significant products, 5-methyl-2-ethylpyridine and a hydrocarbon, $C_{17}H_{14}$, m.p. $135-6^\circ$, yielding a picrate, m.p. $134-5^\circ$ and a 1 : 3 : 5-trinitrobenzene addition compound, m.p. $165-6^\circ$, which identify it as 1 : 2-cyclopentenophenanthrene, indicate for *isorubijervine*, as for rubijervine, a normal sterol structure, for the non-nitrogenous portion of the molecule.³⁸

Protoveratrine, $C_{39}H_{61}O_{13}N$, was first isolated by Salzberger³ and re-examined by Poethke.⁴ It has recently been investigated by Jacobs and Craig,⁴⁰ to whom the above formula is due and who describe it as crystallising from alcohol in platelets and decomposing at temperatures varying from 275° to 283° , depending on the rate of heating; it has $[\alpha]_D^{27^\circ} - 40^\circ$ (pyridine). The following data are mainly due to Poethke. The base has $[\alpha]_D^{20^\circ} - 9.1^\circ$ ($CHCl_3$) and dissolves in sulphuric acid, giving a blue colour passing into violet on warming. Hydrochloric and phosphoric acids on warming give a cherry-red solution, which develops an odour of *isobutyric acid*. The hydrochloride, B. $HCl \cdot H_2O$, forms small tablets, m.p. $234-6^\circ$ (*dec.*); the hydrobromide, B. $HBr \cdot 3H_2O$, melts at $230-2^\circ$ (*dec.*); the picrate at $216-220^\circ$ (*dec.*); and the aurichloride at 199° (*dec.*).

Poethke shows that on alkaline hydrolysis protoveratrine yields acetic, *l*-methylethylacetic and methylethylglycolic acids and the alkamine *protoverine*. It is therefore a triacyl ester of protoverine.

PROTOVERINE and *iso*PROTOVERINE, $C_{27}H_{43}O_9N$. Protoverine was first obtained crystalline by Jacobs and Craig,⁴⁰ who showed that *isoprotoverine* is also formed in the alkaline hydrolysis of protoveratrine, by the further action of the alkali on protoverine. The latter crystallises with solvent, e.g., B. $2MeOH$, softens gradually to an effervescing resin at $195-200^\circ$, $[\alpha]_D^{25^\circ} - 12^\circ$ (pyridine); B. H_2O has m.p. $210-6^\circ$. In presence of hydrochloric acid and acetone protoverine forms acetylprotoverine hydrochloride, $C_{30}H_{48}O_9NCl$, m.p. $278-281^\circ$ (*dec.*), from which the free base, m.p. $253-6^\circ$ (*dec.*), can be recovered by the use of sodium carbonate. It contains seven replaceable hydrogen atoms; two more must be engaged in the acetyl combination, which agrees with the nine replaceable hydrogens found for protoverine, and accounts for the nine oxygen atoms of the latter as hydroxyl groups. Protoverine could not be catalytically hydrogenated but is reduced by sodium in boiling butyl alcohol to a dihydro-derivative, which does not melt but begins to decompose above 300° , has $[\alpha]_D^{25^\circ} - 54^\circ$ (pyridine) and in view of the action of alkali may be a derivative of either protoverine or its isomeride.

*iso*Protoverine crystallises, without solvent, from methyl alcohol; it begins to decompose above 240° , effervesces at 264° , and has $[\alpha]_D^{28^\circ} - 42^\circ$

(pyridine); it combines with acetone but the product could not be crystallised. Unlike its isomeride, *isoprotoverine* can be hydrogenated, forming a dihydro-derivative, which crystallises with solvent, *e.g.*, $C_{27}H_{45}O_9N \cdot 2MeOH$, slowly decomposes at $315-320^\circ$ and has $[\alpha]_D^{25} - 49^\circ$ (pyridine). The products of selenium dehydrogenation of protoveratrine have been described by Craig and Jacobs⁴⁰ (1942); they include the three acids already mentioned as hydrolytic products, 5-methyl-2-ethylpyridine, 2:5-dimethylpyridine, a base, C_8H_9ON , giving a picrate, m.p. $114-7^\circ$, with cevanthridine (p. 703) and probably cevanthrol. These products indicate that protoverine has a ring structure similar to that of cevine.

Protoveratridine, $C_{32}H_{51}O_9N$. Poethke⁴ has shown that, as Salzberger suspected, this alkaloid does not occur naturally, but is formed from germerine by loss of a molecule of methylethylglycollic acid in Salzberger's process of extraction. It forms glancing crystals, m.p. $266-7^\circ$ (*dec.*), and yields a crystalline hydrochloride, m.p. $243-5^\circ$ (*dec.*), picrate, m.p. $244-6^\circ$ (*dec.*), aurichloride, and platinichloride, m.p. $195-200^\circ$ (*dec.*). On alkaline hydrolysis protoveratridine yields *l*-methylethylacetic acid, and germine, also formed by the alkaline hydrolysis of germerine (*see below*). The alkaloid gives a red colour with sulphuric acid and a carmine-red colour with hydrochloric acid, an odour of *isobutyric* acid being developed on warming.

Germerine, $C_{37}H_{59}O_{11}N$. This alkaloid was isolated from *Veratrum album* by Poethke,⁴ who assigned to it the formula $C_{36}H_{57}O_{11}N$, which has to be altered to that given above to accommodate the new formula found by Craig and Jacobs⁴⁰ for germine (*see below*). It crystallises from benzene in leaflets, m.p. $193-5^\circ$ (*dec.*), $[\alpha]_D^{20} + 10.8^\circ$ ($CHCl_3$), and forms well-crystallised salts: hydrochloride, $B \cdot HCl \cdot 2H_2O$, needles, m.p. 215° (*dec.*); hydrobromide, $B \cdot HBr$, needles, m.p. $212-3^\circ$ (*dec.*); acid sulphate, $B \cdot H_2SO_4$, leaflets; picrate, m.p. $186-7^\circ$ (*dec.*). The aurichloride is amorphous. Germerine with strong sulphuric acid gives a colourless solution which becomes carmine-red on standing or on warming, and with Fröhde's reagent it slowly produces a reddish-violet colour, whereas protoveratridine is at once coloured violet by this reagent. On alkaline hydrolysis germerine gives germine, *l*-methylethylacetic acid and methylethylglycollic acid. On standing with an aqueous solution of barium hydroxide germerine is converted into protoveratridine (*see above*) by loss of 1 mol. of methylethylglycollic acid.

GERMINE, $C_{27}H_{43}O_8N$. This alkaloid is produced by the hydrolysis of either germerine or protoveratridine, but it also occurs naturally in white and green hellebores. It was first obtained by Poethke⁴ and has been investigated recently by Craig and Jacobs,⁴¹ who have altered Poethke's formula, $C_{26}H_{41}O_8N$, to that given above, which makes it isomeric with cevine (p. 702), a base it closely resembles in several respects. Craig and Jacobs prepared their alkaloid by saponifying the mixture of amorphous alkaloids left after the removal of all directly crystallising bases from the total alkaloids of *V. album*, and separating it from the associated alkamines, rubijervine, *isorubijervine* and *isogerminine* so produced. Germine

crystallises with solvents, *e.g.*, from methyl alcohol, as B. 2MeOH, in prisms, effervescing at 163–173° and finally melting at 220°; $[\alpha]_D^{25} + 5^\circ$ (EtOH), or $+ 21.1^\circ$ (dil. acetic acid). The aurichloride, B. HAuCl₄, forms golden-yellow leaflets: the picrate sinters at 175° and decomposes at 190–205°. The amine oxide crystallises in needles, m.p. 249° (*dec.*). Germinine, like cevine, contains eight replaceable hydrogen atoms. In presence of hydrochloric acid it combines with acetone to form acetylgerminine hydrochloride, C₃₀H₄₇O₈N.HCl, platelets gradually shrinking above 255° to a resin, m.p. 275° (*dec.*). The free base recovered from the salt melted gradually at 235–9° (*dec.*). It has not been possible to hydrogenate germinine, but it is reduced by sodium in boiling butyl alcohol to dihydrogerminine, C₂₇H₄₅O₈N, which resinifies $>258^\circ$ and melts at 265°; $[\alpha]_D^{28} - 57^\circ$ (pyridine). This still contains eight replaceable hydrogen atoms and yields a hydrochloride, m.p. $>265^\circ$ (*dec.*).³³ On oxidation with chromic acid germinine yields the hexanetetracarboxylic acid, isolated as the tetramethyl ester, m.p. 63–4°, $[\alpha]_D^{25} + 21^\circ$ (MeOH), already obtained from cevine, but no decevinic acid could be obtained from the oxidation acids. On dehydrogenation with selenium at 340° germinine, like cevine, yields β -picoline, 5-methyl-2-ethylpyridine, cevanthrol and cevanthridine. A hydrocarbon provisionally formulated as C₁₈H₁₈, m.p. 160–7°, was also obtained.

*iso*GERMININE, C₂₇H₄₃O₈N. This was found by Craig and Jacobs⁴⁰ in the chloroform mother liquors from the crystallisation of germinine, and is produced by the action of sodium hydroxide in methyl alcohol on germinine.³³ It crystallises from methyl alcohol without solvent and then darkens $>245^\circ$, sinters $>250^\circ$ and melts at 260°; $[\alpha]_D^{25} - 46.5^\circ$ (EtOH). In presence of platinum oxide as catalyst in methyl alcohol, it hydrogenates to dihydroisogerminine, which darkens $>265^\circ$ and melts at 277–8° (*dec.*); $[\alpha]_D^{28} - 61^\circ$ (pyridine). The dihydro-base still contains eight replaceable hydrogen atoms.³³

Structure of the Veratrum Alkamines. These substances, with the exception of jervine (p. 705), are all tertiary bases containing one ethylenic linkage and having all their oxygen atoms in the form of hydroxyl groups. On selenium dehydrogenation they all yield as one basic substance, 5-methyl-2-ethylpyridine. The hydrocarbons produced in this reaction are mainly of two types, *cyclopenteno*fluorenes and *cyclopentenophenanthrenes*. Recognition of the former type is based mainly on the evidence of ultra-violet absorption curves, *e.g.*, the hydrocarbons C₁₇H₁₆ from cevine (p. 703) and C₂₀H₂₂, C₂₄H₃₀ and possibly C₂₁H₂₄, all from jervine (p. 707), give curves closely resembling that of fluorene and are regarded as probably homologues of a tetracyclic fluorene, possibly a *cyclopenteno*fluorene (I), while a second set, represented by C₂₀H₁₆ and C₂₂H₂₀ from jervine, may be homologues of either 1:2- or 2:3-benzofluorene.³² For this type of veratrum alkamine, which includes cevine, germinine and protoverine, Jacobs and Craig⁴³ have proposed the nuclear structure (II) of which the heterocyclic portion needs modification to accommodate the secondary base jervine, for which the partial formula (IIa) was

suggested. Formula (II) explains the formation of the supposed hexanetetracarboxylic acid $(\text{COOH} \cdot \text{CMe} \cdot \text{CH}_2 \cdot \text{COOH})_2$, resulting from the oxidation of cevine (p. 704) or germine (p. 711) by oxidative scission of rings (a) and (b) at the points indicated, but as it has since been found (Huebner and Jacobs²⁷) that this acid has not the structure suggested it is now thought that, as in rubijervine and *isorubijervine*, in this type of veratrum alkamine the normal sterol system of rings is also present. Rings (e) and (f) account for the production of 5-methyl-2-ethylpyridine and though the points of attachment have not been proved,³⁹ their location at C¹⁶ and C¹⁷ is supported by the formula assigned to solanidine (p. 665), and this alkamine also yields 5-methyl-2-ethylpyridine on selenium dehydrogenation.⁴²

In the 1943 paper⁴³ a more detailed discussion of the formula is given with a suggestion for a possible mode of formation for cevanthridine, and for possible location of the hydroxyl groups, one of which in rubijervine and *isorubijervine* is placed at C³, as in solanidine, to account for the formation of sparingly soluble digitonides. This is also considered a certain position for one hydroxyl group in the other veratrum alkamines. In cevine there are possibly hydroxyl groups at C³, C²¹, C²³ and C¹⁵. If the formation of the hexanetetracarboxylic acid by oxidation of cevine or germine is correctly interpreted, there cannot be hydroxyl groups at C¹, C² or C⁷. There is at present no definite evidence as to the position of the ethylenic linkage in these bases.

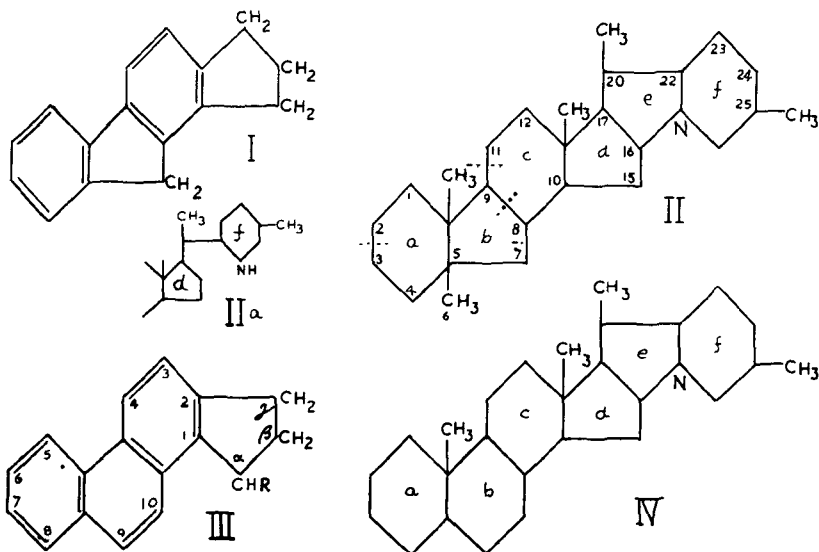

*iso*Rubijervine and rubijervine, like the other veratrum alkamines, yield 5-methyl-2-ethylpyridine on selenium dehydrogenation, but the two significant hydrocarbons formed in this reaction are from the former, the 1 : 2-cyclopentenophenanthrene (III : R = H) synthesised by Ruzicka

*et al.*⁴⁴ and from the second a methylcyclopentenophenanthrene, which is possibly identical with α methylcyclopentenophenanthrene (III : R = CH₃), also synthesised by Ruzicka *et al.*⁴⁴ The formation of these cyclopentenophenanthrenes suggests that rubijervine and its isomeride have a normal sterol structure, in which case they might be expected to yield, like solanidine and solasodine (p. 666), γ -methylcyclopentenophenanthrene⁴³ (Diels's hydrocarbon). Support for the sterol type of formula for rubijervine and its isomeride is provided by the fact that, as already described (p. 707) they undergo a transition analogous with that of cholesterol *via* cholestenone to *allo*- and *epiallo*-cholesterols. A similar transformation could not be effected with cevine. Further, rubijervine and *isorubijervine*, alone among the veratrum alkalamines, but in common with solanidine, form sparingly soluble digitonides. They are therefore regarded as having a nuclear ring system (IV) like that of solanidine and which differs from that (II) of the other veratrum alkalamines by the enlargement of ring (*b*) from 5 to 6 carbons and the elimination of the angular methyl at C⁵.

Biological Work on Veratrum Alkaloids. Much of the early pharmacological work on these alkaloids was done with "veratrine," the mixture of alkaloids obtained from *sabadilla* seeds and consisting largely of veratridine and cevadine with a small amount of cevine, and it is only recently that the individual alkaloids have been used. The ester alkaloids cevadine, germerine, protoveratridine, protoveratrine and veratridine vary in activity but in general are more potent pharmacologically than the alkalamines cevine, gervine, jervine, protoverine and rubijervine. The intravenous L.D./50 dose, mgm./kilo, for mice of protoveratrine is 0.048 and of its hydrolytic alkalamine, protoverine, it is 194 : the corresponding figures for cevadine and its alkalamine, cevine, are 1.0 and 87.0 respectively, and for the alkalamines jervine and rubijervine 9.3 and 70.0 respectively. Protoveratrine is much the most toxic alkaloid of the series.

Neither the drugs yielding these alkaloids nor the alkaloids themselves are now recognised in the British or United States Pharmacopœia, but the drugs still appear in non-official publications along with "veratrine," which may be either amorphous, *i.e.*, the mixture already referred to, or crystalline, *i.e.*, the alkaloid cevadine.

It is customary to regard "veratrine," aconitine and delphinine as a group of poisonous alkaloids, exhibiting considerable similarity in action. "Veratrine" stimulates the sensory nerve endings and when applied to the skin gives rise to pricking sensations, and in contact with the mucous membrane of the nose induces violent sneezing. The individual ester alkaloids of the group cause a decrease in rate of respiration and in this respect there seems to be little difference between cevadine, germerine and veratridine. Small doses of the ester alkaloids lead to vasodilatation and fall in blood pressure. This effect is also produced by jervine in large doses, but not by cevine. It is accompanied by decrease in heart rate and, especially after veratridine, by a decrease in rate and depth of respiration. In view of the accumulating evidence of structural similarity between the

cardiac glucosides and the veratrum alkaloids, special interest attaches to the action of the latter on the heart. According to Krayer and Acheson,⁴⁵ the major effects are (1) a positive inotropic action, (2) a moderate change in sinus rate, (3) the production of irregularities, and (4) prolongation of the beat.

The most interesting effect of the ester alkaloids is their action on the skeletal neuromuscular system, first observed by Bezold and Hirt in 1867, and described by Krayer and Acheson as follows: "Veratrine renders certain tissues capable of responding to brief stimuli in a characteristically prolonged manner. These responses we designate as veratrine responses. Instead of the normal single all-or-none impulse, the tissues exhibit a repetitive response consisting of a series of all-or-none impulses, which long outlasts the stimulus. The prolonged veratrine response is therefore similar to the after discharge observed in some reflex systems. The veratrine response is found in all varieties of nerve and skeletal muscle, which have been tested. The phenomenon has been observed in the heart only in special circumstances. It occurs in a number of non-striated, invertebrate muscles, but its occurrence in vertebrate smooth muscle has not been established." Much pharmacological work has been done on "veratrine," and since individual veratrum alkaloids have become available, much progress has been made in the investigation and interpretation of the action of these substances. In their comprehensive monograph on "The Pharmacology of the Veratrum Alkaloids," Krayer and Acheson⁴⁵ review the whole of this work and discuss in detail the views and theories, which have been evolved as to the mode of action of these bases. The monograph includes an exhaustive bibliography. There has been recently some revival of interest in the treatment of eclampsia by preparations of green hellebore.^{45(a)}

In the intensive search of recent years for insecticides, it was natural that the veratrum group should receive attention, as white hellebore (*Veratrum album*) and sabadilla seeds have long been used for the destruction of insect pests. Methods for the evaluation of insecticides have been worked out by Jaretsky and Janecke,¹² and by Allen, Dicke and Brooks,¹² and have been used for preparations of sabadilla and its alkaloids. According to Ikawa, Dicke, Allen and Link,⁴⁶ veratridine in kerosene is highly toxic to the house-fly and cevadine and the residual mixed alkaloids of sabadilla less so, though they are effective "knock-down" insecticides and are more potent than the pyrethrins. Cevine is not toxic. For some insects cevadine is more toxic than either "veratrine" or veratridine. Ground sabadilla seed has also been used alone or mixed with slaked lime,⁴⁷ and is stated to have a considerable range of activity against insect parasites. Alkaloidal extracts of *Veratrum viride* (American hellebore) were found to be highly toxic to the American cockroach,⁵ *Periplaneta americana*, but individual alkaloidal components of this drug, jervine and ψ -jervine were not toxic and germine only partly toxic; the results indicate the presence of another and more toxic alkaloid such as germerine. A useful summary of information on sabadilla as an insecticide has been

published in the *Bulletin of the Imperial Institute*, which also provides each quarter a bibliography of insecticides of vegetable origin.⁴⁸

REFERENCES

- (1) The first systematic investigation of all three species was made by WRIGHT and LUFF: sabadilla, *J. Chem. Soc.*, 1878, 33, 338; white hellebore, *ibid.*, 1879, 35, 405; green hellebore, *ibid.*, 1879, 35, 421. See also BOSETTI, *Arch. Pharm.*, 1883, 221, 82; G. MERCK, *Annalen*, 1855, 95, 200; E. MERCK, *Chem. Soc.*, Abstr., 1891, 60, 844. (2) JACOBS and CRAIG, *J. Biol. Chem.*, 1943, 148, 41. (3) SALZBERGER, *Arch. Pharm.*, 1890, 228, 462. (4) POETHKE, *ibid.*, 1937, 275, 357, 571; 1938, 276, 170. (5) SEIFERLE, JOHNS and RICHARDSON, *J. Econ. Entom.*, 1942, 35, 35. (6) JACOBS and CRAIG, *J. Biol. Chem.*, 1944, 155, 565. (7) SAITO, *Bull. Chem. Soc. Jap.*, 1940, 15, 22; JACOBS and CRAIG, *J. Biol. Chem.*, 1945, 160, 555. (8) *Apoth. Zeit.*, 1906, 21, 41, 53. (9) "Die Fabrikation der Alkaloide," Berlin, 1927. (10) "Die Pflanzenstoffe," Jena, 1929; SAITO.⁷ (11) GSTIRNER, *Pharm. Zeit.*, 1932, 77, 509; JACOBSEN, *Dansk. Tids. farm.*, 1935, 9, 302; KÜRSCHNER and IMMENKAMP, *Pharm. Zent.*, 1936, 77, 458; DUCOMMUN, *Pharm. Acta Helv.*, 1936, 11, 322; NOVOSIL'TSEVA and MOGIL'SKII, *Farmatsiya*, 1945, 8, 30 (*Chem. Abstr.*, 1947, 41, 3258). (11a) HUMMELSHEIM, *Arch. exp. Path. Pharm.*, 1933, 172, 227; CHRISTENSEN and MCLEAN, *J. Amer. Pharm. Assoc.*, 1936, 25, 414; VIEHOVER and COHEN, *Amer. J. Pharm.*, 1939, 111, 86; COHEN, *ibid.*, p. 240; WU, *Bull. Nat. Form. Comm. U.S.A.*, 1947, 15, 74. (11b) MANCEAU *et al.*, *Ann. pharm. franc.*, 1945, 3, 11. (12) JARETZKY and JANECKE, *Arch. Pharm.*, 1940, 227, 34, 82; LINDEWALD and STREUBERT, *Suddeut. Apoth. Zeit.*, 1942, 82, 59; ALLEN, DICKE and BROOKS, *Soap*, 1943, 19, No. 4, 99, 121; SEIFERLE *et al.*⁵ (13) SWANSON and HARGREAVES, *J. Amer. Pharm. Assoc.*, 1930, 19, 122. (13a) *Dansk. Tids. Farm.*, 1945, 19, 222. (14) *Annalen*, 1877, 185, 224. (15) *Ber.*, 1890, 23, 2700. (16) Cf. FREUND and SCHWARZ, *ibid.*, 1899, 32, 800. (17) MACBETH and ROBINSON, *J. Chem. Soc.*, 1922, 121, 1574. (18) FRANKFORTER, *Amer. Chem. J.*, 1898, 20, 361. (19) HORST, *Chem. Zeit.*, 1902, 26, 334. (20) *J. Biol. Chem.*, 1938, 125, 625. For previous papers see, *ibid.*, 1937, 119, 141; 120, 447; 1938, 124, 659. (21) FREUND (with SPEYER), *Ber.*, 1904, 37, 1946 (with SCHWARZ), *J. pr. Chem.*, 1917, [ii], 96, 236. (22) *J. Chem. Soc.*, 1935, 122 (with CROWFOOT), *ibid.*, 1936, 414. (23) *J. Biol. Chem.*, 1941, 139, 293. (24) *Ibid.*, 1939, 129, 79; 1941, 139, 263. (25) CRAIG, JACOBS and LAVIN, *idem*, p. 277. (26) *J. Gen. Chem. Russ.*, 1934, 4, 875. (27) CRAIG and JACOBS, *J. Amer. Chem. Soc.*, 1939, 61, 2252; *J. Biol. Chem.*, 1940, 134, 123; 1941, 141, 253; HUEBNER and JACOBS, 1947, 170, 181. (28) *Ber.*, 1876, 9, 1115. (29) *Ibid.*, 1919, 52, 1984. (30) *Bull. Chem. Soc. Jap.*, 1934, 9, 15; 1936, 11, 168, 172. (31) *J. Biol. Chem.*, 1943, 148, 51; 1947, 170, 635. (32) JACOBS, CRAIG and LAVIN, *ibid.*, 1941, 141, 51. (33) CRAIG and JACOBS, *J. Biol. Chem.*, 1943, 149, 451. (34) SCHÖPF and HERRMANN, *Ber.*, 1933, 66, 298. (35) SEXTON, *J. Chem. Soc.*, 1928, 2825; OPPENAUER, *Rec. trav. Chim.*, 1937, 56, 137. (36) JACOBS and CRAIG, *J. Biol. Chem.*, 1944, 152, 641. (37) SCHOENHEIMER and EVANS, *ibid.*, 1936, 114, 567. (38) *J. Biol. Chem.*, 1945, 159, 617. (39) ROTHEN and CRAIG, *J. Amer. Chem. Soc.*, 1943, 65, 1102. (40) *J. Biol. Chem.*, 1942, 143, 427; 1943, 149, 271. (41) *Ibid.*, 1943, 148, 57. (42) CRAIG and JACOBS, *Science*, 1943, 97, 122; cf. ROCHELMMEYER, *Arch. Pharm.*, 1936, 274, 543; 1937, 275, 336, and PRELOG and SZPILFOGEL, *Helv. Chim. Acta*, 1942, 25, 306. (43) CRAIG and JACOBS, *J. Biol. Chem.*, 1941, 141, 253; 1943, 149, 451; (43a) 1945, 160, 243. (44) *Helv. Chim. Acta*, 1933, 16, 833. (45) *Physiological Reviews*, 1946, 26, 383; see also JAGUES, *Rev. Can. biol.*, 1946, 5, 246. (45a) WILLSON, *Amer. J. Obstet. Gyn.*, 1946, 52, 273. (46) *J. Biol. Chem.*, 1945, 159, 517; *J. Econ. Entom.*, 1944, 37, 400; ALLEN, LINK, IKAWA and BRUNN, *ibid.*, 1945, 38, 293. (47) FISHER and STANLEY, *ibid.*, p. 125; ANDERSON, *ibid.*, p. 564. (48) *Bull. Imp. Inst.*, 1946, 44, 102, 124; 1947, 45, 156.

ALKALOIDS OF UNDETERMINED CONSTITUTION

ALKALOIDS OF *ALSTONIA* SPP.

THE barks of *Alstonia* species (Apocynaceæ) had a considerable reputation throughout the tropics as effective anti-malarial drugs, which led to their inclusion in the British Pharmacopœia, 1914, and to their chemical examination by various workers. The following is a list of the species examined and of the alkaloids found. The figures in brackets are percentages of total alkaloids.

- (1) *Alstonia constricta* F. Muell. Alstonine (chlorogenine), alstonidine, porphyrine, porphyrosine (Hesse ¹); alstonine, and three uncharacterised, amorphous bases A, B and C (Sharp ²) (0·4); alstonine and alstoniline (Hawkins and Elderfield).^{2(a)}
- (2) *Alstonia macrophylla* Wall. Villalstonine, macralstonine, macralstonidine and base M (Sharp,³ cf. Santos) (0·9).
- (3) *Alstonia somersetensis* F. M. Bailey. Villalstonine, macralstonidine (Sharp ³) (1·4).
- (4) *Alstonia villosa* Blum. Villalstonine, base V (Sharp ³) (1·45).
- (5) *A. verticillosa* F. Muell. Echitamine (Sharp ³) (0·27).
- (6) *A. scholaris* R. Br. Ditamine, echitamine (ditaine of Harnack ⁴) and echitenine (Hesse ⁵); echitamidine (Goodson ⁶) (0·16 to 0·40).
- (7) *A. spectabilis* R. Br. Ditamine, echitamine, echitenine, alstonamine (Hesse ⁷).
- (8) *A. angustiloba* Miq. Echitamine (Goodson ⁶) (0·17).
- (9) *A. congensis* Eng. Echitamine, echitamidine ⁶ (0·2 to 0·6).
- (10) *A. Gilletii* De Wild. Echitamine.⁶
- (11) *A. spathulata* Blume. Echitamine ⁶ (0·06).

Most of these barks also contain considerable quantities of unnamed and uncharacterised amorphous alkaloids. The barks fall into three groups as sources of (a) alstonine, only found in *A. constricta*; (b) villalstonine, found in Nos. (2) to (4); and (c) echitamine, isolated from Nos. (5) to (11). It is unusual to find species belonging to the same genus divided into such well-marked groups, in respect of their alkaloidal constituents.

Alstonine, $C_{21}H_{20}O_3N_2$. The base was first obtained crystalline by Sharp.² It is unstable, and cannot be recrystallised without loss, but has been obtained by precipitation, followed by trituration with water, as a microcrystalline, yellow powder, $B \cdot 4H_2O$, sintering at 77° and decomposing at 130°, or from dry alcohol in pale yellow crystals, $B \cdot 1\cdot25 H_2O$, sintering at 87° and decomposing at 254°. It yields well-crystallised salts: the sulphate, $B_2 \cdot H_2SO_4 \cdot 5H_2O$, forms stout, pale orange rods, m.p. 209° (*dec.*); $[\alpha]_D + 118\cdot6^\circ$ (dry salt; H_2O). Leonard and Elderfield^{2(b)} describe two hydrated sulphates, *viz.* $B_2 \cdot H_2SO_4 \cdot 2H_2O$, m.p. 195–6°, $[\alpha]_D^{25} + 127^\circ$

(H_2O) and $\text{B}_2 \cdot \text{H}_2\text{SO}_4 \cdot 4\text{H}_2\text{O}$, m.p. 203–4°, $[\alpha]_{\text{D}}^{25} + 120^\circ$; the acid sulphate, $\text{B} \cdot \text{H}_2\text{SO}_4$, occurs in yellow prismatic needles, m.p. 246–8° (*corr.*, *dec.*), $[\alpha]_{\text{D}} + 113 \cdot 1^\circ$ (H_2O); the hydrochloride forms yellow, pentagonal plates, m.p. 286° (*corr.*, *dec.*), and shows a purple fluorescence in solution in alcohol; the picrate separates from alcohol in rosettes of reddish-orange needles, m.p. 194–5° (*corr.*). Dilute solutions of the salts are yellow and show a marked blue fluorescence. Alstonine behaves as a monoacidic base, contains one methoxyl but no methylimino group, and, unlike echitamine, does not give indole colour reactions.

Sharp² has also shown (1938) that alstonine on catalytic hydrogenation yields tetrahydroalstonine, $\text{C}_{21}\text{H}_{24}\text{O}_3\text{N}_2$, colourless rods, m.p. 230–1° (*corr.*), $[\alpha]_{\text{D}} - 107 \cdot 0^\circ$ (CHCl_3) or -88° (pyridine), which can be hydrolysed by alcoholic potassium hydroxide to methyl alcohol and tetrahydroalstoninic acid, isolated as the hydrochloride, $\text{C}_{20}\text{H}_{22}\text{O}_3\text{N}_2 \cdot \text{HCl}$, hygroscopic needles, m.p. 296° (*corr.*, *dry*, *dec.*), $[\alpha]_{\text{D}} - 22 \cdot 1^\circ$ (MeOH). On dehydrogenation with selenium at 300°, alstonine, tetrahydroalstonine and tetrahydroalstoninic acid, all yield the oxygen-free base, *alstyrine*, $\text{C}_{18}\text{H}_{20}\text{N}_2$ or $\text{C}_{19}\text{H}_{22}\text{N}_2$, pale yellow plates, m.p. 113° (*corr.*). Alstonine, tetrahydroalstonine and alstyrine all yield methiodides, melting at 246°, 236° and 221° respectively. All three have been used as starting-points for exhaustive methylation, but in no case could this process be carried far enough to eliminate either nitrogen atom. On oxidation with permanganate alstonine yields *N*-oxalylanthranilic acid.

Leonard and Elderfield^{2b)} have also carried out degradation experiments with alstonine and its tetrahydride. On fusion with potassium hydroxide at 300–350° in nitrogen, alstonine furnishes harman (p. 490) and indefinite basic and acidic fractions. Tetrahydroalstonine on like treatment produces harman, *norharman*, and three unidentified bases, each of which fluoresces blue in alcoholic hydrochloric acid: Base A, $\text{C}_{17}\text{H}_{16}\text{N}_2$, m.p. 171·5 to 172·5°, forms a picrate, m.p. > 267°; is probably a substituted β -carboline. Base B, $\text{C}_{16}\text{H}_{16}$ or $_{18}\text{N}_2$, gives a picrate, m.p. 261° (*dec.*). Base C, $\text{C}_{17}\text{H}_{18}\text{N}_2$, isolated as the picrate, m.p. 203·5–205·5°. From the acid products of the fusion indole-2-carboxylic acid was isolated.

On thermal decomposition of alstonine at 300–330°, the bases produced distilled at 120–170°/0·15 mm., and on fractionation as picrates gave three products: Base D, $\text{C}_{17}\text{H}_{18}\text{N}_2$, picrate, m.p. 254–6°. Base E, $\text{C}_{18}\text{H}_{20}\text{N}_2$, or $\text{C}_{19}\text{H}_{22}\text{N}_2$, picrate m.p. 193·5–195°, not identical with Sharp's alstyrine, and base F, $\text{C}_{13}\text{H}_{12}\text{N}_2$, m.p. 79–81°, picrate, m.p. 261–262·5°, hydrochloride, m.p. about 275° (*dec.*), methiodide, m.p. 283–4° (*dec.*). Base F has an ultra-violet absorption spectrum very similar to that of 2-ethyl- β -carboline, but it is not that substance nor is it 1 : 2-dimethyl- β -carboline, 2 : 3-dimethyl- β -carboline, 1-ethyl- β -carboline or 3-ethyl- β -isocarboline. Base F was also produced when alstonine was distilled with zinc dust.

Tetrahydroalstonine gives with the Adamkiewicz test, as modified by Harvey *et al.*, a colour similar to that given by yohimbine, which is taken to indicate the presence of a tetrahydro- β -carboline ring system. Further, the ultra-violet absorption curves for yohimbine and tetrahydroalstonine

are similar, except that the latter shows an inflection at about 2,500 Å, which disappears in the case of hexahydroalstonol, $C_{20}H_{26}O_2N_2$, m.p. 282–4° (*dec.*), $[\alpha]_D^{27} - 78^\circ \pm 3^\circ$ (pyridine), which is formed by the reduction of tetrahydroalstonine with sodium in boiling *n*-butyl alcohol. It gives a picrate, m.p. 237–8° (*dec.*), and an acetyl derivative, m.p. 95–6°; in its formation a carbomethoxy group is reduced to a primary carbinol group and two atoms of hydrogen are added. The authors suggest that the data so far provided indicate that alstonine has a β -carboline nucleus with substituents at positions 2 and 3, an unlocated carbomethoxy group and a still unexplained residue, $C_6H_{10}O$.

Alstoniline, $C_{22}H_{18}O_3N_2$. This alkaloid was obtained by Hawkins and Elderfield ^{2(a)} in working up *A. constricta* bark by a special process for alstonine. It occurs in the anhydrous form as yellow-brown needles, decomposing at 372°, and as a monohydrate, B . H_2O , also in yellow-brown needles, decomposing at 356°. Each form gives its own series of salts, but the ultra-violet absorption curves of the two are similar so that the hydration does not seem to imply a fundamental change in the ethylenic linkage. The anhydrous form changes to the monohydrate on crystallation from 95 per cent. alcohol.

The following salts of the anhydrous form are described: sulphate, $B_2 \cdot H_2SO_4$, m.p. 260–4° (*dec.*); picrate explodes above 350°; methiodide, B . MeI, decomposes over a wide range.

The monohydrate gives the following salts: hydrochloride, B . HCl . H_2O , fine-red needles decomposing over a wide range; picrate B . $C_6H_3O_7N_3 \cdot H_2O$, m.p. 294° (*dec.*). Attempts to obtain a methiodide produced a new monohydrate, yellow needles, m.p. 189–190°.

Alstoniline is susceptible to oxidation and in some reactions is recovered as the oxide, $C_{22}H_{18}O_4N_2 \cdot H_2O$, m.p. 212–3° or 219–221.5° (*dry*), which can be prepared by the aeration of the hydrated base in alcoholic solution. Alstoniline monohydrate absorbs four atoms of hydrogen in presence of platinic oxide, but on exposure to air during working-up, the reduced product changes into alstoniline oxide. Alstoniline sulphate and hydrochloride absorb 8 and 4 atoms of hydrogen respectively, producing stable products, m.p. 233–4° (*dec.*) and 231–2°.

All Hesse's alkaloids accompanying alstonine are amorphous except *alstonidine*,¹ needles, m.p. 181°, which also yields crystalline salts, but for which no formula has been suggested.

Villalstonine, $C_{40}H_{50}O_4N_4$. This alkaloid, isolated by Sharp,³ is a colourless granular powder, sintering at 218° and melting at 260°; it yields well-crystallised salts. The hydrochloride, B . 2HCl . 4 H_2O , forms colourless needles, m.p. 270° (*dec.*), $[\alpha]_D + 56.3^\circ$ (H_2O); the hydrobromide, B . 2HBr . 4 H_2O , is similar and has m.p. 293°; the sulphate, B . $H_2SO_4 \cdot 6H_2O$, crystallises with difficulty in prismatic rods, m.p. >310°, $[\alpha]_D + 52.94^\circ$ (H_2O); the oxalate, B . $H_2C_2O_4$, separates from alcohol in colourless leaflets, m.p. 235° (*dec.*), $[\alpha]_D + 55.6^\circ$ (H_2O). The base gives a pink colour, changing to bluish-violet with vanillin and hydrochloric acid, and a brown, changing through purple to blue with sulphuric acid,

Villalstonine contains two methylimino groups; two of the nitrogen atoms are non-basic. It yields a dimethiodide, B. 2MeI, rosettes of stout needles, m.p. 287° (*dec.*). One methoxyl group is present as a methyl ester, and is eliminated on alkaline hydrolysis of the alkaloid, the product being an amphoteric substance, isolated as the hydrochloride, C₃₈H₄₇O₂N₄ · CO₂H · 2HCl, m.p. 291–3° (*dec.*).

Macralstonine, C₄₄H₅₄O₅N₄. This base is sparingly soluble in most solvents except chloroform, but can be crystallised from pyridine by addition of dry alcohol, in colourless, rectangular rods, m.p. 293° (*dec.*), [α]_D + 27·5° (CHCl₃). The sulphate, B. H₂SO₄, forms prismatic rods, m.p. 263° (*indef., dec.*), [α]_D – 36·8° (H₂O). The base contains one methoxyl and three methylimino groups.

Macralstonidine, C₄₁H₅₀O₃N₄, forms colourless platelets from dry alcohol, becomes yellow on exposure to light and vitreous on heating, with final decomposition at about 270°; it has [α]_D + 174·5° (C₆H₆). The hydrochloride, B. 2HCl, forms rosettes of colourless needles, m.p. 326° (*dec.*), [α]_D + 136·5° (H₂O). The alkaloid contains two methylimino groups but no methoxyl group.

Base M. This substance, which is present in traces in *A. macrophylla*, has only been obtained as a crystalline sulphate, m.p. about 257°, [α]_D – 71·9° (H₂O).

Base V, found in minute quantity in *A. villosa*, forms prisms from alcohol, m.p. 273° (*dec.*), [α]_D + 54·6° (CHCl₃).

Echitamine, C₂₂H₂₈O₄N₂. This alkaloid has been examined by Harnack,⁴ Hesse,⁵ Bacon,⁵ and Goodson and Henry.⁸ The free base is supposed to have been obtained by Hesse in the form of a crystalline tetrahydrate, which at 100° lost 3H₂O, giving a crystalline monohydrate, m.p. 206°, [α]_D – 28·8° (EtOH). The hydrochloride, when crystallised quickly from water, forms long anhydrous needles, m.p. 295° (*dec.*), [α]_D¹⁵ – 58° (H₂O), or stumpy prisms, B. HCl · H₂O, m.p. 292°, when crystallised slowly; the hydrobromide occurs in transparent prisms, B. HBr · H₂O, m.p. 258° (*dec.*) or 268° (*dry, dec.*), [α]_D – 43·5° (H₂O). These salts are less soluble than the sulphate, B₂ · H₂SO₄ · H₂O, rosettes of needles, decomposing from 275°, [α]_D¹⁵ – 51·6° (H₂O). The picrate crystallises from dilute alcohol in rosettes of needles, B. C₆H₂(OH)(NO₂)₃ · 2H₂O m.p. 98°.

The alkaloid contains one methylimino group and one methoxyl group. The latter is present as a methyl ester, since all attempts to prepare free echitamine result in the production of a methoxyl-free substance, C₂₁H₂₆O₄N₂, yielding salts, which are acid to litmus, those of echitamine being neutral. This substance, *demethylechitamine*, crystallises as a dihydrate from 70 per cent. alcohol in prisms or hexagonal plates, m.p. 290° (*air-dry, dec.*) or 268° (*dry, dec.*). On methylation it is reconverted into echitamine (Goodson⁶). It yields a hydrochloride, B. HCl, prisms, m.p. 306° (*dec.*), and like echitamine gives an intense blue colour with Hopkins and Cole's glyoxylic acid reagent. Echitamine yields a diacetyl derivative, the hydrochloride of which forms needles, m.p. 271° (*dec.*), a nitroso-derivative, rosettes of yellow needles, m.p. 157° (*dec.*) and a

dinitro-derivative $C_{22}H_{26}O_4N_2 \cdot (NO_2)_2 \cdot 4H_2O$, red rosettes of minute needles, m.p. 156° (*dec.*) or 184° (*dry, dec.*). On distillation with 50 per cent. potash solution or with soda lime, echitamine yields methyl alcohol, methylamine, an unidentified base and a substance giving indole colour reactions. These results indicate that the formula of echitamine may be extended thus: $C_{19}H_{20}O(OH)(CO_2Me)(NH)(NMe)$.

Echitamidine, $C_{20}H_{26}O_3N_2$. This alkaloid was isolated by Goodson⁶ from the mother liquors of echitamine hydrochloride obtained from *A. congensis* and *A. scholaris*. It crystallises from wet ether in rosettes of six-sided plates, m.p. 135° , with softening at 122° or 244° (*dry, dec.*), $[\alpha]_D^{16} - 515^\circ$ (EtOH), and behaves as a monoacidic base; the hydrochloride, $B \cdot HCl \cdot 4H_2O$, forms prisms, m.p. 179° (*dry, dec.*), $[\alpha]_D^{16} - 473^\circ$ (H_2O); the sulphate, $B_2 \cdot H_2SO_4 \cdot 11H_2O$, rosettes of needles, m.p. 169° (*dry, dec.*), $[\alpha]_D^{17} - 362^\circ$ (H_2O) and the picrate, m.p. $226-7^\circ$. The alkaloid probably contains one methylimino and no methoxyl group.

Ditamine, $C_{16}H_{19}O_2N$, and **echitenine**, $C_{20}H_{27}O_4N$, which according to Hesse accompany echitamine in *A. scholaris* and *A. spectabilis* are ill-defined products. **Alstonamine**, also found in the latter, is crystalline but of unknown composition.

Pharmacological Action. At the end of their monograph on the bark of *Alstonia scholaris*, Flückiger and Hanbury say "The bark has been recommended as a tonic and antiperiodic, being extravagantly praised as a substitute for quinine."⁹ In most of the tropical and sub-tropical areas in which Alstonias occur, the barks of the local species have a reputation as anti-malarials and *A. scholaris* and *A. constricta* barks were officially recognised in the British Pharmacopœia 1914. Since it became possible to test drugs on malaria in birds and monkeys, the various Alstonia alkaloids have been so tested¹⁰ and none has been found to show more than slight activity. This is not quite conclusive as to the therapeutic value of the bark because some proportion of the total alkaloids is amorphous and some is soluble in water and is not extracted by indifferent solvents. It may be argued that these fractions may contain an active ingredient. It has however been found by Mukerji, Ghosh and Siddons¹¹ that the total alkaloids of *A. scholaris*, used as sulphates, are inactive in monkey malaria, and that a tincture of the bark, which should contain all the alcohol-soluble components of the bark, had no curative effect on malaria in human patients. It did however produce a slight fall in temperature, and while this effect lasted the patients appeared to be comparatively free from subjective symptoms. These results were confirmed by Das Gupta, Siddons and Chakravarti,^{11(a)} using extracts of *A. scholaris* in human malaria. It seems possible therefore that the early reputation of Alstonia barks as effective anti-malarial drugs may be due, partly to this antipyretic effect and partly to their use in the days before the diagnosis of malaria was as certain as it is to-day. In these galenic preparations the alkaloid alstoniline was probably present as the oxide and as that alkaloid can now be isolated as such, it will be interesting to see whether it exhibits anti-malarial activity.^{2(b)} A preparation of the total alkaloids of *Alstonia*

constricta var *mollis* has been examined by Keogh and Shaw,¹² and in its action on isolated intestine, uterus, heart, circulation and striated muscle is said to resemble quinine; but in animal experiments showed little anti-malarial action.

According to White,¹³ alstonine sulphate causes contraction and increased tone in isolated rabbit uterus and induces a fall in blood pressure in the anæsthetised cat, which is unaffected by atropine.

Wakim and Chen^{13(a)} state that alstonine hydrochloride has about two-thirds of the activity of quinine against *Plasmodium lophuræ* in ducks but is more toxic. Large doses have a deleterious action on the heart, and fatal doses cause primary respiratory failure in anæsthetised cats, dogs and rats. Villalstonine behaves similarly but is less active.¹⁴ Echitamine, according to Trevan,¹⁵ is toxic to mice in doses of 0.3 to 0.5 mgm. per 20 gm., and acts by paralysis of the medulla. Raymond-Hamet¹⁶ has investigated the influence of echitamine on the effects induced by administration of adrenaline: unlike ergotoxine, yohimbine and other indole alkaloids, it exerted no sympathicolytic action, and he was unable to confirm the atropine-like effect on the cardiac vagus attributed to it by Harnack.¹⁷

REFERENCES

- (1) *Annalen*, 1880, 205, 360. (2) *J. Chem. Soc.*, 1934, 287; 1938, 1353. (2a) *J. Org. Chem.*, 1942, 7, 573. (2b) *Ibid.*, p. 556. (3) *J. Chem. Soc.*, 1934, 1227; cf. SANTOS and SANTOS, *Bull. Univ. Phil. Nat. Appl. Sci.*, 1936, 5, 153. (4) *Arch. exp. Path. Pharm.*, 1877, 7, 126; *Ber.*, 1878, 11, 2004; 1880, 13, 1648. (5) *Annalen*, 1875, 176, 326; 178, 49 (with JOBST); 1880, 203, 144; *Ber.*, 1880, 13, 1841; cf. BACON, *Phil. J. Sci.*, 1906, 1, 1007. (6) *J. Chem. Soc.*, 1932, 2626. (7) *Ber.*, 1878, 11, 1546; *Annalen*, 1880, 203, 170. (8) *J. Chem. Soc.*, 1925, 127, 1640. (9) "Pharmacographia," Macmillan & Co., London, 1879. (10) GOODSON, HENRY and MACFIE, *Biochem. J.*, 1930, 24, 874; BUTTLE, quoted by SHARP² (1934); MAIER, quoted by HAWKINS and ELDERFIELD^{2(a)} and LEONARD and ELDERFIELD.^{2(b)} (11) *Ind. Med. Gaz.*, 1942, 77, 723; (a) *ibid.*, 1944, 79, 408; MUKERJI, *Nature*, 1946, 158, 170. (12) *Austr. J. Exp. Biol.*, 1943, 21, 183. (13) Quoted by SHARP² (1934). (13a) *J. Pharm. Exp. Ther.*, 1947, 90, 57. (14) Quoted by SHARP.³ (15) Quoted by GOODSON and HENRY.⁶ (16) *C. R. Soc. Biol.*, 1934, 116, 1022; 1941, 135, 1565; *Compt. rend.*, 1939, 209, 1013. (17) *Arch. exp. Path. Pharm.*, 1877, 7, 126.

ALKALOIDS OF ARISTOLOCHIA SPP.

The Aristolochias are used in medicine as tonics due to the presence of bitter principles, though Hesse¹ suggested that *A. reticulata* Nutt, then the serpentine root of commerce, might contain aristolochine, and the view that the bitter constituents are of alkaloidal character has been confirmed by Krishnaswamy, Manjunath and Rao,² for *A. indica* L.

Three apparently different bases have been isolated from this genus of plants and named aristolochine. Pohl's alkaloid³ was obtained from *A. clematitis* L. and *A. rotunda* L. It was assigned the formula $C_{32}H_{22}O_{13}N$, which Hesse³ reduced to $C_{17}H_{11}O_7N$, and is described as crystallising from ether in yellow needles, m.p. 215° (*dec.*), soluble in alkalis and giving a green coloration with sulphuric acid. The same substance was obtained by Castille⁴ from *A. Siphon* Hérit. and by Ryo⁵ from *A. debili*. The former states that it can be reduced to a colourless substance, $C_{17}H_{13}O_7N$, which

is fluorescent in solution. Hesse³ obtained from *A. argentina* Griseb., in addition to the acids referred to below, an alkaloid, itself amorphous but yielding crystalline salts, which he named aristolochine, suggesting at the same time that Pohl's base was probably a homologue of aristic and aristidinic acids and should be renamed aristolochic acid. The third claimant is the aristolochine of Krishnaswamy *et al.*,² which, like Pohl's base, has m.p. 215°, but differs considerably in composition, and the description below is taken from this source. Rosenmund and Reichstein⁶ have published a historical review of work done on *Aristolochia* spp. and have concluded that the aristolochic acid (*see below*) they have prepared from *A. Siphon* is identical with the "aristolochia yellow" of Frickhinger,⁷ and substances referred to above, *viz.*, Pohl's aristolochine, Hesse's aristic acid, Castille's aristolochic acid and Krishnaswamy's *isoaristolochic* acid.

Aristolochine, $C_{17}H_{19}O_3N$, is a crystalline powder, m.p. 215° (*dec.*), $[\alpha]_D - 268.6^\circ$, dissolves in alkaline solutions, but is sparingly soluble in organic solvents. The hydrochloride has m.p. 268° (*dec.*), $[\alpha]_D^{25^\circ} - 236.2^\circ$, and the picrate, m.p. 222° (*dec.*). The base contains one replaceable hydrogen, one methoxyl group, and the nitrogen atom carries two methyl groups.

isoAristolochic acid, $C_{17}H_{11}O_7N$, occurs in *A. indica*² and *Bragantia wallichii* Lour.² has m.p. 275°, yields a red sodium derivative and a benzoyl ester, m.p. 170–1°, contains one replaceable hydrogen atom, but no methoxyl or methylenedioxy group, and furnishes a methyl ether, m.p. 267° (*dec.*). It is oxidised by hydrogen peroxide in presence of alkali to a dibasic acid, $C_{16}H_{13}O_9N$, m.p. 164.5°.

From the roots of *A. argentina*, Hesse³ obtained the following alkaloids:—

Aristinic acid, $C_{18}H_{13}O_7N$. This crystallises from hot acetic acid in greenish-yellow leaflets or needles, m.p. 275° (*dec.*). The potassium salt, $C_{18}H_{12}O_7NK \cdot 2H_2O$, forms reddish needles and the methyl ester yellow needles, m.p. 250°.

Aristidinic acid, $C_{18}H_{13}O_7N$, occurs in greenish-yellow needles, m.p. 260° (*approx.*), and contains one methoxyl group.

Aristolic acid, $C_{15}H_{11}O_7N$, crystallises in orange-red needles, m.p. 260–270°, and, like the two foregoing alkaloids, gives a green solution with concentrated sulphuric acid.

Aristolochic Acid. Rosenmund and Reichstein⁶ prepared their material from roots and rhizomes of *A. Siphon*. It has the formula $C_{17}H_{11}O_7N$, m.p. 275° (*dec.*), and forms a methyl ester, m.p. 280° (*dec.*), $[\alpha]_D \pm 0^\circ$, which is difficult to saponify and on hydrogenation gives a bright yellow substance, m.p. 312°, $C_{18}H_{11-13}O_4N(?)$, which forms a diacetyl derivative, m.p. 306°. Aristolochic acid evolves a small amount of methyl iodide on boiling with hydriodic acid, presumably from a methylimino group, and is decarboxylated when heated with copper and quinoline, forming a neutral product, $C_{16}H_{11}O_6N$, m.p. 206°. The acid does not contain reactive carbonyl, or groups reacting with acylating agents.

According to Ryo⁵ aristolochine causes cardiac and respiratory

paralysis in frogs and mice : exerts some pressor action and increases the rate of respiration in rabbits. Skeletal muscle is stimulated by small and paralysed by large doses. In rabbits it causes hæmorrhagic nephritis and an arsenic-like, gastro-intestinal irritation in dogs. Serpenterary root is used in medicine solely as a bitter tonic. Its appearance is, no doubt, the foundation for the belief, common among natives of the tropics, than it is an antidote for snake-venom.

REFERENCES

(1) *Pharm. J.*, 1891-92, 51, 551 ; *Arch. Pharm.*, 1895, 233, 684. (2) *J. Indian Chem. Soc.*, 1935, 12, 476 ; 1937, 14, 39 ; 1938, 15, 646. (3) *Arch. exp. Path. Pharm.*, 1892, 29, 282 ; cf. HESSE, *Arch. Pharm.*, 1895, 233, 684. (4) CASTILLE, *J. Pharm. Belg.*, 1922, 4, 569. (5) RYO, *Folia Pharmacol. Jap.*, 1927, 4, 123. (6) *Pharm. Acta Helv.*, 1943, 18, 243. (7) *Buchner's Rep. Pharm.*, 1851, [iii], 7, 1.

ALKALOIDS OF CASSIA ABSUS

Two alkaloids, *chaksine* and *isochaksine*, were isolated as carbonates from the seeds of this plant by Siddiqui and Ahmed,¹ and the formula $C_{12}H_{21}O_2N_3$ was assigned to them. Both were described as quaternary bases, forming salts, $C_{12}H_{20}ON_3X$, by loss of water and *chaksine* sulphate on treatment with barium hydroxide yields *isochaksine*. Later Kapur, Gaiind, Narang and Ray² suggested the new empirical formula $C_{11}H_{21}O_3N_3$, and Puri, Sharma and Siddiqui³ found that the analytical results with the benzoyl benzoate supported the C_{12} formula, but those for organic acid salts were in better agreement with the C_{11} formula. *Chaksine* has only been prepared in an impure state, $[\alpha]_D + 32^\circ$ (EtOH). The iodide has m.p. 168° (*dec.*) ; chloride, m.p. 178° , bromide, m.p. 186° ; nitrate, m.p. 220° (*dec.*) ; sulphate, m.p. 316° (*dec.*) ; picrate, m.p. $239-240^\circ$ (*dec.*) and platinichloride, m.p. 232° (*dec.*). The hydrogen carbonate, $B \cdot HCO_3$, formed by adding a saturated aqueous solution of potassium bicarbonate to the iodide in methyl alcohol, melts at $117-9^\circ$ and is converted by the action of benzoyl chloride, in presence of sodium hydroxide, into benzoyl-*chaksine* benzoate, $C_{26}H_{29}O_4N_3 \cdot 0.5H_2O$, m.p. $183-4^\circ$, $[\alpha]_D^{36} - 29^\circ$ ($CHCl_3$), which is slowly dehydrated at 100° *in vacuo* to the anhydrous form, m.p. 273° , $[\alpha]_D^{36} + 15.9^\circ$ ($CHCl_3$). A few preliminary degradation experiments have also been made with *chaksine*.

isochaksine forms a picrate, m.p. 184° , a platinichloride, m.p. 172° (*dec.*), and a chloride, which loses a molecule of water at 90° , forming a product, m.p. $250-2^\circ$ (*dec.*). The carbonate, B_2CO_3 , m.p. 128° (*dec.*), is formed when *chaksine* acid carbonate is heated in alcohol.

REFERENCES

(1) *Proc. Ind. Acad. Sci.*, 1935, 2A, 421 ; *J. Ind. Chem. Soc.*, 1941, 18, 589. (2) *Ibid.*, 1940, 17, 281. (3) *J. Sci. Ind. Res.* (India), 1946, 4, 701 ; see also AGGARWAL, RAY and SEN, *Sci. and Cult.*, 1946, 12, 201.

ALKALOIDS OF DENDROBIUM SPP.

The stems of these plants constitute the drug "Chin-Shih-Hu," used in China and Japan as a tonic and antipyretic. Some uncertainty

exists as to the species used, but Read gives the Chinese name as "Shik Hu" and the source as *D. moniliforme* Sw., with *D. monile* Lindl. and *D. Macrae* as quoted by other authors. From this drug Suzuki *et al.* isolated dendrobine and an unnamed base.¹ They have also obtained dendrobine from *D. Linawianum*, and recorded the presence of alkaloids in *D. flaviflorum* and *D. tosaensis* and their absence from *D. longicalcaratum*.

Dendrobine, $C_{16}H_{25}O_2N$, crystallises in colourless needles or prisms, m.p. 134° , $[\alpha]_D^{16^\circ} - 51.5^\circ$ (EtOH) and yields well-crystallised salts: B. HCl, m.p. 246° (*dec.*), $[\alpha]_D^{14^\circ} - 41^\circ$ (H_2O); B. HI, m.p. 223° (*dec.*), $[\alpha]_D^{14^\circ} - 34.5^\circ$ (H_2O); aurichloride, B. $H AuCl_4$, needles, m.p. 181° ; methiodide, B. MeI, m.p. 231° (*dec.*), $[\alpha]_D^{15^\circ} - 30.9^\circ$ (MeOH). The base sublimes slowly at 50° . It contains a methylimino but no methoxyl group, behaves as a tertiary amine and appears to be a γ -lactone furnishing dendrobinic acid, $C_{16}H_{27}O_3N$, m.p. 227° (*dec.*), $[\alpha]_D^{31^\circ} - 27.5^\circ$ (EtOH), which yields an unstable hydrochloride, an amorphous aurichloride, m.p. 85° (*dec.*) and a crystalline methiodide, m.p. 211° (*dec.*). Methyl dendrobinate has m.p. 94° , $[\alpha]_D^{14.5^\circ} - 17.5^\circ$ (EtOH), and gives an acetyl derivative, m.p. 75° .

Dendrobine methiodide is convertible into the methoxyhydroxide, m.p. 251° (*dec.*). With cyanogen bromide cyanonordendrobine, m.p. 188° , was obtained, from which nordendrobine, m.p. $117-8^\circ$, $[\alpha]_D^{10^\circ} - 21.6^\circ$ (EtOH), was prepared *via* the carbamide. Dendrobine has also been prepared by Chen and Chen,² who record for certain of the salts, m.p.s. different from those given above, *e.g.*, B. HCl, m.p. 193° , B. HI, m.p. $284-5^\circ$, but whose data are otherwise in agreement with those of Suzuki *et al.*

Chen *et al.*² state that dendrobine produces moderate hyperglycemia, diminishes cardiac activity in large doses, lowers blood pressure, depresses respiration, inhibits isolated rabbit intestine and contracts isolated guinea-pig uterus. It has a weak analgesic, antipyretic action. Chen and Rose² found that the convulsions induced by injection of dendrobine can be controlled by use of sodium isoamylethylbarbiturate: they appear to be central in origin due to action on the cord and medulla.

REFERENCES

- (1) (With KEIMATSU and ITO), *J. Pharm. Soc. Japan*, 1932, **52**, 162; 1934, **54**, 138, 146; (with KEIMATSU), 1932, **52**, 183. (2) *J. Biol. Chem.*, 1935, **111**, 653; *J. Pharm. exp. Ther.*, 1935, **55**, 319; LEE, VAN ARENDONK and CHEN, *ibid.*, 1936, **56**, 466; CHEN and ROSE, *Proc. Soc. Exp. Biol. Med.*, 1936, **34**, 553.

ALKALOIDS OF *DICHROA FEBRIFUGA*

Dichroa febrifuga Lour, of the botanical family Saxifragaceæ, is a Chinese anti-malarial drug known as Ch'ang Shan, of which the roots are used. It was stated to contain two alkaloids, *dichroine-A*, m.p. 230° (*dec.*), and *dichroine-B*, m.p. $237-8^\circ$ (*dec.*), of which the second proved active in chick malaria,¹ but according to Tonkin and Work² neither acid nor aqueous extracts gave alkaloidal reactions though they showed considerable activity against a trophozoite-induced infection of *P. gallinaceum* in chicks.

The roots and leaves have been re-examined by Koepfli, Mead and Brockman,³ who have isolated two alkaloids. *Febrifugine*, $C_{16}H_{19}O_3N_3$, m.p. 139–140°, $[\alpha]_D^{25} + 6^\circ$ ($CHCl_3$), was obtained from both root and leaves. It yields a dihydrochloride, m.p. 220–2° (*dec.*), and is stated to have about 100 times the activity of quinine against *P. lophuræ* in ducks. The second base, *isofebrifugine*, is isomeric with the first, has m.p. 129–130°, $[\alpha]_D^{25} + 131^\circ$ ($CHCl_3$), gives a hygroscopic hydrochloride and is convertible into febrifugine by heat. Both alkaloids have almost identical ultra-violet absorption spectra with maxima at 225, 266, 275 and 302 $m\mu$ and minima at 250, 271 and 288 $m\mu$, and there is evidence that two of the nitrogens are in a quinazoline ring. The total alkaloidal content is about 0.1 per cent. of the dry weight of the roots.

A further contribution to this subject has been made by the Chinese workers⁴ quite recently, in which they describe briefly five bases, of which the three dichroines are interconvertible isomerides of the formula, $C_{16}H_{21}O_3N_3$. The melting points of the salts are also decomposing points:—
 Dichroine- α , m.p. 136°; sulphate, m.p. 230°; B. HCl, m.p. 210°.
 Dichroine- β , m.p. 146°; sulphate, m.p. 224°; B. HCl, m.p. 219°;
 B. 2HCl, m.p. 238°.
 Dichroine- γ , m.p. 161°; sulphate, m.p. 224°; B. HCl, m.p. 219°;
 B. 2HCl, m.p. 238°.
 Dichroidine, $C_{18}H_{25}O_3N_3$, m.p. 213°.
 4-Ketodihydroquinazoline, $C_8H_6ON_2$, m.p. 215°.

They also state that analytical studies of the oxidation products of dichroine- α indicate that the dichroines are quinazoline derivatives, as already indicated by Koepfli *et al.* for their alkaloids. With the probable exception of dichroine- α , these bases are active against malaria in chicks in the descending order: dichroine- γ (1), dichroine- β (4); dichroidine; quinazolone (40); the figures in brackets are effective doses (mgm./kilo.). There are also two neutral substances present, umbelliferone (dichrin-A) and dichrin-B, m.p. 179–181°.

REFERENCES

(1) JANG, FU, WANG, HUANG, LU and CHOU, *Science*, 1946, **103**, 59. (2) *Nature*, 1945, **156**, 630; WORK, *ibid.*, 1948, **161**, 400; HOOPER, *ibid.*, 1946, **157**, 106. (3) *J. Amer. Chem. Soc.*, 1947, **69**, 1837. (4) JANG, FU, HUANG, WANG, *Nature*, 1948, **161**, 400, with a list of prior publications from 1943 in China.

ALKALOIDS OF *ERYTHROPHLÆUM GUINEENSE* G. Don.

This tree occurs widely distributed in Africa and the bark is known under a variety of native names, *e.g.*, “sassy bark” in West Africa, where it was formerly used as an ordeal poison; in East and Central Africa it is said to have been an ingredient in arrow-poisons. The bark was first examined by Gallois and Hardy¹ who isolated a toxic alkaloid, erythrophleine, which was examined by Harnack and Zabrocki² and later by Harnack,³ whose results differed from those of Gallois and Hardy and were generally confirmed by Power and Salway.⁴ Recently interest

in this and other species of the same genus has revived and a number of chemical and pharmacological investigations have been made. Dalma⁵ isolated from *E. guineense* bark, collected in forests at the mouth of the Congo, four alkaloids, cassaine, cassaidine, *nocassaidine*, subsequently shown to be cassaidine,¹⁴ and homophleine, which is amorphous. In a second sample of bark from the same locality, but possibly derived from a sub-species of *E. guineense*, Dalma found 0.1 per cent. of alkaloids of which about one-tenth was cassaine, while in a third specimen from central Congo forests 0.5 per cent. of amorphous base was isolated, which appeared to be erythrophleine. Paris and Rigal⁶ isolated from the bark of *E. guineense* four alkaloids for which they record the following melting-points: (a) 105–6°, picrate, m.p. 332–4° (*dec.*); (b) 114–6°; (c) 105°, and (d) 112°, and from the seeds two more: (e) 185–6°, picrate, m.p. 277–8°, acetyl derivative, m.p. 123–4°, and (f) m.p. 124°.

These results seem to indicate a remarkable capacity for variation in the alkaloidal components of *Erythrophlœum guineense*, or a need for botanical investigation of the genus *Erythrophlœum*, and for care on the part of chemists in making certain of the botanical authenticity of the plant material they investigate.

Paris and Rigal state that the toxicity to guinea-pigs of *E. couminga*, *E. guineense*, *E. ivorensis* and *E. Fordii* decreases in that order. Laborde⁷ recorded the presence of an alkaloid resembling erythropleine in *E. couminga*, a species found in Madagascar and the Seychelles, and in some of the earlier papers on Dalma's alkaloids there are references to "madagascar," $C_{26}H_{41}O_6N$, coumingine and coumingaine, of which coumingine has been fully described. To these Schlittler has added coumingidine and Ruzicka *et al.*¹⁹ have given a preliminary description of a third, well-defined, but still un-named alkaloid from this species, in which they have also recorded the presence of cassaine and cassaidine.

Alkaloids closely resembling erythrophleine have been recorded in the Australian species *E. chlorostachys* by Petrie,⁸ in *E. lasianthum* of S. Africa by Kamerman,⁹ and in an unidentified bark from Mozambique by Jacobsohn.¹⁰

All the erythrophleum alkaloids examined in detail so far are of the same type, *viz.*, acyl esters of either monomethylaminoethanol, *e.g.*, erythrophleine and coumingidine or dimethylaminoethanol, such as cassaine or cassaidine. The acyl substituents are complex, yield 1 : 7 : 8-trimethylphenanthrene on selenium dehydrogenation, and contain at least one hydroxyl group, which may be acylated by an aliphatic acid, *e.g.*, coumingine forms three components on hydrolysis, β -hydroxyisovaleric acid, $Me_2 \cdot C(OH) \cdot CH_2 \cdot COOH$, cassaic acid, $C_{17}H_{27}(CHOH)(CO)(COOH)$, and dimethylaminoethanol,

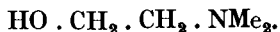

Erythrophleine, $C_{24}H_{39}O_5N$. This formula, adopted by Blount, Openshaw and Todd,¹¹ is based on analyses of the sulphate $B \cdot 0.5H_2SO_4$, and on the composition of the well-defined hydrolytic products, prepared

and characterised by these authors. The base has not been crystallised; the commercial sulphate is a cream-coloured, amorphous powder, but a crystalline specimen has been mentioned by Chen *et al.*²¹ The salt is readily soluble in water and in several organic solvents, including benzene.¹¹ The base contains one hydroxyl, one methoxyl and one methylimino group, and gives a positive reaction for carbonyl with 2 : 4-dinitrophenylhydrazine. Harnack³ first showed that erythrophleine could be hydrolysed by boiling with hydrochloric acid and described the products as methylamine and amorphous, nitrogen-free erythrophleic acid. Blount, Openshaw and Todd¹¹ investigated this reaction and found that the best results were obtained by the use of *N*/3-sulphuric acid under carefully controlled conditions. The products are erythrophleic acid, $C_{21}H_{32}O_5$, and β -methylaminoethanol; the latter was identified as the picrate, m.p. 148°, and the *N*-methyl-*N*- β -hydroxyethyl-*N'*- α -naphthylthiourea, m.p. 125°. On this basis the formula of erythrophleine may be extended thus : $C_{20}H_{31}O_3 \cdot CO \cdot O \cdot CH_2 \cdot CH_2 \cdot NHCH_3$.

Erythrophleic acid melts at 218°, has $[\alpha]_D^{20} = 40^\circ$ ($CHCl_3$), contains one methoxyl group and on hydrogenation, with platonic oxide catalyst, takes up one molecule of hydrogen rapidly, to saturate one ethylenic linkage, and a second molecule slowly, in reduction of a carbonyl group. The methyl ester of the acid sublimes at 140°/10⁻⁴ mm. as a white powder, yielding a 2 : 4-dinitrophenylhydrazone, m.p. 219°, crystallising in small orange-red plates. On dehydrogenation with selenium at 270–300°, erythrophleic acid yields 1 : 7 : 8-trimethylphenanthrene, m.p. 143–4°, and a selenium compound, $C_{19}H_{16}Se$, m.p. 161–2°. Erythrophleic acid contains one hydroxyl group but no crystalline acyl derivative has yet been obtained. The ultra-violet absorption spectrum (max., *ca.* 2210Å; log ϵ , 4.2) probably indicates an $\alpha\beta$ -position of the double bond in relation to the carboxyl group. From these data, and assuming that the formation of 1 : 7 : 8-trimethylphenanthrene on dehydrogenation implies a diterpenoid structure, the partial formula I was suggested for this acid: the positions of the methoxyl and carbonyl groups are still unknown and the ethylenic linkage may be at C²—C¹ instead of C²—C³ as shown.

The authors point out that erythrophleic acid may be a methoxy-derivative of cassaic acid, $C_{20}H_{30}O_4$ (p. 728). Ruzicka, Dalma and Scott¹³ (1941) have pointed out that formula I cannot be the basis of a general formula for the erythrophleum alkaloids, because their degradation to 1 : 7 : 8-trimethylphenanthrene would then imply the migration of a methyl group from C⁸ to C⁷ for which a substituent at C⁷ is essential.

These conditions do not obtain in cassanic acid (p. 728) although this acid dehydrogenates to 1 : 7 : 8-trimethylphenanthrene.

Cassaine, $C_{24}H_{39}O_4N$. This alkaloid was first isolated by Dalma⁵ and was further examined by Faltis and Holzinger.¹² According to Dalma it is

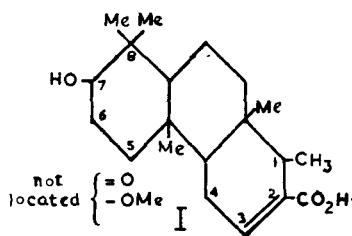

best isolated from alcoholic solution as the acid sulphate $B. H_2SO_4 \cdot 2H_2O$, m.p. $\sim 290^\circ$ (*dec.*). The base has m.p. 142.5° , $[\alpha]_D^{20} - 111^\circ$ (EtOH) or -114.6° (N/10-HCl) and yields a hydrochloride, $B. HCl \cdot H_2O$, m.p. $212-3^\circ$, an oxime, m.p. $123-5^\circ$, and an acetyl derivative, m.p. $123-4^\circ$. Of the four oxygen atoms one is present as hydroxyl, another as carbonyl and the other two as an ester group, since the alkaloid is hydrolysed by boiling *N*-hydrochloric acid to (a) a base identified (F. and H.) as dimethylaminoethanol and (b) cassaic acid (ketohydroxycassenic acid), $C_{20}H_{30}O_4$, m.p. 203° , $[\alpha]_D^{20} - 126.3^\circ$ (EtOH). The acid retains the hydroxyl and carbonyl of the parent alkaloid and its methyl ester, m.p. $189-190^\circ$, yields an acetyl derivative, m.p. $189-191^\circ$, of which the semicarbazone has m.p. $246-7^\circ$. In a later investigation Ruzicka and Dalma¹³ have shown that cassaine contains one ethylenic linkage and on catalytic hydrogenation gives a dihydro-derivative, m.p. $115-6^\circ$, $[\alpha]_D^{20} \pm 0^\circ$ (EtOH) or -6.5° (N/10 - HCl), which is hydrolysed by potassium hydroxide in alcohol, to ketohydroxycassanic acid, $C_{20}H_{32}O_4$, m.p. $253-5^\circ$, $[\alpha]_D^{20} \pm 1^\circ$ (EtOH) or -5° (N/10 - NaHO), also formed by the hydrogenation of cassaic acid, and reducible by sodium in alcohol to dihydroxycassanic acid, $C_{20}H_{34}O_4$, m.p. $262-5^\circ$, $[\alpha]_D^{20} - 7^\circ$ (N/10 - NaHO), of which the methyl ester has m.p. $172-4^\circ$. The name cassanic acid (*see below*) is applied to the hydroxyl-free, carbonyl-free, saturated, parent acid, $C_{20}H_{34}O_2$, of this series. On dehydrogenation by selenium at 340° in an open vessel, dihydroxycassanic acid yields 1 : 7 : 8-trimethylphenanthrene, m.p. $142-3^\circ$, picrate m.p. $133-5^\circ$, which is accompanied by what is probably 1 : 7 : 8-trimethyltetrahydrophenanthrene, when this operation takes place in a sealed tube.¹³

Ketohydroxycassanic acid, $C_{20}H_{32}O_4$, has also been used for another mode of degradation by Ruzicka, Dalma and Scott¹³ (1941). On oxidation by chromic acid in acetic acid it yields diketocassanic acid, $C_{20}H_{30}O_4$, m.p. 225° , $[\alpha]_D^{20} - 44^\circ$ (EtOH), which forms a methyl ester, m.p. 108° , $[\alpha]_D^{20} - 46^\circ$ (EtOH), and is reduced by sodium amyloxide at 220° to cassanic acid, $C_{20}H_{34}O_2$, m.p. 224° , $[\alpha]_D^{20} + 3^\circ$ (CHCl₃), which on selenium dehydrogenation also yields 1 : 7 : 8-trimethylphenanthrene.

On oxidation by chromic acid cassaic acid yields dehydrocassaic acid (diketocassenic acid), $C_{20}H_{28}O_4$, m.p. $238-9^\circ$, $[\alpha]_D^{20} - 164.5^\circ$ (EtOH), a diketo-acid of which the methyl ester has m.p. $129-130^\circ$ and forms a dioxime, m.p. $130-2^\circ$, and a disemicarbazone, m.p. 290° (*dec.*).⁵ When cassaine is hydrolysed by alkali, cassaic acid is replaced as a product by allocassaic acid, m.p. $222-4^\circ$, $[\alpha]_D^{20} + 81.8^\circ$ (EtOH). Absorption spectrum observations indicate that the ethylenic linkage in cassaic acid and cassaine is in the $\alpha\beta$ -position to the carboxyl group and has probably shifted to the $\beta\gamma$ -position in the alkaline hydrolysis, leading to allocassaic acid.

Ruzicka, Engel, Ronco and Berse¹³ have shown that the carboxyl group in cassanic acid is not at position C² by replacing this carboxyl group by isopropyl, dehydrogenating the product with selenium to a hydrocarbon, $C_{20}H_{22}$, which proved not to be identical with a synthetic specimen of 1 : 7 : 8-trimethyl-2-isopropylphenanthrene.

Cassaidine, $C_{24}H_{41}O_4N$. First isolated by Dalma⁵ and examined in

detail by Ruzicka and Dalma¹⁴; it is prepared from the mother liquors containing the total, ether-soluble alkaloids of *E. guineense* bark after removal of cassaine as acid sulphate. The base has m.p. 139·5°, $[\alpha]_D^{20}$ - 98·0° (EtOH), and yields a hydrochloride, m.p. 251°, acid sulphate, m.p. 228°, and amorphous acetyl and benzoyl derivatives. Zerevitinov determinations indicate the presence of two hydroxyl groups: no carbonyl group is present. On hydrolysis by boiling 2*N*-hydrochloric acid, two products are formed, (a) dimethylaminoethanol (aurichloride, m.p. 194°), and (b) cassaidic acid, C₂₀H₃₂O₄, which decomposes at 275-7°, $[\alpha]_D^{20}$ - 100° (EtOH), gives a methyl ester, m.p. 162-3°, and an amorphous diacetyl derivative, m.p. ~ 90-125°, and is oxidised, by chromic anhydride in acetic acid at 35-40°, to diketocassenic acid (dehydrocassaic acid), C₂₀H₂₈O₄, identical with that resulting from oxidation of cassaic acid, the non-nitrogenous, hydrolytic product of cassaine (*see below*). Hydrogenation of cassaidine with platonic oxide as catalyst produces a mixture of bases including dihydrocassaidine, C₂₄H₄₈O₄N, m.p. 96·7°, $[\alpha]_D^{20} \pm 0^\circ$ (EtOH), yielding a hydrochloride, m.p. 247°, and hydrolysed by potassium hydroxide in alcohol to dihydroxycassanic acid, C₂₀H₃₄O₄, also derivable from cassaine (*see above*). The absorption spectrum of cassaidine indicates that, like cassaine, it is an $\alpha\beta$ -unsaturated ester, *viz.*, the β -dimethylaminoethyl ester of cassaidic acid.

The formula of cassaidic acid may be extended thus:—

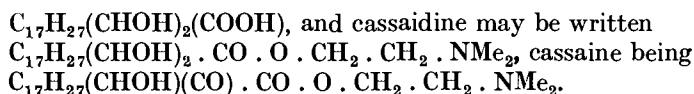

HOMOPHLEINE, C₅₆H₉₀O₉N₂, amorphous, resembles erythrophleine in appearance and characters.

Coumingine, C₂₉H₄₇O₆N. The formula C₂₈H₄₅O₆N first used has been changed¹⁶ to that now given. This alkaloid was isolated from the bark of *Erythrophloeum couminga* Baill. by Dalma and has been examined by Ruzicka, Dalma and Scott.¹⁵ It has m.p. 142°, $[\alpha]_D^{20}$ - 70° (EtOH), and forms a hydrochloride, m.p. 195°, and an oxime, m.p. 165°. Crude coumingine, but not the pure alkaloid, reacts with acetic anhydride in pyridine to form an acetyl derivative, C₃₀H₄₇O₇N, m.p. 154-5°. On hydrogenation in acetic acid and with platonic oxide as catalyst, coumingine gives a dihydro-derivative, m.p. 95-6°, $[\alpha]_D^{20} + 8^\circ$ (EtOH), yielding a hydrochloride, m.p. 160-2°, and convertible by the action of potassium hydroxide in alcohol into ketohydroxycassanic acid, already described under cassaine. On acid hydrolysis coumingine yields dimethylaminoethanol and coumingic acid, C₂₅H₃₈O₆, m.p. 200°, $[\alpha]_D^{20}$ - 81° (EtOH), which forms a methyl ester, m.p. 217-8°, $[\alpha]_D^{20}$ - 83° (EtOH), giving an oxime, m.p. 124-5°.

On alkaline hydrolysis coumingic acid and coumingine yield cassaic acid, C₂₀H₃₀O₄, for which and its derivatives somewhat different (*cf.* p. 728) constants are now recorded, *viz.*, acid, m.p. 223-4°, $[\alpha]_D^{20}$ - 123° (EtOH); methyl ester, m.p. 188-9°, $[\alpha]_D^{20}$ - 124° (EtOH); acetyl derivative of

methyl ester, m.p. 150°; oxidation product, diketocassenic acid, m.p. 249°, $[\alpha]_D^{20} - 152^\circ$ (EtOH), and its methyl ester, m.p. 132-3°, $[\alpha]_D^{20} - 156^\circ$ (EtOH).

From these results it was concluded that coumingine is an ester of cassaine with an acid, which was later identified by Ruzicka, Dalma, Engel and Scott¹⁶ as β -hydroxyisovaleric acid,

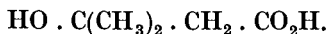

Coumingidine, $\text{C}_{28}\text{H}_{45}\text{O}_6\text{N}$, or $\text{C}_{27}\text{H}_{43}\text{O}_6\text{N}$. This alkaloid, found by Schlittler¹⁷ in the bark of *E. couminga*, is a secondary base and is best isolated as the nitroso-derivative, m.p. 174-174.5°, from which it is regenerated by the use of cuprous chloride.¹⁸ It has m.p. 160-1° and forms a hydrochloride, m.p. 217-9°; phenylthiocarbamate, m.p. 146°, and acetyl-derivative, m.p. 155°, $[\alpha]_D^{20} - 64.5^\circ$ (EtOH).

Dihydrocoumingidine, obtained by catalytic hydrogenation, and isolated as the perchlorate, m.p. 166-8°, forms an acetyl derivative, m.p. 115-116.5°. On hydrolysis by *N*/2- H_2SO_4 , coumingidine yields monomethylaminoethanol, identified as the 3 : 5-dinitrobenzoyl derivative, m.p. 195-196.5°. When either acetyl- or nitroso-coumingidine is treated with potassium carbonate in methyl alcohol, the amino-alcohol is split off and the nitrogen-free hydrolytic acid is obtained as a methyl ester, $\text{C}_{26}\text{H}_{40}\text{O}_6$, m.p. 204-6°. This, on treatment with potassium hydroxide in methyl alcohol, gives an acid, $\text{C}_{20}\text{H}_{30}\text{O}_4$, m.p. 209-211°, of which the methyl ester has m.p. 170-1°; this acid is not identical with *allocassaic* acid (p. 728). The methyl ester, $\text{C}_{26}\text{H}_{40}\text{O}_6$, still retains the ethylenic linkage and its dihydro-derivative, $\text{C}_{26}\text{H}_{42}\text{O}_6$, m.p. 162°, on alkaline hydrolysis furnishes an acid, $\text{C}_{20}\text{H}_{32}\text{O}_4$, m.p. 232-4° (methyl ester, m.p. 114°), which in spite of its rather low melting-point is believed to be identical with keto-hydroxycassanic acid (dihydrocassaic acid) for which Faltis and Holzinger¹² recorded m.p. 229-235°, while Ruzicka and Dalma¹³ found m.p. 253-5°. Direct hydrolysis of coumingidine by acid or alkali proceeds less smoothly than with other alkaloids of this group, but one of the products from hydrolysis by alkali, or by oxalic acid, is cassaic acid.

An unnamed third alkaloid, $\text{C}_{25}\text{H}_{39(41)}\text{O}_6\text{N}$, has been isolated by Ruzicka, Plattner and Engel¹⁹ from *E. couminga* by chromatographic fractionation of the residual alkaloids after removal of secondary bases by nitrous acid. It has m.p. 149-151°, and $[\alpha]_D^{17} - 47^\circ$ (EtOH), and forms an acetyl derivative, m.p. 100°.

A summary of work done on the *Erythrophloeum* alkaloids has been published by Engel.²⁰

Pharmacology. It has long been known that erythrophleine possessed local anæsthetic properties, and was the only alkaloid exhibiting action of the digitalis type. This cardiac action has been confirmed by Chen, Chen and Anderson,²¹ who used a commercial, erythrophleine sulphate described as crystalline. Santi and Zweifel²² showed that this was also the case with Dalma's alkaloids which they arranged in the following order of increasing toxicity : *norcassaidine* (now known to be *cassaidine*)

cassaine, erythropleine, homophleine, couningine. Cassaine is distinguished from the other four by producing intense excitation. Trabucchi²³ arranges the alkaloids in the following decreasing order of local anæsthetic activity: (1) "madagascar," (2) homophleine, (3) erythropleine, (4) cassaine, (5) *nor*cassaidine; percaïne, used as a standard in these experiments, came between (3) and (4). The first two are more irritant locally. According to Chen, Hargreaves and Winchester,²⁴ the potency of couningine in the cat is similar to that of scillaren—A (a cardiac glucoside of squill); the other alkaloids, coumingaine, cassaine, *nor*cassaidine, are less potent than erythropleine. They all produce emesis in cats. Acetylation reduces the cardiac activity, but raises slightly the emetic action of cassaine. These authors add that the Erythrophiæum alkaloids like other cardiac drugs increase blood pressure in cats and stimulate rabbit intestine and guinea-pig uterus. This has been confirmed by further work of Santi *et al.*,²⁵ who put these activities, and also a vaso-constrictor action, in approximately the following descending order: coumingine, erythropleine, homophleine, cassaine, *nor*cassaidine.

Further work has been done by various pharmacologists on several of the special activities referred to above, *e.g.*, the action of erythropleine on the isolated uterus and intestine of the rabbit by Rothlin and Raymond-Hamet,²⁶ and the effects of cassaine, cassaidine, erythropleine and coumingine on the isolated mammalian heart by Maling and Krayner,²⁷ who state that erythropleic acid is devoid of any characteristic action on the heart in a dose at least 100 times as large as the minimal positive inotropic dose of erythropleine sulphate; a similar result by Chen is quoted by Blount *et al.*¹¹ Ruzicka, Plattner and Engel²⁸ have prepared a series of esters of dimethylamino- and diethylamino-ethanol with bile acids and these have been tested pharmacologically as hydrochlorides. They showed a slight and uncharacteristic digitalis action, and in some cases local anæsthetic action accompanied by marked local irritation. Owing to their ready hydrolysis the oral dose may be ten times the subcutaneous dose without causing toxic symptoms.

REFERENCES

- (1) *Bull. Soc. Chim.*, 1876, 26, 39.
- (2) *Arch. exp. Path. Pharm.*, 1881–82, 15, 403.
- (3) *Arch. Pharm.*, 1896, 234, 561.
- (4) *Amer. J. Pharm.*, 1912, 84, 337; *cf.* MAPLETHORPE, *Pharm. J.*, 1923, 111, 85.
- (5) *Ann. Chim. Appl.*, 1935, 25, 569; *Helv. Chim. Acta*, 1939, 22, 1497.
- (6) *Bull. Sci. Pharmacol.*, 1940, 47, 79.
- (7) *Ann. Mus. Col. Marseille*, 1907, [2], 5, 305.
- (8) *Proc. Linn. Soc. N.S.W.*, 1921, 46, 333.
- (9) *S. Afr. J. Sci.*, 1926, 23, 179.
- (10) Quoted by DALMA⁵ (1939).
- (11) *J. Chem. Soc.*, 1940, 286.
- (12) *Ber.*, 1939, 72, 1443.
- (13) *Helv. Chim. Acta*, 1939, 22, 1516; (with SCOTT), 1941, 24, 179E; (with ENGEL, RONCO and BERSE), *ibid.*, 1945, 28, 1038.
- (14) *Ibid.*, 1940, 23, 753.
- (15) *Ibid.*, 1941, 24, 63.
- (16) *Idem.*, p. 1449.
- (17) *Idem.*, p. 319E.
- (18) JONES and KENNER, *J. Chem. Soc.*, 1932, 713.
- (19) *Experientia*, 1945, 1, 160 (*Chem. Abstr.*, 1946, 40, 3760).
- (20) "Analytical and Synthetic Work in the Field of the Erythrophiæum Alkaloids," Thesis, Zurich, 1945.
- (21) *J. Amer. Pharm. Assoc.*, 1936, 25, 579; 1938, 27, 564.
- (22) *Boll. Soc. ital. Biol. sper.*, 1936, 11, 758, 760; *cf.* DALMA, *ibid.*, p. 791, and SANTI, *Arch. exp. Path. Pharm.*, 1939, 193, 152.
- (23) *Arch. Farm. sperim.*, 1937, 64, 97.
- (24) *J. Amer. Pharm. Assoc.*, 1938, 27, 9, 307; CHEN (with ROSE), *Proc. Soc. Exp. Biol. Med.*, 1942, 49, 351; (with ANDERSON, HENDERSON and MILLS),

ibid., 1943, 53, 200. (25) *Boll. Soc. ital. Biol. sperim.*, 1937, 12, 720, 721; (with PELLIZARI), *ibid.*, p. 723; (with ZWEIFEL), *ibid.*, pp. 337, 724; CACCIAVILLANI, *ibid.*, p. 339; SANTI,²² (26) *Arch. int. Pharmacodyn.*, 1939, 63, 10. (27) *J. Pharm. exp. Ther.*, 1946, 86, 66; cf. VAN DER BERG, *Acta brev. Neerland. Physiol. Pharmacol. Microbiol.*, 1938, 8, 211. (28) *Helv. Chim. Acta*, 1944, 27, 1553.

ALKALOIDS OF *FRITILLARIA* SPP.

The chemistry of some species of the genus is in a confused state owing to the uncertain botanical origin of the materials used. The following is a list of the species examined and their alkaloidal components so far known: more detailed descriptions of the better defined alkaloids are given later:—

Fritillaria imperialis L. - Imperialine.¹

F. raddeana Rgl. Raddeanine.²

F. Roylei Hook. This is said to be one source of the Chinese drug "Pei-mu," of which there are at least two varieties, "Szechuan" and "Chekiang." Read³ gives *F. Roylei* Hook as the source of the former, and for the latter *F. verticillata* Willd., var *Thunbergii* Bak., *F. Thunbergii* Miq., *F. collicola* Hance or *Uvularia cirrhosa* Thunb. In view of this it hardly seems useful to say that "pei-mu" or even "Chekiang pei-mu" has been found to contain certain named alkaloids. It does, however, seem to be reasonably well established that *F. Roylei* contains peimine and peiminine.⁴ From "Szechuan pei-mu" Chou and Chen⁴ obtained fritimine.

F. sewerzowii Rgl. Alginine.⁵

F. verticillata Willd. From this species Yagi⁶ obtained *fritilline*, $C_{25}H_{41}O_3N \cdot H_2O$, m.p. 214°, and an amorphous base, m.p. 117°, while from *F. verticillata* var. *Thunbergii*, Fukuda⁷ isolated verticine, verticilline and fritillarine.

Li's "Chekiang pei-mu"⁸ yielded peimunine, $C_{19}H_{30}(32)O_2N$, m.p. 223–4°, $[\alpha]_D - 27.6^\circ$, and a second crystalline base, m.p. 130–3° (cf. peimine and peiminine, below).

Imperialine, $C_{35}H_{60}O_4N$. This alkaloid, isolated from the bulbs of *F. imperialis* L. by Fragner,¹ crystallises in short needles, m.p. 254° (*dec.*), $[\alpha]_D - 35.4^\circ$ ($CHCl_3$), and yields crystalline salts; B. HCl; platinumchloride, $B_2 \cdot H_2PtCl_6$; aurichloride, B. $HAuCl_4$. The base, mixed with sucrose, gives with sulphuric acid a series of colours; yellowish-green, pale-green, flesh, cherry red and on long standing dark violet.

Peimine. This alkaloid was isolated by Chou and Chen⁴ (1932), who assigned to it the formula $C_{19}H_{30}O_2N$, which was altered by Chi *et al.*⁴ (1936) to $C_{26}H_{43}O_3N$, also given by Chou and Chu⁴ (1947), but changed to $C_{27}H_{45}O_3N$ by Wu.⁴ The recorded m.p. varies from 215° to 224° and $[\alpha]_D$ from $\pm 0^\circ$ to -25° (EtOH). The hydrochloride has m.p. 295° (*dec.*); hydrobromide, m.p. 288° or 293.5–294°; hydriodide, m.p. 282–3°; acid sulphate, m.p. 278–280°; nitrate, m.p. 268–9°; platinumchloride, m.p. 233–5° (*dec.*); aurichloride, m.p. 164–5°. The diacetyl derivative melts indefinitely, but forms a hydrochloride (dihydrate), m.p. 298°. The

alkaloid has two active hydrogen atoms but contains neither a methoxyl nor a methylimino group. Wu⁴ suggested that peimine may be a dihydroxy-dihydrosolanidine (*cf.* p. 663) with $\text{—}\overset{5}{\text{C}}=\overset{6}{\text{CH}}\text{—} \rightarrow \text{—}\overset{5}{\text{CH}}\text{—}\overset{6}{\text{CH}_2}\text{—}$. Chi *et al.*⁴ regard verticine (*see below*) as probably identical with peimine.

Peimine, $\text{C}_{26}\text{H}_{41}\text{O}_3\text{N}$. First prepared by Chou and Chen,⁴ who adopted the formula $\text{C}_{18}\text{H}_{22}\text{O}_2\text{N}$, which was changed, first to $\text{C}_{26}\text{H}_{43}\text{O}_2\text{N}$ by Chi *et al.*,⁴ then to $\text{C}_{25}\text{H}_{41}\text{O}_3\text{N}$ by Wu,⁴ and seems to have been finally settled as $\text{C}_{26}\text{H}_{41}\text{O}_3\text{N}$ by Chu and Chou⁴ (1947), who state that peimine, $\text{C}_{26}\text{H}_{43}\text{O}_3\text{N}$, is oxidised by Beckmann's mixture to peiminine by the conversion of a secondary alcohol group to carbonyl. Peiminine has been stated to have m.p. 135° , $[\alpha]_{\text{D}}^{18} - 67.3^\circ$ (EtOH), and to form a hydrochloride, m.p. 295° , and a hydrobromide, m.p. 292° , but Chi *et al.*⁴ found that the base sinters at 140° , melts at $147\text{--}8^\circ$, re-solidifies at 157° and re-melts at $212\text{--}3^\circ$, which is also the m.p. after drying at 110° *in vacuo*. They also regard peiminine as identical with verticilline (*see below*). Chou and Chu⁴ prepared a monoacetate, m.p. 174° , a semicarbazone, m.p. $255\text{--}6^\circ$, and a phenylhydrazone hydrochloride, m.p. 266° .

Chou⁴ has described recently the isolation of four minor alkaloids from *F. Roylei*; they occur in the drug to the extent of 0.001 to 0.002 per cent.

Peimidine, $\text{C}_{27}\text{H}_{45}\text{O}_2\text{N}$, m.p. 222° , $[\alpha]_{\text{D}}^{26} - 74^\circ$ (EtOH), isolated as the hydrobromide, m.p. $> 300^\circ$, yields a hydrochloride, B. HCl, m.p. 318° , and an amorphous platinichloride.

Peimiphine, $\text{C}_{27}\text{H}_{46}\text{O}_3\text{N}$, m.p. 127° , $[\alpha]_{\text{D}}^{21} - 69^\circ$ (EtOH), also isolated as the hydrobromide, forms a hydrochloride, m.p. 287° , and an amorphous aurichloride.

Peimisine, $\text{C}_{27}\text{H}_{43}\text{O}_4\text{N}$, m.p. 270° , $[\alpha]_{\text{D}}^{25} - 51^\circ$ (EtOH), isolated as the hydrochloride, m.p. 257° , forms an amorphous aurichloride and a crystalline oxime, m.p. 196° .

Peimitidine, $\text{C}_{27}\text{H}_{44}\text{O}_3\text{N}$, m.p. 188° , $[\alpha]_{\text{D}}^{20} - 68^\circ$ (EtOH), forms a hydrochloride, m.p. 291° (*dec.*), an amorphous aurichloride and a very soluble platinichloride.

Fritimine, $\text{C}_{38}\text{H}_{62}\text{O}_3\text{N}_2$. Obtained by Chou and Chen⁴ (1933) from a variety of Szechuan "pci-mu," different from that yielding peimine and peiminine (*see above*). It has m.p. 167° , $[\alpha]_{\text{D}}^{22} - 50^\circ$ (EtOH), and forms a hydrochloride, m.p. 230° .

Verticine, $\text{C}_{18}\text{H}_{33}\text{O}_2\text{N}$ or $\text{C}_{19}\text{H}_{35}\text{O}_2\text{N}$. Obtained by Fukuda⁷ from *F. verticillata* var. *Thunbergii* (*see above*), has m.p. $224\text{--}224.5^\circ$, $[\alpha]_{\text{D}}^{10} - 10.66^\circ$ (EtOH), yields a crystalline platinichloride and contains one methoxyl group. Chi *et al.*⁴ suggested its identity with peimine (*see above*).

Verticilline, $\text{C}_{19}\text{H}_{33}\text{O}_2\text{N}$. Of the same origin as verticine, sinters at 130° , melts at $148\text{--}150^\circ$, re-solidifies at $157\text{--}9^\circ$ and re-melts at $212\text{--}3^\circ$ (*cf.* peiminine with which its identity has been suggested); it yields a crystalline platinichloride.

Fritillarine, $\text{C}_{16}\text{H}_{33}\text{O}_2\text{N}$, isolated as the perchlorate from the residual bases of *F. verticillata* var. *Thumb.*, is amorphous and has m.p. $130\text{--}1^\circ$.

Raddeanine, $C_{21}H_{35}O_2N$, has m.p. $255-7^\circ$, and forms the following salts: perchlorate, m.p. $204-5^\circ$; hydrochloride, m.p. $167-8^\circ$; aurichloride, m.p. $130-2^\circ$; methiodide, m.p. $248-250^\circ$. The benzoyl derivative melts at $235-6^\circ$. The alkaloid is unchanged by boiling with potassium hydroxide in alcohol.²

Arginine, $C_{23}H_{39}O_3N$, has m.p. $271-2^\circ$, $[\alpha]_D + 108.5^\circ$ (EtOH), forms a hydrochloride, m.p. $323-5^\circ$, and a methiodide, m.p. $310-1^\circ$. The nitrogen atom is tertiary and there are three hydroxyl groups.⁵

Pharmacology. According to Yagi,⁹ imperialine is a heart poison, and Narumi¹⁰ states that verticine, verticilline and fritillarine behave in frogs qualitatively similarly to Yagi's fritilline.⁶ Respiration is paralysed, voluntary and reflex movements cease, the heart is damaged. The blood vessels are constricted by these alkaloids and on the isolated nerve muscle preparation a veratrine-like effect is produced. In rabbits the symptoms again are like those found with fritilline; various cerebellar co-ordinating centres are paralysed. Large doses slow respiration and lower the blood pressure, small doses of verticine and verticilline have the reverse effect. The movement of the intestine is inhibited and the tone of the uterus increased.

According to Chen, Rose, Anderson and Chou⁴ (1935), fritimine lowers blood pressure in the anaesthetised cat and temporarily depresses respiration; it induces contraction in the guinea-pig uterus and inhibits the isolated small intestine of the rabbit. Chen, Chen and Chou¹¹ state that peimine and peiminine, perfused through the inferior vena cava in frogs, both cause a decrease in heart rate, complete A-V block and periodicity. They induce a fall in blood pressure in cats, inhibit the activity of isolated rabbit intestine at a concentration of 1:10,000, and cause some hyperglycaemic action in rabbits. The minimum lethal dose in mice is 9 mgm./kilo. According to Zolotukhina,¹² raddeanine stimulates the central nervous system in dogs, cats and rabbits, but in large doses paralyses. The toxic dose for rabbits is 10 to 30 mgm./kilo. The same author states that arginine is mainly notable for its local anaesthetic action but also shows some mydriatic activity.

REFERENCES

- (1) FRAGNER, *Ber.*, 1888, 28, 3284. (2) SADIKOV and LAZUREVSKI, *J. Gen. Chem. Russ.*, 1943, 13, 159. (3) "Chinese Medicinal Plants from the Pen Ts'ao Kang Mu, A.D. 1596" (Pekin, 1936). (4) CHOU and CHEN, *Chin. J. Physiol.*, 1932, 6, 265; 1933, 7, 41; (with ROSE and ANDERSON), *ibid.*, 1935, 9, 21; cf. LIU, CHANG and CHANG, *Chin. Med. J.*, 1936, 50, 249; CHI, KAO and CHANG, *J. Amer. Chem. Soc.*, 1936, 58, 1306; 1940, 62, 2896; CHOU and CHU, *ibid.*, 1941, 63, 2936; 1947, 69, 1257; WU, *ibid.*, 1944, 66, 1778; CHOU, *J. Amer. Pharm. Assoc.*, 1947, 36, 215. (5) JUNOSOV, KONOVALOVA and OREKHOV, *J. Gen. Chem. Russ.*, 1939, 9, 1911. (6) *Arch. int. Pharmacodyn.*, 1913, 23, 277. (7) *Sci. Rep. Tohoku Imp. Univ.*, 1929, [i], 18, 323. (8) *J. Chin. Pharm. Assoc.*, 1940, 2, 235 (*Chem. Abstr.*, 1942, 36, 1940); LIU, CHANG and CHANG,⁴ (9) *Arch. int. Pharmacodyn.*, 1910, 20, 117. (10) *Tohoku J. Exp. Med.*, 1935, 26, 325; 1936, 28, 26. (11) *J. Amer. Pharm. Assoc.*, 1933, 22, 638. (12) *Farmakol. i. Toksikol.*, 1944, 7, No. 6, 51; 1945, 8, No. 6, 15 (*Chem. Abstr.*, 1946, 40, 5843, 7411).

ALKALOIDS OF *GARRYA* SPP.

Early investigations¹ indicated the presence of an alkaloid in *G. fremontii* and *G. racemosa*. Six species were examined recently by Oneto,² who found no alkaloid in *G. flavescens*, amorphous bases in *G. fremontii* and *G. buxifolia*, and alkaloids yielding crystalline hydrochlorides in *G. elliptica*, *G. wrightii* and *G. veatchii*. The bark of the last-mentioned species was worked up for total alkaloids, which on fractionation yielded two crystalline bases.

Garryine, $C_{22}H_{32}O_2N \cdot H_2O$, m.p. 96°, after shrinking at 88°, $[\alpha]_D^{27.5}$ — 84.23° (EtOH), gave the following salts: B. HCl, m.p. 251–2° (*dec.*); B. HBr, m.p. 229–230° (*dec.*); B. HI, m.p. 203–4° (*dec.*), and sulphate; the latter decomposes over a long range.

Veatchine, $C_{22}H_{32}O_2N$, m.p. 122–3°, $[\alpha]_D^{27.5}$ — 69.01°. The following salts were prepared: B. HCl, m.p. 251–2° (*dec.*); B. HBr, m.p. 229–230°; B. HI, m.p. 222–3° (*dec.*).

REFERENCES

- (1) ROSS, *Amer. J. Pharm.*, 1877, 7 [iv], 585; MOELLER, *Pharm. Zentr.*, 1884, 25, 405; ARMENDARIZ, *Apoth. Zeit.*, 1898, 13, 178. (2) ONETO, *J. Amer. Pharm. Assoc.*, 1946, 35, 204.

ALKALOIDS OF *GEISSOSPERMUM VELLOZII*

From "pereiro bark" of this species (also known as *Tabernaemontana laevis* Vell.) used in Brazil as a febrifuge, Hesse isolated two alkaloids, geissospermine and pereirine,¹ and a third, vellosine, was found by Freund and Fauvet.² Geissospermine has been investigated by Bertho *et al.*,³ whose data are used in the following account.

Geissospermine, $C_{40}H_{50}O_3N_4 \cdot 1.5H_2O$, crystallises from dilute methyl alcohol, has m.p. 145–7° (*dec.*), $[\alpha]_D^{20}$ — 101.9° (EtOH), and on recrystallisation from ethyl acetate gives the dihydrate, B. $2H_2O$, m.p. 210–2° (*corr.*), $[\alpha]_D$ — 108.2 (EtOH). The sulphate, B. $H_2SO_4 \cdot 6H_2O$, m.p. 226° (*dec.*), $[\alpha]_D$ — 84.2° (H_2O); oxalate, B. $H_2C_2O_4 \cdot 5H_2O$, m.p. 193° (*dec.*); and dimethiodide, B. $2MeI \cdot 4H_2O$, m.p. 261–2°, $[\alpha]_D^{20}$ — 61.5° (EtOH), are all well crystallised. The alkaloid contains one methoxyl group, a labile, basic methylimino group and two active hydrogen atoms (Zerewitinoff). It gives a colourless solution with pure sulphuric acid, a blue colour with sulphuric acid containing ferric sulphate and a purple colour with nitric acid. For a detailed study of the colour reactions, see Raymond-Hamet.⁴

Bertho *et al.*³ have shown that geissospermine is hydrolysed by cold, strong hydrochloric acid to two isomeric bases, $C_{26}H_{26}O_2N_2$, presumably by the scission of an ether linkage between the two halves of the molecule. *Base A* discolours at 155°, m.p. ~ 205° (*dec.*), $[\alpha]_D^{21}$ — 101° (EtOH), and shows colour reactions similar to those of the parent base, which resemble those of yohimbine and it is suggested that base *A*, the corresponding half of geissospermine, and the minor alkaloid pereirine (p. 736) probably have the same ring system as yohimbine. *Base B*, isolated as the hydrochloride, m.p. 159–160°, is crystalline, m.p. ~ 160° (*dec.*), gives no colour

with nitric acid, is free from methoxyl but contains one methylimino group and forms a hydrobromide, m.p. 225–6° (*dec.*), and a methiodide, B . MeI, m.p. 230–1° (*dec.*). The latter gives an amorphous monoacetyl derivative, $C_{22}H_{28}O_3N_2 \cdot MeI$, decomposing at 237°.

Geissospermine is converted by phosphorus and hydriodic acid in boiling acetic acid to a deoxy-base, $C_{20}H_{26}ON_2$, m.p. 212–3° (*dec.*), which gives no colour with nitric acid and forms a methiodide decomposing at 246°. The function of the third oxygen atom in geissospermine has not been ascertained; it gives no carbonyl or hydroxyl group reactions. Two of the nitrogens are tertiary and from the results of pyrolytic experiments the other two appear to occur in a pyridine and an indole nucleus. The two active hydrogens are also still unexplained.

Distillation of geissospermine with zinc dust affords 3-ethylpyridine, identified as the picrate, m.p. 126°, and platinichloride, m.p. 183°, and an indole base giving a picrate, m.p. 256–7° (*dec.*). The mixed minor alkaloids accompanying geissospermine, on distillation with zinc dust, gave (1) a base forming a picrate, m.p. 128–130°, and a platinichloride, m.p. 188–190°, which may be 2-methyl-6-ethylpyridine, and (2) a hydrocarbon, $C_{20}H_{40}$, m.p. 44.5 to 45.5°.

Pereirine, $C_{20}H_{26}ON_2 \cdot 0.5H_2O$. According to Bertho and Moog³, this amorphous alkaloid, m.p. 134–5°, $[\alpha]_D^{20} + 137.5^\circ$ (EtOH), gives a methiodide decomposing at 233–5° and a methyl ether, m.p. 195–7° (*dec.*), and is stable to dilute mineral acid. Bertho and Sarx³ state that chromatographic examination shows the alkaloid has not been obtained pure.

Vellosine, $C_{23}H_{28}O_4N_2$, crystallises from hot alcohol in prisms, m.p. 189°, $[\alpha]_D + 22.8^\circ$ ($CHCl_3$). The hydrobromide, m.p. 194–5°, and the hydriodide, m.p. 217–8°, both crystallise with one molecule of water. Vellosine contains two methoxyl groups and behaves as a monoacidic, tertiary base. On heating with mineral acids it loses water, forming *apovellosine*, $C_{46}H_{54}O_7N_4$. In physiological action it resembles brucine and is toxic to rabbits in doses of 0.075 gm. per kilogramme of body weight.²

Raymond-Hamet⁴ has published, with a bibliography, a critical historical account of the botany and chemistry of pereiro bark, the botanical source of which he suggests should be named *Geissospermum læve* (Vellozo) Baillon. There seems to be some doubt as to whether vellosine was actually obtained from this species.

REFERENCES

- (1) *Annalen*, 1880, 202, 141. (2) *Ibid.*, 1894, 282, 247; cf. HESSE, p. 266. (3) (With VON SCHUCKMANN), *Ber.*, 1931, 64, 2278; (with MOOG) *Annalen*, 1934, 509, 241; (with SARX), *ibid.*, 1944, 556, 22. (4) *Bull. Sci. Pharmacol.*, 1937, 44, 449.

ALKALOIDS OF GELSEMIUM SPP.

The existence of alkaloids in the rhizome and roots of the North American plant *Gelsemium sempervirens* Ait (Loganiaceæ) was first demonstrated by Wormley¹ and later a crystalline alkaloid, gelsemine, was isolated by Gerrard.² Thompson³ found in addition to gelsemine an amorphous alkaloid, *gelseminine*. Gelsemine was later examined by

Spiegel ⁴ and by Göldner, ⁵ who adopted the formula $C_{22}H_{26}O_3N_2$, which was altered by Moore ⁶ to $C_{26}H_{22}O_2N_2$. A third alkaloid, sempervirine, possibly identical with Thompson's gelseminine, was isolated by Stevenson and Sayre, ⁷ together with the amorphous fractions *gelsemidine* and "*gelsemoidine*." From the latter Forsyth, Marrian and Stevens ⁸ isolated a methiodide, $C_{20}H_{22(24)}O_3N_2 \cdot MeI$, m.p. 296–7° (*dec.*), $[\alpha]_D + 3.9^\circ$ (H_2O), which differs from Moore's *apogelsemine* methiodide (*see below*) in specific rotation but has the same composition and melting-point. Forsyth *et al.* also isolated from gelsemium preparations a crystalline picrate, $C_{20}H_{24}O_4N_2 \cdot C_6H_3O_7N_3$, melting at 152°, and as tail products of this, picrates, m.p. 118° and 140°, in addition to a picrate, $C_{19}H_{36}O_2N_2 \cdot 2C_6H_3O_7N_3$, m.p. 185°, and a methiodide, $C_{18}H_{20}O_2N_2 \cdot MeI$, m.p. 261° (*dec.*). From "*gelsemoidine*" picrate, the same authors separated as the benzoyl derivative, the alkaloid *gelsemicine*, which Chou ⁹ first obtained from gelsemium root. Chou has also prepared from Chinese gelsemium (*G. elegans* Benth.) a series of five new alkaloids, ¹⁰ and Chi, Lee and Lee ¹⁰ state that the drug "*twan-chan-tsaio*" of Kwangsi, which may be *G. elegans*, contains an alkaloid giving a hydrobromide, m.p. 287°.

Processes for the isolation and separation of the gelsemium alkaloids will be found in the papers cited and a number of methods of estimation, both chemical and biological, have been described, and standards suggested. ¹¹

Gelsemine, $C_{20}H_{22}O_2N_2$, crystallises from acetone in prisms, m.p. 178°, loses one mol. of acetone at 120° and has $[\alpha]_D + 15.9^\circ$ ($CHCl_3$). The hydrochloride, B. HCl, has m.p. 333° (*dec.*), $[\alpha]_D + 2.6^\circ$ (H_2O); the hydrobromide, m.p. 325° (*dec.*); the nitrate, B. HNO_3 , m.p. > 280°; the methobromide, m.p. 313–4°, and the methiodide, m.p. variable from 286–301° (*dec.*), $[\alpha]_D^{18} + 6.0^\circ$ (H_2O). According to Moore, ⁶ the methiodide has $[\alpha]_D + 8.9^\circ$ (H_2O) and on treatment with potassium hydroxide solution regenerates gelsemine.

Moore also states that gelsemine, on treatment with acetic anhydride, yields acetyl-gelsemine, $C_{20}H_{21}ON_2 \cdot OAc$, prisms, m.p. 60–70° or 106–8° (*dry*), but this is not confirmed by later workers. When boiled with hydrochloric acid, gelsemine takes up one molecule of water, forming *apogelsemine*, $C_{20}H_{24}O_3N_2$, an amorphous base which yields crystalline salts, and a methiodide, m.p. 295° (*dec.*), $[\alpha]_D + 12.4^\circ$ (H_2O), and *isoapogelsemine* (m.p. 310°). A third product, in which a molecule of hydrogen chloride has been added, is chloro-*isoapogelsemine*, $C_{20}H_{23}O_2N_2Cl$.

According to Chou and Chu, ¹² gelsemine, on treatment with zinc and hydrochloric acid, in presence of palladium chloride or platinum chloride, yields (a) *isogelsemine*, m.p. 200–2° (*dry*), $[\alpha]_D^{10} + 38.8^\circ$, of which the methiodide, B. MeI, has m.p. 279–280° (*dec.*), and (b) an unnamed base, $C_{18}H_{22}O_4N$, m.p. 265–7° (*dec.*), $[\alpha]_D^{15} - 14.9^\circ$ (MeOH), giving a hydrobromide, m.p. 305–8° (*dec.*), and a methiodide, m.p. 262–5° (*dec.*). On hydrogenation in presence of platinic oxide, gelsemine and *isogelsemine* give *dihydrogelsemine*, $C_{20}H_{24}O_2N_2 \cdot COMe_2$, m.p. 224–5°, $[\alpha]_D^{17} + 78.5^\circ$ ($CHCl_3$), forming crystalline salts: B. HCl, m.p. 318–320° (*dec.*); B. HBr,

m.p. 328–330° (*dec.*); B. HNO₃, m.p. 285° (*dec.*), and B. MeI, m.p. 301–2° (*dec.*). The dihydro-base on treatment with nitric and sulphuric acid at –7° forms dinitrogelsemine, C₂₀H₂₀O₂N₂(NO₂)₂, m.p. 257–8° (*dec.*), $[\alpha]_D^{23} + 6.6^\circ$, of which the methiodide has m.p. 255–6° and $[\alpha]_D^{18} - 68.5^\circ$ (MeOH). Marion¹³ found that a mixture of bases and neutral products is obtained when gelsemine is heated to 320° with either soda-lime or selenium. The neutral products included 2:3-dimethylindole, characterised as the picrate, m.p. 154–5°. The bases gave two picrates, m.p. 210° and m.p. 238° (*dec.*), not yet identified.

Forsyth *et al.*⁸ pointed out that gelsemine is remarkably inert; they were unable to repeat Moore's preparation of an acetyl derivative, to obtain reactions with hydroxylamine, or to induce normal degradation of the methiodide and they confirmed Moore's failure to induce reaction with boiling alkali. By hydrogenation of gelsemine in dry acetic acid in presence of Adams's platinum oxide catalyst they succeeded in preparing a hexahydro-derivative, C₂₀H₂₈O₂N₂, m.p. 170°, which forms a methiodide, m.p. 296°, and does not give the gelsemine colour reaction with sulphuric acid and dichromate. On fusion with potash, gelsemine gave the amorphous base providing the picrate, m.p. 152°, already referred to.

In view of the strychnine-like pharmacological action recorded for gelsemine, Janot and Berton^{8(a)} have compared the ultra-violet absorption spectra of the two alkaloids, which proved to be remarkably similar. That of sempervirine was quite different and also unlike those of indole, quinoline and cinchonamine, with which it was also compared.

Gelsemine dissolves in sulphuric acid, giving a colourless solution, which on the addition of a crystal of potassium dichromate becomes red, then violet and finally green. A solution in alcohol gives a pink colour with dimethylaminobenzaldehyde in hydrochloric acid.

Addendum. Witkop²² has shown recently that on distillation with zinc, gelsemine yields skatole (3-methylindole) and two basic products, of which the stronger has the formula C₁₁H₁₁N, forms a picrate, m.p. 185–7°, and is probably a dimethylisoquinoline, not identical with the known 1:3; 1:4; or 3:4-dimethylisoquinolines. The weaker base yields a picrate, C₁₄H₁₁N · C₆H₃O₇N₃, m.p. 218–220°. The formation of skatole and a dimethylisoquinoline implies simple breakage thus:—C₂₀H₂₂O₂N₂ → C₉H₉N + C₁₁H₁₁N and it is suggested that gelsemine may have a structure of the yohimbine type (XIV; p. 508), which in this reaction breaks across ring C.

Sempervirine, C₁₉H₁₆N₂ · H₂O. From the alkaline liquid, after removal of gelsemine by ether, Moore⁶ observed that amyl alcohol extracted two amorphous alkaloids, of which the more basic was probably Thompson's gelseminine. From this material crystalline sempervirine was obtained by Stevenson and Sayre,⁷ and later by Chou,⁹ but a formula was first assigned to it by Hasenfratz.¹⁴ It forms yellow needles, m.p. 228°, from chloroform, or orange-yellow to brown-red crystals, m.p. 258–260°, from alcohol, $[\alpha]_D \pm 0^\circ$, *pK* value ~ 10.6. The salts crystallise well: B. HCl · 2H₂O, yellow prisms, m.p. > 300°; B. HBr · 2H₂O, m.p. 325°

(*dec.*). The nitrate, $B. HNO_3 \cdot 2H_2O$, has m.p. 282° (*dec.*), and is sparingly soluble in water. The methiodide has m.p. 348° (*dec.*). Sempervirine has been less investigated than gelsemine but it appears to be equally unresponsive to reagents. According to Forsyth *et al.*,⁸ the methiodide yields an amorphous product with potassium hydroxide solution, and cyanogen bromide merely converts the alkaloid into the hydrobromide. Sempervirine absorbs three molecules of hydrogen rapidly and five molecules in all. The presumed "decahydro-derivative," resulting from this operation, formed yellow needles, m.p. 205° , and on analysis gave results indicating the formula $C_{19}H_{24}ON_2$. The base dissolves in sulphuric acid with a bluish-violet fluorescence.

Addendum. More fundamental results are recorded by Goutarel, Janot and Prelog and by Prelog in two papers,²³ received too late for detailed description. They propose for sempervirine, the formula originally suggested by Barger and Scholz for yobyryne (IVa; p. 508) with a possible alternative having the ethylenic linkages at $C_3 - C_{14}$ in ring D moved to $C_3 - C_4$. Sempervirine contains one active hydrogen (Zerevitinov) and no methylimino group and on degradation yields a series of products already associated with yohimbine. When heated with selenium at $295-300^\circ$ it is isomerised to yobyryne (IVb: p. 508), and is oxidised by selenium dioxide in boiling xylene to yobyryne (V: p. 508). Refluxed with Raney nickel in boiling xylene for 10 hours it is converted into tetrahydroyobyryne (VI: p. 508).

This association of sempervirine with yohimbine is of biological interest since the former alkaloid is derived from a plant of the Loganiaceæ in which alkaloids of the strychnos group seemed to be characteristic, whereas the yohimbine group of alkaloids have so far only been found in the Apocynaceæ and Rubiaceæ.

Gelsemicine, $C_{20}H_{24}O_4N_2$, crystallises in broad, orthorhombic prisms, has m.p. 171° , $[\alpha]_D^{24} - 140^\circ$ (EtOH), and yields a hydrochloride, needles, m.p. $139.5-140^\circ$, and a picrate, m.p. 203° .

Forsyth *et al.*⁸ found that gelsemicine contains three active hydrogen atoms (Zerevitinov determination), yields a non-basic, monobenzoyl derivative, m.p. 232° , and behaves as a secondary base giving *N*-methylgelsemicine hydriodide, m.p. 227° , on treatment with methyl iodide. It does not react with either hydroxylamine or 2:4-dinitrophenylhydrazine. On hydrogenation in dry acetic acid in presence of Adams's platinum oxide catalyst it absorbs three molecules of hydrogen.

Chou⁹ also obtained an amorphous alkaloid giving a hydrochloride, $[\alpha]_D^{25} + 35^\circ$.

Two varieties of Chinese gelsemium have been examined by Chou *et al.*, *viz.*, "Kou-wen" and "Ta-ch'a-yeh,"¹⁰ both said to be derived from *Gelsemium elegans* Benth. The alkaloids found in "Kou-wen" are as follows:—

Koumine, $C_{26}H_{22}ON_2$, rhombic prisms from acetone, m.p. 170° , $[\alpha]_D^{23} - 265^\circ$ (EtOH); *B. HCl*, m.p. 255° (*dec.*); *B. HBr*, m.p. 269° (*dec.*).
Kouminine, amorphous, m.p. 115° , $[\alpha]_D \pm 0^\circ$, yields a crystalline hydro-

chloride and hydrobromide, both melting above 300°. *Kouminicine*, amorphous and lævorotatory. *Kouminidine*, prisms, m.p. 200°. Chi, Kao and Huang¹⁰ have confirmed the existence of koumine, purified kouminidine, $C_{19}H_{25}O_4N_2$, m.p. 299°, and shown kouminine to be a mixture of gelsemine with other bases.

“Ta-ch'a-yeh” contains gelsemine, koumine, kouminine and *kounidine*, $C_{21}H_{24}O_5N_2$, m.p. 315°; hydrochloride, m.p. 318°.

According to Okanishi,¹⁰ the toxic components of *G. elegans* are identical with those of *G. sempervirens*.

Pharmacological Action. Most of the early observations on the gelsemium alkaloids were made on amorphous preparations, and the results recorded are probably further confused by the fact that while in English journals the first crystalline alkaloid obtained was called gelsemine and the residual amorphous fraction gelseminine, these two names were used in the opposite sense in some German publications.

Cushny¹⁵ found that in the frog *gelsemine* hydrochloride produced tetanic convulsions and later paralysis of the motor nerve ends. In mammals these effects were not observed for the dosages used. Dale,⁶ using Moore's gelsemine hydrochloride, found that intravenous injection of 0.1 gm. produced practically no effect in rabbits. More recently Raymond-Hamet¹⁶ has recorded that 0.2 mgm. per kilo of gelsemine hydrochloride given intravenously produced in the dog a prolonged fall in blood pressure and increased respiration, while a dose of 8 mgm. per kilo augmented the pressor action of adrenaline and almost abolished the apnoea caused by the latter. According to Henderson and Chen,¹⁷ hydrogenation of gelsemine has little effect on its pharmacological action; both gelsemine and its dihydro-derivative relax rabbit intestine, contract isolated rabbit uterus, lower arterial blood pressure in cats and show the same toxicity in mice, the intravenous 50 per cent. lethal dose being 104 mgm. per kilo body-weight. Christensen and Gramling¹¹ found that, unlike sempervirine and gelsemicine, gelsemine in doses of 20 mgm. did not produce emesis in pigeons.

Both Cushny¹⁵ and Dale⁶ found the amorphous gelsemium alkaloids represented by such fractions as “gelseminine” much more active than gelsemine. Cushny stated that “gelseminine” resembled coniine in action and showed a greater depressant effect on the central nervous system, but unlike coniine it exerted no pressor effect. It was also a powerful mydriatic. Dale found that 0.001 gm. of the hydrochlorides of the amorphous alkaloids injected into rabbits caused death from respiratory failure in 25 minutes, preceded by convulsions. These results are explained by the subsequent isolation from such amorphous fractions, of the potent alkaloids sempervirine and gelsemicine.

According to Raymond-Hamet,¹⁸ *sempervirine* resembles sparteine, which, like it, is an oxygen-free alkaloid, in annulling the cardiac effects of electrical stimulation of the vagus and in common with gelsemine and *gelsemicine* produces on intravenous injection a prolonged fall in blood pressure, while it augments the hypertensive action of adrenaline. It also

induces a marked and lasting decrease in sensitivity of the guinea-pig intestine to adrenaline and acetylcholine.

Gelsemicine is more toxic than gelsemine but its effects on arterial pressure are less marked. It appears to be the alkaloid to which gelsemium owes its characteristic effects. According to Hou,¹⁹ it is very toxic for the rabbit, rat and dog, death being due to respiratory arrest. In minute doses it stimulates respiration, but as the dose is increased, progressive paralysis of the respiratory centre occurs. It has but little effect on the circulation, but is active on the isolated frog heart, dog and rabbit intestine and uterus and shows mydriatic action. Chen and Chou¹⁹ have made a similar investigation of the action of gelsemicine in pigeons, cats and monkeys. Its intense toxicity led Chen²⁰ to compare it with pseudoaconitine and aconitine, whence it appeared that the toxicity of each alkaloid varied with the animal species: thus for intravenous injection in mice the order is gelsemicine > aconitine > pseudoaconitine, but in rabbits and guinea-pigs it is reversed thus: pseudoaconitine > aconitine > gelsemicine.

de Espanes²¹ states that the fluid extract of Chinese gelsemium produces bradycardia in the chloralosed dog and that the electrocardiographic effects are similar to those induced by an extract of *G. semper-virens*. Chou, Wang and Cheng¹⁰ state that koumidine causes muscular weakness and shows inhibitory effect on the respiratory centre. Chou, Pak and Hou¹⁰ find that koumine resembles gelsemine in action and that kouminicine is much more toxic to mammals.

REFERENCES

- (1) *Amer. J. Pharm.*, 1870, 42, 1. (2) *Pharm. J.*, 1883, [iii], 13, 641. (3) *Ibid.*, 1887 [iii], 17, 803. (4) *Ber.*, 1893, 26, 1045. (5) *Ber. deut. pharm. Ges.*, 1895, 5, 330. (6) *J. Chem. Soc.*, 1910, 97, 2223; 1911, 99, 1231. (7) *Pharm. J.*, 1911, [iv], 32, 242; (with STEVENSON), *J. Amer. Pharm. Assoc.*, 1915, 4, 60; (with WATSON), *ibid.*, 1919, 8, 708. (8) *J. Chem. Soc.*, 1945, 579. (8a) *Compt. rend.*, 1943, 216, 564. (9) *Chin. J. Physiol.*, 1931, 5, 131, 295. (10) (With PAK and HOU), *ibid.*, 1931, 5, 345; (with WANG and CHEN), *ibid.*, 1936, 10, 79; cf. OKANISHI, *Proc. Jap. Pharm. Soc.*, 1933, 62; MINESHITA, *ibid.*, 1934, 8, 40; CHI, KAO and HUANG, *J. Amer. Chem. Soc.*, 1938, 60, 1723; CHI, LEE and LEE, *J. Chem. Eng. China*, 1938, 5, 40. (11) PITTENGER, *J. Amer. Pharm. Assoc.*, 1923, 12, 1063; SWANSON and HARGREAVES, *ibid.*, 1928, 17, 23; CHRISTENSEN and GRAMLING, *ibid.*, 1937, 26, 82; 1938, 27, 1208; NEUGEBAUER, *Apoth. Zeit.*, 1930, 45, 80; LYNCH and EVERS, *Analyst*, 1941, 66, 108; FERREIRO, *Thèse Pharm.*, Paris, 1940 (*Chem. Abstr.*, 1947, 41, 136); WU, *Bull. Nat. Form. Comm.*, 1947, 15, 68. (12) *J. Amer. Chem. Soc.*, 1940, 62, 1955; 1941, 63, 827. (13) *Can. J. Res.*, 1943, 21, B, 247. (14) *Compt. rend.*, 1933, 196, 1530; *Bull. Soc. Chim.*, 1933, [iv], 53, 1084. (15) *Ber.*, 1893, 26, 1725; *Arch. exp. Path. Pharm.*, 1893, 31, 49; cf. CHEN, PAK and HOU¹⁰; DE ESPANES, *Compt. rend. Soc. biol.*, 1938, 127, 1002, 1176, 1178; RISI, *Zeit. Biol.*, 1939, 99, 446. (16) *Compt. rend.*, 1937, 205, 1449. (17) *J. Amer. Pharm. Assoc.*, 1943, 32, 178. (18) *Compt. rend. Soc. biol.*, 1937, 126, 690, 1151; (with ROTHLIN), *ibid.*, 1934, 117, 754, 859; 1941, 135, 478; cf. CHOU.⁹ (19) *Proc. Soc. Exp. Biol. Med.*, 1931, 28, 779; *Chin. J. Physiol.*, 1931, 5, 137, 181, 279; see also CHEN (with CHOU and HOU), *ibid.*, 1939, 14, 319; (with LEE), *ibid.*, 1939, 14, 489. (20) (With ANDERSON and BROWN ROBBINS), *Quart. J. Pharm.*, 1938, 11, 84. (21) *Compt. rend. Soc. Biol.*, 1938, 129, 386; (with CAHEN), *Compt. rend.*, 1938, 206, 280. (22) WITKOP, *J. Amer. Chem. Soc.*, 1948, 70, 1424. (23) *Experientia*, 1948, 4, 24; *Helv. Chim. Acta*, 1948, 31, 588.

ALKALOID OF *GENTIANA KIRILOWI*

This plant contains the alkaloid *gentianine*, $C_{10}H_9O_2N$, m.p. 79–80°, of which salts have been prepared: hydrochloride, m.p. 171–2°; nitrate, m.p. 238–240°; oxalate, m.p. 152–3°; and methiodide, m.p. 190–1°. On catalytic hydrogenation, dihydrogentianine, m.p. 75–6°, is formed. On solution in alcoholic sodium hydroxide, gentianine forms sodium gentianate, m.p. 132–4°, from which the alkaloid is regenerated by acids. Oxidation of gentianine by permanganate in acetone produces an acid, $C_9H_7O_4N$, m.p. 260–2° (*dec.*), which on further oxidation by aqueous alkaline permanganate, leads to pyridine-3:4:5-tricarboxylic acid. Zinc dust distillation of gentianine yields pyridine. The alkaloid is regarded as 3-vinylpyridine fused at positions 4 and 5 with a cyclic lactone, which may be of type (a) or (b):—

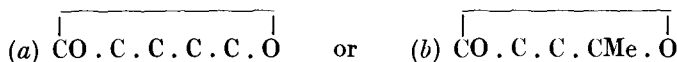

(PROSKURNINA, *J. Gen. Chem. Russ.*, 1944, 14, 1148.)

ALKALOIDS OF *HOLARRHENA* SPP.

In 1858 Haines¹ isolated from the bark of *Holarrhena* (*Wrightia antidyenterica* Wall., known in India as “kurchi,” the alkaloid conessine. It was prepared from the seeds of the same plant by Stenhouse,² who named it “wrightine,” and by Warnecke,² in a crystalline condition from the same source. It was also obtained by Polstorff and Schirmer³ from the African species *H. africana* D.C., by Pyman⁴ from *H. congolensis* Stapf., together with a second alkaloid, holarrhenine, by Henry and Brown⁵ from *H. Wulfsbergii*, and by Siddiqui *et al.*^{5(a)} from *H. febrifuga* Klotsch.

In recent years much interest has been displayed in the Indian species and other alkaloids, named in the following list, have been isolated from it, though it should be noted that doubts have been expressed by several authors⁶ as to the individuality of some of these substances.

Bertho⁶ (1939), in the course of a critical examination of extraction methods, has confirmed the occurrence of conessine, conessidine, conkurchine, kurchine, holarrhimine, kurchicine and a new alkaloid, conkurchinine. He suggests that *norconessine* is impure kurchine and points out that several of these alkaloids, notably conessidine and conkurchine, on treatment with alkali, yield high-melting products, which are only recoverable in the normal forms by solution in acid and re-precipitation by ammonia. “Kurchenine” is such a form of conkurchine (*cf.* p. 745), and it is suggested that *lettoceine* is also of this type.

Irani^{6(a)} has isolated from an alcoholic extract of kurchi seeds a crystalline gluco-alkaloid, which froths at 65°, melts at 200° (*dec.*), forms a benzoyl derivative and gives a dark-green colour with ferric chloride. When a saturated solution of picric acid is added to an aqueous solution of the gluco-alkaloid hydrolysis occurs, the products being conessine picrate, a second picrate, m.p. 113–6°, and galactose.

Conessine, $C_{21}H_{31}(NMe)(NMe_2)$
*nor*Conessine, $C_{23}H_{33}N_2$
 Conessimine, $C_{21}H_{31}(NH)(NMe_2)$
*iso*Conessimine, $C_{21}H_{31}(NMe)(NHMe)$
 Kurchine, $C_{23}H_{33}N_2$
 Conimine, $C_{21}H_{31}(NH)(NHMe)$
 Conamine, $C_{21}H_{31}(NMe)(NH_2)$
 Conarrhimine, $C_{21}H_{31}(NH)(NH_2)$

Conessidine, $C_{21}H_{32}N_2$
 Konkurchine, $C_{21}H_{32}N_2$
 Konkurchinine, $C_{23}H_{36}N_2$
 Holarrhenine, $C_{24}H_{38}ON_2$
 Holarrhimine, $C_{21}H_{31}(OH)(NH_2)_2$
 Holarrhine, $C_{20}H_{30}O_3N_2$
 Kurchicine, $C_{20}H_{30}ON_2$
 Lettoeine, $C_{17}H_{25}O_2N$

Conessine, $C_{24}H_{40}N_2$, crystallises from boiling acetone in large colourless plates, m.p. 125° , $[\alpha]_D - 1.9^\circ$ ($CHCl_3$),⁴ + 21.6° (EtOH).⁷ The hydrochloride, B. $2HCl \cdot H_2O$, forms masses of silky needles, m.p. $> 340^\circ$, $[\alpha]_D^{20} + 9.3^\circ$ (H_2O)⁸; the hydrobromide⁴ has $[\alpha]_D + 7.4^\circ$, the acid oxalate, B. $2H_2C_2O_4$, crystallises in prisms, m.p. 280° (*dec.*), readily soluble in hot and sparingly in cold water. The platinichloride is a crystalline powder; the picrate has m.p. $222-4^\circ$ (*dec.*). Dihydroconessine has m.p. 97.5° , $[\alpha]_D^{19} + 37.3^\circ$ (EtOH). On oxidation with potassium iodate in dilute sulphuric acid *dioxyconessine*, $C_{24}H_{42}O_2N_2$, is formed (Warnecke²). This crystallises from alcohol on addition of water in needles, m.p. $294-5^\circ$, $[\alpha]_D + 11.79^\circ$ (EtOH), and forms an amorphous dibenzoyl derivative, which is still diacidic, so that the two oxygen atoms appear to be present as hydroxyl groups. On further oxidation with chromic acid, it yields dimethylamine and a lactone acid, $C_{22}H_{33}O_4N$.

Work by Siddiqui *et al.* has served to establish relationships between the alkaloids to which extended formulæ are assigned in the foregoing table. S. and R. H. Siddiqui⁹ showed that on appropriate treatment with cyanogen bromide, followed by hydrolysis of the cyano- and dicyano-derivatives formed, conessine, $C_{21}H_{31}(NMe)(NMe_2)$, was demethylated to *isoconessimine*, $C_{21}H_{31}(NMe)(NHMe)$, and conimine, $C_{21}H_{31}(NH)(NHMe)$. Conessine on treatment with sulphuric acid in acetic acid,¹⁰ is isomerised to *neoconessine*, m.p. $128-9^\circ$, $[\alpha]_D^{37} + 96.8^\circ$ (EtOH), and this on further action by sulphuric acid yields *isoconessine*, b.p. $239-241^\circ/3$ mm., $[\alpha]_D^{35} + 97^\circ$ (EtOH), which Siddiqui, Siddiqui and Sharma¹¹ demethylated to (a) *isonorisoconessine* (B. HI, m.p. $292-3^\circ$), and (b) *isoconimine*, isomerides of *isoconessimine* and conimine respectively, and which are also formed from the latter by the action of sulphuric acid. The relationships thus established are shown in the following table:—

Alkaloid	Isomerised by H_2SO_4 to	Methylated to	Demethylated to
Conessine . . .	<i>iso</i> Conessine ¹⁰	—	<i>iso</i> Conessimine and conimine. ⁹
<i>iso</i> Conessine . . .	—	—	<i>isonoriso</i> Conessine and <i>isoconimine</i> . ¹¹
<i>iso</i> Conessimine . . .	<i>isonoriso</i> Conessine ¹⁰	Conessine ⁶	—
Conimine . . .	<i>iso</i> Conimine ¹⁰	Conessine ⁶	—
Conessimine . . .	—	Conessine ⁶	—
<i>isonoriso</i> Conessine . . .	—	<i>iso</i> Conessine ¹⁰	—
<i>iso</i> Conimine . . .	—	<i>iso</i> Conessine ¹⁰	—

Conessine forms a dimethiodide, B. $2MeI \cdot 3H_2O$, m.p. $303-4^\circ$ (*dec.*), $[\alpha]_D^{23} + 11.5^\circ$ (H_2O). The aqueous solution of the quaternary ammonium

base formed from this by the action of silver oxide, on distillation yields trimethylamine, methyl alcohol and a crystalline product,⁸ which Kanga, Ayyar and Simonsen¹² showed was a mixture of two bases, of which they isolated and characterised *apoconessine*, needles, m.p. 68.5°, yielding a picrate, m.p. 234° (Späth¹³), and a methiodide, m.p. 283–5°, which reverts to *apoconessine* on treatment with silver oxide. Späth and Hromatka¹³ found that in the formation of *apoconessine* the methyl alcohol arises from a secondary reaction, that *apoconessine* should be represented by the formula $C_{23}H_{35}N$, and that it contains three ethylenic linkages (hexahydro*apoconessine*, m.p. 69–70°), one of which is originally present in *conessine*, which yields a dihydro-derivative (*see above*), also formed by the hydrogenation of dioxyconessine (Osada¹⁴). The same authors found that *apoconessine* methochloride was transformed by sodium amalgam into trimethylamine and a hydrocarbon, $C_{21}H_{30}$, m.p. 74–6°, $[\alpha]_D^{15} - 183.7^\circ$ (pyridine), hydrogenated to $C_{21}H_{36}$, m.p. 56–8°, $d^{52}_D 0.9547$, $n^{52}_D 1.50664$, $[\alpha]_D^{15} + 14.5^\circ$ (benzene).

The conclusion is drawn that *conessine* contains four hydrogenated, carbocyclic rings with a ring containing one nitrogen atom attached. This complex includes one ethylenic linkage resistant to reduction. The nitrogen eliminated in the formation of *apoconessine* was originally in an acyclic structure as an NMe_2 group.⁴ Siddiqui and Sharma¹⁵ obtained from *conessine* and *isoconessine* hydriodides, ammonia and *conessene*, $C_{21}H_{30}$, b.p. 185–192°/3 mm., $[\alpha]_D^{31} + 35.0^\circ$, which, like Späth and Hromatka's hydrocarbon, contains three ethylenic linkages, but is not identical with it.

Siddiqui *et al.*¹⁵ have also investigated the nitration and the bromination of *conessine*, and its oxidation by permanganate and by chromic acid, and have carried out various reactions with the products; one outcome of this work is the suggestion that the structure of *conessine* includes the chain $.CH : CH . CH_2$.

norConessine, $C_{23}H_{38}N_2$, was obtained by Haworth¹⁶ from the mother liquors remaining from the isolation of *conessine* as the hydrogen oxalate. It is a colourless, viscid oil, b.p. 238–240°/0.7 mm., $[\alpha]_D + 6.7^\circ$ (EtOH), yielding well-crystallised salts. The dihydrogen dioxalate separates from alcohol or water in nodules, m.p. 225–7° (*dec.*); the dihydrochloride has m.p. 340° (*dec.*), and the dimethiodide forms pale yellow prisms, m.p. 310–2° (*dec.*). With potassium iodate in presence of dilute sulphuric acid *norconessine* yields dihydroxynorconessine, $C_{23}H_{40}O_2N_2$, m.p. 264–6°, and the dimethiodide, on treatment with silver oxide, gives the corresponding ammonium hydroxide which decomposes when heated under reduced pressure into trimethylamine and the corresponding *apo*-base, *aponorconessine*, $C_{22}H_{33}N$, b.p. 190–2°/0.2 mm. The latter furnishes a picrate, m.p. 244–5°, and a methiodide, m.p. 274–6°, which could not be degraded further. Dihydroxynorconessine decomposes on melting, forming a vapour, which gives the pyrrole pinewood reaction. According to Bertho⁶ (1989) *norconessine* is identical with *kurchine* (*see p. 745*).

Conessimine, $C_{21}H_{31}(NH)(NMe_2)$. This is one of four isomerides

$C_{23}H_{38}N_2$, which differ from conessine by CH_2 , and was isolated by Siddiqui and Pillay.⁶ It has m.p. 100°, b.p. 230°/1.8 mm., $[\alpha]_D^{38} - 22.3^\circ$ ($CHCl_3$), yields a hydrochloride, m.p. 342–4°, $[\alpha]_D^{26} - 15.1^\circ$ (H_2O); a hydriodide, m.p. 318–9° (*dec.*); aurichloride, $B \cdot HAuCl_4$, m.p. 165° (*dec.*), and a picrate, m.p. 172–4°. Conessimine contains one reactive hydrogen atom, two methyl groups attached to nitrogen and a secondary nitrogen atom (nitroso-derivative, m.p. 240° (*dec.*)). On methylation with formaldehyde and formic acid, it is converted into conessine, $C_{21}H_{31}(NMe)(NMe_2)$.

*iso*Conessimine, $C_{21}H_{31}(NMe)(NHMe)$, isolated by Siddiqui,⁶ has m.p. 92° or 88–92° as a dihydrate, $[\alpha]_D^{28} + 30.0^\circ$ (EtOH). The hydrochloride has m.p. 335°, hydriodide, m.p. 316°; picrate, m.p. 198–200° (*dec.*); and platinichloride, $B \cdot H_2PtCl_6$, m.p. 285° (*dec.*). It contains one reactive hydrogen atom and two methylimino groups and on methylation furnishes conessine. Sulphuric acid isomerises it to *isonorisoconessine*,¹⁰ $[\alpha]_D^{35} + 101^\circ$ (EtOH); picrate, m.p. 166°; hydriodide, m.p. 289° (*dec.*).

Kurchine, $C_{23}H_{38}N_2$, isolated by Ghosh and Ghosh,¹⁷ has m.p. 75°, $[\alpha]_D^{32} - 7.6^\circ$ ($CHCl_3$) or $+6.4^\circ$ (EtOH), forms a hydrogen oxalate, m.p. 221°, dihydriodide, m.p. 278° (*dec.*), diperchlorate, m.p. 250° (*dec.*), dimethiodide, m.p. 286.5°, and aurichloride, m.p. 160–6°. On catalytic hydrogenation it yields dihydrokurchine, of which a picrate, m.p. 176°, an acetyl derivative, m.p. 112°, a nitroso-compound, m.p. 109°, and a *p*-toluenesulphonate, m.p. 174°, have been prepared. Kurchine contains two methylimino groups; according to Bertho⁶ (1939) *norconessine* (*see above*) is impure kurchine.

Conimine, $C_{21}H_{31}(NH)(NHMe)$, isolated by Siddiqui, has m.p. 130°, $[\alpha]_D^{28} - 30^\circ$ (EtOH), and yields a hydrochloride, m.p. 318–320° (*dec.*); platinichloride, $B \cdot H_2PtCl_6$, m.p. 296–8° (*dec.*); and picrate, m.p. 140–1°. It contains two reactive hydrogen atoms and one methylimino group; is *N*-methylated to conessine and formed by the demethylation of conessine by the action of cyanogen bromide. Sulphuric acid isomerises it to *isoconimine*, $[\alpha]_D^{35} + 89^\circ$ (EtOH) [hydriodide, m.p. 332° (*dec.*); picrate, m.p. 135°], which is also formed by the demethylation of *isoconessine*.¹¹

Conamine, $C_{21}H_{31}(NCH_3)(NH_2)$, has m.p. 130°, $[\alpha]_D^{28} - 19^\circ$ (EtOH) (Siddiqui⁶).

Conarrhimine, $C_{21}H_{31}(NH)(NH_2)$, has not been obtained pure owing to its tendency to form eutectic mixtures, m.p. 160° and 175°, with holarrhimine, but its presence has been established by the isolation from such mixtures of nitrosohydroxyapoconarrhimine, $C_{21}H_{31}(N \cdot NO)(OH)$, m.p. 160–3° (Siddiqui⁶).

Conessidine, $C_{21}H_{32}N_2$, m.p. 123°, $[\alpha]_D^{21} - 63.5^\circ$ ($CHCl_3$), was obtained by Bertho, von Schuckmann and Schönberger.⁶ It yields a dihydriodide, m.p. 259° (*dec.*), a diperchlorate, $B \cdot 2HClO_4 \cdot H_2O$, m.p. 243° (*dec.*), and a dimethiodide, m.p. 269° (*dec.*), and contains one methylimino group. According to Bertho⁶ (1939, 1944) it also occurs as a stable dihydrate, m.p. 291–2° (*dec.*), with characters similar to those of the conkurchine hydrates.

Conkurchine, $C_{21}H_{32}N_2$, was first isolated by Bertho *et al.*⁶ The base

has m.p. 152–3°, $[\alpha]_D^{20} - 51.9^\circ$ (EtOH), and forms a nitrate, $B \cdot 2HNO_3$, which colours at 180° and explodes on further heating, carbonate, $B_2 \cdot H_2CO_3$, m.p. 149–150°, dihydriodide, $B \cdot 2HI$, m.p. 278° (*dec.*), sulphate, $B_2 \cdot H_2SO_4$, and oxalate, $B_2 \cdot H_2C_2O_4$. The diacetyl derivative forms a monohydrate, m.p. 182–3° (*dec.*), and an alcoholate, m.p. 263°. Hydrogenation in methyl alcohol, with platinic oxide as catalyst, leads first to dihydroconkurchine, m.p. 97–8°, and eventually to tetrahydroconkurchine, m.p. 340–1° (hydrated) or 101–4° (anhydrous). Methylation of these hydrogenated products, with formaldehyde and formic acid, reduces conessine and dihydroconessine respectively (*see p. 743*). With methyl iodide in boiling ethyl alcohol, conkurchine forms dimethylconkurchine dimethiodide, $C_{25}H_{42}N_2I_2$, m.p. 277° (*dec.*). A normal monomethiodide is only obtainable indirectly (*see below*). Conkurchine condenses with aromatic aldehydes to form Schiff bases, and the salicylidene compound, $C_{28}H_{36}ON_2$, m.p. 244–5°, $[\alpha]_D^{16.5} + 15.6^\circ$ ($CHCl_3$) is recommended as a means of isolating the alkaloid from kurchi bark extracts. With acetoin condensation involves two molecules of base and the product formed is $C_{46}H_{68}N_4$, m.p. 256–7° (*dec.*), which is hydrolysed by dilute nitric acid forming conkurchine nitrate. Neither acetaldehyde nor glycollic aldehyde condenses with the alkaloid. Dihydro- and tetrahydroconkurchine do not condense with aldehydes, and it is assumed that the condensation requires an ethylenic linkage in the heterocyclic ring and that conkurchine may contain in addition to the NH_2 group a $NH \cdot C \ddot{C}$ group in equilibrium with $N : C <$. A crude kurchi bark extract yielded 16.4 per cent. of conkurchine, isolated as the salicylidene derivative.

In working up alkaloidal fractions from the original kurchi extract, Bertho *et al.*⁶ isolated three substances: (a) m.p. 323°, (b) m.p. 335–6°, and (c) m.p. 302–3° (*dec.*), $[\alpha]_D - 34.87^\circ$ (EtOH), which on solution in dilute hydrochloric acid and re-precipitation by alkali remain unchanged, but on recovery in like manner from solution in strong hydrochloric acid yield conkurchine and, from solution in dilute nitric acid deposit, conkurchine nitrate. They were at first regarded as “molecular associates” of conkurchine but are now thought to be due to the addition of the elements of water to ethylenic linkages in conkurchine. Form (b) is the substance formerly named “kurchenine” (1933). Form (c) is a “dihydrate,” $C_{21}H_{32}N_2 \cdot 2H_2O$, of this stable type. It condenses with salicylic aldehyde to form two salicylidene derivatives, (1) $C_{28}H_{40}O_3N_2$, m.p. 205.5° (*dec.*), and (2) $C_{28}H_{38}O_2N_2$, m.p. 205.5°, described respectively as di- and monohydrates. From another high-melting fraction there was isolated as the sparingly soluble nitrate, a base, $C_{23}H_{38}N_2$, m.p. 87–8°, provisionally named “nitrate base II.”

Addendum. In a later paper²⁸ (1947) it is shown that a normal conkurchine monomethiodide, m.p. 266° (*dec.*), can be obtained by hydrolysing benzylideneconkurchine methiodide, m.p. 245.5°, with $2N-HCl$. This and the dimethylconkurchine dimethiodide referred to above, as well as by-products formed with them, were subjected to a number of reactions, the results of which provide material for a

preliminary discussion bearing on the structure and tautomerism of the alkaloid, and the formation from it of *pseudoammonium* bases of the type $C_{21}H_{30}N_2(:R)$ MeOH, where R is an arylidene residue, when the arylideneconkurchine methiodides are treated with silver oxide.

Conkurchinine, $C_{25}H_{36}N_2$. This is a ditertiary base, first isolated by Bertho ⁶ (1939); it melts at 161°, has $[\alpha]_D^{25} - 47.0^\circ$ (EtOH), and forms a dihydrated diperchlorate, which darkens from 260°, and a dimethiodide, m.p. 255–6° (*dec.*). The alkaloid is decomposed by dilute nitric acid forming conkurchine nitrate, $C_{21}H_{32}N_2 \cdot 2HNO_3$, presumably by hydrolysis, the other product being a four-carbon compound, which it is suggested may be a hydroxybutyraldehyde, the condensation product of the two

being of the type $C_{21}H_{29} = N - (CH_2)_3 - CH : N$ and no methylimino group being present. On this basis conkurchine (*see above*) would be a primary-secondary base, $C_{21}H_{29}(NH)(NH_2)$.

Holarrhenine, $C_{24}H_{38}ON_2$, crystallises from ethyl acetate in silky needles, m.p. 197–8°, $[\alpha]_D - 7.1^\circ$ ($CHCl_3$), is soluble in alcohol or chloroform, but sparingly so in cold ethyl acetate, acetone or ether. The hydrobromide, $B \cdot 2HBr \cdot 3H_2O$, crystallises from water in flat needles, m.p. 265–8° (*dry*), $[\alpha]_D + 11.0^\circ$ (H_2O). The alkaloid gives, like conessine, analytical results for three *N*-alkyl (probably methyl) groups, and the oxygen is present as hydroxyl, since the base yields an acetyl derivative, oblong plates (m.p. 180°, from acetone), which is still diacidic (Pyman ⁴).

Holarrhimine, $C_{21}H_{31}(NH_2)_2(OH)$, m.p. 183°, $[\alpha]_D^{25} - 14.2^\circ$ ($CHCl_3$), furnishes a dihydrochloride, m.p. 345°, $[\alpha]_D^{25} - 22.8^\circ$ (MeOH); a hydrobromide, m.p. 358–360° (*dec.*); and picrate, m.p. 198–200° (*dec.*). It contains five active hydrogen atoms, but no methoxyl or methylimino groups (Siddiqui and Pillay ⁶). It is converted by treatment with formaldehyde and formic acid into tetra-*N*-methylholarrhimine, $C_{25}H_{44}ON_2$, m.p. 233–5°, $[\alpha]_D^{35} - 45.5^\circ$ (EtOH). The latter yields a hydrochloride, m.p. 315–6° (*dec.*); hydriodide, m.p. 302–3° (*dec.*); hydrobromide, m.p. 306–7°; platinichloride, $B \cdot H_2PtCl_6$, m.p. 251–2°; picrate, m.p. 272–5°; monomethiodide, m.p. 286–7° (*dec.*); and monobenzoyl derivative, m.p. 176°. With excess of benzoyl chloride in presence of pyridine, holarrhimine gives a tribenzoyl derivative, m.p. 269–270°. It contains one ethylenic linkage (dibromide, m.p. 290–5°), and with methyl iodide in chloroform gives a dimethiodide, $C_{23}H_{42}ON_2I_2$, m.p. 279°, convertible by alkalis into methylholarrhimine, $C_{22}H_{38}ON_2$, m.p. 170°, yielding a dihydrochloride, m.p. 266° (*dec.*), and a picrate, m.p. 205° (Siddiqui ⁶). According to Bertho ²⁸ it forms a disalicylidene derivative, m.p. 246–7°.

Kurchenine (*see under* Conkurchine, p. 745).

Holarrhine, $C_{20}H_{38}O_3N_2$, m.p. 240°, $[\alpha]_D^{25} - 17.0^\circ$ (MeOH), yields a platinichloride, $B \cdot H_2PtCl_6$, m.p. > 300°, and a picrate, which darkens at 275° and is not melted at 320° (Siddiqui and Pillay ⁶).

Kurchicine, $C_{20}H_{36}ON_2$, m.p. 175°, $[\alpha]_D^{32} - 11.4^\circ$ ($CHCl_3$) – 8.45° (EtOH), yields a dihydrochloride, m.p. > 260°; dihydrobromide, m.p. > 260°

(*dec.*), $[\alpha]_D^{32} - 27.2^\circ$ (H_2O), and aurichloride charring from 195° (Ghosh and Ghosh¹⁷).

Lettocine, $C_{17}H_{25}O_2N$, is a pale brown microcrystalline powder, m.p. $350-2^\circ$; it yields a crystalline hydriodide, B. HI, m.p. 256° (*dec.*); picrate, m.p. 198° , and is recovered unchanged from boiling acetic anhydride.¹⁸ Bertho suggested that it may be a condensed form of a Kurchi alkaloid (p. 742).

Addendum. In a recent paper Bertho *et al.* have described a new process for the isolation of kurchi alkaloids. From the final residue a new base, $C_{23}H_{34}N_2$, m.p. 129.5° , was isolated as the carbonate, m.p. 91° ; it provides the following salts: B, 2HI, $2H_2O$, (*dec.*) 174° ; B, $2HClO_4$, $2.5H_2O$, m.p. 283° , and a mono-acetyl derivative, m.p. 254° . In a second paper Bertho, Schönberger and Kaltenborn describe further products obtained in the oxidation of conessine by chromic acid and by potassium permanganate.²⁹

Pharmacological Action. According to the early work of Keidel,¹⁹ conessine is toxic, producing narcosis and finally death from paralysis of the respiratory centre. Giemsa and Halberkann,⁸ on the contrary, were able to give comparatively large doses by mouth to dogs and to human beings without producing narcosis, and Burn²⁰ found that, though both conessine and holarrhenine induce narcosis in frogs, this effect is inappreciable in mammals. Both alkaloids produce local anaesthesia, but cause necrosis on subcutaneous injection. Oxyconessine has no general or local anaesthetic action, but produces a curare-like effect in frogs.

A later pharmacological investigation of conessine by Chopra, Ghosh, Gupta and David²¹ confirms Burn's results in general, and White²² found that *norconessine* closely resembled its homologue in action, the loss of a methyl group having but little qualitative effect on the general activity. *Kurchicine* and *isoconessine* show considerable similarity in action to conessine, but *kurchicine* diminishes while *isoconessine* increases the coronary outflow in the isolated rabbit heart. Findlay, quoted by White,²² found that *Entamoeba histolytica* grown on a buffered serum medium, pH 7.2, was killed by emetine at 1 in 5,000,000; by conessine at 1 in 20,000; and by *norconessine* and *dioxyconessine* at 1 in 5,000. Meissner and Hesse have made the interesting observation that conessine, in common with harmine, α -isoquinine, ethyl *apoquinine* and amino-dihydroquinine, inhibits the growth of the tubercle bacillus *in vitro*.²⁴

Kurchi bark is principally used in India as a remedy for amoebic dysentery, and in recent years there has been a revival of medical interest in the drug in this connection.²³ It is generally used in the form of a bark extract but, in imitation of emetine bismuth iodide, "kurchi bismuth iodide," consisting of the bismuth iodides of the mixed alkaloids of the bark, has also been used.^{23(a)} On the pharmaceutical side Datta and Bal have studied the pharmacognosy of the bark²⁵ and a method of alkaloidal assay has been devised by Schroff and Dhir,²⁶ who have also described a process for the preparation of kurchi bismuth iodide, a product for which they, and also Mukherjee and Dutta,²⁷ have provided methods of assay.

REFERENCES

- (1) *Trans. Med. Soc. Bombay*, 1858, 4, 28; *Pharm. J.*, 1865, [ii], 6, 432. (2) *Ibid.*, 1864, [ii], 5, 493; *WARNECKE, Ber.*, 1886, 19, 60. (3) *Ibid.*, pp. 78, 1682; see also *PARIS, Bull. Sci. Pharmacol.*, 1938, 45, 453; 1942, 49, 33. (4) *J. Chem. Soc.*, 1919, 115, 163. (5) *Trans. Roy. Soc. Trop. Med. Hyg.*, 1923-24, 17, 381. (5a) (With MISRA and SHARMA), *J. Sci. Ind. Res. (India)*, 1945, 3, 555. (6) *SIDDIQUI, J. Ind. Chem. Soc.*, 1934, 11, 283; *Proc. Ind. Acad. Sci.*, 1936, 3A, 249, 257; (with PILLAY), *J. Ind. Chem. Soc.*, 1932, 9, 553; *BERTHO, Arch. Pharm.*, 1939, 277, 237; *Annalen*, 1944, 555, 214; *VON SCHUCKMANN, BERTHO and SCHÖNBERGER, Ber.*, 1933, 66, 786. (6a) *IRANI, Curr. Sci. (India)*, 1946, 15, 229. (7) *ULRICI, Arch. Pharm.*, 1918, 256, 57. (8) *GIEMSA and HALBERKANN, ibid.*, p. 201. (9) *J. Ind. Chem. Soc.*, 1934, 11, 787. (10) *Proc. Ind. Acad. Sci.*, 1935, 2A, 426; (with VASISHT), *J. Sci. Ind. Res. (India)*, 1945, 3, 559. (11) *Proc. Ind. Acad. Sci.*, 1936, 4A, 283. (12) *J. Chem. Soc.*, 1926, 2123 (*ibid.*); cf. *SIDDIQUI et al.*¹¹ (13) *Ber.*, 1930, 63, 126. (14) *J. Pharm. Soc. Japan*, 1927, No. 546, 98 (German abs.), 680 (Jap. text). (15) *Proc. Ind. Acad. Sci.*, 1937, 6A, 191, 199; 1939, 10A, 417; *J. Sci. Ind. Res. (India)*, 1946, 4, 435; (with VASISHT), *ibid.*, p. 440. (16) *J. Chem. Soc.*, 1932, 631. (17) *J. Ind. Chem. Soc.*, 1928, 5, 477; *CHOWDHURY and PEACOCK, ibid.*, 1937, 14, 486; *GHOSH and BOSE, Arch. Pharm.*, 1932, 270, 100. (18) *PEACOCK and CHOWDHURY, J. Chem. Soc.*, 1935, 734. (19) *Inaug. Diss. Göttingen*, 1878. (20) *J. Pharm. Exp. Ther.*, 1915, 6, 305. (21) *Ind. Med. Gaz.*, 1927, 62, 132. (22) *J. Pharm. Exp. Ther.*, 1933, 48, 79; cf. *BAKSH, ibid.*, 1936, 58, 373; *BERTHO, Arch. exp. Path. Pharm.*, 1944, 203, 41. (23) *BROWN, Brit. Med. J.*, 1922, i, 993; *CAIUS and MHASKAR, Ind. Med. Res. Memoirs*, No. 6, 1927; *ACTON and CHOPRA, Ind. Med. Gaz.*, 1929, 64, 481; 1933, 68, 6; *GHOSH, ibid.*, 1933, 68, 13; *LEAKE, J. Amer. Med. Assoc.*, 1932, 98, 195. For action of kurchicine, see *CHOPRA, GUPTA and CHOPRA, Ind. J. Med. Res.*, 1933-34, 21, 277; and *BAKSH, J. Pharm. Exp. Ther.*, 1936, 58, 361. (23a) *GUPTA, J. Proc. Inst. Chem. India*, 1946, 18, 182. (24) *Arch. exp. Path. Pharm.*, 1930, 147, 339. (25) *Ind. J. Pharm.*, 1945, 7, 123; cf. *SCHROFF, BAL and DHIR, ibid.*, 1940, 2, 195. (26) *Ibid.*, 1939, 1, 20. (27) *Science and Cult. (India)*, 1945, 10, 506. (28) *BERTHO, Ber.*, 1947, 80, 316. (29) *Annalen*, 1947, 558, 62; 557, 220.

ALKALOIDS OF *LOLIUM PERENNE* L.

In the course of a biochemical investigation of pasture grasses in New Zealand, an alkaloid was found in extracts of darnel or rye grass. The alkaloid showed in presence of ammonia a marked green fluorescence, which disappeared on acidification.¹ It was thought that it might be the cause of facial eczema in cattle, and processes for its estimation in plant material^{2(a)} and in animal tissues and fluids^{2(b)} were devised, depending on measurement of colour in chloroform solution in which the green fluorescence is well shown. The total alkaloids were extracted and separated into four fractions, A, B, C and D,³ of which A is the desired alkaloid, now named *perloline*, and B is largely *perloline dihydrochloride*. C is the alkaloid later named *perloidine*.⁷

D is a volatile base, C_8H_7N , b.p. $134-8^\circ$, $D_4^{15} 0.9595$, $n_D^{12} 1.4963$, giving a picrate, m.p. $154-6^\circ$, and a mercurichloride, m.p. $151-2^\circ$; it is isomeric with the picolines and resembles β -picoline, but does not oxidise to nicotinic acid or reduce to β -pipercoline and so cannot be β -picoline; it may contain some α -picoline. A base similar to D has been isolated from tall fescue grass.⁴

Perloline, $C_{36}H_{22}O_3N_4(OMe)_4 \cdot H_2O$, is isolated as the dihydrochloride $B \cdot 2HCl \cdot 7H_2O$, which forms golden yellow needles; m.p. $220-265^\circ$, $[\alpha]_D \pm 0^\circ (H_2O)$. The monohydrated base occurs as pale yellow needles,

m.p. 181°, becomes anhydrous at 70° in a high vacuum and then crystallises from alcohol, by addition of ether in prisms as a mono-alcoholate, B. EtOH, m.p. 252°. The dipicrate has m.p. 242°, and the diperchlorate, m.p. 284° (*dec.*); the mercurichloride exists in two forms, yellow, m.p. 265°, and orange-red, m.p. 201°; the reineckate decomposes at 195–205°. The base gives a monoacetyl derivative, m.p. 296–300° (*dec.*).

The absorption curves of perloine and its hydrochloride show maxima at 470 m μ and 398 m μ respectively.⁶ Perloine contains one alcoholic hydroxyl group and four methoxyl groups: no evidence of a reactive carbonyl group, a methylenedioxy group, a lactone, carboxyl or ester group was found and the two remaining oxygen atoms must be present as unreactive carbonyl or ether groups. No methylimino group, or methyl to carbon group, could be detected: of the four tertiary nitrogen atoms two are basic. On boiling with 50 per cent. sulphuric acid the base yields demethylated perloine, C₃₆H₂₂O₃N₄(OH)₄ · H₂O, m.p. >350°, of which the hydrochloride has m.p. 210°, the amorphous picrate, m.p. 206°, and the pentacetyl derivative, m.p. 216° (*dec.*). With methyl iodide perloine forms di-*N*-methylperloine dihydriodide, C₄₀H₃₂O₇N₄(Me)₂(HI)₂, m.p. 264°, which on special alkaline treatment yields di-*N*-methylperloine as a monohydrate, m.p. 199°, giving yellow, non-fluorescent salts, of which the dihydrochloride has m.p. 268–270° and the acetyl derivative m.p. 219–221° (*dec.*).

Some of these substances in further reactions give small yields of perloidine, *e.g.*, the molecular sublimation at 0·01 mm. of demethylated perloine, also oxidation of the latter, or of dimethylperloine, by alkaline permanganate, or warming a solution of demethylated perloine in sodium hydroxide solution.⁷ Perloine could not be reduced by any of the means tried: it has been subjected to a number of reactions designed to yield degradation products of constitutional interest but only preliminary results are available so far. Neither perloine nor its demethylated or methylated derivatives give indole colour reactions, but the vapours evolved during some oxidations and a fraction resulting from alkaline pyrolysis of perloine, had indole-like odours and gave pink to purple colours with dimethylaminobenzaldehyde.⁷

An investigation of eighty-five plant species, representing forty genera of the Gramineæ and ten species each of Cyperaceæ and Juncaceæ, resulted in the recognition of perloine in only four species in addition to *Lolium perenne*, viz. *L. temulentum* L., *L. multiflorum* Lam., *Festuca arundinaceæ* Schreb. and *Setaria lutescens* (Weigel) F. T. Hubb.⁷

Hofmeister has recorded the presence of a liquid toxic alkaloid, *temuline*, C₇H₁₂ON₂, in *L. temulentum*.^{7(a)}

Perloidine, C₂₅H₁₃O₂N₄, occurs naturally and is also produced in small yield by the oxidation of perloine in various ways. It crystallises in silky needles, m.p. 325–6°, sublimes at 180°/0·04 mm., and yields a dihydrochloride, B. 2HCl · 2H₂O, m.p. > 350°. It shows a marked blue fluorescence in neutral or acid aqueous solution, which with the hydrochloride is visible at 0·15 parts per million. The base is phenolic; it

precipitates with the usual alkaloidal reagents, but gives no characteristic colour reactions, *e.g.*, with ferric chloride or the Millon or Adamkiewicz reagents. No well-defined degradation products have been obtained.⁷

According to Cunningham and Clare,⁸ perloine produces toxic effects in mice, rabbits and sheep when injected intravenously or intraperitoneally, but only in doses large in comparison with toxic doses of nicotine or strychnine. Doses of 59 mgm. per 100 gm. body-weight given orally to sheep for thirty-two days followed by 96 mgm. per 100 gm. body-weight, for four days, produced no toxic effects and it is unlikely that such concentrations would be reached by the ingestion of pasture plants. The toxic symptoms produced on injection were not similar to those of any known cattle disease. Perloine possesses photodynamic properties of a mild order but photosensitisation was not produced in sheep by oral administration and even mild positive effects were only induced by intravenous injection of large doses. It is suggested that the lack of cumulative effects is due to the rapid destruction of perloine, which is shown to occur after administration orally or by injection.

REFERENCES

- (1) MELVILLE and GRIMMETT, *Nature*, 1941, 146, 782; *N.Z. Journ. Sci. Tech.*, 1943, 24B, 149. (2) (a) BATHURST, REIFER and CLARE, *ibid.*, p. 161; (b) CLARE, *ibid.*, p. 163. (3) GRIMMETT and WATERS, *ibid.*, p. 151. (4) SHORLAND, WHITE and GRIMMETT, *ibid.*, p. 179. (5) REIFER and BATHURST, *ibid.*, p. 155. (6) SHORLAND, *ibid.*, p. 159. (7) WHITE and REIFER, *ibid.*, 1945, 27, 38; CLARE and MORICE, *ibid.*, p. 36; REIFER and WHITE, *ibid.*, p. 242. (7a) *Arch. exp. Path. Pharm.*, 1892, 30, 203. (8) *N.Z. Journ. Sci. Tech.*, 1943, 24, 167.

ALKALOIDS OF LUNASIA COSTULATA

Lunasia costulata Miq (*Lunasia amara* Blanco) is a native of the Malayan Archipelago where the bark and leaves are used as stomachics and the extremely hard wood to form arrow points. The early history of the drug is recounted, and the work on its botany, pharmacognosy and chemistry is critically reviewed by Dieterle and Beyl.¹ Boorsma² isolated three alkaloids from the bark: lunasine, lunacrine and lunacridine. Wirth³ and Amelink⁴ confirmed the presence of the first two but Dieterle and Beyl found all three of Boorsma's alkaloids. The bark has also been examined by Steldt and Chen,⁵ who obtained four alkaloids: lunacrine; lunacridine, as described by Boorsma; lunamarine, probably identical with the lunacridine of Dieterle and Beyl; and lunamaridine. Lunasine was not found.

Lunasine, $C_{16}H_{21}O_5N$, m.p. 188–9° (*dec.*), $[\alpha]_D - 38^\circ$, contains a methoxyl and a methylimino group.³

Lunacrine, $C_{16}H_{19}O_3N \cdot H_2O$, m.p. 95.5° or 115° (*dry*), $[\alpha]_D^{28} - 58^\circ$ (EtOH); solutions show a blue fluorescence in ultra-violet light. It contains one methoxyl, one methylenedioxy and one methylimino group. The following salts have been prepared: B. HCl, m.p. 164–5°, $[\alpha]_D^{28} - 23^\circ$ (H_2O); B. HBr, m.p. 170–1°; B. HI, m.p. 196–7°, picrate, m.p. 208°, aurichloride, m.p. 176–7°. The methiodide, $C_{17}H_{22}O_3NI$, m.p. 130–1°,

on treatment with silver oxide produces an isomeride of lunacrine, m.p. 85–6.^{1,5} This behaviour resembles that of other Rutaceous alkaloids, e.g., skimmianine (p. 414).

Lunamarine, $C_{18}H_{15}O_4N$, probably identical with the lunacridine of Dieterle and Beyl. M.p. 245–6°, $[\alpha]_D \pm 0^\circ$. Solutions in alcohol fluoresce blue in ultra-violet light.⁵

Lunacridine, $C_{17}H_{23}O_4N$, probably identical with Boorsma's lunacridine, m.p. 79–83·5°, $[\alpha]_D^{28} + 31\cdot6^\circ$. Solutions show a weak blue fluorescence in artificial light.⁵

Lunamaridine, $C_{18}H_{15}O_2N$, m.p. 209–210°.

The median lethal dose of lunacrine hydrochloride is 78·7 \pm 3·8 mgm. per kilo given intravenously in mice. Oral doses of 1 gramme of lunamarine are not fatal. The m.l.d. of lunacridine by mouth is 1,097 \pm 167 mgm. per kilo. Lunamarine stimulates isolated rabbit intestine and uterus, but lunacrine and lunacridine inhibit peristaltic movement of the isolated intestine. All three alkaloids reduce arterial blood pressure in cats.⁵

REFERENCES

- (1) *Arch. Pharm.*, 1937, 275, 174, 276. (2) *Meded. Lands. Plant.*, 1899, 31, 13, 126; *Bull. Inst. Bot. Buit.*, 1904, No. 31, 8, 25; cf. BRILL and WELLS, *Philipp. J. Sci.*, 1917, 12, A 167. (3) WIRTHE, *Pharm. Weekbl.*, 1931, 68, 1011. (4) AMELINK, *ibid.*, 1932, 69, 1390. (5) *J. Amer. Pharm. Assoc.*, 1943, 32, 107.

ALKALOIDS OF *LYCOPodium* SPP.

Recent interest in the alkaloids of the club mosses dates from 1934, when Orekhov¹ called attention to *Lycopodium annotinum* as a source of alkaloids. In the following year Muszynski² gave a preliminary account of chemical and pharmacological work on the alkaloids of five European *Lycopodium* species, and later Oficjalski³ recorded the toxicities of Muszynski's alkaloids. Most of the recent work on the genus has been done on American species by Marion and Manske, who distinguish their alkaloids provisionally, by the letter L and a number, e.g., L13, a trivial name being assigned when the individuality of an alkaloid has been clearly established. The following list records the alkaloidal constituents of nine *Lycopodium* spp. so far examined. Lycopodine has been found in all the species except *L. saururus*. Nicotine occurs in four species. It has also been found in one of the horse-tails, *Equisetum arvense* L.,⁸ and is the only alkaloid so far found both in flowering plants and the pteridophyta, thus establishing an alkaloidal link between the phanerogamia and cryptogamia.

- (1) *L. annotinum* L. Annotinine (L7), lycopodine, obscurine (L6), (L8), (L9), (L10), (L11), (L12). (Manske and Marion.⁴)
 (2) *L. clavatum* L. (European specimen.) Clavatine, clavatoxine, lycopodine (Achmatowicz and Uziębło⁵). (American specimen.) Lycopodine, nicotine, (L13), (L18), (L19). Marion and Manske⁶ suggest that the American and European forms may be different varieties of one species, or possibly distinct species.

- (3) *L. complanatum* L. Lycopodine (Bödeker⁷).
- (4) *L. flabelliforme* Fernald. Re-named from *L. complanatum* L. Complanatine (L1), lycopodine, nicotine, obscurine (L6), (L2), (L3), (L4), (L5). (Manske and Marion.⁸)
- (5) *L. lucidulum* Michx. (*Urostachya lucidulus* Herter.) Lycopodine, nicotine, (L13), (L20), (L21), (L22), (L23), (L24), (L25). (Manske and Marion.⁹)
- (6) *L. obscurum* L. var. *dendroideum* (Michx.) D. C. Eaton. Lycopodine, obscurine (L6), (L13), (L16), (L17). (Manske and Marion.¹⁰)
- (7) *L. sabinæfolium* Willd. Lycopodine, nicotine, (L13), (L26). (Marion and Manske.¹¹)
- (8) *L. saururus* Lam. Pillijanine (Adrian,¹² Arata and Canzoneri,¹³ Dominguez¹⁴). Saururine, sauroxine (Deulofeu and de Langhe¹⁵).
- (9) *L. tristachyum* Pursh. Lycopodine, nicotine, (L13), (L14) and (L15). (Marion and Manske.¹⁶)

Lycopodine, $C_{16}H_{25}ON$. Bödeker,⁷ who first isolated the alkaloid, assigned to it the formula $C_{32}H_{52}O_3N_2$. This was changed to that now given by Achmatowicz and Uziębło⁵ and confirmed by Manske and Marion.⁸ It has m.p. $115-6^\circ$, $[\alpha]_D^{20} - 9.01^\circ$ (acetone), and forms a perchlorate, m.p. 283° (*dec.*), methiodide, m.p. $335-7^\circ$, methochloride, m.p. $238-240^\circ$, and according to Bödeker a crystalline hydrochloride and aurichloride. No methoxyl or methylimino group or active hydrogen (Zerevitinov) is present and it does not hydrogenate even under pressure at 200° in presence of Raney nickel. The oxygen atom is probably present as a cyclic ether and the nitrogen atom may be common to two rings. On selenium dehydrogenation, a complex mixture of bases is formed, from which 7-methylquinoline, b.p. $75-80^\circ/2$ mm. picrate, m.p. 242° , and 5:7-dimethylquinoline, picrate, m.p. 246° , were isolated. Heated with phthalic anhydride in a sealed tube at 250° , lycopodine yields, in addition to 7-methylquinoline, a substance forming an oily picrate, and a crystalline perchlorate, $C_{14}H_{23}N \cdot HClO_4$, m.p. 285° (Marion and Manske¹⁷).

The following is a descriptive list of the known subsidiary alkaloids. The figures in brackets after the formulæ refer to the numbered items in the distribution list (pp. 752-3):—

- Annotinine*, $C_{16}H_{21}O_3N$, (1). M.p. 232° ; perchlorate, m.p. 267° . In a later paper (1947) Manske and Marion⁴ record the results of the action of alkali and of halogen acids on annotinine, and of the oxidation of the base and discuss the reaction products. They conclude that two of the oxygen atoms are present as a lactone group and that the third oxygen may form an ether bridge in a 5- or 6-membered ring.
- Clavatine*, $C_{16}H_{25}O_2N$, (2). M.p. $212-3^\circ$, $[\alpha]_D^{20} - 365.7^\circ$ (acetone); B. MeI, m.p. $317-8^\circ$, OMe and NMe absent.
- Clavotaxine*, $C_{17}H_{27}O_2N$, (2). M.p. $185-6^\circ$. OMe and NMe absent.
- Complanatine*, $C_{18}H_{31}ON$, (4). M.p. 169° ; perchlorate, B. $2HClO_4 \cdot H_2O$, m.p. 190° .

754 ALKALOIDS OF UNDETERMINED CONSTITUTION

- Obscurine*, $C_{18}H_{28}ON_2$, (1), (4), (6). M.p. 282° ; perchlorate, B. $2HClO_4 \cdot H_2O$, m.p. 299° (*dec.*).
- Pilljanine*, $C_{15}H_{24}ON_2$, (8). M.p. $64-5^\circ$; B. $H_2SO_4 \cdot 0.5H_2O$; B. $2H_2PtCl_6$.
- Saururine*, $C_{16}H_{19}N$, (8). Oil; picrate, m.p. 202° ; B. MeI, m.p. $242-4^\circ$.
- Sauroxine*, $C_{17}H_{26}ON_2$, (8). M.p. 198° , $[\alpha]_D^{20} - 71.8^\circ$ (EtOH); B. MeI, m.p. 258° .
- L1 (see complanatine, p. 753).
- L2, $C_{18}H_{29}O_2N$ (4). M.p. 97° , perchlorate, m.p. 231° .
- L3, $C_{18}H_{31}O_2N$ (4). Perchlorate, m.p. 246° .
- L4, $C_{16}H_{27}N$ (4). Perchlorate, B. $HClO_4 \cdot 0.5H_2O$, m.p. 225° .
- L5, $C_{18}H_{28}O_2N_2$ (4). Perchlorate, m.p. 282° .
- L6 (see obscurine, above).
- L7 (see annotinine, p. 753).
- L8, $C_{16}H_{25}O_2N$ (1). M.p. 180° ; perchlorate, m.p. 318° (*dec.*).
- L9, probably a mixture of (a) $C_{16}H_{23}ON$ and (b) $C_{20}H_{31}O_4N$; m.p. 122° , forms two perchlorates, (a) m.p. 276° and (b) m.p. 273.5° , yielding a base, m.p. 98° .
- L10, $C_{16}H_{27}ON$ (1). Perchlorate, m.p. 223° .
- L11, $C_{16}H_{21}O_3N$ (1). M.p. 174° ; perchlorate, m.p. 239° .
- L12, $C_{18}H_{25}O_3N$ (1). M.p. 119° ; perchlorate, m.p. 244° .
- L13, $C_{16}H_{25}ON$ (2), (5), (6), (7), (9). M.p. 130° ; perchlorate, m.p. 274° .
- L14, $C_{16}H_{25}N$ (9). Perchlorate, m.p. 238° .
- L15, $C_{32}H_{31}O_4N$ (9). Perchlorate, m.p. 231° .
- L16, $C_{16}H_{25}ON$ (6). Perchlorate, m.p. 221° .
- L17, $C_{18}H_{27}O_3N$ (6). Perchlorate, m.p. 296° .
- L18, $C_{11}H_{19}ON$ (2). Picrate, m.p. 195° .
- L19 (no formula) (2). M.p. 231° .
- L20, $C_{17}H_{27}O_2N$ (5). M.p. 259° ; perchlorate, m.p. 271° .
- L21, $C_{13}H_{21}ON$ (5). Perchlorate, B. $HClO_4 \cdot 0.5MeOH$; m.p. 201° , picrate, m.p. 107° .
- L22, $C_{16}H_{27}ON$ (5). M.p. 108° ; perchlorate, m.p. 254° .
- L23, $C_{16}H_{25}O_2N$ (5). M.p. $161-2^\circ$; perchlorate, m.p. 300° .
- L24, $C_{16}H_{25}ON$ (5). Perchlorate, m.p. 278° .
- L25, $C_{16}H_{25}O_2N$ (5). Perchlorate, B. $HClO_4 \cdot 0.5H_2O$, m.p. 297° .
- L26, $C_{15}H_{25}ON$ (7). M.p. 171° .

Most of these bases have been isolated and characterised as perchlorates for which formulæ are only given in the list when they are not the usual anhydrous mono-salts. Most of the bases are either C_{16} or C_{18} types, and in this connection Manske and Marion¹⁰ suggest that sauroxine may be $C_{16}H_{24}ON_2$, which equally well suits the analytical results quoted by Deulofeu and Langhe.¹⁵

Addendum. In a later paper Manske and Marion⁴ report on *L. annotinum* var. *acrifolium* Fern., which they suggest should be raised to specific rank as *L. acrifolium* (Fern.) N. Comb., since its alkaloidal constituents differ from those of *L. annotinum*. It contains annotinine as the

chief alkaloid, with lycopodine and the following new bases of which L28, L29 and L31 have not been crystallised, but yield crystalline perchlorates :—

L27 (*acrifoline*), $C_{16}H_{23}O_2N$, m.p. 97° , perchlorate, m.p. 266° .

L28, $C_{17}H_{27}O_2N$, perchlorate, m.p. 211° .

L29, $C_{16}H_{23}O_2N$, perchlorate, m.p. 274° .

L30, $C_{16}H_{25}O_2N$, m.p. 178° , perchlorate, m.p. 311° (*dec.*).

L31, $C_{20}H_{29}O_4N$, perchlorate, m.p. 217° (*dry*).

The same authors⁴ (1948) have isolated nicotine and the two following alkaloids from *Lycopodium cernuum* L. :—

L32 (*cernuine*), $C_{16}H_{26}ON_2$, m.p. 106° ; perchlorate, B. $HClO_4 \cdot 1.5H_2O$, m.p. 110° .

L33, m.p. 218° .

Pharmacological Action. Oficjalski³ found, for the alkaloids he examined, that the toxic dose for cats ranged from 0.005, in the case of pillijanine, to 0.05 gm. per kilo for clavatine. Rabbits and rats required larger doses. According to Achmatowicz and Uziębło,⁵ lycopodine, clavatine and clavotoxine stimulate the respiratory centre in mammals and paralyse the central and peripheral nervous system in frogs. De Espanes¹⁸ found that in dogs, anaesthetised with chloral, intravenous injection of 0.5 mgm. per kilo of saururine produced a rise in blood pressure, accompanied by tachycardia, potentiated the pressor effect of adrenaline, and decreased the depressor effects of acetylcholine and pilocarpine. Doses of 2–4 mgm. per kilo produced a fall in blood pressure, electrocardiographic changes, cardiac arrest and cessation of respiration. Manske's alkaloids, annotinine, complanatine, lycopodine, obscurine, L8 and L9, were examined by Lee and Chen.¹⁹ All have a marked pressor action in cats, obscurine being the most potent. By intravenous injection in anaesthetised cats none affect respiration. Lycopodine, complanatine, obscurine and L9 stimulate isolated rabbit uterus and lycopodine, L8 and L9 contract isolated guinea-pig uterus. The toxicities were determined by intravenous injection in mice and are expressed as L.D. $50 \pm S. E.$ in mgm. per kilo. : lycopodine, 27.58 ± 1.16 ; complanatine, 14.87 ± 0.46 ; obscurine, 99.17 ± 11.29 ; annotinine, 114.6 ± 2.94 ; L9, 40.28 ± 1.49 . A detailed comparison of annotinine and lycopodine has been made by Marier and Bernard²¹ with special reference to their action on the autonomous nervous system. The club-mosses have in some areas a local reputation as antipyretics and, according to Nikonorow,²⁰ an aqueous extract of *L. clavatum* is an effective antipyretic against fever induced in rabbits by subcutaneous injection of hay infusion, but Lee and Chen¹⁹ found that lycopodine had no curative action on malaria in ducklings.

REFERENCES

- (1) *Arch. Pharm.*, 1934, 272, 673. (2) *Ibid.*, 1935, 273, 452. (3) *Bull. Sci. Pharmacol.*, 1937, 44, 470. (4) *Can. J. Res.*, 1943, 21B, 92; 1948, 26, 1; *J. Amer. Chem. Soc.*, 1947, 69, 2126. (5) *Rocz. Chem.*, 1938, 18, 88 (*Brit. Chem. Abstr.*, 1938, Aii, 338). (6) *Can. J.*

Res., 1944, 22B, 187. (7) *Annalen*, 1881, 208, 863. (8) *Can. J. Res.*, 1942, 20B, 87. (9) *Ibid.*, 1946, 24B, 57. (10) *Ibid.*, 1944, 22B, 53. (11) *Ibid.*, 1946, 24B, 63. (12) *Compt. rend.*, 1886, 102, 1322. (13) *Gazzetta*, 1892, [I], 22, 49. (14) *Rev. Cent. Estud. Farm. Bioquim.*, 1931, 20, 534 (*Chem. Zentr.*, 1932, i, 3452). (15) *J. Amer. Chem. Soc.*, 1942, 64, 968. (16) *Can. J. Res.*, 1944, 22B, 1. (17) *Ibid.*, 1942, 20B, 153. (18) *Rev. Soc. Arg. Biol.*, 1944, 20, 413 (*Brit. Abstr.*, 1945, Aiii, 789). (19) *J. Amer. Pharm. Assoc.*, 1945, 34, 197. (20) *Acta polon. Pharm.*, 1939, 3, 23 (*Chem. Abstr.*, 1941, 35, 3766). (21) *Can. J. Res.*, 1948, 26, 174.

ALKALOIDS OF MITRAGYNA, ADINA AND OUROUPARIA SPP.

These three *Rubiaceous* genera contain alkaloids about which comparatively little is known. Some of them, described as new, have subsequently been identified with known bases. In the following list the superseded names are shown in brackets :—

- Adina rubrostipulata* K. Schumann. Mitrephylline¹ (rubradinine; Denis).²
Mitragyna diversifolia Hook. Mitraversine.³
M. inermis Kuntze (*M. africana* Korth). Rhyncophylline (mitrinermine).⁴
M. parvifolia Korth. Unnamed, crystalline alkaloid.⁵
M. rotundifolia (Roxb.) Kuntze (*M. diversifolia* Hook). Rhyncophylline and rotundifoline.⁶
M. speciosa Korth. Mitragnine,³ mitraspecine⁷ and a base, or bases, giving an amorphous picrate, m.p. 123–7°.⁸
M. stipulosa Kuntze (*M. macrophylla* Hiern). Rhyncophylline.⁴
Ourouparia formosana Mats. Formosanine.⁹
O. Gambir Baill. (*Uncaria Gambir* Roxb). Gambirine, uncharacterised.¹⁰
O. Kawakamii Hayata. Hanadamine.¹¹
O. rhyncophylla Mats. Rhyncophylline and isorhyncophylline.¹²

The alkaloid *crossoptine*, which Blaise¹⁶ isolated from *Crossopteryx kotschyana* Fenzl, has been examined by Raymond-Hamet, who assigns to it the following formula and constants: C₂₂H₂₈O₄N₂, m.p. 218–9°, [α]_D – 24° (CHCl₃), and suggests that it is mitrinermine, which is now known to be rhyncophylline. He also considers that the bark used was probably derived from a *Mitragyna* sp.¹⁶

It is of interest to note that rhyncophylline occurs in two genera, *Mitragyna* and *Ourouparia*. Raymond-Hamet⁹ suggested in 1936 that rhyncophylline, hanadamine and formosanine are chemically and pharmacologically related to the *Mitragyna* alkaloids and the first chemical evidence of this is the identification of mitrinermine with rhyncophylline (Barger *et al.*).⁶ Millat⁶ has recently expressed doubt of this identification.

The formulæ and chief characteristics of these alkaloids are summarised in the table on p. 757.

Some progress has been made towards the determination of structure in three of these alkaloids, mitragynine, rhyncophylline and rotundifoline. The functions of the oxygen atoms, so far as known, are shown in the extended formulæ in the table. The bases are monoacidic and the second nitrogen is non-basic and usually assumed to be present in an indole ring. In rhyncophylline it is a secondary nitrogen as indicated by Zerevitinov

Name and Formula	Physical Constants of Base	Salts
Mitragynine $C_{16}H_{21}N_2(OMe)_2(O\cdot CO\cdot Me)$	amorph., m.p. 105-115° b.p. 230-240°/5 m.m.	Picrate, 217-223°; B.HCl, m.p. 243°; B. $C_8H_4O_2$, m.p. 175-6° (<i>dec.</i>). methiodide, amorphous, m.p. 211-5°.
Mitraphylline $C_{20}H_{23}O_3N_2(OMe)$	m.p. 270°; $[\alpha]_D^{15}$ -9.84°	Picrate, m.p. 166°.
Mitrasersine $C_{20}H_{19}ON_2(MeO)_2(OH)$	m.p. 237°	B.HCl, m.p. 208-210°.
Mitraspecine $C_{25}H_{27}O_2N_2(OMe)_3$	m.p. 244-5°; $[\alpha]_D^{23}$ -59.15°	Picrate m.p. 136°.
Rhyncoophylline $C_{19}H_{22}ON_2(OMe)(O\cdot CO\cdot Me)$	m.p. 208-9°. $[\alpha]_D^{15}$ -14.5°	- - - -
<i>iso</i> Rhyncoophylline	amorph., m.p. 60-70°, $[\alpha]_D^{17}$ +8.3°	B.HClO ₄ , m.p. 150° (<i>dec.</i>).
Rotundifoline $C_{19}H_{20}O_2N_2(OMe)(O\cdot CO\cdot Me)$	m.p. 233-4°; $[\alpha]_D^{15}$ +124°	- - - -
Formosanine $C_{21}H_{24}(26)O_4N_2$	m.p. 202-218°; $[\alpha]_D$ + 91.3°	- - - -
Hanedamine $C_{15}H_{20}ON_2(O\cdot CO\cdot Me)(OH)$	m.p. 187°; $[\alpha]_D^{18}$ -123.7°	B. H_2AuCl_4 , m.p. 156° (<i>dec.</i>). platinichloride, amorph., m.p. 228-9°.

determination and the formation of an acetyl derivative, m.p. 151-3°, $[\alpha]_D^{26}$ - 7.6°. All three bases are hydrolysed by alkali and the resulting acids are amorphous. Rhyncoophylline provides *rhyncoophyllic acid*, $C_{21}H_{26}O_4N_2$, which slowly decomposes above 150°, and according to Kondo *et al.*¹² is methylated by diazomethane to *isorhyncoophylline*. The latter is converted by boiling acetic anhydride into rhyncoophylline and its acetyl derivative.

Rotundifoline yields *rotundifolic acid*, $C_{21}H_{24}O_5N_2$, which froths at about 165°, and on heating with quicklime is decarboxylated to a base, $C_{20}H_{24}O_3N_3$, m.p. 200-2°.⁸

Heated with potassium hydroxide in methanol, mitragynine at first appears to combine with a molecule of the alcohol to form a product, $C_{25}H_{34}O_5N_2$ (picrate, m.p. 135-6°), containing four methoxyl groups, which on further action of the reagent is converted into a monocarboxylic acid, $C_{21}H_{23}O_4N_2$ (picrate, m.p. 157°), containing two methoxyl groups and which does not re-form mitragynine on methylation (Ing and Raison,⁸ *cf.* Field³). Oxidation of mitragynine by permanganate produces only acetic and oxalic acids.

The most interesting product arising from more drastic degradation experiments is a base, $C_{14}H_{14}ON_2$, m.p. 115-120°, obtained by distilling mitragynine with zinc dust. It contains a methoxyl and a methylimino group, and has a reactive methylene group, since it forms a *p*-nitrobenzylidene derivative, m.p. 255°. This base closely resembles both *ind*- and *pyr-N*-methylharmine, but is not identical with either.

Among products of the distillation of rhyncoophyllic acid with lime is a neutral substance, $C_{10}H_9ON$, m.p. 182-4°, which it is suggested may be a

methylcarbostyryl; it is soluble in hot alkali and when distilled with zinc dust produces a substance giving a positive Ehrlich reaction.

Pharmacological Action. Under the name "Kratom" the leaves of *M. speciosa* are chewed as a narcotic in Siam. The view that "kratom" can be used as a cure for the opium habit is not generally accepted.¹³ According to Grewal,¹⁴ mitragynine exerts a general depressant effect on plain muscle, facilitates the passage of autonomic impulses and in some respects resembles both cocaine and quinine, but has no action on pathogenic organisms. According to Raymond-Hamet,⁴ rhyncophylline (mitrinermine) lowers blood pressure, paralyzes sympathetic nerve endings and, unlike yohimbine, but like echitamine, does not reverse the action of adrenaline. The same author anticipated, by pharmacological comparison, the chemical identification of mitrinermine with rhyncophylline and showed that the latter is markedly more toxic to frogs than mitraphylline, and Massion¹⁵ states that the latter resembles mitragynine in action but is weaker.

REFERENCES

- (1) RAYMOND-HAMET, *Bull. Sci. pharmacol.*, 1935, 42, 602; 1939, 46, 327. With a bibliography and critical review of previous work. (2) DENIS, *Bull. Acad. roy. Belg.*, 1937, [v], 23, 174; 1939, [v], 25, 177. (3) FIELD, *J. Chem. Soc.*, 1921, 119, 887; RAYMOND-HAMET and MILLAT, *J. Pharm. Chim.*, 1937 [viii], 25, 391. (4) RAYMOND-HAMET, *Compt. rend.*, 1934, 199, 587; *Compt. rend. Soc. Biol.*, 1934, 116, 1337; 1938, 128, 777; *Arch. int. Pharmacodyn.*, 1937, 56, 303; (with PERROT and LARRIEU), *Bull. Sci. pharmacol.*, 1930, 37, 401; (with PERROT and MILLAT), 1936, 43, 694; (with MILLAT), *J. Pharm. Chim.*, 1934, [viii], 20, 577; BARGER *et al.*⁶. (5) HOOPER, *Pharm. J.*, 1907, 78, 453. (6) BARGER, DYER and SARGENT, *J. Org. Chem.*, 1939, 4, 418; *cf.* MILLAT, *Ann. pharm. franç.*, 1946, 4, 27. (7) DENIS *Bull. Acad. roy. Belg.*, 1938, [v], 24, 653. (8) ING and RAISON, *J. Chem. Soc.*, 1939, 986. (9) RAYMOND-HAMET, *Compt. rend.*, 1936, 203, 1383; *Arch. Int. Pharmacodyn.*, 1939, 63, 336. (10) RAYMOND-HAMET, *Bull. Acad. Med.*, 1934, [iii], 112, 513. (11) KONDO and OSHIMA, *J. Pharm. Soc. Jap.*, 1932, 52, 63. (12) KONDO (with FUKUDA and TOMITA), *J. Pharm. Soc. Jap.*, 1928, 48, 54; (with IKEDA), *ibid.*, 1937, 57, 237; RAYMOND-HAMET, *C. R. Soc. Biol.*, 1934, 115, 255. (13) *Fourth Rept. Govt. Laboratory*, Bangkok, 1925, p. 5. (14) *J. Pharm. exp. Ther.*, 1932, 46, 251. (15) *Arch. int. Pharmacodyn.*, 1934, 48, 217. (16) BLAISE, "Les *Crossopteryx* africains. Etude botanique." Thèse, Doct. Pharm., Paris, 1932; RAYMOND-HAMET, *Bull. Sci. Pharmacol.*, 1940, 47, 194; *cf.* HESSE, *Ber.*, 1878, 11, 1546.

ALKALOIDS OF THE NYMPHAEACEÆ

Several alkaloids have been recorded for plants of this sub-order. From *Nymphæa alba* Linn., Burés and Plzák¹ isolated *nymphæine*, $C_{14}H_{23}O_2N$; it is amorphous, has m.p. 76–7°, gives a hydrochloride, m.p. 230° (*dec.*), contains a hydroxyl group, appears to be a secondary base, and to contain a pyrrole ring. It is toxic to frogs and produces tetanus-like symptoms.

From *N. lutea* L. (*Nuphar luteum* Sibth.) Achmatowicz and Mollowna² obtained two alkaloids.

α -*Nupharidine*, $C_{15}H_{23}ON$, b.p. 121–121.5°/2 mm., $[\alpha]_D^{18} - 112.1^\circ$, forming a hydrochloride, m.p. 258–9°; hydriodide, m.p. 185–7°; picrate, m.p. 165–7°; platinumchloride, m.p. 245–7°, and methiodide, m.p. 185–7°.

β -*Nupharidine*, $C_{15}H_{23}ON$, b.p. $127-8^{\circ}/2.5$ mm., yields a similar series of salts: B. HCl, m.p. $269-270^{\circ}$; B. HI, m.p. $273-5^{\circ}$, picrate, m.p. $152-3^{\circ}$, platinichloride, m.p. $230-2^{\circ}$.

Both alkaloids contain a hydroxyl group and a tertiary nitrogen but neither a methoxyl nor a methylimino group. Each contains one ethylenic linkage and hydrogenates to an oily dihydro-derivative: dihydro- α -nupharidine gives a hydrochloride, m.p. $240-2^{\circ}$, and a picrate, m.p. $190-2^{\circ}$; dihydro- β -nupharidine hydriodide melts at $279-280^{\circ}$.

From *Nuphar japonicum* Arima and Takahashi³ isolated a *nupharidine*, $C_{15}H_{23}O_2N$, m.p. $220-1^{\circ}$, $[\alpha]_D^{30} + 17.6^{\circ}$, of which salts were prepared, B. HCl, m.p. $245-6^{\circ}$ (*dec.*), B. HI, m.p. $265-6^{\circ}$, B. HNO_3 , m.p. 195° (*dec.*), and picrate, m.p. 175° . An alkaloid has also been isolated from an unidentified species of this sub-order by Raymond-Hamet.⁴

REFERENCES

(1) *Časopis Českoslov. Lek.*, 1934, 14, 179; 1935, 15, 223, 243. (2) *Rocz. Chem.*, 1939, 19, 493; cf. GRÜNING, *Ber.*, 1883, 16, 969; GORIS and CRETE, *Bull. Sci. Pharmacol.*, 1910, 17, 13. (3) *Bull. Chem. Soc. Jap.*, 1931, 52, 815. (4) *Compt. rend.*, 1941, 213, 386 (bibliography of early work).

ALKALOIDS OF *ORIXA JAPONICA*

From the roots of this plant Terasaka¹ isolated four alkaloids of which one, kokusagine, resembles skimmianine (p. 414), which Obata² has found along with kokusagine in the fruits of the plant.

Orixine, $C_{18}H_{21(23)}O_6N$, has m.p. 152.5° , $[\alpha]_D^{17} + 83.3^{\circ}$, and forms an aurichloride, m.p. 155° (*dec.*). It is a weak, tertiary base, contains one methylenedioxy and two methoxyl groups and is converted by hydrochloric acid in ether into isoorixine, m.p. 195° , $[\alpha]_D^{20} + 27.4^{\circ}$. Dilute hydrochloric acid under pressure produces *orixidine*, $C_{15}H_{13}O_4N$, m.p. 195° , and a *phenolic base*, $C_{15}H_{15}O_5N$, m.p. 113° (*dec.*).

Kokusagine, $C_{13}H_9O_4N$, m.p. 194° , $[\alpha]_D \pm 0^{\circ}$, aurichloride, m.p. 171° , picrate, m.p. 178° (157° ; Obata); contains one methoxyl and one methylenedioxy group and is converted by methyl iodide at 100° into isokokusagine, m.p. 247° (cf. skimmianine \rightarrow isoskimmianine, p. 414).

Kokusagine, $C_{14}H_{13(15)}O_4N$. Crystallises in prisms, m.p. 171° , forms a hydrochloride, m.p. 225° (*dec.*), and a picrate, m.p. 218° ; contains three methoxyl groups (cf. skimmianine, p. 414).

Kokusaginoline, $C_{17}H_{13}O_5N$, m.p. 283° , contains one hydroxyl and two methoxyl groups.

REFERENCES

(1) *J. Pharm. Soc. Japan*, 1931, 51, 99; 1933, 53, 219. (2) *Ibid.*, 1939, 59, 136.

ALKALOIDS OF *PICRALIMA KLAINIANA*

This Apocynaceae species is widely but sparsely distributed in tropical Africa, where the seeds enjoy an undeserved reputation as a specific for malaria. The drug is rich in alkaloids of which nine have been isolated and characterised.¹

Akuammine, $C_{22}H_{28}O_4N_2$, minute needles from boiling alcohol, in which it is sparingly soluble, m.p. 255° , $[\alpha]_D - 66.7^\circ$ (EtOH) or -73.4° ($CHCl_3$); B. HCl. H_2O , m.p. 227° , $[\alpha]_D^{22^\circ} - 26.6^\circ$ (H_2O); B. HBr. H_2O , prisms, m.p. 228° , $[\alpha]_D^{20^\circ} - 26.1^\circ$ (H_2O); picrate, m.p. 199° ; picrolonate, m.p. 194° ; perchlorate, m.p. 215° . Akuammine yields a monoacetyl derivative, m.p. 226° , and a methiodide, m.p. 274° , and contains one methoxyl and one methylimino group. On treatment with alkali in alcohol it is converted into *akuammine hydrate*, $C_{22}H_{30}O_5N_2$, which also occurs in the seeds and yields a methiodide, m.p. $> 300^\circ$.

Akuammidine, $C_{21}H_{24}O_3N_2 \cdot H_2O$, needles, m.p. 248.5° , $[\alpha]_D^{16^\circ} + 21^\circ$ (EtOH) or $+70.2^\circ$ (*N*/10-HCl), yields well-crystallised salts: B. HI. $3H_2O$, prisms, m.p. 90° or 238° (*dry*); perchlorate, m.p. 70° or 110° (*dry*); picrate, m.p. 215° ; contains one methoxyl and one methylimino group. The acetyl derivative has m.p. 272° , and the methiodide m.p. 195° or 233° (*dry*).

Akuammiline, $C_{22}H_{24}O_4N_2$. Prisms, m.p. 160° , $[\alpha]_D^{20^\circ} + 47.9^\circ$ (EtOH); the hydrochloride B. HCl. H_2O forms needles, m.p. 196° , $[\alpha]_D^{20^\circ} - 29.6^\circ$ (H_2O); hydriodide, B. HI, hair-like needles, m.p. 210° ; methiodide, rosettes of needles, m.p. 233° , $[\alpha]_D^{20^\circ} - 83.3^\circ$ (EtOH). One methoxyl group is present.

Akuammigine, $C_{22}H_{26}O_3N_2 \cdot H_2O$. Yellowish tablets, m.p. 125° , $[\alpha]_D^{20^\circ} - 44.4^\circ$ (EtOH); the hydrochloride, B. HCl, forms prisms, m.p. 287° , $[\alpha]_D^{20^\circ} - 37.8^\circ$ (MeOH); picrate, garnet-red prisms, m.p. 240° . The base contains one methoxyl group.

ψ -**Akuammigine**, $C_{22}H_{26}O_3N_2$. Colourless prisms, m.p. 165° , $[\alpha]_D^{20^\circ} - 53.8^\circ$. The hydrochloride, B. HCl. H_2O , has m.p. 183° or 218° (*dry*), $[\alpha]_D^{20^\circ} - 15.4^\circ$ (EtOH); picrate, m.p. 223° ; methiodide, m.p. 275° . One methoxyl and one methylimino group are present.

Akuammenine, $C_{20}H_{22}O_4N_2$. This base has only been isolated as the scarlet-red picrate, m.p. 225° ; it contains one methoxyl group.

Akuammicine, $C_{19}H_{20}O_2N_2$, crystallises in leaflets, m.p. 177.5° , $[\alpha]_D^{19^\circ} - 737.5^\circ$ (EtOH or $CHCl_3$); the hydrochloride, B. HCl. $2H_2O$, forms prisms, m.p. 144° or 171° (*dry*), $[\alpha]_D^{16^\circ} - 626.2^\circ$ (H_2O), and the methiodide prisms, m.p. 252° . The alkaloid contains one methoxyl but no methylimino group.

ψ -**Akuammicine**, $C_{19}H_{20}O_2N_2$, forms plates from alcohol, m.p. 187.5° , and yields a hydrochloride, B. HCl. H_2O , needles, m.p. 216° , and a picrate, m.p. 196° . It contains one methoxyl but no methylimino group.

The names, extended linear formulæ, yields and typical colour reaction of the nine alkaloids are given in the table on p. 761.

The alkaloids whose names are asterisked in the table yield crystalline monomethiodides except akuammigine, in which case it is amorphous. All these methiodides behave as quaternary iodides, indicating the presence of at least one tertiary nitrogen atom in the parent alkaloid. No evidence that the second nitrogen atom in akuammine is present as an imino group has been obtained. This base gives a benzoyl derivative, which behaves as a normal *O*-benzoyl ester, and with nitrous acid it yields nitroakuam-

Name	Extended Linear Formula	Yield on Seeds per cent.	Colour Reactions	
			Conc. HNO ₃	Piperonal + HCl
Akuammicine *	C ₁₂ H ₁₁ ON ₂ (OMe)	0-0064	Bright green, becoming blue on dilution with water.	Magenta, changing to ultramarine blue on standing.
Pseudakuammicine	C ₁₁ H ₁₁ ON ₂ (OMe)	0-0037		
Akuammenine .	C ₁₄ H ₁₁ O ₂ N ₂ (OMe)	0-0006	Yellow Bright yellow Brown, changing to yellow None Blood-red Blood-red	Pink, changing to a methyst on standing.
Akuammidine *	C ₁₄ H ₁₁ O ₂ N ₂ (OMe)	0-0340		
Akuammigine *	C ₁₁ H ₁₃ O ₂ N ₂ (OMe)	0-0100		
Pseudakuammigine	C ₁₁ H ₁₃ O ₂ N ₂ (OMe)(NMe)	0-0170		
Akuammiline *	C ₁₁ H ₁₁ O ₂ N ₂ (OMe)	0-0107	None Blood-red Blood-red	
Akuammine *	C ₁₇ H ₁₇ O ₂ N ₂ (OH)(OMe)(NMe)	0-5600		
Akuammine hydrate *	C ₁₇ H ₁₉ O ₂ N ₂ (OH)(OMe)(NMe)	—		

mine. Akuammidine also yields a monobenzoyl derivative, but this is neutral in reaction and insoluble in acids, and the entering acyl group is apparently attached to a nitrogen atom; this, however, does not necessarily imply the presence of an imino group in akuammidine, and may be due to the scission of a heterocyclic nucleus. A nitroso-derivative of akuammidine has not been obtained, nitrous acid converting the base into an intractable amorphous product. Akuammigine, pseudakuammigine and akuammiline also yield neutral benzoyl derivatives, apparently similar in type to benzoylakuammidine, but have not yet been obtained in a satisfactory condition for analysis. Benzoyl chloride converts akuammicine into a basic substance which is very soluble in water, cannot be extracted from its aqueous solution by immiscible solvents and has so far only been isolated as an impure picrate. The alkaloids are inactive in bird malaria.²

A series of papers on the pharmacological action of akuammine has been published by Raymond-Hamet³ in which it is established *inter alia* that the alkaloid has a local anaesthetic action almost equal to that of cocaine.

REFERENCES

- (1) HENRY and SHARP, *J. Chem. Soc.*, 1927, 1950; HENRY, *ibid.*, 1932, 2759; cf. CLINQUART, *J. Pharm. Belg.*, 1927, 9, 187. (2) GOODSON, HENRY and MACFIE, *Biochem. J.*, 1930, 24, 874. (3) *Compt. rend.*, 1940, 211, 125; *Arch. exp. Path. Pharm.*, 1942, 199, 399; *C. R. Soc. Biol.*, 1943, 137, 404; 1944, 138, 199.

ALKALOIDS OF *RAUWOLFIA* SPP.

The alkaloids of this genus of plants seem more attractive to biologists than to chemists, for in the last ten years the number of papers published on their chemistry has been far outnumbered by those on their pharmacological action. The following is a list of the species in which alkaloids have been recorded.

(1) *R. caffra* Sonder. Alkaloids A and B and a third alkaloid, which should be called "rauwolfine Koepfli," to distinguish it from the rauwolfine of van Itallie and Steenhauer (Koepfli¹).

(2) *R. canescens* L. Rauwolscine (Mookerjee²).

(3) *R. heterophylla* Roem. and Sch. *Chalchupine-A*, m.p. 168°; picrate, m.p. 150-2°; hydriodide, m.p. 240°; platinichloride, m.p. 261-2°.

Chalchupine-B, m.p. 240°; picrate, m.p. 154–6°; hydriodide, m.p. 258–260°; tartrate, m.p. 250–6°. The colour reactions of A indicate that the structure includes an indole group (Deger³; Paris and Daza³).

(4) *R. monobasiana* Stapf. (a false iboga, p. 768). Pharmacological examination of an extract. (Raymond-Hamet.⁴)

(5) *R. natalensis* Sond. Several amorphous alkaloids (Rindl and Groenewoud⁵).

(6) *R. serpentina* Benth. Ajmalicine, ajmaline, ajmalinine, serpentine, serpentinine (Siddiqui and Siddiqui⁶). From a geographical variety of the species, isoajmaline, neoajmaline and unnamed alkaloids, m.p. 220° and m.p. 234° (S. Siddiqui⁶). From the same species van Itallie and Steenhauer⁷ isolated alkaloids B, C and A (rauwolfine) which may be identical with Siddiqui's serpentine, ajmalinine and ajmaline respectively.

(7) *R. vomitoria* Afz. (sample from French Guinea). Ajmaline, isoajmaline, ajmalicine, ajmalinine and possibly serpentinine, cf. *R. serpentina* (Paris⁸).

The species which has received most attention as a drug is *R. serpentina* for which Schroff and Bhatia and more recently Dutt *et al.* have devised assay processes.⁹ Information regarding native uses of plants of this genus will be found in short accounts published by Raymond-Hamet,¹⁰ (who uses the synonym *Ophioxylum serpentinum* Willd. for *R. serpentina* Benth.), Lewin¹¹ and Watt and Breyer-Brandwijk.¹²

Ajmaline, C₂₀H₂₆O₂N₂.3H₂O. Regarded as identical with the rauwolfine of van Itallie and Steenhauer (*see below*). It is only completely dehydrated at 200°, has m.p. 159–160°, [α]_D^{33°} + 128° (CHCl₃), and yields crystalline salts, B.HCl.2H₂O, m.p. 133–4°; platinichloride, m.p. 217–8°; picrate, m.p. 126–7° or 223° (*dry*). The *N*-benzoyl derivative has m.p. 214–6° (*dec.*). Methyl iodide converts it into methylajmaline hydriodide, C₂₁H₂₅O₂N₂.HI, m.p. 230–1°; the base recovered from this forms stellate clusters of needles, m.p. 130–1°. Ajmaline forms a dibromo-derivative, m.p. 230° (*dec.*); an amorphous trinitro-compound, m.p. 238–258° (*dec.*), and a monosulphonic acid. On heating at 200°, or on boiling with alcoholic potassium hydroxide solution, it is partly converted into isoajmaline m.p. 265–6°, [α]_D^{35°} + 72.8° (EtOH), which behaves as a diacidic base B.2HCl, amorphous, m.p. 238–240° (*dec.*), [α]_D^{34°} + 98.7° (H₂O). isoAjmaline was subsequently found to occur naturally in a specimen of the drug collected in the Dun Valley (item 6, *see above*) along with a third isomeride, neoajmaline, m.p. 205–7°, which is convertible into isoajmaline by heating at 270° or by the action of alcoholic potash (Siddiqui⁶).

The two oxygen atoms are believed to be present as a betaine group,

and the extended formulæ $\overline{\text{NMeR(NH)}} \cdot \text{CO} \cdot \text{O}$ and $\overline{\text{NMeR(NH)}} \cdot \text{CO} \cdot \text{O}$ are suggested for ajmaline and isoajmaline respectively.

Ajmalinine, C₂₀H₂₆O₃N₂.1.5H₂O, forms hexagonal prisms from moist ethyl acetate, m.p. 180–1°, [α]_D – 97° (CHCl₃), gives a doubtfully crystalline hydrochloride, m.p. 240–5°, [α]_D^{40°} – 44° (H₂O), an amorphous *O*-benzoyl derivative, m.p. 140–150° (*dec. from 100°*), and a crystalline

methiodide, m.p. 233–4° (*dec.*). One methoxyl group is present. At 210° ajmalinine is converted into apoajmalinine, $C_{13}H_{17}O_3N$, rectangular plates, m.p. 270–2°, $[\alpha]_D \pm 0^\circ$. This base is also regarded as a betaine.

Ajmalicine (no formula). Crystallises in silky needles or rectangular plates, m.p. 250–2°, B. HCl (*amorph.*), m.p. 260° (*dec.*); picrate (*amorph.*), m.p. 212–5° (*dec.*).

Serpentine, $C_{20}H_{20}O_3N_2 \cdot 1.5H_2O$, forms bright yellow plates, m.p. 158°; the hydrochloride, B. HCl, has m.p. 133–5° or 260–1° (*dry*), $[\alpha]_D^{40^\circ} + 188^\circ$ (H_2O); nitrite, m.p. 165–6° (*dec.*); methiodide, B. MeI, m.p. 271–2° (*dec.*). It forms a monobromo-hydrobromide, m.p. 257–8° (*dec.*), and on heating at 210° isomerises to isoserpentine, prismatic rods, m.p. 230–2°, from alcohol, of which the hydrochloride has m.p. 271–2° (*dry*) and $[\alpha]_D^{34^\circ} + 168.08^\circ$ (H_2O), and picrate, m.p. 263–4° (*dec.*). Serpentine contains one hydroxyl and one methoxyl, but no methylimino group.

Serpentinine, $C_{20}H_{20}O_5N_2 \cdot 1.5H_2O$, has m.p. 263–5°, hydrochloride, m.p. 271–2° (*dec.*), $[\alpha]_D^{34^\circ} + 166.93^\circ$; picrate, m.p. 263–4°; and aurichloride, m.p. 194–5° (*dec.*). It is a secondary base giving a nitroso-derivative, m.p. 159–160° (*dry*); contains a methoxyl but no methylimino group.

From the same raw material van Itallie and Steenhauer⁷ isolated three alkaloids: (B) m.p. 262° (*cf.* serpentinine); (C) m.p. 177°, $[\alpha]_D - 76.4^\circ$; (*cf.* ajmalinine) and (A) rauwolfine, (*cf.* ajmaline).

Rauwolfine, which resembles Siddiqui's ajmaline (p. 762), but to which the formula $C_{21}H_{26}O_2N_2$ is assigned, has m.p. 160°, $[\alpha]_D + 131.1^\circ$ ($CHCl_3$); hydrochloride, B. HCl. $2H_2O$, m.p. 139–140°, $[\alpha]_D + 96.6^\circ$. It is isomerised by heat or alkali to isorauwolfine, m.p. 263–5°, $[\alpha]_D + 75^\circ$ (EtOH) (*cf.* ajmaline \rightarrow isoajmaline).

R. caffra Sonder. From this S. African species Koepfli¹ isolated three alkaloids: (A) forming hair-like needles, m.p. 294–5°, (B) crystalline, but uncharacterised and rauwolfine, $C_{20}H_{26}O_3N_2 \cdot 2.5H_2O$, which forms buff-coloured tablets, decomposes at 235–8° (*vac.*), and dissolves in sodium hydroxide, though not in sodium carbonate solution. Rauwolfine chloride, $C_{20}H_{25}O_2N_2Cl \cdot H_2O$, forms faintly pink plates, m.p. 297–300° or 300–3° (*dry, dec.*), $[\alpha]_D^{20^\circ} + 29^\circ$ (H_2O) or $+ 45^\circ$ (EtOH).

It is unfortunate that the name rauwolfine has been used for two distinct alkaloids, but if van Itallie and Steenhauer's rauwolfine proves to be ajmaline, the difficulty will disappear.

Rauwolscine, $C_{21}H_{26}O_3N_2$. This alkaloid, isolated as the oxalate, B. $H_2C_2O_4 \cdot 2H_2O$, m.p. 245–6°, from the leaves of *R. canescens* L. by Mookerjee,² has m.p. 231–2° (*dec.*), $[\alpha]_D^{30^\circ} - 40^\circ$ (EtOH), and forms a hydrochloride, B. HCl, m.p. 278–80° (*dec.*), $[\alpha]_D^{30^\circ} + 74^\circ$ (H_2O), nitrate, m.p. 257–8° (*dec.*), and picrate, m.p. 208°. It contains two active hydrogen atoms and yields a monoacetyl derivative, m.p. 216–8° (*dec.*). With concentrated ammonia solution at room temperature, rauwolscine is converted into rauwolscinic acid, $C_{20}H_{24}O_3N_2 \cdot H_2O$, m.p. 262–4° (*dec.*), $[\alpha]_D^{23^\circ} + 136.8^\circ$ (H_2O), which forms a hydrochloride, m.p. 255.5–257.5° (*dec.*), and on esterification with methyl alcohol reverts to rauwolscine.

Rauwolscine gives colour reactions like those of yohimbine and the absorption curves of the hydrochlorides of the two alkaloids are very similar. Heated to 300°/5 mm. rauwolscinic acid forms harman (p. 490) and 3-ethylindole and on fusion with potassium hydroxide decomposes into indole-2-carboxylic acid, isophthalic acid, harman and an unidentified indole derivative. Rauwolscine itself on distillation with zinc dust produces harman, 2-methylindole (scatole) and isoquinoline. It is suggested that the alkaloid has the skeletal structure suggested by Scholz (formula XIV, p. 508) for yohimbine, the positions of the hydroxyl and carbomethoxy groups being still undetermined.

Pharmacology. According to Chopra *et al.*,¹³ extracts of *R. serpentina*, the total alkaloids of the drug and the alkaloid serpentine, lower the carotid blood pressure of chloralosed normal cats. Ajmaline and serpentinine raise it. These two also depress the cardiac musculature, produce splenic contraction, stimulate respiration and increase peristalsis of the guinea-pig intestine. Serpentine and the total alkaloids of the drug have the opposite effect on these organs. In hypertension induced in cats by adrenaline or ephedrine the blood pressure is lowered by the total alkaloids and by serpentine and to a less extent by ajmaline and serpentinine. In 1943 Chopra *et al.*¹³ stated that in addition to the medullary stimulants ajmaline, serpentine and serpentinine, there is present in *R. serpentina* a hypnotic principle, since (a) an alcoholic extract of the drug, (b) the total alkaloids of the drug, and (c) the residue left after removal of the three alkaloids named, from the total alkaloids, are all sedative and hypnotic. This component antagonises the medullary stimulation due to picrotoxin. Gupta, Kahali and Dutt¹⁴ found that a resinous, non-alkaloidal fraction isolated from the Dun Valley variant of the plant, exerted the characteristic sedative action for which Rauwolfia preparations are used clinically in India,¹⁴ and suggested that for this purpose the resin freed from alkaloids should be used. The *iso*- and *neo*-ajmalines found in this Dun Valley variant have been examined by Bhatia and Kapur,¹⁵ who found that both have a slight stimulant action on the nervous system followed by depression, cause depressant effects on plain muscle of the heart, blood vessels and intestine and lower blood pressure in intact, decerebrate and spinal animals in normal conditions, or after experimental hypertension. *neo*Ajmaline has a powerful stimulant action and *iso*ajmaline a slight depressant effect on rabbit and guinea-pig uterus. Gupta and Kahali¹⁸ have examined total alkaloids from *R. serpentina* collected in three districts and note that the differences in action observed are due to the variation in the relative amounts of the individual alkaloids present.

Raymond-Hamet has given much attention to the action of the Rauwolfia alkaloids. Using Siddiqui's ajmalinine, he found that it provokes hypotension accompanied by renal dilatation and exerts a true sympatholytic action.¹⁶ Ajmaline and serpentine¹⁷ also induce hypotension and a decrease in intestinal action; serpentinine diminishes the renal constrictive action of adrenaline, but does not alter its hypertensive effects.¹⁸

A preliminary report on rauwolscine by Chakravarti¹⁹ indicates that it is a cardiovascular depressant, shows hypotensive action and a relatively high toxicity. Koepfli's rauwolfine produces a fall in blood pressure, and stimulation of respiration; in frogs it has a curare-like action.²⁰ The rauwolfine of van Itallie and Steenhauer⁷ has been examined by Hartog²¹ and by de Boer,²² especially in regard to its cardiac action. According to Raymond-Hamet,²³ it reverses the action of adrenaline.

Work on *R. heterophylla* has been confined to the action of aqueous extracts of the plant, which are sympathicolytic and diminish the tone of the intestine in chloralosed dogs.²⁴ In spite of its local reputation as an anti-malarial drug, it gave negative results in schizonticidal tests in malaria in ducklings.²⁵ Though *R. vomitoria* has been stated⁸ to contain the same alkaloids as *R. serpentina*, the pharmacological effects of the two plants do not seem to be identical especially as regards action on the intestine.²⁶

REFERENCES

- (1) KOEFLI, *J. Amer. Chem. Soc.*, 1932, **54**, 2412. (2) *J. Ind. Chem. Soc.*, 1941, **18**, 33, 485; 1943, **20**, 11; 1946, **23**, 6. (3) *Arch. Pharm.*, 1937, **275**, 496; PARIS and DAZA, *Bull. Sci. Pharmacol.*, 1941, **48**, 46; cf. JANOT and MENDOZA, *Compt. rend.*, 1939, **209**, 653. (4) *Compt. rend.*, 1940, **210**, 789. (5) *Trans. Roy. Soc. S. Africa*, 1932, **21**, 55. (6) *J. Ind. Chem. Soc.*, 1931, **8**, 667; 1932, **9**, 539; 1935, **12**, 37; R. H. SIDDIQUI, *Inaug. Diss. Aligarh.*, 1934 (bibl.); S. SIDDIQUI, *J. Ind. Chem. Soc.*, 1939, **16**, 421. (7) *Arch. Pharm.*, 1932, **270**, 313. (8) *Ann. Pharm. franç.*, 1943, **1**, 138. (9) *Ind. J. Pharm.*, 1941, **3**, 59; DUTT, *et al.*, *ibid.*, 1947, **9**, 54. (10) *Compt. rend.*, 1935, **201**, 1050. (11) "Gifte und Vergiftungen," Aufl. 4, p. 777. (12) "Medicinal and Poisonous Plants of S. Africa," p. 144. (13) (With GUPTA and MUKHERJEE), *Ind. J. Med. Res.*, 1933, **21**, 261; (with DAS and MUKHERJEE), 1937, **24**, 1125; (with CHAKRAVARTI), *ibid.*, 1941, **29**, 763; (with BOSE, GUPTA and CHOPRA), *ibid.*, 1942, **30**, 319; 1943, **31**, 71; cf. GUPTA and KAHALI, *ibid.*, 1943, **31**, 215; GUPTA, *Report Advisory Sci. Board, Ind. Res. Fund Assoc.*, 1942, p. 71. (14) *Ind. J. Med. Res.*, 1944, **32**, 183; *J. Amer. Pharm. Assoc.*, 1947, **36**, 416. For clinical trials see CHOWHAN, *Ind. Med. Gaz.*, 1940, **75**, 382; GUPTA *et al.*, *ibid.*, 1943, **78**, 547. (15) *Ind. J. Med. Res.*, 1944, **32**, 177. (16) *Bull. Sci. Pharmacol.*, 1936, **43**, 364. (17) *C. R. Soc. Biol.*, 1940, **134**, 94, 369. (18) *Compt. rend.*, 1940, **211**, 414; 1946, **223**, 927. (19) *Sci. and Cult.* (India), 1942, **7**, 458. (20) GEILING, quoted by KOEFLI.¹ (21) *Arch. int. Pharmacodyn.*, 1935, **51**, 10. (22) *Cardiologia*, 1937, **1**, 1. (23) *Compt. rend.*, 1935, **201**, 1050. (24) RAYMOND-HAMET, *ibid.*, 1939, **209**, 384, 599; *C. R. Soc. Biol.*, 1938, **129**, 462; 1939, **132**, 213. (25) CORNATZER *et al.*, *Elisha Mitchell Sci. Soc.*, 1944, **60**, 167. (26) RAYMOND-HAMET, *Bull. Acad. Med.*, 1939, **122**, 30; *C. R. Soc. Biol.*, 1941, **135**, 627; 1944, **138**, 40.

ALKALOIDS OF THE STEMONACEÆ

Four species belonging to this botanical family have been investigated.

Suzuki has explained that the plant from which he isolated stemonine and stemonidine¹ is not, as at first supposed, *Stemona japonica* Miq. After further investigation it has been named *Stemona ovata* Nakai and from it he has isolated² a third alkaloid, isostemonidine, m.p. 137°, $[\alpha]_D^{20} - 84.9^\circ$, to which the following extended formula has been assigned,

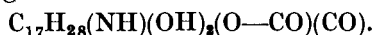

Stemonine, $C_{17}H_{28}O_4N$, m.p. 151°, $[\alpha]_D^{16} - 113.84^\circ$, crystallises in prisms, yields crystalline salts (B. HCl, m.p. 302° (dec.)), and behaves

as a secondary base, yielding methylstemonine methiodide m.p. 276° (*dec.*), with methyl iodide. The functions of the oxygen atoms are indicated by the following extended formula: $C_{16}H_{20}(NH)(OH)_2(O-CO)$. (For another stemonine *see below*.)

Stemonidine, $C_{19}H_{31}O_5N$. The base has m.p. 116°, $[\alpha]_D^{12} - 7.65^\circ$, and yields a hydrochloride, m.p. 260° (*dec.*), and a methiodide, m.p. 248°. It is a tertiary base and of the five oxygen atoms two are in a lactone group and a third is present as methoxyl: the functions of the other two are unknown. The alkaloid is unaffected by hydrogen chloride (25 per cent.) in alcohol or acetic acid. The permanganate oxidation products vary with the conditions of the experiment:—

(a) In acetone there is formed a base yielding a methiodide, $C_{19}H_{29}O_5N \cdot MeI$, m.p. 235°;

(b) In dilute sulphuric acid at 10° two substances are formed, (1) a neutral product, $C_{16}H_{23}O_5N$, m.p. 208°, $[\alpha]_D - 58.3^\circ$, in which a lactone and a methoxyl group but no carbonyl group is present and (2) a compound, $C_{11}H_{17}O_4N$, m.p. 202°, $[\alpha]_D - 24.17^\circ$, which forms a semicarbazone, m.p. 258°, and contains a methoxyl but no lactone group: it reduces ammoniated silver but does not give pyrrole reactions.

On distillation with zinc dust the alkaloid gives an easily hydrogenated pyrrole base, and on dehydrogenation by platinised asbestos at 260–290° it yields (1) an amorphous dehydro-base, which forms an oxime and a methiodide, $C_{17}H_{23}O_4N \cdot MeI$, *decomp.* 227–8°, and contains a lactone and a methoxyl group, (2) a neutral pyrrole derivative, and (3) an acid giving a dark green colour with ferric chloride² (1939).

From *S. sessilifolia* Miq., Furuya³ isolated *hodorine*, $C_{19}H_{31}O_5N$, an amorphous base yielding crystalline salts: B. HCl, m.p. 244–5° (*dec.*); B. HBr, m.p. 258–9°. The same species was re-investigated by Schild,⁴ who described an unnamed alkaloid, $C_{22}H_{33}O_4N$, m.p. 86–7°, b.p. 220°/0.0006 mm., $[\alpha]_D^{20} - 47.1^\circ$ ($CHCl_3$), giving a perchlorate, m.p. 243°, methiodide monohydrate, m.p. 230–3° (*dec.*), and methochloride dihydrate, m.p. 169°. The latter is converted by silver oxide into the betaine, $C_{23}H_{37}O_5N \cdot H_2O$, m.p. 227–9° (*dec.*). The parent alkaloid, referred to subsequently as A, contains a lactone group, behaves as a tertiary base, and on catalytic hydrogenation in acid solution yields a substance, $C_{22}H_{35}O_4N$, m.p. 134°, $[\alpha]_D^{20} - 13.2^\circ$ ($CHCl_3$), and in neutral solution a second substance, $C_{22}H_{35}O_4N$, m.p. 118–120°, $[\alpha]_D^{19} - 10.8^\circ$ ($CHCl_3$). The absorption spectrum of A indicates that no aromatic ring is present, but its colour and other reactions imply the presence of a pyrrolidine ring. Kondo *et al.* have suggested that Schild's alkaloid may be identical with tuberostemonine (*see below*).

From *S. tuberosa*, Loureiro, Lobstein and Grumbach obtained *stemonine*, $C_{22}H_{33}O_4N$, m.p. 160°, $[\alpha]_D + 76.5^\circ$, which gives pyrrole reactions and whose pharmacological action is described.⁵ (For another stemonine *see p.* 765.) Suzuki's investigation of the same plant⁶ led to a different result, the isolation of the alkaloid *tuberostemonine*.

Tuberostemonine, $C_{22}H_{33}O_4N \cdot MeOH$. This alkaloid was at first

assigned the formula, $C_{19}H_{29}O_4N$, which was changed by Kondo, Suzuki and Satomi⁶ to that now given. It has m.p. 65–88° (*dec.*), or when solvent-free, 86–8°, and $[\alpha]_D - 25.4^\circ$ (acetone) and forms a hydrobromide, m.p. 120° (*dec.*), and a perchlorate, m.p. 242° (*dec.*). It is a non-phenolic, tertiary base which contains a lactone but no methoxyl, methylenedioxy or methylimino group, and does not react with carbonyl reagents or provide evidence of active hydrogen atoms. The methiodide, B . MeI . H_2O , has m.p. 236–8° (*dec.*), the methochloride B . MeCl . $2H_2O$, m.p. 172°, and the methylmethosulphate, m.p. 253° (*dec.*). It is not hydrolysed by acids, is recovered unchanged from attempts at electrolytic or Clemmensen reduction and treatment with phosphorus and hydriodic acid yielded no definite product. In presence of much platinic oxide, in methanol or 2*N*-hydrochloric acid, a dihydro-derivative, m.p. 133°, yielding a hydrochloride, m.p. 281°, is formed. The constants of the alkaloid and of its derivatives agree closely with those of Schild's base A from *S. sessilifolia* (*see above*) and Kondo *et al.* have suggested that the two are identical. Tuberoestemonine methohydroxide at 145° *in vacuo* yields hydroxy-*N*-methyltuberoestemonine, $C_{23}H_{37}O_5N$, m.p. 123–5°, which does not react with methyl iodide, but with cyanogen bromide forms an adduct, $C_{23}H_{37}O_5N \cdot CNBr$, m.p. 232° (*dec.*), which is unaffected by boiling acid or alkali. Tuberoestemonine also forms a cyanogen bromide adduct, $C_{22}H_{33}O_4N \cdot CNBr$, m.p. 200–2°.

With magnesium methyl bromide tuberoestemonine gives a product, which on treatment with ammonium chloride solution yields a substance (a), $C_{24}H_{41}O_4N$, m.p. 110–2°, but with dilute sulphuric acid, furnishes the dehydrated compound, (b) $C_{24}H_{39}O_3N$, m.p. 164°. The results of this reaction are represented as follows:—

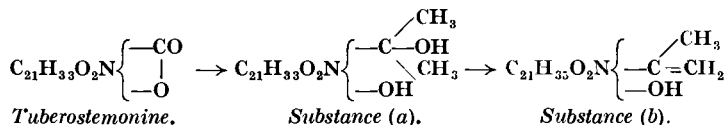

Tuberoestemonine is oxidised by silver oxide to a neutral substance, $C_{22}H_{29}O_4N$, m.p. 178°, which retains the lactone group and gives the Ehrlich pyrrole reaction. Vapours giving the pyrrole pine-shaving test are produced when tuberoestemonine is distilled with zinc dust. When heated with palladised asbestos at 260–270° the alkaloid gives off only water and carbon dioxide and forms an acid substance, $C_{18}H_{23}O_5N$, m.p. 171–5°, and a series of neutral, nitrogenous products of which the most abundant, $C_{22}H_{27}O_3N$, forms yellow tablets decomposing at 275°.

From the Chinese drug "pai-pu," said to be derived from a species of *Stemona*, Lee and Chen have isolated two alkaloids, *paipunine*, $C_{24}H_{37}O_4N$, m.p. 105.5–106.5°, $[\alpha]_D^{25} - 53.7^\circ$ (acetone), and *sinostemonine*, $C_{21}H_{36}O_5N$, m.p. 138–138.5°, $[\alpha]_D^{25} - 37^\circ$ (H_2O). The pharmacological action of paipunine is described.⁷

REFERENCES

- (1) *J. Pharm. Soc. Japan*, 1921, No. 852, 567; 1929, 49, 78; 1931, 51, 43; 1934, 54, 101. (2) *Ibid.*, 1934, 54, 100, 101; KONDO, SUZUKI and SATOMI, 1939, 59, 184,

(3) *Chem. Soc. Abstr.*, 1913, i, 1033; *Chem. Zent.*, 1913, i, 1823. (4) *Ber.*, 1936, 69, 74. (5) *Compt. rend.*, 1932, 194, 386. (6) *J. Pharm. Soc. Japan*, 1934, 54, 96; 1939, 59, 177; 1940, 60, 149; 1941, 61, 111. (7) *J. Amer. Pharm. Assoc.*, 1940, 29, 391.

ALKALOIDS OF *TABERNANTHE IBOGA*

Tabernanthe Iboga Baill., found in the Gabun district of French West Africa, where it is known as Iboga, has received much attention in France from economic botanists and pharmacologists since 1867, when it first appeared in Europe. An interesting account of work done with it was published in 1940 by Raymond-Hamet,¹ from which it appeared that little is known of its components beyond the fact that it contains amorphous alkaloids and a crystalline alkaloid *ibogaine*, possibly accompanied by a second, crystalline alkaloid, m.p. 206–7°. According to the same author,² *ibogaine* has the formula $C_{19}H_{24(26)}ON_2$ and yields a hydrochloride, B. HCl, $[\alpha]_D^{25} - 37.3^\circ$ (H_2O) or -67.1° (MeOH). Older figures for the base itself are m.p. 152°, $[\alpha]_D - 48.3^\circ$ (EtOH) or -12.88° (C_6H_6).³ It contains one methoxyl group; gives indole colour reactions,⁴ and on distillation with zinc dust or soda-lime yields products showing reactions of indole, or indole derivatives with the β -position free. The ultra-violet absorption spectrum, according to Brustier *et al.*,⁵ resembles that of quinoline rather than that of indole.

More recently Delourme-Houdé² has also isolated *ibogaine*, to which he assigns the formula $C_{20}H_{26}ON_2$. He has also named and assigned a formula to the second alkaloid, *viz. tabernanthine*, $C_{21}H_{28}ON_2$. It forms needles or orthorhombic plates, m.p. 209°, $[\alpha]_D - 40^\circ$ (acetone), gives a hydrochloride readily soluble in chloroform, contains one methoxyl group and is unsaturated. The ultra-violet absorption spectrum shows maxima at 2,700 and 3,000 Å and minima at 2,575 and 2,800 Å, whereas *ibogaine* has a maximum at 2,950 Å and a minimum at 2,575 Å. It gives indole colour reactions with glyoxylic and phosphovanillic reagents.

The amorphous alkaloids include a substance, giving fluorescent solutions in organic solvents, which is thought to be a decomposition product of *ibogaine*.

Methods for the isolation and estimation of the alkaloids of the root are described. The seeds of the plant contain alkaloids giving colour reactions different from those of the root alkaloids.

Iboga is used by natives of the Gabun in much the same way as *coca* is used by South American Indians and that aspect of its action has been discussed by Raymond-Hamet,⁶ who has also published a series of papers dealing with its action on isolated organs and the intestine.⁷ Like *cocaine*, *ibogaine* potentiates the pressor action of adrenaline and abolishes the sino-carotid reflexes, but unlike it also augments considerably the action of tyramine, and slightly that of *dl*-ephedrine.⁸ According to Vincent and Sero it inhibits the action of serum cholinesterase.⁹

Delourme-Houdé² finds that *tabernanthine* injected into dogs is hypotensive, decreases the rate and amplitude of respiration, reduces the reflex hypertension induced by occlusion of the carotids and, like

ibogaine, increases the hypertension produced by injection of adrenaline but also prolongs the hypotension resulting from injection of acetylcholine.

REFERENCES

The author is RAYMOND-HAMET unless stated otherwise.

(1) *Rev. bot. appl. Agr. trop.*, 1940, 20, 251; *Compt. rend.*, 1939, 209, 523; 1940, 210, 789. (2) *Bull. Soc. chim.*, 1942, [v], 9, 620; DELOURME-HOUDÉ, *Ann. pharm. franc.*, 1946, 4, 30. (3) DYBOWSKI and LANDRIN, *Compt. rend.*, 1901, 133, 748; HALLER and HECKEL, *ibid.*, p. 850. (4) *Bull. Soc. Chim. biol.*, 1943, 25, 205. (5) BRUSTIER, VINCENT and SERO, *Compt. rend.*, 1943, 216, 909. (6) (With PERROT), *Bull. Acad. Med.*, 1941, 124, 423. (7) *C. R. Soc. Biol.*, 1941, 135, 176; (with ROTHLIN), *ibid.*, 1938, 127, 592; *Arch. int. Pharmacodyn.*, 1939, 63, 27. (8) *Compt. rend.*, 1940, 201, 285; 1946, 223, 757; *C. R. Soc. Biol.*, 1940, 133, 426; 134, 541; see also LAMBERT and HECKEL, *Compt. rend.*, 1901, 133, 1236. (9) *C. R. Soc. Biol.*, 1942, 136, 612.

ALKALOIDS OF *TAXUS BACCATA*

Taxine, $C_{37}H_{51}O_{10}N$, is contained in the leaves, shoots and fruits of the yew (*Taxus baccata*), from which it was first isolated by Lucas.¹ It was investigated by Marmé,² Hilger and Brande,³ Amato and Capparelli,⁴ Thorpe and Stubbs,⁵ Winterstein *et al.*,⁶ Kondo *et al.*,⁷ Takahashi⁸ and Gulland *et al.*⁹

A phytochemical investigation of taxine in the yew has been conducted by Kuhn and Schäfer,¹² who have devised special methods for the detection, estimation and purification of the alkaloid. Masson¹³ states that *Taxus canadensis* contains an alkaloid giving the colour reactions of taxine but different from it in being crystalline and having m.p. 238–9°; no ephedrine was present.

Taxine is amorphous, as are also its derivatives, and special methods have to be used in isolating it in a pure state. Gulland and Virden⁹ have shown that ephedrine is also present in the yew.

Taxine, in the purest form in which it has yet been obtained, has m.p. 121–4° after sintering at 115°, $[\alpha]_D^{17} + 95.7^\circ$ (EtOH).⁹ It is soluble in ether, chloroform or alcohol, but insoluble in water or light petroleum. The salts are amorphous, including the aurichloride, m.p. 132–4° (two forms, m.p. 90–105°, 110°, Kondo). The methiodide has m.p. 123–5°, and with alkali produces trimethylamine and a product, $C_{35}H_{44}O_{10}$, m.p. 120–140°. Taxine, on reduction, takes up four atoms of hydrogen and forms a tetrabromide on addition of bromine. On oxidation with permanganate, benzamide, benzoic acid, acetic acid, oxalic acid and benzonitrile are stated to be produced. Cinnamic acid seems to be a constant product of the action of alkalis and acids on the alkaloid. Warmed with dilute sulphuric acid for ten hours, taxine yields a crystalline compound, $C_{11}H_{15}O_2N$, which may be a β -dimethylamino- β -phenylpropionic acid.⁶ Winterstein and Guyer⁶ suggest the following partial formula from the observations so far made: $NMe_2 \cdot CHPh \cdot CH_2 \cdot CO \cdot C_{24}H_{34}O_6 \cdot OAc$. Callow, Gulland and Virden⁹ obtained evidence of the presence of four replaceable hydrogen atoms and of a lactone group, thus accounting for six out of the ten oxygen atoms required by the formula. The remaining

four are required for the acetyl and β -dimethylamino- β -phenylpropionyl ester groups. These authors found that taxine on hydrolysis by boiling dilute sulphuric acid yielded, in addition to the products already mentioned, a resinous substance, which after purification had m.p. 155–165°, and is represented by the formula $C_{24}H_{34}O_7$, and named *anhdroxatine*. It is assumed to be formed by the loss of a molecule of water and of the two esterifying acids, so that taxine is regarded as a diacyl ester of *xatine*, $C_{24}H_{34}O_6(OH)_2$. The following partial formula was suggested for taxine: $NMe_2 \cdot CHPh \cdot CH_2 \cdot CO \cdot O(AcO)(CO \cdot O)(OH)_4(C_{23}H_{30})$, and more detailed suggestions have been made by Takahashi⁸ as a result of his investigation of taxine and its non-nitrogenous associate taxinin.

Pharmacological Action. Taxine is mainly of interest owing to the occurrence of cases of poisoning, due to farm animals eating yew shoots and also the occasional use of the leaves as an abortifacient. In the human subject the fatal symptoms are those of gastrointestinal irritation, cardiac and respiratory failure. The taxine prepared by Gulland⁹ was investigated by Bryan-Brown,¹⁰ who found the lethal intravenous dose in rabbits was 2 to 3 mg. per kilo; the heart was slowed to a varying extent owing to interference with the conducting mechanism, respiration was first accelerated and then slowed. Death was due to cardiac and respiratory failure.¹¹

REFERENCES

- (1) *Arch. Pharm.*, 1856, 85, 145. (2) *Bull. Soc. chim.*, 1876, [ii], 26, 417. (3) *Ber.*, 1890, 23, 464. (4) *Gazzetta*, 1880, 10, 349. (5) *J. Chem. Soc.*, 1902, 81, 874. (6) (With IATRIDES), *Zeit. physiol. Chem.*, 1921, 117, 240; (with GUYER), 1923, 128, 175. (7) *J. Pharm. Soc. Japan*, 1922, 1074; 1925, No. 524, 2. (8) TAKAHASHI, *ibid.*, 1931, 51, 37; 1932, 52, 27, 36; 1934, 54, 117. (9) CALLOW, GULLAND and VIRDEN, *J. Chem. Soc.*, 1931, 2188, 2148. (10) *Quart. J. Pharm.*, 1932, 5, 205 (with a bibliography). (11) Cf. NICHOLSON, 3rd Rep. *Univ. Camb. Inst. Anim. Path.*, 1932–33, pp. 196–199; WINTERSTEIN and IATRIDES,⁸ (12) *Deut. Apoth. Zeit.*, 1937, 52, 1265. (13) *Chem. Abstr.*, 1942, 36, 7238.

MINOR ALKALOIDS

Acacia spp. According to White, the tops of *A. floribunda* Sieb., *A. longifolia* Willd. and *A. pruinosa* Cunn. contain tryptamine (3- ω -aminoethylindole), usually in association with β -phenylethylamine (*N.Z. Journ. Sci. Tech.*, 1944, **25**, B, 157).

Alangium lamarckii Thw. The bark yields *alangine*, $C_{19}H_{25}O_2N$, m.p. 205–8° (*dec.*), $[\alpha]_D + 9^\circ$ (EtOH), of which a hydrochloride, m.p. 264°, picrate, m.p. 84°, methiodide, m.p. 201° (*dec.*), and other salts have been prepared. The base is monoacidic and tertiary, contains one methoxyl group and possibly an alcoholic hydroxyl, but no methylimino group.¹ Pharmacological work has been done on an amorphous, alkaloidal preparation by Chopra and Chowhan,² and on an injectable extract of the plant by Raymond-Hamet³ (1) Parihar and Dutt, *Proc. Ind. Acad. Sci.*, 1946, **23**, A., 325 (see also 1942, **16**, A, 328). (2) *Ind. J. Med. Res.*, 1934, **21**, 507. (3) *C. R. Soc. Biol.*, 1941, **135**, 1011).

Anchusa officinalis L. *Cynoglossine*; B. HCl, crystalline. Paralyzes peripheral nerve terminations. *Consolidine*; gluco-alkaloid; hydrolysed to glucose and consolicine (also present as such). Paralyzes the central nervous system. The same alkaloids are also present in *Echium vulgare* L. and *Cynoglossum officinale* L. (Greiner, *Arch. Pharm.*, 1900, **238**, 505).

Arachis hypogæa L. *Arachine*, $C_5H_{14}ON_2$, with choline and betaine. Yellowish-green syrup; crystalline platinichloride, m.p. 216°; and aurichloride; produces transient narcosis in frogs and rabbits with partial paralysis (Mooser, *Landw. Versuchs-Stat.*, 1904, **60**, 321 (*Chem. Soc. Abstr.*, 1905, [i], 79)).

Argemone mexicana L. As a result of pharmacological and clinical investigations in India it was established that certain outbreaks of epidemic dropsy in that country were due to the consumption of mustard seed oil containing argemone seed oil.¹ Argemone seed contains berberine and protopine (p. 169), but Mukherji, Lal and Mathur² isolated from samples of the oils concerned, a colourless alkaloid, $C_{19}H_{15}O_4N$, m.p. 190°, which fluoresces blue in solution in alcohol, does not give the colour reactions of protopine and is regarded as forming part of the complex molecule of the toxic constituent. *Argemone mexicana* is also suspected of toxicity to cattle,³ but in such cases there is a tendency to regard the latex of the plant as the source of the poison though the information available is confusing (1) Sarkar, *Ind. Med. Gaz.*, 1939, **74**, 752; *Ann. Biochem. Exp. Med.*, 1941, **1**, 59, 271; *Curr. Sci.*, 1942, **11**, 239; Sen, *ibid.*, 239; Chopra and Pasricha (with Goyal, Lal and Sen), *Ind. Med. Gaz.*, 1939, **74**, 193; (with Banerjee), *ibid.*, 1940, **75**, 261; Lal, Das Gupta and Adak (with Argawala), *Ind. J. Med. Res.*, 1941, **29**, 813; (with Mukherji), *ibid.*, p. 839. (2) *Ibid.*, p. 861. (3) Hurst, "The Poison Plants of New South Wales," 1942, 125).

Artemisia abrotanum L. *Abrotine*, $C_{21}H_{22}ON_2$. Crystalline, bitertiary base; sulphate (crystalline), and platinichloride (Giacosa, *Jahresb.*, 1883, 1356).

Arthrophytum leptocladum M. Pop. (Chenopodiaceæ). The green part of the plant contains three bases, *N*-methylphenylethylamine, $C_6H_5 \cdot CH_2 \cdot CH_2 \cdot NHMe$, *dipterine* and *leptocladine*, $C_{13}H_{16}N_2$. The latter is shown to be 3:4-dimethyl-3:4:5:6-tetrahydro-4-carboline, which brings it into close relationship with harmine (p. 489). It has m.p. 109–110°, forms two picrates, one from water, m.p. 112–4°, and the other from alcohol, m.p. 176–7°, a dipicrate, m.p. 181–2°, hydrochloride, m.p. 234–5° (*dec.*), platinichloride, m.p. 197–8° (*dec.*), methiodide, m.p. 227–8° and a benzoyl derivative, m.p. 132–3°. Leptocladine was synthesised by condensing dipterine (p. 774) with acetaldehyde in presence of dilute sulphuric acid (Juraschevski, *J. Gen. Chem. U.R.S.S.*, 1939, 9, 595: 1941, 11, 157).

Asteracantha longifolia Ness (Acanthaceæ). This plant, formerly named *Hygrophila spinosa*, contains an alkaloid, $C_{10}H_{12}O_3N_4$, m.p. 216–7°, which forms an oxalate, m.p. 221–2°, and a sulphate, m.p. 210–1°, and may be a purine derivative (Basu and Lal, *Quart. J. Pharmacol.*, 1947, 20, 38).

Astragalus spp. Members of this genus are included in the group of "loco" weeds causing disease in cattle in the United States. From *A. earlei*, Pease and Elderfield¹ isolated α - and β -earleines, which were later shown by Stempel and Elderfield² to be betaine and choline respectively: these are also present in *A. wootoni*, along with trigonelline (p. 7).³ (1) *J. Org. Chem.*, 1940, 5, 192, see also p. 198; (2) *Ibid.*, 1942, 7, 432; *J. Amer. Chem. Soc.*, 1941, 63, 315. (3) Knowles and Elderfield, *J. Org. Chem.*, 1942, 7, 389).

Boerhaavia diffusa L. (Nyctaginæ). There is present an alkaloid *punarnavine*, $C_{17}H_{22}ON_2$, m.p. 236–7° (*dec.*), which forms a sulphate, m.p. 204–5°, picrate, m.p. 114–5° (*dec.*), and platinichloride, m.p. 118° (*dec.*) (Basu and Sharma, *Quart. J. Pharm.*, 1947, 20, 41; cf. Chopra *et al.*, *Ind. Med. Gaz.*, 1923, 58, 203; *Ind. J. Med. Res.*, 1940, 28, 475; Agarwal and Dutt, *Proc. Acad. Sci. U.P.*, 1934, 4, 73; 1935, 5, 240; Prasad, *J. Amer. Pharm. Assoc.*, 1948, 37, 103).

Casimiroa edulis La Llave and Lejarza. *Casimiroine*, $C_{22}H_{14}O_6N_2(OMe)_2$, rosettes of needles, m.p. 196–7°, $[\alpha]_D \pm 0^\circ$; aurichloride, m.p. 195–6°; picrate, m.p. 165°. Absorbs H_2O and loses CO_2 by action of alkalis, forming *casimiroitine*, $C_{23}H_{22}O_7N_2$, m.p. 171°. *Casimiroedine*, $C_{17}H_{24}O_5N_2$, needles, m.p. 222–3°, $[\alpha]_D - 36.5^\circ$; aurichloride, m.p. 90° or 145–8° (*dry, dec.*) (Bickern, *Arch. Pharm.*, 1903, 241, 166; Power and Callan, *J. Chem. Soc.*, 1911, 99, 1993; de Lille, *An. Inst. Biol. Univ. Mèx.*, 1934, 5, 45).

Ceanothus spp. *C. americana* L. *Ceanothine*, $C_{20}H_{36}O_4N_4$, m.p. 227–8° and 234°, $[\alpha]_D - 309.4^\circ (CHCl_3)$; hydriodide, m.p. 250° (*dec.*). Two other bases, m.p. 240° and m.p. 188° (Gordin, *Pharm. Rev.*, 1900, 18, 266; Clark, *Amer. J. Pharm.*, 1926, 98, 147; 1928, 100, 240; Bertho and Liang, *Arch. Pharm.*, 1933, 271, 273; cf. Julian, Pikel and Dawson, *J. Amer. Chem. Soc.*, 1938, 60, 77).

C. velutinus Dougl. Base, $C_{23}H_{26}O_4N_2$, m.p. 270° (dec.) (Richards and Lynn, *J. Amer. Pharm. Assoc.*, 1934, **28**, 332).

Chloroxylon swietania D.C. The timber (East Indian satinwood) contains *chloroxylonine*, $C_{18}H_{11}O_3N(OMe)_4$, m.p. 182–3°, $[\alpha]_D^{18} - 9.8$; B. HCl., m.p. 95°; B. HBr., m.p. 125°; B. H_2AuCl_4 ; m.p. 70°; no hydroxyl group. Irritant causing dermatitis when applied to the skin.¹ Mukerjee and Bose² identify chloroxylonine with skimmianine (p. 414) which they have isolated from the bark of the plant (1) Auld, *J. Chem. Soc.*, 1909, **95**, 964; Cash, *Brit. Med. J.*, 1911, ii, 784. (2) *J. Ind. Chem. Soc.*, 1946, **23**, 1).

Chrysanthemum cinerariæfolium Bocc. "Chrysanthemine" is a mixture of choline and stachydrine (Marino-Zuco, *Chem. Soc. Abstr.*, 1891, **60**, 333; 1892, **62**, 84; Yoshimura and Trier, *Zeit. Physiol. Chem.*, 1912, **77**, 290).

Convolvulus pluricaulis Choisy. From this perennial herb, Basu and Dandiya isolated a crystalline alkaloid, *sankhpuspine*, $C_{17}H_{23}O_3N$, which melts at 162–4° and yields a picrate, aurichloride and platinichloride, decomposing at 76°, 208° and 180° respectively (*J. Amer. Pharm. Assoc.*, 1948, **37**, 27).

Croton spp. *C. gubouga* S. Moore. 4-Hydroxyhygric acid, m.p. 242° (dec.), $[\alpha]_D - 84.9^\circ$ (Goodson and Clewer, *J. Chem. Soc.*, 1919, **115**, 923).

C. Tiglium L. *Crotonoside* (6-amino-2-hydroxypurine-d-ribose) (Cherbuliez et al., *Helv. Chim. Acta.*, 1932, **15**, 464, 978).

Cryptolepis sanguinolenta Sch. contains *cryptolepine*, $C_{17}H_{16}ON_2$, m.p. 193–4°; B. HCl. $3H_2O$, golden-yellow needles. Causes fall in body temperature and has marked vasodilator properties (Clinquart, *Bull. Acad. Med. Belg.*, 1929, [v], **9**, 627; Delvaux, *J. Pharm. Belg.*, 1931, **13**, 955, 973; Raymond-Hamet, *Compt. rend.*, 1938, **207**, 1016; *C. R. Soc. Biol.*, 1937, **126**, 768).

Daucus carota L. Pyrrolidine; *daucine*, $C_{11}H_{18}N_2$, b.p. 240–250°, $[\alpha]_D + 7.8^\circ$ (Pictet and Court, *Bull. Soc. Chim.*, 1907, [iv], **1**, 1001).

Elæagnus spp. *E. angustifolia* L., *E. hortensis* M. B., *E. orientalis* L., and *E. spinosa* L., contain two alkaloids of which one has been crystallised and named *elæagnine*, $C_{12}H_{14}N_2$. It has m.p. 180–181.5°, $[\alpha]_D \pm 0^\circ$, and forms a hydrochloride, m.p. 253.6°–254.6° (Massagetov, *J. Gen. Chem.*, U.R.S.S., 1946, **16**, 139). Two alkaloids have also been isolated in an impure state from *Hippophaë rhamnoides* belonging to the same botanical family, Elæagnaceæ (*Idem, ibid.*, p. 775).

Equisetum palustre. The alkaloid *palustrine*, first obtained by Glet, Gutschmidt and Glet,¹ has been prepared again and further examined recently by Karrer and Eugster.² It has the formula $C_{17}H_{29}O_2N_3$, m.p. 121°, $[\alpha]_D^{18} + 15.8^\circ$ (H_2O), and forms salts:—B. 2 HCl. H_2O , m.p. 188–190° (dec.), $[\alpha]_D^{18} + 8.8^\circ$ (H_2O), gives an acid solution in water; picrate, m.p. 150–150.6°; platinichloride B. H_2PtCl_6 , m.p. 221–3°. The base contains two active hydrogen atoms, but no methoxyl: it absorbs two atoms of hydrogen. The plant has given rise to poisoning cases in cattle, and a short statement of the pharmacological action of palustrine is included

in the paper (1). *Zeit. Physiol. Chem.*, 1936, **244**, 229; (2). *Helv. Chim. Acta*, 1948, **31**, 1062).

Erythraea centaureum. The plant contains 0.8 per cent. of alkaloids from which *erythricine*, $C_{10}H_9O_2N$, m.p. 81–3°, has been isolated. It forms a picrate, m.p. 122–4°, oxalate, m.p. 151–2°, nitrate, m.p. 114°, hydrochloride, m.p. 165–6° (*dec.*), and appears to be a lactone, hydrolysing to a C_{10} acid and oxidising to a C_9 acid (Feofilaktov and Ban'kovskii, *Farmatsiya*, 1946, **9**, No. 5, p. 10).

Flindersia australis R. Br. *Flindersine*, $C_{23}H_{26}O_7N_2$, m.p. 182–3° (*dec.*), $[\alpha]_D \pm 0^\circ$; picrate, m.p. 174°; platinichloride, m.p. 262° (Matthes and Schreiber, *Ber. deut. Pharm. Ges.*, 1914, **24**, 385).

Galanthus Woronovi (Amaryllidaceæ). The leaves and bulbs contain two alkaloids: *galantine*, $C_{13}H_{13}N(OMe)_3(OH) \cdot H_2O$, m.p. 132–3°, or 160–4° (*dry*), $[\alpha]_D - 87^\circ$; hydrochloride, m.p. 198–9°, hydrobromide, m.p. 201–3°; perchlorate, m.p. 199–201°. *Galantidine*, $C_{13}H_{15}ON(CH_2O_2)$, m.p. 235–8°; hydrochloride, m.p. 197–9°; hydrobromide, m.p. 213–213.5°, $[\alpha]_D + 32.3^\circ$; methiodide, m.p. 232–3° (Proskurnina and Areshkina, *J. gen. Chem. U.R.S.S.*, 1947, **17**, 1216).

Girgensohnia spp. *G. diptera* Bge. contains *N*-methylpiperidine and *dipterine*, $C_{11}H_{14}N_2$, m.p. 87–8°, $[\alpha]_D \pm 0^\circ$; hydrochloride, m.p. 177–8°, picrate, m.p. 189–190°, and picrolonate, m.p. 242–3°, which was later shown to be *N*-methyltryptamine.¹ *G. oppositiflora* Pall. contains *N*-methylpiperidine and *girgensohnine*, $C_{13}H_{16}ON_2$, m.p. 147–8°, $[\alpha]_D \pm 0^\circ$. The latter forms a hydrochloride, m.p. 145–8°, and a picrolonate, m.p. 192–4°, and on hydrolysis by alkali yields piperidine, hydrocyanic acid and *p*-hydroxybenzaldehyde, indicating that it is *N*-piperidyl-*p*-hydroxyphenylacetone nitrile, and this has been confirmed by comparison with a synthetic specimen.² (1) Jurashevski and Stepanova, *J. Gen. Chem. Russ.*, 1939, **9**, 2203; Jurashevski, *ibid.*, 1940, **10**, 1781. (2) Jurashevski and Stepanova, *ibid.*, 1946, **16**, 141).

Hedyotis auricularia Linn. Contains *hedyotine*, $C_{16}H_{22}O_3N_2$, yielding a hydrochloride, m.p. 245°, nitrate, m.p. 252° (*dec.*), aurichloride, m.p. 305–310° (*dec.*), and picrate, m.p. 265° (*dec.*) (Dey and Lakshminarayanan, *Arch. Pharm.*, 1933, **271**, 485). A different alkaloid was isolated in small quantity by Ratnagiriswaran and Venkatachalam and named *auricularine*, $C_{42}H_{55}ON_5 \cdot H_2O$; it has m.p. 201° (*dec.*) and forms an oxalate, m.p. >230° (*dec.*), and a picrate, m.p. 217–8° (*dec.*). A third base, giving a hydriodide, which decomposed at 215–220°, and amorphous bases were also found (*J. Ind. Chem. Soc.*, 1942, **19**, 389).

Heliopsis longipes (A. Gray) Blake. This plant is the source of *affinin* formerly believed to be derived from *Erigeron affinis* D.C. *Affinin* has m.p. 160–2°/0.3 mm. and n_D^{27} 1.5128 and has been identified as *N*-isobutyl-2:6:8-decatrienoamide. The substance is toxic to house flies at a concentration of 122.8 mgm. per c.c. of solvent (Acree, Haller and Jacobsen, *J. Org. Chem.*, 1945, **10**, 286, 449; 1947, **12**, 781).

Helleborus viridis L. contains *celliamine*, $C_{21}H_{35}O_2N$, silky needles, m.p. 127–181°, tertiary base; no methoxyl group. *Sprintillamine*,

$C_{23}H_{45}O_4N$, silky needles, m.p. 228–9°, tertiary base, yields a crystalline hydrochloride, m.p. 287–8° (*dec.*), and a methiodide, m.p. 251–2°, has a methylimino but no methoxyl group. *Sprintilline*, $C_{25}H_{41}O_3N$, m.p. 141–2°, sinters from 132°, yields a crystalline hydrochloride, m.p. 278–9° (*dec.*); tertiary base, contains no methoxyl group. *Alkaloid V*, $C_{25}H_{43}O_6N$, needles, m.p. 267–8° (*dec.*), weakly basic.¹ No alkaloids were found in the closely related *H. niger* L. According to Franzen,² the first three alkaloids belong pharmacologically to the aconitine, cevadine, delphinine group of alkaloids, which paralyse the bulbospinal centres, but show a marked phase of respiratory stimulation, not described for this group, nor do they so far show any of the typical sensory effects of aconitine. The irritant action of crude hellebore preparations is said not to be due to any of these alkaloids ((1) Keller and Schöbel, *Arch. Pharm.*, 1927, 265, 238; 1928, 266, 545. (2) *Arch. exp. Path. Pharm.*, 1931, 159, 183).

Helvella esculenta. Liquid, volatile alkaloid, $C_8H_{12(14)}N_2$; picrate, m.p. 145–150° (Aye, *Arch. Pharm.*, 1933, 271, 537).

Hydrocotyle asiatica Linn. (Umbelliferae). The early history of this African and Asiatic drug has been summarised by Flückiger and Hanbury,¹ who, it may be noted, say that Boileau's claim that it cures leprosy is generally disbelieved.² This claim has, however, been revived recently and the anti-leprotic action of the drug attributed to a glucoside.³ It has been repeatedly analysed in a preliminary manner with conflicting results, and has been re-examined recently by Basu and Lamsal,⁴ who have isolated an alkaloid, *hydrocotyline*, $C_{22}H_{33}O_8N$, m.p. 210–2° (*dec.*), yielding a picrate, m.p. 110–2° (*dec.*), oxalate, *dec.* 295°, aurichloride, m.p. 134–6° (*dec.*), and platinichloride, m.p. 171–3° (*dec.*) ((1) "Pharmacographia," London, 1879; (2) quoted by Bouton, "Medicinal Plants of Mauritius," 1857; Hunter, Medical Reports, Madras, 1855; (3) *East African Med. J.*, 1945, 22, 243; *Brit. Med. J.*, 1945, No. 4392, p. 338; (4) *Quart. J. Pharm. Pharmacol.*, 1947, 20, 135).

Inula royleana D.C. According to Chopra, Kohli and Handa, this plant contains about 3 per cent. of an alkaloid, *royline*, $C_{21}H_{33}O_6N$, m.p. 120–1°, $[\alpha]_D^{17} - 42.5^\circ$; aurichloride, m.p. 142° (*dec.*). The base produces a fall in blood pressure and stimulation of tone and peristaltic movement of the intestines on injection into urethanised cats (*Ind. J. Med. Res.*, 1945, 33, 139).

Isopyrum spp. *I. biternatum*. *Isopyroine*, $C_{28}H_{46}O_6N$, m.p. 160°; B. HCl, m.p. 255–7°; B₂. H₂PtCl₆, m.p. 238° (Frankforter, *J. Amer. Chem. Soc.*, 1903, 25, 99).

I. thalictroides L. *Isopyrine*; ψ -*isopyrine* (Hartsen, *J. Chem. Soc.*, 1873, 511; Mirande, *Compt. rend.*, 1919, 168, 316).

Isotoma longiflora. This Peruvian plant contains an alkaloid, m.p. 190°, forming a hydrochloride, m.p. 160°. Pharmacological results are recorded and it is suggested that the alkaloid resembles lobeline of which it may be a derivative (Sanchez, *Rev. Med. exptl.* (Peru), 1945, 4, 284; *Chem. Abstr.*, 1948, 42, 1850).

"*Kai-ho-chien*." This Liliaceous plant is stated by Tang and Chang

to contain a small amount, 0.032 per cent., of an alkaloid, $C_{20}H_{24}O_3N$, m.p. 245–6°. (*J. Chin. Chem. Soc.*, 1945, 12, 181; *Brit. Abstr.*, 1947, Aii, 368.)

Leontice Eversmannii Bge. *Leontamine*, $C_{14}H_{26}N_2$, b.p. 118–9°; dichloroplatinate, m.p. 248° (*dec.*); dipicrate, m.p. 194–5°; dimethiodide, m.p. 265–8°; contains four saturated rings. *Leontidine*, m.p. 116–8°; hydrochloride, m.p. 293° (*dec.*); platinichloride, m.p. 258–9° (*dec.*) (Orekhov and Konovalova, *Arch. Pharm.*, 1932, 270, 329).

Leptactina senegambica (Rubiaceæ). The root-bark contains about 1 per cent. of alkaloids, including *leptactinine*, m.p. 264–6°, which forms a picrate, m.p. 258° (*dec.*), picrolonate, m.p. 196°, and styphnate, m.p. 240–2°. The colour reactions with numerous alkaloidal reagents are recorded, some of which indicate that an indole nucleus is present. Pharmacological effects of an extract of the root bark are described (Paris and Bouquet, *Ann. pharm. franc.*, 1946, 4, 233).

Lophantæra lactecens (Malpighiaceæ) contains *lophanterine*, a crystalline alkaloid, m.p. 175–7° (*dry*), $[\alpha]_D^{24} - 92.7^\circ$ (EtOH), forming a hydrochloride, m.p. 188–9°, sulphate, m.p. 194–5°, and picrate decomposing >280°. It is said to resemble quinine in action (Ribeiro and Machado, *Anais Assoc. Quim. Brasil.* 1946, 5, 39; *Brit. Abstr.*, 1947, Aii, 266).

Mesembrianthemum spp. *M. anatomicum* Harv., *M. expansum* L. and *M. tortuosum* L. contain *mesembrine*, $C_{17}H_{23}O_3N$, amorphous, yielding a crystalline picrate, m.p. 193–4°, picrolonate, platinichloride, $B_2 \cdot H_2PtCl_6$, m.p. 181°, and a methyl ether, m.p. 220–2°. It contains one methoxyl, one phenolic hydroxyl and one methylimino group and is a local anæsthetic and mydriatic, and is regarded as possibly belonging to the tropane group (Hartwich and Zwicky, *Apoth. Zeit.*, 1914, 29, 925 (*Chem. Soc. Abstr.*, 1915 [i], 710); Rimington and Roets, *Onderstepoort J.*, 1938, 9, 187).

Monniera cuneifolia Michx. (*Herpestis monniera* HB and K. (Scrophulariaceæ). The plant contains alkaloids, of which the chief item, *herpestine*, has been obtained crystalline. It has the formula $C_{34}H_{46}O_6N_2$, m.p. 116–8°, is diacidic and forms the following salts: sulphate, *dec.* 120°, tartrate, m.p. 209–210°, platinichloride, *dec.* from 242°, aurichloride, m.p. 210–3° (*dec.*) (Basu and Walia, *Ind. J. Pharm.*, 1944, 6, 85, 91; Basu and Pabrai, *Quart. J. Pharm. Pharmacol.*, 1947, 20, 137).

Mucuna pruriens. Mehta and Majumdar state that the seeds contain two alkaloids: *mucunine*, which forms a hydrochloride, m.p. 65°, and a platinichloride, m.p. >300°, and *mucunadine*, which is more basic and forms a hydrochloride, m.p. 75° (*Ind. J. Pharm.*, 1944, 6, 92).

Ormosia dasycarpa Jacks. *Ormosine*, $C_{20}H_{33}N_3$, m.p. 85–7°, long needles: methiodide (abnormal); picrate, m.p. 178° (*dec.*). *Ormosinine*, $C_{20}H_{33}N_3$, m.p. 208–5°; methiodide, needles, m.p. 245°. Morphine-like in physiological action (Hess and Merck, *Ber.*, 1919, 52, 1976).

Pentaclethra macrophylla Benth. *Paucine*, $C_{27}H_{39}O_5N_5 \cdot 6.5H_2O$. Yellow leaflets, m.p. 126° (*dec.*); $B \cdot 2HCl \cdot 6H_2O$, colourless needles, m.p. 245–7°; picrate, red prisms, m.p. 220° (*dec.*); $B \cdot H_2PtCl_6 \cdot 6.5H_2O$,

m.p. 185°. Furnishes dimethylamine when heated with potassium hydroxide; toxic (*Merck's Report*, 1894, p. 11).

Pithecolobium Saman Benth. Alkaloid, $C_8H_{17}ON$; hydrochloride, $[\alpha]_D^{17} - 13.1^\circ$; aurichloride, m.p. 184–5°. *Pithecolobine*, $C_{17}H_{36}ON_3$, $[\alpha]_D^{17} - 12.12^\circ$ (EtOH); B. 2HCl, $[\alpha]_D^{17} - 19.3^\circ$; yields methylamine and piperidine on distillation with zinc dust (Greshoff, *Ber.*, 1890, 23, 3541; van Itallie, *Pharm. Weekbl.*, 1932, 69, 941).

Premna integrifolia Linn. (Verbenaceæ). From the stem bark of the plant two amorphous alkaloids have been obtained: *ganiarine* characterised as the platinichloride, m.p. 239–241°, and *premnine*, $C_{14}H_{15}ON$, m.p. 82°, yielding a crystalline hydrochloride, m.p. 211–3°, picrate, m.p. 98–101° (*dec.*), and platinichloride decomposing at 254–6°. Some preliminary pharmacological results are recorded (Basu and Dandiya, *J. Amer. Pharm. Assoc.*, 1947, 36, 389).

Pycnarrhena manillensis Vidal. *Ambaline*,



m.p. 123°, $[\alpha]_D^{26} + 143.2^\circ$ ($CHCl_3$); aurichloride, m.p. 185° (*dec.*); B. 2HCl, m.p. 265°; oxime, m.p. 197° (*dec.*) (Quibilan and Santos, *Univ. Philipp. Nat. Appl. Sci. Bull.*, 1933, 3, 353). *Ambalinine*, $C_{15}H_{12}O(OCH_3)_2(NMe)$, m.p. 203–4°; platinichloride, m.p. 240° (*dec.*); aurichloride, m.p. 170° (*dec.*); picrate, m.p. 238° (*dec.*) (Villanos and Santos, *ibid.*, 1935, 4, 338).

Rocella fuciformis. *Picrorocelline*, $C_{27}H_{28}O_5N_2$, m.p. 192–4°, gives benzaldehyde and benzoic acid on oxidation (Stenhouse and Groves, *Annalen*, 1877, 185, 14).

Sarracenia purpurea. According to Walti,¹ this pitcher plant on distillation with alkali yields a basic product from which on neutralisation by acid only ammonium salts could be isolated, which is said to be sufficient to account for the pharmacological results recorded for a neutralised distillate of the plant by Bates and Judovich² (1) *J. Amer. Chem. Soc.*, 1945, 67, 2271; (2) *Anæsthesiology*, 1942, 3, 663; Judovich, *ibid.*, 1943, 4, 313).

Sedum acre L. (Crassulaceæ). Nicotine (p. 36) and *sedamine*, $C_{14}H_{21}ON \cdot 0.3H_2O$, m.p. 89° (*corr.*); hydrochloride, m.p. 205° (Kolesnikow and Shvartsman, *J. Gen. Chem. U.R.S.S.*, 1939, 9, 2156; Marion, *Can. J. Res.*, 1945, B, 23, 165).

Sphæranthus indicus Linn. From this plant, of the botanical family Compositæ, an alkaloid, *sphæranthine*, $C_{13}H_{19}O_5N$, m.p. 166–8° (*dec.*), has been isolated and the following salts prepared: B. HCl, m.p. 158–160° (*dec.*), $B_2 \cdot H_2SO_4$, *dec.* 185°, tartrate, m.p. 182° (*dec.*); picrate, m.p. 154–6° (*dec.*), and platinichloride, *dec.* 196–8° (Basu and Lamsal, *J. Amer. Pharm. Assoc.*, 1946, 35, 274).

Syndesmon thalictroides Hoffm. Abnormal fasciated specimens yielded 3-methylquinoline-4-carboxylic acid and methyl and ethyl *isocarbostryl*-3-carboxylates (Beattie, *J. Amer. Chem. Soc.*, 1908, 40, 415).

Thesium minkwoizianum (Santalaceæ). From this plant Mashkovskii records the isolation of *thesine*. The alkaloid is very toxic; at sufficient

concentration it depresses intestinal muscular activity but does not affect uterine tone; it lowers blood pressure and depresses the brain motor centres, causing a general loss of tone in the skeletal muscle system (*Farmakol. i Toksikol.*, 1943, 6, No. 1, 25 (*Chem. Abstr.*, 1945, 39, 1465).

Trianthema monogyna L. (Ficoidæ). Contains an *alkaloid*, $C_{32}H_{46}O_6N_2$, m.p. 125–7°, forming a sulphate, m.p. 110–1°, oxalate, m.p. 138°, picrate, m.p. 112°, and aurichloride, m.p. 150–3° (Basu and Sharma, *Quart. J. Pharm.*, 1947, 20, 39; cf. Chopra *et al.*, *Ind. J. Med. Res.*, 1940, 28, 475; see also Prasad, *J. Amer. Pharm. Assoc.*, 1948, 37 103).

Triclisia Gilletii. *Triclisine*, $C_{16}H_{31}O_{10}N$, m.p. 255–260° (*dec.*), $[\alpha]_D + 116.7^\circ$ (0.5N-HCl). *Tricliseine*, $C_{33}H_{40}O_7N$, m.p. 135°, $[\alpha]_D + 68.5^\circ$ (0.5N-HCl) (Castagne, *Chem. Zent.*, 1934, ii, 76; 1935, i, 2828; cf. Delvaux, *Chem. Abstr.*, 1936, 6129).

Tylophora spp. (Asclepiadaceæ). *T. asthmatica* Wight and Arn.¹ *Tylophorine*, $C_{24}H_{27}O_4N$, crystalline, m.p. 275° (*dec.*)² $[\alpha]_D^{29} - 15.8^\circ$ (CHCl₃); B. HCl, m.p. 261–5° (*dec.*); B. HBr, m.p. 252–5° (*dec.*)³ *Tylophorinine*, $C_{23}H_{27}O_4N \cdot 0.5H_2O$, crystalline, m.p. 232–3° (*dec.*)² (1) Hooper, *Pharm. J.*, 1891, 21, 6. (2) Ratnagiriswaran and Venkatachalam, *Ind. J. Med. Res.*, 1935, 22, 443. (3) Chopra, Ghosh, Bose and Ghosh, *Arch. Pharm.*, 1937, 275, 236; Chopra, De and Chakerburty, *Ind. J. Med. Res.*, 1935, 23, 263).

T. brevipes (Turcz) F. Vill. *Tylophorine* (Brill and Wells, *Philipp. J. Sci.*, 1917, 12, 167).

Valeriana officinalis. Fresh root contains (a) *chatinine*, B. HCl, m.p. 115°; picrate, m.p. 97–8°, and (b) *valerine*; uncharacterised,¹ (c) pyridine base, $C_{10}H_{15}N$, picrate, m.p. 147–8°.² (d) 2-acetylpyrrole, m.p. 90°.³ From the dried root Blackie and Ritchie⁴ prepared a water-soluble, amorphous base, which reduced blood pressure, had some cardiac action and showed inhibition of movement in isolated rabbit intestine (1) Chevalier, *Compt. rend.*, 1907, 144, 154; Goris and Vischniac, *ibid.*, 1921, 172, 1059. (2) Tschitschibabin and Oparina, *C. R. Acad. Sci. U.R.S.S.*, 1934, 119. (3) Cionga, *Compt. rend.*, 1935, 200, 780. (4) *Pharm. J.*, 1939, 142, 299).

Vinca pubescens Urv. (a) *Vinine*, $C_{19}H_{26}O_4N_2$, m.p. 211.5–213°, $[\alpha]_D - 70.12^\circ$ (EtOH); B. HCl, m.p. 212° (*dec.*); B₂. H₂SO₄, m.p. 229–230° (*dec.*); platinichloride, m.p. 226–7°. (b) *Pubescine*, $C_{26}H_{26}O_4N_2$, m.p. 227–8°, $[\alpha]_D - 134.2^\circ$ (EtOH). (a) and (b) lower blood pressure. (c) *Base*, m.p. 194° (Orehov, Gurevitsch and Norkina, *Arch. Pharm.*, 1934, 272, 70).

Viscum album L. *Base*, $C_9H_{11}N$; platinichloride, m.p. 250° (*dec.*) (Leprince, *Compt. rend.*, 1907, 145, 940; Crawford and Watanabe, *J. Biol. Chem.*, 1916, 24, 169). Choline (Einleger, Fischer and Zellner, *Monats.*, 1924, 44, 277).

Vitex negundo Linn. (Verbenaceæ). Basu and Singh have isolated from the leaves an alkaloid, *nishindine*, $C_{15}H_{21}ON$, m.p. 266°, yielding the following salts: tartrate, m.p. 238°; hydrochloride, m.p. 198–200°;

sulphate, m.p. 210–2°. On oxidation with permanganate the alkaloid provides a quinolinecarboxylic acid, m.p. 254°, and on fusion with potash quinoline is produced (*Quart. J. Pharm. Pharmacol.*, 1947, **20**, 136).

Withania somnifera Dunal. Amorphous alkaloid; aurichloride, m.p. 185°. Boiled with alcoholic potassium hydroxide, yields a crystalline base, $C_{12}H_{16}N_2$; leaflets, m.p. 116°. Physiologically inactive (Power and Salway, *J. Chem. Soc.*, 1911, **99**, 490. Cf. *Amer. J. Pharm.*, 1891, **63**, 77; Trebut, *Lancet*, 1886, [i], 467).

Zygadenus spp. *Z. intermedius* contains *zygadenine*, $C_{39}H_{63}O_{10}N$, needles, m.p. 200–1°, $[\alpha]_D - 48.2^\circ$; toxic resembling cevadine in action.¹ According to Vorlakov,² *Z. sibiricus* contains three alkaloids, one crystalline and devoid of veratrine-like activity, and two amorphous, possessing this type of action and said to be capable of replacing veratrine ((1) Mitchell and Smith, *Amer. J. Physiol.*, 1911, **28**, 318; Heyl, Hepner and Loy, *J. Amer. Chem. Soc.*, 1913, **35**, 258; Marsh and Clauson, *Bull. Bur. Plant. Ind.*, U.S.A., 1915, No. 125 (bibl.). (2) *Farmatsiya*, 1941, No. 1, p. 27).

Alkaloids have been recorded in the following plants:—

Achillea spp. *A. millefolium* L. contains *achilleine*, amorphous; hydrolysed to achilletine, $C_{11}H_{17}O_4N$, also amorphous, ammonia and a reducing sugar.¹ *A. moschata* contains achilleine and *moschatine*, $C_{21}H_{27}O_7N$, an ill-defined gluco-alkaloid.² ((1) Zanon, *Annalen*, 1846, **58**, 21. (2) von Planta, *ibid.*, 1870, 155, 153.)

Adenantha pavonina. The leaves are stated to contain an alkaloidal substance, m.p. 88°. (Patel, Shah and Parikh, *Curr. Sci.*, 1947, **16**, 346.)

Adenocarpus spp. Alkaloids have been recorded in *A. hispanicus* (Santos Ruiz and Llorente, *Anal. Fis. Quim.*, 1941, **37**, 624) and in *A. intermedius* (Rivas, *ibid.*, 1942, **38**, 197).

Ajuga chita (Labiatae). In this hæmostatic drug the presence of alkaloids has been recorded by Aliev. (*Farmatsiya*, 1946, **9**, 21; *Chem. Abstr.*, 1948, **42**, 287.)

Anisomeles malabarica. Alkaloidal material recorded by Rao and Majumdar. (*Indian J. Pharm.*, 1945, **7**, 123.)

Aplopappus hartwegi (Gray) Blake, contains uncharacterised alkaloids and yields pyridine on steam distillation from its suspension in strong alkaline solution. (Buehrer, Mason and Crowder, *Amer. J. Pharm.*, 1939, **111**, 105.)

Asarum europeum L. According to Abdul'menev, the root of this plant contains 1.7 per cent. of uncharacterised alkaloid, *asarine*. The root produces in frogs, rabbits and dogs, acceleration of respiration, nausea and emesis; the cardiac activity of the leaves is thought to be due to a glucoside. (*Farmatsiya*, 1945, **8**, No. 4, p. 39; *Chem. Abstr.*, 1946, **40**, 7411.)

Baccharis cordifolia (Compositae). *Baccharine*, crystalline, neutral to litmus. (Arata, *Pharm. J.*, 1879 [iii], **10**, 6.)

Bryonia dioica Jacq. Amorphous base. (Power and Moore, *J. Chem. Soc.*, 1911, **99**, 937.)

Brucea javanica (Simarubaceae). The source of a Chinese anti-dysenteric drug, "Ya-tan-tzu." Stated to contain an alkaloid, *yatanine*.¹ No alkaloids

have been recorded from *Brucea anti-dysenterica* or *B. sumatrana*.² (1) Liu, Chang and Chuan, *Chin. med. J.*, 1941, 60, 229; *J. Trop. Med. Hyg.*, 1942, 45, 36; cf. Lan, *J. Chin. Chem. Soc.*, 1940, 7, 144. (2) Power and Lees, *Pharm. J.*, 1903 [iv], 17, 183; Power and Salway, *ibid.*, 1907, 79, 126; Salway and Thomas, *ibid.*, p. 128.)

Burassia madagascariensis. (Davidson, *East African Med. J.*, 1945, 22, 80; cf. Spencer et al., *Lloydia*, 1947, 10, No. 3, p. 145.)

Cassia Siamea Lam. Alkaloid, C₁₄H₁₉O₃N. Toxic. (Wells, *Philipp. J. Sci.*, 1919, 14, 1.)

Celastrus paniculata Willd. Two alkaloids have been found in the seeds of this plant, *celastrine*, C₁₉H₂₅O₃N, m.p. 260° (dec.), and *paniculatine*, which was not characterised. For other "paniculatines" see pp. 502 and 674. (Basu and Pabrai, *J. Amer. Pharm. Assoc.*, 1946, 35, 272.)

Cephalaria gigantea. Uncharacterised alkaloids were recorded by Mirzojan, Jaroschenko, Amirzadian and Serpetschian. (*Proc. Acad. Sci. Armenian S.S.R.*, 1946, 4, 83; *Brit. Abstr.*, 1947, Aiii, 162.)

Chlorocodon whiteii. Mascré and Paris have recorded the presence of alkaloids in the root, stem and seed of this plant. (*Ann. pharm. franc.*, 1947, 5, 228.)

Clematis angustifolia Jacquin. The roots contain unidentified alkaloids. (Tang and Chao, *Pharm. Arch.*, 1940, 11, 60.)

Combretum micranthum. From the leaves of this W. African native drug Lahmann prepared a non-volatile alkaloid, *combretine*. (*Heil u. Gewurz-Pflanzen*, 1943, 2, 1; *Chem. Abstr.*, 1946, 40, 7523.)

Daemia extensa (Asclepiadaceæ). Dutta and Ghosh¹ were unable to confirm the presence of an alkaloid in spite of previous records² to the contrary. (1) *J. Amer. Pharm. Assoc.*, 1947, 36, 250; Gupta, Roy and Dutta, *Ind. J. Med. Res.*, 1946, 34, 181. (2) Dymock, Warden and Hooper, *Pharmacographia Indica*, 1891, Vol. II, p. 442.)

Daphniphyllum spp. From the bark of *D. macropodium* Miq. Yagi¹ isolated an amorphous alkaloid, *daphnitracrine*, C₂₇H₄₁O₄N, m.p. 75–84°, which closely resembles in pharmacological action, the amorphous base, *daphniphylline*, prepared from *D. bancanum* Kütz by Greshoff and examined by Plugge.² (1) *Arch. Internat. Pharmacodyn.*, 1910, 20, 117. (2) *Arch. exp. Path. Pharm.*, 1893, 32, 277.)

Eremosparton aphyllum. The roots are rich in alkaloids, which have not been characterised. The root extract slows respiration, lowers blood pressure and raises the pulse rate on intravenous injections in dogs. (Lyubushin, *Farmakol i Toksikol.*, 1946, 9, No. 2, 30; (*Chem. Abstr.*, 1947, 41, 3220).)

Erodium cicutarium l'Herit. Geraniaceæ. (Koskoroski, *Chem. Zentr.*, 1938, ii, 3269.)

Esenbeckia febrifuga Juss. Brazilian angostura bark (cf., p. 415); contains 3.9 per cent. of alkaloids. (Hartwich and Gamper, *Arch. Pharm.*, 1900, 238, 568.)

Eugenia Jambos L. *Jambosine*, crystalline, m.p. 77°. (Gerrard, *Chem. Soc. Abstr.*, 1885, 48, 396.)

Fraxinus malacophylla Hems. (Oleaceæ). The source of a Chinese drug "Pai-chi-ang-kan," or "Ken-ken-yao," and stated to contain an alkaloid, "sinine" resembling quinine.¹ Tonkin and Work² found the drug inactive in malaria in chicks and, like Mukerji,³ were unable to confirm the presence of an alkaloid. (1) Liu, Chang, Chuan and Tan, *Chin. Med. J.*, 1941, 59, 575. (2) *Nature*, 1945, 156, 630. (3) *Ibid.*, 1946, 158, 170.)

Gastrolobium calycinum Benth. *Cygnine*, C₁₉H₂₄O₃N₂. Convulsant poison. (Mann and Ince, *Proc. Roy. Soc.*, 1907, 79B, 488.)

Gonioma kamassi E. Mey. Alkaloid with curare-like action. (Dixon, *Proc. Roy. Soc.*, 1911, 83B, 287.)

Hydrangea umbellata Rheder (Saxifragaceae). A Chinese anti-malarial drug said to contain several crystalline alkaloids. (Jang, Fu, Huang, Wang, *Nature*, 1948, 161, 401.)

Ipomoea sidæfolia Choisy. The seeds, "piule," contain a gluco-alkaloid with narcotic properties. (Santesson, *Arch. Pharm.*, 1937, 275, 532.)

Jatropha gossypifolia L. var. *elegans* Muell. *Jatrophine*, $C_{14}H_{20}O_6N$. (Barriga Villalba, *J. Soc. Chem. Ind.*, 1937, 46, 396T.)

Yulocroton montevidiensis. *Yulocrotine*, $C_{19}H_{26}O_3N_2$. (Anastasi, *Anal. Asoc. quim. argent.*, 1925, 13, 348.)

Leonurus sibiricus L. (Labiatae) *Leonurine*, $C_{10}H_{14}O_2N_2$, m.p. 262–3° (dec.),¹ or $C_{13}H_{19}O_4N_4$, m.p. 238°.² ((1) Shu, *J. Chin. Chem. Soc.*, 1934, 2, 237; (2) Kubota and Nakashima, *Fol. Pharmacol. Jap.*, 1930, 11, 153.) *Leonurus cardiaca*. The dried plant contains 0.35 per cent. of alkaloids. (Tariverdieva, *Farmatsiya*, 1946, 9, 15.)

Lunaria biennis (L. *annua*) Mnch. Crystalline base, m.p. 220°. (Hairs, *Bull. Acad. Roy. Belg.*, 1909, 1042.)

Maytenus spp. "Chuchuara" or "chuchuhuasha" from Peru contains an amorphous alkaloid which lowers body temperature and reduces blood pressure. (Raymond-Hamet and Colas, *Bull. Acad. Méd.*, 1935, 114, 139; Perrot, Millat and Colas, *Bull. Sci. Pharmacol.*, 1937, 44, 325.)

Melia azadirachta L. (neem or margosa). The bark, according to Cornish,¹ yields a minute amount of a bitter alkaloid, *margosine*. The fruit is reported to be toxic and to contain an alkaloid, *azaridine*.² The leaves are stated to be insect-repellent and from them an alkaloid *paraisine*³ has been prepared. The flowers are alkaloid-free.⁴ ((1) *Ind. Ann. Med. Sci.*, 1857, 4, 104; (2) Carratala, *Rev. Asoc. med. Arg.*, 1939, 53, 338; (3) Volkonsky, *Arch. Inst. Pasteur Algérie*, 1937, 427; (4) Subramanian and Rangaswamy, *Curr. Sci.*, 1947, 16, 182.)

Momordica charantia L. A preliminary examination has indicated the presence of two alkaloids of which one has been named *momordicine*. (Rivera, *Amer. J. Pharm.*, 1941, 113, 281.)

Ochrosia elliptica Labill. (*Bleekaria calocarpa* Hassk.). According to Raymond-Hamet¹ the pharmacological action of an aqueous extract of the bark of this species does not support the claim that the bark contains quinine² though alkaloids are present.³ ((1) *C.R. Soc. Biol.*, 1940, 133, 262. (2) Jacques, "Un arbre à quinquina en Nouvelle Calédonie," Noumea, 1937. (3) Greshoff, *Meded. uii's Lands Planten*, 1890, 7, 59; 1898, 25, 130.)

Orthosiphon stamineus Benth. The presence of an alkaloid has been recorded by Tang and Hsü. (*J. Chin. Chem. Soc.*, 1940, 7, 116; cf. Dietzel and Schmidt, *Arch. Pharm.*, 1936, 274, 10.)

Ostryoderis chevalieri Dunn. An alkaloid, $C_{15}H_{22}O_2N_2$, $[\alpha]_D - 75^\circ$, has been recorded by Balansard and Martini. (*Bull. sci. pharmacol.*, 1939, 46, 268.)

Oxylobium parviflorum Benth. *Lobine*, $C_{23}H_{31}O_4N_3$. Toxic. (Mann and Ince, *Proc. Roy. Soc.*, 1907, 79B, 485.)

Palicourea rigida H.B.K. *Douradine*; crystalline, m.p. 235°. (Santesson, *Arch. Pharm.*, 1897, 235, 143.)

Persea gratissima Gaertn. (Avocado pear). The leaves are reported to contain pharmacologically active alkaloids. (Stellfeld, *Tribuna Farm.*, 1938, 6, 96; Appelman, *Calif. Avocado Soc. Year-book*, 1944, 37.)

Physalis mollis Nuttall (Solanaceae). The presence of an alkaloid has been

recorded, but the insecticidal properties of the plant appear to be due to a glucoside. (Harris, *J. Amer. Pharm. Assoc.*, 1948, 37, 145.)

Picrasma crenata. Stated to contain an uncharacterised alkaloid *sigmine*, which lowers the contractility and tonicity of the isolated duodenal preparation of the rabbit. In dogs it is hypotensive and lowers concentration of blood sugar, 3 to 4 hours after injection. (Pereira, *Ann. fac. med. Univ. S. Paulo*, 1938, 14, 269; (*Chem. Abstr.*, 1939, 33, 3877).)

Piscidia erythrina L. Alkaloid, amorphous, m.p. 26–7°; B. HCl, m.p. 124° (Danckwortt and Schütte, *Arch. Pharm.*, 1934, 272, 701.)

Polyporus frondosa. Amorphous base yielding crystalline salts. (Bamberger and Landsiedl, *Monats.*, 1911, 32, 641.)

"*Pseudo ademno calima elegans*." This toxic Brazilian plant was found to contain a lævorotatory alkaloid, mol. wt. 527, $[\alpha]_D - 20^\circ$. (Mello and Fernandes, *Rev. soc. brasil. quim.*, 1940, 9, 155.)

Quebrachia Lorentzii Griseb. *Loxopterygine*, $C_{26}H_{34}O_2N_2(?)$. Amorphous, m.p. 81°; amorphous, bitter salts; blood-red colour with nitric acid, bluish-violet colour with sulphomolybdic acid. (Hesse, *Annalen*, 1882, 211, 274.)

Quisqualis indica. The seeds of this plant, used as an anthelmintic, are stated to contain alkaloids. (Hsu and King, *J. Chin. Pharm. Soc.*, 1940, 2, 132.)

Ramondia pyrenaica Rich. An oily alkaloid, most abundant in the leaves, was recorded by Girard and Marzat (*Bull. trav. soc. pharm. Bordeaux*, 1938, 76, 150).

Ryania spp. Plants of this genus including *R. acuminata*, *pyrifera*, *sagotiana*, *speciosa*, *subuliflora* and *tormentosa* contain alkaloids possessing insecticidal properties and preparations of the plants have been protected by patent for use against insect pests. (Folkers, Rogers and Heal, U.S.P. 2,400,295; for insecticidal tests see Pepper and Carruth, *J. Econ. Entom.*, 1945, 38, No. 1, 59; Ivy and Ewing, *ibid.*, 1947, 40, 568; Doehlert, *Chem. Abstr.*, 1946, 40, 2580.)

Sansevieria zeylanica. An alkaloid is present in the roots and rhizomes. The juice contains aconitic acid. (Scheidlin and Dodge, *Amer. J. Pharm.*, 1947, 119, 232.)

Sarcocephalus Diddierichii (West African boxwood). Cardiac poison. (Gibson, *Biochem. J.*, 1906, 1, 39.)

Saussurea Cappa Clarke. The root contains *saussurine*¹ which, according to Prasad,² accounts for the effect of the drug in controlling attacks of bronchial asthma, especially of the vagotonic type. ((1) Ghosh, Chatterjee and Dutta, *J. Ind. Chem. Soc.*, 1929, 6, 517; (2) *Ind. J. Pharm.*, 1945, 7, 81.)

Smilax pseudo-china (Tu-fu-ling). Among other products, probably alkaloids. (Liu and Kuo-Chen Chen, *J. Chinese Chem. Soc.*, 1945, 12, 122; *Chem. Abstr.*, 1946, 40, 3851.)

Spigelia marylandica L. *Spigeline*. Liquid; toxic. (Dudley, *Amer. Chem. J.*, 1881, 1, 138.)

Talauma mexicana Don. (Magnoliaceæ). The leaves have been stated to contain a liquid alkaloid, *talaumine*, forming a crystalline hydrochloride. According to Raymond-Hamet, an extract of the leaves has a nicotine-like action. (*C.R. Soc. Biol.*, 1939, 132, 459: with a bibliography.) The drug is known in Mexico as "yoloxochitl" and a number of non-alkaloidal components have been obtained from it and characterised by Pallares and Garza. In a paper received too late for detailed reference, the same authors have described the isolation from this source of the alkaloid, *aztequine*, $C_{36}H_{40}O_7N_2$, regarded as belonging to the bisbenzylisoquinoline group (p. 346), in support of which a series of degradation products have been prepared and described. (*Arch. Inst.*

Cardiol. Mex., 1947, 17, 833 ; (*Chem. Abstr.*, 1948, 42, 2730) ; *Archiv. Biochem.*, 1948, 16, 275.)

Ustilago maydis. Alkaloids isolated from this maize fungus were named *ustilagine* and *ustilagotoxine* and are stated to resemble ergotinine and ergotoxine respectively. (Mas, *Bol. Soc. Quim. Peru*, 1938, 4, 3.)

Zanthoxylum budrunga. From the bark *Khastagir* isolated two alkaloids, *budrugaine*, which chars above 180° but does not melt, and *budrugainine*, m.p. 155° (*Curr. Sci.*, 1947, 16, 185 ; *Chem. Abstr.*, 1948, 42, 326.)

INDEX

(Botanical names are printed in italics. Prefixes such as *nor-*, *iso-*, *proto-*, *apo-*, are printed in italics and disregarded for indexing purposes: Where more than one page number is given, a chief descriptive reference is indicated by the use of heavier type.)

- ABRINE, 484
 Abrotine, 772
Abrus precatorius, 484
Abuta spp., 371
Acacia spp., 771
 Acetylcholine, 262, 518
 Acetylornithine, 170, 171, 172
Achillea spp., 779
 Achilleine; achillettine, 779
 Acolyctine, 686
 Aconine, 673, 675, 679, 685
 Aconines, nuclear structure, 693
 Aconite alkaloids, 673
 Aconitine, 673, 674, 775
 oxidation products, 676
 Aconitines, pharmacological action, 690
 Aconitinone, 676
 Aconitoline, 676
 Aconitum and delphinium alkaloids,
 interrelationship, 692
Aconitum spp., 673, 674, 678, 680, 682,
 684, 685, 686, 687, 689, 690, 695
Actinodaphne spp., 319, 322
 Actinodaphnine, 322, 323
 Acutumine, 268, 272
Adenantha pavonina, 779
Adenocarpus spp., 779
Adhatoda vasica, 617, 620
Adina spp., 756
Adumia spp., 169, 210
 Adlumidine, 169, 172, 210
 pharmacological action, 212
 Adlumine, 169, 171, 210
 pharmacological action, 212
Ægle marmelos, 414
 Affinin, 774
 Agmatine, 518
Aizoaceæ, 1
 Ajacine, ajacinine, ajacinoidine, ajaconine,
 694
 Ajmalicine, 762, 763
 Ajmaline, 762; *isoajmaline*, 762, 764;
 neoajmaline, 762, 764
 Ajmalinine, 762
Ajuga chia, 779
 Akuamma alkaloids, 760
 Akuammenine, 760
 Akuammicine, ψ -akuammicine,
 akuammidine, akuammigine,
 ψ -akuammigine, akuammiline, 760
 Akuammine, 760
 hydrate, 760
 pharmacological action, 761
 Alangine, 771
Alangium lamarckii, 771
 Alginine, 732, 734
 Alkaloidal amines, 630
 Alkaloids of undetermined constitution,
 716
 α -Alkyldihydrochelerythrines, 278
 Aloperine, 118, 150
 Alstonamine, 716
 Alstonia alkaloids, pharmacological action,
 720
Alstonia spp., 716, 718, 719, 720
 Alstonidine, alstoniline, 716, 718
 Alstonine, 716
 degradation products, 717
 Alstyrine, 717
Amanita muscaria, 658
 Amaryllidaceæ, alkaloids, 406
 minor alkaloids, 411
 Ambaline, ambalinine, 777
 Aminodihydroquinine, 748
 β -Amino-4-ethylglyoxaline, 671
 Aminolaudanosine, 311
 Ammodendrine, 35, 116, 139
Ammodendron Conollyi, 35, 116
 Ammothamnine, 116
Ammothamnus lehmanni, 116, 151
 Amcibicides, synthetic, 402
 Amphiporine, 49
Amphiporus lactifloreus, 49
isoAmylamine, 518
isoAmylputrescine, 630
 Anabaseine, 45
 Anabesine, 35, 43, 44, 50, 53
Anabasis aphylla, 35, 43, 53, 118
Anacyclus pyrethrum, 2
 Anagyramide, 140
 Anagryrine, 116, 137, 138, 140, 142, 148,
 152
Anagyris fetida, 116, 140
 Analgesics, synthetic, 263, 265
Anamirta paniculata, 349
 Anatabine, 35, 43, 46
Anchusa officinalis, 771
Andira spp., 631
 Andirine, 631
 Angelic acid, 604
 Angeline, 631
 Angostura bark, alkaloids, 415
 Anhalamine, 154
 constitution, 156
 Anhalidine, 154, 156
 Anhaline (Hordenine), 154, 161, 633

- Anhalinine**, 154, 156
Anhalonidine, 154, 155, 160, 161
 constitution, 157
Anhalonine, 154, 155, 160, 161
 constitution, 158
Anhalonium alkaloids, pharmacology, 160
Anhalonium spp., 154
Anhydroberberilic acid, 332
Anhydroecgonine, 97
Anhydrolupinine, 120
Anhydroxatine, 770
Anisomeles malabarica, 779
N-(2-*p*-Anisylethyl)-*N*-methyl-
 cinnamide, 330, 631
Annona ambotay, 371
Annotinine, 752, 753, 755
Anodmine, 47
Anolobine, 317
Anonaceæ, alkaloids, 317, 329, 349
Anona muricata, 317
Anonaine, 318
Anthorine, 673
Anthranoyllappaconine, 686
Anthranoyllycoctonine, 687, 694, 696
Anti-histamine drugs, 113, 197, 644
Anti-malarial drugs, synthetic, 475
Aphyllidine, 35, 53, 54
Aphylline, 35, 54, 138, 148
Aplopappus hartwegi, 779
Aporeidine, 173, 276
Aporeine, 173, 178, 275
Aporphine alkaloids, 232, 273, 284, 306,
 314, 317, 319
 interrelationships and syntheses, 309,
 310, 311, 323
 pharmacological action, 312, 316, 327
Apuleia molaris, 151
Arachine, 771
Arachis hypogæa, 771
Arariba rubra, 490
Archangelisia flava, 329
Areca nut alkaloids, 8
 pharmacological action, 12
Arecaidine; arecaine, 10
Arecolidine, 12
Arecoline, 9, 12
Argemone spp., 169
Argemone mexicana, 771
Argemonine (protopine), 169
Aribine, 490
Aricine, 419, 465, 466
Aristidinic acid, 722
Aristinic acid, 722
Aristolic acid, 722
Aristolochia rumicifolia, 371
Aristolochia spp., 721, 722
Aristolochic acid, 722
*iso*Aristolochic acid, 722
Aristolochine, 722
Arnepavine, 173, 195, 276
Artabotrine, 317, 318
 methyl ether, 319
Artabotrinine, 319
Artabotrys suaveolens, 317
Artarine, 330
Artemisia abrotanum, 772
Arthropodium leptocladium, 631, 772
Asarine, 779
Asarum europæum, 779
Asclepias syriaca, 85
Asiminine, 317
Aspidosamine, 511
Aspidosine, 512
Aspidosperma spp., 511
Aspidospermatine, 511
Aspidospermicine, 511
Aspidospermine, 500, 511
Asteracantha longifolia, 772
Astragalus spp., 772
Atherosperma moschatum, 320
Atherospermine, 320
Atisine, 673, 687
 isoatisine, 687
Atroglyceryltropeine, 74
Atrolactyltropeine, 73
Atropa spp., 65, 67, 68, 69
Atropamine, 71
Atropine, 64, 65, 66, 70, 79, 83, 86, 161
 constitution, 72
 pharmacological action, 105, 107, 110,
 112, 196, 197
 synthetic substitutes, 109, 113
*apo*Atropine, 64, 65, 71
 pharmacological action, 107
*nor*Atropine, 64, 66, 83
 ψ -Atropine, 73
Atroscine, 84, 85
Attagenus piceus, 49
Aureine, 601
Auricularine, 774
Aurotensine (*d*- and *dl*-scoulerine), 170,
 171, 173, 291
Avocado pear, 781
Azaridine, 781
Aztequine, 783

Baccharis cordifolia; baccharine, 779
Bakankosine, 554
Banisteria spp., 488
 "Banisterine," 488
Baptisia spp., 116
Baptitoxine, 142
d-Bebeerine (α -bebeerine), 363, 364, 367
l-Bebeerine (curine), 363, 364, 369, 374,
 377
 dimethyl ether methochloride, 392
*iso*Bebeerine, 363, 365
 β -Bebeerine, 363, 364
Bebeerine-B, 363, 364
Belladonna alkaloids, 1, 65, 69
Belladonnine, 64, 65, 71
Bellaradine, 67
Bellatropine, 71
Benzaconine, 673, 675
Benzhyphaconine, 681
Benzmesaconine, 680
Benzoylaconine, 675
Benzoyllecgonine, 96
Benzoylheteratisine, 689

- Benzoyloscine**, 86, 88
Benzoylpseudoaconine, 684
Benzoyltropine, 64, 93, 107
Benzoyl- ψ -tropine, 100
 pharmacological action, 106, 107
1 : 2-Benzphenanthridine, 279
Benzylmethylamine, 636
Benzylmorphine, 217, 260
Benzylisoquinoline alkaloids, 182, 196
Berberamine, 329, 346, 350, 362
 pharmacological action, 349
Berberamine methyl ether, 346, 356
Berberal, 332, 340
*iso*Berberal, 332
Berberidaceæ, 328
Berberilene, 337
Berberilic acid, 332
Berberinal, 333
Berberine, 162, 169, 170, 171, 287, 328, 329, 331, 344, 345, 631
Berberine, quaternary ammonium bases
 from tetrahydro-derivative, 337
Berberine and related bases,
 pharmacological action, 345
 syntheses, 334
Berberineacetone, 333
*epi*Berberine, 297
*proto*Berberine, 336
 ψ -Berberines, 335
Berberinium hydroxide, 333
Berberinol, 333
Berberis spp., 328, 331, 346
Berberoline, 332
Berberonic acid, 507
Berrubine, 329, 343
 "Berbine," 336
Betaine, 518
Bicucine, 170, 209
 pharmacological action, 212
Bicuculline, 169, 170, 171, 172, 209, 210
 pharmacological action, 212
Bikhaconine, 685
Bikhaconitine, 674, 685
Bisbenzylisoquinoline alkaloids, 196, 346, 349, 352, 353, 783
 characters and relationships, 358
Bisocclaurine alkaloids, 346
Bisdihydrodioscorine, 92
Bismatridine, 148
Bis-(8-quinolyloxy)-1 : 5-pentane diethiodide, 391
Blekkaria calocarpa, 781
Bocconia spp., 169
Boerhaavia diffusa, 772
Boldea fragrans, 325
Boldine, 325, 327
Bourreria verticillata, 395
Boxwood alkaloids, 363
Brassica spp., 648
Bromocodide, 217
Bromomorphide, 217, 254
1-Bromosinomenine, 271
Brucea ferruginea, 556
Brucea javanica, 779
Brucidine, 576, 583
Brucidone, 583
Brucine, 553, 556, 581
 constitution, 561
 pharmacological action, 596
*iso*Brucine, 562
*neo*Brucine, 575, 583
 ψ -Brucine, 559
Brucinolic acid, 571
Brucinolones, 571, 574
Brucones, 584
Bryonia dioica, 779
Budrugaine; *budrugainine*, 783
Bulbocapnine, 171, 172, 306
Bulbocapnine and allied alkaloids,
 pharmacological action, 313
Buphanine, 406
 pharmacological action, 412
Buphanitine, 411
Burassia madagascariensis, 780
Buxine; *Buxus sempervirens*, 363

Cacalia hastata, 601
Cacotheline, 566
Cactaceæ, 154
Cadaverine, 518
Calabar bean alkaloids, 539
 "Calabarine," 540
Calabash curare, 373
 alkaloids, 380
 formulæ and characters, 384
 non-alkaloidal constituents, 385
Calabash-curarine I., 380, 382, 385
Calabash-curarines II and III, 382
Calebassine, 383, 385
Calebassinine, 385
Calycanine, 486, 487
Calycanthidine, 488
Calycanthine, 485, 486, 488
 isocalycanthine, 485, 488
Calycanthus spp., 485, 486
Calycotamine, 146
Calycotome spinosa, 117
Calycotomine, 117, 146
Campestrine, 601
Canadine (tetrahydroberberine), 162, 170; 171, 172, 291, 333, 336, 338, 343
 pharmacological action, 345
 α -Canadine, 172
Candicine, 161
Capauridine (dl-capaurine), 170, 171, 339
Capaurimine, 171, 339
Capaurine, 170, 171, 339, 345
Capnoidine, 170, 171, 211, 212
Capparis sola, 372
Capsaicin, 2
Carboline, 492
Carica Papaya, 599
Carnegia gigantea, 159
Carnegine, 158, 159
Carpaine, 599
 pharmacological action, 600
Carpamic acid, 599
 "Carpasemine," 600

- Carpyrine**, 599
Carthamoidine; 601
Casealutine (*l*-isocorypalmine), 170, 291
Caseanine (*l*-tetrahydropalmatine), 170, 291
Casimiroa edulis, 772
Casimiroëdine, casimiroine, casimiroitine, 772
Cassaic acid, 728, 729
*allo*Cassaic acid, 728, 730
Cassaïdic acid, 729
Cassaïdine, 728
Cassaine, 726, 727, 729
Cassanic acid, 728
Cassia absus, 723
Cassia Siamea, 780
Castor-oil seed, 5
 "Cathine," 635
Caulophylline, 118
Caulophyllum thalictroides, 118, 146
Ceanothine, 772
Ceanothus spp., 772, 773
Celastrine, 780
Celastrus paniculata, 780
Cellianine, 774
Cephæline, 394, 395, 396, 779
*iso*cephæline, 398
*nor*cephæline, 398
Cephalis Ipecacuanha, 394
Cepharanthine, 350, 357, 358, 362
Cephalaria gigantea, 780
Ceratocarpus spp., 169
Cereus coryne, pharmacological action of bases, 161
Cereus pecten aboriginum, 159
Cernuine, 755
Cevadilla seeds, 700
Cevadilline, 701, 705
Cevadine (crystallised veratrine), 701, 702, 775, 779
Cevanthridine, 703, 710, 712
Cevanthrol, 703, 710
Cevine, 701, 702, 710, 712
Chairamidine, 419, 467
Chairamine, 419, 467
Chaksine, *isochaksine*, 723
Chalchupines A and B, 761, 762
Chatinine, 778
Chavicine, 2
l-Cheilanthifoline, 170, 171, 339
Cheiranthin, 649
Cheiranthus spp., 649
Cheirinine, cheiroline, 649
Chelerythrine, 169, 173, 277, 278, 279
 ψ -Chelerythrine, 277, 279, 280, 281
Chelidonine, 169, 173, 278, 279, 281, 282, 283
Chelidonium majus, 119, 277, 283
Chin-Shien-Tiao-Hu-Lu, 351
Chlorocodides, α - and β -, 217
Chlorocodon whiteii, 780
Chlorogenine. *See* Alstonine.
Chloromorphides, α - and β -, 217, 254, 255
Chloroxytonine, 773
Chloroxylon swietenia, 414, 773
Choline, 413, 773
Choline-esterase, 262
Choline-esterases, inhibition by physostigmine and by synthetic drugs, 548, 551
d-Chondocurine, 377
Chondodendrine (bebeerine), 363, 367
*iso*Chondodendrine (*isobebeerine*), 363, 365
d-Chondrocurarine salts, 377, 378
d-Chondrocurine, 377
Chondrodendrine (bebeerine), 363, 367
 β -Chondrodendrine (β -bebeerine), 363, 364
iso-Chondrodendrine, 363, 364, 365, 368, 370, 376
 dimethyl ether, 366, 377
Chondrodendron candidans, 364, 371
Chondrodendron iquitianum, 371
Chondrodendron limaciiifolium, 371, 372
Chondrodendron microphyllum, 364, 377
Chondrodendron platyphyllum, 363, 377, 392
 alkaloids, 364
Chondrodendron polyanthum, 371
Chondrodendron tomentosum, 363, 371, 373, 377, 391
 alkaloids, 376
Chondrodine, 363, 364
Chondrofoline, 364, 365
Chrycentrine, 172, 313
Chrysanthemine, 773
Chrysanthemum cinerariæfolium, 773
 "Chuchua," 781
 "Chuchuhuasha," 781
Cicuta virosa, 13
Cinchamidine, 419, 429
Cinchene, 439
Cinchenine, 438, 439, 440
*apo*Cinchenine, 440, 441
Cincholoipon, 438
Cincholoiponic acid, 438, 443
Cinchomeronic acid, 183
Cinchona alkaloid structure, synthesis, 457
Cinchona alkaloids, bactericidal action of some derivatives, 478
 centres of asymmetry, 445
 constitution, 435
 formulæ and characters of transformation products, 449, 451
 general formula, 443
 hydroxydihydro-bases, 448, 452-4
 melting-points and specific rotations, 446
 minor, 463
 optical relationships, 446
 pharmacological action, 469
 relative anti-malarial efficiency, 470
 stereoisomerism 443
 syntheses, 454
 transformation products, 448
 vinyl-free analogues, 447
*apo*Cinchona alkaloids, 448, 449, 450-4
Cinchona bark, analyses, 420
 experimental plantations, sources of supply, 419
Cinchona febrifuge, 420

- Cinchona Pelletierana*, alkaloids, 466
Cinchona spp., alkaloids, 418, 424
Cinchona, total alkaloids. See Totacuina.
 Cinchonamine, 419, 465
 Cinchonhydrines, 449, 452
 Cinchonicine (cinchotoxine), 419, 442, 451
 Cinchonidine, 419, 427
 constitution, 435
*apo*Cinchonidine, 448, 452
 β -Cinchonidine, 448, 452
 Cinchonifine (dihydrocinchonine) 428
 Cinchonine, 419, 421, 427, 583
 constitution, 435
 oxidation, 436
 structural formula, 442
*hetero*Cinchonine (*h*-cinchonine), 451
*iso*Cinchonines, 451
 Cinchoninic acid, 454
 "Cinchonino," 421
 Cinchoninone, 437, 438, 442
 Cinchotenidine, 436
 Cinchotene, 436
 Cinchotine (dihydrocinchonine), 419, 428
 Cinnamylcocaine, 93, 95
Cissampelos insularis, 370
Cissampelos Pareira, 363
 Clavatine; clavatoxine, 752, 753, 755
Claviceps purpurea, 517
 Clavine, 518
Clematis angustifolia, 780
 Coca leaves, alkaloids, 92
 Cocaethylene, 96
 Cocaine, 79, 92, 93, 99, 100
 detection, 94
 homologues, 96
 pharmacological action, 106, 110
 substitutes, 111
 α -Cocaine, 100
*iso*Cocaine, 95
 Cocaines, 81, 93
 ψ -Cocaines, 94, 95, 97, 100
 pharmacological action, 110
 Cocamine and *isococamine*, 95, 96
Cocculus spp., 329, 350, 351
 Coclaurine, 196, 352
*iso*Coclaurine, 196, 364, 365
*nor*Coclaurine, 353
 Cocoberine, 414
 Codamine, 178, 193, 194, 220
 Codeine, 177, 178, 200, 216, 219, 222, 226,
 227, 235, 262
 constitution, 222
 formulæ, 240
 isomerides, 217, 218, 235
 pharmacological action, 196, 198, 211,
 259, 265
 "apoCodeine," 217
 ψ -apoCodeine, 217, 227
 β -Codeine, 218
*iso*Codeine, 235
 ψ -Codeines, 224, 226, 235
*hetero*Codeines, 216
 Codeinone, 222, 224, 225, 226, 236, 245,
 249
 ψ -Codeinone, 224, 225, 226, 236, 247
- Cælocline polycarpa*, 329
 Colchicine, 651, 655
 pharmacological action, 656
 Colchicine, 650
 pharmacological action, 656
Colchicum autumnale, 650
 "Colloturine," 490
 Colubrines, α - and β -, 553, 559, 560
 pharmacological action, 597
 Columbamine, 328, 329, 342, 345
 Combretine, 780
Combretum micranthum, 780
 Complanatine, 753, 755
 Conamine, 743, 745
 Conarrhimine, 743, 745
 Conchairamidine, 419, 467
 Conchairamine, 419, 467
 Concusconine, 419, 467
 Condelphine, 695
 Conessidine, 742, 743, 745
 Conessimine, 743, 744
*iso*Conessimine, 743, 745
 Conessine, 742, 743, 745, 748
*apo*Conessine, 744
*iso*Conessine, 748
*nor*Conessine, 743, 744, 745
*isonoriso*Conessine, 745
*aponor*Conessine, 744
 Conessine and allied alkaloids,
 relationship, 743
 Conhydrine, 17
 ψ -Conhydrine, 18
 γ -Coniceine, 13, 19
 Coniceines, 17, 19, 20
 Coniine, 14, 56
 pharmacological action, 108
*iso*Coniine, 16
 Conimine, 743, 745
*iso*Conimine, 745
Conium maculatum, 13
 Conkurchine, 742, 743, 745
 Conkurchinine, 742, 743, 747
 Conquinamine, 419, 465, 466
 Conquinine, 424
 Consolicine, 771
 Consolidine (ex *Anchusa*), 771; (ex *Del-*
phinium), 696
 Consoline, 696
 Convolvamine, 64, 67, 91
 Convolvicine, 64, 67, 91
 Convolvidine, 64, 67, 91
 Convolvine, 64, 67, 91
Convolvulus hamadae, 67, 101, 103
Convolvulus pluricaulis, 773
Convolvulus pseudocantabricus, 67, 91
 Conyryne, 15, 16
Cooperia spp., 406
 Coptine, 328
Coptis spp., 328, 344
 Coptisine, 170, 328, 344
*nor*Coralydine, 292
 Cordrastine, 170, 211
 Corlumidine, 171, 211
 Corlumine, 171, 172, 211
 pharmacological action, 212

- Cornutine, 517
 Coronarine, 501
 Corybulbine, 170, 171, 172, 289
 constitution, 290
*iso*Corybulbine, 172, 290
 Corycavamine, 172, 303
 pharmacological action, 305
 Corycavidine, 172, 303
 Corycavine, 172, 303
 pharmacological action, 305
 Corydaldine, 285, 286, 290, 399
 Corydaline, 170, 171, 172, 284, 290
 Corydalis alkaloids, minor, 313
 pharmacological action, 314
 Corydalis and allied genera, alkaloids,
 284
Corydalis spp., 160, 170, 171, 172, 313
 Corydic acid, 285, 286
 Corydillie acid, 285
 Corydine, 172, 173, 308
*iso*Corydine (luteanine), 171, 172, 173, 308
Corynanthe spp., 500
 Corynantheidine, 504, 514
 Corynantheine, 500, 503, 504
 Corynanthic acid, 502, 503
 Corynanthidic acid, 504
 Corynanthidine, 500, 504
 Corynanthine, 502, 503, 505
 Corypalline, 160, 170, 171
 Corypalmine, 170, 171, 172, 291, 342
*iso*Corypalmine, 170, 212, 291, 294
 Corytuberine, 172, 308
Coscinium spp., 329
 Cotarnic acid, 200, 201, 202
 Cotarnine, 187, 201, 202, 203, 206
 pharmacological action, 211
*neo*Cotarnine, 205
 Cotarnone, 202
 Cotaronitrile, 208
 Coumingaine, 726
 Coumingic acid, 729
 Coumingidine, 726, 730
 Coumingine, 726, 729
Courbonia virgata, 372
 Crinamine, 411
Crinum spp., 406
Crossopteryx kotschyana, 756
 Crossoptine, 756
Crotalaria spp., 601
Croton spp.; crotonoside, 773
Cryptocaria spp., 319
 Cryptocavine, 171, 172, 173, 299
 Cryptolepine, 773
Cryptolepis sanguinolenta, 773
 Cryptopalmatine, 293
 Cryptopidene, 296
 Cryptopine, 171, 172, 178, 292, 295
 constitution, 296
 synthesis, 298
 Cryptopine and allied alkaloids, pharmaco-
 logical action, 305
 subgroup, alkaloids, 284, 294
 *α -allo*Cryptopine (*β -homochelidonine*), 169,
 170, 171, 172, 173, 301
 constitution and synthesis, 302
 *β -allo*Cryptopine (*γ -homochelidonine*), 169,
 173, 301, 388.
 Cucullarine, 172
 Cularidine, 172, 313
 Cularine, 170, 172, 212, 313, 314
 Cupreine, 419, 430
 *α -apo*Cupreine; *β -isocupreine*. See
 *apo*Quinine, 452
*apo*Cupreine ethers, bacteriostatic
 potencies, 479
 Curaethaline, 372
 Curare, alkaloids, 371
 pharmacological action, 390
 types, 373
 C-curare I. See Calabash-curare I.
 Curbine, 572
 Curine (*l*-beberine), 363, 367, 368, 374,
 377, 391, 392
 Cuscamidine, 420, 466
 Cuscamine, 420, 466
 Cusco bark, alkaloids, 466
 Cuscohygrine, 66, 67, 93, 103
 Cusconidine, 420, 466
 Cusconine, 419, 466
 Cuspareine, 415
 Cusparia bark, alkaloids, 415
 pharmacological action, 418
 Cusparidine, 415
 Cusparine, 415, 416, 418
Cyclea insularis, 370
 Cygnine, 780
 Cynoctonine, 674, 686
Cynoglossum officinale; cynoglossine, 771
Cyrocarpus spp., 319
 Cytisamic acid, 145
 Cytisine, 49, 116, 140, 141, 142, 151
 distribution in plants, 116
 pharmacological action, 153
 Cytisinolic acid, 143
 Cytisolidines, 143
 Cytisoline, 142
Cytisus spp., 117, 151, 631

Dactylicapnos macrocapnos, 172
Daemia extensa, 780
 Damascenine, 632
 damasceninic acid, 633
Daphnandra spp., 319, 326, 327
 Daphnandrine, 326, 327
 Daphnimacrine; daphniphylline, 780
Daphniphyllum spp., 780
 Daphnoline, 327, 328
Datura spp., 65, 68, 82, 83
 Daturine, 65, 70
 Daucine, 773
Daucus carota, 773
 Dauricine, 350, 353, 362
 Deaminocolchinal methyl ether, 652
 Decevenic acid, 703
Dehaasia spp., 319
 Dehydrocorydaline, 170, 285, 286
 Dehydrolaudanosoline, 189, 389
 Dehydromorphine, 215
 Dehydrosinomenine, 271

- Dehydrosparteines, 136, 138
 Dehydrothalictrifoline, 172, 290
 Delatine, 696
 Delcosine, 695
 Delphamine, 697
 Delpheline, 696
 Delphinine, 697, 775
 pharmacological action, 700
Delphinium spp., alkaloids, 693
 Delphinoidine, 700
 Delphisine, 700
 Delphocurarine, 694
 Delphonine, 693, 697
 Delsoline, 695
 Delsonine; *isodelsonine*, 696
 Deltaline, 697
 Demerol, 265
 Demethoxyemetine, 398, 400
 Demethylcularines, 172, 313
 Demethylechitamine, 719
bis-Demethylsinomenylidene, 270
 De-*N*-methylsparteines, 134
 Demethyltetrandrine, 351, 356
 Dendrobine, 724
Dendrobium spp., 723
 Deoxy-cinchona bases, 443, 444, 446
 Deoxycodines, 236, 238, 252
 dihydro-derivatives, 253
 Deoxylupanine (*dl*-sparteine), 129, 138
 Deoxymorphines and their hydro-
 derivatives, 253, 254
 Deoxystrychnines, 564, 580
 Deoxytetrahydrosinomenine, 269
 Deoxyvasicine, 617
 Deoxyvomices, 587, 588, 589, 590
 Deoxyyohimbine, 514
 Deoxyyohimbol, 505, 514
 Diacetylmorphine, 260
 3 : 6-Diacetylmorphine,
 pharmacological action, 265
 Diacetylyohimbine, 514
Dicentra spp., alkaloids, 172, 299, 313, 314
 Dicentrine, 172, 173, 310, 323
*iso*Dicentrine; *epidicentrine*, 315
Dichapetalum cymosum, 7
Dichroa febrifuga, 724
 Dichroines, α -, β -, γ -, 725
 Dicinchonine, 466
 Dicinchonine, 419, 466
 Diconquinine, 419, 466
Dicranostigma franchetianum, 173
 Dicrotic acid, 603
 Dicrotaline, 601, 603
 Dictamnal; dictamninc acid, 413
 Dictamnine; *isodictamnine*, 413
Dictamnus albus, 413
 α -Didehydrosparteine, 136
 pharmacological action, 152
Diehytra. See *Dicentra*.
 β -Diethylaminoethyl fluorene-9-
 carboxylate hydrochloride, 196
 Dihydroatisine, 687
 Dihydroberberine, 383
 Dihydro- ψ -chelerythrine, 279, 281
 Dihydro-cinchona bases, syntheses, 458
 Dihydrocinchonine, 452
 Dihydrocinchonidine, 429
 Dihydrocinchonine, 428
 Dihydrocinchotoxine, 452
 Dihydrocodeine, 260
 Dihydrocodeinone, 245, 260, 270
 Dihydrocodeinone oxime, reactions, 244
 Dihydrocodelacodeinone, 249
 Dihydrocryptopine and
 isodihydrocryptopine, 296
 Dihydrocupreicine, 452
 Dihydrocupreidine, 431
 Dihydrocupreine, 431
 Dihydrodeoxymorphines, 254, 260-2
 Dihydroecgonidine, 99
 Dihydro- β -erythroidines, 387
 pharmacological action, 391, 392
Dihydronorharman, 498
 Dihydrohemicytisylene, 144
dl-Dihydrolysergic acid, synthesis, 530
 Dihydro- α -matrinidine, 149
 Dihydromorphine, 219, 260, 261
 Dihydromorphinone, 246, 260
 Dihydroniquidines, 453, 461
 Dihydroniquine, 453
 Dihydropapaverines, 185
 Dihydroquinicine, 454
 Dihydroquinidine, 430
*epi*Dihydroquinidine, 427
epi-C³-Dihydroquinidine, 454
 Dihydroquinine, 429
*epi*Dihydroquinine, 426
epi-C³-Dihydroquinine, 444, 454
 Dihydrosanguinarine, 281
 Dihydroscopoline, 86
 Dihydrosinomenine, 268, 269, 270
 Dihydrospherophysines, 631
 Dihydrostrychnidine, exhaustive
 methylation, 577
 Dihydrostrychnoline, 564
 Dihydrothebaceine, 269
 Dihydrothebaine, 243
 Dihydrothebainol, 243
 Dihydrothebainol-6-methyl ether, 243
 Dihydrothebainone- Δ -5 : 6-methyl
 enolate, 243
 Dihydrothebainone, 247, 248, 249
 Dihydrothebainones, 247, 248, 250, 261,
 270
 Dihydrotoxiferine I and
 isodihydrotoxiferine I, 382
*nor*Dihydrotropidine, 74
 Dihydrotropilidene, 77, 78
 Dihydrovomices, exhaustive
 methylation, 593
 Dihydroxydihydrosolanidine, 733
 2 : 9-Dihydroxy-3 : 10-dimethoxy-
 tetrahydrop*protoberberine* See
 Seoulerine.
 α : β -Dihydroxy- γ -(2-methylphenoxy)-
 propane, curarising action, 392
 Dihydroxytropane, 91, 100
 Diketocassenic acid, 728
 2 : 8-Diketonoicidene, 567, 568, 573, 574
 Dilupine, 117, 132

- 2 : 3-Dimethoxy-6 : 4'-dialdehydro-5-dimethylaminoethylidiphenyl ether**, 367
2 : 3-Dimethoxy-6 : 4'-dicarboxy-5-vinyldiphenyl ether, 367, 368
2 : 6'-Dimethoxy-5 : 3'-dicarboxy-4'-vinyldiphenyl ether, 368
 Dimethoxystyrychnine (brucine), 566
O-Dimethylbebeerine, 375
O-Dimethylbebeerine methosalts, 375
6 : 8-Dimethylergoline, 530
N-Dimethylmezcaline, 161
 Dimethylstrychnine, 563
O-Dimethyltubocurarine iodide, 374
 Dinitrostrychninic acid, 565
 Dinitrostrychol, 568
 Dinitrostrycholamide, synthesis, 569
 Dinitrostrycholcarboxylic acid, 565, 568
Dioscorea spp., 91, 92
 Dioscorine, 91
 Dioxydehydroemetine, 401
 Diphylline (stylophine), 173, 293
 Dipterine (*N*-methyltryptamine), 772, 774
2 : 3'-Dipyridyl, 35
 Diquinicine, 466
 Disinomenine and ψ -form, 256, 271, 272, 346
 Disinomenol, 271
 Ditaine. *See* Echitamine.
 Ditamine, 716, 720
 Dithebaione, 255, 256, 346
 Dimetathebaione, 256
1 : 1'-Dithebaol, 272
 Diversine, 268, 273; for another diversine *see* p. 350.
 Domesticine, 312, 315, 329
 isodomesticine, 316, 329
 "domesticine," 316
 Donaxarine, 485
 Donaxine, 484
Doryphora spp., 320
 Doryphorine, 320
 Douradine, 781
 Drug addiction, 260, 262
Duboisia Hopwoodii, 35, 37, 38, 42
Duboisia Leichhardtii, 65
Duboisia myoporoides, 66, 82, 83, 89, 100

EARLEINES, α - and β - (betaine and choline), 772
 Ecboline, 517
 Ecgonines, 93, 96
 constitution, 97
 pharmacological action, 110
 Ecgoninic acid, 98
Echinops Ritro, 413
 Echinopseine; echinopsines, 413
 Echitamidine, 716, 720
 Echitamine, 716, 719, 758
 Echitenine, 716, 720
Echium vulgare, 771
Eclipta alba, 85
Elæagnus spp.; eleagnine, 773
Elæophora abutilifolia, 372
Ekissarrhena grandiflora, 372

 Emetamine, 394, 395, 397
 Emetine, 346, 394, 396, 779
*iso*Emetine, 398-401
 Emetine and allied alkaloids, formulæ, 399, 401
 methylation, 398
 oxidation, 399
 therapeutic uses, 402
 Emetoline (*noremetine*), 398
 Ephedine, 636
Ephedra spp., 634
 Ephedrine, 173, 634, 636, 674
*l-nor*Ephedrine, 638
 ψ -Ephedrine, 173, 635, 638
nor-d- ψ -Ephedrine, 638
 Ephedrines, configuration, 641
 constitution, 639
 pharmacological action, 197, 642
 syntheses, 640
*iso*Ephedrines, 640
Equisetum arvense, 1, 752
Equisetum palustre, 773
Erechtites hieracifolia, 601
Eremosparton aphyllum, 780
 Ergine; *iso*ergine, 526
 Ergobasine. *See* Ergometrine.
 Ergoclavine, 518, 519
 Ergocornine, 518, 524
 pharmacological action, 536
 structure of polypeptide from, 526
 Ergocorninine, 518, 524
 Ergocristine, ergocristinine, 518, 522, 523, 535, 536
 Ergokryptine, ergokryptinine, 518, 523
 Ergoline, 530
 Ergometrine, 517, 524
 isomerides and analogues, 528
 pharmacological action, 534, 536
 Ergometrinine, 517, 524
 Ergomonamine, 517
 Ergonovine. *See* Ergometrine.
 Ergosine; ergosinine, 517, 518, 523
 Ergostetrine. *See* Ergometrine.
 Ergot alkaloids, 517
 characteristics, 519
 constitution, 525
 dihydro-derivatives, 532
 hydrolytic products, 526
 pharmacological action, 533
 relative sympathicolytic activities, 535
 Ergotamine, 517, 522
 pharmacological action, 161, 534
 Ergotaminine, 517, 522
 Ergothioneine, 518
 pharmacological action, 536
 Ergotic acid, 518
 Ergotine, 517
 Ergotinine (ergocristinine), 517, 520, 522, 783
 ψ -Ergotinine, 517, 522
 Ergotism, 536
 Ergotocine. *See* Ergometrine.
 Ergotoxine, 517, 520, 521, 783
 pharmacological action, 534

- Erigeron affinis*, 774
Erodium cicutarium, 780
Erysimum spp., 649
 Erysoline, 650
 " Erysocine," 390
 Eryrodine, 390
 Erysonine, 390
 Erysofine, 390
 Erysothiopine, 390
 Erysothiovine, 390
 Erysovine, 390
Erythraea centaurium; erythricine, 774
 Erythraline, 388
 constitution, 389
 Erythramine, 388
 constitution, 389
 Erythratine, 389
Erythrina spp., alkaloids, 386
 combined bases, 390
 curarising potencies, 388, 390
 liberated bases, 390
 Erythroidines, 387
 curarising potency, 388, 391, 392
 Erythropleic acid, reactions and
 structure, 727
 Erythropleine, 725, 726
 Erythropleine and associated bases
 pharmacological action, 730
Erythroplœum guineense, 725
Erythroplœum spp., 726, 729, 730
Erythroxyton coca, 92
Erythroxyton spp., 92, 93
Eschscholtzia californica, 173
Esenbeckia febrifuga, 780
 Eseramine, 540, 547
 Eserethole, 541
 synthesis, 545
 noreserethole, synthesis, 544
 Eseridine, 540, 547
 Eserine. *See* Physostigmine.
 Eserine blue; " eserine brown," 541
 Etheseroline, 542
 2-Ethoxy-5 : 4'-dicarboxy diphenyl ether,
 353, 355, 357
 O-Ethylarmepavine, 196
 O-Ethylbebeerilene, 369
 Ethylbenzoylecgonine, 96
 Ethylapocinchene, 441
 Ethylcodamine, 195
 Ethylmorphine, 217, 260
 Ethylapoquinine, 473, 748
 Ethilyohimbine, 514
 Eucurarine, 372
Eugenia jambos, 780
Eurycles spp., 406
Evoidia meliifolia, 329
Evoidia rutecarpa, 498
 Evodiamine, 498
 synthesis, 500
 isoEvodiamine, 498
 Eximidine; eximine, 172, 310

Fagara carolinianum, 631
Fagara spp., 414, 415
Fagara xanthoxyloides, 380

 Fagaramide, 2
 β -Fagarine. *See* Skimmianine.
 Fagarines, 414
 Fangchinine, 351
 fangchinoline, 356
 Febrifugines, 725
 Feng-fan-chi, 351
Ferreira spectabilis, 631
Festuca arundinaceæ, 750
Fibraurea chloroleuca, 329
Flindersia australis; flindersine, 774
 Floribundine; floripavidine; floripavine,
 173, 276
 Fluorocurine, 385
 Fly agaric, 658
 Fœnugrec, 7
 Formosanine, 756, 757
Fracinus malacophylla, 780
Fritillaria spp., alkaloids, 732
 pharmacological action, 734
Fritillarine; fritilline; fritimine, 732,
 733, 734
 Fuchsisenecionine, 601
Fumaria officinalis, 173
 Fumarine. *See* Protopine.

Galanthus Woronovi; galantidine;
 galantine, 774
Galega officinalis; galegine, 630
Galipea officinalis, 415, 416
 Galipidine, 415
 Galipine, 415, 416, 418
 constitution, 417
 Galipoidine, 416, 417
 Galipoline, 416, 417, 418
 Gambirine, 756
 Ganiarine, 777
Garrya spp.; garryine, 735
Gastrolobium calycinum, 780
 Geissospermine, 735
Geissospermum spp., 735, 736
 Gelsemicine, 737, 739, 740, 741
 Gelsemidine, 737
 Gelsemine, 49, 736, 737, 740
 apo- and iso-gelsemines, 737
 Gelseminine, 736, 737, 740
Gelsemium spp., alkaloids, 500, 736
 pharmacological action, 740
 Gelsemoidine, 737
 Geneserine, 540, 547
Genista spp., 117
 Genisteine, 117, 138, 139
Gentiana Kirilowi; gentianine, 742
Geoffrea surnamensis; geoffroyine, 681
 Gerinerine, 701, 705, 710
 Germine, 701, 710, 712
 degradation products, 711
 isogermine, 711
Girgensohnia spp., 1, 774
 Girgensoinine, 774
 Glaucentrine, 172, 312
 Glaucidine, 178, 311
 Glaucine, 172, 178, 311, 320
 pharmacological action, 318

- isoGlaucine, 320
Glaucium spp., alkaloids, 173
Gloriosa superba, 650
 Glyoxaline group, 621
 Gnoscopine (*dl*-Narcotine), 178, 205
 β -Gnoscopine, 205
Gonioma kamassi, 781
 Gourd curare, 373
 alkaloids, 380
 Gramine, 484
 Graminifoline, 601
 Granatane, 62, 81
 Granatolines, pharmacological action, 108
 Grandiflorine, 671
 Grantianine, 601, 603
 Grantianinic acid, 603
 Greenheart alkaloids, 363
 Guvacine, 9
 isoguvacine, 10
 guvacoline, 10
Gymnocalyctum gibbosum, 154
- Halostachis caspica*; halostachine, 631
 Hamadine, 67
 Hanadamine, 756, 757
 Han-fang-chi, 350, 351, 362
 hanfanchines, A, B, C, 350
 Hanssen's C₁₀ acid ex brucine or
 strychnine, 567, 575
 Hanssen's C₁₀ acid ex brucine, 566, 575
 Harmaline, 488, 489, 490
 pharmacological action, 496
 syntheses, 494
 Harmalol, 488, 489, 496
 Harman, 486, 490, 507
 pharmacological action of derivatives,
 495, 514
 norHarman (3-carboline), 486, 495, 508
 Harmine, 488, 489, 490, 514, 748, 772
 norHarmine, 490
 apoHarmine, 489, 492, 494, 497
 Harmol, 489
 parasiticial action of ethers, 403
 pharmacological action, 496, 497
 Haslerine, 511
 Hastacine, 601, 603
 hastaneceine; hastaneceinic acid, 603
 Hedyotine; *Hedyotis auricularia*, 774
Heliopsis longipes, 774
 Heliotric acid, 603, 613
 Heliotridane, 606, 608
 synthesis, 609
 ψ -heliotridane, 606
 Heliotridine, 602, 603, 604, 607
 constitution, 608
 Heliotrine, 601, 603
Heliotropium lasiocarpum, 601
 Hellebores, green and white, alkaloids,
 701, 705, 718
Helleborus spp., 774, 775
Helvella esculenta, 775
 Hemipinic acid, 201
*meta*Hemipinic acid, 188
*normeta*Hemipinic acid, 165
- Hemisparteilene, 185
 Hemlock alkaloids, 13
 pharmacological action, 21
 Henbane, alkaloids, 66
 pharmacological action, 106
 Herapathite, 424
Hernidium alipes, 631
Hernandia spp., 319
 Herpestine; *Herpestis monniera*, 776
 Heteratisine, 689
 Hetisine, 689
 Hexahydroanagyryne (*d*-sparteine), 130,
 137
 Hexahydroanagyryline, 141
 Hexahydroxybyrine, 505
 hexahydroxyhimbol, 514
 Hexalupine, 117, 132
 Hieracifoline, 601, 603
 hieracinecic acid, 602
Hippophæ rhamnoides, 773
 Histamine; histidine, 518
 Hodorine, 766
Holarrhena spp., alkaloids, 742
 pharmacological action, 748
 Holarrhenine; holarrhene, 743, 747
 holarrhimine, 742, 743, 747
 Homatropine, 74
 pharmacological action, 109, 110
 ψ -homatropine, 101
 α -Homochelidonine, 169, 277, 278, 283, 295
 β -, γ -Homochelidonines. *See* α -, β -allo-
 cryptopines.
 Homopocinchonine, 440
 "Homocinchonine," 427
 Homophleine, 729
 Homoquinine, 430
 Homotrilobine, 360
 Homotropine, 107
 Hordenine (Anhaline), 154, 155, 161, 633
Hunnemannia fumaricifolia, 173
 hunnemannine, 173, 302
Hydrangea umbellata, 781
 Hydrastal; hydrastic acid, 164, 165
 Hydrastine, 162, 209, 210, 328
 constitution, 163
 formula, 166-7
 pharmacological action, 167, 212
 Hydrastinic acid, 164
 Hydrastinine, 163, 187, 209
 pharmacological action, 161, 167, 211
Hydrastis canadensis, alkaloids, 162, 200,
 328, 386
 Hydrocinchonidine, 429
 Hydrocotarnine, 160, 178, 200, 201, 203
Hydrocotyle asiatica; hydrocotyline, 775
 Hydrocupreidine and ethers of, 431
 Hydrocupreine and ethers of, 431
 Hydroergotinine. *See* Ergotoxine.
 Hydrohydrastinine, 158, 160, 164, 165, 172
 Hydroipecamine, 397
 Hydroquinidine, 419, 430
 Hydroquinine, 419, 429
 Hydrorhombimine, 118, 151
 9-Hydroxycodine, 284, 285
 14-Hydroxycodineone, 241, 246

- 7-Hydroxycodeinone**, 271
Hydroxydihydrocinchonidine, 452
Hydroxydihydrocinchonines, 452
Hydroxydihydroquinidines, 454
Hydroxydihydroapoquinidines, 453
z-Hydroxydihydroquinine, 454
Hydroxydihydroapoquinines, 453
7-Hydroxydihydrothebainol, 271
Hydroxyheliotridane, 603, 604, 606, 607
4-Hydroxyhygric acid, 773
Hydroxylaudanosines, 188
Hydroxylupanine, 117, 131
Hydroxymagnoline, 355
 α -Hydroxy- β -phenylpropionyltropeine, 73
Hygric acid, 42, 101
Hygrines, 67, 93, 101, 102, 103
Hygrinic acid (hygric acid), 42, 101
Hygroline, 102
Hygrophila spinosa, 772
Hyoscine, 64, 65, 66, 83, 84, 86, 89
 pharmacological action, 106, 107, 111
apoHyoscine, 86
dl-norHyoscine, 89
Hyoscyamine, 64, 65, 66, 69, 71, 79, 82,
 83, 84
 constitution, 72
 pharmacological action, 106, 110
norHyoscyamine, 64, 65, 66, 82, 83
 ψ -Hyoscyamine, 66, 83
Hyoscyamus spp., 65, 66, 67, 68
Hypaconine, 681
Hypaconitine, 673, 674, 681
Hypaphorine, 386, 484
Hypecoum spp., 173
Hypoquebrachine, 511
Hypoxonitine, 681
- IBOGA**; **ibogaine**, 768
Ignatius beans, 553
Illigera spp., 319
Imperialine, 732
Indaconitine, 673, 684
Indole alkaloids, 484
Indolizine, 16
Insularine, 362, 370
Integerrimine; **integerrineic acid**, 601,
 603
Inula royleana, 775
Iodotropine, 59
Ionidine, 173
Ipecacuanha, alkaloids, 394
 interrelationships, 397
 therapeutic uses, 402
Ipecamine, 397
Ipomoea sicefolia, 781
Isatidine, 601, 603
 constitution, 612
Isatineic acid, and monolactonic acid,
 608, 613
Isatinecine, 608, 612
Isatropylcocaines, 95, 96
Isopyrines; **isopyroine**, 775
Isopyrum spp., 775
Isotoma longiflora, 775
- JABORANDI alkaloids**, 621
 pharmacological action, 628
Jaborine, 621
 ψ -jaborine, 621, 628
Jacobine, 601, 603
Jacodine, 601, 604
Jaconine, 601, 604
Jambosine, 780
Japaconine, 679, 685
Japaconitine; **japbenzaconine**, 679
Jateorhiza (jatrorrhiza) palmata, 329, 342
 jateorhizine. See **Jatrorrhizine**.
Jatropha gossypifolia, **jatrophine**, 781
Jatrorrhizine (jateorhizine), 329, 342, 345
Javanine, 420, 466
Jequirity seeds, 484
Jervine, 701, 705, 711
isoJervine, 705, 706, 707
Jervinals, 706
Jesaconitine, 674, 679
Jesanisaconine, 679
Julocroton montevidiensis, 781
- "Kai-ho-chien," 775
Ketodihydromethylmorphimethine, 235
**1-Keto-6 : 7-dimethoxy-2-methyl-
 tetrahydroisoquinoline**, 354
Ketohydroxycassanic acid, 728, 729, 730
Ketohydroxycassenic acid. See **Cassaic
 acid**, 728
**1-Keto-6-methoxy-7-ethoxy-2-
 methyltetrahydroisoquinoline**, 355
Ketoyobyrine, 504, 506, 508
Kobusine, 674, 680
Kokusagine; **kokusaginine**;
 kokusaginoline, 759
Koumine, 739
Kouminicine, 740
Kouminidine, 740
Kouminine, 739
Kounidine, 740
Krameria triandra, 631
Kukoline, 350, 362
 "Kurchenine," 742, 746
 "Kurchi bismuth iodide," 748
Kurchicine, 742, 743, 747, 748
Kurchine, 742, 743, 744, 745
- LANTHOPINE**, 178, 259
Lappaconine, 686
Lappaconitine, 674, 686
Lasiocarpine, 601, 604
Lathreine, 47
Laudaline, 187
Laudanine, 178, 191, 195, 220
 pharmacological action, 197, 198
 synthetic isomerides, 194
isoLaudanine; ψ -**laudanine**, 194
Laudanidine (l-*laudanine*), 178, 193
Laudanosene, 187
Laudanosine, 178, 187, 194, 195
 pharmacological action, 197, 198
 syntheses, 188

- Laudanosoline, 189
dl-homolaudanosoline, 191
 Laudanosolines, alkylated, 191
Lauraceae, alkaloids, 317, 319
 Laurales, alkaloids, 319
Laurelia spp., 319, 322
 Laureline, 319, 322
 constitution, 323
 Laurepukine, 323, 324
 Laurtetanine, 320, 323, 327
*nor*Lelobanidine, 23, 29
 Lelobanidines, 23, 28, 29, 30, 31, 32
 Lelobanines, 29, 30, 32
*nor*Lelobanines, 29, 30
 Lelobine group, 23, 28, 29
 Leontamine, 776
Leontice Eversmannii, 776
 Leontidine, 776
Leonurus biennis, 781
Leptactina senegambica; leptactine, 776
 Leptocladine, 772
 Lettocine, 743, 748
Leucaena glauca, 2, 4
 Leucanine, 3
 Leucenol (leucanine), 2, 4
Litsea spp., 319, 320, 321, 326
 Lobelan, 34
 Lobelanidine, 23, 25, 27
*nor*Lobelanidine, 23, 25, 28
 Lobelanine, 23, 24, 25, 26, 27
*nor*Lobelanine, 23, 27
 Lobelia alkaloids, 22
 pharmacological action, 33
 synthetic substitutes, 34
Lobelia spp., 22, 23, 33, 34
l-Lobeline, 23, 27, 49, 775
 Lobeline group, 23, 24, 33
 Lobinaline, 33, 34
 Lobinanidines, 23, 31, 32, 33
 Lobinanine, 31, 32
*iso*Lobinanine, 31
 Lobine, 781
 Lobinine, 23, 30, 31, 32
*iso*Lobinine, 23, 30, 31, 32, 34
 Lobinine group, 23, 28, 30, 31
 Lodal, 211
 Lohitam, 47
 Loiponic acid, 439
Lolium spp., 750
Lolium perenne, alkaloids, 749
 Longilobine, 601, 604
 Longineic acid, 604
Lophantera lacteans; lophanterine, 776
 Lophophorine, 154, 155, 156, 160, 161
 constitution, 158
 "Loturine," 490
 Loxopterygine, 782
 Luciculine, 690
 Lucidusculine, 673, 690
 Lumicolchicine, 651
 Lunacridine; lunacrine; lunamaridine;
 lunamarine, 751, 752
Lunasia costulata, alkaloids, 751
 Lunasine, 751
 Lupanines, 117, 128, 136, 137, 142, 148,
 152
 constitution, 129
 formulae, 131
 isolupanine, 129, 136, 138
 Lupin seeds, poisonous properties, 119, 151
 Lupinane group, 116
 pharmacological action, 152
 Lupinanes, 121, 123, 124, 126, 136, 148
*nor*Lupinanes, 124, 125, 126, 148
 synonyms, 124
 Lupinidine. *See* Sparteine.
 Lupinine, 35, 117, 120, 147
 allolupinine, 123, 127
 epilupinine, 126
 isolupinine, 123, 126
 Lupinic acid, 120
 α -*nor*Lupinone, 126
Lupinus luteus, 117, 119
Lupinus spp., 117, 118
 Luteanine (*iso*Corydine), 171, 173, 308
 Lysaconitine, 673, 686, 687, 696
 Lycoctonic acid, 686
 Lycoctonine, 686, 687, 694, 695
 Lycopodine, 752, 753, 755
 Lycopodium alkaloids, series L1 to L33,
 754, 755
Lycopodium spp., alkaloids, 752
 pharmacological action, 755
 Lycoramine, 406, 408
 Lycorenine, 406, 409
 Lycorine, 389, 406
 pharmacological action, 410
*homo*Lycorine, 406, 411
 ψ -Lycorine, 406, 411
 ψ -*homo*Lycorine, 408
 Lysergic acids, 527
 formulae, 528
 hydrazides, 527
 urethanes, 532
d-Lysergic-(+)- β -butanolamide,
 pharmacological action, 534
 MACLEYINE. *See* Protopine.
Macoubea guyanensis; macoubeine, 372
 Macralstonidine; macralstonine, 716, 719
 "Madagascar," 726
 Magnolamine; magnolaminic acid, 355
Magnolia fuscata, 349, 350, 354, 355
 Magnoline, 350, 354, 355
Mahonia spp., 329, 345
 "Ma-Huang," 634
 Mandelyltropeine, 74
 Mandelyl- ψ -tropeine, 101
Mandragora spp., 66, 82, 83
 mandragorine, 66, 83
 Margosa; margosine, 781
 Matridine, 148
 Matriline, 118, 138, 147, 149
 Matric acid, 147, 148
 Matrinidines, 148
Maytenus spp., 781
 Meconidine, 178, 221, 259
 Meconin, 200, 206

- Melia azadirachta*, 781
Menisarine, 350, 360, 361
normenisarine, 350, 361
Menisidine, 350, 362
Menisine, 350, 356, 362
Menispermaceae, alkaloids, 329, 349, 350, 351, 371
 pharmacological action, 361
Menispermine, 349
Meratia praecox, 486
Meroquinine (meroquinene), 437, 438, 440, 443
Meroquininenitrile, 442
Mesaconine, 680
Mesaconitine, 673, 674, 680
Mesaconitone, 681
 "Mescal buttons," pharmacological action of alkaloids, 161
Mesembrianthemum spp.; mesembrine, 776
Metaphanine, 361
Meteloidine, 64, 83
Methoxychelidonine, 169, 282
2-Methoxy-5 : 4'-dialdehyddiphenyl ether, 353, 357, 359, 361
 corresponding acid, 354, 357, 360
3-Methoxy-4 : 6-dihydroxyphenanthrene ex codeinone, 226
6-Methoxyepidine, 440
2-Methoxy-2' : 3'-methylenedioxy-5 : 6'-dimethyl-4 : 5'-diethyldiphenyl ether, 357, 358
3-Methoxyppyridine, 1
Methylacylegonines, 93
6-Methyl-8-amino-ergolen and -isoergolen, 531
6-Methyl-8-aminoergolines, 532
N-Methylanabasine, 35, 45, 53
l-N-Methylanatabine, 35
N-Methylanhalamine, 154
O-Methylanhalamine, 154
O-Methyl-d-anhalonidine, 154, 155
N-Methylanonaine, 315
O-Methylbebeerilene, oxidation products, 368
Methylbenzoylaconine, 675
Methylbenzylegonine (cocaine), 93
Methylbenzoyl- α -oxodelphonine, 698
Methylapocinchenine, 441
Methylcinchonine, 442
Methylcocaine, 96
O-Methylisochondrodendrine, 350
N-Methylcoclaurine, 348, 353
N-Methylconiines, 17
N-Methylectisamides, 141, 145
N-Methylcytisine, 117, 144, 145, 146
 pharmacological action, 153
 α -Methyldihydroberberine, 333
Methyldihydrooxymorphine, 260
Methyldihydromorphinone, 246, 262
Methyldihydrothebaines, reactions, 238
 α -Methyldihydrotropidine, 78
7 : 7'-Methylenebisdihydrocodeinone, 272
N-Methylephedrine; *d-N-methyl- ψ -ephedrine*, 689
N-Methylgranatoline, 59
N-Methylgranatonine, 58
Methylharmine, 492, 757
Methylhemisparteilene, 135
N-Methyllaurotetanine, 821
Methyllycaconitine, 696
Methyl *N*-methylmatrine, 147
N-Methylmezcaline, 154, 155
Methylmorphol, 223
Methylmorphimethines, 218, 219, 223, 225, 237, 240
Methylmorphol, 223
N-Methylmyosmine, 40
Methylnormarcotine, 200
N-Methylnicotone, 42
N-Methylnorpapaverinium phenolbetaine, 194, 195
Methylpelletierine, 55, 56
Methylisopelletierine, 55, 57
N-Methylphenylethylamine, 772
N-Methylpiperidine, 1, 774
Methylporphyroxine, 220
O-Methylpsychotrine, 394, 395, 397, 400
1-Methylpyrrolidine; **1-methylpyrroline**, 67
Methylstrychnine, 562
 β -Methyltetrahydrocoptisine, 345
 α -Methyltetrahydropalmatine, 287
Methylthebaol, 225
1-Methyltropacocaine, 81
 α -Methyltropidine, 77, 78
1-Methyltropinone, 81
N-Methyltyrosine, 631
Mezcaline (mescaline), 154, 156, 160, 161
Micranthine, 326, 327, 328
Mikanoidine, 601
Mimosa pudica, 4
Mimosine, 3, 4
 Miotic action by physostigmine and its substitutes, 549
 "miotine," 550
Mitragyna spp., alkaloids, 756
Mitragynine, 756, 757
 pharmacological action, 758
Mitraphylline; **mitraspecine**; **mitraversine**, 756, 757
Mitrinermine, 756
Mo-fang-chi, 351
Momordica charantia; **momordicine**, 781
Monimiaceae, 317, 319
Monniera cuneifolia, 776
Monocrotalic acid, 604, 612
Monocrotaline, 601, 604
 constitution, 610, 612
 monocrotic acid, 604, 612
Monolupine, 117, 132
Monspessulanine, 117, 146
Moringa pterygosperma; **moringinine**, 685
Morphenol, 224, 226
Morphine, 213, 219, 227
 constitution, 222
 estimation, 176
 formule; 284
 isomerides, 217, 219, 224, 336, 335, 336
 manufacture, 179

- Morphine, **pharmacological action**, 196, 198, 259
 substitutes, 268
*apo*Morphine, 214, 217, 222, 224, 231, 232
 constitution, 227
 pharmacological action, 265
 synthesis of dimethyl ether, 228
*neo*Morphine, 219
 pharmacological action, 265
*pseudo*Morphine, 215, 346
 constitution, 255
 ψ -Morphines, α -, β -, γ -, 215
 constitution, 255
 Morphine alkaloids, bimolecular types, 255
 Morphine sub-group, alkaloids, 213
 constitution, 222
 ketones, 245
 pharmacological action, 259
 Morphol, 224, 226
 Morphothebaine, 222, 227, 230, 232
 pharmacological action, 266
 Morphothebaine dimethyl ether, 231, 273
 Moschatine, 779
Mucuna pruriens; mucunadine;
 mucunine, 776
 Mu-fang-chi; mufangchine, 351
 Muricine; muricinine, 317, 319
 Muscarine, 658
pseudomuscarines, 658, 660
 Mydriatic alkaloids, 64
 synthetic substitutes, 109
 Myoctonine, 673, 686, 687
 Myosmine, 47, 50
- NANDAZURINE, 329
Nandina domestica, 315, 329, 343
 Nandinine, 329, 343
 Nantenine, 316, 329
 Napelline, 674, 678
 α -Naphthaphenanthridine alkaloids, 277
 pharmacological action, 233
 Narceine, 178, 205, 206, 207, 208
 pharmacological action, 211
*homo*Narceine, 207
nor-Narceine, 208, 209
 ψ -Narceine, 207
Narcipoetine, 406
 Narcissine, 406
Narcissus spp., 406
 Narcotine, 177, 198, 200, 206
 pharmacological action, 211
 stereoisomeric forms, 178, 205, 206, 208
 synthesis, 205
*iso*Narcotine, 204
*nor*Narcotine and methyl ethers, 200
 Narcotines, α - and β -, 205, 206
 Narcotoline, 178, 206
 pharmacological action, 211
 Necic acids, 602
 constitution, 612
 Necines, 602, 607
 constitution, 608
Nectandra spp., 819, 868
- Neoline, 674, 678
 Neonicotine, 43
 Neopelline, 673, 674, 678
 Neopine (β -codeine), 178, 218, 251
 pharmacological action, 265
 Neostigmine, 550
 Neprotine, 329, 341
 Nicoteine, 43
*iso*Nicoteine, 35, 46
 Nicotelline, 35, 46
Nicotiana spp., 35, 43, 47, 48
 alkaloids of, 35
 biological work on, 47
 Nicotimine, 35, 43, 45
 Nicotine, 35, 36, 752, 753, 777
 constitution, 38
 isomerides, 43
 monomethiodides, 40, 42
 pharmacological action, 49, 153
 syntheses, 40
 α -Nicotine, 43
*meta*Nicotine (*isonicotine*), 39
*nor*Nicotine, 35, 37, 41, 47
 constitution, 38
 isomerides, 42, 43
 Nicotinic acid, 7
 Nicotoine, 35, 46
 Nicotyrine, 35, 40
 constitution, 38
 isomerides, 43
 synthesis, 40
*nor*Nicotyrine, 41
Nigella spp., alkaloid, 632
 Niquidine, 449, 451, 453, 461, 471
*iso*Niquidine, 449, 453
 Niquine, 453, 471
 Nishindine, 778
 Nonalupine, 118, 132
 Nucidine; nucine, 567
 Nux-vomica seeds, 553
Nymphaeaceae, alkaloids, 758
 Nymphæine, 758
 Nupharidines, 758, 759
- OBELINE, 47
 Obscurine, 752, 753, 754, 755
 Ochotensimine, 171, 314
 Ochotensine, 171, 172, 314
 Ochrobirine, 171, 301
Ochrosia elliptica, 781
 Octadehydromatrine, 149
*cyclo*Octadiene, 60
 Octahydropyridocoline, 137
 Octahydropyrrocoline, 16
 Octahydrostrychnidine, 581
 Octalupine, 118, 132
*cyclo*Octatetræne, 61
*cyclo*Octatriene, 60
 Ophiocarpine, 171, 338
 Opianic acid, 200, 201
 Opium alkaloids, 175
 pharmacological action, 259
 Opium, estimation of morphine and other
 alkaloids, 176, 177
 sources and production, 175

- Oripavine, 173, 276
Orixa japonica, 414
 alkaloids of, 759
 Orixine, 759
Ormosia dasycarpa; ormosine;
 ormosinine, 776
Orthosiphon stamineus, 781
 Oscine (scopoline), 84, 86, 87, 88, 89
 norOscine, 89
Ostryderis chevalieri, 781
 Othonecine, 604
 Othofenine, 601, 604
Ouroparia spp., alkaloids, 756
N-Oxalylanthranilic acid ex strychnine,
 569
 Oximinoquinicine, 442
 Oxoaconitine, 677
 Oxoisoatisine, 688
 Oxodelphinines, 697, 698, 699
 Oxonine, 677
 Oxonitine, 676, 680
 Oxyacanthine, 329, 346, 353, 362
 constitution, 347
 methyl ether, 356, 357
 pharmacological action, 349
 Oxyberberine, 329, 332, 333
*iso*Oxyberberine, 333
 Oxychelidonine, 169, 282
 Oxydehydrocorydaline, 288
 Oxydimorphine. *See* ψ -Morphine.
 Oxyhydrastinine, 164, 165, 332
 norOxyhydrastinine, 332
Oxylobium parviflorum, 781
 Oxymatrine, 118, 150
 Oxynarcotine, 178, 209
 Oxyanguinarine, 173, 282
 Oxysparteine, 54, 136, 138, 142
- PACHYCARPINE (*d*-sparteine), 118
Pachycereus marginatus, 161
 Paipunine, 767
Palicourea rigida, 781
 Palmatine, 328, 329, 342, 345
 Palmatine and associated alkaloids,
 constitution, 342
 Palmatine-acetone, 288
 Palmatisine, 674
 Palustrine, 773
 Paniculatine ex *Aconitum paniculatum*,
 674
 Paniculatine ex *Celastrus paniculata*, 780
 Paniculatine ex *Pausinystalia paniculata*,
 501, 502
Papaver somniferum, (opium poppy),
 alkaloids, 175
Papaver spp., alkaloids, 173, 196, 232, 274
 Papaveraceous alkaloids,
 α -naphthaphenanthridine sub-group, 277
 Papaveraldine, 178, 182
 Papaveramine, 178, 259
 Papaverine, 161, 177, 178, 182, 195, 259
 pharmacological action, 196, 198, 211,
 259
 special reactions, 186
 syntheses, 184
- proto*Papaverine, 195
 ψ -Papaverine (papaverine), 178, 187
 Papaverinic acid, 183
 Papaverinol, 183, 188
 Papilionaceæ, alkaloids, 116
 Paraberine, 336
 Paraisine, 781
 Paramenispermine, 349
 Paramorphine. *See* Thebaine.
 "Pareira brava," alkaloids, 368, 364,
 377
 Paricine, 419, 466
 Paucine, 776
Pausinystalia spp., 500, 501
 Payta bark; paytamine; paytine, 513
 Pectenine, 159
 Peganine. *See* Vasicine.
Peganum Harmala, alkaloids, 488, 617
 Peimidine, 733
 Peimine, 732, 734
 Peiminine, 732, 733
 Peimiphine, 733
 Peimisine, 733
 Peimitidine, 733
 "Pei-mu," 732
 Peimunine, 732, 734
 Pelletierine, 55
 constitution, 56
 Pelletierine and associated bases,
 pharmacological action, 62, 108
*iso*Pelletierine, 55, 57, 58
*pseudo*Pelletierine, 55, 58
 constitution, 59
 synthesis, 61
 Pellitorine, 2
 Pellote. *See* Mescal buttons.
 Pellotine, 154, 155, 156
 constitution, 157
 pharmacological action, 161
 Pelosine. *See* Bebeerine.
Pentaclethra macrophylla, 776
 Pentalupine, 118, 132
 Pepper. *See* Piper spp.
 Pereirine; pereiro bark, 735, 736
 Periloidine, 749, 750
 Perloline, 749, 751
Persea gratissima, 320, 781
 Pethidine, 265
Petrocapnos spp., alkaloids, 173
Petrosimonia monandra, 1
Pheanthus ebracteolatus, 350
 Pheanthine, 350, 356
Phellodendron amurense, 329
 Phenanthridine group, alkaloids, 406
 Phenylalkylamines, 631
 Phenyldehydrosparteine, pharmacological
 action, 152
 Phenyl-dihydrothebaines, 238
 Phenylglycollytropheine, 74
Phoradendron spp., 631
 Phthalidisoquinoline alkaloids, 162, 173,
 200, 209
 pharmacological action, 211
Physalis mollis, 782
Physostigma venenosum, alkaloids, 589

- Physostigmine**, 262, **540**
 pharmacological action, 548
 synthetic work, 541-7
isoPhysostigmine, 540, **547**
Physostigmol; **physostigmol ethyl ether**,
 541
Physovenine, 540, **548**
Picraconitine, 675
Picralima klaineana, alkaloids, 759
Picrasma crenata, 782
Picrorocelline, 777
 "Picrosclerotine," 517
Pillijanine, 753, **754**, 755
Pilocarpidine, 621, **626**
 isopilocarpidine, 626, 627
 syntheses, 625
Pilocarpine; *isopilocarpine*, 621, **622**
 syntheses, 625
 β -**Pilocarpine**, 621
neoPilocarpine, 627
 ψ -**Pilocarpine**, 621, **628**
Pilocarpine and associates,
 pharmacological action, 628
Pilocarpus spp., alkaloids, 621
Pilocereine; *Pilocereus sargentianus*, 154
Pilolic acid, 622; *isopilopic acid*, 625
homoPilopic acid; *homoisopilopic acid*,
 622, 624, 626
Pilosine, 621, **627**
 pilosinine, 627
 synthesis, 628
Piper spp., 1, 2
 piperidine, 1
 piperine, 1
 piperovatine, 2
Piptanthus nepalensis, 118
Piscidia erythrina, 782
Pithecolobine; *Pithecolobium Saman*, 777
 "Piule," 781
Platynecic acid (senecic acid lactone), 605,
 613
Platynecine, 602, 605, **607**
 constitution, 609
Platyphylline, 602, **604**, 613
 pharmacological action, 614
Pneumus Boldus (Boldea fragrans), 319, 325
Podalyria spp., 118
Polyporus frondosa, 782
Pomegranate root bark, alkaloids, 55
Pontaconitine, 674
Poroidine; *isoporoidine*, 64, 66, **90**
Porphyryne; *porphyrosine*, 716
Porphyroxine, 178, **220**
Pot curare, 373
 alkaloids, 378
Premna integrifolia; *premnine*, 777
Prostigmine, 262, **550**
Protocurarine, 378, **391**
Protoeuridine; *neoprotocuridine*, 378, 392
Protocurine, 378
Protopine, 169, 170, 171, 172, 173, 178,
 208, **299**
 constitution and synthesis, 300
 pharmacological action, 305
Protoveratridine, 701, **705**, **710**
Protoveratrine, 701, 705, **709**
Protoverine; *isoprotoverine*, 709
Pseudaconine, 682, 684, 685
Pseudaconitine, 673, **682**, 684
 α -**Pseudaconitine**, 684
 "*Pseudo ademno calima elegans*," 782
Pseudocinchona africana, 500, 503, 504
Pseudocinchona pachyceras, 504
Pseudojervine, 701, **707**
Psilocaulon absimile, 1
Psychotrine, 394, **396**
Pterophine, 602, **605**
Pterophneic lactone, 605
Pubescine, 778
Pukateine, 322, 323, 327
 constitution, 323
 methyl ether, 319, 322, 323
Punarnavine, 772
Pungent principles of plants, 2
Punica Granatum, alkaloids, 55
 pharmacological action, 62
Purapurine, 666
Putrescine, 67, 518
Pycnarrhena manillensis, 777
Pyraconine; *pyraconitine*, 675
Pyridine, ex belladonna, 67
Pyridine group alkaloids, 1
Pyridole, 21, 492
Pyrobikhaconitine, 685
Pyrodelphinine, 698
Pyrohyapaconitine, 681
Pyroindaconitines, 685
Pyrojapaconitine, 679
Pyrojesaconitine, 679
Pyromesaconitine, 680
Pyro- α -oxodelphinine, 698
isoPyrooxodelphinine, 698
Pyropseudaconitine, 682
Pyroxonine, 677, 680
Pyroxonitine, 677
Pyrrolidine, 773
Pyrrolidine group alkaloids, 599
Pyrrolizidine group alkaloids, 601

QUEBRACHAMINE, 511, **512**
Quebrachia Lorentzii, 511, 782
Quebrachine (yohimbine), 500, **501**, 511,
 513
Quebracho alkaloids, 500, 511
Quinamicine, 465
Quinamine, 419, **463**
apoQuinamine, 465
Quinazoline group alkaloids, 617
Quinenine (quinene), 438, 439, 440
apoQuinenine, 440
Quinetum, 420
Quinicine (quinotoxine), 419, **425**, 442, 448
Quinidine, 419, **424**
 configuration, 448
 constitution, 435
 isomerides, 453-4
 pharmacological action, 479
 transformation products 448
epiQuinidine, 419, 426

- Quinidinechloride**, 439
*apo*Quinidines, 452
 methyl ethers. *See iso*Quinidines.
*iso*Quinidines, 453, 454
Quinidinone, 437
Quininal, 436
Quinine, 419, 421, 748, 776, 780, 781
 configuration, 443
 constitution, 435
 detection, 424
 isomerides, 453-4
 pharmacological action, 478
 salts, 422-3
 synthesis, 461
 synthetic replacements, 474, 476
 transformation products, 448
Quinine and other cinchona bases; relative
 anti-malarial efficiencies, 471
 effect of structural change on anti-
 malarial efficiency, 472
Quininechloride, 439
 ethochloride, curariform action, 392
 479
*epi*Quinine, 419, 426
h-Quinine, 419, 449, 454
*apo*Quinines, 452
*iso*Quinines, 444, 453
Quininic acid, 437, 438, 454
Quininone, 437, 438, 442
 "Quinoidine," 426
Quinoline, alkylquinolines, occurrence in
 Cusparia bark, 416
Quinoline group alkaloids, 413
*iso*Quinoline group alkaloids, 154
Quinolyphenetoleldicarboxylic acid *ex*
 cinchonine, 441
Quinolylpiperidylcarbinols, syntheses, 460
Quinolylquinuclidine alkaloids, 418
Quinotoxine, 425. *See also* Quinicine.
*β-iso*Quinotoxine, 444, 454
Quinovatine, 466. *See also* Aricine.
Quinuclidine, 436, 443
 and derivatives, syntheses, 455
Quirandine, 511
Quisqualis indica, 782
Quitenidine, 437
Quitenine, 436
- RADDEANINE**, 732, 734
Ramondia pyrenaica, 782
Ranunculaceæ, 328
Rauwolfia spp., alkaloids, 761
 pharmacological action, 764
Rauwolfine, 761, 762, 763, 765
Rauwolscine, 761, 763, 765
Remijia Purdieana, alkaloids, 465
Remijia spp., 418, 424
Repandine; *repanduline*, 327
Retama sphaerocarpa, 118
Retamine, 117, 139
Retronecanol, 605, 606, 607, 609
*iso*Retronecanol, 607, 609
Retronecic acid, 605
Retronecine, 602-6, 607
 constitution, 609
- Retrorsine**, 602, 605
Rhatanine, 631
Rhœadales, alkaloids, 169, 209
Rhœadine, 173, 178, 275
Rhœagenine, 275
Rhombifoline; *rhombinine*, 118, 151
Rhyncophyllic acid, 757
Rhyncophylline; *isorhyncophylline*, 756,
 757
 pharmacological action, 758
Ricinidine, 6
Ricine, 5
Ricininic acid, 5
Ricinus communis, 5
Riddelic acid, 605
Riddelline, 602, 605
Rocella fuciformis, 777
Rœmeria refracta, alkaloids, 173
Rœmerine, 173, 312, 314, 317, 318
Rosmarinecine, 605
 constitution, 612
Rosmarinine, 602, 605, 613
Rotundifolic acid, 757
Rotundifoline, 756, 757
Royline, 775
Rubijervine, 701, 705, 707, 712, 713
 dehydrogenation products, 708
 isomerides, 708
 possible nuclear structure, 712
*iso*Rubijervine, 701, 708, 712
 dehydrogenation products, 709
 isomerides, 709
 possible nuclear structure, 712
Rubijervone; *isorubijervone*, 708
Rubradinine, 756
Rubremetine, 399, 400, 401
Rubreserine, 541
Rutaceæ, 329
Rutæcarpine, 498
 syntheses, 499
Ryania spp., 782
- SABADILLA** seeds, 700, 701, 702, 714
 alkaloids, 702
Sabadilline (*cevadilline*); *sabadine*; *sabadinine* (*cevine*), 701, 705. *See also*
 Cevine, 702
Salsamine, 160
Salsola Richteri, alkaloids, 159
Salsolidine, 159, 160
Salsoline, 158, 159, 161
Sanguinaria canadensis, alkaloids, 173
 277, 283
Sanguinarine, 169, 173, 277, 278, 279,
 280
Sankhpuspine, 773
Sansevieria zeylanica, 782
Sarcocapnos spp., 173
Sarcocephalus Didderschii, 782
Sarothamnine, 117, 138
Sarracenia purpurea, 777
Sarsapogenin, conversion to a
 dihydrosolanidine, 666
Sassy bark, 725

- Sauroxine ; saururine, 753, 754
Saussurea Cappa ; saussurine, 782
 Sceleranecic acid, 605
 Sceleratine, 602, 605
Schænocaulon officinale, 700
 Scopine, 64, 66, 88, 107
 ψ -scopine, 89
 nor- ψ -scopine, 89
 Scopolamine, *see* Hyoscyne ;
 *nor*scopolamine, *see nor*Hyoscyne.
Scopolia spp., 66, 68, 82, 85
 Scopolic acid, 86
 Scopoligenine, 86
 Scopoline, *see* Oscine ; *nor*Scopoline, *see*
 *nor*Oscine.
 Scopolinic acid, 33
 Scoulerine, 170, 171, 172, 173, 290, 291
 Secaleminosulphonic acid, 518
 Secaline, 517
 Sedamine, 777
Sedum acre, 35, 777
 Sekisanine ; sekisanoline, 406, 411
 Sempervirine, 500, 737, 738, 740
 Senecic acid, 605, 606, 613
 Senecic acid lactone, 605, 613
 Senecifolic acid, 606
 Senecifolidine, 602, 606
 Senecifoline, 602, 606
 Senecifolinine, 603, 606
 Senecio alkaloids, 601
 toxicology, 614
 Seneciocic acid, 613
 Senecionine, 602, 606
 Seneciphyllic acid, 605, 606
 Seneciphylline, 602, 606
 Sensibamine, 518, 519
 Sepeerine, 363
 Septentrionaline, 674, 686
 Serpentine ; serpentinine, 762, 763
Sesbania tripeti, 118
Setaria lutescens, 750
 Shobakunine, 329, 340
Sida rhombifolia, 635
 Silvasenecine, 602
 Sinactine (*l*-tetrahydroepiberberine), 173,
 268, 272, 329, 338, 339
 Sinalbine ; sinapic acid ; sinapine, 648
 Sinomenine, 268, 273, 351
 hydrate, 270
 Sinomenol, 270
Sinomenium acutum, alkaloids, 268, 329,
 349, 350, 351
 pharmacological action, 273
 Skatole, 738
Skimmia spp., 413, 414
 Skimmianal, 414
 Skimmianic acid, 414
 Skimmianine, 414, 752, 778
*iso*Skimmianine, 414
 Sigmine, 782
 Sinine, 780
Sinostemonine, 787
Smilax pseudo-china, 782
 Socratines, α -, β -, γ -, 47
 Solaceine, 671 ;
 Solanaceous alkaloids, 64
 analytical methods, 69
 distribution in plants, 65-7
 pharmacological action, 105
Solandra spp., 66, 82
 Solandrine, 82
 Solaneine, 662
 Solangustidine ; solangustine, 671
 Solanidine, 661, 662, 671, 708, 712, 713
 dehydrogenation products, 663
 heterocyclic residue, 665
 proximate derivatives, 664
 structure, 665, 667
 Solanine, 661
 Solanine-s. *See* Solasonine.
 "Solanines," pharmacological action, 671
 Solanocapsidine, 671
 Solanocapsine, 670
Solanum nigrum, 48
Solanum spp., 661, 666, 669, 670, 671
 Solasodine, 666, 713
 Solasonine, 666, 669
 Solauricidine, 669
 Solauricine, 668
 Sophocarpidine. *See* Matrine.
 Sophocarpine, 116, 118, 148, 150, 152
 Sophochryesine, 118, 150
Sophora spp., alkaloids, 118, 138, 150
 pharmacological action, 152
 Sophoramine, 118, 150
 Sophoridine, 118, 150, 152
 Sophorine (cytisine), 142
 Sparteilene, 135
 Sparteine, 49, 54, 116, 117, 118, 130, 133,
 138, 142, 148, 169, 674
 pharmacological action, 152
d-Sparteine (pachycarpine), 138, 142
 ψ -Sparteine, 138
*iso*Sparteines, 134, 136, 152
 Spartioidine, 602
Spartium junceum, 118
 Spartyrine, 136
 Spathulatine, 118, 132
 Sphæranthine ; *Sphæranthus indicus*, 777
Sphærophysa salsula ; sphærophysine
 (spherophysine), 630
Spigelia marylandica ; spigeline, 782
 Spilanthol, 2
 Sprintillamine, 774
 Sprintilline, 775
 Squalidine, 602, 606
 Squalineic acid, 606
l-Stachydrine, 42, 773
Stachys spp., 7
 Staphisagroine, 700
 Staphisine, 699
Stemonaceæ spp., alkaloids, 765
 Stemonidine, 765, 766
*iso*Stemonidine, 765
 Stemonine ex *Stemona ovata*, 765
 ex *S. tuberosa*, 766
Stephania cepharantha, 346, 350
Stephania spp., alkaloids, 350, 351, 361,
 362
 Stephanine, 361

- epi*Stephanine, 228, 361, 362
*ψ-epi*Stephanine, 281, 361
*proto*Stephanine, 361
 Stephanoline; *homostephanoline*, 361
 Steroidal alkaloids, 661
 Stramonium, 48
 alkaloids of, 65
Strophanthus spp., 7
 Struxine, 553, 560
 Strychnine, 553, 560
 Strychnidine, 563, 564, 567, 576, 597
*neo*Strychnidine, 575, 576, 583, 597
 Strychnidone, 583
 Strychnine, 488, 553, 554, 589
 alkaline degradation, 581
 constitution, 561
 degradation products, synthetic
 experiments, 581
 des-bases derived from, 577
 development of formulæ, 573
 discussion on formulæ, 582
 detection, estimation and isolation,
 554, 556
 oxidation products, 565, 570
 reduction products, 563, 584
*iso*Strychnine, 562, 580
 reduction products, 563
*neo*Strychnine, 575, 576, 583, 584
*pseudo*Strychnine (*ψ*-strychnine), 553, 557,
 582, 583
 Strychninic acids, 561
 Strychninolic acid, 570
 Strychninolone, 570
 Strychninonic acid, 570
 Strychnoethaline, 372
 Strychnoline, 564
 Strychnone; *ψ*-strychnone, 559, 584
Strychnos Henningsii alkaloids, 553
Strychnos spp., 371, 372, 373, 553
 alkaloids, 553
 pharmacological action, 596
Strychnos toxifera bark, alkaloids, 380, 382
Strychnos vacacoua alkaloids, 554
Stylophorum diphyllum, alkaloids, 173
 Stylopine (*l*-tetrahydrocoptisine), 170, 171,
 172, 173, 293
 Suaveoline, 317, 319
 Suisenine, 406, 411
 Surinamine, 631
 Sympatholytic drugs, 514, 515, 535
Symplocos racemosa, 490
Syndesmon thalictroides, 777

Tabernaemontana spp., 501, 735
 Tabernaemontanine, 501
Tabernanthe Iboga, alkaloids;
 tabernanthine, 768
 Talatisamine; talatisidine;
 isotalatisidine, 674, 690
 Talatisine, 674, 689
Talauma mexicana; talaumine, 782
 "Tarconines," 206
 Taxine, 769
 pharmacological action, 770

Taxus baccata, 635, 769
 Tazettine, 389, 406, 410
 "Telepathine," 488
Telitoxicum spp., 371, 372
 Teloidine, 64, 84, 89
 Temuline, 750
 Tetrahydroyohimbine, 508
 Tetrahydroanagryne (*l*-lupanine), 130,
 137
 Tetrahydroberberine. *See* Canadine.
 quaternary ammonium bases, 337
 Tetrahydroprotoberberine subgroup,
 alkaloids, 284
 pharmacological action, 293
 Tetrahydro-*ψ*-berberine, 335
 Tetrahydro-*ψ-epi*berberine, 334
 Tetrahydroberberrubine, 344
 Tetrahydrocolumbamines, 172, 291, 342
 Tetrahydrocoptisines, 170, 173, 293, 344
 Tetrahydrodeoxycodeine, 252, 253, 269,
 272
 Tetrahydrohemicytisylenes, 141, 144, 145
 Tetrahydrojatrorrhizine, 291, 342
 Tetrahydropalmatine, 170, 171, 172, 291,
 292, 294, 342
 Tetrahydropapaverine, 186
 Tetrahydropapaverolines, 289
 Tetrahydroridelline, 605
 Tetrahydroshobakunine, 329, 340
 Tetrahydrostrychnine, 564
 Tetrahydrothebaine, 243
 Tetrahydroxybyrine, 504, 505
 Tetrahydroxybyrinescarboxylic acid;
 tetrahydroxybyrinescarboxylic acid, 506
 Tetrahydroworenine, 293, 344
 Tetralupine, 118, 132
 Tetramethylcocaurimethine, 353
 Tetramethyldiaminobutane, 67
 Tetrandrine, 349, 350, 351, 355, 357, 362
 isotetrandrine, 346, 350, 356
d-Thalictrifoline, 172, 290
 Thalictrine, 328, 340
Thalictrum foliolosum, 328
 Thebaine, 173, 178, 198, 219, 222, 226,
 227, 247, 248, 261
 basic degradation products, 225
 formulæ, 237, 239, 241, 242, 243
 pharmacological action, 211, 259, 266
 reduction products, 242, 244
*iso*Thebaine, 173, 227, 232, 266, 312
 Thebainol, 247, 248, 249
 Thebainone, 247, 248, 249, 261, 269
*meta*Thebainone, 247, 248, 249
 Thebainone methyl enolate, 243
 Thebaizone, 248, 250
 Thebaol, 226
 Thebenidine, 230
 Thebenine, 222, 227, 228
 pharmacological action, 266
bis-1 : 1'-Thebenone, 272
 Thermopsine, 118, 150
 homothermopsine, 118, 151
Thermopsis spp., 1, 118, 151
 minor alkaloids, 150
 Thesine; *Thesium minkwitzianum*, 777

- Thunbergin**, 351
Tigloidine (tiglyl- ψ -tropeine), 64, 66, 89
Tiliacora racemosa; tiliacarine, 350
Tinospora spp., 329
Tobacco alkaloids, 35
 smoke, alkaloids, 46
Toddalia aculeata; toddaline;
 toddalinine, 329
 Tomato grafts on alkaloid-bearing
 solanaceae, 48
d-Tomentocurine, 377
 "Totaquina," 419, 420
Toxiferine, 380
Toxiferines I and II, 382, 384
Toxiferines, IIa and IIb chlorides, 383,
 384
C-Toxiferine I, 383, 385
C-Toxiferine II, 382, 384
Trachelantamidine, 606
Trachelantamine, 602, 606, 607
 pharmacological action, 614
Trachelanthus korolkovi, 602
Trachelantic acid, 606, 607
Trachelantidine, 607
Trachelantine, 602, 607
Triantha monogyna, 778
Trichocereus spp.; trichocereine, 161
Trichodesma spp., 601, 602
Trichodesmine, 602, 607
Trichisia Gilletii; tricliseine; triclisine,
 778
Trigonella Faenumgræcum, 7
Trigonelline, 7, 413, 671, 772
Trilobamine, 350, 357
Trilobine, 350, 358, 359, 360, 362
*iso*Trilobine, 350, 359, 360
Trilupine, 117, 132
Trimethylcochlorine, 353
Trimethylcolchicine acid, 651
Trimethylpapaveroline, 194, 195
Tritopine. See Laudanidine.
Tropacocaine, 62, 64, 79, 100
 pharmacological action, 106
Tropane, 87, 108
Tropane group alkaloids, 64, 776
 pharmacological action, 105
Tropeines, 73, 79, 81
Tropenone, 80
Tropic acid, 72
Tropidine, 59, 74, 75, 77, 78, 98
Tropigenine (*nortropine*), 64, 75, 86, 90,
 91, 98
 ψ -**Tropigenine** (*nor-ψ-tropine*), 76
Tropilene, 74, 75, 77
Tropillidene, 75, 77, 98
Tropine, 59, 64, 67, 73, 75, 77, 84, 86, 89,
 97, 98, 99, 101, 107, 110, 441
 constitution, 74
 syntheses, 77
Tropine and allied amino-alcohols, alka-
 loids derived from, 64
*nor*Tropine, 64, 75, 86, 90, 91, 98
nor-ψ-Tropine, 76
 ψ -Tropine, 64, 75, 77, 89, 99, 100, 110
Tropinic acid, 59, 75, 76, 77, 98
Tropinone, 59, 74, 75, 77; 80
 syntheses, 79
 nortropinone, 76
Tropylscopine (*tropylscopeine*). See
 Hyoscyne.
d-**Tropyltropine**. See Atropine.
l-**Tropyltropine**. See Hyoscyamine.
Tropyl-ψ-tropeine, 101
Truxillines, 93, 95
Trymatococcus amazonicus, 372
Tryptamine, 465, 491, 771
Tryptophan, 491, 518
Tube curare, alkaloids, 373
Tuberostemonine, 766
Tubocurarine chloride, 368, 374, 377, 378,
 391
Tuduranine, 268, 273, 312
Tylophora spp.; tylophorine;
 tylophorinine, 778
Tyrosine, 518

Ulex europæus, 118, 140
Ulexine (cytisine), 140, 142
Umbellatine, 329, 340, 345
Ungernia seweritzovii; ungerine, 406
Upas tree, 554
Ustilago maydis; ustilaginine;
 ustilagotoxine, 783

Valeriana officinalis; valerine, 778
*iso*Valeric acid, 90
Valeroidine, 64, 66, 90, 100
*nor*Valeroidine, 90
*iso*Valeryl*nortropine*. See Poroidine.
Vallesia spp., 500, 511
Vallesine, 511, 512
Vascanellea hastata, 599
Vasicine (peganine), 488, 617
*iso*Vasicine, 617
Veatchine, 735
Vellosine, 372, 735, 736
Veratramine, 701, 707
Veratridine (amorphous veratrine), 701,
 704
 "Veratrine," commercial, 701
Veratrine (crystallised). See Cevadine.
Veratrosine, 701, 707
Veratroylbikaconine, 685
Veratroylmethylpseudaconine, 682
Veratroylpseudaconine, 682
 α -**Veratroylpseudaconine**, 684
Veratroyltropine, see Convolvamine;
 veratroylnortropine, see Convolvine.
Veratrum spp., 701, 707, 708, 710, 714
 alkaloids, 700
 insecticidal action, 714
 pharmacological action, 713
 alkaloidal types, 701
Veratrum alkalamines, structure, 711
Verine, 704. See Cevine.
Verticine; verticolline, 732, 733, 784
Villalstonine, 716, 718
Vinca pubescens; yinipe, 778

- Vinylquinuclidinecarboxylic acid, 464
 β -Vinyl- α' -quinuclidone-oxime, 442, 444
Virgilia capensis, 118
 Virgolidine; virgiline, 118, 147
Viscum album, 778
Vitex negundo, 778
 Vomicidine and derivatives, 591, 592
 oxidation, 594
 Vomicine, 553, 586, 589, 592
 constitution, 586
 exhaustive methylation, 592
 oxidation, 594
 pharmacological action, 596
 reduction products, 589
 and derivatives, formulæ, 587, 593, 595
*iso*Vomicine, 587, 588, 589
 Vomicinic acid and derivatives, 588
 Vomipyrine, 595
- WIELAND'S C₁₇ acid ex brucine, 566, 567, 575
Withania somnifera, 779
 Worenine, 328, 344
 Wuchuyine, 498
- XANTHALINE. *See* Papaveraldine.
 α - and β -Xantherines, 330
 "Xanthopierit," 331
Xanthorrhiza apiifolia, 328
Xanthoxylon. *See* *Zanthoxylum*.
 Xatine, 770
Xylopi macrocarpa, 317
Xylopi polycarpa, 329
- "YAGRENE," 488.
 Yatanine, 779
 Yobyrine, 500, 504, 505, 507, 509, 514, 739
 synthesis, 510
 Yobyrone, 505, 507, 739
 Yohimbé, alkaloids, 500
 "Yohimbenine," 500
 Yohimbenone, 505
 Yohimbic acid, 501, 505
 isomerides, 502, 503, 505
 Yohimbine, 161, 500, 501, 503, 505, 511, 735
 constitution, 504
 formulæ, 508
 reaction products, 507
*apo*Yohimbine, 503, 504, 506, 509
 α -*iso*Yohimbine, 503, 506
*nor*Yohimbine. *See* Yohimbic acid.
 Yohimbine and isomerides, 500, 502, 503, 505, 506
 constitution, 504
 pharmacological action, 513
 Yohimbol; *alloyohimbol*; *epiyohimbol*, 505
 Yohimbone, 504, 505
*allo*Yohimbone, 505
 Yulocrotine, 781
- Zanthoxylum brachyacanthum*, 301, 330, 336, 338
Zanthoxylum budrunga, 783
Zanthoxylum spp., 330, 331, 336, 338, 631
Zephyranthes spp., 406
 Zygadenine, 779
Zygadenus spp., 701, 779