

Smart choice for power

xantrex



**Save
more
than
time**

Our new Xantrex GT 3.0 Grid Tie Solar Inverter costs less per watt and is easier to install than any other grid tie inverter on the market.

When Xantrex set out to develop our new grid tie inverter, we listened to the experts – renewable energy dealers and installers. The result is a high performance three-kilowatt string inverter that offers superior PV energy harvest, easy installation, state-of-the-art design and high reliability. And with an MSRP of only \$2500 for 3000 watts of power, our GT 3.0 also offers the best price/performance in the industry.

For details on our breakthrough inverter, visit www.xantrex.com/gridtie. Or call 1-800-234-6431 and we'll send you our new brochure.

Xantrex GT 3.0 Grid Tie Solar Inverter

- ▶ Breakthrough price/performance
- ▶ Superior PV Energy harvest
- ▶ All-in-one three kilowatt system design
- ▶ Lightweight, easy to install

www.xantrex.com

You've grown up. So has solar.



Early solar systems were designed to generate energy for the basics, like light bulbs. Times have changed. Now, you can power your home with solar, run a factory, or live completely off the grid. And as your needs grow and change, we at SMA America are growing with you.

At SMA, we're always working to bring you the latest developments in solar technology. That's why we're proud to introduce two additions to our family: the Sunny Boy 6000 and Sunny Island 4248.

The Sunny Boy 6000 is the inverter for large homes and small to medium-sized businesses. Use the Sunny Boy 6000 in place of multiple smaller inverters for a solid, streamlined system of any size. Install it indoors or out, and count on a 95% real-world efficiency rate.

Our Sunny Island 4248 can power a home or business, or take you off-grid altogether. It's a sturdy 4200 Watt energy source and a dependable backup system, giving you the power you need if the power goes out. The Sunny Island 4248 is designed to work seamlessly with the Sunny Boy system you already have, and because it's modular, it expands on demand.

While the Sunny Boy 6000 and Sunny Island 4248 are new, they're already in use in Europe and elsewhere, performing efficiently and dependably. Just like our entire line of Sunny Boy products, these are tried and true.

We hope you'll dream up more bright ideas for solar powered applications. Because whether it's to run your mountain vacation home or your business in the city, count on SMA America to help you turn ideas into energy.

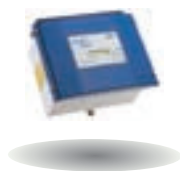



Sunny Island 4248

Sunny Boy 6000

SMA America, Inc.
12438 Loma Rica Drive • Grass Valley, CA 95945
Tel. 1.530.273.4895
Fax 1.530.274.7271
Email: info@sma-america.com
Web: www.sma-america.com



Solar today...
Energy tomorrow



1-866-357-2221
www.evergreensolar.com



**There's a reason
why Evergreen Solar is
fully integrated.**

We're fully integrated so you get the best in solar.



Producing our own wafers, cells, and modules assures that the highest quality components go into every one of our panels. And since they're made with String Ribbon™ technology, our panels take advantage of one of the newest, fastest-growing, most environmentally friendly manufacturing processes available in the world.



Evergreen Solar is an independent company. Solar is our *only* business. Our commitment to the environment is matched only by our commitment to our customers. Visit our website to learn more. If, like us, you want the best in solar, go with the pure choice.



Think ever green.

RECYCLED POWER



At U.S. Battery, we're committed to doing our part in keeping the environment clean and green for future generations, as well as providing you with premium deep cycle products guaranteed to deliver your power requirements when you need them.



**DON'T SETTLE
FOR ANYTHING LESS
THAN U.S. BATTERY
PRODUCTS!**

1675 Sampson Ave. Corona, CA 91719 (800) 695-0945 / 653 Industrial Park Dr., Evans, GA 30809 (800) 522-0945

Sanyo Modules = More kWh per Watt

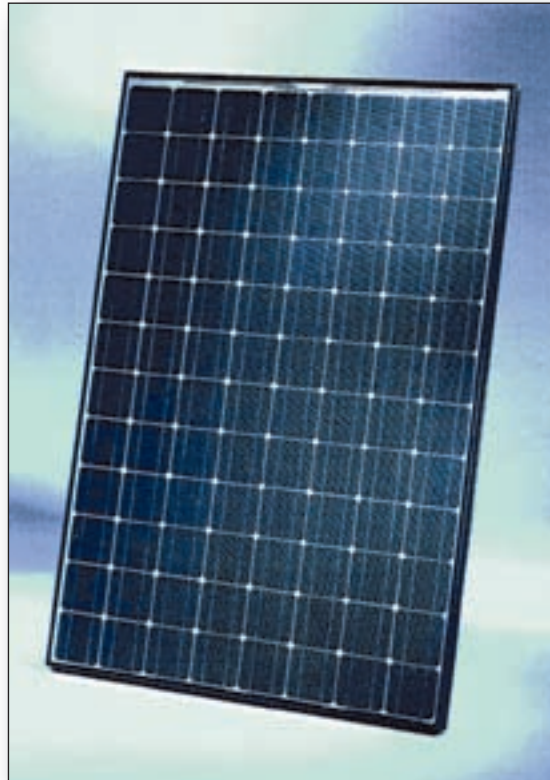

Sanyo 190W module

High efficiency HIT technology produces more energy per watt

Sanyo modules outperform the competition because they maintain higher voltages at higher temperatures – which means *more* energy and *better* performance!

- Approximately 5% higher power than other crystalline modules – providing a higher rebate in some states (per PTC ratings*)
- More power, less installation space required

That's why SunWize GTS Grid Tie Systems rely on Sanyo modules. Prepackaged systems available from 1085 to 3150 watts. Visit our web site, www.sunwize.com or call 800-817-6527 for more information.

*PTC stands for PVUSA Test Conditions. PTC watt rating is based on 1000W/m² irradiance, 20° C ambient temperature and 1 m/s wind speed.



MITSUI COMTEK CORP.

The Advanced Technology Subsidiary of Mitsui & Co.,





ReadyWatt Makes Power Independence and Clean Energy as Easy as 1-2-3

Your ReadyWatt™ Dealer can help you decide which system will best meet your needs



Your ETL® listed system includes the PV Powered® StarInverter™, the highest efficiency inverter available today, with a ten year warranty. Made in the USA.

Both the built in meter and free Windows® based software continuously monitor and display your system's power production and calculate how much CO₂ is being kept from the Earth's atmosphere.



	1	2	3
ReadyWatt™ System	GT 900	GT 1800	GT 2800
Estimated Annual Output			
Based on 4.5 hours of sun a day.	1,000 kWh	2,000 kWh	3,500 kWh

Each system comes complete with all the components you need

Equipment			
PV Module	Isofotón 150	Isofotón 150	Isofotón 150
Module Quantity	6	12	21
Roof Mounts	(2) 3-module	(4) 3-module	(7) 3-module
PV Junction Box	1	1	1 (fused)
MC Cables	(1) 50'	(2) 50'	(2) 50' & (1) 100'
PV Grounding	Lay In clamps	Lay In clamps	Lay In clamps
Grounding Wire	30'	60'	120'
ReadyWatt GT Power Center			
Inverter	PVP1800	PVP1800	PVP2800
AC Grid Disconnect	GE 30A 240VAC	GE 30A 240VAC	Square D 30A 240VAC
Dimensions h/w/d	30" x 52" x 8"	30" x 52" x 8"	30" x 52" x 9"
Weight	100 lbs	100 lbs	125 lbs
Specifications and Ratings			
Array Size In Sq. Ft.	82.7	165.5	289.6
DC Watts - STC	900	1800	3150
Warranty			
ReadyWatt & System Equipment	10 year	10 year	10 year
Isofotón Power output	25 year	25 year	25 year

Your ReadyWatt™ Solar Electric System also features:

- Isofotón 150 Watt, UL® listed, high efficiency solar modules for your home
- 25 year power output warranty



Isofotón® is the sixth largest photovoltaic module manufacturer in the world. With over 23 years experience, they are the number one PV provider in Europe and are now in the USA.

Call Today for a ReadyWatt™ Dealer Near You! 800 GO SOLAR

www.energyoutfitters.com • Grants Pass, OR • Cedar Grove, NJ • Littleton, CO • Bozeman, MT • Laguna Beach, CA • Calgary, AB • Barrie, ON



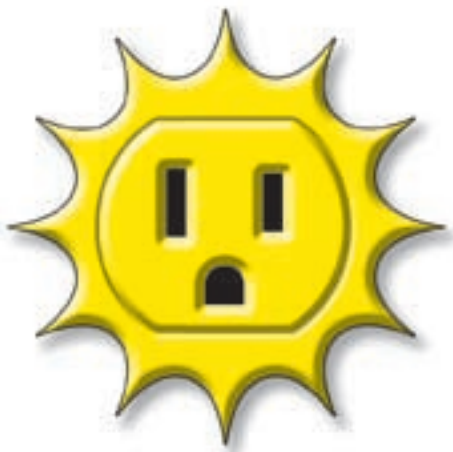

HP104

contents



14 **oasis** in Brooklyn

Susan Boyle & Benton Brown

A 19th century icehouse gets a green renovation, including building-integrated solar electricity, hydronic heating, and a living roof.

22 **zero-energy** home

William Ball

The first grid-tied solar-electric home in Arkansas is finally on-line. But the process started years ago with William's pioneering persistence.

28 **solar** spa

Bob Owens

A simple solar hot water project provides hot-tub luxury at low cost.

34 **green building** products

Rachel Connor & Laurie Stone, with Dan Chiras

The lowdown on the best products for building your home with concern for the earth and for your own comfort.

42 **hydro** how-to

Dan New

Part 2. How to measure the two most important variables used in determining your site's hydroelectric potential.

50 **emergency** solar

Douglas Lais

A mobile power system in a box provides backup peace of mind.



On the Cover

Where's the PV? Benton Brown and Susan Boyle on the roof of their newly renovated, energy-efficient icehouse in Brooklyn, NY. And yes, those are solar-electric panels they are sitting on.



58 **sun-seeking** *in the UK*

Anthony Skelton

An incentive program too good to resist inspires the doubling of a grid-tied photovoltaic system in the United Kingdom.

66 **efficient** *fridges*

Jennifer Barker

Tips for choosing a new energy-efficient refrigerator.

72 **solar-electric** *basics*

Scott Russell

A perfect solar primer—solar-electric systems and components defined and simplified for the renewable energy novice.

82 **REview**

Joe Schwartz

Direct Power & Water's Power Rail photovoltaic rack mounts make for fast, easy, and aesthetic installation of rooftop arrays.

86 **hot water** *booster*

Barry Butler

The Solar Wand in-tank heat exchanger for simple and inexpensive solar domestic hot water applications.

94 **pedal** *power*

Frank R. Leslie

Crank out some watts with a simple exercise bike conversion.

98 **vertical axis** *wind*

Robert Preus

Insights on the rare and misunderstood vertical axis wind turbine.

102 **wire** *size*

Kent Osterberg

Balancing cost and voltage drop when choosing low-voltage DC wire.

Regulars

10 From Us to You
HP crew
Brighten your holidays.

64 What the Heck?
Joe Schwartz
Gutter.

106 Code Corner
John Wiles
Multistrand wire.

110 Independent
Power Providers
Don Loweburg
Utility monopolies.

112 Book Review
Ian Woofenden
Wind Power.

116 Power Politics
Michael Welch
Global warming.

118 Word Power
Ian Woofenden
Shock.

120 Home & Heart
**Kathleen
Jarschke-Schultze**
Fire on the mountain.

134 Ozonal Notes
Richard Perez
Electric cooking.

80 Subscription Form

124 Letters

130 RE Happenings

136 Q&A

138 Readers'
Marketplace

140 Installers Directory

144 Advertisers Index



Holidays are a time for giving. Unfortunately, that includes giving to the electric companies. The U.S. Department of Energy reports that each year in the United States, holiday lights consume 2.2 terawatt-hours—that's 2.2 billion kilowatt-hours (KWH)—of electricity. At 10 cents per KWH, that's US\$220 million annually to power our holiday displays.

On a typical evening during the season, 37.1 billion holiday lamps are lit, at an average of 0.4 watts each. That adds up to 14,840 megawatts, or the equivalent of 14.8 modern nuke plants.

Home Power isn't ready to throw in with Scrooge or the Grinch, but we think something can be done about these excesses. For starters, is it really necessary to have the brightest display on the block? Maybe, if your kid is an astronaut and you want to say "Hi!" in lights. But the rest of us might consider celebrating the season with more simplicity and efficiency.

Holiday lights are on for about five hours a day, thirty days each year, and that adds up. Instead, give a gift to the whole planet by switching your incandescent light strings to LEDs (light-emitting diodes), which use 90 percent less energy. LED strings are available in a variety of colors, and you can buy them at most stores that carry holiday lighting.

Just think, 90 percent less energy consumed and that much more money in our pockets. This means more goodies for our stockings, and fewer lumps of coal. Maybe a PV system to power your lights will be the next gift you receive. "Ho, ho, ho!"

—Season's greetings from the whole *Home Power* crew

Think About It...

"Laughter is the sun that drives winter from the face."

—Victor Hugo

Legal: Home Power (ISSN 1050-2416) is published bimonthly for \$22.50 per year at PO Box 520, Ashland, OR 97520. International surface subscription for US\$30. Periodicals postage paid at Ashland, OR, and at additional mailing offices. POSTMASTER send address corrections to Home Power, PO Box 520, Ashland, OR 97520.

Paper and Ink Data: Cover paper is Aero Gloss, a 100#, 10% recycled (postconsumer-waste), elemental chlorine-free paper, manufactured by Sappi Fine Paper. Interior paper is Connection Gloss, a 50#, 80% postconsumer-waste, elemental chlorine-free paper, manufactured by Madison International, an environmentally responsible mill based in Alsip, IL. Printed using low-VOC vegetable-based inks. Printed by St. Croix Press Inc., New Richmond, WI.

HP staff

- Publisher** Richard Perez
- Publisher & Business Manager** Karen Perez
- CEO & Technical Editor** Joe Schwartz
- Advertising Manager** Connie Said
- Marketing Director** Scott Russell
- Customer Service & Circulation** Nat Lieske
Shannon Ryan
- Managing Editor** Linda Pinkham
- Senior Editor** Ian Woofenden
- Submissions Editor** Michael Welch
- Associate Editor** Claire Anderson
- Art Director** Benjamin Root
- Graphic Artist** Dave Emrich
- Chief Information Officer** Rick Germany
- Solar Thermal Editor** Chuck Marken
- Solar Thermal Technical Reviewers** Ken Olson
Smitty Schmitt
- Green Building Editors** Rachel Connor
Laurie Stone
Johnny Weiss
- Transportation Editors** Mike Brown
Shari Prange
- Regular Columnists** Kathleen Jarschke-Schultze
Don Lowebug
Richard Perez
Michael Welch
John Wiles
Ian Woofenden

HP access

Home Power Inc.
PO Box 520, Ashland, OR 97520 USA
800-707-6585 or 541-512-0201
Fax: 541-512-0343
hp@homepower.com
letters@homepower.com

Subscriptions, Back Issues & Other Products: Shannon and Nat
subscription@homepower.com

Advertising: Connie Said
advertising@homepower.com

Marketing & Resale: Scott Russell
marketing@homepower.com

Editorial Submissions: Michael Welch
submissions@homepower.com

www.homepower.com

Copyright ©2004 Home Power Inc. All rights reserved. Contents may not be reprinted or otherwise reproduced without written permission. While *Home Power* magazine strives for clarity and accuracy, we assume no responsibility or liability for the use of this information.

**PV Modules? Wind Generators? Inverters?
Batteries? Balance-of-System Items?**

AEE Solar Has It All!

FEATURED THIS MONTH



NEW!

Shell PowerMax Ultra PV Modules

Now available in 85-watt
and 175-watt versions.



Whisper H-Link Grid-Tie Wind System

Includes *Whisper H-80*
1000-watt wind generator
and *Wind Boy* inverter.



MK Batteries

Sealed gel and AGM
batteries from 30 to
250 amp-hours.



PV-Grounding Lugs

NEC-compliant lay-in-lugs with
stainless steel set screws for
module grounding.
item code: 51.3414



NEW!

Sunny Boy 6000

6 kW grid-tie inverter – higher
efficiency and lower price per
watt, plus proven reliability.



At AEE Solar Supersource, we offer our dealers & installers:

- ▶ Competitive prices on top brands.
- ▶ Unsurpassed technical expertise, Off-grid or grid-tie, solar, wind or hydro.
- ▶ **NEW!** Online ordering – call your rep to get started.
- ▶ The widest selection in the business, including all the items necessary for NEC-compliant installations.
- ▶ A 25-year industry-wide reputation for delivering the highest standards in dealer satisfaction.

Call 800-777-6609

8:30 - 5:00 Pacific Time, Monday - Friday

www.aeesolar.com

AEE Solar
SUPERSOURCE

Bringing Power to the People Since 1979

formerly **Alternative
Energy Engineering**



1155 Redway Drive • PO Box 339, Redway, CA 95560
707-923-2277 tel • 707-923-3009 fax • info@aeesolar.com

THE ONLY ONE-STOP, FULL-SERVICE WHOLESALE DISTRIBUTOR YOU'LL EVER NEED!

Connecting People to Solar-Powered Solutions



- Power Range 35-187 watts
- NEW +10% -5% Power Tolerance
- Class 1 Div 2 for KC35-KC120
- UL Listed
- Building Quality Modules Since 1975
- Now Manufactured in North America

The Power of Choice

From our comprehensive family of modules to our 25 year warranty, Kyocera Solar takes a pro-active approach to anticipating the needs of our customers. Call 800-223-9580 or click www.kyocerasolar.com to learn more.

THE NEW VALUE FRONTIER



KYOCERA Solar, Inc.

Grid-tie with Back-up Made Easy

We've eliminated the three reasons for not including battery back-up capability in grid-tie PV systems: poor performance, complexity and battery life.

High Performance

Side-by-side, real world testing completed by OutBack in Grass Valley, CA has shown that the KWH performance of our grid-tie inverter system with battery back-up is within 5% of the KWH performance achieved by a SMA Sunny Boy 2500. The tests were conducted with near identical PV arrays. The OutBack battery back-up inverter performs better than some batteryless inverters!

Simple Installation

Our new PS1 makes grid-tie with battery back-up quick and easy to install - even outdoors with limited wall space. The PS1 system is available factory wired with a complete ETL listing. We've taken all the guesswork and complexity of the assembly process out of the picture!

Maintenance Free

Designed to work with four Group 27 or 31 sealed AGM type batteries (such as those offered by Concorde, MK, Deka etc.) eliminates the need for periodic watering. Our advanced charge control algorithm and smart battery management techniques should allow for battery life to exceed 10 years in typical grid-tie back-up applications.

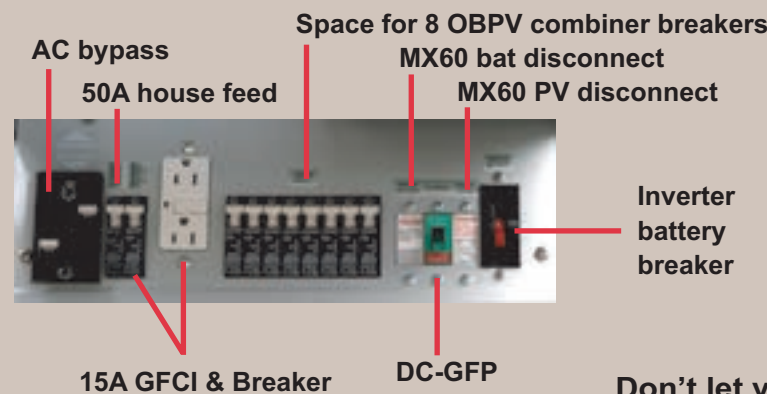
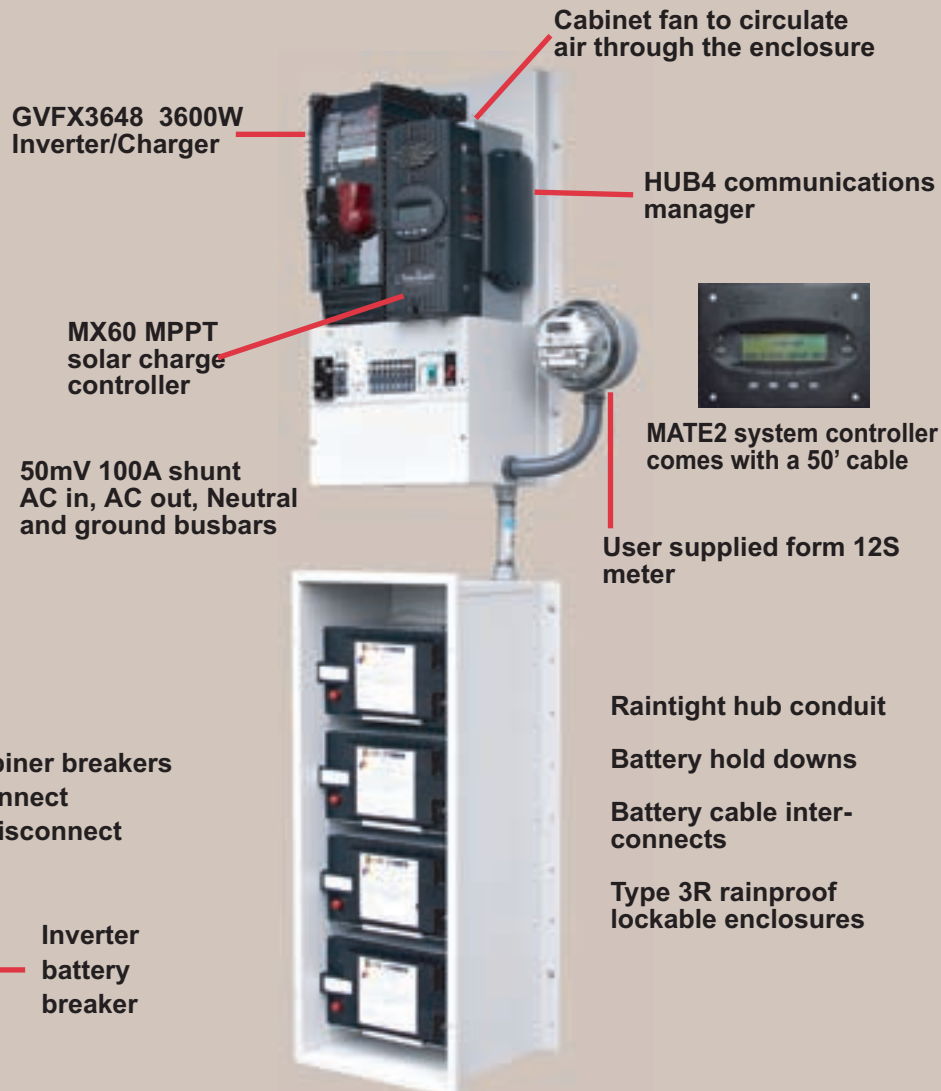

Don't let your lights go out just because your neighbors do.
PS1-GVFX3648
Estimated price \$4999.00
 (Batteries not included)



19009 62nd Ave NE, Arlington, WA 98223
 Phone 360-435-6030 - Fax 360-435-6019

SUPPORT YOUR LOCAL INSTALLER
 Visit us at - www.outbackpower.com

Brooklyn Oasis

**Susan Boyle
& Benton Brown**

©2004 Susan Boyle & Benton Brown



Rebuilding the Icehouse

We finally found what we were looking for. To most people, it was just an abandoned, pigeon-filled building with boarded-up windows, in an industrial pocket of the Crown Heights neighborhood of Brooklyn, New York. But to us, this 1860s icehouse had the potential to become our new home.

Green Building

We had lived in Brooklyn for six years and wanted to stop renting and buy a building where we could live, rent out apartments, and have a workshop. Because of Benton's welding and shop equipment, moving every few years was an exhausting thought.

After looking for about two years, we finally found the right building, in the right place, for the right amount of money. We competed with other prospective buyers to secure ownership of the property. Once we did, we used Benton's artistic sense to come up with a design for the six units. With his welding and construction experience, we started a general contracting company. We partnered that with Susan's environmental background and did tons of research to fill in the missing pieces.

Our plan was to create a "green building" as we renovated the icehouse into six residential apartments. We started by getting the zoning changed from manufacturing to residential, and researching sustainable design techniques and grants that we could apply to the renovation.

Our goal was to have the building certified by the Leadership in Energy and Environmental Design (LEED) program. This is a rating system for high-performance buildings in the United States. We were honored and encouraged when we received a US\$75,000 grant from our local natural gas utility, KeySpan. The "Green Cinderella" grant has made it possible for us to follow through on many of the sustainable aspects in the building's renovation.



The new, energy-efficient icehouse nears completion.

Susan and Benton on their solar-electric rooftop in the Crown Heights neighborhood of Brooklyn.



Recycled & Salvaged Materials

We began the construction with a lot of demolition. First we removed the masonry outbuildings, including a 70-foot (21 m) tall stairwell tower, and about 7,000 square feet (650 m²) of wood floors, including the large floor joists. Over the 150-odd years of the icehouses's existence, the entire property surrounding it had been covered with one- and two-story structures, all connected to the main building. With the demolition of these structures, we created a much-needed yard. This increased the permeable surfaces on the property—helping to manage storm water and creating an area to landscape.

During the demolition process, we salvaged about 75 percent of the material, which we reused throughout the building. We milled about 40 of the 100-year-old beams into 10-inch (25 cm) wide flooring. We also made stair treads, windowsills, shelving, molding, and large carriage-house-style doors with the salvaged lumber.

We then installed new structural steel and poured new concrete. The roof and the three floors below are concrete made with 30 to 50 percent fly ash. Fly ash is the by-product of burning coal. Typically, only 10 percent of a concrete mixture is fly ash. The fly ash replaces some of the Portland cement, which requires large amounts of energy to produce. Additionally, it helps strengthen the concrete, making it more durable.



Seven kilowatts of Uni-Solar photovoltaic laminates cover almost the entire 1,200-square-foot area of the icehouse's rooftop addition.

Radiant Heating System

Pouring new concrete floors gave us the perfect opportunity to install 14,000 square feet (1,300 m²) of radiant floor heating throughout the building. In total, we used 16,000 linear feet (4,900 m) of tubing. Because radiant heat is delivered via the floor, the heat remains low in the room, which is ideal for the icehouse because the apartments have very high ceilings, ranging from 13 to 18 feet tall (4–5.5 m).

These Energy-Star-rated, condensing boilers provide energy-efficient heating for the icehouse's apartments.



All of the apartments have large, operable windows with transoms, which allow hot air to escape. In some apartments, we installed large exhaust fans to help purge any hot air that accumulates. The building itself has solid, 2-foot (0.6 m) thick, brick perimeter walls, which we imagine were part of the original 1860s design to keep the ice cold.

The "green" or vegetated roofs also helps keep the building cool in the summer months. We covered approximately 2,300 square feet (215 m²) with two vegetated roofs that make up about half of the building's total roof area. One green roof area is flat with 4 inches (10 cm) of soil, while the other is sloped with only 2 inches (5 cm) of soil.

Along with helping to cool the building, there are many additional benefits of having green roofs, such as:

- Storm and sewer relief through water retention
- Cooling the air outside, which diminishes the urban heat island effect
- Air cleaning
- Water filtration
- Insulating qualities

Installing the radiant floor heating throughout the building involved thousands of feet of PEX tubing.



Plants for the roofs were selected based on their ability to survive dry conditions with minimal maintenance.

Roof-Integrated Solar Electricity

We were interested in producing energy, while reducing our electrical load. This led us to select a 7.2 KW solar-electric array and high-efficiency Energy Star appliances. The solar-electric array is 56, 18-foot-long (5.5 m), roof-integrated photovoltaic (PV) laminates made by Uni-Solar.

We chose Uni-Solar’s photovoltaic laminates because of their low profile. The standing-seam roof that is specified for the laminates worked perfectly—in appearance and practicality—with the building design. We wanted to produce as much energy as we could within the constraints of the available roof area. We had about 1,200 square feet (110 m²) of roof area to work with. Most of the roof is just long enough for 18-foot Uni-Solar laminates.

In one smaller section, the roof is 40 feet (12 m) long. We spoke to Uni-Solar about double-length laminates, and initially it was a possibility. As time passed and the installation date grew closer, Uni-Solar was not able to offer the longer configuration. So instead, we used two, 18-foot (5.5 m)



Besides lending a lush, colorful landscape to what would otherwise be a barren surface, the icehouse’s green roofs provide the building with additional insulation, act as evaporative coolers, and help manage water runoff.

laminates with the wiring at opposite ends. The laminates at the top of the roof’s slope have the wiring under the ridge cap, and the wiring of the lower laminates goes through a hole in the roof, so the laminate is completely flat.

We installed three Sunny Boy 2500 inverters at the top of the stairwell on the fourth floor, just below the laminate-covered roof. This allows convenient access for us. We record the PV system’s production at least once a month, but often check the inverters for daily energy production numbers.

The system was designed and installed by ETM Solar Works of Endicott, New York. It is grid-tied with no batteries, and connected to three different utility meters. Unfortunately right now, there is no buyback in New York City on two of the three meters because they are considered commercial. So any unused electricity that is generated goes back into the grid for free. But with our normal usage, we typically will not be producing any excess energy.

We went online in December 2003, and at the half-year mark, we had produced 4,419 AC KWH. As New York City becomes more aware of “green” technologies, we hope there will be more incentives for building owners in the future, making it easier for people to install green roofs and photovoltaic systems, and to be more energy efficient.

Green Roof Plant Types

For 4-Inch Soil Depth

Botanical Name	Common Name	Height (in.)	Flower Color	USDA Zone	Bloom Time
<i>Allium schoenoprasum</i>	Chives	10	Mauve	4	Apr.
<i>Sedum floriferum</i> 'Weinestaphaner Gold'	Bailey’s Gold	4	Yellow	3	Jul.–Aug.
<i>Sedum spurium</i> White Form	White spurium	6	White	4	Aug.
<i>Talinum calycinum</i>	Fameflower	12	Rose-Pink	6	Jun.–Jul.
<i>Sedum spurium</i> 'Fuldaglut'	Dragon’s Blood sedum	6	Red	4	Sep.–Nov.
<i>Sedum kamtschaticum</i>	Russian stonecrop	6	Yellow	4	Jun.–Jul.
<i>Lavandula</i> sp.	Lavender	6	Purple	4	Jul.–Aug.

For 2-Inch Soil Depth

<i>Sedum sexangulare</i>	Six-sided sedum	4	Yellow	4	Jun.–Jul.
<i>Talinum okanoganense</i>	Fameflower	2	White	5	Jun.–Aug.
<i>Sedum reflexum</i>	Blue stonecrop	4	Yellow	4	Jun.–Jul.
<i>Sempervivum</i> mixed	Hens and Chicks	6	Pink	3	Jul.–Aug.
<i>Sedum boehmeri</i>	Duncecaps	5	Grey	5	Sep.–Oct.
<i>Sedum cyaneum</i>	Rose Carpet	2	Pink	4	May–Jun.
<i>Sedum acre</i> 'Aureum'	Golden stonecrop	3	Yellow	4	Jun.–Aug.

New Approaches

We live in the unit on the top floor, where we are able to keep a close eye on the green roof, the inverters, and the photovoltaic laminates. The remaining five apartments were rented by October 2004. We are looking forward to maintaining and adding to the sustainable aspects of the icehouse for years to come.

As renewable energy becomes more and more efficient and affordable—as most predict it will—we hope to add to our renewable energy production. We are always researching and looking at new ways to make the building more sustainable. A good example of this is installing awnings on the south-facing windows to keep the interior spaces cooler in the summer. We are also on the lookout for new technologies that enable us to conserve more energy.

We have gained an immense amount of knowledge throughout the planning, design, and construction phases of the project. In the planning phase, we learned how New York City processes zoning changes, and what is required by building codes. While in the design and construction phases, we learned everything from what type of strainer to use for an 80-year-old pedestal sink to how to install a standing-seam roof, to tying in a radiant manifold, and to calculating the saturated weight load of a green roof. We have learned it all by actually doing it.

Green Appeal

Because of the various green building tours that have taken place in New York City over the past year, many prospective tenants have contacted us. They are excited by the idea of living in a “green” building with a lot of light

Tech Specs

System type: Batteryless, grid-intertied PV

System location: Brooklyn, New York

Solar resource: 4.5 average daily peak sun hours

Production: 600 AC KWH per month

Utility electricity offset by PV system: 30 to 50 percent, depending on season

Photovoltaics

PV: 56 Uni-Solar, PVL 128 laminates; 128 W, 24 V

Arrays: Three arrays; #1 and #2, two 9-laminate series strings in parallel, 297 Vmp; #3, two 10-laminate series strings in parallel, 330 Vmp; 7,168 W total

Array disconnect: Square D HU361

Array installation: Building-integrated laminates on south-facing roof, 25 degree tilt angle

Balance of System

Inverters: Three SMA Sunny Boy 2500U, 240 VAC output, 600 VDC maximum DC input voltage, 234 to 550 VDC MPPT voltage window

System performance metering: Inverter-integrated LCD meters and utility KWH meters

Icehouse Laminate PV System

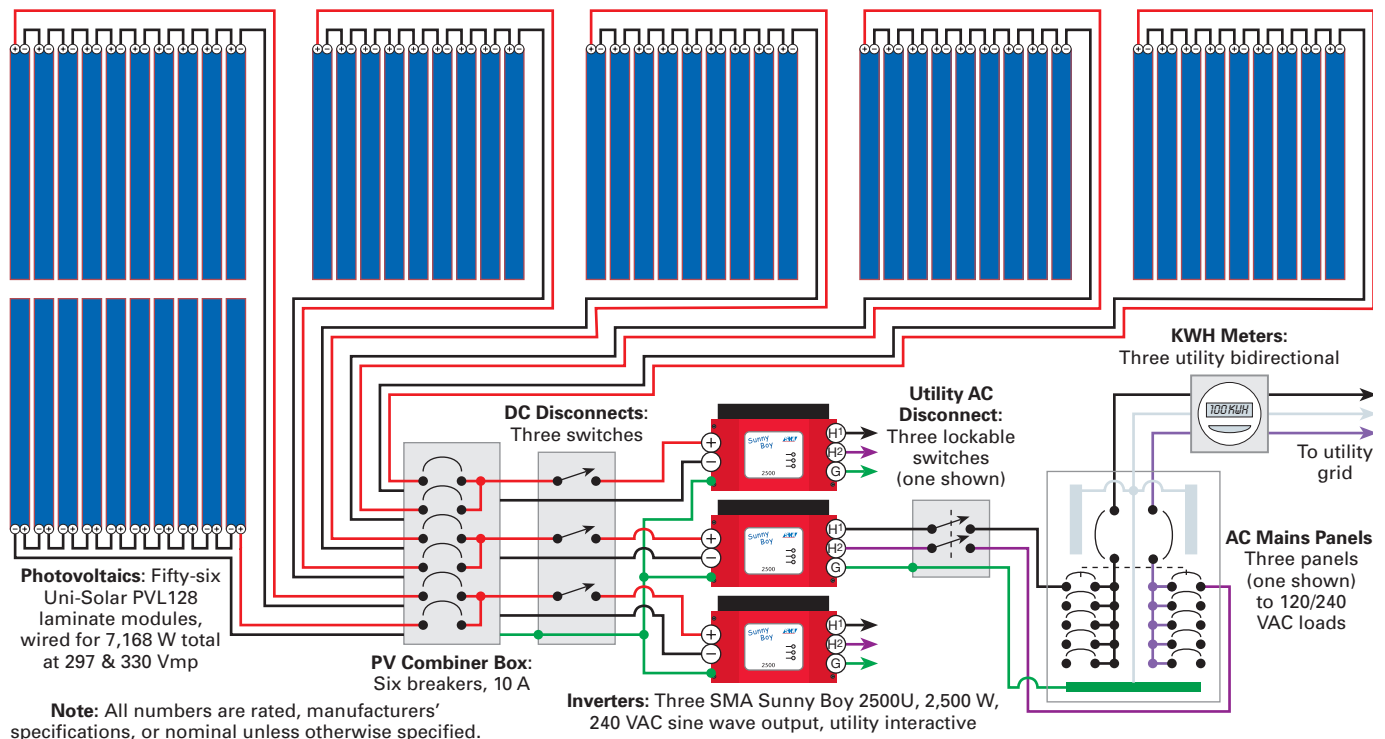

Average Sun Hours & Projected Array Output

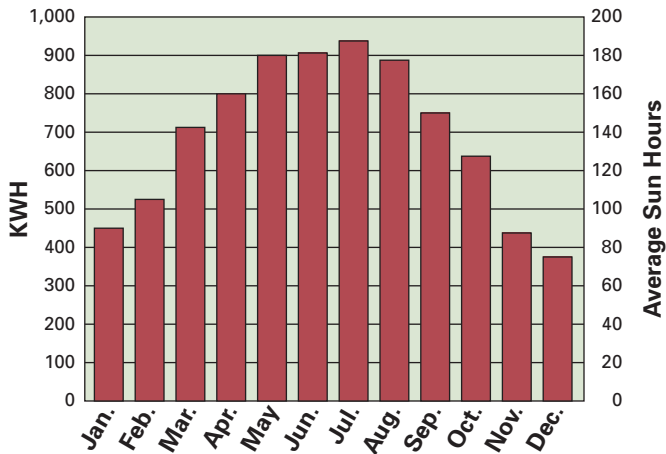

and fresh air, while using less energy than a conventional building. Without advertising at all, we received about two inquiries a week. If people's schedules did not allow them to wait until our building was ready, they always asked if we knew of other buildings like ours.

Our neighbors monitor our progress closely. They are supportive and enjoy seeing the improvements to the facade, such as lights, new doors, and windows. Many of our neighbors have lived in Crown Heights for more than twenty years, and watched the building fall into disrepair. They seem to like seeing the building being brought back to life. Ideally, the building will be a good example of how to build with more energy consciousness and with environmental awareness, while using the natural resources available in the city.

Access

Susan Boyle & Benton Brown, Big Sue Inc., 925 Bergen St., Brooklyn, NY 11238 • bigsuellc@earthlink.net

Watts Radiant, Jim Nesbitt, Edwards, Platt & Deely, 868 Wyandanch Ave., North Babylon, NY 11704 • 800-276-2419 or 631-253-0600 • Fax: 631-253-0303 • jnesbittepreps@aol.com • www.wattsradiant.com • Radiant heating PEX and manifolds

St. Lawrence Cement, 3 Columbia Cir., Albany, NY 12203 • 800-462-8800 or 518-452-3563 • Fax: 518-452-3045 • pflanders@stlawrencecement.com • www.stlawrencecement.com • Fly ash concrete

Heat Transfer Products Inc., PO Box 429, E. Freetown, MA 02717 • 800-323-9651 or 508-763-8071 • Fax: 508-763-4909 • sales@htproducts.com • www.htproducts.com • Boilers

Katrin Scholz-Barth Consulting, 122 4th St. SE, Washington, DC 20003 • 202-544-8453 • katrin@scholz-barth.com • www.scholz-barth.com • Green roof

Firestone Building Products Co., 525 Congressional Blvd., Carmel, IN 46032 • 800-428-4442 or 317-575-7000 • Fax: 317-575-7100 • www.firestonebpco.com • Vegetated roof membrane

Sarnafil Inc., 100 Dan Rd., Canton, MA 02021 • 800-451-2504 or 781-828-5400 • Fax: 781-828-5365 • webmaster@sarnafilus.com • www.sarnafilus.com • Vegetated roof membrane

Barrett Co., Millington, NJ 07946 • 800-647-0100 • Fax: 908-647-0278 • information@barrettroofs.com • www.barrettroofs.com • Drainage mat for vegetated roof

Emory Knoll Farms, Ed Snodgrass, 3410 Ady Rd., Street, MD 21154 • 410-452-5880 • Fax: 410-452-5319 • ed.snodgrass@greenroofplants.com • www.greenroofplants.com • Green roof plants

ETM Solar Works, Dr. Gay Canough, 533 Woodford Ave., Endicott, NY 13760 • 877-785-6498 or 607-785-6499 • Fax: 607-786-3388 • info@etmsolar.com • www.etmsolar.com • Solar-electric installation

United Solar Ovonic (Uni-Solar), 3800 Lapeer Rd., Auburn Hills, MI 48326 • 800-843-3892 or 248-475-0100 • Fax: 248-364-0510 • info@uni-solar.com • www.uni-solar.com • Uni-Solar PV

MBCI Metal Roof and Wall Systems, PO Box 4141, Rome, NY 13442 • 800-559-6224 or 315-339-9701 • Fax: 315-339-2446 • grideout@ncilp.com • www.mbc.com • Galvalume standing-seam metal roof

SMA America Inc., 12438 Loma Rica Dr. Unit C, Grass Valley, CA 95945 • 530-273-4895 • Fax: 530-274-7271 • info@sma-america.com • www.sma-america.com • Sunny Boy 2500U inverters

Becker Engineering, P.E., 97 Catherine St., Valley Stream, NY 11581 • 516-561-5922 • Fax: 516-823-0219 • jbecker@bepc.us • www.beckerny.com • Structural engineering



RADIANT & SOLAR

Radiant is the most efficient way to heat with the sun's energy. Connect right to a solar water heater for added comfort and efficiency.

- SAVE ON FUEL COSTS
- RETROFIT EXISTING STRUCTURES
- BUY DIRECT & GET LOWEST PRICES
- SIMPLE DO-IT-YOURSELF PACKAGES

www.radiantec.com 800.451.7593

No Power? No Problem!

There is more to a working renewable energy system than a cheap deal on a pile of hardware.

We Provide:

Complete service. We do solar, wind, microhydro and pumping systems. Load analysis, site survey, system design, sales, installation, user training, and tech support long after the warranties expire. We live on renewable energy, have 20 years of experience, and have established over 500 systems. We specialize in NEC® compliant, safe systems that will make your Electrical Inspector smile!

Equipment for DIY. We offer reasonable deals and technical reality checks. Why settle for a packaged system when you can have yours custom designed by an expert?

Your best resource is a local pro. Tap into our network of qualified, competent Electron Connection associates across the country.

Going into the Biz? Why talk to a "sales technician" when you can talk to an electrician? We KNOW what works and how it works. We offer technical support, system design help, prompt shipment, fair pricing and NO BULL. Local referrals always. Electrical competence required.

Electron Connection

Bob-O Schultze
CA Electrical Lic #613554
OR CCB Lic #149724



800-945-7587

 toll free

www.electronconnection.com

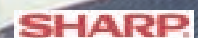
 online catalog

PO Box 203, Hornbrook, CA 96044 USA

Voice / Fax: 530-475-3401 • E-mail: bob-o@electronconnection.com

Energy Independence

The Complete Grid Connected System



The Whisper wind turbine can now be directly connected to the electrical grid through the SMA Windy Boy inverter. Depending on your location and energy consumption, a single Whisper Link system will reduce or even eliminate your monthly electrical expense. You can become your own electric company!



Whisper H80



Whisper Link



SMA Windy Boy



Home

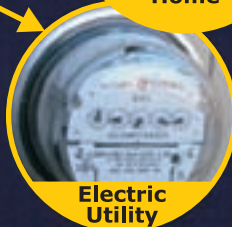

Electric Utility

Southwest Windpower
Renewable Energy Made Simple

2131 N. First Street
Flagstaff, AZ 86004 USA
Tel 928-779-9463 • Fax 928-779-1485
www.windenergy.com
info@windenergy.com

A Long & Winding Road to a Solar Home

William Ball

©2004 William Ball

Building Arkansas' first solar home to be net metered with the largest utility in the state required skills not normally expected of a builder. It's been a long, winding road, but we're now on our way.



Author William Ball surveys the completed excavation and poured footings on Arkansas' first net-metered, solar-electric home. The trailed 2.4 KW PV array provides electricity for construction.



This home looks like any other, except it's solar powered. Inverters are visible on the right side of the building.

On the heels of the 1973 oil embargo, there was a push in the United States to develop renewable energy resources and become independent of foreign oil. A few years before, President Nixon had created the U.S. Environmental Protection Agency, and the U.S. Department of Energy was to lead us down the “soft” path to energy independence. It seemed so logical—clean, homegrown energy.

I began doing business as Natural Environments in 1976 in Little Rock. At that time, solar thermal systems were getting past the R&D phase, and photovoltaics (PVs), with the right incentives, held great promise. Then things fizzled. Oil was discovered in the North Atlantic, the Alaska pipeline was built, and OPEC lifted their embargo. It was good news for an oil hungry world, but bad news for the renewable energy (RE) industry.

Landmarks that should have been reached in years have taken decades. If you were going to survive in the RE business, you also needed a “real” job. So, I began to build homes—nice homes, with three-step crown molding, Italian marble, and gold-plated plumbing trim, but nothing solar. When you build custom homes, you build what your clients want, and they didn’t want anything solar.

It was always a real treat when we got to do a PV-powered billboard light or maybe a system for a boat dock. Then I attended the 1991 International Solar Energy Society (ISES) World Solar Conference held in Denver. I got a feeling I had not had for at least ten years, the feeling that maybe the time had finally arrived. I was determined to make RE happen in Arkansas, without really knowing how to start.

First, You Become a Lawyer

In 1993, I read that our public service commission (PSC) had convened hearings to deal with “integrated resource planning.” Maybe if we were planning our energy future, we could plan to use renewable energy. Now remember, I was in the solar energy business, so I didn’t have any money for an attorney.

After poring over the commission’s rules and procedures, I managed to successfully intervene, *pro se* (legalese for appearing in a legal proceeding on one’s own behalf). I found myself at the table with the commissioners, and with lawyers for electric utilities and gas and telephone companies. I felt something like a stepchild in the family. The group, however, welcomed me, but was curious as to why I was there. I must confess, there were times during the year-and-a-half process that I wondered myself.

I managed to achieve a consensus of the parties that recognized the hidden costs to the production of electricity from fossil fuels. One of the pilot programs that the utility proposed involved replacing worn-out, smaller, electric water heaters with larger storage tanks, insulated and fitted with timers, and with time-of-use KWH meters used on the home. The idea was that peak loads would be reduced by heating water during off-peak periods.

I demonstrated how, for the same cost, a batch solar water heater could serve the same need and reduce usage an average of 2,200 KWH per year rather than the 200 KWH that would be saved by the proposed program. Just as it appeared that some progress was being made, retail

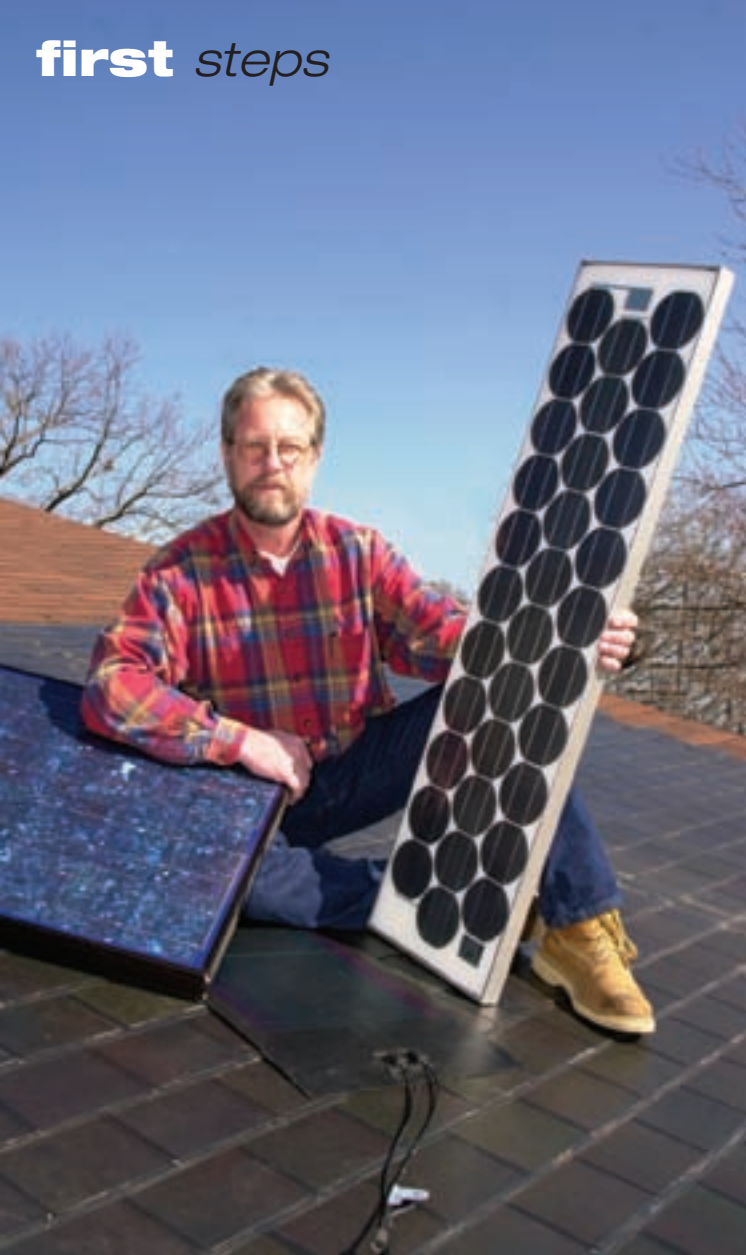

PV Smorgasbord: William Ball sitting on 1 KW of PV shingle while displaying a 77 W Solarex module, a 128 W laminate, and an ancient ARCO 32 W module.

competition was being discussed in California. In the face of a possible competitive market, the Arkansas utility decided that *no* programs would be enacted. The utility adopted “interruptible power” contracts to meet their demand-side management goals. I realized that I would need to try another approach.

Second, You Become an Activist

During the nineties, energy pricing remained relatively stable and low. Although solar-electric systems were coming down in price and up in reliability, unless your state or utility offered some kind of incentive, or you lived off-grid, it wasn't happening. It was clear that a lot of work would need to be done in the areas of education and public awareness.

At about the same time that I was intervening with the public service commission, I formed the Arkansas

Renewable Energy Association and the Arkansas Earth Day Committee. Both are nonprofit groups that sponsor events and seminars. For one project, we converted a 30-year-old postal van into a solar-electric vehicle full of displays. We began to tour the state, making steam, pumping water, and running fans and other appliances, all demonstrating the power of the sun.

One year for Earth Day, we raised enough money to sponsor a week-long tour all around the state with four solar-powered cars. By 1999, most people in the state had heard or seen something about renewable energy. It was time to turn it up a notch.

Politics Anyone?

It is said that you should never watch the making of laws or sausage. I wasn't really sure where to start, but I knew I needed two things—a draft bill and someone in the legislature to sponsor it. I began to research every incentive for renewable energy that I could find.

Based on my research, I wrote my first draft, which called for five major items:

- A green pricing program
- Emissions disclosure
- A state sales tax exemption
- A renewable portfolio standard that required the utilities to begin using RE
- Net metering

I secured sponsorship from a state representative and was ready for the 1999 session of the Arkansas legislature. As fate would have it, the same session undertook the effort to deregulate the electric utilities. It was an extended session that left my ideas undeveloped and relegated to interim study. It would not be until the following session in 2001 that a pared-down version of my bill that contained only net metering would be passed into law without a single “no” vote.

The law went into effect on October 1, 2001, but it was still too early to celebrate. Next it would go before the public service commission for rules, procedures, and contracts. It was time to put the *pro se* hat back on and make sure we got a fair shake. Finally after three years, seven appearances before legislative committees, and another intervention as a party to the net metering docket, it was time. Net metering was ready—can we build the house now?

Location, Location, Location

You know how you look and look for something only to find it right in front of you? That turned out to be the case when I began to look for just the right lot to build on. For several years, I had been driving by an undeveloped lot in the neighborhood every day on my way to the office. There was never a “for sale” sign and I really didn't think much about the vacant lot.

As my wife Marcie and I began to think about building a “spec” zero-energy home, we looked high, low, and all around for a suitable location. (Building a spec home refers to a builder/developer financing and building a home to



Mike Glancy from local utility Entergy Arkansas, Arkansas Renewable Energy Association president Bob Harp, and contractor William Ball cut the ribbon upon commissioning the net metering system.

be sold to an unidentified person after it is completed.) Everything we found was too far out of town, too expensive, or did not have optimal solar exposure. One evening on my way home, I noticed that the lot in the neighborhood had a “for sale by owner” sign posted. I stopped and walked over the property.

Here was a steep hill facing south with a wonderful view of the valley below. The steep slope probably kept others from building on the lot, but it was perfect for a solar home. Because of the grade, even the tops of the mature trees on the south side would never shade the roof. My office was two minutes in one direction and my home was two minutes in the other, right on the way coming or going. After a quick phone call, the lot was ours.

Design Support

There may have been a bit of a “be careful what you wish for” feeling, but at long last we were going to design and build a state-of-the-art solar home. I read years ago in a building publication that some 3,000 decisions need to be made in the course of building the average home. This home would be far from average, and because I planned to also expose it as a demonstration project, every decision was hashed and rehashed.

Once the basic decisions about the structure were worked out, we began to think about the PV system and our goal of the home being as near to “net zero” as possible. At this point we turned the proposed house plan over to the Arkansas Tech University Center for Energy, Natural Resources, and Environmental Studies for an energy

load evaluation. Tech, along with the Arkansas Energy Office, the DOE, Little Rock Million Solar Roofs Partnership, and of course, the Arkansas Renewable Energy Association, were all on board with the demonstration.

When the numbers came back from Tech, we knew we had met our goal of designing an energy-efficient structure. In a nutshell, this home would be about 82 percent more efficient than the average home, and require between 600 and 800 KWH of electricity per month. Considering Arkansas’ climate and average meter readings, the 2,800-square-foot (260 m²) home’s usage was low. It would require somewhere between 5 and 6 KW of PV to meet the goal.

After years of dreaming and months of planning, we were ready with the design of the home and the engineering of the equipment. All we needed now was to arrange our construction financing and we could break ground.

All the Way to the Bank

I wasn’t kidding myself. I knew it would be easier to get a loan for a US\$40,000 bass boat than getting a PV system rolled into a construction loan. Because this was a first for our region, the bank could only provide financing for the appraised value of the home, which would not include the costs of the solar-electric system.

Undeterred, I was ready to proceed. We would make it happen somehow. That somehow came in the form of Frank Kelly and his wife Jo. The previous year, I had presented several half-day seminars on PV for architects and engineers. Frank, a certified financial advisor, attended one of the sessions. He was deeply interested in solar energy.

PV laminated roof panels ready to go up on the roof.



Months later, Marcie and I were shooting grades on the lot, preparing to break ground when a neighbor walked over and said, "Hi Bill, what are you building?" It was none other than Frank Kelly. When I told him we were going to build a solar home, without hesitation he replied, "Well, we want it."

Frank said he could come up with the additional down payment that would be required to get the long-term mortgage financing. At long last, we were ready to begin construction. But first, we would need temporary electricity to run the saws, compressors, and other tools we would be using during construction.

Building with Solar Electricity

In 2000, my company designed and built two portable PV trailers for the Arkansas Energy Office for demonstration purposes. Each trailer sported a foldout array of 40 Solarex 60-watt modules. The panels had been installed previously at another state-supported project in Arkansas and were already almost fifteen years old. The reused modules were still producing at nearly 100 percent.

One of the trailers also featured a Trace 3,600-watt inverter and 18 KWH of battery storage. There was our temporary electricity. Chris Benson, the director of the energy office, agreed that the home would be a great place to demonstrate one of the trailers. And what could be better than using solar electricity to build a solar-powered home?

The Net Effect

See an upcoming issue of *Home Power* for a detailed article on the home's energy systems. The home has recently begun to net meter. Early results indicate that the home will indeed be able to "zero out" the electricity bill several months of the year. Since completion, the home has hosted workshops for state legislators, PSC commissioners and staff, state electrical inspectors, utility and electrical engineers, architects, and the general public.

In a way, it took over a decade to make this first home a reality in Arkansas, but now the lid is off the box. Stellar Sun has designed several more net-zero homes, two currently under construction. Several new commercial buildings in Little Rock will soon have grid-tied systems capable of making upwards of 10 percent of their load, and at least one sizable solar residential subdivision is on the drawing board. It took a lot of hard work and help from a lot of good people from all walks of life to help me prove what I said about renewable energy early in my career—"The future is now."



This 32-year-old postal van, which was converted to run on electricity, serves as a demonstration tool for various renewable energy technologies.

Access

William Ball, Stellar Sun, 2121 Watt St., Little Rock, AR 72227 • 501-225-0700 • Fax: 501-225-2920 • bill@stellarsun.com • www.stellarsun.com

Frank Kelly, homeowner, 27 Overlook Dr., Little Rock, AR 72207 • 501-225-8398 • frankkelly10@comcast.net

Arkansas Tech University Center for Energy, Natural Resources & Environmental Studies, Murray Clark, 1815 Coliseum Dr., Russellville, AR 72801 • 479-964-0877 • Fax: 479-964-0882 • murray.clark@mail.atu.edu • http://ces.atu.edu

Arkansas Energy Office, Chris Benson, #1 State Capitol Mall, Little Rock, AR 72201 • 800-558-2633 or 501-682-7319 • Fax: 501-682-2703 • cbenson@1800arkansas.com • www.1800arkansas.com/energy

City of Little Rock MSR Partnership, John Barr, City of Little Rock Public Works, 701 West Markham St., Little Rock, AR 72201 • 501-371-4646 • Fax: 501-371-4843 • jbarr@littlerock.state.ar.us



Ecovillage Training Center, Camp-Ups and Plenty present

Basic PV in Belize

A hands-on workshop
in the Toledo District of southern Belize,
December 6–10, 2004

Lodging and meal package. Lectures, labs and installs.
For info: www.thefarm.org/etc • hareef99@yahoo.com

1.800.329.3283

www.earthsolar.com • contact@earthsolar.com

EarthSolar, LLC • 6315 Canyon Dr. • Amarillo, Texas 79110

LOWEST PRICES IN THE NATION!

KYOCERA

KC120
120 Watts



KC125G, 125Watts **\$CALL**
KC167G, 167Watts **\$CALL**

KC167g
167 Watts



Southwest Windpower
Renewable Energy Made Simple

Call for Lowest Price in the Nation

H-40 Turbines
900W (180Kw mo. @ 15 mph avg)
\$CALL

H-80 Turbines
1000W (300Kw mo. @ 15 mph avg)
\$CALL

AIR X
• 12, 24, 48 Volt



Call for Lowest Price in the Nation



SunDanzer

SUN-MAR The World's Leader in Composting Toilet Technology

Excel Excel Compact
NE



DCR165 DC Refrigerator
DCF165 DC Freezer
DCR225 DC Refrigerator
DCF225 DC Freezer

Call for Lowest Price in the Nation



STABER
HXW2304
Super Efficient Washer

Call for Lowest Price in the Nation

Kill A Watt



Call for Lowest Price in the Nation

PRICES SO LOW WE CAN'T PRINT THEM!

bp solar



BP 3125, 125W **\$CALL**

SHARP

SHELL SIEMENS

SQ75, 12V **\$CALL**

UNI-SOLAR

US3, 2.8W US21, 21W
US5, 5W US32, 32W
US11, 10.3W US42, 42W
US64, 64W

WHISPER H-175 Turbines

"The Most Powerful Turbine of the Lineup"

3000W (820Kw mo. @ 15 mph avg)

Call for Lowest Price in the Nation



OutBack Power Systems

True Sine Wave inverters
FX2024 (2000VA continuous)
CALL FOR LOW QUOTE
FX2548 (2500VA continuous)
CALL FOR LOW QUOTE



MX60 Charge Controller
Fully adjustable setpoints to allow use with any battery.
CALL FOR LOW QUOTE



MATE System Display/Remote
Complete system remote.
PC compatible.
CALL FOR LOW QUOTE



Rolls-Surrette
Solar Deep-Cycle Batteries
FREE Freight on Quantity Orders!
CALL FOR DETAILS.



Model S-530 **\$CALL**
Model S-460 **\$CALL**
530 AH (100 hr rate)
460 AH (100 hr rate)
12.25" x 7.125" x 16.75"
117 lb (wet), 90 lb (dry)

NOTICE!

Services that Earth Solar provides:

If you purchase your system from Earth Solar we provide the following services absolutely free of charge:

- FREE Load Calculation & Design**
- FREE Code compliant engineering**
- FREE System diagrams**
- FREE Phone consultations**
- FREE Troubleshooting**

Earth Solar provides installation nationally and internationally.

Please call us if you have a project that needs a professional touch.

SOLAR CHILL

Solar Air Conditioning Available NOW!

\$CALL

Dankoff ETAPUMP
Integrated Systems



Call for Lowest Price in the Nation

GRUNDFOS SQFlex

Call for Lowest Price in the Nation

SEATPOWER
Prosine 2.5Kw True Sine Wave Inverters
12 Volt **\$CALL**
24 Volt **\$CALL**



Notepower 75 **\$CALL** Prosine 1000 GFCI **\$CALL**
Prowatt 150 **\$CALL** Prosine 1000 **\$CALL**
Prowatt 250 **\$CALL** Prosine 1800 GFCI **\$CALL**
Prowatt 800 **\$CALL** Prosine 1800 **\$CALL**
Prowatt 1500 **\$CALL** Prosine 3.0Kw 12V **\$CALL**
Prowatt 2500 **\$CALL** Prosine 3.0Kw 24V **\$CALL**

CONTACT US ABOUT OUR 2003-2004 SOLAR AND WIND SEMINARS! 1-800-329-3283 or contact@earthsolar.com

My

Bob Owens

©2004 Bob Owens

Solar-Heated

Hot Tub



Bob and Barbara Owens' hot tub in their screen room, with the solar hot water system running. Water from the collector flows into the hot tub when the tub needs a temperature boost.

What could be better than relaxing in your hot tub after a hard day's work? Relaxing in your *solar-heated* hot tub, of course! If you have put off purchasing or using a hot tub because of its high energy use, this article will show you how to heat your hot tub (spa) with solar energy.



The Owens' roof-mounted, flat-plate solar collector. Note the piping detail that allows the water to flow easily.

The basic design I used is the drainback solar hot water system, not to be confused with the freeze-prone draindown system. When the solar hot water pump is not operating, all the water is in the hot tub; the collector and piping contain only air. This provides freeze protection in cold climates. In this application, the hot tub serves as both the drainback tank and solar storage tank.

Hot tub temperature is generally maintained between 95 and 105°F (35–41°C), much hotter than pools are. So the black plastic solar collectors used to heat pools cannot be used for hot tubs. The higher temperatures require a glazed flat-plate collector or evacuated tubes. One or two flat-plate collectors will be needed. I used one, 3 by 7 foot (0.9 x 2.1 m) flat-plate collector for my hot tub. During the winter and on cloudy days, it needs help from an electric heater to maintain its temperature. Two collectors would allow higher temperatures to be maintained, and quicker recovery after cloudy days.

Design Choices

Dissolved oxygen and sanitizing chemicals (usually bromine) in hot tub water can cause a cast-iron pump to

deteriorate. Choose a circulation pump with a bronze or stainless-steel flanged body instead.

Also consider the maximum vertical height that the pump can push water. For collectors mounted at ground level or on top of a one-story roof, select a pump like the Taco 008B with a head capacity of about 15 feet (4.6 m). If you're mounting collectors on top of a two-story roof, choose a pump like the Taco 009B, which has a head capacity of about 30 feet (9 m). Be sure to order the pump with the mounting flange set. This allows threaded pipe to be attached to your pump, and for your pump to be removed easily for servicing.

The last item you need to select is a differential controller, which senses the temperature difference between two locations (the collector and the hot tub, in this case). The unit uses this temperature difference to control an internal relay, allowing your circulation pump to be cycled on and off as needed. The model I chose was the Goldline GL-30 differential control. It has proven itself to be a very reliable unit over the years, and comes with a five-year warranty.

If you want to digitally monitor your sensor temperatures, the GL-30 has an optional TD-GL display that integrates with the controller to give you up to three digital readouts (collector, storage, and auxiliary). You will also need to

Bob enjoys a glass of wine in his hot tub.





The Owens' hot tub with the solar step-box in its installed position, lid closed.

order two sensors for your controller. The SAS-10, 10 K sensor is the one that goes with the GL-30.

Different controllers may require different value sensors. Be sure to get the sensors that match your unit. I used a 10 K, strap-in sensor for both the collector and storage tank locations. In my system, the flat-plate unit is the collector and the hot tub is the storage tank.

Installation

First determine where you are going to put the pump and controls. Keep in mind that most circulation pumps should be mounted with the motor oriented horizontally. This will prolong bearing life. In my system, I also needed to install the pump below the water level of the hot tub since the pump is not self-priming, and needs the water for cooling while it is running. Access to a 120-volt, ground-fault circuit interrupter (GFCI) outlet or tapping into the hot tub's power supply will also be necessary to run the pump and controller.

Most hot tubs don't have the space to install both the pump and controller inside the cabinet. I chose to use a box to both house the equipment and serve as a step for easier access into and out of my hot tub. Steps are often sold as

accessories to your hot tub. Purchasing one and adapting it to pump storage is a possibility.

I built my box out of 1/2-inch and 3/4-inch (13 & 19 mm) pressure-treated plywood. The dimensions are 10 inches high, 18 inches wide, and 38 inches long (25 x 46 x 97 cm). The top of the box is covered with 1-inch by 4-inch (2.5 x 10 cm) pressure-treated pine slats over 1/2-inch (13 mm) plywood. This provides rigidity, water drainage, and a handsome top for our box. The top is hinged to allow easy access to the pump and controller.

To ensure complete drainage, mount the collector with the long dimension vertical and the manifold with a slight downward pitch—a minimum slope of 1/4-inch per foot (6 mm per 30 cm) is recommended. The hot water return pipe should also be as vertical as possible. For more details on collector and drain line installation, refer to Chuck Marken and Ken Olson's article about drainback systems in *HP97*.

Water Quality for Solar-Heated Pools & Hot Tubs

Keeping your pool or hot tub water's acidity in check is vital when you're using solar collectors with copper waterways. Ideally, you should use water with a pH of 7 (neutral). Distilled water (which has a neutral pH) is great if you have unlimited funds. Nonbillionaires usually opt for careful monitoring of the hot tub or pool water. Anything below a pH of about 6.5 will start to corrode the walls of copper tubes in a collector. Excessive amounts of chlorine or other acidic additives can drop the pH below the threshold of copper's corrosion resistance.

Public pools and spas are mandated to have a certain chemical composition for health and safety reasons. Many of these pools have water with a pH that will harm copper tubing. I can't remember seeing a solar-heated municipal pool that uses copper collectors.

If the pH of the water in your pool or tub is too acidic, consider installing a closed-loop heat exchanger. In this system, a stainless-steel plate heat exchanger transfers heat from a copper-friendly collector loop fluid to the acidic water in a pool or tub. This adds complexity and expense to a solar hot tub heater, but an ounce of prevention can be worth a set of collectors.

Many people have used the design that Bob shares with us in this article without any problem. Just make sure you keep the pH neutral or close to it.

—Chuck Marken

Because this system is unpressurized and circulates water of only 105°F (41°C), chlorinated polyvinyl chloride (CPVC) piping can be used to simplify installation. CPVC is a direct replacement for copper in residential hot water lines. It is rated for continuous use at 100 psi at 180°F (82°C).

If you have never worked with CPVC piping, this is a great beginner's project. You work with it just like you would the PVC piping used in outdoor plumbing projects and lawn sprinkler systems. Make all cuts at 90 degrees with a miter box. Use CPVC glue formulated for this type of pipe and fitting. CPVC pipe is treated to be UV tolerant, but prolonged sun exposure requires it be painted with a latex paint for protection.

All hot tubs have a faucet (hose bib) at a low point in their plumbing to allow for drainage using a hose. Tie the pump intake line into the hot tub plumbing at the faucet, moving the faucet closer to the pump so it can be used to vent air when priming the pump. This will still allow the hot tub to be drained. Install a ball-type shutoff valve into the intake line. This allows the pump to be removed for service without having to drain the hot tub. To reduce strain on the plumbing, support the pump in the horizontal position with suitable mounting hardware.

Install the hot water line from the collector panel so that it will completely drain into the hot tub. This is accomplished

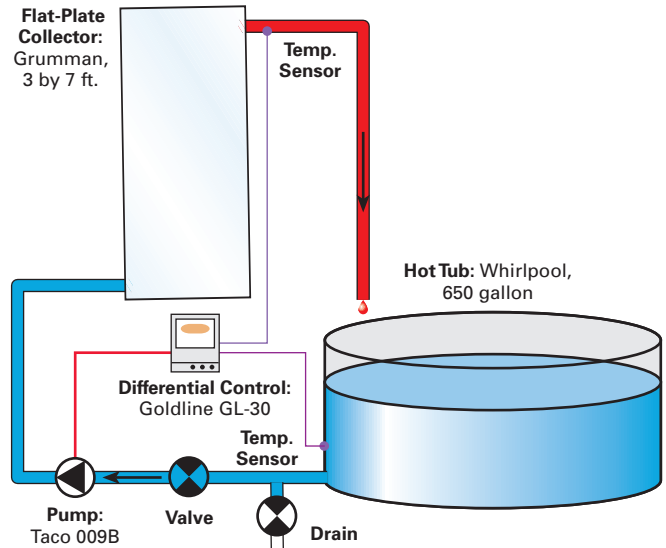

Collectors and pipes should be slightly slanted to allow the water to drain from the collectors.

by always having the pipe run downhill. Use either 3/4- or 1-inch pipe so air can easily return to the collector when the pump stops. Bring the pipe over the top of the hot tub, with its end a few inches above the water line so air can enter.

I mounted the controller inside the step box, and wired it according to the manufacturer's directions. Romex cable was used from the controller to the pump, and two-conductor thermostat wire to the two sensors. I attached one sensor to the collector panel with a screw clamp and the other to the inside of the hot tub below the water line with aluminized foil tape used for air conditioning (not regular duct tape).

Attach the collector panel sensor onto the hot water output line, out of direct sunlight, and cover it with a piece of foam pipe insulation. All connections should be soldered and taped. Before making the final connections to the controller, use an ohmmeter to check that the circuits are reading a resistance that matches the air or hot tub temperature.

Vent any air in the line to the pump by opening the faucet. Initially, this may need to be done several times before the pump is primed and pumping correctly. Check for leaks. Monitor the pump through a couple of on/off cycles to check the sensor and controller function. That's all there is to it.

Bob uses a multimeter to test the voltage to the pump relay.



Hot Tub Solar H₂O Costs

Item	Cost (US\$)
Grumman solar collector, 3 x 7 ft.	\$300
Taco 009B pump	300
Pipe, fittings, glue, etc.	200
Goldline GL-30 controller	150
Shipping	100
Crating	75
System Total	\$1,125

Tech Specs

System type: Drainback solar hot water
Location: Brandon, Florida
Climate: Mild, nonfreezing
Solar resource: 5.3 average daily peak sun hours
Percentage of hot water produced annually: 75%
Maximum hot tub temperature: 105°F
Collector: Grumman, 3 x 7 ft.
Heat transfer fluid: Tap water
Collector installation: Roof, facing south with 30 degree collector tilt
Circulation pump: Taco 009B
Pump controller: Goldline GL-30

Relax & Enjoy

My wife Barbara and I first became familiar with the hot tub lifestyle twenty years ago when we lived in a Florida condominium. Some of our friends and neighbors enjoyed hot tubs that they had installed on their balconies. We spent many evenings in their hot tubs, enjoying glasses of wine and watching the sun set. When we settled in Tampa, Florida, we took our hot tub with us and set it up in our screen room where it still sits today.

As I became more involved in the environmental movement, I started working on energy-related projects around the home. While looking through back issues of *HP*, I saw an ad for a hot tub heated with wood. There was no way I could cut and burn wood in the city, but solar hot water panels could do the job! I installed a domestic solar hot water system for our home (see *HP93*). After consulting with Smitty at AAA Solar in Albuquerque, New Mexico, I took the plunge and ordered everything I needed for my solar hot tub retrofit. Now, most evenings I sit back, relax, and enjoy our solar-heated hot tub!

Access

Bob Owens, 1338 Corner Oaks Dr., Brandon, FL 33510 • 813-684-4648 • Bowens1@tampabay.rr.com

AAA Solar Supply Inc., 2021 Zearing NW, Albuquerque, NM 87104 • 800-245-0311 or 505-243-4900 • Fax: 505-243-0885 • info@aaasolar.com • www.aaasolar.com

Goldline Controls Inc., 61 Whitecap Dr., North Kingstown, RI 02585 • 800-294-4225 or 401-583-1100 • Fax: 401-583-1200 • technical_service@goldlinecontrols.com • www.goldlinecontrols.com • Goldline controls

Taco Inc., 1160 Cranston St., Cranston, RI 02920 • 401-942-8000 • Fax: 401-942-2360 • marcha@taco-hvac.com • www.taco-hvac.com • Taco pumps

"Florida Batch Water Heater," by Robert Owens, *HP93*

"SDHW Installation Basics, Part 3: Drainback System," by Chuck Marken & Ken Olson, *HP97*



HELIOTROPE THERMAL



DELTA-T

For automatic operation of solar heating systems

DTT-84 & DTT-94 differential controls established the standards almost 30 years ago and their reliability has been proven in nearly a million installations.



SCV "Soft" Solar Check Valve

Symbol of reliability



HELIOTROPE THERMAL

4910 Seaport Ave.
Richmond Ca 94804
415.237.9614 Voice
415-237-7018 Fax
info@heliotropethermal.com



Dealer Inquiries Welcome!
Visit Our Online Store at
www.Affordable-Solar.com

Products

- Affordable Solar Bookstore
- Appliances Energy Efficient
- Batteries & Accessories
- Charge Controllers
- DC Voltage Converters
- Education
- Electrical & Safety Supplies
- Inverters
- Inverter Accessories
- Inverters by Manufacturer
- Meters
- Mounts & Trackers
- Power Panels
- Power Panel Accessories
- Pre-Packaged Systems
- Solar Lighting Systems
- Solar Panels
- Solar Panels by Manufacturer
- Solar Water & Pool Heating
- Water Pumps & Accessories
- Wind Generators & Towers

Featured This Month

KYOCERA

KYOCERA Solar, Inc.

KC167G	167W
KC125G	125W
KC120	120W
KC80	80W
KC70	70W
KC60	60W
KC50	50W
KC45	45W
KC40	40W
KC35	35W

W/ MC connectors \$612
W/ MC connectors \$458

All Multi-crystal



\$449
\$323
\$292
\$265
\$219
\$205
\$195
\$169



BP3160B	160W	24V	\$609
BP3125U	125W	12V	\$479
BP380U	80W	12V	\$315



Shell Solar

Shell 175-PC	175W	24V	\$699
Shell 165-PC	165W	24V	\$669
Shell 85-P	85W	12V	\$349
Shell 80-P	80W	12V	\$317

Concorde

PVX-2120L	12V	210 amp-hr	\$317
PVX-2240	6V	220 amp-hr	\$159



TriStar TS-60	60 amp	\$179
---------------	--------	-------



VFX3524	3500W	24V	Call for Sale Price
---------	-------	-----	---------------------

MX60 Charge Controller	\$499
------------------------	-------

Surrette

S-460	6V	460 amp-hr	\$169
-------	----	------------	-------

Servel

RGE 400	8cu.ft	Propane	\$975
---------	--------	---------	-------

Crystal Cold

18cu.ft	Propane	\$2,099
---------	---------	---------



Southwest Windpower



12V 400W Wind Turbine	\$499
-----------------------	-------

Complete Systems

1.5 kW Solar Electric System for Off Grid Remote Home	\$9,999
---	---------

Welcome Message

Welcome to Affordable Solar! Our staff has over two decades of solar electric system experience. Our online store has solar panels, wind turbines, inverters, solar water pumps, solar pool systems, solar hot water systems and other solar and wind electric power equipment.

Brands & Pricing

We sell solar and wind energy products wholesale to the public like BP Solar, Dankoff Solar, Evergreen, Fronius, Heart, Isofoton, Kyocera, OutBack, Photowatt (Matrix Solar), RWE Schott (ASE), Sanyo, Sharp, Shell (Siemens), SMA Sunny Boy, Solar Converters, Statpower, SunWize, UniSolar, and Xantrex (Trace).

Appliances

At Affordable Solar we also offer energy efficient and propane appliances such as refrigerators, freezers, clothes washers, sun ovens, composting toilets, and propane stoves from manufacturers such as Conserv, Crystal Cold, Danby, Equator, Frostek, Peerless, Servel, Staber, Sun-Mar and others.

Knowledge & Expertise

Talk with our Affordable Solar staff about how to design your own solar or wind energy system for on grid or offgrid location; how to choose the best solar powered water pumping system; how to use a composting toilet; what is the best solar panel charge controller combination to use with your RV or marine application; and to learn when to choose a modified sine wave inverter versus a true sine wave inverter.

Featured Brands

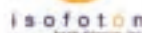

Whether it's for environmental, political, or health reasons, many homeowners today are turning over a new leaf and building green. Besides producing their household's electricity from renewable energy sources like the sun and wind, many are incorporating natural, recycled, or reclaimed building products into their home's design and construction.

TOP 10

Eco-Friendly Building Products

Rachel Connor & Laurie Stone, with Dan Chiras

©2004 Rachel Connor & Laurie Stone, with Dan Chiras

By choosing green building products, you can help conserve our dwindling supply of nonrenewable resources, divert and reuse materials once destined for landfills, and minimize the impacts on our remaining forests. Using green materials and energy-efficient products also can decrease the amount of energy required to heat and cool your home—reducing your utility bills—and can help make your home a healthier place for you and your family.

"A decade ago, green building was stymied by the lack of product; there was only a handful of green building materials on the market," says author and green building expert Dan Chiras. "Today, the number is approaching two thousand and expanding rapidly."

Although building green can be costlier upfront, it pays off in the long run, saving homeowners money by reduced replacement costs, greater energy efficiency, and higher performance and durability.

If you're interested in building green, where do you begin? And how can you spare your pocketbook, while supporting good planetary practices? To help guide your decision-making, *Home Power's* green building editors asked Dan to choose his top ten green building products. Dan is the author of numerous books on ecological building, including *The Natural House*, *The New Ecological Home*, and *The Natural Plaster Book*. Here is his list, with our narratives.

Straw bale with a southern flair: Michael Pierce and Elise Lang's Farmington, Georgia, home.



Courtesy Shawn Schreiner



Courtesy Enviroshake

ENERGY-EFFICIENT WINDOWS

Windows provide light, permit views, and connect us to the outside world. However, during cold weather, a typical home can lose more than 25 percent of its conductive heat through its windows. Windows also can admit an overabundance of solar radiation, causing uncomfortable temperature swings within the house. Ideally, a window should provide ventilation and thermal insulation, and mitigate unwanted solar heat gain.

Single-paned window units have an insulative value of approximately R-1; double-paned windows have an R-value of 2. And “superwindows,” or high performance windows, which incorporate special plastic films, low-emissivity (low-E) coatings, and gas-filled space (argon or krypton gas)

between the panes, can have R-values above R-4. The higher the R-value, the more energy efficient your window, and the more comfortable your home will be.

Thin plastic films, like Southwall Technologies’ Heat Mirror, are factory stretched between a window’s double panes to create additional insulating spaces. These films also may be coated with low-E coatings to increase the window’s R-value. Low-E coatings allow visible light to pass through, but block longer wavelength infrared radiation (heat). By specifying the number and placement of these low-E coatings, you can optimize window energy efficiency and maximize your home’s thermal comfort. Argon or krypton gas, instead of air, can be used between the panes of glass to minimize conduction inside the window, further increasing its insulative value.

When you’re replacing windows in your home, remember that installing standard windows in a highly insulated wall can compromise the building envelope’s overall insulation value. Purchase the highest performance windows you can afford, and be sure that window installers carefully seal and reinsulate the rough window openings to minimize air leakage. Poor installation can negate the energy gains of a super-efficient window.

Replacing windows can be expensive, but there are cost-effective alternatives, including using window films, shades, shutters, and insulation panels. A proper edge seal, and radiant and vapor barriers all increase the performance of these products.

ENVIRONMENTALLY FRIENDLY INSULATION

The most common form of insulation in homes today is fiberglass, fabricated primarily from silica sand, which is spun into glass fibers and held together with an acrylic or phenol-formaldehyde binder. Studies have shown that fiberglass insulation may pose a health risk to applicators who may inhale the fibers. Workers and residents may also be exposed to formaldehyde used as a binding agent. Formaldehyde is released from insulation during and after installation.

In studies performed in the 1990s by the medical research arm of the U.S. Department of Labor, three different kinds of glass fibers were found to be toxic to cells and to damage DNA. In a 1994 article in the *American Journal of Industrial Medicine*, John R. Goldsmith, MD, summed up the current research by stating that fiberglass has “been shown by industry-sponsored studies in Europe and the United States to be associated with possibly increasing the risk of mortality from lung cancer and chronic pulmonary disease.”

Formaldehyde is classified by the International Agency for Research on Cancer as a “probable human carcinogen.” In some individuals, formaldehyde exposure can cause eye, nose, and throat irritation, headache, nausea, and a variety of asthma-like symptoms. Many fiberglass insulation manufacturers have replaced the formaldehyde binders with more benign acrylic binders.

Due to its recycled content, and superior energy and acoustic performance, cellulose insulation is an environmentally preferable product that is cost-competitive



Courtesy Rivertown Media & Communications

Scrap paper gets new life as Nu-Wool cellulose insulation.

with fiberglass. Paper waste composes 75 to 95 percent of cellulose insulation. Unlike some fiberglass insulation, cellulose insulation does not contain formaldehyde-based binders that can off-gas. Up to 25 percent of the product is composed of ammonium sulfate or borate—nontoxic chemical additives that provide insect- and fire-resistant qualities. The borate additive is more desirable—ammonia sulfate can cause significant odor problems if it is not applied precisely to specifications. Although wet blown insulation is much healthier than its fiberglass counterpart, chemically sensitive individuals may want to order loose-fill cellulose made without recycled newsprint.

Other eco-friendly insulation alternatives also are available, such as insulation made from recycled cotton, perlite (volcanic rock), and mineral wool (from recycled steel slag or rocks).

3



Courtesy www.phoenixorganics.com

LOW- AND ZERO-VOC FINISHES

Paints and finishes may be one of the leading causes of indoor air pollution, releasing low levels of toxic substances into the air for months after application. The source of these toxic substances is a variety of volatile organic compounds (VOCs) that, until recently, were used to improve the performance and durability of coatings. New environmental regulations and consumer demand have spurred the development of low- and zero-VOC paints and finishes. These products are durable, affordable, and pose less harm to human health and the environment.

Low- and zero-VOC paints, stains, and finishes use water instead of petroleum-based solvents as a carrier. The carrier keeps the paint in a liquid state for easy application. As the paint dries, the carrier evaporates, leaving a film of coating.

Paints with petroleum-based solvents contain substantial amounts of VOCs, which can off-gas into the surrounding area as the paint dries. Levels of VOCs in waterborne paints are significantly lower than solvent-borne coatings. The actual amount of VOCs can vary from product to product, but is listed on the paint can. Low-VOC paints will still emit an odor until dry. If you are particularly sensitive, buy paint that contains fewer than 25 grams of VOCs per liter.

A U.S. Environmental Protection Agency (EPA) standard allows any paint with 0.5 grams of VOCs per liter or less to be labeled "zero-VOC." Although zero-VOC paints pose fewer risks to your health and to the environment than paints containing high levels of VOCs, even many zero-VOC paint formulas still contain toxic ingredients, including acetone, ammonia, formaldehyde, and biocides. And these chemicals can have serious adverse effects on indoor air quality. Adding a color tint can raise the VOC level from zero to 10 grams per liter.

Natural paints and finishes are formulated with plant-based, instead of petroleum-based, ingredients like plant oils, dyes, and resins. They also may incorporate milk casein, natural latex, and beeswax; and minerals such as clay, chalk, and earthen pigments. Water-based natural paints give off almost no odor. Plant-oil-based natural paints usually have a fresh fragrance of citrus or essential oils. According to the Green Affordable Housing Coalition, a group of San Francisco Bay Area green building design professionals, allergies and sensitivities to these paints are uncommon.

ENGINEERED LUMBER

Because of knots, pitch pockets, and other inconsistencies, only part of a log may be suitable for processing into high-grade dimensional lumber. In contrast, engineered wood products can make use of 60 to 70 percent of the raw material, and their production is not dependent upon a diminishing supply of old-growth timber. Engineered wood products can be made using second-growth resources and nontraditional wood species that aren't endangered. Even though they're made from smaller trees, they are often stronger and straighter than traditional lumber products.

Glue-laminated beams (glue-lams) are engineered for strength by bonding smaller pieces of wood together to create a larger beam that is stronger than any similarly sized piece of solid lumber. This combined strength enables a builder to achieve spans not normally possible with standard dimensional lumber. Trus Joist's TJI joists are a high-tech combination of an OSB material and flanges made from a laminated veneer lumber or sawn lumber. TJI Joists are resource-efficient—consuming up to two-thirds less wood than traditional sawn lumber—and manufactured to resist bowing, shrinking, and twisting caused by changes in temperature and moisture conditions. Using these joists can reduce the amount of wood required in a residential flooring or roofing system by at least 50 percent.

4



Courtesy Trus Joist-Weyerhaeuser

STRAW BALES, ADOBE, STRAW-CLAY, AND NATURAL PLASTERS

According to Dan, an essential criterion for what makes a building material “green” is its embodied energy—the amount of energy required to extract or harvest the raw materials that are used to manufacture the products, process the materials to create finished merchandise, and transport both the raw and finished materials during the various stages of the production-consumption cycle. From an ecological standpoint, the lower a material’s embodied energy, the better. Building with local, natural materials, such as earth and straw, dramatically reduces the total embodied energy of a new home or remodeling project, and also makes a healthy, beautiful home. For more information on the embodied energy of building materials, and building with earth and straw, see “From the Ground Up: Natural House Building Primer” in *HP99*.



Courtesy Shawn Schreiner

Satomi Lander of Kingston, New Mexico, demonstrates the artful technique of applying earthen plaster to this straw bale home.



Courtesy © 1996 Forest Stewardship Council A.C.

The FSC logo identifies products that contain wood from well-managed forests in accordance with the rules of the Forest Stewardship Council.

FOREST STEWARDSHIP COUNCIL (FSC) CERTIFIED LUMBER

In many forests around the world, logging practices continue to destroy habitat, pollute water, and displace indigenous peoples. While many environmentalists strive to minimize the use of wood in construction, avoiding wood use altogether is difficult. Fortunately, the FSC, a nonprofit organization that encourages the responsible management of the world’s forests, has developed a set of principles and criteria for forest management that address legal issues, indigenous rights, labor rights, and environmental impacts surrounding forest management. FSC-certified lumber is available around the world. For a list of FSC-certified product manufacturers visit their Web site (see Access).

PLASTIC LUMBER

According to the Food and Agriculture Organization of the United Nations, the world lost 39.7 million acres of forest each year during the 1990s. Today, alternatives to lumber abound, especially for outdoor projects. Many companies now manufacture plastic lumber made from 100 percent recycled materials. Trex decking and railing products are made primarily from recycled plastic grocery bags, reclaimed industrial plastic wrap, and waste wood from woodworking manufacturers. The combination of reclaimed wood and plastic capitalizes on the best qualities of each material. Plastic shields the wood from moisture and insect damage, preventing rot and splintering, and wood protects the plastic from ultraviolet damage and lends a solid, natural feel to the material. Once installed, these products are nearly maintenance free, providing years of durable performance. Many consumers are choosing plastic lumber as a safer substitute for pressure-treated (also known as CCA-treated) wood, which has been impregnated with toxic preservatives.



Courtesy Trex Company Inc.



Courtesy Raker Creative LLC/Re-New Wood Inc.

Eco-shake roofing shingles are made from post-industrial recycled PVC and 100 percent reclaimed wood fibers.

ENVIRONMENTALLY FRIENDLY ROOFING MATERIALS

Most homeowners know from experience that asphalt roofs need to be replaced every ten to twenty years. These “disposable roofs” produce a vast amount of waste—more than 11 million tons each year, according to shinglerecycling.org. However, new roofing products are paving the way for recycled rooftops across the country.

Teel’s Panelshakes are made from post-consumer plastic milk jugs and waste wood fibers. Enviroshakes incorporate a mixture of post-industrial recycled plastic, recycled rubber elastomers from tires, and cellulose fiber materials. Re-new Wood’s Eco-shake combines two recycled materials: reinforced vinyl and cellulose fiber. The Eco-shake shingle dramatically reduces the amount of materials that would otherwise find its way into landfills, and helps preserve forests by using only waste wood products. The shingles come with 50-year warranties. And because this product resists fire and hail, many insurance companies offer substantial discounts—up to 28 percent—for homes on which they’ve been installed, says David Adamson, founder of EcoBuild, a green-building consulting firm in Boulder, Colorado.

RECYCLED TILE

Environmentally friendly materials for flooring, countertops, and bathroom surfaces include sustainably harvested wood and grass, and resilient products composed of natural, nontoxic, and recycled materials. Dan’s favorite—tile made with recycled materials—reuses a common waste material and turns it into a durable, maintenance-free building material. Many recycled tiles are made from 100 percent recycled glass. These tiles take less than one-half of the energy to produce than ceramic tile, and use less than one-fourth of the energy required to produce a cast-glass tile.

Bedrock Industries’ Blazestone tiles, available in a variety of hues and shapes, are created from post-consumer and post-industrial recycled glass. They offer several colors (cloud white, pond, cedar, turtle, and java) made with only 100 percent post-consumer recycled glass. Aurora Glass produces a range of luminous recycled glass tiles, from 1-inch accent tiles to 6-inch field tiles, made from recycled window and other glass products that would otherwise wind up in a landfill. Sandhill Industries fabricates their richly colored tiles from 100 percent post-industrial plate glass. And Terra Green Ceramics offers three series of recycled glass tile, all manufactured with at least 58 percent recycled glass content, the majority of which comes from airplane windshields. These recycled tiles, which are well suited for bathroom and shower wall applications, may be used as an accent in combination with a field of less expensive tile.



Courtesy Jerry Stone/Terra Green Ceramics Inc.

LOW- AND NO-FORMALDEHYDE PRESSED WOOD PRODUCTS

Particleboard is widely used in cabinets and furniture. Unfortunately, conventional particleboard uses formaldehyde as a preservative and in its binder. Low doses of formaldehyde, which can off-gas from particleboard products, cause watery eyes or burning sensations in the eyes, nose, and throat. Larger doses can cause nausea, breathing difficulties, headache, and fatigue. High doses can cause asthma attacks. Both the EPA and the National Institute for Occupational Safety and Health classify formaldehyde as a “probable human carcinogen.” Today some types of particleboard are now manufactured with resin binders that do not contain formaldehyde. If formaldehyde-free particleboard or plywood products are not available in your area, the next best choice is to seal the particleboard to prevent formaldehyde off-gassing.

Oriented strand board (OSB) is a construction panel made with layers of wood “strands” that are aligned, formed into panels, and pressed with an exterior-grade adhesive resin. Exterior-grade OSB contains phenol formaldehyde, which is less harmful than the urea formaldehyde used in interior-grade plywood. According to the EPA, pressed woods that contain phenol formaldehyde resin generally emit lower levels of formaldehyde than those containing urea formaldehyde resin.



Free of formaldehyde binders, Advantech oriented strand board (OSB) carries a 50-year limited warranty.

Green Guidelines

Decided to go green? Consider these criteria when you're choosing a particular product:

- Manufactured by socially and environmentally responsible companies
- Produced sustainably—harvested, extracted, processed, and transported efficiently and with minimal impact to the environment
- Low embodied energy
- Locally produced
- Made from recycled materials
- Made from natural or renewable materials
- Durable
- Recyclable
- Nontoxic
- Nonpolluting

—Adapted from *The New Ecological Home: A Complete Guide to Green Building Options* by Daniel Chiras

Access

Rachel Connor & Laurie Stone, Solar Energy International, PO Box 715, Carbondale, CO 81623 • 970-963-8855 • Fax: 970-963-8866 • sei@solarenergy.org • www.solarenergy.org

Dan Chiras, Sustainable Systems Design, 9124 Armadillo Trail, Evergreen, CO 80439 • 303-674-9688 • danchiras@msn.com • www.danchiras.com

Aglaia Natural Paints, Environmental Building Supplies, 819 SE Taylor St., Portland, OR 97214 • 800-322-6843 or 503-222-3881 • Fax: 503-222-3756 • ebs@ecohaus.com • www.aglaiapaint.com • Natural, plant-based paints & finishes

American Formulating & Manufacturing (AFM) • 800-239-0321 or 619-239-0321 • info@afmsafecoat.com • www.afmsafecoat.com • Low- & zero-VOC paints & finishes

Aurora Glass, 2345 W. Broadway, Eugene, OR 97402 • 888-291-9311 or 541-681-3260 • Fax: 541-681-8755 • auroraglass@auroraglass.org • www.auroraglass.org • Recycled glass tile

Bedrock Industries, 1401 W. Garfield St., Seattle, WA 98119 • 877-283-7625 or 206-283-7625 • Fax: 206-283-0497 • info@bedrockindustries.com • www.bedrockindustries.com • Recycled glass tile

BioShield Paints, 1330 Rufina Cir., Santa Fe, NM 87505 • 800-621-2591 or 505-438-3448 • Fax: 505-438-0199 • info@bioshieldpaint.com • www.bioshieldpaint.com • Natural, plant-based paints & finishes

Enviroshake, PO Box 1462, Chatham, Ontario, Canada N7M 5W8 • 866-423-3302 or 519-380-9265 • Fax: 519-380-0689 • info@enviroshake.com • www.enviroshake.com • Enviroshake recycled-content roofing shingles

Forest Stewardship Council, 1155 30th St. NW Ste. 300, Washington, DC 20007 • 202-342-0413 • Fax: 202-342-6589 • info@fscus.org • www.fscus.org • Database of FSC-certified product manufacturers

Huber Engineered Woods, 1 Resource Sq., 10925 David Taylor Dr. Ste. 300, Charlotte, NC 28262 • 800-933-9220 • www.huberwood.com • Formaldehyde-free oriented strand board (OSB)

Re-New Wood Inc., PO Box 1093, Wagoner, OK 74467 • 800-420-7576 or 918-485-5803 • customerservice@ecoshake.com • www.ecoshake.com • Eco-shake recycled-content roofing shakes

Sandhill Industries, 6898 S. Supply Way Ste. 100, Boise, ID 83716 • 208-345-6508 • 208-345-4424 • sales@sandhillind.com • www.sandhillind.com • Recycled glass tile

Southwall Technologies Inc. • 800-365-8794 or 650-962-9111 • Fax: 650-967-8713 • archsales@southwall.com • www.southwall.com/products/heatmirror.html • Heat Mirror window film

Teel Global Resource Technologies, 426 Hitchcock St., Baraboo, WI 53919 • 800-322-8335 • Fax: 608-355-3088 • www.teel-grt.com • Panelshakes recycled-content roofing shingles

Terra Green Ceramics Inc., 1650 Progress Dr., Richmond, IN 47374 • 765-935-4760 • Fax: 765-935-3971 • custsrv@terragreenceramics.com • www.terragreenceramics.com • Recycled glass tile

Trex Company Inc. • 800-289-8739 • question@trex.com • www.trex.com • Plastic lumber

Trus Joist-Weyerhaeuser, 200 E. Mallard Dr., Boise, ID 83706 • 800-338-0515 or 208-364-1200 • Fax: 208-364-1300 • www.trusjoist.com • Engineered wood products

The New Ecological Home: A Complete Guide to Green Building Options, Daniel Chiras, 2004, Paperback, 336 pages, ISBN 1-931498-16-4, US\$35 from Chelsea Green, PO Box 428, White

River Junction, VT 05011 • 800-639-4099 or 802-295-6300 • Fax: 802-295-6444 • info@chelseagreen.com • www.chelseagreen.com

GreenSpec Directory, 4th ed., Dwight Holmes, Larry Strain, Alex Wilson, & Sandra Leibowitz, 2004, Paperback, 448 pages, ISBN 1-929884-12-5, US\$89 from BuildingGreen Inc., 122 Birge St. Ste. 30, Brattleboro, VT 05301 • 800-861-0954 or 802-257-7300 • Fax: 802-257-7304 • info@buildinggreen.com • www.buildinggreen.com • Online version also available

Green Building Materials: A Guide to Product Selection and Specification, Ross Spiegel & Dru Meadows, 1999, Hardcover, 336 pages, ISBN 0-47129-13-31, US\$75 from John Wiley and Sons, 10475 Crosspoint Blvd., Indianapolis, IN 46256 • 877-762-2974 • Fax: 800-597-3299 • www.wiley.com



BIO SHIELD
Healthy Living Paints
Zero VOC Interior Paints, Clay-based Wall Coverings, Color Washes, Pigments and Milk Paints.
NEW! Aqua Resin Stain Finish Water-based, Zero VOC Interior/Exterior Wood Stains.
For a FREE Color Catalog call us at (800) 621-2591
www.bioshieldpaint.com

new from CHELSEA GREEN PUBLISHING
The New Ecological Home
A Complete Guide to Green Building Options
by DANIEL D. CHIRAS
\$35 | Paperback
8 X 10 | 336 pages
88W Illustrations and Photographs
Resource Guide | Appendices
Glossary | Index
The most comprehensive overview of green building techniques, materials, products, and technologies for environmentally conscious home buyers and builders.
www.chelseagreen.com
800.639.4099

This is a great one! It will inspire a whole generation of builders to treat more lightly on the Earth. —Doug Pratt, Real Goods Technical Editor

Other books by Dan Chiras from Chelsea Green
The Natural Home A Complete Guide to Healthy, Energy-Efficient, Environmental Homes \$25.00 | paperback 8 x 10 | 400 pages
The Solar House Passive Heating and Cooling \$29.95 | paperback 8 x 10 | 200 pages

ēco-shake®

The genuine wood shake alternative.



Re-New Wood, Inc (800) 420-7576 www.ecoshake.com

Working For Your Environment.

DEKA SOLAR
RENEWABLE ENERGY GEL BATTERIES



TECHNOLOGICALLY-ADVANCED AND ENVIRONMENTALLY-CONSCIOUS.

East Penn recycles 100% of scrap lead-acid batteries at our state-of-the-art, E.P.A. permitted recycling facility. In fact, we safely recycle 20,000 batteries a day on site.

We are the world's largest and most modern single-site battery manufacturer offering premium quality valve regulated lead acid batteries in both Gel and AGM types to exceed the solar industry's high standards.

QUALITY SYSTEM
REGISTERED
ISO 9001

PROVEN PRODUCT IN DEMANDING PHOTOVOLTAIC APPLICATIONS • LESS THAN 2% PER MONTH STAND LOSS MEANS LITTLE DETERIORATION DURING TRANSPORT AND STORAGE
U.L. RECOGNIZED COMPONENT • MINIMUM MAINTENANCE • COMPETITIVE WARRANTY • MADE IN THE U.S.A.



DOMESTIC INQUIRIES:
800-372-9253 • solarinquiries@mkbattery.com

EAST PENN
manufacturing co., inc.

INTERNATIONAL INQUIRIES:
610-682-3263 • www.dekabatteries.com

Intro to Hydropower

Part 2: Measuring Head & Flow

Dan New

©2004 Dan New

Measuring the stream course—Anna and Joe work downstream, shooting vertical drop (head) with a sight level, and getting a rough measurement of the pipe run at the same time.

Small-scale hydro is the only renewable energy source that works for you 24 hours a day, 7 days a week. In the first article in this series (*HP103*), I explained the basics of hydroelectric system theory, and reviewed system components. This article focuses on measuring a stream's head and flow. Before you can begin designing your hydro system or estimating how much electricity it will produce, you'll need to make four essential measurements:

- Head (the vertical distance between the intake and turbine)
- Flow (how much water comes down the stream)
- Pipeline (penstock) length
- Electrical transmission line length (from turbine to home or battery bank)

This article will discuss how to measure head and flow. Head and flow are the two most important facts you need to know about your hydro site. You simply cannot move forward without these measurements. Your site's head and flow will determine everything about your hydro system—

pipeline size, turbine type, rotational speed, and generator size. Even rough cost estimates will be impossible until you've measured head and flow.

When measuring head and flow, keep in mind that accuracy is important. Inaccurate measurements can result in a hydro system designed to the wrong specs, and one that produces less electricity at a greater expense.



A handheld sight level, or peashooter, is a handy and inexpensive tool for determining the head of your hydro site.

Measuring Head

Head is water pressure, created by the difference in elevation between the intake of your pipeline and your water turbine. Head can be measured as vertical distance (feet or meters) or as pressure (pounds per square inch, newtons per square meter, etc.). Regardless of the size of your stream, higher head will produce greater pressure—and therefore higher output—at the turbine.

An altimeter can be useful in estimating head for preliminary site evaluation, but should not be used for the final measurement. It is quite common for low-cost barometric altimeters to reflect errors of 150 feet (46 m) or more, even when calibrated. GPS altimeters are often even less accurate. Topographic maps can also be used to give you a very rough idea of the vertical drop along a section of a stream’s course. But only two methods of head measurement are accurate enough for hydro system design—direct height measurement and water pressure.

Direct Height Measurement

To measure head, you can use a laser level, a surveyor’s transit, a contractor’s level on a tripod, or a sight level (“peashooter”). Direct measurement requires an assistant.

One method is to work downhill using a tall pole with graduated measurements. A measuring tape affixed to a 20-foot (6 m) section of PVC pipe works well. After each measurement, move the transit, or person with the sight level, to where the pole was, and begin again by moving the pole further downhill toward the generator site. Keep each transit or sight level setup exactly level, and make sure that the measuring pole is vertical. Take detailed notes of each measurement and the height of the level. Then, add up the series of measurements and subtract all of the level heights to find total head.



View through the sight level—Anna measured 7 feet 4 inches on the leveling rod. By subtracting the height of her eye, she determined the head for this section to be 1 foot 8 inches.

Another method is to work uphill, with your assistant walking up the slope as you site through the transit or sight level until the bottoms of the assistant’s feet are level with the transit. At this point, the head will be the same as the distance from your eye to the ground where you are standing. Once you’ve recorded this measurement, move to the spot where your assistant was standing, and repeat the process. Multiply the number of times you do this by the height of the shooter’s eye from the ground for the total head.

Measuring Downhill

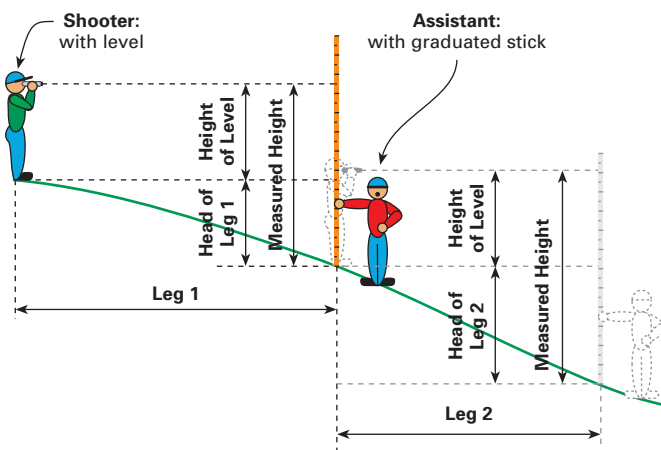

1. Subtract height of level from measurement on stick to determine head for each leg.
2. Repeat multiple legs from intake location to turbine location.
3. Add the head of each leg together to determine total head.

Measuring Uphill

1. Height of level is head for each leg.
2. Repeat multiple legs from turbine location to intake location.
3. Multiply the height of level times the number of legs to determine total head.

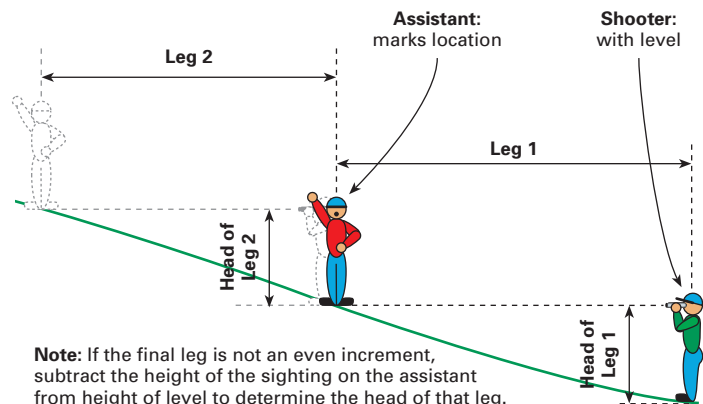

Note: If the final leg is not an even increment, subtract the height of the sighting on the assistant from height of level to determine the head of that leg.



Courtesy of Liquid Sun Hydro

A pressure gauge connected to a hose can provide accurate head measurements. Convert pressure to height, or purchase a gauge like the one above and read height directly.

Water Pressure Measurement

If the distance is short enough, you can use one or more garden hoses or lengths of flexible plastic tubing to measure head. This method relies on the constant that each vertical foot of head creates 0.433 psi of water pressure (10 vertical feet creates 4.33 psi). By measuring the pressure at the bottom of the hose, you can calculate the elevation change.

Run the hose (or tubing) from your proposed intake site to your proposed turbine location. If you attach multiple hoses together, make sure that each connection is tight and leak free. Attach an accurate pressure gauge to the bottom end of the hose, and completely fill the hose with water. Make sure that there are no high spots in the hose that could trap air. You can flush water through the hose before the gauge is connected to force out any air bubbles.

If necessary, you can measure total head over longer distances by moving the hose and taking multiple readings. Keep in mind, however, that there is less than 1/2 psi difference for every vertical foot. Except for very steep hillsides, even a 100-foot hose may drop only a few vertical feet. The chance for error significantly increases with a series of low-head readings. Use the longest possible hose, along with a highly accurate pressure gauge.

The pressure gauge must be graduated so that measurements are taken in the middle of its range. Don't use a 0 to 800 psi gauge to measure 5 to 15 psi pressure. Select instead a 0 to 30 psi gauge. Liquid Sun Hydro now sells pressure gauges calibrated in feet, which makes head measurement a snap.

Computing Net Head

By recording the measurements described in the previous sections, you have determined gross head—the true vertical distance from intake to turbine, and the resulting pressure at the bottom. Net head, on the other hand, is the pressure at the bottom of your pipeline when water is actually flowing to your turbine. This will always be less than the gross head you measured, due to friction losses within the pipeline. You will need to have water flow figures (described in the following sections) to compute net head. Longer pipelines, smaller diameters, and higher flows create greater friction. A properly designed pipeline will yield a net head of 85 to 90 percent of the gross head you measured.

Net head is a far more useful measurement than gross head and, along with design flow, is used to determine hydro system components and electrical output. Here are the basics of determining pipe size and net head, but you should work with your turbine supplier to finalize your pipeline specifications.

Head loss refers to the loss of water power due to friction within the pipeline (also known as the penstock). Although a given pipe diameter may be sufficient to carry all of the design flow, the sides, joints, and bends of the pipe create drag as the water passes by, slowing it down. The effect is the same as lowering the head—less water pressure at the turbine.

Head loss cannot be measured unless the water is flowing. A pressure gauge at the bottom of even the smallest pipe will read full psi when the water is static in the pipe. But as the water flows, the friction within the pipe reduces the velocity of the water coming out the bottom. Greater water flows increase friction further.

Larger pipes create less friction, delivering more power to the turbine. But larger pipelines are also more expensive, so there is invariably a trade-off between head loss and system cost. Size your pipe so that not more than 10 to 15

Head Loss in PVC Pipe*

Design Flow in Gallons per Minute & (Cubic Feet per Second)

Pipe Size (in.)	25 (.05)	50 (0.1)	100 (0.2)	150 (0.33)	200 (0.45)	300 (0.66)	400 (0.89)	500 (1.1)	600 (1.3)	700 (1.5)	800 (1.78)	900 (2.0)	1,000 (2.23)	1,200 (2.67)
2	1.28	4.65	16.80	35.70	60.60	99.20	-	-	-	-	-	-	-	-
3	0.18	0.65	2.33	4.93	8.36	17.90	30.60	46.10	64.40	-	-	-	-	-
4	0.04	0.16	0.57	1.23	2.02	4.37	7.52	11.30	15.80	21.10	26.80	33.40	-	-
6	-	0.02	0.08	0.17	0.29	0.62	1.03	1.36	2.20	2.92	3.74	4.75	5.66	8.04
8	-	-	-	0.04	0.07	0.15	0.25	0.39	0.50	0.72	0.89	1.16	1.40	1.96

*In feet per 100 feet of pipeline

percent of the gross (total) head is lost as pipeline friction. Higher losses may be acceptable for high-head sites (100 feet plus), but pipeline friction losses should be minimized for most low-head sites.

The length of your pipeline has a major influence on both the cost and efficiency of your system. The measurement is easy, though. Simply run a tape measure between your intake and turbine locations, following the route you'll use for your pipeline. Remember that you want to run the pipeline up out of the creek bed, when possible, to avoid damage during high water.

Measuring Flow

The second major step in evaluating your site's hydro potential is measuring the flow of the stream. Stream levels change through the seasons, so it is important to measure flow at various times of the year. If this is not possible, attempt to determine various annual flows by discussing the stream with a neighbor, or finding U.S. Geological Survey flow data for your stream or a nearby larger stream. Also keep in mind that fish, birds, plants, and other living things rely on your stream for survival. Never use all of the stream's water for your hydro system.

Flow is typically expressed as volume per second or minute. Common examples are gallons or liters per second (or minute), and cubic feet or cubic meters per second (or minute). Each can be easily converted to another, as follows:

- 1 cubic foot = 7.481 gallons**
- 1 cubic meter = 35.31 cubic feet**
- 1 cubic meter = 1,000 liters**

Three popular methods are used for measuring flow—container, float, and weir. Each will be described in detail below.

Container Fill Method

The container fill method is the most common method for determining flow in microhydro systems. Find a location along the stream where all the water can be caught in a bucket. If such a spot doesn't exist, build a temporary dam that forces all of the water to flow through a single outlet. Using a bucket or larger container of a known volume, use a stopwatch to time how long it takes to fill the container. Then divide the container size by the number of seconds.



Anna gets her feet wet—the container fill method of measuring flow means getting in the stream and timing how long it takes to fill a container of known volume.

For example, if your container is a 5-gallon paint bucket and it takes 8 seconds to fill, your flow is 0.625 gallons per second (gps) or 37.5 gallons per minute (gpm).

Float Method

The float method is useful for large streams if you can locate a section about 10 feet (3 m) long where the stream is fairly consistent in width and depth.

Step 1. Measure the average depth of the stream. Select a board able to span the width of the stream and mark it at 1-foot (0.3 m) intervals. Lay the board across the stream, and measure the stream depth at each 1-foot interval. To compute the average depth, add all of your measurements together and divide by the number of measurements you made.

The Float Method of Estimating Flow

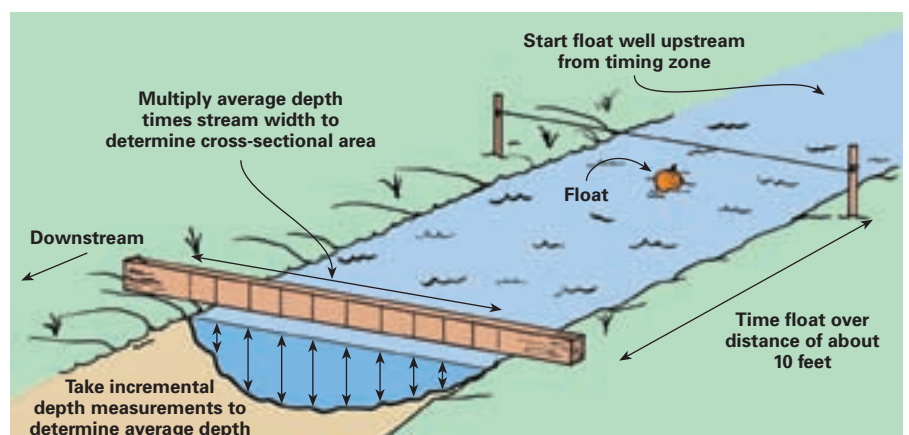

The Weir Method of Measuring Flow

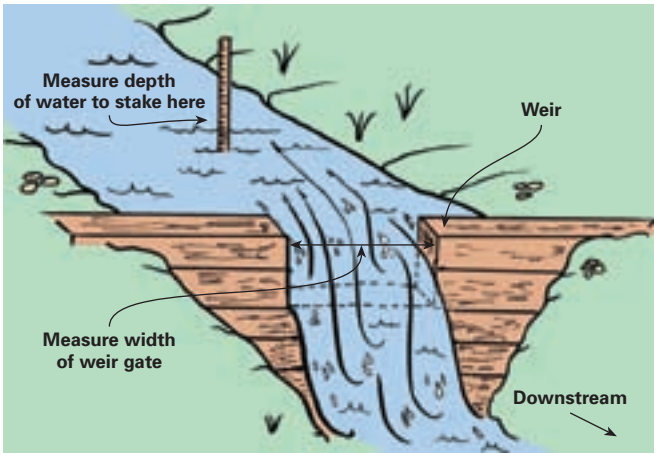

Step 2. Compute the area of the cross-section you just measured by multiplying the average depth you just computed by the width of the stream. For example, a 6-foot-wide stream with an average depth of 1.5 feet would yield a cross-sectional area of 9 square feet.

Step 3. Measure the speed. A good way to measure speed is to mark off a 10-foot (3 m) length of the stream that includes the point where you measured the cross-section. Remember, you only want to know the speed of the water where you measured the cross-section, so the shorter the length of stream you measure, the better.

Use a weighted float that can be clearly seen—an orange or grapefruit works well. Place it well upstream of your measurement area, and use a stopwatch to time how long it takes to travel the length of your measurement section. The stream speed probably varies across its width, so record the times for various locations and average them.

The Weir Method (continued)

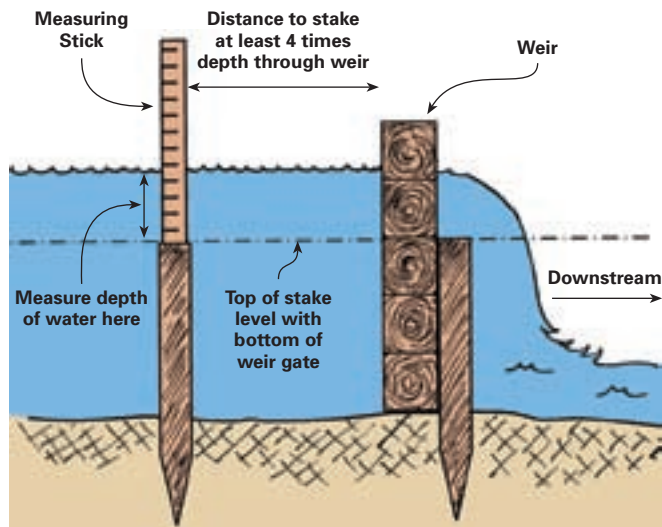

With these time and distance measurements, you can now compute the water speed. For example, assume the float took an average of 5 seconds to travel 10 feet. That's 2 feet per second, or 120 feet per minute. You can then compute flow by multiplying the feet traveled by the cross-sectional area. Using the sample cross-sectional area and speed examples, 120 feet per minute times 9 square feet equals 1,080 cubic feet per minute (cfm) flow.

Step 4. Correct for friction. Because the streambed creates friction against the moving water, the bottom of the stream tends to move a little slower than the top. This means actual flow is a little less than what was calculated. By multiplying the result by a friction factor of 0.83, you get a closer approximation of actual flow.

Weir Method

A weir is perhaps the most accurate way to measure small- and medium-sized streams. All the water is directed through an area that is exactly rectangular, making it very easy to measure the height and width of the water to compute flow.

This kind of weir is a temporary dam with a rectangular slot, or gate. The bottom of the gate should be exactly level, and the width of the gate should allow all the water to pass through without spilling over the top of the dam. A narrower gate will increase the depth of the water as it passes through, making it easier to measure.

Weir Flow Table*

Depth (in.)	Additional Fraction of an Inch							
	None	+1/8	+1/4	+3/8	+1/2	+5/8	+3/4	+7/8
0	0.00	0.01	0.05	0.09	0.14	0.19	0.26	0.32
1	0.40	0.47	0.55	0.64	0.73	0.82	0.92	1.02
2	1.13	1.23	1.35	1.46	1.58	1.70	1.82	1.95
3	2.07	2.21	2.34	2.48	2.61	2.76	2.90	3.05
4	3.20	3.35	3.50	3.66	3.81	3.97	4.14	4.30
5	4.47	4.64	4.81	4.98	5.15	5.33	5.51	5.69
6	5.87	6.06	6.25	6.44	6.62	6.82	7.01	7.21
7	7.40	7.60	7.80	8.01	8.21	8.42	8.63	8.83
8	9.05	9.26	9.47	9.69	9.91	10.13	10.35	10.57
9	10.80	11.02	11.25	11.48	11.71	11.94	12.17	12.41
10	12.64	12.88	13.12	13.36	13.60	13.85	14.09	14.34
11	14.59	14.84	15.09	15.34	15.59	15.85	16.11	16.36
12	16.62	16.88	17.15	17.41	17.67	17.94	18.21	18.47
13	18.74	19.01	19.29	19.56	19.84	20.11	20.39	20.67
14	20.95	21.23	21.51	21.80	22.08	22.37	22.65	22.94
15	23.23	23.52	23.82	24.11	24.40	24.70	25.00	25.30
16	25.60	25.90	26.20	26.50	26.80	27.11	27.42	27.72
17	28.03	28.34	28.65	28.97	29.28	29.59	29.91	30.22
18	30.54	30.86	31.18	31.50	31.82	32.15	32.47	32.80
19	33.12	33.45	33.78	34.11	34.44	34.77	35.10	35.44
20	35.77	36.11	36.45	36.78	37.12	37.46	37.80	38.15

*In cfm per 1-inch gate width

Example Site Analysis

Gross head: 100 feet

Pipeline length: 500 feet

Acceptable head loss: 10 to 15 percent (10–15 feet)

Design flow: 100 gpm

To determine what size pipe would be best, look up your design flow (100 gpm) in the head loss chart on page 44. In this example, the maximum acceptable head loss is 10 to 15 feet, which means we cannot exceed 3 feet of loss for every 100 feet of our 500-foot pipeline. Reading down the 100-gpm column, we find that a 3-inch pipeline would have a head loss of 2.33 feet per 100 feet of pipe—within our limits.

To determine total head loss, multiply 2.33 feet times 5 (for 500-foot pipeline), which equals 11.65 feet. To calculate net head, subtract the total head loss from the gross head (100 feet minus 11.65 feet). This gives us a net head of 88.35 feet.

Note the huge difference in head loss as pipe diameter gets smaller. Using a 2-inch pipeline, head loss for this example would be 16.8 feet per 100 feet, with a total head loss of 84 feet. Net head for this example would be 100 feet minus 84 feet, and result in only 16 feet of net head! This example shows how incorrectly sized pipelines can absolutely cripple a hydro system.

Choosing a 4-inch pipe would result in less head loss than 3-inch pipe, and deliver more power to the turbine, but the performance improvement is not sufficient to justify the added cost. Your turbine manufacturer should be well versed in measuring head losses, and can be an excellent resource for pipe diameter recommendations.

The depth measurement is not taken at the gate itself because the water depth distorts as it moves through the gate. Instead, insert a stake well upstream of the weir gate and make the top of the stake exactly level with the bottom of the weir gate. Measure the depth of the water from the top of the stake.

Once the width and depth of the water are known, a weir table is used to compute the flow. The weir table shown here is based on a gate that is 1 inch (25 mm) wide. Simply multiply the table amount by the width (in inches) of your gate. For example, assume your weir gate is 6 inches wide, and the depth of the water passing over it is 7¹/₂ inches. On the left side of the table, find “7” and move across the row until you find the column for “+1/2”. The table shows 8.21

cfm flow for a 1-inch gate with 7¹/₂ inches of water flowing through it. Since your gate is 6 inches wide, simply multiply the 8.21 by 6 to get 49.26 cfm.

A weir is especially effective for measuring flow during different times of the year. Once the weir is in place, it is easy to quickly measure the depth of the water and chart the flow at various times.

Design Flow

Even though your flow may be very high after exceptionally rainy periods, it probably won't be cost effective to design your turbine system to handle all that water for just a few days of the year. Instead, it makes sense to build a system that uses flow you can count on for much of the year. This is called design flow, and it is the maximum flow your hydro system is designed to accommodate.

Next Steps

Determining the potential of your water resource is the first step for a well-designed and viable hydropower system. As you can see, measuring head and flow are not difficult or complex tasks. With your net head and design flow, you have enough information to begin the next step—talking with turbine suppliers about potential designs. But there are still a few more issues to consider. Next time, I'll discuss losses, efficiency, transmission, and predicting the electrical output of your system. Once you have that information, you'll be ready to install your hydropower system.

Access

Dan New, Canyon Hydro, 5500 Blue Heron Lane, Deming, WA 98244 • 360-592-5552 • Fax: 360-592-2235 • dan.new@canyonhydro.com • www.canyonhydro.com

Liquid Sun Hydro, PO Box 85, Rockport, WA 98283 • 360-853-7435 • info@liquidsunhydro.com • www.liquidsunhydro.com • Pressure gauges calibrated in feet





HYDROSCREEN CO. LLC

- **Self Cleaning**
- **Easy Installation**
- **High Capacity**
- **No moving parts**
- **Pipe, ramp and box mountings**

**Precision Wedge Wire
Coanda Screens**
for Hydro, Agricultural, and
Domestic Diversions from
10 gpm to 500 cfs

– We specialize in creatively engineering solutions for your unique hydro diversion screening needs.

– Our solutions are cost effective with numerous screen mounting options; we also have durable 304 SS mounting boxes.



Visit us at www.hydroscreen.com or call (303) 333-6071
e-mail: RKWEIR@AOL.COM
Mention this ad for special savings!

Experience Hands-On Training

SOLAR ENERGY INTERNATIONAL



Call or write for the **FREE 2005 workshop catalog**

Upcoming Workshops:

Advanced Photovoltaics
Biodiesel
Carpentry Skills for Women
Home-Built Wind Generators
Intro to Renewable Energy
Micro-Hydro Power
Natural House Building

PV Design & Installation
RE for the Developing World
Solar Home Design
Solar Hot Water
Solar Water Pumping
Successful Solar Businesses
Utility Interactive PV

Wind Power
Women's Photovoltaics

Online Courses
PV Design Online
Solar Home Design Online

SEI



Workshops offered in:

Arizona • California • Colorado • Costa Rica • New York • Nicaragua • Texas • Utah • Washington

Check our website for workshop dates:

www.solarenergy.org

Hands-On Education for a Sustainable Future

voice: 970.963.8855 • fax: 970.963.8866
e-mail: sei@solarenergy.org • www.solarenergy.org
P.O. Box 715, Carbondale, CO, USA 81623

Three Men and a Baby!

Introducing the "Water Baby"...
Another breakthrough in water powered generators.



- Brushless permanent magnet design
- Adjustable while running
- Operates with as little as 3 gpm
- 12, 24, 48 volts and higher available



ENERGY SYSTEMS & DESIGN, LTD.
www.microhydropower.com 506-433-3151

Eco-Innovation
 Renewable Energy Systems

Hydro Wind Solar DIY Kits

1 kW hydro from \$899.00 www.ecoinn.co.nz

Canyon Industries, Inc.
 PO Box 36
 Daring, WA 98244

Pelton and Crossflow Turbines

Canyon 1215-2

COMPLETE STAND ALONE HYDROELECTRIC POWER SYSTEMS

TYPICAL PELTON INSTALLATION

phone: (360) 592-5552
 fax: (360) 592-2235
www.canyonhydro.com
 please contact us for your free brochure

- Manufacturing Turbines Since 1976 -

User Friendly Hydro Power

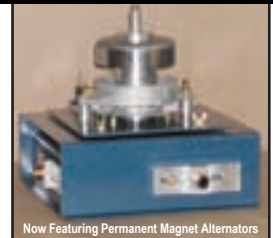

Now Featuring Permanent Magnet Alternators

Alternative Power & Machine
 4040 Highland Ave. Unit #H • Grants Pass, OR 97526 • 541-476-8916
altpower@grantspass.com

www.apmhydro.com

Harris Hydroelectric

Hydro-Power for Home Use

Introducing a new adjustable
 Permanent Magnetic Brushless Alternator

- 25 - 30% more efficient than Hi Output Alternator
- Marine Grade Construction throughout
- Re-connectable Stator
- Retrofittable on existing turbine



632 Swanton Road
 Davenport, CA 95017
 831-425-7652



www.harrishydro.com

MOBILE EMERGENCY SOLAR-ELECTRIC SYSTEM

Douglas Lais

©2004 Douglas Lais

My wife got me started on building a mobile photovoltaic (PV) system by suggesting that I put a solar-powered light in our storage shed. I'd been interested in renewable energy for some time, so this was a perfect opportunity to actually build something.

This system could be relatively small in size and modest in cost, and still be a great hands-on learning experience. As I pondered the how-tos of building it, I realized that I didn't want to let all that new hardware just sit in a seldom-used outbuilding. It dawned on me that if the electronics were put into a portable box instead of on a wall, and if the solar-electric panel could be easily moved between the box and an outside rack, and if the box had wheels—I'd have a mobile PV system.

Mobile & Versatile

I could move the system up to the house for emergency lighting in case of a utility outage. I could wheel it out to the pickup for a weekend camping trip. And I could use it to recharge batteries for flashlights, radios, or cell phones. Deciding to make the unit mobile suggested many new possibilities, so the system I finally built was as versatile as I could make it.

The system could be considered a working model, a proof-of-concept, adapting some ideas from its bigger brothers. For instance, I used terminal strips to connect the wires instead of wire nuts. This gives a cleaner look, and makes replacing parts easy. More important, it gives me the experience of routing all my wires to a couple of focal points. It's akin to having a distribution center right in the box, eliminating the expense and weight of a separate distribution panel.

Since the project was not planned for a dedicated purpose with a predictable load, I started with a 32-watt (W) Uni-Solar module, and built the system based on it. The other main components are a 10-amp (A) Morningstar



The portable PV system can be wheeled around like a hand truck.

charge controller; a single, 12-volt (V), 33 amp-hour (AH) AGM battery; a 1.3-watt trickle charger that plugs into a wall socket; and a 150-watt ProWatt inverter. I'll cover each of these separately, and then describe the assembled unit.

PV Module & Charge Controller

Uni-Solar modules are a good choice for mobile applications because they do not use glass. The solar cells are deposited in three layers onto a sheet of stainless steel and then coated with a flexible polymer. They feel a little cushiony to the touch, and resist impact damage. The manufacturing technique also makes them slightly larger than other modules of comparable output, and a bit more expensive.

My PV charge controller is a Morningstar SunSaver 10L, which has a low voltage disconnect (LVD) feature that disconnects DC loads wired through the controller from the battery when the voltage drops to 11.5 volts. DC loads are reconnected when the battery is recharged to 12.6 volts. These voltage settings are not adjustable, and should be considered if DC loads will be wired through the charge controller.

Battery & Breaker

My single battery is a 12 V, 33 AH, absorbed glass mat (AGM) Ever-On that I purchased from a local Batteries Plus store for US\$75. It's a type commonly used in electric wheelchairs. The battery can be isolated from the rest of the circuit for safety reasons by a 20 A circuit breaker located on its charging circuit, and by a 10 A fuse and DC switch on its load circuit.

I had a hard time locating a 10 A, DC breaker, so I used a fuse/switch combination. It was also impossible to find the 20 A, DC panel-mounted breaker anywhere in my hometown of Rochester, Minnesota, but I finally located one on the Internet. Most Internet electronic supply companies deal with bigger stuff, but I found a Carlingswitch breaker at Custom Marine Services.

Inverter

The inverter is a ProWatt 150, ordered from Innovative Power Systems. Using the schematics I saw in *Home Power* as instructional guides, I wired the inverter directly to the battery (through a fuse).

I used the SunWize Technologies catalog to help me calculate wire sizes. I'd seen all the pictures of heavy black battery wires, but the small size of my system allowed me to use #12 (3 mm²) copper throughout.

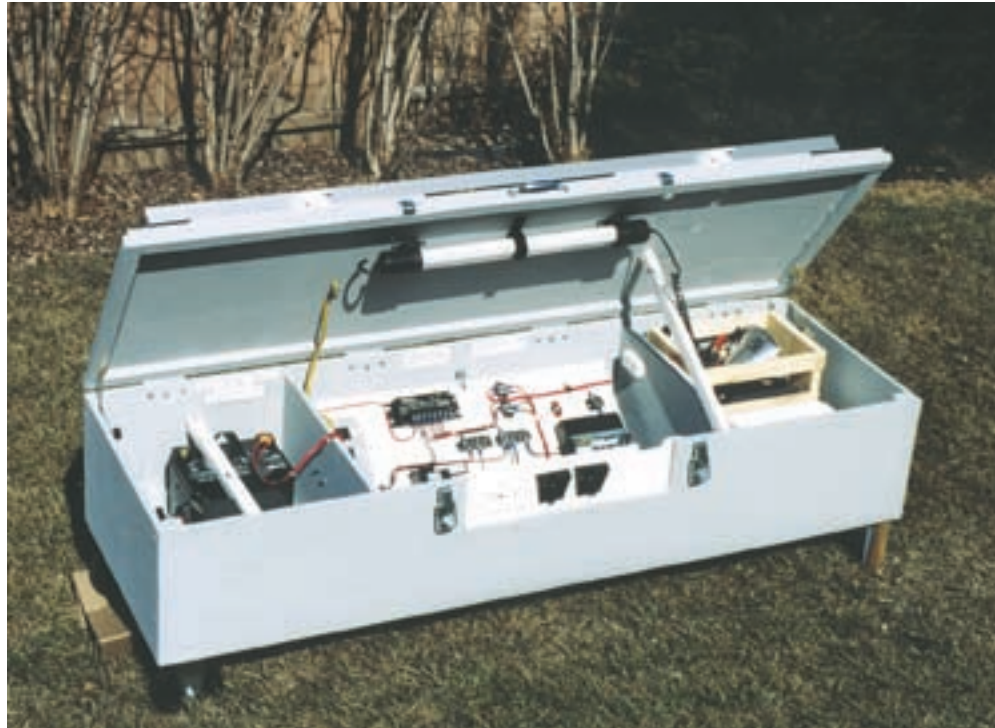

Inside the box—the battery on the left, balance of system in the middle, trouble light on the lid, AC and DC output receptacles on the front, and extra gear stored on the right.

The Box

Now for the fun part—how everything came together. The box that houses the battery and electronics is plywood and measures 59 by 19 by 12 inches high (150 x 48 x 30 cm). It has a hinged lid to which the PV is attached, and a pair of wheels under the heavy end, where the battery is. It can be moved around like a hand truck by using its two legs as handles.

The PV panel is clamped to the lid with four window-sash latches. I spent a couple hours wandering in hardware stores before discovering them. They are narrow enough to fit the edge of the panel, and work well as quick release mechanisms.

Lais System Costs

Item	Cost (US\$)
Uni-Solar US-32 module, 32 W	\$190
Hardware	102
Ever-On battery, 33 AH 12 VDC	75
Morningstar SunSaver 10L controller	60
Electronic parts	49
ProWatt 150 inverter, 150 W	40
Circuit breaker	35
Plywood	27
Compact florescent (CF) lights	25
Wire	8
Total	\$611



A gnomon can be temporarily used to orient PV panels. When the shadow disappears, the panel is pointing directly at the sun.

A 12-foot (3.7 m) extension cord is hardwired to the junction box on the PV. It can be wound around a pair of hooks on the back of the panel when the panel is latched to the box. The other end of the cord can be plugged into a polarized, DC-rated plug (from an RV shop) located on the lid. The cord feeds electricity to the interior of the box.

The electronics and wiring harness are mounted inside the box on a plywood component panel. The component panel is hinged to the bottom of the box. This allows the panel to be tilted back and forth for free access to both sides. Weatherproof output receptacles for AC and DC are mounted on the front of the box.

The box's hinged lid allows the PV panel to be tilted for maximum solar exposure.



Tech Specs

System Overview

System type: Mobile, off-grid PV

Location: Rochester, Minnesota

Solar resource: 5.4 average daily peak sun hours

Production: 3.2 AC KWH per month average

Photovoltaics

Modules/array: One Uni-Solar US-32, 32 W STC, 12 VDC

Array installation: Portable ground mount, adjustable tilt

Array disconnect: Carlingswitch, Series M, 20 A DC breaker

Balance of System

Charge controller: Morningstar SunSaver 10L, 10 A, 12 VDC, with LVD

Inverter: ProWatt 150, 150 W, 12 VDC input, 120 VAC modified square-wave output

Energy Storage

Battery: One Ever-On, AGM, 12 VDC, 33 AH at 20-hour rate

Battery/Inverter disconnect: 20 A automotive fuse, and 12 VDC manual switch

Velcroed on the inside of the lid is a 14 W, DC fluorescent light. It illuminates the interior, but can also be removed and used as a trouble-light with an extension cord. For a backup light, I added a 13 W, AC compact fluorescent light in a clamp-lamp fixture. A storage compartment stores a multimeter, a small AM/FM radio, a flashlight, extension cords, jumper cables, spare fuses, extra parts, a car battery charger, and a few tools.

PV Adjustment & Placement

Rochester, Minnesota, is at 44 degrees latitude. I designed the system so that the lid/PV can be propped open by an extension arm at any angle between 30 and 55 degrees. The degrees are marked on the lid, so the arm can be adjusted quickly. The open lid also doubles as a sunshade for the electronics.

A second method for adjusting the panel for maximum solar gain is the use of a gnomon, a device that uses a cast shadow to determine sun angle. Mine is a wooden disc with a dowel in its center. It is hung on the face of the PV panel, and the box is moved in elevation and azimuth until the shadow disappears. Voila—it is pointing directly at the sun.

I also built an A-frame to hold the PV panel in case I decide to keep the box indoors. The A-frame is hinged at the top, and the legs can be spread out to any angle. A chain keeps them from sliding apart on slick surfaces. The PV can be attached by the same kind of sash locks, making it a snap to remove. The extension cord can be fed through any appropriate opening into the house. I have mine going through the house fresh-air intake and down into the basement to the power box.

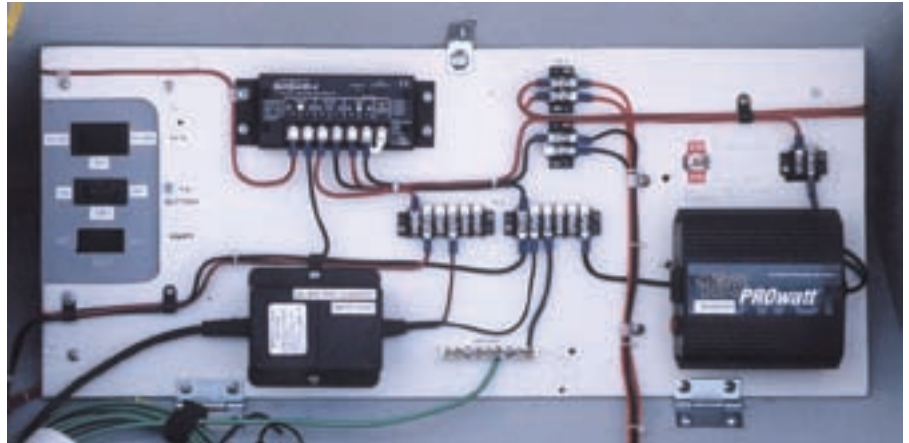

The component panel, in the center of the box, is mounted on hinges for easy access to both front and back.

PV Performance

Figuring out the PV performance took a long time because we had a long winter stretch of eight weeks with almost no sunny days. A full charge on a sunny day gave the battery 15 AH, almost exactly what my calculations predicted.

The second sunny day only increased that by about 4 AH, or 26 percent of the first day's charge. The third day only increased the charge by 1.5 AH, or about 10 percent of the first day's charge. So the charge rate slows down as the battery gets full and the charge controller begins regulating PV output to keep the battery from overcharging. That may be old news to others, but it was new to me.

Calculating the Load

Under ideal conditions, the PV can give the battery about 15 AH per full day of sunlight. So, I thought that a consumption of about 9 AH over a period of four hours

would be a good baseline load. The load would consist of a 14 W DC compact fluorescent light, a 3 W radio, a 3 W charger for AA flashlight batteries, and a 4.8 W cell phone charger. With an inverter loss of 1.6 W, the total load would be 26.4 W, or about 2.2 AH per hour, for a total consumption of 8.8 AH over the four hours.

If much more than that were used, the consumption rate would pass the charging rate, and each night the battery would be weaker. A fully charged battery would yield two nights of use. If there was just one cloudy day, the battery would only have a one-night reserve. A second cloudy day would put an end to lights at night. So you can see how critically small the system is, and that the first place I need to expand is also the most expensive—a second PV. I'd like to be able to fully charge a depleted battery in a single day.

Lais Mobile PV System

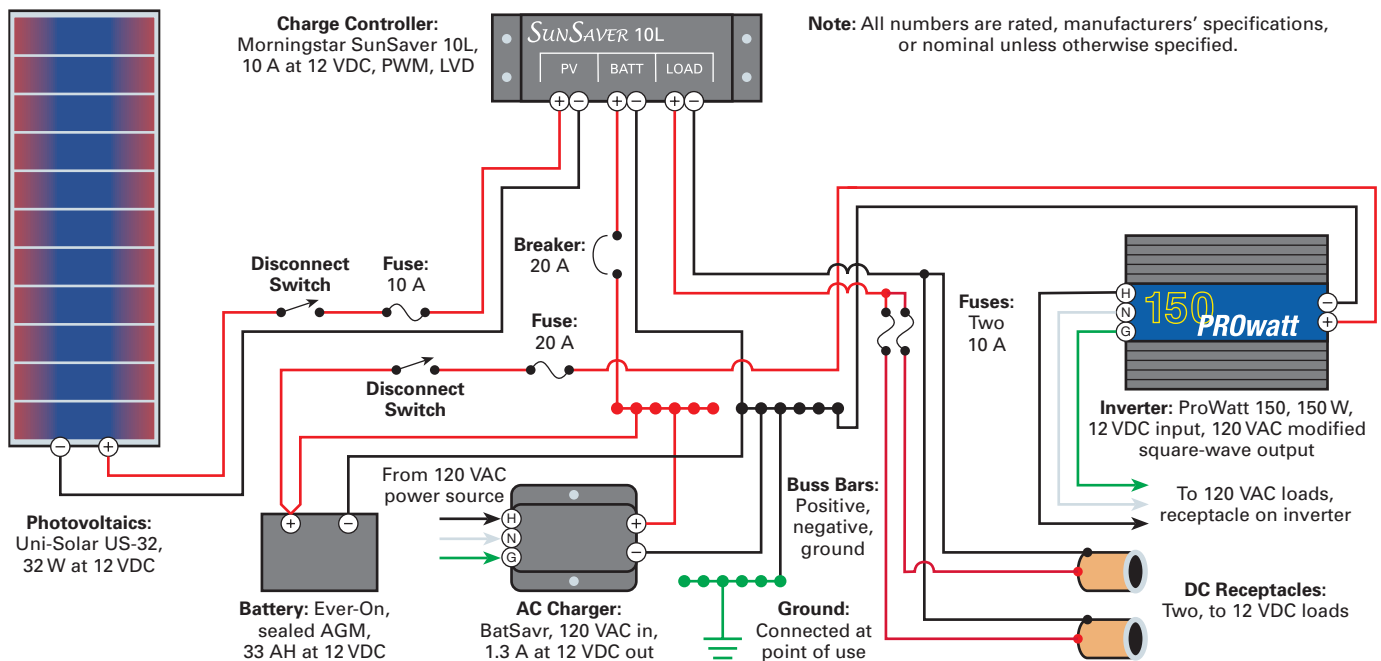

Having said that, I have to admit that the next component I plan to buy is another battery. Recently, the lights flickered in the house during a storm, and my wife looked at me and asked if we were ready. We were, but I would have felt a lot more confident if I'd had a larger reserve.

I would not have felt more confident if I'd had another PV sitting out in the rain. If my goal had been just emergency backup power, it would have been more cost effective to eliminate the PVs entirely, and simply plug a set of batteries into a wall charger.

The cost of the whole system was about US\$200 more than my first rough estimate. Looking at my materials list, there really isn't much room to cut costs and still be true to my original intent. The knowledge and satisfaction gained, however, are priceless.

But What's It For?

People often ask me why I made my emergency electricity system. Well, besides having a portable, backup source of renewable electricity, it was simply for the joy of taking something that was in my mind, and using my hands to create it in the physical world. Now I can walk around it with my hands in my pockets and kick the tires. For me, there's more satisfaction in that than in a favorable cost analysis.

Grounding

Coiled in the box is a green grounding cable made of #10 (5 mm²) stranded wire. One end is connected to the black negative wires in my box, and the other end is fitted with a choice of a ring terminal or a clamp. It is meant to be connected between the box and the load whenever the box is powering any load that has its own grounding system.

Grounding is one of those subjects that can be confusing, so let me just mention a few essentials. All voltages in a system are measured relative to zero volts ground—where you put the negative test probe (black) when measuring voltage. There could be many volts difference between the “zero volts ground” on two unconnected circuits. So, when approaching a system that is separate from your own, you should have a grounding cable in your hand and attach it before you turn on the electricity.

A mobile energy source, such as a generator or a car battery, has what is called a “floating ground.” You want to wire those floating grounds together, so you don't become the electrical conductor! Your house, the utility grid, your PV array, and your wind turbine are all tied together by grounding cables, which ensures the safety of a common reference voltage.

Lais System Loads

DC Loads	Watts	Hours/Day	WH/Day
CF light	13.0	3.00	39.0
Radio	3.0	4.00	12.0
Total DC WH per Day			51.0

AC Loads	Watts	Hours/Day	WH/Day
CF light	13.0	2.00	26.0
Cell phone charger	4.8	4.00	19.2
AA battery charger	12.0	0.25	3.0
Total AC WH per Day			48.2
Grand Total WH per Day			99.2

I'm happy to have moved from observer to participant in the greening of America. I don't see many PV systems in Minnesota, but my heart skips a beat whenever I see a new wind turbine going up in a cornfield. The artisans of technology have finally come full circle, and have created machines that will benefit us all on our journey back to the garden.

Access

Douglas Lais, 2014 18th St. NW, Rochester, MN 55901 • 507-358-3981 • douglaslais@charter.net

Innovative Power Systems, 1153 16th Ave. SE, Minneapolis, MN 55414 • 612-623-3246 • Fax: 612-623-4041 • info@ips-solar.com • www.ips-solar.com • Uni-Solar PV module, Morningstar charge controller, ProWatt inverter

Custom Marine Services, 1548-B Francis Marion Rd., Florence, SC 29506 • 800-992-7922 or 843-673-2820 • Fax: 800-992-7923 or 843-673-2829 • cms2820@sc.rr.com • www.cmsquick.com • DC circuit breakers

SunWize Technologies, 1155 Flatbush Rd., Kingston, NY 12401 • 800-817-6527 or 845-336-0146 • sunwize@besicorp.com • www.sunwize.com • Catalog, system sizing worksheets

Batteries Plus, 915 37th St. NW, Rochester, MN 55901 • 507-282-5767 • Fax: 507-282-5870 • batteriesplusroch@juno.com • www.batteriesplus.com • Batteries

Radio Shack, 100 Throckmorton St., Fort Worth, TX 76102 • 800-843-7422 or 817-415-3011 • Fax: 817-415-3240 • support@tandy.com • www.radioshack.com • DC switches, terminal strips

Universal Marine & RV, 2850 Highway 14 W, Rochester, MN 55901 • 800-554-5033 or 507-288-4000 • Fax: 507-285-0136 • info@2universal.com • www.2universal.com • DC fluorescent light, BatSavr battery maintainer

Morningstar Corporation, 1098 Washington Crossing Rd., Washington Crossing, PA 18977 • 215-321-4457 • Fax: 215-321-4458 • info@morningstarcorp.com • www.morningstarcorp.com • Charge controller

United Solar Ovonic (Uni-Solar), 3800 Lapeer Rd., Auburn Hills, MI 48326 • 800-843-3892 or 248-475-0100 • Fax: 248-364-0510 • info@uni-solar.com • www.uni-solar.com • Uni-Solar PV



The BEST Tool for Solar Site Analysis

Easy to Use

Ingenious design projects your horizon onto a sun chart for the full year.

Perfect for optimal siting of:

- Photovoltaic Arrays
- Solar Hot Water Systems
- Solar Homes
- Greenhouses
- Gardens

Includes sun paths from 0-66° North & 0-49° South. With metal case & tripod \$255, Handheld \$175, (+S&H).



Fast & Accurate

Rt 1 Box 260-1, Linden, TN 37096
317 501-2529
info@solarpathfinder.com • Fax 931-589-5400

SolarPathfinder
FAST ACCURATE SOLAR SITE ANALYSIS
www.solarpathfinder.com

Independence ♦ Sustainability ♦ Security



Call for Free Estimate 1-866-765-9463

- ◆ Cash rebates and tax credits pay up to 50% of system.
- ◆ Home value increases without raising your taxes.
- ◆ Realize 10-20% return on your investment.
- ◆ Reduce our dependence on foreign oil.
- ◆ Protect our natural resources.
- ◆ Eliminate your electric bill.

EcoEnergies

The Leading Solar Electric and BackUp Power Experts

www.ecoenergies.com 100% financing available
California Contractor #723331; Category: B General, C-46 Solar & HIC

You can't always rely on the grid

You have invested in an **alternative energy generating system**. Make sure your **battery is NOT your weakest link!**

Insist on North America's best deep-cycle battery... *Rolls*

- ✓ **Dual-container construction** - eliminates leaks, stray current, and decreases maintenance
- ✓ **Unsurpassed cycling** - the most dense active material in the industry - 3300 cycles (50% DOD)
- ✓ **Modular construction** - easier installation
- ✓ **Average life expectancy is 15 years - warranted for 10 years**



Rolls
BATTERY ENGINEERING
1-800-681-9914

Rolls Battery Engineering Ltd. PO Box 673, Salem, MA 01970 Email: sales@rollsbattery.com www.rollsbattery.com



Factory Authorized
Warranty And Out Of Warranty Repairs

Introducing The Inverter Doctor !

The Nation's Number One Choice For Inverter Repairs

We offer in-house inverter repair and maintenance services for the RV, Marine, Telecommunication, Remote Home and Grid Intertie industry. Our expertly trained technicians use only the latest state of the art test equipment for fast accurate diagnosis, so that your system is up and running in a hurry. In fact most of our repairs are ready to be shipped back or picked up by our customers within 48 hours !

Attention alternative energy dealers, we are currently seeking companies that are interested in joining our nationwide network of Satellite Service Centers. Learn how you can enhance your bottom line and the level of service to your customers.

Visit us on the Web at [Http://www.Inverterdoctor.com](http://www.Inverterdoctor.com)
Or Call Us At 1-866-523-4948

Quick Response Team

We're the people that make it happen for your business. Same day shipping. Three fully stocked warehouses. Unequaled customer service. Prepackaged systems. Technical support.

Steve Schultz of New England Solar says, "SunWize's customer service is the best. They do whatever they can to get us the products we need."

Call us at 800.817.6527 and find out how SunWize can help your business. Visit us at www.sunwize.com.

Be successful, choose SunWize!

Reliable People . . . Reliable Products . . . Reliable Power!



SunWize[®]

UPGRADE YOUR HEAD!

Send us your old hat with any inverter manufacturers' logo on it and we will send you one of ours!
(Or send us \$10 USD instead and we will send one postage paid)



Hat Upgrade Program
OutBack Power Systems
19009 62nd Ave NE
Arlington, WA 98223
(360)435-6030

Also ask us about the inverter trade-in program managed by Ebay!

MAX, the MX60, not included.

www.outbackpower.com

HIGHEST RELIABILITY

- Failure rate of <2 per 1,000 units shipped
- Over 100,000 sold and installed in more than 50 countries
- Available in 15 or 30 amps at 12/24 volts or 48 volts



PROSTAR™

**World's Leading
Mid-range
PV Controller**

For further information, contact your nearest PV distributor or Morningstar.



Phone: +1-215-321-4457
Fax: +1-215-321-4458
info@morningstarcorp.com
www.morningstarcorp.com

FREEDOM COMES IN MANY FORMS

REMOTE POWER
The Harvester™



WIRELESS LED LIGHTING
SOLELED™



WATER PURIFICATION
The Harvester™ WP



SolarOne™ Solutions

Your first steps to freedom from the tyranny of wires and fossil fuels.

SolarOne™ offers its "liberating" Harvester™ for "on the spot" power, water purification and lighting. Also, check out our wireless SoLED™ Solid State Solar Overhead Outdoor Lights for Pathways, Parks and Shelters. Visit us on the web!

www.solarone.net

info@solarone.net toll free 877.527.6461

Doubling Up on SOLAR

Anthony Skelton

©2004 Anthony Skelton



A 1,020-watt PV array on the roof of Anthony Skelton's house in Leek Wootton, United Kingdom, is only half of his total solar array.

In February 2000, I installed a 1 KW grid-connected photovoltaic (PV) system. Regular readers of *Home Power* may remember that I wrote it up for *HP79*. A lot has happened since then.

Monitoring My Solar Roof

Three years ago, I had a phone call from the University of Northumbria, asking if I would consider being part of a monitoring project of domestic PV systems. The U.K. Department of Trade and Industry (DTI) had asked the university to carry out the two-year monitoring exercise for them.

Only eight sites were to be monitored in the U.K., and I accepted this opportunity to be one of them. I would receive monthly output data about my solar-electric system, along with weather data, average array temperature, and many other details that would never have been available otherwise.

The university installed the monitoring equipment over a few days. A data logger was fitted in the garage, and the various weather and power sensors were connected to this unit. Every Tuesday at 7 AM, the computer at the university autodial into the system. The modem in the garage is

powered via a time clock to be on-line only between 6:30 and 7:30 AM, so the data logger answers the call, and all the data for the previous week is downloaded.

The data from my system for 2001–2002 has now been published on the DTI Web site. If you are interested in the details, you can download a PDF document showing the system's performance from the Promised Files section of *Home Power's* Web site. Look for System F in the PDF file called "Monitoring of Domestic PV Installations."

Incentives

An incentive program (called a "scheme" in the U.K.) was announced by the government to encourage the installation of PV in the domestic sector and kick-start the PV industry in the U.K. This scheme is known as the Major Demonstration Program. It would be available to anybody installing a PV system with a capacity of between 500 and 5,000 watts peak (Wp). The grant covers 50 percent of the total cost of professionally installed systems. Only 5 percent value-added tax (VAT) is applied on professionally installed systems (normal VAT rate in the U.K. is 17.5 percent).

At an early stage, I contacted Steve Wade, of Wind and Sun near Leominster, to get his advice on the proposed

project. I wanted to install a second grid-connected system similar to the one I installed on the house in February 2000. The difference this time was that it would be fitted to the roof of my garden shed.

Steve suggested using twelve BP 585 panels (a total of 1,020 Wp) fitted with the premade DC plugs and sockets (MC connectors) for easy installation. The inverter would be the BP GCI 1200 (branded for BP, but made by SMA). To mount the panels, Steve suggested using a new racking system by Osmer, a German company. This was a purpose-made aluminum extrusion for the BP panels that looked very smart from the sample Steve had brought along with him.

I already had some PVs on the shed roof in the garden, powering a low-voltage DC system for the garden lights and also for the water feature in my ornamental garden pool. This allowed me to install the new mounting system quite easily, due to the support frame I had made a few years previously. This support frame was now going to be the base to mount the new Osmer racking system.

After some measuring, I concluded that I could fit another two BP 585 modules on the roof, and still keep my original 12-volt system. So I would have twelve modules for the new grid system, and two modules for the 12-volt battery backup system. I could have used the two existing 255BP modules, but due to differing sizes, it would not have looked right. To make this fully compliant with electrical regulations, Steve would supply and install all the necessary AC and DC disconnect switches.

Twelve of the fourteen panels on the shed roof make up the other half of Anthony's grid-intertied solar array. The other two panels power a 170-watt, stand-alone, battery-based system.



Tech Specs

System Overview

Location: Leek Wootton, Warwick, England

Solar resource: 3 average daily peak sun hours

Production: 68.33 AC KWH per month average

Utility electricity offset by PV system: 35%

Photovoltaics

Modules: 12 BP 585, 85 W, 12 VDC

Array: 1,020 W, 144 VDC nominal

Array disconnect: Santon, 16 A, 750 VDC

Array installation: Roof-mounted, Osmer Elektrotechnik SOL-50 mounting system, oriented 5 degrees east of south, 35 degree tilt angle (fixed)

Balance of System

Inverter: BP Solar GCI 1200 (SMA-Sunny Boy), 300 VDC maximum input, 850 W, 230 VAC, 50 Hz AC output, 180–253 VDC MPPT window

System performance metering: Sunny Boy Control Light display

The application form, with a quote from Wind and Sun for the installation, was sent to the Energy Saving Trust, which was operating this scheme on behalf of the government. In less than two weeks, I received a letter offering a grant of £3,577.87 (US\$6,332.83).

The Solar Expansion

A date in August was set for the installation to take place. This gave me time to remove the old modules on the roof and make sure the support rack was in good order. Early one Saturday morning, Steve turned up with a carload of modules, boxes, and tool kit.

The weather could not have been better for climbing about on the shed roof. Most of the day was spent fitting the frame and support beams, and ensuring that all was square. Within the shed, I had paneled a section to



The grid-intertied BP inverter and related components, as well as the independent battery-based system, are housed inside the garden shed.

mount equipment. A separate consumer fuse board was fitted to accommodate the new inverter, plus all the AC and DC disconnection switches.

On Sunday morning, we made a few final adjustments to the PV rack. Due to its design, all modules were installed within an hour. The MC connectors on the modules paid off, and the interconnection between panels was done in minutes. The modules were connected in series, so the nominal array voltage is 144 VDC, and the SMA inverter typically sees voltages between 200 and 220 VDC. All the aluminum trim and end plates were then fitted, completing the solar-electric system.

Solar Roof #2 Goes On-Line.

After lunch, Steve programmed the inverter with his laptop computer to comply with UK electrical requirements, since they differ slightly from the rest of Europe. This included things like the upper and lower limits of voltage and frequency, and the reconnection time after grid failure or disconnection.

A transfer switch allows the central heating system ignition and pump to be powered by the battery-based backup PV system.



I then had the job of throwing the switches on. The inverter takes three minutes before it connects to the grid, assuming the grid is within spec! I walked back into the house to the Sunny Boy display, which shows real-time information about inverters connected to it and keeps a running log of production for each unit connected. All communication is done over the existing house mains wiring, so you can locate the display wherever you want it.

I had it scan to see if it would find the new inverter; it did, and identified it by its serial number. The second solar-electric system was now producing—I could see the units start to add up on the display.

12-Volt Backup

Because the BP inverter needs the grid to be present before it starts to generate, I think it is important to have an independent solar-electric system just in case the grid goes down, so I kept my 12-volt setup too. A backup system needs a battery bank and inverter, which in my system is connected via a switch to the house's central heating system ignition and pump.

Skelton System Costs

Item	Cost (UK£)
12 BP 585 S PV modules	£4,056
Delivery, installation & commissioning	900
BP GCI 1200 inverter (SMA SWR-850)	847
Osmer support structure	325
Sunny Boy Control Light display	315
DC disconnect & box	55
Cable connectors, clips & misc.	50
AC lockable disconnect & box	41
Cable, 4M	30
Tax, 5%	331
Less 50% grant	-3,475
Total	£3,475

£=US\$1.77

The Skelton Double Grid-Tied PV System

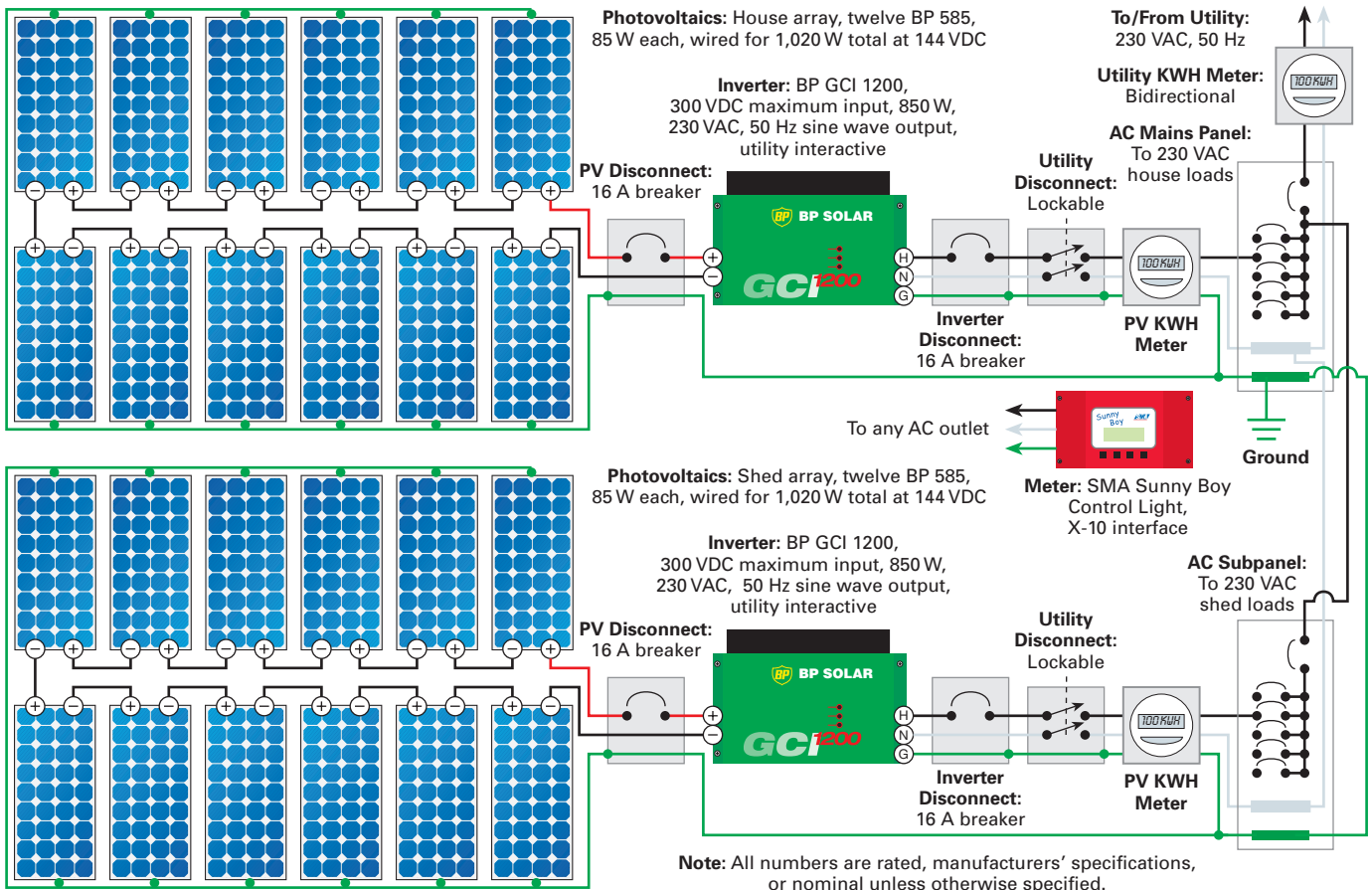

I purchased the ASP 880 W sine wave inverter (model TC08/12) secondhand from Wind and Sun. Energy is stored in six, 2-volt cells (560 AH). That's a little big for this setup, but I managed to obtain them a few years ago at a good price. The cells are the gel type that are used in some forklift trucks. A Heliotrope CC60 regulator looks after this small system, and gives me the solar array and battery voltages, and charging current on its LCD display

We have mains gas supply, which relies on mains electricity to pump water through the radiators and power the ignition for the gas boiler. This load is only about 70 W, and can be transferred from the grid to inverter at the flick of a switch. It was a small alteration in wiring, but it will mean a lot if the grid fails—at least we will have hot water and a warm house. I fitted a standard wall socket outlet to allow appliances to be connected to the inverter if necessary.

The 93 Million Mile Journey

The PV system on the garden shed has been in operation since August 2002. With the information collected from the Sunny Boy display over one year, the annual production is 820 KWH from this system. Add the existing solar-electric system (installed in February 2000) on the house, with an annual production of 850 KWH, and you have a solar power station with an impressive track record.

When I installed the first system, I spent quite a bit of time looking for phantom loads, after reading articles in *Home Power* on this subject. I was amazed at just how wasteful some appliances are, even when they appear to be switched off. After some simple alterations, like fitting a switch to the TV and VCR to allow me to switch them off properly, and doing the same to the microwave to name but two, my total phantom-load savings per day was more than 2 KWH! Not believing this, I double-checked all the readings I had taken, and it was correct.

The energy I use has to travel a vast distance, so it would be madness to waste it. It is really important to do an energy audit before any solar-electric system is installed.

An SMA Sunny Boy Control Light system monitors performance of both inverters in the comfort of the house.



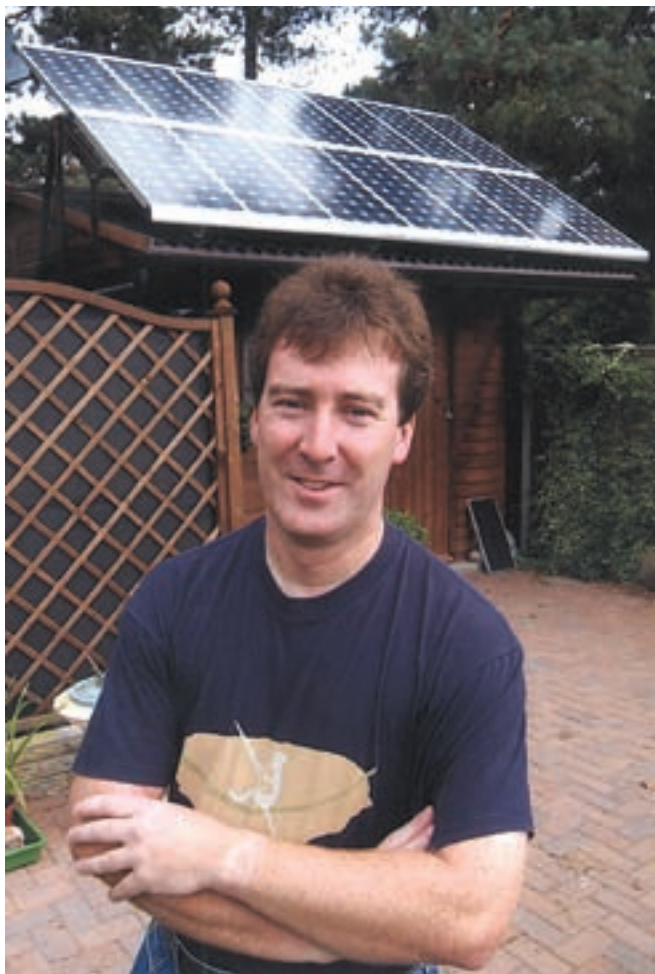

Courtesy Coventry Evening Telegraph

Anthony Skelton, in front of the garden shed PV system that doubled his home's PV power.

It is certainly the cheapest thing to do to save considerable amounts of energy (even if you don't plan to fit a PV system) and unnecessary expense on additional modules to supply the phantom loads.

These two solar-electric systems really do a great job, producing 1,600 KWH per year between them. Detailed records have been kept since the systems have been installed. They are supplying from 13 percent of the house load in December to 69 percent in June. Solar energy is my interest, so the old question about payback time is of no concern to me. What is important to me is clean energy independence.

Access

Anthony Skelton, Hillcrest, Hill Wootton Rd., Leek Wootton, Warwick, UK CV35 7QL • Phone/Fax: 01926 854289 • anthony@skelton800.fsnet.co.uk

Wind & Sun Ltd., Humber Marsh, Stoke Prior, Leominster, Herefordshire, UK HR6 0NR • 01568 760671 • Fax: 01568 760484 • info@windandsun.co.uk • www.windandsun.co.uk • System equipment & installation

BP Solar European & African Headquarters, Building 202, Chertsey Rd., Sunbury on Thames, Middlesex, UK TW16 7LN • 01923 779543 • Fax: 01923 762686 • www.bpamoco.com • Solar modules & inverter

Osmer Elektrotechnik, Alter Postweg 7, D 28865, Lilienthal, Germany • 04298-9095-0 • Fax: 04298-9095-99 • info@osmer-solar.de • www.osmer-solar.de • PV rack

Advanced Solar Products AG, Hauptstrasse 36B, CH-8637 Laupen/ZH, Switzerland • +41 (0) 55 246 4114 • Fax: +41 (0) 55 246 4116 • info@asp-ag.com • www.asp-ag.com • Stand-alone 12 V inverter

Energy Saving Trust, 21 Dartmouth St., London, UK SW1H 9BP • 0845 727 7200 • Fax: 020 7654 2444 • contact@saveenergy.co.uk • www.est.org.uk/solar • Solar grant scheme



SUNFRAME™

PV MODULE FRAMING AND MOUNTING SYSTEM FOR PITCHED ROOFS

Add aesthetics to the benefits of PV power

Low, clean lines. Your choice of clear or dark bronze anodized finish. Like a skylight, SunFrame becomes a natural feature of any home.

To be sure, it also meets strict structural standards, including Uniform and California building codes, and delivers the installation ease you've come to expect from UniRac.

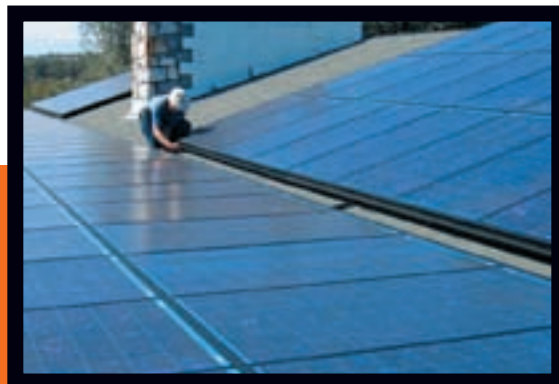

www.unirac.com



THE STANDARD IN PV MOUNTING STRUCTURES™

UniRac, Inc. 505.242.6411 505.242.6412 Fax
3201 University Boulevard SE, Suite 110 • Albuquerque NM 87106-5635 USA

U.S. and other patents pending.



BACKWOODS Solar Electric Systems

For an earth restored and a world at peace.

Solar • Wind • Hydro

Specializing in Independent Electric Power for the Remote Home where utility power is not available. For 26 years, your questions have been personally answered by the good folks at Backwoods Solar that use these products everyday. Our catalog / planning guide teaches the basics of installing solar, wind and hydro electric residential power and we offer free system design service either by telephone, email, or your visit to Backwoods. We can also refer you to solar helpers around the country.

**185 PAGE
CATALOG / PLANNING GUIDE
Free to Home Power readers
in the U.S.A.**

Visit us or write:
Backwoods Solar Electric Systems,
1589-HP Rapid Lightning Creek Rd,
Sandpoint, Idaho 83864 USA

Phone: (208) 263-4290 • Fax only (208) 265-4788

Website: www.backwoodssolar.com • Email: info@backwoodssolar.com

HuP[®] Solar-One[™] Batteries

**The Best Battery Warranty in RE Just Got Better!
Now 7 Years Free Replacement, 3 Years Prorated!
Thousands Upon Thousands of 2 Volt Cells Sold!
Less Than Two Tenths of One Percent Warranty Claims!**

For complete details on the new HuP Solar-One warranty and our complete line of RE products contact:

Northwest Energy Storage

800.718.8816 or 941.697.1344 Fax 941.697.0767
www.nwes.com www.hupsolarone.com batteries@nwes.com

**HuP Solar-One, The Better Built Battery!
What Are You Waiting for?**



Gutter

Used In: Many electrical systems, especially those incorporating several components such as disconnects, inverters, and KWH meters

AKA: Wireway

What It Is: A sheet-metal enclosure with removable cover, used for housing and protecting electrical wiring

What It Ain't: Somewhere you want to end up

Using gutters is a convenient way to protect electrical wiring from abrasion, dirt, dust, and water, and route multiple wires from several electrical components. If I had to pick one wiring enclosure that results in a superclean installation, a gutter would be it.



Forget about snaking multiple conduit runs or juggling several smaller junction boxes—multiple components and many wires call for gutters.

Gutters are sheet-metal troughs manufactured in 1- to 10-foot (0.3–3 m) lengths. While 4- and 6-inch (10 and 15 cm) width/depth dimensions are most common, the width and depth of the gutter you choose will vary depending on the size and number of wires being routed through it. Gutters for both indoor and outdoor use are available at most electrical supply stores. Outdoor gutters have waterproof covers; always use sealing washers on all conduit fittings entering the gutter to ensure a weather-tight installation.

While gutters are made with regularly spaced knockout holes for various-sized conduit, they may not accommodate your particular installation needs. Many installations will require punching or drilling holes in custom locations along the gutter. A slug-buster (also called a hole punch) is the best tool for the job. Hole-saw bits manufactured to cut metal also can be used.

Joe Schwartz • joe.schwartz@homepower.com

INCREASE YOUR SOLAR OUTPUT

With Solar Boost™ Maximum Power Point Tracking (MPPT) charge regulators
Patented technology extracts more power from the PV array – up to 30% more!
Reasonably priced and Quality built. Available in a variety of sizes.

Blue Sky Energy, Inc. (formerly RV Power Products) manufactures and distributes worldwide. We have been producing quality product since 1993.

Contact us today for more information.
Visit our web site www.blueskyenergyinc.com
or email to: sales@blueskyenergyinc.com
800-493-7877 or 760-597-1642 • Fax 760-597-1731
2598 Fortune Way, Suite K Vista, CA 92081 USA



Blue Sky
ENERGY

The TriMetric

Model 2020

BATTERY SYSTEM MONITOR



Displays vital battery system data to help users provide better battery care, increase conservation awareness and aid system maintenance.

- Volts • Amps • Amp-hours • Min/Max volts
- Days since charged • Battery % full
- Remote locatable • More !

Bogart Engineering • (831) 338-0616

www.bogartengineering.com

19020 Two Bar Rd. Boulder Creek, CA 95006 USA

The PentaMetric

A NEW BATTERY SYSTEM MONITOR



When you need **A LOT MORE** than a TriMetric

- 3 amp/amp-hour channels/2 volts channels: 2 battery systems and/or solar & wind inputs • 29 different (Battery DC) data
- Complete control from remote display unit and/or from "Windows" computer • Output control for generator start or battery alarms • Audible/visual alarms for low or high battery • Customize display to show only data you want • Print your own label to identify switches • Complete data logging designed to identify system problems

Coming Soon! Beta-testers wanted!

More info on website.

Anticipated System Price: \$290 (with computer interface only); \$320 (with front panel display only); \$400 for both.

"Prototype" price includes: one-year money back guarantee; free upgrades to eliminate bugs (such a deal!); \$100 reward for every bug you discover (if you are the first to discover it), and are able to reproduce the problem so we can fix it.

"That item is in-stock and ready to ship."

"Our Tech Dept will be able to answer your question."

"Our pumps have the longest warranty in the business."

WE'VE GOT THE ANSWERS YOU'RE LOOKING FOR.

Dankoff Solar Features a Complete line of:

- Pumps- Submersible and Surface • BP Solar Modules
- BOS including Outback, Xantrex, Fronius, SMA, and Unirac

CALL FOR A DEALER REFERRAL

Serving the renewable energy market since 1983



Featuring Exceptional Customer Service and Technical Expertise



Toll-Free (888) 396-6611

www.dankoffsolar.com

Buying an *Energy-Efficient* Refrigerator

Jennifer Barker

©2004 Jennifer Barker



The Kenmore #74982 (shown) and #74282 models provide ample space and excellent energy values.

In most households, refrigerators consume more energy than any other use except heating, air conditioning, and hot water. For on-grid utility customers looking to save energy on refrigeration, the choice is pretty straightforward. New Energy Star refrigerators provide energy savings by using high-efficiency compressors, improved insulation, and more precise temperature and defrost mechanisms that improve energy efficiency.

Today's Energy Star models use about half the energy of refrigerators manufactured before 1993, about 40 percent less energy than conventional models sold in 2001, and at least 15 percent less energy than required by current federal standards. Replacing a 15-year-old refrigerator with a new Energy Star model can save enough energy over the course of a year to light the average household for more than four-and-a-half months, and can eliminate more than 400 pounds (180 kg) of pollution each year.

Buying an efficient refrigerator should be as easy as 1-2-3. First, do your homework. Next, do some "preshopping." Then bring home a refrigerator that will serve your needs, save pounds of pollution every year, and keep dollars in your pocket instead of the utility's.

Space Has Value

Refrigerator space can be given a specific value in dollars per cubic foot of chilled space per year. The comparison table in this article of selected models

displays this value as a factor of the purchase cost, spread over the appliance's expected life, plus the cost of electrical energy.

Analyze your refrigerator space needs. Over the decades, although their efficiency has increased, refrigerators have become bigger and bigger—and more space costs money to build, to heat, and to cool. Is your need for space a matter of necessity, convenience, or just habit? Many individual factors, including things like root cellars and distance to grocery shopping, can influence your need for space.

Features

Decide what style and features you want, but consider that many features will use extra energy over the appliance's lifetime. Large, side-by-side refrigerator/freezers can carry an energy penalty because they have more surface area proportional to interior space. Through-the-door ice dispensers can increase energy use by 5 to 10 percent. Automatic defrost refrigerators, which use an internal heater to melt ice from the coils, can draw more than 600 watts for a short period during the defrost cycle, costing you about 12 percent more in overall energy use. The bottom line for energy efficiency: Avoid all extra features and penetrations, such as snack doors, and ice and water dispensers, if you can.

Remember the story you were told in grade school about how every time you opened the refrigerator door, the cold

Ultra-high-efficiency refrigerators, like the Sun Frost, can be a good choice for off-grid applications.



The GE Monogram refrigerator will hold enough food for a big crowd.

air rolled down and was replaced by warm air, making the refrigerator use more energy? This is only partly true. The cold air does drop—you can feel it on your feet—but air has a low mass, so the interior air is quickly recharged. Think about this as you compare the 24/7 energy penalty of an extra door penetration versus the energy cost of just opening the door when you need ice or a snack.

The most efficient configuration is a basic box shape with a solid exterior and manual defrost. Energy use will be about the same whether the refrigerator has a top or bottom freezer, *but* there will be more usable freezer space in a chest freezer or bottom freezer (if it is configured as a drawer) than in the freezer compartment of a standard upright refrigerator.

I can't repeat this often enough—refrigerators on the Energy Star list are there because they use at least 15 percent less energy than similar models, even with inherently inefficient designs. Find the most efficient model for the size, and leave out the watt-costly bells and whistles.

Needs

Look in your refrigerator. How much of the space is occupied by condiments that only get used once in a great while? How many of the jars actually say "refrigerate after opening"? In many condiments, salt, sugar, and vinegar—agents that already act as preservatives—are the primary ingredients.

Food safety is important, but if something does not need to be stored in a cold space, or you almost never use it, you might consider reserving your valuable refrigerator space for higher priority occupants.

Preshopping

Do some preshopping by visiting the Energy Star Web site (see Access). There, you can download the latest list of

Refrigerator Comparison

Common Models	Suggested Retail (US\$)	Configuration	Defrost	Total Volume (c.f.)	Fridge Volume (c.f.)	Freezer Volume (c.f.)	Adjusted Volume* (c.f.)
Sanyo SR-1030	\$395	Top freezer	Auto	10.31	7.95	2.36	11.80
Whirlpool ET5WSEXKQ	479	Top freezer	Auto	14.50	10.70	3.80	16.89
Frigidaire FRT15HB3DW	379	Top freezer	Auto	14.75	11.01	3.74	17.11
Kenmore 74982	820	Top freezer	Auto	18.80	13.80	5.00	21.95
Kenmore 74282	920	Top freezer	Auto	21.60	15.10	6.50	25.70
GE Profile PTS25LHRWW	1,349	Top freezer	Auto	24.59	17.51	7.08	29.05
GE Monogram ZIS480	5,399	Side-by-side	Auto	30.61	17.77	12.84	38.70

High-Efficiency Models

SunDanzer DCR225	\$1,049	Chest fridge	Manual	8.10	8.10	0.00	8.10
SunDanzer DCF165	949	Chest freezer	Manual	5.80	0.00	5.80	9.45
Sun Frost RF12	1,979	Top freezer	Partial	10.12	8.07	2.05	11.41
Sun Frost RF16	2,655	Top freezer	Partial	14.31	10.40	3.91	16.77
Sun Frost R10	1,595	Fridge only	Partial	9.13	9.13	0.00	9.13

Assumptions: On-Grid KWH costs = US \$0.10
Off-Grid KWH costs = US \$0.75

Fresh food compartment = 38°F
Freezer compartment = 5°F

Ambient = 90°F
Life expectancy = 15 years

Energy Star refrigerators or use their search feature to find only the size and configuration you're considering.

Next, go to your favorite appliance store, whether it's on the Internet, in a "big box," or your local sales-and-service appliance center. Find out what brands they carry. Many refrigerator models appear across the brand spectrum. Sometimes all that is different is the brand name or shelf configuration. Compare the models you've selected on the Energy Star list.

Testing, Location & Use

The National Appliance Energy Conservation Act dictates minimum standards for the energy consumption of refrigerators and freezers. Standards vary depending on the refrigerator's size and configuration. On January 1, 2004, the Energy Star criteria for refrigerators changed to require all full-size models to be at least 15 percent more energy efficient than the minimum federal standard.

U.S.-made refrigerators are tested at an ambient temperature of 90°F (32°C) in an attempt to approximate real-time energy use at room temperature with regular door

openings. The temperature in the fresh food compartment is set at 38°F (3°C), and the freezer is set at 5°F (-15°C).

The amount of energy used directly relates to the ambient temperature in the area where the refrigerator is kept. The penalty for each 10°F (5.5°C) increase in ambient temperature can increase energy use by as much as 70 percent! Keeping your refrigerator and freezer in a cool location can really save energy. But there is a caveat: To comply with warranty restrictions, most refrigerators must be kept in areas with temperatures above 45°F (7°C).

It is important to realize that stand-alone chest freezers are tested at a temperature setting of 0°F (-18°C). So if you are comparing a fridge/chest freezer combo with a top-freezer refrigerator (for example), you need to know that the chest-freezer combo may use a little more energy because it is also keeping your food at a colder temperature for the long term.

Making Your Choice

To make your shopping easier, the comparison table shows a selection of today's most energy-efficient

Annual KWH	Annual KWH per Adjusted Volume	Annual Cost per Adjusted Volume	
		On-Grid	Off-Grid
350.0	29.67	\$5.20	\$24.48
372.0	22.02	4.09	18.40
376.0	21.98	3.68	17.96
392.0	17.86	4.28	15.88
422.0	16.42	4.03	14.70
475.0	16.35	4.73	15.36
592.0	15.30	10.83	20.77

78.9	9.74	—	\$15.94
133.6	14.13	—	17.29
171.0	14.98	\$13.06	22.80
254.0	15.14	12.07	21.91
101.0	11.06	12.75	19.94

*The “adjusted volume” is a formula used to try to equalize energy consumption when comparing units with different refrigerator-to-freezer proportions.

refrigerators in their respective size categories. In terms of efficiency, many people think smaller is better. But in the 10-cubic-foot (0.28 m³) range, Sanyo’s SR-1030 (and at least two other identically sized brands) uses almost as much energy as models that are 40 percent larger, and more than twice as much energy as the similarly sized Sun Frost RF12.

Three models are listed in the 14- to 15-cubic-foot (0.4 m³) range. These are modest-sized refrigerators, less efficient per cubic foot than the larger ones, but more economical overall to purchase and run than any other size on the list. The Sun Frost RF16 reigns as the energy queen here, using 70 percent as much energy as the others and exceeding current standards by 36 percent. But if you are on-grid, the low up-front cost and easy availability of the Whirlpool ET5WSEXKQ makes it attractive. Of all the models listed, the Frigidaire FRT15HB3DW is the winner in terms of low cost to own and operate, but it is a special-order purchase.

In 18- to 19-cubic-foot (0.5 m³) and 21- to 22-cubic-foot (0.6 m³) sizes, Kenmore models shine, exceeding even current Energy Star ratings. They have a host of

models similar to the #74982 and #74282, all with the same energy usage profile, but with different configurations and features.

If you want a bigger-than-big fridge, General Electric’s 24.59-cubic-foot (0.7 m³) Profile PTS25LHRWW is the largest top-freezer refrigerator on the Energy Star list, and its performance exceeds that of same-sized Energy Star side-by-sides by as much as 20 percent.

Need bigger than that? GE claims that its 30.61-cubic-foot (0.87 m³) Monogram ZIS480, built-in, side-by-side is the most efficient model per cubic foot of space. It is also quieter than anything they’ve made to date.

Many more models shine when it comes to the features you might be looking for. The costs in the table are estimates to allow you to make reasonable comparisons. Use them as your yardstick, and make sure that anything you buy measures up when it comes to the trade-off between up-front cost, features you can live with for a long time, and energy performance.

It’s up to you to lay out your personal long-term strategy, which may include learning to use your expensive refrigerator space more effectively. Our behavioral choices, as well as our purchases, affect our bottom-line costs in refrigeration, as in everything else!

General Electric’s huge, top-freezer model—the Profile.



Off-Grid? Consider a DC Fridge

Alternating current (AC) Energy Star units represent a pretty impressive energy savings. But if you are off-grid and on a tight energy budget, is “impressive” enough? Refrigerators range from conventional to Energy Star to ultra-high efficiency. The ultra-high-efficiency units cost more, but they can save energy in terms of kilowatt-hours.

Just how much should you spend to save a kilowatt-hour of energy? I live off-grid and have a direct current (DC) refrigerator and freezer—two separate units in different locations. Why would I want to spend the bucks for more than a basic consumer-level fridge and keep my freezer out in the shed?

Conserve First

Energy production costs more than energy conservation. Where I live, with five average sun hours per day, producing an extra kilowatt-hour a day from a solar-electric system with generator backup would cost about US\$5,000 up front. I would need to expand our solar-electric array and battery bank, and provide extra generator run-time during the 15-year life of an average fridge (assuming I already have a generator and my inverter is big enough to handle the increased load). So buying the most efficient refrigerator and freezer I can find pays off immediately by avoiding that expense and hassle.

In addition, using a DC fridge and freezer means avoiding inverter efficiency loss, which averages

15 percent, depending on the inverter model and total load. It also means I can add more discretionary loads to my house without maxing out the inverter’s capacity. As a side benefit, if our inverter ever needs servicing, I won’t have to turn off food-storage cooling.

Because I wouldn’t need to run a generator as often in winter, I’d stave off the day when it would need servicing or replacing, and save on fuel. Another point of interest is that large loads withdraw energy from a battery faster, making less total energy available before the battery is fully discharged. It is worth noting that the larger and less efficient a refrigerator’s compressor is, the more it will tax your batteries.

I bought a Sun Frost R10, 10-cubic-foot (0.28 m³) refrigerator and a SunDanzer DCF225 8.1-cubic-foot (0.23 m³) chest freezer, both of which run directly off our 24-volt DC system. For those who want to store their food for the fewest watt-hours, SunDanzer makes ultra-high-efficiency chest refrigerators.

DC units have a few potential drawbacks. They may cost more initially, but can make up for their initial cost rapidly if you live off-grid. Your local appliance repairperson might (but won’t necessarily) sniff at the idea of servicing them. You will have to do without some features, notably the auto-defrost freezers found in almost all standard refrigerators today. And they only come in a few sizes (excluding the huge and enormous).

Access

Jennifer Barker, EORenew, PO Box 485, Canyon City, OR 97820 • 541-575-3633 • info@solwest.org • www.solwest.org • BPA certified energy auditor

Energy Star Programs Hotline & Distribution (MS-6202J), 1200 Pennsylvania Ave. NW, Washington, DC 20460 • 888-STAR-YES or 202-343-9451 • Fax: 202-775-6680 • energystar@optimuscorp.com • www.energystar.gov

U.S. Department of Energy, Office of Energy Efficiency and Renewable Energy (EERE), Appliance and Commercial Equipment Standards • www.eere.energy.gov/buildings/appliance_standards • Energy efficiency standards for residential and commercial products

“Chilling the Watt-Hours on a Mass-Market Fridge,” by John Bertrand, in *HP95*

Refrigerator Manufacturers:

- Frigidaire • www.fridgidaire.com
- General Electric • geappliances.com
- Kenmore • www.sears.com
- Sanyo • www.sanyo.com
- SunDanzer • www.sundanzer.com
- Sun Frost • www.sunfrost.com
- Whirlpool • www.whirlpool.com



The Very Best RE Resources Available!



OFF-GRID...

William Kemp, one of North America's leading authorities on renewable energy, has written the most comprehensive book available to walk you through every facet of choosing and installing an off-grid renewable energy system.



...OR ON-GRID!

His new book is a complete guide to using all forms of energy as efficiently as possible, allowing you to save money and the planet! Learn how to use renewable energy to supplement your grid power and protect your family from power blackouts. Everything from using the sun to heat your water, to what fuel to put in your gas tank.

Available at any bookstore or at www.aztext.com

RE Dealers - call for volume discounts. These books save you hours of time educating buyers! 613-379-3066

SunDanzzer

Cool with Solar

- Energy-Efficient
- Automatic operation
- Thick polyurethane insulation
- Lockable lid
- Interior light
- Corrosion resistant coated steel exterior
- Patented low-frost system
- Easy to clean interior
- Low maintenance

12/24 VDC Energy Efficient Refrigeration

(866) Sun-Danz
(866) 786-3269
www.sundanzzer.com

Save Up To 30 Gallons of Water With Each Load of Laundry!



Only Top Load Horizontal-Axis Washer Made in the USA

- Avg. of 15 gallons of water & 1 oz. soap per load (great for wells & septic systems)
- Stainless steel inner & outer tubs
- Dual, re-greasable bearings on front & rear
- No front rubber gasket to worry about leakage or mildew
- Total front access to parts--*most simple design on the market*
- Simple, mechanical switches--no expensive electronic buttons!
- High extraction spin speed
- MADE IN THE USA!



Call 1-800-848-6200 to learn more!

www.staber.com

Staber Industries, Inc. 4800 Homer Ohio Ln Groveport, OH 43125



Sun Frost

Energy Efficient Refrigerators & Freezers

Customized To Fit Your Needs



- ▶ Available in DC or AC
- ▶ Select From Over 10 Models
- ▶ Choose from 1000's of Colors, Finishes & Woods

Providing an Effective Alternative for Energy Conscious Consumers. Now Making Stylish Home Composting Systems Too!

Please Contact Us For More Info

P.O. Box 1101, Arcata, CA 95518
tel: (707)822-9095 ■ fax: (707)822-6213
info@sunfrost.com ■ www.sunfrost.com

Solar-Electric Systems

SIMPLIFIED

Scott Russell

©2004 Scott Russell

Perhaps what the home-scale renewable energy (RE) world needs most are ways to introduce people to RE technologies and the gizmos that make it possible. After all, even the best ideas aren't embraced until they are explained in simple terms.

So whether *you* are the rookie who wants to understand how solar-electric systems work, or that better describes your spouse, friend, or prospective customer, this article explains the guts and bolts of the three most common options in solar-electric systems: grid-intertied, grid-intertied with battery backup, and off-grid (stand-alone).

Understanding the basic components of an RE system and how they function is not an overwhelming task. Here are some brief descriptions of the common equipment used in grid-intertied and off-grid solar-electric systems. Systems vary—not all equipment is necessary for every system type. In the diagrams, the numbers in red correspond to the components needed.

GRID-INTERTIED SOLAR-ELECTRIC SYSTEM

Also known as on-grid, grid-tied, or utility-interactive (UI), grid-intertied solar-electric systems generate solar electricity and route it to the electric utility grid, offsetting a home's or business's electrical consumption and, in some instances, even turning the electric meter backwards. Living with a grid-connected solar-electric system is no different than living with grid power, except that some or all of the electricity you use comes from the sun.

In many states, the utility credits a homeowner's account for excess solar electricity produced. This amount can then be applied to other months when the system produces less or in months when electrical consumption is greater. This arrangement is called net metering or net billing. The specific terms of net metering laws and regulations vary from state to state and utility to utility. Consult your local electricity provider or state regulatory agency for their guidelines.

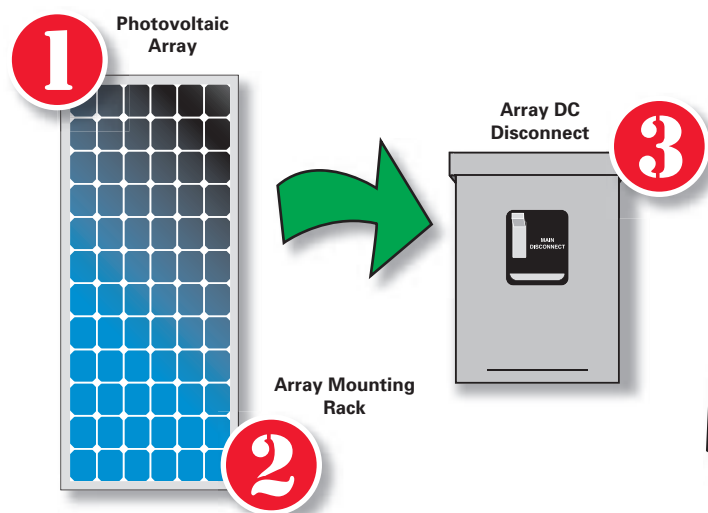

1 Solar-Electric Panels

AKA: solar-electric modules, photovoltaic (PV) panels

PV panels are a solar-electric system's defining component, where sunlight is used to make direct current (DC) electricity. Behind a PV panel's shimmering facade, wafers of semiconductor material work their magic, using light (photons) to generate electricity—what's known as the *photovoltaic effect*. Other components in your system enable the electricity from your solar-electric panels to safely power your electric loads like lights, computers, and refrigerators.

PV panels are assigned a rating in watts based on the maximum power they can produce under ideal sun and temperature conditions.

You can use the rated output to help determine how many panels you'll need to meet your electrical needs. Multiple modules combined together are called an array.

Although rigid panels are the most common form of solar electricity collector, PV technology also has been integrated into roofing shingles and tiles, and even peel-and-stick laminates (for metal standing-seam roofs).

PV modules are very durable and long-lasting—most carry 25-year warranties. They can withstand severe weather, including extreme heat, cold, and hail stones.



2 Array Mounting Rack

AKA: mounts, racks

Mounting racks provide a secure platform on which to anchor your PV panels, keeping them fixed in place and oriented correctly. Panels can be mounted using one of three approaches: 1) on a rooftop; 2) atop a steel pole set in concrete; or 3) at ground level. The specific pieces, parts, and materials of your mounting device will vary considerably depending on which mounting method you choose.

Usually, arrays in urban or suburban areas are mounted on a home's south-facing roof, parallel to the roof's slope. This approach is sometimes considered most aesthetically pleasing, and may be required by local regulators or homeowner's associations. In areas with a lot of space, pole- or ground-mounted arrays are another choice.

Mounting racks may incorporate other features, such as seasonal adjustability. The sun is higher in the sky

during the summer and lower in the winter. Adjustable mounting racks enable you to set the angle of your PV panels seasonally, keeping them aimed more directly at the sun. Adjusting the tilt angle increases the system's annual energy production by a few percent. The tilt of roof-mounted arrays is rarely changed—adjusting the angle is inconvenient and sometimes dangerous, due to the array's location.

Changing the tilt angle of pole- or ground-mounted arrays can be done quickly and safely. Pole-mounted PV arrays also can incorporate tracking devices that allow the array to automatically follow the sun across the sky from east to west each day. Tracked PV arrays can increase the system's daily energy output by 25 to 40 percent.

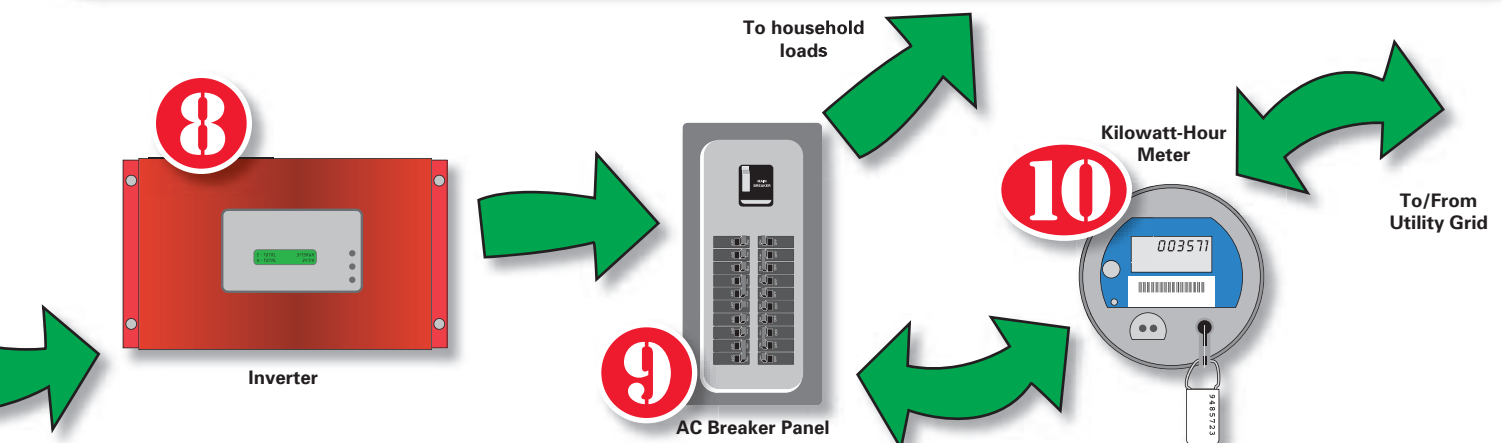

3 Array DC Disconnect

AKA: PV disconnect

The DC disconnect is used to safely interrupt the flow of electricity from the PV array. It's an essential component when system maintenance or troubleshooting is required. The disconnect enclosure houses an electrical switch rated for use in DC circuits. It also may integrate either circuit breakers or fuses, if needed.



4 Charge Controller

AKA: controller, regulator

A charge controller's primary function is to protect your battery bank from overcharging. It does this by monitoring the battery bank—when the bank is fully charged, the controller interrupts the flow of electricity from the PV panels. Batteries are expensive and pretty particular about how they like to be treated. To maximize their life span, you'll definitely want to avoid overcharging or undercharging them.

Most modern charge controllers incorporate maximum power point tracking (MPPT), which optimizes the PV array's output, increasing the energy it produces. Some battery-based charge controllers also include a low-voltage disconnect that prevents overdischarging, which can permanently damage the battery bank.



GRID-INTERTIED SOLAR-ELECTRIC SYSTEM WITH BATTERY BACKUP

Without a battery bank or generator backup for your grid-intertied system, when a blackout occurs, your household will be in the dark, too. To keep some or all of your electric needs (or "loads") like lights, a refrigerator, a well pump, or computer running even when utility power outages occur, many homeowners choose to install a grid-intertied system

with battery backup. Incorporating batteries into the system requires more components, is more expensive, and lowers the system's overall efficiency. But for many homeowners who regularly experience utility outages or have critical electrical loads, having a backup energy source is priceless.

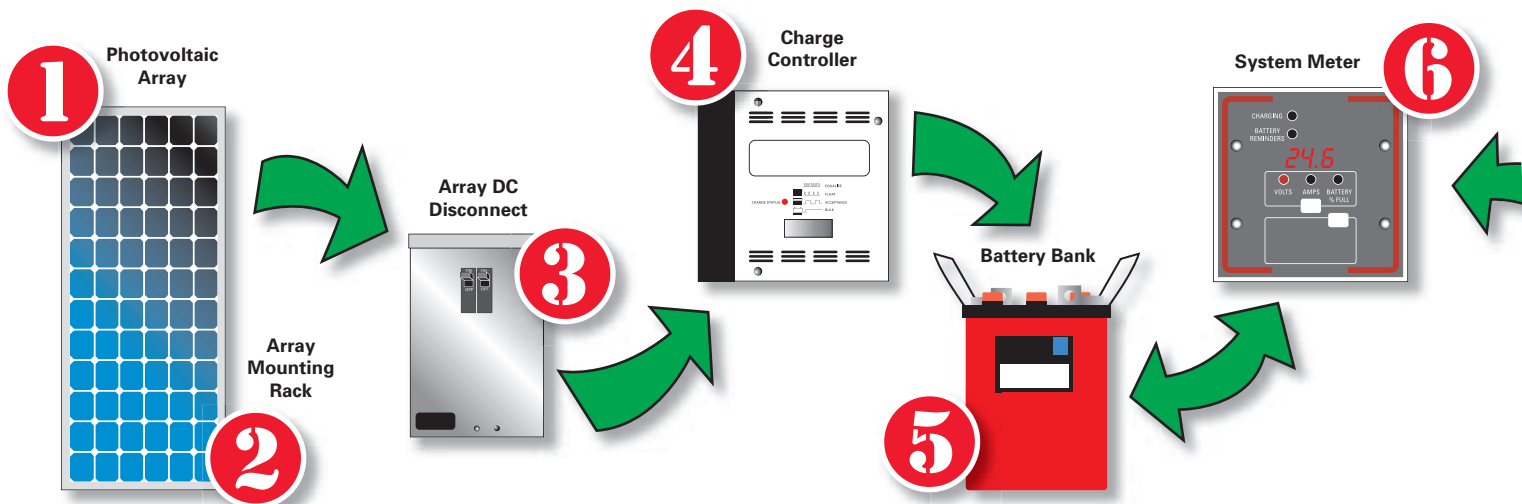

5 Battery Bank

AKA: storage battery

Your PV panels will produce electricity whenever the sun shines on them. If your system is off-grid, you'll need a battery bank—a group of batteries wired together—to store energy so you can have electricity at night or on cloudy days. For off-grid systems, battery banks are typically sized to keep household electricity running for one to three cloudy days. Grid-intertied systems also can include battery banks to provide emergency backup power during blackouts—perfect for keeping critical electric loads operating until grid power is restored.

Although similar to ordinary car batteries, the batteries used in solar-electric systems are specialized for the type of charging and discharging they'll need to endure. Lead-acid batteries are the most common battery used in solar-electric systems. Flooded lead-acid batteries are usually the least expensive, but require adding distilled water occasionally to replenish water lost during the normal charging process. Sealed absorbent glass mat (AGM) batteries are maintenance free and designed for grid-tied systems where the batteries are typically kept at a full state of charge. Gel-cell batteries can be a good choice to use in unheated spaces due to their freeze-resistant qualities.



6 System Meter

AKA: battery monitor, amp-hour meter

System meters measure and display several different aspects of your solar-electric system's performance and status, tracking how full your battery bank is; how much electricity your solar panels are producing or have produced; and how much electricity is in use. Operating your solar-electric system without metering is like running your car without any gauges—although possible to do, it's always better to know how much fuel is in the tank.



7 Main DC Disconnect

AKA: battery/inverter disconnect

In battery-based systems, a disconnect between the batteries and inverter is required. This disconnect is typically a large, DC-rated breaker mounted in a sheet-metal enclosure. This breaker allows the inverter to be quickly disconnected from the batteries for service, and protects the inverter-to-battery wiring against electrical fires.

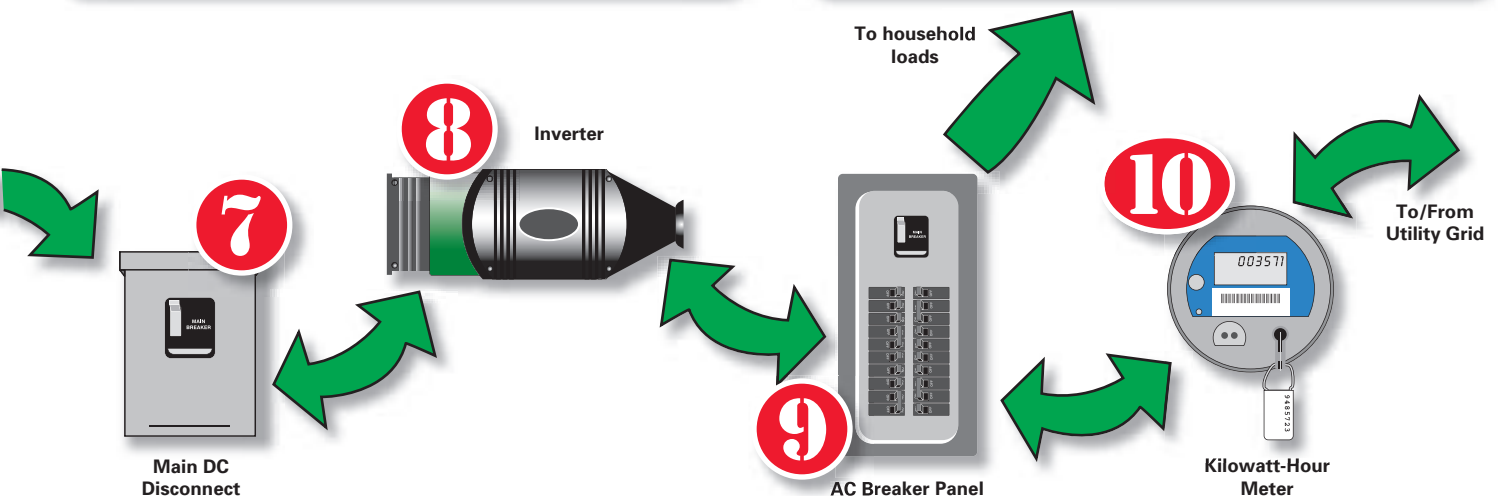



Inverter

Inverters transform the DC electricity produced by your PV modules into the alternating current (AC) electricity commonly used in most homes for powering lights, appliances, and other gadgets. Grid-tied inverters



synchronize the electricity they produce with the grid's "utility-grade" AC electricity, allowing the system to feed solar-made electricity to the utility grid.

Most grid-tie inverters are designed to operate without batteries, but battery-based models also are available. Battery-based inverters for off-grid or grid-tie use often include a battery charger, which is capable of charging a battery bank from either the grid or a backup generator during cloudy weather.



Most grid-intertie inverters can be installed outdoors (ideally, in the shade). Most off-grid inverters are not weatherproof and should be mounted indoors, close to the battery bank.

OFF-GRID SOLAR-ELECTRIC SYSTEMS

Although they are most common in remote locations without utility grid service, off-grid solar-electric systems can work anywhere. These systems operate independently from the grid to provide all of a household's electricity. That means no electric bills and no blackouts—at least none caused by grid failures.

People choose to live off-grid for a variety of reasons, including the prohibitive cost of bringing utility lines to

remote homesites, the appeal of an independent lifestyle, or the general reliability a solar-electric system provides. Those who choose to live off-grid often need to make adjustments to when and how they use electricity, so they can live within the limitations of the system's design. This doesn't necessarily imply doing without, but rather is a shift to a more conscientious use of electricity.

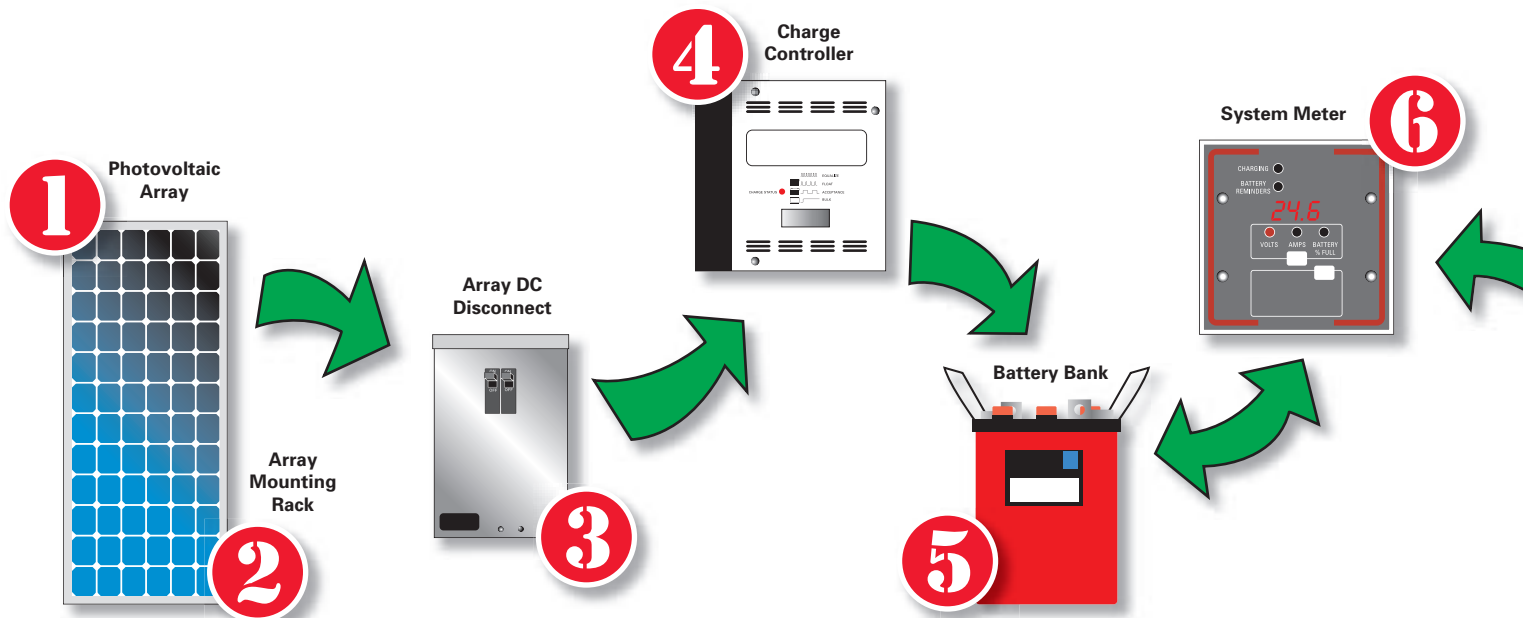

9 AC Breaker Panel & Inverter AC Disconnect

AKA: mains panel, breaker box, fuse box

The AC breaker panel is the point at which all of a home's electrical wiring meets with the "provider" of the electricity, whether that's the grid or a solar-electric system. This wall-mounted panel or box is usually installed in a utility room, basement, garage, or on the exterior of the building. It contains a number of labeled circuit breakers that route electricity to the various rooms throughout a house. These breakers allow electricity to be disconnected for servicing, and also protect the building's wiring against electrical fires.



Just like the electrical circuits in your home or office, an inverter's electrical output needs to be routed through an AC circuit breaker. This breaker is usually mounted inside the building's mains panel, which enables the inverter to be disconnected from either the grid or from electrical loads if servicing is necessary, and also safeguards the circuit's electrical wiring.

Additionally, utilities usually require an AC disconnect between the inverter and the grid that is for their use. These are usually located near the utility KWH meter.

10 Kilowatt-Hour Meter

AKA: KWH meter, utility meter

Most homes with a grid-tied solar-electric system will have AC electricity both coming from and going to the electric utility grid. A bidirectional KWH meter can simultaneously keep track of how much electricity flows in each of the two directions—just the information you need to monitor how much electricity you're using *and* how much your solar-electric system is producing. The utility company often provides intertie-capable meters at no cost.

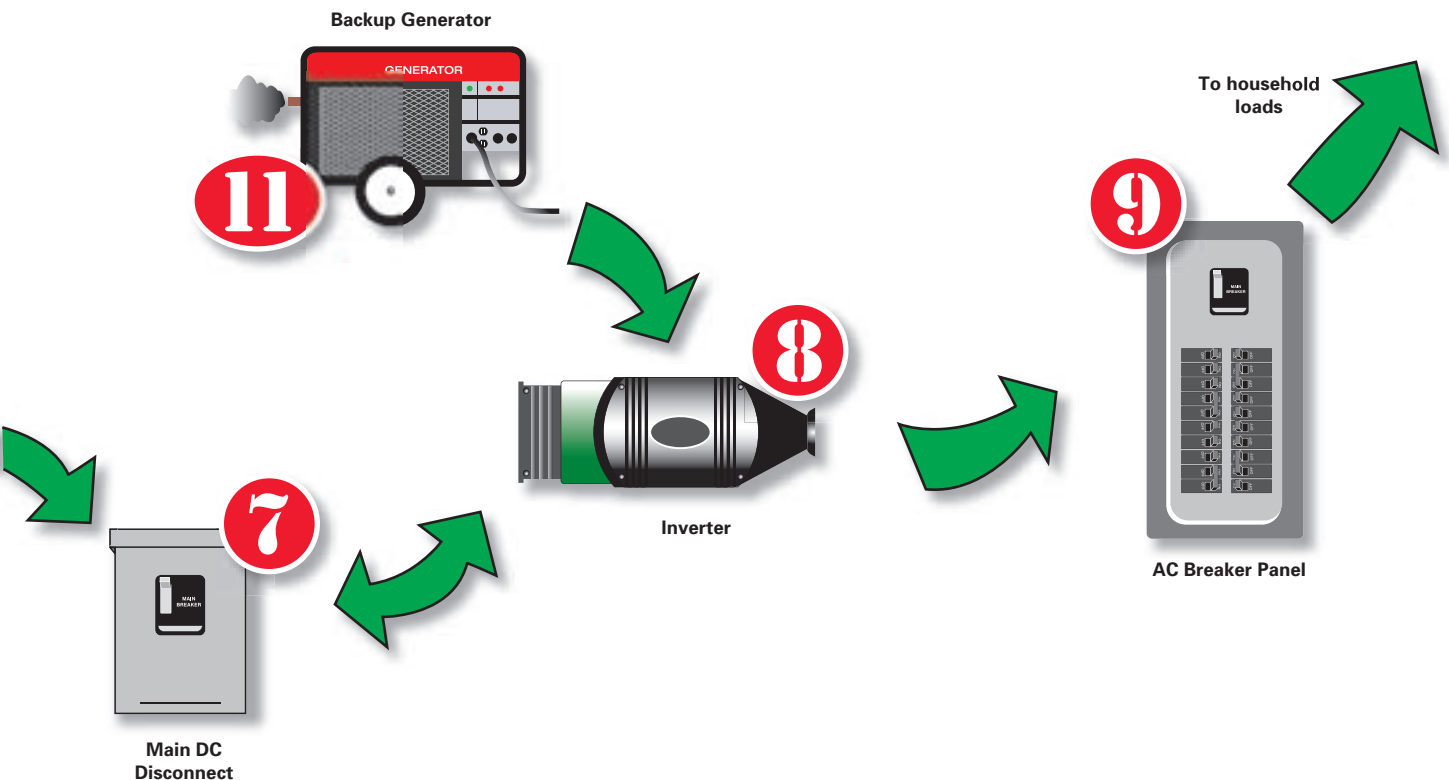

11 Backup Generator

AKA: gas guzzler

Off-grid solar-electric systems can be sized to provide electricity during cloudy periods when the sun doesn't shine. But sizing a system to cover a worst-case scenario, like several cloudy weeks during the winter, can result in a very large, expensive system that will rarely get used to its capacity. To spare your pocketbook, size the system moderately, but include a backup generator to get through those occasional sunless stretches.

Engine generators can be fueled with biodiesel, petroleum diesel, gasoline, or propane, depending on the design. These generators produce AC electricity that a battery charger (either stand-alone or incorporated into an inverter) converts to DC energy, which is stored in batteries. Like most internal combustion engines, generators tend to be loud and stinky, but a well-designed solar-electric system will require running them only 50 to 200 hours a year.



Solar-Electric Systems Demystified

As you can see, the anatomy of a photovoltaic system isn't that complicated. All of the parts have a purpose, and once you understand the individual tasks that each part performs, the whole thing makes a bit more sense. Now you're ready to look at the system articles and schematics in *Home Power* without your eyes glazing over, and you'll have a clearer understanding of what is going on in the articles.

To solidify your understanding, your next task should be to examine a solar-electric system in person. The National Tour of Solar Homes each fall is one way to see a variety of systems. Also, many renewable energy fairs and workshops feature tours of solar homes. Check the listings for your area in the *Happenings* calendar in each *Home Power* issue to find out where you can learn more about RE systems and meet the people who are using renewable energy in your area.

Access

Scott Russell • c/o *Home Power* magazine,
PO Box 520, Ashland, OR 97520 •
scott.russell@homepower.com



4 Things You Should Expect When Choosing Renewable Energy Equipment

The decision to live with renewable energy is a long term commitment. To make the right decision consider the following:

- **Inventory** : Make sure your supplier can provide what you want, not what they have.
- **Experience** : Does your supplier use what they sell?
- **Service** : 78% of Renewable Energy suppliers are part time. Make sure yours is full time.
- **Knowledge** : Make sure your supplier can answer all of your technical questions without giving you the run around and leaving you even more confused.



FREE
Solar Design Guide
Packed full of industry secrets, useful charts and product selection guides.
www.nationalsolarsupply.com/free

Think INSIDE the box



Our Innovative Patented Power Package features:

- Save installation time & money with plug-n-play design
- Simple, pre-tested prior to shipment, modular
- Meets NEC-690 standards
- Grid-tie or stand alone power capability
- 16 models available – sized to meet your needs
- High quality system components

Products & services we also offer:

- Radiant heating systems
- Energy efficient appliances
- Solar and wind packages
- Kohler back-up generators

xantrex Certified Dealer



**Planetary
Systems**
power your environment

Planetary Systems, Inc.
P.O. Box 340 / 262 Badger Rd., Ennis, MT 59729
Phone (406) 682-5646 / FAX (406) 682-5644
www.planetarysystems.com



SOLAR CONVERTERS INC.

We design and manufacture Power Control Solutions for your Renewable Energy Systems!



Linear Current Boosters

- Increases Solar Pump Performance**
- 12 / 24 V @ 7 amps
 - MPPT
 - Voltage Limited
 - Fused Output



DC Autotransformers

- Bi-Directional DC-DC Converter**
- Battery Balancer / Equalizer
 - Converts Battery Power to Different Voltages
 - Up / Down Converter



Battery Desulphators

- Extends Battery Life**
- Recovers Sulphated Batteries
 - Single unit 12 to 48 V
 - Adjustable Pulse Strength



Linear Voltage Boosters

- Keeps a Constant Battery Voltage to your Equipment**
- Charge a Battery from a Lower Voltage Battery or PV
 - Water Pump Booster and Controller



Generator Starters

- Starts / Stops Gensets based on Battery Charge**
- Single unit 12 to 48 V
 - Controls any Generator
 - Temp. Compensated

ALSO...

- MPPT Power Tracker™ Charge Controllers
- Cathodic Protection Controllers
- Voltage Controlled Switches
- Solar Lighting Controllers

Please visit www.solarconverters.com for MORE products and details

C1-199 Victoria Road S., Guelph, ON, N1E 6T9, Canada Phone: 519-824-5272 Fax: 519-823-0325 E-mail: info@solarconverters.com



Give a
Subscription to
Sunshine this Winter

Save with Our Annual Winter Gift Special

There's never been a better time to introduce your friends and family to *Home Power*.

Give a one-, two-, or three-year gift subscription and get a one-year subscription or renewal for yourself *free!* That's six issues delivered to you at no charge—a \$22.50 savings.

Seasons greetings from the *Home Power* crew.

Order online at www.homepower.com/giftspecial
or by phone, 800-707-6585 or 541-512-0201

International orders welcome. Offer expires January 31, 2005.



Wondering where to start?

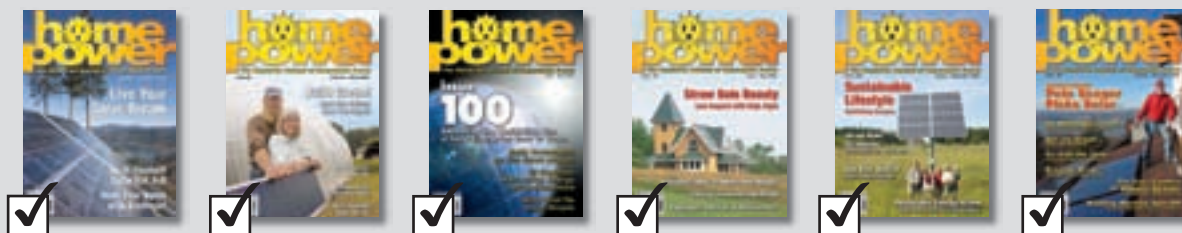

Our **Quick Start** special! Get our last six issues and a one-year subscription for just **\$45** plus S&H. Save \$36!



Add Solar1, our Renewable Energy Basics CD-ROM, to the deal for another **\$19**, regularly \$29!

Back-issue substitutions welcome. Order online at www.homepower.com or call 800-707-6585 or 541-512-0201.

Digital Back Issues Instant (paperless) satisfaction!

Every back issue of *Home Power* is available in PDF at www.homepower.com!



Search, browse, purchase, & download complete issues directly to your computer!

Haven't been to homepower.com in a while? Check it out!

- Our online store is always open for business! Subscribe or renew, shop specials, CD-ROMs, back issues, and gifts, or review your order history!
- In need of technical advice & RE information? Search our directory of RE businesses, browse upcoming events, articles, stocks, job openings, or e-mail us your tech questions!

DP&W Power Rail PV Mounts

Joe Schwartz

©2004 Joe Schwartz

Application: Power Rail is a top-clamping, PV mounting system designed for quick and secure installation of parallel-to-the-roof solar-electric arrays.

System: I worked with Bob-O Schultze of Electron Connection installing an 17.75 KW solar-electric system consisting of 96 Sharp, 185 W modules, Direct Power and Water (DP&W) Power Rail, and 6 PV Powered, 2,800 W inverters. The system is installed on the office of a building contractor and developer in Medford, Oregon.

Big Systems, Fast Installs

The substantial rebates now available for solar-electric systems in several U.S. states have simultaneously driven the out-of-pocket cost of PV systems down, and the size of them up. Larger systems are the obvious end result when these rebates are coupled with a rapidly growing acceptance of PV technology in mainstream America, and the greater energy needs of this new market.

Several PV mount manufacturers, including DP&W, have developed top-clamping, track mounting systems that greatly reduce the time required to install large PV arrays. The result is less time on the roof for the installers, and lower installation costs for the customers.

Power Rail

The central components of DP&W's Power Rail system are the extruded aluminum rails. These rails are manufactured with channels that accept both the Power Rail system's mounting foot and PV module mounting hardware. Once the mounting feet are installed, bolts for fastening the rails to the mounting feet are simply slid in from either end of the rail. The rails are bolted to the mounting feet.



DP&W Power Rail bolts easily to mounting feet, which (in this case) connect to S-51 clamps on standing-seam roofing.

Features

- Easy rack layout
- Substantially reduced installation time compared to conventional PV roof mounts.
- All individual mount components can be positioned by a single installer.
- Slotted rails make for easy adjustment of bolt locations (no need to worry about misdrilled holes or inconvenient rafter spacing).
- Compatible with all PV modules currently available

The shape of the rails' channels is designed to hold the heads of the bolts in a captive position. Since the head of the bolt cannot rotate, a single socket/ratchet combination or ratcheting box end wrench can be used to secure the hardware. Make sure to use a torque wrench, set to the recommended torque specification, for the final tightening of all rack hardware.

Once the rails are in place, two different clamps are used to secure the PVs to the rails, working from the top down. One clamp is designed for use between modules; a different one is used at the outside edge of the last module in a row. These mid- and end-clamps are secured with locking stainless nuts to the captive stainless steel bolts. These nuts do not require the use of an additional lock washer, so there's one less thing to drop off the roof.

Roof Interface Options

Several options are available for mounting the Power Rails to the roof surface. The standard 5-inch (13 cm) mounting foot, which we used in the evaluation system, holds the modules 3.3 inches (8.3 cm) above the roof surface. This allows for adequate air circulation to keep the panels'



Clamps at the ends of the Power Rail secure the PV panels along their outside edges.

S-5! Attachment Hardware

Metal Roof Innovations' S-5! mounting clamps were used in conjunction with the Power Rail mounting system reviewed here (see Access). These clamps are not manufactured by DP&W, but are a good option if you're fastening PV module racks and combiner boxes to a standing-seam metal roof. The clamps can even be used for mounting heavy equipment like air conditioners or heat pumps to a building's roof surface.

These aluminum clamps use two hex-head setscrews to fasten the clamp to the upright seam in standing-seam roofing. In turn, the rack or equipment-mounting hardware is bolted to the S-5! clamp with an included $\frac{3}{8}$ -inch (10 mm) diameter stainless bolt. When torqued to the correct specification for a given standing-seam roof type, a secure equipment/roof attachment is assured without penetrating the roofing surface. Four models of S-5! clamps are available for various types of standing-seam roofing. Consult the

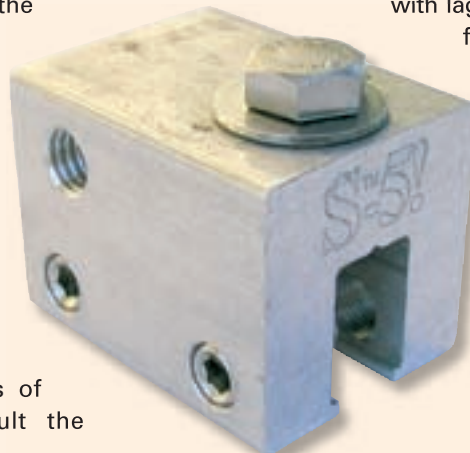

manufacturer to determine correct clamp for your roof type, and the required torque specifications.

What's the advantage of these clamps over traditional roof/mount interfaces? First and foremost, S-5! clamps require no roof penetrations. This means no caulking, and no potential for leaks from inadequately sealed penetrations. Using S-5! clamps also significantly reduces installation time. PV rack layout and fastener positioning is greatly simplified because locating rafters is not required as long as the roofing is installed to manufacturer's specifications. This means no hitting (or missing!) rafters with lag bolts, and no additional rafter blocking for through-bolts.

We installed 96 PV modules in the system used to evaluate the DP&W Power Rails, and there were only two roof penetrations—both for the electrical conduit that protects the wire runs coming down from the arrays. If we had used traditional mounting feet, it would have easily required close to 100 roof penetrations, and significantly more time spent on a hot metal roof.

Tech Specs

Power Rail extrusions: Type 6061-T6 structural aluminum

Mid- and end-clamps: Type 304 stainless steel

Standard mounting feet: Type 5052-H32 aluminum

PV and rack hardware: All stainless steel, with self-locking nuts

Cost: US\$130 (for two 75-watt modules) and up depending on number and type of modules used

operating temperature down and the output up during the summer months. Low profile arrays blend into a building's roof, and look great.

The standard mounting feet are also available in 6- and 7-inch (15 & 18 cm) sizes for increased roof clearance and cooling. Because the roof surface we were working on was standing-seam metal, we opted to use the standard mounting feet in conjunction with S-5! roof clamps to minimize the number of roof penetrations (see sidebar).

DP&W also manufactures a Power Post roof-to-mount interface that is used in conjunction with the standard mounting feet. These posts are typically used in new construction and are designed to be installed to a roof's sheathing and rafters before the roofing material is installed. These posts are flashed with standard roof jacks to create a leak-free mount. Power Posts are available in 3-, 4-, 5-, 6-, and 7-inch sizes, and are a great way to go in new construction, or if the building is being reroofed at the same time the PV array is installed.

Power Rail makes for quick, clean PV installations. With the Rail in place, and two PVs secured, RE installer Bob-O Schultze of Electron Connection gets ready to install the rest of the panels.



Power Rail Engineering

When the array is mounted parallel to the roof surface, the Power Rail system is designed to withstand 125 mile per hour (56 m/s) wind loads, providing the maximum span between roof supports (mounting feet) is 80 inches (203 cm), and the maximum cantilever (overhang) at the ends of the rails is 32 inches (81 cm). For locations with maximum wind loads of less than 90 miles per hour (40 m/s) and snow loads not exceeding 30 pounds per square foot (146 kg/m²), a span of 96 inches (243 cm) between roof supports and a maximum cantilever of 36 inches (91 cm) is allowable.

Off the Roof

It's much more pleasant to be driving home early from the job in an air-conditioned truck or sitting on your porch with a cold one, than sweating and steaming away on a hot roof. Anyone who has installed a roof-mounted PV array during the warm weather months surely can relate to that. DP&W's Power Rail mounting system makes for fast, secure roof-mounted PV installations that look as good as they function.

Access

Reviewer: Joe Schwartz, *Home Power*, PO Box 520, Ashland, OR 97520 • joe.schwartz@homepower.com • www.homepower.com

Power Rail Manufacturer: Direct Power and Water Corporation, 4000-B Vassar Dr. NE, Albuquerque, NM 87107 • 800-260-3792 or 505-889-3585 • Fax: 505-889-3548 • jrandall@directpower.com • www.directpower.com

S-5! Roofing Clamps: Metal Roof Innovations Ltd., 8655 Table Butte Rd., Colorado Springs, CO 80908 • 719-495-0518 • Fax: 719-495-0045 • info@s-5solutions.com • www.s-5solutions.com

Bob-O Schultze, Electron Connection, PO Box 203, Hornbrook, CA 96044 • 800-945-7587 • Fax: 530-475-3401 • bob-o@electronconnection.com • www.electronconnection.com • System design & installation



the Alternative Energy STORE
Making Renewable Energy Affordable™

Sample of Specials

<p>Danby Gas Refrigerator</p> <ul style="list-style-type: none"> • 8 cu ft propane refrigerator • Effective alternative to electric fridges <p style="text-align: center;">On Sale for \$889!</p>	<p>Lakota 900W Wind Turbine</p> <ul style="list-style-type: none"> • Space-age carbon fiber blades • Reacts quickly to wind gusts • Highest power - weight ratio <p style="text-align: center;">On Sale for \$1439!</p>
---	--

www.AltEnergyStore.com

Toll Free: 1(877) 878-4060 ext 7 • Fax: 1(877) 242-6718 • Email: Sales@AltEnergyStore.com

POWER-RAIL™ TOP-CLAMP MOUNTING SYSTEM



POWER-FAB
PV HARDWARE



© Cobalt Power Systems, Inc.

© Cobalt Power Systems, Inc.

4000-B Vassar Drive NE • Albuquerque, NM 87107 • **800-260-3792** • Fax 505-889-3548 • Email jrandall@directpower.com

PV Powered

Maximize Your PV Array,
Install a StarInverter Today!



PV Powered Inverters Speak for Themselves:



- True Continuous Output Power at 2800, 1800 and 1100 Watts
- Lowest Parts Count = Highest Efficiency = Highest Reliability
- Low Price Leader, Made in the USA
- Backed by a 10-Year Warranty



PV Powered • Bend, Oregon • www.vvpowered.com • 541-312-3832

Solar Wand

Hot Water Assist for Cold Climates

Barry Butler

©2004 Barry Butler

Do you want a freeze-protected solar domestic hot water system (SDHW), but the cost and complexity are slowing you down? This article will show you a simpler and cheaper way, using your existing water heater.

This system uses a double-walled heat exchanger that screws into your existing hot water tank. These systems are relatively new to the market, since the double-walled heat exchanger that fits into existing water tanks only became commercially available in January 2003. Instead of a pumped open loop in the hot water tank to provide solar-heated water, the Solar Wand system uses only the pumped antifreeze in a solar collector closed loop, and natural conduction and convection.

The solar-assist system costs less because it is less complex and has fewer parts. But the system may not deliver as much solar energy to the residence since it uses only the water storage capacity of the existing hot water tank. Previous articles in *Home Power* (HP84 and HP85) have covered the fundamentals of solar water heating systems and other alternatives for cold climate SDHW systems.

These systems typically use a maximum of two solar collectors, which may be plumbed in series or parallel. The collectors are installed on a roof or mounted on the ground, with their highest point above the top of the hot water tank. The assembly containing the heat pipe radiator, the pressure relief/vacuum recovery valve, and the overflow reservoir is mounted on the highest point in the system, usually just above the collectors.

The in-tank heat exchanger is inserted into the water tank, and the pump, valves, and temperature gauges are mounted on top of the hot water tank. The differential control box is mounted on the wall near the top of the hot water tank. Here's a closer look at the function of each of these components.

Collectors

For a solar-assisted hot water system using flat-plate collectors, use a selective surface absorber because it delivers more solar energy to the water tank. The collector's copper tubes bonded to the sheets can be arranged in parallel paths horizontally or vertically, or in a single fluid flow path, called serpentine. The serpentine configuration is best because the antifreeze fluid must pass serially through all tubing in the collector at a single flow velocity, eliminating the need to balance parallel flow paths.

For colder northern U.S. climates, which have more overcast skies, evacuated tube collectors are a good choice. These collectors have a space with a vacuum between the absorber plates and the outside air. While more expensive than flat-plate collectors, they lose less solar heat to the atmosphere, so they are more efficient. The design of evacuated tube collectors reduces the heat loss caused by convection (evacuated space), radiation (selective absorber), and conduction (long, thin glass paths).



These collectors will easily bring the pressurized antifreeze closed loop to 212°F (100°C) in the middle of winter, improving heat transfer into the water tank. The 212°F closed-loop temperature is well below the boiling point of the 16 psi pressurized loop, which is 247°F (119°C).

DC Circulation Pumps

Closed-loop antifreeze systems do not need high flow rates, and do not have large head losses. Photovoltaic-powered pumps with a 10-watt photovoltaic (PV) module have worked well in some installations, demonstrating that low-head pumps are acceptable. Just like an automobile's radiator, the closed-loop antifreeze system is always maintained full. This means that the pump never has a differential fluid level pressure



Solar installer Andrew Gerl of Blazing Solar of Mesa, Arizona, on the roof with solar thermal collectors, the PV module for the pump, and the TPFRS radiator/reservoir unit.

Solar Wand Cutaway View

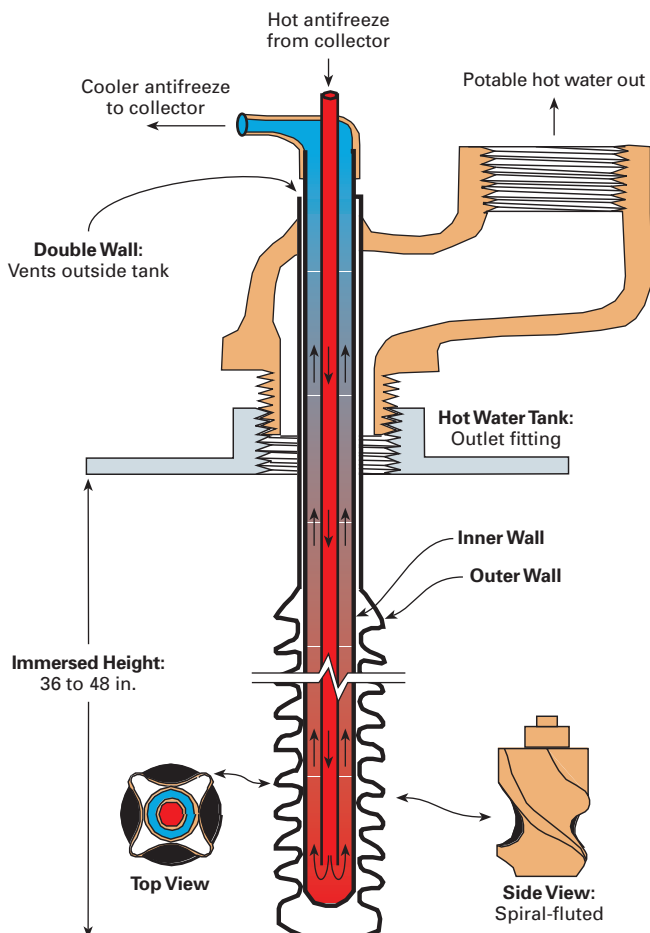

head to pump against, just the dynamic fluid friction in the fluid tubing, which is estimated to be less than 1 psi in most systems.

The choice of pump will depend on cost and availability in your area, and the distance between the hot water tank and the solar collectors. For distances of 30 feet (9 m) or less, the lowest head, low-speed pumps are preferred. For distances higher than 30 feet, the higher-speed Laing models, with about a 20-watt PV module and linear current booster (LCB), are preferred. All of these pumps are extremely quiet, except the Hartell, which has more noise and vibration, but is not unacceptably loud.

Controller & Sensors

The controller is the brain of the system. It tells the pump when to turn on and off, which is determined by the collector and storage tank temperatures. All of its intelligence is focused on determining whether the collector outlet is sufficiently warmer than the bottom of the tank to warrant turning the circulating pump on. Sensors are located at the collector outlet, and at the bottom of the solar storage tank.

The Independent Energy GL-30 is an example of a good differential control. It has an adjustable temperature differential setting of 5 to 25°F (3–14°C). These controls have a high-limit cut-out that will shut the circulation pump off once the tank reaches a predetermined high temperature limit, adjustable from 110 to 230°F (43–110°C). The GL-30 uses industry standard 10 K-ohm sensors. These thermistor sensors read 10,000 ohms at 77°F (25°C).

Solar Pump Comparisons

Pump	Voltage	Watts	Rpm	Head (ft.) at 0.5 Gpm	Pressure (psi) at that Head
Hartell MD 101 U	120 VAC	140	1,720	20.0	8.66
Grundfos UP 15-42 F	120 VAC	85	2,590	18.5	8.01
Laing SM 909	120 VAC	69	3,450	14.0	6.06
Taco 006 BT4-1	120 VAC	60	3,250	10.5	4.55
Laing SM 303	120 VAC	35	3,450	6.0	2.60
Laing D-34/700B	12 VDC	24	3,450	10.5	4.55
Ivan Labs EL SID 2x2	12 VDC	10	1,720	2.5	1.08

The PV-powered pumps circulate only when the sun is shining at more than 400 watts per square meter (you can just see your shadow). A snap switch cut-off or pump controller must be used to shut the pump off if the tank gets too hot. PV-powered pumps, panels, and controllers now cost only slightly more than 120-volt AC pumps and controllers.

Heat Exchanger

A heat exchanger transfers the heat from the solar-heated closed loop to the domestic water. Factors that increase heat transfer are:

- Greater surface area
- High thermal conductivity
- Maximum temperature differential between the two fluids

A typical Solar Wand installation using a Laing AC pump.

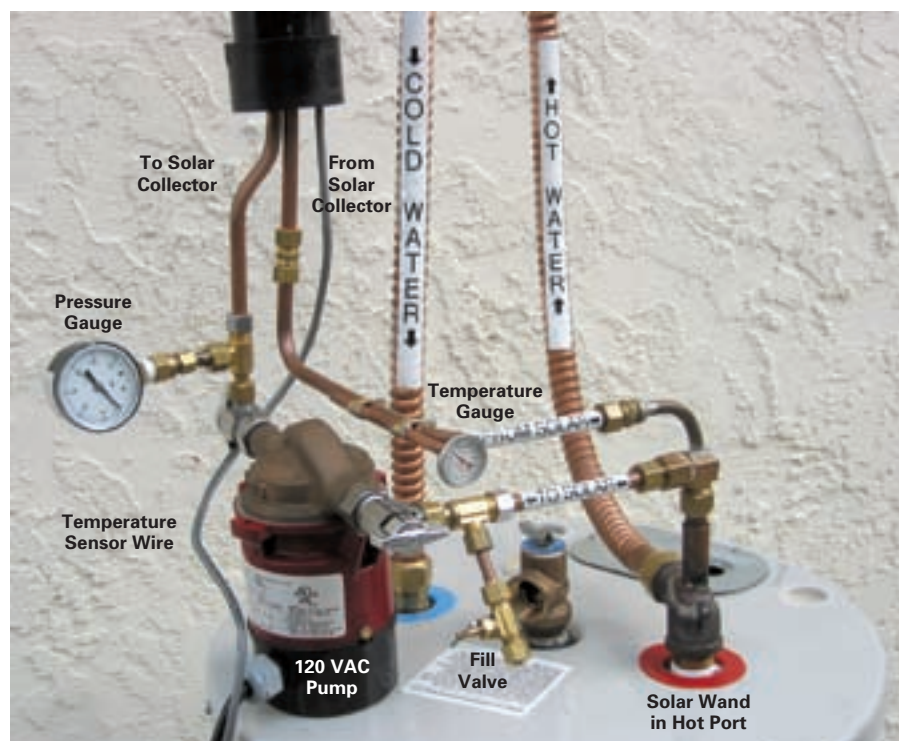

Heat exchangers may be categorized as single or double wall, which refers to the number of barriers between the two fluids exchanging heat. Single-wall heat exchangers are usually not permitted in potable (drinkable) water systems when a nonpotable heat transfer fluid is used. For example, systems that use glycol should not be used with a single-walled heat exchanger because of the potential for contamination of the potable water in the event of a leak.

Double-wall heat exchangers are required to ensure that the heat transfer fluid will not contaminate the potable water. The space between the two walls of the heat exchanger is usually vented to permit detection of a leak.

The Solar Wand heat exchanger used in this solar-assisted hot water system is unique, since it screws into the home's existing hot water tank. The wand is inserted into the tank via the standard hot water outlet, and uses a brass coupling, which is required to limit corrosion in the tank and piping. The wand is fitted with a new $\frac{3}{4}$ -inch male National Pipe Thread outlet for the hot water. The wand has a flow area equal to $\frac{1}{2}$ -inch pipe for a short distance in the outlet fitting. In most cases, the homeowner does not even notice the resulting flow loss from 19.5 gpm (74 lpm) to 18 gpm (68 lpm). (Residences subject to plumbing codes are required to have a $\frac{3}{4}$ -inch pipe serving a domestic water heater. Check with your local building inspector for requirements.)

The wand is double walled, with the space between the two walls vented to the outside of the hot water tank. The standard length 48-inch (122 cm) wand has about 2 square feet (0.19 m²) of heat exchanger surface area in the hot water tank. The solar wand's immersed heat exchanger transfers the closed loop's heat directly to the tank's water via conduction, and does not require a second pump. Convection maintains the normal tank stratification—hot on top and cold on the bottom.

The wand's small surface area—dictated by the size of the hole it must fit through to get into the tank—must be offset by higher temperature differentials. The temperature differential is based on a fluid flow in the solar closed loop of about 0.5 gallons (1.9 l) per minute. The wand transfers 3,600 BTUs per hour under these average conditions. Using hot water from the tank lowers the tank temperature. This increases the temperature difference, which increases the heat transfer. As tank temperature rises, heat transfer slows.

A Solar Wand System

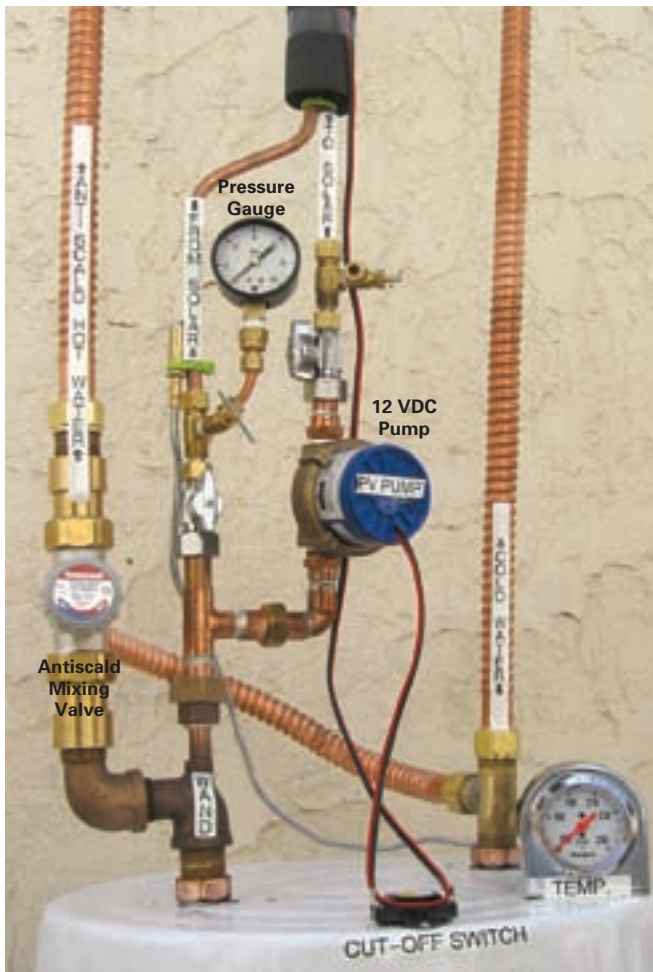
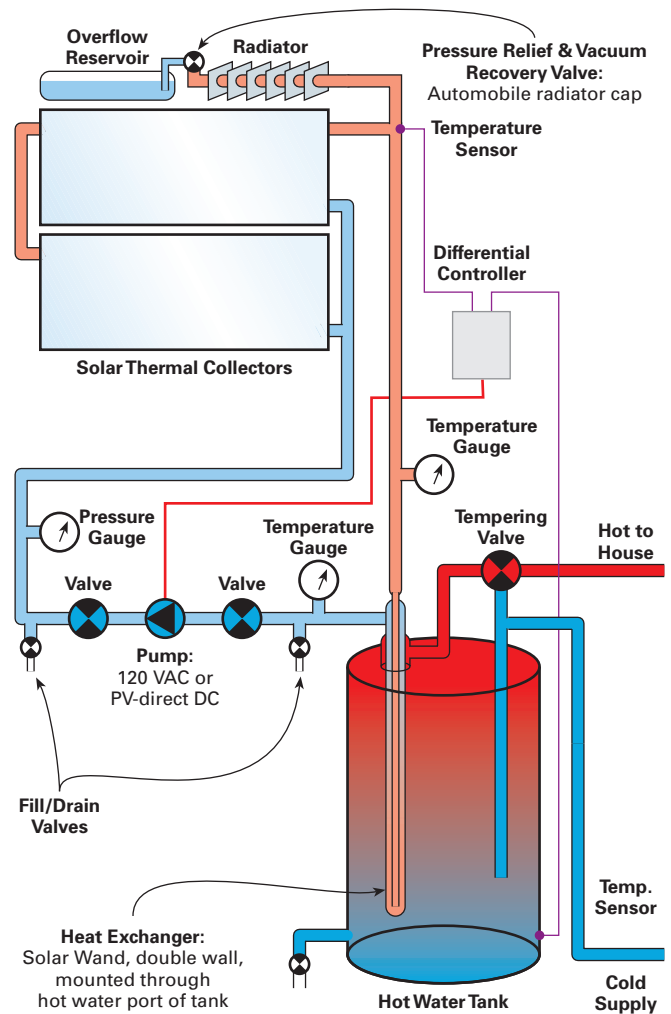

A typical Solar Wand installation using a PV-powered DC pump with cut-off switch, and an antiscald mixing valve.

The solar wand is not the best heat exchanger. The heat exchange surface area inside the tank is only 2 square feet, limited by what will fit through the port into the tank. But this system has significant cost advantages over special hot water tanks, which have built-in heat exchangers. The wand can simplify the system, can be relocated from old to new tanks, and be very cost effective compared to external, double-wall heat exchangers.

TPFRS

One device—the overtemperature, overpressure, fluid overflow, and recovery system (TPFRS)—replaces the conventional components of fluid expansion tank, pressure relief valve, air separator/air removal valve, and manually operated coin vents for trapped air removal. It also serves the additional function of a heat dissipater for the collector if the water tank gets too hot and the controller turns off the circulation pump.

The TPFRS must be placed at the highest point in the closed loop, and uses a small section of finned, baseboard heater, radiator pipe to connect the solar collector closed loop to the automotive-type radiator cap. This cap limits the system pressure to its rated value, usually 16 psi above the static head in the system. Each day, as the closed-loop fluid heats up, any trapped air and excess fluid is forced past the

A TPFRS unit showing the radiator on the left, automobile radiator cap in the middle, and the overflow reservoir on the right.



System Water Temperatures*

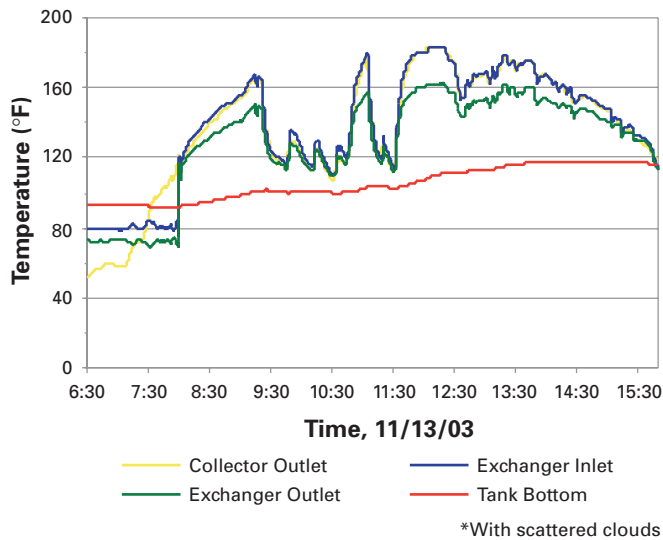

cap and into the bottom of a fluid reservoir, which captures the fluid and releases the air.

When the closed-loop system cools down, only fluid is drawn back into the system, via the radiator cap's vacuum recovery valve. This is the same way a car's radiator stays full of fluid and helps eliminate corrosion-causing air in the system. These parts are inexpensive and proven to have a long life.

The heat dissipation function is a simple steam heat pipe. When no one is home to use hot water, the tank temperature may max out, especially in summer. When this happens, the controller shuts off the closed-loop fluid circulation pump. The collector starts to boil in minutes. The steam from the collectors tries to reach the radiator cap. Steam at 16 psi reaches 247°F (119°C). The hot steam reaches the radiator,

Natural Gas Usage* Comparison for a Southern California Home

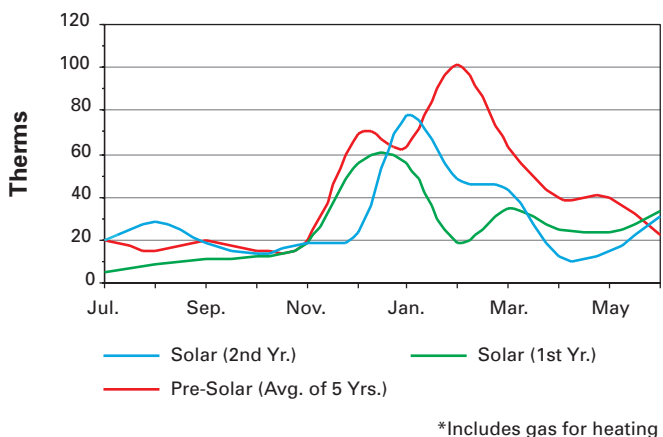

and the radiator fins conduct the heat from the pipe to the outside air, condensing the steam in the pipe.

This steam heat pipe safely dissipates the solar heat from the collector to the outside air. It keeps the collector at a maximum temperature of 247°F (119°C), just below the temperature of 250 to 325°F (121–163°C) where glycol in the collector fluid breaks down and forms corrosive acids.

The collector closed loop circulates an antifreeze solution—usually a 50:50 mixture of propylene glycol and water. The solar collector overtemperature protection slows the breakdown of the glycol water mixture. Follow the manufacturer's instructions for replacement. As long as oxidation has not darkened the fluid significantly, it is usually OK.

Gauges & Meters

The pressure gauge tells you if the closed loop is within an acceptable range of pressure. This ranges from 5 to 30 psi, depending on the fluid temperature and height of the collectors above the gauge. The difference in pressure between pump on and off is about 1.5 psi, so you can see whether the pump is operating and circulating. If there is no circulation because of low antifreeze level, the pressure gauge will not change when the pump switches on and off.

Two temperature gauges are used to read the fluid loop temperature at the input and output of the wand heat exchanger. A temperature difference of 15 to 20°F (8 to 11°C) indicates effective operation. Choose gauges that will measure temperatures in excess of 247°F (119°C), since on hot summer days, these temperatures could be reached.

The Goldline GL-30 controller has a liquid crystal display option, which shows the collector outlet temperature and the tank bottom temperatures, measured by the thermistor sensors. This is an excellent option.

Hot Water Storage & Antiscald Valve

Hot water tanks heated electrically or with gas are stratified, meaning that hotter water is at the top and colder water is at the bottom. As hot water is drawn from the tank, cold water is directed to the bottom of the tank via a plastic dip tube on the cold water inlet. The solar in-tank heat exchanger does not upset normal tank stratification.

Typical wand systems will heat the hot water tanks to 160°F (71°C) or above on summer days. An antiscald valve is mandatory for this type of system. The antiscald valve is put in place to limit the temperature of the hot water delivered to the house to 120°F (49°C). It accomplishes this task by blending hot water from the tank that exceeds 120°F with cold water from the cold water supply.

If the hot water in the tank is heated to 160°F (71°C) and the incoming water supply is 50°F (10°C), for each gallon of 120°F (49°C) water delivered, only 0.64 gallons (2.5 l) of water would come from the solar-heated hot water tank. The balance is cold water, blended in to prevent scalding. This means a 40-gallon (150 l) tank heated to 160°F by solar energy will provide as much hot water as a 60-gallon (230 l) tank holding 120°F water.

Typical Solar Wand System Costs

Item	Approximate Cost (US\$)
2 ACR Fireball 2001 flat-plate collectors, with mounts	\$1,050
Internal heat exchanger, double wall	250
Honeywell AM mixing valve	250
Goldline GL-30 controller with 2 sensors & digital display	200
Coolant system, incl. temperature, pressure & overflow protection & recovery system	175
Copper pipe, pipe insulation & wire to collectors, 3/8 in.	150
Laing SM 909 AC circulating pump	150
Valves, temp. gauges & pressure gauges	100
ABS pipe & elbows	75
Shipping	63
Fluid Tec filling pump, with tubing	25
Peak Sierra propylene glycol	12
Total	\$2,500

Solar Wand

The Solar Wand heat exchanger provides a low-complexity, low-cost solar hot water system, and may produce up to half of the hot water for a family of four people. Over its installed lifetime, each system can displace up to 55 tons of carbon dioxide if you are using a gas water heater and 36 tons of carbon dioxide for an electric hot water heater.

Access

Barry Butler, Butler Sun Solutions, PO Box 1666, Solana Beach, CA 92075 • Phone/Fax: 858-259-8895 • butlersunsolutions@adelphia.net • www.butlersunsolutions.com • Solar Wand in-tank heat exchangers & parts for solar-assisted hot water systems

SolarRoofs.com, Al Rich, 5840 Gibbons Dr. Ste. G, Carmichael, CA 95608 • 888-801-9060 or 916-481-7200 • Fax: 916-481-7203 • richsolar@aol.com • www.solarroofs.com • Solar collector manufacturer

Thermomax USA/Canada, Patrick Spearing, 3181 Kingsley St., Victoria, BC, Canada V8P 4J5 • 250-721-4360 • Fax: 250-721-4329 • patrick@solarthermal.com • www.solarthermal.com • Evacuated tube collectors

Goldline Controls Inc., 61 Whitecap Dr., North Kingstown, RI 02852 • 800-294-4225 or 401-583-1100 • Fax: 800-343-0827 or 401-583-1200 • technical_service@goldlinecontrols.com • www.goldlinecontrols.com • Differential controller

Ivan Labs Inc., 305 Circle West, Jupiter, FL 33458 • 561-747-5354 • Fax: 561-746-9760 • ivandelsol@juno.com • 12 VDC circulating pumps & Delta-T controls

Laing Thermotec Inc., Mike Solso, 2295 Main St., San Diego, CA 92154 • 619-575-7466 • Fax: 619-575-2739 • customerservice@lainginc.com • www.lainginc.com • 12 VDC & 120 VAC circulating pumps

Honeywell Water Controls, 65 Access Rd., Warwick, RI 02886 • 800-247-2919 or 401-738-4290 • Fax: 800-777-2726 or 401-738-4156 • www.honeywellwatercontrols.com • Antiscald valves for DHW systems

Solar Converters Inc., Dan Pringle, C1-199 Victoria Road S., Guelph, ON, Canada N1E 6T9 • 519-824-5272 • Fax: 519-823-0325 • info@solarconverters.com • www.solarconverters.com • Linear current amplifiers & Delta-T controls for PV-powered pumps

Solar Rating and Certification Corporation, c/o FSEC, 1679 Clearlake Rd., Cocoa, FL 32922 • 321-638-1537 • Fax: 321-638-1010 • srcc@fsec.ucf.edu • www.solar-rating.org • Solar collector & system rating organization



Butler Sun Solutions "SOLAR WAND"
Since 2003 "Dedicated to conserving the earth's energy and water resources."

SOLAR ASSISTED HOT WATER
 Closed Loop Antifreeze System

"Solar Makes \$ & Sense"
 Energy - Savings Pay For System
 Employment - Create American Jobs
 Environment - Reduce CO₂ Emissions

Solar Collector ACR Fireball 2001 or Thermomax Evacuated Tube

Differential Pump Control
 115 VAC

OG-300 Certified

Your Water Heater

Straight Forward Installation; 40 Sq. Ft. Solar Collectors, AC or PV Powered Pump

Kits Including Anti-Scald Valve From \$2,500

"Solar Wand" Double-walled heat exchanger screws into your tank

*Patents Pending
858-259-8895 www.butlersunsolutions.com

Solar Parts and Systems for the Do-it-yourselfer

Serving North America for 25 years

Online Catalog and Design Guide
www.aaasolar.com

AAA Solar Supply
(800) 245-0311
Albuquerque, NM

Curriculum

Learn the latest techniques you need to know to be a successful dealer in the solar industry. Topics include:

- Sales & Marketing
- Finance
- Installation
- Service
- How collectors are made
- Certification

Faculty

Tom Lane
Author "Lessons Learned"
Brandon Leavitt
President, Solar Service Inc.
Manny Suarez
AET Marketing
Buzz Schaberg
AET/Solar World Nat. Sales Dir.
Billy Byrom
President, AET & Thermafin



EAGLE SUN SEMINARS

March 24-26
Jacksonville, FL

A True Business Opportunity
Sponsored by AET and ECS

Reservations

Call 1-800-874-2190 for reservations or information. Tuition is only \$250 per person. Lunches included. (Hotel and airfare not included). Mail checks to:

AET Solar
PO Box 61326
Jacksonville, FL 32236

Get \$50 off registration price with prior purchase of *Lessons Learned, 1977 to Today*. Reservation deadline is Jan. 15th, 2005. Seating is limited.

AET Solar

To learn more about AET, the industry leader in hot water solar collectors, visit us at: www.aetsolar.com.

SunPumps™ Inc.

Quality First!

SOLAR PUMPING PRODUCTS



SCS SERIES BRUSHLESS DC
Brushless DC Submersible Pumps up to 2 HP, heads up to 700 feet and flow rates up to 50 GPM.



SCS SERIES
Diaphragm Submersibles with heads up to 230 feet & flow rates up to 4.3 GPM.



SCB SERIES
Centrifugal Booster Pumps from 12 volt Home Pressure Systems to 180 volt High Pressure Booster Pump Systems.



SC-P SERIES
Pool Circulating Pumps from 1/2 to 2 HP.



PCA & PCB SERIES
New Micro-processor based pump controllers up to 3 HP.

Current boosting and voltage boosting models available.

We also manufacture:

Jet Pumps
Triplex Piston Pumps
Jack Pump Retrofit Kits

For free system sizing, technical support, or to place an order call:

Phone: 1-800-370-8115
(928) 348-9652
Fax: (928) 348-9653

www.sunpumps.com



SunPumps stocks all parts and will rebuild any original SolarJack pump or controller.

Increasing energy costs driving you crazy?

Take control with Sunda vacuum tube technology for year round solar water heating - Domestic Hot Water, Home Heating, Pools & Spas, Agricultural and Industrial Applications

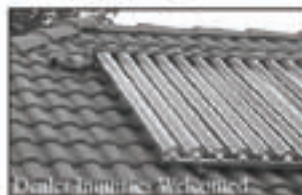

Features

- Higher efficiencies in cold and overcast conditions
- Easy installation & servicing
- Attractive pricing



Sun Spot Solar & Heating, Inc.

Website: www.sssolar.com / Email: info@sssolar.com

Tel: (570) 422-1292

U.S. Sales Agent for Sunda Evacuated Tube Collectors



Solar Domestic Water Radiant Heating

Evacuated tube heat pipe technology

www.btfsolar.com

BTF Ltd.

POB 409 Fennville MI 49408 USA

Tel. 269-236-6179 info@btfsolar.com



SUN EARTH INC.

Quality Solar Energy Products

INTRODUCING COMPRAIL™ PV Mounting Systems



www.sunearthinc.com

SunEarth, Inc.

8425 Almeria Ave. • Fontana, CA 92335 • TEL (909) 434-3100

CYCLE POWER!

A Reward for Exercise

Frank R. Leslie

©2004 Frank R. Leslie



Exercising on my stationary cycle instead of a real bicycle was a drag. I needed a little more exercise on rainy days, and I wanted something that would be useful for battery charging as well. I also wanted an interactive display for a renewable energy class at Florida Tech.

A suitable flywheel cycle appeared up the street on a recent trash day, and I snatched it for the conversion. Rather than letting this serviceable cycle go into the big green trash truck to be smashed for the landfill, I recycled it into a basic pedal-powered generator to charge a battery.

I had recently bought a surplus 20 VDC Ametek servo motor that had driven a magnetic tape reel hub. It is approximately 6.5 inches long and 4 inches in diameter (17 x 10 cm). The torque needed to turn the shaft by hand increased markedly when I shorted the leads, so it was clearly a permanent magnet motor.

I knew that it had a mechanical problem from the clacking noises inside the motor as I turned it by hand, but I grudgingly paid US\$8 for it. I disassembled it to find that one of the eight, curved, permanent magnets (PM) had come completely loose, and the ball bearings were dry and noisy.

The rust stains inside the case suggested that it had been stored outside in the rain. I cemented the magnet back in place with superglue and lubricated the bearings. I used my portable, 1,750 rpm test motor, a suitable pulley arrangement, and a temporary load resistor to determine that, at 362 rpm, the open circuit voltage was about 24 V, and the short-circuit current was 13 A.

The exercise cycle I found was especially easy to adapt, because the flywheel has a wide flat groove in the outer edge. The familiar gear mechanism is identical to a single-speed bicycle drive. The flywheel momentum evens out the pedaling fluctuations.

The layout of the parts will vary with the actual construction of each particular cycle and generator. Use care in anticipating the variability of the distance between the flywheel shaft and the generator shaft. A flexible cloth tape measure can help estimate the belt size to within an eighth of an inch.

The author's wife Jerry can generate 30 watts with moderate pedaling.

Generator Mounting & Drive

The pedal shaft drives a bicycle chain to drive the 10 ³/₄-inch (27 cm) flywheel at 135 rpm, 2 ¹/₄ times faster than the pedals at about 60 rpm. The V-belt drives a 3 ¹/₂-inch (9 cm) pulley on the generator's ⁵/₈-inch (16 mm) shaft to get 435 rpm from the 60 rpm of the pedals. I used an MBL 4L430 (1/2 x 43 inch; 13 mm x 109 cm) V-belt and a steel pulley.

The carriage bolts holding the cycle front foot were removed and replaced with longer ones to also secure the generator mounting plate. The original flywheel was braked by a nylon belt that dragged in the central groove. This brake belt, the belt tensioner control on the handlebars, and the interconnecting control cable were removed. The speedometer was retained since it also indicates rpm of the pedals and the miles "traveled."

The 43-inch (109 cm) V-belt was installed by temporarily disassembling the flywheel axle to place the belt around the axle, but not yet over the flywheel. The belt first is placed over the V-belt pulley and then the belt is carefully rolled on to the flywheel over the ¹/₁₆-inch (1.5 mm) ridge to tension it correctly without stretching it. The generator wiring was connected with the heavy, flexible cord to the battery system.

For an output indicator, six small Christmas-tree lights were connected in series and placed on the handlebars. These glow brightly, yet require only 140 mA at 12 V (about 2 watts). Last holiday season, I bought a string of 100 of these bulbs for US\$1.50.

Interconnection Cord

A nominal 12 VDC electrical system requires low-loss wiring with large conductors to reduce voltage drop. The cable cost is also a consideration, and a heavy-duty outdoor, 16-3 (1.3 mm², 3-conductor) extension cord had the best quality and largest wire size for the cost.

The interconnecting cable (cord) drives a zener diode that has a forward voltage drop of approximately 0.4 V at several amps. The diode's reverse voltage rating should exceed twice the maximum generator voltage. The circuit is also fused and passes through an ammeter to the battery. Since the cable is rated for 120 VAC, medium-duty, outside service, it will perform well under these less stressing conditions.

Exercise Bike Costs

Item	Cost (US\$)	
	Min.	Max.
Exercise cycle	\$0.00	\$25.00
Motor, PM tape	5.00	15.00
V-pulley, ⁵ / ₈ x 3 ¹ / ₂ in.	5.00	5.80
V-belt, MDL 4L430, 1/2 x 43 in.	5.00	5.60
Extension cord, 16-3, 50 ft.	4.50	4.99
Misc. bolts, hardware	1.00	2.00
Mounting board	0.00	2.00
Angle brackets, ³ / ₄ in.	0.80	1.80
Total	\$21.30	\$62.19



The belt-driven PM motor is mounted on a plywood platform.

Testing & Results

Before the generator was finally attached, the practicality of the arrangement was tested by lashing the generator in place and using a Radio Shack 22-168A digital multimeter to capture the peak maximum charging current. I like this meter because it has a computer interface.

The battery accepted 6.7 amps with some really energetic pedaling. This quick test verified that a reasonable performance would be obtained from the completed system. An earlier load test of a similar generator driven by a test motor showed the case was warm to the touch after four hours at 4 A. The generator will likely survive normal pedaling. After final construction, another testing showed that light pedaling would yield 0.5 to 1.1 A, moderate pedaling would yield 2 to 3.2 A, and strong pedaling would yield 4.5 to 6 A.

A cyclist-powered generator is "biomass powered," of course. The more you pedal it, the more food is required, or you might begin to lose weight. A trained bicyclist will find this load is rather light at low speeds, while the pedal speed can be increased to produce more electricity with strong effort. At 4 A output at 12 V, the output is 48 watts. A half-hour of pedaling will thus produce 24 watt-hours of energy and a lot of conditioning!

I've taken this cycle to a ham radio emergency-power field day, to the Florida Institute of Technology for an outreach presentation on renewable energy; to an elementary school; and to two public events—Malabar Days and the Grant Seafood Festival. The younger folks really loved it, since they could power a small TV set with it.

Pedal power is a relatively small energy source compared to PVs, wind generators, and hydro turbines. But it can be a fun homebrew, and gives you a real sense of how much energy it takes to make the electricity we so often take for granted.

Access

Frank R. Leslie, 1017 Glenham Dr. NE, Palm Bay, FL 32905 • 321-768-6629 • fleslie@fit.edu • www.fit.edu/~fleslie

Astro Too Electronic Wholesalers Inc., 6949 W. Nasa Blvd., Melbourne, FL 32904 • 321-727-9010 • Fax: 321-727-9709 • astrotoo@astrotoo.com • www.astrotoo.com • Surplus electronics

Ametek Lamb Electric, 627 Lake St., Kent, OH 44240 • 330-673-3451 • Fax: 330-673-8994 • webmaster@ametek.com • www.ameteklamb.com • 20 VDC PM motor

Radio Shack, 100 Throckmorton St. Ste. 1800, Fort Worth, TX 76102 • 800-843-7422 or 817-415-3011 • Fax: 817-415-3240 • customer.relations@radioshack.com • www.radioshack.com • Digital multimeter, parts



RENEWABLE ENERGY SOLUTIONS!

**WIND POWER
MICROHYDRO
GENERATORS &
ALTERNATORS**

HUMAN POWER GENERATOR

WINDSTREAM POWER SYSTEMS INC.
PO Box 1604 HP, Burlington, VT 05402 Tel 802 658 0075 Fax 802 658 1098
info@windstreampower.com • www.windstreampower.com
Independent Power Systems Throughout the World – Our 29th Year

On Grid / Off Grid / Battery Systems
All Power Conversion Equipment is Pole Mounted

SOLARTRAX™
POWER STATIONS
PROFESSIONALLY ENGINEERED

The 200 SERIES:
Mini Solar Tracking Stations
for Residential and Remote Applications.

DEFICIAL DISTRIBUTOR OF:
SHARP
and
xantrex
Smart choice for power

www.solartrax.com Buy Now On-Line METROLIN

WWW.SOLARTRAX.COM Covina, California Phone 828 331-8570 Fax 828 331-8584

Beautifully Crafted Yurts Designed to be the best.

- Outstanding wind and snow load
- State-of-the-art materials and technology
- Hand-crafted quality



YURTS

Since 1896

866.839.8787

www.RainierYurts.com

2-KS-33P

- Voltage: 2V
- Container: Dual-Container, modular construction
- Capacity: 2,470AH (100hr), 1,750AH (20hr)
- Weight: 208 lb Wet, 145 lb Dry
- Dimensions: 24 ¹³/₁₆ H x 13 ³/₄ L x 8 ⁵/₁₆ W
- Warranty: 10 years
- Operational Life: 15-20 years

1-800-681-9914
sales@rollsbattery.com



Surrette Battery
Company, Ltd.



You Say You Want a Revolution? We'll Show You How.

 **Solar Water and Space Heating** **Photovoltaic Installation** **Wind System Installation** **Alternative Construction** 

We all want to change the world. Call or click for more information.

Midwest Renewable
Energy Association

7558 Deer Road
Custer, WI 54423

phone (715) 592-6595
fax (715) 592-6596

info@the-mrea.org
www.the-mrea.org

Thoughts on VAWTs

Vertical Axis Wind Generator Perspectives

Robert Preus

©2004 Robert Preus



A Pinson vertical axis wind turbine (VAWT) in front of a Winpower horizontal axis wind turbine (HAWT). This Pinson turbine is an H-Rotor derivative. It features pitch adjustment for improved performance.

Most people's image of a wind generator is either an old twenty-bladed water pumper on a Midwestern farm or a modern, three-bladed, utility-sized giant. Both of these are HAWTs—horizontal axis wind turbines. Having propeller blades that rotate around a horizontal axis is the common theme for all HAWTs. The VAWT, or vertical axis wind turbine, is an entirely different animal, and appears in a variety of forms.

Currently, no residential vertical axis wind turbines are available in the United States. A few are made in Europe and one is made in New Zealand. I have no information on the quality or reliability of these machines. Some are just prototypes and some are in production. It is often hard to tell what's what from the published information.

Types of VAWTs

There are three common configurations for a VAWT. The simplest is a Savonius, which can be as crude as a 55-gallon drum cut in half and offset, forming two cupped

"blades." They can also be constructed from bent stainless steel. Other designs stack multiple, small Savonius rotors (blade sets) out of sequence with each other for smoother output. Another variation is a spiral Savonius rotor. The first time you see one, you might not even recognize it as a wind generator.

The other common vertical axis wind turbines are H-Rotors and Darrieus turbines. The H-Rotor is two or more straight, vertical blades rotating around a vertical axis. Darrieus turbines (often called eggbeaters) have two or more blades curved in a half hoop.

The Savonius rotor is a drag device. In other words, the wind simply pushes the blades around, and the Savonius only works because there is less resistance when the backs of the blades come around to the wind, because of their shape. A drag device has a lower maximum efficiency. It is limited to a rotational speed at its perimeter of less than the wind speed, and it has to physically occupy all of the area that it sweeps.

The other machines mentioned above are lift devices. A lift device relies on the aerodynamic design of the blade to convert the wind's energy into rotational motion that is 90 degrees to the wind, and much faster than the wind speed. This is similar to the design of an airplane wing, which lifts a plane into the air. An H-Rotor with two or more skinny blades traveling at six times the speed of the wind will generate more than a Savonius sweeping the same area and covering every square inch of it.

Wind Turbine Configurations

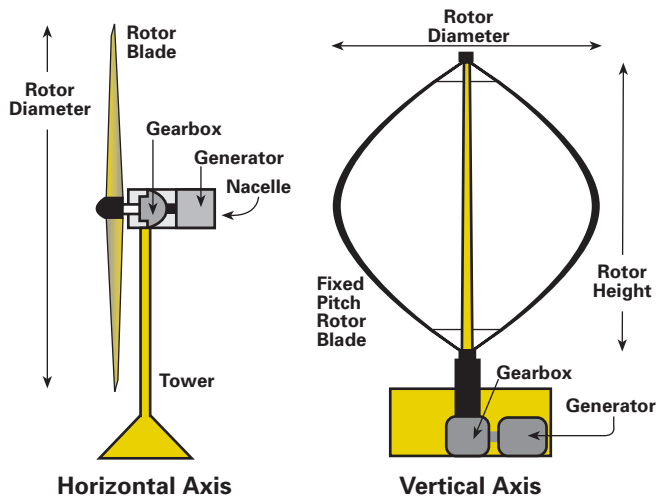

A drag device's blades travel *with* the wind, and are limited to traveling at the wind speed. A lift device's blades travel *through* the wind, and are driven at much higher speeds. The H-Rotor weighs and costs a fraction of what the Savonius does. The higher costs for the Savonius design are due to the amount of raw materials required and some design issues, which I will describe in further detail below. There is not likely to ever be a cost-effective, commercially produced Savonius variation. The H-Rotor and Darrieus VAWTs are more efficient and more likely to be commercially produced.

Advantages & Disadvantages

Some VAWT enthusiasts make strong claims of superiority for these machines. Many feel that ignoring this type of design is some kind of a conspiracy. Let's examine the specific issues in more detail.

Yawing. VAWT supporters are quick to point out that a VAWT is always pointing into the wind and does not need to reorient (or yaw) like a HAWT when the wind changes direction. This point is valid, but the value of this advantage is often overstated.

It is true that a VAWT does not need a tail and that yawing in turbulent winds does create wear and tear on HAWTs, especially two-bladed ones. But under most conditions, properly sited wind generators do not see lots of rapid wind direction shifts (thirty-plus degrees). Wind direction usually shifts more slowly, and HAWTs will typically follow the changes smoothly. If a site experiences rapid and frequent changes in wind direction, don't place *any* wind generator there! Turbulent winds are very hard on any wind generator—HAWT or VAWT.

Speed Control. Offsetting the VAWT advantage of not needing to yaw is the fact that controlling the output of a VAWT is difficult. You can't have it yaw out of the wind to reduce output, like a side-furling HAWT. This can be a serious problem. A VAWT that makes 2 KW at 20 mph (9



The Darrieus pictured here is a small utility-scale machine. Note the extruded aluminum blades and the guy wires, which are typical for a Darrieus.

m/s) will want to make 16 KW at 40 mph (18 m/s). You cannot let this happen.

A 2 KW wind generator is not strong enough to handle the forces involved to generate 16 KW. If it were built strongly enough, both the wind generator and the rest of the system components would be much more expensive. Yet most of the time, it would only generate as much as the original 2 KW machine, because output is limited by the wind and swept area, not by alternator capacity. (An alternator converts the mechanical rotation of the blades into electricity.) There are ways to deal with the additional forces of generating at higher wind speeds, but all of them add complexity and cost. This problem is easily handled with a side-furling HAWT.

Fatigue. Another equally serious disadvantage for VAWTs is fatigue. If fatigue is a problem for the HAWT, it is the archenemy of the VAWT. There are two reasons for this. One is that during part of its revolution, a VAWT blade has lift on one side of the blade and then no lift, then lift on the other side, then no lift. This cycle is repeated in every revolution that the machine makes. The other source



This small Savonius rotor was formed from stainless steel. Metal covers the whole swept area.

of fatigue occurs because for part of each rotation, the blade is operating in the turbulence downwind created by the upwind blade(s), and usually a tube or tower in the center.

Does this mean that a VAWT cannot be built to last? No, it only means that designing a VAWT blade and mounting structure is more challenging than designing a HAWT.

Urban Use. Some people say that a VAWT is better suited or safer for use in the city and a HAWT is not suitable or can even be dangerous in the city. The issues for urban siting of wind generators are appearance, noise, performance in turbulence, height, and safety.

Appearance is an aesthetics issue and is highly subjective. I like the appearance of both HAWTs and VAWTs. I have never conducted a poll to determine if there are significant differences in the general public's response to the different wind generator configurations. The challenge of minimizing noise is fairly well understood in HAWTs today and would be a similar challenge for VAWT designs.

The VAWT does have an advantage in dealing with wind direction shifts, but general turbulence will increase fatigue on a VAWT just like a HAWT. Often VAWT proponents point out that a VAWT can be installed on a roof or on the ground, while HAWTs must be on tall, expensive towers. But roofs and the ground are poor sites for *any* type of wind turbine. Turbulence and drag from the ground, trees, and buildings rob much of the energy available in the wind, and turbulent winds are hard on all types of wind generators. Vibration from wind generators on buildings can be an irritant at least, and a structural problem at worst. The standard guideline of installing a wind generator at

least 30 feet (9 m) above anything within 500 feet (150 m) holds true for VAWTs, and installing VAWTs on tall towers where they belong has its own set of design problems.

The H-Rotor and Darrieus turbines have at least as much potential for safety issues (such as throwing blades) as a HAWT. All wind generators are by nature rotating machinery. If they fail, they can lose parts. In a residential-size system, this is usually no more dangerous than a tree limb blowing down.

No Magic Bullet

There is an all-too-common belief that a VAWT approach will revolutionize the small wind industry. This seems to be a lot of wishful thinking by people who don't understand physics. It is fed by the seemingly endless string of companies promoting roof-mounted, high-tech variations on the Savonius rotor. Most of these inventions claim to capture more than 100 percent of the energy in the wind at low speeds. The maximum they can actually capture is around 30 percent. If they claim more than that, be very suspicious.

Some of you, especially VAWT enthusiasts, may think that I am opposed to VAWTs. I am not. In fact, I would like to see some models on the U.S. market. I even looked at developing a 500-watt VAWT several years ago. What stopped me was simply limited resources, not the technical problems that come with VAWTs.

There is no magic here. High-quality, detailed engineering, design, and manufacture can produce a good wind generator—HAWT or VAWT. Some special problems must be overcome in designing a VAWT. We need a good solution for power control in high winds and better design for fatigue than is used in the best HAWTs.

If you want to have a wind generator installed or install one yourself, it will be a HAWT. That is what is available on the market today. If you want to build one yourself, there is more information on building HAWTs, and it is a less risky option. If you are a brave experimenter and have a suitable place to put it, you can try a VAWT.

So far, no VAWTs are produced commercially in the United States for several reasons. The most important is that there is no easy way to provide power control in high winds compared to the ease of side-furling a HAWT. VAWTs are also less efficient and tend to be more expensive. The high fatigue cycles inherent in a VAWT make successful design more difficult. The advantage for the VAWT of having no tail or yawing system does not seem to be enough to counter the disadvantages.

Access

Robert W. Preus, PE, Abundant Renewable Energy, 22700 NE Mountain Top Rd., Newberg, OR 97132 • 503-538-8298 • Fax: 503-538-8792 • robert@abundantre.com • www.abundantre.com

American Wind Energy Association (AWEA), 122 C St. NW Ste. 380, Washington, DC 20001 • 202-383-2500 • Fax: 202-383-2505 • windmail@awea.org • www.awea.org

Photos by Mick Sagrillo, Sagrillo Power & Light





Residential Wind & Hybrid Systems
from
Abundant Renewable Energy

North American Distributor for: **African Wind Power**

The **AWP3.6**

- Direct Grid Connect without Batteries
- 24 & 48 volt Battery Charging Systems
- Largest Swept Area in its class.
- Quiet, Consistent, Reliable

Web Site: **www.AbundantRE.com**

Phone: **(503) 538-8298** • Email: **info@AbundantRE.com**

See web site for our list of dealers



Read about the AWP3.6
in *Home Power*:

AWP Review:
Issue 102, page 82

Direct Grid Tie:
Issue 100, page 22

Choose a Wind Generator:
Issue 90, page 50

KTA SERVICES INC.

Electric Vehicle Components & Systems Since 1984

Components, Conversion Kits, Publications, Videos, & Engineering Design
Services for the EV Hobbyist & Manufacturer

We stock and sell the largest variety of the very best.

Components & Publications Catalog.....\$5.00

944 West 21st Street, Upland, CA 91784 USA

Tel: (909) 949-7914 • FAX: (909) 949-7916 • Web: www.kta-ev.com

**ZAPSUCKER
.COM**



WIND TURBINE INDUSTRIES CORPORATION

Wind Turbine Industries, Corp.
16801 Industrial Circle S.E.
Prior Lake, MN 55372
(952)447-6064 Fax (952)447-6050
E-mail: wtic@windturbine.net
Web: www.windturbine.net
President: Archie J. Pavak
Manager: Steven T. Turek



The exclusive manufacturer of the Jacobs® wind energy systems since 1986. The wind plants range in size from 10kW to 20kW, with rotor sizes ranging from 23 ft. (7m) to 29 ft. (8.8 m). These systems can provide power for a broad range of applications, which include Grid Intertie (utility bill reduction) or off-grid/remote battery charging. The Jacobs® wind energy systems have over 70 years of history providing clean, quality, reliable and efficient power in the USA and around the world.

JACOBS®
WIND ENERGY SYSTEMS

As seen in *HP 90*, pg 50
Dealer Inquiries
Welcome

PROVEN
PROVEN WIND TURBINES

**New 15 KW Model
Available**

Reliable • Quiet • Rugged • Elegant
Wind Turbines

Solar Wind Works
CA Contractor's License: #796322

Renewable Energy Power Systems
• Sales—PV, Wind, & Microhydro
• Design—Off-Grid or On-Grid
• Installation & Service

Toll Free! 877-682-4503
PO Box 2511, Truckee, CA 96160
info@solarwindworks.com • www.solarwindworks.com

Low-Voltage PV Wire Sizing Economics

Kent Osterberg

©2004 Kent Osterberg

Choosing the right wires for connecting your PV array to your charge controller, or to your load (in direct PV-to-load systems) is an important step for successful PV system design. The wires must be the right size for the application, and they must have the right insulation ratings for voltage, sunlight, moisture, and temperature.

Code Corner articles in *Home Power* have discussed which type of wires should be used in a PV system and the ampacity of wires per the *National Electrical Code (NEC)*. The *NEC* is a safety standard; the amperages computed in it represent the maximum safe amperage in a given wire for safe operation. In a PV system, wires selected must be at least as large as what the *NEC* would require—usually larger wires are selected to minimize voltage drop.

Here, I'm going to focus on the problem of selecting the *economical* size for the wires that carry electricity from the PV array. When electrons flow through wire, energy is lost. And energy is money! Energy loss is lower in larger wire, but is the extra investment in larger wire worth it?

A fine print note (FPN) in article 210.19(A)(1) of the 2002 *NEC* says that "conductors for branch circuits..., sized to prevent voltage drop exceeding 3 percent at the farthest outlet of power,... and where the maximum total voltage drop on both feeders and branch circuits to the farthest outlet does not exceed 5 percent, provide reasonable efficiency of operation."

FPNs are explanatory material and are not enforceable as requirements of the *NEC*. However, the 3 percent and 5 percent rule is widely followed as the basis for allowable voltage drop in the renewable energy industry. But often, voltage drop calculations do not lead to optimum economical wire selection for low-voltage systems.

Economics

To get the most economical PV system, you want to choose wire so that the system has the lowest cost per watt.

That is, you should choose the system that has the minimum value for the equation:

$$\text{Cost per Watt} = \frac{\text{PV Cost} + \text{Wire Cost}}{\text{PV Output} - \text{Wire Losses}}$$

Another way to view this process is to compare the cost of one watt of PV to the cost of a watt saved by increasing the wire size. If PV modules cost US\$5 per watt, it certainly is good to invest in larger wire if the saved electricity costs less than US\$3 per watt by increasing wire size and wire costs. But it usually isn't a wise choice to invest in wire that will give you more electricity at the cost of US\$10 per watt saved. You'd be better off buying more PV modules at US\$5 per watt.

Other costs in a system, such as the PV mounting structure, charge controller, trenching, etc., do not influence which wire is the most economical. Also, these calculations assume that the choice of wire doesn't affect other costs in the system.

In some cases, upsizing the wire may mean an increase in conduit size as well. Assume for present purposes that it doesn't. Since a well-designed system should have provision for future expansion, the minimum possible size of conduit is usually not the best choice anyway.

To simplify things for now, I'm going to assume that the load being supplied is a maximum power point tracking (MPPT) device. A fan or pump with a linear current booster will operate at the maximum power point of a PV system. An MPPT charge controller will also work at the maximum power point of a PV system as long as the PV voltage is high enough and the battery isn't near the top end of the charge cycle.

The formula above can be used to determine if #12 (3 mm²), #10 (5 mm²), or #8 (8 mm²) is the most economical choice to wire a 36-cell, 12-volt nominal, 75-watt PV module that is located 100 feet (30 m) from the load. Assume that

the PV module costs US\$4.25 per watt or US\$319, and that it is operating at its peak power point with a cell temperature of 60°C (140°F). A 60°C cell temperature corresponds to full sun with 30°C (86°F) ambient temperature and a light breeze. In this case (see the IV curve on following page), the peak power point for a typical 75-watt PV module is at 14.53 volts and 4.28 amps, which equals 62.1 watts (V x A).

To use the formula, add PV module cost to the cost for 100 feet of each of the wire sizes being considered, then divide each of those calculations by the PV watts, minus the power loss for the given wire size. To calculate power loss for any size wire, obtain the wire resistance for the wire size you're calculating from the 2002 *NEC*, Table 8, which provides resistance figures in ohms per 1,000 feet. Voltage drop is calculated by multiplying current times resistance ($V = I \times R$). Divide the voltage drop figure by 10, so it represents a 100-foot transmission distance. This figure is then multiplied by 2 since the total wire length in the circuit is 200 feet, round-trip. Power loss is then calculated by multiplying the voltage drop by the current ($P = V \times I$).

The wire cost and power loss figures for this example can be found in the table below. The table, calculated by using the formula, shows the resulting cost per watt of the various wire sizes for the example above. The cost of the wire is the actual price from a local hardware store for coated wire, type THHN/THWN.

Using #10 is a slightly better choice than using #12. Using #8 would reduce the power loss from 4.4 to 2.8 watts at an additional cost of US\$19, which is US\$11.18 per watt! If you think PV modules are expensive, why would you invest US\$11.18 per watt in copper?

The table shows that the most economical design is a system that operates with a voltage drop of 7.1 percent. Most designers would consider this to be an excessive amount—a poor design. However, pursuing a lower voltage drop by using #8 wire is actually a poor choice because it is beyond the point of diminishing returns, even though #8 wire improves the voltage drop to 4.5 percent.

What About Voltage Drop?

I'm not trying to argue that a large voltage drop is good; it isn't. But a small voltage drop is not necessarily an indication of a good design. Voltage drop shouldn't be the only concern in sizing wire for a PV system. Yes, it needs to be considered, but it isn't a good, single design criterion.

Take a look at a typical IV curve for a PV module and observe that the power curve is nearly flat near the maximum power point. It really doesn't matter if the PV array is operating at 14.0 volts or 15.0 volts—the output will be nearly the same. That's a 6.7 percent change in voltage, and the wattage provided by the PV module stays nearly the same. So it shouldn't be surprising that a 3 percent voltage drop in the wire is not an indicator of a good design.

The voltage associated with the peak power output of a PV module also depends on the cell temperature. Over an operating cell temperature range of 25°C (77°F) to 60°C (140°F), the peak power voltage of a 36-cell module will change by approximately 2.85 volts or 16 percent. For cooler operating temperatures, the operating point for a battery charging system with a conventional charge controller will usually be to the left of the peak power point shown in the IV curve graph.

Cost Comparison per Watt for Three Wire Sizes

Wire Size (AWG)	*Wire Resistance (Ω/1000 ft.)	PV Cost (US\$)	Wire Cost (US\$)	PV Operating Volts	PV Operating Amps	Actual PV Watts	Distance from PV (ft.)	Wire Loss (Watts)	Watts Delivered	Volt Drop	% Volt Drop	US\$ per Watt
Operating MPPT Load												
#12	1.930	\$319	\$19	14.50	4.28	62.1	100	7.1	55.0	1.65	11.4%	\$6.15
#10	1.210	319	34	14.50	4.28	62.1	100	4.4	57.6	1.04	7.1%	6.13
#8	0.764	319	53	14.50	4.28	62.1	100	2.8	59.3	0.65	4.5%	6.28
Charging a Battery at 14.4 V												
#12	1.930	\$319	\$19	15.90	3.68	58.5	100	5.2	53.3	1.42	8.9%	\$6.34
#10	1.210	319	34	15.44	3.92	60.5	100	3.7	56.8	0.95	6.1%	6.21
#8	0.764	319	53	15.10	4.06	61.3	100	2.5	58.8	0.62	4.1%	6.33
Charging a Battery at 15.5 V												
#12	1.930	\$319	\$19	16.75	3.08	51.6	100	3.7	47.9	1.19	7.1%	\$7.05
#10	1.210	319	34	16.38	3.36	55.0	100	2.7	52.3	0.81	5.0%	6.75
#8	0.764	319	53	16.12	3.54	57.1	100	1.9	55.1	0.54	3.4%	6.75

*For solid wire, from the 2002 *NEC*, Table 8

IV Curve

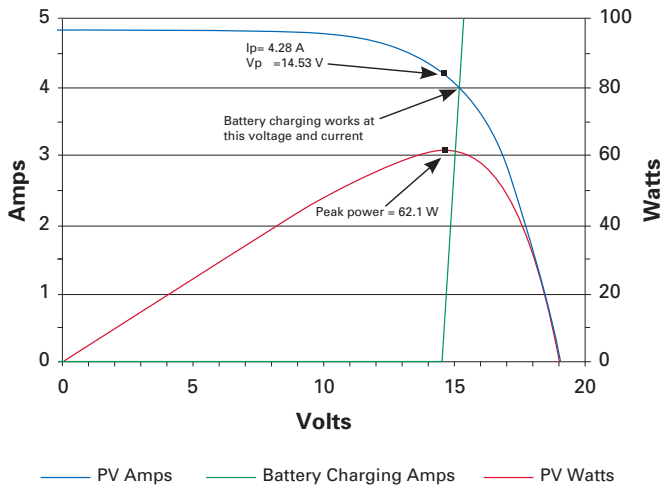

In this case, increasing the wire size to reduce wire losses will probably produce little additional output because the operating point will move even farther to the left of the peak power point. In warm climates, the operating point is often on the right side of the peak power point.

For this case, larger wire size will move the operating point closer to the peak power point. However if the peak power voltage is less than the battery voltage, even a wire with zero voltage drop will not get the system to operate at the peak power point. Efforts to reduce voltage drop by using larger wire may not be economical.

Maybe you are still not convinced, so let's look at the previous example, but change the load so that it is a battery that is being charged at 14.4 volts. Since the battery is being charged with a standard charge controller, the PV module isn't operating at its maximum power point. The battery voltage and the voltage drop in the wire determine the operating point.

Again, the PV operating voltage and current come from the typical IV curve, but the process is a little more complicated than getting the voltage and current that correspond to the peak power point. For a battery charging circumstance, the operating point is the intersection of the IV curve and the voltage-current curve for the battery and wire resistance.

Results in the table show that #10 wire is still the most economical choice. Notice that the PV module is operating to the right of the peak power point in the IV curve in all of these cases, and that with #8 wire, it operates the closest to the peak power point. A system using #8 instead of #10 wire delivers 2.0 additional watts at a cost of US\$9.50 per watt! Call me cheap, but I'd rather invest in more PV at US\$4.25 per watt than more wire at US\$9.50 per watt.

Do you need larger wire if you are trying to equalize a battery at 15.5 volts? Maybe. The #8 wire provides an additional 2.8 watts and 0.27 volts at about the same cost per watt as the #10 wire. The extra 0.27 volts may be needed to equalize flooded batteries—that would justify using the #8 wire. Notice that the PV module is operating further

to the right of its peak power point than it did before. So the output is down and the cost per watt is up. However, increasing wire size is not an appropriate way to correct the fact that the PV module is operating to the right of the peak power point.

Optimum Wire Size for PV Systems

To choose the wire size that will give the lowest cost per watt for a PV system, the cost of the PV panels and the cost of the wire must be considered. Both of these quantities are moving targets. The cost of PV panels has slowly but steadily decreased over the years. The price of copper is rather erratic. These facts mean that the optimum wire selected today may not be exactly the same next week. Fortunately, prices will not change greatly and the optimum choice will be similar to the results in this article. If you want to determine the optimum wire using the current price of wire and PV modules, look for the WireSelection spreadsheet in the Promised Files section on the *Home Power* Web site.

The calculated wire costs in the downloadable spreadsheet include an equipment-grounding wire. For sizes #10 (5 mm²) and below, the equipment-grounding wire is the same as the conductor size; #8 (8 mm²) and #6 (13 mm²) conductors use a #10 (5 mm²) equipment ground; #4 (21 mm²) and larger are assumed to have an equipment ground that is two sizes smaller than the current carrying conductors. The cost for the equipment-grounding conductor, which is usually bare, is assumed to be 75 percent of the cost of an insulated wire of the correct size.

If you are installing a PV system for a house, future expansion of the system should be considered during the installation. A conduit that is initially oversized is suddenly a big asset and money saver when a PV system is expanded.

Words of Warning

The spreadsheet isn't intended to replace the ampacity calculations of the *National Electrical Code*. The maximum allowed ampacity for wire depends on the type of insulation, the ambient temperature, and the number of current-carrying wires in a conduit or the environment in which the wire is located.

Generally you'll find that the spreadsheet gives optimum ampacities much lower than ampacities allowed by the *NEC*. However, high ambient temperatures and large numbers of current carrying conductors in a conduit cause significant ampacity reductions per the *NEC*. So you must still check to make sure that 1.56 times the rated short circuit of the PV system is less than the wire ampacity per the *NEC*.

The same is true for wire. If you plan on future growth, consider installing wire of sufficient ampacity to handle the higher current.

By now, I hope you are convinced that selecting wire to obtain 2 or 3 percent voltage drop can be questionable economically. The best way to improve the efficiency of PV systems is to increase the system voltage, not the wire size. Design your PV system to operate at 24 volts or 48 volts and you will achieve better efficiency, lower cost per watt, and lower percentage voltage drops.

For better efficiency yet, use an MPPT charge controller. In cool weather, it will keep the PV array at the peak power point and boost the current to the battery bank. In hot weather, the maximum power point voltage of a 36-cell PV module will be below the battery voltage. In this case, the MPPT will not keep the PV array operating at the maximum power point unless the PV array voltage is higher than the battery voltage, such as charging a 24-volt battery from a 36-volt PV array.

Because an MPPT charge controller is more expensive than a conventional charge controller, it probably won't be economical for a small PV system. Many MPPT charge controllers do not become economical until the PV system is larger than 500 watts.

For economic purposes, the percent voltage drop in PV array wiring is not really that important. Power loss is the important factor. For high-voltage systems, very low voltage drops (less than 1 percent) are often appropriate. But for low voltage systems (12–48 VDC), voltage drops above 4 percent often make economic sense.

Access

Kent Osterberg, Blue Mountain Energy, 70177 Ponderosa La., Cove, OR 97824 • 541-568-4473 • kent@coveoregon.com



Earn a degree in Renewable Energy

with a concentration in Photovoltaic Design and Installation



SAN JUAN COLLEGE, FARMINGTON, NM

- ◆ Two-year AAS degree or one-year certificate. Both emphasize full NEC compliance.
- ◆ Combine science with hands-on learning.
- ◆ Tuition \$420/semester out-of-state and \$300 in-state.

Tom Munson, (505) 566-3003 or (800) 241-6327
munsont@sanjuancollege.edu

www.sanjuancollege.edu/reng

North American Board of
NABCEP
Certified Energy Practitioners



NABCEP™ Solar PV Installer Certification

Exam Date: March 19, 2005

Applications due to NABCEP by January 7, 2005

WHY GET CERTIFIED?

- **Certification based on industry standards of safety**
- **Distinguishes you among your peers**
- **More customers look for certification as sign of competence and quality**

For the Exam Application and additional information please visit our web site at: www.nabcep.org or call (518) 889-8126

Flexible Cables

& Proper Termination

John Wiles

Sponsored by the Photovoltaic Systems Assistance Center, Sandia National Laboratories

Many off-grid and some larger utility-interactive renewable energy systems use fine-stranded, flexible cables. These flexible cables are easier to pull through conduit and to bend in tight spaces than large, stiff, standard cables. However, there have been reports of field-made connections that have failed when flexible, fine-stranded cables have been used with mechanical terminals or lugs that use a setscrew to hold the wire in the terminal.

Those of you who have used these flexible cables in your own PV systems (as I have) may have noticed that the terminals need periodic retightening. You torque them to specification when you first install them. After a few months, they may need another tightening to get the torque back up to specification. This can go on for a year or more. Overtightening these connections can result in sheared strands of the very fine individual wires in the cable, stripping the setscrew, or deforming the terminal. These problems don't only happen with the larger cables, but even in small, fine-stranded cables like two-conductor, #18 (0.8 mm²) "zip cord" used for lamp cords.

While some electrical equipment uses stud-type terminals that are compatible with fine-stranded wire (provided the correct lugs are used), many circuit breakers, fuse holders, disconnects, PV inverters, charge controllers, power distribution blocks, and some PV modules have setscrew terminals (see photo below).

Examples of mechanical, setscrew terminals.



Fine-Stranded Conductors

By definition, fine-stranded conductors and cables have stranding more numerous than Class B stranding. Class B stranding (the most common) will normally have 7 strands of wire per conductor in sizes #18 through #2 (0.8–33 mm²), 19 strands in sizes #1 through #4/0 (42–107 mm²), and 37 strands in sizes 250 kcmil through 500 kcmil (127–253 mm²).

The photo below shows the differences between standard Class B cables and fine-stranded cables. Both cables pictured are #2/0 AWG (67 mm²). The THHN Class B cables on the left have 19 separate conductors each with a diameter of 0.084 inches (2.13 mm). The fine-stranded cables on the right have 1,330 separate conductors, each with a diameter of 0.01 inch (0.25 mm).

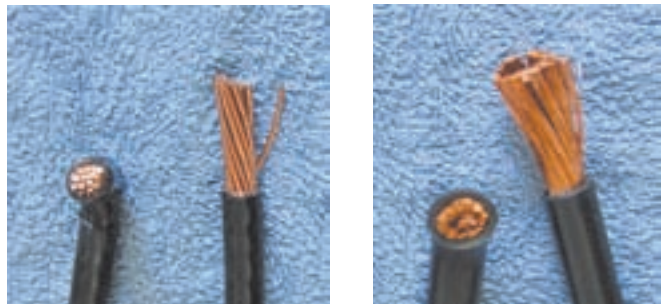

Standard Class B conductors (left) and fine-stranded conductors (right).

Commonly used building-wire cables, such as USE, THW, RHW, THHN, and the like, are usually found with Class B stranding, but are also readily available with higher stranding. Fine-stranded cables are frequently used in PV systems for battery-interconnect cables, battery-to-inverter cables, and power conductors in large (100 KW plus) utility-interactive inverters.

Some PV modules are supplied with fine-stranded interconnecting cables with attached connectors (sometimes called "MC connectors"). While these crimped-on connectors listed with the module are suitable for use with the fine-stranded conductors, an end-of-string conductor with mating connector may also be supplied with the fine-stranded conductor, and the unterminated end of that conductor

may not be compatible with some mechanical terminals. A simple and safe solution is to use end-of-string conductors with Class B stranding, which are readily available.

According to UL Standard 486 A and B, a terminal, lug, or connector must be listed and marked for use with non-Class B stranded conductors. With no marking or factory instructions to the contrary, the terminal should only be used with Class B stranded conductors, since they may not be suitable for use with fine-stranded cables. UL engineers state that few (if any) of the normal, screw-type mechanical terminals that the PV industry commonly uses have been listed for use with fine-stranded wires.

UL suggests three problems may arise when fine-stranded cables are used with inappropriate terminations. First, the turning screw tends to break the fine wire strands, reducing the amount of copper available to meet the listed ampacity. Second, some of the fine strands may slide past the side of the pressure screw and not be fully engaged in the connection. Third, the initial torque setting may not hold the cable, which continues to compress after the initial tightening.

Even after subsequent retorquing, the connection may still loosen. This creates a higher-than-normal resistance connection that heats both the copper and the lug, causing expansion and further loosening. The connection may eventually fail. The photo above right shows a failed mechanical terminal from a 225 KVA, utility-interactive PV system.

Ring Connectors with Stud Terminals

Crimp-on compression lugs in various sizes that are suitable for use with fine-stranded cables are available. Factory-supplied markings and literature indicate which lugs are suitable. An example is the ILSCO FE series of lugs in sizes #2/0 (67 mm²) and larger. Burndy makes a YA series of lugs in sizes #14 (2 mm²) and up. In both cases, the lugs are solid copper.

Crimp-on compression lugs must be installed on the cables using the tools recommended by the manufacturer. Common, low-cost, tin-plated aluminum, crimp-on lugs are not suitable for use with fine-stranded conductors. The photo below right shows an example of a typical lug that is not rated for use with fine-stranded cables.

Pin Adapters

Burndy and others make pin (aka pigtail) adapters that can be crimped on fine-stranded cables. The protruding pin of these adapters can be inserted into a standard screw-type mechanical connector. Again, not all pin or pigtail adapters are listed for use with fine-stranded conductors; some are intended for use with aluminum wire and others provide only a conversion to a smaller wire size for a Class B conductor.

Parallel Conductors

In some cases, it may be easier to parallel two smaller conductors to carry the same current as one larger conductor. The NEC only allows paralleling of

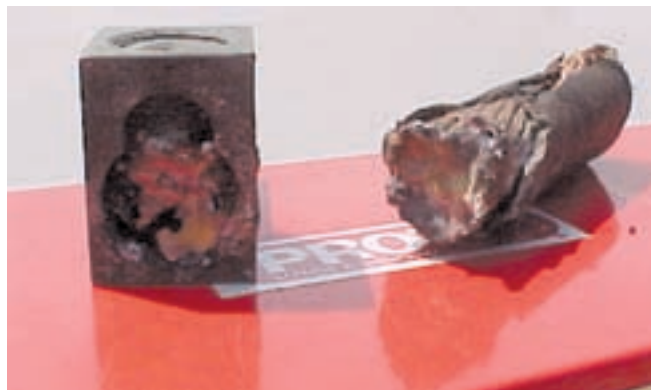

Destroyed mechanical terminal and fine-stranded cable from a large, utility-interactive PV system.

conductors that are size #1/0 (53 mm²) and larger. This may eliminate the need for fine-stranded cable. Of course, the terminals on the equipment must be designed to accept more than one conductor. Setscrew mechanical terminals are frequently listed for only one conductor per hole, while a stud-type terminal will usually accept more than one crimp-on lug.

Make It Fine

All electrical equipment listed to UL standards has terminals rated for the required current and sized to accept the proper conductors, sufficient wire-bending space to accommodate the Class B stranded conductors, and provisions to accept the appropriate conduit size for these conductors where conduit is required. It is therefore often unnecessary to use the fine-stranded cables.

Whenever fine-stranded conductors are used, they should be terminated properly. With owner-installed and operated systems, the owner can take responsibility for keeping all terminals tight. Otherwise, flexible cables should always be terminated with the appropriate connectors.

Fortunately, some manufacturers have recognized the termination issues related to fine-stranded wire, and modern designs use stud, rather than setscrew terminals on equipment typically used in conjunction with fine-stranded

A typical compression lug—not marked for fine-stranded cables.



cable. In these cases, fine-stranded cable can be safely used with the appropriate, rated ring lugs.

Access

John C. Wiles, Southwest Technology Development Institute, New Mexico State University, Box 30,001/MSC 3 SOLAR, Las Cruces, NM 88003 • 505-646-6105 • Fax: 505-646-3841 • jwiles@nmsu.edu • www.nmsu.edu/~tdi

Sponsor: Sandia National Laboratories, Ward Bower, Department 6218, MS 0753, Albuquerque, NM 87185 • 505-844-5206 • Fax: 505-844-6541 • wibower@sandia.gov • www.sandia.gov/pv

The 2002 NEC and the NEC Handbook are available from the National Fire Protection Association (NFPA), 11 Tracy Dr., Avon, MA 02322 • 800-344-3555 or 508-895-8300 • Fax: 800-593-6372 or 508-895-8301 • custserv@nfpa.org • www.nfpa.org



PC Software for Sine Inverters
WinVerter™





OutBack
Power Systems

xantrex

www.RightHandEng.com (425) 844-1291

ZOMEWORKS
Passive Energy Products



Zomeworks has been a leading developer and manufacturer of passive energy products since 1969. Our innovative product lines include photovoltaic mounting structures, temperature regulating enclosures and architectural sun control devices.

New F-168 Track Rack and SUPER Shock Absorber!

- Solar Products
PV Mounting Racks
Battery Enclosures
- Cool Cell™
Temperature Regulating Enclosures
PV Cool Cell
Hydrogen Vents
- Sun Control Products
Sunscreen® Reflector/Shader
SkiLight Tracker M2W

INTRODUCING...
F-168 Track Rack for more than 2 KW and our new SUPER Shock Absorber!

Learn about architectural heating & cooling with Zomeworks Double Play Systems

ZOMEWORKS Corporation, PO Box 25805 (1011 Sawmill Rd. NW), Albuquerque, NM 87125
www.zomeworks.com • zomework@zomeworks.com • 800-279-6342 • 505-242-5354 • fax 505-243-5187

Log-on to your future @ www.solarenergy.org

Renewable Energy Online Education

Photovoltaic Design Online Course

Jan. 10 – Feb. 18 • Mar 14 – Apr 22 • May 31 – Jul. 8

Solar Home Design Online Course

Jan. 31 – Mar. 11

"The course was exactly what I had hoped for. It covered all of the key areas and built on them in each successive chapter. Well planned and increasing challenging. Well worth the cost and I am looking forward to applying the knowledge to my own design. The contacts and links were exceptional and will be used over and over again."

-- Spring 2003 Course Participant

Online alums get tuition discounts to future hands-on workshops!

Start your renewable energy education from home...TODAY!

Solar Energy International

www.solarenergy.org • sei@solarenergy.org • 970-963-8855

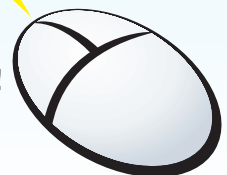



Hutton Solar Delivers

Are you a Dealer or Installer?

Hutton Solar understands your time is valuable. That's why we have established a national dealer/installer referral network to connect you to those in need of your products and services. Members of this coast-to-coast referral program save time by allowing us to identify opportunities for them. Our network is growing and we want you to be a part of it. There's no risk, only the opportunity to expand your business potential. Call 877-648-8866 to join At Hutton Solar, our results are electrifying!

Looking for a Dealer/Installer in your area?

One of the most frustrating and time-consuming aspects of any project can be finding the right resources. With Hutton Solar's expansive dealer/installer network, we can connect you with the qualified experts who will get the job done right, coast-to-coast. Log on to HuttonSolar.com and use the "need a dealer in your area" feature on the home page. Let Hutton Solar work for you.

huttonsolar.com
The first dealer in your area

www.huttonsolar.com • 877-648-8866



Things that Work!
Model 4-1850
Home Power #67



Digital Power Meters

20-CTR: Measures AC Power up to 10 kW, 100-250 vac single or two phase. Remote display. Easy to install.

ONE Meter: Semi-custom power meter. Multiple independent AC or DC power channels. Several display options. Can be configured for Whole House power monitoring. PC interface, 8000+ data memory. Internet connection optional.

4-1850WX: Special meter for Refrigerator Replacement Programs. Detects Defrost Cycle, displays cost/kWh-hrs per year. **California CEC eligible meters.**

Other Models available. Check our website or call for details.

CUSTOM APPLICATIONS and DISPLAY OPTIONS:
We can build a digital power meter to meet your needs, including large displays. Perfect for trade shows, public buildings and educational purposes. Several signs to choose from including the popular Beta Brite scrolling LED sign. Please call with your needs/ideas.

Brand Electronics
421 Hilton Rd.
Whitefield, ME 04353
For information only, call 207-549-3401
info@brandelectronics.com

To order, call toll free
1-888-433-6600
www.brandelectronics.com



ELECTRO AUTOMOTIVE

Electric Car Conversions Since 1979

Books ⚡ Videos ⚡ Kits ⚡ Components

- ⚡ **Catalog** Send \$6.00 for our catalog, or visit our web site.
- ⚡ **"Convert It"** We wrote the book on electric car conversions - literally! Send \$30.00 postage paid for this hands-on how-to conversion manual, written in plain English for the home hobbyist mechanic.
- ⚡ **Conversion Kits** Complete custom bolt-in kits for the VW Rabbit and Porsche 914, or a universal kit for other small cars and light trucks.
- ⚡ **Web Site** Visit our web site for our complete catalog, price list, gallery of conversions, and extensive conversion information section.

P.O Box 1113-HP, Felton, CA 95018-1113 ⚡ 831-429-1989

WWW.ELECTROAUTO.COM ⚡ ELECTRO@CRUZIO.COM

Protecting RE Independence

Don Loweberg

©2004 Don Loweberg

The regulated or investor-owned utility (IOU) is an economic invention dating back about 100 years in the United States. A brief history of its development is useful for understanding and predicting utility behavior today, especially as distributed generation with on-site renewable energy technologies becomes integrated into the utility grid.

Robber Barons Write the Rules

By 1900, the basic technical model for electric generation—a large, centrally located, combustion-powered alternating current (AC) generator—was well established in most major U.S. cities. Other than the fact that it has expanded across the country to urban and rural areas alike, interestingly, this model remains little changed more than 100 years later. In contrast, huge technological changes in other industries, such as the communications and electronics industries, have been made. Has the monopoly status of utilities insulated them from market-driven changes?

In the early twentieth century, private holding companies controlled by J. P. Morgan, Rockefeller, and others were aggressively expanding their electricity generation holdings. Simultaneously, and possibly in reaction to the unrestrained growth and high prices for electricity charged by these holding companies, cities began establishing their own public power systems, consistently delivering electricity at lower prices. During this time, the number of public power systems grew rapidly. By 1912, more than one-third of utilities were publicly held. By 1923, the number of public utilities had peaked to its highest level ever—to 3,066.

Despite this, it was the modern “regulated” utility that would become the dominant economic model for electricity generation and distribution in the United States. At first glance, the regulated monopoly seemed to balance the needs of public benefit and corporate profit. A board of regulators would guarantee public benefit, while profits would be guaranteed by eliminating competition within protected territories and setting a predetermined rate of return on investment.

A couple of viewpoints about what drove this shift to utility regulation exist. One possibility is that the corporate holding companies began to exhaust themselves in the roiling waters of competition. Along with guaranteed profit, the regulated utility model offered secure territories with no competition.

During distributed electricity’s early days, public power was outcompeting private power cartels at a record rate. By creating the regulated utility or IOU, the corporate holding companies blocked the growth of public power systems. Today, the fraction of publicly held utilities in the United States has declined to about 15 percent, not including federally owned projects.

Legalistic Con Job

Since monopolies are illegal, the legal justification for a regulated monopoly requires an intellectual contrivance—that of a “natural” monopoly, an enterprise that is inherently so big that competition is considered impossible. An example of a natural monopoly would be the electricity transmission and distribution system in a given region. Because the magnitude of private investment required to establish these infrastructures is so huge, the federal government and individual states allow the creation of regulated monopolies via the Federal Energy Regulatory Commission and Public Utilities Commissions.

But Paul M. Johnson, professor of economics at Auburn University, says that “instances of true ‘natural monopoly’ situations seem upon close and systematic investigation to be extremely rare. The vast majority of actual real-world monopolies are not ‘necessitated’ by economies of scale, but instead have been politically conferred by government at the instigation of formerly dominant firms grown fearful of emerging competition.”

Ruling the Roost

For more than 100 years, IOUs have used the cloak of regulation and their natural monopoly status to stifle competition. Their primary success was curbing the growth of publicly owned electric power systems. Not until 1978 was the IOU stranglehold on the electricity business eased with the passage of the Public Utility Regulatory Policy Act (PURPA), which helped spawn the growth of the cogeneration industry. Under PURPA, a federal law, independent generators of electricity could finally connect to the utility grid. For the first time, factories could install on-site electric generation (often using waste material for fuel) and sell excess electricity to the regulated utility. Because PURPA also applied to electricity generated with renewable energy, this legislation also helped launch the wind-electric industry in the United States.

Despite the doors that PURPA opened, independent generation today remains limited not only due to wholesale prices offered by the utilities, but because of the roadblocks of "avoided cost" practices, which stipulate that independent generators must sell excess electricity only to their local utility at the lowest possible price, and predictably onerous and costly utility interconnection practices allowed by regulators.

Protecting PV & Distributed Generation

Distributed generation (DG) is defined as the use of small-scale power generation technologies located at or close to the load being served. Our focus here is photovoltaic (PV) DG, but generally the concepts would apply to all DG.

DG holds a status that differentiates its technologies from larger forms of generation such as centralized power plants. In this case, the competitive market and public-good incentives, rather than a natural monopoly, supply the technologies. Because a monopoly enterprise engaging in a competitive market constitutes anticompetitive behavior, the franchise of IOUs does not extend to distributed generation.

California's Public Utilities Code, section 2775.5 (b), echoes this principle: "The commission shall deny the authorization sought (by a utility) if it finds that the proposed program will restrict competition or restrict growth in the solar energy industry or unfairly employ in a manner which would restrict competition in the market for solar energy systems any financial, marketing, distributing, or generating advantage which the corporation may exercise as a result of its authority to operate as a public utility."

IOUs tend to dominate the market, and have controlled the electricity business in the United States for almost a century. They have resisted, and even sabotaged, small moves towards liberalizing generation with strategies like avoided-cost pricing and by denying distribution or transmission services to independent generators. Most recently, California private utilities have attempted to impose departing load charges and exit fees on net-metered residential and commercial PV installations. These fees, they argue, compensate them for lost revenue due to the reduction in a customer's need for utility-provided electricity. Though regulators struck down this "solar tax," the intention of the utilities was clear—stifle any and all competition.

To promote the wide-scale adoption of PV-generated power, some PV industry leaders have advocated utility ownership of PV at customer-owned sites. Though their goal of incorporating PV widely and quickly into the mainstream grid is well intentioned, it is fundamentally flawed in its execution when they advocate utility ownership and control. As the successful PV programs in California and other states amply demonstrate, delivering incentives that encourage end-user ownership of PV distributed generation has been very effective in stimulating the grid-connected PV market. To protect consumer interest and promote the widespread integration of small-scale renewable energy technologies, distributed generation must remain a competitive business enterprise, free from the control of "regulated" utilities.

Access

Don Loweberg, IPP, PO Box 231, North Fork, CA 93643 • 559-877-7080 • i2p@aol.com • www.i2p.org

U.S. Department of Energy survey of nonutility generation as of year 2000 • www.eia.doe.gov/cneaf/electricity/ipp/ipp_sum2.html

For a quick overview of the history of electric utilities and some biting critique on deregulation read: *The Last Energy War: The Battle over Utility Deregulation*, Harvey Wasserman, 2000, Paperback, 77 pages, ISBN 1-58322-017-8, US\$4.75 from Seven Stories Press, 140 Watts St., New York, NY 10013 • 212-226-8760 • Fax: 212-226-1411 • info@sevenstories.com • www.sevenstories.com



ROCKY MOUNTAIN POWER SOURCE

High Efficiency Generators

- SAVE MONEY—CUT COSTS
- HEAT & ELECTRICITY
- RUNS ON BIODIESEL
- EFFICIENT BACK-UP GENERATOR
- HIGHLY EFFICIENT CO-GENERATION SYSTEM
- LONGEVITY
- LOW MAINTENANCE
- 2 YEAR PAYBACK

For more information please contact Rocky Mountain Power Source @ (970) 876-0832 or email @ RMPS4U@hotmail.com

OFF LINE
Independent Energy Systems

Our 21st Year Offgrid!
We provide excellent service & technical support.
Residential Power • Water Systems • Communications
Wind • PV • Hydro • Custom Design • Installation
All Major Brands

California Rebates!

OFF LINE
Located in the central Sierra, near Yosemite

e-mail: ofln@aol.com
www.psnw.com/~ofln
P.O. Box 231, North Fork, CA 93643

(559) 877-7080
CA Lic. #661052

Wind Power:

Renewable Energy for Home, Farm, & Business—by Paul Gipe

Reviewed by Ian Woofenden

©2004 Ian Woofenden

If you buy only one book on wind energy, make it this one. Wind-energy expert Paul Gipe has made a great book even better in his 2004 update of the classic *Wind Power for Home & Business*. I recommend this book to students, homeowners, and anyone who wants a clear picture of what they're getting into when they are bit by the wind energy bug.

The book is clearly written and well organized. It starts with terminology and basic principles, and proceeds in a logical order through applications, wind measurement, estimating output, the economics of wind, and evaluating specific wind turbines. Paul then covers specifics of towers, purchasing a wind-electric system, on-grid and off-grid systems, siting, and installation. The book closes with information on operation and maintenance, and a heavy emphasis on safety. Citing deaths and injuries in the wind industry, Paul gives readers a healthy dose of reality—wind technology has its hazards!

Extensive appendices cover a wide variety of topics, with listings of small- and medium-sized turbines from all over the world to resources for further study. This section also includes conversion tables, wind speed distribution tables, wind maps, and tables for estimating output. In short, Paul left no stone unturned in writing this book—you won't find a better resource.

I'm particularly pleased that Paul emphasizes the difference between power and energy. This distinction is

a breath of fresh air in a day when many manufacturers seem to be scrambling to claim that they have the highest power wind turbine. Paul reminds us that it's energy we want, not peak output: "To gauge the potential of a

wind turbine, ignore the size of the generator or its purported efficiency and get right to what matters most: the monthly or annual energy output for your site." If these numbers aren't available, he says, "Remember that nothing outside the wind itself...is more important in determining a wind machine's capability of capturing the energy in the wind than the area swept by the rotor." There's no substitute for swept area!

Paul makes an equally important point about wind turbine longevity: "Wind turbines must first be reliable; second, they must be cost effective." Efficiency is third—it means nothing if the turbine does not last. Paul explains why heavier, more robust turbines that spin at lower speeds will last longer. He has seen

thousands of turbines in operation and has cataloged failures—this guy knows more about specific turbines than anyone I know.

My main criticism of this fine book is that it tries to do too much. Not only does it cover home-scale wind turbines, it covers "medium-sized" (ranch to village) turbines and utility-scale turbines. Information on these very different technologies is blended together throughout the text. For those primarily interested in small wind systems, it's a bit

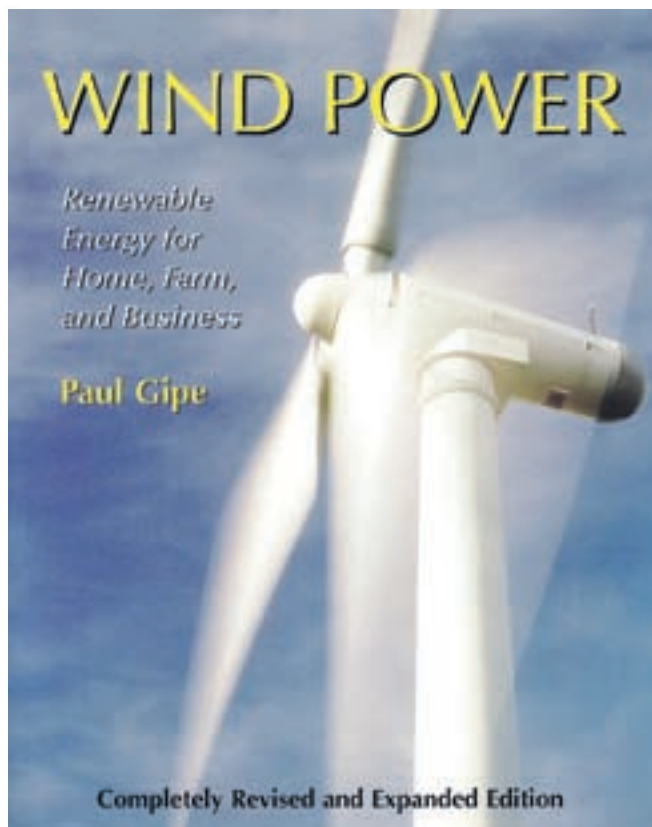

distracting to have coverage of big wind systems mixed in. If I were Paul's publisher, I may have suggested two separate books.

No book can teach you everything you need to know to choose, buy, install, maintain, and live with a wind-electric system. Some lessons have to be learned firsthand, and I urge you to get some real-world experience through workshops or participating in installations before you dive into your own installation. But this book is one I recommend as a very *large* first step in your wind energy education. It's not cheap, but it's a much better buy than Paul's lightweight introductory book, *Wind Energy Basics*, and worth every penny. His clear explanation of terms, concepts, and recommended practices will save you many hours and many dollars.

Access

Wind Power: Renewable Energy for Home, Farm, and Business, Paul Gipe, 2004, Paperback, 496 pages, ISBN 1-931498-14-1, US\$50 from Chelsea Green Publishing Company, PO Box 428, White River Junction, VT 05001 • 800-639-4099 or 802-295-6300 • Fax: 802-295-6444 • info@chelseagreen.com • www.chelseagreen.com

Reviewer: Ian Woofenden, PO Box 1001, Anacortes, WA 98221 • ian.woofenden@homepower.com



Searching for a Canadian renewable energy company?

ENERGY ALTERNATIVES has provided thousands of reliable, long lasting and expandable power systems in some of the most remote areas of Canada during our **21 YEARS OF OPERATION.**



Choose from our **DIY packaged systems** or **turn-key professional installation.**

DEALERS WANTED Energy Alternatives offers a comprehensive dealer training program, fast delivery, excellent pricing and superior technical support.



FREE Buyers Guide (for Canadian customers)

BC Electrical contractor # 86683



www.EnergyAlternatives.ca

TOLL FREE (800)265-8898

FORCEFIELD

www.wondermagnet.com

NdFeB Magnets
Magnet Wire
Books
Weird Science

Needful Things
for the homebrew renewable energy enthusiast!

www.otherpower.com
877-944-8247 (toll free)
970-484-7257
2806 W. Vine Dr.
Fort Collins, CO 80521
ff@wondermagnet.com

MAKE YOUR ELECTRICITY FROM SCRATCH!

EV Solar Products

Solar Electric Systems
Wind Generators
Solar Hot Water
Backup Power

Design • Sales • Installation

www.evsolar.com

Tel: 928-636-2201 Fax: 928-636-1664
2655 N. Highway 89 Chino Valley, AZ 86323
Solar Solutions Since 1991

Battery Filling Systems

Put the fun back in watering your batteries!



- **One Connection**
- **One Minute**
- **Accurately Fills Each Cell, Every Time!**

See Product Review, *Home Power Magazine* Issue 100, Page 82

Master Distributor for BFS, deep cycle & industrial batteries

All Battery Sales & Service



1-800-562-3212

Fax: 425 742-1739

vern@allbatterysalesandservice.com

front

back

Pretty Cool Shirts

16 Bucks

Two sided, Blue or White, Sizes: S to XXL • Shipping: \$5 US, \$8 CAN, \$10 INT
Order online at www.homepower.com or call 800-707-6585 or 541-512-0201

100% ORGANIC COTTON

Renewable Energy

On Video

Renewable Energy with the Experts

An Instructional Video (VHS) Series on the Basics of Residential Renewable Energy

- Residential Solar Electricity with Johnny Weiss, 48 min.
- Residential Wind Power with Mick Sagrillo, 63 min.
- Residential Microhydro Power with Don Harris, 44 min.
- Batteries with Richard Perez, 57 min.
- Solar Water Pumping with Windy Dankoff, 59 min.

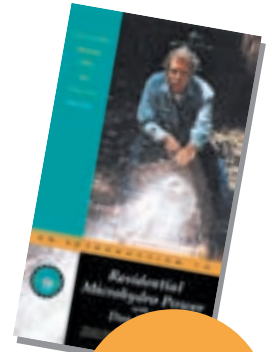

\$ 39.95 each
(plus shipping)

Shipping \$5 USA, \$6 Canada, \$10 International

Home Power • Box 520, Ashland OR 97520
800-707-6585 • 541-512-0201
www.homepower.com

Advertise in

home power

The Hands-On Journal of Home-Made Power

Since 1987, *Home Power* has been connecting manufacturers, resellers, and installers to end users of clean energy technologies.

Today, more than 80 percent of our readers live on-grid and over 70 percent of them will be installing both solar-electric and solar hot water systems. And that's just the beginning...

Home Power readers are also purchasing wind and microhydro power systems, energy efficient appliances, green building products, and low or no emissions vehicles.

Give the people what they want. Advertise in *Home Power*!

For all the details, contact Connie Said at advertising@homepower.com • phone: 541.512.0201

Cut Your Own Lumber!

Model 613



LUCAS MILL

Call for Free Brochure and Video

Call For Prices!

U.S. Pat. No. 5,819,626/Australian Pat. No. 688020

The Ultimate Portable Saw Mill

PACKAGE DEAL INCLUDES:

- Engine & Saw Carriage
- 2 - Sets of End Frames & Braces
- 2 - Hold Down Spikes
- 2 - 17" Carbide-Tipped Saw Blades
- 12 Volt Diamond Wheel Grinder
- Swing Blade Sawing System
- 2 - 19 ft. 4 in. Tracks
- Extra Gas Filled Strut
- 2 - Year Warranty (Engine and Mill)

© 2004 Bailey's Inc.

Bailey's
Est. 1975

The World's Largest Mail Order
Woodsmen Supplies Company -
Selling at Discounted Prices.

Call today and
mention source
code: H7Q5
for your FREE
Master Catalog

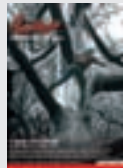

TOLL FREE **1-800-322-4539** TOLL FREE

www.baileys-online.com

Get the credit you deserve for caring about the planet at the



Permaculture Credit Union

We are making loans that make a difference to the people who make a difference.

We offer a 0.75% sustainability discount on loans for earth-friendly projects, including:

- Solar heating and electricity systems
- Home energy efficiency upgrades
- Fuel-efficient vehicles
- Efficient windows & insulation
- Rainwater catchment systems

Call us for loan programs and current rates.

(505) 954-3479 or toll-free (866) 954-3479

www.pcuonline.org

4250 Cerrillos Road, P.O. Box 29300
Santa Fe, NM 87592-9300

*Do something nice for yourself, your community,
and the earth...call the PCU today*

share
what
you
know!

Write for Home Power

We're always looking for fresh and inspiring new articles to publish. If you've got a renewable energy story to tell or an area of relevant expertise or experience, consider sharing what you know with other Home Power readers.

See our complete submissions guidelines and a list of article ideas on our Web site.

www.homepower.com/writing



BackHome MAGAZINE

Your Guide to Self-Reliant Living

Take control of your own life. Thousands of people have gone BACKHOME to enjoy less complicated, more rewarding lives . . . and you can join them. In each bimonthly issue, find articles on topics such as: Alternative Home-Building Techniques, Organic Gardening, Selecting a Home Business, Living Mortgage Free, and much, much more!



Subscribe to BACKHOME for just \$21.97 per year. Call us at 800-992-2546, write to us at P.O. Box 70HP, Hendersonville, NC 28793 or visit our Web site

www.BackHomeMagazine.com

Imagine the Unthinkable

Michael Welch

©2004 Michael Welch

Global warming is at least as important as gay marriage or the cost of Social Security. And if it is not seriously debated in the general election, it will measure the irresponsibility of the entire political class. This is an issue that cannot, and must not, be ignored any longer.

So ends a recent political commentary column by Walter Cronkite, the last of the great major media reporters (*Philadelphia Inquirer*, March 15, 2004).

Cronkite's column discussed a leaked Pentagon report called "Imagining the Unthinkable," which pondered the possibility that global warming would result in abrupt and catastrophic changes, and that this threat to the world is greater than terrorism. At any rate, if the Pentagon is thinking about it, maybe we should be worried too.

Pentagon: "Global Warming Is Real"

The key term in this report is "abrupt." Its authors try to make it clear that the "what if" scenario they paint is different than most other scenarios. They suggest that the consequences of global warming could appear quite suddenly—much more quickly than humanity, business, and government can adapt to. The report is based on the possibility of a level of climate change that would trigger the abrupt events being reached around 2020, but states, "Keep in mind that the duration of this event could be decades, centuries, or millennia and it could begin this year or many years in the future." The report authors say that this scenario is unlikely, and that it is a study of the extreme case.

Without painting too graphically the ugliness of abrupt climate change as stated in the Pentagon report, in general terms it could:

- Make winters colder, summers drier, and increase the intensity of storms and typhoons;
- Reduce the availability of food, water, and energy; and
- Ultimately result in the deaths of millions of humans, create heavily fortified borders in Europe and the United States to keep migrants out, increase global conflict, and result in economic malaise.

The Pentagon decided to study the potentially abrupt effects of climate change because officials there got their hands on another earlier report by the National Research Council of the National Academy of Sciences called *Abrupt Climate Change: Inevitable Surprises*. This first report points

to evidence that "periods of gradual change in Earth's past were punctuated by episodes of abrupt change, including temperature changes of about 10 degrees Celsius, or 18 degrees Fahrenheit, in only a decade in some places." The report used computer modeling and went back hundreds of centuries, and also mentioned more recent historical information, including the U.S. "dust bowl" drought of the 1930s.

It is hard to fathom what an 18°F temperature swing would really mean to life on Earth, and even harder to accept the possibility that it could happen in the not-too-distant future. We just don't know for sure. More common and earlier climate change scenarios predict changes over 50 to 75 years. With a dragged-out period of time like that—roughly a full lifetime—folks don't seem immediately willing to make the kind of lifestyle changes necessary to stop global warming. Without an actual crisis at hand, perhaps we are thinking (wishfully, maybe) that something will come up in time to turn this around. But that kind of thinking will not work if things accelerate as fast as these reports warn.

Wake-Up Call

Another possibility discussed among scientists is that climate change will progress slowly to a point, eventually reaching a threshold. Then the effects of the change will accelerate quickly and seem as abrupt as the Pentagon report predicts. There is no longer any question that humans are a significant contributor to the current increase in global warming—that myth is laid to rest. The question becomes, do we let it slide until we hit crisis level, or do we begin right away to fix things to see if we can avoid the crisis?

Time for Change

So, what do we do to turn this around? The specifics of how to change the direction of global warming are difficult to pin down, considering the magnitude of the task. Climate-change activists have been working for decades and are hard-pressed to come up with globally effective methods, but they continue to chip away at the problem. Certainly it does not help when the U.S. government does things like refusing to ratify the Kyoto Protocol, the United Nations' framework for reducing greenhouse gas emissions. It also is not helpful when most prominent elected officials

won't even talk about the problem while campaigning, and those who do, pay it little more than lip service.

In light of the U.S. government's unwillingness to take action, it's time for a grassroots effort to stymie global warming. With each of us taking individual responsibility and action to address this problem, maybe those in power will learn by our example and finally understand that sweeping changes need to be made. This is exactly how solar energy has been gaining a foothold, both nationally and internationally. Little by little, those of us implementing RE in our own lives are turning it into a national interest.

Curbing Climate Change

Using solar energy helps slow global warming, but not enough for us to rest on our laurels. We need to do a lot more. The biggest problem that we can each address individually is the burning of fossil fuels, especially in motor vehicles. Decreasing our dependency on petroleum vehicle fuels means trying to cure an addiction that we've had for 75 or so years, and it won't be easy.

My partner and I are trying to figure this out for ourselves right now. Not only will we need to make some hard decisions, but they are going to cost us some money. Here are some goals you might consider:

- Drive less, walk and bike more, live as close as possible to your destinations, and telecommute to work if you can.
- Drive efficiently, and combine trips when driving is necessary.
- Drive a fuel-efficient vehicle. A hybrid gets 50 to 60 mpg, and a motor scooter can get 150.
- Use fuels from renewable sources, like veggie oil, plant-derived alcohol, or solar electricity for an EV.

My thanks to Walter Cronkite for helping me think again about climate change. It "cannot, and must not, be ignored any longer." Let's take personal action now.

Access

Michael Welch, c/o Redwood Alliance, PO Box 293, Arcata, CA 95518 • 707-822-7884 • michael.welch@homepower.com • www.redwoodalliance.org

Read the Cronkite opinion piece archived at: www.globalsecurity.com/environment/make_global.htm

For further info on climate change, global warming, and energy use, see:

- www.pewclimate.org
- www.climateark.org
- www.ucsusa.org
- www.citizen.org/cmep



Shell Solar
Distributor

**SAME LOCATION
FOR 20 YEARS
DEALER INQUIRES
WELCOME**

HITNEY SOLAR PRODUCTS, INC.
Harmony with Nature

**SAME DAY SHIPPING FRIENDLY SERVICE
LARGE INVENTORY IN STOCK**
PHONE: 928-636-1001 FAX 928-636-1664
EMAIL: SUNPOWER@ANGELFIREAZ.NET

LOW ENERGY SYSTEMS, INC.
RADIANT AND SOLAR HEATING DESIGN & SALES
WITH STATE-OF-THE-ART SOFTWARE

STIEBEL ELTRON
Solar Collectors & Dual Coil Tanks

Solar Differential Controls

TAKAGI Paloma
Tankless Water Heaters

Solar Design Software

NEW LOCATION
4975 EAST 41ST AVE.
DENVER, CO 80216
1-800-873-3507
SALES@TANKLESSWATERHEATERS.COM

If You're Concerned About
the **Future of Our Planet...**

You Should be Reading...
E/The Environmental Magazine

Visit Us on the Web:
www.emagazine.com

Shock

Muscular Spasm Caused by Charge Flow

Ian Woofenden

©2004 Ian Woofenden

Derivation: From Old French choquier, collide with, akin to Middle Dutch schocken to jolt.

Electrical current is the flow of charges. We try to keep this flow within wires and appliances. But sometimes we become part of the circuit ourselves, and get a nasty reminder of electricity's danger.

The movement of electrical energy has two basic components—voltage and amperage. Remember the simple formula for power—volts times amps equals watts. Voltage can be thought of as the “push,” the electrical pressure. Amperage is the flow rate of charges.

For voltage to push charges, there needs to be a circuit—a complete electrical loop with a wire from the energy source to the load and one returning to the source. The wires in the circuit provide a closed path that is full of moveable charges.

But sometimes things don't go as planned. Wires fray, appliances malfunction, or conditions change. The charges can then try to use the ground as a pathway back to the source. And, if you're in the wrong place at the wrong time, you can become part of that path. For instance, what if the insulation rubs off an ungrounded outdoor wire, and you happen to touch it while standing on the ground? Your body offers a new path, so the charges will travel through you to ground. You'll feel a tingle, a shock, or worse.

You've handled 1.5-volt flashlight batteries, and even 9-volt batteries from radios and such, and haven't been shocked. You may have even touched the posts of your car's starting battery with no ill effects. So what's the big deal? It may seem like these low-voltage sources pose no threat, and that only high-voltage devices are dangerous. But that's a dangerous oversimplification that could come back to bite you.

Under most conditions (but not all!) voltages below 40 V are not hazardous. But it's actually not the voltage alone but the amperage through your body that is lethal, and it doesn't take much. From 100 to 200 milliamps (mA, or $1/1000$ A) is enough to kill you. This is the current in a 15-watt, 120 VAC lightbulb. (See the table for levels of shock for different amperages.) The particular pathway that charges follow through your body makes a difference too. If you touch a hot wire with your right hand and are standing on the ground with your right foot, the charges may not flow through vital organs, which could save your life.

The voltage does play a role in shock, and that's because of the basic principle stated in Ohm's law—amperage equals voltage divided by resistance. Your skin protects you electrically because it has a fairly high resistance to the flow of electrical charges when it's dry—in the range of 100,000 ohms. This explains why we can handle low voltage electrical sources without being shocked. It takes a bit of push to get through your skin, which is not very conductive, into your tissues and organs, which are very conductive. Open wounds are much more vulnerable to shock than your skin.

Stand in a puddle, or worse yet, in salt water, and the conductivity of your skin goes way up. Resistance can drop to 1,000 ohms or less. You can experiment with an ohmmeter, with one probe contacting each hand, and see the difference when you lick your fingers before touching the probes. (This is not dangerous; the voltage is very low.)

Besides not standing in puddles while holding bare wires, how can you avoid shocking experiences? Properly grounding appliances and equipment is the first step. This allows fault currents to bleed off to ground, providing a more inviting path than your body or tripping the circuit breaker. Another precaution is using ground fault circuit interrupters (GFCIs). These devices monitor the charge flow on both legs of a circuit, and if it's uneven (indicating a flow to ground), they disconnect the circuit. Although they are not foolproof, they are another line of defense.

Possible Health Effects of 60 Hz AC

Amperage	Effect
1 mA	Barely perceptible
16 mA	Max an average man* can grasp & “let go”
20 mA	Paralysis of respiratory muscles
100 mA	Ventricular fibrillation threshold
2 A	Cardiac standstill & internal organ damage
15–20 A	Common fuse or breaker opens circuit

*Differences in muscle and fat content affect the severity of shock.
From the National Institute for Occupational Safety & Health

The first line of defense against shock is human intelligence. Turn off switches or breakers before you start working on your electrical system. Test the circuit with a voltmeter to make sure it's dead. Avoid making yourself the pathway for errant charges. A shock will make your muscles contract, so don't grip any exposed metal with your hand—a shock may prevent you from letting go. Instead, use the back of your hand to touch potentially live wires and objects. In the event of a shock, this will enable you to pull away safely. If you have to troubleshoot a live circuit, always keep "one hand in a pocket" to make sure you do not provide a short across the circuit being tested. Then your only electrical excitement will be the thrill of making your own electricity from renewable sources.

Access

Ian Woofenden, PO Box 1001, Anacortes, WA 98221 • ian.woofenden@homepower.com



- A diverse line of quality trackers for: Grid-Intertie, Commercial Applications, Remote Homes and Water Pumping.
- Trackers from 150 W to 15 kW.
- Complete pre-engineered TrackKits™ available.
- Patented technology.
- 15 years of solar tracking experience.

Array Technologies, Inc

505-881-7567

www.wattsun.com

BZ Products Model MPPT500

Voltage Converting 500 watt 38 amp MPPT Charge Controller

- Boost charge current up to 30% 15% boost typical.
- Up to 38 amps output current
- 95 % efficiency
- 500 watt PV input
- Universal PV input 12 to 48 volts
- Selectable 12, 24 or 48 volt output
- Digital metering
- PWM float control
- Battery temperature sensor standard
- Optional remote metering
- Five year warranty
- Available world wide
- Patent pending



BZ Products, Inc.

314-644-2490 • bzp@brick.net
7614 Marion Ct., St. Louis, MO 63143, USA



AUTOMAGIC BATTERY WATERING



WE MAKE WATER FROM YOUR GAS

Hydrogen and oxygen battery gas catalytically recombined into pure water and returned to each battery cell. Keeps battery topped off for extended periods of time and reduces maintenance costs. Explosive hydrogen gas is virtually eliminated from the battery area. Corrosive spray and fumes are contained and washed back into each battery cell. Electrolyte kept strong longer, extending the useful power and life of the battery. HYDROCAP Vents simply replace the battery's caps. Battery maintenance is greatly reduced. Write or call for more information.



Hydrocap
GAS-TO-WATER BATTERY CAPS

305-696-2504
975 NW 95 St.
Miami, FL 33150

Solar Panels • Wind Turbines • DC Lighting



ABS Alaskan, Inc.

Alternative Energy & Remote Power
2130 Van Horn, Fairbanks, AK 99701
toll free: 800-235-0689 fax: 907-451-1949

visit us online: www.absAK.com

Alaska Battery Anchorage, AK ph: 907-562-4949 fax: 907-563-4900
Distribution Center Renton, WA ph: 425-251-5745 fax: 425-251-5748

Micro Hydro • Complete Systems • & More

Meanwhile,

Back at the Ranch

Kathleen Jarschke-Schultze

©2004 Kathleen Jarschke-Schultze

Once again we have had a dry year at our home on Camp Creek. Rainfall has been about two-thirds of our “normal.” The creek stopped running around the beginning of August, with only small pools and seepage remaining in a few shady places. When the leaves on the trees turn gold, the water will start to come back, slowly relieving the drought and fire danger.

Lightning Strikes

Several months ago, we had a terrific thunder and lightning storm. The lightning was right over us. There was no time between the lightning and the explosion of thunder. In the middle of the storm, the rain began to fall. It was a “toad strangler,” to use the local vernacular. We received about a half-inch of rain in less than an hour.

We could still hear the thunder in the distance when the spotter plane started flying a grid over our canyon to look for fires. Scanning the hills around us, we saw nothing. The plane moved on after about twenty minutes of circling. It was still in sight on the horizon when our neighbor called. He said a fire crew had just crossed his bridge and hiked up the hill behind his house.

After a bit, we could hear their chain saws up on the ridgeline. Through our binoculars, we could see them using hand pumps on a burning dead snag. When they had put the flames down, they felled the snag. The rest of the strike area was on the other side of the ridge from us. Thank goodness for the rain.

Lightning Strikes Twice

A few weeks later on the last weekend of July, we had gone to the SolWest Renewable Energy Fair in John Day, Oregon. On Sunday, we received a call from our neighbor, Karen Perez. A lightning storm had come through the night before, and a wildfire was moving towards our little canyon.

I checked my cell phone messages. Our friend Dave, who lives a few miles away, had left a message. Basically it said, “Fire in your area! Call-Call-Call!” I did call. Dave had tried to go see what was happening up at our place, but had been shooed back by a county sheriff.

As he drove back home, the highway patrol was setting up a roadblock. He found out that all the campgrounds around nearby Iron Gate Reservoir had been evacuated. When he left the roadblock, our next-door neighbor was

trying to talk his way past to come rescue his dogs, which were still on the creek.

On the Road

We were nine hours away. That is an awful feeling. I tried to call our house sitter, Shay. Apparently the phone lines had already burned up. We threw everything—camping gear and our entire booth display—helter-skelter into our car in a mad rush and took off. (Many thanks to Don DeLong for all his help while I was panicking.) Once we were on the road, I called Karen and had her call Shay on the two-meter ham radio.

Since a number of the people in our large rural area are amateur radio operators (hams), we have a two-meter ham radio set to a neighborhood frequency. This radio is always on. (For any hams passing by, it is 146.400 simplex.) Although Shay is not a ham, when lives or property are in danger, anyone may use ham frequencies.

It turned out that our neighbor had made it into the canyon with a sheriff escort to get his dogs. He was at our house when Karen called on the radio. We made plans for our house sitter to leave and take our dog to our friend Dave’s house and drop her there.

Decisions, Decisions

Our cell phone signal kept dropping away as we sped along the highway toward home. I requested our neighbor’s cell number from Karen, and called and left a message for him. He called and had to leave a message for me since we were in dark territory by then. We finally connected. He was on his way back to the creek and asked what we wanted saved from our house. I will tell you now—that is a knock-you-on-your-butt question. We had to think fast.

We told him where our important papers were. All in one place, ready to go. (I did learn something from the Salmon River fires in 1987.) The main computer in the office was next. Then what? What was absolutely irreplaceable? I told him, “All of the watercolors by my friend, Sarah. They’re in almost every room.” I didn’t want to make too big a list since he was also going to save his own irreplaceable possessions. What a wonderful neighbor to think of us.

I couldn’t help wondering, what if everything burns up? Well, we had been camping at the fairgrounds in John Day. In the car with us, we had our tent, sleeping bags, favorite pillows, four days’ worth of clothes, some solar lanterns,

wallet, purse, camera, and all the accoutrements to make coffee in the morning. My dog-daughter, Emma, was safe with "Uncle Dave." I started to cheer up.

Home at Last

We knew we wouldn't get by the roadblock on the main road, so we came in on the back road. We rounded a corner and could see the lake and the fire burning on the other side of a small inlet. A very big helicopter was hovering low, dipping its water bucket into the lake. On our side of the water, a man crouched by his pickup, camera in hand. We saw the official emblem on the door of the truck. When we drove by, he turned towards us and raised his hand as if to stop us. We smiled and waved, treating it as just a friendly gesture, while we drove by without slowing down. We didn't want to be stopped.

When we reached the house, Bob-O put the box scraper on the tractor and positioned it to dig a fire line around the house. We laid out water hoses in strategic places. I took a few things from our car and replaced them with things I thought more important.

We listened to our scanner for the rest of that day and the next day. The firefighters gained control of the fire. Although the fire did not come close to our house, it did come very close to our only exit road. We did not know till two days later that Bob-O's son, Allen, was working with his hotshot crew on the fire. He took a break from mopping up and came to check on us. What a great kid.

So life goes on at our little ranchette. Bob-O is fond of saying, "You know, people see our names in that glossy magazine and they think our lives are so glamorous." Of course he says this when we are knee- or elbow-deep in some hard, dirty job. I have to say, humor gets us through a lot here in our wild paradise.

Access

Kathleen Jarschke-Schultze is making wine and mead from her grapes and honey at her home in northernmost California. c/o Home Power magazine, PO Box 520, Ashland, OR 97520 • kathleen.jarschke-schultze@homepower.com





Make every day special
The natural ingredients of our products
get their energy from the sun



simmonsnaturals.com

Off the grid since 1980 42295 Hwy. 36, Bridgeville, Ca 95526

ALTERNATIVE POWER EMERGENCY KIT NEW



Freeplay Ranger
Wind Up Radio
AM/FM with Built-in
Solar Panel



Freeplay Sherpa
Wind Up Flashlight
with Dual Intensity Xenon bulb

FREE

Catalog #15



both for only
\$79⁹⁵

FREE
US Ground Shipping
On Orders Over \$25

800-522-8863 • ccrane.com



Innovation. It's what our cookers have been famous for since 1854.

Now you can enjoy all the renowned cooking capabilities of an ESSE range cooker, and at the same time experience the warmth and visual feast of a log burning stove. It is the perfect heating and cooking solution for cottages, chalets and log cabins or for those who want a kitchen with a difference.

Conventional it is not, appealing and versatile we think so. *Call Lucky Distributing today and find out how you can become an exclusive, authorized dealer.*



Lucky Distributing
Toll Free: 1800-777-5526
www.ouzledale.co.uk

Renewable Energy Basics on CD-ROM

A collection of the best basics
articles from 15 years of
Home Power magazine.



- Visit our online store to view a complete table of contents for *Solar1*.
- All contents are in PDF, featuring original magazine layouts as published.
- Get this or any *Home Power* CD-ROM for \$19 with your one-year subscription.

Order by phone at 800-707-6585 or 541-512-0201
or online at www.homepower.com



What are you waiting for?

Solar9, the latest addition to *Home Power*'s CD-ROM archive, features six full, as-published, back issues in simple, searchable Portable Document Format (PDF). Contents include: Issues 95 to 100 (6/03 – 5/04); our new renewable energy glossary; wind & solar resource data; and more. Green means go.

\$29 (plus shipping)

www.homepower.com
phone 800.707.6585 or 541.512.0201

Intentional Communities



Dedicated to communicating the experience and wisdom of intentional community.

We've been at it for 30 years, and nobody covers the world of community like *Communities* magazine.

1 year subscription \$20 (\$24 Canada)
Sample issue \$6 (\$8)

800-462-8240 fic.ic.org/cmag

MALLARD WIND GENERATORS

Economical, Strong, & Very Reliable

**MALLARD
600E**



SALE

600 Watt
\$369
Regular price
\$450

800 Watt
\$389
Regular price
\$475

We also have charge regulators, tower kits & plans, PMAs, blades, and lots of friendly advice & customer support.

Mike's Windmill Shop

www.mikeswindmillshop.com • 928-532-1607
Major Credit Cards Accepted • Call for Volume Pricing

sunelec.com

*Clearance on
Solar Modules & Laminates*

phone 305 536-9917 • fax 305 371-2353

johnkimball@sunelec.com

Miami, Florida U.S.A.

SoL

 is "Solar-on-Line"
*Internet-based Distance Courses
with practical skills workshops*

Internet-based distance courses year-round
Practical skills workshops offered in the US and Mexico
Visit the Solar-On-Line website for schedule and details

**For current schedule
of On-line Courses & Workshops
Click on SoL www.solar-on-line.org**

E-mail: SoL@SoLEnergy.org • Phone/Fax: 720-489-3798

See Happenings in this issue for the 2004 schedule of courses.

Do You Need Batteries?...

RAE Storage Battery Company

Since 1943... Quality & Service

**Surrette Solar 1, 400 Series,
Type CH 375 - L16**

Engineered under careful guidelines
by Dave Surrette - Family owned
business Est. 1935

Gambissara Solar for export

212-206-6344 • 1201 Broadway,
Room 809, New York, NY 10001

**Newly established factory
warehouse. U.S. Battery Co.
Corona, CA**



Phone 860-828-6007
Fax 860-828-4540
51 Deming Rd., POB 8005,
Berlin, CT 06037

Energy Payback

Dear *Home Power*, I want to thank you for the work you've done in your first 100 issues. It was you people who first got us into renewable energy more than five years ago, and now we produce more than 95 percent of our home's electricity from the wind and sun. "RE Myths Debunked" in *HP100* was just the ammunition I've been looking for—great article. There is one item that I think was overlooked in that article, and in others before it. Under, "Myth: It takes more energy to build PVs than they can ever produce," we've all been missing the central point. As a society, we've been living with and using electricity for generations now, so it isn't going away. The question facing us is simply, "What is the best way to produce it?" The argument that PVs don't earn back the energy used to produce them is not only wrong, it's pointless. What we should be doing is comparing PVs to traditional generating devices.

Suppose you could build a highly efficient, natural gas-fired electrical generator using less than half the embodied energy that it takes to build a PV panel with similar output—how long would it take for the natural gas generator to recoup its embodied energy? The answer—it never would. This is because the natural gas generator must be fed fossil fuel for the rest of its life to produce electricity, at an efficiency rate of less than 100 percent, I might add. It is not an energy-producing device at all; rather, it is an energy conversion device. So even if a PV had an average lifespan of 30 years, but took 40 years to earn back its "embodied energy" (it really only takes two to four years), it would still be better for us ecologically than any of our traditional energy sources anyway. Something to think about. Sincerely, Rudy Ruterbusch, Elberta, Michigan • randolph.ruterbusch@united.com

Grid-Connect Quandary

I wonder if anyone has successfully disconnected a Sunny Boy 2500 from the grid and been able to sync it with a portable generator or car inverter? This might allow me to run major appliances during the day if our utility craps out again. Any thoughts would be appreciated. Thanks, Richard Katz, San Francisco, California • richard@katznip.com

Hi Richard. I have a friend who has Sunny Boys. He has a small battery bank and an OutBack inverter too. When the grid goes down, the OutBack is running and the Sunny Boys sync with it. He takes advantage of the combined availability of both inverters to power his home, and regulates the battery voltage with a voltage-controlled switch that shuts off the OutBack-to-Sunny Boy connection so that the array does not charge the batteries via the Outback's AC charger.

But I doubt if the Sunny Boy would synch to anything but the best of generators, because the voltage and frequency are probably not steady enough. Most "car inverters" are not high quality enough to do this job. Most of them are not even true sine wave. Michael Welch • michael.welch@homepower.com

Hydronic Heating or SDHW?

Hello *HP* crew, I'm writing to get an unbiased (that is, not trying to sell me anything) opinion about how I might proceed with my solar energy systems. I've been reading your magazine and dreaming about having a PV system for more than ten years. I've recently been given a 2 KW PV system by my utility. (I plan to write an article about it in the near future.) It consists of twelve Sharp 165 W panels connected in two series strings to a Sunny Boy 1800U inverter. It is located on a southeast-facing roof. I'm not sure if you can tell from the picture, but I've got enough room for another row (1 KW) of panels. I plan to install them sometime in the future. I'm going to cut the chimney down to roof height to eliminate shading concerns. I'm not using it, since my furnace and water heater vent out the side of the house.



I also want to use a solar-powered water heating system. I have room for one or two systems on the roof below the future third row of PV. My question is whether or not I should install a hydronic heating system. My main floor has existing hardwood and tile surfaces. The system would have to be installed between the floor joists in the basement. I've read that higher temps are required for this type of installation, and I'm not sure if it's feasible with the space I'd have for collectors. I currently have a high efficiency (95%) gas furnace for heating and a gas Tagaki demand water heater, so would just filling the roof with PV make more sense? My gut feeling is that a solar collector for hot water would be a good idea—it might require two collectors, since the roof is facing southeast. Maybe it's best in my case not to go for the hydronic heating system. What do you folks think? Thank you, John Lentz • jlentz@sprintmail.com

Hi John, Although your home's size and "tightness" (resistance to air infiltration), and the cost of gas in your area might have some bearing on an answer to your question, they are probably inconsequential in this situation. The home size might be too large and roof area too small to consider extra

collectors for space heating. From an economic standpoint, the local price of natural gas will affect the payback on any heating investment. Economically, a 95 percent efficient, natural gas furnace is a tough heating system to beat when you consider the costs of both the solar heating system and the retrofit of a radiant floor. Your situation makes "go with your gut" right on. Keep your existing furnace and install a collector or two for domestic solar hot water heating. Good luck, Chuck Marken • chuck.marken@homepower.com

Displacing Gas Usage

Richard, Awhile back we exchanged a couple of e-mails in which we discussed the fact that being grid-tied, and with my PV system's production in balance with my usage, I really had no more motivation to replace electrical items or conserve electricity just to lower my consumption. In fact, I was trying to increase my load.

I just finished my third year tied to the grid and once again I had a monetary surplus of nearly US\$150 on my PG&E account. Total shortage and surplus for three years is 1,000 KWH shortage off-peak and a 2,780 KWH credit on-peak. We have been extremely pleased. But we still wanted to get more benefit out of that time-of-use (TOU) credit. We vary our lifestyle a little bit to get it. But we still didn't want to be wasteful just to use it.

Recently, I acquired a solution. I bought a '97 Solectria Force that was available at a good price. In less than a week of charging, the car has increased my KWH total by almost 100. The car has also replaced my daughter's Suburban and my Audi for about 100 miles of short, around-town trips.

In the total scheme of things, I think this is a good move, but I hate watching the KWH climb. What do you think? Mike, Vacaville, California • quilters@cwnet.com

Hello Mike, I think that this is a great move. Not only are you using your PG&E surplus, you are displacing gasoline use while you do it! I salute you! Richard Perez • richard.perez@homepower.com

NiMH Batteries

Hello, I really enjoy your magazine. I have a question about batteries for energy storage. Your articles all feature the use of lead-acid batteries. These have several limitations, especially when deep cycled. Have nickel metal-hydride (NiMH) batteries been tried for this purpose? They seem to work quite well in cell phones and hybrid cars where they are deep cycled all the time. Henry Tunis, Sunnyvale, California • yellowpine@earthlink.net

Hello Henry, The problems with a big NiMH battery are cost and availability. Most of the larger cells (30 AH and up) are being used in hybrid-electric vehicles and are very expensive. You are correct though, NiMH would be a great technology for RE systems. Richard Perez • richard.perez@homepower.com

Nuclear Waste

Michael Welch ("Nuke Waste in the Courts," HP103) refers to the Yucca Mountain Project being paid for by tax dollars. This is incorrect. In 1982, Congress created the Nuclear Waste Fund, so that customers who use nuclear

power would pay for the disposal of spent fuel. Utilities pay into a federal government fund one-tenth of a cent for every kilowatt-hour of electricity generated using nuclear power (appropriations do pay for the share of nuclear waste from defense-related activities). The U.S. Department of Energy's (DOE) nuclear waste management program, including the Yucca Mountain Project, is paid for entirely by the fund and the defense appropriations. The *quid pro quo* for the nuclear utilities, by the way, was that the DOE would begin accepting spent fuel in 1998 for interim storage until the repository opens; this has not happened. William Bailey, Oakton, Virginia • wbailey3@cox.net

Hi William, What you say is true, and I appreciate your scrutiny so we can correct the way I misstated the situation. The Nuclear Waste Fund was established to pay for a high-level nuclear waste storage, and the money does come from nuclear power ratepayers through their utility bills. As you mention, defense appropriations also go into the fund, and those come directly from tax dollars. But there are problems with the fund and project that many believe will eventually call for tax dollar appropriations for the nuke dump.

First, the cost overruns are going to be huge. As you say, it was assumed that some storage facility would be usable by 1998. Since it was not, and costs continue to mount, there is no way the fund will be able to provide all the money needed. Because the fund is set to a fixed amount of money per KWH, the collectable money for the fund is losing value relative to potential construction costs. This translates to the per-KWH fee losing about 50 percent of its value since 1982.

Further, the government still wants to build interim fuel-storage facilities. If built, the money for those facilities will also likely come from the Nuclear Waste Fund, which means less money available for a long-term repository. And once the nuke plants begin shutting down from old age, money stops being collected. (This will be a problem even if there is enough fund money to build a repository, because post-construction upkeep is going to be quite expensive.)

If you look at the current administration's predictions regarding the adequacy of the Nuclear Waste Fund, you will see a rosy picture painted. But I am of the opinion that the cost overruns on this project will greatly outstrip the available funds—historically that's the way this entire industry has worked. Who do you think will pay for that? Not the nuclear utility shareholders, that's for sure. Finally, there is merely a fine line between the federal government's forced collection of extra money from ratepayers and terming that money a "tax." Michael Welch • michael.welch@homepower.com

Net Metering Safety

I recently ordered Home Power for my parents. My stepfather mentioned that sending electricity from a consumer's PV system to the grid could be dangerous. He said, in effect, that workers might be electrocuted when lines were being repaired. He also said that the electricity could be switched off by the company, but not by the consumer, whose system is feeding electricity to the grid. Can you explain this problem? Thanks. Michael Cleereman • everyhuman2012@yahoo.com

Hello Michael, All inverters that are certified for utility-intertie use will shut off within 34 milliseconds of utility grid failure. The linemen are safe. See Joe Schwartz's excellent article on this topic in HP71. Richard Perez • richard.perez@homepower.com

Whisper 175 Experience

Dear Mr. Woofenden, You may have read some of my postings on the AWEA e-mail list. I am familiar with your articles on wind energy in *Home Power*. I installed my Whisper 175 under the California Energy Commission's buydown program back in August 2002. In the first nine months of service, it suffered three breakdowns. The last breakdown in May 2003 required seven months of repair in the Southwest Windpower factory. The furling mechanism was the main problem, but other problems like the yaw shaft bearings and the wrong spindle shaft also were an issue. When I tried to fly my 175 again on March 28, 2004, the factory had not tested their new furling mechanism design. Subsequently, that and a blade balance problem have prevented me from re-flying the unit.

It has been more than a year since I have generated any electricity with my 175. Complaints to the California Energy Commission have yielded few results. I have been e-mailed by other 175 owners with similar problems, but the energy commission has labeled my problem an "isolated case." The problems with the 175 are not a secret. But few people are willing to speak out and merely tell the truth like Real Goods did in their summer 2004 catalog. On page 74, they stated that the 175 is not recommended for sites with rapidly shifting winds or high winds. If I had known that originally, I may have chosen another wind turbine.

I can document everything I have told you and can elaborate on many other problems I have had. I realize that Southwest Windpower (SWWP) has been an advertiser in *Home Power* for many years. But I have always found your articles to be truthful even if the truth hurts. I have enjoyed Mick Sagrillo's "Apples & Oranges" articles very much. I am currently waiting for SWWP to send me a bladeplate so I can get my wind generator back together. I have been waiting a long time. They told me more than three weeks ago that the bladeplate was waiting to be plated. I just want to start recouping some of my investment. I look forward to your response. Sincerely, Ken Schnauffer • www.kndkatz.com

Hi Ken, Thanks for your letter. Sharing real-world experiences with other HP readers is very useful. I need to say up front that of the renewable energy resources, wind energy is the most difficult to tap. I urge everyone I speak with about wind energy to invest in rugged equipment for the long term, and install the turbine on a tall tower. Even when you do everything right, things can go wrong.

It's a tough job making high-quality wind generators. This is partly because consumers generally seem to want equipment to be inexpensive. Second-time wind generator buyers generally don't care about the price as much. They want dependability more than low cost.

Yes, we've heard that the Whisper 175 has had its troubles. But every wind generator manufacturer I know of has had

trouble at one time or another with their machines. I offered Andy Kruse, co-owner of Southwest Windpower, the chance to respond to your letter—see below. Regards, Ian Woofenden • ian.woofenden@homepower.com

Hi Ken, Everything that could go wrong with your repair has gone wrong. Your repair was caught in the middle of the transition of moving the Whisper product line from Duluth, Minnesota, to Flagstaff, Arizona. Subassemblies were outsourced to various vendors around the country, which required design changes to improve the machine's manufacturability.

Though your machine was always a top priority, the entire production line was down for as much as a year. This included new orders as well. Our manufacturing department gave our sales department reports about every three months that production would be back up, and this information was relayed to you and the other customers on the waiting list. Though we were finally able repair your machine in May, all the bugs were not worked out of the new design. This was discussed on the AWEA wind home e-mail list in great detail.

A list of changes SWWP has made to the Whisper 175 follows:

- Changing the rotor spindle from a two-bearing design to a three-bearing design. This minimized warpage of the rotor can during operation. Warpage caused the magnets to come in contact with the stator, which was very bad.
- New yaw shaft. A major problem was the machine snapping off at the yaw. We increased the diameter by a factor of two.
- Blade straps. The centrifugal force of the machine caused the blades to naturally pull outward. From time to time, the bolts would shear, causing a blade to fly off. Blade straps connected the bolts from both blades, canceling out the effect.
- Tail straps. We put new straps on the tail to keep the tabs that hold the tail on from vibrating and breaking off.
- New tower insert. The original design used six bolts to hold the entire weight of the wind turbine in the tower. Over time, the bolts would shear and drop to the top of the tower. The new design has a lip on the tower insert so all weight is supported on the weight of the insert.
- Return spring. At times the return-assist spring would get hung up on a tab, causing the turbine to get stuck in furl. We incorporated a spindle in the middle of the spring, which kept it straight and prevented it from bending and getting caught.
- Furl bolt. The furling device had a small-diameter bolt. The small radius caused the bolt to wear prematurely in high winds. We doubled the size of the bolt. The furl-pin ears were also thickened to increase wear surface.
- New paint. We're using a more corrosive-resistant paint. Although we do not recommend using the 175 in marine environments, we wanted to make sure it will last even if it is.
- Update the electronics. We took the advice of some engineers at NREL to make some repairs to the controller to make it more reliable.

We then introduced the machine to the market—it has done very well. We did miss a couple of things, which included:

- Strengthen the root section of the blade.
- Redesign of the redesigned tower insert. Now it is made of a large aluminum billet.

If you continue to have problems, we will simply replace the machine. In July of this year, the production line for the machine finally went back into operation. As I said in the beginning, everything that could go wrong with the 175 transition went wrong. We are deeply sorry for the delays, and we hope that your machine will now give you years of trouble-free operation. Andy Kruse • andy@windenergy.com

Choosing System Components

I am in the design stage of creating a new garage workshop and office addition to my existing log home. The current garage space, which was built before the house was by the previous owner, is not big enough to house the six work and storage areas that I need. It is definitely not solar friendly, and is extremely cold in the winter months. The building I am considering will have work areas for three vehicles, a tractor and several attachments, a 24-foot trailer, a complete woodworking workshop, a crafts area for "le boss," a small bakery (bakery for making dog and horse treats), and an office area for trading the stock market. Natural light will be allowed in through a "steeple of windows" at the uppermost part of the structure. The building will be situated so that the backside will face due east and the front will face due west. The north side will join the existing house. Since there are very few trees on the property, the building will have an open window to the sun from 9 AM until sunset.

I want to incorporate renewable energy into my plans, including solar-electric generation and solar hot water heating for the domestic water supply, the building's floor heating, and snow melting. Is there a listing somewhere that compares solar panels by size, power generation, cost per panel, and cost per power generated? Also, I'm looking for comparison information for which batteries to use in the system. Can you direct me to this information? Sincerely, Pat Cipollone • pat_j.cipollone@fuse.net

Hi Pat. When it comes to choosing solar panels, your installer will have his or her own preferences. Although I know of no listing that compares all the solar panels on the market, in general they all perform well; only marginal differences exist in price-per-watt, so select your modules based on personal preference, and consider their ease of installation.

For battery choice, personal preference also comes into play. But cost becomes a factor as you decide how long you want your battery bank to last. You will get a lot more deep cycles out of an industrial battery than you will with some of the more common batteries in use. Many folks choose L-16 type of batteries because they fall somewhere in the middle of cost versus cycles. My personal preference is to buy the best battery I can afford, because once I lift the batteries around and get them into place, I don't want to do it again for a long time. Again, your installer should help you through some of these choices.

One way to make your installation cheaper, and better looking, is to orient at least some of your roof so that it faces

south, and design it with a slope that will allow you to do the installation with standoffs instead of using longer legs on the top of the arrays. Since you're in the design stage, this may be the most critical thing to look at for now. Michael Welch • michael.welch@homepower.com

Washing Machine with Suds Saver

Hello Linda, I am a subscriber to *Home Power* and just finished reading your article about washing machines. My washing machine is also ready to retire. I am looking for a feature that I grew up with called "suds saver," where the rinse water drains into a tub and can then be used for the next load of wash. Have you run across any washing machines with this feature? I think Kenmore used to make them, but I could be wrong. My parents read the article too. They live on a farm and currently have ten horses, dogs, cats, and four children—sounds like they need a Maytag Neptune. Mom said that years ago it was impossible to get a washing machine *without* a suds saver. Best wishes, Jo Marie • jomarie@redjellyfish.net

Hi Jo Marie, I've never heard of a machine with this feature, but it sounds good. For my place, the plan is to put in a greywater system for the washing machine so that the water can be reused for plants. The amount of water used in the Neptune is noticeably less, however, than the former machine, and it uses less detergent. Thanks for writing, and if any of our readers know more about the suds saver, I hope they'll write us. Best, Linda Pinkham • linda.pinkham@homepower.com

Hi Jo Marie, My mom's washing machine had that feature. It was a great one, and saved both water and energy. Our washer was next to a deep tub, and the washer had one hose that hooked over the tub edge and went down to the bottom. Another tube from the washer was hollow, yet was designed to plug straight into the tub drain and keep water from exiting the tub, thus allowing the first hose to fill and suck from the tub. The washer would fill from the water heater, and the soapy water would drain afterwards through the tube that went to the tub drain. But after the rinse cycle, that water would fill the tub via the other hose, and get sucked back out again during the wash cycle for the next load. Thus, only the first wash cycle and all the rinse cycles would come from the water heater. Michael Welch • michael.welch@homepower.com

Too Good to Waste

Dear *Home Power*, I heard Richard Perez on the *Coast to Coast AM* radio show recently. I enjoyed hearing Art Bell's enthusiasm for some of the things discussed. It seems to me that Mr. Bell must have an impressive RE setup, yet I still heard some ideas from Mr. Perez to make it better. Mr. Perez, and all of your staff, keep up the good work.

My dream is still to have solar electricity. I've built a compact, well-insulated, Energy Star appliances-equipped, solar-oriented electric home, with woodstove backup. I want to build a solar-powered backup generator to power the freezer and the refrigerator during a utility failure.

I found in your archive a few issues that may provide the information I need to get started. I'm off now to find them on the CDs I received when I first subscribed to *HP*. I'm no engineer, and my brain begins to melt when I read some

of the diagrams you provide, but now more than ever for me, it's time to get busy and do it. Mississippi sunshine is too good to waste! Claire Calhoun, Mt. Olive, Mississippi • claire22@bellsouth.net

Thai Biodiesel

I just picked up *HP103* and the first article I turned to was Lizzy Scully's "Wanted: Cleaner & Greener Wheels." I was very interested in this article since I just returned from Thailand and saw the push for biodiesel going on there. While in Thailand, when I purchased a new car for my wife, I chose a Honda Jazz with a diesel engine to support this effort.

This small Asian country's government is pushing hard for energy conservation. One of the major moves is toward biodiesel—mostly based on coconut and palm oils. Because Thailand is a major production base in Southeast Asia for automobiles, the Thai government is trying to encourage its manufacturers to adapt engines that can be powered by either biodiesel or gasohol to replace fossil fuels. Also Thai energy officials have held talks with officials from China, Japan, and Korea to persuade them to promote more crop-based fuels. (By the way, the Pacific Ethanol & Biodiesel Conference & Expo II is being held in Bangkok, Thailand. For complete conference details, see "RE Happenings" in this issue.)

Among the other energy conservation moves in Thailand that I noticed was how incandescent lightbulbs are almost impossible to buy. Everything for home lighting is compact fluorescent. The city of Bangkok is trying to close the night markets early to save electricity. The Thai version of The Home Depot carries solar water heaters, small hydropower systems, and even small PV systems. It just amazes (and embarrasses) me that a small country with such limited funds can achieve so much, while a nation like the United States seems utterly helpless to kick our petroleum habit.

But then there is also the Thai mind-set. While helping my wife wash dishes at our new home, I left the water running. She quickly reminded me to turn the water off. I did and explained that in the United States, water is cheap and I just forgot. She told me that in Thailand, water is also cheap and abundant, but that was no reason to waste it. How many Westerners have that attitude?

Thank you for the only magazine I read from cover to cover. And I am now a proud subscriber. The guilty feeling of downloading the free issues from the Web just got to be too much for me. Tony Colonello • kwainoi@isp.com

Hi Tony, Thanks for the great letter. I recently heard that because of its fat content, coconut oil is now rarely being used in foods in the West, something that has caused the coconut market to plummet. Biodiesel production seems like a natural for that industry—Go Thais! Michael Welch • michael.welch@homepower.com

Washer Woes

Joe, I purchased a Frigidaire Gallery washing machine based on the recommendation in *HP103*. However, this washing machine won't run on the Trace 2500 Series inverter I've been running for years in my off-grid home. When running on the inverter, the washing machine motor

heats up and shuts down due to overtemperature. The Frigidaire repairman said that the washing machine will not run properly on the inverter's modified square wave AC output. Now I'm stuck with a US\$700 washing machine I can't use. John Kirk, Bonners Ferry, Idaho

Hello John, Sorry to hear about the compatibility issue between your inverter and the washing machine. We didn't run the Frigidaire Gallery on a modified square wave inverter as part of the review. We rarely test appliances on modified square wave inverters these days, as fewer and fewer people are using them. Home Power has been educating our readers about the advantages of sine wave inverters, and steering them away from modified square wave inverters for more than ten years. Complaints about appliances that will not run on modified square wave inverters have been increasing over the years. This is typically due to appliance designs becoming more advanced and more efficient. Instead of getting a new washing machine, think about getting a new sine wave inverter. Best, Joe Schwartz • joe.schwartz@homepower.com

U.S. PV Module Shortage

Dear Mr. Welch, Being a reader of *Home Power* for about two years, it was interesting for me to hear about the situation of solar electricity in Germany from an U.S. perspective (see "Power Politics," *HP103*). I share most of your views, but would like to add a few remarks. Under Germany's incentive system, payments for solar electricity are guaranteed by law for a period of twenty years, plus the year in which the PV array was first intertied with the grid. The decrease of 5 percent each year applies only to new PV arrays. So the electricity from a PV array installed in 2005 will be sold for 5 percent less than the electricity from a PV array installed this year.

In Germany, the greatest amount of electricity I've ever heard of being generated by a PV array is about 1,100 KWH per year per 1 KWp—this is generally considered to be a very good result. Under the conditions of the German Erneuerbare-Energien-Gesetz (renewable energy act), it makes sense to sell the generated solar electricity completely to the grid, so there is no extra saving on the utility bill.

The recent improvement of the rate-based incentives you refer to in your article equals the amount of subsidies provided by the former 100,000-Dächer-Programm (100,000 Roofs Program), a loan program. My family has undertaken the extremely bureaucratic process of receiving such a loan three times, and we are glad that this program has been stopped and replaced by the improved rate-based incentives. There have been remarkable improvements in the German energy policy in the last years, especially as far as renewable energy is concerned. But the companies dealing with fossil fuels and nuclear energy still dominate the market and make the government act on their behalf. As the share of renewable energy grows, the lobbying and propaganda against renewable energy is expected to sharpen as well.

Perhaps it would be interesting for you (in case you haven't already heard) to take a brief look at the history

of grid-intertied PV in Germany. First, there were local groups of solar activists who managed to persuade several city councils to require municipally owned utilities to pay for grid-intertied PV. This system was very successful and was finally introduced on the federal level by the present government, formed by the Social Democrats and the Green Party. Yours sincerely, Kilian Becker, Wegscheid, Germany • kilian.becker@avantis.pa.shuttle.de

Hi Kilian, Thanks so much for writing. It is great to hear from our German readers and friends. Your descriptions are appreciated, especially the things that did not get uncovered in my own research, like about the 100,000 Roofs Program. Sounds like yours was a path similar to ours, but now has better results because of higher incentives and greater government interest.

We in the United States started out with more local programs (state by state, mostly) too, and worked hard to get intertie rights, even going to the point of promoting guerrilla solar to help win the fight. We are not done yet. I suppose that some day we might have a nationwide net billing law, but that remains to be seen.

We would love to print articles in our magazine on some typical German systems, maybe even including how the German laws came about. Is there any chance that you or someone you know might be interested in writing for us? I know our readers would be interested.
Michael Welch • michael.welch@homepower.com

From left: Dandelion, Claire, and Shawn.



Courtesy Michael Shoppen/mshoppen@yahoo.com

The Ever-Expanding Home Power Crew

Like the rest of the renewable energy movement, Home Power is growing. I'm happy to announce that Claire Anderson and Dave Emrich both recently joined the HP crew.

We caught up with Claire on the West Coast leg of a 10-month, cross-country, freelance writing journey in her Ford pickup that runs on waste vegetable oil. Claire was the managing editor for Mother Earth News magazine, and also worked as a program coordinator at the Real Goods Solar Living Institute. She has a master of science degree in sustainable systems—a program that provided her with a wide-angle, holistic perspective on agriculture, building, and energy. She is an accomplished editor and will be wordsmithing with the HP editorial crew. I can't resist mentioning that by the time this issue of HP has hit the streets, Claire and her partner Shawn Schreiner will be proud, first-time parents. Girl or boy? Stay tuned...



Courtesy Margot Franklin

Dave on his bike, ready to roll.

With a bachelor's degree in graphic design from the University of Oregon, Dave Emrich has ten years of graphic design experience, and is working with Art Director Ben Root on Home Power article layouts and schematics. A few years back, in an environmental move that many of us only wish we could actually make, Dave gave away his car. Since then, Dave has logged thousands of miles on his bike—pedaling to where he needs to be, while taking in an iPod earful of reggae.

Welcome to the crew, Claire and Dave—we're psyched to have you on board!

—Joe Schwartz, for the whole HP crew



*Send your letters to
Home Power magazine at
letters@homepower.com or
PO Box 520, Ashland, OR 97520*

INTERNATIONAL

Solar On-Line (SóL); Internet courses on PV, green building & international development. SóL, PO Box 217, Carbondale, CO 81623 • 720-489-3798 • info@solenergy.org • www.solenergy.org

Solar Energy International online; Internet courses on PV Design & Solar Home Design • see SEI in Colorado listings.

BELIZE

Dec. 6–10, '04; Basic PV; Toledo District. Hands-on workshop with lectures, labs & installs • hareef99@yahoo.com • www.thefarm.org/etc/belizesolar2004.html

BRAZIL

Feb. 15–17, '05; Latin America RE Fair; Rio de Janeiro. For RE businesses in Latin America—in conjunction with RIO 5 World Climate & Energy Event • RIO 5–LAREF Organization, a/c PML, Av. Rio Branco, 25/18° andar, 20093-900 Rio de Janeiro, RJ, Brazil • (+55-21)-2233-5184 • info@rio5.com • www.rio5.com

CANADA

Alberta Sustainable Home/Office; Calgary. Open last Sat. every month 1–4 PM, private tours available. Cold-climate, conservation, RE, efficiency, etc. 9211 Scurfield Dr. NW, Calgary, AB T3L 1V9 • 403-239-1882 • jdo@ecobuildings.net • www.ecobuildings.net

COSTA RICA

Feb. 21–27, '05; Homebuilt Wind Generators workshop; Fundacion Durika, Costa Rica. Build wind generators from scratch • Solar Energy International, PO Box 715, Carbondale, CO 81623 • 970-963-8855 • sei@solarenergy.org • www.solarenergy.org • Coordinator: Ian Woofenden • 360-293-7448 • ian.woofenden@homepower.com

Mar. 7–13, '05; RE for the Developing World: Hands On; Rancho Mastatal, Costa Rica. Solar electricity, hot water & cooking; biogas & other RE technologies • Solar Energy International (see above).

GERMANY

Jan. 26–27, '05; Clean Energy Power 2005; Berlin. Consumer & trade fair for RE, alternative mobility & energy efficiency • www.energiemessen.de

Feb. 25–27, '05; Erneuerbare Energien 2005; Böblingen. Consumer & trade fair for RE; Energy-efficient building & reconstruction • www.erneuerbareenergien.com

Mar. 16–18, '05; ENEX–New Energy 2005; Polen. RE trade & consumer fair • www.enex-expo.com

ITALY

May 5, '05; SolarExpo; Vicenza. Int'l. Conf. & Exhibition on RE, distributed generation & green building • Chiara Borsato • +39 0439 849 855 • press@solarexpo.com • www.solarexpo.com

NICARAGUA

Jan. 3–14, '05 (again Jul. 31–Aug. 11); Solar Cultural Course; Managua. Lectures, field experience & ecotourism • Richard Komp • 207-497-2204 • sunwatt@juno.com • www.grupofenix.org

SOUTH AFRICA

Apr. 18–22, '05; RE World Africa 2005; Midrand, Johannesburg • Conference, exhibition & energy fair • Christopher Raubenheimer • +27-11-463-2802 • chris.raubenheimer@terrapinn.co.za • www.powergenerationworld.com/2005/renew_ZA

THAILAND

Dec. 1–3, '04; Pacific Ethanol & Biodiesel Conference & Expo; Bangkok. Biofuel presentations, workshops, papers & exhibits • Wendy Vincent • +01.605.338.6829 • wendyv@thestrattongroup.com • www.pacificethanol.com

UNITED KINGDOM

Apr. 18–21, '05; Int. Power Sources Symposium & Exhibition; Brighton Corn Exchange. Storage of RE • Int. Power Sources Symposium • www.ipss.org.uk

U.S.A.

American Wind Energy Assoc.; Info about U.S. wind industry, membership, small turbine use & more. www.awea.org

Info on state & federal incentives for RE. North Carolina Solar Center, Box 7401 NCSU, Raleigh, NC 27695 • 919-515-5666 • www.dsireusa.org

Ask an Energy Expert; online or phone questions to specialists. Energy Efficiency & RE Network (EREN) • 800-363-3732 • www.eere.energy.gov

Stand-Alone PV Systems Web site; Design practices, PV safety, technical briefs, battery & inverter testing. Sandia Labs • www.sandia.gov/pv

ARIZONA

Dec. 17, '04–Jan. 3, '05; Christmas Campout; San Simon, AZ. Talks, demos, RE & homesteading skills, music, storytelling, day trips & vendors. All RE folks welcome. RSVP: Carla & Don Emery DeLong • 520-845-2288 or 520-678-2271 • doncarla@vtc.net • www.carlaemery.com

Apr. 23, '05; Tucson Solar Potluck; Catalina State Park, Tucson, AZ. Solar potluck. Bring solar oven &/or bring a dish. Music, food, PV demo, solar fountains & kids' activities • 520-885-7925

Scottsdale, AZ. Living with the Sun; free energy lectures, 3rd Thurs. each month, 7 PM, City of Scottsdale Urban Design Studio. Dan Aiello • 602-952-8192; or AZ Solar Center • www.azsolarcenter.org

CALIFORNIA

Apr. 23, '05; Sustainable Living & Arts & Music Festival; Humboldt State Univ., Arcata, CA. RE workshops and exhibits, RE-powered music • Associated Students, HSU, Arcata, CA 95521 • 707-826-4221 • hsuas@humboldt.edu

Arcata, CA. Campus Center for Appropriate Technology, Humboldt State Univ. Workshops & presentations on renewable & sustainable living. CCAT, HSU, Arcata, CA 95521 • 707-826-3551 • ccat@humboldt.edu • www.humboldt.edu/~ccat

Hopland, CA. Ongoing workshops, including beginning to advanced PV, wind, hydro, alternative fuels, green building techniques & more. Solar Living Institute, 13771 S. Hwy. 101, Hopland, CA 95449 • 707-744-2017 • sli@solarliving.org • www.solarliving.org

COLORADO

Carbondale, CO. SEI hands-on workshops & online distance courses on PV, solar pumping, wind power, microhydro, solar thermal, alternative fuels, green building & women's courses. Solar Energy International, PO Box 715, Carbondale, CO 81623 • 970-963-8855 • sei@solarenergy.org • www.solarenergy.org

FLORIDA

Mar. 12–13, '05; Green Living & Energy Expo; Coral Shores High School, Tavernier, FL. Environmental education, incl. workshops, vendors, panels & more on energy efficiency, RE & resource conservation • Cristina Lindley • 305-292-4501 • www.keysglee.com

ILLINOIS

Chicago, IL. Urban Enviro Living Workshops. 2nd & 4th Thurs. each month, 7 PM. Sustainability, energy efficiency & conservation, RE & green building • 312-842-8727 • hometown.aol.com/ecadvocate

IOWA

Prairiewoods & Cedar Rapids, IA. Iowa RE Assoc. meets 2nd Sat. every month at 9 AM. Call for changes. IRENEW, PO Box 3405, Iowa City, IA 52244 • 563-432-6551 • irenew@irenew.org • www.irenew.org

MICHIGAN

West Branch, MI. Intro to Solar, Wind & Hydro; 1st Fri. each month. System design & layout for homes or cabins • 989-685-3527 • gotter@m33access.com

NEW MEXICO

May 20–22, '05; 3rd Annual Adobe Conference of the Adobe Association of the Southwest; El Rito, NM. Celebrating the Work of Simone Swan. Cutting Hall Auditorium, Northern New Mexico Community College • Quentin Wilson • 877-806-2987 or 505-581-4156 • info@adobeasw.com • www.adobeasw.com

Feb.–Mar. & again Oct.–Nov. each year. Intro to Homemade Electricity; Deming, NM. Five Thurs. eves. Mimbres Valley Learning Center • 505-546-6556 ext. 103

NORTH CAROLINA

Saxapahaw, NC. How to Get Your Solar-Powered Home; Call for dates. Solar Village Institute, PO Box 14, Saxapahaw, NC 27340 • 336-376-9530 • info@solarvillage.com • www.solarvillage.com

OREGON

Cottage Grove, OR. Adv. Studies in Appropriate Tech.; 10 weeks, 14 interns per quarter. Aprovecho Research Center, 80574 Haxelton Rd., Cottage Grove, OR 97424 • 541-942-8198 • apro@efn.org • www.aprovecho.net

PENNSYLVANIA

Philadelphia, PA. Penn. Solar Energy Assoc. meeting info: PO Box 42400, Philadelphia, PA 19101 • 610-667-0412 • rose-bryant@erols.com

TEXAS

El Paso, TX. El Paso Solar Energy Assoc.; meets 1st Thurs. each month. EPSEA, PO Box 26384, El Paso, TX 79926 • 915-772-7657 • epsea@txses.org • www.epsea.org

Houston, TX. Houston RE Group: e-mail for meeting times: HREG • hreg04@txses.org • www.txses.org/hreg

WASHINGTON, DC

Dec. 6–7, '04; Renewable Energy in America—Phase II; Washington, DC. ACORE policy conference for developing & deploying RE • American Council On Renewable Energy • www.americanrenewables.org

WISCONSIN

MREA '05 workshops; Basic, Intermediate & Adv. RE; PV Site Auditor Certification Test; Veg. Oil & Biodiesel; Solar Water & Space Heating; Masonry Heaters Intro; Wind Site Assessor Training & more. MREA, 7558 Deer Rd., Custer, WI 54423 • 715-592-6595 • info@the-mrea.org • www.the-mrea.org



Send your renewable energy event info to happs@homepower.com

Missing Something?

Most *Home Power* back issues are still available!
 Prices vary. Complete set (68): \$150 + S&H.
 See our index of articles at www.homepower.com



Issue 103 Oct/Nov 2004

Pete Seeger Picks Solar • Microhydro Intro - Part 1 • Adobe Building Primer • RE Financing • Masonry Heaters • Washing Machine Spin-Off • And more!



Issue 102 Aug/Sep 2004

Solar- and Wind-Powered Green Businesses • How-to Load Analysis • Wind Basics • Small PV System • MPPT Basics • Toyota Prius • And more!



Issue 101 Jun/Jul 2004

Straw Bale Construction • Grid-Tie and Off-Grid Solar • Hybrid Vehicles • Solar Thermal Heating • Hydrogen Debate • Efficiency Ideas • And more!



Issue 100 Apr/May 2004

Wind & Solar Grid-tie • RE Myths Debunked • Solar Investment • Solar Hot Water History • Sun Science • Straw Bale Building • And more!



Issue 99 Feb/Mar 2004

Grid-tie Payback • Introduction to Green Building • Solar Hot Air 2 • Thermoelectric Power • Microhydro Expert Interview • Heating with Wood • And more!



Issue 98 Dec/Jan 2004

Pumps • Burma PV • Solar Hot Air • Solar Livestock Watering • Battery Finance • DC-to-DC Electricity • Women's PV Workshop • And more!

PDF back issues available for download at www.homepower.com
 Also available on CD-ROM.

Order online or call 800-707-6585 or 541-512-0201

SOLAR ROAST
 — SUN IN YOUR CUP —

ENJOY 100% EMISSIONS FREE ORGANIC COFFEE
 ROASTED WITH ONLY THE RAYS OF THE SUN

EVERY COFFEE BEAN IS ROASTED USING OUR CUSTOM-BUILT SOLAR DRUM ROASTER, POWERED BY PHOTOVOLTAICS AND HEATED WITH A 10-FOOT SOLAR CONCENTRATOR.

ITS COMBUSTION-FREE HEATING PRODUCES A SMOOTH, FULL FLAVOR, MAKING SOLAR ROAST THE BEST COFFEE UNDER THE SUN!

HELOS 12 SOLAR ROASTER

— ORDER ONLINE AT: —
WWW.SOLARROAST.COM

GREAT NORTHERN

Waking Up the Northland to Renewable Energy & Sustainable Living!

Bringing the finest in technology, equipment, and knowledge to the northern midwest.

Working to deploy Renewable Energy Systems since 1988.
 All major manufacturers equipment on hand.
 Educational opportunities available.

Great Northern Solar

SOLAR

Christopher LaForge,
 NABCEP Certified installer

ipp
 MEMBER

77480 Evergreen Road, Suite #1, Port Wing, WI 54865
 (715) 774-3374 • golar@cheqnet.net

A Clean and Quiet Revolution

Enjoy the freedom of driving electric. Join the EAA today and declare your independence from high gas prices and imported oil.



For more information visit us at <http://eaaev.org>

AC Propulsion tzero

ELECTRIC AUTO ASSOCIATION

Never Pay High Heating Bills Again!

"Buying a Classic Central Boiler is one of the best decisions I have made...my heat and hot water cost me zero. Since installing the boiler I saved between \$300 and \$400 per month..."

- Don P., CT

CLASSIC
Outdoor Wood Furnace

0 DOWN AND
0 PAYMENTS
FOR **1** YEAR



LIMITED TIME ONLY, OAC
at participating dealers



©2004 Central Boiler ad3277

800-248-4681 • centralboiler.com

Unsecured installment loans provided by EnerBank USA to homeowners who meet bank's qualifications. Loan terms vary from 24 months to 132 months based upon the amount of the loan. APR varies from 8.5% to 13.8% based upon the amount of the loan, the repayment term and creditworthiness of borrower as determined by bank. Interest rates are subject to change. Limited time offer. Deferred First Payment loan is available only through participating Central Boiler authorized dealers. EnerBank USA, 1245 E. Brickyard Rd., Suite 100, Salt Lake City, UT 84106.

ELECTRIC GORILLA



Clean
Silent
Powerful

See our new webpage about

SOLAR CHARGING
Electric Vehicles

Click on **SOLAR**

- Farm / Ranch / Parks
- Towing-Hauling-Work
- Stealth Security Patrols
- Getting Around **FUN**



650 lb load, 4000 lb. tow
No exhaust or heat
Knobby or road tires
24 and 36 volt versions
13 to 19 Mph top speeds
Built-in 110-volt charger



Anne Brooks of Brooks Solar

Proudly **Made in the U A**

5672 Littler Drive, Huntington Beach, CA 92649 USA
info@GorillaVehicles.com (714) 377-7776

See our website, or call for a brochure package.

www.GorillaVehicles.com

Fat Spaniel Technologies

Solar Monitoring Solutions

www.fatspaniel.com



Visualize
Renewable Energy™

2 W, Santa Clara St.
5th Floor
San Jose, CA 95113-1824
408-279-5262
sales@fatspaniel.com

EXPORTING 1,427 W



Aug 5 @ 10:58 AM

BATTERY BOX VENTILATOR & BACK DRAFT DAMPER

- Positive hydrogen venting
- Stops back drafts
- Minimal power consumption

* Available from dealers and distributors
across the U.S. and Canada



POWER VENT
12v & 24v - \$79
48v - \$104
+ \$10 S&H (cont. U.S.)

Zephyr Industries, Inc.
POB 52, Salida, CO 81201
719.530.0718
www.zephyrvent.com

**THE
POWER
VENT**

**www.
homepower
.com**

Meridian
energy systems, inc.

Design ~ Sales ~ Installation ~ Service



Austin, Texas

WWW.MERIDIANSOLAR.COM

1-877-477-3050

Solar-Electric Cooking

Richard Perez

©2004 Richard Perez

Energy-intensive thermal jobs, such as cooking, heating domestic hot water, and space heating, are generally not done with solar electricity. These jobs are usually done with direct solar heat, propane, natural gas, or wood. But this is not always the case. In the decades that I've lived off-grid, I've found that solar electricity can be used to cook some of our meals.

On-Grid or Off-Grid?

This information applies mostly to folks who live off-grid and use batteries. I know of homeowners with on-grid PV systems who routinely use electric ranges, heat water, and even do some space heating using solar electricity. The utility is your "battery" and the only concern is whether you make all the energy you use on an annual or monthly basis. It's better for the environment to cover even a portion of these large electrical loads with solar generation, since gas appliances are always tied directly to finite fossil fuels.

Off-grid, it's a different story. Even if you have an array large enough to supply the power demanded by electric cooking, at times, this energy must come from the battery. And anyone who has experience living with batteries can tell you that the more deeply you use them, the shorter their lifetime is.

Two main criteria determine when it's prudent to cook with solar electricity in an off-grid situation. First, are the batteries fully recharged and is the system regulating? Second, will the PV energy be available in the next day or so to refill the batteries if cooking discharges them?

Nonelectric Fuels

Almost all off-grid homesteads have either a propane-fired stove or a wood cookstove as a primary heat source for cooking. Karen and I have used both at our remote homestead. Cutting, splitting, and stacking wood is time consuming, and cooking on a woodstove can be

inconvenient at times. We currently use a propane stove for the bulk of our cooking. Since we live six miles up a rutted dirt road, propane (a fossil fuel that comes from natural gas) is expensive and hard for us to obtain. So our primary reason for using PV electricity to cook is to reduce our use of propane.

During the summer months, we want to avoid introducing more heat into our home. The amount of waste heat (heat not used for cooking) is far greater with a range than with a smaller, electric cooking appliance. This is particularly true of ovens.

Electric cooking appliances generally have high power demands—more than a kilowatt. Power is the instantaneous use of electricity. But if used wisely, the cooking load can be low in energy consumption when the cooking device is operated only for a short period of time. Energy is the quantity of electricity used over a period of time.

Most PV systems experience an energy surplus in the summer, and wind-electric systems often have an energy surplus in winter. Electric cooking can serve as a diversion load of sorts. People typically wouldn't add more modules to a given system to allow for electric cooking, but rather use up energy that's lost to regulation during times of surplus production.

Cooking with Electricity

The use of electricity to cook food is widespread, and appliances to do this are readily available. As with all appliances used with RE systems, efficiency is the key. Pick appliances that are efficient and deliver the heat to the food—not to the surroundings. All of the appliances referred to below are sized to run on a 15-amp household circuit, so their draw is 1,500 watts or less at 120 VAC.

Microwave. We use a microwave several times a day. It's used to reheat coffee, heat up leftovers for lunch, and to make popcorn in the evenings. All of



these are short-duration jobs. Our microwave draws 1,350 watts. At this power level, it takes about 1.5 minutes to reheat coffee and the energy consumption is low, about 34 watt-hours. This is well within the capability of almost all PV systems. The other jobs are also short in duration. It takes a minute or so to reheat leftovers, and three minutes to make popcorn.

While the microwave is a high-power device, its energy consumption is low since it operates for only a few minutes at a time. The microwave is a big energy saver since it means that the propane stove does not have to work to do these jobs. Microwaves are entirely suited to off-grid living, but be advised that almost all of them are phantom loads and should be used on a switched outlet or plug strip.

Toaster. Toast is popular in our home. Here again, the appliance is high in power and low in energy consumption since it only takes a few minutes to make toast. Some toasters allow you to choose how many pieces of bread are toasted. This also saves energy since there is no need to run the toaster elements for four pieces of toast if only two pieces are required. Our toaster draws 1,500 watts and will make four pieces of toast in 2 1/2 minutes. This is an energy consumption of about 63 watt-hours.

Electric Kettle. Heating water on the propane stove to make coffee or tea can take anywhere from 5 to 15 minutes depending on the stove. Electric kettles can do this job faster and with no use of fossil fuel. An electric kettle is efficient since the heating element is encapsulated with the water, while on a stove, much of the heat bypasses the kettle and is wasted. In general, an electric kettle will use about 100 watt-hours of electricity to heat water for a pot of coffee or tea that will serve four to six people.

Toaster Oven. A toaster oven can be used for broiling foods, making hot sandwiches, and many other cooking jobs. The key to using the toaster oven efficiently is in the operating time, so keep your cooking time short.

Our toaster oven also has a convection feature that circulates hot air throughout the cooking chamber. This also reduces cooking time and energy consumption. The oven makes fantastic pizza and pastries. Cooking times vary with the food, but in general, cooking a meal in the toaster oven consumes less than 500 watt-hours—that's roughly equivalent to the AC output of a single 150-watt PV module on a sunny day.



Other Cooking Appliances. Electric frying pans, hot plates, crockpot cookers, and rice cookers can all be used off-grid. Once again the key is efficient, short-duration use. It only takes a few minutes to fry burgers in an electric frying pan. Crock-style cookers, such as crockpots and rice cookers, operate for much longer than a few minutes, but they only operate at maximum power until the food reaches temperature. Then they regulate the amount of heat and thereby the power required. When choosing a crock-style cooker, check out the built-in insulation—it's key to energy consumption.

Solar-Electric Cooking

Using PV-supplied electricity to cook food is the *other* type of solar cooking. While we still have and use our solar ovens, which require no electricity, there are many times when the convenience of solar-electric cooking wins out—like making coffee early in the morning, or churning out a few pieces of toast for breakfast.

If a PV system is meeting your off-grid needs, and if during portions of the day the batteries are full and the system is regulating, consider doing some cooking with solar electricity. We love it here!

Access

Richard Perez, *Home Power*, PO Box 520, Ashland, OR 97520 • 541-941-9716 • richard.perez@homepower.com • www.homepower.com





Matrix
Solar Technologies

FREE solar energy for the next 10 billion years...

Don't let this deal pass you by.

540-A Silver Creek Rd. NW Albuquerque, NM 87121
Phone: (505) 833-0100 Fax: (505) 833-0400
www.matrixsolar.com



©Matrix Solar Technologies is a subsidiary of ATS Automation Tooling Systems

questions & answers

The Diesel Difference

Hello, I have read many articles in *Home Power* about biodiesel. My question is very low-level: What is the fundamental difference that makes biodiesel applicable to diesel engines and not other engines? Why can't biodiesel be used in gasoline-powered cars and generators? Thanks, Brian Zacher, Tucson, Arizona • brian.zacher@smsc.com

Hello Brian, When the diesel engine was first designed more than 100 years ago by Rudolf Diesel, it was designed to run on vegetable oil. Even at the turn of the century, Diesel recognized the potential for vegetable-based fuels. In 1912 he stated, "The use of vegetable oils for fuels may seem insignificant today. But such oils may become in the course of time as important as petroleum."

Diesel engines run on an adiabatic cycle (compression) for ignition and don't use spark plugs as do gasoline engines, which require far less compression. Petroleum diesel, vegetable oil, and biodiesel all have a much higher flash point (the temperature at which they will ignite) than gasoline, which makes them unsuitable for use in low-compression engines with spark plugs. Highly compressing the fuel-air mixture, as in a diesel engine, reduces the flash point enough for combustion to occur without a spark. Richard Perez • richard.perez@homepower.com

Refrigerator Efficiency

I've been enjoying *Home Power* in the paper edition since HP88. We're still in the conservation stage around here, since our siting-shading situation for panels is lousy. But the water heater has gone "tankless." The current issue at hand is a 12-year-old fridge that accounts for 40 percent of our electric bill. Didn't I read in a recent issue of *Home Power* of a Web address where energy consumption for refrigerators was compared independently of the government's Energy Star ratings? I dug through the last four issues but can't find it again! Any Web addresses you have would be appreciated! Thanks, Ron Ham • hamhome@earthlink.net

Hi Ron, Check out the article on efficient refrigerators in this issue. And take a look at the American Council for an Energy-Efficient Economy's appliance guides. You'll find them on the Web at www.aceee.org. Regards, Ian Woofenden • ian.woofenden@homepower.com

Meter Choice

Dear Editor, I am going to buy a new multimeter. I have found a Fluke 189, which measures amps and volts DC and AC, and can chart three days' worth of data, which can be downloaded to a computer. I would like to know what professional installers use, since the 189 will only handle 10 amps DC max. I like the idea of being able to chart my usage and outputs from individual components. Any suggestions? Thanks, Louis Hecox • lhcox@aol.com

Hello Louis, One of my meters is a Fluke 189. Great meter! I use a Fluke i200s clamp for measuring AC amps. It has settings for both 200 A and 20 A ranges, which is nice since it keeps the accuracy high. For highly accurate DC measurements, I use shunts and read DC millivolts on the meter. Fluke makes

DC clamp-on meters as well, but their measurements won't be as accurate as reading millivolts across a shunt. Let me know if you have any additional questions. Best, Joe Schwartz • joe.schwartz@homepower.com

MX60 Capability

After reading Richard Perez's expansion article in HP103, I would like to know how many of those Sharp 185s a single OutBack MX60 charge controller can handle. According to the OutBack brochure, the controller is actually rated at 70 amps; however, I don't understand how to figure the limits based on different voltage configurations.

I would like to run ten or twelve Sharp 185s at as high a voltage as possible (125 ft. run) through an MX60 and then to a 24- or 48-volt battery bank. Would the MX60 handle ten panels wired at 48 volts to a 24- or 48-volt battery? Ten panels wired at 120 volts? How about twelve panels wired at 48, 72, or 96 volts?

Does it make any difference if the battery bank is 24 or 48 volt? I need this information so I can make decisions regarding panels, wire size, and battery configuration. Thanks much! James Maginel • jmaginel@semo.edu

Hi James, The MX60 is listed at 60 amps continuous. There is a setting for the maximum output amps, which can be set as high as 70 amps without any problems. This is running the equipment above its listing, which may not be acceptable to your local inspector.

The MX60 is also rated for 100 percent continuous duty, as are the OutBack OBDC-60 and OBDC-70 circuit breakers. The adjustable current limit is provided to prevent tripping the circuit breakers when the PV array is producing more than normal—such as during an edge-of-cloud condition, or when snow reflection and cold temperatures are present.

The maximum PV array size is primarily dependent on the battery bank voltage. With a 48 VDC battery, the maximum wattage output (going into the battery) is as follows:

48 VDC x 60 amps = 2,880 watts DC

48 VDC x 70 amps = 3,360 watts DC

This of course is the output of the MX60 into the battery. The losses of the MX60 are in addition to this (although it's a very small amount) and you'll also have additional losses (such as wiring losses) to consider. Panels also do not operate at a steady-state temperature of 25°C (77°F) in the real world. You typically get less than the nameplate rating as far as wattage output.

With a 24 VDC battery bank, you need to cut the maximum wattage output levels in half because the controller is still limited to 60 or 70 amps maximum output.

Our recommendations for maximum nameplate wattage rating is as follows:

Colder climates—48 VDC: 3,000 watts DC;

24 VDC: 1,500 watts DC

Warmer locations—48 VDC: 3,500 watts DC;

24 VDC: 1,750 watts DC

The lower value for colder climates allows for higher production levels in the wintertime without the controller limiting the output.

The maximum number of series-connected Sharp 185s is three. This puts the open circuit voltage of the solar panels right at the limit of the MX60 in cold conditions. If you are in a really cold location (Montana, etc.), this might be an issue. So, for a 48 VDC system with Sharp 185s wired three in series, eighteen is the maximum advised number of modules. For colder locations you might look at limiting the array to fifteen modules. I hope this helps! Christopher Freitas, OutBack Power Systems • cfreitas@outbackpower.com

Clearing Snow Off PVs

Hi, We live in the Milwaukee, Wisconsin, area and cannot figure out what to use to clear the snow off our roof-mounted 4.2 KW system. Our solar-thermal panels clear themselves, which is good since they are on the upper roof! Do you know of any farm-type tools or very long-handled tools that would be able to be retrofitted for this purpose? I cannot believe we are the first to run into this problem since solar energy has been big in California and Colorado, which get lots of snow! It would need to be at least 20 feet long with something soft on the end, so as not to damage the panels.

If you would like to see our house, the Midwest Renewable Energy Association (MREA) pictures it on their solar tour page on their Web site (www.the-mrea.org/events_solartour.org). It is a great log home, green built, and solar heated and powered. We are in our first year here and very thrilled to be living with solar electricity, but lose all use of the PVs when it snows. Any help you can give us is greatly appreciated. Katie Moertl • baasym@yahoo.com

Hi Katie, I live in coastal California, so I don't have this problem. I have an idea, though untried. Go to your local industrial, grocery, or restaurant supply store, and buy a heavy-duty squeegee. These things are 12 to 18 inches wide or more, and use flexible rubber about a quarter-inch thick. I found one in United Grocers. They come with a 5- to 6-foot handle, and have standard push-broom-type fittings.

The second thing you need is an extendable fiberglass pole. You should be able to find one of those at the same supply store, or a fully stocked hardware store. These poles have telescoping nested tubes as a handle, and are made specifically for washing windows. Some of them come with a squeegee for that purpose, but the ones I have seen were light-duty, hence the need for that heavy-duty squeegee. You might have to keep the squeegee indoors so that it doesn't get too brittle from freezing.

I checked out the photo of your place on the MREA Web site—it is very nice. I noticed a row of PV modules above the row of solar thermal collectors. The PV modules are on a lower parallel plane than the collectors, so that means that snow sliding off the panels will bank against the top of the collectors. Consider increasing the height of the PV rack stand-offs to eliminate this problem. Perhaps our readers can share their snow removal ideas. Michael Welch • michael.welch@homepower.com



Send your questions to
Home Power magazine at
letters@homepower.com or
PO Box 520, Ashland, OR 97520

ADVANCED COMMUNICATION SOLUTIONS INC.
"Keeping you connected to your world"

Satellite Phones / Radio-telephones / Home Cellular
Cellular Amplifiers & In-Building Repeater Systems
Antennas / Long-range Cordless Phones / RF Cables

Globalstar
Satellite Phones

CellSocket™

VOYAGER

MAXRAD

EnGenius™

ANTENEX™

Prescott Valley, Arizona • (928) 772-7515
www.advanced-comm-solutions.com

your complete guide to

COOKING WITH THE SUN

200 Photos and Diagrams
Solar Cooker Designs
Beginner Tips

\$15
+ shipping

Order online at
www.homepower.com
or call 800-707-6585
or 541-512-0201

HYDROELECTRIC SYSTEMS: Pelton and Crossflow designs, either complete turbines or complete systems. Assistance in site evaluation and equipment selection. AC Systems for standalone or grid interconnect operation. Manufacturing home and commercial size turbines since 1976. Send for a free brochure. Canyon Industries Inc., P.O. Box 36 HP, Deming, WA 98244, 360-592-5552. e-mail: citurbine@aol.com web page: canyonhydro.com • HP10402

EARTH SHELTERED HOMES This definitive manual by noted authority Loren Impson features detailed building instructions for amazingly affordable and practical Ferro Cement Domes. Only \$15 from Loren, 71 Holistic, Mt. Ida AR 71957 www.2BbyD.com • HP10403

COSOLAR.COM discount prices from Colorado Solar Electric. New Shell SQ80 in stock \$328. OutBack Inverters in stock 1-800-766-7644 • HP10404

SINGLE AND DUAL AXIS SOLAR TRACKER CONTROLS up to 48V and 5A output. www.theanalogguy.com • HP10405

WIND TURBINES! Best prices nationwide. Bergey & AWP. www.pineridgeproducts.com 406-738-4284 • HP10406

SURPLUS INDUSTRIAL BATTERIES: Save up to 70% on unused military and industrial batteries. Many types and sizes, super H.D. Factory crated. Also chargers, wind and solar equipment, new and used. D.P.S.D. Inc. 3807 W. Sierra Hwy. #6, Acton CA 93510. 661-269-5410. Fax 661-269-3601. • HP10407

RADIO/TELEPHONES Voice-Fax-Web 1-8 lines 20mi. CELLULAR Antenna pkg improves access 208-263-9755 PDT • HP10408

VIDEOS AVAILABLE: NEW- "GUERRILLA SOLAR INSTALL", "Introduction to Solar Electricity", "Introduction to Solar Pool Pumps", "How To Solar Installation Video" VHS and DVD www.igotsolar.com • HP10409

ECOMALL: The largest environmental portal of earth-friendly companies and resources. Renewable energy companies, news and information. www.ecomall.com. To advertise, call 845-679-2490. • HP10410

LARGE GAS REFRIGERATORS 12, 15 & 18 cubic foot propane refrigerators. 15 cubic foot freezers 800-898-0552 Ervin's Cabinet Shop, 220 N County Rd. 425E., Arcola, IL 61910 • HP10411

XXXXXX UNI-SOLAR XXXXXXXXXX 64 Watts \$319 New 105AH AGM 12V batteries-Reg \$185, Sale \$75. TraceX SW5548 (GTI unit) \$1995. Ex 2KW inverter SB \$850. Buy, sell New/Used 760-949-0505 • HP10412

HONDA GENERATORS - 1000 to 10,500 watts. Fast shipping and great prices! www.hayesequipment.com 1-800-375-7767 • HP10413

DC SUBMERSIBLE WELL PUMPS. Complete, ready to install. \$187 includes IMMEDIATE FREE SHIPPING. Visit www.nemosolar.com or call 1-877-684-7979 • HP10414

I AM A SOLAR WHOLESALER looking for retailers to carry my solar electronic and hobby goods. Phone # (916) 486-4373. Please leave message. • HP10415

TELLURIDE COLORADO: Off the Grid Properties! Hot Springs, Riverside, solar powered homes, large and small ranches. Find your own place in the sun with the only solar powered real estate office in Colorado. T.R.I. (970) 728-3205 1-800-571-6518 www.solarrealty.net • HP10416

EDTA RESTORES SULFATED BATTERIES. EDTA tetra sodium salt, \$12/lb. plus \$5 S&H for 1st lb. plus \$1 S&H for each additional lb. Trailhead Supply, 325 E. 1165 N., Orem, UT 84057, (801) 225 3931, email: trailheadsupply@webtv.net, info. at: www.webspawner.com/users/edta. • HP10417

SOLAR ELECTRIC INC. Lowest prices under the sun! 5555 Santa Fe St #D, San Diego, CA 92109; 800-842-5678, www.solarelectricinc.com • HP10418

www.LOWESTCOSTSOLAR.com Do it Yourself! PV Panels, Wind Turbines, Charge Controllers, Kits BEST PRICES, ONLINE SUPPORT • HP10419

SOLAR HEATERS FOR SALE! Get free heat from the sun for your home, office, garage, etc. Visit us today at www.hotboxsolar.com or by phone at 1-607-481-0992. HotBox Solar. 263 Glenwood Ave. Elmira Heights, NY. 14903 • HP10420

VARI-CYCLONE: DC powered ceiling fan, 40% more airflow with no increase in power consumption. For more info contact RCH Fanworks, the #1 manufacturer of DC powered ceiling fans, 2173 Rocky Crk. Rd. Colville, WA 99114 PH: 509-685-0535, email: info@fanworks.com, Web: www.fanworks.com, Dealer inquiries welcome. • HP10421

SURVIVAL UNLIMITED.COM - Emergency Preparedness & Survival Supplies. Wind Power from 439.00+. Many great products & prices! 1-800-455-2201 www.survivalunlimited.com • HP10422

CONVERT WOOD TO ELECTRICITY: Complete 7 KW 120/240VAC steam engine powered generator sets ready to run. steamgen@juno.com www.geocities.com/steamgen 918-520-7711 • HP10423

WWW.EARTHTOYS.COM - Online library and emagazine all about alternative energy systems and equipment • 10424

FREE SOLR EDU KIT or VHS:Trth Lies 911 \$25mbrshp 845-246-0600 WoodstockMuseum.org • HP10425

Huge \$ savings SURPLUS AGM BATTERIES fully reconditioned and tested. Recondition your batteries, eliminate water loss, and gassing. Save BIG \$'s and extend the life of your batteries. Call Tim Ivie 661.609.1069 or visit www.hyperpowerusa.com • HP10426

WIND FARM DEVELOPMENT for Farmers and Landowners. 1 or more turbines www.techlinepower.com 414-374-0021 • HP10427

ALTERNATIVE HYDRO SOLUTIONS MAY HAVE JUST THE PRODUCT FOR YOU. We produce water current turbines for the world market. Our turbines produce DC power 24 hours a day, 7 days a week. More information is on our website at <http://www.althydrosolutions.com> or you can use Suite 421, 323 Richmond St. E., Toronto, Ontario, Canada M5A 4S7 or 416.368.5813 • HP10428

OZARKS MOUNTAIN SPLENDOUR! Affordable ranches and farms Back Home Real Estate 1 800 938 8800 • HP10429

SOLAR CELLS New 5" monocrystal 50 per pack - 125 watts \$150.00 make your own solar panels email for specs: none1120@juno.com • HP10430

PLEASE HELP SPREAD THE MESSAGE OF PEACE with a Peaceumbrella.com t-shirt. \$14.95 from www.peaceumbrella.com • HP10431

WANTED: ONE 6' FIBERGLASS BLADE for Jacobs blade act. gov. 907 656 1401, or johnstam@starband.net • HP10432

HYBRIDCARSTORE.COM has the largest selection of pre-owned hybrids in the USA. We have '04 Prius! Ask about delivery options. 877-4ahybrid (877 424 9274) • HP10433

SUN CHART SOFTWARE. For positioning solar collectors. www.VisualSunChart.com • HP10434

HEARTLAND SWEETHEART WOOD COOKSTOVE. Includes heat shields, freshair kit, water jacket. Teal. Unused. \$3500 OBO. 304-349-2036 • HP10435

JACOBS GENERATORS long & short case, governors, and some parts. 405-567-3750 • HP10436

FOR SALE N ARIZONA 3000 FT HUALAPAI MTS-NEW 1580 SF OFF GRID SANTA FE ICF HOME 40 acres w/well & outbldgs. Solar system incl. \$365,000. 928-706-4783 • HP10437

2 COMPLETE SOUTHWEST AIR 403 WINDMILLS. Best offer 888-239-9890 • HP10438

7.5KVA ASCOMWARREN INDUST. SINE INVERTER \$3500. 24ea 1005AH C&D Cells \$1200. 505 439-0231 • HP10439

KEEP IT GREEN! Tree seedlings for planet earth & your landscape. Giant Sequoia, Coast Redwood & more. 888-387-3379. Jonsteen.com • HP10440

AQUAIR UW HYDRO GENERATOR (24 volt). Purchased new thru Backwoods Solar; used only to test in stream. Perfect condition. Paid \$995-asking \$895. Call 207-452-2929 • HP10441

New Frigidaire Gallery washing machine. Great machine, but not compatible with modified square wave inverter. John Kirk, Bonners Ferry, Idaho • 208-661-2947 • Solar home construction services also available.

SERVEL KEROSENE REFRIGERATOR. Good shape. \$300. 417 532 5636 • HP10442



Readers' Marketplace Rates

Rates: 25¢ per CHARACTER, include spaces & punctuation. \$20.00 minimum per insertion. All Readers' Marketplace ads are published in both the print and Web versions. Please send a check or Visa, MasterCard, American Express, or Discover card data with ad. Please, no money orders. We do not bill Readers' Marketplace ads; they must be paid for in advance of publication. Your cancelled check or credit card bill is your receipt.

Submit your ad by—

- **E-mail** (preferred): readersmarketplace@homepower.com;
- **Fax**: 541-512-0343;
- **Phone**: 800-707-6585 or 541-512-0201

Help us prevent fraud! *Home Power* Readers' Marketplace ads from individuals must supply serial number(s) for equipment being sold. Businesses must supply published phone number(s) and a physical address. While *Home Power* is doing everything we can to prevent fraud, we can assume no responsibility for items being sold.

Statement of Ownership, Management, and Circulation (Required by 39 U.S.C. 3685). 1. Publication Title: HOME POWER 2. Publication #00-8699. 3. Filing Date: September 10, 2004. 4. Issue Frequency: Bi-Monthly. 5. Number of issues published annually: 6. 6. Annual Subscription Price: \$22.50. 7. Mailing address of known office of publication: P O Box 520, Ashland OR 97520-0018 (312 N. Main St., Phoenix, OR 97535). 8. Headquarters of general business office of the publisher: P O Box 275 Ashland, OR 97520. 9. Names and addresses of Publisher, Editor, and Managing Editor: Publisher and Editor-in Chief, Richard A. Perez & Karen L. Perez, P O Box 931, Ashland, OR 97520; Managing Editor, Linda Pinkham Medford, OR. 10. Owner (if owned by a corporation its name and address must be stated immediately there under the names and addresses of stockholders owning 1% or more of the total amount of stock: Home Power Inc Ashland OR, Richard and Karen Perez Ashland OR, Joseph E Schwartz, Phoenix OR, Dale and Marilyn Hodges Medford OR, Scott and Stephanie Sayles McMinnville OR. 11. Known bondholders, mortgagees, and other security holders owning or holding 1% or more of total amount of bonds, mortgages or other securities: None. 13. Publication Name: Home Power. 14. Issue date for circulation data: Issues 98-103. 15. Average no. of copies each issue during preceding 12 months - a. Total no. of copies (net press run) 39,848. b. Paid and/or Requested Circulation; (1) paid/ requested outside-county mail subscriptions (include advertisers' proof copies/exchange copies): 8,977 (2) Paid In-County Subscriptions: 53 (3) Sales Through Dealers and Carriers, Street Vendors, Counter Sales, and other non-USPS Paid Distribution: 21,941 (4) Other Classes Mailed Through the USPS: 4,083 c. Total Paid and/or requester circulation: 35,054. d. Free distribution by mail (samples, complimentary, and other free) (1) Outside-County: 224 (2) In-County: 14 (3) Other Classes Mailed Through USPS: 932. e. Free distribution outside the mail: 175. f. Total free distribution (sum of 15d and 15e): 1,345. g. Total distribution (sum of 15c. and 15f.): 36,399. h. copies not distributed: 3,449. i. Total (sum of 15g. and h): 39,848 j. Percent Paid and/or Requested Circulation: 96.3% No. of Copies of Single Issue nearest to filling date - a. Total no. copies (net press run) 39,000. b (1) Paid/Requested Outside-County Mail Subscriptions (include advertiser's copies and exchange copies): 9,603. (2) Paid In-County Subscriptions: 50 (3) Sales Through Dealers and Carriers, Street Vendors, Counter Sales, and other Non-USPS Paid Distribution: 20,981. (4) Other classes Mailed Through the USPS: 2732 c. Total Paid and/or requester circulation: 33,366. d. Free distribution by mail (samples, complimentary, and other free): (1) Outside County: 231. (2) In-County: 17. (3) Other Classes Mailed Through the USPS: 1053. e. Free distribution outside the mail (carriers and other means) 195. f. Total free distribution: 1496. g. Total distribution: 34,862. h. Copies not distributed: 4,138. i. Total (sum of 15g. and h.): 39,000. Percentage of paid and/or requested circulation: 95.7%. 16. This statement of ownership will be printed in the December 2004/January 2005 issue of this publication. 17. I certify that the statements made by me above are true and complete. Karen L. Perez, Publisher and CFO 9/10/04.

installers directory

Do you want a renewable energy system, but don't want to install it yourself? You deserve a system that meets your expectations and budget! A renewable energy professional will design and install a safe, code-compliant system, and offer you service and support after the sale. Check out the state-by-state installer listings below.

Home Power does not guarantee the quality provided by the businesses listed below— please shop carefully, request references and certifications, and compare.

Alaska

Remote
Power
Inc.

Remote Power Inc., Greg Egan, President. Licensed electrician since 1982. Outback certified field service technician. MREA trained wind system installer. Design, installation, sales & service of wind, pv, & hydro systems. We have affiliated installers statewide. Bush jobs no problem. We stock inverters, PV panels, efficient appliances, etc. at our shop near Fairbanks. Call 1-888-257-3639 or 1-907-457-4299

Arizona

www.
gswpowersystems
.com

Generator Solar & Wind Power Systems Design, Sales, installation & maintenance. Off-grid & grid-tied, prime power or back-up. Complete systems, hybrid systems, or sub systems & components. We can do it. Covering all of Arizona & dedicated to helping all present & potential customers. (928) 639-2297, (928) 300-4067, altpwrsys@hotmail.com

Good
Power
Company

Good Power Company, Stand Alone or Grid Tie systems for homes, business, solar wells and outdoor lighting. Solar, wind and motor generator systems. Licensed contractor serving ALL of Arizona. Remote home specialist! Free estimates. Call Dave Haycock for prompt courteous design, sales, installation and service. (520) 560-3856, espdave@hotmail.com. References. ROC195768

California

ACRO
ELECTRIC

Acro Electric is a full service, turn-key, res. & comm. solar electric contractor. We design, install, & handle all necessary CEC, utility forms and contracts. Quality installations are backed by 31 years experience. Approved by the League of California Homeowners (www.homeowners.org) & Better Business Bureau (www.midcalbbb.org). Free site analysis & brochure. (209)847-2977 • www.acroelectric.com

A

Akeena Solar is the nation's largest residential solar electric installer with two NABCEP-Certified PV Installers on staff. Our design/build services coupled with our complete financial analyses, based on actual site conditions, support our growing list of satisfied customers in making the switch to clean reliable energy. Serving CA, NJ, MA, RI, CT, & NY. Visit www.akeena.net or call 888-akeena-8

CARLSON
SOLAR

Carlson Solar. has been serving Southern CA since 1988. We are a licensed, bonded, and insured solar-electric installation company, specializing in both grid-tie and off-grid systems. We are NABCEP certified and take great pride in our excellent customer service. Saving the environment one house at a time. Call toll-free 1-877-927-0782 or visit us at www.carlsonsolar.com

Cobalt
Power Systems Inc.

Cobalt Power Systems Inc. is a full-service, licensed installer of PV systems in the SF Bay Area. We offer free consultations, detailed proposals, professional system design by an electrical engineer, expert installations, and competitive pricing. We handle all the paperwork for the client, and we oversee all inspections. Please contact us at 650-948-9574 or www.cobaltpower.com.

Eco-Energies

EcoEnergies is recognized as Northern California's leading Renewable Energy Experts. We specialize in Solar Electric, Cogen, and Wind powered systems. Our entire engineering staff is NABCEP certified and dedicated to unparalleled quality, customer service and customized solutions. Start saving Your Money while saving Your world! Call for Free Estimate 1.866.765.9463

California, cont.

Electron
Connection

Electron Connection Licensed in CA and Oregon. NABCEP Certified installer. Serving northernmost California and southern Oregon. PV, wind, microhydro installs. (800) 945-7587 email: bob-o@electronconnection.com, www.electronconnection.com

EMPOWER
ENERGY

Empower Energy, Southern CA. We design, sell, install, & service high quality residential & commercial solar, wind, & hydro systems. Specializing in grid-tied & remote stand alone systems in any part of CA. Make renewable energy a part of your home, ranch, or business. Lic. in CA since 1995, (#711993). Cert. SMA & Sharp installer. 818 222-8700, toll free 800 494-2366, EmpowerEnergy.net, Info@EmpowerEnergy.net

FEATHER
RIVER
SOLAR
ELECTRIC

Feather River Solar Electric Bill Battagin of Taylorsville has been designing, installing and servicing renewable energy systems since 1982. PV, micro-hydro, hybrids; grid intertie or stand alone systems. CA Elect. Lic. # 681552, Outback Cert. Tech. We live and work with RE. Serving Plumas, Lassen, Sierra, Butte Cos. 530.284.7849 frenergy@psln.com, www.freenergy.net

www.
horizonsolar
.com

Horizon Industries, San Diego Calif solar showroom, retail installation: Horizon Industries has been servicing, designing and installing solar hot water, solar pool heating, and solar electric on and off grid systems in San Diego county since 1984. Our showroom is at 120 N. Pacific #G7, San Marcos, (760) 744-1001.

FF LINE

Offline Independent Energy Systems, Since 1983. An electrical contracting co., we specialize in utility intertie (with state rebate & net metering) & off grid systems. Owned & operated by Don & Cynthia Loweberg in Central CA East of Fresno. We run our home & business with solar electricity. POB 231, North Fork, CA. 93643, (CA lic# 661052) ph 559 877 7080, fx 559 877 2980, ofln@aol.com www.psnw.com/~ofln

SKY
POWER
SYSTEMS

Sky Power Systems, provides affordable solar electric solutions, residential & commercial. NABCEP certified. Quality, 100% turnkey, affordable installations. Special pricing & design/installation advice for DIY. CEC rebates; long-term, 100% financing available. Free \$\$ analysis & site evaluations, toll free (CA only) 888-41SOLAR (888-417-6527), www.skypowersystems.com, Lic. # 800947, Bonded & Insured.

SOLAR
WIND
WORKS

Solar Wind Works specializes in consultation, sales, design, service, & installation of complete RE power systems. US Distributor for Proven Wind Turbines. We supply all components necessary for a complete, efficient, system— Grid-connected or grid-independent. POB 2511, Truckee, CA 96160, 530-582-4503, Toll Free: 877-682-4503, FAX: 530-582-4603, chris@solarwindworks.com, www.solarwindworks.com

Canada

ENERGY
ALTERNATIVES

Energy Alternatives has been serving Canadians for over 20 years. A licensed electrical contractor (BC Lics # 86683) with professional installers throughout Canada. Expert consultation & design services, turn-key installed systems or DIY packaged system kits. Extensive inventory for fast delivery. Visit www.EnergyAlternatives.ca, Call 1-800-265-8898. Canadian dealer inquiries welcome.

Colorado



Burnham-Beck & Sun, Solar & Wind Energy Systems. Located in Fort Collins, Colorado, we make site evaluations, system designs, and installations in Northern Colorado, Southern Wyoming. We drop-ship equipment anywhere in the US. Retail products include PV modules, wind turbines, inverters, batteries, efficient appliances. 970-482-6924. mailto: BurnhamBeckSun@aol.com. www.burnhambeck.com



Solar Solutions Ltd. provides photovoltaic, wind & hybrid power systems & components for stand alone systems, grid tied, RV's & remote water pumping. Committed to providing the highest quality service & customer satisfaction. A proud member of Colorado SEIA and a lifetime member of the Colorado RE Society and ASES. Xantrex Certified Dealer. 888 44solar or 888 447-6527 www.solarsolutions.com

Florida



ECS Solar Energy Systems (tel) 352-377-8866 www.ECS-solar.com / tom@ECS-solar.com We service FL, the Caribbean and the Southeastern U.S. FL's first solar contractor since 1977. Solar pool heating, hot water, and electric systems—commercial & residential. Solar lic. # CVC056643 Florida state certified for "grid-connected" systems. Contact us now to receive a free solar informational booklet.

Mexico



SC Solar designs/install PV systems—residential, US military, solar lighting, water pumping, traffic management power systems. Solar thermal & micro hydro. Custom UPS systems for off grid. Installation area: NC, SC, VA, GA, TN, & Mexico. For more info & credentials: 803-802-5522 www.scsolar.com CCR# & Cage Code #1SLJ5.

Michigan



Backwards to the Future Ltd, installing, designing and supplying solar equipment since 1986. OEM supplier of evacuated tube heat pipe technology for DHW & hydronic heating. Systems building integration by joint venture with registered architect. State licensed residential builder & solar mechanical contractor. POB 409 Fennville MI 49408 tel: 269 2366179 email: info@BTFsolar.com www.BTFsolar.com



S.U.R. Energy Systems, LC is South East Michigan's premier provider of wind, solar electric, and solar thermal systems. Any combination of design, sales, and installation. "Do it yourself" assistance to custom turnkey systems. We do power point seminars. Willing to travel. VISA, MC www.sur.biz sales@sur.biz 734.913.9944

Montana



Planetary Systems, Inc. In business 10+ years. Sales/design/installation of complete RE electrical, water & hydronic heating systems. Our patented RE "Power Package" simplifies installation & reduces costs. Can be shipped nationwide & installed locally. CAD schematic system drawings/technical support provided. Xantrex Certified Dealer. Phone (406) 682-5646, www.planetarysystems.com

Nevada



Alternative Energy Solutions, Reno, Nevada. We design, sell, install and service PV, wind, off grid and grid tie RE systems, Nevada State Licensed and Bonded Contractor, NABCEP PV Certified Installer. Xantrex / Trace Authorized Service Center, Xantrex Certified Dealer, Outback Factory trained field service technicians and Certified Uni-Solar field laminate installer. 775-857-1157 toll free 1-866-491-SOLR



Solar Unlimited, Inc. serves Nevada's Renewable Energy design, sales, service, and installation needs, including PV, wind, net-metering and off-grid systems. We are authorized dealers for Solarwall, Gillette, Xantrex, Outback, African Wind Power and more. Licensed and insured. Call toll free 866-SOLAR99 or visit www.solarunlimited.net.

New Hampshire



Sunweaver Incorporating innovative technologies for power, water and heat. Encouraging knowledge and direction towards resource responsible solar living. Installing in New England and the Caribbean since 1985. www.sunweaver.org. mailto: info@sunweaver.org 603-942-5863 Showroom hours: Monday-Saturday 11am-6pm

New Jersey



Akeena Solar is the nation's largest residential solar electric installer with two NABCEP-Certified PV Installers on staff. Our design/build services coupled with our complete financial analyses, based on actual site conditions, support our growing list of satisfied customers in making the switch to clean reliable energy. Serving CA, NJ, MA, RI, CT, & NY. Visit www.akeena.net or call 888-akeena-8

New Mexico



Positive Energy Inc. High quality renewable power systems. Licensed, bonded, and insured electrical contractor serving Santa Fe and northern NM. Owner Allan Sindelar is NABCEP certified and is a certified dealer/installer for Xantrex, Outback, and Sunnyboy. 505 424-1112. E-mail: info@positiveenergysolar.com. Website: www.positiveenergysolar.com

New York



Daystar Energy Systems We're making it easy to choose renewable energy. Unparalleled pricing guarantee, exceptional installation service, and backed up with a comprehensive warranty. Not your average installer, ask about our Sweat Equity and Referral Incentive Programs. Putting customers first in NY and NJ. Call Desi 585-224-9105 www.daystarenergysystems.com



Solar & Wind FX Inc. NY's only Off-grid Design & Training Center, where a client can see the latest RE & Green building technologies. A family owned, full service company focusing on Western NY that provides site evaluation, design, installation & the all important, service after the sale. Member of NESEA & NYSEIA, SEI alumni & a NYSEIDA installer. 585-229-2083, solarandwindfx.com



Suntric Renewable Electric Systems, Experienced, qualified installers of photovoltaic, wind, and micro-hydro stand alone systems. Located on the western end of the Adirondack Park in northern New York State. Site evaluations, design consultations, sales and service. Off grid since 1976. Edwin & Pamela Falk, 6920 Abbey Road, Lyons Falls, New York 13368 • 315-348-6893

North Carolina



Solar Village Institute, Inc. NC's premier solar, wind, micro-hydro dealer-installer-educators. Off-grid since 1992. Top quality, pro work, guaranteed. NC, SC, VA, GA, AK. Specializing in Wind/Solar hybrid off-grid systems. New/remodels. Christopher W. Carter, Pres. SEI alumni, Xantrex Cert. dealer. David Del Vecchio, installation manager. www.solarvillage.com, chris@solarvillage.com, 800 376 9530

Ohio



Third Sun Solar & Wind Power, Ltd. is Ohio's leading renewable energy contractor. Complete design and installation of off-grid, utility tied, PV and wind systems in OH, KY, IN, IL, MI, PA, WV. Owner Geoff Greenfield is NABCEP Certified Solar PV Installer. We are committed to excellent customer service & the highest quality systems. www.third-sun.com. (740) 597-3111.

Oregon



Electron Connection Licensed in CA and Oregon. NABCEP Certified installer. Serving northernmost California and southern Oregon. PV, wind, microhydro installs. (800) 945-7587 email: bob-o@electronconnection.com, www.electronconnection.com



Solar/wind Power of Portland, and our partner, Inland Electric, installers of solar electric & hot water systems, wind power, & solar shades, serving the Portland/Vancouver Metro area. Oregon Energy Trust ID #10012. Free information packet, or visit our showroom: 10006 SW Canyon Rd., Portland, OR 97225. Phones: 503/297-5781, or 800/550-2950. WEB: www.solarwindpdx.com, solarwind@ecosky.com.

RE Installer? Get Listed.

Our readers continue to look to *Home Power* for referrals to RE installation professionals in their area.

For more information or to get your business listed in HP's installers directory, e-mail advertising@homepower.com or call 541.512.0201.

Pennsylvania

www.
windturbine-1
.com

Appalachian Wind Systems, LLC has been serving PA, WV & MD for 6 years. Distributor for Cyclone wind turbines, Synergy wind turbines, Sun solar panels, LED lighting, stand alone & grid tie inverters and other products. Site evaluations and financial analyses. We also sell, service & install 10–60 meter NRG meteorological towers & first stage wind analysis. For more information, call 724-452-0326

South Carolina



SC Solar designs/installs PV systems—residential, US military, solar lighting, water pumping, traffic management power systems. Solar thermal & micro hydro. Custom UPS systems for off grid. Installation area: NC, SC, VA, GA, TN, & Mexico. For more info & credentials: 803-802-5522 www.scsolar.com CCR# & Cage Code #1SLJ5.

Texas



Meridian Energy Systems specializes in the design and installation of high quality solar and wind energy systems throughout the State of Texas...and beyond. Factory trained technicians and NABCEP Inaugural Certificiant on staff. Visit our website www.meridiansolar.com or call toll-free: 888-477-3050



North Texas Renewable Energy Inc. North Texas' premier solar and small wind energy service. Complete system design and installation. Available service contract Independence—Reliability—Conservation. Jim Duncan answers@NTREI.com 817.917.0527

Utah



Solar Unlimited, Inc. Southern Utah's leading design, sales, service and installation professional for all your alternative and Renewable Energy needs, including PV, wind, net-metering or off grid systems. We are authorized dealers for Solarwall, Gillette, Xantrex, Outback, African Wind Power and more. Licensed and insured. Call toll free 866-SOLAR99 or visit www.solarunlimited.net.

Vermont

Independent
Power & Light

Independent Power & Light serving Northern Vermont since 1988. David Palumbo designs, sells, and installs solar electric systems. NABCEP Certified installer, Outback Power Certified Field Service Tech. Specializing in efficient off grid homes. Phone: 802-888-7194, e-mail: IP&L@sover.net, www.independent-power.com



Vermont Solar Engineering has provided the finest in renewable energy throughout New York and New England, since 1991. We design, install, and support solar electric, wind electric, and solar hot water systems. K. Herander, NABCEP™ certified installer. Xantrex Certified Dealer. NYSERDA eligible installer. Vermont Solar and Wind Partner. www.vermontsolar.com 1-800-286-1252

Virginia



Dunimis Technology Inc. Providing alternative energy systems since 1992. NABCEP certified solar technicians on staff. We specialize in the more demanding upscale off-grid residential & commercial installations. Installations completed in ID, TX, PA, NJ, NC, VA, and WV. P.O. Box 10, Gum Spring, VA 23065, Phone 804-457-9566, jryago@wwjv.net, www.pvforyou.com

Washington



Power Trip Energy Corp. "Craft Your Personal Energy Policy" Electrical contractors specializing in renewable energy & a holistic approach to your power needs incorporating complete wiring packages & efficiency analysis. We serve all of Washington, grid-tied & off-grid, residential & commercial. www.powertripenergy.com, (360) 643-3080, info@powertripenergy.com, WA Cont # POWERTE964JN.



SolarWind Energy Systems, LLC P.O. Box 1234, Okanogan, WA 98840 (509) 422-5309 www.solar-wind.us WA Cont. # SOLARES983RQ. Serving Eastern WA & Northern ID grid-tied & off-grid RE systems. Solar PV, wind, solar hot water, remote stock watering. Design, installation, service, maint. Solar Energy International (SEI) trained. Lic. & bonded. bclark@solar-wind.us or jmartin@solar-wind.us



Sound Power Design • Site Surveys • Installation • Service. Contractor Reg. # SOUNDPI983NW www.soundpower.us phone 425-844-8748 fax 425-844-8928 Licensed, bonded, insured electrical contractor. Renewable energy specialist. We will travel anywhere in Washington to install PV, wind, and microhydro systems.

Wisconsin



Great Northern Solar, In business since 1988. NABCEP certified. "Waking the Northland to renewable energy & sustainable living!" We install PV, wind and microhydro systems. Large focus on education—workshops on residential and commercial installations available. MREA instructor. Chris LaForge at 715 774-3374, email: gosolar@cheqnet.net 77480 Evergreen Rd Ste #1 Port Wing, 54865

Wyoming



Creative Energies Wyoming's premiere full-service RE company. Solar & wind power for remote cabins, homes & ranches, utility grid-tied solar & wind power, solar hot water & heating, solar water pumping & passive solar home design. We custom design a system that fits your needs & budget. Trace certified dealer. Phone/fax: 307-332-3410 toll free 866-332-3410 info@creativeenergies.biz www.creativeenergies.biz

RE Installer? Get Listed.

Our readers continue to look to *Home Power* for referrals to RE installation professionals in their area.

For more information or to get your business listed in *HP's* installers directory, e-mail advertising@homepower.com or call 541.512.0201.

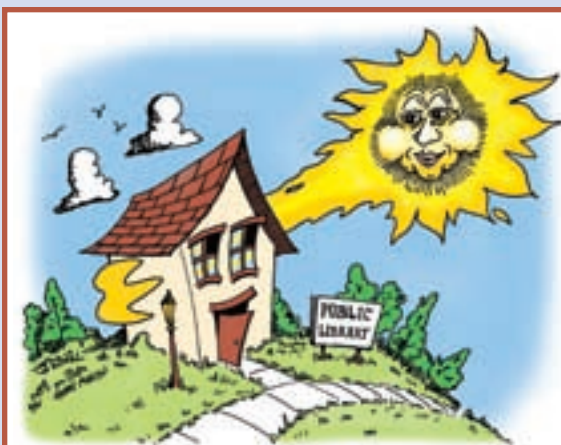

adopt a library!

When Karen and I were living with kerosene lamps, we went to our local public library looking for a better way to light up our nights. We found nothing about small-scale renewable energy. As a result, one of the first things we did when we started publishing *Home Power* sixteen years ago was to give a subscription to our local public library.

If you'd like to do the same for your public library, we'll split the cost of the subscription with you. Inside the U.S., you pay \$11.25 and we'll pay the rest. Outside the U.S., the same offer stands, so call us for rates.



— Richard Perez, Publisher

Check with your local library before signing them up. Eligible libraries must be open to the general public.
PO Box 520, Ashland OR 97520 • 800-707-6585 • 541-512-0201 subscription@homepower.com • www.homepower.com

Shipping: \$2 US, \$3 CAN, \$4 INT

\$25 each when you buy four or more. Full set (9) for \$190—a \$71 savings!

Order online at www.homepower.com or call 800-707-6585 or 541-512-0201

Solar9: Issues #95–100 (June '03–May '04)

Home Power's newest CD-ROM features our milestone 100th issue! Includes spreadsheets for load analysis and wire sizing; U.S. solar and wind resource data; our new renewable energy glossary; and more.

Solar8: Issues #89–94 (June '02–May '03)

Features enhanced navigation. Includes spreadsheets for load analysis, wire sizing, and the Energy Master for system design; 30 years of solar insolation data & wind data for 900 U.S. sites; manuals and spec sheets of popular RE equipment; and much more.

Solar7: Issues #83–88 (June '01–May '02)

Includes spreadsheets for load analysis, wire sizing, and the Energy Master for system design; classic introductory articles from the *HP* archives; 30 years of solar insolation data & wind data for 900 U.S. sites; bonus video clips in QuickTime video format; and much more.

Solar6: Issues #77–82 (June '00–May '01)

Includes spreadsheets and tools for system design; classic introductory articles from our archives; solar insolation & wind data; and much more. **PLUS, a second CD** featuring the *Energy Pathways* video on the basics of renewable energy.

Solar5: Issues #71–76 (June '99–May '00)

More than 1,400 pages of *Home Power*; guerrilla solar video clip; five hours of audio lectures (MREF '99) on batteries, inverters, ram pumps, etc.; spreadsheets for load analysis, wire sizing, and system design; 30 years of solar insolation data; and much more.

Solar4: Issues #61–70 (October '97–May '99)

More than 1,200 pages of *Home Power*; three hours of audio lecture (MREF '98) on batteries, inverters, and RE system Q&A; video clips from the "RE with the Experts" series; spreadsheets for load analysis, wire sizing, and system design; and much more.

Solar3: Issues #43–60 (October '94–September '97)

More than 2,000 pages of *Home Power*; two hours of audio lecture on batteries and inverters (MREF '97); spreadsheets for load analysis, wire sizing, and system design; an interactive tour of the original *Home Power* facilities; and much more.

Solar2: Issues #1–42 (November '87–September '94)

Contains More than 3,900 pages of *Home Power*. Navigate easily among the gems of *HP's* roots, and reconnect with the original authors and timeless features that established the unrivaled "Hands-On Journal of Home-Made Power."

Solar1: Renewable Energy Basics

Fifteen years of *Home Power* introductory articles on one CD-ROM. Organized into fifteen topical categories, there's no better resource for those new to renewable energy. See www.homepower.com for a complete table of contents.

Back Issues on CD-ROM



AAA Solar Supply 92	Direct Power & Water Corp 85	Hutton Communications 109	SMA America Inc 2
ABS Alaskan 119	E/The Environmental Magazine 117	Hydrocap 119	Smart Power 71
Abundant Renewable Energy 101	Eagle Sun Seminars 92	Hydroscreen Co LLC 47	Solar Converters 79
Adopt a Library 142	Earth Solar 27	Inverterdoctor.com 56	Solar Depot IFC
Advanced Communication Solutions 137	EcoEnergies Inc. 55	KTA Services Inc 101	Solar Energy International 48, 108
Advertising in Home Power 114	Ecolnnovation 49	Kyocera Solar Inc 12	Solar Pathfinder 55
AEE Solar Supersource 11	eco-shake/ReNew 41	Low Energy Systems 117	Solar Roast 132
Affordable Solar 33	Electric Auto Association 133	Matrix Solar Technologies 135	Solar Wind Works 101
All Battery Sales & Service 113	Electro Automotive 109	Meridian Energy Systems 133	SolarOne Solutions 57
Alternative Energy Store 84	Electron Connection 20	Mike's Windmill Shop 123	Solartrax Power Stations 96
Alternative Power & Machine 49	Energy Alternatives 113	MK Battery/East Penn Mfg 41	SOL-Solar-On-Line 123
B.Z. Products 119	Energy Outfitters 7	Morningstar 57	Southwest Windpower 21
BackHome 115	Energy Systems & Design 49	MREA Workshops 97	Staber Industries, Inc. 71
Backwoods Solar Electric Systems 63	Esse Range Cookers 121	National Solar Supply 78	Statement of Ownership 139
Bailey's Inc 115	EV Solar Products 113	North American Board of Certified Energy Practioners 105	Sun Electronics 123
Belize Workshops 26	Evergreen Solar 4	Northwest Energy Storage 63	Sun Frost 71
BioShield 40	Fat Spaniel Technologies 133	Offline 111	Sun Pumps Inc 93
Blue Sky Energy Inc 64	Forcefield 113	Outback Power Systems 13, 57	Sun Spot Solar 93
Bogart Engineering 65	Fronius International IBC	Permaculture Credit Union 115	SunDanzer 71
BP Solar OBC	Gorilla Vehicles 133	Planetary Systems Inc 79	SunEarth Inc 93
Brand Electronics 109	Great Northern 132	PV Powered 85	SunWize 6, 56
BTF Ltd 93	Harris Hydroelectric 49	Quick Start Specials 81	Surette Battery 97
Butler Sun Solutions 91	Heaven's Flame 137	Radiantec 19	U.S. Battery 5
C. Crane Company 121	Heliotrope Thermal 32	Rae Storage Battery Company 123	UniRac 62
Canyon Industries 49	Hitney Solar Products 117	Rainier Yurts 96	Wattsun (Array Tech Inc) 119
Central Boiler 133	Home Power Back Issues 132	Renewable Energy Videos 114	Wind Turbine Industries 101
CheapestSolar.com 101	Home Power CD-ROMs 143	RightHand Engineering 108	Windstream Power Systems 96
Chelsea Green 40	Home Power Solar1 CD-ROM 122	Rocky Mountain Power Source 111	Winter Special 80
Communities magazine 123	Home Power Solar9 CD-ROM 122	Rolls Battery Engineering 55	Writing for HP 115
Dankoff Solar Products 65	Home Power Sub Form 81	San Juan College 105	Xantrex 1
	Home Power T-shirts 114	Simmons 121	Zephyr Industries Inc 133
	Homepower.com 81		Zomeworks 108

Coming Next Issue:

- **Minnesota Rebate Dollars Fund a Solar Dream Home**
- **Go Tankless! Small Water Heaters Offer Big Savings**
- **Choose the Right Tower for Your Wind Turbine**
- **Road Review: Is Ford's New Hybrid SUV Up to Speed?**

Minnesota homeowner Alan Stankevitz walks his talk—
"Invest in today's dollars to offset tomorrow's costs."



homepower

The Hands-On Journal of Home-Made Power

Issue 104

December 2004
January 2005

TOP 10
*Eco-Friendly
Building Products* p. 34

Big City Solar

Living Green in NYC p. 14

**Ultimate Beginner's Guide
to Solar-Electric Systems** p. 72

Cool Savings
Choose an Energy-Efficient Fridge p. 66

Solar Hot Tubbing
An Easy Do-It-Yourself Project p. 28

Stream Dreams
Measure Your Site's Hydroelectric Potential p. 42

homepower.com

\$6.95 US \$10.95 CAN



Display until February 1

SOLAR CONTRACTORS: take a good look at



COMMERCIAL

LOWER PRICES



BETTER TECH SUPPORT



REBATE ASSISTANCE



**WE SUPPLY
GRID-TIED AND
OFF-GRID SYSTEMS**

*ONE OF THE LARGEST
INVENTORIES IN THE U.S.*

*PRODUCT DELIVERY
FROM THREE LOCATIONS
TO YOUR JOB SITE*

*PREPACKAGED
ENGINEERED RESIDENTIAL
SYSTEMS*

*DESIGN ASSISTANCE
FOR COMMERCIAL PROJECTS*

*ASSISTANCE WITH
REBATE FILING*

*EXPERIENCED ENGINEERS
AND MASTER TECHNICIANS*

**25 YEARS OF EXPERIENCE
AND STAYING POWER**



**Homeowners
Call us for the name of
your nearest Sol-Gen Contractor**



RESIDENTIAL

HUGE INVENTORY



MORE LOCATIONS



TIMELY DELIVERY



DESIGN ASSISTANCE



xantrex
Smart choice for power
AUTHORIZED DISTRIBUTOR

OutBack
Power Systems
AUTHORIZED DISTRIBUTOR

SOLAR DEPOT - PETALUMA
1240 HOLM ROAD
PETALUMA, CA 94954
707.766.7727
FAX 707.766.7722
ORDER LINE 800.822.4041

SOLAR DEPOT - SACRAMENTO
8605 FOLSOM BLVD
SACRAMENTO, CA 95826
916.381.0235
FAX 916.381.2603
ORDER LINE 800.321.0101

SOLAR DEPOT - CORONA
1520-H COMMERCE ST.
CORONA, CA 92680
951.737.7652
FAX 909.737.7630
ORDER LINE 800.680.7922



bp solar
Distributor

WWW.SOLARDEPOT.COM



www.fronius.com

It's a whole new technology, but it's easy to pick up.

Fronius grid-tied photovoltaic inverters use a new high-frequency, phase-shifting architecture to deliver higher reliability and performance, while reducing size and limiting weight. The FRONIUS IG 3000 weighs just 26 pounds! Integrated AC and DC disconnects help cut installation costs, while a large LCD display provides both real time and cumulative performance tracking. And once installed, inherent higher efficiency is maximized with intelligent thermal management to offer the highest performance available.

While the technology is new, the expertise is not. For 50 years Fronius has been leading the way in creating power conversion technologies, with more than 60,000 inverters in operation all over the world. Experience that's built into every new FRONIUS IG 2000 and IG 3000.

So when you're ready to consider a whole new inverter technology to improve reliability and performance, find out more about Fronius. We promise it will be light reading.



POWERING YOUR FUTURE



energy independence

For your home, for your business, for your country.



1.3 MWp BP Solar electric system at the U.S. Marine base at 29 Palms, CA

www.bpsolar.com

SUBSCRIBE!

to **HOME POWER** magazine **FAST & EASY** at www.homepower.com
or call 800-707-6585, international 541-512-0201, or fax 541-512-0343

Or, complete and mail this form. Enclose payment as a check, money order, or credit card information.
Tape the form closed carefully or use an envelope so your check won't fall out. Allow up to three weeks for your first issue to arrive.

Shipping Information

Name:

Address:

City:

State:

Zip:

Country:

Phone:

E-mail:

(Never sold or shared.)

(No spam, guaranteed.)

- New Subscription**
- Renewal Subscription**
- Gift Subscription**
- Change of Address**

Old Zip Code

	USA	Canada*	International*
1 Year: 6 issues Save \$19.20 off the newsstand price!	<input type="checkbox"/> \$22.50 Standard <input type="checkbox"/> \$43.00 1st class	<input type="checkbox"/> \$30.00 Standard <input type="checkbox"/> \$43.00 1st class	<input type="checkbox"/> \$30.00 Ground <input type="checkbox"/> Call for price Air
2 Years: 12 issues Save 10% more!	<input type="checkbox"/> \$40.50 Standard <input type="checkbox"/> \$81.50 1st class	<input type="checkbox"/> \$55.50 Standard <input type="checkbox"/> \$81.50 1st class	<input type="checkbox"/> \$55.50 Ground <input type="checkbox"/> Call for price Air
3 Years: 18 issues Save 15% more!	<input type="checkbox"/> \$57.50 Standard <input type="checkbox"/> \$119.00 1st class	<input type="checkbox"/> \$80.00 Standard <input type="checkbox"/> \$119.00 1st class	<input type="checkbox"/> \$80.00 Ground <input type="checkbox"/> Call for price Air

HP 104

* Canadian and international orders must be in U.S. funds drawn on a U.S. bank.

\$ Subtotal:

Specials add price to subscription above

- Quick Start** With your subscription above, get our six most recent back issues sent to you right away.
- Quick Start + 1** Quick Start above, **PLUS** our Solar1—Renewable Energy Basics on CD-ROM sent right away.
- First Year + CD** First-time subscribers only: Subscription, **PLUS** any selection from our CD-ROM library.

Enter number of the Solar CD-ROM to add to special.
1 through 9 currently available.

	USA	Canada*	International*
<input type="checkbox"/> Add \$27.50 to your subtotal above	<input type="checkbox"/> Add \$35.00 to your subtotal above	<input type="checkbox"/> Add \$37.00 to your subtotal above	
<input type="checkbox"/> Add \$46.50 to your subtotal above	<input type="checkbox"/> Add \$54.00 to your subtotal above	<input type="checkbox"/> Add \$56.00 to your subtotal above	
<input type="checkbox"/> Add \$21.00 to your subtotal above	<input type="checkbox"/> Add \$22.00 to your subtotal above	<input type="checkbox"/> Add \$23.00 to your subtotal above	

\$ Additional:

Subscription cost plus cost of special

\$ Total:

Billing Information if different from above

Name:

Address:

City:

State:

Zip:

Country:

Phone:

E-mail:

(Never sold or shared.)

(No spam, guaranteed.)

Payment Information

- Check Enclosed***
- Visa**
- MasterCard**
- American Express**
- Discover**

Card Number:

Expiration Date:

Signature:

CSC Number:**

\$ Total:

* Make checks or money orders payable to *Home Power* magazine.

**The last 3 or 4 digit number on the signature strip on the back of your card.
(On the front of American Express cards.)

Energy Survey

The following optional questions about your renewable energy use help us tailor the magazine to meet your needs. All information is kept confidential. We appreciate your input.

I use, or plan to use, renewable energy for:

- | Now | Future | |
|--------------------------|--------------------------|--|
| <input type="checkbox"/> | <input type="checkbox"/> | All electricity |
| <input type="checkbox"/> | <input type="checkbox"/> | Most electricity |
| <input type="checkbox"/> | <input type="checkbox"/> | Some electricity |
| <input type="checkbox"/> | <input type="checkbox"/> | Backup electricity |
| <input type="checkbox"/> | <input type="checkbox"/> | Recreational electricity (RVs, boats, camping) |
| <input type="checkbox"/> | <input type="checkbox"/> | Vacation or second home electricity |
| <input type="checkbox"/> | <input type="checkbox"/> | Business electricity |
| <input type="checkbox"/> | <input type="checkbox"/> | Transportation |
| <input type="checkbox"/> | <input type="checkbox"/> | Water heating |
| <input type="checkbox"/> | <input type="checkbox"/> | Space heating |

My site(s) have the following renewable energy resources:

- Solar power
- Wind power
- Hydro power
- Biomass
- Geothermal power
- Tidal power
- Other (explain)

Electric utility grid use:

- I have the utility grid at my location.
I pay _____¢ for grid electricity (cents per kilowatt-hour).
_____% of my total electricity is purchased from the grid.
- I sell my excess electricity to the grid.
The grid pays me _____¢ for electricity (cents per kilowatt-hour).

I use, or plan to use, the following renewable energy products (check all that apply):

- | Now | Future | |
|--------------------------|--------------------------|--------------------------------|
| <input type="checkbox"/> | <input type="checkbox"/> | Photovoltaic modules |
| <input type="checkbox"/> | <input type="checkbox"/> | Wind generator |
| <input type="checkbox"/> | <input type="checkbox"/> | Hydroelectric generator |
| <input type="checkbox"/> | <input type="checkbox"/> | Battery charger |
| <input type="checkbox"/> | <input type="checkbox"/> | Instrumentation |
| <input type="checkbox"/> | <input type="checkbox"/> | Batteries |
| <input type="checkbox"/> | <input type="checkbox"/> | Inverter |
| <input type="checkbox"/> | <input type="checkbox"/> | Controls |
| <input type="checkbox"/> | <input type="checkbox"/> | PV tracker |
| <input type="checkbox"/> | <input type="checkbox"/> | Engine/generator |
| <input type="checkbox"/> | <input type="checkbox"/> | Methane digester |
| <input type="checkbox"/> | <input type="checkbox"/> | Thermoelectric generator |
| <input type="checkbox"/> | <input type="checkbox"/> | Solar oven or cooker |
| <input type="checkbox"/> | <input type="checkbox"/> | Solar water heater |
| <input type="checkbox"/> | <input type="checkbox"/> | Wood-fired water heater |
| <input type="checkbox"/> | <input type="checkbox"/> | Solar space heating system |
| <input type="checkbox"/> | <input type="checkbox"/> | Hydrogen cells (electrolyzers) |
| <input type="checkbox"/> | <input type="checkbox"/> | Fuel cells |
| <input type="checkbox"/> | <input type="checkbox"/> | RE-powered water pump |
| <input type="checkbox"/> | <input type="checkbox"/> | Electric vehicle |

Feedback

Please write to us here. Tell us what you like and don't like about *Home Power*. What would you like to read about in future issues? Thanks for your attention and support.

It's okay to print my comments as a letter to *Home Power*.

Fold Here

Return Address:



NO POSTAGE
NECESSARY
IF MAILED
IN THE
UNITED STATES



BUSINESS REPLY MAIL
FIRST-CLASS MAIL PERMIT NO. 49 ASHLAND OR
POSTAGE WILL BE PAID BY ADDRESSEE



HOME POWER
PO BOX 520
ASHLAND OR 97520-9903

