

# ZELPI® RETRACTORS

The Zelpi Retractor features a unique locking mechanism that guarantees against slipping and provides a 5" minimum exposure. The Zelpi comes with varying-length arms to accommodate differing patient anatomy. The varying length arms provide limited pressure on muscles and tissues to help reduce tissue necrosis. The blades are angled at 90°. This design is low profile, providing less bulk in the surgeon's work area than the conventional crank retractors.

The Zelpi Retractors are cost-effective, eliminating the cost of expensive multi-blade retractor systems.

Left Handed Zelpi Retractors are available upon request. Zelpis can be ordered with the locking mechanism reversed for easier use for a left-handed person.

### ZELPI RETRACTORS 90° 5" Minimum Exposure

- 3" 741-1230-2
- 4" 741-1240-2
- 5" 741-1250-2

### Also available

- 1.5" 741-1215-2
- 2" 741-1220-2

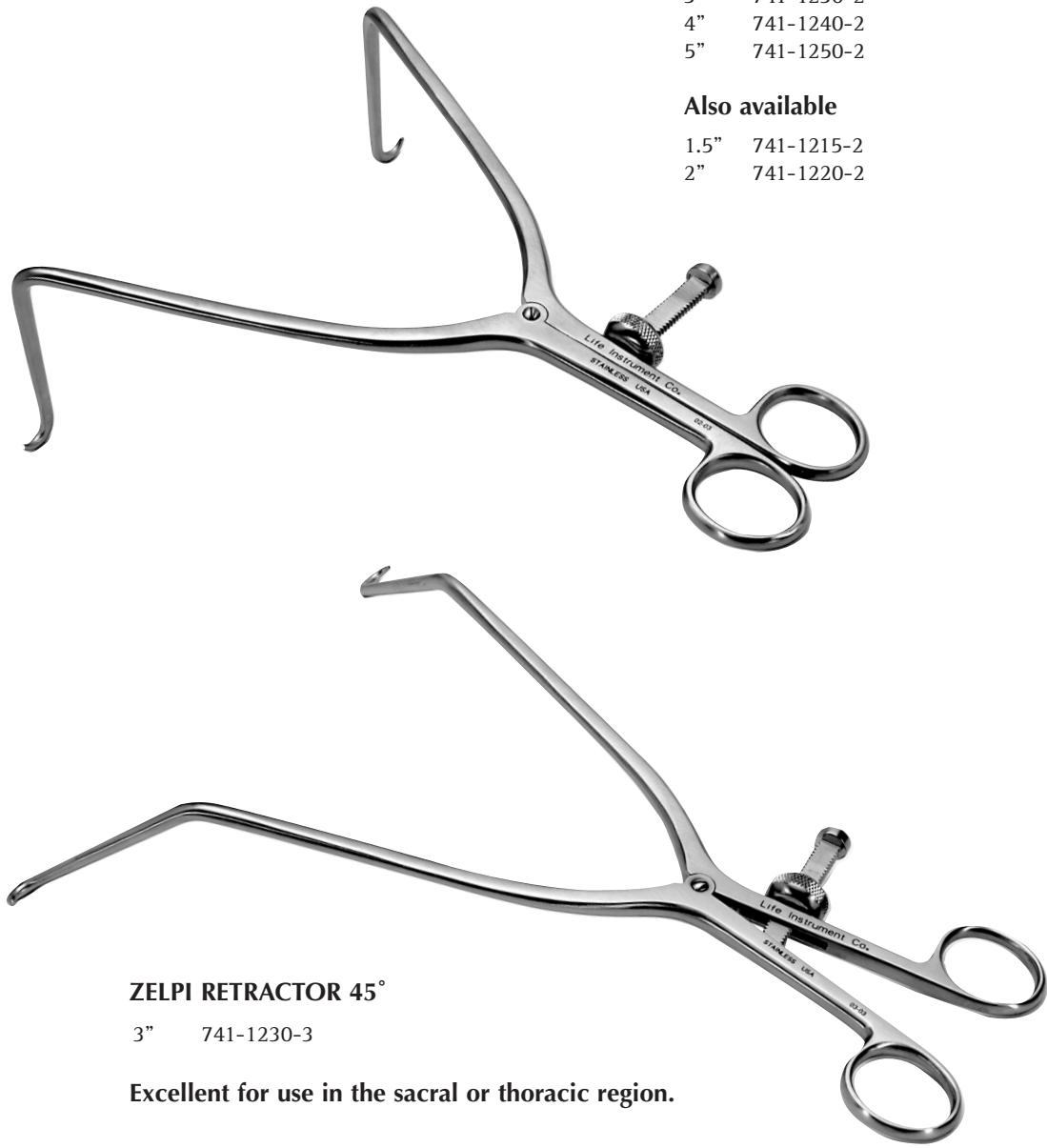

### ZELPI RETRACTOR 45°

- 3" 741-1230-3

Excellent for use in the sacral or thoracic region.

## RADIOLUCENT ZELPI® RETRACTOR

Life Instruments' Carbon Fiber Radiolucent Zelpis are not visible on Xray and provide excellent retraction for Lumbar Spine procedures. They have been particularly helpful during A/P intraoperative imaging, allowing surgeons to see critical anatomy without interference. Avoiding manipulation, removal, and replacement of our retractors has allowed surgeons to experience less radiation exposure and shorter operative times.

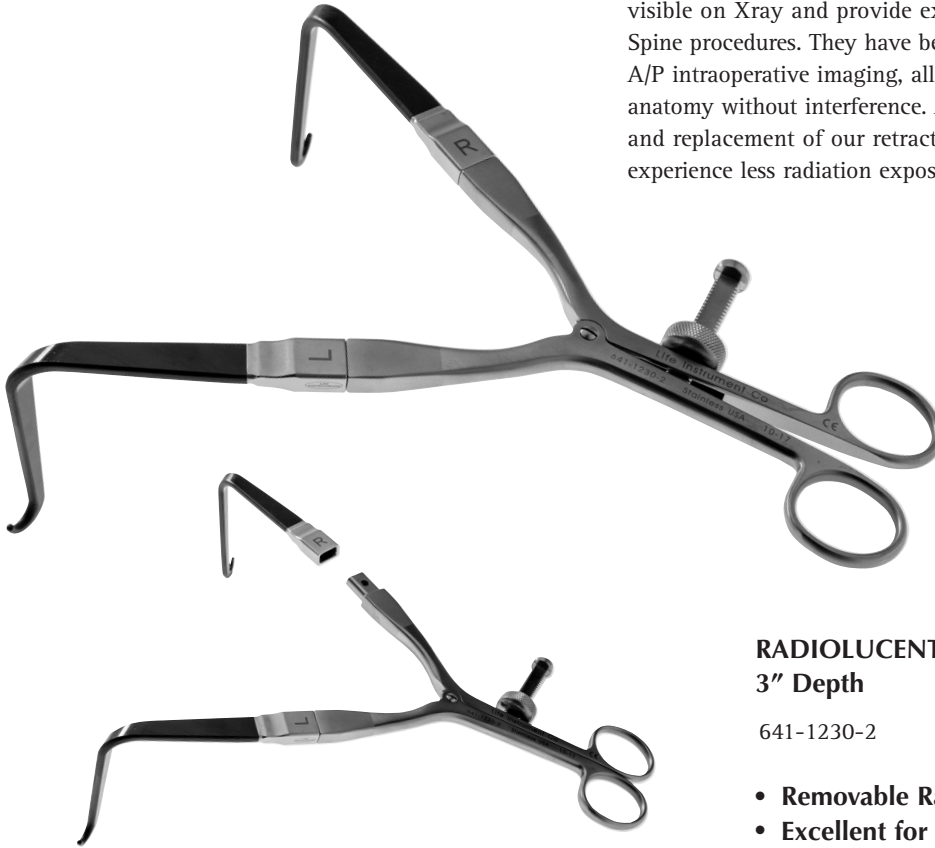

### RADIOLUCENT ZELPI RETRACTOR 3" Depth

641-1230-2

- Removable Radiolucent Arms
- Excellent for Intraoperative Imaging
- Trademark spindle locking

## LATERAL PLIF RETRACTORS

The Lateral Plif Retractor provides greater exposure enabling the surgeon to retract past the transverse process. The retractor comes with a tommy bar wrench that assists with extra torque to attain the 7" maximum exposure.

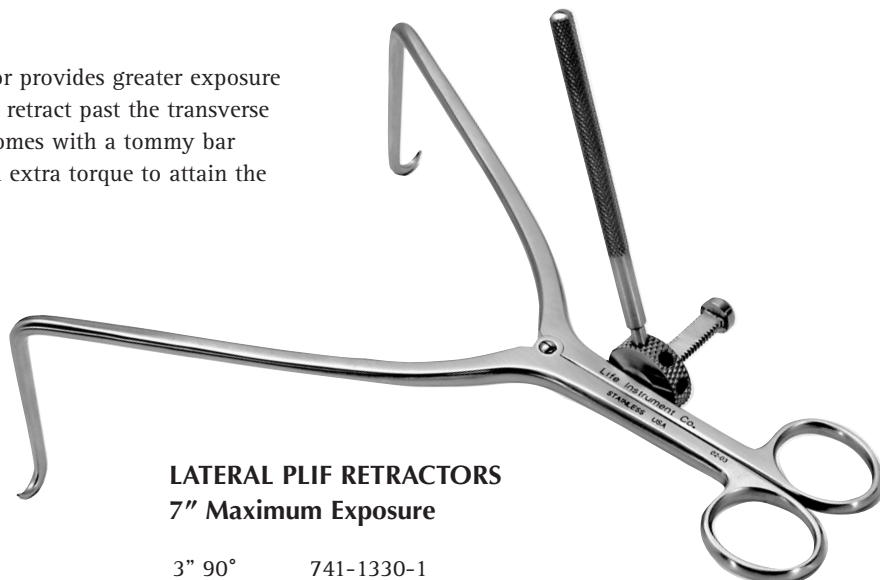

### LATERAL PLIF RETRACTORS 7" Maximum Exposure

3" 90°	741-1330-1
4" 90°	741-1340-1
Wrench	741-1330-5

# ZELPI® RETRACTORS

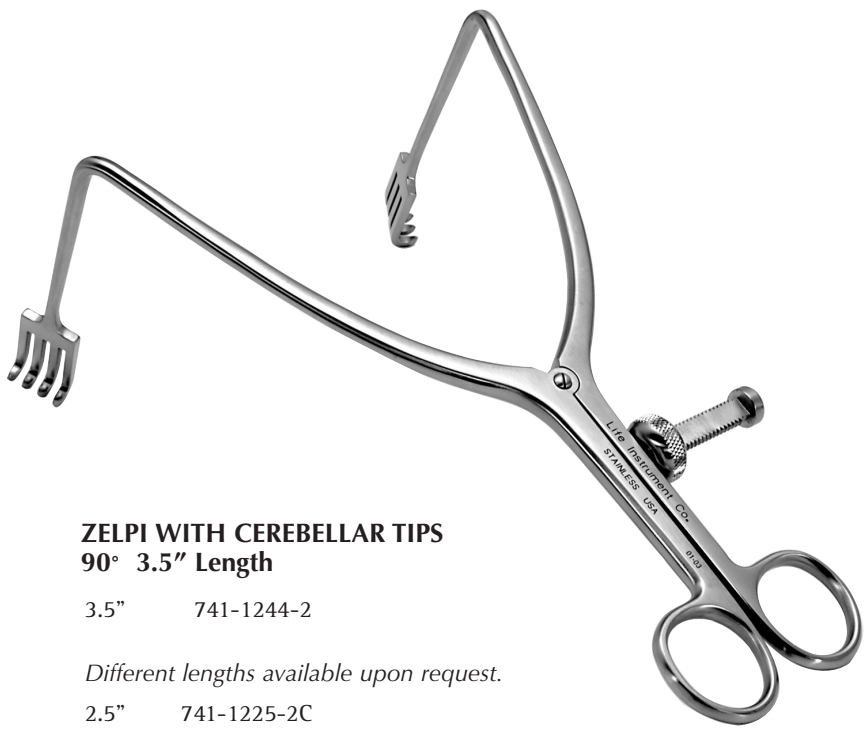

**ZELPI WITH CEREBELLAR TIPS**  
**90° 3.5" Length**

3.5" 741-1244-2

*Different lengths available upon request.*

- 2.5" 741-1225-2C
- 3" 741-1234-2C
- 4" 741-1244-2C
- 5" 741-1254-2C
- 6" 741-1246-2C



**ZELPI WITH CEREBELLAR TIPS**  
**45° 3.5" Length**

741-1244-3

## OFFSET ZELPI RETRACTORS

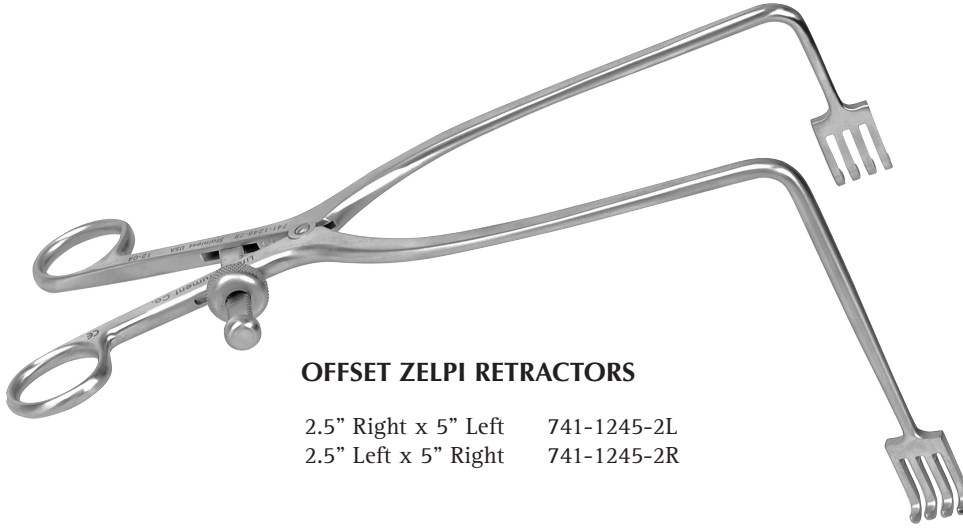

### OFFSET ZELPI RETRACTORS

2.5" Right x 5" Left 741-1245-2L  
2.5" Left x 5" Right 741-1245-2R

## DOUBLE PRONG ZELPI RETRACTOR

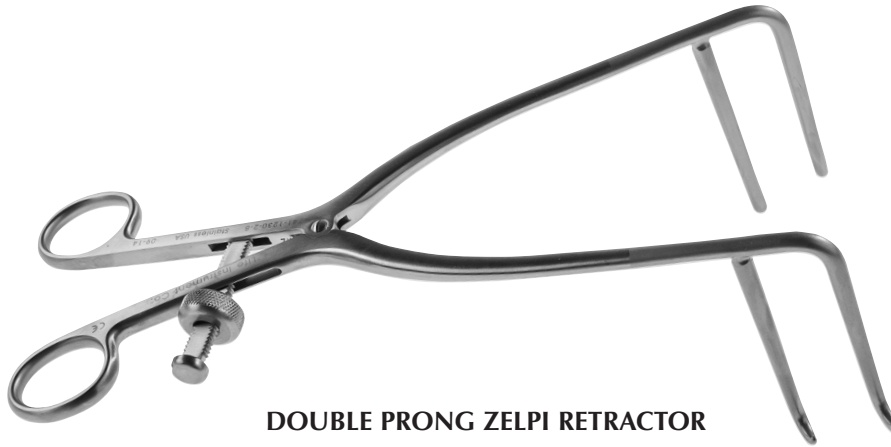

### DOUBLE PRONG ZELPI RETRACTOR

3" Deep 741-1230-2-8

## DEEP ZELPI RETRACTOR



### DEEP ZELPI RETRACTOR

3" Deep with Stop on Left Arm to Prevent "Creeping"

741-1230-2-1

# GELPI RETRACTORS



**ZELPI CEREBELLAR 90°  
GELPI STYLE RATCHETT**  
3" 741-1234-2-1

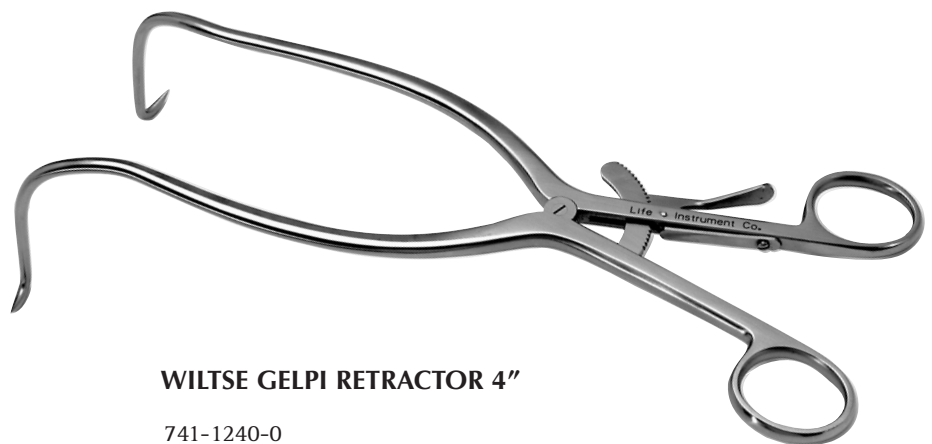

**WILTSE GELPI RETRACTOR 4"**  
741-1240-0

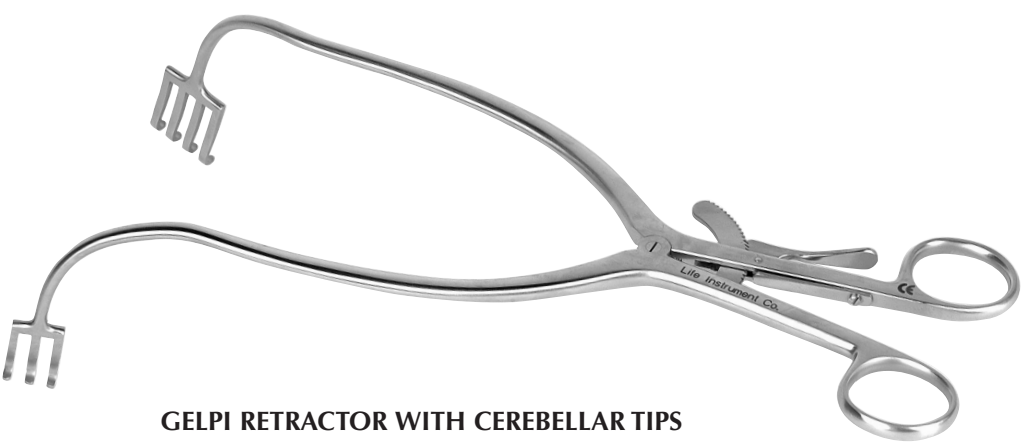

**GELPI RETRACTOR WITH CEREBELLAR TIPS**  
741-1241-0

## LARGE GELPI RETRACTOR



**LARGE GELPI RETRACTOR**

3" 741-1230-0 70°

## DEEP GELPI RETRACTOR 3"

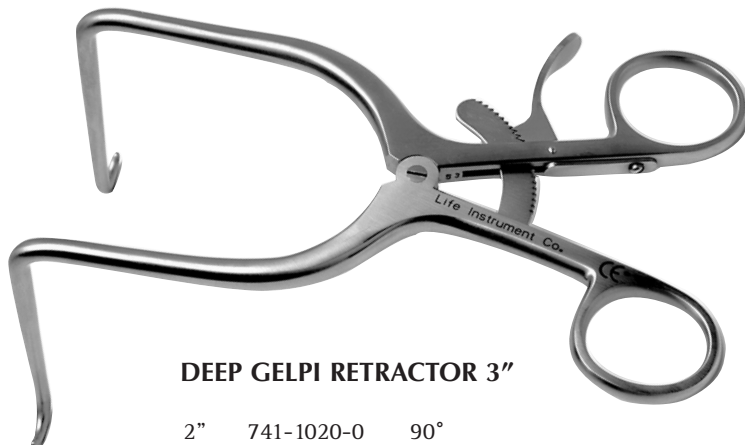

**DEEP GELPI RETRACTOR 3"**

2"	741-1020-0	90°
3"	741-1030-0	90°
4"	741-1040-0	90°

## MISKIMMON RETRACTOR



**MISKIMMON RETRACTOR**  
8" Length 200mm

741-0701-0

### MEYERDING RETRACTOR



**MEYERDING RETRACTOR**  
7.5" Length 190mm

2 3/8" x 1" (60 x 25mm) 741-0705-0

### GELPI RETRACTOR

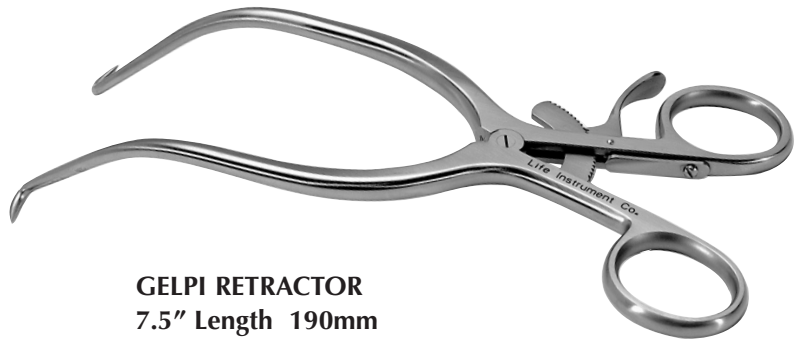

**GELPI RETRACTOR**  
7.5" Length 190mm

741-1010-0

### WEITLANDER RETRACTORS

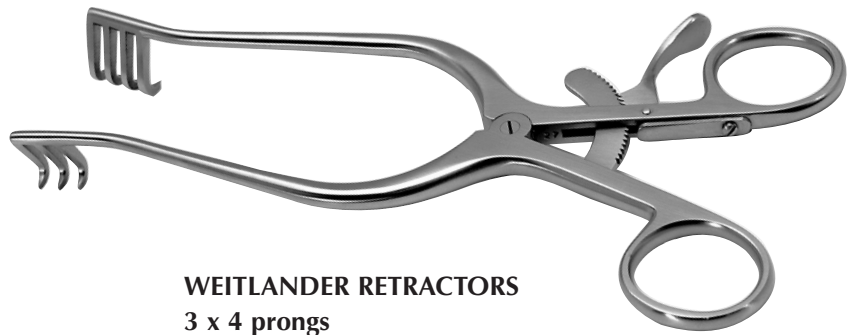

**WEITLANDER RETRACTORS**  
3 x 4 prongs

**SIZE**

- 5 1/2" 741-5501-0
- 6 1/2" 741-6500-0
- 7 3/4" 741-7750-0
- 9" 741-0900-0

TO ORDER, CALL 800-925-2995

## ADSON CEREBELLAR RETRACTORS

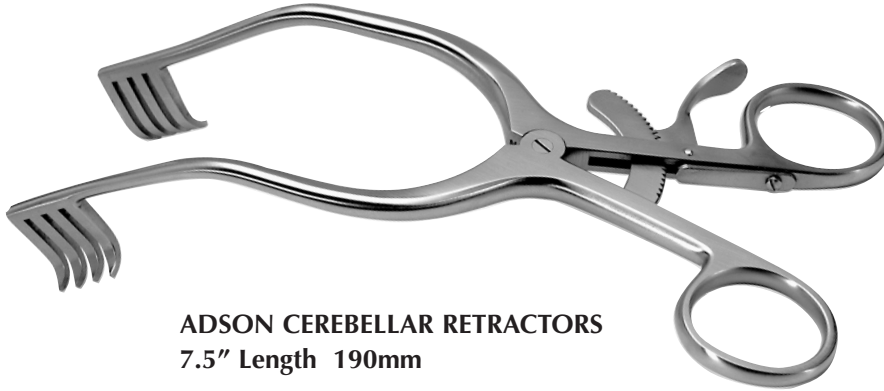

**ADSON CEREBELLAR RETRACTORS**  
7.5" Length 190mm

Sharp 741-0702-0  
Blunt 741-0702-0B

## ANGLED ADSON CEREBELLAR RETRACTORS



**ANGLED ADSON CEREBELLAR RETRACTORS**

**Sharp Tips**

60° 741-0702-1-60  
90° 741-0702-1-90

**Blunt Tips**

60° 741-0702-1B-60  
90° 741-0702-1B-90





## WILLIAMS RETRACTORS



### WILLIAMS RETRACTORS Micro Dissectomy Retractor

SIZE	
10mm x 70mm Left	741-0713-1
10mm x 70mm Right	741-0713-2
20mm x 70mm Left	741-0703-1
20mm x 70mm Right	741-0703-2

SIZE	
10mm x 50mm Left	741-0513-1
10mm x 50mm Right	741-0513-2
20mm x 50mm Left	741-0503-1
20mm x 50mm Right	741-0503-2

*Left/Right denotes blade side.*

## DUCKER RETRACTORS



### DUCKER RETRACTORS

50mm x 20mm Left	741-0750-1
50mm x 20mm Right	741-0750-2
70mm x 20mm Left	741-0770-1
70mm x 20mm Right	741-0770-2



### DOUBLE DUCKER RETRACTORS Double open blade - Interlocking

60mm x 21mm	741-0960-0
73mm x 21mm	741-0973-0
90mm x 21mm	741-0990-0



## MCELROY RETRACTORS



### MCELROY RETRACTORS 5" depth 125mm

#### SIZE

9"	740-0901-0
11"	740-1101-0
13"	740-1301-0 Extra Long

## MEYERDING RETRACTORS

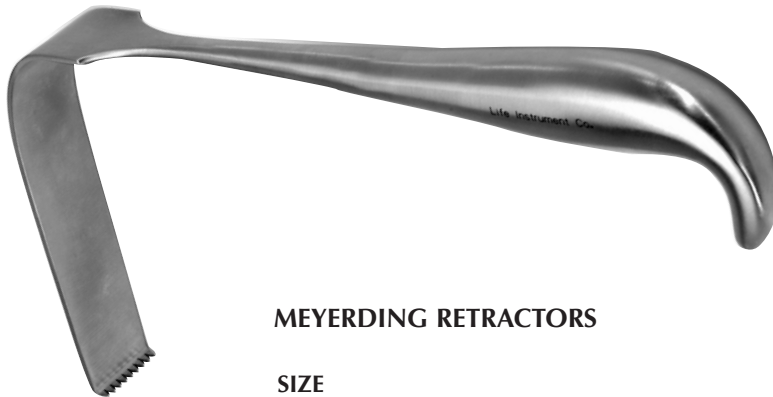

### MEYERDING RETRACTORS

#### SIZE

17mm x 55mm	748-0917-0
25mm x 80mm	748-0925-0
25mm x 125mm	748-0925-L
25mm x 150mm	748-0925-LC
50mm x 94mm	748-0950-0

# TAYLOR RETRACTORS



## MICRO TAYLOR RETRACTORS Blade width *only* 3/4" 19mm

**SIZE**

2"	50mm	748-9512-0
3"	75mm	748-9513-0
4"	100mm	748-9514-0
5"	125mm	748-9515-0
6"	150mm	748-9516-0



## CONCAVE MICRO TAYLOR RETRACTOR

3"	748-9523-1
4"	748-9524-1



## TAYLOR RETRACTORS Blade width 1 1/4" 30mm

3"	75mm	748-9503-0
4"	100mm	748-9504-0
6"	150mm	748-9506-0

## RADIOLUCENT PEEK CERVICAL RETRACTOR SYSTEM



### RADIOLUCENT PEEK CERVICAL RETRACTOR SYSTEM

748-0001-P

**\* Quick Connect Feature Holds Blade in Frame \***

Catalog #	Quantity	Description
748-1000-P	1	Transverse Retractor Frame Double Hinged Arms with Peek Connector
748-2000-P	1	Longitudinal Counter Retractor Frame Double Hinged Arms with Peek Connector
748-0030-1	2	Peek Blade Toothed 30mm
748-0035-1	2	Peek Blade Toothed 35mm
748-0040-1	2	Peek Blade Toothed 40mm
748-0045-1	2	Peek Blade Toothed 45mm
748-0050-1	2	Peek Blade Toothed 50mm
748-0055-1	2	Peek Blade Toothed 55mm
748-0060-1	2	Peek Blade Toothed 60mm
748-0065-1	2	Peek Blade Toothed 65mm
748-0030-2	2	Peek Blade Blunt 30mm
748-0035-2	2	Peek Blade Blunt 35mm
748-0040-2	2	Peek Blade Blunt 40mm
748-0045-2	2	Peek Blade Blunt 45mm
748-0050-2	2	Peek Blade Blunt 50mm
748-0055-2	2	Peek Blade Blunt 55mm
748-0060-2	2	Peek Blade Blunt 60mm
748-0065-2	2	Peek Blade Blunt 65mm
748-0700-0	2	Blade Holders
748-0000-PT	1	Sterilization Tray for Peek Cervical Retractor

# CERVICAL INSTRUMENTS



Special Peek Connector enables radiolucency in the AP plane.



### PEEK BLADES

Non-rotating

	TOOTHED	BLUNT
30mm	748-0030-1	748-0030-2
35mm	748-0035-1	748-0035-2
40mm	748-0040-1	748-0040-2
45mm	748-0045-1	748-0045-2
50mm	748-0050-1	748-0050-2
55mm	748-0055-1	748-0055-2
60mm	748-0060-1	748-0060-2
65mm	748-0065-1	748-0065-2



748-1000-P

TO ORDER, CALL 800-925-2995

## CERVICAL INSTRUMENTS

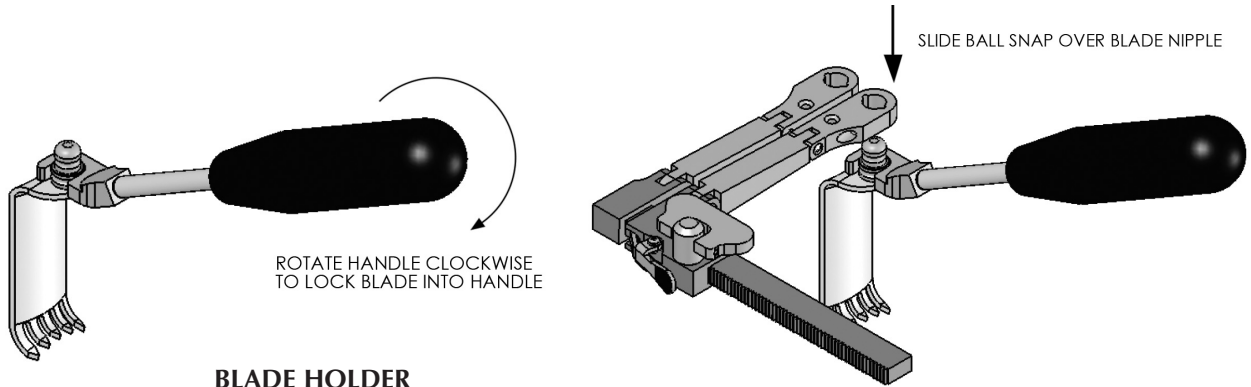
**BLADE HOLDER**

748-0700-0

**TRANSVERSE RETRACTOR FRAME WITH PEEK CONNECTOR**

748-1000-P

**LONGITUDINAL RETRACTOR FRAME WITH PEEK CONNECTOR**

748-2000-P



## ANTERIOR CERVICAL RETRACTOR SYSTEM

*\* Titanium Blades \**

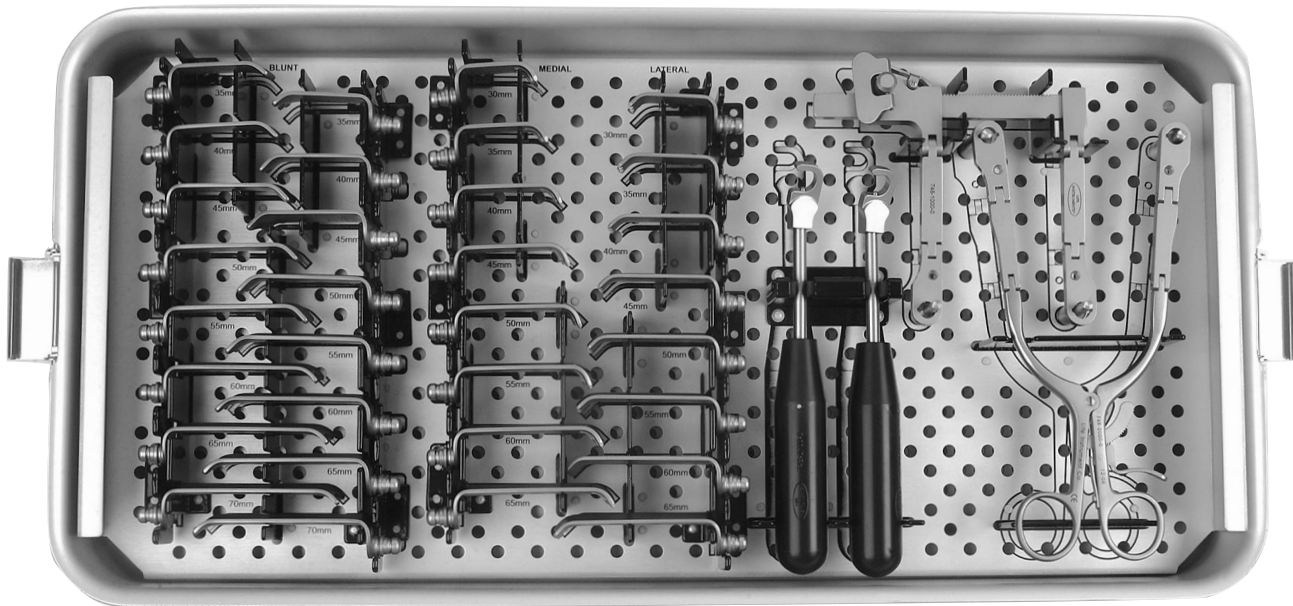

### RETRACTOR SYSTEM

748-0000-0

For complete system information please see pages 11.8 and 11.9.

Catalog #	Quantity	Description
748-1000-0	1	Transverse Retractor Frame Double Hinged Arms
748-2000-0	1	Longitudinal Counter Retractor Frame Double Hinged Arms
748-1030-1	1	Retractor Blade Medial 30x23 Toothed Titanium
748-1035-1	1	Retractor Blade Medial 35x23 Toothed Titanium
748-1040-1	1	Retractor Blade Medial 40x23 Toothed Titanium
748-1045-1	1	Retractor Blade Medial 45x23 Toothed Titanium
748-1050-1	1	Retractor Blade Medial 50x23 Toothed Titanium
748-1055-1	1	Retractor Blade Medial 55x23 Toothed Titanium
748-1060-1	1	Retractor Blade Medial 60x23 Toothed Titanium
748-1065-1	1	Retractor Blade Medial 65x23 Toothed Titanium
748-1035-2	2	Retractor Blade 35x23 Blunt Titanium
748-1040-2	2	Retractor Blade 40x23 Blunt Titanium
748-1045-2	2	Retractor Blade 45x23 Blunt Titanium
748-1050-2	2	Retractor Blade 50x23 Blunt Titanium
748-1055-2	2	Retractor Blade 55x23 Blunt Titanium
748-1060-2	2	Retractor Blade 60x23 Blunt Titanium
748-1065-2	2	Retractor Blade 65x23 Blunt Titanium
748-1070-2	2	Retractor Blade 70x23 Blunt Titanium
748-1030-3	1	Retractor Blade Lateral 30x23 Toothed Titanium
748-1035-3	1	Retractor Blade Lateral 35x23 Toothed Titanium
748-1040-3	1	Retractor Blade Lateral 40x23 Toothed Titanium
748-1045-3	1	Retractor Blade Lateral 45x23 Toothed Titanium
748-1050-3	1	Retractor Blade Lateral 50x23 Toothed Titanium
748-1055-3	1	Retractor Blade Lateral 55x23 Toothed Titanium
748-1060-3	1	Retractor Blade Lateral 60x23 Toothed Titanium
748-1065-3	1	Retractor Blade Lateral 65x23 Toothed Titanium
748-0700-0	2	Blade Holders
748-0000-T	1	Sterilization Tray: Includes Outer Tray and Lid, 1 Level Insert

\* See page 11.12 for Micro Titanium Blades 14mm width.

TO ORDER, CALL 800-925-2995

## CLOWARD CERVICAL RETRACTORS



### CLOWARD CERVICAL RETRACTORS

#### SIZE

13mm (no lip)	748-7513-0
18mm	748-7518-0
20mm	748-7520-0
23mm	748-7523-0
40mm	748-7540-0 Special with 5" Life handle

## NO-LIP CLOWARD CERVICAL RETRACTORS



### NO-LIP CLOWARD CERVICAL RETRACTORS

18mm without lip	748-7518-0C
20mm without lip	748-7520-0C
23mm without lip	748-7523-0C

## CERVICAL RETRACTORS

### CERVICAL RETRACTORS WITH DOUBLE FINGER HOLD

3" depth 75mm

Serrated	743-0603-0
Smooth	743-0613-0





### CERVICAL DISTRACTORS



#### CASPAR STYLE DISTRACTORS

- Right Distractor      743-1000-1
- Left Distractor      743-1000-2

#### Custom 100mm length

- Right Distractor      743-1000-1-1
- Left Distractor      743-1000-2-1



### HINGED DISTRACTOR

#### HINGED DISTRACTOR

743-1011-0

### CERVICAL DISTRACTION SCREW RETRACTOR BLADE



**Fits over Caspar Screw.  
Does not interfere  
with Distractor.**



#### CURVED CERVICAL DISTRACTION RETRACTOR BLADE

749-0018-1



#### CERVICAL DISTRACTION SCREW RETRACTOR BLADE

749-0018-0

TO ORDER, CALL 800-925-2995

## CERVICAL DISTRACTION SCREW



### CERVICAL DISTRACTION SCREW

SIZE	SINGLE	PACK OF 10
12mm	743-0012-0	743-0012-P10
14mm	743-0014-0	743-0014-P10
16mm	743-0016-0	743-0016-P10

*\* Non-Sterile \**

## DISTRACTION SCREWDRIVER



### DISTRACTION SCREWDRIVER

743-1001-0

## CALIPER

CALIPER  
749-1090-0

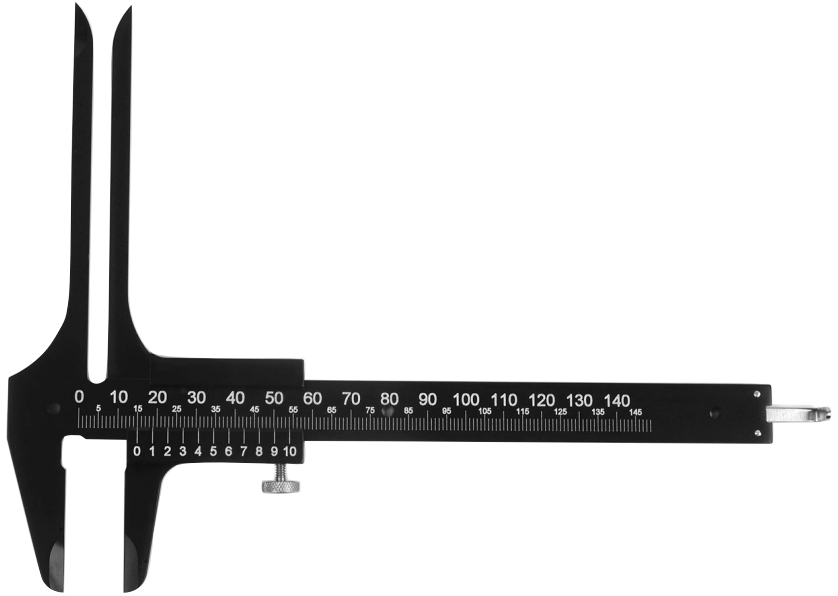

## TWIST DRILL



TWIST DRILL  
743-1003-0

## DRILL GUIDE

### DRILL GUIDE

Drill Guide Right	743-1002-1
Drill Guide Left	743-1002-2



# CERVICAL RETRACTOR CASPAR STYLE

## LONGITUDINAL RETRACTOR FRAME SINGLE HINGE

743-1301-0



## TRANSVERSE RETRACTOR FRAME SINGLE HINGE

743-1101-0



## RETRACTOR BLADES



MEDIAL

BLUNT

LATERAL

### MEDIAL BLADES

- 40 x 23mm 749-1140-1
- 45 x 23mm 749-1145-1
- 50 x 23mm 749-1150-1
- 55 x 23mm 749-1155-1
- 60 x 23mm 749-1160-1

### BLUNT BLADES

- 45 x 23mm 749-1145-2
- 50 x 23mm 749-1150-2
- 55 x 23mm 749-1155-2
- 60 x 23mm 749-1160-2
- 65 x 23mm 749-1165-2

### LATERAL BLADES

- 40 x 23mm 749-1140-3
- 45 x 23mm 749-1145-3
- 50 x 23mm 749-1150-3
- 55 x 23mm 749-1155-3
- 60 x 23mm 749-1160-3

## BLADE EJECTOR

### BLADE EJECTOR

749-0000-0



TO ORDER, CALL 800-925-2995

## McCULLOCH STYLE SYSTEM

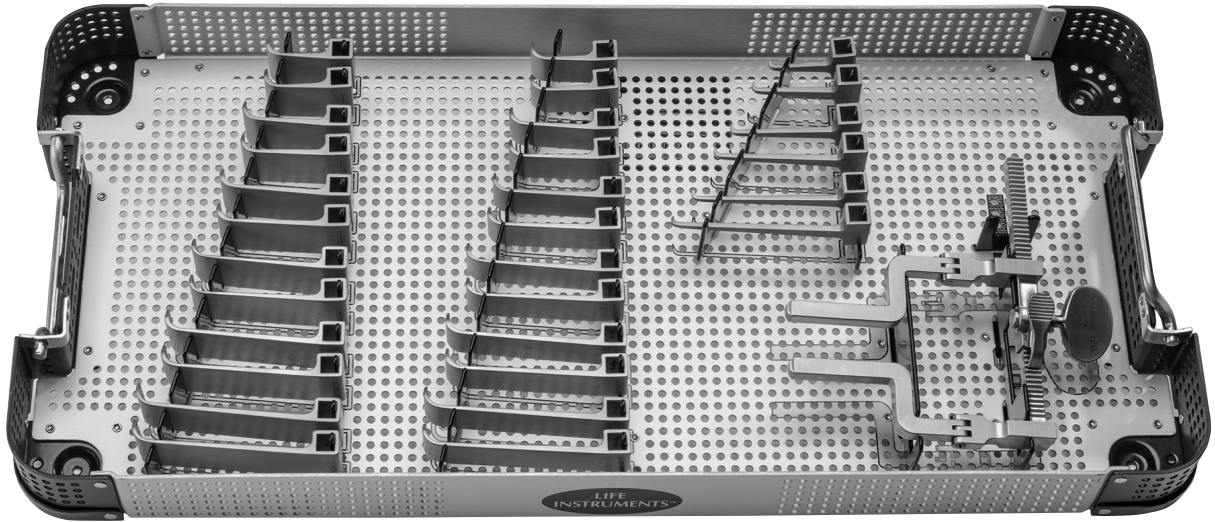

### McCULLOCH RETRACTOR SYSTEM

Matte Finish Stainless Steel

744-2000-0

#### Standard Set

Catalog #	Quantity	Description
744-0001-0	1	Hinged Retractor Frame
749-2030-0	2	Small Muscle Blades 20x30mm
749-2040-0	2	Small Muscle Blades 20x40mm
749-2050-0	2	Small Muscle Blades 20x50mm
749-2060-0	2	Small Muscle Blades 20x60mm
749-2070-0	2	Small Muscle Blades 20x70mm
749-2080-0	2	Small Muscle Blades 20x80mm
749-2730-0	2	Large Muscle Blades 27x30mm
749-2740-0	2	Large Muscle Blades 27x40mm
749-2750-0	2	Large Muscle Blades 27x50mm
749-2760-0	2	Large Muscle Blades 27x60mm
749-2770-0	2	Large Muscle Blades 27x70mm
749-2780-0	2	Large Muscle Blades 27x80mm
749-0030-0	1	Hook 30mm
749-0040-0	1	Hook 40mm
749-0050-0	1	Hook 50mm
749-0060-0	1	Hook 60mm
749-0070-0	1	Hook 70mm
749-0080-0	1	Hook 80mm
744-2000-T	1	Sterilization Case for Retractor System

*Additional length components available.*

COMPONENTS

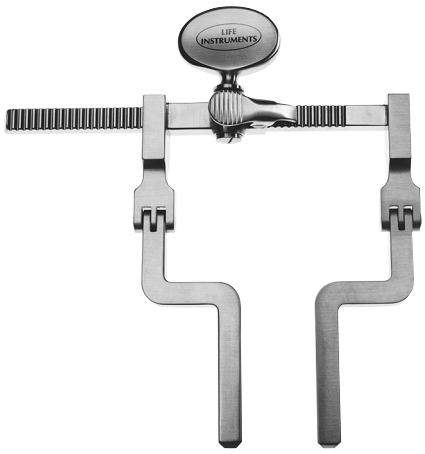

**FRAME**  
744-0001-0



**HOOK**



**SMALL AND LARGE MUSCLE BLADES**

ADDITIONAL ITEMS



**LONG SMALL MUSCLE BLADE**



**LONG LARGE MUSCLE BLADE**

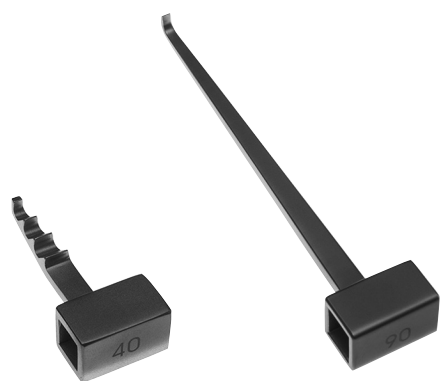

**STEPPED HOOK**

**LONG HOOK**

Catalog #	Quantity	Description
749-2090-0	1	Long Small Muscle Blade 20x90mm
749-2000-0	1	Long Small Muscle Blade 20x100mm
749-2011-0	1	Long Small Muscle Blade 20x110mm
749-2012-0	1	Long Small Muscle Blade 20x120mm
749-2490-0	1	Long Large Muscle Blade 24x90mm
749-2400-0	1	Long Large Muscle Blade 24x100mm
749-2411-0	1	Long Large Muscle Blade 24x110mm
749-2412-0	1	Long Large Muscle Blade 24x120mm

Catalog #	Quantity	Description
749-0030-1	1	Stepped Hook 30mm
749-0040-1	1	Stepped Hook 40mm
749-0050-1	1	Stepped Hook 50mm
749-0060-1	1	Stepped Hook 60mm
749-0070-1	1	Stepped Hook 70mm
749-0080-1	1	Stepped Hook 80mm
749-0090-1	1	Stepped Hook 90mm
749-0100-1	1	Stepped Hook 100mm
749-0110-1	1	Stepped Hook 110mm
749-0090-0	1	Extra Long Hook 90mm
749-0100-0	1	Extra Long Hook 100mm
749-0110-0	1	Extra Long Hook 110mm

TO ORDER, CALL 800-925-2995

## RADIOLUCENT RETRACTORS



**PINION**  
Included with Frame

644-0001-K



**RADIOLUCENT CARBON FIBER PEEK  
RETRACTOR FRAME**

644-0001-0

### CARBON FIBER PEEK BLADES

SIZE	20mm width	25mm width
50mm	649-2050-0	649-2550-0
70mm	649-2070-0	649-2570-0
90mm	649-2090-0	649-2590-0
110mm	649-2011-0	649-2511-0

*Additional blade sizes available upon request.  
Please visit our website at [www.lifeinstruments.com](http://www.lifeinstruments.com).*

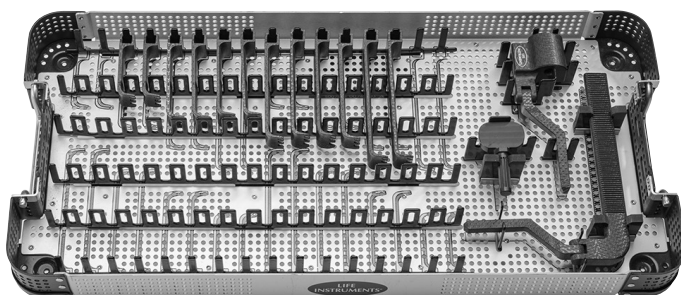

**RADIOLUCENT RETRACTOR TRAY**

644-0000-T

# MICRO LUMBAR DISCECTOMY RETRACTOR



**RETRACTOR FRAME**

749-1401-0

## SPECULAS

40mm	749-1440-0
45mm	749-1445-0
50mm	749-1450-0
55mm	749-1455-0
60mm	749-1460-0
65mm	749-1465-0
75mm	749-1475-0



## BLADES

35mm	749-1435-1
40mm	749-1440-1
45mm	749-1445-1
50mm	749-1450-1
55mm	749-1455-1
60mm	749-1460-1
65mm	749-1465-1
70mm	749-1470-1
75mm	749-1475-1



TO ORDER, CALL 800-925-2995

## OFFSET LAMINA SPREADERS

### OFFSET LAMINA SPREADER

741-1106-1



### OFFSET LAMINA SPREADER WITH LOCKING SPINDLE

741-1106-1S



## LAMINA SPREADERS

### LAMINA SPREADER WITH LOCKING SPINDLE

3" Deep      741-9503-0S  
5" Deep      741-9505-0S

*Available without teeth upon request.*





# LAMINA SPREADERS

## LAMINA SPREADERS

- Small 6.5" 741-6506-0
- Small 6.5" 741-6506-0S with Spindle
- Small 6.5" 741-6506-0C no teeth - serrations only
- Large 10" 741-9503-0



SMALL



LARGE

# LONG TAPERED SPREADER

## LONG TAPERED SPREADER

- 741-6570-0T
- 741-6570-0 Spreader without taper



## MULTI ACTION RETRACTORS



### PLAN B MULTI ACTION RETRACTOR WITH LOCKING SPINDLE

50mm	741-7550-0
75mm	741-7575-0
100mm	741-7500-0

Can be used with Life Instrument Arm and Universal Attachment to stabilize to O.R. table. See page 10.3.

## LOVE NERVE ROOT RETRACTORS

### LOVE NERVE ROOT RETRACTORS

Straight	746-1070-0
45°	746-1070-1 5" from bend (125mm)
90°	746-1070-2

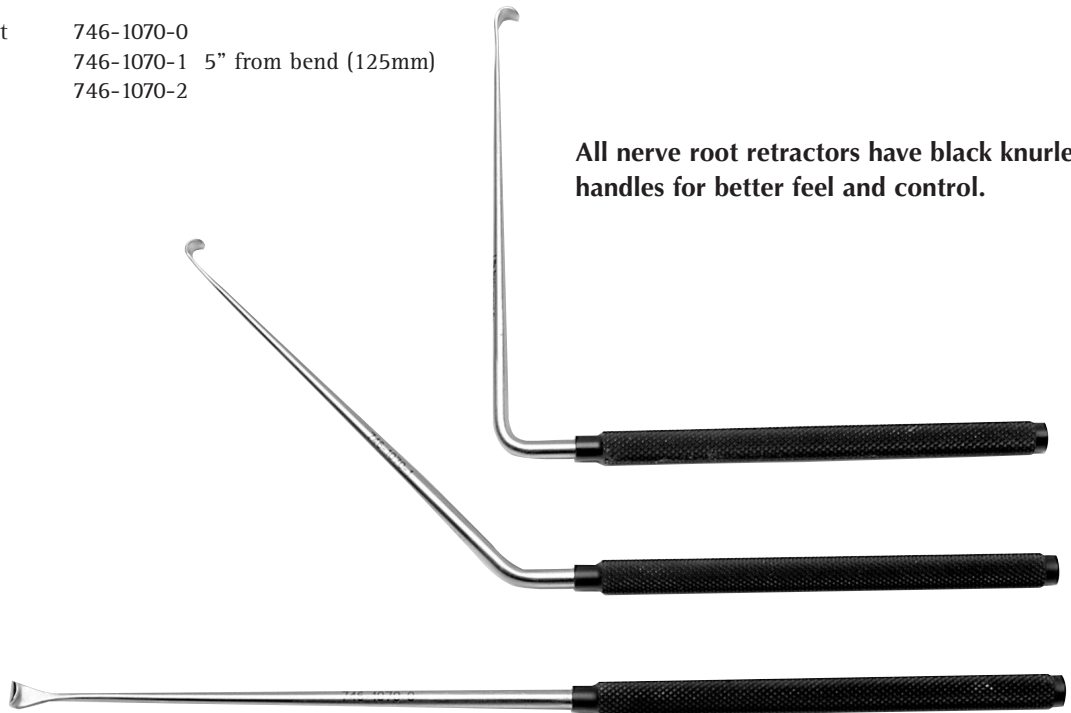

All nerve root retractors have black knurled handles for better feel and control.

## SCOVILLE RETRACTORS



### SCOVILLE RETRACTORS Large Handle

#### 8mm

45°	746-1080-1-2	5" working length
Bayonet	746-1080-3-2	4.5" working length

#### 10mm

45°	746-1010-1-2
Bayonet	746-1010-3-2

## WIDE SCOVILLE NERVE ROOT RETRACTORS

### WIDE SCOVILLE NERVE ROOT RETRACTORS 7" from bend 45°

10mm	746-1210-1
12mm	746-1212-1
14mm	746-1214-1

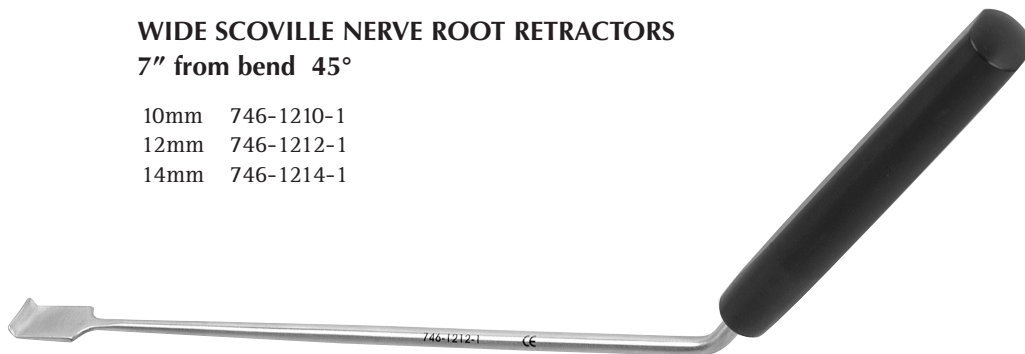

## SCOVILLE NERVE ROOT RETRACTORS

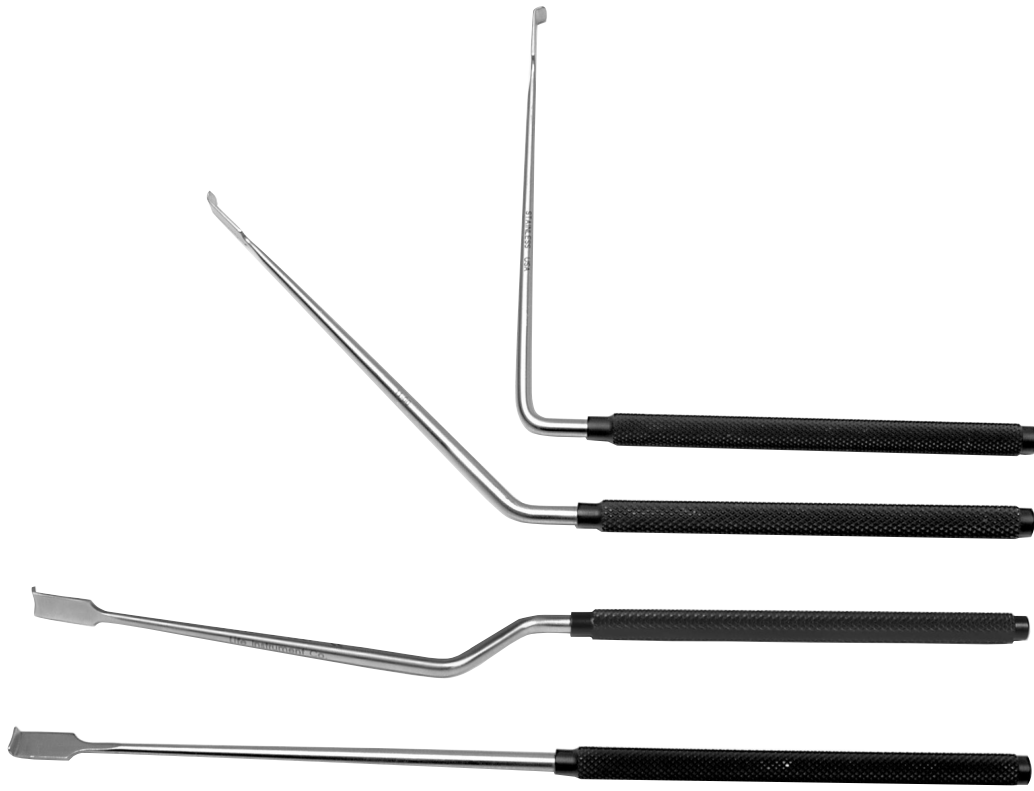

### SCOVILLE NERVE ROOT RETRACTORS

#### 8mm

Straight	746-1080-0
45°	746-1080-1 5" from bend (125mm)
90°	746-1080-2
Bayonet	746-1080-3

### HESS NERVE RETRACTORS

#### 3mm

45°	746-1030-1
90°	746-1030-2
Bayonet	746-1030-3



#### 5mm

45°	746-1050-1
90°	746-1050-2
Bayonet	746-1050-3

**All nerve root retractors have black knurled handles for better feel and control.**

*Custom handles available upon request.  
No lip available upon request.*

# EXTRA LONG NERVE ROOT RETRACTORS

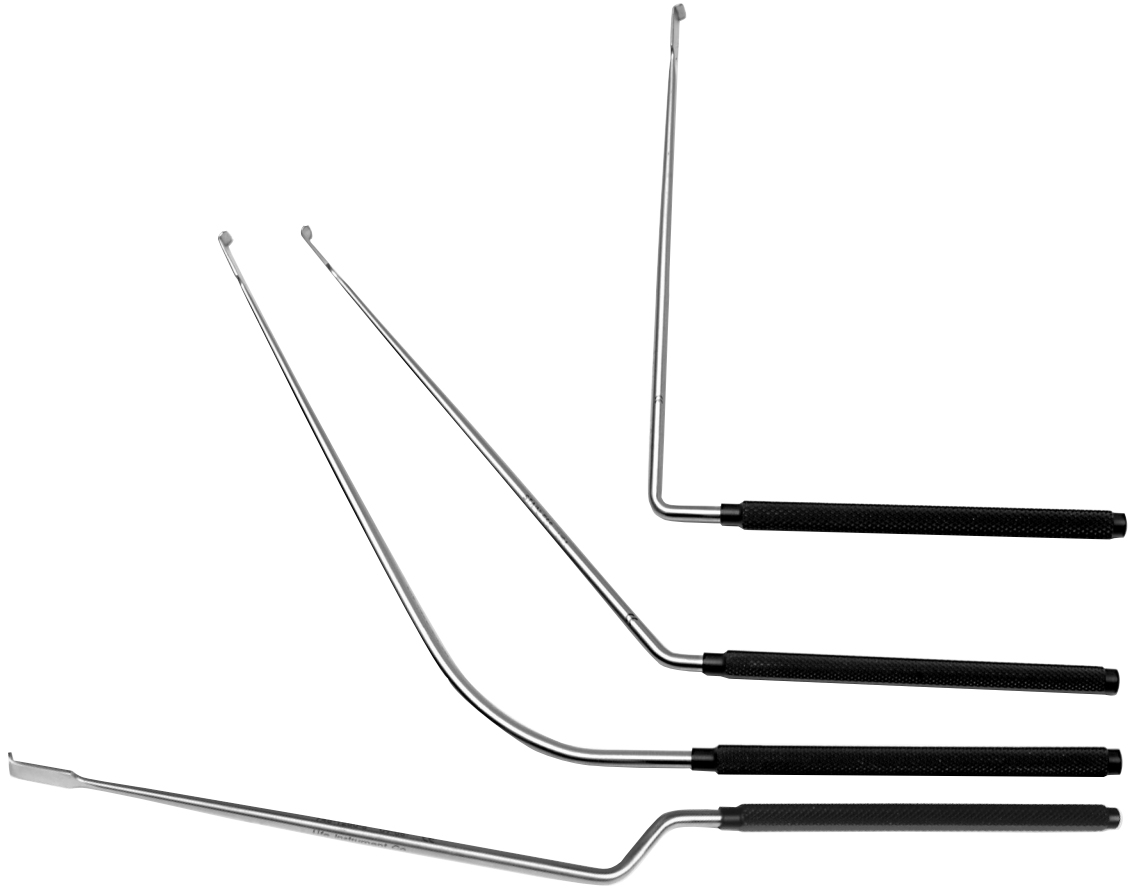

## SCOVILLE RETRACTORS

### 8mm

90°	746-1280-2	7" from bend (175mm)
45°	746-1280-1	7" from bend (175mm)
Full Curve	746-1280-4	
Bayonet	746-1280-3	6" from bend (150mm)

## HESS NERVE RETRACTORS

### 3mm

90°	746-1230-2	7" from bend (175mm)
45°	746-1230-1	7" from bend (175mm)
Bayonet	746-1230-3	6" from bend (150mm)

### 5mm

90°	746-1250-2	7" from bend (175mm)
45°	746-1250-1	7" from bend (175mm)
Bayonet	746-1250-3	6" from bend (150mm)

*Custom handles available upon request.*



**All nerve root retractors have black knurled handles for better feel and control.**

## MEMORY METAL INSTRUMENTS



### NERVE ROOT RETRACTORS

#### Nitinol Shaft

#### BAYONET

8mm	4.5" working length	746-1080-3N
8mm	6" working length	746-1280-3N
5mm	6" working length	746-1250-3N

#### 45°

5mm	7" working length	746-1250-1N
8mm	7" working length	746-1280-1N

#### 90°

5mm	7" working length	746-1250-2N
8mm	7" working length	746-1280-2N

*\* Great for Custom Angles and Hard to Reach Areas \**

*\* Returns to Original Form After Sterilization \**

## V-STYLE NERVE RETRACTOR

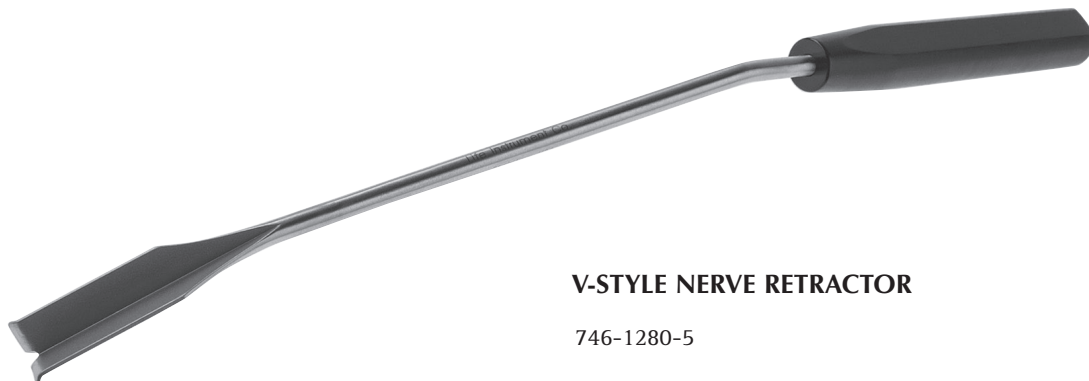

### V-STYLE NERVE RETRACTOR

746-1280-5

# NERVE ROOT RETRACTORS



## NERVE ROOT RETRACTORS

Regular 8.5"	215mm	746-8520-0
Fine 8.5"	215mm	746-8520-1 (not shown)
Fine 10.5"	265mm	746-1020-1
Regular 10.5"	265mm	746-1020-0
Anterior 16.5"	420mm	746-1620-0 (shown on p. 7.5)



Nerve Hook	13mm	746-1020-0C
Nerve Hook	5mm	746-1020-1-2
Nerve Hook	3mm	746-1020-1-1



Fine Nerve Hook 6mm 746-0860-1

## BAYONET NERVE HOOK



### BAYONET NERVE HOOK 6" working length 150mm

746-1120-3	Down (shown above)
746-1120-3R	Right
746-1120-3L	Left
746-1120-3U	Up

## MICRO BAYONET NERVE HOOK



### MICRO BAYONET NERVE HOOK

746-1101-3M

## MURPHY PROBES



### MURPHY PROBES 2.7mm ball size

Murphy Ball Hook	8.5" 215mm	747-8100-1
Murphy Ball Hook w/Suture Hole		747-8100-2 (not shown)
8.5" Straight Ball Probe	215mm	747-8100-0
Murphy Ball Hook Long	10.5" 265mm	747-1050-1
Long Straight Ball Probe	10.5" 265mm	747-1050-0

## BALL PROBES



### BALL PROBES 9" length 230mm

Ball Probe #1	Straight	747-9001-0
Ball Probe #2	8mm 65° Bend	747-9002-0
Ball Probe #3	10mm 80° Bend	747-9003-0
Ball Probe #4	12mm 75° Bend	747-9004-0
Ball Probe #5	13mm 80° Bend	747-9005-0
Set of 5		747-9000-0



### BAYONET BALL PROBES

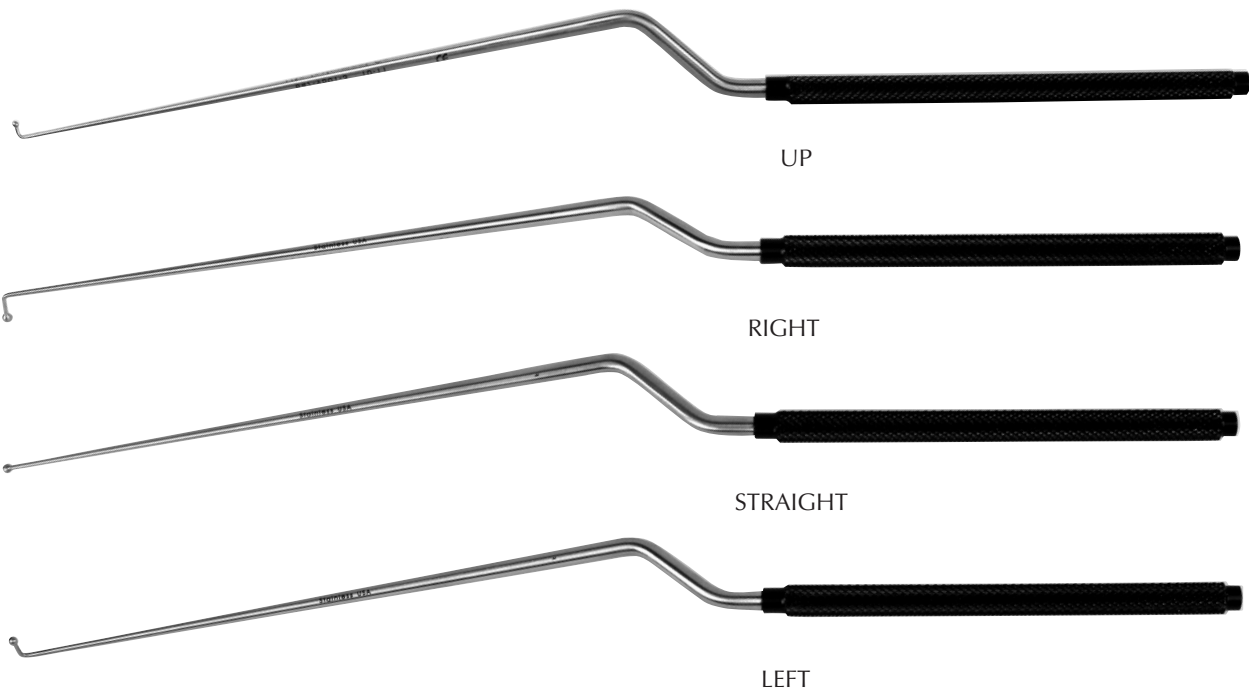

#### BAYONET BALL PROBES 6" working length

Ball Probe Straight	847-9503-3C
Ball Probe 5mm Up	847-9501-3
Ball Probe 5mm Right	847-9501-3RC
Ball Probe 5mm Left	847-9501-3LC
Ball Probe 9mm Up	847-9503-3
Ball Probe 9mm Right	847-9503-3RC
Ball Probe 9mm Left	847-9503-3LC

### FLEXIBLE BALL PROBES

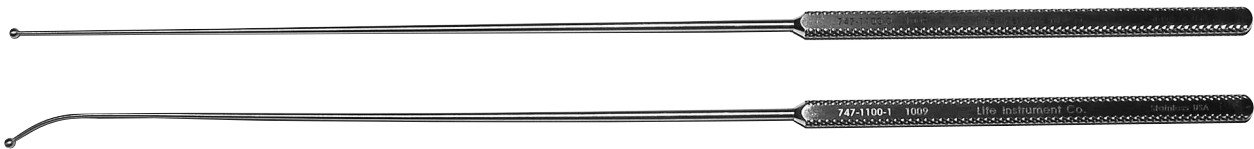

#### FLEXIBLE BALL PROBES 10.5" overall length

Ball Probe Straight	747-1100-0
Ball Probe Curved	747-1100-1

## MICRO BALL PROBES

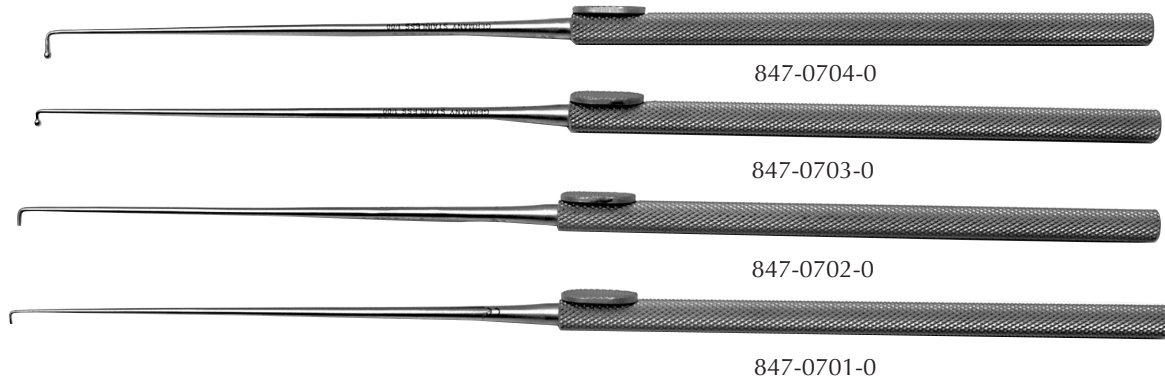

### MICRO BALL PROBES AND HOOKS 7" length 175mm

Nerve Hook 2mm	847-0701-0
Nerve Hook 3mm	847-0702-0
3mm Ball Probe	847-0703-0
4mm Ball Probe	847-0704-0

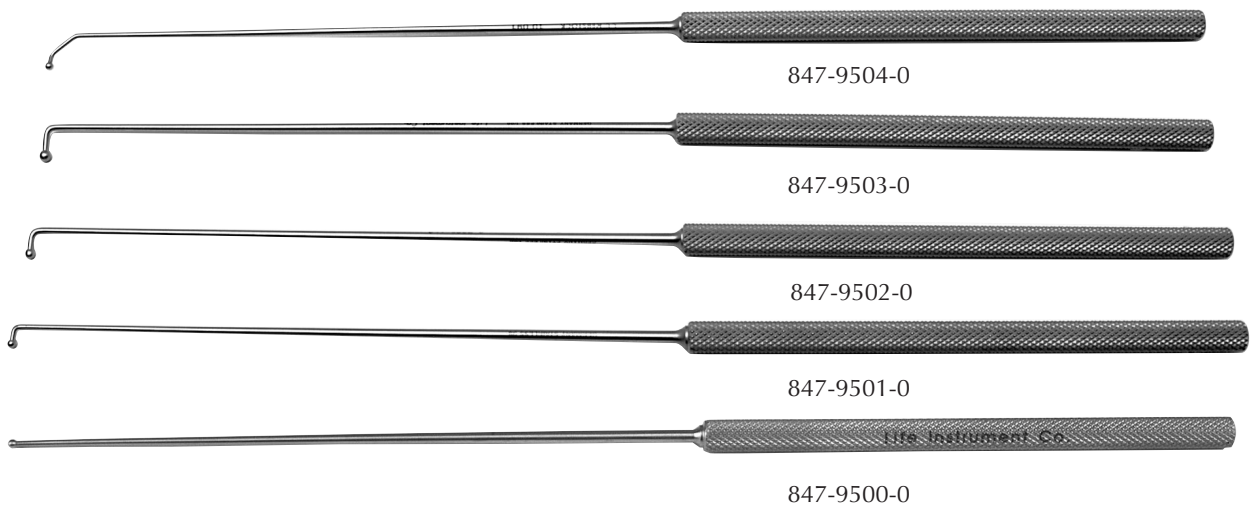

### MICRO BALL PROBES 9.5" overall length 245mm

5mm Ball Probe	847-9501-0
7mm Ball Probe	847-9502-0
9mm Ball Probe	847-9503-0
Curved Ball Probe	847-9504-0
Straight Ball Probe	847-9500-0



### MICRO NERVE HOOK 9.5" overall length 245mm

846-0905-1 5mm

# CARBON FIBER RETRACTORS



**CARBON FIBER ANTERIOR RETRACTORS  
WYLIE STYLE**  
Blade width 25mm

<b>BLADE DEPTH</b>	
3"	645-2530-0
4"	645-2540-0
6"	645-2560-0
8"	645-2580-0

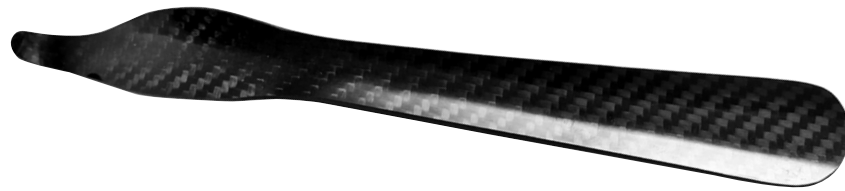

**HOHMANN STYLE RETRACTOR**  
9.5" overall length

10mm	643-9510-0
18mm	643-9518-0
25mm	643-9525-0



**CLOWARD RETRACTOR**  
100mm blade

648-7520-0

## SUCTION SCOVILLE RETRACTOR



**SUCTION SCOVILLE RETRACTOR**  
7mm

746-1150-1



## SCOVILLE RETRACTOR WITH SUCTION TIP



**SCOVILLE RETRACTOR WITH SUCTION TIP**  
5" from bend

5mm	790-0805-0	8 FR
8mm	790-0808-0	8 FR

See pages 8.1 through 8.5 for additional suction tubes.

