

# hi-fi news

THE HOME OF REAL HI-FI

& Record Review

Exclusive

# SUPERIOR SASHA

Wilson's best-seller gets a Series-2 makeover



## Ayre AX-5

The 'Diamond' amplifier

## Lindemann MB25

Network streaming preamp

## Consonance Isolde

Opera Audio's turntable & arm

### GROUP TEST

## Integrated amplifiers

Five £1500+ favourites tested

## Your headphones' hidden flaw

HFN's Special Investigation, p14

## Speaker matching perfected?

Devialet exclusive, p6 & p98

• PLUS 18 pages of music reviews & features • VINYL RE-RELEASE *Foxtrot* by Genesis on 180g LP  
• OPINION 11 pages of letters and comment • VINTAGE REVIEW The B&O Beogram 4000 turntable  
• SHOW BLOG We report from Paris & San Francisco • READERS' CLASSIFIEDS Hi-fi bargains galore

UK £4.50 US \$9.99 Aus \$9.95



---

MUSICAL FIDELITY

---

MF-100

SUPERIOR PERFORMANCE HEAD PHONES



When music matters most

VERY HIGH QUALITY • MUSICAL FIDELITY DESIGNED  
NEODYMIUM DRIVE UNITS



**ABOVE:** Lindemann's MB25 combines CD, USB host and network media player in one elegant package. See p28



**ABOVE:** The Isolde belt-drive turntable and partnering T8 tonearm from Consonance make for a cost-effective solution. See p32

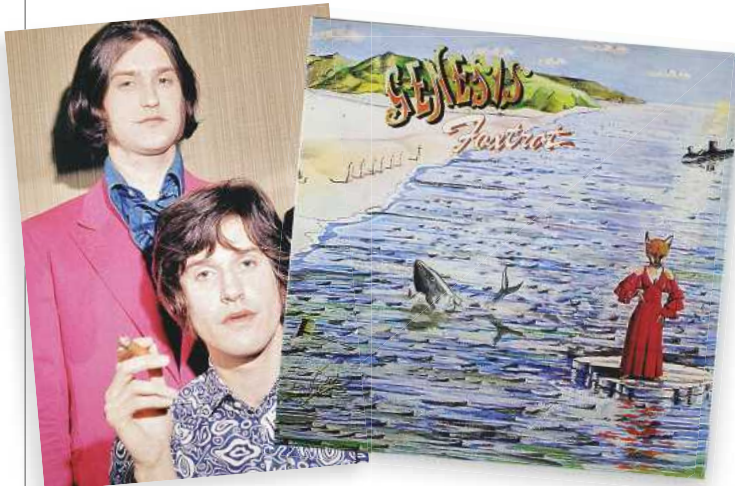

**VINYL:** The Kinks' *Face To Face* is this month's Vinyl Icon (p72) while Steve Sutherland relives a concert from his youth in the sticks as *Foxtrot* by Genesis is reissued as a 180g LP (p70)

**RIGHT:** *Hi-Fi News & RR* is the exclusive UK representative of EISA's Audio and Home Theatre panels. Paul Miller is EISA's Audio and HT Panel Manager



System-matching remains one of the 'arts' of compelling hi-fi. You might think that assembling a system from the most highly recommended of players, amps and loudspeakers will guarantee you the best sound for your money. But it ain't necessarily so. Sure, the combination will likely sound good, but I wouldn't bank on it sounding *great*. Unfortunately, life and hi-fi are rarely that simple.

Quite often it takes a subtle blend of qualities between the components, one compensating for or enhancing the performance of the other. With a following wind and an experienced hi-fi dealer, a sympathetically matched system will always exceed the sum of its parts. It'll sound great whatever the price.

So you can imagine my surprise when Devialet, the French company behind the iconic hybrid digital amplifier, approached *Hi-Fi News* with exclusive, pre-launch information about a technology that aims to take the hit-or-miss from amp/speaker matching.

You'll need to use one of Devialet's amplifiers, of course, and there are currently a very limited number of loudspeakers mapped into its 'brain', but the concept is intriguing. You can read more about this latest

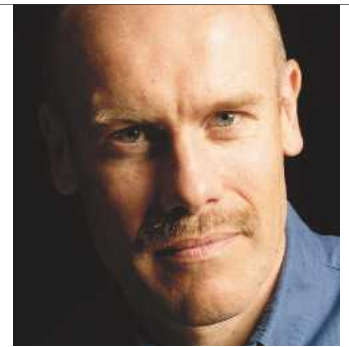

innovation, called SAM, in our News and Opinion pages (p6 and p98) but my initial experience suggests this rapidly expanding company is on to a winner. The real winners are Devialet owners of course, as the SAM upgrade will be free.

Want to hear it for yourself? The first public demonstration will be at the High End Show in Munich, mid-May. If you miss

## 'Are the days of hit-or-miss speaker matching finally over?'

this, we'll certainly have the technology featured at our own *Hi-Fi Show Live* at the Beaumont Estate in Old Windsor on the 1st-2nd November.

We also have the exclusive review of Wilson's latest Sasha floorstanders in this issue (p20). The Mk1 was Wilson's most popular loudspeaker, so there's a lot riding on Series-2. But I wonder what they'd sound like with SAM?

**PAUL MILLER EDITOR**

### HI-FI NEWS' EXPERT LINE UP: THE FINEST MINDS IN AUDIO JOURNALISM BRING THEIR EXPERIENCE TO BEAR ON ALL AREAS OF HI-FI & MUSIC

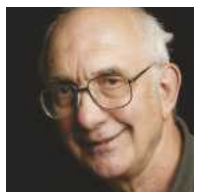

**BARRY FOX**  
Investigative journalist supreme, Barry is the first with news of the latest developments in hi-fi and music technologies



**JOHN BAMFORD**  
JB brings huge industry experience, a penchant for massive speakers and a love of hi-res audio in all its diverse guises



**KEN KESSLER**  
is currently our Senior Contributing Editor and almost singularly responsible for the renaissance in valves and 'vintage hi-fi'



**KEITH HOWARD**  
has written about hi-fi for 30 years, and edited *Hi-Fi Answers* for nine. KH performs our speaker and headphone lab tests



**STEVE HARRIS**  
Former Editor of this very title from 1986 through to 2005. A lifetime in audio and a love of jazz makes Steve a goldmine



**JOHN HOWES**  
Foremost collector and archivist of vintage hi-fi, famous for the UK's bi-annual Audio Jumble, John shares his experience with *HFN*



**STEVE SUTHERLAND**  
Worked on *Melody Maker* and then edited *NME* from 1992-2000, the Britpop years. Steve brings a unique slant to our Vinyl Release pages

# LUXMAN

PURE CLASS A INTEGRATED AMPLIFIER

## L-550AX

## L-590AX



L-550AX

L-590AX

Distributed by  
Select Audio  
Tel 01900 601954  
[www.selectaudio.co.uk](http://www.selectaudio.co.uk)  
[www.luxman.co.jp/global](http://www.luxman.co.jp/global)

# CONTENTS

JUNE 14

## VINYL & RECORD REVIEWS

- 68 Vinyl Frontier**  
Chris Heard brings you the best new LP reissues and re-releases
- 70 Vinyl Release**  
A 'well weird stand-out album by a band who were becoming weirder by the day...' Steve Sutherland on Genesis's *Foxtrot*, on 180g vinyl
- 72 Vinyl Icon**  
Arguably one of rock's first concept albums with its theme of social observation. Johnny Black on the making of The Kinks' *Face To Face*
- 78 Classic Rock Venues**  
Steve Sutherland continues his tour of the world's iconic rock venues, this month bringing you the story of the Friars club in Aylesbury
- 85 Music Reviews**  
Our selection of audiophile LP and hi-res downloads plus the latest rock, jazz and classical albums

## DEFINITIVE PRODUCT REVIEWS

- 20 Wilson Sasha Series-2**  
Revamp for the Sasha uses tech from flagship Alexandria XLF, but at £28.5k is this speaker a steal?
- 24 Ayre AX-5**  
Big-ticket luxurious integrated said to 'throw 55 years of preamplifier history out the window'. A success?
- 28 Lindemann Musicbook 25**  
Ready to downsize? This high-end compact network and USB music player also has a CD drive
- 32 Consonance Isolde/T8**  
Chinese deck with carbon fibre arm hopes to make a mark with its ease of use and sheer value for money
- 39 Group Test: £1.5-2k amps**  
At this price, integrated amps offer a wide choice of features, power and style. We test five of the best



- 50 Dynaudio Excite X38**  
'Resounding bass, thrilling dynamics, incredible control...' can the Excite flagship speaker live up to its billing?
- 54 Cambridge Audio 851E/W**  
High-end amps without heavy duty price tags as company wrings greater performance from its Class XD tech
- 58 PS Audio Power Plant 3**  
How the company's most affordable mains regenerator can transform the sound of your system
- 61 In-akustik LS-1603**  
Pristine speaker cable from Germany offers sizzling sound quality
- 62 Schiit Audio Magni**  
'Budget Esoterica' continues – is this the best £100 headphone preamp?

## VINTAGE

- 114 Buying vintage hi-fi**  
How to secure the best vintage hi-fi buys, this month looking at the pros and pitfalls of used arms and pick-ups
- 120 Vintage Review**  
How do the classic components of yesteryear measure up today? This month we take B&O's Beogram 4000 turntable to the test bench

## NEWS AND OPINION

- 06 News**  
Devialet unveils digital speaker matching tech, Oppo launches planar magnetic headphones, Sonus faber celebrates its 30th and a new CD and amp from Yamaha
- 08 Show Blog**  
From tubes and prototype bamboo speakers to a hall for headphones... Ken Kessler hot-foots it south then west to bring you best that both Paris and San Francisco had to offer
- 14 Investigation**  
Ever stopped to consider whether the headband forming part of your headphones is having a detrimental effect on their sound? Keith Howard has, and sees if he can measure it
- 98 Opinion**  
Insider comment on the audio topics of the day from Paul Miller, Barry Fox, Jim Lesurf, Steve Harris and, writing from the US, Barry Willis
- 106 Sound Off**  
Your experiences with aftermarket 'tweaks', clearing up Clearaudio confusion, a reader's hi-res system on a shoestring, plus what's going on with DSD and PCM recordings?
- 138 Off The Leash**  
As traditional hi-fi brands embrace the modern world so Ken Kessler applauds those who have prevented us drowning in a sea of 'dreck'



**ABOVE: For our Group Test of £1500-£2000 amplifiers, turn to p39**



**LEFT: Cambridge Audio's 851E preamp and 851W power amp sees the company harness its proprietary Class XD technology in a bid to offer true high-end sound at affordable prices. Does it succeed? See p54**

**SUBSCRIBE!**  
**hi-finews**  
KEF Anniversary book  
See page 82

# Devialet unveils SAM

FRENCH AMPLIFIER INNOVATORS LAUNCH NEW LOUDSPEAKER MATCHING SYSTEM

SAM (Speaker Active Matching) has been described by Devialet as its 'second technical revolution' following the ADH concept at the heart of its amplifiers. SAM was conceived to allow any Devialet amplifier to adapt its behaviour to the attached loudspeaker by processing the audio signal in the digital domain according to a detailed mathematical model of the loudspeaker's bass performance (up to 150Hz).

The proprietary code accounts for the speaker's electrical, mechanical and acoustical behaviour and runs in real time on the amplifier's 'spare' 400MHz SHARC DSP (one of three).



Sample-by-sample, it claims to compute the exact voltage to be applied to the loudspeaker to ensure that its low frequency acoustical response remains a faithful image of the recorded signal [see illustration].

Currently only one B&W and Vivid loudspeaker are accommodated [see Opinion, p98] but once a wider range is mapped by Devialet, and the system goes 'live', its customers will be able to select their

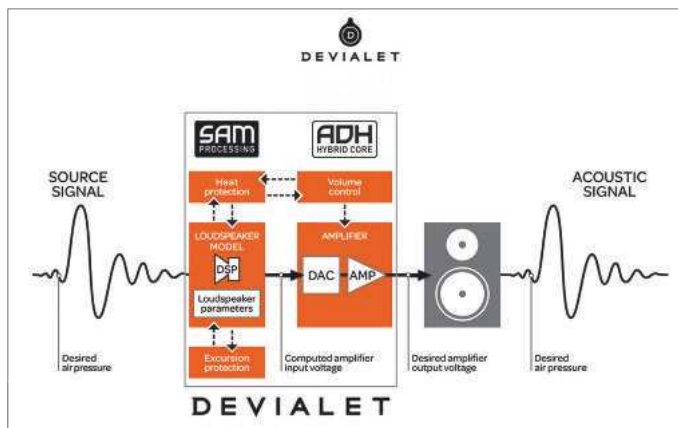

own speaker from a list and download and install the SAM software via Devialet's website 'Configurator'.

Despite the investment in staff and resources to complete this

multi-year coding project, SAM will be free to existing Devialet owners who may now vote online for their favourite models to be included! **Devialet, 0208 971 3909; <http://en.deviale.com>, [www.absolutesounds.com](http://www.absolutesounds.com)**

## Oppo's head start

KING OF BLU-RAY LAUNCHES HIGH-END CANS

Encouraged by the dominant position it has achieved in the high-end BD/Universal player market, Oppo is stretching out with the launch of a new open-backed headphone and partnering headphone preamplifier. The £1099 PM-1 is a planar magnetic design which employs a 'unique 7-layer diaphragm', a sandwich of different polymers, driven by a spiralling pattern of flat conductors etched on both sides of the outer film. Oppo claims a purely resistive 32ohm impedance for the PM-1 headphone together with a generous 102dB/1mW sensitivity.

**Oppo BD UK Ltd, 0845 060 9395; [www.oppo-bluray.co.uk](http://www.oppo-bluray.co.uk)**



## HI-FI NEWS' NUGGETS

### MERIDIAN - TO ORDER

Celebrating 25 years of digital speaker design, Meridian has announced the availability of three new DSP 'Digital Active Loudspeakers'. These are the £43k Special Edition DSP8000 SE, the £24k DSP7200 SE and £10k DSP5200 SE, all featuring a new Meridian-designed semi-horn-loaded tweeter with beryllium dome for 'outstanding transient response and wide bandwidth'. [www.meridian-audio.com](http://www.meridian-audio.com)

### ISOTEK EVO3

The Optimum is the third of IsoTek's high-performance power cables to be upgraded to the new advanced EVO3 (Evolution 3) version. Three 3mm<sup>2</sup> silver-plated OCC copper conductors are employed, insulated with a Teflon dielectric, screened by a mylar wrap and copper shield and clamped by a PVC jacket. Price is £595/terminated 2m length. [www.isoteksystems.com](http://www.isoteksystems.com)

## Sonus faber's 30th

LIMITED EDITION ANNIVERSARY STANDMOUNT

Inspired by its Extrema standmount from 1991 and by way of celebrating the company's 30th anniversary, Sonus faber recently unveiled its astonishing Ex3ma. The cabinet is fashioned from a carbon-fibre monocoque, reinforced with two aluminium alloys, milled from solid billets, and clad with hand-selected and polished wooden sidecheeks. The two-way design (with diamond-treated beryllium dome tweeter and 180mm sandwich-coned bass mid unit) is augmented by a rear-mounted ABR, modelled on KEF's legendary B139 unit. **Sonus faber, 0208 971 3909; [www.sonusfaber.com](http://www.sonusfaber.com), [www.absolutesounds.com](http://www.absolutesounds.com)**



## Yamaha's stereo sprint

MORE HIGH-END HI-FI FROM YAMAHA

Following the launch of its flagship CD-S3000 and A-S3000 [*HFN* Nov '13], Yamaha has continued its two-channel re-boot with the release of the £1700 A-S2100 MOSFET integrated amp and £1600 CD-S2100 SACD player/USB DAC. The A-S2100 employs a balanced power amp architecture based on that debuted in the '3000, the use of FETs claimed by Yamaha to 'give a similar sound to a valve amp'. Power is rated at 160W/4ohm. The CD-S2100 features a 32-bit DAC from ESS and offers USB and S/PDIF inputs alongside single-ended and balanced (XLR) outputs. Available in the summer. **Yamaha Music Europe GmbH (UK), 0844 811 1116; <http://uk.yamaha.com>**



## M2Tech's DSD DAC/Pre

M2TECH ADDS DSD64 AND DSD128 TO YOUNG 384/32 DAC

Building on the 384kHz/32-bit performance of its Young DAC, M2Tech has added compatibility with DSD64 and DSD128 media files via its asynchronous Class 2 USB interface. Extra features, including a digitally-governed volume control, full IR remote control and balanced XLR analogue outputs are now also included. M2Tech's new volume control operates in fine 0.5dB steps over a 96dB range while ±6dB balance and phase inversion allow further, subtle adjustment.

**M2Tech Srl, Italy; [www.m2tech.biz](http://www.m2tech.biz)**



## Pro-Ject's Superpack

HEAVYWEIGHT TURNTABLE, ARM AND PICK-UP



Inspired by Pro-Ject's earlier, and costlier, Xtension turntables the Xtension 9 Evolution features a similar and very dense MDF chassis (available in black, red, white, olive and mahogany finishes). The 5.4kg belt-driven alloy platter is damped with an internal layer of elastomer and runs on an inverted ceramic bearing. The

top surface is fashioned from recycled vinyl LPs for the ideal interface! Also, Pro-Ject's 9CC Evolution tonearm is pre-mounted on the deck while, in the UK, an Ortofon Quintet MC completes the 'Superpack' for just £2200.

**Pro-Ject AS, 01235 511166; [www.project-audio.com](http://www.project-audio.com); [www.henleydesigns.co.uk](http://www.henleydesigns.co.uk)**

## HI-FI NEWS? JUST ASK...

If you can't always find a copy of this magazine, help is at hand! Complete this form, hand it in at your local store and they'll arrange for a copy of each issue to be reserved for you. Some stores may even be able to arrange for it to be delivered to your home. **Just ask!**

*Subject to availability*

Please reserve/deliver my copy of **Hi-fi News**

on a regular basis, starting with issue.....

Title.....First name.....

Surname.....

Address.....

.....

.....

Postcode.....

Telephone number.....



IF YOU DON'T WANT TO MISS AN ISSUE...



## Upcoming Events

IMPORTANT DATES FOR YOUR HI-FI DIARY

- 15-18 MAY** High End Show, M.O.C, Munich, Germany; [www.highendsociety.de](http://www.highendsociety.de)
- 30-01 JUN** T.H.E. Show, Hilton Hotel, Newport Beach, CA, USA
- 08-10 AUG** High End Audio Visual Show, Hong Kong
- 05-10 SEP** IFA Berlin, The International Funkausstellung, Germany <http://b2c.ifa-berlin.de>
- 01-02 NOV** The Hi-Fi Show Live 2014, Beaumont Estate, Windsor; [www.hifinews.co.uk/show](http://www.hifinews.co.uk/show)

# Paris Salon Hi-Fi Show

Words & pictures: Ken Kessler



Now comfortably ensconced in the Novotel Paris Tour Eiffel, the Salon Hi-Fi Home Cinema & Technologies d'Intérieur marked its 36th 'édition' with renewed excitement. Whatever the reasons, the show had a wonderful vibe. If the French can conquer the divisive politics that have split the industry, Paris could be served by one show rather than two, and this is the one I'd prefer to see as a showcase for high-end audio.

As with every show of late, headphones dominated in both presence and pulling power. On a poignant note, organiser Jean-Marie Hubert welcomed Monster as an exhibitor – he was the company's first European distributor many decades ago. Show standouts included Jarre's wild take on wireless systems in the form of a skull and bulldog, while Sony France pushed high-res Blu-ray audio with a vengeance. *Bon chance, say I.*

Sangean showed an array of digital kit with features like Bluetooth and streaming. Nicest for this old codger was the primarily analogue AM/FM WR-12, with sound that falls in with the rich tradition of Tivoli, Roberts and others that understand the appeal of the vintage look. [www.sonoprof.fr](http://www.sonoprof.fr)

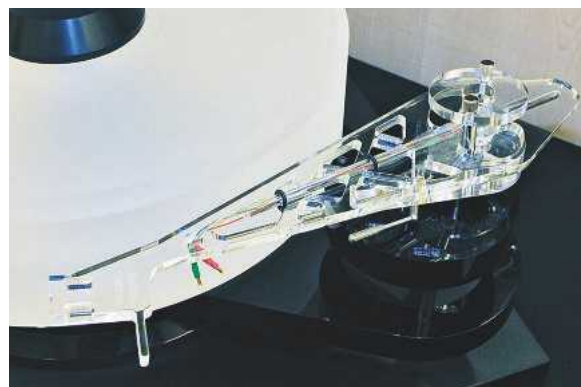

Scheu Analog's gloriously transparent Cantus unipivot tonearm certainly isn't new, but I thought I heard someone say it's been refined recently. No matter: it's still the most photogenic tonearm around. The Cantus is offered in 9in and 12in forms, selling for, respectively, €1200 and €1300. Counterweight is made of tungsten. [www.scheu-analog.de](http://www.scheu-analog.de)

Jean Michel Jarre's range of upscale iPod docks now includes fun shapes: the €399 AeroSkull features two speakers hidden behind sunglasses, plus a subwoofer. If the French had a sense of humour and didn't have 'Yank issues', they could sell millions to the US Marines by calling it the 'Jarre-head'. [www.jarre.com](http://www.jarre.com)



Aah, Accuphase! I wish it had a higher profile here. Celebrating its 40th Anniversary, the company showed two new gems, the DP-410 MDS CD player (€5490) with three digital inputs (USB, coaxial, and optical) and the entry-level 2x90W E-260 Integrated Amplifier (€4990), with handsome vintage styling and analogue meters. [www.accuphase.com](http://www.accuphase.com)







Left to right: Jozefina Lichtenegger, MD of European Audio Team (EAT), her husband Heinz of Pro-Ject turntable fame, and Izzy Lachowicz of Absolute Sounds at the latter's first Paris show. Can't possibly imagine why Heinz is grinning from ear-to-ear.



Teac's 90W/ch AI-501DA integrated amplifier (€799), atop the matching PD-501HR CD player (€799), marries cool retro looks via round analogue meters with modern touches like a USB DAC with 32/192 processing. Each each unit measures just 290x81.2x264mm (whd). [www.teac.com](http://www.teac.com)



Fostex's GM250MG (on the left) is said to have a cult following in France. Standing 1066x340x376mm (hwd) and costing €13,500-per-pair, it features a 25mm G2000 magnesium dome tweeter, 130mm magnesium midrange and 250mm woofer. Sensitivity is said to be 90dB/1W/1m, while frequency response is rated from 40Hz-40kHz. [www.fostex.jp](http://www.fostex.jp)



Loved Magnat's RV3 Hybrid Integrated Amplifier especially for its Teutonic build quality and looks, and it comes fully-loaded: phono MM/MC, ALPs pots, remote control and front panel headphone socket for 1/4in jacks. Spec says 2x150W output into 8ohm, valve preamp section uses ECC8s that were burned in for 60 hours. Footprint is 434x360mm. [www.magnat.de](http://www.magnat.de)



Been following this for years – now I have the specs: BC Acoustique's EX-888 valve integrated (€1599) accepts five line sources, offers pre-out, contains four KT88s and a preamp with two each of 12AX7 and 12AU7, for 2x40W in ultralinear mode or 2x20W in triode. Offered in black or silver, it's a great-looking piece. [www.bc-acoustique.com](http://www.bc-acoustique.com)

JoSound's Ra cabinets – that's a prototype to the right of Voxativ's Ampeggio – contain Voxativ's drivers, and are badged as 'Voxativ by JoSound'. Cabinets are made in Swindon with sustainable bamboo as the signature material. We were assured that no pandas went hungry. [www.josound.net](http://www.josound.net)



# The perfect high-end system, in two simple steps:

1.

2.

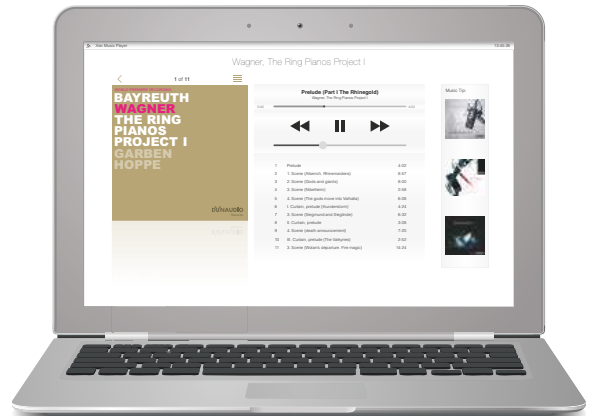

# San Francisco Audio Show

Words & pictures: Ken Kessler



Being the 'bad cop' is not pleasant. And I certainly don't want to denigrate the efforts of those who organised the California Audio Show in the Westin Hotel at San Francisco Airport last autumn. They mean well, they're sincere and they're honest. But it was small. It was quiet. The signals it sent out were this: does the USA need shows in Denver, Newport Beach, Dallas, New York, Chicago... have I left any out? Probably.

Nevertheless, the hours I spent there were certainly well spent. The crowd could scrutinise gear in 40 rooms, the Wilson Duette Series II demo was as good as it gets and the hotel was perfectly suited for the event. In the headphone hall, no kidding, you could find people born *after* Reagan left office. Maybe I'm way off the mark in missing the old Penta show, but perhaps the future of hi-fi shows really is boutique-y events like this.



Swiss-made Klangwerk speakers are slim, handsome and utterly wife-friendly – unless you're married to Hyacinth Bucket. This is the active Ella. It stands 1129x216x189xmm (hwd) has a 25mm magnesium tweeter, three 145mm mid-woofers and a claimed 40W+120W of Class G amplification. [www.klangwerk.ch](http://www.klangwerk.ch)

One of the show's major launches, Ayre's KX-5 preamp was seen and heard driving the VX-5 power amp and DX-5 A/V Engine through Wilson Audio's Duette Series 2 loudspeakers. Features include a volume control using a 46-position 'Variable Gain Transimpedance' (VGT) amplification circuit, six programmable inputs and the unique Equilock gain stage. [www.ayre.com](http://www.ayre.com)



San Francisco dealer Loggie Audio demonstrated a system using Ypsilon Aelius amplifiers and an Esoteric P-02 transport/D-02 DAC/G-01 master clock, feeding the YG Acoustics Sonja 1.2 loudspeakers. The latter brand is on a roll lately, as it seems to be enjoying support at a number of shows. [www.loggieaudio.com](http://www.loggieaudio.com)

More staggering sound: retailer Music Lovers Audio's system included VTL's S-200 Stereo Signature amplifier (a debut, I believe) and Vivid's Giya G-3 loudspeakers, fed by a VTL TL-7.5 Series III Reference line-stage, a dCS digital source and a Brinkmann turntable. [www.musicloversaudio.com](http://www.musicloversaudio.com)





## Scala V2, A new Utopia

Scala V2 has retained all the qualities of the original: timeless design and extraordinary musicality.

The new Scala Utopia boasts a re-engineered bass unit with improved power handling, for stunning integrated bass and even greater control.

This has also further refined the midrange register with focus and clarity, resulting in a more precise and remarkable sound stage.

The Scala V2 takes you closer to the music with enhanced emotion and listening pleasure.

Discover the full Utopia family at [www.focal.com](http://www.focal.com) or visit one of our partner retailers below.

 **FOCAL**<sup>®</sup>  
THE SPIRIT OF SOUND

**KJ WEST ONE**  
London  
0207 486 8262

**MIDLAND AUDIO XCHANGE**  
Belbroughton  
01562 731100

**THE MUSIC ROOM**  
Glasgow  
0141 333 9700

**MARTINS OF NORWICH**  
Norwich  
01603 627010

**JORDAN ACOUSTICS**  
Bournemouth  
01202 911886

**HMF SOLUTIONS**  
London  
020 7824 8311

**THE AUDIO WORKS**  
Cheadle  
0161 428 7887

**ACOUSTICA**  
Chester  
01244 344227

**LOUD AND CLEAR**  
Edinburgh  
0131 555 3963

**TOM TOM AUDIO**  
St Albans  
01727 810047

Focal UK [info@focal-uk.com](mailto:info@focal-uk.com) 0845 660 2680



Acapella, best known for amazing horn speakers, showed its LaMusika integrated amplifier, with a heart-stopping price tag of US \$99,400, and \$19,000 for the optional phono stage. A valve/power MOSFET hybrid with five balanced inputs, it is said to deliver 160A output current/±86V maximum output voltage – you do the maths. [www.acapella.de](http://www.acapella.de)



Texan brand Raven's gorgeous valve amps include what I believe is the prototype of the Shaman monoblock with a dozen 6550s. Also shown were spectacular integrateds and preamps, all with sublime finishing. The tube hardcore needs to follow the way this brand develops, because it seems to have access to an amazing array of NOS valves. Website is still under construction, so be patient. [www.ravenaudio.com](http://www.ravenaudio.com)



It wasn't what I expected among a plethora of headphone amps designed to drive all manner of cans, but here is Headamp's aftermarket tube hybrid Blue Hawaii headphone amp for electrostatics, the company demo'ing with Stax Earspeakers. Not sure what other makes might work, though. Valves are four 6CA7s, power supply is outboard. [www.headamp.com](http://www.headamp.com)



Acapella's new Atlas loudspeaker uses its signature spherical horn and the Ion TW1 tweeter in a relatively compact package measuring 160x38x76cm (hwd) without the horn, or 160x78x94cm (hwd) with the horn. Like the amp, the price is thought-provoking at \$94,320 per pair. Sensitivity is a claimed 93dB/1W/1m. [www.acapella.de](http://www.acapella.de)



Another launch to the show's credit was Rethm's two-box Gaanam SET integrated amplifier, with one unit being the power supply module and the other being the amplification module. This delivers 16W/ch from 6C33C output tubes; the preamp section uses two 6922 valves, one per channel, based on 'an extremely simple circuit'. The power supply is choke regulated, and zero feedback is used. [www.rethm.com](http://www.rethm.com)

Next  
month

Hi-Fi News alights at the  
Stockholm Hi-Fi Show

# Ringling on the ears...

Do headphone headbands carry unwanted sound? **Keith Howard** finds out

Imagine that instead of each of your stereo loudspeakers sitting in splendid isolation, optimally aligned with respect to the listening seat, there was a large band of metal or plastic curving between them, joining the two cabinets. If you know anything of loudspeaker design and the efforts taken to quell structural resonances, you'd immediately suspect this structure of colouring the sound and – by carrying vibrations from one speaker to the another – of messing with the stereo image.

Anyone who built such a structure would be thought a fool, and yet this is little different from the standard design of over-ear headphone that we've accepted for decades, where two capsules are linked by a headband. If it would be so obviously bad for loudspeakers, why do we readily accept that it's OK for headphones?

## POOR CONTROL

Those of you who read my headphone reviews in *HFN* will have noticed me banging on recently about headband resonances and how poorly controlled they are in some designs. To date my comments have been purely subjective, based on wearing the headphones during the lab test of impedance versus frequency which squirts pink noise into the left capsule only.



Commonly I hear a character being imparted to the pink noise which disappears if I reach above my head and grasp the headband with my hands to provide damping – a sure sign of structural resonance that's sufficiently severe to be audible. At the same time the sound becomes more clearly localised in the left channel, rather than being spread out towards the centre and right of the soundstage as a result of vibration being carried by the headband to the other capsule.

I thought it high time to attempt a measurement of this effect, not only to quantify it but to see how easily headphone manufacturers might themselves contrive to measure it and so take the necessary steps to suppress it. I suspect that too many of them are falling down

on the job. So I assembled the artificial 'head' I use for headphone testing – actually a layered assembly of cut MDF sheet glued together to form an approximate head shape, with a GRAS 43AG ear and cheek simulator let into one side – and initially brought up two headphones from the basement that had evinced headband resonances when I reviewed them. These were the PSB M4U 2 [see *HFN* Dec '13] and the NAD HP50 [*HFN* Jan '14].

## SIMPLE TEST

The test procedure I'd devised was as simple as could be: first measure the frequency response of the left capsule in the normal way then, while still sending signal to the left capsule only, turn the headphone around and measure the frequency



**BELOW:** The M4U 2 from Canadian company PSB International is a closed-back design whose capsules fold up into the headband to aid portability

response of the sound being carried over to the right capsule.

That both the PSB and NAD were closed-back types would clearly facilitate this procedure as the artificial ear is then doubly isolated from 'hearing' the active capsule via any acoustic radiation into the room. But if the results were interesting, of course I'd want to try to measure open-back models too.

The results from the PSB and NAD are summarised in the first two sets of frequency response graphs, Figures 1 and 2, which each overlay

three traces. The top, black trace is the response measured from the active (left) capsule with the headband raised from the artificial head; the red trace is that measured from the inactive (right) capsule, again with the headband raised clear of the head; and the green trace is from the inactive capsule but with the headband lowered on to the head to provide some damping. In both graphs (and all the others appearing on these pages) the vertical division is 10dB.

### TELLING RESULTS

Straightforward this may be as a test procedure but, as the graphs show, it appears to elicit telling results. In both cases the responses for the inactive capsule quite closely mirror those of the active capsule above 1kHz, albeit 30-40dB down. This apparently represents the vibration carried over from the active capsule via the headband. Below 1kHz the responses from the active and inactive capsules are significantly different, the peaky nature of the inactive capsule response and the changes that result from lowering the headband onto the head indicating that the disparities are due to resonances within the structure of the headphone, principally the headband.

Indeed, ripples in the active capsule response at around the same frequencies as the peaks in the inactive capsule response suggest that headband resonances are having an effect on the output of the active capsule too. This is supported by the graph in Figure 3

which shows a cumulative spectral decay waterfall from the NAD's left capsule, over the frequency range 20Hz-1kHz. The resonances clearly visible at around 200 and 300Hz correspond with peaks in the inactive capsule frequency response.

### HEAD IN THE WAY?

At this juncture some of you may be thinking: just a minute, can we be sure that what we are looking at here is vibration carried from the active to the inactive capsule via the headband and not via the structure of the artificial head? While there's every reason to suppose that the earpads of the active

capsule will provide compliant isolation of the driver reaction force, nevertheless this is an important thing to check. And it's easily done. I used a small baffle to close off the active capsule and then compliantly isolated it (and thus the active



**ABOVE:** NAD's HP50 sees the capsules able to rotate on the headband for easy storage

capsule) from the head using a coil spring of high enough compliance to ensure effective vibration isolation from a low frequency.

Figure 4 shows the result of doing this with the PSB M4U 2, headband

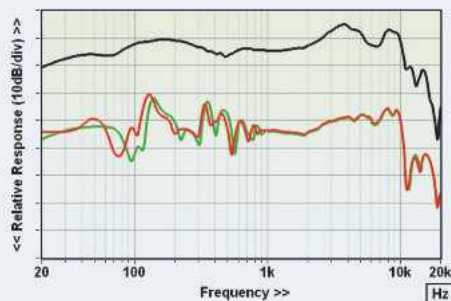

**FIGURE 1.** PSB M4U2 results (black: left capsule, headband raised; red: right capsule, headband raised; green: right capsule, headband lowered)

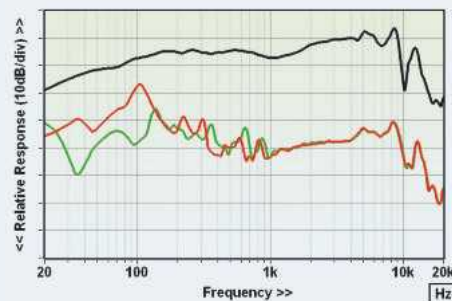

**FIGURE 2.** NAD HP50 results (black: left capsule, headband raised; red: right capsule, headband raised; green: right capsule, headband lowered)

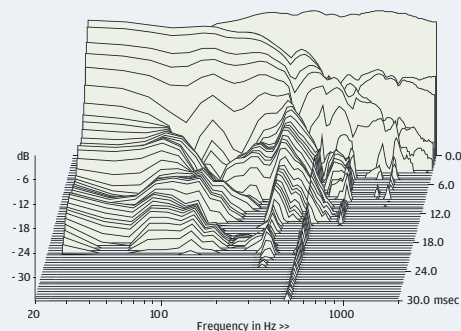

**FIGURE 3.** Cumulative spectral decay waterfall, NAD HP50 left (active) capsule (resonances at the same frequencies as the inactive capsule)

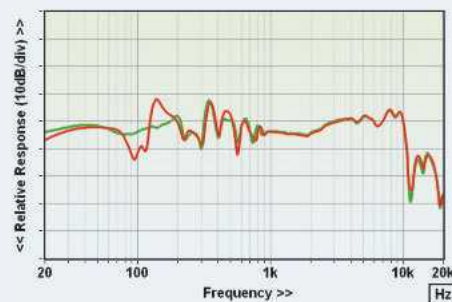

**FIGURE 4.** Decoupling test, PSB M4U2 (red: right capsule, headband lowered; green: right capsule decoupled from head, headband lowered)

# A box that knows no bounds.

Listen to unlimited music with Spotify Connect



## NAD D 7050 Direct Digital Network Amplifier

The D 7050 Direct Digital Network Amplifier now features Spotify Connect, so you can stream millions of songs wirelessly using any smart device or computer, with NAD's legendary true hi-fi sound. The D 7050 is a completely modern twist on the amplifier of yore. It offers NAD's most advanced power-packing Direct Digital™ amplifier technology, along with Apple AirPlay, WiFi, and aptX Bluetooth for the ultimate in high fidelity streaming and convenience. A 24-bit/96kHz asynchronous USB input connects your computer for incredibly accurate high res audio playback, and we added a premium headphone amplifier output in case you don't want to disturb your neighbours with the D 7050's powerful digital sound.

Designed for the digital audiophile, the D 7050 with Spotify Connect's effortless control of music, is a compact solution with endless options.



HEART+ SOUL YOU CAN HEAR

[www.NADelectronics.com](http://www.NADelectronics.com)



Available at all Sevenoaks Sound & Vision Stores.





**FIGURE 5.** Absorbent test, PSB M4U2 (red: right capsule, headband raised; green: right capsule, headband raised, left capsule surrounded by acoustic wadding)

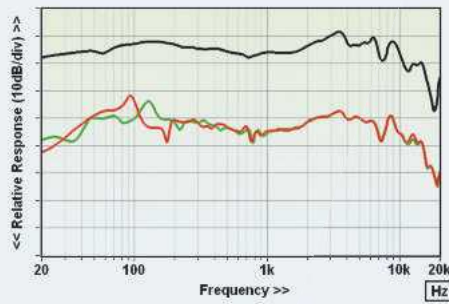

**FIGURE 6.** Focal Spirit Classic results (black: left capsule, headband raised; red: right capsule, headband raised; green: right capsule, headband lowered)



lowered; here the red trace is the right capsule output without compliant isolation of the active left capsule, whereas the green trace is with compliant isolation in place.

Above about 200Hz the traces are very similar but at around 140Hz there seems to be a resonance that disappears when the active capsule is compliantly isolated. While this could be due to a resonance within the artificial head, I'm more inclined to ascribe it to the headphone being stretched wider in the process of adding the isolated baffle.

**NOT AN ISSUE**

I wouldn't expect the head to resonate at this frequency (I chose the layered construction to suppress resonance), and if it does then why is a resonance at around 140Hz notably absent in the other results (some of which we've yet to see)?

I'm pretty confident as a result that structural resonances within

**RIGHT:** Good results from the traditional, open-back Sony MDR-MA900 with no sign of the headband resonance peaks apparent in tests undertaken on other designs

**BELOW:** The Spirit Classic from Focal boasts a headband machined from aircraft-grade aluminium. In the tests it behaved better than the PSB's and NAD's

the head are not an issue but were they ever to be then applying a thin layer of damping material between each layer of MDF during assembly would probably be sufficient to suppress them, or a hollow head could be filled with kiln-dried fine sand to similar effect.

**TRAVEL BY AIR**

Something else we should check and eliminate too is the possibility that acoustic coupling through the air is occurring between the two capsules. Because both the PSB and NAD have sealed, closed-back capsules this seems unlikely, nevertheless we should test it.

This I did by placing a cardboard box full of polyester speaker wadding on its side close to the active capsule, so that the wadding surrounded it. This should be effective at absorbing any sound radiated

from the active capsule down to a few hundred hertz but, as Figure 5 shows, it made little difference to the PSB measurement. This should reassure us that we really are seeing the effect of the headband in Figs 1 and 2 – not resonances within the artificial head or acoustic coupling between the capsules via the air.

Having established that this simple measurement method gives credible results – results, moreover, that support my subjective observations of headband resonance – I was keen to repeat

the tests on some other headphones I have to hand. First I tried the Focal Spirit Classic, another closed-back design, with the results shown in Figure 6. As before, the black trace shows the frequency response from the active left capsule with its

headband raised off the head, the red trace the right capsule response with the headband raised and the green trace the right capsule response with the

headband lowered.

It's pretty clear from this that the Focal's headband is better behaved than either the PSB's or the NAD's but still there is one low frequency resonance apparent that will probably be audible.

**OPEN-BACK 'PHONES**

At this juncture it wasn't at all clear that open-back headphones could be tested in the same way without acoustic coupling between the capsules being an issue. But anxious to measure one of my favourite headphones, the open-back Sony MDR-MA900 [HFN Oct '12], I gave

'Resonance is a real problem with certain headphones'



# McIntosh®

LEGENDARY PERFORMANCE™

...BECAUSE ORDINARY ISN'T FOR EVERYONE.

Meticulously crafted since 1949, McIntosh Laboratory creates some of the world's most prestigious audio equipment. Fusing cutting edge audio technology with exquisite build quality and reliability, McIntosh is the No.1 luxury brand for the discerning music and film lover.



### McIntosh MHA100

2-Channel Headphone Amplifier (new)

3 headphone impedance ranges  
Small, compact size



### McIntosh MXA70

2-Channel Integrated Audio System (new)

50 Watts x 2 channel  
6 inputs including 4 digital



### McIntosh MT5

2-Channel Precision Turntable (new)

High output moving coil  
Includes dust cover



### McIntosh MCD550

2-Channel SACD/CD Player (new)

8 Channel, 32 bit, 192kHz DAC  
USB input for digital audio playback



### McIntosh MA8000

2-Channel Integrated Amplifier (new)

300 Watts x 2 channel  
Discrete eight band tone control



### McIntosh MA5200

2-Channel Integrated Amplifier (new)

100 Watts x 2 channel  
9 total inputs

0% Finance\* available on most McIntosh products. Please call or see the Jordan Acoustics web site for details.

\*subject to status & conditions

Bournemouth Showroom

T: 01202 911 886

e-mail: [bournemouth@jordanacoustics.co.uk](mailto:bournemouth@jordanacoustics.co.uk)

web: [www.jordanacoustics.co.uk](http://www.jordanacoustics.co.uk)



Glenrothes Showroom

T: 01592 744 779

e-mail: [glenrothes@jordanacoustics.co.uk](mailto:glenrothes@jordanacoustics.co.uk)

web: [www.jordanacoustics.co.uk](http://www.jordanacoustics.co.uk)

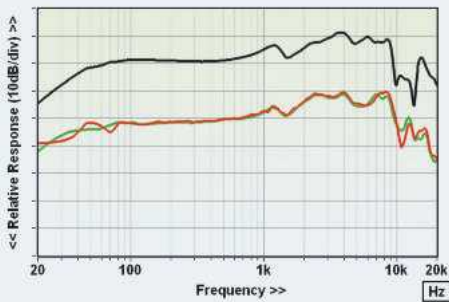

**FIGURE 7.** Sony MDR-MA900 results (black: left capsule; red: right capsule; green: right capsule with left capsule surrounded by absorbent – headband lowered in all cases)

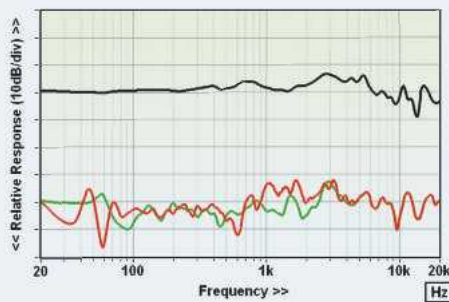

**FIGURE 8.** Audeze LCD-2 results (black: left capsule; red: right capsule; green: right capsule with left capsule surrounded by absorbent – headband lowered in all cases)

it a try – with the gratifying outcome that acoustic coupling proved to be no problem at all.

Figure 7 shows the Sony result but here the three traces are not as previously: the black trace shows the left capsule response with the headband touching the head (the Sony has insufficient head clamping force to hold its headband free), the red trace shows the right capsule response and the green trace the right capsule response with the box of acoustic wadding in place to suppress the left capsule's acoustic output.

As you can see, the red and green traces almost overlap so acoustic coupling is not significant. And while the inactive capsule response is only a little over 20dB below that of the

active capsule, there is no sign here of the headband resonance peaks so obvious in the previous designs.

**ROOM NOISE**

An even better result was obtained from the Audeze LCD-2, reviewed in the March 2013 issue of *HFN* (Figure 8, trace colours the same as for the Sony).

Here the response from the inactive capsule is about 40dB down on the active capsule – low enough that I suspect ambient room noise of affecting the result – and again there is no obvious sign of low frequency headband resonance.

Is this low level of vibration transmission the result of the fact that the Audeze LCD-2 is built using a lighter diaphragm? That has to be

'Headphone manufacturers must take the issue seriously'



**ABOVE RIGHT:** Weighing some 600g, the Audeze LCD-2 is still comfortable to wear thanks to its well-padded headband. Results were the best here, the 'phones showing no obvious sign of low frequency headband resonance

**LEFT:** The author's artificial 'head' used for the tests. Layered sheets of cut MDF have been glued together to form an approximate head shape while into one side is mounted a GRAS 43AG ear and cheek simulator

the most likely factor. Case proved, I think, that headband resonance is a real problem with certain headphones, and that vibration transmission from one capsule to the other varies widely between different designs. But what to do about this?

**EASY TO HEAR**

First, headphone manufacturers must take the issue of headband resonance more seriously. It is easy to hear, easy to measure and – as some headphones demonstrate – amenable to control with careful design and choice of materials.

Second, even in the absence of obvious headband resonance we could do with understanding just how significant the effect of inter-capsule vibration transmission is.

In providing a measure of low-level channel mixing it is possible that it is not much of a problem at all. If it is then – as I've suggested before – compliant isolation of the drive units, effective from low frequencies, might be needed to suppress it. ☺

# Wilson Audio Sasha Series-2

Design details from Wilson Audio's mighty Alexandria XLF flagship have now trickled down to the Sasha W/P  
 Review: **John Bamford** Lab: **Keith Howard**

It has been almost five years since the evergreen WATT/Puppy modular combo transmogrified into the Sasha W/P, during which time Utah's Wilson Audio has certainly not been resting on its laurels. The company's awesome flagship Alexandria XLF [*HFN* Nov '12] hit the headlines not only for its majestic 'concert level' performance envelope but the eye-watering circa £200k price tag. Technology details from the XLF then trickled down to the £50k Alexia [*HFN* Mar '13], and now some of those design features are being employed to upgrade the more affordable Sasha too.

Enter this brand new Sasha Series-2. The Sasha W/P (to give it its full nomenclature) has been Wilson's best-selling model, its DNA dating back to the 1980s and the famous WATT/Puppy two-box combination [see boxout]. As Wilson Audio followers will already appreciate, the Sasha W/P is no longer a two-way mini-monitor sitting on top of an optional passive subwoofer pedestal.

It might look as if it is, since it retains the W/P's two-box enclosure paradigm with its separate mid/treble 'head'; but the Sasha is a complete three-way floorstander with its crossover in the upper portion of the woofer enclosure 'pedestal'. Two umbilical cables terminated with spade connectors exit the top of the woofer cabinet and attach to a terminal block at the rear of the Sasha's upper module, one each for the midrange driver and tweeter.

Costing £1000 more than the outgoing Sasha, the Series-2 stands just a centimetre or so taller (a fraction over 1.2m tall on its floor spikes) and now sports a customised version of the

company's Convergent Synergy Tweeter first introduced in the XLF.

This is a 25mm doped silk dome HF unit, replacing the Sasha's inverted titanium dome. Overall the cabinet is subtly more contoured, showing more than a little influence of the bigger Alexia. There are also some changes around the back, including the fiendishly clever Alexia-style alignment mechanism for adjusting the position of the upper module, which now offers much greater flexibility (20 positions). The woofer enclosure with its twin 20cm bass drivers has been substantially upgraded. And the connection plate to the input terminal block is no longer

recessed, making it easier to use heavy duty speaker cables with thick spade connectors.

Wilson claims a 30% reduction in its already vanishingly low

cabinet resonances, the company's laser vibrometer instrument capable of measuring panel movements as small as one-millionth of an inch, we're told.

## CRITICAL TIME ALIGNMENT

I can't imagine any loudspeaker designers arguing against the notion that precise time alignment of a speaker's drivers relative to one's listening seat is critical to achieve accurate reproduction of harmonic expression and holographic imaging. Hence many manufacturers' endeavours to produce perfect point source transducers. For Dave Wilson, the

**RIGHT:** Series-2 Sasha has sturdier enclosures and employs Wilson's latest 25mm tweeter, married to a 178mm midrange driver and two 203mm woofers

'The image scale defies the Sasha's relatively modest proportions'





## WATT/PUPPY LEGACY

The story of the WATT/Puppy one of the audio industry's more endearing legends. Recording engineer Dave Wilson had already produced his go-for-broke multiple-enclosure Wilson Audio Modular Monitor (WAMM) speaker system, but required a compact mini-monitor for use 'in the field' at recording sessions. In the early '80s he built the Wilson Audio Tiny Tot (WATT), a two-way in a truncated pyramid enclosure – never imagining that hi-fi enthusiasts would want to buy it. But they did. And after Wilson made a pedestal woofer enclosure to accompany it, the Puppy, the WATT/Puppy two-box system became the most popular loudspeaker worldwide in the over-\$10k price sector. It's been constantly refined; the W/P's ninth iteration (2009) dispensed with the mini-monitor and separate subwoofer approach to become the buy-it-all-at-once Sasha W/P floorstander.

primary thing that counts is the quest to reproduce music in a way that 'preserves the numinous and emotional impact of the live event'.

Being able to adjust precisely the position of each driver fore and aft and its firing angle *in situ* in a listening room is necessarily complicated (and expensive) to attain in a domestic situation.

In the three-box Alexia the tweeter and midrange are housed in separate modules, the position of each adjustable in minuscule amounts to dial-in a nominally perfect group delay performance. (Visitors to *HFN's* The Hi-Fi Show in Windsor last October will have witnessed a demonstration of the efficacy of this.)

The Sasha isn't quite so elaborate, the tweeter and midrange unit housed in a single head module. But of course they reside in individual chambers within, and in the Series-2 the construction of the upper module is much more intricate. It now features a two-plane baffle to better optimise the axis response angles of HF and midrange drivers.

The tweeter portion of the baffle is made of Wilson's proprietary X-Material composite (as in the Alexia) while the midrange portion remains formed of the S-Material that the company developed specifically for use in midrange baffles. There are separate tweeter and midrange grilles, each designed to lessen frame induced diffraction.

The cabinets are finished in a range of automotive grade paints – including the gold shown on this

month's cover, while the review sample is in Sea Foam. The speaker ships with a detailed user manual containing propagation delay tables to assist accurate setup. For most purchasers the expertise of a Wilson-trained installer will best ensure they are calibrated for ultimate performance.

## PUTS YOU 'THERE'

For auditioning the new Series-2 Sasha I was privileged to have the speakers driven by Constellation Audio's fabulous Virgo II line stage preamplifier with its separate power supply and a pair of partnering Centaur Mono power amps, using a Metronome Technologie T6A/Nausicaa Signature CD transport/DAC combo as a source. Cabling throughout was courtesy of Transparent. The resultant sound was nothing short of sublime.

If you asked me to cite specific qualities that characterise the sound of the new Series-2 Sasha, the two that come instantly to mind would be resolution and dynamics, the speaker serving up elegant and unforced details that sounded more like the real thing than simply hi-fi artefacts.

Hearing Natalie Merchant's *Live In Concert* [Warner/Elektra 7559 62479-2] showcased the speaker's ability to 'put you there', the scale of the image it delivered defying the Sasha's relatively modest proportions. Merchant's utterly charming interpretation of Bowie's 'Space Oddity' and her cover of Neil Young's 'After The Goldrush' found me as if transported to the 



discover  
your  
inner  
sound



new from ADL  
**ADL-H118**  
headphones



**ADLEH008**  
dual-driver headphones

Dual Dynamic Driver Earphones  
a (Alpha) treated drivers  
Carbon fiber finished  
Make the ultimate connection to your music



**ADL A1**

DSD (2.8M/5.6M) • 24bit/192kHz  
High Resolution DAC AMP For Android devices or PCs

*"STACKS EASILY - GOES ANYWHERE - SUPERB SOUND"*

## WILSON AUDIO SASHA SERIES-2

Wilson Audio claims 92dB sensitivity for the Sasha Series-2 which accords pretty well with our measured pink noise figure of 91.5dB. But whereas I was recently able to say of the smaller Duette Series 2 [HFN Apr '14] that this 'is achieved without recourse to punishingly low impedance', that isn't so of the new Sasha. Wilson Audio specifies a minimum modulus of 2.17ohm at 90Hz; we measured a dip down to 2.0ohm at that frequency. Were it not for quite well controlled impedance phase angles then the minimum EPDR (equivalent peak dissipation resistance) would surely have fallen below 1ohm but in actuality it bottoms out at 1.1ohm at 72Hz – still a very challenging load for the partnering amplifier albeit not quite as scary as the 0.9ohm we recorded for the Alexia. Contrast these figures with those recorded for the Duette S2 and the Alexandria XLF which were 2.0 and 1.7ohm respectively.

The on-axis frequency response trend – measured here at a typical seated ear height of 97cm from the floor – is essentially flat in trend except for the merest hint of a presence band dip and a peak in output just below 20kHz [see Graph 1, below]. Response errors of  $\pm 1.2$ dB (300Hz-20kHz) is fair although not outstanding at the price. Diffraction-corrected near-field measurement of the LF response recorded a bass extension of 49Hz (-6dB re. 200Hz) but the slow roll-off beginning at 90Hz should make it easy to achieve a more extended bass in-room with the assistance of boundary gain. The cumulative spectral decay waterfall [Graph 2, below] evinces fast initial energy decay but a few resonances are visible as ridges in the treble. KH

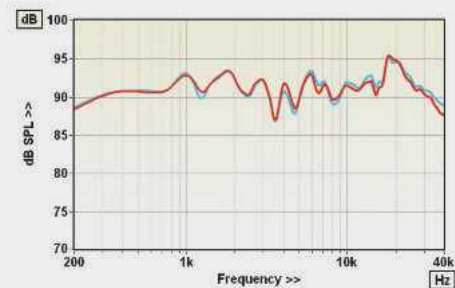

ABOVE: The Sasha 2's forward response is flat in trend, albeit with a hint of a recessed presence band

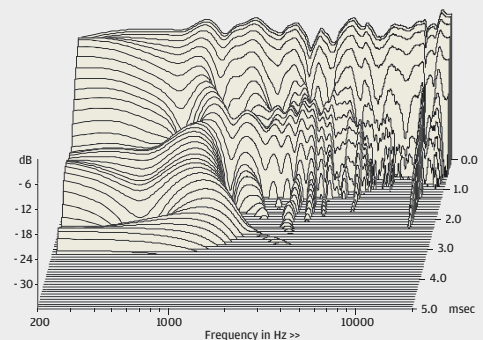

ABOVE: Very fast decay of any cabinet resonances with only a few ridges visible above 3kHz

## HI-FI NEWS SPECIFICATIONS

|  |                                   |
|--|-----------------------------------|
| Sensitivity (SPL/1m/2.83Vrms – Mean/IEC/Music) | 92.1dB/91.5dB/91.4dB              |
| Impedance modulus min/max (20Hz–20kHz)         | 2.0ohm @ 90Hz<br>7.8ohm @ 19.7kHz |
| Impedance phase min/max (20Hz–20kHz)           | -42° @ 61Hz<br>34° @ 3.5kHz       |
| Pair matching (200Hz–20kHz)                    | $\pm 1.2$ dB                      |
| LF/HF extension (-6dB ref 200Hz/10kHz)         | 49Hz / >40kHz/>40kHz              |
| THD 100Hz/1kHz/10kHz (for 90dB SPL/1m)         | 0.1% / 1.0% / 0.3%                |
| Dimensions (HWD)                               | 1146x356x562mm                    |



**LEFT:** Reflex bass enclosure vents via a rear-firing port, as does the midrange chamber in the upper module. Back plate conceals resistors for level matching the midrange driver and tweeter

Keith Richards' *Main Offender* [Virgin CDVUS 59] and pressing vigorously on the system's loud pedal showcased the Series-2's ability to stop and start with breathtaking alacrity. On the rollickin' track 2, 'Wicked As It Seems', Richards' electric guitar sounded spookily real, while the sizzle of the snare and the crack of the rim shots caused me to wince, highlighting the Sasha's lightning-fast transient attack. I flinched more than once, then steeled myself in preparation for a ruckus when the bass guitar enters the melee, only to discover that the speaker was barely cruising. Again, it held everything in realistic proportion: the bass guitar sounded 'just right'.

When you want to rave, this Sasha Series-2 will seriously kick ass – with dangerous SPLs. The majestic bass underpinning George Michael's 'Spinning the Wheel' from *Older* [Egean/Virgin CDV2802] was delivered without any hint of drama from the Sasha. Everything appeared utterly effortless and grounded, the stygian bass unfolding in a natural way as it pressurised the room.

Wilson's new Sasha 2 is a fabulous speaker. Is it worth £28.5k? Well, it's £20k cheaper than Wilson's slightly bigger Alexia. And with many exotic speaker designs costing considerably more, any music lover would have to declare the Sasha Series-2 not only wonderful but also a steal. ☺

## HI-FI NEWS VERDICT

Judged alongside competing high-end models Wilson's Sasha Series-2 is certainly a lot of speaker for the money. And given its overall capabilities – its transparency to source, fearsome dynamics and proficiency in creating an enormous soundstage with lifelike height – it should really come with a warning sticker, as to hear it is to want it. Driven by suitably high quality ancillaries it'll blow you away.

Sound Quality: 88%



best seats in the house in New York's Neil Simon Theatre in 1999. The distance in the fore-and-aft plane of the soundstage I was witnessed was all-enveloping.

Similarly with a 1968 recording of Alfredo Catalani's opera *La Wally* [Decca 425 418-2], the soprano voice of Renata Tebaldi was projected into the listening room in quite remarkable fashion, the power and emotion of the performance spine-tinglingly authentic in timbre, dynamics, and scale.

## EFFORTLESS HIGH LEVELS

What really struck me was the *height* of the perceived image. Properly calibrated, the speaker images way beyond its boundaries and the confines of your listening space, allowing you to clearly perceive varying acoustic envelopes of different recording environments.

Will this new Sasha rock? You betcha. Spinning up the CD of

# Ayre AX-5

Under the bonnet of this luxuriously appointed, fully balanced integrated amplifier lie some novel design features. Its sound quality is something special as well

Review: **John Bamford** Lab: **Paul Miller**

**I**s there something in the Colorado air that caused Boulder, situated in the foothills of the Rocky Mountain National Park, to become such a hotbed of America's high-end audio scene? It's home to PS Audio, Jeff Nelson's Boulder Amplifiers (of course), Avalon Acoustics, Ayre Acoustics – and YG Acoustics is barely 20 miles away too. Boulder, it seems, is something of a hi-fi haven.

Audio observers may recall that Ayre Acoustics' owner Charles Hanson was the founder of loudspeaker specialist Avalon Acoustics before selling that company, and setting up Ayre Acoustics in 1994, in order to focus on the design of high-end electronics. While I've never met Hansen I've long considered him a thoughtful and creative designer never afraid to push boundaries and think outside the box.

## A SIMPLE SIGNAL PATH

If not the first, Ayre Acoustics was certainly *one* of the first high-end specialists to embrace the new dawn of higher resolution digital audio around the turn of the century by producing a universal DVD-Audio/SACD player. It was based on a Pioneer 'engine'. Today Ayre is one of only a handful of specialists with a universal Blu-ray disc player in its product portfolio – based on an Oppo engine that uses a MediaTek platform.

Ayre's A-to-D and D-to-A converters are legendary in many high-end circles. And it is Hansen and his colleagues who have designed the innards of Neil Young's forthcoming Pono portable hi-res audio player [[www.ponomusic.com](http://www.ponomusic.com)]. I'm told Hansen was chuffed to secure the design contract as he's been a Neil Young fan since his teenage years!

I've been looking forward to hearing this brand new AX-5 integrated since listening to an assembly of its larger siblings driving a Wisdom Audio loudspeaker system

at *HFN's* The Hi-Fi Show in Windsor last October, in UK distributor Symmetry Systems' demonstration room. In some ways the AX-5 represents a distillation of Ayre's 'purist' philosophies, as it employs both the company's 'Diamond output circuit' [see boxout] and the elaborately-designed volume control trickled down from its flagship KX-R preamplifier (£13,995) introduced in 2008 and recently upgraded to the KX-R Twenty in celebration of Ayre's 20th anniversary this year.

Says Charles Hansen: 'With the KX-R we threw 55 years of preamplifier history out the window and created a new topology. In 99.9% of preamplifiers the signal comes in at a lower level than a power amplifier

requires; a gain circuit boosts the signal, and a volume control in front of the [fixed] gain circuitry attenuates the signal. The drawback of this is that noise in the circuit remains fixed and ultimate signal/noise ratio is only achieved at maximum, unattenuated, volume.

'In the KX-R the gain of the circuit is variable by changing its transconductance, though we use the name 'VGT' for Variable Gain Transimpedance. For our latest AX-5 integrated we eliminated the preamp stage altogether and simply made the gain of the power amplifier variable using VGT – and added an input selector. This is the simplest possible signal path in any audio amplifier ever made.'



**RIGHT:** The amplifier modules are embedded under heatsinks but the most remarkable feature is surely the belt-driven stepped attenuator – one for each channel!





In the fully-discrete, fully-balanced, zero loop feedback AX-5, Ayre's VGT circuit governs how much gain is generated by the amplifier's input stage, four complementary differential JFETs. The volume knob on the right of the fascia acts as an encoder to control a pair of motor-driven Shallco silver contact rotary switches (one for each channel, conjoined using toothed belts), each of which contains dozens of hand-selected, low-noise resistors.

Volume level can be adjusted over a range of 69dB in 46 steps of 1.5dB. A single resistor mounted in a terminal block governs the AX-5's overall gain range and can easily be changed should the need arise, to accommodate overly-sensitive or insensitive partnering loudspeakers.

#### ULTRA-PURIST AIMS

Ayre's VGT methodology certainly imbues the AX-5 with peerless S/N performance, although it's not entirely without consequence [see Lab Report]. And while it works flawlessly, the amplifier's elaborate stepper motor system results in a Heath Robinson-esque 'clunk' each time the volume is adjusted – not that you'll really notice when playing music at enthusiastic listening levels. I soon came to ignore it, although there were occasions when

I yearned for finer volume adjustment, finding the 1.5dB steps just a bit too coarse. I'd prefer 1dB steps for sure, as provided in the aforementioned KX-R flagship preamp.

Coarse volume adjustment aside, clearly the design of the AX-5 has been carefully considered. It might be an integrated amplifier with ultra-purist intentions, however it's far removed from the old-fashioned concept of utilitarian 'hair shirt' hi-fi components. Befitting its price its sculpted aluminium chassis is reassuringly robust and beautifully finished; it sports a large, easy-to-read status display; and microprocessor control allows its six line inputs (four balanced, two single-ended) to be individually enabled and named to match source components.

Gain offset for each input can be adjusted via the setup menu; one of the inputs can be assigned as a processor pass-through; and the amplifier ships with one of Ayre's lovely RC30 multi-component IR remote control handsets whose large keys are backlit with a fibre optic array that distributes light from a blue LED inside. It's a joy to operate.

**ABOVE:** Rotary encoders are for source selection and volume, plus navigation of the setup menu when in standby. Push buttons are for tape output on/off and mute/standby

Naturally the AX-5's front panel display can be dimmed (three intensity levels) or disabled via the handset. However, some enthusiasts might bemoan the absence of a balance control, phase inversion or a mono switch. And if your pride-and-joy speaker cables are terminated with 4mm banana plugs you might not care for the amplifier's Cardas binding posts, which are designed

for spade connectors.

I powered up the AX-5, configured one of its inputs to interface with the balanced outputs of my resident T+A DAC 8 [HFN Oct '12], hooked up with Signal Projects' Hydra

interconnects, and left the amplifier to gently simmer for a couple of days before settling down to critical listening.

'Perhaps it's the absence of any over-bright glare that's so refreshing'

#### HOOKED BY DETAIL

From the outset I was struck by its refreshingly clear and open sound quality. Despite appearing quite luscious and smooth in tonality, easy-going and warmly-balanced, the sound was incredibly detailed: I was hooked.

It proved wonderful at peeling away the layers of heavily multi-tracked rock albums, the AX-5 bringing out low-level details in exhilarating fashion. I was captivated listening to *Beneath The Waves* by Kompendium, the darkly romantic concept album penned by Rob Reed, founder of Welsh progressive rock band Magenta [96kHz/24-bit DVD-A; 7 Stones/Tigermoth Tmpcd1012], the amplifier providing a sparkingly clean window through which to observe individual elements of the music's arrangements and myriad production effects. Percussion details were beautifully rendered and natural-sounding, while

#### DIAMOND CIRCUIT

Developed in the 1960s by Professor Richard Baker of MIT and patented as 'A Gateable Bridge Network Having Power Gain', the Diamond Circuit describes two pairs of bi-polar transistors with their respective emitters and bases tied together. It is commonly used in the output stage of buffer ICs that have unity voltage gain but boost current to drive a load – and in many of today's DAC chips. Ayre's Charles Hansen believes that when employed in an amplifier's output section it simply sounds better than other solid-state push-pull topologies where two phases of a signal are recombined to form a full wave, possibly because the diamond circuit is the only one in which the two half-signals are joined at a single point, with no intervening circuitry. Ayre biases its diamond output section to operate in Class A/B. Says Hansen: 'I don't really know why it sounds better... but that is the beauty, the mystery, and the art of audio circuit design. If we knew all of the answers then everything would sound perfect.'

# Xpression Carbon

Xpress your sound,  
Xpress your look...



March 2014



February 2014



**NEW UKX VERSION  
AVAILABLE NOW!**

Includes free acrylic  
platter with Bordeaux  
and Midnight Blue  
finishes.

## A Classic Made New...

The Xpression Carbon is the latest version of Pro-Ject Audio Systems' original turntable, the Pro-Ject 1. This new model employs a brand new carbon fibre tonearm with an Evolution-inspired support structure. The superior motor, with isolation blobs designed by Ortofon, drives a high-quality platter that can be fitted with either a Cork or Felt mat. The plinth is available in three stunning finishes\*, and the arm is rounded off with an Ortofon 2M Silver cartridge to create a comprehensive package that would suit any system.

Available in the UK through Henley Designs Ltd.

T: 01235 511 166

E: [sales@henleydesigns.co.uk](mailto:sales@henleydesigns.co.uk)

W: [www.henleydesigns.co.uk](http://www.henleydesigns.co.uk)

 /HenleyDesignsLtd

 /HenleyDesigns1



\* Bordeaux finish shown

## INTEGRATED AMPLIFIER



**ABOVE:** Cardas speaker terminals are joined by four balanced and two single-ended line inputs, plus tape out XLRs. The RJ-11 sockets provide 'AyreLink' system comms

further down the frequency scale the intense vocals of Steve Balsamo were particularly well projected beyond the plane of my monitors.

I can't listen to the guitar break and chord progression in *Beneath The Waves*' title track without hearing Don Henley's 'Boys Of Summer' circling in the back of my head, so Henley's *Building The Perfect Beast* album came next – Mo-Fi's 'Ultradisc II' remaster [UDCD 705], which is a little more full-bodied and has appreciably sweeter and more pure-sounding highs than the 1984 Geffen issue.

This contains a busy assemblage of electric percussion bouncing between the channels to make up its joyous beat, the song soon deteriorating into a cacophony if not kept in check by a 'sympathetic' replay system.

### MEETING THE CHALLENGE

The AX-5 didn't fully pull its punches to conceal the recording's shortcomings, leaving me craving a little more upper bass 'bloom' to flesh out the track's stridency. But I was left convinced of the Ayre's transparency as a consequence.

Meanwhile it proved adept at serving up infectious rhythms and delivered a beguiling musical fluidity, with a fine sense of 'body' and definition to instruments, fast and detailed bass lines, a well projected and enticingly warm midrange and high frequencies free of grain or splashiness.

I've observed in the past that when I use my Levinson No383 amp to listen to Reference Recordings' *Testament* album with the Dallas Wind Symphony and Turtle Creek

Chorale [RR-49CD], the amplifier's mellow warmth and 'tubbiness' tends to congeal the massed voices. The AX-5 proved far better at separating the voices in this challenging recording. Yes, the sound appeared leaner, nonetheless the tonal qualities of the orchestra were more clearly defined and the depth of the image enhanced.

Thanks to the amplifier's supreme clarity, stereo imaging was exceptional when auditioning audiophile-quality recordings containing realistic spatial elements, with outstanding inner detailing.

Moreover the AX-5's neutral honesty rendered brass in an appropriately aggressive manner: for example, the first movement of Stravinsky's *Rite of Spring* [Telarc CD-80054]. Quite how it manages to sound so vivid and highly detailed yet 'sweet' at the same time is difficult to put into words. Perhaps it's the absence of any over-bright glare, a condition that often plagues highly revealing solid-state electronics, that's so refreshing.

This is a musically engrossing, gorgeous sounding amplifier that should be high on any hi-fi enthusiast's wish list. ☺

### HI-FI NEWS VERDICT

Once you're accustomed to the mechanical clunking of the volume control's stepper motor, the AX-5 is a lovely amplifier to use thanks to its large display, customisable input naming and illuminated handset. It delivers fabulous detail and musical insight without sounding in the least bit analytical, its sweet tonality and subjective warmth adding charm and innate listenability. It really is a class act.

Sound Quality: 88%



### AYRE AX-5

This is the first Ayre amplifier to be comprehensively tested in *Hi-Fi News* and the results are intriguing. The AX-5 has a couple of exceptional measurement 'features' and others that may well account for the AX-5's 'character'. The frequency response, for example, is as ruler flat from near-DC to 100kHz as makes no difference ( $\pm 0.04\text{dB}$ ) while the A-wtd S/N ratio is possibly the widest I've ever encountered for an integrated amp at a massive 102.4dB (re. 0dBW). Many amplifiers are still 20dB behind this figure these days. The power output meets Ayre's 125W/8ohm specification at 2x130W/8ohm but the 250W/4ohm rating is not, at least with a 1% THD criteria, at 2x225W/4ohm. There's more available under dynamic conditions at 160W/280W into 8/4ohm but limited current restricts power to 215W/125W into 2/1 ohm loads.

There's also a marked difference in distortion versus level into 8, 4, 2 and 1ohm loads [see Graph 1, below]. While the trend into 8ohm is fairly uniform (0.008% at 1W, 0.045% at 10W and 0.35% at 100W), those into lower impedances are evidently more undulating. How the AX-5 performs will clearly be speaker-load dependent, at least to a degree. Perhaps because of its VGT topology, the volume position, or overall gain, also impacts on the AX-5's distortion trend. For a fixed 10W power output, the lowest distortion is achieved at the maximum volume position (46), with THD increasing as the volume control is reduced [see Graph 2 where the power output remains constant at 10W/8ohm]. Readers may view an in-depth QC Suite report for Ayre's AX-5 amplifier by navigating to [www.hifinews.co.uk](http://www.hifinews.co.uk) and clicking on the red 'download' button. PM

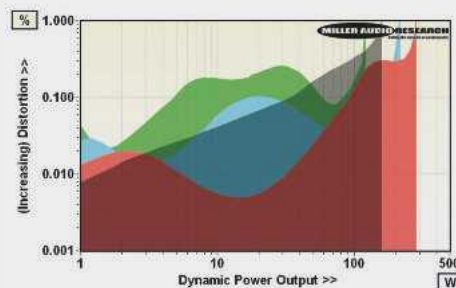

**ABOVE:** Dynamic power versus distortion into 8ohm (shaded black trace), 4ohm (red), 2ohm (cyan) and 1ohm (green) speaker loads

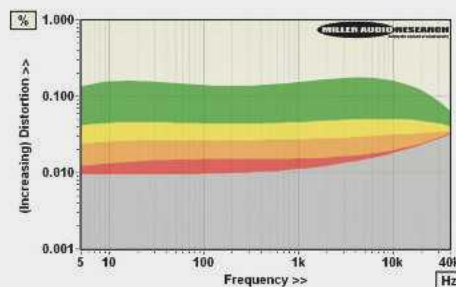

**ABOVE:** Distortion versus frequency from 5Hz-40kHz, all at 10W/8ohm (grey, Vol '46'; red, '43'; orange, '40'; yellow, '38'; green, '34')

### HI-FI NEWS SPECIFICATIONS

|                                      |                               |
|--------------------------------------|-------------------------------|
| Power output (<1% THD, 8/4ohm)       | 130W / 225W                   |
| Dynamic power (<1% THD, 8/4/2/1ohm)  | 159W / 280W / 215W / 125W     |
| Output impedance (20Hz-20kHz)        | 0.164-0.170ohm                |
| Frequency response (20Hz-100kHz)     | -0.01dB to +0.04dB            |
| Input sensitivity (for 0dBW/125W)    | 70mV / 815mV (Balanced in)    |
| A-wtd S/N ratio (re. 0dBW/125W)      | 102.4dB / 123.4dB             |
| Distortion (20Hz-20kHz re. 10W/8ohm) | 0.0095-0.023% (max vol, '46') |
| Power consumption (Idle/Rated o/p)   | 160W/480W                     |
| Dimensions (WHD) / Weight            | 440x120x480mm / 21kg          |

# Lindemann Musicbook 25

More than just a network music player, this midi-sized component features a built-in CD transport, DAC, headphone amp and preamplifier with digital *and* analogue inputs  
 Review: **John Bamford** Lab: **Paul Miller**

The high-end audio landscape has changed beyond all recognition in recent years. Visit any of the world's major hi-fi exhibitions today and you'll find high-end manufacturers demonstrating their wares using computer audio as a source.

No, this is not simply a 'fashion thing'. Imagine, for instance, Wilson Audio wanting to show off the capabilities of its flagship Alexandria XLF loudspeakers priced not far short of £200k. To demonstrate them at their best the company will play hi-res 'master' recordings stored on a HDD – as will any specialist audio company designing and manufacturing today's state-of-the-art amplifiers, loudspeakers and, of course, digital-to-analogue converters.

## A NEW WAY OF LIFE

The migration of music consumption from packaged media to computer files might necessarily have started with compressed files (due to internet bandwidth restrictions), the cost of data storage and consumer desires to play music on portable devices. The convenience of having a music library accessible at one's fingertips, for instant replay anywhere, always was a no-brainer for general consumers. The fact that it can be done today losslessly, without compromise – *ie*, at better than CD quality – has gradually made it a way of life for progressive audiophiles too.

These days pretty much any specialist hi-fi electronics producer possessing the technical and financial wherewithal has some form of computer audio related component in its portfolio alongside its disc players (if it still makes them) and amplifiers. Enter Lindemann audiotechnik, a boutique brand from Germany focused on high-end music replay for the past 20 years [see boxout]. Lindemann was, in fact, one of the world's first high-end brands to offer

a USB-to-S/PDIF converter for conveniently connecting a computer to an existing DAC in a hi-fi system. It was quick off the mark to make a USB-equipped DAC too.

Identifying what the company sees as a new trend for 'downsizing' complicated audio rigs, it has entered what represents new territory for the company in developing a new range of midi-sized products dubbed Musicbook. Extremely handsome they look too, housed in 6.5mm-thick aluminium cases boasting immaculate fit 'n' finish and with added-value OLED displays that lend a serious touch of class.

Lindemann's Musicbook components *are* expensive: the range is aimed at audio enthusiasts who really don't want to compromise sound quality when choosing something bijou and modern looking. Currently the line-up comprises four source components with computer audio very much to the fore, and which also provide preamp functionality. If you want a complete compact system there's an

identically-sized and styled power amp to make a two-box stack. Priced at £1590, the Musicbook 50 is a 2x100W/8ohm Class D power amplifier employing 'patented, improved UCD technology'.

## DIFFERENT OPTIONS

As for which of the front end/preamps you'll choose depends largely on how you want to manage and play your digital library. Do you want to store music on a NAS drive or a computer remote from the listening room and 'pull' data using a network music player (streaming), or simply push data from a computer to a DAC? In acceding this to be a fundamental choice when setting up a computer audio system, Lindemann has made its Musicbook front-ends either/or. If you want your preamp to be a USB DAC you'll choose the Musicbook 10 (£2650). Add £340 and the Musicbook 15 (£2990) includes CD playback as well. Meanwhile the Musicbook 20 (£3650) omits an asynchronous USB input and

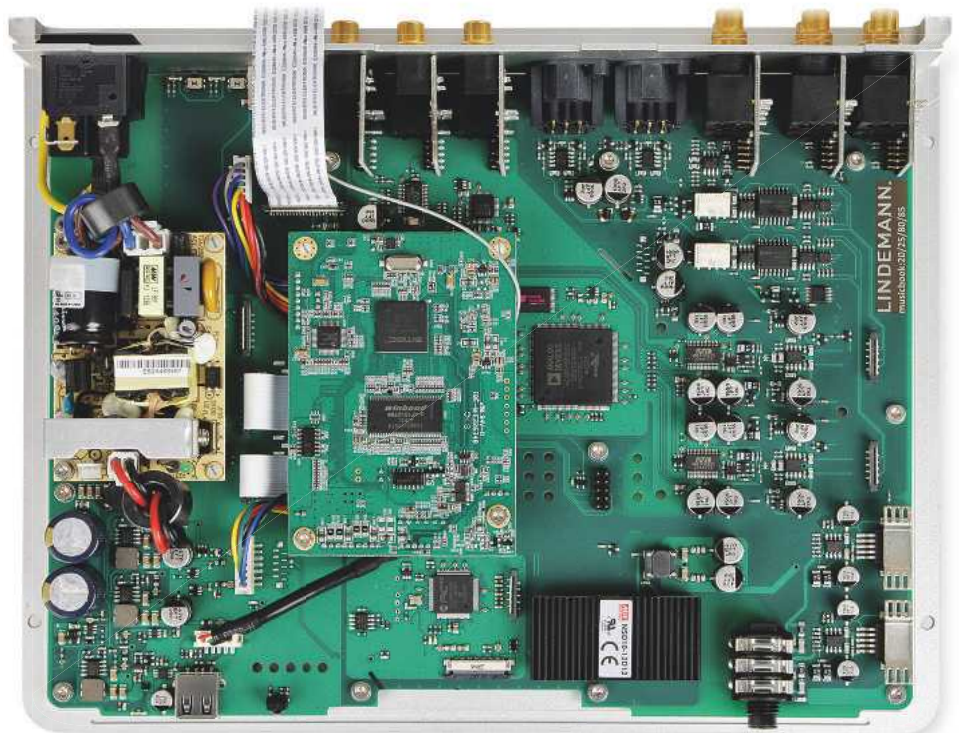

**RIGHT:** Slot-loading CD drive is hidden under the lid (not shown) while the chassis holds a switchmode PSU, Anagram 'Sonic Scrambling' and digital filter on an Analog Devices DSP with Wolfson WM8742 DACs at the output

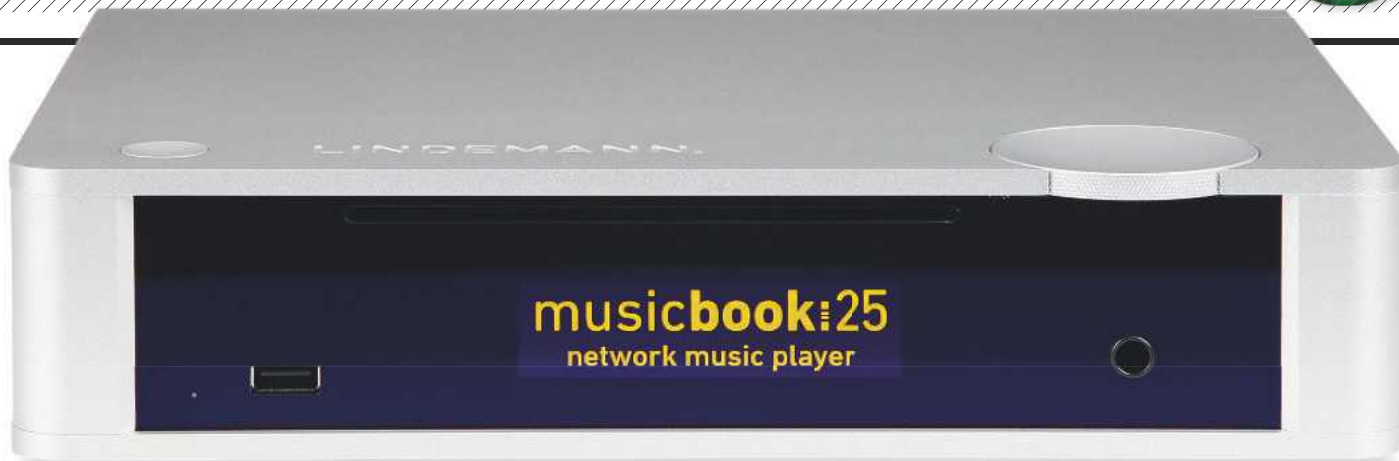

features a network music player instead, designed to be operated via a tablet or smartphone. Finally – yes, you’ve guessed it – the £3890 Musicbook 25 under scrutiny here is a Musicbook 20 ‘streaming preamp’ with added CD playback functionality. A near-invisible slot-in CD mechanism sits above the front panel’s display screen.

All four Musicbook front ends are identically equipped with four (two RCA, two Toslink) digital inputs for other sources and, being fully-fledged analogue preamplifiers, two single-ended (RCA) analogue inputs – enough for a phono amplifier and an FM tuner or old tape deck, say.

They also feature discrete Class A headphone amplifiers whose volume can be controlled remotely and separately from the preamp’s analogue outputs. And they all have two outputs (XLR and RCA) should you wish to feed two playback systems simultaneously, plus RCA and Toslink S/PDIF outputs – making it perfectly feasible to feed a third system. The Musicbooks’ variable analogue outputs, governed by a resistor network to control volume in 1dB

steps, can be ‘fixed’ to line level should you wish to connect them to an existing integrated amplifier. And in endeavouring for sonic purity, the digital outputs are disabled until activated via the setup menu. Also in the menu are settings for channel balance and display brightness.

You can control almost everything from the minimalist front panel whose multifunction dial adjusts volume (turn), selects an input (press and turn), mutes the output (short press) and stops/ejects a CD (press once and once again to eject). But to navigate tracks on a CD you’ll need to use the accompanying remote controller – or

Lindemann’s Musicbook control app. The RCU is very nice, formed of aluminium and gloss black acrylic with an ultra-slim profile [see bottom of p31]. It’s a shame it doesn’t illuminate, as it’s actually a *rechargeable* handset (via a mini USB socket). A charging cable is supplied.

Lindemann’s free control apps for iOS and Android are of course essential for navigating and playing music files over the network. Operation proved seamless via

‘Chris Layton’s cymbals rang and sizzled with authenticity’

**ABOVE:** Multifunction wheel controls many functions but you’ll drive it via its control app. USB port allows playback from FAT 16/32 formatted HDD and memory sticks, etc

my iPhone; album art display is included, and the app furthermore provides access to additional settings such as re-naming the Musicbook’s ‘Digital 1-4’ and ‘Analog 1-2’ inputs to match your partnering ancillaries. Gapless playback is supported with WAV, AIFF, FLAC, ALAC and MP3 files. Streaming 192kHz/24-bit files requires a wired Ethernet connection; via WLAN the limit is 96kHz/24-bit. Naturally the UPnP/DLNA network player functionality includes access to internet radio stations, the unit employing the ubiquitous vTuner platform.

### INVITING BALANCE

I found myself marginally preferring the sound of the Musicbook 25’s CD playback to streaming music via my home network. Heck, there really wasn’t much in it: only back-to-back A/B comparisons revealed a slight muting of dynamic contrasts and softening of transients. And my preference was easily turned on its head when listening to worthwhile hi-res audio files. For example, ‘Oh Daddy’ and ‘The Chain’ from Fleetwood Mac’s *Rumours* [Warner 7599-27313-2] appeared a smidgen more vivid and vital via compact disc than playing the WAV files (ripped using dBpoweramp) pulled from my ‘digital library’ via LAN and rendered by the Musicbook’s network player.

But this marginal subjective difference was made irrelevant when streaming the laughably superior 96kHz/24-bit version stored in my computer HDD, ripped from my copy of the 2001 DVD-Audio release of this famous album [Warner 9362-48083-9].

The longer I listened to the Musicbook 25 the more I grew to admire its voicing, its invitingly warm balance and delicate treble: not *too* smooth or over-sweetened. This meant that the sharp attack of the late Stevie Ray Vaughan’s evergreen ‘Tin Pan 

## LINDEMANN’S LEGACY

The German hi-fi manufacturing landscape is as vibrant as the British hi-fi scene once was. Among the country’s many high-end audio companies is Lindemann audiotechnik GmbH, founded by Norbert Lindemann in 1992 and situated in Krailling, a 20-minute drive west of Munich. Having studied electronics in the ’70s, Lindemann worked as an engineer for a PA company before making his passion for high fidelity replay his profession, by setting up his own company. The first Lindemann component was the AMP1 current mode integrated amplifier, soon followed by partnering BOX1 loudspeakers. The company boasts many innovations having introduced one of the world’s first upsampling CD players and, in 2001, Lindemann’s 820 disc spinner laid claim to being the first SACD player made in Germany. It’s no longer in production, the £7k 825 CD player/DAC being Lindemann’s flagship source in its heavyweight 800 separates series. Lindemann still makes loudspeakers: its Birdland speaker range features bespoke ceramic-coned drivers by Accuton, housed in multi-layer composite enclosures formed of birch plywood, cork and furniture-grade linoleum.



## Moon Nēo

Renaissance Audio is proud to present the new MOON Nēo series by Simaudio. The Nēo series sets a new standard for performance, build quality and appearance for affordable high-end audio. Available as black as standard with silver and two tone option. The full range is available now, see [www.renaissanceaudio.co.uk](http://www.renaissanceaudio.co.uk) for details and prices.



### Nēo 250i

Integrated Amplifier, versatile and intuitive to use, delivers a seductive performance and represents an outstanding value.



### Nēo 260D

CD Transport/DAC, provides superb flexibility with a sonic performance that is without equal in its price category.



### Nēo 380D

Streamer/DAC, a new standard for digital playback. It will recover and deliver detail you previously thought was simply not there.



### Nēo 400M

Mono Power Amplifier, delivers finesse, detail and refinement that challenges your perception of reality vs recorded music.

## NETWORK AUDIO PLAYER



**ABOVE:** Four S/PDIF and two RCA analogue inputs should be adequate for most requirements. Power amp connection can be balanced (XLR) or single-ended (RCA)

Alley (aka Roughest Place In Town)' from *Couldn't Stand The Weather* [Epic Legacy EPC 494130 2] had plenty of energy and dynamism, the leading-edge bite of the guitar sharply etched and suitably angry.

Similarly, Vaughan's bombastic interpretation of Jimi Hendrix's 'Voodoo Chile (Slight Return)' fizzled with power and passion, with the driving bass and drums of the accompanying Double Trouble combo appearing faithfully vital, with real speed and attack, while the sound of Tommy Shannon's bass guitar was deep and well-formed, and the cymbals of Chris Layton's drum kit rang and sizzled with convincing authenticity.

### RELAXED DEMEANOUR

Moreover, with what you might term 'run of the mill' pop and rock recordings the network player's subtle 'softening' could often be judged advantageous, as it obviated excessive brightness and listening fatigue. You wouldn't – or at least you shouldn't – judge the capability of a hi-fi component listening to shoddy recordings and low bitrate internet radio stations, but the fact that the Musicbook 25 doesn't throw a spotlight on sonic deficiencies might be considered a boon for many music collectors.

Playing Nora Jones's *Feels Like Home* [192kHz/24-bit download from HDtracks] the Musicbook 25 sounded all of a piece, Jones' close-miked breathy vocals appearing to hover seductively in the soundstage in 'Sunrise' and remaining intimate and vivid in 'What Am I To You', with its thicker production quality.

Thanks to the player's smooth and relaxed demeanour female vocals fared particularly well throughout the listening tests.

The title track from 2011's *Paper Airplane* by Alison Krauss & Union Station [Rounder 11661 06652] was a fine exemplar of the Lindemann's ability to serve up a three-dimensional image, with Alison Krauss's voice depicted exquisitely in the deep soundstage.

Skimming through a selection of audiophile hi-res recordings from AIX, Channel Classics, 2L and Reference Recordings confirmed the Musicbook's compatibility with all sampling rates up to 192kHz. It also substantiated the '25's extremely satisfying sound quality, showing that it was more than capable of corroborating the benefits of increased recording resolutions.

Only if you crave *uber*-accurate instrumental separation and forensic detail might you feel slightly short-changed. Then you'll need to dig wa-ay deeper into your savings. Lindemann's Musicbook 25 is, after all, considerably cheaper than many audiophiles' compact disc players – never mind that it constitutes a 24-bit/192kHz-capable network music player, DAC, headphone amp and analogue preamplifier all housed as one compact component. It certainly makes a convincing argument for 'downsizing'. ☺

### HI-FI NEWS VERDICT

Used both as a network player and when playing CDs, the Musicbook 25 sounds highly civilised, with a rich midband and pleasing treble devoid of digital 'grain'. It is expensive for sure, but considering the unit's luxurious build quality and comprehensive functionality, not to mention its pleasingly compact form factor, it crafts a pretty esoteric hi-fi experience and thus it can be warmly recommended.

Sound Quality: 78%



## LINDEMANN MUSICBOOK 25

Lindemann's literature says the MB25 is utilising the 'latest generation sonic scrambling DAC (Anagram), minimum phase apodizing filter and balanced conversion in dual-differential mode'. In practice the MB25 appears to be employing an Anagram digital filter running on a separate DSP (as adopted by Cambridge Audio in its digital products) with the company's low-bit scrambling (a technique to randomise fixed quantisation errors at low bits) but output to a pair of Wolfson WM8742 24-bit/192kHz DACs. Somewhere along the chain there's a sample period offset between left and right channels [see Graph 2, below], the right lagging the left by 0.023msec at 44.1kHz, for example, leading to a progressive interchannel phase shift that necessarily increases with frequency.

Tested at volume '78' for a maximum undistorted output of 3.95V (THD is as low as 0.0005-0.0009 through mid and high frequencies but increases to 0.004% at 20Hz), the MB25's 107.5dB A-wtd S/N ratio is a little lower than possible (CD and digital inputs) but still perfectly acceptable. Lindemann's digital path is otherwise very clean and jitter held to exceptionally low levels – 130psec for CD and just 10-20psec for all 24-bit digital input sample rates. Distortion is also very low indeed through the crucial –10dBfs to –30dBfs levels at ~0.0004% [see Graph 1, below]. Responses with CD and 48kHz media are perfectly 'standard' (–0.6dB/20kHz and –0.3dB/20kHz, respectively) but are more obviously 'shaped' by the digital filter [see Graph 2] with 96kHz/192kHz media (–3dB/26kHz and –3dB/49kHz).

Readers are invited to view comprehensive QC Suite test reports for the Lindemann Musicbook 25's CD player and digital inputs by navigating to [www.hifinews.co.uk](http://www.hifinews.co.uk) and clicking on the red 'download' button. PM

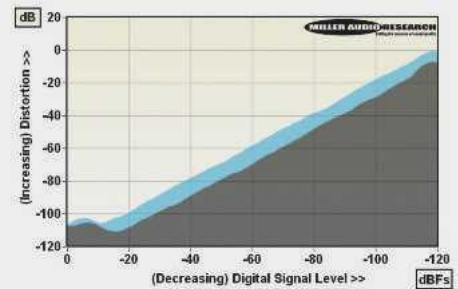

**ABOVE:** Distortion vs. 24-bit/48kHz digital level over a 120dB dynamic range (1kHz, black; 20kHz, blue)

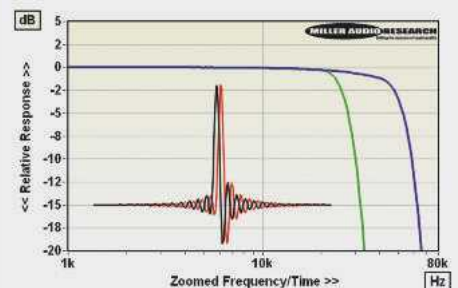

**ABOVE:** Zoomed freq. resps (96kHz, green; 192kHz, blue) and impulse responses (left, black; red, right)

### HI-FI NEWS SPECIFICATIONS

|                                      |                          |
|--------------------------------------|--------------------------|
| Maximum output level (Balanced)      | 3.95Vrms at 97ohm        |
| A-wtd S/N ratio                      | 107.8dB                  |
| Distortion (1kHz, 0dBfs/-30dBfs)     | 0.0009% / 0.0004%        |
| Dist. & Noise (20kHz, 0dBfs/-30dBfs) | 0.00045% / 0.0005%       |
| Frequency response (20Hz-20kHz)      | +0.0dB to –0.3dB         |
| Digital jitter (48kHz/96kHz/192kHz)  | 12psec / 15psec / 18psec |
| Resolution @ –100dB                  | ±0.1dB                   |
| Power consumption                    | 12W (1W standby)         |
| Dimensions (WHD) / Weight            | 280x65x220mm / 3.5kg     |

# Consonance Isolde/T8

One of two new Consonance turntables from Opera Audio, the Isolde comes complete with a custom carbon fibre tonearm and looks to be promisingly good value

Review: **Adam Smith Lab: Paul Miller**

The price region from £1000 to £2000 is the source of a wide range of eminently capable hi-fi components, particularly when it comes to turntables. Naturally, the lower end is well catered for but, despite some very good models in this sector, ultimately the designs are constrained by a need to bring the deck in at a relatively tight budget. Arguably, the higher the price, the looser are the reins on the design team, but in this hotly contested £1-2k region there are more than a few models that punch well above their weight.

A newcomer that sits pretty much slap bang in the middle of this price sector is the latest offering from Beijing's Opera Audio Company. The Consonance Isolde (named after Wagner's operatic character) is a neat and pleasant looking turntable, rather more traditional in style than some of the company's previous – and indeed current – offerings.

With the apparent discontinuation of the highly effective but ever-so-slightly mad Forbidden City Liu model (if you've seen one in red, you'll understand my reservation), along with the Droplet LP3.1 and Droplet LP6.1, the Isolde occupies the lower rung of Consonance's ladder, sitting below fellow newcomer, the Die Walküre, and the range-topping Droplet LP5.0.

The Droplet model has been around for a few years now and gained great acclaim for its fine performance, but it is somewhat modern and striking in its appearance, as is the essentially triangular Die Walküre. So the addition of the Isolde is a fine attempt to lure in buyers with more traditional stylistic preferences.

There's a well finished wooden plinth, with the Isolde's motor recessed into the top plate and driving the periphery of the acrylic platter via a rubber belt. Sat on top of the platter is a very stiff foam mat of debatable sonic merit – more on this later.

**RIGHT:** The motor is neatly integrated into the left rear corner of the plinth and the acrylic platter is topped with a thick foam mat that has a tendency to attach itself to records

This also has an unfortunate attraction to records and has a tendency to stick to them like a limpet when they are removed from the platter, which is annoying.

## GROPING FOR SPEED CHANGE

The motor is a DC type and a multi-turn adjustment potentiometer is located on the rear panel to facilitate correct speed setup, in conjunction with a supplied 12in stroboscopic disc that is very clear and easy to read. Unfortunately, this pot is also the only means provided of varying speed, so changing from 33.3 to 45rpm, or vice versa, involves the use of the strobe disc and reaching over the deck to twiddle until the desired speed is attained.

This is hardly a very satisfactory method; even if one does not have a particularly large collection of 7in or 12in singles, there are an increasing number of LPs being

released that play at 45rpm and, frankly, providing an easy method of switching, or even offering a two-step motor pulley to permit manual change, would surely have been a better option.

Underneath, the Isolde sits on four silver legs with felt pads top and bottom that locate into recesses in the underside of the plinth. Each recess contains what appears to be a squash ball and these simply rest on top of the legs. Although these legs are adjustable for easy levelling, they are very tall and this, combined with the rubber spheres, mean that the deck sits a few inches off the support surface and does not feel particularly stable – more of this later, too [also see PM's Lab Report, p35].

The collar for the Consonance T8 arm comes pre-mounted into the plinth and the arm is simply dropped into place and secured by two hex screws. The small box







visible at the rear is fixed to the arm pillar and contains the output phono sockets, thus meaning there is no need to battle with output lead routing below the deck, or the sometimes awkward process of plugging in an arm lead underneath.

The T8 is available on its own for £795 and its 'above decks' configuration means it will be easy to attach to any turntable, particularly those with a suspended chassis where arm lead dressing is crucial to optimum suspension operation. The downside is that the use of a lid may be impeded by the lead protruding from the rear and, to cater for this, the cover supplied with the Isolde fits onto the centre spindle and covers platter and arm only.

The arm itself has a carbon fibre armtube and its headshell comprises a simple platform that is attached with one screw. Bias is applied by the thread and weight method, and tracking-force by simply sliding the counterweight along the rear stub, in conjunction with a stylus force gauge. Two weights are provided

and I had to use both right near the end of the arm to successfully balance my Ortofon Kontrapunkt B cartridge, so be aware of this if your transducer of choice is particularly weighty. With the deck suitably set up, warmed up and connected to my Anatek MC1 phono stage, Naim Supernait amplifier and floorstanding PMC loudspeakers, I sat down to listen.

### CALL FOR EXPERIMENTATION

The first track to be cued up was 'New York Morning', the recent single from Elbow's new album, *The Take Off And Landing Of Everything* [Fiction 3754768] and initial impressions were favourable. Guy Garvey's vocals were located nicely centre-stage and the lowest backing notes during the introduction were pleasingly deep.

However, when things moved up a gear, the Consonance sounded both confused and rather shouty in the midrange and decidedly bloated and wobbly in the bass. Listening further confirmed these initial

'Backing piano was detailed, atmospheric and pitch stable'

**ABOVE:** The wooden plinth sits on metal feet that are adjustable for height and locate into four recesses, each equipped with an isolating insert. The belt drives the platter's periphery

impressions and so I set to in order to see what could be done.

Firstly, the annoying mat went west, to be replaced by a simple felt item, which tidied up the midband very effectively. I also carried out some experimentation with those spongy feet and came to the conclusion that the deck actually worked best with the underside of the plinth sitting directly onto the four legs, rather than locating them in their intended recesses. Returning to Elbow, now the bass was fulsome but not overblown and the midband was far more controlled but without losing any of the intimacy of the musical performance.

One area which was not of concern at any point throughout this experimentation, however, was the treble. The Isolde is a very smooth performer here but not at the expense of any detail; it never seemed muffled or reined-in at any point. It was, in fact, at the top end that the increase in budget allocation made itself felt. Cheaper decks simply do not offer the level of sophistication exhibited by the Isolde and, it has to be said, neither do one or two of its similarly-priced competitors.

With these thoughts fresh in my mind, I broke out the strobe disc and wound the platter back down to 33.3rpm to enjoy the delights of 'Baby I'm A Fool' from Melody Gardot's *My One And Only Thrill* [Verve 1796787]. Miss Gardot's vocals were an absolute joy, being husky, breathy and alluring, with the backing track gently underpinning everything.

The Isolde had no trouble in setting up a fine sense of perspective to the performance, with very good central image stability. Depth information was also commendable but the deck did fall ↪

## OPERA AUDIO

Opera-Consonance was founded by an engineer, Shihui Liu, in 1994 and its inception resulted from him designing a single, home-grown valve amplifier. He was subsequently asked to make another that could be sold – and the rest, as they say, is history. The company has gradually forged itself a solid reputation for good design and fine build quality and is well known for its wide selection of amplifiers, in particular. These range from simple, low-powered 300B valve designs right up to the mighty Calaf transistor powerhouse; but a complete Consonance system can be assembled, as they also manufacture turntables, tonearms, CD players, loudspeakers and an all-in-one amplifier/CD player/tuner. They even make interconnect, loudspeaker and mains cables to put it all together! Interestingly, Consonance was also the first manufacturer of turntables in China and Shihui Liu is a committed vinyl fan, demonstrating his equipment using an analogue source at every show the company attends. Even more impressively, he still creates all the company's new designs himself.

# OPPO®



BDP-103D DARBEE EDITION

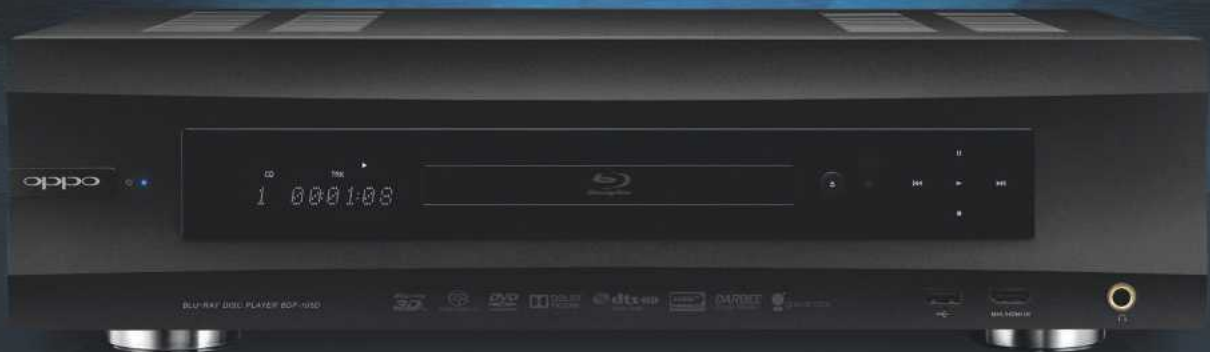

BDP-105D DARBEE EDITION

## SEEING IS BELIEVING

Based on the multi-award-winning BDP-103EU and BDP-105EU, these new models add Darbee's Visual Presence™ technology to establish a fundamental breakthrough in image realism.

"It's like lifting a veil." DVP embeds real depth information, bringing unparalleled levels of clarity and depth for a more dynamic, lifelike experience.

For video purists, the 'source direct' mode provides genuine native playback.

## HEARING IS BELIEVING

OPPO BDP-105D builds on its predecessor's audiophile reputation by adding DSD 128 (5.6Mhz) support to the USB DAC, and can now also stream DSD 64 (2.8Mhz) over the network.

BDP-105D features an all-new analogue audio stage powered by two ESS Sabre<sup>32</sup> Reference DACs, balanced XLR outputs, a Toroidal linear power supply, headphone amplifier, asynchronous USB DAC input, and iOS/Android Apps for media control.



LOOK OUT FOR OUR FORTHCOMING  
PLANAR MAGNETIC HEADPHONES PM-1 & HEADPHONE AMP HA-1

More details on our website

[www.oppo-bluray.co.uk](http://www.oppo-bluray.co.uk)

## CONSONANCE ISOLDE & T8

As the Isolde's acrylic platter lacks a recess for the LP label, the deck was tested with the (stiff) foam mat in place. Fine adjustment of the DC motor is possible [see picture, opposite] but there remains some very low-rate drift in absolute speed of approximately  $\pm 0.25\%$  over the duration of an LP side, so it's worth keeping an eye on this. Fortunately Consonance supplies a very nice strobe disc for the purpose! Peak-weighted wow and flutter are usefully low, particularly the former at just 0.03% although the 'sharpness' of the main spectral peak is affected by a low-rate  $\pm 1\text{Hz}$  component [see Graph 1, below] which is also revealed on both through-groove and through-bearing rumble measurements ( $-69.5\text{dB}$ , DIN B-wtd). This is probably an (imperceptible) rocking mode of the turntable plinth balancing on what appears to be four squash balls...

The partnering T8 tonearm is a low effective mass design (9g) with a straight carbon-fibre tube and adjustable headshell/cartridge mounting block. The lightweight main tube is also sufficiently rigid to offer a relatively high 194Hz main bending mode but there are also strong harmonic/torsional modes at 290Hz and 440Hz. The gimbal bearing itself is not especially substantial and this, in addition to the small outrigger appendages, is probably responsible for the higher rate modes at 1kHz and above [see Graph 2, below]. Some play was also detected in the bearing mount, although this may be a deliberate attempt at decoupling. Readers are invited to view full QC Suite reports for Consonance's Isolde turntable and T8 tonearm by navigating to [www.hifinews.co.uk](http://www.hifinews.co.uk) and clicking on the red 'download' button. **PM**



**ABOVE:** The rear of the Isolde has a mains socket and dial-up speed control. Above, the output RCAs are an integral part of the tonearm cabling; earth lead is hard-wired

short of my reference Michell Gyro SE in terms of soundstage *width*. The Gyro is an absolute master in this respect, however, so the Consonance deserves great credit for not sounding overly constrained by comparison.

Moving on to the track 'Your Heart Is As Black As Night' I was also pleased to hear that the Isolde and T8 were more than capable in terms of instrument rendition. Patrick Hughes' trumpet work was a delight to behold and the backing double-bass line set up a solid musical foundation without ever intruding.

This type of material suited the Isolde, playing to its strengths in the upper mid and treble regions, and allowing it to show off its abilities in bringing everything together as a cohesive whole.

### ISOLDE'S COMFORT ZONE

In order to push things along a little further, I popped Disclosure's *Settle* [UIR 00602537394883] onto the platter and cued up the track 'Help Me Lose My Mind', which features London Grammar on support duties. Hannah Reid's vocals were well rendered and the backing drum machine sounded crisp and vivid, but when the bass line kicked in properly I found myself feeling just a little short-changed.

The notes were deep and taut but the Isolde's polite manner that had proved so beneficial with Melody Gardot now started to work against it. While the music bumped along nicely enough, I found myself wishing for a little more impact and punch, as the Consonance never really set my foot tapping – not a problem I usually have with this particular track.

In an attempt to move back to the Isolde's comfort zone, I stayed with the sound of London Grammar but this time with their own LP, *If You Wait* [Ministry of Sound

MADART1LP] which, unfortunately, involved another session with the strobe disc and that infernal pitch knob! With 45rpm dialled in and the track 'Night Call', the Isolde's true colours once again showed through.

Hannah Reid's vocals are much more vivid on this pressing and they stretched out of the loudspeakers very well. Even better, the backing piano was detailed, atmospheric and – above all – pleasingly pitch stable, which is not something that can be said of all belt drive designs.

I have also found this particular aspect to be a slight concern on some previous Consonance turntables, so was very pleased to hear that it is no longer an issue: the Isolde was as stable as could be wished for. As a result of this, the track was most enjoyable. Later on, a drum machine kicks in and this is quite a strange beast as it does not have any great punch or bass impact – it just does its thing behind the main action.

As a result it can exhibit a tendency to become enmeshed with the subsequent vocals but the Consonance Isolde/T8 dealt with this well, also making sure it did not overpower proceedings. ☺

### HI-FI NEWS VERDICT

The Consonance Isolde turntable and T8 arm are an endearing combination. Although they require a little fettling to perform at their best, the end result is a highly enjoyable one, especially if your taste in music extends to more atmospheric performances. The quality of its engineering is good and it is easy to setup and use – speed change notwithstanding. All in all, a welcome addition to the market.

Sound Quality: 75%

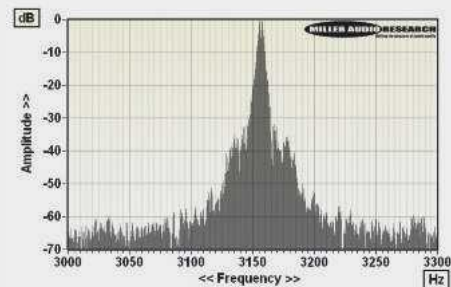

**ABOVE:** Wow and flutter re. 3150Hz tone at 5cm/sec (plotted  $\pm 150\text{Hz}$ , 5Hz per minor division). Note the correlated wow at  $\pm 1\text{Hz}$  and  $\sim \pm 15\text{-}25\text{Hz}$  flutter

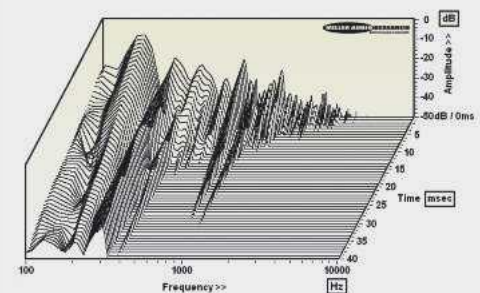

**ABOVE:** Cumulative tonearm resonant decay spectrum, illustrating various bearing, pillar and 'tube' vibration modes spanning 100Hz-10kHz over 40msec

### HI-FI NEWS SPECIFICATIONS

|                                      |                      |
|--------------------------------------|----------------------|
| Turntable speed error at 33.33rpm    | 33.41rpm (+0.24%)    |
| Time to audible stabilisation        | 5sec                 |
| Peak Wow/Flutter                     | 0.03% / 0.04%        |
| Rumble (silent groove, DIN B wtd)    | $-68.9\text{dB}$     |
| Rumble (through bearing, DIN B wtd)  | $-69.5\text{dB}$     |
| Hum & Noise (unwtd, rel. to 5cm/sec) | $-57.9\text{dB}$     |
| Power Consumption                    | 3-4W                 |
| Dimensions (WHD) / Weight            | 380x180x480mm / 14kg |

Music is food  
for the soul.  
Without music  
the world would  
be a very quiet,  
still place indeed  
and dare I say -  
**without Audio  
Note (UK) to  
play the music,  
quieter still.**

Based in Brighton, Luxurie is the UK's only  
dedicated Audio Note (UK) specialist dealer.



Luxurie  
4 Old Church Hall  
15 Ditchling Rise  
Brighton, East Sussex  
BN1 4QL, England



web site



clients

t: 01273 590 716

e-mail: [audionote@luxurie.me](mailto:audionote@luxurie.me)

web: [www.luxurie.me](http://www.luxurie.me)



*exposure*  
high fidelity engineering

# 3010s2

unleash the passion with real hi-fi sound

**hi-fi** |'hī'fī| informal  
*adjective*  
of, used for, or relating to the reproduction of music or other sound with high fidelity.  
*noun* (pl. -fis |'ha 'faizl)

## high fidelity

*noun*

the reproduction of sound with little or no distortion, giving a result as similar to the original as possible.



Exposure Electronics Ltd:  
Unit 18, Winston Business Centre  
43 Chartwell Road  
Lancing Business Park Lancing  
BN15 8TU

Tel: +44 1273 423877

Fax: +44 1273 806648

Please visit [www.exposurehifi.com](http://www.exposurehifi.com)

The new HP-A4 stereo USB DAC from Fostex  
Linear PCM up to 24bit/192kHz | DSD up to 5.6MHz



*A match made in heaven*

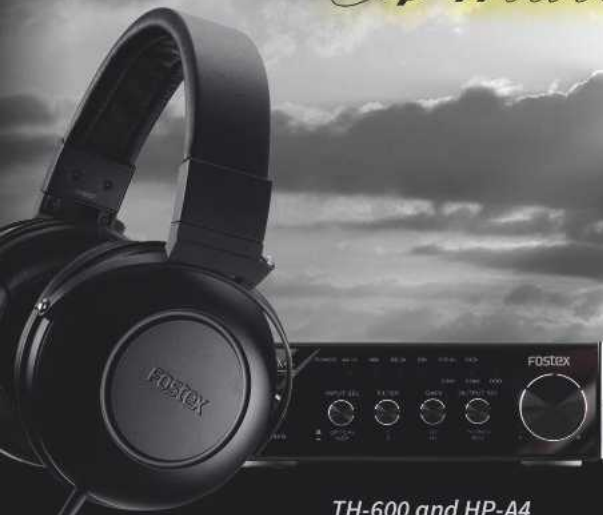

TH-600 and HP-A4



TH-900 and HP-A8C

Buy any DAC and headphone combination and get 10% off. 30 day money back home trial\*  
Call us now for details - 03301 222500

\*if you aren't satisfied with the exceptional audio quality, return the items in as new condition for a full refund.

# hi-finews GROUP TEST

The latest generation of mid-price integrated amplifiers offers a wide variety of features, power output and styling – but what about the sound? We try five of the best...

## INTEGRATED AMPLIFIERS £1500-£2000

### TESTED THIS MONTH

|                        |       |
|------------------------|-------|
| EXPOSURE 3010S2        | £1495 |
| NAD C 390DD            | £1999 |
| NAIM NAIT XS2          | £1595 |
| REGA ELICIT-R          | £1600 |
| SIMAUDIO MOON NEO 250I | £1890 |



Cutting-edge gear, cherry-picked by the *Hi-Fi News* editor



The pinnacle of sound quality within its peer group



Great sound, great value and a cut above its rivals

### • CD PLAYERS • TURNTABLES • CARTRIDGES • SPEAKERS • AMPLIFIERS • HEADPHONES • INTERCONNECTS •

It's remarkable how many changes the humble integrated amplifier has undergone over the years. Like a buoy on a rough sea, it has been pushed one way and pulled the other, as the tides of fashion and buyers' needs change.

Once, integrations came replete with a profusion of knobs and switches – a filter or two here and a tone control or three there. Then the 1980s arrived, and suddenly the breed was stripped bare: less was more, and the pricier the product the sparser it was.

The Exposure, Moon, Naim and Rega tested here are essentially '80s children, offering relatively few features and Class AB power that produces a fair punch from a compact package. However, the NAD is a modern reinvention of the more traditional integrated amplifier – it is packed with features but everything is now done in the digital domain, right down to the Class D power amplifier section. It even has digital inputs and an integral DAC with USB connectivity – in contrast to, say, the Exposure which is little more than a power amp with a volume control.

So, *HFN* readers looking for a sub-£2000 integrated need first to decide what they want from it. If you're already kitted out with a good digital converter and just need a high quality all-rounder then all bar the NAD fit the picture. Conversely, if you want future expandability, digital inputs and basic room EQ, then the NAD is the obvious choice. Sonics differ dramatically too – even between the four similarly priced conventional designs.

Each has its own family sound which is quite distinct. Meanwhile the fifth amp here uses Class D to achieve its sound, but still comes over as recognisably a NAD. All of the integrations here sound good in their way so, ideally, prospective purchasers should audition them in their own systems to determine the best for them. However, this test should prove a great tool to help draw up your shortlist.

#### BENCHMARK RECORDINGS

A wide variety of source material was used, but four songs became particular benchmarks during the listening period. First was Peter Gabriel's 'Humdrum' from *Peter*

*Gabriel 1* [Virgin PGCD1], which is a clean, even and dry 1977 rock recording transcribed from the analogue master tape with care.

Randy Crawford's 1981 'You Might Need Somebody' [*Secret Combination*, Warner 256 904] is a beautiful soul recording, where she displays her amazing voice to great effect. It's a warm and inviting cut with plenty of air, the musicianship is superb and its production is refreshingly devoid of gimmickry.

4hero's 'Universal Love', from *Parallel Universe* [Selector SEL3], is a powerful slice of drum and bass music that blends deliciously warm sounding analogue synthesisers with powerful electronic beats and a pile-driving sub-bass. It's an exhaustive workout for any integrated amplifier.

Kate Bush's 'Snowflake' [*50 Words For Snow*, Fish People FPCD007] is a beautiful, brooding and subtle modern recording that is done to extremely high standards, with breathtaking depth and great intricacy to the lead vocals and piano alike. ↻

REVIEWS BY NICK TATE  
LAB TESTS BY PAUL MILLER

### • CD PLAYERS • TURNTABLES • CARTRIDGES • SPEAKERS • AMPLIFIERS • HEADPHONES • INTERCONNECTS •



# Exposure 3010S2

Most famous for its big black pre-power amplifier combinations of the 1980s, Exposure traditionally sold to people who wanted punchy solid-state amps that sounded smoother and creamier than rival Naims. Nowadays, the sound hasn't changed much but the size has and most of its wares are more affordable products such as this – Exposure's top integrated.

It's a nice device, with a decent finish and clear ergonomics – unlike the fiddly Rega, for example. Styling is pretty conventional; its fascia is a thick slab of brushed aluminium and the knobs have a smooth and silky action. Like most others here it has six inputs, but is unusual for having an MM/MC phono module option.

The manufacturer says much attention has been paid to squeezing the best sound out of the circuitry. To this end, special capacitors feature in the signal path and the circuit topology has been mapped with a view to keeping signal and power supply paths short. Cascode circuitry is used for improved power supply immunity, says Exposure, and there's a fast bipolar transistor output stage with high quality relays fitted in the preamplifier section.

**A NATURAL EASE**  
 Right from the off, the Exposure proved a highly impressive performer, offering a well rounded tonality that sat bang in the middle of the group. Others like the Naim were rather a lot brighter, whereas the Rega sounded appreciably warmer. As well as its lovely even balance, it was big-hearted and bold; the stereo soundstage was



spacious and the amp had lots of easily delivered power on tap. The result was an expansive rendition of Peter Gabriel's 'Humdrum'. But it wasn't all about size, because the 3010S2 had delicacy and detail in spades. The rich, sonorous timbre of the piano was lovely, the instrument coming across in all its ringing glory.

The all-electronic 4hero track didn't change this impression; here we had a crisp and open midband able to throw up every element of the mix into sharp relief, but it didn't sound edgy or forced in any way. Rather, the music flowed with a natural ease that most of the others here lacked.

By comparison, the clear and explicit Nait XS2 didn't gel as well, sounding a little less natural, while the Rega made the recording feel slightly opaque and veiled.

The Exposure went on to showcase Randy Crawford's beautiful vocal chords, and conjured up a wonderfully relaxed yet stirring performance dripping with feel. Indeed, this amplifier has no weak points at all – and is also very strong in most areas. This makes it a truly satisfying way to play music, much more than its price would suggest.

Sound Quality: 85%  
 0 - - - - - 100

ABOVE: One of the more minimalist amps here, source selection and volume knobs are your lot. However, they have a fine, silky action and the brushed alloy fascia looks sleek

## HI-FI NEWS LAB REPORT

Distortion really does decrease as the 3010S2 is left to warm up – from 0.015% to 0.010% over 30 minutes at 10W/8ohm. Once toasty, the 3010S2 holds to ~0.01% from 1-100W/8ohm although THD in our sample did increase more sharply through the treble via the right channel (0.020% vs. 0.10%, L/R). As for power output, the 3010S2 beats its rated 110W at 2x135W and 2x225W into 8/4ohm with sufficient dynamic headroom to accommodate 175W, 325W and a huge 555W into 8, 4 and 2ohm loads [see Graph, below]. Output is short-circuit protected to 335W (18.3A/1ohm) but it's still the beefiest amp in our test and very tolerant of difficult speakers. Output impedance is also usefully lower than with previous-generation Exposure amps at 0.017ohm while the frequency response holds true to within ±1dB from 8Hz-23kHz. The 80dB S/N ratio (re. 0dBW) is a little lower than average but this is white noise rather than hum and likely to have a flattering subjective influence. PM

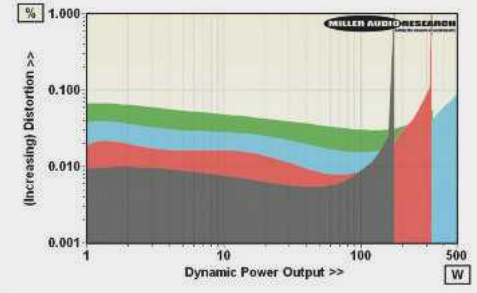

ABOVE: Dynamic power output versus distortion into 8ohm (black trace), 4ohm (red), 2ohm (blue) and 1ohm loads (green)



ABOVE: In addition to six RCA line inputs, the Exposure's back panel offers two sets of preamp outputs for bi-wiring, and two pairs of speaker outputs, plus IEC mains in

|                                     |                          |
|-------------------------------------|--------------------------|
| Power output (<1% THD, 8/4ohm)      | 135W   225W              |
| Dynamic power (<1% THD, 8/4/2/1ohm) | 175W   325W   555W   30W |
| Output impedance (20Hz-20kHz)       | 0.017-0.032ohm           |
| Frequency response (20Hz-100kHz)    | -0.16dB to -12.7dB       |
| Input sensitivity (for 0dBW/110W)   | 25mV   265mV             |
| A-wtd S/N ratio (re. 0dBW/110W)     | 80.4dB   100.8dB         |
| Distortion (20Hz-20kHz, 10W/8ohm)   | 0.005-0.027%             |
| Power consumption (Idle/Rated o/p)  | 23W   265W               |
| Dimensions (WHD)                    | 440x115x300mm            |



# NAD C 390DD

A good number of readers will have started their hi-fi systems with NAD's superb Class A/B 3020 integrated amplifier back in the early '80s, but now it's 2014 and the growing number of digital sources makes a good case for a Class D amplifier that keeps the signal in the *digital* domain all the way up to the speaker outputs. The breed's low power consumption also reflects the way the world is turning, and it's also able to serve up high levels of output power with relative ease.

The new C 390DD sees NAD developing its M2 Direct Digital Amplifier into something more mainstream, with all preamplification done digitally. This should eliminate phase shift and analogue noise and distortion, says the manufacturer, and it also offers the prospect of room correction.

Inside it sports a powerful 35-bit architecture with a 108MHz master clock. The C 390DD comes standard with optical and coaxial digital inputs, plus one digital interface module – a 96kHz/24-bit USB input, but you can add HDMI and analogue phono inputs at extra cost. NAD's Digital PowerDrive circuit is designed to sense the speaker load and alter the amplifier characteristics accordingly. The C 390DD feels nice to use, although doesn't rival the other four here in the style or build quality stakes.

### KEEPING A GRIP

After the great start out of the blocks for the Exposure, it was interesting to hear the NAD putting in a feisty performance too. It's quite different to the 3010S2's, but is still very enjoyable to listen to. This amp

sounds polished, tonally even and rather svelte-sounding; there are no stand-out peaks or troughs. Bass is strong but not boomy, midband open and treble nicely finessed.

The Peter Gabriel track showed how – on the densely layered end section – the amp was capable of keeping a good grip on the individual elements of the mix, with the cymbals sparkling out with wonderful delicacy. Vocals lacked some body and sounded a little too smooth, but were always pleasant.

However, the bass disappointed. It proved clean and satisfyingly fulsome but was also a tad wooden. For example, the bass guitar work appeared to be a little 'slowed down' and lacking in passion.

The Kate Bush track sounded nice enough, but again the NAD failed to quite get into the groove of the music. Things seemed to plod along a bit, lacking the magic that the Rega conjured up with this song, for example. 4hero was the same; a lovely hi-fi sound with wonderfully accurate image location and lots of low level detail, but still it failed to move me. And that's the NAD's problem – it's a classy sounding amplifier but just a bit too polished.

Sound Quality: 75%



**ABOVE:** Dumpy looking fascia has a large volume control and display, but source selection buttons are fiddly. Navigation buttons to the left give access to advanced functions

### HI-FI NEWS LAB REPORT

While the C 390DD offers some +10dB of digital gain, I'd not set the volume higher than -2.0dB as this represents the maximum 150W/8ohm output for a peak level (0dBFs) digital input. Into 4ohm the maximum volume is -5dB and the output also 150W. Because a digital amp is more linear with increasing digital signal level (and output) its profile of THD versus level is typically the reverse of an analogue amp – distortion decreases here from 0.011% at -30dBfs (or 0.15W/8ohm) to 0.0022% at 0dBfs (or 150W/8ohm). [See Graph below.] Requantisation noise from the PWM stage forces THD (and noise) up to 0.22% at 20kHz/1W (all sample rates) and 3.4% at 40kHz/1W (96kHz/192kHz) so beware supertweeters! Frequency response(s) show a brightening into 8ohm loads of +0.7dB/20kHz (48kHz media), +4.5dB/45kHz (96kHz) and +6.8dB/85kHz (192kHz). Jitter is low enough at 700psec (24-bit/96kHz) but disappointingly high at 5775psec with standard 48kHz inputs. PM

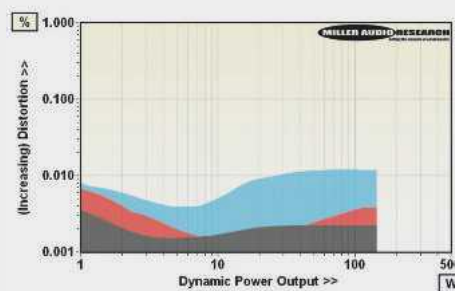

**ABOVE:** Power output versus distortion into 8ohm (black trace), 4ohm (red) and 2ohm (blue). Max o/p is fixed at 150W



**ABOVE:** MDC expansion card slots sit far left, with digital inputs (AES/EBU, USB, optical and coaxial) adjacent. Two pairs of speaker binding posts take centre stage

|                                    |                                  |
|------------------------------------|----------------------------------|
| Power output (<1% THD, 8/4ohm)     | 150W / 150W                      |
| Dynamic power (<1% THD, 8/4ohm)    | 150W / 150W                      |
| Output impedance (20Hz–20kHz)      | 0.035–0.045ohm                   |
| Frequency response (20Hz–90kHz)    | +6.8dB to -0.56dB (192kHz media) |
| Digital jitter (48kHz/96kHz @ 10W) | 5775psec / 715psec               |
| A-wtd S/N ratio (re. 0dBW/150W)    | 92.3dB / 113.4dB                 |
| Distortion (20Hz–20kHz, 10W/8ohm)  | 0.0018–0.22%                     |
| Power consumption (Idle/Rated o/p) | 34W / 358W                       |
| Dimensions (WHD)                   | 435x132x388mm                    |



When you hear the new  
**twenty<sup>®</sup>26**

a want will become a need



The pinnacle of the **twenty<sup>®</sup>** series, the **twenty26**, features the same traits as its siblings - finesse, delicacy and musicality - but with an added ability to convey huge dynamic impact and the sheer scale of a musical performance. This exceptionally transparent design excels with a vast array of amplifiers due to its ease of drive and well-tempered balance, and delivers the greatest level of overall clarity of any of the **twenty<sup>®</sup>** series, or indeed of any speaker in this class.

**twenty26** in Amarone

**Book a demonstration**

See our dealer listing online, or contact us

T +44 (0) 870 4441044  
[www.pmc-speakers.com](http://www.pmc-speakers.com)

**twenty<sup>®</sup>** series - the award winners

**twenty21**



**twenty22**



**twenty23**



**twenty24**





# Naim Nait XS2

The original Nait was one of the first ever 'super integrated' amplifiers. Before its arrival in 1983, anyone serious about sound was generally expected to buy a separate preamplifier and power amp combination. This, its distant descendant, is an altogether more powerful and refined product, but retains the brand's distinctive styling and love of DIN socketry on the back panel – although thankfully RCA phonos are now provided too!

The XS2 is beautifully presented, in a slim aluminium case with green backlit Naim logo and control buttons. It has the feel of an expensive product and works easily and elegantly. Inside, this latest version gets more power than its predecessor, and superior sound is claimed too. This comes from a redesigned internal layout with constant current source drive electronics, and specially made film-type capacitors at critical points in the signal path. Ceramic heatsinks are used to keep the amplifier cool, and a special toroidal transformer supplies the juice.

As per most Naim amplifiers, the XS2 can be upgraded by the addition of optional FlatCap, HiCap or SuperCap power supply units.

### TRANSIENT PROWESS

One of the most distinctive amplifiers in the group, it has the unusual combination of strong bass and a pronounced upper presence region, which throws a spotlight on vocals, guitars and percussion. It's also one of the most detailed, and very good at separating out the various strands of the mix.

For example in the busy end section of 'Humdrum', the Naim let me hear the cor anglais better than most others here – indeed the



Moon and Rega managed to lose it completely. However, its tonal balance may be a little forward for some tastes, and somehow it didn't quite beguile as much as some of the other amps either.

Bass is nicely judged overall: it doesn't sound especially powerful but is less prone than most to letting go when the volume is loud and the music complex. Kate Bush showed how spacious the midband is by the standards of the group – it pushes very wide, stage left and right, and there's loads of detail inside. Treble is good but a little bright for some, and slightly unsophisticated compared to others here; the Exposure and Moon do better by a fair way in this respect.

The 4hero track demonstrated the Naim's prowess with attack transients, giving a crisp, clearly delineated sound with intelligible gaps between the notes. Unlike the Rega for example, they don't blur into one another, and the result is that it sounds far less congested. All this detail makes for a percussive, rhythmically explicit sound – yet curiously it still lacks the Rega's effortless musical flow. Although the Randy Crawford track was more muddled via the Elicit-R, somehow it proved more tuneful. A fine little amplifier, but still not for everyone.

Sound Quality: 81%



**ABOVE:** XS2 fascia is a model of simplicity. Unusually, volume control is far left, with illuminated Naim logo in the centre. The five source selection and mute buttons are also backlit

### HI-FI NEWS LAB REPORT

This latest version of the longstanding Nait series of integrated amplifiers offers an enhanced 2x83W/8ohm and 2x128W/4ohm power output and very flat distortion trend that holds to 0.006-0.009% over the full 70W rated dynamic range. The same largely unvarying THD trend is also seen under dynamic conditions where the Nait XS2 increases its momentary output to 105W, 178W and a huge 275W into 8, 4 and 2ohm before being limited by protection to 130W/1ohm [see Graph below]. Nevertheless, the Nait XS2 is very tolerant of difficult speaker loads. Overall gain is higher than average – and far higher than necessary to accommodate modern digital sources – at +44.5dB while the A-wtd S/N ratio is just slightly below average at 78dB (re. 0dBW), though it'll never be identified as conspicuously 'noisy'. As with other Naim amps, the output impedance is held high by series resistance to 0.23ohm and the response marginally rolled-off at -1dB/20kHz. PM

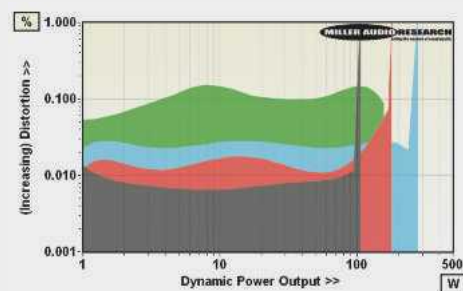

**ABOVE:** Dynamic power output versus distortion into 8ohm (black trace), 4ohm (red), 2ohm (blue) and 1ohm loads (green)

|                                     |                           |
|-------------------------------------|---------------------------|
| Power output (<1% THD, 8/4ohm)      | 83W / 128W                |
| Dynamic power (<1% THD, 8/4/2/1ohm) | 105W / 178W / 275W / 130W |
| Output impedance (20Hz–20kHz)       | 0.233–0.245ohm            |
| Frequency response (20Hz–100kHz)    | -0.1dB to -20.7dB         |
| Input sensitivity (for 0dBW/70W)    | 17mV / 144mV              |
| A-wtd S/N ratio (re. 0dBW/70W)      | 78.0dB / 96.5dB           |
| Distortion (20Hz-20kHz, 10W/8ohm)   | 0.004–0.022%              |
| Power consumption (Idle/Rated o/p)  | 9W / 235W                 |
| Dimensions (WHD)                    | 432x70x314mm              |



**ABOVE:** Crowded back panel includes USB upgrade socket, one set of speaker outputs, link plug for power supply upgrade and five RCA/DIN socket line inputs



**JANSZEN**  
ELECTROSTATIC SPEAKERS

Sound so clear.

Sound so natural.

Hearing is believing!

Stands just one metre tall;  
easy to place, any position,  
any room.

**JansZen - the originator  
of the Electrostatic speaker.**

True hi-fidelity from a legendary name.



EU distributors  
[www.soundsetup.co.uk](http://www.soundsetup.co.uk)  
Tel: +44 (0)1242 506446

JANSZEN



# Rega Elicit-R

Of late, Rega has branched out into electronics with not inconsiderable success. The Elicit-R is a recent arrival that's a little different, as it has a built-in MM phono stage that can be switched to a line-level input via a rear panel switch if desired. Rega says it's of especially high quality, so should be used for your best audio source.

Inside, the Elicit-R's power amplifier circuitry is based on a complementary pair of Darlingtons forming an emulated Class-A driver stage. This is fed by a discrete FET line preamp complete with programmable stepped attenuator volume control. Rega says that polypropylene capacitors are featured throughout the signal path, and the new R version gets improved power supplies which take the power output up a bit over the old model.

This amplifier's ornate aluminium casework is very well made and looks great, but I was disappointed to find the user interface isn't quite as nice; eg, the gain control action was poor and the buttons fiddly.

### SONIC FINGERPRINT

Like the cheaper Rega Brio-R, this is a tonally warm and fulsome performer, one which gushes with emotion and cuts to the heart and soul of the song. But still it sounds a little soft and indistinct in some respects. For buyers using anything less than really sophisticated loudspeakers, this may be no bad thing, as the Elicit-R's distinct sonic fingerprint will complement rather than confound them. Indeed, because it is one of the most euphonic solid-state amplifiers around, it should prove handy for taming forward-sounding systems.



However, the Rega does come over as rather veiled and opaque across the midband, and is a good deal less transparent than, say, the Naim or Exposure. Yet this amplifier always proved great fun to listen to.

'Humdrum' had less space between instruments than with all the other amplifiers here, with a rather dense and foggy quality to instruments at the back of the mix, but the playing seemed to have more passion than with all but the Exposure 3010S2.

Peter Gabriel's singing was wonderfully tuneful, almost as if he had woken up refreshed and revitalised from a deep sleep! The piano and guitar danced with one another and the ending section took on great emotional poignancy.

Randy Crawford also sounded like she was singing from the heart, the Rega pulling the listener's attention from the rich texture of her lovely voice to the emotions it was conveying. 4hero seemed less technically accomplished, but suddenly the sound was painting an amazing picture in my mind with the music. Dynamics were excellent, and the song gelled together beautifully. Yet you couldn't excuse that imprecise stereo imaging and slightly tizzy upper treble.

Sound Quality: 80%



**ABOVE:** Beautiful finished alloy fascia shows nice use of LEDs, but is spoilt by the volume control knob's imprecise action; silver source buttons are rather fiddly too

### HI-FI NEWS LAB REPORT

Ostensibly a combination of Rega's 50W Brio-R power amp and Elicit II FET preamp circuits, the integrated Elicit-R achieves a substantially higher output of 2x125W/8ohm and 2x200W/4ohm (Rega's rated specification is 105W and 167W, respectively). The revised PSU offers a decent headroom too, allowing the Elicit-R to deliver a full 155W, 285W and 480W into 8, 4 and 2ohm loads [see Graph below]. Maximum current is 15.5A but Rega limits the amplifier's output to just 25W into 1ohm by way of short-circuit protection. Distortion is very uniform at 0.005-0.006% from 1W up to the rated 105W at 1kHz, increasing with frequency from 0.0009%/20Hz through to 0.050%/20kHz. The frequency response is flat from 20Hz-20kHz within ±0.2dB and only rolls away to -2dB/100kHz. Overall gain is high at +43.7dB and the A-wtd S/N ratio just fractionally below average at 84dB (re. 0dBW) but hum and noise is usefully suppressed at just -73dBV (0.2mV). PM

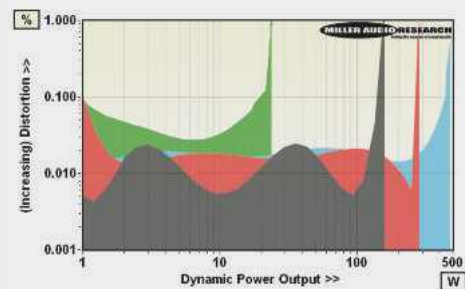

**ABOVE:** Dynamic power output versus distortion into 8ohm (black trace), 4ohm (red), 2ohm (blue) and 1ohm loads (green)

|                                     |                          |
|-------------------------------------|--------------------------|
| Power output (<1% THD, 8/4ohm)      | 125W / 200W              |
| Dynamic power (<1% THD, 8/4/2/1ohm) | 155W / 285W / 480W / 25W |
| Output impedance (20Hz-20kHz)       | 0.024-0.082ohm           |
| Frequency response (20Hz-100kHz)    | -0.2dB to -1.95dB        |
| Input sensitivity (for 0dBW/105W)   | 26mV / 272mV             |
| A-wtd S/N ratio (re. 0dBW/105W)     | 83.7dB / 103.9dB         |
| Distortion (20Hz-20kHz, 10W/8ohm)   | 0.0009-0.050%            |
| Power consumption (Idle/Rated o/p)  | 37W / 270W               |
| Dimensions (WHD)                    | 432x82x340mm             |



**ABOVE:** Rear panel sports five line inputs, one switchable between line and MM phono. Rec out, preamp out and a pair of speaker terminals complete the picture

High-End Show 2014 in Munich.  
We will be pleased to welcome you,  
room E 217.



## Nagra HD DAC converter. High definition, unlimited emotion!

It is time to rediscover the pleasure of listening to music,  
whatever the format, from red-book CD to DSD 2x.

[www.nagraaudio.com](http://www.nagraaudio.com)

**NAGRA**  
Swiss Made

**R.T.Services**  
AUDIO SALES DISTRIBUTION. ESTABLISHED IN 1986

Accuphase  
Leben  
Nagra  
Peak Consult

Tel: +44 (0) 1235 810 455  
E-mail: [info@rtsaudio.co.uk](mailto:info@rtsaudio.co.uk)  
Web: [www.rtsaudio.co.uk](http://www.rtsaudio.co.uk)



# Simaudio Moon Neo 250i

Canada isn't quite the hi-fi powerhouse that the USA or Britain is, but has some very respectable names nonetheless, one of which is Moon. The brand makes middle to high-end products, and has won many friends for its clean-sounding amplifiers and CD players. The new Neo 250i is one of its cheaper amps, aimed at a slightly less specialist market than some of its products – with the 3.5mm socket on the front hinting that iDevice owners may be in its sights, for example.

That's not to say Moon has scrimped on the ingredients: there's a very large custom-specified toroidal transformer providing the power and the amp is said to operate fully in Class A up to 5W. The rigid all-alloy case cools the specially made bipolar output transistors, which work along with selected audiophile passive componentry, the company says.

The amp comes in a choice of all black or all silver, or you can specially order a mixture of the two. Overall, it feels nicely made, with its controls silky and its casework solid, topped off by a finish which is better than anything else here.

### CRISP AND CLEAR

Although the Neo range is new, it was reassuring to hear that that company hasn't strayed far from its traditional sound. The Peter Gabriel track confirmed the openness and clarity of this amplifier – something I've come to associate with the brand. His distinctive voice sounded crisp and clear, intimate and emotive. There was no haze, fog or general mush, and even throughout the highly modulated and dense ending section his diction



remained clear. At the same time, other elements in the mix were also wonderfully carried – cymbals and maracas glinting through from behind the powerful piano and classical guitar work. Even the accordion sounded authentic.

The Moon also impressed at frequency extremes: bass was quite strong and firm by the standards of the group, and the treble was delicate and detailed, with a good sense of air. The backing synths on 'Humdrum' had a more realistic tonal patina than with the NAD, for example. Kate Bush was a pleasure too, with her fine piano work realistically recreated, sounding like a real instrument rather than a digital sample of the same. Randy Crawford showed the Moon's fine presence region, with a purity to her voice which separated out well from backing instrumentation and hung in a spacious stereo soundstage with consummate ease.

However, the 250i wasn't so convincing in the bass. It sounded soft compared to the others. It was prone to overhang and this tended to slur the bottom end, and slow things down compared to the taut, tight Exposure, for example.

Sound Quality: 78%



**ABOVE:** The sculpted fascia looks great and feels classy in use: input selectors have a crisp action and volume control is silky. Unusually, a 3.5mm input is fitted for an iDevice

### HI-FI NEWS LAB REPORT

Taken on face value, the '50W' Neo 250i might appear the least capable of the amplifiers in this month's test but by achieving 2x65W and 2x105W into 8 and 4ohm, rising to 76W, 138W, 228W into 8, 4 and 2ohm under dynamic conditions it demonstrates a good tolerance of difficult speaker loads. Maximum current is 10.7A although the 250i's output is limited into very low 1ohm loads to 50W or 7A [see Graph, below]. Distortion is low through the midrange at ~0.002% up to 20W/8ohm and 0.005% at the rated 50W – 10x lower than Simaudio's own specification – and increasing gently to 0.03% at 20kHz. The frequency response is slightly tailored with a mild -0.3dB/20Hz bass roll-off and matching -0.4dB/20kHz loss at HF, increasing to -5.8dB/100kHz. Output impedance is a moderate but uniform 0.026-0.05ohm through the audio range but the A-wtd S/N is especially impressive at 91dB (re. 0dBW). PM

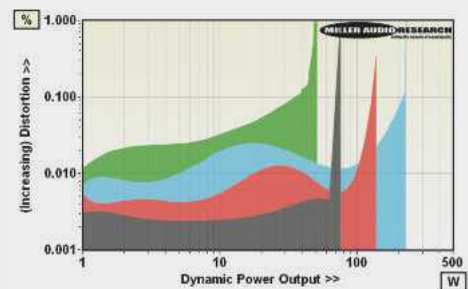

**ABOVE:** Dynamic power output versus distortion into 8ohm (black trace), 4ohm (red), 2ohm (blue) and 1ohm loads (green)

|                                     |                         |
|-------------------------------------|-------------------------|
| Power output (<1% THD, 8/4ohm)      | 65W / 105W              |
| Dynamic power (<1% THD, 8/4/2/1ohm) | 76W / 138W / 228W / 50W |
| Output impedance (20Hz–20kHz)       | 0.026–0.050ohm          |
| Frequency response (20Hz–100kHz)    | -0.30dB to -5.8dB       |
| Input sensitivity (for 0dBW/50W)    | 86mV / 619mV            |
| A-wtd S/N ratio (re. 0dBW/50W)      | 90.9dB / 107.9dB        |
| Distortion (20Hz-20kHz, 10W/8ohm)   | 0.002–0.026%            |
| Power consumption (Idle/Rated o/p)  | 12W / 175W              |
| Dimensions (WHD)                    | 429x89x366mm            |



**ABOVE:** Rear has five line inputs and a preamplifier out, plus IR in/out sockets and RS-232 control port, with a single pair of loudspeaker binding posts



### Introducing the brand new Sasha Series-2 with entirely new head unit

With Sasha Series-2, precise time alignment, so critical to harmonic expression, dynamic alacrity, and musicality, has reached an unprecedented degree of refinement for a two cabinet loudspeaker. And the Wilson Convergent Synergy Tweeter, which transformed the sound of the Alexandria XLF, has now been modified for Sasha's two cabinet configuration.

### Radically Enhanced Time Domain Performance

The new two-plane baffle of the Sasha Series-2's upper module optimizes the axis response angles of both the Wilson Audio midrange driver and the Convergent Synergy Tweeter's axis response which requires a different geometry than the titanium tweeter used in the previous model. The tweeter portion of the baffle is now also made from the latest generation of X-Material, like in the Alexia. The midrange portion of the baffle continues to be S-material. S-material was developed specifically for use in midrange baffles, and is a wonder of midrange beauty and low-resonance. In combination with X-material, S-material reduces measurable and audible noise and coloration in the midrange.

Rigidity and resonance control are further enhanced via a new bracing strategy and the redistribution of the two composites. The Series-2 now also employs separate tweeter and midrange grills, each geometrically designed to lessen frame-induced diffraction.

Call Oxford Audio to find out more and to arrange an audition.



FINANCE: ASK ABOUT OUR BUY NOW PAY LATER SCHEME. 0% APR NO DEPOSIT NO FEES.



## Hi Fi - Home Cinema - Custom Install

TELEPHONE  
**01865 790 879**

E-MAIL  
[info@oxfordaudio.co.uk](mailto:info@oxfordaudio.co.uk)

WEB SITE  
[www.oxfordaudio.co.uk](http://www.oxfordaudio.co.uk)

ADDRESS  
Cantay House  
Park End Street  
Oxford  
OX1 1JD

BUSINESS HOURS  
10am to 6pm Mon-Fri  
10am to 5pm Sat  
Closed Sunday & Bank Holidays

Follow us on:   

Call Jon Harker on **01865 790 879** to find out more.



# GROUP TEST VERDICT

• CD PLAYERS • TURNTABLES • CARTRIDGES • SPEAKERS • AMPLIFIERS • HEADPHONES • INTERCONNECTS •

Sonically, the NAD C 390DD was never less than pleasing. Open, even and spacious, it proved a polished performer but fell down the rankings thanks to its rather matter of fact, emotionally uninspiring sound. Still, many prospective purchasers will still find it appealing because of its power, operational flexibility and upgradeability – although few are likely to buy it for its looks or finish.

The Moon 250i was a very nice amplifier indeed. One of the best balanced here, it didn't have any breathtaking strengths or glaring weaknesses, appearing instead to do most things very well. In terms of tonal balance and general transparency it was excellent: highly neutral with no quirks or foibles. There was a lot of low-level detail and stereo imaging was good too.

The trouble came with fast, propulsive music where it dragged its feet a little in the bass, which tended to slow things down. If you're a fan of more sedate, acoustic programme material, however, you will rank this amplifier more highly.

## CHARM AND CHARACTER

The Elicit-R was typically Rega – a loveable, charming and rather eccentric product. Beautifully built with interesting styling, it was let down by a slightly imprecise volume control. It was riotously good fun to listen to, but nowhere near as transparent as some of the others. While it sounded emotionally engaging and musically convincing, it clouded out rather too much low-level detail along the way. Some listeners might rank it higher than third place, others lower – it's all down to taste.

Naim's new Nait XS2 was another big character. In a great many respects it is excellent. Firstly, its styling and build quality are undeniably impressive for a product

of this price – it feels like a slice of the high-end that has been shrunken down, rather than the other way round.

Secondly, its sound is distinctive and in many ways superb. Soundstaging is breathtakingly wide and stereo images are served up very accurately within. It has a highly detailed and very propulsive sound that consistently pushes the musical performance with real zeal.

Yet curiously the Naim just doesn't seem able to gel everything together quite as well as either the

Rega or Exposure. The Nait may also sound a little bright with more edgy speakers, so careful listening would be needed for a synergistic match.

And so this month's champion is Exposure's 3010S2. Here is an

amplifier that suffers none of the foibles of the lower ranking amps yet has a special charm all of its very own. Big-hearted, powerful and expansive, every type of music played through the Exposure gets a good airing.

## A COHESIVE BLEND

It's able to communicate very well in hi-fi terms (soundstaging, depth perspective, detail, dynamics, etc) yet blends it all together cohesively. Like the Moon it's a just a fraction on the warm side of neutral, never

erring far enough to impose its character on the music. As such, it sounds great across a wide variety of music and the Exposure will work with a good spread of loudspeakers too. ⏻

'The Exposure sounds big-hearted, powerful and expansive'



**ABOVE:** Rega's Elicit-R (bottom) is typically charming and a sumptuous listen. Naim's Nait XS2 (middle) adds fantastic soundstaging and detail, while Exposure's 3010S2 proves a brilliant, consummate all-rounder and worthy winner

• CD PLAYERS • TURNTABLES • CARTRIDGES • SPEAKERS • AMPLIFIERS • HEADPHONES • INTERCONNECTS •

# Dynaudio Excite X38

The Excite speaker range from Denmark aims to eke out high quality sound from modestly-priced systems

Review: **John Bamford** Lab: **Keith Howard**

**A**t just over one-metre tall, the X38 is the largest floorstander in Dynaudio's latest Excite range [see boxout]. This is a new series of entry-level speakers from the Danish company, all designed to be easy to drive, so that cost of ownership is not hampered by the need for meaty and expensive amplifiers. Top of the range it might be, yet this handsome three-way is just £2850 and promises to deliver proper 'grown-up' sound via its complement of proprietary drivers.

Speaking with dealers, to garner opinions on which speaker models are currently proving popular with UK consumers, reveals that Dynaudio has hit an interesting price-point with the X38. While there are plenty of compact floorstanders to choose from at around £2000 – such as Neat's popular Motive SX1 (£1885) and PMC's twenty.23 (£2300) – acquiring a more ambitious hi-fi monitor often requires digging *much* deeper into one's bank account.

As one dealer pointed out, B&W's venerable 804, once a hugely popular model at £2750, today wears a £5750 price tag in its 804D guise with its much more costly diamond tweeter. The Excite X38's nearest rival might be B&W's £3000 CM10 which is a little smaller and more demanding of a partnering amplifier [HFN Sept '13].

Since Excite models are clearly aimed at style-conscious consumers who might choose with their eyes as well as their ears, this X38 looks considerably more sleek and modern than the 380 floorstander (£5650) we tested last year from Dynaudio's more longstanding Focus series [HFN June '13]. Its baffle looks cleaner thanks to the use of magnetically-attached grilles while the fact that it's also relatively narrow at 235mm makes it more living-room friendly for house-proud audiophiles who insist that loudspeakers must not visually dominate their living rooms. It's 175mm shorter, 40mm narrower and 50mm shallower than the Focus 380, and just two-thirds the weight at 22kg – but I wouldn't have expected it to be only *half* the price.

With its pair of 180mm woofers and 110mm midrange driver, married to a 27mm

soft-dome tweeter, it looks considerably more expensive than it is.

Says Dynaudio's product manager Roland Hoffmann: 'For our new Excite models we've improved our woofers to give them more headroom and focused on the crossover design, to ensure easy amplifier matching. We've also altered the phase relationship of the drivers, adjusting directivity slightly upwards towards the listener. We think this improves image staging. Many small-ish floorstanders sound good at knee-height and consequently benefit significantly from being slightly tilted back. Try it!'

## BI-WIRING 'NOT THE WAY TO GO'

The X38's twin long-throw woofers and midrange driver have supple rubber surrounds and one-piece cones formed for smooth dispersion. They are made of Dynaudio's magnesium silicate polymer [MSP] for light weight and high rigidity. The drivers' chassis are die-cast aluminium, and as with the drivers in the Focus 380 feature neodymium magnets and large but lightweight voice coils made of aluminium.

The company sets great store in its use of aluminium wire instead of copper for its voice coils, which allows for more windings and a larger coil diameter without increasing mass. The woofers hand over to the midrange driver at 550Hz which in turn crosses over to the tweeter at 2kHz. The X38's 27mm tweeter has a silk dome treated with a proprietary coating; an aluminium voice coil suspended in magnetic oil (ferrofluid) to maximise power handling and improve the dome's excursion capability; and a damping chamber integrated into the rear of the assembly to act as an acoustic absorber, reducing back-wave energy.

While this 42-litre three-way is generously appointed, you'll only find a single set of input terminals at the rear. Dynaudio has long eschewed bi- or tri-wiring. To quote the company's literature: 'Our loudspeakers

**RIGHT:** A pair of 180mm woofers is married with a 110mm midrange driver and 27mm fabric dome tweeter in this purposeful-looking three-way reflex floorstander



## MAXIMUM EXCITEMENT

With its latest Excite range seen at last summer's Munich High End show, Dynaudio says it aims to 'provide a touch of luxury at affordable prices'. It's not the first loudspeaker specialist to look towards owners of middle-market, modestly-priced amplifiers (and AV receivers) and claim to deliver hi-fi heaven at less than other-worldly prices. However, it is better placed than many to trickle-down engineering from its more expensive designs, as it manufactures everything in-house, developing and building drive units to suit each model. If the X38 is a bit too large for you there's a smaller two-way floorstander in the range. The 93cm-tall Excite X34 (£2000) sports the same 27mm fabric-domed tweeter married with two 14cm bass/mid drivers. The line-up also includes a compact standmount/bookshelf model, the 28.5cm tall X14 (£900) featuring the 27mm tweeter and a solitary 140mm bass/mid unit; and there's a centre channel speaker for AV systems, the X24 Center (£620) where the tweeter is combined with two 110mm drivers. Excite models come in satin black; walnut and rosewood veneers with black grilles; and satin white with grey grilles.

feature carefully fine-tuned crossovers, optimised using selected parts and advanced circuitry to achieve a truly balanced and smooth frequency response. Therefore, dividing the frequency sections through bi-wiring or bi-amping is neither beneficial nor optional.'

On this subject Roland Hoffmann comments further: 'We aim for our drivers to have balanced frequency roll-on/roll-off characteristics so we don't have to use steep filters to suppress unwanted colorations or resonance peaks. We favour overall impedance correction, and design most of our crossovers as a 6dB filter, adjusting and fine-tuning them individually for every model. Separating such a design, bridging across its sections with metal strips (for the majority who will use single lengths of speaker cable) is really *not* the way to go.'

The X38's integral base feet afford excellent stability whether on hard or carpeted floors. The speaker can stand either on resonance-absorbing rubber feet or four easy-to-adjust spikes.

### PACKING A PUNCH

With appropriate music recordings the Excite 38 packs a serious punch. Bass is tremendously tight and fast, with subjectively fine extension too, given the speaker's modest proportions. Naturally it won't flap the bottom of your trouser legs in the manner of a heavyweight high-end monitor or well set-up subwoofer, nevertheless low frequencies are sufficiently plentiful to give a good sense of musical realism when listening at moderate sound pressure levels. The midband has good presence, making the

X38 an excellent monitor for analysing a recording's fine detail when you want to critically 'listen in', while the tweeter exhibits plenty of sparkle without fatiguing hardness – so the sound rarely appears analytical or matter-of-fact. Kick off your shoes and relax to the music, rather than deliberately focusing on a recording's technical quality, and the X38 sounds comfortably relaxed and colourful.

No, it doesn't sound overtly *coloured*. When I say its delivery is 'colourful' I mean that the speaker paints rich tonal hues rather than serving up a clinically

'The speaker paints in rich hues, avoiding a clinical rendition'

bleached rendition of instrumental timbres. In a manner not too dissimilar to some ATC monitors I've enjoyed listening to over the years, the sound is crisp and tightly controlled while simultaneously

warm and inviting, encouraging prolonged and hugely entertaining listening.

Hearing a recent free download track from Channel Classics, 'Sans Parure', by trumpeter Eric Vloeimans performing with the Holland Baroque Society from the album *Old New & Blue* [SACD, CCS SA 35613], showed the X38 to be capable of creating a creditably wide and deep sound image when given room to breathe.

With the X38s positioned a metre or so free of boundary walls in my listening room, the speakers almost 4m apart and 6m away from the listening seat, I was able to enjoy a large-scale image of the musicians performing at the end of my room. The instrumental timbres appeared deeply-coloured and rich in texture, with the acoustic ambience of the setting portrayed beautifully in this immensely atmospheric and brooding piece. ↻





# High End – Made in Germany



Master Innovation

The Clearaudio catalogue of high quality pressings inc. Deutsche Grammophon re-issues available now



For orders and information contact;

0118 9814238 [info@soundfoundations.co.uk](mailto:info@soundfoundations.co.uk)

sound foundations  
[www.soundfoundations.co.uk](http://www.soundfoundations.co.uk)

## DYNAUDIO EXCITE X38

Dynaudio's claim of 88dB sensitivity for the X38 holds up if you simply average our FFT response data from 200Hz to 20kHz but the industry-standard pink noise figure – which better represents the sensitivity achieved with music signals – is about a decibel lower at 86.9dB. Dynaudio's specified 4ohm nominal impedance is spot on, though, given that we measured a minimum modulus of 3.3ohm at 123Hz, just above the 3.2ohm minimum implied by a 4ohm nominal rating. Impedance phase angles are quite high at low frequencies, so the EPDR (equivalent peak dissipation resistance) falls to a minimum of 1.6ohm at 101Hz, which is about typical for modern floorstanders of this size and will not trouble a worthy partnering amplifier.

Measured on the tweeter axis with grilles removed, the frequency response is essentially flat in trend to 10kHz, with only a hint of a presence band suckout, before rising a little through the final audible octave [see Graph 1, below]. Despite this, errors were well controlled at  $\pm 2.9$ dB and  $\pm 3.2$ dB for the review pair and the matching error was commendably low at  $\pm 0.8$ dB (all 200Hz-20kHz). Diffraction-corrected nearfield bass measurement showed the -6dB point to occur at 56Hz (re. 200Hz) – typical for this form of speaker – but also indicated that low frequency output is peaked up by around 3dB at 90Hz. At the opposite end of the frequency range, the ultrasonic output from the soft-dome tweeter begins to drop away from 20kHz. The cumulative spectral decay waterfall [Graph 2] shows fast initial energy decay across the spectrum but some low-level resonances are visible at treble frequencies. KH

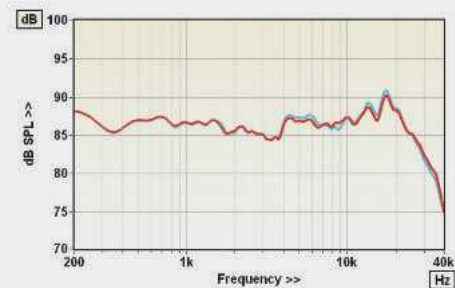

ABOVE: The X38's forward response is flat in trend, albeit with peaks in the deep bass and high treble

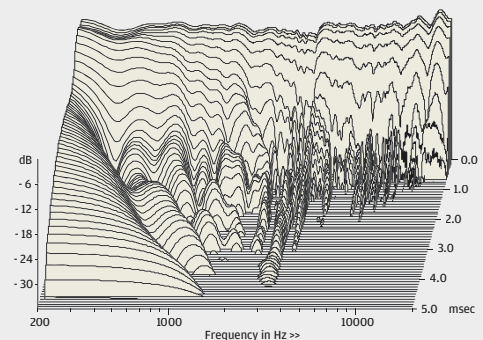

ABOVE: Some cabinet resonant modes are visible at LF with driver modes at 3kHz, 4kHz and around 10kHz

**LEFT:** A large profiled port vents the enclosure on its rear panel. Only a single set of terminals is provided, as Dynaudio considers its network design a crucial performance factor [see text]

100W Mark Levinson No.383, however, the sound sweetened up considerably, the X38 dispensing a more refined sense of air and treble purity. And with the more powerful amp providing better grip, that dynamic and punchy bass also gained weight and control.

Where Dynaudio's slightly larger Focus 380 floorstander commands attention, such is its forthright and dynamic music delivery, the Excite X38 seems to present a rather more charming and seductive sound image. When chilling to the hypnotic soundscapes of Patrick O'Hearn's *So Flows The Current* album [Paras Recordings PRC 1117], I was greeted by a wide and deep sonic picture in which the underpinning bass notes added satisfying gravitas to the ambient melodic patterns.

Similarly, with the chill-step electronica of Phaeleh's *Tides* [Aftergo AFTRCD1004], the X38's subjectively pungent and bouncy bass delivery added a gratifyingly solid foundation to the enchanting rhythmic melodies from the Bristol-based composer [<http://phaeleh.co.uk>]. Albeit artificially created, the soundstage image was both open and airy, individual sounds within the music's arrangements presented with precise and clear outlines. By dissecting each composition's elements the X38 is both rewarding and entertaining, allowing the music to envelop the senses. ☺

### HI-FI NEWS VERDICT

The unusually high sound quality rating I'm affording the Excite X38 reflects its notably high cost/performance ratio. This is a great all-rounder for less than a king's ransom – and, although not luxuriously appointed, perfectly nicely finished. Clearly the cost-of-parts budget has been carefully managed by its designers to deliver plenty of 'sound per pound'. It's a fine compact floorstander for the money.

Sound Quality: 85%



Furthermore the X38's execution of fine detail admirably revealed the improved realism when playing the track at higher resolutions.

### A LITTLE EXPERIMENT

As an experiment I tried driving the X38s with a little 45W integrated amplifier, a vintage Pioneer A-300R Precision, and enjoyed perfectly respectable sound when I didn't strive for excessive, party-level SPLs. Thanks to the relatively easy-going nature of the speaker's tweeter, high frequencies remained commendably refined. When hooked up to my

### HI-FI NEWS SPECIFICATIONS

|  |                                  |
|--|----------------------------------|
| Sensitivity (SPL/1m/2.83Vrms – Mean/IEC/Music) | 87.7dB/86.9dB/86.4dB             |
| Impedance modulus min/max (20Hz–20kHz)         | 3.3ohm @ 123Hz<br>13.6ohm @ 76Hz |
| Impedance phase min/max (20Hz–20kHz)           | -50° @ 91Hz<br>24° @ 59Hz        |
| Pair matching (200Hz–20kHz)                    | $\pm 0.8$ dB                     |
| LF/HF extension (-6dB ref 200Hz/10kHz)         | 56Hz / 33.0kHz/31.7kHz           |
| THD 100Hz/1kHz/10kHz (for 90dB SPL/1m)         | 0.6% / 0.4% / 0.2%               |
| Dimensions (HWD)                               | 1049x205x310mm                   |

# Cambridge Audio 851E/W

High-end amps without heavy duty price tags? Cambridge Audio updates its flagship pre/power amplifier package with the latest iteration of its Class XD technology  
Review: **Andrew Simpson** Lab: **Paul Miller**

**W**hen you've an established reputation for class-leading budget and midmarket hi-fi separates, every now and again it's worth reminding your rivals that you can also hold your own in the big league. And with this newly released pre/power amp duo that's exactly what Cambridge Audio has done, and with sensible prices to boot.

These new 851E/851W amplifiers are the latest additions to CA's flagship Azur 851 range, joining the 851A integrated, 851C DAC/CD player [*HFN* Aug '12] and recently released 851D upsampling DAC.

## MORE FACILITIES NOW

The 851E preamplifier replaces the outgoing 840E and brings with it a greater wealth of connectivity than its predecessor. You get eight analogue inputs, with three shared over balanced (XLR) and single-ended (RCA) connections – but there are no *digital* inputs. You also get pre-outs served over balanced and single-ended connections, which join a pair of fixed level single-ended and subwoofer outputs (RCAs), alongside trigger connections for linking to other CA separates. The front panel's 6.35mm headphone socket is another bonus that I'm sure will be welcomed by many listeners.

The 851E also updates the 840E with a few technical changes. Whereas the 840E used a resistor ladder and relay design volume control, the 851E employs a multiplying DAC chip, meaning its rotary control is digitally governed. This brings improved levels of reliability and lower noise, says Cambridge Audio. Meanwhile, both amps make use of CA's Terrapin impedance buffering modules, which claim to improve stereo separation and imaging compared to more commonplace op-amps.

Weighing in at a whisker over 19kg, the 851W power amp's heft is largely due to

its two toroidal transformers. The smaller of these supplies the 851W's sensitive input circuitry, leaving the main power amplifier duties to the larger toroid, which is specially wound to reduce interactions between each channel's output windings.

With ten Sanken transistors per channel, including a pair per side for the Class XD's dynamic biasing [see boxout], the 851W's casework can get a bit toasty to the touch. All of the power amp's heat-sinking is housed within the unit's mostly alloy casework – this is heavily perforated to allow for heat dissipation, which adds to the unit's stealthy appearance.

The 851W's rear panel hosts a pair of single-ended (RCA) and balanced (XLR) inputs per channel, selected via discreet toggle switches. There's also a balanced (XLR) pass-through socket per side, a large mains switch and trigger connections for linking the power and pre together.

Each of the 851W's speaker outputs gets two sets of quality multi-way binding posts, although they're quite close together, so you'll need to be careful when clamping down spade connectors or bare wire. Like its preamp sibling, the power amp offers configuration options aplenty, selected via switches on its rear panel.

You can run it in stereo mode driving a pair of speakers via single or bi-wired connections, as a monoblock in a bi-amped configuration, or as a bridged monoblock, which increases its output to around 500W [see Lab Report]. With all this juice on tap, CA has sensibly installed its CAP5 protection in the 851W, to help it steer clear of DC spikes, overheating, short-circuits and clipping.

Both amps feel solidly built and well finished, sporting 7mm-thick alloy faceplates in matching brushed silver or black. In use the preamp is intuitive to



**RIGHT:** Five pairs of Sanken power transistors are employed per channel, all mounted on internal heatsinks that are vented through the 851W's perforated casework



control, thanks to its backlit screen and sensibly laid out front panel (copied from its integrated cousin). A quick press of the 851E's standby button brings both amplifiers to life when linked up via their control bus sockets.

The preamp's inputs each receive their own select buttons and a second press on inputs 1 to 3 lets you toggle between balanced and single-ended signals. The preamp's features continue with bass and treble trim pots, and a 'Direct' switch for the purist. Each input also has its own sub-menu, allowing you to name inputs and set gain levels individually.

A quick push on the preamp's 'Mode' button shifts the rotary dial from volume to balance control, while a longer push takes you into a deeper menu of extended features, including screen brightness levels

and configuring auto-standby settings to switch the amps into and out of standby when sensing/not sensing an audio signal.

**SOUNDSTAGE FOCUS**

When driving my reference Audiovector Mi 3 Signature floorstanders with a 44.1kHz/16-bit FLAC rip of Jon Strong's *Follow Me* [Linn Records AKD 023], via my Audiolab M-DAC plumbed into the 851E's balanced input, I was immediately struck by the Cambridge amps' expansive soundstage. The opening guitar strums of 'The Judas Kiss' rang out from well wide of my left speaker and really caught my ear as they resonated with such energy,

**ABOVE:** Nicely laid out soft-touch controls and backlit screen makes the preamp a breeze to use via its front panel or the supplied remote control. Screen can be turned off too, if desired

before falling away with natural decay. Likewise, as the song progressed, the way these amps allowed the drummer's cymbal crashes to wash across the soundstage was equally striking, and I had the sense that the 851W was having no problems 'opening up' my speakers.

*'Cymbal crashes were striking as the 851W opened-up my speakers'*

But it's not just soundstage width that these amps have the measure of, it's how

they evenly populate the sonic space they create, well able to control the music under their command. There are many amps that can grab your attention with their cavernous sonic landscapes, but I often find that instruments heard at the soundstage's boundaries can seem a little lost and acoustically thin, with less body than those placed centre stage. Thankfully this is not the case with the Cambridge combo, and whether presented far afield or between the speakers, each instrument's sound is equally wholesome.

Stereo imaging is yet another key area where these amps score well. Kristin Hersh's track 'Your Ghost' from her *Hips And Makers* CD [4AD CAD 4002] allowed the amps to really take control of proceedings and make the speakers virtually disappear, as they brought

**CROSSOVER DISPLACEMENT**

**Class A is the sledgehammer approach to eliminating crossover distortion, which is caused by the music signal crossing from positive to negative-going (or vice-versa) and transistors momentarily switching off. In Class A the complementary pairs of output transistors always have sufficient standing current to ensure they remain conducting at all times, but the implementation is costly. Cambridge's elegant Class XD alternative doesn't eliminate crossover distortion, it shifts it away from the zero-crossing point of the waveform – hence the name 'Crossover Displacement' or XD. Class XD tracks the audio signal and applies a negative bias current, offsetting the position of the crossover point without creating a DC offset. At low signal levels the crossover point is shifted below the maximum negative swing of the audio waveform, yielding all the benefits of pure Class A. At higher signal levels the offset crossover point falls within the negative cycle of the music waveform – there's the same number of 'transitions' but the nature of the distortion is more easily accommodated by negative feedback. PM**



0% APR Available

# High End Cable

www.highendcable.co.uk  
Please call Dave Jackson on 01775 761880



## BRANDS

Acoustic Systems  
 Analysis Plus  
 Ansuz Acoustics  
 Argento Audio  
 Atacama  
 Audience  
 Bel Canto  
 Chord Company  
 Furutech  
 JEFF ROWLAND Design Group  
 Inakustik  
 Michael Green Audio  
 Nordost Corporation  
 Norma Audio Electronics  
 Quantum QRT  
 Raidho Acoustics  
 Revelation Audio Labs  
 Purist Audio Design  
 StereoLab  
 STAX earspeakers  
 Telos Caps  
 Townshend Audio  
 Van den Hul  
 Vertere

## POWER

Audience adeptResponse  
 IsoTek  
 IsoL-8  
 Quantum Qx2 & Qx4  
 QBase  
 Qv2 & Qk1  
 Power supply upgrading  
 Sparkz

## Hi-Fi

Atacama Hi-fi Racks  
 Audience speakers  
 Raidho Acoustics Speakers  
 Raidho Rack  
 Bel Canto Electronics  
 Norma Audio Electronics  
 STAX headphones

## DE-COUPLING

CableSpike  
 Cable Lift  
 Darkz  
 MiG's  
 Panda Feet  
 Sort Füt & Sort Kones

## MORE

D-fi system cables  
 Firewire  
 USB Cables  
 Digital cables  
 Optical cables  
 HDMI  
 ipod cables  
 dCS Owners cable upgrades  
 DIN cables  
 Jumpers  
 Sub woofer cables  
 Auric Illuminator  
 ECO  
 Enhancement CDs  
 Fuse upgrades  
 Telos caps  
 TWEAKS

Room treatment  
 Room Tuning Resonators

At High End Cable we offer some of the finest audiophile cables available today. We also have the fantastic range of Raidho Acoustic speakers, but did you know we also offer some of the finest high performance components which are not only affordable, but beautifully designed to grace any rack. Please call or visit the website for more details



JEFF ROWLAND DESIGN GROUP products offer stunning performance and elegant looks.



High End Cable use Bel Canto at many of our shows and those who attend can understand why. Great sound at the right price points.



Highly acclaimed Audio Electronics from Italy. High End Cable have taken this brand on following recommendation from others in the business both in the EU and further abroad. When you hear what Norma Audio Electronics can do, you will know why too.



## CAMBRIDGE AUDIO 851E/W

The technical prowess of this pre/power is beyond doubt, so there's greater interest in comparing the new 851E/851W with the older 840E/840W [HFN Aug '08]. The gain of the 851E preamp, for example, is unchanged at +18dB (balanced in/out) and the A-wtd S/N ratio is actually 1-2dB less than that of the 840E at 101dB (re. 0dBV), but this is still state-of-the-art. The response is unchanged – flat to within  $\pm 0.08$ dB out to 100kHz – but distortion has been halved down to a ludicrously low 0.00007-0.0004% (20Hz-20kHz, re. 0dBV)!

The overall gain of the 851W power amp is also unchanged at +22dB and the power output exactly the same at 2x243W and 2x400W into 8/4ohm respectively. There's slightly more headroom under dynamic conditions, however, as the 851W stretches out to 295W, 565W and 965W into 8, 4 and 2ohm loads. The 2ohm figure represents the 851W's current limit of 22A, so the power into 1ohm almost halves to 490W [see Graph 1, below]. Interestingly, levels of compensation look to have been slightly relaxed in the 851W as distortion increases beyond that measured for the 840W at 20kHz/10W (0.0085% versus 0.0016%). Once again distortion on the left channel is higher than the right (0.019% for 20kHz/10W). The amp's output impedance is reduced from 0.032ohm (840W) to 0.022ohm here but high frequency stereo separation is slightly inferior (84dB versus 90dB at 20kHz) as is the A-wtd S/N ratio (96dB versus 99dB re. 0dBV).

Readers may view comprehensive QC Suite test reports for the Cambridge Audio 851E preamp and 851W power amp by navigating to [www.hifinews.co.uk](http://www.hifinews.co.uk) and clicking on the red 'download' button. PM

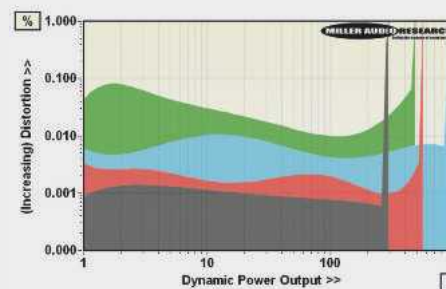

ABOVE: Dynamic power output versus distortion into 8ohm (black trace), 4ohm (red), 2ohm (blue) and 1ohm (green) speaker loads

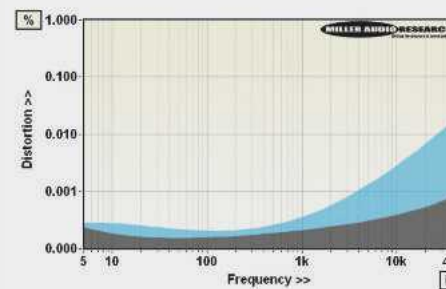

ABOVE: THD vs. extended frequency; 851E (1V out, black trace) vs. 851W (10W/8ohm, blue trace)



ABOVE: No shortage of analogue inputs here, with lots of single-ended (RCA) and balanced (XLR) options to choose from on the preamp [top]. The power amp can be set to stereo, mono or bridged mono, so you can add more amplifiers down the line

Kristin's maudlin vocals to life in my room. What's notable on this and other material is how these amps manage to make voices sound clean and clear, without making them too clinical or over-exposed.

And the Cambridge Audio 851s impart very little of their own character on the music and nor do they overtly favour any particular musical genre. They pack lots of detail into the music, but they don't come out 'all guns blazing' with it: instead the amps sound confident yet unstressed, no matter how demanding the music and its volume levels become.

### NEVER WRONG-FOOTED

Via a 24-bit/96kHz FLAC rip of Tom Waits' 'Satisfied' from *Bad As Me* [Epitaph Records 7177-2], the amps presented the music with just the right amount of vitriolic sting, without the music straying into hard-edged or fatiguing territory. I could enjoy Waits' performance as it should be heard – loud, raucous and reminiscent of Captain Beefheart (revered by Waits) at his best.

Moving into smoother territory via a vinyl re-master of Pink Floyd's *Wish You Were Here* album [Harvest SHVL 814], fed from my Pink Triangle Export turntable and Primare R32 phono stage, the Cambridge amps handled the opening track's dynamic swings with consummate ease. With the amps in the driving seat, Nick Mason's drums kicked in with real impact when required, before moving to one side to allow the more delicate passages to draw me

in. Perhaps telling of the 851W's substantial reserves, the amps never sounded wrong-footed when asked to scale the sonic heights with each towering chorus from 'Shine On You Crazy Diamond'.

The 851W's bass is well controlled and never lethargic, although it's not as bottomless as some. On the Floyd album, for example, Roger Waters' bass guitar notes sounded well rounded with excellent texture that gave them plenty of body. Rehearing the earlier Kristin Hersh material revealed that, although the track's kick-drum had all the presence of low rolling thunder, via the Cambs combo it was perhaps not as bone-shakingly powerful as I've heard it on some of the cost-no-object breeds.

However, this is actually a compliment, because these Cambridge Audio products sound so good you couldn't help but compare them to alternatives from way up the price ladder to really discover their limits. ☺

### HI-FI NEWS VERDICT

These amps represent a genuine introduction to true high-end amplification at the same time offering real value for money. Features-wise they're fully loaded – although a digital input or two would perhaps have been welcome. But where they really score highly is in their sound. They're clean, neutral and engaging across the board, and there's plenty of power to drive most speakers with ease.

Sound Quality: 87%



### HI-FI NEWS SPECIFICATIONS

|                                      |                                   |
|--------------------------------------|-----------------------------------|
| Power output (<1% THD, 8/4ohm)       | 243W / 400W                       |
| Dynamic power (<1% THD, 8/4/2/1ohm)  | 295W / 565W / 965W / 490W         |
| Output imp. (20Hz–20kHz, pre/power)  | 91ohm / 0.021–0.081ohm            |
| Freq. resp. (20Hz–100kHz, pre/power) | –0.0 to +0.1dB / –0.19 to –0.74dB |
| Input sensitivity (for 0dBV/0dBW)    | 125mV (pre) / 228mV (power)       |
| A-wtd S/N ratio (re. 0dBV/0dBW)      | 100.7dB (pre) / 96.0dB (power)    |
| Distortion (20Hz–20kHz, 1V/10W)      | 0.00007–0.0004%/0.0002–0.007%     |
| Power consump. (pre/idle/rated o/p)  | 26W / 166W/680W                   |
| Dimensions (WHD 851E/851W)           | 430x115x385/430x148x365mm         |

# PS Audio Power Plant 3

The message of PS Audio's cheapest mains regenerator is simple: if you take mains quality for granted, you're missing out on a means of enhancing system sound quality  
 Review & Lab: **Keith Howard**

**K**eenly priced as PS Audio's mains regenerators are, considering what they comprise and where they come from (Boulder, Colorado), you might well look at the range-topping P10 [HFN Apr '13] and conclude either that it's too costly for you or that you don't need that many outlets. In which case your eyes are likely to be drawn down-range either to the P5 or this, the baby of them, the P3.

## FOUR DISCRETE ZONES

It's not as if you'll be slumming it. Whereas the P10 (£4400) in UK form offers nine outlets in five zones with 1500VA output capability, the P3 has three regenerated outlets in three zones providing 750VA capability, plus a further outlet in a fourth, high-current zone (zone D, labelled HC) that is not regenerated but just filtered.

So if the 250VA capability of one of the regenerated zones isn't sufficient for your power amplifier, you can plug it in here and still obtain some potential benefit while having three regenerated outlets free to provide low distortion, low source impedance mains voltage to signal sources and a preamp.

**BELOW:** Unlike the P10, the P3 doesn't have large side-mounted heatsinks but internal ones that are cooled by twin fans. So there are ventilation holes top and bottom

Output sockets and power capability aren't all you lose, though, compared to the P5 and P10. Whereas they have a touch-screen display on the front panel, the P3 simply provides an alphanumeric LED display. Concomitant with that you lose a little of the functionality that the larger models provide.

So you can't view the input and output waveforms, for instance. But you can still enable/disable the different zones, vary the output voltage, switch between Sinewave and Multiwave output waveforms and degauss connected equipment using the Cleanwave function, all via the supplied infra-red remote. Parameters in the display vary accordingly.

The P3 also features an internal web page so that if it's connected to a local area network via the Ethernet port on the back panel (which can either be connected directly to a wired router or via a wireless bridge) you can access advanced features such as naming of the P3 and labelling of outputs, usually with the name of whatever item in your system is connected to it.

Given that the P3 is, in effect, a high-voltage power amplifier and a fan-cooled one at that, there's an obvious concern over whether transformer noise or fan noise will intrude, particularly when listening at low levels. Well, the fans are loud at full chat. But so long as you don't work the P3 so hard as to need assisted

cooling, its noise level is inconsequential. Still, I'm nervous of any audio electronics with ventilation holes, particularly when they are on the top plate and as large as the P3's. The sensible thing to do is to place the P3 on an intermediate rack shelf so that it is protected from above while, of course, leaving sufficient room for airflow. This should still allow you to try vibration isolation with it, something which is recommended by PS Audio.

What PS does *not* recommend, unsurprisingly, is the use of any form of mains conditioner or filter upstream of the P3. Note that, whereas PS Audio once extolled the virtues of balanced mains supply, the P3 – like the P5 and P10 – generates unbalanced mains voltage.

## HEADPHONE LISTENING

Reasoning that the regenerated outputs of the P3 will mostly be used to power source components and headphone amplifiers, I decided to use exclusively headphones for the listening assessment. The P3 was tasked with powering the Teac HA-501 headphone amplifier I enthused about [HFN Apr '14] and/or the Chord QuteHD DAC feeding it, each connected to a regenerated output of its own.

Throughout the P3 was connected to the wall socket using a chunky PS Audio Power 5 mains lead, also supplied, whereas mains connection was via an everyday





# LAB REPORT

## PS AUDIO POWER PLANT 3



**ABOVE:** Three of the four output sockets carry regenerated mains, the fourth provides high current capability for larger power amplifiers but is only filtered. An Ethernet socket provides access to extra features via an internal web page

mains lead from the P3 to the Teac. The Chord has a power supply that was plugged directly into the P3.

### ADDING SOME FLESH

At first, I went back and forth between wall socket and P3 with the mains connection to the HA-501, leaving the QuteHD plugged into a wall socket. Searching for a description of what the P3 brings to the sound, the best I could come up with is that it adds flesh to the bones of what you hear via the wall socket. The sound filled out tonally and elements

within it became more substantial and better organised. With some items of music I tried, like Free's 'I'll Be Creepin', there

**John Gorka's "Italian Girls" suddenly sounded like a real high-res recording'**

was a sense of the change not being exclusively positive, ie, some of the energy of the performance could seem diminished; but on other items the change was transformative.

On Todd Rundgren's *a cappella* 'For Lack Of Honest Work', for instance, it wasn't merely that Rundgren's solo voice became warmer and weightier but, more remarkably, that I grasped for the first time precisely what some of the voices in the chorus (all Rundgren, multi-tracked) were singing. What I was used to hearing was the overall effect of the harmony – with the P3 powering the '501 I was made more aware of just how those harmonies were constructed.

With the '501 connected to the wall socket and the QuteHD moved to and from the P3, the effect was if anything greater, albeit of similar character. On Nat King Cole's *Welcome To The Club* [24-bit/88.2kHz SACD rip] the sound gained in substance, became a little cleaner

on trumpets and vocal sibilants, and conveyed a greater sense of ease and authority. It didn't sound like a recording of such vintage (1959).

I'm not the greatest fan of American folk/country music but Natalie Merchant's song version of Edward Lear's 'Calico Pie' has undoubted pace and energy that was only bolstered by the ministrations of the P3, which also played down some of the rougher edges, particularly on her vocal.

Plugging both the '501 and the QuteHD into the P3 had the hoped

for synergistic effect. John Gorka's whimsical 'Italian Girls', ripped from an AIX DVD-A, suddenly sounded like a

real hi-res recording, the vocal and the acoustic guitar both gaining in clarity, dynamics and sheer plausibility. And the macho stomp of 'I'll Be Creepin' was magically restored to make it unreservedly superior to the version without the P3 in circuit. ☺

### HI-FI NEWS VERDICT

If you've never tried mains regeneration, you should – and the P3 provides a relatively painless way to do so. While £1950 isn't small change for most of us, still it represents great value for a product that is capable of transforming sound quality, particularly of source components, as the P3 so clearly can. PS Audio has all but cornered this market and the baseline P3 enhances the strength of its offer.

Sound Quality: 85%



As testing mains regenerators falls outside the normal gamut of HFN lab reports, I've had to build two special items of ancillary equipment to undertake it safely. The first of these incorporates an inline Hall-effect current transducer from LEM Components that can record currents of up to 80A at slew rates of greater than 60A/μs over a bandwidth exceeding 100kHz, while adding a series resistance of only 0.18mohm. Built into a box with flying leads terminated in a mains plug at one side and a mains socket at the other, it can be inserted into the mains feed to any audio component to capture mains charging current via an oscilloscope. Overlaid charging current waveforms from the wall socket (red trace) and from the P3 (blue trace) are shown in Graph 1 below, with the 'load' being a mono power amplifier outputting 14.14V rms into an 8ohm dummy load (ie 25W continuous output power). The P3's current pulses are textbook whereas those from the wall socket have a lower peak value and longer duration as a consequence of the mains waveform being flat-topped.

Measurement of mains distortion has to accommodate mains regenerators that have unbalanced, balanced or floating outputs, for which I've built a balanced attenuator that feeds a battery-powered INA217 low-noise, low-distortion instrumentation amplifier. Together these generate a voltage output one-hundredth that of the difference between the live and neutral lines. Voltage waveforms from the wall socket (red trace) and P3 on sine waveform output (blue trace) are shown in Graph 2, while the test table lists individual amplitudes of the first four odd harmonics (each referenced to the amplitude of the 50Hz fundamental) plus a THD figure calculated from the first 14 harmonics. Note when comparing these results to those from the P10 [HFN Apr '13] that (1) the P3 is delivering less output current, and (2) distortion was measured here in the on-load not the no-load condition. KH

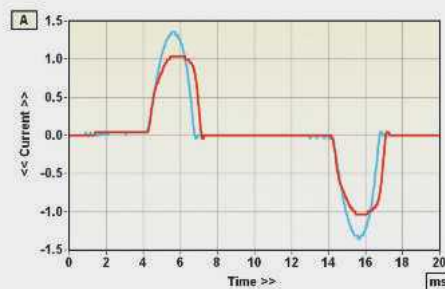

**ABOVE:** Distorted mains (charging) current waveform (red) versus significantly more linear waveform delivered by the PS Audio P3 Power Plant (blue)

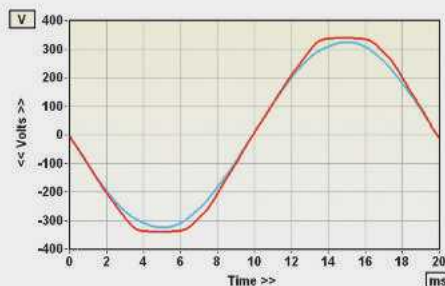

**ABOVE:** Mains voltage waveform, from wall socket (red) versus PS Audio P3 Power Plant (blue)

### HI-FI NEWS SPECIFICATIONS

| Harmonic       | Mains | P3    |
|----------------|-------|-------|
| 3rd            | 0.63% | 0.17% |
| 5th            | 2.37% | 0.39% |
| 7th            | 0.90% | 0.25% |
| 9th            | 0.38% | 0.10% |
| THD (2nd-14th) | 2.66% | 0.51% |

*Cranage Hall*  
Cheshire

Media Partner  
**Hifi Pig**  
Magazine

15.06.2014

[www.audioshow.co.uk](http://www.audioshow.co.uk)



register online for free tickets or ring 07561803670



*Renaissance  
Amplification*

revealing more music

For your nearest dealer call 0203 5442338 (charged at local rate)  
Another fantastic product from NuNu Distribution Limited  
[www.nunudistribution.co.uk](http://www.nunudistribution.co.uk)

NuNu Distribution Ltd



# In-akustik Referenz LS-1603

German build quality turns to cables as the extensive In-akustik range becomes available in the UK. Here's its flagship. Review & Lab: **Paul Miller**



**A**rguably Germany's best-kept cable secret, the In-akustik brand is also remarkably extensive, offering everything from loudspeaker to Ethernet and analogue interconnects to HDMI, across four different ranges. Being an offshoot of the Braun Group, In-akustik is not short of resources. Even the copper in its conductors is smelted and refined in Germany, the highest quality OFC batches being selected for its flagship 'Referenz' range of audio cables.

Top of the tree is its LS-1603 speaker cable, now available in the UK pre-terminated with In-akustik's own rhodium-coated KS-103 spade connections. A 3m set is priced at £1474, which buys a lot of very sophisticated and largely hand-made cable. In-akustik's 'high-speed waveguide' geometry begins with 16 multicore conductors, grouped as signal and return pairs, that are wound around a hollow polyethylene (PE) tube. Each conductor comprises multiple, lacquer-coated copper strands wound around a solid PE core, insulated by foamed



**ABOVE:** In-akustik's flagship Referenz speaker cable is directional – the 'ends' marked by solid alloy terminations

PE and jacketed in a solid PE. Measured in my lab, LS-1603 offered an incredibly low 6.3mohm/m series resistance and 0.13µH/m loop inductance but the Litz-like construction pushes parallel capacitance up to 303pF/m. Not all amplifiers will be equally happy driving lengths beyond this 3m set...

sound that's too heavy or congested. There's no hint of splashiness here, so if you see the LS-1603 described as 'bright sounding' or 'emphasising detail' then it's just as likely the extra zing is coming from a lesser amplifier driving long runs. With a capable amp and speakers, it'll sound wonderfully polished. ⬇

### POLISHED PERFORMER

The mono Devialet 500 amplifiers used in my system handled this reactance with impunity, the inserted lengths of LS-1603 cable encouraging a very smooth and civilised sound. Me'Shell Ndegéocello's 'Peace Beyond Passion' sounded clean and detailed, tending towards the sparse rather than cluttered when the going got really busy. So the bass is firm and crisp just as the treble is faintly restrained rather than wholly open and zesty. But rather this than a

**LEFT:** Each hand-made cable comes with a signed quality assurance certificate. Construction is exemplary



### HI-FI NEWS VERDICT

While certainly in the 'high-end' bracket, In-akustik's Referenz LS-1603 is not as prohibitively priced as some on the market. The cable is clearly assembled with meticulous attention to detail and beautifully finished, and will surely last a lifetime. Some amplifiers may demur at driving lengths over the default 3m as it does present an above average capacitance, but as a tool for fine-tuning exquisite hi-fi systems, it's likely to be just the ticket.

Sound Quality: 80%



# Schiit Audio Magni

Under £100 *and* with high-end cred? Schiit Audio's Magni is the headphone amp to buy if you're watching the pennies. And it's made in the USA...

Review: **Ken Kessler** Lab: **Paul Miller**

**Y**ou can stop laughing now. Or maybe not. The joke has not worn off, and Schiit is managing to live with a name that they probably devised after one too many Dirty Martinis: emphasis on the 'dirty'. The products themselves benefit from Scandinavian nomenclature – Asgard, Bifrost, *et al* – so, should this stunning little Magni headphone amplifier tempt you, you needn't approach the salesman with the embarrassing request, 'Do you stock Schiit?'

The thing is, if you throw enough fancy components at the problem, and follow basic sound design practice, you're likely to get a reasonable result. But work on something that requires component costs of one-tenth of that flagship silver disc spinner, and you're into a new world of pain. It's where real skill comes in, and not everyone has it. Even though standards have recently risen, you need only listen to the average entry-level compact disc player to realise that the ability to make great products at this end of the market remains in short supply.

What the absurd name did do is call attention to a brand found at hi-fi shows in huge halls filled with hundreds of like-minded souls. Headphones and the natural adjunct – the amplifiers needed to drive them with more finesse than a weedy socket offered by tablet or smartphone – have been grouped as a separate genre for a few years, and Schiit Audio must compete with the rest in a field that still has a 'Wild West' feel to it.

As its founders are seasoned designers of, and I quote, 'fully balanced differential power amplifiers, fully discrete I/V conversion stages, audiophile D/A converters, relay-switched stepped attenuator volume controls in preamps, *etc.*' they could have launched Schiit with whatever they liked. Being savvy, they chose headphone amps, though they also

**RIGHT:** Not an IC audio op-amp in sight – the Magni employs all discrete circuitry with a low-noise JFET input, a fast (voltage) preamp stage and substantial output power transistors

make DACs and we're promised that other two-channel products will follow.

## CATERING FOR TODAY

Schiit recognises that the traditional audiophile path of table radio to console to separates is long gone. 'Today, nobody starts with a table radio. Everyone... starts with an iPod and headphones screwed into their ears. Headphones are now the standard.' This is blunt, but honest and right on target. These guys know their Schiit.

Acknowledging, too, that many newbies soon reach the limits of earbuds, tablet, iPod and computer performance, they asked, what do they do if they don't possess the gene or the budget that aspires to £20,000 wires and £6,000 cartridges? The simplest, most obvious move is to a headphone amplifier, something we as audiophiles would deduce immediately, but which is not part of the conditioning of, say, a

17-year-old who's never known life in front of a pair of speakers.

Schiit works with 'simple, discrete circuit topologies' for the analogue sections, while 'innovative bit-perfect management systems' are employed 'on the digital side to avoid asynchronous sample rate conversion'. It also uses Class A designs

'where practical and single gain stages when possible'. It eschews op-amps, integrated or discrete, except as DC servos, or in the Modi: the least-expensive DAC.

Both Mike Moffat and Jason Stoddard are

lab rats comfortable with two Stanford Research SR1 audio analyzers, 'one kitted out with their ultra-low-jitter reference and analysis tools'. Both are unreconstructed audiophiles [see boxout], so they undertake listening tests with a wide variety of popular headphones.

Despite being built down to a price, the company's entry-level headphone

'This is honest,  
right on target.  
These guys know  
their Schiit'

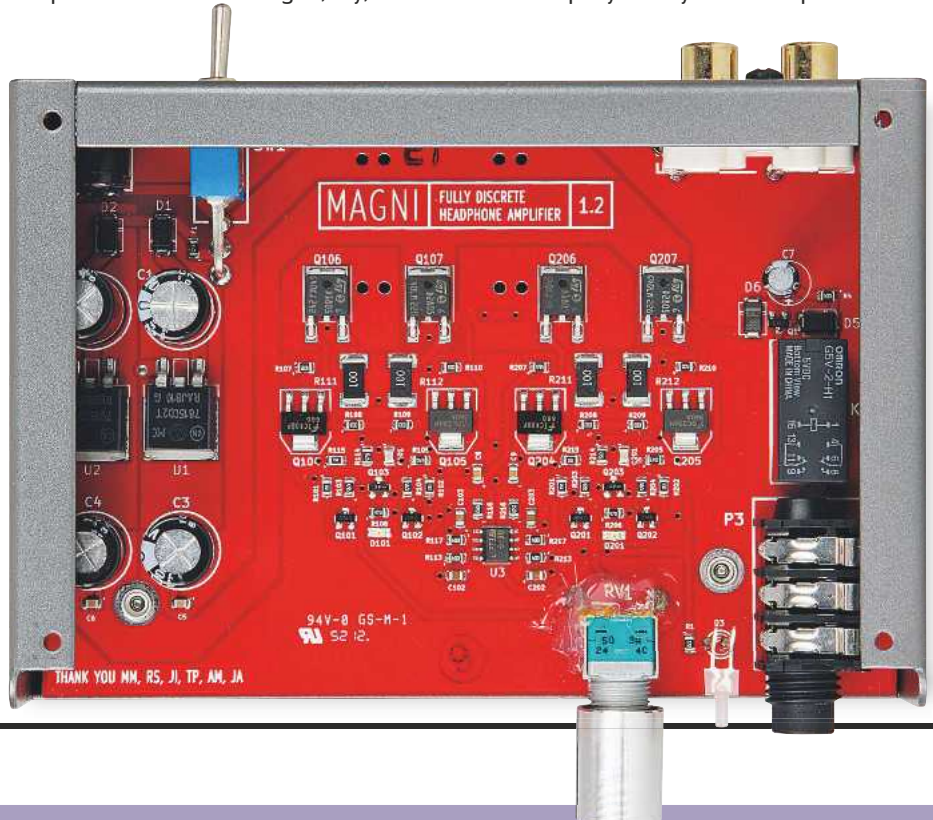



amp, the £99 Magni, is far from Schiit-y. Its build quality, fit and finish do not suggest cost-cutting, and the two controls – the rear-panel on/off toggle and the front panel rotary – feel solid and encouraging. Schiit wants its equipment to be ‘something you can pass down to your children’. And would you believe that the Magni is made in the USA... not China (wall wart excepted)?

This is budget esoterica at its most blissfully simple, inexpensive and compact; it weighs a reassuring 0.45kg. Editor Miller explained that he’s been devising accurate tests for measuring headphone amplifier output: Schiit claims that the Magni delivers 1.2W/32ohm [see PM’s lab Report]. It certainly drove the new Focal Spirit Classic, which barely made a peep with the feed from an iPod. Ironically, this suits the sort of headphones that one might not expect to be partnered with a £99 amp: I also gave it a whirl with a grand’s worth of AKG K812s and it was a delight.

This baby runs warm, but it’s suitably ventilated and never caused any worries. A regulated 16V wall wart AC transformer feeds the Magni, and its back accepts line signals via phonos. At the front is the

1/4in socket, inviting you to use ‘real’ cans, which are driven by a discrete gain stage design – not IC op-amps – with ‘fast VAS transistors and massive output power transistors’. Schiit also uses a DC servo to eliminate coupling capacitors from the output, operation being Class A/B and DC-coupled throughout.

#### WHAT IS THIS SCHIIT?

As much as one may want to believe that only expensive equipment needs coddling, the Magni benefited from warm-up as much as the D’Agostino I have sizzling in the other room. It grew progressively smoother and more refined as the minutes passed by, settling down to optimum after a half-hour. And it behaved just like a full-size amplifier, reacting to its loads with changes in composure.

These included the easy-peasy B&W P3, the hungrier Focal Spirit Classic and the extreme high-end AKG K812. Oldies included Sennheiser HD414s and Grado RS-1s. None of the headphones caused any consternation – this unit drove everything I plugged into it. Source was another matter, but only because this is ‘Budget

**ABOVE:** Front face of the all-steel Magni just has a rotary gain control and 1/4in headphone socket, plus ‘on’ LED. The unit is powered from an AC wall wart plug

Esoterica’ and I did not want to feed it with something utterly out of context: I even felt a bit guilty using the B&Ws for most of the listening, because they cost £169.

Instead, I stuck with an iPod classic, via a 32-pin-to-phonos adapter, without some clever DAC inbetween. This is about minimalism, and about how it will be used in the real world. Yes, I also fed it from my computer with some high-res downloads, and even a burst with the Audio Research CD6, but the remarks here are based mainly on its use with the iPod. I was reminded of the wonders of the affordable goodies from Audio Alchemy, all those years ago: this Schiit rocks.

A dose of powerpop opened the sessions, with The Wonders’ CD single ‘That Thing You Do’ [Play-Tone Records 664055 2] possessing all of the snap I was hoping to hear. Its punchy opening drum salvo leads into a deliriously authentic, deliberately thin-sounding electric bass/jangly guitar mix, fronted by Beatlesque harmonies. Yes, it’s too knowing a pastiche to fool anyone who doesn’t realise that it came from a movie made in 1996, but its sincerity, jauntiness and affection for the genre make it as ‘lovable’ as Ringo c.1964.

Through the Magni, the sound was acceptably wide, if not as airy as the £69-dearer Musical Fidelity V90 HPA (which also has a fine DAC). What it lost in absolute refinement, it made up for with solid, extended bass, convincing decay on the kick-drum and good spacing of the vocalists. In a mood for more post-Fab Four pop, I gravitated toward Badfinger’s *Timeless... The Musical Legacy* [Apple CDSAPCOR 31], longing to hear the 

#### BY ANY OTHER NAME

It helps, maybe, to know something of Mike Moffat, late of Theta, who has teamed up with Jason Stoddard, ex-Sumo, to form Schiit. Mike, whom I’ve known seemingly forever, is sixtysomething going on 14: he delights in the sort of jokes that would inspire consternation in a pool hall or a prison. If you’re of a fragile constitution, wondering why the risqué name, and not accepting defences like ‘one of Europe’s biggest-selling soft drinks is named “Pschitt”’, we understand. But we also suggest that you do not let potty-mouth puns (the website asks, ‘Why don’t you check out our Schiit?’) deter you: this is a *serious* brand. Moffat and Stoddard have designed dozens of high-end products, including Theta’s Andromeda III and the Cobalt 307. MM is responsible for some of the finest digital processors I have ever used. Period. Just about the only puns they’ve resisted so far are a Class A amp called ‘Hot Schiit’, the ‘Schiit-Kicker’ subwoofer and an MC step-up called ‘Schiit Head’. Let’s not give them any ideas, eh?



## Tune Audio

*"a sound less ordinary"*

Tune Audio horn and horn-loaded speakers bring the true sound of musical perfection into the domestic environment. The range includes the Prime, Marvel and Anima models, together with an active full-horn sub. Engineered and constructed to superb standards, the loudspeakers are available in an almost infinite variety of finishes and are hand built to order.

These loudspeakers are the result of many years of painstaking experimentation and development, and offer high efficiency, very low distortion and immense dynamic range. The designs bring listeners as close to the original recording as is possible.

Sensibly priced and an acceptable size for 'real world' use, Tune Audio speakers are genuinely exceptional.

## ModWright Instruments

*"for the most discerning listener"*

Anyone can hear music, and many systems will play music. But to truly hear the music on a level that transports a listener to a different time and place requires absolute reproduction of sound.

Equipment from ModWright Instruments will bring a listener this experience: true sound from a true enthusiast's company.

The range includes pre-amplifiers, power amplifiers and a truly superb integrated amplifier - all built to extreme standards using the highest quality components.

A perfect listening experience should feel amazing, and this is what equipment from ModWright Instruments achieves.



Finance now available

**0% APR** representative

see our website for full details

Finance is offered on any purchases from £500 up to £15000

BD Audio Ltd. acts as a credit intermediary and only offers credit products for V12 Retail Finance Ltd.

Credit is offered subject to age and status

# BD Audio Ltd

retail, import, distribution

Tune Audio, ModWright Instruments, Mulidine, Acoustic Solid, Signal Projects, Audio Note UK, Aktyna, DSPEaker, Ortofon, Hifi Racks, Jolida, Puresound, FiiO, Moth... and much, much more

01684 560853

[www.bd-audio.co.uk](http://www.bd-audio.co.uk)

[info@bd-audio.co.uk](mailto:info@bd-audio.co.uk)



## HEADPHONE AMP



**ABOVE:** Rear panel is basic, with just one pair of RCA phonos for the stereo input signal, on-off switch and 16V power socket. Casework is two-tone with good finish

opening piano of 'Come And Get It'. Suitably church-like bass followed in cadence, sweet vocals above, cymbals far left – the mix of textures caused no loss of composure. The track is actually minimalist, but through the Magni, it acquired a definite grandeur.

Which is exactly what was needed by the strings-driven 'Maybe Tomorrow' – one of rock's great, lost ballads. So heart-wrenching, even without knowing the tragedies that befell the band, it begs for delicacy and refinement. The Magni remains a bit Eliza Doolittle, pre- 'Rain In Spain', but the device earns A-for-effort because it never turns coarse. At least, not as coarse as its name.

### THE LAD FROM LANCS

While lacking the stage width of the much costlier Meridian Prime, the Magni can swing from out-of-the-ear stereo to in-the-head mono with convincing solidity and a wonderful retention of low-level details. The title track of George Formby's *When I'm Cleaning Windows – His 52 Finest 1932-1946* [Retrospective RTS 4104] was recorded the year Quad was founded – 1936 – yet it sounds refreshingly 'full frequency' and as rewarding as anything decades younger. Then again, the playing is peerless.

Speech therapists would love the Magni: with the B&Ws, I heard every nuance of his Wigan accent, his inability to keep a straight face and that spectacular 'banjolele' strumming. And the orchestra! Slick, like you wouldn't believe: woodwinds and trumpets were vivid, if reduced in scale. Of course, being pure mono, it's entirely in-your-skull, but the experience is enough to make you thirst for a bottle of stout. To chase your whelks.

Even better is his 'Chinese Laundry Blues' – suddenly there's

rich bass and an increase in level. Hard to fathom that it's even older: from 1932.

But I followed it with the audiophile-grave live material on Little Feat's *Rad Gumbo: The Complete Warner Bros. Years* [Warner 8122796057], where the Magni was able to flex its muscles, spread its wings. It embraced the rhythmic fluidity, the funk that made this band so genuinely inimitable.

This in itself is enough to warm most of us to so inexpensive a headphone amplifier. Headphones are unnatural at the best of times, and yet they represent the future mode of listening for the multitude.

Which raises a point: at this price level, should we be as concerned with sonic absolutes as much as we should be grateful just for the sheer musical fun on offer? I have often maintained that one cannot approach product X at £100 with the same expectations of something costing £1000... or £10,000. So, had this device measured badly, or had a weird suck-out somewhere, or cut off at 60Hz, or any other measurable crime, I wouldn't care.

I love this little baby. No Schiit. ☺

### HI-FI NEWS VERDICT

While challenged by units costing £50 more – small change to many – the tenets of this series dictate that every pound counts. I am not suggesting that I've heard every headphone amp below £100, but I can't imagine this much glorious sound from anything less expensive. It joins NAD's PP2 phono amp and a bunch of Pro-Ject Boxes in a select group of components that let you wallow in decent sound for under a ton.

Sound Quality: 83%



### SCHIIT AUDIO MAGNI

Second only to the Teac HA-501 in raw power output [see *HFN* Apr '14], Schiit's Magni is surely the most the most capable single-input headphone amp at this very affordable ~£100 price point. Rated at 1.2W/32ohm, the Magni delivered a full 2W/25ohm under test (<1% THD) with a maximum output voltage capability of 8.95V into 47kohm. Couple this with the engineered low output impedance (sub-1ohm to 2ohm from 20Hz-20kHz depending on volume position) and the Magni will drive even the lowest impedance, power hungry 'phones with relative ease. The DC-coupled output stage also offers an incredibly flat and extended response, to within ±0.01dB from 1Hz-5kHz before rolling very gently away to -0.18dB/20kHz and -2.8dB/100kHz [see black trace, Graph 2 below].

The +12.5dB gain is more than sufficient and there's enough headroom to accommodate inputs in excess of 6V at lower volume settings. Distortion increases linearly with output level from 0.001% at 1V to 0.5% at 5.3V (all at 1kHz) and also with frequency, reaching 0.012%/20kHz. Driving a 25ohm load, distortion increases very slightly to 0.002%/1kHz and 0.02%/20kHz but the general trend remains the same [see red infills, Graph 2 below]. The harmonic complement varies somewhat with gain, being mainly 2nd harmonic at +12dB but with equal 2nd-4th harmonics at -6dB. Arguably the Magni's greatest feature, aside from its prodigious power output, is its fabulously wide 98dB A-wtd S/N ratio – another figure for the record books at this price and well beyond. Readers are invited to view a comprehensive QC Suite test report for the Schiit Audio Magni headphone preamp by navigating to [www.hifinews.co.uk](http://www.hifinews.co.uk) and clicking on the red 'download' button. PM



**ABOVE:** Continuous power output versus distortion (up to 1% THD) into 25ohm 'headphone' load

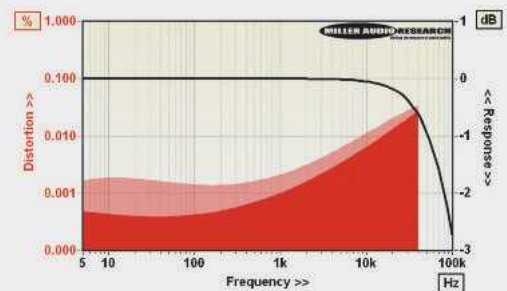

**ABOVE:** Frequency response (black) from 5Hz-100kHz into 25ohm and distortion versus frequency (red, 1V; shaded, 40mW) from 5Hz-40kHz

### HI-FI NEWS SPECIFICATIONS

|   |                    |
|---|--------------------|
| Maximum output (re. 1% THD into 47kohm)   | 8.95V              |
| Max. power output (re. 1% THD into 25ohm) | 1996mW             |
| Output Impedance (20Hz-20kHz)             | 0.86-1.03ohm       |
| Maximum gain                              | +12.5dB            |
| A-wtd S/N ratio (re. 0dBV)                | 98.4dB             |
| Frequency response (20Hz-20kHz/25ohm)     | +0.01dB to -0.18dB |
| Distortion (20Hz-20kHz, re. 40mW)         | 0.0016-0.020%      |
| Power consumption                         | 5W                 |
| Dimensions (WHD)                          | 127x32x89mm        |

# The New Noble Line



*Harmonious  
Sound & Design*



MBL N51 Integrated Amplifier £9950



MBL N41 DSD DAC £9950



MBL N31 CD / DAC  
£10950



Trigon's timeless elegance pleases the eye and prepares the ear and mind for a transcendent sonic experience

**EXCELLENCE IS THE KEY**

Every so often a product comes along which re-writes the rule book in it's market - sometimes this can be because it simply sounds sensational compared to it's peers, sometimes the design or build can be the best of the best, sometimes it can be inspirational innovation that wins this accolade - when a product combines all three of these elements then you have something very special indeed.

Consider a Music Server which offers bit perfect CD ripping (multiple formats), innovative design and sensational build, and combines ease of use with audiophile performance -with these attributes you have the Trigon Chronolog.

Available with entirely silent internal SSD storage from 60Gb (around 150 albums) to 960Gb (around 2250 albums), there is a model for every collection - of course there is nothing to stop you connecting your own external hard drive to the Trigon Chronolog, and letting the high end internal DAC work it's magic on your music collection !

Full iPad/iPod/iPhone compatibility allows the user to control all aspect of the Trigon Chronolog from the comfort of their sofa - both Single Ended and True Balanced outputs are made available for all system topologies.



Trigon Chronolog Reference Music Server £4850



# audioemotion

www.audioemotion.co.uk

e: info@audioemotion.co.uk

facebook.com/audioemotion

t: 01333 425 999



## Perreaux Audiant DP32 DAC / PRE £2395

- ESS Technology's 32-bit Sabre DAC
- Asynchronous 24-bit/192kHz USB input
- Two stages of jitter reduction
- Fully balanced audio signal
- Ultra-low distortion



## Xindak CS300 Tube Integrated Amplifier £2450



## Perreaux Audiant 100P Stereo Power Amplifier £2195

- High power MOSFET transistors
- Custom transformer and high-current power supply
- Triple filtered power supplies



The Quad Vena is a DAC and integrated amp in a single chassis, offering wireless Bluetooth connectivity alongside an extensive range of inputs and outputs.

D/A conversion is handled by the same high-performance 24-bit/192kHz chipset used in Quad's acclaimed Platinum CD players, while support for the aptX codec ensures superior sound quality over Bluetooth.

The Class AB power amp section is of the highest quality, delivering 45W per channel into 8 ohms. Vena is an exceptionally neat and simple solution for superb sound from any source: from smartphones, tablets, PCs and Macs to traditional hi-fi separates.



## NEW QUAD Vena

## Wireless Bluetooth DAC and Integrated Amplifier £600



music is our passion



# Vinyl Frontier

BEHIND THE MUSIC WITH HI-FI NEWS & RECORD REVIEW

Johnny Cash's *American Recordings* found him a new audience; Billy Joel's *Stranger* interprets inner-city blues, White Stripes offer another view. **Chris Heard** listens

**S**urely the most gracious and accomplished comeback in music was executed by Johnny Cash during the 1990s and noughties with his *American* series of LPs, now newly reissued on 180g vinyl on Universal's Back To Black imprint.

Cash was in his early 60s and had been dropped by Columbia when he was encouraged by Rick Rubin, the head of American Recordings (formerly Def American, nominally a rap and hard rock label), to take his Martin Dreadnought guitar into Rubin's living room and perform a selection of simply-played songs without adornment. The first fruit of this collaboration was the 1994 album *American Recordings*, the first of six largely superb stripped-down acoustic works and still the place to start for those unfamiliar with this spectacular episode of Cash's six-decade career.

The tracks were a combination of earlier Cash recordings reworked for the record, a handful of covers and the odd bespoke track written with Cash in mind by his admirers. Rubin's vision in nurturing Cash and the respectful way he worked with such a true legend during the sessions would seem to have been the key to the series' success.

After the relative ignominy of being kicked off a label he had served for 30 years, Cash was suddenly reinvented, his essence reinvigorated, in no small part due to this masterstroke of understatement pulled off by Rubin. *American Recordings* caught the zeitgeist, helping to fuel the

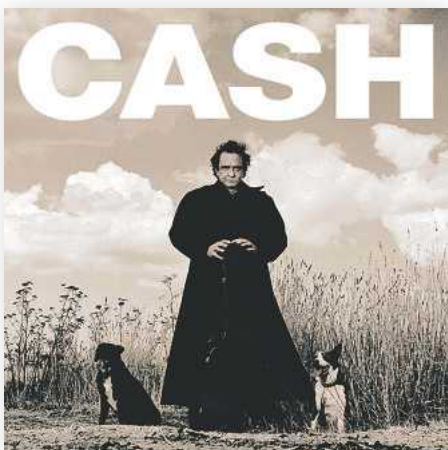

➔ Johnny Cash 'suddenly reinvented' in the *American Recordings* series



➔ *White Blood Cells*: Chris's choice from four new White Stripes albums

creative fires that led to a decade or so of folk-based acoustic music becoming the fashionable stuff to play and listen to.

## THE REVOLVER OF RAP

Before Rubin's label set the template for the new Americana, Def Jam (as it was formerly known) was home to some of the USA's most visceral hip-hop artists – the kings of the castle being New York's Public Enemy. And so we come to the single most important LP in the history of the genre, *It Takes A Nation Of Millions To Hold Us Back*, first released in 1988.

I know how much hip-hop polarises people, not least those tasteful folk who have spent a lifetime acquiring sophisticated turntables via which to indulge in the most exquisite of recorded performances, but I would urge any sceptics to be open-minded about this extraordinarily powerful and devastatingly exciting record.

*It Takes A Nation Of Millions* is the *Revolver* of rap; the Beethoven of beats; the one hip-hop album you cannot afford to be without on 180g vinyl (now reissued on Back To Black). The record was to its time what Marvin Gaye's *What's Going On* was almost two generations earlier: the voice of a disaffected black community, socially-conscious and lyrically potent; an explosion of eloquent fury on the part of lyricist and vocalist Chuck D at a time when the legacy of Reaganomics was one of despair and lack of hope among huge swathes of urban

## CHRIS HEARD

Chris Heard is an experienced music journalist and, as our picture illustrates, a longstanding vinyl LP collector. He runs an online record store specialising in vinyl reissues and new releases, and in the spring of 2012 opened a music (and coffee) shop nestling amid the splendour of the Malvern Hills.



African-Americans. But where Gaye might have demonstrated prosaic restraint and melodic subtlety, Public Enemy went for an all-out assault on the senses. Chuck D's barely-concealed fury at the conditions of his community is delivered with a spitting-fire intensity, his peerless rhymes being paired with gloriously body-shaking drums and angle-grinder samples which make for a thrilling, if relentless, ride.

On tracks such as 'Bring The Noise', 'Don't Believe The Hype' and 'Black Steel In The Hour Of Chaos', the band set out their radical agenda, pulling no punches, while 'Night Of The Living Baseheads' hits new sonic highs. The overall sound is that of proto-rappers like the Last Poets and Gil Scott-Heron mixed up with the politics of Black Power and the anger of The Clash together in one brutal, searing brew.

## WITTY OBSERVATIONS

Listening to Public Enemy's diatribe, it's both curious and reassuring to think that they inhabit the same world – and indeed the same city – as Billy Joel, and that Joel's landmark long-player *The Stranger* is his own rather more sedate interpretation of the inner-city blues. Admittedly, Joel's reflections were made more than a decade earlier, from the standpoint of a different ethnic community (owing more to Woody Allen than Malcolm X), but together they help to piece together the patchwork quilt of artistic expression that makes NY the world's most singular musical melting pot.

*The Stranger* is simply a high-calibre songwriter's album, the observations of a clever, witty guy seeing the world from the cafés and cocktail bars of Manhattan and the blue-collar bar-room dives of the suburbs, and writing what he sees. It's the sound of Bruce Springsteen watching *Annie Hall* – 'Movin' Out (Anthony's Song)', 'Scenes From An Italian Restaurant', 'Only The Good Die Young': vignettes that would not sit out of place in a Scorsese short starring Robert De Niro.

It was Joel's fifth studio album and the one that sent his career into orbit, and it

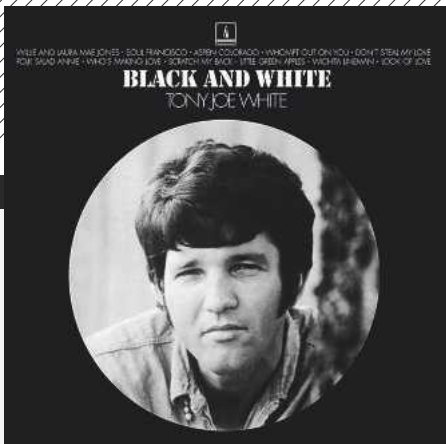

➔ *Black And White*, from 1968, has songs all written by Tony Joe White

can't possibly sound any better than it does on this 45rpm double LP from Mo-Fi.

#### FOUR WHITE STRIPES

Detroit's The White Stripes (singer-guitarist Jack White and his former wife Meg White on drums) were one of the handful of truly important acts of the noughties: a howling wolf of raucous poetry and youthful swagger that fed new life into the blues format and flew the flag for post-Nirvana alt. rock of the highest order. Between 1999 and '03 they released four studio albums which are among the most consistently rewarding catalogues of any artist this side of the Millennium. Now these records – *The White Stripes* (1999), *De Stijl* (2000), *White Blood Cells* (2001) and *Elephant* (2003) – have been given another limited run on XL Records.

I urge you to buy them while you can, but if you can only run to one of them, make it *White Blood Cells*, featuring the sleazy garage-punk of 'Hotel Yorba' and the breath-of-fresh-air single 'Fell In Love With A Girl'. Taking its cues from post-punk mutant blues protagonists such as The Gun Club and The Cramps, the LP ranks among the most impressive contemporary indie records. Meanwhile, Jack White – a vinyl evangelist, let it be noted – has proved himself to be a class act; durable and self-deprecating, too, as his 2012 solo debut

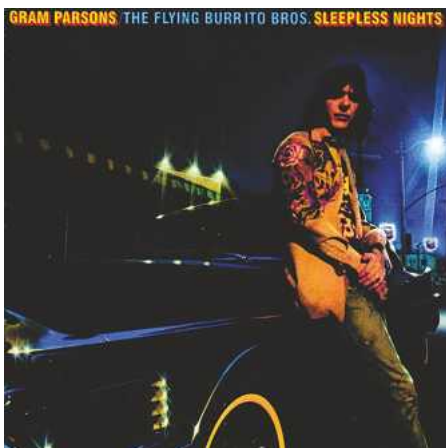

➔ Gram Parsons' *Sleepless Nights* compilation is on Music On Vinyl



album *Blunderbuss* (about his break-up from Meg) showed.

#### BLUE-EYED SOUTHERN SOUL

Before Jack White, there was Tony Joe White – no blood relation but a spiritual ancestor all the same. The 70-year-old White's debut album from 1968, *Black And White* [now reissued on Music On Vinyl] is choc-full of quality fare: 'Soul Francisco', 'Little Green Apples' and the Elvis staple 'Polk Salad Annie' – all from his own pen. White, who also wrote 'Steamy Windows' for Tina Turner and the Brook Benton classic 'Rainy Night In Georgia', embodies all that is great about bluesy, blue-eyed southern soul.

This is the poor white man's front-porch blues of collard greens and fried chicken that has been drawing music obsessives such as Jack White (and myself!) to Tennessee for three or four decades now in search of the source of all that great music, from the side-streams of the Mississippi river to the dense swamps of Louisiana.

#### THE HIPPEST DADDY

If White was, and remains, the coolest of dudes, then Cecil Ingram Connor III – better known as Gram Parsons – was surely the hippest daddy of them all; he was the original Cosmic Cowboy who may have dressed like a Hillbilly but had the soul of a poet and a vision that only truly

➔ 'The observations of a clever, witty guy', Billy Joel's *The Stranger* is on Mobile-Fidelity at 45rpm (two LPs)

great artists possess. Parsons' posthumous compilation *Sleepless Nights* [Music On Vinyl reissue] collects together some of the material from his brief-ish spell as the singer in The Flying Burrito Brothers, the West Coast country-rockers formed from the fallout of The Byrds who, for one shining moment, struck the motherlode by connecting rock, blues, folk and soul in a single sparkling rhinestone-studded Nudie suit.

Parsons did create better work than *Sleepless Nights* (for the essential Gram one should turn to the first Burritos album and his two 'proper' solo LPs), but there are glimpses here of his rare, prodigious and ultimately unfulfilled talent (he died in 1973 aged just 26). The title track itself and 'Brand New Heartache', recorded with his musical soulmate Emmylou Harris, point to a unique performer, while 'The Angels Rejoiced' and his take on his pal Keith Richards' 'Honky Tonk Women' speak of his ability to embrace all styles.

Parsons, a young man of considerable emotional literacy, at the peak of his powers and in the prime of his life, represented all that was great about the myth of American rock music during its golden age. ☺

'It's a front-porch blues of collard greens and fried chicken...'

# Vinyl Release

BEHIND THE MUSIC WITH HI-FI NEWS & RECORD REVIEW

## Genesis *Foxtrot* (180g vinyl)

It was the band's breakthrough LP, reaching No 12 in the UK charts with one of the finest prog rock tracks of all time: 'Supper's Ready'. **Steve Sutherland** listens again...

**P**ray indulge me, officer, if I briefly philosophise. What's really true – the way you remember things happening, or the way the facts have been recorded by history?

I'm pondering this because over 40 years ago – 42-ish to be vaguely precise – I witnessed a gig I recall one way while what little historical evidence there is recalls it quite another. The venue was the Alexander Rooms in Salisbury Wiltshire, that bit's for sure. Salisbury was the town I grew up in and The Alex Rooms were made up of a nondescript, low-ceiling-ed suite with a tiny dance floor and an even smaller bar – the sort of place that serves as a functional catch-all in backwater market towns the length and breadth of the UK, anonymous enough to host municipal matters, sports prize-givings and wedding receptions.

### ONLY GIG IN TOWN

We used to call it the Alex Disco and, apart from rock and pop royalty (Led Zeppelin, The Sweet) making rare and miraculous visits to the City Hall, it was the only gig in town. There was indeed a 'disco' there

every Saturday so far as I remember. That meant it was really just a place to hang out for the local bored teens – somewhere for the boys to smoke and sink pints of snakebite at the bar while eyeing up the girls who'd be slugging back vodka and limes and swaying around their handbags to The Chi-Lites' 'Have You Seen Her?'.

Sometimes a band on their way up from the second division of the British gig circuit would have been booked to intrude upon this drunken mating ritual. If they were lucky, they'd draw a handful of starstruck fans from the outlying villages. If they weren't, the night could turn ugly. Or perhaps I should say, *uglier?*

Anyway, I think I only saw three bands there in all my teenage years and that's possibly why I recall them all appearing in one night. The way my mind has stored it, the show I'm to recount, was some kind of package deal associated with that most English and eccentric of labels, Charisma.

### STEVE SUTHERLAND

Steve edited NME from 1992-2000, the Britpop years, launching NME.com and reviving the NME Awards. Previously he was Assistant Editor on Melody Maker. Among his many adventures he has been physically threatened by Axl Rose, hung out awhile with Jerry Garcia and had a drink or two with Keith Richards...



First on were Stackridge, and a band more English or eccentric it would be hard to imagine. A bloke called Mutter Slater played the flute. There was a violin and some gently psychedelised ditties about tea and tennis, a female explorer, an elephant and a monster called a Snark.

They were great and so were the band I came to see – Lindisfarne who, because they played acoustic guitars, had very long hair and beards and looked like they were reasonably well acquainted with the smoking of the weed, were about the closest we could imagine coming to seeing Crosby, Stills, Nash & Young. They did 'Lady Eleanor' and me and my mates vaguely wiggled-out.

And then, after them, there was this entirely other kettle of kippers. They looked unremarkable enough, though we thought it was weird that the guitarist was sitting down. But the sound they started making was really rather creepy, like an aural dark fog sweeping in cold and damp.

Mostly this sound was made by what I later learned was a Mellotron, a wondrously unreliable form of early synthesiser that was wont to give any song it came near a damn good dose of the Phantom Of The Operas.

### FOXY LADY

This wash of sinister, quasi-classical noise went on for a bit until the drummer and bass player began to insist some kind of staccato morse code over the proceedings. Then, quite suddenly, as if from a metaphorical puff of smoke, there he – *it?* – stood. The singer. In a red dress. Wearing a fox's head. Let me tell you, it was effing scary. And some tiny minds were duly blown. The band in question were, of course, Genesis. The singer, Peter Gabriel. And the song, 'Watcher Of The Skies', the number we later discovered was to usher in the album they were about to put out

'There he stood.  
The singer. In a red  
dress. Wearing a  
fox's head'



Genesis pictured in 1974 (l-r): Phil Collins (drums and backing vocals), Mike Rutherford (bass guitar), Tony Banks (keyboards), Peter Gabriel (vocals), Steve Hackett (guitar)

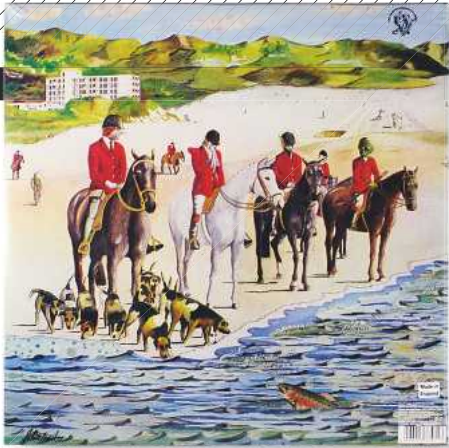

➔ Priced £15.99, the 180g re-release of *Foxtrot* by Genesis is available to order online from [www.rockbox.co.uk](http://www.rockbox.co.uk)

and the one we're here – at long last – to talk about: *Foxtrot*.

Turns out it was the band's fourth LP, some continuity rendered by the cover artwork which, like *Trespass* and *Nursery Cryme* before it, was painted in true *Alice In Wonderland* style by a wacko artist called Paul Whitehead. The covers were whimsical, full of little details and clues which, no matter how long you pondered them, really meant absolutely nothing. Much like the album as it happens.

As I said, 'Watcher' was the opener, the name nicked from a line by that most doomed of romantic poets, John Keats. The song's about aliens landing on earth or something. It doesn't matter. It sounds utterly ominous even without our Peter toggged up as a transvestite Reynard – an image, by the way, that is captured in the cover artwork but never once referred to in any of the songs.

### SILLY STORIES

Peter, it transpires, was a shy youth prone to stage-fright; an unfortunate state which also afflicted his band mates who were pretty much the inverse of the name of their label. Phil Collins was on drums, Steve Hackett, guitars, Tony Banks, keyboards, Mike Rutherford, bass – and they liked to concentrate on their complicated riffage rather than, at that this early-ish point in their careers, putting on any kind of show.

Consequently, there were some mighty uncomfortable tunings-up between songs so Peter developed a defence mechanism – first the fox in the dress, then the flower headdress, etc. He also started telling silly stories while his mates were making sure the notes would come out right.

*Foxtrot* was the start of all this malarkey, the stuff for which the band would soon become famous.

Anyway, the album. On the night in question they also played something called 'Get 'Em Out By Friday', which lasted nearly



ten minutes and was really a kind of BBC *Play For Today* crossed with the *Twilight Zone*. It begins about an unscrupulous landlord who gets this geezer called The Winkler to evict his tenants so he can get new ones in and put up the rent.

It concludes with the landlord being some sort of government bigwig in charge, I think, of making sure that there is a new law enforcing some sort of genetic control which means humans are not allowed to grow more than four feet tall so loads of them can be rammed into tiny flats that make landlords loadsa money. Or something like that. And it's all, every fiddly note of it, absolutely splendid.

The other thing they played which we discovered later on the album was a fantastically incomprehensible thing called 'Supper's Ready' which went on, like, forever, like Wagner's 'Ring Cycle' or something. Split into seven movements over nigh-on half an hour, it was the sort of thing you got totally lost in and when we bought the album later, the fact that we learned movement II was called 'The Guaranteed Eternal Sanctuary Man', movement IV, 'How Dare I Be So Beautiful', or movement VII, 'As Sure As Eggs Is Eggs (Aching Men's Feet)' neither enhanced nor hindered our enjoyment one jot.

Let's face it, *Foxtrot* is one well weird stand-out album by a band who were becoming weirder by the day. Which is

really saying something in a year that saw Yes release their magnificently nonsensical *Close To The Edge* and Jethro Tull deliver us their concept album, *Thick As A Brick*.

A trawl of the more cobwebby corners of the internet will reveal that Genesis never actually played Salisbury Alexander Rooms on a bill with Lindisfarne. Neither was Stackridge on the bill, though all three bands did grace us Wiltshire yokels with their individual brilliance on separate occasions in that halcyon summer of '72.

Which just goes to show that... OK officer, I'll come quietly. ☺

### RE-RELEASE VERDICT

Containing some of the most powerful and memorable songs in the whole Genesis catalogue, this EMI reissue promises 'higher bass response and an even warmer high-fidelity sound'. Cosy words, but one thing's for sure, and that was that our copy was flat while its surfaces were dead quiet.

As for sound quality, bass was indeed deep and there was no splash to the treble despite the sheer complexity and density of mixes such as the epic 'Supper's Ready'. Supplied in a gatefold sleeve with original artwork, this LP receives a thumbs-up. HFN

Sound Quality: 89%

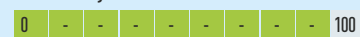



# The Kinks *Face To Face*

For many the LP marks the moment the band suddenly developed their uniquely-British identity, yet the tracks that became associated with the quintessential Kinks sound did not appear on the original release. Rather, they were added later. Nonsensical? Read on...

Words: **Johnny Black**



**A**ll too often dismissed as a transitional album, *Face To Face* actually ranks alongside The Kinks' finest releases, and here's why.

Convention holds that the band's presiding genius, Ray Davies, reached his songwriting zenith with the 1968 concept offering *The Kinks Are The Village Green Preservation Society*, and that *Face To Face* was little more than a halfway house between The Kinks' revolutionary rock style (arguably the start of heavy metal) and their more sophisticated, quintessentially English observational pop from the latter half of the decade.

That argument holds some water if *Face To Face* is considered in the form in which it first reached the market place – a 14-track album whose highest profile song was the hit single 'Sunny Afternoon'.

#### ADDED CLASSICS

It was an excellent album by any standards but, curiously, it's a bunch of Kinks' classics that don't appear on the original release which justify its elevation to Vinyl Icon status. Yes, I know that sounds nonsensical, but on some reissues, enlightened compilers have added 'Well Respected Man', 'Dedicated Follower Of Fashion' and 'Dead End Street' – classics which, to any but the cloth-eared, clearly belong among the *Face To Face* tracks.

I will, of course, be taking a good look at the 'original' album but bear with me while I examine those extraneous additions. On its release in September 1965,



DECOR RECORDS

➔ (L-r): Pete Quaife, Dave Davies, Ray Davies and Mick Avory

➔ Live in 1967 on Dutch TV. Ray plays a Fender acoustic and Dave a Gibson Flying V

➔ Original 1966 stereo release

'Well Respected Man' was recognised as a single unlike anything else in The Kinks' canon. Until then, the group had been the UK's heaviest rock band and, when they strayed into quieter territory, Davies' lyrics were generally introspective and not a little angst-ridden.

Suddenly, though, he threw 'Well Respected Man' into the mix. Not only was the sound musically lighter, more sophisticated and decidedly retro, but the lyric was a social comment about the upper-middle class milieu that working class Davies had found himself in, largely because of the band's well-heeled management team,

Robert Wace

and Grenville Collins. Kinks' bassist Pete Quaife once said, 'Robert was so upper class we had to teach him how to swear. He couldn't do it.'

Davies realised that this song – the first of a new direction – didn't belong on the album they were making around this time, *The Kink Kontroversy*, so he released it only on an EP – *The Kwyet Kinks* – where it was less out of place.

Davies' next song in the same style was 'Dedicated Follower Of Fashion'. Released in February 1966,



it dished out the same treatment as 'Well Respected Man', but focused instead on a foppish fashion victim. It was a Top 5 single in the UK, but its very success caused Davies considerable anxiety. 'People started coming up to me on the street and singing the chorus in my face: "Oh

yes he is, oh yes he is," as if to say that I knew who I was. Unfortunately, my inner and somewhat distorted sense of reality told me

that this was not who I wanted to be: I didn't know who I was.'

#### NEW POP LANGUAGE

Once again, perhaps because of Davies' antipathy, the song did not appear on a Kinks album – although it would have been perfect for *Face To Face*. Pete Townshend of The Who was one of many who understood what was happening to Davies' creativity. 'The Kinks were quintessentially English,' Townshend has said. 'I always think that Ray Davies should one day be Poet ➔

**'It's a bunch of classics not on the album that justify the LP's elevation'**



➔ The band play Torquay Town Hall in August 1966



## VINYL ICONS

### PRODUCTION NOTES

*Face To Face* was the fourth album by The Kinks for the long-established British company Pye Records, whose best-known artists prior to the beat group era were probably skiffle king Lonnie Donegan and MOR songtrush Petula Clark.

Pye Studios was located in the then modern premises of ATV house in Great Cumberland Place, just a few paces away from London's famed Marble Arch. The room used by The Kinks benefited from a top-notch Neumann desk and a four-track reel-to-reel Ampex tape recorder, with Telefunken, Neumann and STC microphones and Tannoy monitors. 'I used that room a lot,' said Shel Talmy, an independent producer who had worked closely with The Kinks from the start of their career. 'This was a basement studio in a modern building that housed Pye Electronics at the time. I did a lot of The Kinks stuff there. It was a good room acoustically, about 20ft by 30ft. A very comfortable room, with good equipment for the time.'

Despite The Kinks' reputation for frequent fraternal fisticuffs and general surliness, Talmy insists, 'I always remember The Kinks as being professional in the studio. I respected their opinion and they mine.' Although musically a great album, *Face To Face* lacked the sonic sophistication to properly render the band's increasingly complex material and, as a result, Talmy was ditched soon after, so that Davies could control his own material. Talmy, however, does not seem resentful. 'Those old recordings, they still blow me away,' he concludes. 'It was a golden time, and I feel privileged to have been involved.'



← Promo shot from 1966 shows (l-r) Ray Davies, Mick Avory (drums), guitarist Dave Davies and bass player Pete Quaife

Laureate. He invented a new kind of poetry and a new kind of language for pop writing that influenced me from the very beginning.'

In essence, The Kinks had started out as a heavily American-influenced rock band, but were now transforming into the epitome of Englishness. Although it lacks 'Well Respected Man' and 'Dedicated Follower Of Fashion', *Face To Face* was the album that brought this transformation to fulfilment, an achievement the more remarkable because it emerged from a period of intense unhappiness in the band.

### NERVOUS BREAKDOWN

Not long after the success of 'Dedicated Follower', Ray Davies suffered a nervous breakdown. 'I was a zombie,' he told Phil McNeill of the *NME* many years later. 'I'd been on the go from when we first made it until then, and I was completely out of my mind.'

Bassist Pete Quaife didn't see it the same way. 'He was faking it or at least exaggerating it,' asserted Quaife. 'I really don't think he cared about whether the band survived or not. In fact, we were all just wishing it would fold and we could get away from the responsibilities.'

Whichever version was true, when the band went into Pye Studios to record *Face To Face* in May 1966, they got off to a racing start, laying down three tracks – 'Sunny Afternoon', 'Fancy' and 'I'm Not Like Everybody Else'. According

to Davies, 'I tried not to write, but when I was coming out of the breakdown, I started.'

'Sunny Afternoon', he says, 'worked a treat' and required only one take. Describing his singing approach, he has said, 'I certainly didn't want to sound American. I was very conscious of sounding English.'

Fancy, too, came quite easily. 'I remember writing "Fancy" really late one night. I had this silly old Framus guitar that I played on all those records. I had the wrong strings on it but it had a nice quality. It was a picking sound, and it could sustain one note, as Indian music does.'

'The song deals with perception. I think love is like something that you hold. You've got to put love in your hand like that, but you must

never grasp it.' Things looked promising until, on June the 4th 1966, Pete Quaife was badly injured while driving home

after a gig in Blackpool, obliging the already unstable band to draft in a replacement, John Dalton.

Sessions for the album had to continue, but despite the problems, producer Shel Talmy has stated, 'They'd just come in and record. I think the studio was an oasis of sanity by comparison with what was going on outside.' Other standout tracks include the



KWYET KINKS



↑ The single 'Dedicated Follower Of Fashion' and EP *Kewt Kinks* both featured songs written around the same time as tracks that would appear on *Face To Face*. Some later releases of the LP saw them added

← US record producer Shel Talmy. He also worked with The Who

'We were all just wishing the band would fold and we could get away'

# oppo

## OPPO PM-1

### PLANAR MAGNETIC HEADPHONES

A new reference in high-end headphones. Featuring proprietary OPPO innovations including the unique 7-layer diaphragm, double-sided spiralling coils, and an FEM-optimized magnet system.

## OPPO HA-1

### HEADPHONE AMPLIFIER

Building upon the success of the BDP-105 audiophile disc player, HA-1 combines an uncompromising Class A balanced amplifier with the performance of the ESS 9018 Sabre<sup>32</sup> Reference DAC.



NOW ON DEMONSTRATION. Call to make an appointment at our London West End demo room.

**AVaficionado**  
For the discerning and those in the know...

0845 370 0054  
or buy online at  
[www.AVaficionado.co.uk](http://www.AVaficionado.co.uk)



# futureshop

connecting you with AV excellence .co.uk

Hi-Fi Cable, Home Cinema Cable & AV Connectivity Specialists

Expert Advice & Sales

0208 905 1555

+44 20 8905 1555



Wireworld Platinum Starlight USB



AudioQuest Diamond Ethernet



Atlas EOS 4sq Rhodium Power



Nordost Heimdall 2 Audio Cable



Chord Signature Reference Cable



Monster ISF 2000 HDMI Cable



Van Den Hul The Rock 3T Cable



Tellurium Q Black Speaker Cable

Hi-Fi Cable & Home Cinema Cable Specialists

Bring your hi-fi to life with our high performance award winning cables

[www.futureshop.co.uk](http://www.futureshop.co.uk) - call 0208 905 1555

FutureShop.co.uk, Unit 5 MODA Centre, Stirling Way, Borehamwood, Herts, WD6 2BW, England, UK

# CADENZA



2012 Yearbook



2010 Yearbook



August 2009



April 2010



May 2011



The Cadenza series represents another example of Ortofon's constant push toward technological perfection. By taking various design characteristics acquired through market leaders, such as the MC Jubilee and Kontrapunkt series, Ortofon have developed Cadenza to elevate any decent Hi-Fi system to a whole new level.

The range consists of 5 different models, including a Mono version, but they all adhere to Ortofon's core principles of accurate information retrieval and phenomenal sound performance. Since they were originally introduced in 2009, each model has received high-praise from owners and reviewers alike.

**ortofon**  
accuracy in sound

Available in the UK through **Henley Designs Ltd.**

T: +44 (0)1235 511 166

E: [sales@henleydesigns.co.uk](mailto:sales@henleydesigns.co.uk)

W: [www.henleydesigns.co.uk](http://www.henleydesigns.co.uk)

 /HenleyDesignsLtd

 /HenleyDesigns1

# Alternate Format Discography

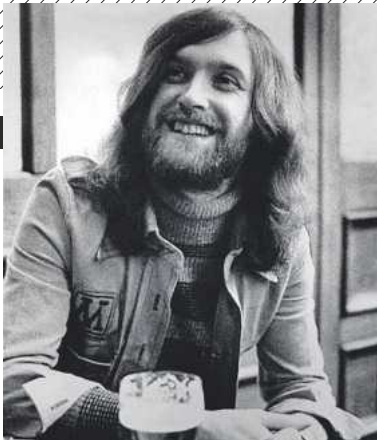

➤ RCA Records publicity shot of Ray's brother Dave from 1971

atmospheric 'Rainy Day In June', whose thunderstorm effects mirror Davies' mood at the time. 'It was from my fantasy in the back garden,' he later revealed. 'I love rain and the moistness after a storm, and it was about fairies and little evil things within the trees that come to life.'

'Dandy' (memorably covered by Herman's Hermits) tackles territory not dissimilar to 'Dedicated Follower Of Fashion', but the central character is rumoured to have been Ray's guitarist brother Dave Davies, whose wild lifestyle and sexual dalliances apparently provided lyrical inspiration.

Perhaps even more intimately revealing is the heartfelt 'Rosie Won't You Please Come Home', a direct plea to Ray's sister who had moved to Australia. 'I lived with Rosie,' he explained. 'I called Rosie "Mum" until I was five years old.'

## PURPLE PATCH

The last song recorded for the album was 'Little Miss Queen Of Darkness' on June the 21st and perhaps it was a little rushed, because drummer Mick Avory has cited it as the one track he'd like to re-record. 'I did a 16-bar drum solo with phrases as an overdub,' he says, 'and it went out of sync with the track near the end. The producer thought it was ok, but I hated it, particularly as I could have corrected it in a few minutes.'

Space doesn't permit detailed examination of every track on *Face To Face*, but the quality is very high indeed, far outshining any previous Kinks effort. That Ray Davies was, creatively at least, in a purple patch, is underlined by the fact that even before the completed album hit the shops, The Kinks were back in the studio to record *Dead End Street*, another Kinks' classic. But that will have to wait for another day... ☺

*Face To Face* presents a particularly arduous challenge to devotees looking for a 'best' version. One factor which complicates the issue is that Pye took a different approach to stereo than most other studios. While most went for widescreen separation, Pye often aimed for a 'compatible' mix – a compromise which would sound acceptable on both stereo and mono record players. This appears to have been the case with *Face To Face*.

Tony Hatch, one of the era's top producers, has explained how, 'having got our multi-track recording, the next process would be the mix-down. At Pye we experimented with both separate mixes and "compatible" mixes and decided to go for "compatible" by which you could play a stereo record on a mono record player and the output would be mono.'

This might explain why Kinks' producer Shel Talmy's mono and stereo mixes of *Face To Face* – yes, he did do both – can each sound like mono. In essence, all of the elements on the multi-track masters were located towards the middle of the stereo mix to achieve the desired 'compatible' effect. 'The biggest problem with "compatible" mixes,' points out Hatch, 'was balancing the reverb plus phasing. In mono, also, sounds placed dead centre in the sound picture will leap forward.'

Remember this as you read on...



## ORIGINAL VINYL (1966)

*Face To Face* first appeared in the UK in mono and stereo versions [Pye NPL 18149/NSPL18149]. Kinks fans tend to prefer the mono with repeated criticisms over the years that the stereo release is marred by everything from missing vocal overdubs to isolated stereo effects on mono songs, low levels of lead vocals and bizarre panning.



The album was also issued on audio cassette but in limited quantities and only in certain territories. Precise details are virtually impossible to ascertain. I can find no trace of an 8-track cartridge version but, intriguingly, an artifact called *Face To Face* Vol.1 (R-6228) was released by Reprise in America, in the now almost forgotten PlayTape format. PlayTapes were self-winding two-track cartridges with a playing time of between eight and 24 minutes. The Vol.1 release featured four songs from the LP – 'Dandy', 'Party Line', 'Session Man' and 'Rosie Won't You Please Come Home' – but presumably didn't sell well enough to justify the release of Vols 2 or 3.



## VINYL REISSUE (1979)

The first reissue popped up in Germany in mono only [200 731-241] with no added tracks or sonic enhancements. In 1980 came similar Spanish [ZL-342] and British [NPL 18149] editions.

## FIRST CD VERSION (1986)

In 1980, Pye was re-named PRT and in this guise was responsible for the first CD edition [CDMP 8829], which was digitally remastered. It did a good job, achieving sonic clarity, resonant bass, and tolerably low levels of hiss. There are moments when it sounds as if mono mixes have been enhanced to create pseudo-stereo, but this is probably just a consequence of

the original stereo mix having been created for 'compatible' use on the hardware of the time.

Derived from the same PRT digital tapes was 1989's all-mono Castle Classics reissue [CLACD 158]. Some say this has the left and right channels reversed, but as it's mono how would they know?

A 1993 Japanese CD release, *The Kink Kontroversy/Face to Face* [VICP-5329; 28CP-2], was also faithfully derived from the PRT masterings and conveniently illustrates how The Band's style changed over those two albums, but it is otherwise unremarkable.

## JAPANESE RE-MASTERED CD (1998)

The Japanese upped the stakes somewhat with this 20-bit Simon Heyworth remaster of the mono *Face To Face* [VICP-60224] plus seven bonus cuts and liner notes by Frank Smyth. This was well received and stands as probably the best-sounding reissue up to that time.

## JAPANESE MINI LP-STYLE CD (2007)

This cutely collectible mini replica LP CD [BVCM-37973] basically sees the 1998 Simon Heyworth remaster reissued in a paper sleeve with two sleeve note inserts.

## DELUXE EDITION CD (2011)

Digitally remastered by Andrew Sandoval and Dan Hersch (of Digiprep and Rhino fame), the audio quality is undeniably superior on this 2CD edition from Universal [277 262-0]. It offers both gritty mono and warmly expansive stereo mixes of every track from the original album. Finally, the stereo *Face To Face* sounds like stereo. Add in the unreleased material, alternative versions, BBC sessions, brief but informative interviews and liner notes by Daniel Rachel, and this is the one I'd plump for.



# Friars, *Aylesbury*, Bucks

Able to boast over 90,000 members, the club currently stages events at its fourth and largest ever venue. **Steve Sutherland** takes you to the heart of the live music experience with the story of Friars, to be found in the UK market town of Aylesbury

**H**is name was Peter Frampton, but he didn't play guitar. Or, at least, not very well as far as I recall. Still, he was some kind of hero to me. Mr Frampton, you see, was one of those one-in-a-million teachers who not only wasn't a sadist, but actually seemed to kinda 'get' the kids. He'd play us Bob Dylan in his English classes, let us use his record player during breaks, brought in Pink Floyd's *Echoes* to play us the week it was released, and took a minibus full of sixth-formers to see The Strawbs play in Swindon.

This was the 1970s and, as I say, teachers like Mr Frampton were one-in-a-million. But, as luck would have it, the pupils of Aylesbury Grammar School had another. His name was Robin Pike and he was a big music fan, taking coach loads to kids up to London to see the likes of Jimi Hendrix and Eric Clapton before hitting on the insane idea of trying to cut out all the travelling by bringing the acts to the kids.

## THE CHALLENGE...

It might give you some inkling of just how insane an idea this was if you take on board the fact that Aylesbury is a pretty small market town in Buckinghamshire whose main claims to fame were the fact that it was built on the site of an Iron Age fort, was the reputed burial place of Saint Osyth, played host upon occasion to William The Conqueror and was not far from where the Great Train Robbers held up the train in the 1960s.

In other words, it had nothing much going for it, music-wise. Mr Pike was not to be discouraged. Hiring an

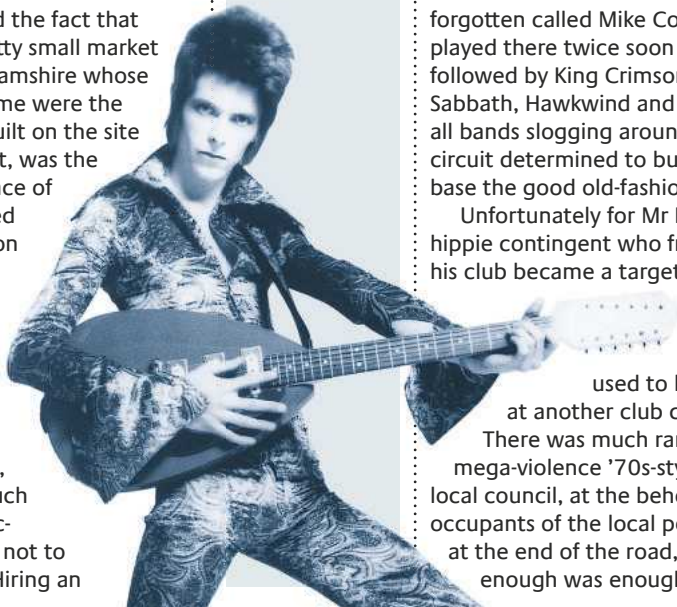

➔ In late 2008

it was announced that Friars would host shows at the town's Waterside Theatre, which it does to this day

➔ Civic Centre

(inset), where the club was based between '75 and '84

↓ David Bowie

came as Ziggy in 1971, then later played keyboards on stage with Iggy Pop in 1977



inconspicuous ex-Services Club called the New Friarage Hall on Walton Street, he got together with a like-minded local called David Stopps and set about running a weekly club for which membership cards were produced by one of his pupils, Kris Needs, who went on to edit the great fanzine *Zig Zag* and DJ around the world.

The club opened on the 2nd of June 1969 with an act now largely forgotten called Mike Cooper. Free played there twice soon after, followed by King Crimson, Black Sabbath, Hawkwind and Genesis – all bands slogging around the UK gig circuit determined to build a fan-base the good old-fashioned way.

Unfortunately for Mr Pike, the hippie contingent who frequented his club became a target for the local skinheads who used to hang out at another club close by. There was much random mega-violence '70s-style and the local council, at the behest of the occupants of the local police houses at the end of the road, decided enough was enough. The club



was closed down on the 6th of July 1970, the council citing, 'damage and disruption'.

Not to be beaten, Friars upped sticks and moved into town to the bigger and more prominent Borough Assembly Hall situated on the Market Square, opening its doors on the 17th of April 1971.

## RIP-ROARING

The headliners were those underground psych-blues legends The Groundhogs, supported by a local loony called John Otway who I had the pleasure of seeing perform many times with his equally nutty oppo, Wild Willy Barrett, both of whom will appear later in our story.

Anyway, till year end, Friars managed to attract the likes of the pre-Stevie Nicks and Lyndsey Buckingham Fleetwood Mac, Lindisfarne, Van Der Graaf Generator, Genesis (the venue became



GEOFFREY TYRELL

virtually their second home!), Mott The Hoople and, on the 25th of September, David Bowie, who rocked up with Mick Ronson and the core of the band that would soon become The Spiders From Mars.

Admission on the night was 50p, Bowie slowly turning from also-ran folkie into all-conquering Ziggy before the crowd's very eyes and ears. He closed his set with a rip-roaring cover of the Velvet Underground's 'Waiting For The Man', which was a neat touch, as the Velvet Underground themselves, by then sadly shorn of Lou Reed, appeared at Friars a few weeks later on a rare trip over from the States.

### SEEING RED

Bowie was back, even more Ziggy-ed up, in January '72. His hair was now cut spikey and dyed red, he sported a cod-piece and stomped about in some fetching new red plastic boots. Glam was being born and Friars was the midwife. By the time he returned in July, Ziggy-mania was in full flow and his record company, RCA, in a bid to spread the epidemic, flew lots of important US journalists over to witness Aylesbury's full-on adoration.

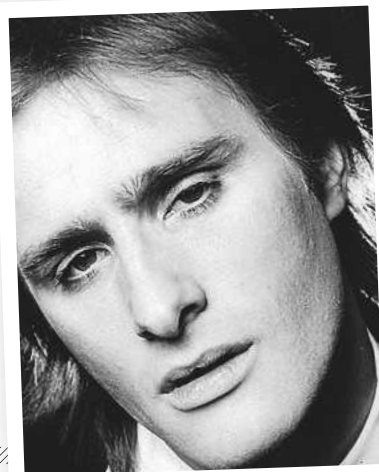

← Wilko Johnson on stage with Dr Feelgood at Friars in '75

→ Genesis made one of their earliest appearances at the venue in October 1970, when it was still located on Walton Street

→ Mott The Hoople's Ian Hunter. In June 2009 the band accepted the Friars Heroes Award

→ Just one of the club's striking gig posters, this time for a Lou Reed show in 1972

← Steve Harley of 'literate glampop outfit' Cockney Rebel

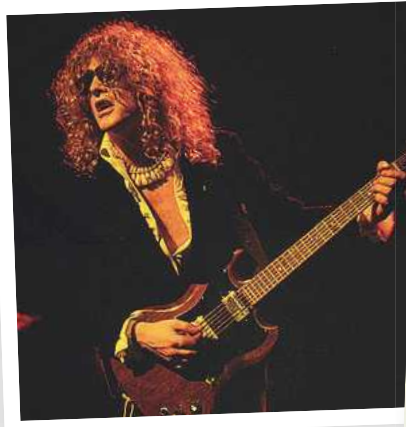

The Zig wasn't the only one to cotton on that the Friars mob was as knowledgeable and appreciative as any London audience without all the in-crowd bulls\*\*t. The infamous White Panthers, The MC5, made sure Aylesbury was on their agenda when they made a brief UK foray, as did Lou Reed who was peddling his early solo stuff at the time with a backing band called The Tots.

Genesis played Friars twice more in '72, Peter Gabriel morphing from shrinking violet under the spotlights into the be-costumed raconteur the world soon learned to love. And another notable new band, speeding into the headlines on Bowie's peacock coat-tails, weirded-out the Aylesbury crowd that summer: Roxy Music, complete with Eno on synthesised gadgets and such.

The next three years were equally ace. The Friars booking team weren't sitting on their laurels and

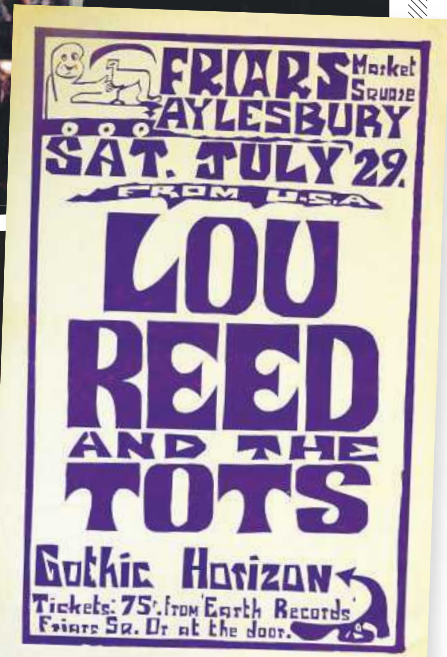

alongside hosting shows by German geek legends Can, they welcomed Queen to town for one of their first big gigs and also Steve Harley's Cockney Rebel, a literate glampop outfit who played Friars a lot on their way to *Top Of The Pops*.

All good things must come to an end, though, and just as the

musical climate was changing in the UK with the arrival of punk, so Friars also got its marching orders, this time because the council decided their

venue would best be knocked down so they could build some shops.

### CONFUSING TIMES

Once again, Friars bounced back, moving immediately to the Maxwell Hall in the Civic Centre, still just off the Market Square, where the venue straddled the changing of the guard and embraced the confusing times by happily accommodating such ↻

'Glam rock was being born and Aylesbury Friars was the midwife'

# CLASSIC VENUES

BEHIND THE MUSIC WITH HI-FI NEWS & RECORD



GEOFFREY TYRELL

hippie legends as West Coast space cadet Captain Beefheart & His Magic Band and the also late, great English bon-viveur Kevin Ayers, alongside pub rock sensations Dr Feelgood, featuring the heroic Wilco Johnson on guitar, and moody new(ish) punks, The Stranglers.

There were many great performances under the new Friars roof between the summer of '75 and the winter of '77, including early assaults by Lemmy's Motörhead, Tom Petty & The Heartbreakers on their breakthrough UK sojourn, and the awesome 1977 Stiff Tour featuring Ian Dury, Elvis Costello, Nick Lowe (with his band Last Chicken In The Shop) and Wreckless Eric.

## THE IDIOT ARRIVES

The shows still most talked about, though, are Blondie headlining over XTC in November of '77, The Jam doing two shows a fortnight later, including Friars' one and only ever matinee, The Ramones rampaging through their set, the first time supported by Talking Heads, the second by The Rezillos, and quite conceivably the cream of the crop, Iggy Pop turning up on the 1st of March '77 to play songs from his new LP, *The Idiot*, its producer, one Mr David Bowie, playing keyboards.

Heading into '78, the Friars crowd had taken punk fully to heart

**'Twenty thousand people turned up and the show was all over the telly'**

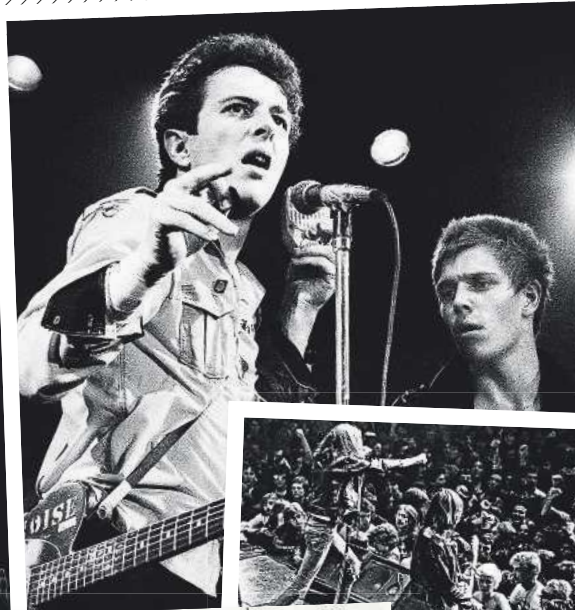

MARK JORDAN



GEOFFREY TYRELL

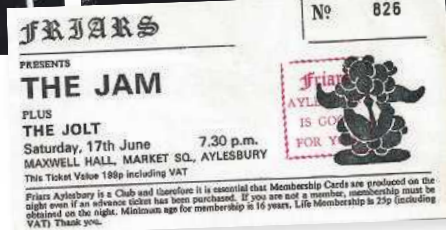

and the club became one of the stalwart venues for a lot of new bands under fire and banned by local councils. In rapid sequence Friars provided safe haven for The Adverts, The Modern Lovers, Buzzcocks, Siouxsie & The Banshees, The Slits, Sham 69, Stiff Little Fingers and The Clash – a run of gigs pretty much unmatched by any other venue in the world. Amazingly, squeezed in amongst all this activity, Friars managed to organise a free open air show in the Market Square featuring those crazy local ne'er-do-wells we mentioned earlier, John Otway and Wild Willy Barrett. Twenty thousand people turned up for the show and it was all over the telly.

Again going with the flow, Friars found itself welcoming the new long raincoat brigade in the guise of early gigs by Wire, The Cure and Gang Of Four. Madness and The Specials brought 2-Tone and ska to town, and this new peroxide pop outfit The Police showed up, incongruously enough with mighty voodoo rockabillicies The Cramps as support.

There was electro in the shape of Gary Numan, Human League and another local lad making good,

Howard Jones. Goth got a look in thanks to shows by Sisters Of Mercy, Bauhaus, The Cult and The Birthday Party, and Marillion, another band with local roots who'd spent their youth in the Friars' audience.

## WATERSIDE MUSIC

In fact, it was Marillion who played the last ever Friars gig at the Maxwell Hall on the 22nd of December 1984. The club owners then pulled the plug, citing an inability to cope with the complex economics of being a venue too big for bands just starting up and too small for the stadium rockers.

Since then the name has resurfaced at another Aylesbury venue – the Waterside Theatre – while an exhibition celebrating the club's past is being held at the Buckinghamshire County Museum in Church Street [[www.aylesburyfriars.co.uk](http://www.aylesburyfriars.co.uk)]. There are many who hope, in true Friars spirit, that the good times are, again, just a riff away. ☺

← Scenes from the punk era at 'The Local Music Club That Rocked The World' (clockwise l-r): Debbie Harry on stage at Friars in 1977; The Clash in 1978; poster for The Ramones in 1977 and a live shot from the gig; ticket for a Jam show in '78

↓ Local heroes Marillion, who played the last show at Maxwell Hall







# Stillpoints™

*A necessity — not an accessory.*

"Fully loading a system with Stillpoints technology - the ESS racks, Ultra SS under the power amplifiers, and, especially, Ultra 5s under the loudspeakers - transformed my system far beyond anything I could have imagined. Whatever the music the change was always the same - hearing more music, more realistically presented, and with vastly deeper involvement. There's simply no going back."

Robert Harley, The Absolute Sound - September 2012

"If you are thinking that these are just audio accessories to stick under your CD player then you are really going to have to think again. Even a brief exposure to them will leave you in no doubt that the importance of equipment supports has been seriously undervalued for years."

Chris Thomas, Hifi+ - Issue 99



To try Stillpoints for yourself, please contact your local stockist.

|   |  |   |  |  |  |  |
|---|--|---|--|--|--|--|
| <b>Analogue Seduction</b><br>Peterborough<br>01733 350878 | <b>Audio Destination</b><br>Tiverton<br>01884 243584 | <b>Choice Hifi</b><br>Richmond<br>0208 392 1959 | <b>Lintone Audio</b><br>Newcastle<br>0191 477 4167 | <b>Martins Hifi</b><br>Norwich<br>01603 627010 | <b>Rayleigh Hifi</b><br>Rayleigh<br>01268 779762 | <b>Studio AV</b><br>Eton<br>01753 863300 |
|---|--|---|--|--|--|--|



Distributed by  
**KOG AUDIO**

[www.kogaudio.com](http://www.kogaudio.com)

[info@kogaudio.com](mailto:info@kogaudio.com)

024 7722 0650

# hi-finews SUBSCRIPTION ORDER FORM

## DIRECT DEBIT SUBSCRIPTIONS UK ONLY

Yes, I would like to subscribe to **Hi-Fi News**

- Print + Digital:** £11.87 every 3 months  
(**SAVE 34%** on shop price + **SAVE 75%** on Digital Download + **FREE GIFT**)
- Print:** £9.79 every 3 months (**SAVE 34%** on shop price + **FREE GIFT**)

## YOUR DETAILS *MUST BE COMPLETED*

Mr/Mrs/Miss/Ms..... Initial..... Surname.....  
 Address .....  
 Postcode ..... Country .....  
 Tel ..... Mobile.....  
 Email ..... D.O.B.....

## I WOULD LIKE TO SEND A GIFT TO:

Mr/Mrs/Miss/Ms..... Initial..... Surname.....  
 Address .....  
 Postcode ..... Country .....

## INSTRUCTIONS TO YOUR BANK/BUILDING SOCIETY

Originator's reference 422562 

Name of bank.....  
 Address of bank.....  
 Postcode .....

Account holder.....  
 Signature..... Date .....

Sort code    Account number

**Instructions to your bank or building society:** Please pay MyTimeMedia Ltd. Direct Debits from the account detailed in this instruction subject to the safeguards assured by the Direct Debit Guarantee. I understand that this instruction may remain with MyTimeMedia Ltd and if so, details will be passed electronically to my bank/building society.

Reference Number (official use only)

**Please note that banks and building societies may not accept Direct Debit instructions from some types of account.**

## CARD PAYMENTS & OVERSEAS

Yes, I would like to subscribe to **Hi-Fi News**, for 1 year (13 issues) with a one-off payment

### UK ONLY:

- Print + Digital:** £49.79 (SAVE 29% on shop price + SAVE 75% on Digital download + FREE GIFT)
- Print:** £41.49 (SAVE 29% on shop price + FREE GIFT)

### EUROPE & ROW:

- EU Print + Digital:** £69.56
- EU Print:** £61.26
- ROW Print + Digital:** £73.30
- ROW Print:** £65.00

## PAYMENT DETAILS

Postal Order/Cheque  Visa/MasterCard  Maestro  
 Please make cheques payable to MyTimeMedia Ltd and write code V604 on the back

Cardholder's name.....  
 Card no: ..... (Maestro)  
 Valid from..... Expiry date..... Maestro issue no.....  
 Signature..... Date.....

Offer ends 23rd May 2014. MyTimeMedia Ltd & Hi-Fi News may contact you with information about our other products and services. If you DO NOT wish to be contacted by MyTimeMedia Ltd & Hi-Fi News please tick here:  Email  Post  Phone. If you DO NOT wish to be contacted by carefully chosen 3rd parties, please tick here:  Post  Phone. If you wish to be contacted by email by carefully chosen 3rd parties, please tick here:  Email

**POST THIS FORM TO: HI-FI NEWS SUBSCRIPTIONS, TOWER HOUSE, SOVEREIGN PARK, MARKET HARBOUROUGH, LEICS LE16 9EF.**



## PRINT + DIGITAL SUBSCRIPTION

**Free book** – KEF 50 Years of Innovation in Sound

13 Issues *delivered to your door*

Save up to **34% off the shop price**

**Download** each new issue to your device

A **75% discount** on your Digital subscription

Access your subscription on **multiple devices**

Access to the **Online Archive** dating back to January 2008

**Exclusive discount** on all orders at [myhobbystore.co.uk](http://myhobbystore.co.uk)



## PRINT SUBSCRIPTION

**Free book** – KEF 50 Years of Innovation in Sound

13 Issues *delivered to your door*

Save up to **34% off the shop price**

**Exclusive discount** on all orders at [myhobbystore.co.uk](http://myhobbystore.co.uk)

# SUBSCRIBE TODAY

DIGITAL  
SUBSCRIPTIONS  
AVAILABLE ONLINE!

# Receive a free *KEF 50 Years... book* when you subscribe today\*

**WORTH £50!**

*"The most authoritative reference work an audio enthusiast could desire"*



Co-authored by former KEF engineer Dr Andrew Watson and *Hi-Fi News* contributor Ken Kessler, this book is the definitive study of KEF's first half century. The book covers the period from KEF's founding in 1961 to the release of the Blade, in a story told by over 30 former employees. A large-format hard bound book, *KEF 50 Years of Innovation in Sound* is copiously illustrated with never-before-seen

photographs and stunning, newly-captured images of classic models. Comprehensive listings of every product produced by KEF, including every drive unit, make this the most authoritative reference work an audio enthusiast could desire!

TERMS & CONDITIONS: Offer ends 23rd May 2014. \*Gift for UK subscribers only, while stocks last. \*\*When you subscribe by Direct Debit. Please see [www.hifinews.co.uk/terms](http://www.hifinews.co.uk/terms) for full terms & conditions.

**SUBSCRIBE SECURELY ONLINE**  
 [www.subscription.co.uk/hifin/v604](http://www.subscription.co.uk/hifin/v604)

**CALL OUR ORDER LINE**  **0844 543 8200**  
Quote ref: V604  
Lines open weekdays 8am - 9.30pm & Saturday 8am - 4pm

BT landline calls to 0844 numbers will cost no more than 5p per minute. Calls from mobiles usually cost more.

# How well does this system measure up?



Gram Amp 2 SE phono preamp (top): *Hi-Fi Choice* recommended plus 8 other recommendations

NEW Majestic DAC/preamp (middle): top score in 4 out of 4 user reviews

Pair of Proprius monoblock power amps (bottom): *Hi-Fi Stars* (Germany) – the reviewer bought them!

Just add turntable, digital sources, interconnects, speaker cables and loudspeakers for a jaw dropping musical treat

For more information on these and our great range of Hi-Fi products including interconnects and speaker cables please visit...

[www.gspaudio.co.uk](http://www.gspaudio.co.uk)



Graham Slee Projects Limited,  
6 Buttercross Drive, Little Houghton,  
Barnsley, S72 0HS  
Tel: 01909-568739

**Superior Performance Hi-Fi Products**



MOBILE FIDELITY SOUND LAB

# RASPBERRIES' BEST

## FEATURING ERIC CARMEN

**CREAM OF THE CROP**

The Raspberries were a band of five young men from the San Francisco Bay Area who were discovered by a record producer in 1966. They were a white, middle-class band who were discovered by a record producer in 1966. They were a white, middle-class band who were discovered by a record producer in 1966.

**HOW IT BEGAN**

The Raspberries were one of the few groups to emerge from the San Francisco Bay Area who were discovered by a record producer in 1966. They were a white, middle-class band who were discovered by a record producer in 1966.

hi-fines NEWS ALBUM CHOICE

### RASPBERRIES

Raspberries Best

Mobile Fidelity MORF 1-032

Like Badfinger, Raspberries suffered from being too Beatles-like. The shame is that both were not mere pastiche acts that sounded like The Beatles in disguise. Raspberries were a US band not unlike those in the fictional study of the era – *That Thing You Do!* – which illustrated how a generation of young musicians were inspired by the Fab Four. But Mersey Worship wasn't Raspberries' main problem: they were performing pop when 'the hip' were into self-indulgence. In a short lifespan of 1970-1975, they managed to deliver 'Go All the Way', 'Tonight', 'Overnight Sensation (Hit Record)' and a few other mini-peaks that charted stateside. This is gorgeous material, the roots of 'power pop'. **KK**

Sound Quality: 89%

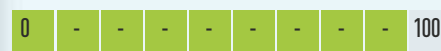

INTROSPECTION

THE END

PRODUCED BY BILL WYMAN

DECCA

### THE END

Introspection

Decca 375 068-3 (180g vinyl)

There's never a shortage of rare 1960s psychedelic LPs, most deservedly forgotten, only listenable when stoned. This rarity from '69, though, has added collectability because of its Rolling Stones connection: Bill Wyman co-produced it while they were recording *Satanic Majesties*. As a result, it boasts guests like Charlie Watts and keyboard legend Nicky Hopkins, plus studio handiwork from Jimmy Miller and Glyn Johns. Yes, it's dated. But, no, it didn't deserve to sit in the can for 18 months, when fashions changed every night. Whimsical rather than heavy, Tolkienesque rather than Crowleyesque, polished rather than a mess, this merits its eBay frenzy. **KK**

Sound Quality: 86%



STEPHEN DALE PETIT

CRACKING THE CODE

### STEPHEN DALE PETIT

Cracking The Code

333 Records 295333LP

What would have been simply an excellent modern blues LP bears a dose of poignancy that will perhaps call attention to it in a way that it might not otherwise have enjoyed: this contains the last recordings made by the legendary Hubert Sumlin, Howlin' Wolf's guitarist. Even so, had that not overshadowed the release, the other guests would have been enough to let you know that this is gonna be a fiery, kick-ass session: Petit is respected enough to attract Dr John, ex-Stone Mick Taylor and Chris Barber. Rocking blues in the idiom that embraces everyone from Johnny Winter to the Fabulous Thunderbirds, it proves the genre's not just alive, but vibrant, too. **KK**

Sound Quality: 88%



genesis

wendy & bonnie

genesis

### WENDY & BONNIE

Genesis

Sundazed LP5258 (180g vinyl)

Stickered 'Wildly Inventive Psych-Folk', Wendy and Bonnie Flowers' only LP is billed as 'one of the most remarkable unheard albums of 1969', and a 45-year backward-looking vantage point makes it all the more so. It seems to be part of a lineage that might also include Wilson Phillips in the 1990s and Haim in the current decade. This is pure, undiluted West Coast 'sister-folk', the kind where sibling harmonies (as with the Everlys) are unrelentingly genetic. *Genesis*, being the sole release by these San Francisco-based sisters, has acquired legendary status, and the light-as-a-feather material transcends any generic labels. Gorgeous, eerie... and timeless. **KK**

Sound Quality: 89%





COMPACT DISC



SUPERAUDIO



DVD



BLU-RAY



VINYL



DOWNLOAD



### DEAN MARTIN

#### This Time I'm Swingin'!

Mobile Fidelity UDSACD2135 (SACD)

OK, so I'm an oddball who rates Dino above Frank, and tied with Nat 'King' Cole. But savour just one play of this stunner from 1960 that found him working with conductor/arranger Nelson Riddle – a match made in heaven – and you'll find it hard to disagree. Dino always made it sound easy, which may be why some critics balk at recognising his superior delivery over his Rat Pack buddy's forced approach. Just listen to two usually-mannered songs from *My Fair Lady* – 'On the Street Where You Live' and 'I've Grown Accustomed to Her Face' – and how he makes them swing. Filled with standards delivered with aplomb, with sound you can't fault. Also on vinyl. *KK*

Sound Quality: 90%



### ELEANOR McEVOY

#### Stuff

MoscoDisc MOSCD4111

Following surprisingly quickly after *If You Leave* [MoscoDisc MOSCD4010], this is, like the title suggests, a catch-all of tracks described as 'the "stuff" the fans wanted but couldn't find'. Although it contains, as McEvoy explains, 'single mixes, audiophile tracks and songs I'd written and performed on other artists' records', nothing suggests a lack of cohesion. If you didn't know it was a 'miscellany', you'd be none the wiser after listening to the chilling and dark beauty of her reworking of Chuck Berry's 'Memphis', followed by the Gallic lilt of 'Milord'. McEvoy always exhibits a wilful eclecticism, which is why she can't be shoe-horned into a genre. Damn, I love this. *KK*

Sound Quality: 88%



### OTIS REDDING

#### The King Of Soul

Atlantic/Rhino 8122796068 (four discs, part mono)

Not the first Otis box set and unlikely to be the last, this deserves your attention because: 1) its 92 tracks span his career; 2) it features enough rarities to attract all but slavering devotees; and 3) the remastering is excellent. Make no mistake, Redding has a legitimate claim to the set's title, the other contenders being Messrs Brown, Gaye, Pickett, *et al*, but this is as fine an argument as any. Let's not downplay its worth for seasoned Redding fans, though: this includes non-LP tracks, live cuts and even his Christmas tunes. Mainly mono, that won't matter because the performances transcend, well, everyone else's. Almost forgot: it's budget-priced! *KK*

Sound Quality: 89%



### STEPPENWOLF

#### Steppenwolf

Analogue Productions CAPP 50029 SA (SACD)

Although familiar to anyone who was sentient in the '60s, or who has a retro fetish that includes repeated viewings of *Easy Rider*, this masterful reissue reveals just how good Steppenwolf's 1968 debut sounds. Audiophiles are aware that Dunhill Records – home of The Mamas and Papas – could deliver sonic masterpieces, but who knew that this early example of 'hard' rock was so well-treated in the studio? I have never heard 'Born To Be Wild' sounding so visceral, the biggest shockers being the sense of space during the drum break at 2m 07s and the fluidity of the bass. The guitar opener on 'Your Wall's Too High' is also a revelation. It's on vinyl too, if you find digitising this gem to be sacrilegious. *KK*

Sound Quality: 91%



hi-finews  
ALBUM  
CHOICE

# All About the Music

**BASICALLY  
SOUND**

Digital & Analogue Audio Specialists

**01362 820800**

enquiries@basicallysound.co.uk

www.basicallysound.co.uk

## Analogue seduction *where music is our passion*



Analogue Seduction are dedicated towards two channel Hi-Fi, specialising in vinyl replay.

As well as our on-line shop we have dedicated demonstration retail facilities based in Peterborough, Cambridgeshire and we can offer our customers home demonstrations.

We stock the finest in amplification, analogue, digital replay and speakers. We also specialise in a cable termination and cable burn in service.

Please visit our website [www.analogueseduction.net](http://www.analogueseduction.net) to browse or purchase products that are not easily available elsewhere.

**New vinyl records now stocked**

**Tel: +44 (0)1733 344768**

## It took over 120 Years....



Coaxial Design  
Patented 1880



Twisted-Pair Design  
Patented 1892



DNA Helix Design  
Patented 2013  
by Wireworld

Most, if not all cables today, are based on Coaxial or Twisted pair designs. But regardless of materials and enhancements used, these designs are old technology and inherently limit performance.

Wireworld utilizes patented cutting edge technology to provide dramatic improvements in sound quality.



Platinum Eclipse 7  
interconnect

Oasis 7  
speaker cable

Aurora 7  
power cord

Platinum Starlight  
USB cable

### The Music Professional's choice

*"Your Series 7 cables have added immeasurably to the quality can achieve in mastering. They provided fantastic results in mastering the 'Beatles U.S. Albums' collection that will be released in 2014.*

Greg Calbi  
Senior Mastering Engineer,  
Sterling Sound Mastering, NYC, USA

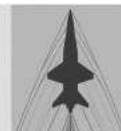

ADAIR  
ACOUSTIC

New  
Wireworld  
London Gallery

Visit the London Gallery at Adair Acoustic to experience the full range of Wireworld cables. Expert product advisors and elegant showroom is sure to make your visit a real pleasure.

Advice • Demo • Home trial

**Call today: 020 7253 2326**

[www.adairacoustic.co.uk](http://www.adairacoustic.co.uk)

2<sup>nd</sup> Floor, 64 Clerkenwell Rd  
London EC1M 5PX

**WIREWORLD®**

CABLE TECHNOLOGY

[www.wireworldcable.co.uk](http://www.wireworldcable.co.uk)





COMPACT DISC



SUPERAUDIO



DVD



BLU-RAY



VINYL

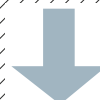

DOWNLOAD

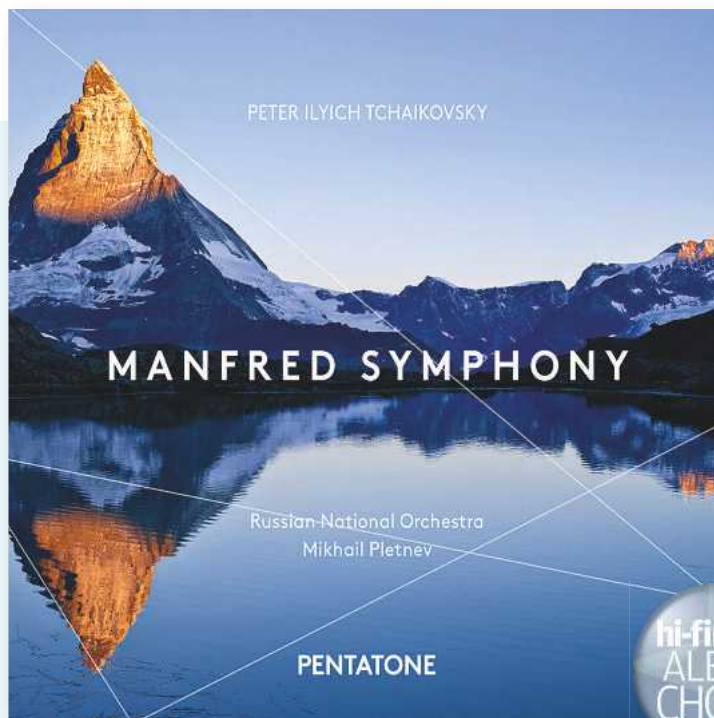

### TOBIAS BECKER BIGBAND Life Stream (96kHz/24-bit; FLAC)

[www.hiresaudio.com](http://www.hiresaudio.com); Neuklang NCD4068

Not to be confused with the German DJ who founded Top Dog Records, *this* Tobias Becker is a young musician who recently completed studies in classical and jazz piano at Stuttgart's University of Music and Performing Arts. Centred on his self-penned *Life Stream Suite*, a composition in four parts for 17-piece ensemble, the album is an impressive outing for Becker who has already garnered an impressive CV for his talent as a musical arranger. It's vibrant and exhilarating big band jazz, redolent of Count Basie at his swingin' best, albeit interspersed with a 21st century twist here and there. The album's excellent sound quality, recorded in Bauer Studios in Ludwigsburg, has captured the vivid colours and textures of the Bigband ensemble most authentically. It will challenge your system's dynamic capabilities when the brass blasts into overdrive, so expect a thrilling ride. *JB*

Sound Quality: 85%



### TCHAIKOVSKY

The Manfred Symphony; Russian National Orchestra/Mikhail Pletnev (96kHz/24-bit; FLAC)

[www.hiresaudio.com](http://www.hiresaudio.com); Pentatone PTC 5186387

Pletnev's first recording with the RNO, Tchaikovsky's *Pathétique* [Virgin Classics, 1991] created a sensation. He went on to record a complete symphony cycle for Deutsche Grammophon, which included a 1993 *Manfred*, and currently a Pentatone cycle is under way. What's interesting is to find this new recording – made in a Moscow studio last April – has consistently longer timings, Pletnev adding 5m+ to his previous reading. It's the proper score, rather than the

cut 'n paste various Russian conductors offer. But, as so often, harmonium in the finale is replaced by a fulsome organ – dubbed in here from a Berlin church. (Only Markevitch followed the letter of the score here.) Superb clarity is greatly helped by antiphonal violins and Mikhail Pletnev – none too quiet himself – gets very fine playing indeed from an orchestra that still, thanks to the winds, sounds very Russian. *CB*

Sound Quality: 90%



### OUR PROMISE

Following our Investigation feature [HFN, Jun '11] where we examined the claimed quality of high-resolution downloads, *Hi-Fi News & Record Review* is now measuring the true sample rate and bit-depth of the HD music downloads reviewed on these pages. These unique reviews will be a regular source of information for those seeking new and re-mastered recordings offered at high sample rates and with the promise of delivering the very best sound quality. (Note: asterisk in headings denotes technical reservation explained below.) PM

### LAB REPORT

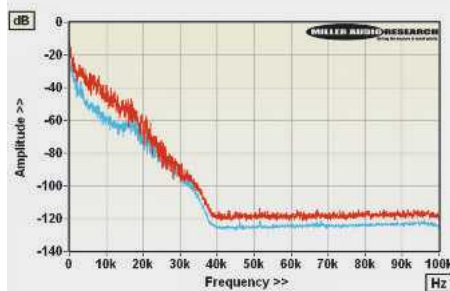

Though a 96kHz file, the audio content is filtered slightly prematurely at ~40kHz with an ultrasonic 'bump' reminiscent of downsampled SACD (observed here by the high level content ending track 1). Good dynamics in the audioband. PM

### LAB REPORT

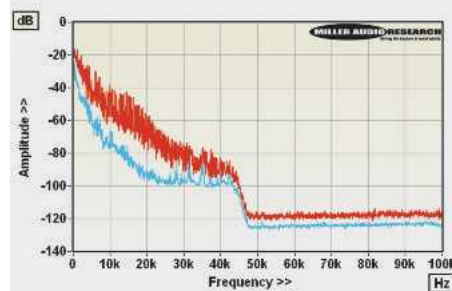

The raw blasts of trumpet fill the 40kHz+ bandwidth of this 96kHz recording with bursts of energy close to the 0dBfs endstops [peak, red trace] while the blue RMS spectrum shows some (inaudible) spuriae from 28-36kHz. PM





COMPACT DISC



SUPERAUDIO



DVD



BLU-RAY



VINYL



DOWNLOAD

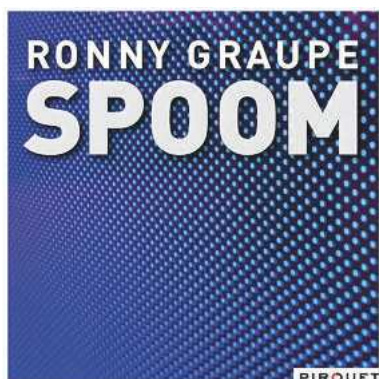

## RONNY GRAUPE

*Spoom* (88.2kHz/24-bit; FLAC)

[www.hiresaudio.com](http://www.hiresaudio.com); Pirouet PIT3072

Pirouet's studio complex in Munich is responsible for many fine audiophile recordings, this eclectic experimental jazz outing being no exception. The sound is intimate and beautifully balanced. Ronny Graupe's *Spoom* is in fact the name of a working jazz trio founded a decade ago, comprising composer Ronny Graupe on electric guitar, Jonas Westergaard on bass and Christian Lillinger on drums. Graupe plays a seven-string guitar and his compositions are – how should I put this? – er, 'difficult'. Full marks should be awarded to his accomplished accompanists for holding proceedings together and attempting to make some sense out of it all. You'll find little in the way of lyricism here, only the 5½m 'Es War Die Nachtigall' midway through the album offering some mild respite. I'll be filing *Spoom* under 'reserved for private consumption'. *JB*

Sound Quality: 80%



## STEFANO BATTAGLIA TRIO

*Songways* (88.2kHz/24-bit; FLAC/ALAC)

[www.hiresaudio.com](http://www.hiresaudio.com); ECM 2286

Born in Milan in 1965, classical and jazz pianist Stefano Battaglia has recorded an astonishing number of albums during his varied career – more than 60 at last count. *Songways*, released on CD last year, continues his association since 2005 with Manfred Eicher's ECM label, and his talented accompanists Salvatore Maiore on double-bass and Roberto Dani on drums. Battaglia describes *Songways* as 'a new harmonic balance between archaic modal pre-tonal chant and dances, pure tonal songs and hymns, and abstract texture'. It certainly weaves a spell, often hypnotically ambient while sometimes exquisitely lyrical, for example on the enchantingly melodic 'Mildendo Wide Song'. Fans of experimental modernism up for a challenge might also care to check out Battaglia's collaboration with Michele Rabbia entitled *Pastorale*, released by ECM in 2010. *JB*

Sound Quality: 80%



## BERLIOZ

*Les Nuits d'été*; *Roméo et Juliette* (excerpt); *La mort de Cléopâtre*; Karen Cargill, SCO/Robin Ticciati (192kHz/24-bit FLAC/ALAC)

[www.linnrecords.com](http://www.linnrecords.com); Linn Records CKD 421

The SCO's young conductor (31) is following in his mentor Sir Colin Davis's recording path with a Berlioz series for Linn. The testing 'Scène d'Amour' from *Roméo et Juliette* I hope doesn't preclude a complete version: the leaner orchestral sound here works well in suggesting the defiant youth of the lovers. But the real discovery is the Scottish mezzo Karen Cargill (2002 Ferrier Award winner and former Associate Artist with the Scottish Chamber Orchestra). Her French is good and she identifies vividly with the passions of the texts, colouring her vocal timbre accordingly; she brings real power to the climaxes of the *Death of Cleopatra* cantata. Her *Nuits d'été* can match either of the two key versions by Régine Crespin and Janet Baker. Texts/translations are given in the booklet PDF. *CB*

Sound Quality: 85%



### LAB REPORT

Recorded at Pirouet's sophisticated studio facility, this 88.2kHz rendering is still not as 'clean' as it might be – note the spurious tones at and around 30kHz. Dynamics are uncompressed, however, and the bandwidth is well-used. *PM*

### LAB REPORT

Much of the piano's output – occupying the bulk of the recording's dynamic range – is sub-5kHz, the brush-stroke percussion providing some 'fizz' up to 30kHz. There's some spurious around 20kHz but otherwise this is clean. *PM*

### LAB REPORT

Available in CD/SACD, 96kHz and 192kHz guises, the latter certainly has a noise floor stretching out to 80kHz and audio content good to ~40kHz. The peak [red trace] to RMS [blue] ratio reflects this recording's generous dynamic range. *PM*



COMPACT DISC



SUPERAUDIO



DVD



BLU-RAY



VINYL

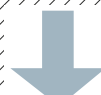

DOWNLOAD

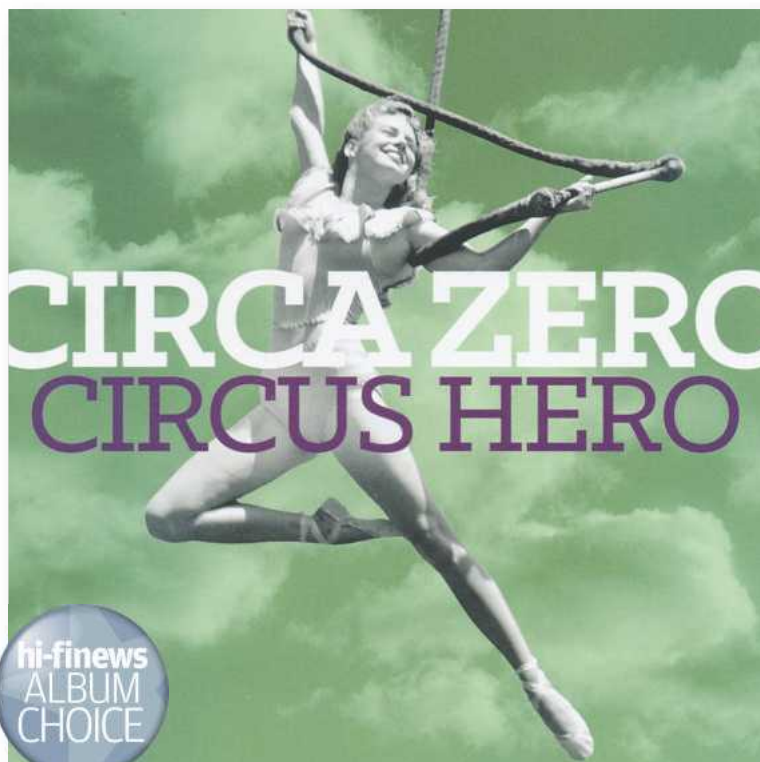

### CIRCA ZERO

Circus Hero

429 Records FTN17981

Whether or not Circa Zero sell millions of downloads, it's great to hear former Police guitarist Andy Summers back in harness alongside an imaginative young songwriter. With an immaculate pedigree stretching back to the British rock 'n' roll scene of the mid-'60s, Summers remains among the most distinctive axe gods working today, and young upstart Rob Giles, best known as part of The Rescues, composes instantly memorable and singable rock-pop tunes ideally suited for decoration by Summers trademark arpeggios and titanic, shimmering, splintered chords. Comparisons with The Police are inevitable, but ultimately these songs stand on their own feet and deserve to be heard by a new generation. *JBk*

Sound Quality: 94%



### EGGS LAID BY TIGERS

Under The Mile Off Moon

ILK Records ILK197CD

I'm so glad I didn't realise that this Danish trio's exotically eccentric album consists entirely of musical settings of texts by Dylan Thomas when I started listening to it. You see, I hate those kinds of projects, so not knowing allowed me to hear it simply as quirky folk-pop rather than as pretentious twaddle. Even now that I know, I still love it. 'The Hand That Signed The Paper' sounds like Steely Dan reinvented as a cheesy 1950s pop band, 'Song' is imbued with an exquisite yearning and 'Let It Be Known' is gleefully uplifting. That three Danes can bring the visions of a drink-sodden Welsh wordsmith so gloriously back to life is as heartening as it is unlikely. *JBk*

Sound Quality: 91%



### FAZE ACTION

Body Of One

Faze Action Records FAR022

On listening to the opening track, 'Prisoner Of Your Love', I was inclined to dismiss this as a sorry regression to the pseudo-funk thumbed-bass codswallop churned out in the '80s by Spandau Ballet, ABC and their ilk. Happily, when I skipped ahead I encountered a much more subtle blend of influences in which the acclaimed Faze Action duo's retro-disco obsessions are nicely melded into North African rhythms, ethnic instrumentation, Maze-like grooves and understated vocals. They could use some help on their lyrics, though. Clichés like 'Echoes Of Your Mind', 'Magic Touch' and, er, 'Freak For Your Love', don't merit even considering in the 21st century. *JBk*

Sound Quality: 90%

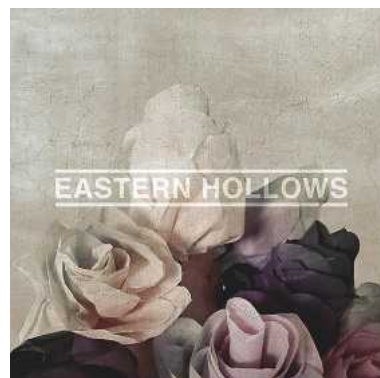

### EASTERN HOLLOWES

Eastern Hollows

Club AC30 AC3011041

Way back in the day, they called this kind of thing 'shoegaze', but the current term is, I believe, 'dreampop'. Whatever nomenclature you apply, this is a compelling slab of drifty, chimey and jangly guitars, half-whispered vocals, massive reverb and idiosyncratic drum patterns. The band hail from Brooklyn, but you'd swear they were English, having fallen through a timewarp from somewhere in the late '80s. The band's creative heart, Travis DeVries, sings like Ian Brown might if he could have actually more or less held a tune. It's hard not to let yourself fall into the deep dark swirling sonic well of 'Summer's Dead' but, be advised, you may never re-surface. *JBk*

Sound Quality: 85%





# Entreq

Energy transforming equipment



#### Entreq Dealers :

**Martins HiFi** ( Norfolk )

[www.martinshifi.co.uk](http://www.martinshifi.co.uk)

[sales@martinshifi.co.uk](mailto:sales@martinshifi.co.uk)

01603 627010

**Rayleigh HiFi** ( Essex )

[www.rayleighbifi.com](http://www.rayleighbifi.com)

[rayleigh@rayleighbifi.com](mailto:rayleigh@rayleighbifi.com)

01268 779762

**Studio AV** ( Berkshire )

[www.studioav.co.uk](http://www.studioav.co.uk)

[sales@studioav.co.uk](mailto:sales@studioav.co.uk)

01753 863300

**Lintone Audio** ( Tyne & Wear )

[www.lintone.co.uk](http://www.lintone.co.uk)

[sales@lintone.co.uk](mailto:sales@lintone.co.uk)

0191 477 4167

**Audio Destination** ( Devon )

[www.audiodeestination.co.uk](http://www.audiodeestination.co.uk)

[info@audiodeestination.co.uk](mailto:info@audiodeestination.co.uk)

P01884 243584

**Acoustic Arts** ( Hertfordshire )

[www.acousticarts.co.uk](http://www.acousticarts.co.uk)

[mail@acousticarts.co.uk](mailto:mail@acousticarts.co.uk)

01582 485316



Nature is the ultimate constructor !

At Entreq we follow the laws of nature and strive to create a balance with a solid foundation . It all starts with the grounding !



COMPACT DISC



SUPERAUDIO



DVD



BLU-RAY



VINYL



DOWNLOAD



### ALFREDO RODRIGUEZ

The Invasion Parade

Mack Avenue MAC1079

Discovered by Quincy Jones, the brilliant young Cuban pianist arrived in the USA in 2009 and made his first album appearance with *Sounds Of Space* in 2012. This time he's taken a look back to his homeland, the exuberant title track conjuring up the annual celebration of the liberating invasion that brought independence from Spain in 1898. Rodriguez's supple, energetic pianism is matched by a fine rhythm section and the saxes of Roman Filiu and Billy Carron, while Esperanza Spalding adds a joyously sparkling vocal on 'El Güije'. There's a sophisticated update of 'Guantanamera' and a movingly melancholic 'Perhaps, Perhaps, Perhaps'. A great album. *SH*

Sound Quality: 90%

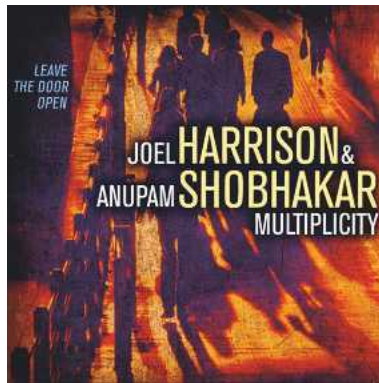

### JOEL HARRISON & ANUPAM SHOBHAKAR

Multiplicity

Whirlwind Recordings WR4648

American guitarist and North Indian sarod master began their collaboration in a work by Harrison for sarod, percussion and jazz quartet. In *Multiplicity*, they're joined by pianist/organist Gary Versace, bassist Hans Glawishnig and drummer Dan Weiss. They mix Indian classical, jazz and blues, the jazzier contributions including incisive piano from Versace and gutsy alto sax from guest artist David Binney. 'Spoonful' is the old blues theme, slide-guitar sounds blending with the bends of the sarod, while 'Deep River' dreamily relocates an old spiritual on some eastern hill. 'Genre-defying' music that actually works. *SH*

Sound Quality: 85%



### SCOTTISH NATIONAL JAZZ ORCHESTRA

American Adventure

Spartacus Records STS 018

Touring *The Spirit Of Duke Ellington* project across the USA and Canada last year, the SNJO spent two intense days at Avatar Studios, NY. Director Tommy Smith lined up a galaxy of American guests, including trumpeter Randy Brecker, vibraphonist Joe Locke, saxophonists Dave Liebman and Bill Evans, and half a dozen more. Guitarist Mike Stern kicks off with a hot workout on Marcus Miller's 'Splatch', then by contrast we hear Kurt Elling sing Mingus's 'Duke Ellington's Story Of Love', which he'd made his own with the Metropole Orkest before bringing it to the SNJO. With zest, precision and incredible musicianship, this big band can be breathtaking. *SH*

Sound Quality: 85%



### HELEN SUNG

Anthem For A New Day

Concord Jazz CIA-34496

Leading an impressive sextet that includes trumpeter Ingrid Jansen and tenor saxist Seamus Blake, the Texas-born pianist makes her Concord debut with a judicious mix of jazz standards and originals. There's a gritty 'Epistrophy' and a foot-tapping 'Armando's Rhumba' (a great guest spot for Paquito D'Rivera), and a fragmented, tongue-in-cheek 'It Don't Mean A Thing'. Sung's originals range from the frenetic 'Chaos Theory' to a deeply ruminative 'Hidden', with violinist Regina Carter. For Sung, who graduated as a classical pianist before switching to jazz, this *New Day* is about finally taking her place in the jazz world, wedding passion and swing to immaculate technique and musical intelligence. *SH*

Sound Quality: 90%



hi-finews  
ALBUM  
CHOICE

THEM FOR A NEW DAY

# IsoTek® Discover the IsoTek Effect

Mains electricity is distorted by numerous factors as it travels from power stations to our homes, eroding your systems performance. The **New Discovery Range** from IsoTek delivers highly effective yet eminently affordable solutions to enhance sound and picture quality, whilst also protecting your valuable equipment from power surges and voltage spikes.\*



“A distinct cleaning up of the sound...  
“A marked benefit for dynamic range, a consequence of lowering the noise floor, as well as a refinement and a general opening up of the soundstage”

IsoTek EV03 Premier, Hi-Fi Choice, March 2013



“More space, lower noise and greater resolution... An increase in timing precision, depth of bass and a much greater sense of musical flow”

IsoTek EV03 Polaris, Hi-Fi Choice, March 2013



## EV03 Premier

IsoTek's most affordable power cable has at its core three 2sqmm conductors made from 99.9999% OFC (oxygen-free copper) and coated in silver to aid conductivity, with a Teflon FEP dielectric extruded over each conductor. A cotton filler is used to give the cable internal strength and reduce microphony whilst maintaining dielectric performance. The cable is terminated with high-quality 24ct gold connectors, designed and manufactured by IsoTek rather than bought off the shelf. No similarly priced power cable is constructed to such a high specification, with correspondingly impressive benefits to sound and picture quality.

- 24ct gold connectors
- Silver plated OFC conductors
- Teflon FEP dielectric
- 16A current capability
- C15, C19 and C7 IEC options
- 1.5m standard length

## EV03 Polaris

Cost effective high-performance power distribution strip that cleans Common and Differential Mode noise from the mains as well as offering surge and spike protection.



Discover IsoTek

## For your free brochure:

IsoTek products are distributed by Sound Foundations.  
+44 (0)1276 501 392 info@soundfoundations.co.uk

www.isoteksystems.com | www.shop.isoteksystems.com  
www.facebook.com/isoteksystems

sound foundations  
www.soundfoundations.co.uk

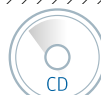

COMPACT DISC



SUPERAUDIO



DVD



BLU-RAY



VINYL



DOWNLOAD

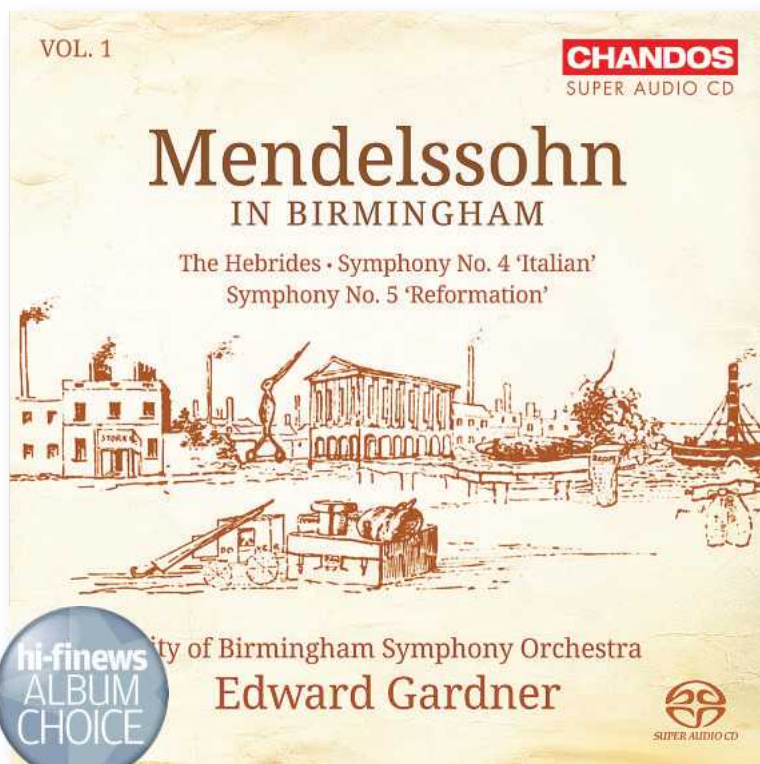

**MENDELSSOHN**

Hebrides Overture; Symphonies 4 and 5  
CBSO/Edward Gardner

Chandos CHSA 5132 (SACD hybrid); downloads up to 96kHz/24-bit

This first volume in Chandos's 'Mendelssohn in Birmingham' series suggests that Gardner's cycle of the symphonies will rank with those of Sawallisch and Abbado. Before the 'Reformation' and 'Italian' we hear a *Hebrides Overture* that's flexible in speeds but classically proportioned – never blowsy in the stormy sea episodes. Gardner drives the outer movements of the 'Italian' hard but the CBSO doesn't sound fazed. And I like the way everything is balanced: eg, lower strings articulating their parts such that the *Andante* has momentum; a wonderful section in No.5 where winds are joined by brass, leading to the Bach-inspired finale. A shame, though, that we don't have divided violins. *CB*

Sound Quality: 85%



**BEETHOVEN**

Diabelli Variations; Piano Sonata in C minor, Op.111; Six Bagatelles Op.126

Andrés Schiff

ECM 481 0446 (two discs)

Tickets to hear Andrés Schiff at Wigmore Hall last year were like gold dust. So if you missed his *Goldberg*/*Diabelli* marathon recital at least you can enjoy *two* versions of the Beethoven here, first on a 1921 Bechstein and then (with the *Bagatelles*) on Schiff's Brodmann fortepiano which has a not unattractive 'buzzy' lower register. This is the more enjoyable option, I feel. Schiff sounds rather as though savouring the music for his own pleasure, while ECM's crystal-clear Bonn recordings register every dynamic nuance – each note coloured with characteristic refinement. *CB*

Sound Quality: 80%

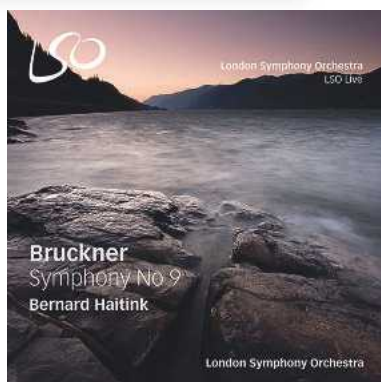

**BRUCKNER**

Symphony 9  
LSO/Bernard Haitink

LSO Live LSO 0746 (SACD hybrid); downloads up to 96kHz/24-bit

When he was a younger man, Haitink's Bruckner performances were shorter: his 1965 Concertgebouw Ninth times at 59m 24s, this one, taken from two 2013 Barbican concerts (when he was 84), spans 67m 10s. Not that you feel it's unduly slow: it's too engrossing for that. So much detail emerges from the composer's big canvas; at the same time the abrupt shifts in mood and pace make perfect sense – although the contrasting trio section sounds almost frolicsome in the context of Bruckner's pugnacious scherzo! The playing of the LSO is wholly admirable – a very fine Ninth, sobering in overall effect. *CB*

Sound Quality: 85%

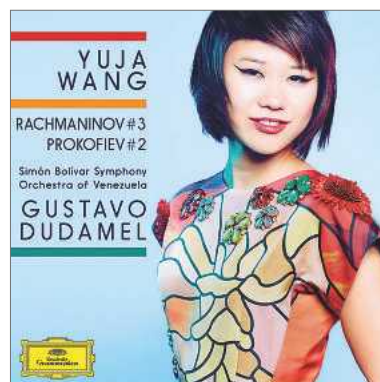

**RACHMANINOV/PROKOFIEV**

Piano Concerto 3/Piano Concerto 2  
Yuja Wang, Simon Bolivar Orchestra/Gustavo Dudamel

DG 479 1304; 96kHz/24-bit download at www.linnrecords.com

The Venezuelan orchestra's concerto debut, with two of the most demanding piano concertos in the repertoire given at a single concert in Feb '13. Hand in glove with Dudamel, Yuja Wang's Prokofiev 2 (an oddly misshapen work) has more colour, more depth than in Bavouzet's new studio recording. While often remarkably sensitive, the Rachmaninov doesn't quite come off to the same satisfying degree, although the soloist's nimble fingerwork is extraordinary and her playing in the finale is thrilling. It's a shame the Caracas concert-hall recordings become messy at climaxes (and this lowers the overall CD rating). *CB*

Sound Quality: 72%





Inspire Hi-Fi

# MONARCH TURNTABLE



# Quite Simply the Best.

CLINICAL IN ITS USE.  
PERFECT IN ITS  
EXECUTION.

"A startlingly musical performer with blistering speed and dynamics allied with smoothness, sophistication and purity of tone." *Hi Fi World*

Now part of the Hi Fi World Magazine - World Standards



**Verdict:**  
Startlingly musical performer with blistering speed and dynamics, yet smoothness, sophistication and purity of tone too. Superb.

**For:**  
• Superb transient speed  
• Excellent dynamics  
• Tonal purity  
• Overall musicality

**Against:**  
• nothing



**WINNER!**  
HI-FI NEWS  
Ultimate Hi Fi Finest  
Product Award 2012

**WINNER!**  
HI-FI WORLD  
AWARDS 2012  
Best Turntable



Home Demo's of the Award Winning Monarch now available. Contact us for details.

The Monarch turntable takes both 9 and 12 inch arms. Available with SME, Audio Origami, Origin Live and other tonearms. Pictured Monarch shows an SME 12 Inch tonearm.

**Superb Part Exchange Deals given against your current turntable.  
Call us for an instant quote...**

**Information & Sales Hotline  
01246 472222**

**www.inspirehifi.co.uk**

Units 2 & 3 / Prospect House / Colliery Close / Staveley / Chesterfield S43 3QE  
T: 01246 472222 M: 07932 367555 E: robert@inspirehifi.co.uk



*ex3ma*



## Super Limited Edition

NEW Sonus faber Extrema Loudspeaker at Guildford Audio



Guildford  
Audio

t.

01483 537 577

m.

07979 515 577

w.

[www.guildfordaudio.co.uk](http://www.guildfordaudio.co.uk)



## Audiodesksysteme vinyl cleaner



- Ultrasonic technology for the most efficient cleaning of LPs
- Contactless cleaning that removes more dirt from the vinyl grooves than conventional suction methods
- Ultra clean LPs give a more correct tonal balance, more detail, and less stylus wear
- Superb results with both older, cherished LPs and brand new audiophile pressings
- High quality German engineering – simple to use

Please visit our new website for further details and prices

The most effective easy-to-use record cleaning machine I have ever tried  
Michael Fremer Stereophile 2012

This machine does more than clean records  
Fred Kaplan Stereophile 2013

info@audioconsultants.co.uk

4 Zephyr House Calleva Park Aldermaston Berkshire RG7 8JN UK

AC/HFN/76

**“a discernible improvement in overall clarity... The PowerBar™ is an excellent quality product”**

Hi-Fi Choice, May 2014

The start of the Russ Andrews range of mains extensions, PowerBar™ features 4, 6 or 8 high-quality, positive-grip and individually wired sockets along with the option of SuperClamp™ surge protection - a “no-brainer” according to Hi-Fi Choice.

**And all from just £89!**

**To claim your PowerBar with FREE integrated SuperClamp**

go to the web address below, select your choice of PowerBar and tick the SuperClamp option. Then enter offer code HFNPOWERBAR at checkout. Or simply phone us on 01539 797300 quoting code HFNPOWERBAR. Offer ends 25th May '14.



✓ Enhanced with Super Burn-in Lite process



✓ Robust extruded aluminium casework

✓ Optional PowerMax Plus™ - our entry level, custom made mains cable

**SAVE 10%** on a PowerMax Plus™ mains cable when you buy both together

✓ 4, 6 or 8 high-performance UK sockets individually wired with high performance cable



**POWERBAR™ mains extension only**  
Code1168

|       |         |
|-------|---------|
| 4 way | £89.00  |
| 6 way | £114.00 |
| 8 way | £139.00 |

**POWERBAR™ with 1m PowerMax Plus™** Code1168

|       |         |
|-------|---------|
| 4 way | £135.75 |
| 6 way | £160.75 |
| 8 way | £185.75 |

Price includes 10% discount

Order now on **01539 797300** or visit  
**www.russandrews.com/powerbar**

Mail Order Direct • 60 Day Cable Home Trial • Cable Upgrade Scheme • Free Delivery (orders over £100 within UK Mainland)

**KIMBER KABLE**  
Exclusive UK distributor

*Russ Andrews*®



**Paul Miller**  
**Editor**

Technician and writer on all things audio for some 30 years, Paul Miller took over the editor's chair in 2006. He invented the QC Suite, used across the audio industry

# Play it again SAM

In a few years Devialet has grown from four engineers to a 60-strong company, second in size only to Focal in France. **Paul Miller** discusses the latest development from this hotbed of innovation

Visitors to the Devialet booth at this year's Munich High End Show in mid-May will get to meet SAM, the newest addition to this French company's portfolio. SAM, or 'Speaker Active Matching' is reckoned by Devialet to be the most significant innovation in its evolution of amplifier technology since ADH, the 'Analogue Digital Hybrid' core that powers every product in its range [see News, p6].

I've been living with SAM for the past couple of weeks, and rarely has a house guest, virtual or otherwise, made such an impact on the sound of my system.

## SAM SHAKES HANDS

SAM is a pre-programmed DSP model of a loudspeaker's low frequency behaviour that 'matches the air pressure received by the recording microphone with the output of the loudspeaker' says Pierre-Emmanuel Calmel, Devialet's co-founder. Eventually any choice of speaker may be downloaded to your Devialet amp (currently only the B&W 802D and a model from Vivid have been mapped).

But before we explore what SAM is it's important to state what it *isn't*. SAM is not invasive – the speaker, its crossover and drivers do not require modification. Neither is SAM a feedback-controlled correction, a room compensation regime or a form of 'bass boost'. Instead, correction is applied dynamically, sample-by-sample in the time domain according to all known performance attributes of the loudspeaker cabinet, crossover and drivers. The real-time model(s) currently operate between 10-150Hz, depending on the capabilities of the loudspeaker.

The position and acceleration of all the drivers is precisely modelled

and controlled according to the cabinet dimensions, volume, compliance of the air, mass of air in the vent and reflex losses. All linear and non-linear Theile & Small driver parameters are accommodated including resonance frequency, Q and force factor, moving mass, suspension compliance, diaphragm area, etc. The list goes on.

Devialet has even invested in a (laser) Scanning Vibrometer from Klippel to develop 3D maps of the speaker's low-frequency drivers. The support of the loudspeaker's manufacturer is not necessarily required, it seems...

Of course, by fully controlling the amplitude and phase response of the speaker's output, SAM promises to maximise the bass extension of any speaker without ever moving its drivers outside their safe excursion range. Similarly, the non-linear inductance of voice coils, eddy currents in the motor system, power dissipation and heating effect of the voice coils can also be precisely mapped. Thermal compression and other distortions, typically unavoidable or uncontrollable with conventional power amp/passive speaker combinations can now be, well, avoided.

## LISTENING WITH SAM

But enough of the theory. What does SAM sound like? In short, it's jaw-dropping. A re-run of Harald Kloser's theme tune from *The Day After Tomorrow* (44.1kHz/16-bit FLAC file) made me jump off the sofa. Without SAM, the dual-mono Devialet 500 and B&W 802D combination sounded fabulous – the breadth and depth of this atmospheric score filling the room with a peerless clarity. Or so I thought. Then I switched in the SAM algorithm for B&W's 802Ds.

From the first note, the first touch of bow on strings it was immediately obvious – not only to myself but also the other



**ABOVE:** Devialet's 'Speaker Active Matching' is switched in or out of the (digital) signal path

three listeners in the room – that the midrange and treble octaves possessed a greater clarity, transparency and sheer poise. But SAM only works up to 150Hz...

Evidently, by precisely anchoring the two bass units there's less harmonic distortion and other colour working up into the higher ranges. But I was still in my seat. Then the first murmur of timpani was revealed and like a freight train gliding on ice it slipped through the orchestra, its weight palpable, its momentum and gravitas undeniable.

For one distracted moment I thought I'd left my 1kW subwoofer connected and the roof was about to be raised. I jumped up only for the pressure wave to pass. Despite my rattled ribs, the 802Ds had not exploded, for this was the cleanest, deepest bass I'd ever heard extracted from a cabinet of this size. SAM had done its stuff, obliging these two 8in bass units to move precisely and safely to accurately reproduce the sound of this deepest and most resonant of instruments.

So is SAM the future of precision amp/speaker matching? For Devialet and its customers, certainly. But I don't expect the concept to migrate further afield anytime soon. ☺

'SAM is a game-changer in loudspeaker performance'

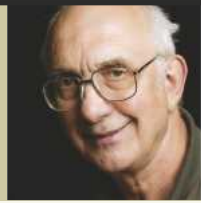

## Barry Fox Technology journalist

Barry Fox trained in electronics with the RAF and worked as a patent agent, but he gave that up to enter journalism. He is one of the world's top technology writers

# Convenience is king

Downloads are down while streaming is up, but what does this mean for sound quality? And as all new HP laptops come with Meridian's Sooloos, we mustn't forget the BBC. **Barry Fox** explains

**B**ob Stuart and his Meridian team have a nice take on compressed audio. 'When MP3 came along people didn't say "great it's worse",' they told me at the official opening of Meridian's first boutique store in London, on the Chelsea Kings Road. 'They said "great it's convenient". We've now got to do something to get people interested in quality again.'

So, on the face of things, it should be good news that the mass market for music downloads is now starting to slump. Unfortunately, this is because the mass market for streamed music is booming. Sites like Deezer, Spotify and 7Digital are letting more people listen online, in real time.

### I WANT IT NOW...

Streaming is convenient and appeals to the 'I want it and I want it now' generation that ignores the fact that audio quality is usually far worse than for downloads. They just don't seem to notice that music often sounds 'underwater' because high compression is needed to keep the data rate low, reduce the need for buffering for fast start time and avoid stuttering pauses.

Of course it's madness to rely on a live internet 'cloud' connection instead of music stored on cheap chips – as people with a BT broadband

connection discover when they exceed a 10GB per month data cap or get a mobile bill for thousands when they stream with a phone or tablet on a beach in Benidorm.

Mobile spectrum is a finite resource so it will always be more expensive to access than FM/DAB/DTTV broadcasts. How the British Broadcast Corporation can seriously consider a switch to

monocast/streaming BBC 3 defies all logic. It may be the cost of streaming, rather than the quality, that makes people re-discover storage. Stored music has to be easy to handle though. That means an appealing user interface.

Meridian has a history of buying in little-known technology and exploiting it. In 2008 it quietly bought the Sooloos high-end music server system, describing it at the time as a 'super deluxe version of iTunes with intelligent use of metadata'. This is now embedded in Meridian's player products. And now, after a deal with computer giant Hewlett Packard (HP), Sooloos is embedded in all new HP laptops and desktop PCs.

Not a lot of people know that. I certainly didn't, even though I recently bought a new HP computer. That's because Sooloos is buried under the clumsy name 'HP Connected Music, powered by Meridian', with no mention of Sooloos.

It's there alongside an audio control panel called Beats, said to offer 'Dr Dre's genius and Jimmy Lovine's vision'. Andre 'Dr Dre' Young is a rapper and hip-hop producer and Jimmy Lovine is Chairman of Interscope-Geffen-A&M Records. Their

system is needed, they say, because 'poor quality, bad music files and crappy equipment have stood in the way of you and the artist you love'.

But what exactly does Beats do?

I once wasted a considerable amount of time asking HP to explain, but got nowhere. Despite being the accidental owner of Beats in a new HP PC, all I can add is that the computer screen offers what look like ordinary but gaily coloured volume, balance and graphic EQ controls.

The Sooloos interface, disguised as HP Connected, is much more interesting. Just like iTunes it ferrets through the



**ABOVE:** Lord Tony Hall, Director General of the BBC, explains his decision to stream BBC 3

PC, cataloguing all the music it finds, downloading whatever sleeve artwork is available from the internet and intelligently displays potted biographies of the artists and composers.

### HANDS-ON TESTING

Meridian says there have already been 5.3 million HP Connected/Sooloos activations, with 400,000 regular users.

I'd ignored HP Connected as just another bit of silliness like Beats. It was only after the chance conversation with Bob Stuart that I did some trial and error hands-on testing. However good HP/Sooloos may be, and it does seem good, its HP manifestation is crippled by the lack of a clear simple overview of what the software offers, and how to get the best results.

For example, it allegedly plays FLAC but I am still trying to find out how to get it to find and play some Studio Master tracks of Claire Martin and Sir Richard Rodney Bennett that I downloaded from the Linn online store. And while I type this it's playing Fletcher Henderson's recording of 'King Porter Stomp' while displaying the artwork for 'Ain't She Sweet'. ☹

'How the BBC can consider a switch to monocast/streaming BBC 3 defies logic'



## Barry Willis

Journalist for top American audio-video publications

While his main interest is high-end audio, Barry Willis also writes about the culinary industry, visual art and theatre for a huge variety of US newspapers and magazines

# Vinyl playback on a budget

You don't have to spend a mint buying a turntable to breathe new life into your neglected vinyl. There are innumerable fine decks from the format's heyday to be had for a song, says **Barry Willis**

The resurgence of interest in vinyl records poses a problem for music fans curious about exploring the format – and for veterans whose interest peaked long ago, but whose libraries still include 'desert island' recordings that were never reissued in any other form.

The problem: how to get one's toes wet without taking a bath. There are many fine turntables available now at prices ranging from daunting to insane. Spending four figures on a record player is an impossible dream for a fresh-out-of-school and debt-burdened 20-something, and probably not a wise allocation of funds for a near-retirement 60-something who simply wants to revisit some favorite tunes.

### DIGGING DEEPER

Yet often overlooked in discussions about vinyl is the fact that during the format's final surge – the late 1970s and early '80s –

manufacturers produced quality turntables by the millions. Companies such as Denon, JVC, Kenwood, Pioneer, Onkyo, Mitsubishi, Sony, Philips, Thorens, and Dual

all made respectable players. Many are still in perfect working condition and are available at accessible prices for those willing to dig a little deeper than simply punching up an order on a website.

The two pictured here – a Dual 604 and a Technics SL-1600 – were both picked up at bargain-basement prices despite eBay listings of over \$200 each. The Dual – a rare direct-drive unit from the German brand that built its reputation over decades with bulletproof idler-driven machines – features a heavy platter with rock-solid speed control, and a low-resonance precision tonearm with



ABOVE: The author's bargain buys – a Dual 604 (left) and Technics SL-1600 after a little TLC

tracking force applied by a simple spring dial. It came fitted with an Audio-Technica AT-15SA moving-magnet cartridge with Shibata stylus, among Audio-Technica's best products at the time it was made.

Found at an estate sale, this player was a mere \$20. All it needed was dusting and a few adjustments. The basic design of the semi-automatic 604 is excellent but it's

marred by a hollow plastic base that's a potential source of resonance. A simple solution is to load the base with some modelling clay or other damping material – or, for those with material

skills, to build a new base from a slab of butcher's block. A few hours' careful work in a cabinet shop could turn this table into a competitor against some very good current products.

The fully manual Technics (with Pickering SXV 3000 cartridge) was found at a Los Angeles thrift store for \$40. In less than mint condition – there are some scratches and smudges on the dust cover – it too needed only some dusting and adjustments. A riff on the proven design of the legendary Technics SL-1200 DJ table, the 1600 looks very much like its more upscale siblings the SL-1700 and SL-1800,

which feature a heavier, semi-isolated sub-chassis and higher quality arm.

Of the two used tables, the Dual 604 is the better engineered; it spins up and locks to speed quicker and more reliably than the Technics. The 1600 on the other hand may not be an ultimate playback machine, but it's more than adequate for those wanting to spin some vinyl without denting their bank accounts.

### FLIMSY ARMS

When these machines were new there was great controversy about direct-drive versus belt-drive; audiophiles complained about 'cogging' from direct-drive units despite their unassailably better speed-fluctuation figures. Belt-drive designs were deemed more musical and became the de facto standard for high-performance audio, but today there exist excellent new direct-drive machines based on core technology from companies such as Technics and Luxman.

In the mid-'80s, with vinyl's decline and CD's ascension inevitable, many Asian manufacturers began to offer low-end belt-drive decks with cheap flimsy arms and lightweight platters that rang like xylophones. Avoid these, but don't shy away from direct-drive players because of half-baked theories. Such older, heavier machines are substantial contenders full of long-term performance. ☺

'In the late 1970s and early '80s, millions of quality turntables were produced'



## Jim Lesurf Science Journalist

Jim Lesurf has spent a lifetime in audio, both as an engineer at UK hi-fi company Armstrong and reader in Physics and Electronics at St Andrew's University

# Ghost in the machine

While testing the effects various computers and USB hubs have on the performance of USB devices **Jim Lesurf** is startled to discover that one of his PCs refuses to shut down. Why could this be?

People discuss many aspects of the performance of audio equipment. But one area that tends to be neglected is the importance of the power supply [see p103]. By this I mean the circuitry inside equipment that converts raw mains AC into smooth DC to power amplifiers and other components. Yet the reality is that the details of these power supply units (PSUs) is often critical when it comes to obtaining the best possible performance.

When I used to design audio equipment for a living, and instrumentation for precision measurements, the PSU design became something I regarded as an integral part of any device I was working on. The PSU had to be tailored to suit the task. And in some cases I found I could get superior results by using an approach that went against common assumptions.

### BRIEF PEAKS

For example, when designing high power audio power amplifiers it has been common for designers to assume that the best PSU for a solid-state design will be stabilised and regulated in order that the voltage across the output devices is held steady. This works nicely when you take measurements, playing test sine waves into resistive loads. But because real music tends to have brief peaks well above the average level, I found you achieved better performance by choosing to use an unregulated PSU. That way, the voltages available were high most of the time, allowing for larger musical peaks.

However, sustained sinewaves would cause the power rail voltages to fall, reducing the thermal burden on the rest of the amplifier. This meant a sacrifice

'I pulled out the connection to the mains and the machine remained on'



**ABOVE:** If a computer you use behaves unexpectedly, the cause could be an external device

in terms of the sinewave values published in reviews. It also meant that more care needed to be devoted to the amplifier design to prevent power voltage variations getting into the signal path. But it gave better performance for music.

Similarly, when designing preamps there was a tendency at one time to use solid-state regulator ICs to clamp the DC power rails to a fixed value. However, I decided that the ICs added problems. My solution was to choose discrete PSU designs that maintained the rail voltages smoothly with minimal noise or ability to pass on clicks and pops from the mains. The result was cleaner performance.

Recently I've been testing USB audio devices. Some of the devices are powered via their USB connection. So I compared the results when using various computers and external USB hubs, etc. It was no surprise, then, that these changed the results in measurable ways. However, when I shut down one computer and pressed its power-off switch, the screen display

didn't go blank. It continued to display the message telling me it was safe to switch off. And when I looked through a grille into the machine its internal indicator LEDs were still lit up! I pulled out its connection to the mains, and the machine still remained on. I'd taken for granted that PSUs would affect background noise, etc, but this looked like a ghost in the machine.

### BE WARNED

I then discovered that the computer only lost power when I unplugged an external USB hub I'd been trying. This had been taking power from its own mains PSU and feeding 5V back into the host computer. And it was supplying enough power to keep the computer on. I'd never encountered anything like this before. So be warned.

The behaviour of external USB items like hubs varies unpredictably from one model to another. Some may do quite odd – or even alarming – things. If a computer system you use behaves oddly or gives curiously unsatisfactory results, the cause may not be software related or due to the operating system. It may be a tail wagging the dog. ☹

# WELCOME TO THE NORTH EAST

ANATEK RESEARCH  
 APOLLO  
 ATACAMA  
 AV INTERNATIONAL  
 CHORD COMPANY  
 CHORD ELECTRONICS  
 CLEARAUDIO  
 DYNAVECTOR  
 EAR YOSHINO  
 GOLDRING  
 GRAHAM ENGINEERING  
 GRAHAM SLEE  
 G F HADCOCK  
 ISOTEK  
 KOETSU  
 KUDOS AUDIO  
 MARTIN LOGAN  
 LYRA  
 MAGNEPLANAR  
 MELODY  
 MICHELL ENGINEERING  
 MONITOR AUDIO



NAD  
 NAIM AUDIO  
 NORDOST  
 NOTTINGHAM ANALOGUE  
 OPERA  
 ORTOFON  
 PATHOS ACOUSTICS  
 PROJECT  
 PS AUDIO  
 PURESOUND  
 REGA  
 REVOLVER  
 ROKSAN  
 SME  
 STAX  
 SUGDEN AUDIO  
 TEAC ESOTERIC  
 TRANSGURATION  
 TRICHORD RESEARCH  
 UNISON RESEARCH  
 USHER AUDIO  
 VAN DEN HUL

**HIFISOUND, Castlegate mill, Quayside, Stockton on Tees. 01642 267012**

# 2NDHANDHIFI.CO.UK

Guaranteed used and ex-demo audio equipment from HiFiSound - the UK's premier source

Call: 0845 6019390 Email: [news@2ndhandhifi.co.uk](mailto:news@2ndhandhifi.co.uk)

## New items added to our website every day

|  |      |  |      |  |      |   |      |
|--|------|--|------|--|------|---|------|
| Roksan Radius 5, ex demo.....          | 799  | Audiolab 8200A, mint boxed ex demo.....                  | 499  | AMR 777 Amp and CD ex demo.....                  | Call | Focal XS Book Active Mini Monitors, ex demo mint..... | 199  |
| Rega RP40, ex display, mint boxed..... | 649  | Audiolab 8200Q and 8200P, Pre Power, mint ex demo.....   | 798  | NAIM NDX, ex dem, boxed complete, near mint..... | 2499 | Martin Logan Summit X, ex demo.....                   | Call |
| EAR 834P Deluxe ex demo.....           | 1299 | TEAC Distinction AI3000 & CD3000, ex dem, was £3500 1999 |      | NAIM HiCap DR, ex demo, near mint boxed.....     | 949  | Monitor Audio RX6, sealed box.....                    | 799  |
| Trichord Dino+ NC PSU, sealed box..... | 599  | NAIM NAC252, ex demo, mint boxed.....                    | 4499 | Chord Qute HD and QBD76HD ex demo.....           | Call | GRADO Headphones, most models, ex demo.....           | Call |

### Analogue

|   |      |
|---|------|
| Alphason HR100S, vgc.....                                 | 499  |
| Clearaudio Concept package, nr mint boxed.....            | 699  |
| Clearaudio Innovation Compact, good condition.....        | 1999 |
| Clearaudio Unify Tonearm excellent boxed.....             | 699  |
| Clearaudio Satisfy Tonearm excellent boxed.....           | 349  |
| Conrad Johnson TEA 1b Phono stage.....                    | 1999 |
| EAR 834 Signature mm/mc phono, ex boxed.....              | 599  |
| Garrard 401, Slate Audio plinth.....                      | 799  |
| Hadcock 242 Export, ex demo as new.....                   | 599  |
| Hadcock 242 Integra, ex demo as new.....                  | 799  |
| Kuzma Stabi Reference, excellent boxed.....               | 3249 |
| Linn Sondek, Lingo, Cirkus, Ittok, Dynavector DV20L.....  | 1799 |
| Linn Sondek, Cirkus, Valhalla, front mount motor.....     | 599  |
| Linn Sondek, Full Inspire LP12, Ittok, DV17/3, boxed..... | 1999 |
| Lyra Erodion Step up.....                                 | 1499 |
| Marantz PH22, vgc manual.....                             | 999  |
| Michell Gyrodec Export, Origin Live Silver, boxed.....    | 1199 |
| Michell QC Power supply, excellent.....                   | 299  |
| Michell ISO, vgc renowned phono stage.....                | 199  |
| Michell Focus One c/w Linn Basik.....                     | 379  |
| Michell Technoarm A in black as new mint boxed.....       | 449  |
| Michell Gyrodec Export DC, Technoarm and HR supply.....   | 1749 |
| Michell Orbe, DC motor superb!.....                       | 1749 |
| Musical Fidelity VLP5/2, excellent.....                   | 99   |
| Project Phonobox 2, ex boxed.....                         | 59   |
| Project RPM9 XP excellent.....                            | 499  |
| Rega RP1, excellent.....                                  | 149  |
| Rega TTPS2, excellent.....                                | 119  |
| Revolver, Linn Basik LVX.....                             | 119  |
| Roksan Xerxes, XPS2, Linn Fit.....                        | 349  |
| Rotel RP3000 Direct Drive TT with matching arm, vgc+..... | 249  |
| SME 3009, excellent boxed.....                            | 249  |
| SME 3012, excellent boxed.....                            | 249  |
| SME 3013, excellent.....                                  | 799  |
| Thorens TD124 c/w plinth.....                             | 599  |
| Thorens TD170, Fully Automatic, excellent.....            | 249  |
| Tom Evans Groove, 0.85mV/100 ohm, excellent.....          | 849  |
| Wilson Benesch Act 1 Tonearm, nr mint superb.....         | 799  |

### Amplifiers

|   |       |
|---|-------|
| Audiolab 8000A, vgc boxed.....                              | 199   |
| Audiolab 8000Q/Ms, silver, excellent boxed.....             | 899   |
| Audio Innovations Series 1000 Mk3 Monoblocks.....           | 1199  |
| Audio Analogue Bellini VB/Donizetti Cento, ex boxed.....    | 2249  |
| Audio Research LSB Preamplifier, excellent boxed.....       | 699   |
| Audio Research Ref 610 Monoblocks, vgc boxed.....           | 14299 |
| Audio Research Ref 210T Monoblocks, as new boxed.....       | 8999  |
| Audiolab 8000MX, excellent.....                             | 899   |
| Audiolab 8000C and P, excellent boxed.....                  | 399   |
| Ayre Acoustics AX7e Integrated amplifier, ex boxed.....     | 1149  |
| Chord Electronics Mezzo 50, excellent.....                  | 999   |
| Cyrus 80X, excellent boxed.....                             | 899   |
| Cyrus 8VS, excellent boxed.....                             | 299   |
| Cyrus SmartPower, excellent.....                            | 279   |
| Cyrus 3 Amplifier, excellent boxed.....                     | 199   |
| Cyrus PSXRs, excellent from.....                            | 229   |
| Emile Ara integrated, superb condition boxed.....           | 1449  |
| Esoteric A03, ex demo boxed.....                            | 3749  |
| Esoteric C03/A03 Pre Power, ex demo.....                    | 7749  |
| Exposure 6/7/8 Combo, vgc+.....                             | 499   |
| Krell KAV280P Preamplifier.....                             | 899   |
| Meridian 501V preamp, excellent.....                        | 299   |
| Micromega IA100, great integrated, ex demo boxed.....       | 599   |
| Monarchy 33 DAC/Pre, excellent boxed.....                   | 649   |
| Musical Fidelity F25 Preamplifier, excellent.....           | 349   |
| Musical Fidelity A1 integrated, rare near mint example..... | 249   |
| Musical Fidelity M3, excellent boxed.....                   | 699   |
| Musical Fidelity XA1 Integrated.....                        | 199   |
| Musical Fidelity M1PWR, excellent boxed.....                | 349   |
| NAIM NAIT XS/2 excellent boxed remote.....                  | 999   |
| NAIM NAP150, excellent boxed.....                           | 349   |
| NAIM NAP90, excellent.....                                  | 299   |
| NAIM NAIT 3, excellent boxed.....                           | 279   |
| NAIM Supernait 2, ex demo boxed.....                        | 2199  |
| NAIM NAC202 excellent boxed, factory serviced 03/14.....    | 1199  |
| Nu Force Reference 9Se v3 Monos boxed mint.....             | 1799  |
| Pathos Logos, ex demo, near mint boxed.....                 | 2699  |
| Primare A31.2 Power amplifier, excellent boxed.....         | 849   |
| Quad 40S2, good condition, late grey version.....           | 349   |
| Quad 44, excellent.....                                     | 199   |
| Quad 66 Preamp, excellent remote.....                       | 349   |
| Quad 99/909, vgc/fair.....                                  | 799   |
| Quad 99 Pre/Power, excellent, remote, Quadlink.....         | 649   |
| Quad Elite Preamp and QSP Power amp, ex boxed.....          | 1279  |
| Rega Brio R integrated excellent.....                       | 379   |
| Roksan Kandy K2 Integrated, excellent boxed.....            | 499   |
| Sugden Ampmaster Bijou Power amplifier.....                 | 399   |
| TEAC Distinction A1000 Integrated, ex demo.....             | 599   |
| Unison Research Preludio.....                               | 999   |

### Digital

|   |      |
|---|------|
| Arcam Alpha 8, excellent.....                       | 149  |
| Arcam CD23, excellent.....                          | 399  |
| Arcam CD73, excellent boxed.....                    | 199  |
| Arcam CD37, excellent.....                          | 799  |
| Arcam Alpha 9 DCS ring dac chipset, lovely!.....    | 279  |
| Bensford TC7510DAC, boxed vgc+.....                 | 99   |
| Cyrus dAD3Q, 24 bit chip, excellent.....            | 329  |
| Cyrus DACXP+, excellent boxed.....                  | 1099 |
| Cyrus Streamline, excellent boxed.....              | 549  |
| Cyrus dad7, excellent, boxed.....                   | 199  |
| Cyrus CDXTse, excellent, boxed.....                 | 449  |
| Cyrus CD6SE2 excellent, boxed.....                  | 399  |
| Denon DNP720AE, near mint boxed.....                | 199  |
| Goldenote Koala, near mint boxed.....               | 759  |
| Goldenote Koala, excellent boxed remote.....        | 749  |
| Levinson 360 DAC, excellent boxed.....              | 1099 |
| Marantz CD63K1, vgc.....                            | 199  |
| Marantz CD94, vgc remote, new belt kit.....         | 399  |
| Marantz CD10, excellent boxed new belt kit.....     | 449  |
| Marantz CD5004, nr mint boxed.....                  | 199  |
| Meridian 200 CD Transport, vgc.....                 | 299  |
| Meridian 589, excellent boxed.....                  | 849  |
| Musical Fidelity ASCD, excellent.....               | 549  |
| Musical Fidelity M1 DAC, excellent boxed.....       | 329  |
| NAIM NDX, ex dem, boxed complete, near mint.....    | 2499 |
| NAIM CDX2, excellent boxed remote, REDUCED.....     | 1199 |
| NAIM CDX, excellent.....                            | 649  |
| North Star Design USB DAC32, excellent boxed.....   | 799  |
| Onyx DAC25B DAC/Headphone amp, excellent boxed..... | 449  |
| PS Audio DigiLink III DAC, excellent boxed.....     | 299  |
| Quad 99CDP, excellent.....                          | 449  |
| Rega Planet 2000, excellent.....                    | 199  |
| Rega Apollo R, excellent.....                       | 449  |
| Resolution Audio Opus 21, nr mint crated.....       | 1299 |
| Roksan Kandy KA1, reasonable condition.....         | 999  |
| Rotel RCD02, vgc.....                               | 799  |
| Shanling SCDT200, excellent with remote.....        | 799  |
| Sony XA900ES, excellent boxed.....                  | 699  |
| Yada 170i iPod transport, great condition.....      | 149  |
| WBA GC-10, ex boxed, £1600 new, BARGAIN.....        | 399  |

### Headspeakers

|  |       |
|--|-------|
| AVI ADM9 T1, gloss white nr mint boxed.....              | 699   |
| B&W 804D, excellent in Piano black boxed.....            | 3999  |
| B&W 800D, near mint, boxed.....                          | 8999  |
| B&W 805s with matching stands, excellent!.....           | 1299  |
| Focal Electra 1028Be, as new.....                        | 2749  |
| Focal Elxa 1038, ex demo as new.....                     | 3999  |
| Kef Reference 105/2 vgc.....                             | 499   |
| Kef Reference 105/4 vgc.....                             | 499   |
| Kef Reference 102 with Kube, excellent.....              | 149   |
| Kudos C10, boxed vgc and cheap.....                      | 999   |
| Kudos C20, boxed vgc and cheap.....                      | 1299  |
| Kudos C2, ex demo boxed.....                             | 949   |
| Kudos X2, vgc boxed.....                                 | 799   |
| Linn Sara 9 with matching stands, vgc+.....              | 349   |
| Linn Living with KuStone stands, vgc+.....               | 99    |
| Linn Voice Auditorium OBX, maple excellent boxed.....    | Call  |
| Martin Logan Aeriun I, excellent boxed.....              | 799   |
| Martin Logan Aeon, vgc.....                              | 899   |
| Martin Logan Source, excellent boxed ex demo.....        | 899   |
| Martin Logan Purity, excellent boxed ex demo.....        | 1299  |
| Martin Logan Vista, excellent boxed ex demo.....         | 1799  |
| Magneplanar MG1.6, superb.....                           | 999   |
| Meridian M1 Active speakers, boxed.....                  | 1199  |
| Monitor Audio PL300, mint crated.....                    | 3999  |
| Monitor Audio 702PMC, excellent boxed.....               | 119   |
| Monitor Audio RX1, various colours sealed new boxes..... | 399   |
| Monitor Audio GX, RX and Platinum ranges ex demo.....    | Call  |
| NEAT Elite SX, near mint boxed.....                      | 949   |
| Sonus Faber Cremona M, as new boxed.....                 | 3249  |
| Sonus Faber Elipsa, superb boxed, due in.....            | Call  |
| Sonus Faber Cremona Auditor, boxed with stands.....      | 1399  |
| Ruark Equinox with matching stands.....                  | 599   |
| Tannoy D900ii, good condition.....                       | 1999  |
| Tannoy D750 Centre, good condition.....                  | 449   |
| Thiel CS7.2, vgc, just refurbished.....                  | 2499  |
| Totem Mani Signature, boxed near mint.....               | 2999  |
| Usher S520 s with S525 Subwoofers, excellent.....        | 899   |
| Usher S520 in birch, excellent boxed.....                | 279   |
| Wilson Sasha, crated excellent condition £28k new.....   | 14999 |
| Wilson Benesch Square One boxed, matching stands.....    | 799   |

### Special System Deals

|  |      |
|--|------|
| Audiolab 8200 Amp and CD.....                          | Call |
| NAIM Unilite and Usher Speaker Bundle.....             | Call |
| Roksan Caspian M2 amp/CD.....                          | Call |
| TEAC Mini Systems with matching speakers.....          | Call |
| TEAC DISTINCTION SERIES - Special deals - ON DEMO..... | Call |
| Yamaha AVR673 and Monitor Audio Speaker bundle.....    | Call |

**Telephone 01642 267012, Tuesday to Saturday 10 'til 5 or email [news@2ndhandhifi.co.uk](mailto:news@2ndhandhifi.co.uk)**



T U R N T A B L E W O R L D

Special offers to celebrate our new website

[www.turntableworld.co.uk](http://www.turntableworld.co.uk) - the analogue specialists - 01642 267012



## Steve Harris Contributing Editor

Steve Harris edited *Hi-Fi News* between 1986 and 2005. He loves jazz, blues music, vinyl and vintage hi-fi and anything that makes good music come to life

# On a power trip

Upgrading your turntable's power supply may bring better sound, but adjusting the PSU to match the exact motor used can take performance to another level entirely, as **Steve Harris** found out...

**Y**ears ago, Linn promoted its turntable by telling us that the source is the most important part of the record-playing system. So what is the source of the source? You could say it's the turntable's power supply.

Vintage turntables run straight off the mains, but most recent designs use a lower-voltage motor that's fed via a power supply unit. This is essentially the same as an audio amplifier, except that it operates at only a single frequency, or two frequencies for two speeds.

Just as it is ultimately the power from the wall socket that drives the speaker, it's the mains electricity, controlled or modified by the power supply, that makes the turntable rotate, and consequently forces the stylus to follow the undulations of the groove.

### PHASE ANGLES

A synchronous AC motor rotates at a speed determined by the frequency of the alternating current that's driving it. To start turning and keep going in the right direction, it has two active coils that need to be energised separately, one placed at 90° of rotation ahead of the other. The simplest way to do this is to feed one of the two 'phases' via a capacitor. This method takes advantage of the fact that when AC is fed

to a capacitor the current will lead the voltage by 90°. But a better way is to synthesise two separate AC voltages to drive the two phases.

This isn't the end of the story. Some designers have provided adjustments to factory-match the voltages and phase angles of the supply to the individual motor so it can run as smoothly as possible. Rega has pioneered this.

**RIGHT: The SG-1 power supply was originally designed to be used with Vertere's RG-1 turntable, until its designer Touraj Moghaddam realised it could be adjusted for use with premium decks from the Roksan range**



It's logical to assume that almost any turntable will benefit from a better power supply, even if this means just giving it a cleaner AC mains waveform, and there have been many aftermarket devices that have claimed to do this. But not long ago, thanks to Touraj Moghaddam of Vertere, I was given a stunning demonstration of how a modern adjustable power supply could transform an older player.

In this case, the older player was a Roksan Xerxes, from around 1987. Its original power supply had already been upgraded to a later Roksan type.

Touraj, of course, designed the Roksan Xerxes and all the subsequent Roksan turntables, before founding Vertere. But following some enquiries from owners of Roksan TMS turntables, he realised that the Vertere record player's SG-1 power supply could usefully be applied to a TMS. And it could be setup just as easily for a Xerxes, even my very early one.

When I took the player over to Vertere, Touraj first reset the SG-1's output voltage and then, after connecting it to the Xerxes, carefully adjusted both voltages and phase

to get the minimum possible vibration with this individual motor.

It's no exaggeration to say the performance was transformed. It had sounded respectable before, but now the music had a pace, grip and immediacy that simply made you sit up and listen. It sounded great.

### BELT OR BRACES?

While it's the power supply's job to provide electrical energy, it's the turntable's job to convert it to mechanical form. Once I asked an eminent hi-fi designer why so many people were now sold on idler-drive turntables, even though they must be noisier, typically, than any belt-drive?

He drew a parallel with amplifier design. A belt-drive deck, he said, was like an amplifier that relies on its reservoir capacitors to provide bursts of current when needed, while an idler drive is like one that really has plenty of it available all the time.

This seemed a convincing argument. But now, especially having heard one particular 30-year old belt-drive deck come to new life so convincingly, I'm not so sure. I'm inclined to think that if you can get your belt to do the job, you don't need to switch to braces. ☺

'It's no exaggeration to say that the deck's performance was transformed'

"The P10 will have an effect ranging from positive to positively startling".

**Hi-Fi News**



**P S A U D I O**

Pioneering world class audio products

"The P10 improves the sound in all aspects. I couldn't live without it in my system".

**Mr Sheridan, Belfast**

# 40 years in the making, PS Audio's range of mains regenerators give you complete control of your mains for the sound you aspire to.

If your high end system is powered directly from the mains or through poor quality conditioning, the true sound of the recording will be compromised. Without PS Audio mains regeneration you will be experiencing:

- Low/high supplied mains (from 220V to 260V)
- Fluctuating mains with variations of up to 20 Volts
- Harmonic distortion (THD) ranging from 1%-3.5% (increased by appliances sharing power in your house)
- Radio Frequency Interference (RFI)
- System dynamics are reduced or suppressed across the range
- Reduced soundstage
- The musical performance of your system is unpredictable at different times of the day

PS Audio has developed a range of mains regenerators that solves these issues and gives you total control of your mains. All you need to do is choose the product that suits your system & budget.

---

For a no obligation demonstration please contact one of the following approved PS Audio dealers:

**North West** - Brian & Trevors 0161 766 4837. **East** - Analogue Seduction 01733 350878.

**Midlands** - Oxford Audio Consultants 01865 790879 / Midland Hifi Studio 01902 380083 / Art Audio Salon - 07878 566814.



### P3

- 850W of continuous regenerated power (1kw on peak)
- 3 regenerated outlets (for front end or low output amps) and 1 high level conditioned outlet (for high output amp)
- Fan cooled (run silent)
- **Price £1,950.00**



### P5

- 1kw of continuous regenerated power (1.2kw on peak)
- 4 regenerated outlets including 1 high current (amp)
- Fan cooled (run silent)
- Touchscreen display
- **Price £2,999.00**

### P10

- 1.25kw of continuous regenerated power (1.5kw on peak)
- 9 regenerated outlets
- 3 high current outlets (high power amps/mono-blocks/projector/TV)
- Heat sink cooling (no fans)
- Touchscreen display
- **Price £4,400.00**



All products in the range provide stable mains to your system, reduce incoming harmonic distortion to virtually nil, and have the ability to step up/down the incoming voltage to provide regenerated mains at the level you require. The result will be obvious to you: improved dynamics, far better base and a much bigger soundstage - always.

**South East** - Guildford Audio 07979 515577 / Audio Venue W5 0208 567 8703 / Audio Venue Maidenhead 01628 633995 / Stereo Now 07870 192618.

**Distributed by: Signature Audio Systems 07738 007776 ● [www.psaudio.com](http://www.psaudio.com)**

## YOUR VIEWS

# Sound Off!

Correspondents express their own opinions, not those of *Hi-Fi News*. We reserve the right to edit letters for publication. Correspondents using e-mail are asked to give their full postal address (which won't be published). Letters seeking advice will be answered in print on our Sound Off pages, but due to time constraints we regret we're unable to answer questions on buying items of hi-fi or any other hi-fi queries by telephone, post or via e-mail.

## IT'S TIME TO TEST GRADO READER'S THOUGHTS ON LATEST CARTRIDGES

A new Reference 1 Series of cartridges was introduced over two years ago by Grado yet I've yet to see one model reviewed in a British hi-fi magazine.

Unlike other manufacturers, Grado appears to give priority to cantilever technology rather than better stylus tips through its more affordable ranges, like the Prestige Series. This continues into the Reference Series until the Sonata 1, which sports a naked diamond stylus as opposed to one mounted on a brass bushing.

The Sonata 1 is the pinnacle of the company's high output cartridges as its Statement Series are all low output cartridges. As such, I would recommend that you review the Sonata 1 because it is particularly useful to LP enthusiasts who want to spend their entire budget on the best quality cartridge without having to allocate part of this sum to buying an MC step-up stage.

What's more, the cartridges in the 1 Series are said by Grado to have 17% lower moving mass than those in the original Reference Series and should therefore have better tracking abilities. Good tracking is a priority for classical

music, because on the whole classical LPs are cut without the compression that is applied to pop music LPs, which is done to make the latter playable on turntables having mediocre cartridges.

My experience of diamond styli mounted in metal bushing is that they cause a thickening to the sound, which some rock enthusiasts like with overly bright recordings. Naked diamond styli reveal the timbre of orchestral instruments more accurately, which is a boon with classical music when one wants to hear the natural harmonics of violins, etc. I also find that styli with naked diamond tips mean less congestion when they are required to track densely scored music, particularly choral works.

Back in November last year you tested five sub-£600 MCs. I think it likely that the Sonata 1 will have a better match of tonal characteristics between centrally and peripherally placed instruments in the soundstage than most of the designs featured in that test. Given the fast-transient Grado sound, I think the Sonata 1 may offer everything your reviewer liked about the Sumiko Blackbird in that November test, but without its excessive treble output. Please put all this to the test for us!

*Chris Taylor, via email*

Paul Miller replies: A cheque will likely be in the post from Grado's marketing department for services rendered, Chris, but in the meantime I will request a review sample from its UK distributor, Armour Home. Incidentally, we have already reviewed Grado's partnering Reference series Master 1 pick-up [*HFN* Dec '09]. Finally, quality pick-ups typically employ a nude rather than shank-mounted diamond.



**ABOVE:** Grado's moving-iron Sonata 1 sports a nude elliptical diamond stylus

Send in your views to:  
Sound Off, Hi-Fi News, AVTech Media Ltd,  
PO Box 718, Orpington, BR6 1AP or  
email your views to: letters@hifinews.com -  
please use 'Sound Off' in your subject field

## Clear statement on Clearaudio

### HOW DO COMPANY'S DECKS RANK IN ITS CURRENT LINE-UP?

I read the review of the Clearaudio Master Innovation turntable in the April 2014 issue with great interest. I own a Clearaudio Master Reference and have been unable to find a comparative review of the two turntables. While it's true they have different motor and platter systems, they share many design features, such as isolation based on a Panzerholz/Aluminium chassis and an LP-supporting platter rotating on a ceramic magnetic bearing.

Given these similarities, I would like to have seen a clear statement on where the company places its Master Reference in the pecking order of the Innovation/Master Innovation line-up, especially since the Reference is not produced anymore. Second, with regards to the offer of an upgrade path from Master Reference to Master Innovation, whether the latter would be a significant improvement over the former.

*Kostas Agath, via email*



**ABOVE:** Clearaudio Master Innovation [*HFN* Apr '14]

Steve Harris replies: Still at the top of the Clearaudio range is the Statement, and other models form a hierarchy below this. The Master Reference topped the Solution series, now replaced by the Innovation series. The big difference is the new drive system, using a DC motor mounted on the turntable chassis, with special isolation that's said to equal the abilities of a free-standing motor, and the Optical Speed Control system. While the Master Reference did have the CMB bearing, the Master Innovation adds the Statement's magnetically-coupled secondary platter. There was thus no longer any need for the complication of three motors. I feel sure Clearaudio believes that the Master Innovation comes closer to the performance of the Statement than any previous model.

## Set-backs for DAB

AND LONG MAY THEY CONTINUE, WRITES ONE REVOX-LOVING FM FAN

I read Barry Fox's Opinion page in the May issue on the latest DAB news with interest. I'm pleased to hear that the FM switch-off has been delayed until at least 2020 (never I hope, or at least for the foreseeable future).

The comparison with the digital TV switch-over, to which Barry refers, is not a fair one. I obviously welcomed the additional TV channel choice and the fact that all existing TVs could be upgraded with a simple cost-effective set-top box. However, I wonder how successful the digital TV switch-over would have been if people had been told to throw away all their existing TVs and buy new ones!

I am very happy with BBC FM broadcasts, both in terms of quality and choice, and have no desire to tune into DAB commercial radio broadcasts with their endless adverts and product placement.

In the context of *Hi Fi News* and its readers, the government should appreciate that many people have invested in superior and sometimes very expensive FM tuners.

Then there are the countless affordable FM devices that will be rendered silent, useless and fit only



**ABOVE:** The quartz-locked Revox B260 tuner was first released back in 1988

for landfill the day the FM signal is switched off. How 'green' is that?

Think of all the great and good FM tuners that *HFN* has reviewed over the decades. Many of these models are still in service and still giving their owners real pleasure.

You can imagine I will be pretty upset if the day comes when I have to bin my Revox B260!

*P Mumford, via email*

Barry Fox replies: Just for the record, I listen to DAB a lot – including in-car. It was the difficulty of fitting DAB to a pre-DAB car (mainly the need for a new aerial) that prompted me to suggest some kind of scheme to help car-owners pay for conversion – like the voucher scheme that operated in the USA which helped viewers convert for digital TV.

## More on Duette 2's drivers

WHY DIDN'T KEN DESCRIBE THE DRIVER USED BY THE WILSON SPEAKERS IN HIS REVIEW?

I was a little bit surprised that a seasoned journalist like Ken Kessler did not mention what drivers are used in the Wilson Duette Series 2 [see *HFN* Apr '14]. But I must congratulate him on his great Investigation piece in the same issue on the Air Force Two turntable. A fascinating read and nice pictures too.

*Christian Roiseux, Belgium*

Ken Kessler replies: Thanks for the kind words Christian. As for the Wilson Duette 2, I said in the body copy that it had an 8in woofer and explained that the tweeter features a rear wave chamber sourced from the Alexia's Convergent Synergy Tweeter. Meanwhile, the caption on the first page of the review says that the tweeter is similar to the one used in the company's Alexia.



**ABOVE:** Wilson Audio's Duette Series 2 costs £17,000, or £19,000 with stands

# 8

## Lanes On Your Entertainment Superhighway



RJ/E Forest



RJ/E Cinnamon



RJ/E Vodka



RJ/E Diamond



Cat 600 Pearl



Cat 700 Pearl



Cat 700 Forest



Cat 700 Carbon

Since its origins in the early 1980's, Ethernet, and the Local Area Network (LAN) systems it enables, has become the copper plumbing of the digital age. Originally deployed only over coaxial cable, the Ethernet protocols (IEEE 802.3) now also apply to fibre-optic and "Category" (Cat 5, 5e, 6, 6e, 7) cables. These 8-conductor (4 twisted pairs) Cat cables are the 8 lanes which stream or transport your digital entertainment to equipment a foot away or several rooms away.

AudioQuest refers to its pre-terminated leading-edge Cat 7 cables as the RJ/E Series ... RJ for the RJ45 connector standard to the application, and E for Ethernet. For AudioQuest, the highest Cat 7 standard (with all 4 pairs using correctly differentiated twist rates and individually shielded) is only the solid foundation to which AQ then adds better materials and unique-to-AQ additional technologies.

The particulars of the RJ45 connectors have also received extreme attention. The plugs used on the Vodka and Diamond models (and available for use with bulk Cat 700 models), feature a unique patented transition-compensating system which reduces reflections caused by the impedance mismatch where 4 twisted pairs meet a straight line of 8 plug contacts.

**What does this all mean? Simple ... better sound!**

**audioquest**

# Celebrating



# Years

 Crystal Cable  
[www.crystalcable.com](http://www.crystalcable.com)

A DECADE OF INNOVATION, TECHNOLOGY, ELEGANCE AND MUSIC

Visit Crystal Cable at Highend Munich, Atrium 4, Room E-229



 **absolute sounds ltd.**

International Distributors & Consultants of Specialised Hi-End Audio & Video Systems  
58 Durham Road, London, SW20 0TW T: +44 (0)20 89 71 39 09 W: [www.absolutesounds.com](http://www.absolutesounds.com)  
E: [info@absolutesounds.com](mailto:info@absolutesounds.com)

## My low-cost, hi-res system

READER RECOMMENDS HIS FROM-SCRATCH JOURNEY INTO HIGH-DEF PRIVATE LISTENING

Many of us find our fine stereo systems sharing space with the family TV, games console, assorted toys and, in my case, a 21-month-old who keeps trying to stuff the soggy end of her biscuit into the grilles of my beloved Martin Logan electrostatics.

In the face of decreasing time before my system I sought an alternative, and so decided to explore the world of high definition downloads. A fresh install of Snow Leopard on to a 2007 MacBook Pro and I was ready to add some FLAC-playing software. VLC will do that, and it's free, though the sound didn't seem much improved over standard CD playback. Turning to the internet I discovered that Audirvana Plus was highly thought of, and that one could try it for free [<http://audirvana.com>].

The files now sounded better, but I was still missing the sense of depth and space I was used to when sat in front of my regular system. Time to do things properly, so I upgraded my headphones to a pair of Sennheiser HD598, introduced a Musical Fidelity V-DAC II and a Pro-Ject Head Box S dedicated headphone amp.

The headphones are cream leather and sport touches of gorgeous burr wood. Meanwhile, the Pro-Ject amp is a solid little box and, despite all the talk in online forums of it struggling to drive Sennheisers, I find them loud enough, thank you! I hooked up the Mac via S/PDIF and turned everything on. The laptop set itself up automatically. Neat.

Anyway, the sound... That was more like it. Bass, mids, highs all

separated. Fourplay's Foreplay in 24-bit/96kHz was pure easy listening with all the tinkering keyboards, pulsating bass and cymbal licks one could wish for.

I was happy for weeks until someone suggested that the DAC would sound even better with its own power supply. Damn that upgrade bug. So I bought a V-PSU II. OK, the resulting collection of boxes and cables now looks like a ham radio set-up but the PSU resolved the quality of the sound further, even if it is a subtle change. Things just sound more 'correct', and it was only when I took the V-PSU out of the system that I realised I'd lost something.

One point is that where I live there is a voltage drop around 9pm which has had an impact on all my systems. With the V-PSU in place no change was discernible. I can thoroughly recommend this low cost introduction to hi-res audio as good value for money. Totting up the spend including the cables, but not the headphones, the total was £500.

*Steven Bell, via email*

Paul Miller replies: As you've discovered, Steven, headphones are not just for MP3 files but are more than capable of realising the musical quality offered by hi-res media. Moreover even the very best 'phones are typically more affordable than a new pair of full-range floorstanders. Can fans will be delighted to learn about the £99 Schiit Magni preamp featured on p62 while this month's Investigation, p14, looks at how headband resonances colour the sound of your 'phones.



ABOVE: Reader Stephen's 'escape' system, though reminders of real life are never far away

## WIRELESS FRONTIER?



Not only are wires still very much the lowest-distortion highest-performance way to send both analog and digital audio information, but when it comes to sending power, "wireless" is just a nifty science project, not part of a home entertainment rig.

The challenge of not adding distortion as AC power goes from the wall to the electronics, and the challenge of not adding distortion as audio power is sent to a loudspeaker, are almost the same. The amount of energy transferred through these cables, and the size of the associated magnetic fields, puts them in a different class from all other audio and video cables.

Speaker cables need to maintain perfect integrity across the audio band and then some, while AC cables only have to try to be perfect in a narrower band. AC cable design is therefore a subset of speaker cable design because AC cables are subject to almost all the same distortion mechanisms, and benefit from almost all the same damage minimizing techniques.

For the most sophisticated power-transfer cables, for the best sound and video, please visit [audioquest.com](http://audioquest.com) for more details.

**audioquest**

[audioquest.com](http://audioquest.com)

# Just the power of suggestion?

TWO READERS WONDER WHETHER ALL TWEAKS CAN BE DISMISSED AS PSEUDO-SCIENTIFIC CLAPTRAP

In response to Paul Miller's talk of snake oil in his April Opinion, I thought I might contribute with a story about an event which I was a party to, as a visitor to a show, a few years ago.

I had made my way to the topmost floor of the venue where a high-end distributor had a room. It was early morning and the person in charge was playing music more or less to himself. I sat down, listened and became immersed in the recording, which was beautifully reproduced. After a short time I was asked for my opinion, which was very positive. The representative then produced eight wooden discs for me to examine.

These discs were about 40mm in diameter, a few millimetres thick and appeared to be made of a black coloured hardwood. He then placed one disc on each corner of each speaker, one at a time. As the last discs were placed, the sound was transformed from being enjoyable to unbelievably good.

I rose from my seat and being the only visitor in the room, walked around what appeared to be the area occupied by the orchestra. I could virtually 'see' where the instruments were placed.

The music was then changed to rock and the same happened again. After a time, one disc was removed from each speaker and the soundstage became smaller until, to my amazement, it collapsed back into the speakers as the last disc was taken away.

The discs were then shunted around the top of the speakers in various positions, but produced the best results when placed in the corners. As other visitors eventually found their way to the top floor, the demonstration was

repeated and the results were the same. If I had not seen and heard this myself, I would not have believed it. Just as you won't believe it, reading this.

I recall that a while while back Totem loudspeakers used to carry small coloured dots, which was rumoured to be a result of similar thinking. So, a further complication is that there seems to be different types of snake oil, when I thought there was only one. Perhaps Ken Kessler should have a good look into some of these ideas, though I think I can guess his response! But once, one did work for me, really.

*Alec Fray, via email*

After reading Paul Miller's: 'A little bit of madness' – his Opinion column in the April issue – I sat back to reflect on my many years of interest in matters hi-fi. Many years ago, Quad founder Peter Walker wrote an article in *Wireless World* in which he argued it was ridiculous to believe that 6ft of mains cable could affect the sound of an amplifier when that same 6ft of copper wire was in series with a 100ft and more of copper wire wrapped around transformer laminations.

At the time, I was working in electrical engineering and to me Peter Walker's reasoning was impeccable. From then on I belonged to the Objectivists camp. If you couldn't measure it, then any improvement to sound must be imaginary, which is Paul Miller's stance. However, I wonder if there are any manufacturers around today who still believe mains cables have no effect on the sound of an amplifier?

I remember many times in the past when, after an evening listening to my hi-fi system and thinking about the beautiful sound, I would find that for some unexplained reason the sound would somehow have degraded badly the very next night, even though I hadn't changed a thing. Very puzzling, though I began to wonder whether the sound of the system had changed or whether the difference was down to my hearing.

When, in the late 1980s, I began to come across theories that the environment can affect our perception of sound, I decided this was something I had to investigate. I believe there is no way at present to test these theories,



ABOVE: Tweeters of Totem Acoustics Sttaf floorstander with blue dots [see *HFN* May '12]



ABOVE: Paul Miller tells of an invitation into 'hi-fi's netherworld' in the Apr '14 issue of *HFN*

though hopefully in the future, an advanced MRI scanner might possibly be able to do the job.

Strictly speaking, the theories about the environment and their effect on us are not solely about hi-fi as they address the effect it has on all of our senses, including sight, smell and taste. But because our perception of sound is also affected it is said that the environment has a profound influence on the pleasure of listening to music in the home. I would have thought Paul Miller would embrace any method that increased our listening pleasure. Anyhow, these are my thoughts on the matter.

*Tom Marsden, via email*

Paul Miller replies: The 'madness' in the title of my Opinion piece referred, of course, as much to the proselytising and high-handed attitude of some who peddle such 'aids'. Otherwise while it has never been our practice to deny the listening experience of any enthusiast, *HFN* still has a duty of care to its readers. If any of our flock derives benefit from placing small objects atop a loudspeaker cabinet then we'll never say they are 'wrong' but the red flag will be raised if a salesman/website attempts a patently farcical explanation for its effect.

And I have never suggested that if 'it cannot be measured, it must be imaginary'. Quite the reverse, in fact. *HFN's* testing regime continues to evolve to encompass new listening paradigms as our ground-breaking lab reports on USB and network audio devices, USB cables, hi-res downloads and mains regenerators clearly illustrates.

# DSD, PCM: what's going on?

CONFUSION REIGNS FOR THIS READER AS HE LOOKS AHEAD TO A FUTURE OF HI-RES RECORDINGS

A few years ago I read a comment in *HFN* about the fact that some record companies do not use DSD for SACD – the proprietary system developed by Sony/Philips to give much greater resolution to recordings compared with CD, along with multichannel capability. Some of the companies then incorrectly put the DSD logo on both the jewel case and the disc, which is confusing and misleading.

I have noticed recently that some labels, who once properly recorded their SACDs in DSD, are now using 24-bit/96kHz PCM. For example, one classical label now appears to be using PCM, stating 'Recorded in 24-bit/96kHz' on jewel cases, but continues to use the DSD logo on cases and discs. Is this because the SACD/DSD system is thought to be obsolete and recording companies are consolidating their operations?

Many of them have been using a high-definition PCM '24-bit/96kHz' resolution for CDs for a number of years. Blu-ray players for video are now widespread among users in general – the greatly increased capacity of these discs, with an even higher resolution of 24-bit/192kHz, probably dictates a move, in audio terms, to BD-Audio for those who want more than plain vanilla CD.

And BD-Audio can contain many audio formats, all in 24-bit/192kHz: linear PCM stereo and 5.1 surround; 'DTS-HD Master Audio' and 'Dolby TrueHD' and up to 7.1 surround; plus the old 'Dolby Digital' 48kHz and 5.1 surround. Whether 24-bit/96kHz or 24-bit/192kHz PCM are technically better than 1-bit DSD at 2,800,400 samples per second, I don't know. There's probably a lot more to it than just the arithmetic.

Decca is now scouring its analogue back-catalogue and re-releasing recordings on its new Blu-ray Pure Audio discs in '24-bit/192kHz' (no multichannel releases, so far), rather as Pentatone has done, to great effect, with many of the Philips 4-channel quadrasonic recordings of the 1970s. Perhaps they



ABOVE: *HFN* reports on the release of the first High Fidelity Pure Audio discs [Dec '13]

are testing the market with some of their classic recordings? With the prevalence of BD, this is probably the way ahead for all high-definition, multichannel recording.

Multichannel SACD hasn't really caught on with the rock and pop fraternity I gather, but I support it for classical music, where it is well suited in surround sound. And DSD is becoming popular for streaming from the net, I read. What is going on?

*Humphrey Britton-Johnson,  
Herefordshire*

Paul Miller replies: Valid points, all, Humphrey but we must distinguish between the logos on the software packaging and the native format of the original recording. Most content on early CDs would have been derived from *analogue* master tapes but the jewel cases still all carried the Compact Disc logo denoting its 44.1kHz/16-bit format (albeit with AAD or ADD suffixes). Fast-forward 30-odd years and today's (digital) recordings are made at a minimum of 96kHz or 192kHz PCM or as a DSD bitstream. Subsequent mixing/mastering in the latter format is pretty tricky so DSD is often downsampled to 88.2kHz or 176.4kHz PCM for the purpose.

However, as SACD discs, by definition, carry DSD data the content must always be returned to this 1-bit format for transfer to the medium. And the SACD jewel case will necessarily carry the SACD logo. Similarly, 96kHz/192kHz masters may be transferred directly to BD-Audio disc in stereo or multichannel guise, converted to FLAC (or other) media files for streaming-based audio systems or even downsampled to 44.1kHz/16-bit for release on plain vanilla CD.

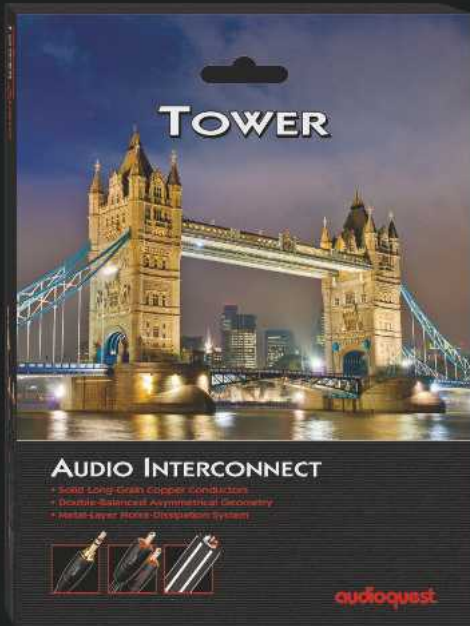

**We've Got Your Back ...**  
**Your Front and Your Sides!**



RCA plugs for the back

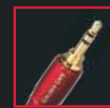

3.5mm plugs for portables and more



DIN plugs for the back



iPod plugs for underneath



3.5mm socket for extension cables

From solid conductors, superior metals (conductors and plugs) and low-interaction insulation to AQ's Noise-Dissipation System and AQ's Dielectric-Bias System, all of AudioQuest's proven distortion-minimizing ingredients are used to ensure that all eight models of Bridges & Falls cables bring you beautiful music, clear dialogue and thunderous sound-effects.

**audioquest**



musicbook:25 - front



musicbook:25 - rear

# LINDEMANN.musicbook:25 listen. relax. enjoy.

**Do you love music?** Do you value perfect sound quality? Are you looking for a network player so you can listen to music in your living room even without a computer? Do you love the convenience of remote control via an app? Do you want to keep CD playback capability as well? Do you also like listening with a good pair of headphones? Would you like to connect a turntable?

**What if you could combine all this now into a single device?** The musicbook 25 is a network music player that perfectly handles not only high-definition music playback on a home network, but CD playback as well. All functions—even on the CD player—can be remotely controlled using an app (iOS and Android).

The built-in D/A converter is ranked, technologically and sonically, among the best currently offered by the market. The built-in analog pre-amplifier used in balanced studio technology and a Class A headphone amplifier guarantee the finest in music enjoyment. Lean back and enjoy your music!

After a development period of several years, Lindemann proudly presents a new cutting-edge product series – one that shows just how much musical satisfaction today's engineering can deliver: musicbook: Smart looks, top features, state-of-the-art technology, Lindemann sound, attractive pricing.

## musicbook:10

USB audio music player with DSD playback  
£2650

## musicbook:15

USB audio music player with DSD playback & CD Drive  
£2990

## musicbook:20

network music player  
£3650

## musicbook:25

network music player & CD Drive  
£3890

## musicbook:50

balanced class-D power amplifier  
£1590

# Streaming & beyond

specially developed app





# audioemotion

www.audioemotion.co.uk

e: [info@audioemotion.co.uk](mailto:info@audioemotion.co.uk)  
f: [facebook.com/audioemotion](https://www.facebook.com/audioemotion)  
t: 01333 425 999

## AUDIO PHYSIC CLASSIC 30 £3450

"True high end sound quality coupled with stunning looks and the ability to work in difficult rooms."

*James Palmer  
hifiwigwam.com*

*Classic 30  
Review*

## AUDIO PHYSIC VIRGO 25 plus+ £9250

"A real stunner! It delivers a sound that is substantially more balanced and mature than that of its predecessor, setting a new benchmark in excellence. Its midrange is sheer poetry; this loudspeaker is simply superb!"

## AUDIO PHYSIC AVANTERA plus+ £13700

# audio physic

A unique blend of the highest standard in loudspeaker aesthetics and design that will emotionally sweep you off your feet with its physical beauty and graceful sonic performance.

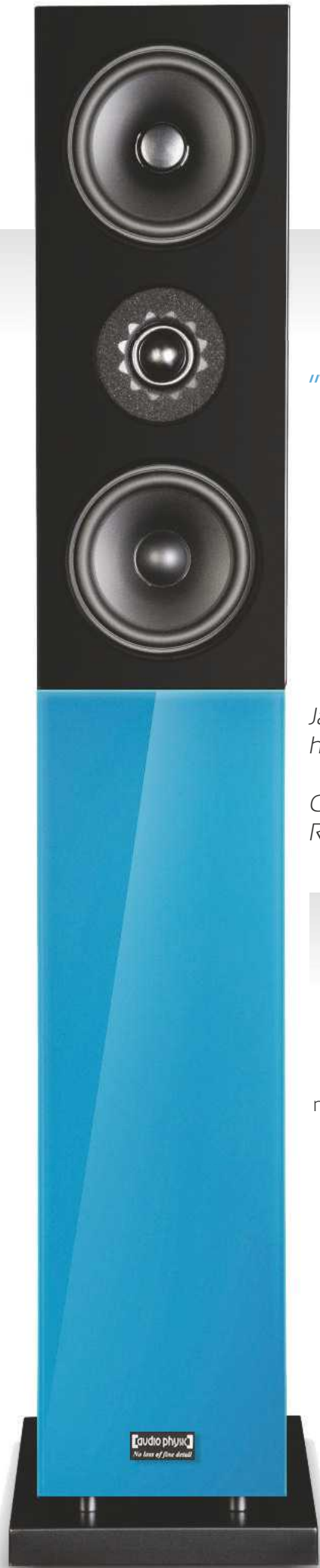

music is our passion



# Tonearms & cartridges

Is it going to be a tried-and-trusted Rega, a sturdy SME or one of hi-fi's more esoteric pre-cherished arms? And what about used cartridges? **Adam Smith** is your guide...

**A**lthough the word 'tonearm' was coined when the arm and its associated soundbox had a major influence on the tone of the sound, this became less relevant as electrical pick-ups became the norm, but the name stuck. It was not until the advent of high fidelity and the stereo LP record that the capabilities of arms and cartridges as separate entities were pushed onwards.

## MATCHING UNITS

This is not to say that some dedicated arm and matching head units are not worthy in their own right. Names like Leak, Connoisseur and Goldring are highly sought after for quality mono reproduction, but one of the first stereo designs to appear on the market was the Decca FFSS, introduced in 1958.

The FFSS offered a big step up in quality due to its unusual construction. The virtual absence of a cantilever put the motor assembly right by the stylus with the result that a much more detailed sound could be achieved.

Production changes to keep the Decca units competitive saw them quickly progress through Mk I, II and III variants, culminating in 1965 with the Mk IV model, which featured an elliptical stylus along with a standard half-inch mounting (SC4E).



**RIGHT:** Decca's renowned FFSS pick-up head, shown here mounted on the matching FFSS arm and fitted to a Garrard 301 turntable – a very popular combination of the time. This was part of a very successful line of arms and cartridges with useful optional extras available, such as cueing devices and bias mechanisms



**BELOW:** Unmistakably a Denon DL103 – the cartridge's chunky and unassuming appearance belies the performance it is capable of. Arriving on the scene in 1962, it remains in production to this very day

All FFSS models have something of a cult following despite occasional concerns over their tracking ability and resultant distortion. Nonetheless, a good example will deliver a magnificent sense of space and presence, not to mention addictive, punchy bass.

Another company that had great success with matched arms and pick-ups was Ortofon. In 1959 it developed its original 1948 range of models into the SPU moving-coil cartridge – a move which brought a huge leap forward in quality. Although the new cartridge was offered in the Type A shell to match the older arms, the important development was the Type G shell as this also took the transformers needed for the units' low outputs.

## BUILD YOUR OWN...

Many versions of shell and half-inch mounting SPU variants followed, both with and without the transformers, and the range has a solid reputation for exquisite

midrange detailing. This makes it beloved of many jazz and classical fans in particular.

Ortofon's own arms were modified to suit the newcomer but, back in England, a young audio enthusiast by the name of Alastair Robertson-Aikman found himself dissatisfied with the arms available to him, so set about designing and building his own. The result was the SME 3009. Precise, delicate

and exquisitely engineered, both the 3009 and its 12in 3012 sibling, featured a detachable headshell that used the same mounting as the

**'The SME 3009 makes a superb secondhand purchase today'**

Ortofon SPU's G shell (early SME shells were, in fact, Ortofon's with SME badges on).

The 3009 stayed in production until 2003 and is widely regarded as one of the most influential designs in vinyl history. It makes a superb secondhand purchase due to its sheer abundance while the high build quality means it will withstand a surprising amount of abuse.



**BEFORE YOU BUY...**

When assessing a potential arm purchase, always check the bearings carefully. Move the armtube gently back and forth, left and right and twist – there should be no play (unless the arm has knife-edge bearings or is a unipivot) and any sign of slackness should be cause for concern. At the very least, the bearings will need adjusting; at worst – replacement.

Cartridge tags can fall off with surprisingly little provocation, but many companies can re-wire both cartridge and output signal leads at affordable prices.

When looking at a cartridge, unless its history is known or some sort of microscopic inspection can be performed on the stylus to ascertain its health, always assume that its useful life will be short. The selection of new original and re-manufactured styli is still surprisingly wide and many companies exist that can re-tip and even fit new cantilevers to all kinds of moving-coil designs.

Finally, never be tempted to check the continuity of a cartridge using a multimeter. Even the relatively low voltage from a modern meter can be enough to burn the coil out. This is especially true when it comes to moving-coil designs.

Another important cartridge arrived on the scene in 1962: the Denon DL103. Its unassuming square body clothed a high quality moving-coil generator and a 16.5µm spherical stylus. It quickly gained a reputation for tracking superbly and sounding punchy and detailed when mated to a quality medium to high-mass tonearm. Myriad variants of the design came and went including gold-plated models, higher specification types and anniversary limited editions.

**SHURE THING**

The DL103 remains in production to this day and can still show many a modern design a thing or two. Do be warned, though, it needs a massy arm – try one in a Rega RB300, for example, and you'll wonder what all the fuss is about. Mate it sympathetically, however, and the Denon comes alive, offering an alluring combination of poise,

**ABOVE:** Original ad for Ortofon's SPU/T and SPU/G cartridges (left) and an early mono Ortofon Type A pick-up head that was followed by the SPU

**BELOW RIGHT:** A relatively early SME 3012 arm – the headshell's resemblance to that of the Ortofon SPU can clearly be seen

**BELOW:** A later Series 2 SME 3009 arm, here shown mounted on another 1970s staple, the Thorens TD125

grip and subtlety, and giving a good sense of pure fun.

It's perhaps surprising that the likes of the DL103 and SPU held their ground, because, as the 1970s progressed there was an ever greater ambition to build cartridges able to track at as near to zero grams as possible, with the result that high compliance MM cartridges became the flavour of the day. SME slimmed its 3009 down to Series II Improved status, following this with the even skinnier Series III, both of which were usually paired with a Shure cartridge.

The Shure M75 range was the staple design of the decade, available in several variants, from the M75-6S with its mounting bracket and 3g tracking weight for music centre use, right up to the flagship M75ED that would happily fly through Shure's own trackability test record at less than a gram. All M75s are sturdy workhorses and can sound eminently pleasing when mounted in the right arm, although they are less dynamically forthright than their chunkier forebears and tend not to offer the sheer insight of a good modern design.

A cartridge of similar age that lacks little, however, is the M75's big brother, the Shure V15. The MkI is somewhat forgotten now, but the MkII and MkIII ruled the roost in their day. Superb tracking ability, smooth sound and a stylish silver body

meant that everyone knew that you owned a high quality transducer that tiptoed across your records with the delicacy of an angel.

The V15 then evolved into the MkIV and MkV before having its final fling in the 1980s as the Ultra 500. All models are highly capable performers in their own right ↻



## BUYING VINTAGE

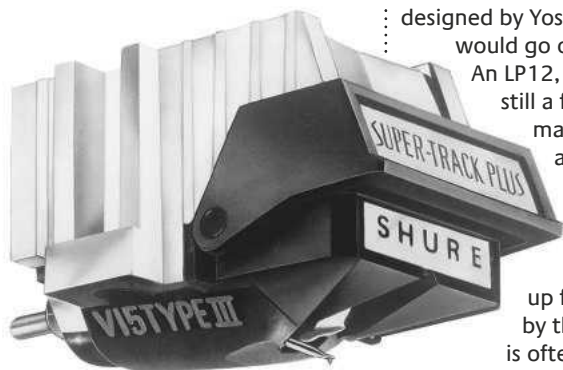

when matched appropriately – the MkII and MkIII benefiting from a low mass arm – but the later variants offer a wider range of arm compatibility. The Ultra 500 in particular could hold its own with moving-coils of the day thanks to its sophisticated and highly detailed sound allied, naturally, to its supreme tracking ability.

### STAR OF SCOTLAND

Another major development in the 1970s was a certain turntable from Scotland, which sent waves through the industry and helped to push arm design in a new direction.

The Linn Sondek never really gelled with SME arms, but the result that designs from other manufacturers grew in popularity as owners tried to partner the deck optimally. One of the first to find favour, and a model actually imported by Linn itself, was the Grace G707 – a development of the company's earlier arms that was originally intended for quadraphonic replay. Still a relatively low-mass design, it worked well with Shures but really sang when partnered with the Supex 900 – a high quality moving-coil



designed by Yoshiaki Sugano, who would go on to found Koetsu. An LP12, Grace and Supex are still a formidable music-making combination and both arm and cartridge are well worth seeking out. Of course, things were shaken up further in 1979 by the arrival of what is often referred to as

the first 'super-arm': the Linn Ittok. British designed and Japanese made, the Ittok was a world away from the dainty S-shaped designs of the 1970s. A little ragged at the top end and somewhat lacking in focus in the midband it may be, but the Linn Ittok boasted a feisty musicality that suited the company's LP12 to a tee.

The triple was completed by the arrival of the Linn Asak MC cartridge which was specifically designed to partner the Ittok. This was possibly the ultimate early 1980s turntable set-up and the three still sound superb today.

Buoyed by the Ittok's success, fellow Scotsman Scott Strachan's Syrinx company followed its rather skinny PU2 with the much beefier-looking PU3 to great acclaim.

Reputedly the PU3 was the first arm to have a tube deliberately shaped to reduce resonance.

Despite its appearance it was quite a low mass-design and beats the Ittok fair and square in terms of midband lucidity and sweetness, even if it lacks a little outright bass grunt.

Another arm of the time that most certainly didn't lack grunt, however, was the Zeta. Launched in 1982 and made by GB Tools – as was the similar-looking Mission 774SM – the Zeta was a superb beast that made suspended turntables go wobbly at the mere thought of supporting it. It's another fine secondhand buy thanks to its dynamic and rhythmic nature.

Although the Ittok may have been the first super-arm, the design considered by many to snatch this crown and, indeed, still hold it today, is the SME V. Revealed in 1984, the Series V looked like nothing else at



**ABOVE:** The Linn Ittok, which was released in 1979. By the early 1980s the classic combination of Linn Sondek LP12, Ittok arm and Asak cartridge had become well established

**TOP LEFT:** The 'Super Track Plus' labelling on the flip-up stylus guard reveals this cartridge to be a Series III Shure V15

**BELOW LEFT:** The Supex 900 MC cartridge still makes fine music matched with a Grace G707 arm and LP12 deck

**RIGHT:** The SME V, launched in 1986 at a price of £1200 after being revealed at shows two years earlier. Still in production, for many it remains the reigning super-arm

the time and, indeed, still looks fresh today. It was rigid, stunningly built and bestowed any turntable it was mated to with a powerful, deep and sophisticated sound.

The cheaper Series IV and Series 300 variants followed and all are bona-fide classics in their own right – even more remarkable considering they are all still in production today! SME's legendary service support means all models can be kept playing for many years to come and all hold their value remarkably well.

### A NEW BREED

The 1980s search for rigidity over lightness also brought about the one piece arm. The most stylish of these was undoubtedly the Alphason HR-100S of 1984 – a sleek S-shaped design made from aircraft-grade titanium. The more affordable Xenon appeared next, followed by the simpler Opal and Delta.

All Alphason arms offer very high performance, with a suitably serviced HR-100S more capable than most. The MCS versions also used silver internal wiring to great effect in the midrange and treble. This wiring is fragile, however, so ☹

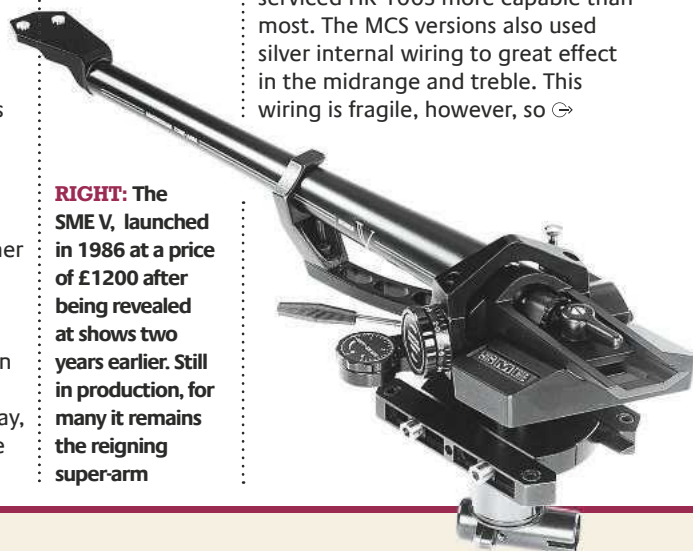

# SERIES V~12

MAGNESIUM TONE-ARM

Based on the multi-award winning Series V pick-up arm, the Series V~12 incorporates the same design and engineering that have made SME a byword for excellence. Coherent musical control is held over the entire frequency range in terms of tonal quality, stability and stereo imaging. Startling dynamic range, neutrality, structurally inert, the Series V~12 embodies every worthwhile feature in a pick-up arm. The 12 inch tone-arm is pressure die-cast in magnesium complete with an integrated headshell to eliminate tone-arm resonances in the audio spectrum and offers a 27% reduction in maximum angular error distortion over 9 inch models. Listening; the benefits of minimal tracking error and harmonic distortion are clearly revealed.



# SME

*“The best pick-up arm in the world”*

## BUYING VINTAGE



examine any potential purchase carefully and treat it tenderly.

The award for bringing the one-piece arm to the masses has to go to Rega and the RB300. Released in 1985 to great acclaim, it took the company's turntables to a new level of performance despite its previous arm, the R200, being a Japanese, Acos Lustre-based design and a very pleasant performer in its own right. The RB300 added grip, punch and super treble clarity to the mix; performance improving even further as one goes higher up the range to the flagship RB1000.

All unmodified Regas make fine used purchases.

Fellow UK manufacturer Helius Designs was another name synonymous with the 1980s vinyl scene, introducing the Orion and Aurum models in the early part of the decade. The Aurum



became the Aureus and the Scorpio joined the pair a little later on.

All three models garnered great acclaim for their neutrality and ability to perform well on a wide range of turntables. As before, thoughtful design and fine build quality mean that early Helius arms still offer much to the prospective purchaser today but tend to fly under the radar due to their low company profile. Consequently, real

bargains can be had, particularly as some early examples don't even have the maker's name on them!

To match the arms of the 1980s, MC cartridges gained in popularity. Ortofon's MC10, 20 and 30 appeared and gave rise to many improved variants, including the 'Super' and then metal-bodied 'Supreme' versions. These were developed further into flagship designs like the MC3000, the MC7500 and the MC Rohmann. The latter pair still qualify for attention as required under Ortofon's Special Repair Service.

### KOETSU AND KISEKI

Meanwhile, Yoshiaki Sugano's Koetsu company pioneered the use of high purity metals and exotic bodies to give high performance cartridges with equally exotic price

tags. All Koetsus beguile with their performance. Even the more humble Black and Red models provide a taste of the MC high life with price tags

that are still accessible.

Another MC manufacturer of the period was Dutch firm Kiseki. Its Blue was the original competitor to the Koetsu Black and Kiseki followed this with a similarly exotic range of other cartridges, ranging from expensive to truly eye-watering in price. Like Koetsus, all models are highly prized and their longevity and high quality is beyond question.

Finally, if you're looking for something a bit more everyday, one of the most enduring designs of the 1980s was Audio-Technica's AT-OC9 with its samarium cobalt magnet and nude elliptical stylus, which won praise for its spirited musicality and crisp detailing.

However, the latter can grate in unsympathetic set-ups and it's worth remembering that the later Micro Line stylus wrought great improvement in this area. Ⓟ



**ABOVE:** The classic Koetsu Black, which sold for £550 in 1985. Its price makes it one of the most accessible MCs from the marque

**ABOVE LEFT:** Cartridges from Dutch company Kiseki, which were launched in the early '80s (l-r) – the 'Blue' 'Wood' and 'Agate' models

**FAR LEFT:** The evergreen Rega RB300 – a solid performer and the basis for many a modification. Original, untweaked arms are the better bet when buying secondhand

**BELOW:** The Helius Orion which, according to its manufacturer, was originally designed to take the Audio Note IO cartridge

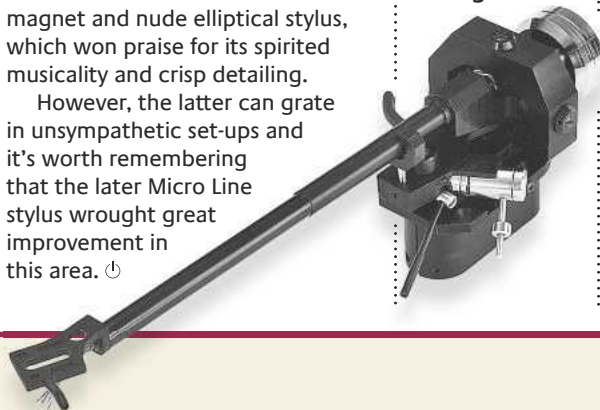

### ALSO CONSIDER...

**Odyssey RP1:** Elegant 1980s design from a small Scottish manufacturer. Beautifully engineered and exquisitely finished, often in gold plate. **Keith Monks MBA9:** Unipivot but with arm tube-to-bearing housing contact through four small troughs of mercury. Treat with great caution!

**Hadcock GH228:** Certainly a less hazardous unipivot design than the Keith Monks MBA9. It's easy to setup and use and is sonically highly capable. A modern version lives on today.

**Dynavector DV-505:** Instantly recognisable heavyweight beast of a tonearm. Capable of excellent performance but too heavy for most suspended-subchassis turntables.

**Naim Aro:** A simple but very effective unipivot that works equally well away from its usual partner, the Linn LP12. Its discontinuation a few years back is still a surprise.

**Decca Deram:** Yes it's a ceramic cartridge but none the worse for that! Needs special loading, which means a vintage amplifier or DIY preamp but sounds superb. Decca also made a matching tonearm which is no slouch, either.

**Stanton 500AL:** The standard hard-use cartridge for many years. Tough as old boots and shrugs off most of the abuse that can be thrown at it, which goes some way to making up for its rather low-key sound.

**Dynavector XX-1:** Possibly the only cartridge with a switch on the front. This controls the inbuilt flux damper that smooths response with highly modulated grooves.

**AKG P8:** A 1970s cartridge that's sometimes said to be one of the best MMs ever made. Unusual suspension design gives superb imaging and clarity but it's prone to failure with age.

**Goldbug Ms Brier:** Quirky MC with a wooden body hand-carved by a lady who was the only female pipe maker in Japan. Apparently. Smooth performer with a luscious midrange.



## Spring "B Grade" and Second hand CLEAR OUT! Big Savings on our normal prices!

### MB845 II Super "They have no equal!"

"5 Globes" Extraordinary sound quality Hi Fi World...  
Two pairs from review and exhibition stock, not quite pristine, with only a few hours on each pair. David Shaw signature with upgrades and Jensen capacitors. Same as the "m" but without the meters

**Was £7,149 Now only £4,999**



Low Distortion  
Tertiary Transformers

### Stereo 40 GAS7 20 + 20 watts of pure triode

Pure triode sound with excellent dynamics and bottom end. Very economical on valves. Will drive almost any speakers. Lots of features. 1 used, 2 ex demo.

**Was £1,399 Now only £1,099**



Low Distortion  
Tertiary Transformers

### Other Bargains:

Pair "Made For Valves" floor standing speakers damaged corner, Walnut, New  
Was £999 Now only £699

Early ST300 300B push pull integrated 28+28w of pure triode ex demo  
Was £1,500 Now only £999

Early ST60 KT88 push pull integrated 60+60w of UL, or 30w triode, used  
Was £1,100 Now only £799

Pr MB25 300B 28+28w mono blocks 1 careful owner lovely condition  
Was £1,995 Now only £999

2 ST40i 35+35w integrated amplifiers Lovely condition fully guaranteed  
Was £999 Now only £499

ST40 II White 35+35w integrated amp 1 careful owner, now sought after  
Was £899 Now only £549

ST50 White 50+50w integrated amp 1 careful owner, now sought after  
Was £999 Now only £699

LA4 line pre amp, remote control Excellent condition, used  
Was £799 Now only £499

Pair MB805 805 SET mono blocks Ex demo almost perfect, new  
Was £5,999 Now only £3,999

2 Ex demo MC TX step up transformers  
Was £349.95 Now only £275

### STOP PRESS!

Just arrived sorry no prices at time of going to press. Email, phone or see our website for info.

- 2 EAR 845P phono pre, used VGC
- 2 Michelle Giro turntables used VGC
- Palmer "stone" belt drive turntable
- Musical Fidelity P270 amp serviced used
- Thorens TD150 turntable "classic" VGC
- Icon Audio LA3 line pre amp VGC
- Audio Lab 8000S integrated amp VGC
- Audio Innovations S 500 EL34 amp used
- Rega Mira int 60+60w amp VGC used
- Cyrus 6V S2 integrated amp used VGC
- Audio Lab 8000 PPA phono stage VGC
- Sugden Audition C integrated amp VGC
- Goldring GL75 turntable used VGC

### KingSound Electrostatics

#### 30%-50% off All Models

| Model (pairs)                      | Was     | Now    |
|------------------------------------|---------|--------|
| King System 1 used                 | £12,000 | £6,000 |
| King full range 1 used             | £9,600  | £6,720 |
| King Tower omni directional 2 used | £2,400  | £1,200 |
| Prince II 3 used                   | £3,500  | £1,990 |
| Queen II (pic) 1 slight damage     | £2,000  | £1,400 |
| Princess II 2 ex demo 2 used       | £800    | £560   |
| Princess 1 ex demo                 | £800    | £400   |
| Hummingbird super tweeter 2 used   | £500    | £290   |

All available for audition in Leicester. Kings, Prince and Queen are only available for collection or local delivery.

### Stereo 60 MK III 80+80 watts KT120 or KT150



all designed by David Shaw  
**Was £2,399 Now £1,899**

All the features you could wish for with high power, remote control, UL/Triode operation, record loop, H/L sensitivity, low distortion, massive bass, point to point wiring, New KT120 or KT150 (+ £200). Same as the latest "m" model.

### MB150 150+150w Mono Blocks

150+150w of pure UL valve power (or 100 + 100w of pure triode), Using 4 KT90, (KT120 & 150 option). Based on our award winning MB90s. Still with the Icon warmth and texture at low volume, with massive headroom and very low distortion. Ex demo Ex condition.

**Was £3,299 Now £2,299**



Low Distortion  
Tertiary Transformers

### Stereo 40 MkIII integrated amp

Stereo 40 MK III our best ever value amplifier. It has everything! 40+40 watts, Triode mode, Valve rectifier. Remote control. Tape loop. Standby switch. KT66/KT88 EL34/6550 compatible. **Two rave reviews in HFW and HFN.**

**Was £1,699 Now £1,399**

"...Bristling with musical energy, smooth & sweet..."  
P Rigby Hi Fi World  
Awarded 5 Globes

Low Distortion  
Tertiary Transformers



### Phono Pre amp Bargains

2 Unique Pure Valve models that make heavenly music! PS2mm in silver, 4 new with minor scratches.

**Was £599 Now only £499**

PS3 Black with silver front. MM or MM+MC. Very advanced preamp, many features: All Valve power supply, David Shaw designed for rich vibrant music that only pure valve designs can give. 5 units in near perfect condition.

**Was £1,999 Now only £1,499**



Choosing new or upgrading your hi fi can be stressful! It's not just the money but the time wasted and that "oh not again!" feeling when things are not quite right. We can help. Since 1999 we have been designing and selling high quality amplification at affordable prices that is now popular worldwide. We make a huge range of pure valve amplifiers to suit many different needs. We have built our reputation on being honest and dispassionate so why not come for an audition in Leicester and find out how we can help you to get that magical holographic sound dancing in front of your ears.

Sincerely *David Shaw*

Limited Stock. All items are "ex demo", "B Grade" or second hand and will have some small blemish. Supplied 100% working and fully guaranteed by us for 12 months new (6 months second hand). If you have a particular query, please email or ring first for clarification. Ideally you will inspect and audition in our showroom. Home trial is only available to personal callers. See our website for more info.

Buy direct from us. Export no problem! (EU £30 per box) Want to know more? See [www.iconaudio.com](http://www.iconaudio.com) or ask for a leaflet.

.....Or ring us on +44 (0)116 2440593 email [sales@iconaudio.com](mailto:sales@iconaudio.com) **icon Audio** 351 Aylestone Road Leicester LE2 8TA (U.K.)

\*Whilst stocks last, Conditions apply ask for details Prices correct with 20% UK VAT at time of going to press but subject to change. E & O E UK Visa, MasterCard AMEX and debit cards accepted

# B&O Beogram 4000 turntable

It was a technical tour-de-force in its time and can lay claim to being one of the most complex decks ever to enter mass production. But how does it measure up today?

Review: **Tim Jarman** Lab: **Paul Miller**

**T**he Beogram 4000 is as much respected for its industrial design as it is for its audio performance. Launched in 1972 at a price of around £160, the 4000 was generally the preserve of wealthy music lovers rather than the traditional hi-fi hobbyist. Despite being expensive, it sold in large numbers and remained available in various forms until the end of the decade, when the 4000 series was replaced by a new range of direct-drive models.

The Beogram 4000 was an integrated turntable: in the sense that the motor unit, arm and cartridge were designed together to work as one optimised system. Prior to the 4000 project, B&O had considered building a conventional turntable with a long arm but this was rejected in favour of tangential tracking, the Beogram 4000's most famous feature.

At the cost of additional complexity, tangential tracking sidesteps the geometrical compromises inherent in conventional arm designs. Since records originate on lathes where the cutting head moves tangentially, it is logical that the best way to play them is on a deck whose pick-up follows exactly the same path as the cutting head. The tangential arm on the Beogram 4000 is short and stiff. Meanwhile, its movement is controlled



**ABOVE:** Slim, elegant and packed with the most advanced technology available, there was no other turntable quite like the Beogram 4000 when it appeared in 1972 and it remains a truly iconic design

by an electronic servo which eliminates the harmful effects of friction and inertia associated with purely mechanical systems.

## SUPERIORITY COMPLEX

If there was ever a competition for the most complex turntable ever to enter mass production then the Beogram 4000's only rival would surely be the Sony PS-B80 [*HFN* Jul '12]. Indeed, a full technical description of the 4000 might fill this entire magazine. The basic structure comprised a die-cast tray that served as the basis for the slim and elegant plinth. This housed another casting, which formed a floating sub-chassis. Beogram 4000s were immensely sturdy; some dealers would demonstrate this fact by placing the unit on the floor and then stand carefully on the lid!

The suspension was constructed using three arched spring steel strips from which the sub-chassis hung on fine wires. This provided highly effective isolation from

external vibrations. Onto the sub-chassis were mounted a substantial bearing for the platter, along with polished chrome runners which supported the arm assembly. The arm was moved by a lead screw driven by a servo motor of the ironless core type. This was an expensive component, but it did allow the arm to move with the finest possible resolution.

The platter, which was another heavy casting, was belt driven. However, rather than have the motor connected directly to the mains as was the conventional practice at the time, the designers chose to run it from an internal precision oscillator. The aim was to create perfect waveforms on demand. As well as giving the best possible performance, this made automatic speed selection a realistic proposition and removed the need to provide different motors for export (60Hz) markets.

The speed could be fine-tuned by the user and to help with this a stroboscope

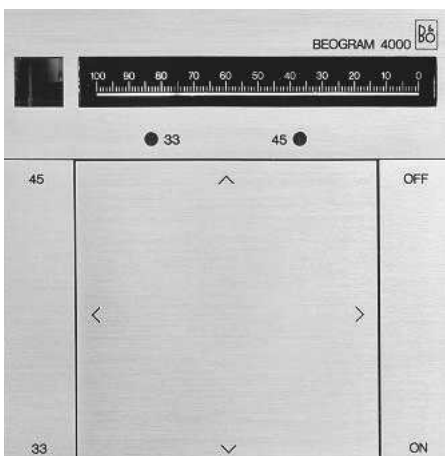

**LEFT:** No knobs or levers here – all functions are controlled via pressure-sensitive metal surfaces





## VINTAGE HI-FI

**RIGHT:** With looks like these, is it any wonder that a Beogram 4000 is part of the permanent Museum Of Modern Art collection in New York? In pure styling terms, few turntables come close

travel: a clever touch which removed the need for additional sensors.

The arm was tipped with a moving-iron cartridge, purpose-designed and originally known as the SP15 but re-named the MMC4000 soon after the deck's release. Supplied as a sealed and calibrated assembly, this cartridge was unusual at the time because of its non-replaceable stylus. B&O initially offered complete replacement units at half-price to allay customers' fears of potentially high operating costs.

Since there is no conventional head shell you can only use B&O cartridges in the Beogram 4000, but this is no hardship since on the whole they work very well and will connect directly to any quality amplifier with an MM-type input. However, an adapter will be needed for the DIN plug if the rest of your system uses RCA sockets. What's more, this must be made to a specification which accommodates the turntable's grounding requirements.

### TIM LISTENS

The Beogram 4000 has a smooth, silky, luxurious sound that encourages long listening sessions. No matter how late it is, there always seems to be time for one more side of an LP.

Another quirk is that vinyl surface noise is unusually well suppressed, making quiet passages and the gaps between tracks sound almost CD-clean.

Furthermore, the use of tangential tracking means that distortion levels do not rise at the beginning and end of each side of the record (as they do with conventional arms), so after a while it is easy to forget that you're listening to vinyl. Nevertheless, one occasionally hear an unusual 'swooshing'

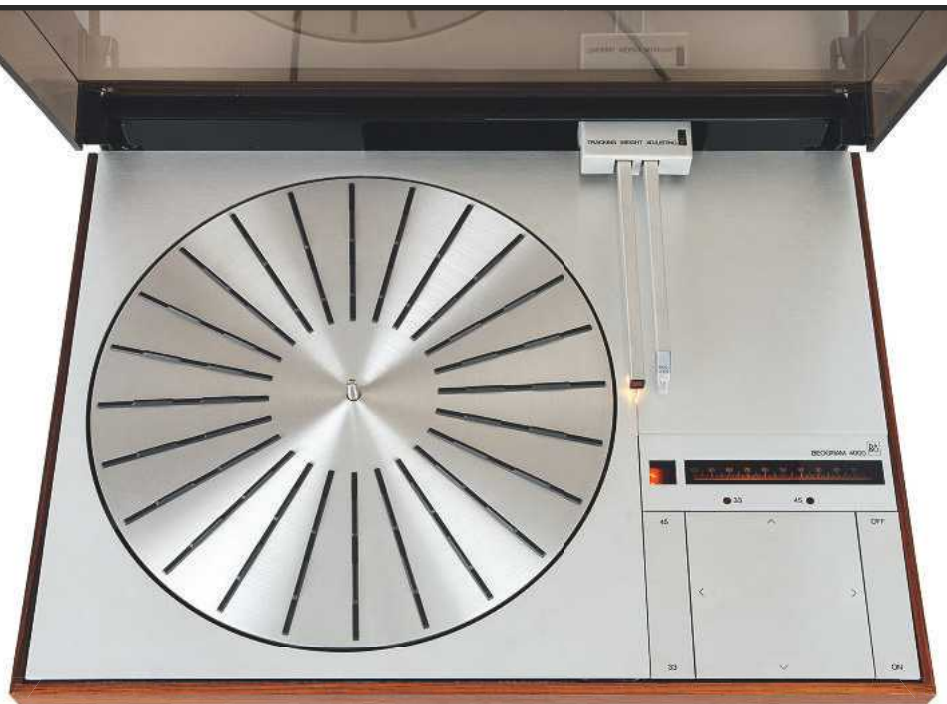

sound which is generated by the record slowly walking round on the hard plastic ribs of the platter if the former is not completely flat. Contemporary reviewers repeatedly complained about this and begged B&O to change the design. This it only did in 1982 for the last of the big tangential-tracking Beograms, the 8002. The stubby, tapered centre spindle and the shallow lid preclude the use of clamp to minimise this effect.

Mussorgsky's *Pictures At An Exhibition* [RCA Victor LSC-2201] proved to be a compelling listen on the Beogram 4000. The recording requires

a turntable which can set sudden bursts of activity against a quiet background, which the 4000 did exceptionally well. Although not the brightest sounding of decks, the B&O rendered the percussion and woodwind, both of which occasionally become quite energetic, with an ease that leaves you wanting for nothing more.

At the bass end, the thundering subsonics of 'Bydlo' were both fulsome and accurate, suggesting that the sophisticated arm is at ease and well behaved. There was no loss of detail as each side came to a close, so you are able to enjoy the likes of the 'Ballet of the Chicks in their Shells' as if it were optimally placed in the centre

**LEFT:** A close up view of the two arms, the one on the left is the sensor and the one on the right is tipped with a purpose-designed moving-iron cartridge. Note that there is no headshell

of the recorded area. To these ears this ability alone places the Beogram 4000's performance above what is achievable with conventional turntables of any type.

The Mussorgsky album is typical of what the original Beogram 4000 customer would have listened to, but even more modern styles do not seem to seriously wrong-foot it. Along with an album of 12in remixes of Howard Jones tracks, The Pet Shop Boys' *Introspective* and Kate Bush's *The Kick Inside*, one of the LPs I tried was *Orchestral Manoeuvres In The Dark's Architecture And Morality* [Dindisc DID12, blue outer sleeve version].

Here, when playing tracks like 'Souvenir', I found that the Beogram 4000 possessed surprisingly good timing for a belt-driven deck. Of course, the accuracy of a good Japanese quartz-locked direct drive was never going to be on the menu, but the heavy platter and powerful motor meant that the B&O came surprisingly close.

True, some will prefer a more vivid top-end when listening to electronica like OMD's, but set this aside and the 4000 just sounds relaxed, solid and natural – surely the purpose of the whole business of hi-fi.

### BUYING SECONDHAND

Finding a used Beogram 4000 is not difficult. Broken styli can now be repaired (see [www.schallplattennadeln.de](http://www.schallplattennadeln.de)) and Soundsmith manufactures complete replacement cartridges (see [www.sound-smith.com](http://www.sound-smith.com)).

The 'tongue' onto which the cartridge mounts is fragile, as are the connections to the coil inside the cartridge itself. The ➤

*Graham Walley*  
LEGACY RANGE

## GN-2

### ***Straight Line Contact Banana Plug***

*I have designed the Straight Line Contact Plug because I enjoy listening to great music and I want to experience the musician's artistry in full. I have listened, compared and evaluated various options and to my ears, the Straight Line Contact Plug gives me the sound I like best.*

*In the GN-2 plug the connection is made by a thin cylindrical wire, plated in gold to protect the sensitive connection between the cable and the binding post from corrosion which may distort the music.*

*By reducing the surface area of the contact between plug and binding post this gives a focused contact that delivers a clearer sound quality than conventional designs.*

*The GN-2 Straight Line Contact Plugs will make a real positive difference to your enjoyment of your music. If they don't, I will happily refund you your full purchase price.*

*Graham Walley*



[www.gnlegacy.co.uk](http://www.gnlegacy.co.uk)

[info@gnlegacy.co.uk](mailto:info@gnlegacy.co.uk)

+44 (0)1332 342233

# Dreams of Venice



A unique opportunity to attend a great concert which will be recorded by the producer of the award winning audiophile CD "Chasing The Dragon". Mike will be using a Decca Tree configuration with valve microphones. The CD will be available from [www.chasingthedragon.co.uk](http://www.chasingthedragon.co.uk). Contact Françoise on 07880 792 331

**Vivaldi ~ Marais ~ Sarasate** performed by the leading Venetian Orchestra  
**INTERPRETI VENEZIANI**

**Saturday 14 June at 7:30pm**

**St John's Smith Square ~ London**

£25 £20 £15 seats available from the box office

020 7222 1061

[www.sjss.org.uk](http://www.sjss.org.uk)



## VINTAGE HI-FI

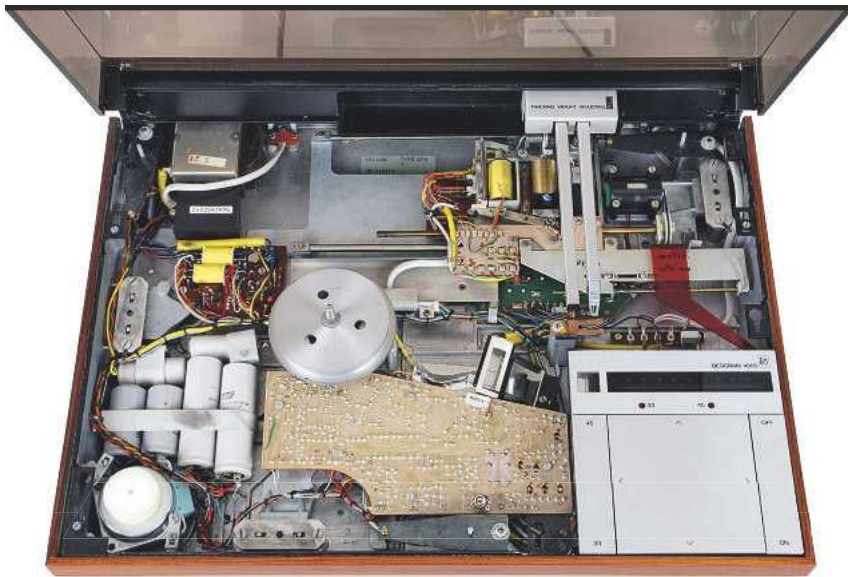

**ABOVE:** Removing the top plate reveals the sheer complexity of both the mechanics and electronics involved. The sub-chassis and cue/lead screw are both clearly visible

latter cannot be repaired, so don't remove the cartridge unless it is absolutely necessary to do so.

Instead of the correct SP15, MMC4000 or MMC20EN cartridges, one occasionally sees units fitted with lesser models, often taken from worn-out music centres. Types MMC3000, MMC20S and MMC20E fall into this category and while they will work, they do not offer the same level of performance. At the other end of the scale, types MMC6000 and MMC20CL are useful upgrades if you can find examples of either in good condition.

### ALSO CHECK...

As to the rest of the turntable, check that the cueing mechanism is free to move, as any stiffness here can burn out the solenoid coil. Another weakness is the disc detector, which can stop working when the photocell in the second

arm fails. This can lead to the stylus being ruined against the ribs on the platter, but note that a worn-out drive belt can also give similar symptoms if it causes the platter to take a long time to get up to speed.

If the arm lifts before the record has finished, check the belt which links the servo motor to the cueing/lead screw is the correct type before diving into the electronics. One that is too tight will cause this symptom. Also note that the machine will not work at all if the bulb in the detector arm fails, though this is rare.

Finally, be aware that even when apparently switched off a fair amount of the circuitry is still active, including the mains transformer. This is a special component which is difficult to replace if it fails – something which is not unknown. ☺

### HI-FI NEWS VERDICT

This very early example of a tangential-tracking turntable shows just what the system is capable of when implemented with care. Sadly, few other manufacturers rose to the technical challenge of making a similar deck, so the B&O remains an unusual, but always pleasurable, way to enjoy music on vinyl. It is also very easy to use, its automation is foolproof, and it looks downright stunning, too.

Sound Quality: 83%



## B&O BEOGRAM 4000 (Vintage)

B&O provides an illuminated strobe to assist in the manual fine-tuning of the Beogram 4000's speed, although, with the strobe 'stripes' stationary, its absolute accuracy was just under -0.4% adrift (just as likely due to the thermal drift of the strobe itself). This will not be audible and is a fine result for a vintage deck complete with an original motor unit. Wow and flutter was a little higher than B&O's 1972 specification at 0.12% (peak-weighted) – a mix of  $\pm 3\text{Hz}$  low-rate and  $\pm 45\text{Hz}$  high-rate components, the latter not the obvious 50Hz flutter that might be guessed from a quick glance at the spectrum [see Graph 1, below]. Rumble, on the other hand, proved a few dB better than B&O's suggested DIN B-weighted figure at -67.3dB (through the groove). A through-bearing/motor figure could not be obtained as the optical wand fouled the rumble-coupler!

The parallel-tracking tonearm may offer a very low 5g effective mass (compatible with the high compliance SP15 moving-iron pick-up tracking at a mere 1g) but the square-section tube still has a relatively low 118Hz main bending mode. This low-Q mode is broadly distributed across the bass spectrum [see Graph 2, below] but is accompanied by higher-Q harmonics/torsional modes at 280Hz, 360Hz and 460Hz. The simplicity of the structure is reflected in the relative cleanliness of this waterfall spectrum with a lone high frequency break at low amplitude at 1.1kHz possibly due to the cartridge mounted into the end of the arm (rather than bolted onto a headshell). Readers may view a comprehensive QC Suite test report for B&O's Beogram 4000 turntable by navigating to [www.hifinews.co.uk](http://www.hifinews.co.uk) and clicking on the red 'download' button. PM

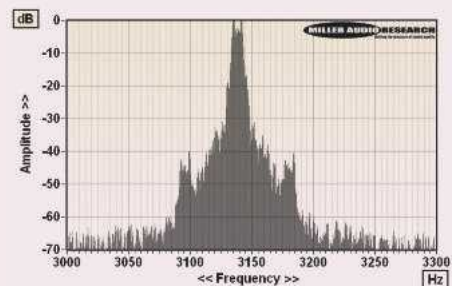

**ABOVE:** Wow and flutter re. 3150Hz tone at 5cm/sec (plotted  $\pm 150\text{Hz}$ , 5Hz per minor division). Note the correlated wow at  $\pm 3\text{Hz}$  and  $\sim \pm 15\text{Hz}$  flutter

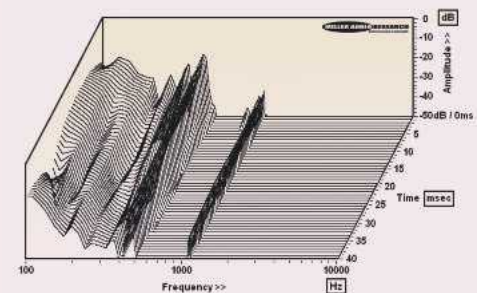

**ABOVE:** Cumulative tonearm resonant decay spectrum, illustrating various bearing, pillar and 'tube' vibration modes spanning 100Hz-10kHz over 40msec

### HI-FI NEWS SPECIFICATIONS

|                                      |                      |
|--------------------------------------|----------------------|
| Turntable speed error at 33.33rpm    | 33.21rpm (-0.38%)    |
| Time to audible stabilisation        | 3sec                 |
| Peak Wow/Flutter                     | 0.06% / 0.06%        |
| Rumble (silent groove, DIN B wtd)    | -67.3dB              |
| Rumble (through bearing, DIN B wtd)  | See lab report       |
| Hum & Noise (unwtd, rel. to 5cm/sec) | -62.5dB              |
| Power Consumption                    | 17W                  |
| Dimensions (WHD) / Weight            | 490x100x381mm / 12kg |

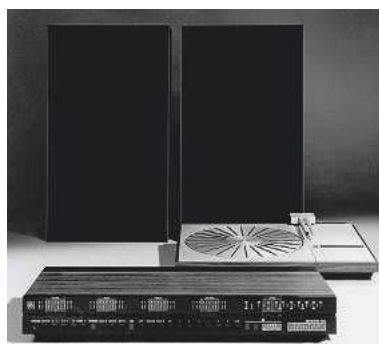

**ABOVE:** B&O also released a receiver to match – the Beomaster 4000 – seen here

# BLUESOUND

A sound experience like no other. Because it's engineered like no other.

NEW



BLUESOUND IS STREAMING, WIRELESS, MULTI-ROOM, 24-BIT TRUE HIGH-DEFINITION SOUND.

FOR THE LATEST PRICES AND OFFERS VISIT [WWW.SSAV.COM](http://WWW.SSAV.COM) OR CONTACT YOUR LOCAL STORE



NEW

£209  
OR LESS

#### PRO-JECT • ESSENTIAL II • TURNTABLE

Entry-level "plug'n'play" two speed turntable with single piece aluminium tonearm and pre-fitted Ortofon OM5e cartridge.



£299  
OR LESS

#### NAD • C 556 • TURNTABLE

Time to enjoy vinyl collections with extraordinary quality! With a minimalist design, the C 556 turntable offers accurate reproduction by using performance-focused parts and components that put music first.



NEW

£575  
OR LESS

#### PRO-JECT • 1 XPRESSION CARBON • TURNTABLE

With its Carbon armtube and supplied Ortofon 2m Silver cartridge, the 1 Xpression Carbon sets new standards in its price range.



NEW

£799  
OR LESS

eptX  
CS7

Bluetooth™

AirPlay

#### NAD • D 7050 • NETWORK AMPLIFIER / DAC

Combines NAD's most advanced digital platform, Direct Digital technology with Apple AirPlay Wi-Fi streaming to create the ultimate plug 'n play solution for wireless music.



£2895

#### NAIM • UNITI 2

#### ALL-IN-ONE NETWORK SYSTEM

Combines an integrated amplifier, CD player, DAB/FM tuner, internet radio, iPod dock, digital-to-analogue converter and high-resolution 24bit/192kHz capable network stream player.



£1195

#### NAIM • UNITIQUTE 2

#### ALL-IN-ONE STREAMING SYSTEM

All-in-one system featuring a 30W amplifier, FM/DAB/Internet radio and wired and wireless connections to play network digital audio. UnitiQute 2 can play USB-stored music files of up to 32bit/192kHz resolution.



SSAV  
.COM

#### PIONEER • N-50 • MUSIC STREAMER

Award-winning audiophile Network player supporting AirPlay® and DLNA wireless technologies, allowing you to stream music wirelessly from your iTunes libraries or iOS devices. When connected to your home network, you can also enjoy a wide variety of online music services remotely.



NEW

£399  
OR LESS

DLNA

AirPlay

#### ARCAM • airDAC • AIRPLAY ENABLED DAC

The Arcam airDAC allows you to network any audio system to an Apple AirPlay® enabled music source and is the only audiophile quality AirPlay enabled device available. It also features a secondary digital audio input and a SPDIF digital output.



NEW

£799  
OR LESS

#### SONY • HAP-S1

#### HI-RES AUDIO PLAYER SYSTEM

Take your music enjoyment to new heights with Sony's new HAP-S1 500GB HDD audio system with 2x40W analogue amplifier, easy music file transfer and smartphone browsing.

PLEASE NOTE: SOME BRANDS/PRODUCTS ARE NOT AVAILABLE AT ALL STORES. SPECIAL/ADDED VALUE OFFERS ARE NOT IN CONJUNCTION WITH ANY OTHER OFFER (NICWAOO). ADVERT VALID UNTIL 04/06/2014. E&OE

[www.SSAV.com](http://www.SSAV.com)

SEVENoaks  
SOUND & VISION



£649  
OR LESS

£649  
OR LESS

**ARCAM • FMJ CD17 / A19 • CD / AMPLIFIER**

Arcam's A19 integrated amplifier delivers 50W per channel and includes 7 analogue inputs, a MM phono input and is the perfect partner for the CD17 CD player.



£799  
OR LESS

£749  
OR LESS

**AUDIOLAB • 8200CD / 8200A • CD / AMPLIFIER**

The award-winning 8200CD features a wealth of digital inputs that will keep it playing all your music regardless of how it may be stored.



£399  
OR LESS

**ARCAM • irDAC • DAC**

Designed to be the heart of a digital system. Includes asynchronous USB and a direct iPod input to optimise sound quality. All inputs can be controlled through an IR remote that will also control iPods, iPhones, PC and Mac computers.



NEW

£975  
OR LESS

£1499  
OR LESS

**CYRUS • CD i / 8 DAC • CD PLAYER / AMPLIFIER / DAC**

With its 2 x 70 w power output and extended range of digital inputs, the 8 DAC amplifier is a great partner for the new CD i CD player.



NEW

ESSAV  
.COM

NEW

ESSAV  
.COM

**MARANTZ • CD6005 / PM6005 • CD / AMPLIFIER**

Replacing the 6004 models, the 6005 amp gains digital inputs using the same 24-bit/192kHz DAC as the CD player which now features enhanced USB playback and improved performance.



£599  
OR LESS

**AUDIOLAB • M-DAC • DAC / PREAMP**

Award-winning DAC featuring a USB input with asynchronous data processing along with two coaxial and optical digital inputs. High-res 24-bit/192kHz music files can be played via its coaxial input.



NEW

aptX  
CSR

Bluetooth

£399  
OR LESS

**NAD • D 3020  
AMPLIFIER / DAC**

Features digital and analogue inputs plus the convenience of wireless streaming with its Bluetooth capability.



£499  
OR LESS

£699  
OR LESS

**NAD • C 546BEE / C 356BEE DAC • CD / AMP / DAC**

Enjoy music from your computer without musical compromise via the DAC or listen to music from CD with the MP3 / WMA compatible CD player.



**AUDIOQUEST • DRAGONFLY v1.2  
DAC / HEADPHONE AMP**

An affordable and easy-to-use device that delivers far superior sound by bypassing the poor quality sound card that is built into your computer.

DragonFly is a sleek, flash drive sized Digital-Audio Converter that connects to a USB jack on a Mac or Windows PC, turning any computer into a true high-fidelity music source.

NEW

£129  
OR LESS

£399  
OR LESS

**NAD • D 1050  
DAC / HEADPHONE AMP**

The best way to add Computer Audio and HD Digital to your hi-fi system. In fact, all digital sources will get a boost when the D 1050 takes over for the inferior digital circuitry found in everything from Blu-ray, DVD and CD players, to music streamers and set-top boxes.



£1899  
OR LESS

£1899  
OR LESS

**ROKSAN • CASPIAN M2 • CD / AMPLIFIER**

The M2 amp boasts 85wpc and five line inputs while the matching CD features a 24-bit DAC plus dedicated power supplies for the outputs.



£599  
OR LESS

£499  
OR LESS

**ROTEL • RA-12 / RCD-12 • AMPLIFIER / DAC / CD**

Amplifier with DAC that supports iPod USB and Bluetooth audio streaming. Includes four analogue line-level inputs and a phono input. The RCD-12 CD player is an ideal partner.



£1499  
OR LESS

NEW  
BLACK  
FINISH

**NAD • M51 • DAC**

This award-winning DAC / pre-amp features optical, coaxial, USB and HDMI inputs, all of which can handle files up to 24-bit/192kHz. The M51 will truly transform any system.



ESSAV  
.COM

**DENON • D-M39DAB • CD / DAB SYSTEM**

This micro component system gives you clean dramatic sound, and more life to iPod and iPhone music libraries via its digital USB input. Includes DAB/DAB+/FM tuner.



NEW

£449  
OR LESS



**MARANTZ • M-CR610 • CD / DAB / NETWORK SYSTEM**

Enjoy great sounding music from diverse sources, including Internet radio, music-streaming services, mobile devices, TV and other digital audio sources.



NEW

£399  
OR LESS



**YAMAHA • CRX-N560D • CD / DAB / NETWORK SYSTEM**

This Hi-Fi system, with a CD player, DAB/DAB+ tuner for digital broadcasts and Network compatibility with AirPlay, combines elegant design with high quality sound.

**Real Stores**

Sevenoaks Sound & Vision have 26 stores nationwide with plans to open more during 2014. Each carries the best in home cinema and Hi-Fi equipment on display, ready for you to watch, listen to and compare in our dedicated demonstration rooms.

**Real Products**

A wide selection of products from the world's leading manufacturers is in stock and available for you to take home. We also offer a delivery and installation service as well as a convenient on-line click and reserve option for many of our products.

**Real People**

Our staff are friendly, knowledgeable and passionate about music and film and the equipment needed to get the most out of your collection. They will be delighted to assist you in making the right selection to ensure you enjoy your system for years to come.

**Real Value**

Fantastic value for money is our aim. Although we remain independent, you will be pleasantly surprised just how competitive we can be - with the added benefit of seeing, hearing and touching the product before you buy, and someone to help if things go wrong.

FOR THE LATEST PRICES AND OFFERS VISIT WWW.SSAV.COM OR CONTACT YOUR LOCAL STORE

**BOWERS & WILKINS • CM10**

Introducing the CM10, a new flagship for the CM series that combines technologies from the Reference ranges with innovative new construction techniques. The result is simply spectacular.

**NEW** £2999  
OR LESS

**BOWERS & WILKINS • 685 S2**

At home on a stand, wall or bookshelf, the versatile 685 S2 is ideal for stereo and home theatre uses in most rooms. And performance is enhanced with the addition of a Decoupled Double Dome tweeter.

**NEW** £499  
OR LESS

PRICE EXCLUDES STANDS

**PMC TWENTY-22**

An astonishingly natural balance and high dynamic capability are the hallmarks of this speaker. It creates a precise sound stage and profound bass performance from its compact cabinet.

**£1970**  
OR LESS

**TANNOY • REVOLUTION DC6T SE**

Award-winning compact, floorstanding speakers featuring Tannoy's unique Dual Concentric™ drive unit along with trapezoidal cabinets. Exclusively finished in luxury Espresso colour real wood veneer.

**£999**  
OR LESS

**MONITOR AUDIO SILVER 6**

2.5 way speaker system combining excellent dynamics with a naturally rhythmic sonic character and tight, controlled bass. The Silver 6 is an outstanding communicator of music and film audio.

**NEW** £999  
OR LESS

**PSB IMAGINE MINI**

Meet the newest and smallest member of the ultra-stylish Imagine Series. The deceptively small Imagine Mini makes a big impact on an already impressive range of award-winning speakers.

**£599**  
OR LESS

**Q ACOUSTICS • CONCEPT 40**

The Q Acoustic Concept 40 floorstanding speakers are the latest addition to the award-winning Concept range and deliver unparalleled sonic performance at its price.

**NEW** £999.95  
OR LESS

**KEF • R500**

The smallest of the floorstanders in the R Series. Uses the latest generation Uni-Q driver array and two 5.25-inch aluminium bass drivers. Its slim proportions and sleek contemporary looks make it perfectly suited for any interior.

**£1499**  
OR LESS

**KEF • LS50**

An innovative concept derived from the legendary LS3/5a. Rarely the case in such a compact design, the LS50 monitor delivers a rich, multi-dimensional 'soundstage experience' that is out of all proportion to its size.

**£799**  
OR LESS

**SONOS THE WIRELESS Hi-Fi SYSTEM**

The Sonos Wireless Hi-Fi System delivers all the music on earth, in every room, with deep, richly textured sound. Sonos is the only system that combines Hi-Fi sound with high-performance wireless. Plus it's simple to set-up, control and expand so you can easily fill your home with music.

**ESSAV**  
.COM

**BOWERS & WILKINS P7 HEADPHONES**

With P7, everything is designed to allow you to lose yourself in music. Bass is tight, vocals are precisely defined, and there's a wonderful sense of space, balance and clarity across the whole frequency range. P7's cable comes with a remote/microphone attachment, so it works seamlessly with your iPhone.

**NEW**

**£329**  
OR LESS

**RUARK AUDIO R7 WIRELESS SPEAKER SYSTEM**

Retro design combining DAB and FM tuners, CD-quality aptX Bluetooth, DLNA network streaming, internet radio, CD playback, auxiliary analogue and digital inputs and a 2.1 speaker configuration in one beautifully crafted unit. The R7 is manufactured to an uncompromisingly high standard with a furniture-grade walnut cabinet and is supplied with spindle legs for free standing use and puck feet for placing on a cabinet.

aptX  
Bluetooth  
DLNA

**NEW** £1999  
OR LESS



Supplied with spindle legs for free standing use or puck feet for mounting R7 on an existing sideboard or cabinet.

**NAD VISO HP50 HEADPHONES**

Designed for long-wearing comfort and listening with ultra-soft noise-isolating earpads. The convenient three-button Apple remote offers full control of all Apple music and call functionality right at your fingertips, plus voice control with Siri-compatible devices.

**NEW**

**£249**  
OR LESS



Best Independent Retailer (Large)  
Consumer Electronics

Award Winner 2014

**Stores Nationwide**

We have a national network of stores and a hard-won reputation for outstanding customer service.

**Website**

Visit our website for a streamlined on-line experience with an outstanding product selection plus the latest product news and store information.

Aberdeen • 01224 252797  
Bishop's Stortford • 01279 506576  
Bristol • 0117 974 3727  
Bromley 020 8290 1988  
Cambridge • 01223 304770  
Chelsea • 020 7352 9466  
Cheltenham • 01242 241171  
Chorleywood • 0845 5046364  
Epsom • 01372 720720  
Exeter • 01392 218895

Guildford 01483 536666  
Holborn • 020 7837 7540  
Kingston • 020 8547 0717  
Leeds (Wetherby) 01937 586886  
Loughton • 020 8532 0770  
Maidstone 01622 686366  
Norwich • 01603 767605  
Oxford 01865 241773  
Reading • 0118 959 7768  
Sevenoaks 01732 459555

Sheffield • 0114 255 5861  
Southampton • 023 8033 7770  
Tunbridge Wells 01892 531543  
Weybridge 01932 840859  
Witham (Essex) 01376 501733  
Yeovil • 01935 700078

\*THESE STORES ARE FRANCHISED AND OPERATE UNDER A LICENCE AGREEMENT TO SEVENOAKS SOUND & VISION

ADVERT VALID UNTIL 04/06/2014. E&OE.

Please Note: Some brands/products are not available at all stores. Special/added value offers are not in conjunction with any other offer (NICWAOO).

**SEVENOAKS**  
SOUND & VISION

Gato Audio  
DIA-250 Integrated Amplifier  
£2990



"The AMP-150 is both physically beautiful and sonically uncompromised... this is pure audiophile heaven."

[6moons.com](http://6moons.com)

**Gato**  **audio**

The Absolute Pinnacle  
of Danish  
High End Audio



Gato Audio CDD-1 High End DAC  
and CD Player  
£5290



Gato Audio AMP-150  
Integrated Amplifier  
£5290



£8950  
Gato Audio FM-6 Speakers

Gato Audio PRD-3  
Preamplifier  
£2190





**AURALiC**  
innovate technologies  
& inspire the music

audioemotion

www.audioemotion.co.uk

w: www.audioemotion.co.uk

e: info@audioemotion.co.uk

t: 01333 425 999

# AURALiC ARIES

USB LIGHTNING AUDIO STREAMER

STREAMING DSD AND DOUBLE RATE ■  
DSD FROM NAS VIA WIFI ■  
FEMTO MASTER CLOCK ■

GAPLESS PLAYBACK ■  
AURALiC LIGHTNING CONTROL APP ■  
from £999

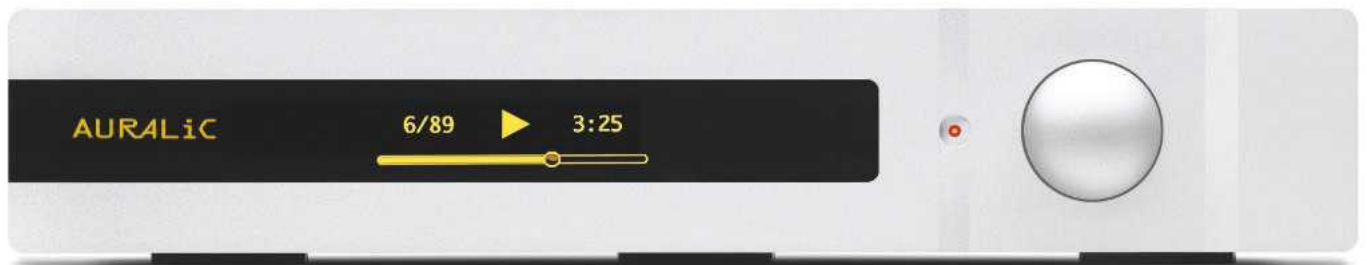

\*artist impression

# AURALiC VEGA

DIGITAL AUDIO PROCESSOR



ORFEO CLASS-A OUTPUT STAGE ■  
ACTIVEUSB ADVANCED BUFFER ■  
FLEXIBLE FILTER MODE ■  
MEGAHERTZ UPSAMPLING ■

NATIVE DSD HANDLING & FEMTO MASTER CLOCK ■  
'BEST HIGH-END DAC' - AVTECH MEDIA AWARD 2013/14 ■

£2890

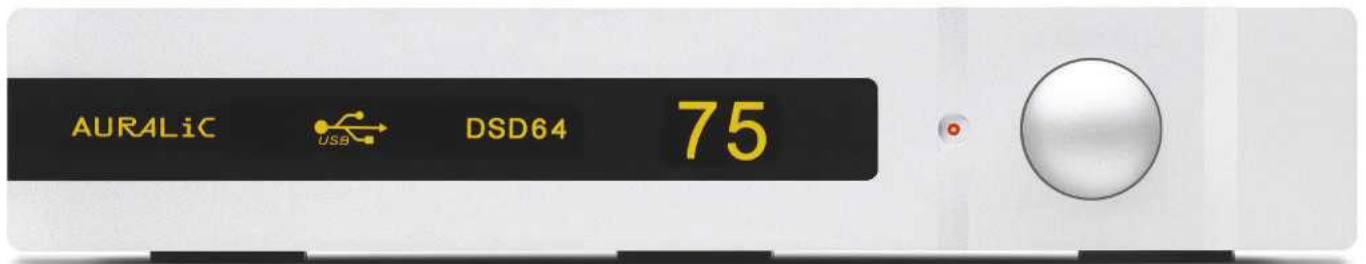

"With deep resolve and HUGE soundstage size, the AURALiC Vega presents music in a way that's impossible to ignore - it's utterly engaging." [digitalaudioreview.net](http://digitalaudioreview.net)

music is our passion



# Sometimes you just can't see the wood for the trees when you're buying hi-fi.

## Clarity is here to help.

with support from

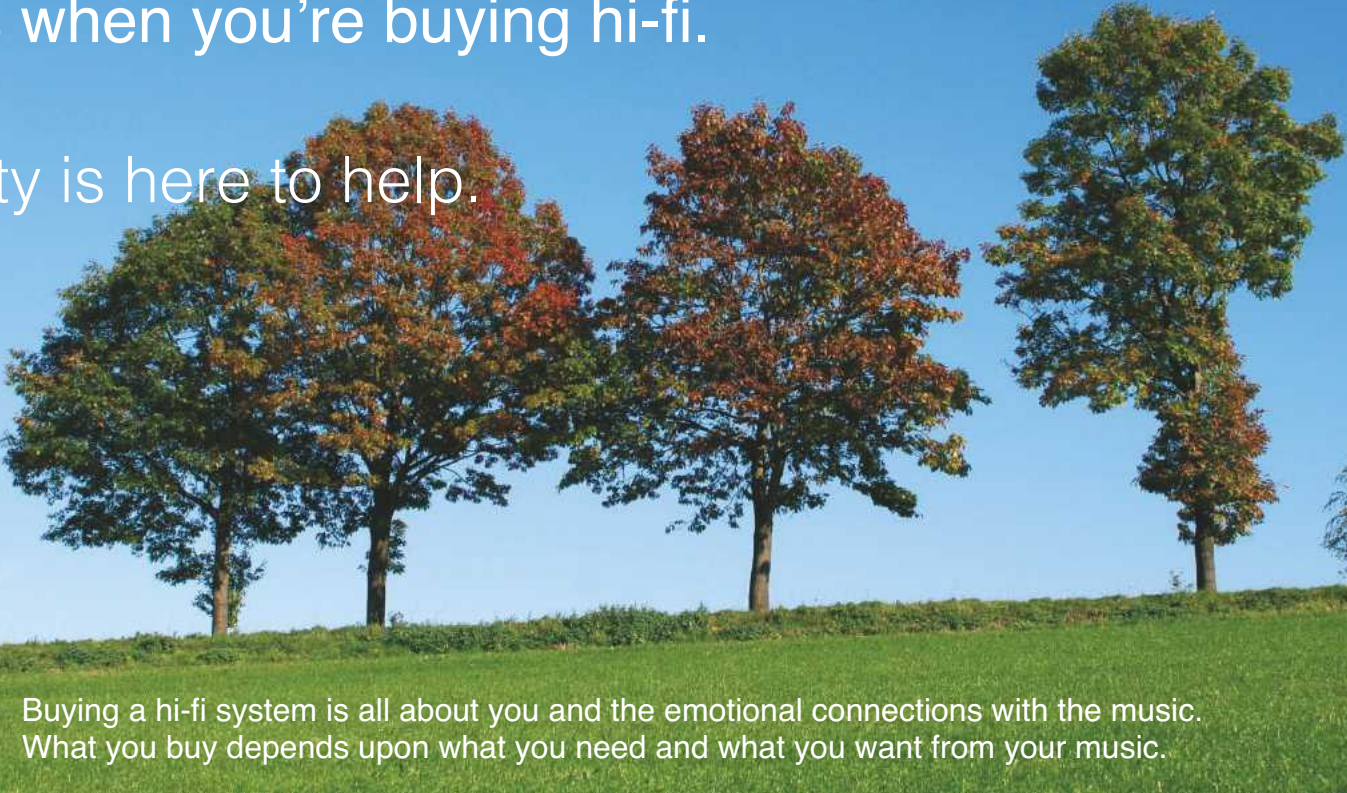

Buying a hi-fi system is all about you and the emotional connections with the music. What you buy depends upon what you need and what you want from your music.

And you can only find the answer at your local expert retailer. You can't audition hi-fi or make comparisons online or by mail order.

- ✓ Free geek time **impartial and honest advice**
- ✓ Transferrable warranty **the freedom to move**
- ✓ Listen **great demo facilities**
- ✓ Knowledgeable staff **a refreshing change**
- ✓ Awful coffee **but we'll always make a cuppa**

Members of **The Clarity Alliance** are the only independent retailers who are trained to industry agreed standards to give you unparalleled levels of product advice and service. Take your time and relax in dedicated listening rooms, try a variety of equipment and music, audition and study each item, get to know it and see how it makes you feel.

[www.clarityalliance.co.uk](http://www.clarityalliance.co.uk)

Let our expert retailers guide you through the myriad of choices and show you some clarity

### EAST

**Basically Sound**  
Norwich  
[www.basicallysound.co.uk](http://www.basicallysound.co.uk)  
01362 820800

**Martins Hi-Fi**  
Norwich  
[www.martinsifi.co.uk](http://www.martinsifi.co.uk)  
01603 627010

### LONDON

**Adair Acoustic Design**  
Clerkenwell  
[www.adairacousticdesign.co.uk](http://www.adairacousticdesign.co.uk)  
0207 253 2326

**Bartletts Hi Fi**  
Islington  
[www.bartlettshifi.com](http://www.bartlettshifi.com)  
020 7607 2148

**Billy Vee Sound Systems**  
Lewisham  
[www.billyvee.co.uk](http://www.billyvee.co.uk)  
020 8318 5755

**Grahams Hi-Fi**  
City of London  
[www.grahams.co.uk](http://www.grahams.co.uk)  
020 7226 5500

**Oranges & Lemons**  
Clapham  
[www.oandlhifi.co.uk](http://www.oandlhifi.co.uk)  
020 7924 2040

**Unilet Sound & Vision**  
New Malden  
[www.unilet.net](http://www.unilet.net)  
020 8942 9567

**MIDLANDS**  
**Nottingham Hi Fi Centre**  
Nottingham  
[www.nottinghamhificentre.co.uk](http://www.nottinghamhificentre.co.uk)  
0115 9786919

**NORTH EAST**  
**Sound Organisation**  
York  
[www.soundorg.co.uk](http://www.soundorg.co.uk)  
01904 627108

### NORTH WEST

**Acoustica**  
Chester  
[www.acoustica.co.uk](http://www.acoustica.co.uk)  
01244 344227

**Chris Brooks Audio**  
Warrington  
[www.chrisbrooksaudio.com](http://www.chrisbrooksaudio.com)  
01925 261212

**SOUTH EAST**  
**Home Media**  
Maidstone  
[www.thehomeofhifi.com](http://www.thehomeofhifi.com)  
01622 676703

**Infidelity**  
Kingston-on-Thames  
[www.infidelity.co.uk](http://www.infidelity.co.uk)  
020 8943 3530

**P J Hi-Fi**  
Guildford  
[www.pjhifi.co.uk](http://www.pjhifi.co.uk)  
01483 504801

**Soundcraft Hi-Fi**  
Ashford  
[www.soundcraftifi.com](http://www.soundcraftifi.com)  
01233 624441

**SCOTLAND**  
**Glasgow Audio**  
Glasgow  
[www.glasgowaudio.com](http://www.glasgowaudio.com)  
0141 332 4707

**Holburn Hi-Fi**  
Aberdeen  
[www.holburnhifi.co.uk](http://www.holburnhifi.co.uk)  
01224 585713

### SOUTH CENTRAL

**Overture**  
Banbury  
[www.overture.co.uk](http://www.overture.co.uk)  
01295 272158

**Oxford Audio Consultants**  
Oxford  
[www.oxfordaudio.co.uk](http://www.oxfordaudio.co.uk)  
01865 790879

**Phase 3**  
Worthing  
[www.phase3.co](http://www.phase3.co)  
01903 245577

**The Sound Gallery**  
High Wycombe  
[www.soundgallery.co.uk](http://www.soundgallery.co.uk)  
01494 531682

**SOUTH WEST**  
**Gulliford Audio**  
Exeter  
[www.gullifordhifi.co.uk](http://www.gullifordhifi.co.uk)  
01392 491194

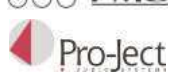

[www.clarityalliance.co.uk](http://www.clarityalliance.co.uk)



clear advice

# BUY SELL EXCHANGE

GREAT VALUE  
NEW & PRE-OWNED  
HIGH END HI-FI

- ▶ Huge range of high end brands
- ▶ Expert system matching advise
- ▶ Used high end hi-fi bought and sold
- ▶ Part exchange welcome
- ▶ All items checked and guaranteed
- ▶ Major credit cards accepted

## HI-FI EXCHANGE

**GUARANTEED HIGH QUALITY NEW & PRE-OWNED HI-FI:**

### LATEST-40

|                                  |         |                                       |         |                                    |         |                                     |        |
|----------------------------------|---------|---------------------------------------|---------|------------------------------------|---------|-------------------------------------|--------|
| Dynaudio C1 & stands             | £2,450  | Lyngdorf Audio RP-1                   | £1,750  | Tube Technology Genesis Monoblocks | £1,390  | Naim Audio NAC 72                   | £375   |
| Mark Levinson No.336             | £3,495  | LFD MCT SE Phono mc                   | £1,800  | BMC Audio CS 600                   | £3,500  | Linn Klimax Kontrol                 | £4,250 |
| Roksan K2 TR-5                   | £600    | Classe Audio CDP102                   | £1,290  | B.A.T. VK-63 SE                    | £8,240  | Linn Klimax Solos                   | £8,995 |
| Sonus Faber Stradivari           | £17,500 | Musical Fidelity M6 CD                | £999    | Audio Research SP 11 MK II         | £2,600  | Musical Fidelity P270.2             | £660   |
| Meridian Audio 596 & MSR         | £250    | Audio Physic Scorpio 25th Anniversary | £3,300  | Sony SCD 1                         | £2,600  | 47 Laboratory 4713, 4705-G, 4799    | £3,500 |
| Sonus Faber Concerto Grand Piano | £1,195  | Edge NL Reference Monoblocks          | £34,990 | Vitus SS-101 mkII                  | £11,900 | QED Reference Audio 1 RCA 0.5 metre | £25    |
| Yamaha DSP-A5                    | £80     | Audio Research LS25 (mkI)             | £2,250  | Audio Physic Tempo 3i              | £675    | B.A.T. VK3i                         | £1,290 |
| KEF 2005 EGG                     | £50     | Chord Company (The) chorus            | £130    | Rogers LS3/5A & AB1 Subs           | £1,995  | BMC Audio PureUSB Cable 2 & 5 m     | £175   |
| REL Quake                        | £200    | Magnum Dynalab MD102                  | £1,690  | Karan Acoustics KA-L Pre           | £2,195  | BMC Audio PureDAC                   | £1,290 |
| Audio Research PH8 black         | £3,890  | Nakamichi RX505E                      | £590    | Acoustic Energy AE1                | £450    | BMC Audio MCCI Phono MC             | £2300  |

### CD Players and DACs

|  |         |   |          |  |         |   |         |
|--|---------|---|----------|--|---------|---|---------|
| 47 Laboratory 4713, 4705-G, 4799       | £3,500  | B&W Matrix 800                                  | £5,990   | Beyond Frontiers Audio Tulip w/ DAC          | £8,500  | Linn Klimax Kontrol                                 | £4,250  |
| Audio Aero La Source                   | £29,500 | Beaurohn B2.2 Revelation                        | £1,800   | BMC Audio CS2 Integrated/ Power Amplifier    | £4,800  | Luxman C800f  | £8,990  |
| Audio Aero Caplitte Signature          | £3,300  | Dali 300 MK2 in Rosewood                        | £1,650   | Bryston 28BSS1-2                             | £12,750 | Mark Levinson 326S + Phono                          | £6,750  |
| Audio Aero La Fontaine                 | £17,500 | Dynaudio C1 & stands                            | £2,450   | Conrad Johnson Prem 8A monoblocks            | £4,950  | Mark Levinson No 326s Reference Dual Mono Pre       | £8,170  |
| AVI Series 21 MC4 Reference            | £690    | Eclipse TD51.2, A502 + Stands                   | £2,000   | Crimson Electronics 640 E3 Monoblocks        | £3,400  | Musical Fidelity Kw Phono                           | £1,450  |
| Ayre Acoustic C5 ce CD/SACD            | £2,750  | Eggleston Works SAVOY                           | £15,000  | Edge G6                                      | £2,250  | Nagra PL-P  | £4,500  |
| Bel Canto Dac3                         | £2,199  | Focal JM Lab Diablo Utopia III & Stands         | £8,100   | Edge NL Reference Monoblocks                 | £34,990 | Naim Audio NAC 72                                   | £375    |
| Bel Canto USB Link 24/96               | £349    | Focal JM Lab Electro 1028Be                     | £2,695   | Edge NL12.1                                  | £8,900  | Nakamichi 410                                       | £198    |
| Bluenote Stibbert valve improved       | £1,800  | Focal JM Lab Grande Utopia III EM               | £121,999 | Halcro DM38 with 220/110 V transformer       | £8,500  | Sony TAE 900  | £2,990  |
| BMC Audio PureDAC                      | £1,290  | Focal JM Lab Scala Utopia 3                     | £18,999  | Halcro DM 88 Monoblocks                      | £24,950 | Tom Evans The Vibe pre & Pulse power supply         | £2,750  |
| BMC Audio BDCC1.1 Belt Drive CD Player | £3,350  | Focal JM Lab Stella Utopia III EM               | £47,990  | Jaedis ja-250                                | £15,000 | TRON Seven Reference Phono                          | £2,490  |
| CIC TLOX                               | £9,990  | Genesis Technologies 5.3                        | £7,000   | Jeff Rowland model 3                         | £2,450  | Vitus SL 101  | £13,995 |
| Classe Audio CDP102                    | £1,290  | Goodmans Maxim                                  | £400     | Karan Acoustics KA M2000                     | £22,990 | VTL TL 6.5 Signature Line Pre                       | £11,350 |
| Cyrus CDBX                             | £400    | Hansen Audio Emperor                            | £32,500  | Krell FPB 650m monoblocks Upgraded to 750mxc | £8,290  |   |         |
| Esoteric P05 D05 Transport/DAC         | £7,990  | Hansen Audio Prince V2                          | £18,000  | Krell kav 150i                               | £950    |   |         |
| Krell Evolution 525                    | £5,990  | Hansen Audio The Knight                         | £9,900   | Krell EVO 302                                | £5,500  | <b>Turntables/Arms/Cartridges &amp; Phonostages</b> |         |
| Krell EVO 505 (110v)                   | £3,395  | Heco celan 500                                  | £550     | Leema Acoustics Corvus                       | £999    | Astin Trew AT8000 phono                             | £450    |
| Krell Evo 505 SACD                     | £3,490  | Infinity PRELUDE 40                             | £4,000   | Linn Klimax Solos                            | £8,995  | Audio Research PH8 black                            | £3,890  |
| Luxman D08 cd player                   | £8,990  | JBL 250 Ti                                      | £2,890   | Luxman M800A stereo power                    | £8,990  | BMC Audio MCCI Phono MC                             | £2,300  |
| Marantz UD 9004                        | £2,690  | KEF 2005 EGG                                    | £50      | Mark Levinson No.336                         | £3,495  | Boulder MS11 & MS01 Phono stage                     | £1,795  |
| Mark Levinson 31 & 30.5 Transp/Dac     | £7,450  | KEF Moun  | £80,000  | Mark Levinson 33H                            | £9,900  | Clear Audio Cartridge                               | £4,000  |
| Mark Levinson No 512 CD/SACD           | £12,255 | KEF Reference 207/2                             | £7,500   | Mark Levinson 532H stereo power amp          | £4,995  | Clear Audio Insider Gold                            | £1,000  |
| Mark Levinson No 512 CD/SACD           | £7,995  | Martin Logan Logos Centre                       | £890     | Mark Levinson No 532                         | £17,362 | Clear Audio da Vinci V2                             | £2,890  |
| McIntosh MCD1100                       | £7,490  | Martin Logan Summit                             | £5,500   | Mark Levinson No 532H Reference              |         | Dynavector DV507 mkII                               | £1,995  |
| Meridian Audio 206 delta sigma         | £150    | Martin Logan Summit                             | £4,990   | High current Dual Mono Power Amp             | £7,500  | ELP LT-LIRC   | £3,500  |
| Meridian Audio 508                     | £600    | Mission 753                                     | £250     | Musical Fidelity 308 K Mono-blocks           | £650    | Gale GT2101 Turntable                               | £7,990  |
| Micro Seiki CDM2                       | £1,490  | Mission 765                                     | £400     | Musical Fidelity P270.2                      | £650    | Garrard 401   | £750    |
| MICROMEGA Microdac                     | £295    | Naim Audio DBL                                  | £5,500   | New Audio Frontiers NAF Performance 2A3      | £4,000  | Jan Allaerts MC1B mk1                               | £1,495  |
| MSB Platinum III                       | £950    | PMC Loudspeakers DB11                           | £700     | Plinius SA 250mkIV                           | £3,495  | Klyne Audio Arts 6PE mm/mc                          | £2,250  |
| Musical Fidelity M6 CD                 | £899    | Proac Response 2.5                              | £1,290   | PS Audio Classic C-250                       | £2,450  | Koetsu Rosewood Standard                            | £1,400  |
| NAD M51                                | £1,100  | Proac Studio 150                                | £575     | Sony TAN R1 monoblocks                       | £8,990  | Kuzma Stabi (wood) & Ref psu                        | £1,990  |
| Opera Consonance Droplet CDP 5.0       | £1,295  | Revel Ultima Studio 2 NEW                       | £8,490   | Sony TA-N1                                   | £5,990  | LFD MCT SE Phono mc                                 | £3,500  |
| Primare BD32                           | £3,500  | Rogers LS3/5A & AB1 Subs                        | £1,995   | Soulution Audio 710 Stereo Power             | £22,990 | Linn Axis   | £300    |
| Proceed CDP CD/HDCD player             | £995    | Roksan K2 TR-5                                  | £600     | Tenor HP 300                                 | £15,500 | Marantz tt15s1                                      | £825    |
| R&T Audio Design Orpheus mk2           | £500    | Shahinian diapson                               | £11,990  | Tom Evans Linear A                           | £3,850  | Origin Live Digital Stylus Force Gauge              | £65     |
| Shanling CD T-300 Omega                | £2,495  | Sonus Faber Concerto Grand Piano                | £1,195   | Tube Technology Genesis Monoblocks           | £1,390  | Passlabs XP15 Phono pre                             | £2,500  |
| Sony SCD 1                             | £2,600  | Sonus Faber Concerto Home & Stands              | £990     | Vitus SS-101 mkII                            | £11,900 | Pink Triangle Export/ Zeta                          | £1,495  |
| Theta CompII                           | £1,595  | Sonus Faber Cremona                             | £2,990   | VTL MB 450-111 Signature Monoblocks          | £17,500 | SME 312s  | £1,850  |
| Wadia H17                              | £400    | Sonus Faber Cremona Elipsa                      | £5,990   | Weiborne Labs DRD45                          | £1,690  | SME Model 10A turntable                             | £4,250  |
| Yamaha S2000 CD/SACD                   | £795    | Sonus Faber Elicta Amator II & Iron Wood stands | £1,590   |  |         | SME Model 30/12A                                    | £21,995 |
| YBA Lacteur CD1 & 1 PSU                | £1,990  | Sonus Faber Guarneri Homage                     |          | <b>Pre Amplifiers</b>                        |         | SME Model 30/2A                                     | £8,790  |
|  |         | Palladio Reference LE                           | £6,750   | Audible Illusions Modulus 3A                 | £2,250  | SME Series V Gold plated arm                        | £2,395  |
|  |         | Sonus Faber Minima Amators & Ironwood Stands    | £1,295   | Audio Innovations 1                          | £240    | SME Series V-12                                     | £3,249  |
|  |         | Sonus Faber Stradivari                          | £17,500  | Audio Research SP 11 MK II                   | £2,600  | SME Model 20/12A                                    | £11,567 |
|  |         | Titan 3Way                                      | £1,295   | Audio Research LS25 (mkI)                    | £2,250  | SME Model 20/3A                                     | £7,990  |
|  |         | Transmission Audio M11                          | £1,750   | Ayre Acoustic K-1xe Pre and phono            | £3,950  | SME Series V (gold print)                           | £2,490  |
|  |         | Verity Audio Tamino                             | £1,990   | B.A.T. VK3i                                  | £1,290  | Sonic frontiers SFP-1 Phono                         | £750    |
|  |         | whatifedate 1950's Corner Horns                 | £6,990   | B.A.T. VK-63 SE                              | £8,240  | Sony TTS8000 with Resinac Sound RS-8000 plinth      | £1,500  |
|  |         | Wilson Audio Maxx 3                             | £49,500  | BMC Audio DAC1PreHR                          | £3,648  | Sumiko Pearwod Celebration II                       | £930    |
|  |         | Wilson Audio Watt Puppy 7                       | £7,490   | Boulder 2010 Pre Amp                         | £15,990 | Thorens TD 126 mkIV                                 | £590    |
|  |         | Wilson Audio WATT Puppy 7                       | £7,490   | Boulder 1010 Pre                             | £6,950  | Tri-Planar MKVII                                    | £2,890  |
|  |         | Wilson Audio WP8                                | £6,750   | C.A.T. SL1 Ultimate                          | £7,295  | van den hul Colibri PXC                             | £2,750  |
|  |         | Zu Audio Omen                                   | £1,200   | Classe Audio CP - 800                        | £4,000  | VPI TNT 4 Flywheel RB1000                           | £4,500  |
|  |         |   |          | Classe Audio CP 500                          | £2,100  | VPI TNT MK1V suspension                             | £2,490  |
|  |         |   |          | Concordant Exquisite + Exclusive             | £1,250  | Wheaton Tri-Planar MK IV                            | £1,795  |
|  |         |   |          | Crimson Electronics 710 Pre Amp              | £4,400  | Wilson Benesch ACT 0.5                              | £750    |
|  |         |   |          | Jaedis JPS2S                                 | £9,990  |   |         |
|  |         |   |          | Karan Acoustics KA-L Pre                     | £2,195  |   |         |
|  |         |   |          | Klyne Audio Arts 7LX3.5 & phono              | £3,250  |   |         |
|  |         |   |          | Krell Evolution 202                          | £5,990  |   |         |
|  |         |   |          | Linn Kaim                                    | £490    |   |         |

100s more bargains online now list your items **FREE** at [www.choice-hifi.com](http://www.choice-hifi.com) today!\*

[www.choice-hifi.com](http://www.choice-hifi.com)

Email: [info@choice-hifi.com](mailto:info@choice-hifi.com) Telephone: 020 8392 1959 / 07768 720456

**STOCKISTS OF:** ACCUSTIC ARTS / AIR TANGENT / AUDIO NOTE / AUDIO PHYSIC / AUDIA / AUROSAL  
BEL CANTO / BURMESTER / CAT / CLEAR AUDIO / DENON / GAMUT / GRAHAM SLEE / GRAHAM TONEARMS  
HALCRO / JM LAB / LAMM / LEXICON / LINN / METRONOME / MONITOR AUDIO / NAD / NUFORCE  
ORIGIN LIVE / ORTOFON / PANASONIC / PARASOUND / PIONEER / PLINIUS / PRIMARE / PROJECT / QED  
REVEL / ROKSAN / SME / TIVOLI / TOM EVANS / TOWNSEND / USHER / VELOCITYNE / YBA AND MANY OTHERS

\*10% commission on final sale value



Cables, amplifiers  
and the unexpected!



## Tellurium Q®

Audio products designed to  
combat phase distortion

"In short, I can honestly say the Tellurium Q  
Black Diamond interconnects and speaker  
cable are the very best leads that I have  
ever had in my system."

Tony Bolton, Hi Fi World 2014

Power amp Product of the Year 2012  
Power cable Product of the Year 2012

hi-fi+ Products of the Year 2010

Hi Fi World  
Cable of the Year 2010

Hi Fi Choice  
2012

Jan 2011  
Jan 2013

2010  
2011  
2012  
2013

HI-FI WORLD  
RECOMMENDED

HI-FI WORLD  
BEST \*\*\*\*\*



Please contact TQ or your nearest dealer to find out  
why there is so much excitement about these new cables  
[www.telluriumq.com](http://www.telluriumq.com)

+44 (0)1458 251997

# Emporiumhifi

[www.emporiumhifi.com](http://www.emporiumhifi.com)

WE NOW HAVE 3 BRANCHES

Head office Norfolk/Suffolk border **01508 518542 / 518468**

Kent and South East **01304 239419**

Wales and West **01554 750262**

### AMPLIFIERS

|   |             |
|---|-------------|
| ART DIAVOLO 300B MONOBLOCKS                                 | £4,000      |
| ATMA-SPHERE S30 MK1 OTL VALVE POWER AMP                     | £1,750      |
| AUDIO MUSIC RT1 2 BOX PRE AMP EX DEMO                       | £4,500      |
| AUDIO SYNTHESIS DESIRE DECADE POWER AMPLIFIER               | £1,350      |
| BLUENOTE DEMIDOFF SILVER INTEGRATED AMP, MINT BOXED         | £2,500      |
| EMILLE KI-240W INTEGRATED VALVE AMPLIFIER                   | £3,250      |
| EMILLE KM-300SE INTEGRATED VALVE AMPLIFIER                  | £4,250      |
| GAMMA SPACE REFERENCE VALVE AMP 300B                        | £1,500      |
| HORNING SATI 520B INTEGRATED LINE VALVE AMPLIFIER WITH PSU  | £5,000      |
| HOVLAND HP100 VALVE PREAMP                                  | £2,000      |
| KRELL KAV-400 XI INTEGRATED AMPLIFIER                       | £1,050      |
| KRELL KP8 300 POWER AMP BOXED                               | £3,500      |
| LEAK STEREO 20 VALVE AMPLIFIER - MAJOR UPGRADES             | £800        |
| LEAK TL12+ MONOBLOCKS (PAIR) SERVICED AND WORKING           | £1,000      |
| LECTOR VFI 700mm INTEGRATED VALVE HYBRID AMP                | £2,500      |
| LINN KLIMAX KONTROL PRE-AMP                                 | £3,000      |
| MARK LEVINSON 33H MONOBLOCKS                                | £10K offers |
| MARK LEVINSON ML360 PREAMP                                  | £2,000      |
| MUSICAL FIDELITY M81 NEW, UNUSED                            | £1,750      |
| NAIM NAP 200 POWER AMP                                      | £1,090      |
| NAIM NAP 250 POWER AMPLIFIER                                | £650        |
| ORPHEUS LABS 2 PREAMP AND 3 STEREO POWER AMP                | £3,000      |
| PYE MOZART HF520 VALVE PRE & POWER AMPS, SPEAKERS OR REPAIR | £900        |
| QUAD 11 CLASSIC INTEGRATED VALVE AMP EX-DEMO                | £3,600      |
| QUAD 180 VALVE MONOBLOCKS                                   | £3,000      |
| ROKSAN PLATINUM ST1308 POWER AMP                            | £2,800      |
| STEREOKNIGHT M100 MONOBLOCKS BOXED                          | £2,500      |
| TOWNSHEND AUDIO ALLEGRI TVC PRE AMP EX DEMO                 | £1,500      |
| TRAFOMATIC EXPERIENCE LINE ONE VALVE PRE AMP                | £1,440      |
| TRAFOMATIC EXPERIENCE TWO 300B VALVE AMO, NEW OLD STOCK     | £2,000      |
| TRON NUCLEUS PRE-AMP  | £1,750      |
| TRULIFEAUDIO BLACK VENUS VALVE INTEGRATED AMP               | £3,500      |
| VIVA AUDIO LINEA XP LINE LEVEL PRE AMP WITH POWER SUPPLY    | £5,000      |
| VIVA LITTLE SOLISTA   | £3,500      |
| VIVA VERONA XL845 SE MONOBLOCKS                             | £8,000      |

### LOUDSPEAKERS

|   |         |
|---|---------|
| ACAPPELLA CAMPANILE                               | £18,000 |
| ACOUSTIC ENERGY AE1 REFERENCE MK3 BLACK           | £1,350  |
| ATC C4 SUBWOOFER                                  | £1,500  |
| ATC SCM10-2 LOUDSPEAKERS STUDIO MONITORS          | £900    |
| AUDIONOTE ANE-LX LOUDSPEAKERS                     | £1,500  |
| B&W 802D CHERRY                                   | £6,500  |
| BD SWING LOUDSPEAKERS                             | £8,000  |
| LSA AUDIO GROUP LSA 2 LOUDSPEAKERS                | £800    |
| MEADOWLARK HERON I LOUDSPEAKERS                   | £1,500  |
| NEAT ULTIMATUM MFS WITH STANDS                    | £2,000  |
| QUAD ESL 2905 ELECTROSTATIC LOUDSPEAKERS          | £3,500  |
| QUAD 2912 - NEW! GREAT TRADE-IN DEALS!            | £3,500  |
| QUAD 22L2 NEW, UNUSED                             | £520    |
| QUAD 988 ELECTROSTATIC LOUDSPEAKERS - BOXED       | £2,000  |
| REFERENCE 3A EPISODE SPEAKERS                     | £4,000  |
| REFERENCE 3A DULCET SPEAKERS GLOSS BLACK          | £925    |
| SONUS FABER CONCERTO DOMUS LOUDSPEAKERS           | £1,100  |
| SPENDOR A5 SPEAKERS                               | £900    |
| TAD HORN SPEAKERS                                 | £5,000  |
| WILSON ALEXANDRIA X1 PIANO BLACK 2007 W/ CRATE    | £35,000 |
| WILSON WATCHDOG 2 PASSIVE SUB & WILSON CONTROLLER | £4,000  |
| WLM LA SCALA SPEAKERS                             | £1,500  |

### CD PLAYERS

|  |             |
|--|-------------|
| AUDIONOTE CD2 1XVII CD PLAYER                  | £2,500      |
| BURMESTER 069 CD PLAYER VERY LITTLE USE, BOXED | £22,000     |
| CALYX AUDIO 24/192 DAC-NEW OLD STOCK           | £1,200      |
| CEC TL0X CD TRANSPORT 5/6 HOURS USE, BOXED     | £10,000     |
| EAR ACUTE VALVE CD PLAYER                      | £2,500      |
| LINDEMANN D880 CD PLAYER                       | £2,750      |
| MBL 1521 CD TRANSPORT                          | £3,500      |
| METRONOME KALISTA REFERENCE CD TRANSPORT       | £20K offers |
| MIMETISM 27.2 CD PLAYER                        | £2,100      |
| NEODIO NR22 HD CD PLAYER, NEW, LATEST SPEC     | £6,000      |
| REGA ISIS CD PLAYER, BOXED                     | £3,000      |
| TEN AUDIO TAD 1 VALVE DAC WITH VOLUME          | £2,500      |

### TURNTABLES

|  |                |
|--|----------------|
| AESTHETIX IO SIG 3 BOX VALVE MMMC PHONO STAGE      | £6,000         |
| ACOUSTIC SOLID MACHINE TURNTABLE WITH ARM          | £2,000         |
| ACOUSTIC SOLID WOOD MPX TURNTABLE                  | £1,500         |
| AUDIO NOTE IO GOLD MOVING COIL CARTRIDGE           | £2,500         |
| BENZ MOVING COIL CARTRIDGES                        | IN STOCK       |
| CLEARAUDIO UNIFY 12" CARBON TONEARM                | £899           |
| CODA D6X FET MMMC PHONO STAGE                      | £1,500         |
| FUNK FIRM SAPPHIRE TURNTABLE WITH FXR2 ARM         | £2,500         |
| FUNK FXR-II (SME SILVER WIRED) TONEARM             | £1,150         |
| GARRARD 301, 401                                   | IN STOCK       |
| INSPIRE HIFI UPGRADE LINN LP12 & FUNK FXR2 ARM     | £2,500         |
| INSPIRE APOLLO TURNTABLE                           | £875           |
| KONDO KSL M7 MM PHONO STAGE                        | £9,000         |
| LINN LP12 SONDEK FULL INSPIRE UPGRADE REGA ARM     | £1,400         |
| LINN SONDEKS WANTED                                | CALL           |
| LUMLEY HELIOSPHERE TURNTABLE                       | £1,750         |
| NVO SPA ONE PHONO STAGE - MM/ MC 13 VALVES         | £2,900         |
| ORACLE DELPHI IV WITH SME IV                       | £2,350         |
| ORTOFON INFLUENCED RMG 309 12" TONEARM             | £850           |
| PLUTO 9A PRESTIGE TONEARM, EXC. CONDITION, BOXED   | £5,500         |
| RESON ROTA 2 /YOTA                                 | £2,000         |
| ROKSAN TMS 3 WITH REFERENCE PSU                    | £4,250         |
| SME 30 FACTORY SERVICED 2013                       | £8,995         |
| SME V TONEARM                                      | £1,500         |
| SUGDEN MASTERCLASS PHONO STAGE                     | £750           |
| SYMPHONIC LINE R66 TURNTABLE                       | £11,000        |
| TRAFOMATIC EXPERIENCE PHONO 1 VALVE MC PHONO STAGE | £1,400         |
| TW RAVEN BLACK RIGHT TURNTABLE, 2 RAVEN 10.5 ARMS  | £23,000 offers |
| VAN DEN HULL COLIBRI XGP MOVING COIL CARTRIDGE     | £1,750         |
| WELL TEMPERED SIMPLEX TURNTABLE                    | £1,250         |

### MISCELLANEOUS

|  |         |
|--|---------|
| HRS TRIPLE TABLE, 4 SHELVES EACH TABLE, NEW, IN CRATES | £30,000 |
| LUXMAN PIJ CLASS A HEADPHONE AMPLIFIER                 | £1,500  |
| NAGRA IV-S STEREO REEL TO REEL                         | £1,400  |
| SILTECH EMPEROR CROWN SPEAKER CABLE 2.5M SET           | £13,000 |

**WE WANT TO BUY YOUR OLD HIFI**  
**WE WANT TO BUY YOUR RECORD COLLECTION**  
**WE PAY CASH & PICK UP FROM ANYWHERE IN THE UK**  
**WE CAN EVEN SEND YOU PACKING MATERIALS**

**CALL NOW FOR A QUOTE**  
**01508 518542 / 518468**

**AUDIO DESTINATION**  
The Finest Audio Products



Owned by husband and wife team: Mike & Caroline - Audio Destination is not your typical Hi-Fi specialist

Audio Destination brings together a range of only the finest audio products and places them in comfortable and relaxed surroundings.

- Tuesday - Friday 9am - 5pm
- Saturday 9am - 4pm
- Demonstration Rooms
- Long-term customer support and care
- Large selection of famous brands

We look forward to seeing you

Call +44 (0)1884 243 584

[www.audiodestination.co.uk](http://www.audiodestination.co.uk)  
email: [info@audiodestination.co.uk](mailto:info@audiodestination.co.uk)  
Audio Destination, Suite 7a Market Walk,  
Tiverton, Devon EX16 6BL

**IAN HARRISON  
HIFI**

**PLEASE PHONE  
FOR PRICES**

- |                        |                  |
|------------------------|------------------|
| Benz Micro Ace SI      | Ortofon 2m Black |
| Benz Micro Glider H    | Denon DI110      |
| Benz Micro Glider SI   | Denon DI103      |
| Ortofon Cadenza Bronze | Denon DI103r     |
| Ortofon Cadenza Blue   | Goldring G1042   |
| Ortofon Rondo Bronze   | Zyx R100         |

[ian.harrison@mercian.myzen.co.uk](mailto:ian.harrison@mercian.myzen.co.uk)  
**TEL: 01283 702875**

Stockists of:

- Arcam • B&W • Focal
- Linn • Naim • PMC
- Rega • Rotel and MORE

**Infidelity**  
INDECENTLY GOOD HI-FI

9 High Street, Hampton Wick,  
Kingston upon Thames,  
Surrey KT1 4DA

Tel: 020 8943 3530

Open: Tues - Sat 10am - 6pm  
[www.infidelity.co.uk](http://www.infidelity.co.uk)



**DRIVERS:**

- ▶ ATC
- ▶ AUDAX
- ▶ ETON
- ▶ FOSTEX
- ▶ LPG ▶ MAX FIDELITY
- ▶ MOREL ▶ PEERLESS
- ▶ SCAN-SPEAK ▶ SEAS
- ▶ SILVER FLUTE
- ▶ VIFA ▶ VISATON
- ▶ VOLT



**SOLENS CAPACITORS AND  
INDUCTORS - USED BY THE  
MOST DISCRIMINATING  
LOUDSPEAKER  
MANUFACTURERS.**

**HARDWARE**

**HOW TO BOOKS**

Contact us for the  
free Solen CDROM  
Catalog.

**FREE!**



**SOLENS**

4470 Avenue Thibault  
St-Hubert, QC, J3Y 7T9 Canada  
Tel: 450.656.2759  
Fax: 450.443.4949  
Email: [solen@solen.ca](mailto:solen@solen.ca)  
Web: [www.solen.ca](http://www.solen.ca)

**All You Need  
In One Place**

- ▶ Premium Loudspeaker Drivers
- ▶ Highest Quality Crossover Parts
- ▶ Crossover Design and Assembly
- ▶ DIY Speaker Kits
- ▶ Wire and Terminals
- ▶ Expert Advice

Some of our Brands:

- ▶ Accuton
- ▶ Audax
- ▶ Aurasound
- ▶ Eton
- ▶ Fostex
- ▶ HiVi Research
- ▶ Peerless
- ▶ SB Acoustics
- ▶ Scan-Speak
- ▶ Seas
- ▶ Raal



**madisound**

Your Worldwide Provider of  
High End Loudspeaker Parts

[madisound.com](http://madisound.com)

**Front End Problems**

then contact  
**"The Cartridge Man"**

It doesn't have to cost an arm and a leg to get  
the best - HiFi News awards 2005. "BEST  
CARTRIDGE UNDER £1000! Agents for  
Croft, Moth, Hadcock, E.A.R. and others.  
"CARTRIDGE MAN STYLUS GAUGES  
NOW AVAILABLE

Web Site: [www.thecartridgeman.com](http://www.thecartridgeman.com)

Email: [thecartridgeman@btinternet.com](mailto:thecartridgeman@btinternet.com)

**020 8688 6565**

**tavistock audio**

— love your music —

- Wilson Benesch •
- Michell Engineering •
- Grado • Naim •
- The Chord Company •
- Kudos • Quadraspire •
- Audiovector • PMC •
- Audiolab • Quad •
- Project •

18 Market Street Tavistock  
Devon PL19 0DE

01822 618 940

[info@tavistockaudio.co.uk](mailto:info@tavistockaudio.co.uk) [www.tavistockaudio.co.uk](http://www.tavistockaudio.co.uk)

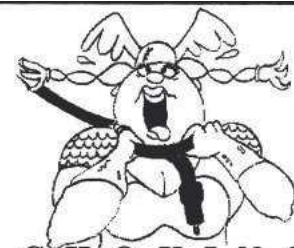

**CHOKING**

THE SOPRANO WITH YOUR CABLES?

Careless cable choices can strangle your  
excellent system. The Cable Company  
database, based on feedback from  
thousands of US home cable trials, can  
tell you what cables will work  
best in your system.

- FREE SHIPPING on purchases over \$100.
- 60 brands, 238 cable products.
- FREE of all US taxes.



**COMPONENTS  
ACCESSORIES  
TUBES**

Call, write, fax or email for details and free consultation  
(215) 862-4870 • fax (215) 862-4871

Visit our website at:  
<http://www.fatwyre.com>  
email: [fatwyre@fatwyre.com](mailto:fatwyre@fatwyre.com)

**THE  
CABLE  
COMPANY**

125 Union Square, New Hope PA 18938 USA  
ALL MAJOR CREDIT CARDS



## Epiphany Acoustics

Headphone Amplifiers . DACs . Interconnects



EHP-02 Portable Headphone Amplifier



Aug 2012



Aug 2012

Best Headphone Amplifier of the Year 2012  
Hi-Fi World

Discover why Epiphany Acoustics are rapidly becoming the name in affordable hi-fi at:

## IAN HARRISON HIFI

SALE! UP TO 40% OFF!

TEL: 01283 702875 ian.harrison@mercian.myzen.co.uk

| PHONOSTAGES  | CARTRIDGES      | TURNTABLES     | TOPEARMS      |
|--------------|-----------------|----------------|---------------|
| TRICHORD     | ORTOFON         | MICHELL        | MICHELL       |
| TOM EVANS    | DENON           | PRO-JECT       | REGA          |
| GRAHAM SLEE  | AIR TIGHT       | THORENS        | SME*          |
| LEHMANN      | TRANSFIGURATION | SRM TECH       | GRAHAM        |
| WHEEST AUDIO | KOETSU          | EAR            | MOTH          |
| ANATEK       | GRADO           | AMAZON AUDIO   | ORTOFON       |
| QUAD         | GOLDRING        | AUDIO TECHNICA | PRO-JECT      |
| CLEARAUDIO   | BENZ MICRO      | DENON          | ROKSAN        |
| ICON AUDIO   | ROKSAN          | INSPIRE        | CARTRIDGE MAN |
| PURE SOUND   | ZYX             | MUSIC HALL     | HELIUS        |
| PRO-JECT     | CARTRIDGE MAN   |                | REED          |
| EAR YOSHINO  | DECCA LONDON    |                | AMG           |
| ROTHWELL     |                 |                | MOERCH        |

PLEASE PHONE TO CONFIRM PRICE & AVAILABILITY PRIOR TO ORDERING. ALL GOODS ARE BRAND NEW & BOXED WITH FULL U.K. GUARANTEES. NO EX-DEM OR EX-DISPLAY GOODS. NO GREY IMPORTS. GOODS ARE NOT SUPPLIED ON APPROVAL. SORRY NO GENERAL CATALOGUES. PLEASE PHONE OR WRITE FOR SPECIFIC REVIEWS, BROCHURES OR PRICES.

\*CALL FOR DETAILS ESTABLISHED 1986.

MAIL ORDER ONLY FROM: IAN HARRISON, 7 MILL HILL, REPTON, DERBY, DE65 6GQ  
TEL: 01283 702875 9am-9pm INCLUDING SUNDAYS.

Specialists in quality Hi-Fi for the home. For all your Hi-Fi needs from Vinyl to Streaming, Amps, Speakers and Headphones

www.hifilounge.co.uk  
01767 448121  
Bedfordshire SG18 8RH

## Oranges & Lemons

www.orangesandlemons.info

Audio-Visual  
Multi-Room  
Hi-Fi

020 7924 2040  
61-63 Webbs Road London SW11

## EQUIPMENT URGENTLY!!! REQUIRED!! NOW!! PHONE 07860-511111

### HEATHCOTE AUDIO: TEL: 07860 511111 - www.heathcoteaudio.co.uk

### ALMOST ALL LISTED ITEMS ARE 1 OWNER/EX DEM

#### SOLID STATE

|   |              |       |
|---|--------------|-------|
| KRELL EVO 402 STEREO POWER AMP DEM+1.....           | EXCLT/BOXED  | £6450 |
| CHAPTER AUDIO 2+ POWER AMP.....                     | MINT/BOXED   | £2750 |
| CHAPTER SONNET-S CD/PRE-AMP/DAC/NEVO 50Q.....       | MINT/BOXED   | £3250 |
| TOM EVANS VIBE PRE AMP LITHOS-7 1 OWNER.....        | MINT         | £2750 |
| PRIMARE I-21 INTEGRATED 1 OWNER.....                | MINT/BOXED   | £595  |
| SONY TA-N220ES 2/3/4 CHANNEL POWER AMP 1 OWNER..... | EXCLT        | £275  |
| KENWOOD DA-9010 DIGITAL INTEGRATED 1 OWNER.....     | EXCLT/BOXED  | £475  |
| PS AUDIO GCA 100 X 5 POWER AMP 1 OWNER.....         | MINT/BOXED   | £1795 |
| BEL CANTO PRE-1 & REMOTE.....                       | EXCLT/BOXED  | £995  |
| AUDIO INNOVATIONS 1000 SILVER PRE-AMP.....          | EXC          | £699  |
| PATHOS INPOWER CLASS A HYBRID MONOS.....            | EXCLT        | £4250 |
| DENSEN B200 PRE/GZMO & B300XS 1 OWNER.....          | MINT/BOXED   | £1850 |
| BEL CANTO PRE-3 & S300 AMPLIFIERS 1 OWNER.....      | AS NEW/BOXED | £1695 |
| TALK ELECTRONICS TORNADO 4 MONOS 1 OWNER.....       | EXCLT/BOXED  | £795  |
| TRIO LO7-C PRE AMP WITH MMCM(RARE).....             | EXCLT        | £695  |
| TRIO LOS-M MONOBLOCS (VERY RARE).....               | DEM          | £695  |
| MARANTZ MA-700 200 WATT MONOBLOCS.....              | DEM/BOXED    | £595  |
| H-CAT P-12A PRE AMP (E2500?).....                   | DEM          | £995  |
| H-CAT P-12B PRE AMP (E2500?).....                   | DEM          | £1495 |
| PASS LABS ALEPH PRE AMP.....                        | EXCLT        | £1195 |
| MERIDIAN 501 PRE AMP.....                           | MINT/BOXED   | £395  |
| LYNGDORF SDAI 2175 INTEGRATED.....                  | EX DEM/BOXED | £1295 |
| MARANTZ PM11 S2 DEM-1 OWNER.....                    | EXCLT        | £1695 |
| DENON PMA-QS10I 30 KILO INTEGRATED.....             | EXCLT/BOXED  | £995  |
| JOHN SHEARNE 2.5 INTEGRATED AMP.....                | 1 OWNER      | £450  |
| JOHN SHEARNE 3.5 POWER AMP.....                     | 1 OWNER      | £450  |
| ADVANTAGE 200 INTEGRATED AMP (E1800?).....          | EXCLT/BOXED  | £895  |
| MUSICAL FIDELTY X-CANS V-3 1 OWNER.....             | AS NEW/BOXED | £275  |

#### VALVE AMPS

|  |              |       |
|--|--------------|-------|
| AUDIO RESEARCH VS-110 POWER AMP 1 OWNER.....           | AS NEW/BOXED | £2250 |
| BALANCED AUDIO TECHNOLOGY VK-60 POWER AMP.....         | EXCLT/BOXED  | £2195 |
| ANTIQUE SOUNDLABS AQ-1009 845 MONOBLOCS.....           | DEM          | £2995 |
| ROGUE AUDIO 150 MONOBLOCS (NEW OLD STOCK £4600+?)..... | BOXED        | £2995 |
| PAPWORTH M-100 MONOBLOCS ONE OWNER.....                | MINT/BOXED   | £2750 |
| PATHOS INPOWER CLASS A HYBRID MONOS (SUPERB E9K?)..... | EXCLT        | £4250 |
| MATTISSE REFERENCE 2 BOX PRE AMP (64 STEP ATT).....    | ONE OWNER    | £3450 |
| AUDIBLE ILLUSION MODULUS 3a 2 BOX PRE LITTLE USE.....  | MINT/BOXED   | £2295 |
| ROGUE AUDIO 66 MAGNUM REMOTE CONTROL PRE.....          | EX DEM       | £795  |
| ART AUDIO INTEGRA EL-34 VALVE INTEGRATED.....          | EXCLT        | £1150 |
| ANTIQUE SOUNDLABS LH-01 PRE-AMP/HPHONE AMP.....        | EX DEM       | £375  |
| ANTIQUE SOUNDLABS MINI PHONO 2 BOX.....                | VGC          | £295  |

#### TRANSPORTS/CD/DACS

|   |             |       |
|---|-------------|-------|
| BARCLAY DIGITAL F-1 SUPER TRANSPORT.....  | DEM-1       | £4995 |
| CHAPTER SONNET-S CD/PRE-AMP/DAC/NEVO 50Q REMOTE & REFERENCE POWER CORD 1 OWNER..... | MINT/BOXED  | £3250 |
| LINDEMANN 680 SACD/CD PLAYER.....   | MINT/BOXED  | £2750 |
| ALCHEMIST KRACKEN 2 BOX CD 1 OWNER.....   | MINT        | £795  |
| KENWOOD DX-9010 TRANSPORT 1 OWNER.....  | EXCLT       | £595  |
| LYNGDORF CD-1 CD PLAYER/TRANSPORT.....  | EXCLT       | £749  |
| VACUUM STATE JLTI (E1300).....  | BRAND NEW   | £795  |
| VACUUM STATE JLTI (E1300).....  | DEM         | £650  |
| STELLO CDA-320 ONE BOX CD/DAC.....  | EXCLT/BOXED | £595  |
| INCA TECH KATANA.....   | VGC         | £395  |
| TRICHORD/PRECISION DIGITAL TURNTABLE.....   | EXCLT       | £395  |
| MERIDIAN 500 TRANSPORT.....   | MINT/BOXED  | £399  |
| SONY XA-1200ES SACD PLAYER.....   | VGC         | £299  |
| SONY CDP-X33ES CD PLAYER 1 OWNER.....   | MINT/BOXED  | £249  |
| CAMBRIDGE AZUR 740C CD 1 OWNER.....   | MINT/BOXED  | £275  |
| MICROMEGA STAGE 2CD PLAYER.....   | MINT        | £199  |

#### LOUDSPEAKERS

|  |             |       |
|--|-------------|-------|
| AUDIO ARTISTRY DVORAK 2 PANELS 2 SUBS & CROSS OVER (SUPERB) EXCLT..... | £1850       |       |
| TANNOY CPA-12 PROFESSIONAL SERIES.....                                 | EXCLT       | £895  |
| B&W 801 MATRIX SERIES-2 IN WALNUT 1 OWNER.....                         | EXCLT       | £1995 |
| B&W 802 SERIES-3 & SOUND ANCHOR STANDS.....                            | ONE OWNER   | £1795 |
| ALR JORDAN CLASSIC 2 (BIRCH VENEER £800+).....                         | NEW/BOXED   | £475  |
| USHER DANCER MINI-X DIAMOND 3 MONTHS USE.....                          | MINT/BOXED  | £1850 |
| FAB AUDIO FAB-1 FERRARI RED.....                                       | DEM         | £4795 |
| ROGERS LS35A 15 OHM MATCHED PAIR.....                                  | VGC         | £995  |
| SPENDOR LS35A MATCHED PAIR.....  | EXCLT       | £995  |
| SNELL C MKIV AMERICAN WALNUT (SUPERB).....                             | EXCLT       | £1195 |
| PODIUM 1s FEW WEEKS USE ONLY (E6000? NEW)1.....                        | 1 OWNER     | £1995 |
| ENSEMBLE FIGURA ONE OWNER.....   | SALE!       | £2995 |
| HALES TRANSCENDENCE 5 (SUPERB).....                                    | EXCLT/BOXED | £1895 |
| ART AUDIO PRECISION MONITOR (PIANO BLACK 6K+).....                     | DEM-1       | £2795 |
| MARTEN MILES CHERRY (8K+ ONE OWNER).....                               | SALE!       | £2995 |
| AURUM CANTUS VOLLA (LAST PAIR).....                                    | DIS BOXED   | £1695 |
| PROAC STUDIO 150 (PREMIUM YEW FINISH).....                             | VGC         | £695  |
| ACOUSTIC REFLEX (CONCRETE Baffle).....                                 | EXCLT       | £399  |
| AURUM CANTUS MUSIC GODDESS (E2500).....                                | DEM         | £1695 |
| AURUM CANTUS LEISURE 3 SE (LAST PAIR £1350).....                       | NEW/BOXED   | £895  |
| AURUM CANTUS BLACK ORCHID (LAST PAIR £1300).....                       | NEW/BOXED   | £895  |
| AMPHION NEON 1 (1 OWNER).....  | EXCLT       | £895  |
| THEIL CS 1.5 (ONE OWNER FROM NEW).....                                 | MINT BOXED  | £995  |

#### VINYL

|   |            |      |
|---|------------|------|
| WILSON BENESCH CIRCLE (ONE OWNER 25 HOURS USE ONLY) AS NEW/BOXED..... | RING       |      |
| NOTTINGHAM ANALOGUE MENTOR TONEARM & COLLAR.....                      | DEM ONLY   | RING |
| PINK LPT/RB250/PSU/CART REBUILT AS EXPORT.....                        | SUPERB!    | £695 |
| AUDIO INNOVATIONS 1000 MC STEP UP.....                                | MINT       | £495 |
| CARTRIDGE MAN MUSIC MAKER II FEW HOURS.....                           | MINT       | £450 |
| VOYD VALDI (1 OWNER FROM NEW).....                                    | SALE BOXED | £695 |
| TOM EVANS MICRO GROOVE.....   | EXCLT      | £375 |
| DENON DP-1200 SPECIAL EDITION (INC ARM/CART).....                     | RARE       | £695 |
| ANTIQUE SOUNDLABS MINI PHONO 2 BOX.....                               | VGC        | £295 |
| MICHELL ISOHERA PHONO STAGE.....                                      | EXCLT      | £395 |
| DENON DL-30L TURNTABLE ARM AND CARTRIDGE.....                         | EXCLT      | £195 |

#### TUNERS/TAPE/STANDS/MAINS

|  |              |       |
|--|--------------|-------|
| MUSICAL FIDELTY A5 DAB/FM TUNER (E1500) 1 OWNER..... | EXCLT        | £599  |
| RICHARD GRAYS POWER COMPANY MODEL 1280 240V.....     | EXCLT        | £1295 |
| BEN DUNCAN PURE POWER ONE OWNER (HEAVY!!).....       | EXCLT        | £375  |
| BLACK RHODIUM SUPERMAINS 25 BRAIDED POWER CORD.....  | BRAND NEW    | £85   |
| TECHNICS ST-GT650 RDS TUNER.....                     | VGC          | £99   |
| TECHNICS ST-GT550 RDS TUNER.....                     | VGC          | £75   |
| MUSICAL FIDELTY X-CANS V-3.....                      | AS NEW/BOXED | £275  |

#### LOUDSPEAKER CABLE

|   |       |      |
|---|-------|------|
| BLACK RHODIUM POLAR NINJA DCT 2.9 METRE PAIR.....           | EXCLT | £650 |
| XLO S 2 SIGNATURE-1 4FT PAIR.....                           | DEM   | £495 |
| SONORAM PLATEAU 4 METRE VERY HEAVY HI END PAIR.....         | EXCLT | £475 |
| RAPPORT (USHER) 5 METRE PAIR FACTORY TERMINATED.....        | DEM   | £249 |
| XLO REF-2.5 METRE PAIR.....                                 | EXCLT | £375 |
| BLACK RHODIUM S-300 BI WIRE 5 METRE BI WIRE PAIR(E400)..... | NEW   | £250 |
| BLACK RHODIUM S-300 BI WIRE 4 METRE PAIR (E240).....        | NEW   | £175 |

#### INTERCONNECT CABLE

|   |           |      |
|---|-----------|------|
| XLO ULTRA 0.5METRE RCA.....                             | MINT      | £149 |
| CHORD CO SIGNATURE 1 METRE PAIR BNC TO BNC.....         | UNUSED    | £299 |
| ACOUSTIC ZEN SILVER REF 2 METRE XLR.....                | VGC       | £595 |
| ACOUSTIC ZEN MATRIX REFERENCE II 1 METRE RCA.....       | VGC       | £275 |
| HARMONIX HARMONIC-STRINGS HS-101 1METRE XLR.....        | DEM/BOXED | £299 |
| ANALYSIS PLUS SOLO CRYSTAL OVAL 0.5 METRE.....          | EXCLT     | £225 |
| VAN DEN HUL MCD102 HYBRID MKIII 1 METRE XLR TO RCA..... | EXCLT     | £75  |
| VAN DEN HUL MCD102 HYBRID MKIII 1 METRE RCA.....        | EXCLT     | £75  |
| AUDIOQUEST/AUDIOTRUTH EMERALD 1 METRE PAIR.....         | EXCLT     | £149 |

**Is this your problem? Here's your answer**



loud    too loud    way too loud

It's a common problem. The usable range of the volume control is all down at the bottom end and fine control at low listening levels is either difficult or impossible. The noise floor may be audible, too. There is a simple and effective solution - the **Rothwell In-Line Attenuators**. They can be used with pre/power or integrated amps to cure the problem of excess gain and bring sonic benefits with even the most expensive equipment.

**"this accessory is heartily recommended" Gramophone**



£39/pair - post free  
01204 366133  
[www.rothwellaudioproducts.co.uk](http://www.rothwellaudioproducts.co.uk)

**studio AV**

We are one of the UK's premier retailers of high performance hi-fi, offering some of the finest products available on the market today.

We have the finest demonstration rooms in the country, where these systems can be heard at their very best.

studioAV, 44 High Street, Eton, Berkshire SL4 6BL  
**01753 631000**  
sales@studioav.co.uk  
www.studioav.co.uk

SEE, HEAR AND FEEL THE DIFFERENCE

**IAN HARRISON HIFI**

**PLEASE PHONE FOR PRICES**

**Ortofon Cartridges**

**New! Quintet Black £poa    Cadenza Black £poa**  
**New! Quintet Bronze £poa    Mc Winfeld £poa**  
**New! Quintet Blue £poa    Xpression £poa**  
**New! Quintet Red £poa    Mc Anna £poa**  
**New! Quintet Mono £poa**

**\*Ortofon Centre Of Excellence Dealer**

[ian.harrison@mercian.myzen.co.uk](mailto:ian.harrison@mercian.myzen.co.uk)  
**TEL: 01283 702875**

**020 7226 5500**  
[www.grahams.co.uk](http://www.grahams.co.uk)



**"One of the five best hi-fi shops in the world"**  
ARENA Magazine

**Grahams Hi-Fi**  
Canonbury Yard  
190a New North Road  
London N1 7BS

**Radlett Audio**  
Sensible hi-fi since 1973

- Rega
- Harbeth
- Croft
- Spendor
- Michell
- Devialet



Saffron Walden [www.radlettaudio.co.uk](http://www.radlettaudio.co.uk)  
01799 599080 [Radlettaudio@hotmail.co.uk](mailto:Radlettaudio@hotmail.co.uk)

[www.soundcinergy.co.uk](http://www.soundcinergy.co.uk)

**sound cinergy**  
specialists in home entertainment

**Exposure • Heed • Lehmann • Linn • Marantz  
Michell Monitor Audio • Neat • Nordost  
Okki Nokki • Ortofon • Project • Roksan**

**37 High Street, Aldridge 01922 457926**

atc  
dynavector  
epson  
focal  
hutter  
isoblu  
kudos  
lyra  
naim audio  
neat acoustics  
nottingham  
pmc  
rega  
well tempered  
more...



**signals**  
hi-fi for grown-ups

Ipswich (01473) 655171  
email: [eng@signals.uk.com](mailto:eng@signals.uk.com)  
[www.signals.uk.com](http://www.signals.uk.com)

anthem  
arcam  
audeze  
dynavector  
focal  
isoblu  
hutter  
kudos  
linn products  
lyra  
magnplanar  
naim audio  
neat acoustics  
nottingham  
primare  
ortofon  
pmc (including fact)  
**rega**  
sennheiser  
sumiko  
roksan  
trilogy

**fresh toy for black stuff:  
regal RP10**



**signals**  
hi-fi for grown-ups

**ipswich (01473) 655171**  
[www.signals.uk.com](http://www.signals.uk.com)

**Micro audio detail revealed.**

**Low amplitude seismic microtremors** are ever present and pass through all buildings and solid supports and into your Hi-Fi system.

However small this vibration may seem to us, it will be huge compared with the minute domain in which a Hi-Fi processes signal information. At the magnet plate of the loudspeaker these vibrations are superimposed onto the voice-coil and the cone where it contaminates the audio signal, blurring and smearing the sound.

Breaking the conduction path by floating your system on **Townshend Seismic Isolation** eliminates this, making the sound clearer with a wider deeper sound stage and a far more relaxing and enjoyable experience.

In addition, sound transmission from your speakers to the floor to your neighbour is dramatically reduced!



For more information or best advice on Seismic Isolation visit: [www.townshendaudio.com](http://www.townshendaudio.com)  
email or phone us on +44 (0) 20 8979 2155.



# Redefining the state of the art...



 **AUDEZE**

Official UK Importer:  
[www.decentaudio.co.uk](http://www.decentaudio.co.uk)  
[info@decentaudio.co.uk](mailto:info@decentaudio.co.uk)  
Tel: 0560 2054669

## HOW TO CONTACT US...

# hi-finevs

& Record Review



### Editorial Team

**Editor** • Paul Miller  
**Art Editor** • Steve Powell  
**Features Editor** • Patrick Fraser  
**Reviews Editor** • Chris Breunig  
**Retouching Manager** • Brian Vickers  
**Test & Measurement** • Paul Miller

### Photography

Andrew Sydenham

### Management Team

**Group Editor** • Paul Miller  
**Group Art Editor** • John Rook  
**Head of Production** • Julie Miller  
**Group Advertising Manager** • Joanna Holmes  
**Subscriptions Manager** • Kate Scott  
**Chief Executive** • Owen Davies  
**Chairman** • Peter Harkness

### Advertisement Team

**Advertising Sales** • Joanna Holmes  
Tel • 01689 869 919  
[joanna.holmes@hifinevs.com](mailto:joanna.holmes@hifinevs.com)

### Subscriptions

**New, renewals and enquiries...**  
**UK:**  
Tel • 0844 543 8200  
Email: [mytimemedia@subscription.co.uk](mailto:mytimemedia@subscription.co.uk)  
**USA/Canada:**  
Tel • (001) 866 647 9191  
**Rest of World:**  
Tel • +44 (0) 1689 869 896  
Email: [mytimemedia@subscription.co.uk](mailto:mytimemedia@subscription.co.uk)

### We Live At...

MyTimeMedia Ltd,  
Hadlow House, 9 High St,  
Green Street Green,  
Orpington, Kent BR6 6BG  
Tel: 0844 412 2262  
Outside UK: +44 (0) 1689 869 840  
[www.hifinevs.co.uk](http://www.hifinevs.co.uk)

Hi-Fi News is a member of the  
Audit Bureau of Circulations (ABC)  
and of EISA ([www.eisa-awards.org](http://www.eisa-awards.org))

HI-FI NEWS & RECORD REVIEW, ISSN 2042-0374, is published monthly with an additional issue in January by AVTech Media Ltd, a division of MYTIMEDIA Ltd, Hadlow House, 9 High Street, Green Street Green, Orpington, Kent BR6 6BG, UK. The US annual subscription price is 65GBP (equivalent to approximately 108USD). Airfreight and mailing in the USA by agent named Air Business Ltd, c/o Worldnet Shipping Inc., 156-15, 146th Avenue, 2nd Floor, Jamaica, NY 11434, USA. Periodicals postage paid at Jamaica NY 11431. US Postmaster: Send address changes to HI-FI NEWS & RECORD REVIEW, Worldnet Shipping Inc., 156-15, 146th Avenue, 2nd Floor, Jamaica, NY 11434, USA. Subscription records are maintained at CDS GLOBAL Ltd, Tower House, Sovereign Park, Market Harborough, Leicester, LE16 9EF. Air Business Ltd is acting as our mailing agent.



# OFF THE LEASH!

KEN KESSLER TELLS IT LIKE IT IS...

As traditional audio brands embrace the headphone, Ken Kessler salutes the pioneers...



Whither goest the headphone? Is it enough to save/revitalise an entire industry? Is there a limit to the number of headphones the world can absorb? What motivates a non-audiophile to spend £300 on 'fashion cans'? These, and a dozen other questions, are now perplexing the bosses of pure audio brands the world over. Without exception, some makers of separates above crud level are looking at a bleak, worrisome future, and the lifeline appears to be two ear-cups, a headband and 2m of wire.

## SERIOUS HI-FI

Because you, the reader of this august publication, are by definition one who appreciates the joys of serious hi-fi equipment without needing to be told, you are conditioned – and the reaction may be conscious or unconscious – to 'understand' what sound quality means. You have no problem accepting that (within reason) decent hi-fi equipment costs more than £49.99, isn't made of plastic and cannot be purchased in stores that sell hair dryers and vacuum cleaners. To you, £300 for headphones is 'normal'.

For you, the battles of Beats By Dr Dre versus the rest of the world means little. You are not dismayed by B&W's (prudent) transition to becoming a manufacturer of

commercially significant headphones and iPod docks, because they still make speakers for purists. To you, such matters are a world away, though a tiny part of you might be cognisant of the market's carnage, because you simply cannot be unaware of the demise of so many specialist hi-fi shops.

## MAGIC WORDS

Moreover, you probably accept that traditional hi-fi brands need to embrace the modern world. So... imagine that you are the head of a mid-sized audio brand with a few decades' existence to provide your provenance. You have seen retailer after retailer close up shop. You have seen borderline audio buyers (as opposed to 'lifers' like us) take their disposable income and spend it elsewhere, on cars, watches or other luxuries. You are freaking out. Then, someone under 30 in your operation says the magic words:

'headphones' – 'headphone amps' – 'portable USB DACs'.

Although it may be too late for some – by years, not months – the move toward a headphone-dependent industry continues inexorably and unabated. I am no longer surprised by the companies now undertaking the development of headphone-related hardware, such brands having accepted that nobody spends real money on iPod

docks (B&W's hugely successful Zeppelins notwithstanding). If anything, I am gratified to see companies shedding their hidebound purism, pandering to the sort of people who bitch about hi-fi but never buy anything.

Such companies, while not abandoning the costly purist separates that remain their core products, will live to see another decade. They have realised that the future is not rosy for £10,000 amplifiers nor speakers that stand as tall as a phone kiosk.

## HATS OFF TO...

Why am I gratified? Because decades ago, I wrote in trade magazines (before any of us knew that streaming, iPods, *et al*, would conspire to destroy hi-fi) that a decrease in the size of the hi-fi 'pie' and an increase in the number of manufacturers after a slice of said pie would lead to disaster. To our detriment, we allowed any schmuck with a soldering iron to call himself a manufacturer of hi-fi components.

Every sale made by the bottom-feeders was taken from a legitimate brand. But the former is now an endangered species. The audio industry has contracted so much that there is no space for the *garagistes*.

Instead – and I say this with full awareness of the cries of 'Sell out!' that will be spat at me by those of you who think it's still 1982 – I must applaud the following brands: Meridian, for its spectacular Prime Headphone Amplifier; Musical Fidelity, for persevering with headphones and delivering the MF100, as well as the super-cool V90 headphone amp; Focal, for following the excellent Spirit headphone with the higher-spec closed-back Professional; Chord, for the Hugo 'reference-class portable DAC/headphone amp'; Cambridge Audio, whose fab DacMagic line now includes the XS portable USB DAC; Audioquest, for dazzling everyone with the DragonFly USB DAC, and for coming up with the even better V1.2; and we mustn't forget Muse-related HRT, who probably kick-started the whole 'portaDAC' concept.

This is not meant to be a complete list, merely a roll-call of brands born of real hi-fi, doing what is necessary to keep the world from sinking into a mire of mass-market mediocrity. And for that, I salute them. ☺

'You easily accept that decent hi-fi equipment costs more than £49.99'

July Issue  
on sale 23<sup>rd</sup> MAY

### ON TEST:

- Group Test: USB interconnects
- Exclusive: Brinkmann LaGrange turntable
- Exclusive: VTL S-200 Signature tube amp
- Exclusive: Oppo PM-1 headphones
- Exclusive: Primare NP30 network/USB DAC

### PLUS:

- Investigation: We visit Sonus faber in Italy
- Show Blog: Stockholm High End 2014
- Classical Compendium: CB's monthly guide
- From The Vault: We storm the HFN archives!
- Vinyl Icons: Johnny Cash's ...At Folsom Prison



# NuWave Phono Converter

PS AUDIO

40 years in the making, the NPC  
is the ultimate in vinyl and  
analogue reproduction.



**Complete control of your vinyl collection – play, record, enjoy.**

The NPC combines a state-of-the-art pure analogue phono pre-amplifier with a high-end analogue PCM/DSD converter. Play anything from your turntable or analogue source via the NPC into your pre-amp. Or record your vinyl collection through the NPC onto your computer and play it back via a DAC.

The result? Your new digital vinyl collection brought to you in the original analogue sound.

**Price: £1,799.00**

For a no obligation demonstration please contact one of the following approved PS Audio dealers:

**North West** - Brian & Trevors 0161 766 4837. **East** - Analogue Seduction 01733 350878.

**Midlands** – Oxford Audio Consultants 01865 790879 / Midland Hifi Studio 01902 380083 / Art Audio Salon – 07878 566814.

**South East** - Guildford Audio 07979 515577 / Audio Venue W5 0208 567 8703 / Audio Venue Maidenhead 01628 633995 / Stereo Now 07870 192618.

**Distributed by: Signature Audio Systems 07738 007776 ● [www.psaudio.com](http://www.psaudio.com)**

# pure virtuosity



For more than a quarter-century, Sonus faber has represented the pinnacle of loudspeaker aesthetics. From its earliest models, incorporating real wood, furniture-grade finishing, seductive curves and even grilles that reveal style and inventiveness, this repository of Italian artisan skills and artistry has achieved what was once deemed impossible: creating speakers that sound as beautiful as they look.

Along with a series of models paying homage to the great luthiers of Cremona, the company has since been inspired by the Teatro Olimpica in Vicenza. It is appropriate that this new family of speakers considered the standards of a famed venue as the ne plus ultra of the reproduction of music with vivacity and power... exactly what defines music from opera to orchestral to rock music to soul to jazz. To achieve this, Sonus faber has exploited all that it has learned since its inception.

Like all Sonus faber loudspeakers, Olympia represents what is possible, while respecting what has mattered.

---

 **absolute sounds** ltd.

International Distributors & Consultants of Specialised Hi-End Audio & Video Systems  
58 Durham Road, London, SW20 0TW T: +44 (0)20 89 71 39 09  
W: [www.absolutesounds.com](http://www.absolutesounds.com) E: [info@absolutesounds.com](mailto:info@absolutesounds.com)

*Sonus faber*®