

ICHTHOLOGY AND PALEOECOLOGY
OF THE
UPPER CRETACEOUS CARDIUM FORMATION AT SEEBE, ALBERTA

ICHTHOLOGY AND PALEOECOLOGY
OF THE
UPPER CRETACEOUS CARDIUM FORMATION AT SEEBE, ALBERTA

by

VIRGINIA T. COSTLEY

A Thesis submitted to the Department of Geology
in partial fulfilment of the requirements for the
degree Honours Bachelor of Science

McMaster University

1981

HONOURS BACHELOR OF SCIENCE
(Geology and Biology)

MCMASTER UNIVERSITY
(Hamilton, Ontario)

TITLE: Ichnology and Paleoecology of the Upper
Cretaceous Cardium Formation at Seebe,
Alberta

AUTHOR: Virginia T. Costley

SUPERVISOR: Professor R. G. Walker

NUMBER OF PAGES: ix,117

ABSTRACT

The Cardium at Seebe is definable in terms of five ichnofacies which correlate with the twelve sedimentological facies of Wright (1980). A revised species list of the ichnofauna has been constructed and is used along with sedimentological data to develop the paleoenvironment at Seebe.

The five ichnofacies differ in grain size, sediment type and degree of bioturbation. Totally bioturbated sands and shales reflect long periods of environmental stability during which communities of varying diversity were established. Where traces are preserved best, namely on the upper surfaces of the previously defined cycles 2 and 3, community analyses were performed. These analyses indicate a general correlation between diversity and environmental stability following the storm deposition of sands. Conditions under which non-bioturbated sands were deposited are also discussed.

This is the first analysis of the ichnofauna at Seebe and as such it includes a detailed study of the systematic ichnology of the area. Ichnologically, the Cardium at Seebe represents a mid-shelf environment

populated largely by deposit feeders. The ichnocoenoses are within the Cruziana-Zoophycos assemblage which is characteristic of deeper water. These are best developed on the upper surfaces of the storm dominated sands. The paleoecological observations are concurrent with Wright's sedimentological observations inas much as they suggest an open marine rather than a nearshore environment.

Acknowledgements

I wish to thank Dr. R.G. Walker for allowing me to undertake this project under his supervision. Although somewhat removed from pure sedimentology, this research has allowed me to exploit my interests in paleoecology and ichnology as far as possible, in the absence of a resident "Ichnologist". Dr. Walker's assistance in the field, support during the winter research period, and critical evaluation of this work has been invaluable.

During the month of August, I was visited in the field by Dr. S.G. Pemberton and Dr. R. Frey, from the University of Georgia. Both provided a wealth of information about the local trace fauna, willingly identified traces which I did not recognize, and provided hints to aid in the recognition of new fauna. Without their technical advice this thesis would not have been possible.

Sincerest thanks go to Amoco Canada Petroleum Co. Ltd. for their assistance in providing transportation and equipment required to complete field studies. Thanks also for an enjoyable and rewarding summer.

Thanks go to the employees of Calgary Power, at Seebe, who granted access to their property and provided the necessary paraphernalia required to cross the Horseshoe Dam in safety.

And now to thank all those who aided in the collection, processing and drafting of data: Maria Marta who typed the manuscript without losing her sense of humour or her eyesight, Jorge Cortez who provided instruction in X-Ray analysis, Dan Potocki and Peter Nielsen for their field assistance, Kathy Niel for the preparation of samples for grain size analysis, and Greg Nadon who waded through the handwritten manuscript in search of corrections! Thanks also to my classmates who persuaded me to continue with this in times of desperation.

Last but by no means least, a very special thank-you to Peter who still maintains that he loves me, even after all the drafting and corrections.

TABLE OF CONTENTS

	Page
Abstract	iii
Chapter 1 Introduction, Objectives and Setting	1
Introduction	1
Objectives	2
Geologic Setting	3
Local Geology	4
Geographic Setting	4
Chapter 2 Previous Work	8
Chapter 3 Ichnofacies and Cycle Descriptions	14
Sedimentological Classification of Facies	14
Totally Bioturbated Shale Facies	19
Bioturbated Shale with Identifiable Traces	19
Non-Bioturbated Sandstone Facies	20
Totally Bioturbated Sandstone Facies	20
Bioturbated Sandstone with Identifiable Traces	21
Chapter 4 Systematic Ichnology	23
Classification of Ichnofauna	23
<u>Arenicolites</u>	24
<u>Chondrites</u>	25
<u>Cylindrichnus concentricus</u>	29
<u>Diplocraterion</u>	29

	Page
<u>Gyrochorte</u>	30
<u>Ophiomorpha nodosa</u>	31
<u>Ophiomorpha, Thalassinoides, and Gyrochorte</u>	33
<u>Thalassinoides</u>	34
<u>Rosselia</u>	36
<u>Paleophycos</u>	37
<u>Paleophycos and Planolites</u>	38
<u>Planolites</u>	40
<u>Rhizocorallium</u>	41
<u>Scalaratuba</u>	46
<u>Scolithos</u>	47
<u>Subway Tunnels</u>	50
<u>Teichichnus</u>	54
<u>Zoophycos</u>	54
<u>Problematica</u>	59
Chapter 5 Diversity and Density Studies	73
Chapter 6 Paleoenvironmental Reconstruction: a Discussion	84
Uses of Trace Fossils	84
Seilacher's Classification	85
Paleoenvironmental Reconstruction	87
Life at Seebe during the Turonian	92
Summary	94
Chapter 7 Conclusions	95
Appendix 1 X-Ray Analysis	99
Appendix 2 Acetate Peel Technique	104

LIST of FIGURES

Figure 1	Location of Field Area	7
Figure 2	Detailed Geologic Map of Seebe	8
Figure 3	Compiled measured section	22
Figure 4	Graph of <u>Rhizocorallium</u> width vs. sep'n.	43
Figure 5	Histogram of <u>Rhizocorallium</u> burrow widths	44
Figure 6	<u>Rhizocorallium</u> burrow orientations	45
Figure 7		
Figure 8		
Figure 9	Species Relationships	77
Figure 10	Study areas: Cardinal	78
Figure 11	Study areas: Ram II Spillway Section	79
Figure 12	Study areas: Ram II lower Spillway Section	80
Figure 13	Ichnological Diagram of Species	81
Figure 14	Legend	82

LIST of TABLES

Table 1	Description of Sedimentary Facies	16
Table 2	<u>Thalassinoides</u> measurements	35
Table 3	<u>Skolithos</u> measurements	49

Table 4	Subway Tunnel measurements	52
Table 5	Revised Species List	62
Table 6	Species Relationships:Trellis Diagram	83

LIST of PLATES

Plate 1	<u>Gyrochorte, Arenicolites, Cylindrichnus</u>	28
Plate 2	<u>Planolites, Paleophycos, Chondrites</u>	39
Plate 3	<u>Rhizocorallium</u>	53
Plate 4	Subway Tunnels	57
Plate 5	Subway Tunnels	58
Plate 6	<u>Diplocraterion, Arenicolites, S.linearis</u> <u>S. verticalis, Thalassinoides, Ophiomorpha</u> <u>Rhizocorallium</u>	64
Plate 7	<u>Thalassinoides, 2 forms, Ophiomorpha</u>	65
Plate 8	<u>Zoophycos</u>	66
Plate 9	Subway Tunnels	67
Plate 10	<u>Thalassinoides, Inoceramid shells, Y-trace</u>	68
Plate 11	<u>Linuparus canadensis</u>	69
Plate 12	Keyhole burrow, <u>Inoceramus</u>	70
Plate 13	Burrows: Problematica	71
Plate 14	Invertebrate fossil, <u>Zoophycos</u>	72
Plate X1	X-ray of Cardinal sands	101
Plate X2	Photo corresponding to X1	102
Plate X3	Photo corresponding to X1	103

CHAPTER 1

INTRODUCTION, OBJECTIVES AND SETTING

Introduction

The Cardium Formation at Seebe, Alberta is a well exposed example of an Upper Cretaceous (Turonian) marine sedimentary sequence. It was first studied in terms of depositional environment by Beach (1955) and has most recently been studied by Wright (1980).

Wright (1980) mapped the Cardium in outcrop at the Horshoe and Kananaskis Dams and completed a detailed study of the stratigraphy, sedimentology and structural geology of this formation. In her study, she defined the Cardium using twelve different facies arranged in five coarsening upward cycles of three different types. Based on this facies analysis, she concluded that the Cardium Formation at Seebe represented environmental conditions below fairweather wave base.

Emphasis is placed on the observation of hummocky cross stratification (henceforth shortened to H.C.S.) as defined and interpreted by Harms et al. (1975).

H.C.S. is believed to form below fairweather wave base by storm waves. Its abundance in the Cardium is significant in the interpretation of depositional environments and processes.

In 1956, Beach applied a turbidity current model, originally proposed for the Viking Formation, to explain depositional processes in the Cardium. Several counter-theories were mounted in response to this, and Wright (1980) amalgamated the most plausible and included them in her study.

Wright also observed a Zoophycos + Rhizocorallium ichnofossil assemblage which is considered distinctive of off-shore environments. A study of the foraminiferal assemblage implies marine conditions removed from the shoreline, below fairweather wave base but shallower than fifty metres (Walker and Wright, 1980).

Objectives

The primary objective of this ichnological study of the Cardium at Seebe is to identify and describe the trace fauna. In addition, preliminary measurements were made of diversity and abundance within ichnocoenoses.

Fieldwork was undertaken during the summer of 1980. Laboratory studies and the compilation of data were completed the following winter. Field studies included

- the following:
- 1) description of traces in situ;
 - 2) measurements of characteristic features such as burrow length and diameter as well as internal and external ornamentation features (where applicable);
 - 3) description of individual traces and trace assemblages in terms of distribution and abundance (i.e. diversity/density studies);
 - 4) establishment of a pictorial record of traces for future reference;
 - 5) collection of samples for laboratory work.

Laboratory analysis involved the preparation of acetate peels as part of a comparative grain size study, x-ray analyses and preparation of molds to aid in the identification of certain traces.

Geologic Setting

The Cardium exposure at Seebe lies just east of the broad low angle westerly dipping thrust sheets which mark the Front Ranges of the Rocky Mountains (Bruce et al., 1980). Immediately to the west of the study area lies Mount Yamnuska, formed by Middle Cambrian Eldon limestones thrust eastward over Upper Cretaceous Belly River mudstones and sandstones along the McConnel Thrust (Bruce et al., 1980).

The Cardium Formation extends from Peace River Country south to the 49th parallel (Stott, 1963), and at Seebe it is Turonian in age.

Local Geology

The study areas are located on the same low angle westerly dipping thrust sheet, multiples of which characterize the foothills. Both the Kananaskis and Horseshoe Dam outcrops lie on the western limit of two separate low angle anticlines separated by a syncline.

The low angle thrust faults which trend NW-SE, are intersected by subparallel normal faults, dipping between 55° and 90° , which show displacement between one and four metres (N_1 and N_6 respectively). Figure 2 (from Wright, 1980), illustrates the fault relationships.

Uplift and thrusting were due to compressional events in the west during the Paleogene and Late Cretaceous (Monger and Price, 1979). Following this orogenesis a new stress system developed. This is the suggested cause for the jointing and normal faulting seen in the Cardium at Seebe (Mueke and Charlesworth, 1966).

Geographic Setting

The study areas are located near the town of Seebe in southern Alberta (latitude $51^{\circ} 6' N$, longitude $115^{\circ} 3.6' W$

near 15-33-24-8W5). Seebe is approached via the Trans Canada Highway-1 west from Calgary, about twenty kilometres east of Canmore. Both outcrops are exposed below Calgary Power dams on the Bow River.

Access to the Kananaskis Dam (or Seebe outcrop) is obtained north of Highway 1 from the Seebe-Exshaw turnoff on Highway 1^x. Approximately 1 km along Highway 1^x is a bridge crossing the Kananaskis reservoir, which may be viewed to the east. The Kananaskis exposure is east of the dam, and may be reached by turning right along a dead-end dirt road just past this bridge (across from the Brewster Ranch).

The Horseshoe Dam outcrop lies beyond the town of Seebe along the main road which terminates just beyond the dam. Assistance and permission from Calgary Power was required to gain access to the Horseshoe Dam outcrop which is best exposed on the north side of the river. The operators at the Control Centre at Seebe are used to the annual field treks by geologists and were most helpful in unlocking the door to the dam and providing a safety line and ladders to facilitate safe access to the exposure. It is wise to call the Calgary Power office at Seebe in advance, both for permission to work on their property and for a report on the water levels which during run-off and heavy rain periods are high enough to prevent safe crossing.

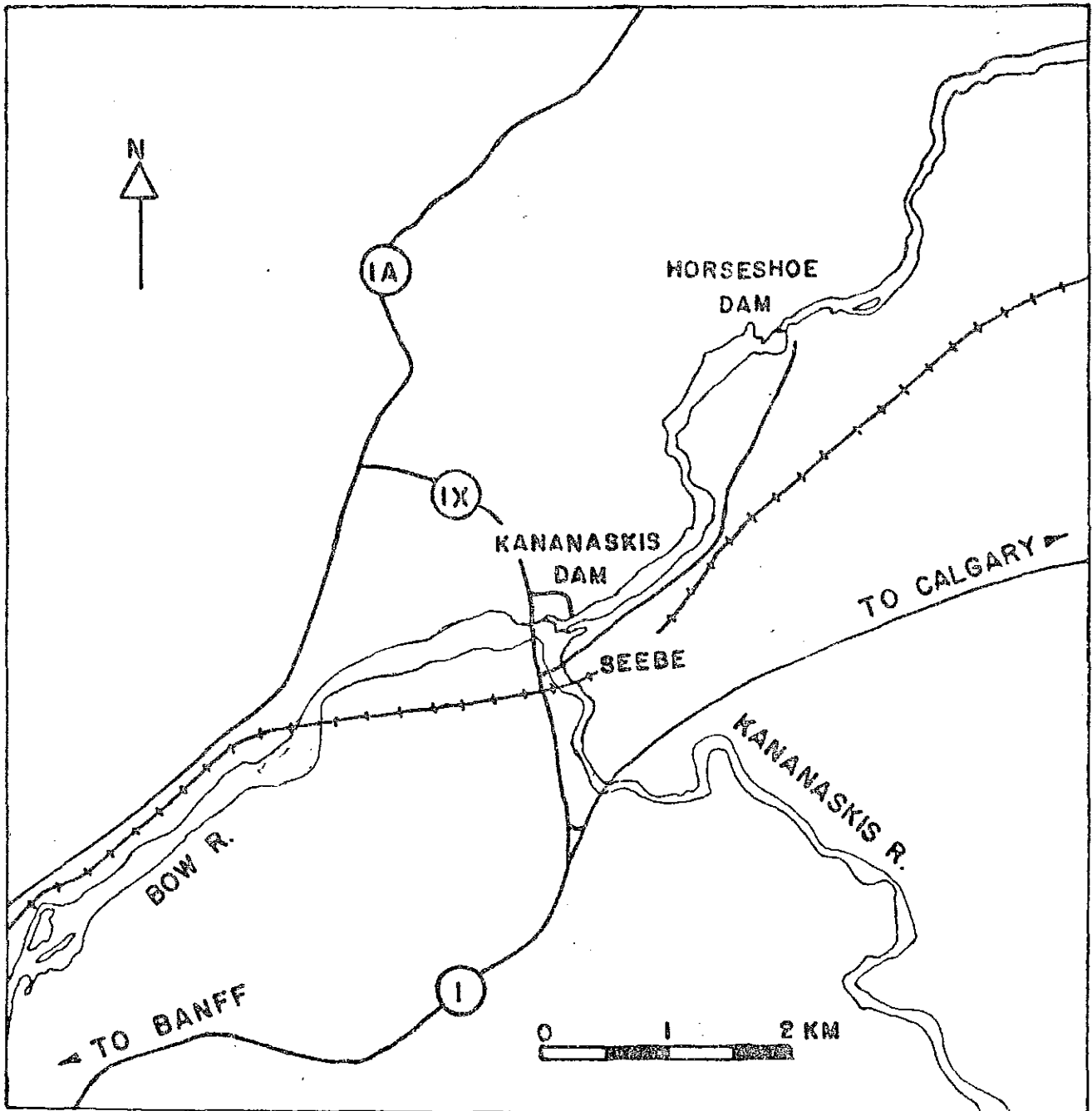

Figure 1. Outcrop Location Map, encircled numbers mark highways (Courtesy of Wright, 1980).

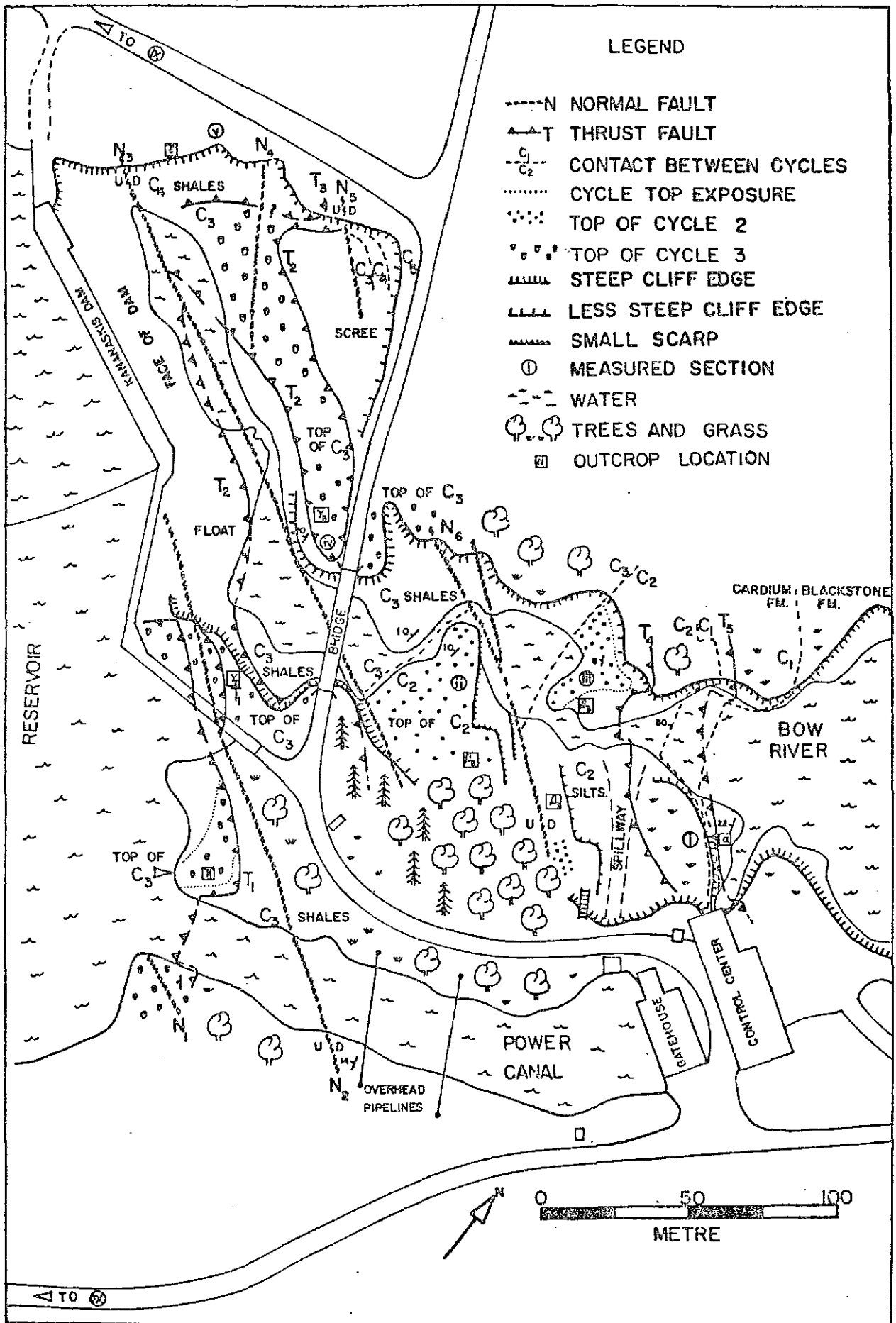

Figure 2. Detailed Geologic Map of the Seebe Outcrop, courtesy of Wright, 1980.

CHAPTER 2

PREVIOUS WORK

This is the first detailed study of the Ichnofauna in the Cardium at Seebe. Previous work has dealt solely with structural and sedimentological problems and these will be discussed here.

Beach (1955) and deWeil (1956) were first to describe depositional environments in the Cardium. Although field mapping and stratigraphic correlation had been done previously, it was not until the discovery of the Pembina oil field in 1953 that petroleum geologists had both the economic incentive and subsurface data required to understand depositional processes as they applied to the Cardium. Beach (1955) developed a turbidity current model for the Viking conglomerates and then applied this to the Cardium based on the criteria defined by Passega (1954). Beach used the extensive laterally uniform pebble layers present in both deposits to support this model. He further stated that these layers were too coarse to be explained by pelagic sedimentation and their presence within shale beds could most easily be explained by a turbidity current model.

DeWeil (1956) preferred an interpretation based on more conventional principles of sedimentation. He felt that the Cardium deposits lacked the individual graded beds required for turbidites. Thus, he described sand lenses striking parallel to the ancient sea coast. He explained their origin in a flat bottomed sea, subject to eustatic changes. These resulted in lateral displacement of the shoreline. In a shallow sea, only a small change would be required for this displacement. His sediment source was a result of a tectonic rise to the west with lateral transport of incoming sediment via longshore currents.

The 1957 Cardium Symposium held by the Alberta Society of Petroleum Geologists resulted in four papers, mostly on subsurface studies of the Cardium. McDonald (1957) discussed the development of a Cardium delta system in the Peace River area based on isopach and structure contour maps. Roessigh (1957) compared the "Cardium sand" at Pigeon Lake and Leduc to turbidity current deposits described by Schneeberger (1955). He described the development of well sorted sharp based sands overlaying shales, with lenticular form and well defined lateral limits. Michaelis (1957) and Nielsen (1957) developed new models to explain the Cardium.

Michaelis (1957) formulated a model for the Cardium based on a study in outcrop of the Pembina area. This model

defines five cycles of regressive sequences each separated by a transgression. His evidence suggested a resemblance of the poorly sorted siltstones to recent deltaic deposits, the interbedded sands and shales to recent delta front sands associated with inflow channels, and the lower fine siltstones which contained burrows and ripple cross lamination to tidal front sediments. The overlying sands were considered to be upper foreshore beach deposits which were sometimes capped by conglomerates. Wave action during a transgression was postulated as the cause for gravel deposits overlying marine shales. Michaelis concluded that sedimentation was active near a distributary channel and this sediment was subsequently redeposited by storm currents.

Nielsen (1957) rejected both deltaic and turbidity current models for the Cardium at Pembina. He felt that the cross lamination within the sandstones was not on a large enough scale to be deltaic. Also, the sets were too well sorted for this model. Turbidity deposits did not fit Keunen's (1957) criteria of graded bedding, regular interbedding of sandstones and shale, poor sorting of dirty sands and the absence of scour. In addition to this, Nielsen felt the basin was too shallow to support turbidity current deposition. Instead, he proposed a model of a continually rising sea, with sands always below

fair-weather wave base. Uplift to the west resulted both in deposition of second or third generation conglomerates and an overall lowering of sea level.

Stott (1961) mapped and measured the Cardium and subdivided it into, in ascending order, the RAM, MOOSEHOUND, KISKA CARDINAL, LEYLAND and STURROCK members. The Moosehound, a non-marine member, is found only in the northerly Cardium exposures. An extensive study in 1963 resulted in the interpretation of the Cardium as an overall regressive sequence within which were found minor cycles of sands and shales representing regressions and transgressions respectively. Stott used observations of sand thickness, lateral continuity, well sorted sands and uniform lamination to develop a beach, off-beach, barrier bar complex. Burrows, ripple cross-lamination and oscillation ripples were considered to be indicative of shallow water and the conglomerates were considered to be formed in a beach-barrier bar deposit.

A suite of beach, offshore and river environments was proposed for the Cardium by Michaelis and Dixon (1969). They noted the dominance of plane beds within the Cardium sandstones and suggested that these were produced by abnormally high velocity currents. Storm activity was suggested as one possible cause.

McCormack (1972) proposed a complex depositional history including lagoon, off beach, backshore, upper and lower foreshore and outer neritic environments based on outcrop and subsurface data and paralleling the ideas of Stott (1963).

Swagor's (1975) study of Carrot Creek emphasized the role of storm deposition. However a turbidity current model was not invoked because of the reverse graded bedding and because Swagor felt a steeper slope was required for turbidity current formation. He rejected the beach model because of his observations of unsorted conglomerates, reverse graded bedding, inclined pebble discs and a coarsening upward sequence. In addition, no evidence of either river activity associated with beach deposits or of westward land deposits was found. He postulated an offshore bar in a sea too shallow for tidal influence. This was affected by sand and gravel deposition in response to wind generated storm waves or storm surge. Coarsening upward sequences were attributed to the storm gaining strength. Waning flow was indicated by the fine grained overlying shales.

Wright (1980), and Wright and Walker (1981) developed some of Swagor's concepts, proposing deposition due to storm-surge-generated density currents below normal wave base for the Cardium at Seebe. The Cardium was

subdivided into twelve facies based on grain size, siltstone: sandstone ratios, bed thickness, sedimentary structures and extent of bioturbation. These facies may be arranged as three different cycle types, all of which coarsen upwards. The dominance of H.C.S. and associated conglomerates indicate an offshore environment predominantly below fairweather wave base. Neither a beach nor a nearshore environment was indicated by preliminary studies of foraminifera and ichnofauna and Wright concludes that the most plausible depositional environment was below the reach of fairweather processes and probably many kilometres offshore.

CHAPTER 3

ICHTNOFACIES AND CYCLE DESCRIPTIONS

Sedimentological Classification of Facies

Twelve facies were defined by Wright (1980) for the Cardium at Seebe, based on grain size, siltstone: sandstone ratios, bed thickness, sedimentary structures and extent of bioturbation. Brief descriptions are included here to facilitate comparison with facies defined by the ichnofaunal assemblage (see Table 1).

Coarsening and thickening upward is common to each cycle defined in the study area. Each cycle begins with shales on siltstones and coarsen upwards into the massive sandstone facies. Six cycle types have been defined for the Cardium at South and Central Alberta (Ainsworth, Duke, Walker and Wright, personal communications, 1979). At the Kananaskis and Horseshoe Dams, Type 1, 2 and 6 cycles have been recognized (Wright, 1980, Table 1).

The Cardium at Seebe may be split into five ichnofacies. These are defined by overall grain size and degree of bioturbation. They are: totally bioturbated shale (TBSH), bioturbated shale with identifiable traces (BIT),

totally bioturbated sandstone (TBSS), non bioturbated sandstone (NBSS) and bioturbated sandstone with identifiable traces (BSIT).

A general correlation of grain size and complexity of ichnocoenoses was found. The fine grained shales (0.01-0.03 mm) were totally bioturbated. Shales with a broader grain size range (0.01-0.05 mm) showed varying degrees of bioturbation. Coarsest sandstones at Seebe (0.1-0.15 mm) contained the most complex ichnoassemblages. This may be a function of exposure to weathering, environmental stability, or it may be that animals came in to colonize newly deposited reverse graded sands of turbidity flows and were unable to completely bioturbate the sediment before the next flow swept them away. Totally bioturbated sandstones in the Cardinal would represent long exposure time in stable conditions while the totally unbioturbated sandstones, found in both Ram cycles, suggest successive rapid deposition of sands too quickly to be colonized by either crustaceans or worms. It is unlikely that no bioturbation occurred in the sands but traces are not apparent in X-ray or in vertical sections. Horizontal grazing traces may be found on the undersides of bedding planes within these sands.

FACIES	GENERAL DESCRIPTION	SEDIMENTARY FACIES	BIOLOGICAL FEATURES	# of OCCURRENCES
A: Less Bioturbated Shale	-fissile dark grey to black shales lightening and becoming more massive upwards.	-well stratified -scattered sideritic concretions -coarsening upwards	-bioturbation low to absent.	S.= 1 H.= 2
B: Bioturbated Shale	-dark grey siltstones weathering to rubbly and becoming more massive upwards silt-sand ratio=5.7 decreasing upward to 4.	-scattered sideritic concretions -coarsening upwards -sharp based sandstone ribs with undulatory top surfaces -poorly preserved sed. structures. -pebble horizons	-dominated by bioturbation which locally causes downward displacement of pebbles (d=2-10 mm) -diverse ichnofauna also ammonites and decapod.	S.= 4 H.= 8
C: Ribby Shale	-black well stratified shales having sharp based sandstone ribs within.	-lumpy concretions throughout -sandstone ribs show ripple cross lamination and become less frequent upwards.	-little bioturbation.	S.= 0 H.= 1
D: Rippled Interbedded Sandstone	-alternating sandstones and dark grey siltstones -siltstones dominate -ave. silt-sand=2.5 -ratio range (.5-20)	-sideritic concretions and ironstaining throughout -symmetrical ripples in top surface of sandstones only recognizable sed. structure.	-diverse ichnofauna	S.= 2 H.= 0

TABLE 1. Sedimentary facies at Seebe, as defined by Wright (1980).

FACIES	GENERAL DESCRIPTION	SEDIMENTARY FACIES	BIOLOGICAL FEATURES	# of OCCURRENCES
E: Thin Bedded H.C.S.	-thin H.C.S. inter thicker, grey sharp based sandstones and siltstones -bed thickness (5- 20 cm), thickening upwards. -grain size (.06-.1mm.) -coarsening upward.	-H.C.S. well developed throughout with no parallel lamination -top surfaces display symmetrical ripples -siltstones may show planar lamination and occasional sand lenses	-localized bioturbation -siltstones usually tho- roughly bioturbated	S.= 2 H.= ?
F: Thick Bedded H.C.S	-similar to thin bed- ded version -grain size (.1-.15mm) -bed thickness(20- 60 cm).	-siltstones with good planar stratification may enclose sand lenses -sands show symmetrical ripples on top surface when bioturbation absent -less common: current ripples, cross lamination.	-siltstone: well biot- urbated -sandstone: locally bio- turbated causing irregular pitting of top surfaces.	S.= 3
G: Amalgamated H.C.S.	-massive H.C.S. lack- ing siltstone inter- beds -grain size (.1mm) -bed thickness (2-8cm)	-considerable local var- iation in preserved str- ucture and bioturbation. -well developed H.C.S. alternates with biotur- bated sands.	-bioturbated sandstone contains identifiable trace fauna	S.= 2 H.= 2
H: Bioturbated Sandstones	-light grey resist- ive sandstones with rust coloured iron staining	-occasional faint lam- inations -upper surface may have pebble veneers. -scour features on top surface (Horseshoe Dam)	-thorough bioturbation destroys any possible previous H.C.S.	S.= 1 H.= 1

FACIES	GENERAL DESCRIPTION	SEDIMENTARY FACIES	BIOLOGICAL FEATURES	# of OCCURRENCES
I: Bioturbated Silty Sandstones	-massive dark gray homogeneous silty sands -preservation is better upwards with increasing grainsize.	-poor preservation of rippled surfaces -laminated sandstone lenses -oriented sideritic concretions.	-extensive bioturbation with some identifiable traces.	S.= 1 H.= 2
J: Clast Supported Conglomerate	-massive well cemented lacking structure -rounded chert pebbles in a sand/silt size quartz and clay matrix.	-homogeneous containing concretions -symmetrical gravel waves on upper surface -local graded bedding	-none reported	S.= 1 H.= 0
K: Matrix Supported Conglomerate	-dark grey containing well rounded chert pebbles in a v.f.g. sand and silt matrix.	-absent -random concretions	-none reported	S.= 1 H.= 1
L: Concretionary Conglomerate	-massive continuous concretion layer -gritty mixture of silt sand and chert pebbles entirely within a sideritic layer.	-absent	-none reported	S.= 1 H.= 2

Table # 1 : Sedimentary facies at Seebe, as defined by Wright (1980)

Totally Bioturbated Shale Facies (TBSH)

This facies occurred three times at Seebe and twice at Horseshoe Dam. Generally homogeneous coarsening upward shales (grain size 0.03-0.07 mm) contained Skolithos, Planolites, Paleophycos, and other less well defined burrows. Horizontal traces dominated at upper and lower contacts while vertical traces were more apparent in the mid section.

This facies corresponds to Wright's B facies and in addition to poorly defined trace fauna, includes ammonites (Scaphites sp, Acanthoceras sp) in both outcrops, decapod crustaceans (Linuparus canadensis) at Horseshoe Dam, scattered chert pebbles and sandstone lenses. Teichichnus, Gyrochorte, and Arenicolites were not seen however. Ophiomorpha was found in the section (13-16 m) at Seebe.

Bioturbated Shale with Identifiable Traces (BIT)

This is similar in appearance to TBSS except that traces are well defined. This suggests preservational rather than environmental differences. This facies occurred three times at Seebe and twice in Ram sections.

Planolites, Paleophycos and Chondrites were clearly defined at the base of Ram I but in higher sections, Planolites and Paleophycos were found more commonly than Chondrites. The clarity of preservation as compared to TBSS was striking.

Non Bioturbated Sandstone Facies (NBSS)

Sandstone beds, less than half a metre thick showed parallel lamination, H.C.S. or a total lack of sedimentary and biogenic structure. Traces were found only on upper and lower contacts. Grain size, approximately 0.1 mm, increased upwards. Maximum bed thickness was 0.7 m. This facies graded up into either totally bioturbated sandstones or bioturbated sandstones with identifiable traces. It overlaps Wright's (1980) facies "D", "E", "F" and "G". Facies "E", "F" and "G" are H.C.S. sandstone facies with varying degrees of bioturbation; "D" is rippled interbedded sandstone facies. Both contain bioturbated shale interbeds. Wright's classification is more specific, whereas for this study it was sufficient to distinguish between bioturbated and non-bioturbated sands.

Totally Bioturbated Sandstone Facies (TBSS)

In contrast, this facies shows no primary structures and in some areas is so bioturbated that individual traces cannot be identified. It occurs once at Seebe, once at Horseshoe Dam and grades up into bioturbated sandstone with identifiable traces. This corresponds approximately to Wright's facies "H". Four identifiable vertical Ophiomorpha burrows were found within the lower part of this facies.

Bioturbated Sandstone with Identifiable Traces (BSIT)

Most of the field-time was spent working in this facies. There are three well exposed horizons which contain the majority of traces found at Seebe. Differences in population diversity and density are discussed in subsequent chapters.

This facies consisted of the coarsest sands (0.1-0.15) of cycles 2 and 3 and showed little or no primary sedimentary structures. Striking patterns of iron staining (Cardinal area I and Ram II), concretions (Ram II), limonite burrow infills and pebble veneers, in addition to the ichnofauna, characterize this facies.

Wright (1980) includes these horizons in facies "G" and "H" but they can be correlated with respect to ichnofauna and defined as a single ichnofacies. The major difference between the three locations lies in the extent of bioturbation and species diversity. Ram I, 9.5 to 13 m, was included in this facies although it lacked in diversity and a pebble horizon. The paleoecological implications of this facies are discussed in Chapter 6.

FIG. 3 COMPILED MEASURED SECTION OF THE SEEBE OUTCROP
SHOWING SEDIMENTARY FACIES AND ICHNOFACIES.

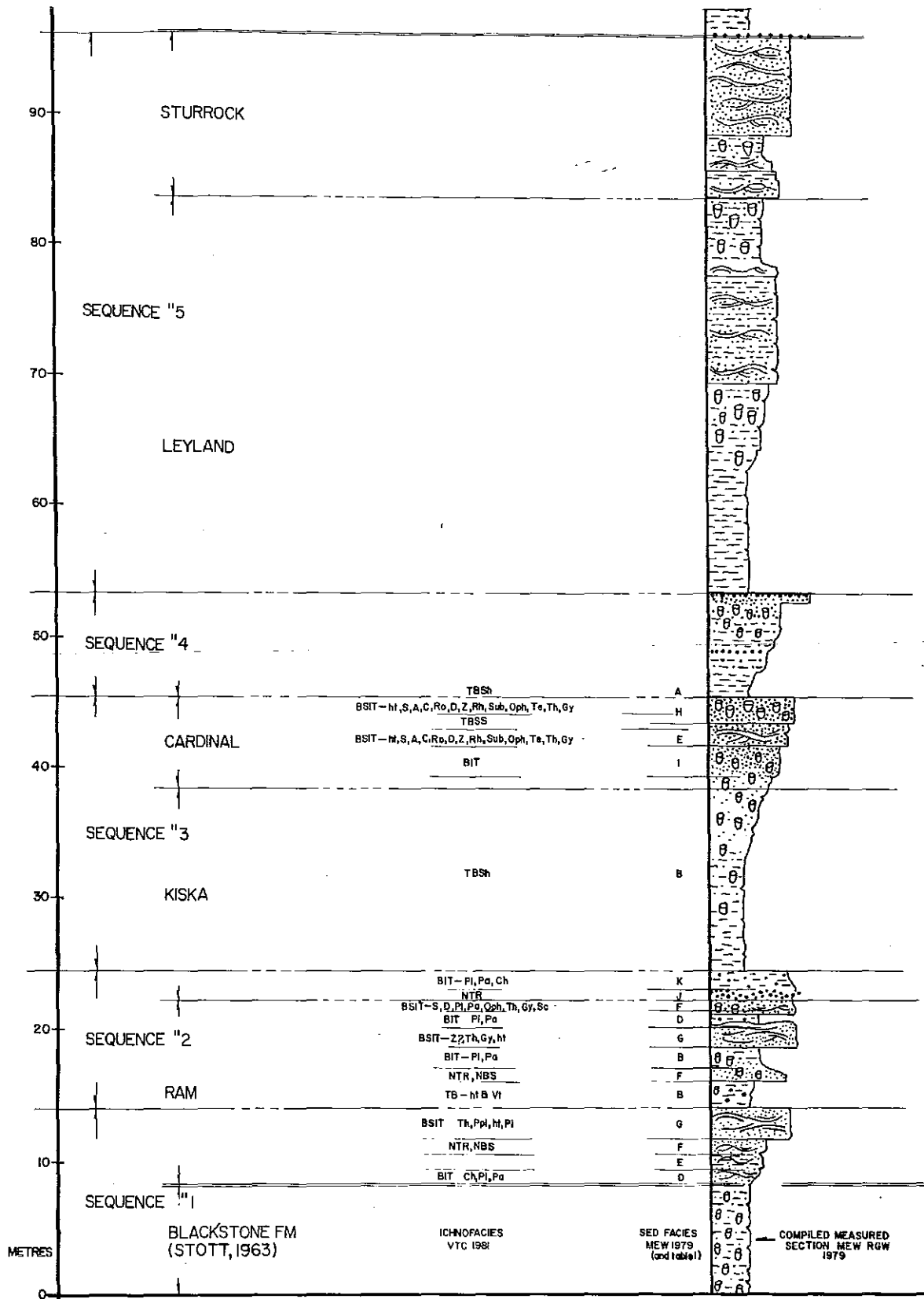

CHAPTER 4

SYSTEMATIC ICHNOLOGY

Classification of Ichnofauna

Ichnofaunal assemblages are a record of animal-sediment interactions and environmental conditions. The same animal may be responsible for several morphologically different traces or, conversely, different animals may make identical traces. Thus, conventional paleontological classification techniques based on morphological criteria are insufficient.

Ichnofossils may be classified either ethologically, taxonomically or through preservation. This permits definitions recognized by paleontologists and sedimentologists and avoids overclassification, a problem in the literature at this time. Wherever possible for each trace, I have combined field observations with details of preservation, ethology and taxonomy.

Ethological classification was based on Seilacher's five groups: domichnia, cubichnia, fodinichnia, pascichnia and repichnia. No fugichnia, escape structures as defined by Simpson (1975), were found. This type of classification

relates organisms by life habits accounting for similarities of traces made by dissimilar organisms with similar modes of life.

Taxonomic classification relates traces of specific organisms by natural descent but current inadequacies in modern trace identification limit this method to arm waving generalizations.

The following descriptions are the result of observations made during fifteen field days at Seebe. On two of these, I was accompanied by professors R. Frey and G. Pemberton from the University of Georgia who provided instruction in field observation and species identification, the latter which they either confirmed or amended.

Sixteen ichnogenera were identified. These are summarized in an updated species list (see Table 2).

Arenicolites (Salter, 1857)

Range: Cambrian - Recent (Treatise)

Cambrian - Cretaceous (Hantzchel, 1975)

This trace was found in the Cardinal Area 1 as pairs of rounded vertical, unsculptured burrows ranging in diameter from 1.0 to 2.6 cm with burrow separation between 3.5 and 5 cm. It was not common and limited vertical exposure meant likely confusion with Skolithos. Wright (1980) reported Arenicolites in several locations within the bioturbated siltstone facies.

These were not observed by me, possibly because of this confusion. One distinct funnel shaped aperture was found.

Densities range from 1 to 4 per m² in ten observations.

Interpretive Ecology

Arenicolites is considered the domicinia of a filter feeding worm (Ireland et al., 1978) most commonly found in association with the shallow water Skolithos ichnofacies or the slightly deeper Cruziana ichnofacies. Both environments provide sufficient organic material and water turbulence to allow a filter feeding organism to survive (Seilacher, 1964, 1967; Farrow, 1967; Hakes, 1976).

Chondrites (Sternberg, 1833)

Range: Upper Cambrian - Pliocene (Ekdale)

Upper Cretaceous - ? (Treatise)

Chondrites forms as regular ramifying tunnel structures which neither cross each other nor anastomose. At Seebe two forms were found. In the area of the Kiska/Cardinal transition, Chondrites (K/C type) was found with a central elliptical branch, (d= 4 mm) and smaller circular or elliptical branches (d= 1-2 mm) off to the side. This form is apparently planar with carbonaceous infill different from the surrounding sandstone. A second less well defined form was found in the shales of the lowest Ram I section, Chondrites R-1 type.

This showed no difference in branch diameter ($d = 0.5$ mm). The sediment infilling was similar to the surrounding shale and no carbonaceous coatings were observed.

Density differences between the two forms are as follows:

$$\text{K/C type} - D_{\text{max}} = 2/\text{m}^2$$

$$\text{R-1 type} - D_{\text{max}} = 50+/\text{m}^2 \text{ (too many to accurately measure)}$$

Type R-1 burrows were found interwoven with Paleophycos, Planolites and each other.

Interpretive Ecology

Showd and Levin (1976) reported two forms similar to K/C and R-1 in the Ordovician of Mississippi. In the larger form ($d = 3.0$ mm) the main branch was presumed to mark the lowest possible level of the sediment/water interface and used to imply that Chondrites mined the sediment on or just below this. The observation of apparently horizontal ($\pm 5^\circ$ from neutral) Chondrites in the Kiska/Cardinal Fault Block supports this idea.

Chondrites is generally considered to be the fodinichnia of a sediment eating organism (Richter, 1927; Seilacher, 1955; Osgood, 1970). However, there is some controversy. Richter (1931) believed the branching pattern was the result of phototaxis of a sediment eater, while Tauber (1949) stated that fillings were composed of fecal

material of a filter feeder under conditions of rapid sedimentation. Simpson (1957) maintained the structure was the response of a deposit feeder which fed from a fixed point on the surface and explored a layer of organic rich sediment to the maximum extent possible, without covering the same layer twice.

Chondrites is not diagnostic of any specific environment (Pemberton, 1976). Simpson, 1937; Seilacher, 1955; and Seilacher and Meischner, 1964, define it as a facies crossing form. Seilacher, 1955, 1963, 1967; Bromley and Asgaard, 1972; and Stanley and Fagerstrum, 1974, confirm this, calling it a marine but not a bathymetric indicator. Variations in form however, may reflect differences in sedimentation rates. A planar system, as found at Seebe, would reflect slow sedimentation and abundant food while an oblique system would indicate either uneven dispersal of food within sediments or rapid deposition (Osgood, 1970; Ekdale, 1977). At Seebe, in conditions where rapid sedimentation is suspected, Chondrites is not found.

There are a variety of organisms suggested to be responsible for Chondrites. These include polychaetes (Simpson, 1957; Ferguson, 1965; Osgood, 1970), tentacles of a sipunculid (Taylor, 1967) and tiny arthropods (Ekdale, 1977).

PLATE 1: A- Arenicolites, Cylindrichnus, and
star shaped trace from the Cardinal
Area 3.

B- Gyrochorte from the Ram II, section 8

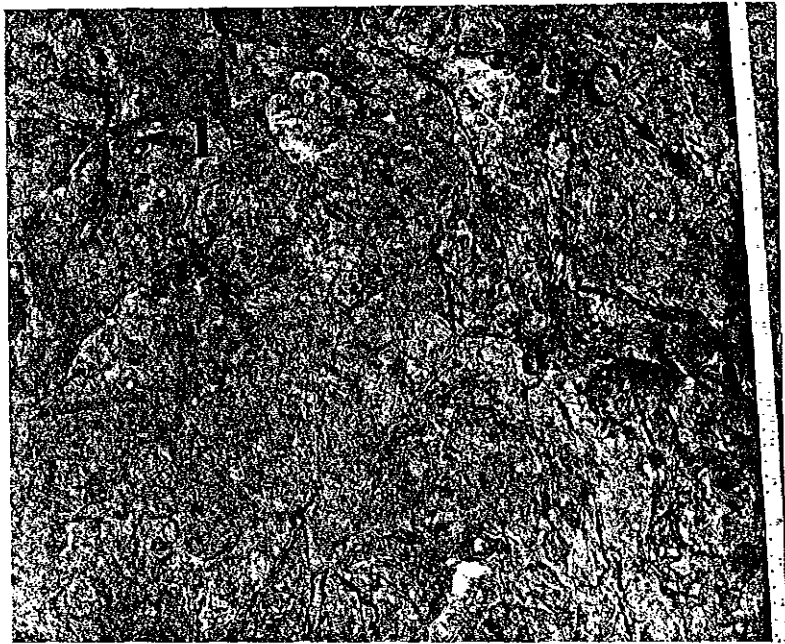

Cylindrichnus concentricus (Toots in Howard, 1966)

Range: Upper Cretaceous (Frey, 1970)

This test-tube shaped burrow was found in association with Skolithos in Ram II (spillway - Section 3) and in several Cardinal locations. Larger than Skolithos and consisting of a central core and a series of concentric layers, the specimens were all vertical, with a diameter greater than 1.0 cm. This allowed distinction from Skolithos (1.0 cm by definition). The maximum density of Cylindrichnus was 12/m², found in the Cardinal Area 2.

Interpretive Ecology

This is a domicinia of a filter feeding organism such as a sea anemone (Howard, 1966; Chamberlain and Clark, 1973) or a crustacean (Frey, 1970).

Diplocraterion (Torell, 1870)

Range: Lower Cambrian - ? (Treatise)

This trace, U-shaped with spreite, similar to Rhizocorallum but always strictly perpendicular to bedding, was found only in horizontal sections and could therefore not be conclusively identified. Iron stained dumbbell shapes found in the spillway Ram II, section 6 and Cardinal, were the only evidence of this trace.

Figure 7 illustrates the interpreted shape of a fully

exposed trace.

Gyrochorte (Heer, 1865)

Range: Cambrian - Tertiary (Treatise)

Gyrochorte was found several times in the sands of Ram II (spillway section 7), and once in the Cardinal at Horse-shoe Dam. The specimens from Ram II showed well defined biserial arrangement of plait-like ridges along winding trails. Found as epi-reliefs on the upper surface of thin sandstone beds as described by Hallam (1970), the ridges maintained a constant width of 0.3 mm, with central groove diameter of 0.1 mm. Thus, total trace width was 0.7 mm.

The Cardinal sample and one Ram II sample show the corresponding smooth winding tramline grooves of hyporeliefs.

Interpretive Ecology

Fuchs (1895), recognized the ridges of Gyrochorte as tunnelling structures and related them to Hancock's (1858) interpretation on tunnelling arthropods. Hallam (1970), stated the trace maker must have been an organism such as a gastropod, crustacean or worm (thereby covering all bases).

Amphipods and Isopods are known to burrow, producing tunnels beneath the sand surface. A problem with this interpretation is that ridge separation commonly reaches 1 cm (Weiss, 1970) which is much greater than recorded for small

arthropods or isopods. Schindewolf and Seilacher (1955), proposed a worm-like burrower whose anterior was raised above the general axis of body movement and could move left or right of the hind part. The exact mechanism of this movement is not stated. Direction of movement along these traces has not yet been established (Hallam, 1970).

Ophiomorpha nodosa (Lundgren, 1891)

Range: Upper Cretaceous - Tertiary (Treatise)

Upper Cretaceous - Recent (Crimes and Harper)

Found in two forms at Seebe, this warty-walled tunnel system was more common in the Cardinal Area 1 and in Ram II, sections 2, 7 and 8. Diameters range from 0.6 cm to 1.2 cm in the Cardinal (Area 1 and Horseshoe Dam, respectively). Both forms have external ornamentation and internal smooth walls. Form A shows alternating horizontal ridges and grooves with no set ridge size or spacing. Form B shows overlapping irregular knobs. One form frequently grades into the other and may reflect preservational differences as much as changes in the animal's burrowing habits.

Vertical and horizontal burrows were found in both Cardinal and Ram II exposures. Horizontal trails were found crossing Thalassinoides in some areas suggesting that the latter was a subsurface burrow or, less likely, that Ophiomorpha burrows were eroded, the animals climbed out onto

a "fresh" surface and before total bioturbation could occur, were covered or swept away by another influx of sand.

Densities vary, from 1 to 8 per m² (including horizontal and vertical exposure, Ram II, Section 8).

In heavily bioturbated areas, vertical burrows are not well defined. This accounts for higher densities in Section 8 beneath the gravel lag versus the spillway.

Interpretive Ecology

Commonly found in coarse, well sorted sandstone, Ophiomorpha nodosa is considered (with some reservations) indicative of low littoral and shallow offshore conditions (Hantzschel, 1952; Hecker et al., 1963; Weimer and Hoyt, 1964; Guy, 1968; Juk and Strauch, 1968; Kennedy and MacDougal, 1969).

Callianassa major is a likely modern analogue of the Callianassid species responsible for Ophiomorpha, found by Weimer and Hoyt (1964) confined to high energy littoral and shallow neritic environments of Sapelo Island.

Ophiomorpha, Thalassinoides, and Gyrolithes

Currently in the literature there exists considerable evidence that these three traces represent a series of burrowing habits by the same decapod crustacean in either different sediment types or different water conditions. In the modern, decapods form a number of different burrows (Rhoads, 1970, and others).

The work of Gernant (1972); Weimer and Hoyt (1964); Kilper (1972); and Seimer (1971), has linked Thalassinoides, Ophiomorpha, and Gyrolithes. The first two are discussed in following pages. These are both found at Seebe. Gyrolithes, considered to have a much narrower and more specific environmental tolerance, will be briefly described here.

Present from the Jurassic to Miocene, this loosely coiled structure grades into Ophiomorpha in the Miocene of Germany (Kilpper, 1962) and into Thalassinoides in the Eocene of Texas (Seimer, 1971). Schmitt (1965), stated that environmental differences resulted in the same organism producing this structure in preference to Ophiomorpha or Thalassinoides in marginal to shallow marine conditions, from data based on sedimentological and microfaunal studies. Gyrolithes has never been found outside this narrow range of conditions and the deep vertical spirals agree with Seilacher's classification of a shallow or subtidal organism.

If this is true, as the evidence suggests, then the absence of Gyrolithes and the presence of Ophiomorpha and Thalassinoides rules out shallow marine conditions (less than 10 m , Gernart, 1972). The Thalassinoides-Ophiomorpha transition has also been noted by Doust (1970). Ager and Wallace (1970) stated that higher energy environments in shallow water contain large numbers of Thalassinoides which grade shoreward into Gyrolithes.

Thalassinoides (Erhenberg, 1944)

Range: Triassic - Tertiary

Horizontal systems of unornamented Y-shape branches are found on exposed surfaces of coarsest sands (grain size 1 mm) in Ram II Spillway sections and on the upper surfaces of the Cardinal, all areas. Bulges are found along the arms of some of these Y shapes in the Cardinal Area 1 and in the Spillway (Ram II).

Iron staining within these burrows produces a striking effect against the pale sandstones. In the Cardinal, Area 1, there were only five reported occurrences. At Horshoe Dam, there were few well defined traces on the north side of the river but 1 or 2 per m² throughout the "Carpark", area 6. Lengthwise striations were evident in some traces in the Kiska/Cardinal section.

Sample measurements are shown in Table 2 .

TABLE 2. Variation in Thalassionides measurements

Location	Measurements (cm)			
	d_{stem}	$d_{(V)}$	l_{stem}	l_V
6 (Carpark)	0.5	0.6		
	0.9	1.0		
	1.0	1.5		
	2.0	2.0		
	0.3	0.5		
Area 2	0.7	0.8	22	35 35*
	1.0	1.2	27	37 39
	1.1	1.3	17	49 51
Ram II (Spillway)	1.0	2.5		
	2.2	2.8		

*

Note that length measurements are related to extent of exposure and are therefore qualitative.

In some samples, concentric laminae were found within the burrows. In areas with more than $3/m^2$, the traces overlapped. Some showed minute longitudinal ridges and grooves ($d= 0.1$ mm) in the arms of the Y. These was never more than one order of branching.

Rosselia (Dalmer, 1937)

Range: Lower Cambrian - Jurassic (Seilacher, 1955)

In cross sections below the cup-like opening, this trace resembles Cylindrichnus, also found in the Cardinal, Area 1. The opening where found, has concentric laminae similar to Zoophycos. The shaft resembles the cross section of a tree with iron stained growth rings. Of the eight samples found in the Cardinal, one showed pyritic/limonitic coating. Internal grain size equalled external (aprox. 0.1 mm). One possible Rosselia was found below Spillway Section 3 in Ram II but this was not confirmed.

Interpretive Ecology

Seilacher (1955) interpreted this as yet another burrow of a polychaete worm which probably mined the surface around the domichnia. Plicka's (1968) interpretation of a spiral feeding swath which left concentric imprints, may also be invoked but this is not convincing (see Figure 8). Two definite statements may be made about the Rosselia at Seebe;

first, they are rarely preserved in total, and therefore differentiated from Cylindrichnus only by size, a dangerously qualitative criteria, and second, where found they are well separated, suggestive of a minority group or a mechanism of inhibition to separate individuals.

If the cup shaped opening is at the level of the sediment-water interface at that time, then where it is preserved, erosion between depositional events was minimal. This will become important in the discussion of environments.

Paleophycos (Hall, 1847)

Range: Mesozoic (Treatise)

Pre-Cambrian - Recent (Hantzschell, 1975)

This ichnogenera was as common as Skolithos, in both sands and shales at Seebe and Horseshoe Dams. In the Ram sections, the horizontal trails found within shale interbeds; in the Cardinal, representation occurred in sands and shale interbeds. This genus, was found branching with diameters of 0.1 cm - 1.5 cm.

Paleophycos heberti is characterized by a clean sand layer which surrounds the dirty sand or shaley infill. P. alternatus, also found in both Ram and Cardinal shales is a partially annulated trace which shows a wider diameter where bumpy. Long longitudinal striations may also be found, suggesting movement within the burrows.

Frey and Pemberton observed two additional species: P. sulcatus, and P. tubularis (pers. com.)

Interpretive Ecology

These four Paleophycos species are considered to be formed by a carnivorous polychaete such as the modern blood-worm, Glycimerus sp. (Frey, pers. com.). The structures represent domichnia of some vermiform animal (Hantzchel, 1975) and are commonly associated with the Cruziana ichnofacies (Seilacher, 1967).

Paleophycos and Planolites

Osgood (1970) pointed out difficulties in differentiating between Paleophycos and Planolites. Both are horizontal, possess distinct lined walls, similar ornamentations and frequently show intersections. However, Frey and Chowns (1972) point out that Paleophycos occasionally displays collapsed structures evident from their cross section, Planolites never exhibits this. Alpert (1975) points out that Planolites never branches while Paleophycos does. If Alpert's classification is followed, a problem arises in the original definition, since this does not differentiate between burrows with similar versus different infill.

PLATE 2: A- Planolites sp.

B- Paleophycus sp. and Chondrites sp.

C- Paleophycus sp.

All photographs from the lower Ram I shales.

(Lens cap measures 5 cm.)

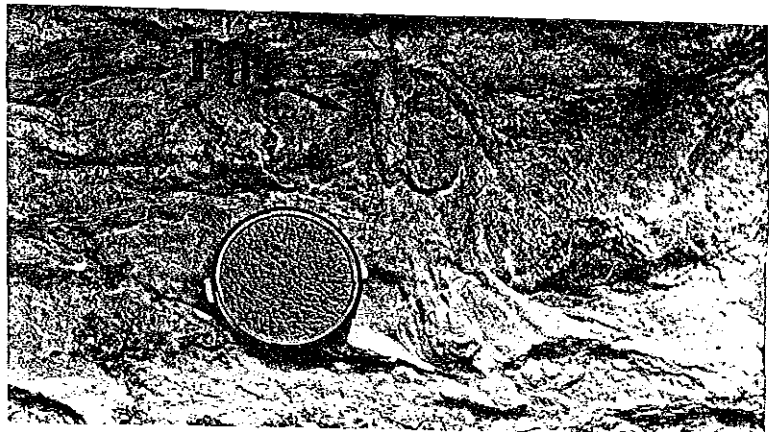

Planolites (Nicholson, 1873)

Range: Precambrian - Mesozoic (Treatise)

Precambrian - Recent (Hantzschell, 1975)

These horizontal to subhorizontal non-branching burrows are found associated with Paleophycos and Chondrites in the shales in the Ram and Cardinal sections. Tube diameters ranged from 0.5 to 1.5 cm. Three species were identified. P. beverliensis forms non descript horizontal burrows with irregular walls, 0.7 to 0.8 cm wide. P. montanus has a smaller diameter (0.5 cm) and similar appearance. P. vulgaris is unilobate, cylindrical to sub-cylindrical, gently curving with a diameter less than or equal to 1.5 cm. These descriptions illustrate the difficulty of species identification in the field.

Interpretive Ecology

This is a facies crossing ichnofossil recorded in sediments associated with Skolithos to Nereites ichnofacies (Crime, 1970). Ekdale (1977, 1978) recognized Planolites in deep sea cores.

The presence of a definite mucous wall lining, and the altered infilling of sediment are suggestive of a fodinichnia. Frey (1970), Hantzschell (1975) and Curran and Frey (1977) suggest this is a feeding burrow of a vermiform polychaete. Frey (1977) suggested that Pleistocene samples in North

Carolina were produced by polychaetes similar to Marphysa sanguinea and Nereis succinea in a wide range of sediment types and habitats. Sediment types include coherent sands and muds. Environments range from tidal flats to shoals to deep marine.

Rhizocorallium (Zenker, 1836)

Range: Cambrian - Tertiary

These "U"-shaped, essentially horizontal traces were found in all Cardinal areas. They consist of parallel arms set off from a vertex. These remain parallel even when the trace curves (see Plate 3), suggesting a chemosensory mechanism for maintaining arm separation. No characteristic ellipsoidal excrement pellets were found. This suggests surface erosion which would eliminate any signs of these pellets. An analog would be modern shallow-burrowing crustacea who logically remove waste material from inside their burrows and deposit it in neat piles around the openings. Another interpretation would suggest high levels of organic reworking, resulting in the destruction of these pellets.

Sixty percent of the population had tube diameters between 1.0 - 1.2 cm. This diameter was maintained regardless of tube separation (see Graphs). Length of burrow is again a qualitative measurement, dependent on exposure in outcrop.

In many cases one arm of the burrow showed concentric laminations. Figure 4 shows variations.

Interpretive Ecology

Measurements of burrow length, width, densities, and preservational features were made. A Rose diagram of the burrow orientations suggests no preferred alignment of burrows overall. In outcrop, Area 2 contains aligned Rhizocorallium, as does Area 6 to a lesser extent. The overall random orientation reflects no dependence on current direction. This in turn implies the originator was a deposit feeder rather than a suspension feeder.

Sellwood (1970), noted that Rhizocorallium is never found in environments where "argillaceous material predominated". Seilacher (1967) suggested a deposit-feeding habit for the animal but Sellwood noted that if the animal were to feed entirely within the burrow, sediment reworking would not supply sufficient food. He suggested the originator was a callianassid crustacean which exhibits deposit and suspension feeding habits at different stages of its life history. McGinitie (1934) stated that callianassids deposit-feed while excavating their burrows and upon their completion, suspension-feed. Sellwood (1970) drew attention to the similarity between a side-on view of stacked Rhizocorallium and Teichichnus. This neatly explains the single occurrence of the latter at Seebe.

FIG. 4 GRAPH SHOWING RELATIONSHIP OF RHIZOCORALLIUM

BURROW WIDTHS TO ARM SEPARATION

A refers to a discrete community in the Cardinal (Horseshoe Dam, Area 6); B includes the parallel aligned community, Cardinal, Area 2.

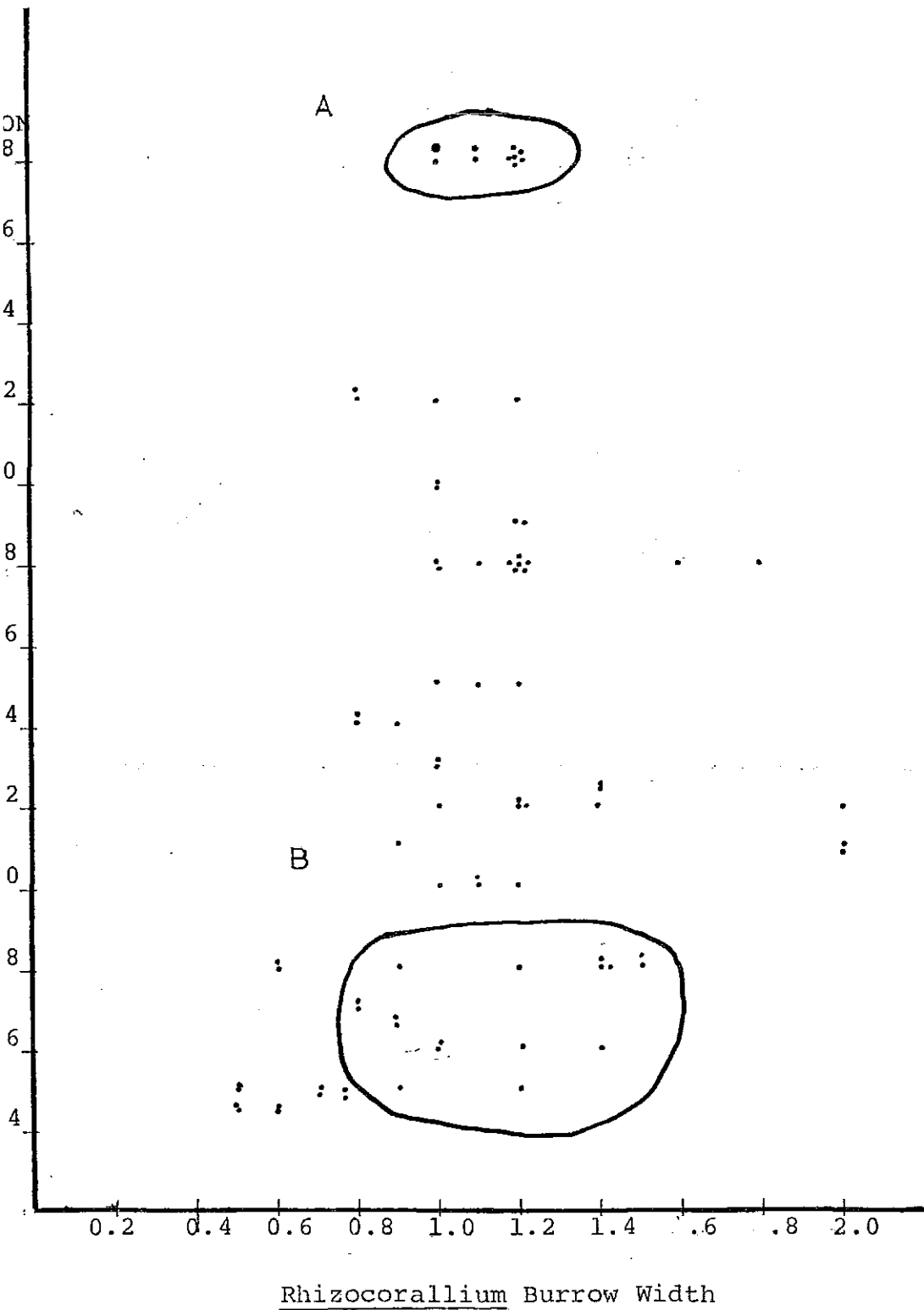
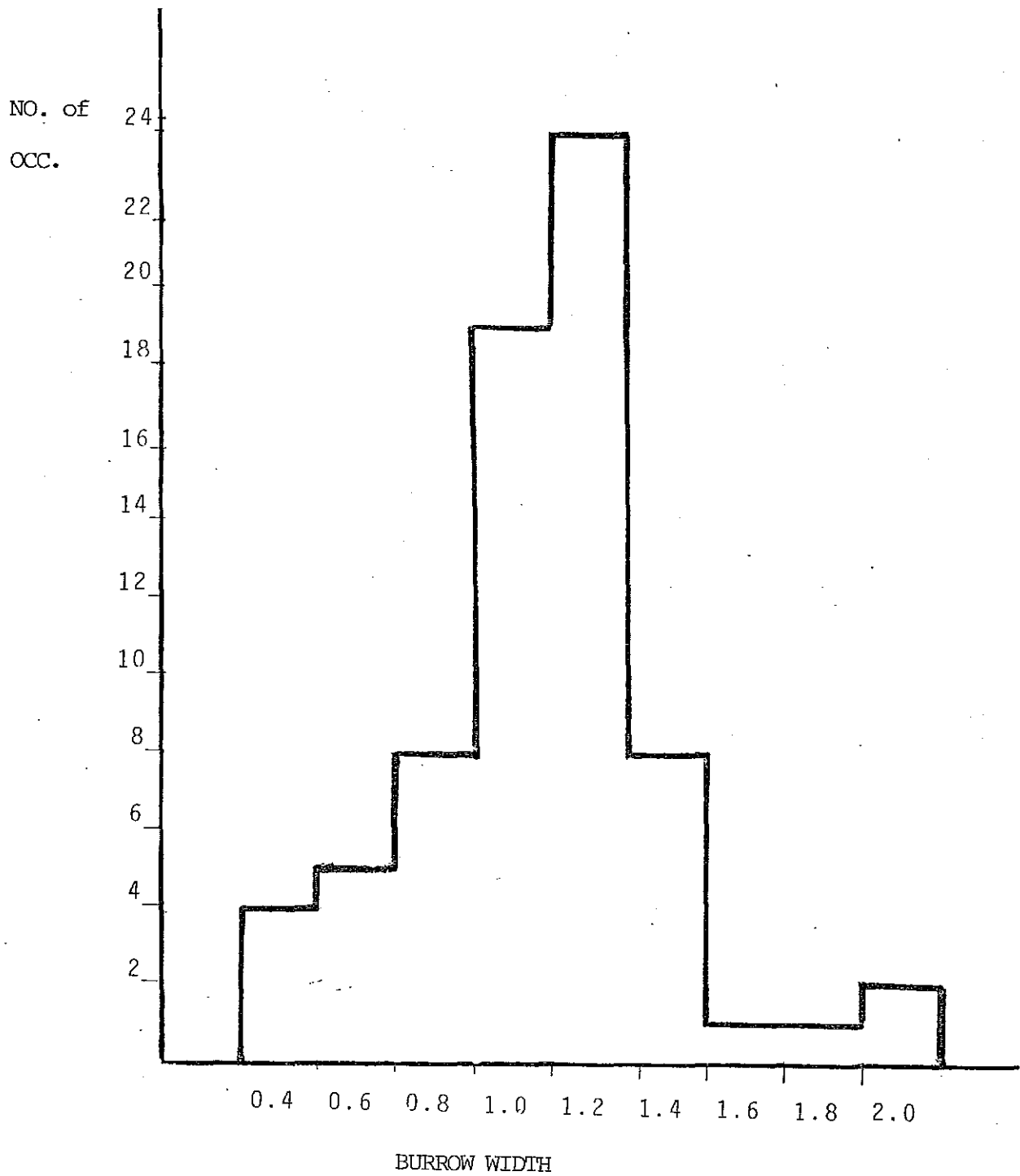

FIG. 5 HISTOGRAM OF RHIZOCORALLIUM BURROW WIDTHS.

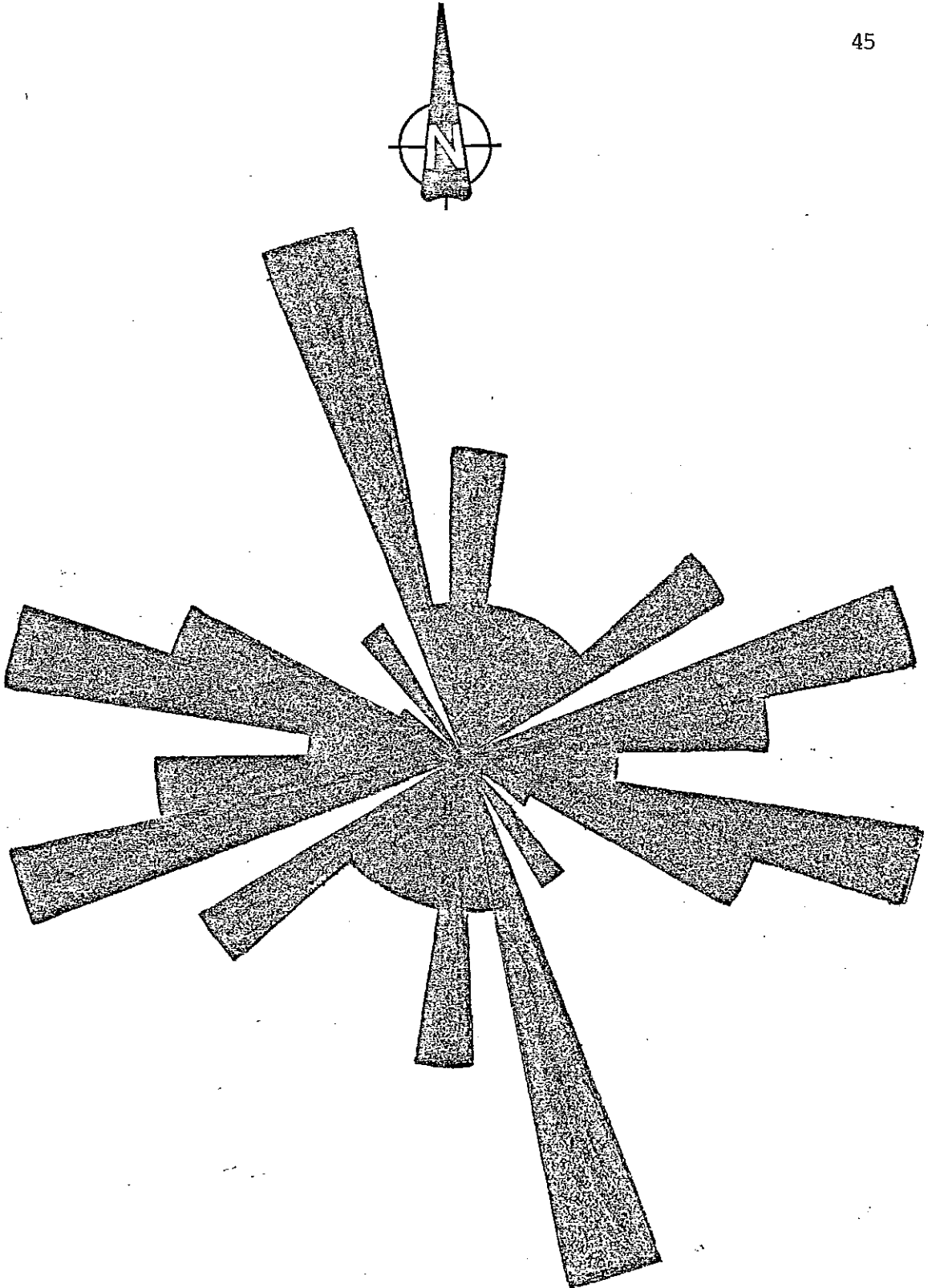

FIG. 6 ROSE DIAGRAM OF RHIZOCORALLIUM BURROW ORIENTATIONS.

These structures are not surface traces for two simple reasons: the trail is too well preserved, and the spreite are well defined in many cases. Surface bioturbation would obscure this clarity. The depth beneath the s/w interface is hard to judge; however, unless these traces undergo a sharp increase in angle, they must be near surface to allow the animal to suspension feed (or scavenge the surface sediments). The essentially horizontal traces at Seebe are indicative of deeper water (Seilacher, 1967). More specifically, they are assigned to the deeper Cruziana and the Zoophycos ichnofacies (Crimes and Harper, 1970). The same authors indicate a shoreward increase in vertical Rhizocorallium. The maximum density recorded was $11/m^2$ in area 2. Densities of $3/m^2$ were common.

Scalaratuba (Weller, 1899)

Range: Lower Mississippian - ? (Treatise)

These are subcylindrical burrows 2-4 mm in diameter, curving in all directions and marked by a central or near-central transverse ridge. Sinuous burrows are parallel or slightly oblique to the bedding plane.

They appear only in the Ram Spillway section 5 and 6, as angular, iron stained traces with a diameter of 4 mm, and variable lengths.

Interpretive Ecology

These represent fodinichnia of a sediment eating worm or worm-like organism (Henbest, 1960; Conkin and Conkin, 1968; Chamberlain, 1971).

Pemberton (1981, pers. comm.) suggests that this observation was in fact a less usual form of Thalassinoides but for this paper, the names have been retained and serve to distinguish between the two forms of traces (see Plate 7).

Skolithos (Haldeman, 1840)

Range: Cambrian - Recent (Alpert, 1972)

This ichnogenus contains 35 named species of vertical tubes or tube fillings with diameters ranging from 0.2-1.0 cm. These never branch, are usually straight and often crowded. Of the five distinct species suggested by Alpert (1972), two were found at Seebe.

S. linearis, usually annulated, appeared in the spillway sections in high densities. S. verticalis is also straight and smooth walled but may be curved and inclined. S. verticalis is never extremely crowded.

The more common form at Seebe is S. verticalis which was found scattered in all horizons except the Ram II, gravel

lag. S. linearis is restricted to Ram II, section 11, where it appears between hummocks in densities up to 94/m², and the Cardinal Area 6, Horshoe Dam.

Preservational differences aid in distinguishing between these forms. S. linearis is more commonly iron stained or shows a dark ring around the burrow. However, in the absence of this both appear as spheres or slight bumps on the outcrop and are distinguished only by size and degree of crowding.

Interpretive Ecology

Ferry and Curran (1977), suggest these as the burrows of Onupus microcephala of the polychaete family. It is generally agreed that these are suspension feeding polychaetes (Crimes and Harper, 1970) but identification at the species level is questionable. These are the smallest, most common suspension feeders at Seebe and their presence suggests periods of quiescent sedimentation.

TABLE 3. Comparative densities and diameters of Skolithos

Location	Density	Diameter
Ram II	94	0.5
(Spillway)		
(<u>S. linearis</u>)	64	0.7
	84	0.6
	80	0.6
	91	0.5
	79	0.7
Cardinal	9	0.6
Several sections		
(<u>S. verticalis</u>)	7	0.5
	4	0.5
	11	0.5
	13	0.6
	4	0.7
Cardinal	4	0.6
Area 6		
(<u>S. linearis</u>)	8	0.7

The densities of S. linearis are independent of burrow diameter. Burrow diameter cannot be used to distinguish between species.

Subway Tunnels (Wright, 1980)B-2 Trace (Perkins et al., 1971)

Range: Upper Cretaceous - ?

These large tunnel-like traces are found several times in the Cardinal and once in Ram II (gravel lag). They occur as essentially horizontal furrows lacking ornamentation or a cemented burrow wall. There are two types, differentiated by size and branching pattern. Type B, essentially linear, unbranched, circular to subcircular burrows have an average diameter of 4 cm, with an average density of $3/m^2$ in the Cardinal Reservoir section. The more common Type A burrows, have the same form as the above except they have branches at approximately ninety degrees (see Table 4).

Scratch marks were observed in two samples but these are not diagnostic. It is possible that these tunnels underwent dissolution while buried, thereby removing their lining and widening the burrows slightly. However, the Ram II tunnel and tunnels in the Horseshoe Dam exposure are the same diameter and gravel infilled. These also lack a definite wall. It remains in the subsurface of a biologically active zone with no apparent wall support or structured lining. Similar burrows have been found by Perkins et al., (1971), in the Cretaceous of Tarrant County, Texas (Bear Creek Section).

Interpretive Ecology

These tunnels are probably the result of an arthropod crustacean similar to Linuparus canadensis which tunnels the subsurface, deeply enough to maintain a circular tunnel without collapsing it. The lack of visible vertical tunnels suggests a near-surface horizontal or subhorizontal system, or a system which was emplaced long after the accompanying surface traces, at a time when thick black shale (silt) covered the shelf. This crustacean would burrow down through the shale to preferentially make his burrow in the sands. The small side tunnels would be the result of infrequent use, use for breeding nests, or less dissolution (unlikely).

An animal as large as Linuparus was probably a scavenging deposit feeder and possibly a carnivore. The extent and size of the burrow systems suggest subsurface communities which may have been the top link in the food chain. Their absence from the surface of Ram II would then be significant.

The extent of tunnels on the Cardinal surfaces suggests greater stability than on the similar Ram II surfaces because of the time to develop such a burrow system. At this time it has not been determined if burrow formation (subway type) was contemporaneous with the

formation of the certain surface or near-surface traces. At the moment the only available field evidence shows these tunnels intersecting and crosscutting surface traces suggesting that these were later developments. This in turn indicates that 'environmental stability' occurred once the deposition of silt began and after the storms, which brought in the sand, subsided. The interpretation is open to criticism but it does agree with the downward displacement of large (2 cm.) pebbles in the shales above the Cardinal, as observed by Wright and Walker, (1980) .

TABLE 4. Measurements of Subway Tunnels

	Length	W 10	W 30	W 50	W 75	B L	B R
	102	7.5	14.5	16.5	18.5	40(9)	40(10)
Cardinal Area 1	59	8	13	15		43(6)	
	64	9.5	9.5	11.5			
	52	3.5	7.5	8.0		30(7)	44(7)
Cardinal Area 2	75	5	7	11	15		
	54	8	10	13			
	114	7.5	8.5		11.5		
	104	5.0	7.5		8.5		
Cardinal Area 1 & 6	101	5.5	7		7.5		
	279	8	8	10	12		
	287			9	7.5	50	93
Cardinal (gravel lag)	69	8	8	8			

PLATE 3: Rhizocorallium from Cardinal Areas 2
and 4. Lens cap measures 5 cm.

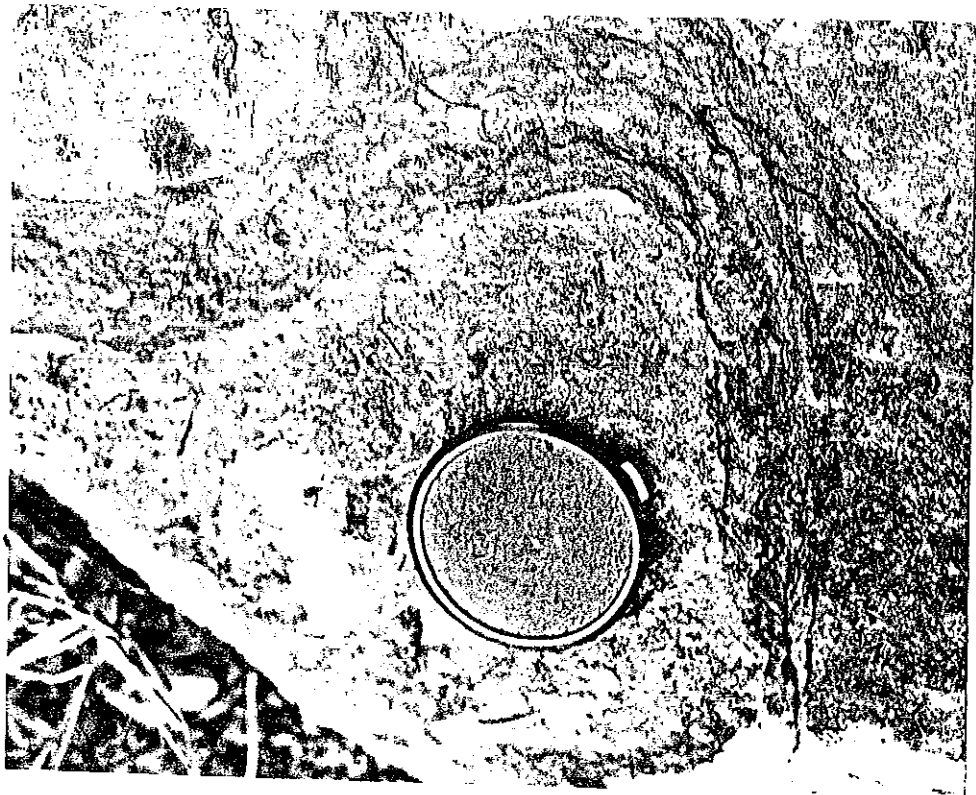

Teichichnus (Seilacher, 1955)

Range: Lower Cambrian - Tertiary

This trace was found only once at Seebe in the Cardinal Area 1 and can easily be confused with vertically stacked Rhizocorallium (Seller, 1970). Blade-like spreiten structures form with variable dimensions supposedly as a result of digging action of a crustacean (Martinsson, 1965). This trace is commonly observed with Rhizocorallium, (Chisholm, 1970) and easily confused with these when vertically stacked. Hestor and Pryor (1972), observed tunnels of Ophiomorpha grading into Teichichnus-like structures suggesting a common originator. Teichichnus is also easily confused with Phycodes.

Zoophycos (Massalongo, 1855)

Range: Ordovician - Tertiary (Chamberlain, 1975)

Zoophycos is the general name for variously shaped spreiten structures with thin tubes, forming a large but variable radius of curvature. Concentric spreite impart a screw shape to this trace.

Three forms were found at Seebe, all specimens but one in the Cardinal. One form, recorded in the lower sands of Ram II, could easily have been mistaken for the feeding swath of Rosselia. The Cardinal Area 6, was known as the "Zoophycos Den". Zoophycos of diameters 5 to 18 cm over-

lapped to allow densities of 12-23 per m² over the entire area. Individual traces were poorly defined and apparently reworked by Paleophycos and Planolites. No Rhizocorallium was found.

The forms at the Kananaskis section were larger, occurred in much lower densities than their Horseshoe Dam cousins (2 or 3/m²), were sometimes raised and usually limonite coated. The grain size within the core of these burrows averaged 0.02 mm, which is considerably finer than the surrounding sand. The Horseshoe samples showed coarser grain size (0.05-1.0 mm).

Several overlapping Zoophycos were found and samples in Area 1 showed a worm tube in the burrow centre (see Plate 8).

Interpretive Ecology

Seilacher (1971) stated Zoophycos was restricted to quiet water conditions regardless of depth, while evidence from deep sea cores suggested these as backfilling of feces and mining spoils as a polychaete moved back and forth between two surface access tubes, while expanding the feeding field. Bischoff (1968) preferred the idea of a worm which wound screw-fashion around a central vertical axis, producing different levels of whorls and preserving an outermost, uppermost marginal trail. Plicka (1968) proposed

that this trace was left as an impression of the feeding swath of a filter feeding polychaete (see Figure 8). This could not apply to any forms at Seebe for a number of reasons, mainly because the traces are too irregular.

If Zoophycos requires quiet water conditions, then the Cardinal surface represents a stable environment. This agrees with the extent of bioturbation found in the uppermost Cardinal sand. Unless there is a grain size preference, then we would expect to find Zoophycos in the bioturbated shales with identifiable traces, if these too represent periods of quiescent sedimentation. This is not found.

PLATE 4: Subway Tunnels

A- Horseshoe Dam

B- Cardinal Area 1



PLATE 5: Subway Tunnels

A- Overview of Cardinal
Area 2

B- Close-up of branching
tunnels

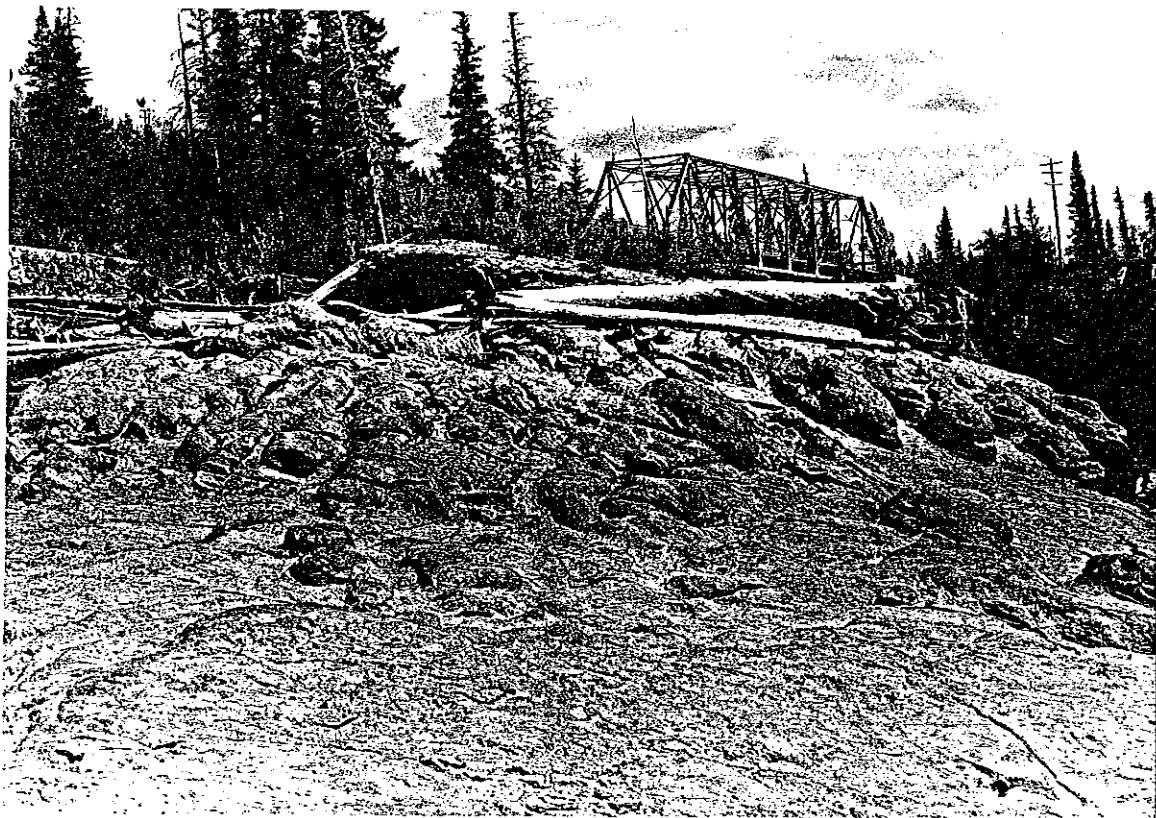

PROBLEMATICA

1. Star shaped traces: These occur in the Kiska/ Cardinal fault blocks and in the Cardinal:Area 3. Dimensions of the star vary and were not accurately measured in the field. See plate 1 . Hantzschel (1970) suggests that Ophiomorpha brood nests take this form. Others (same paper) suggest anything from worms to starfish as the trace originator. The former interpretation is preferable but presents problems since the star traces were found in the same horizon as near-surface burrows. These traces are found in other Cardium sections and deserve a more detailed study.

2. Beaded trace: This trace was found twice at Seebe. It ranges in diameter from 0.6 to 1.1 cm and looks suspiciously like the tail of the unidentified invertebrate. Length measurements of this trace need to be made. See plate X-2 and plate 14 for comparison. Heezens and Hollister (1971) show a similar trace which they attribute to the acorn-worm family, suggesting it as a fecal string.

3. General horizontal trails: These are included here because poor preservation prevented the assignment of a specific name. Trace diameters vary from 0.2 to 2.0 cm. See plate 10. The

traces may be straight curved, overlapping, subhorizontal or horizontal but lack the specificity to be defined as anything other than general traces , probably worm-made since they lack any ornamentation. These traces are associated with all facies assemblages.

4. General vertical trails: Found in the more bioturbated sands and shales, generally poor preservation prevents a species designation. One of the more well developed trails is shown in plate 13.

5. Keyhole Burrow: Found only once, at Horseshoe Dam, this unusual burrow shape could be a freak of preservation except that it extends at least four cm back into the shales. See plate 12.

6. Concretions: The concretion layer exposed in the Ram Spillway section 6, contained steinkern which ranged in size from a few to thirty-five cm (maximum size measured). These contained ammonites and impressions of crustacea. One poorly photographed example is shown in plate 11.

7. Shell impressions: Shell impressions, presumably of the

bivalve Inoceramus sp. are associated with the bivalve hash in the Cardinal: Area 1. They average 5-8 cm and are randomly oriented in "death position".

8. Invertebrate fauna: Shown in plates 14 and 11 are the only recognizable invertebrate crustaceans at Seebe. Linuparus canadensis , shown in plate 11 is considered responsible for the Subway Tunnel trace. It was found in the Leyland shales above the Cardinal at Horseshoe Dam. A second species may be identifiable from the concretion layer in the Ram Spillway Section; however, the photograph is not convincing. A second invertebrate was found in the Ram section 2, see figure 11. This trace is shown in plate 14 at life size. It has been sent to Dr. R. Feldman, an invertebrate specialist for identification.

TABLE 5Revised Species ListRAM 1

shales: general bioturbation

Chondrites sp.Planolites beverleyensisPaleophycus tubularisPaleophycus heberti

sands: general horizontal traces

Gyrochorte sp.RAM 2

shales: general bioturbation

Chondrites sp.Planolites beverleyensisPlanolites montanusPaleophycus tubularis

sands: general bioturbation

Gyrochorte sp.Skolithos linearisSkolithos verticalisCylindrichnus concentricusDiplocraterion sp.Ophiomorpha nodosaZoophycos sp.Thalassinoides 2 sp.CRUSTACEAN:

Unidentified invertebrate

ORGANIC DEBRIS:

coaly tree-like matter

but no roots

Revised Species List (continued)KISKA and LEYLAND

shales: general bioturbation

Chondrites sp.Planolites montanusPlanolites beverlyensisCARDINAL

shaley: general bioturbation

sands Chondrites sp.Planolites beverleyensisPlanolites montanusPaleophycus tubularisPaleophycus herbertiPaleophycus alternatus

sands: general bioturbation

Skolithos linearisSkolithos verticalisGyrochorte sp.Cylindrichnus concentricusZoophycos sp.Rhizocorallium sp.Thalassinoides sp.Ophiomorpha nodosaLEYLAND ONLYCRUSTACEAN:Linuparus canadensisArenicolites sp.Teichicnus sp.Subway TunnelsBIVALVE:Inoceramus sp.ORGANIC DEBRIS:

coaly tree-like matter

but no roots

PLATE 6: A- possible Diplocraterion, Arenicolites
Skolithos linearis and S. verticalis
B- Rhizocorallium (in background),
Thalassinoides, and Ophiomorpha
Both photographs at Horseshoe Dam.

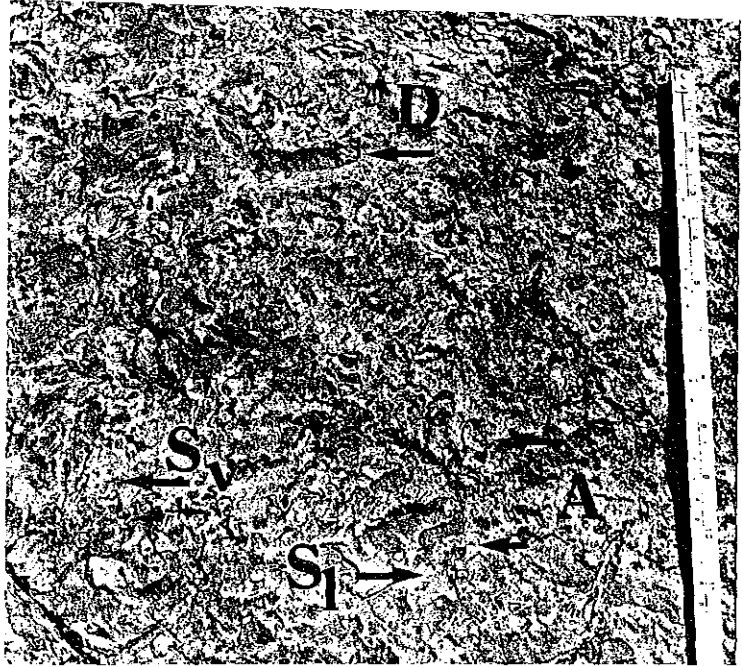

PLATE 7: (clockwise from left to right)

- A- 'Scl' form Thalassinoides in the Ram II spillway section
- B- Ophiomorpha in horizontal section in the Cardinal Area 3
- C- close-up view of Thalassinoides as in A

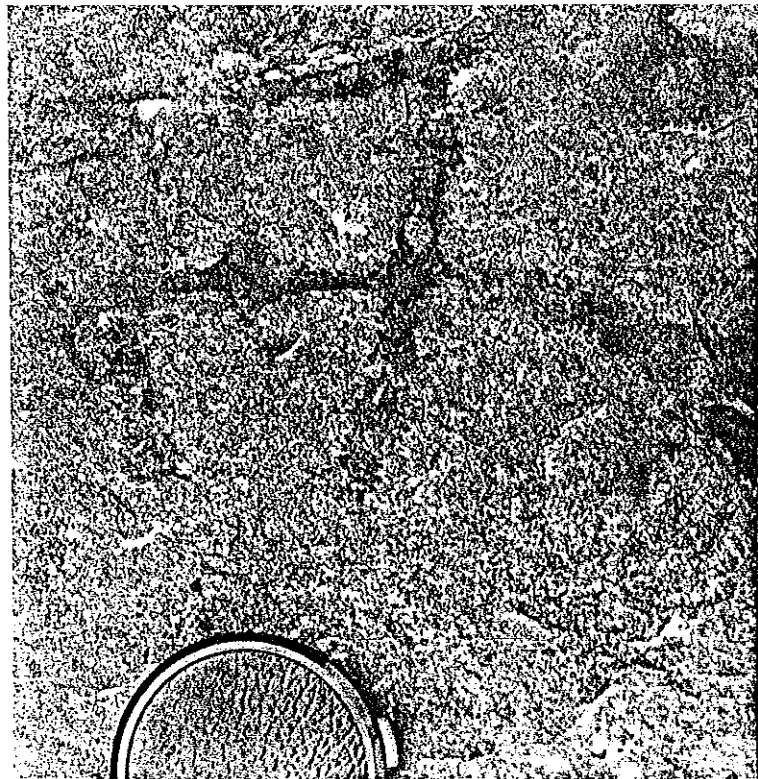
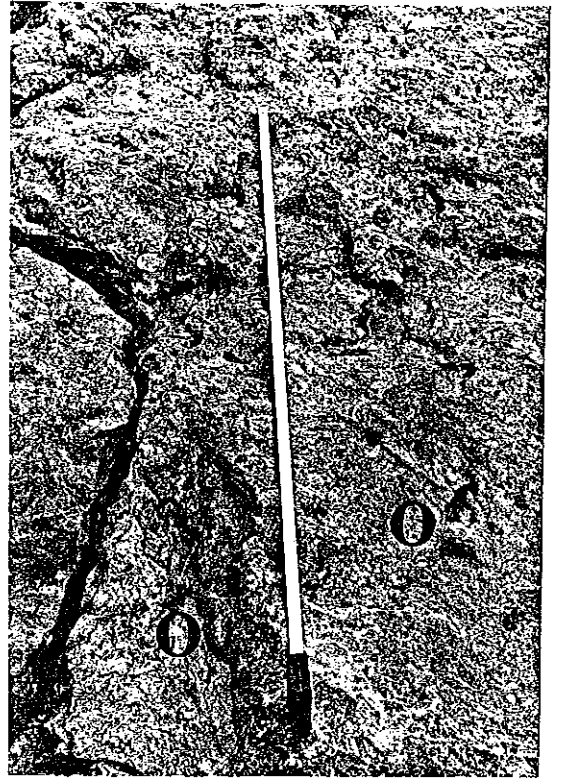
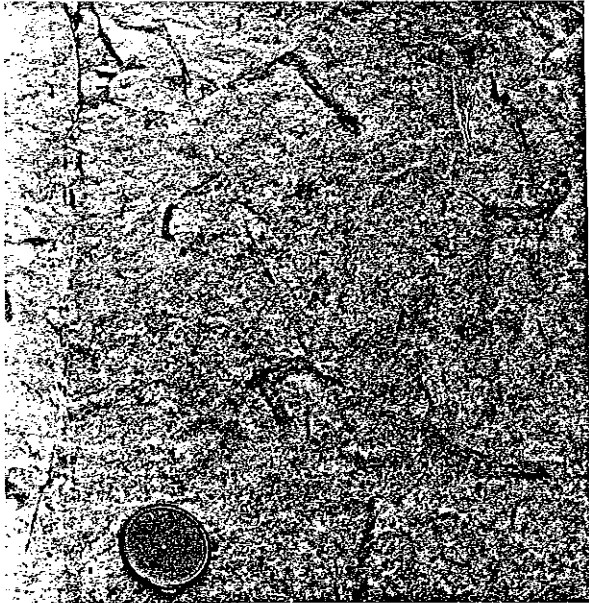

PLATE 8: Zoophycos forms

- A- Cardinal Area 1
- B- Zoophycos Den, Horseshoe Dam
- C- raised Zoophycos, Cardinal Area 2
- D- close-up of Zoophycos Den showing
Paleophycus-like infil of trace

Note: in B , traces have been outlined
for the sake of clarity.

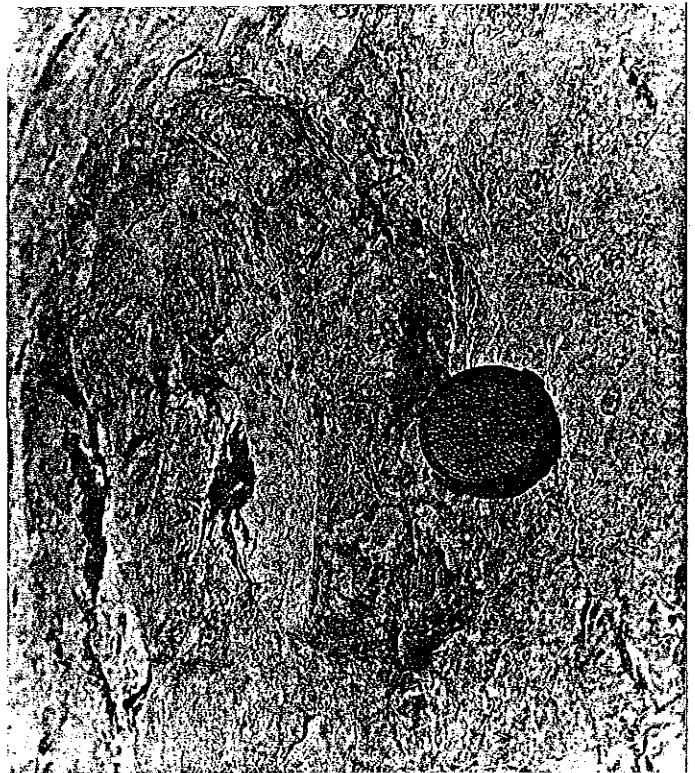
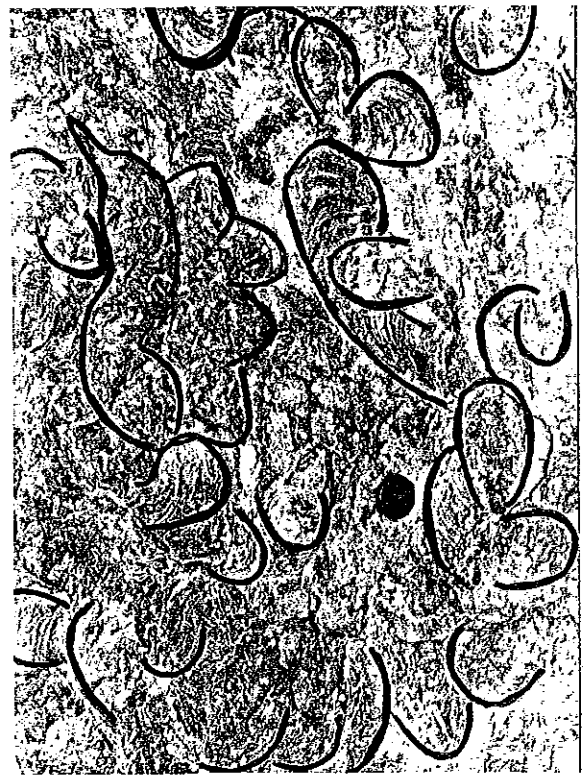

PLATE 9: A & B - Subway Tunnels, Horseshoe Dam

note gravel infill in A.

C- Cardinal surface, Area 4 showing
typical preservational surface

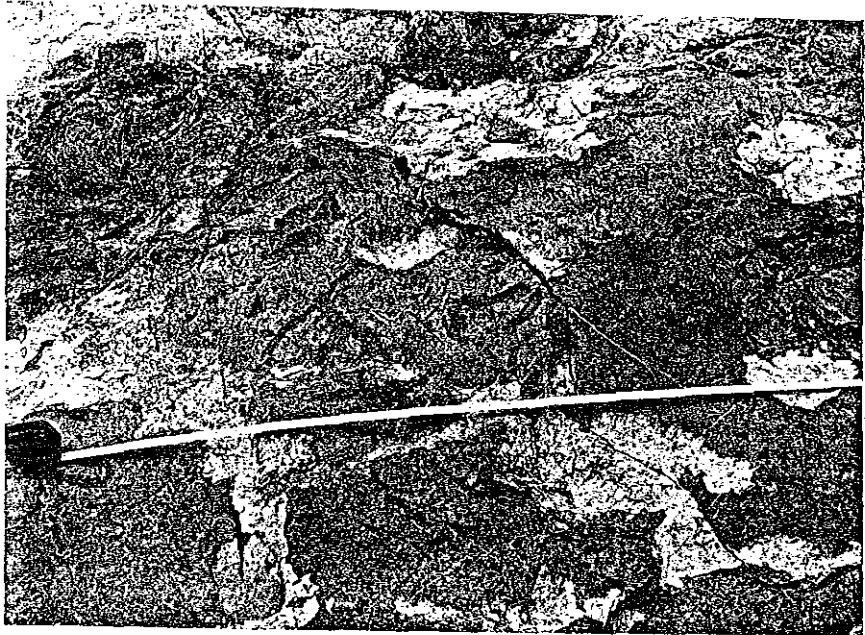
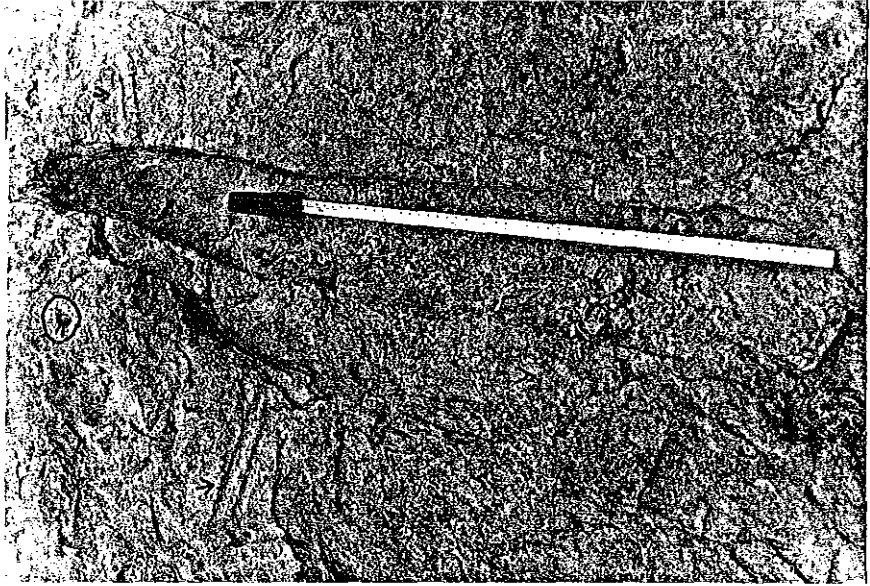
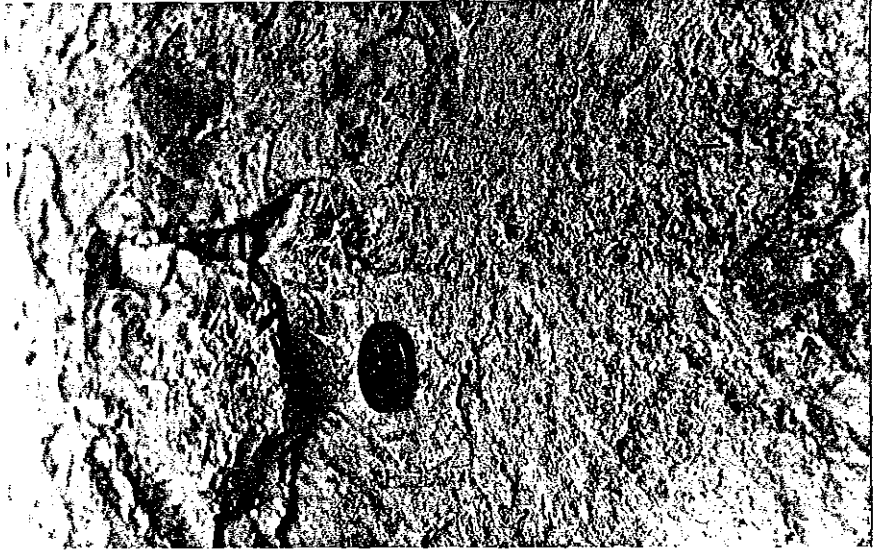

PLATE 10: A- Thalassinoides, Inoceramid shells (B),
and general horizontal trace,
Cardinal Area 1
B- close-up of Thalassinoides showing
infill

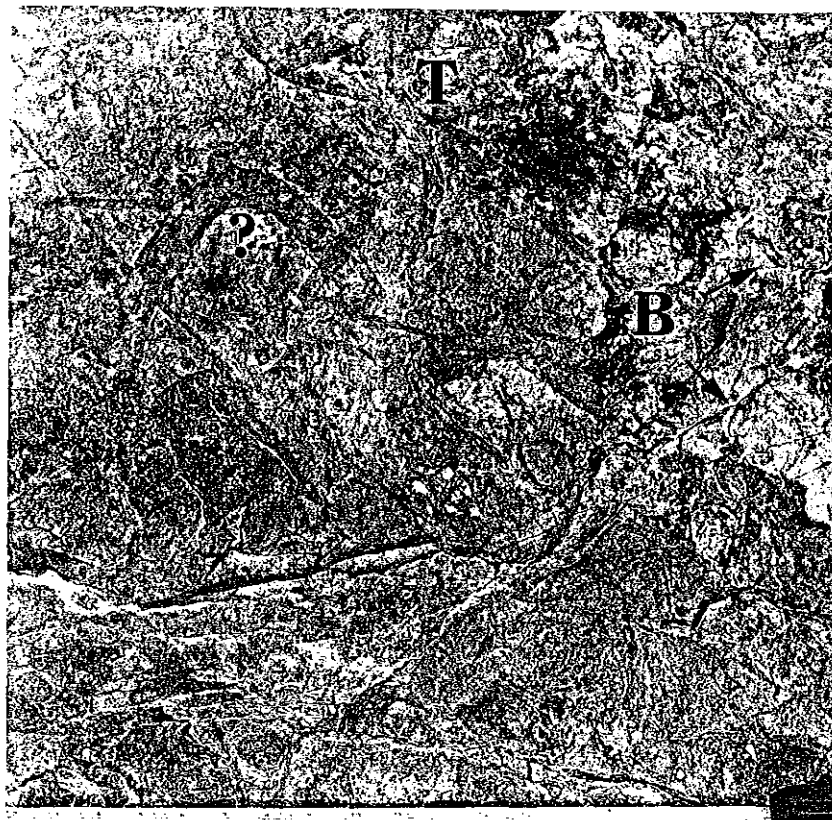

PLATE 11: A & B - Linuparus canadensis , A - courtesy
of Wright and Walker, 1981
B - poorly defined carapace in
Ram II concretions

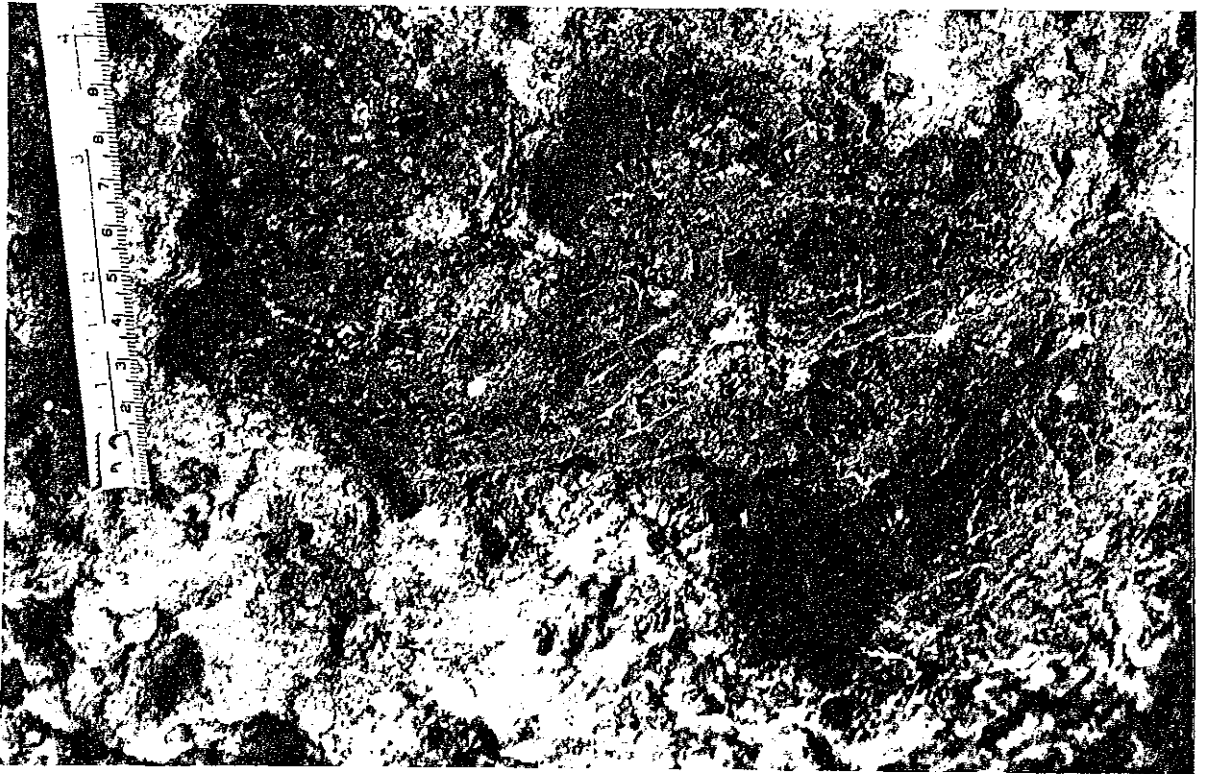
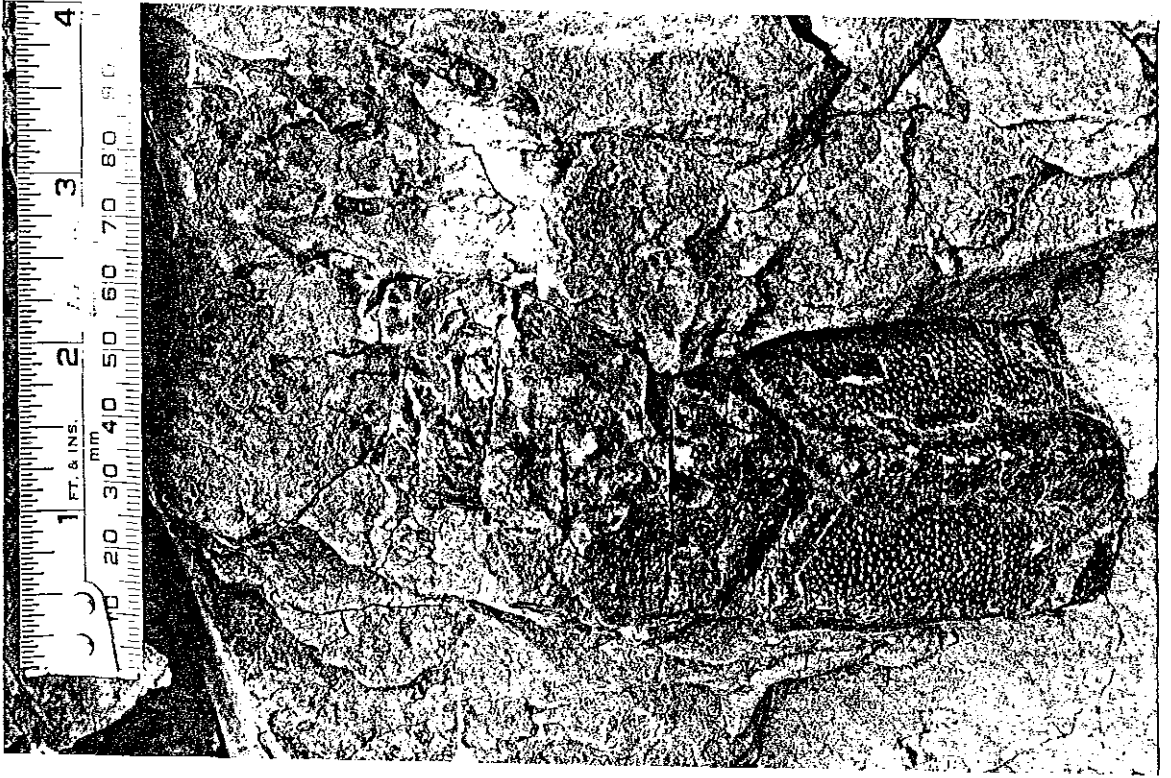

PLATE 12: A- Keyhole burrow, Leyland shales, Horseshoe
Dam

B- Inoceramus sp. in situ, Leyland shales
Horseshoe Dam

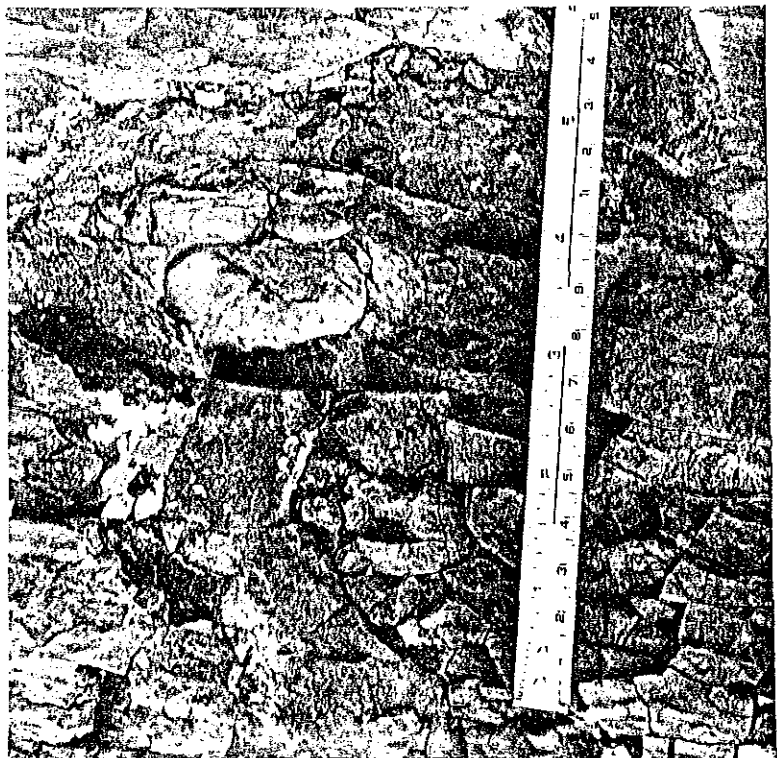
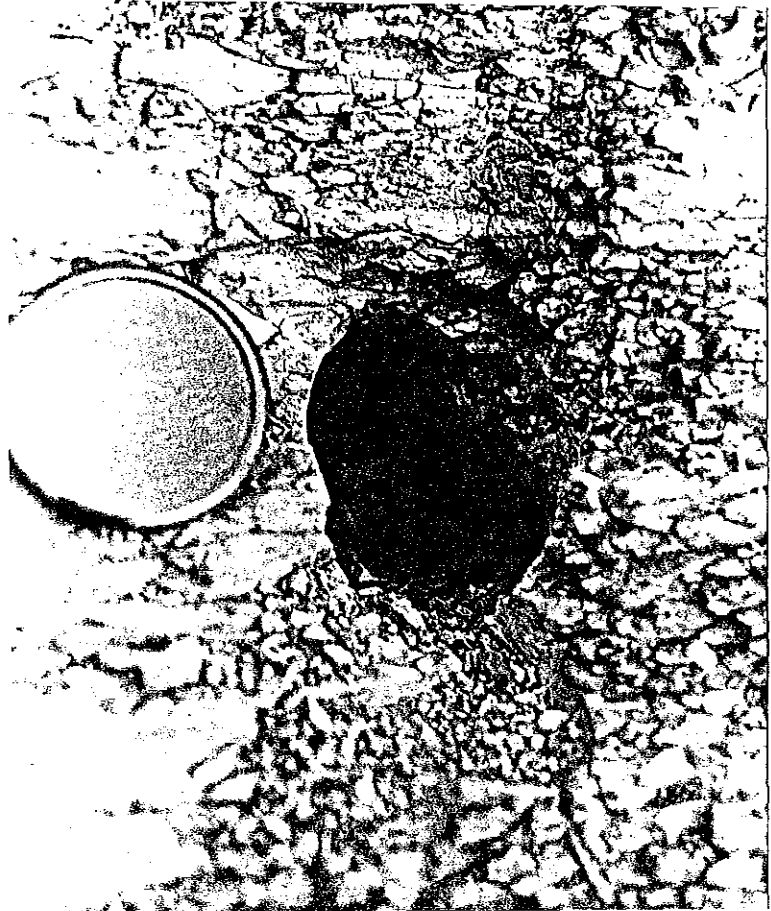

PLATE 13: A- poorly defined burrow surface

Cardinal:Area 4

B- horizontal burrow, typical of

bioturbated shales, probably

Ophiomorpha sp.

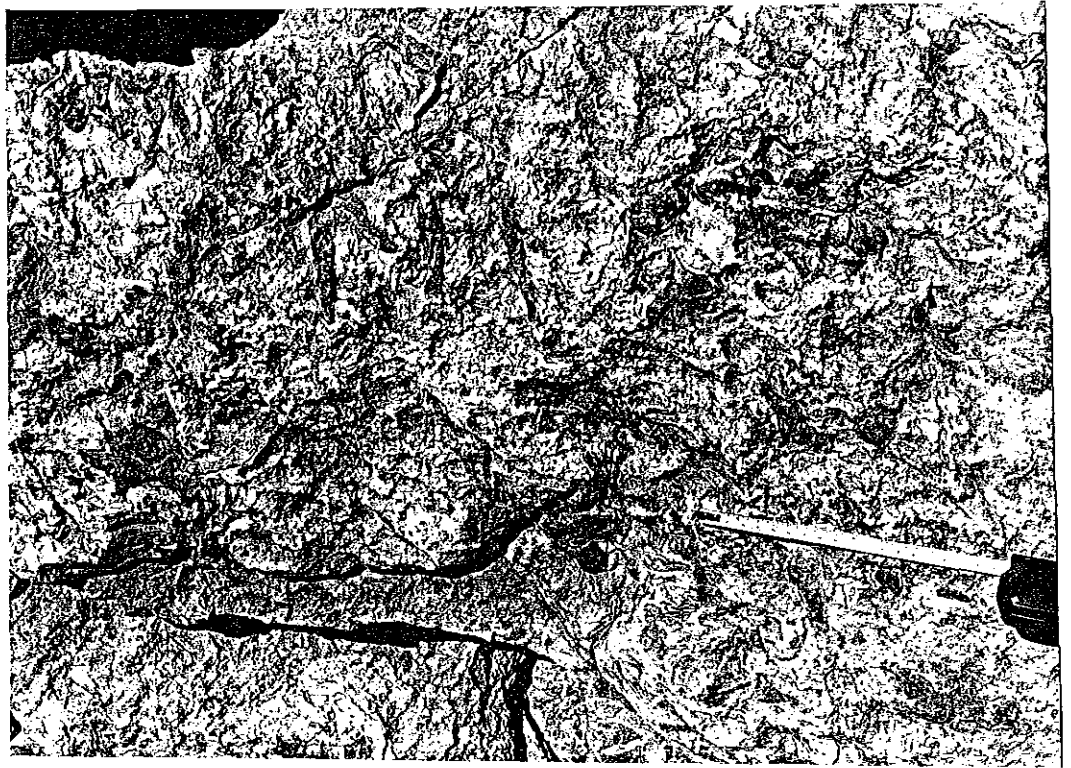

PLATE 14: A- Invertebrate fossil, both halves
life size, found in Ram II, section 2
B- Zoophycos sample showing external
features of burrow

CHAPTER 5DIVERSITY AND DENSITY STUDIES

The diversity and density of an organic community reflects the conditions in which an organism lives (Nicholson, 1933; Lack, 1954). Figure 9 illustrates the difference in diversity between the two major areas of study. These were the Cardinal, at the top of Cycle 3 and the Ram II at the top of Cycle 2; [the accompanying legend (Fig. 14) explains the abbreviations]. The vertical scale on this figure gives the number of species involved in a group relationship from a minimum of two, to a maximum of five (or more). The horizontal scale lists the species which occurred in a given relationship more than twice. "Sc" refers to Scalaratuba type Thalassinoides burrows as explained in Chapter 4. Species not listed here may be found in the revised species list, Table 5 .

Figure 9 gives an immediate indication that the Cardinal surface contains a greater diversity of traces and trace relationships. Table 6 shows a more quantitative indication of one to one relationships. The Trellis diagram is limited in its accuracy by the number of recorded

observations.

In the forty-seven recorded diversity/density studies for the Cardinal (all areas), the most common assemblage (recorded 32 times) was Zoophycos (1-2/m²) + Rhizocorallium (1-3/m²) + Skolithos (1-10/m²) + Subway Tunnels (1/m²) in a metre² quadrat. Another common assemblage included the previous form and Thalassinoides (12 times). Planolites and Paleophycos were common at Horseshoe Dam. Locally, high densities of Subway Tunnels (3 - Area 1), Rhizocorallium (1 - Area 2) and Zoophycos (23 - Area 7) were recorded.

The Ram studies revealed a much less diverse community. The distribution of species was patchy with only three occurrences of the same four species per m² quadrat (see Fig. 9). The common occurrence of Planolites, Chondrites and Paleophycos in the shales and the local abundance of Ophiomorpha in vertical sections as well as the lack of well developed subway tunnels, characterize the Ram II community.

These preliminary diversity/density studies reflect the inexperience of the observer. Random sampling techniques were not utilized and many more quadrats need to be sampled before an accurate diversity/density correlation can be made.

The following qualitative observations were recorded in the areas shown in Figure 10 - 12. In Fig. 10, 'Area 4'

showed low densities of Rhizocorallium and no Zoophycos. Here, Thalassinoides and Rhizocorallium were found together three times. In 'Area 2', subway tunnels were prevalent except for locally high densities of aligned Rhizocorallium and two recorded raised Zoophycos structures (see Plates 3 and 8). 'Area 3' which extended back to the bridge beside the reservoir contained at least one sample of all traces recorded in the Cardinal except Teichichnus. 'Area 1' contained the only observation of Teichichnus, the less common form of Subway Tunnels (B-type), and abundant Inoceramid shells in addition to all other reported traces except Cylindrichnus, Rosselia, Diplocraterion and Gyrochorte.

Figures 11 and 12 show the Ram II spillway section. Each number corresponds approximately to an exposed bedding plane, characterized by preservation and traces present.

The numbers represent communities as follows:

- 1: poorly preserved horizontal traces
- 2: Ophiomorpha, unidentified crustacean (Plate 14) tree fragments (?)
- 3: scattered populations of Skolithos ($64-9 /m^2$) between hummocks (or swales).
- 4: Gyrochorte (2) and Skolithos ($3-7/m^2$)
- 5: Sc-type Thalassinoides, Thalassinoides proper, Skolithos and one reported occurrence of Ophiomorpha

- 6 : concretion layer, Inoceramus shell and crustacean carapace similar to Linuparus, steinkern
- 7 : Ophiomorpha horizon, some Thalassinoides in horizontal section
- 8 : Gynochorte and Skolithos and general horizontal traces
- 9 : no traces recorded
- 10: Planolites, Paleophycos and Chondrites
- 11: Planolites, Paleophycos, Diplocraterion and Skolithos ? varying across the surface
- 12&
- 14: Ophiomorpha horizons
- 13: poorly developed vertical traces

On the top surface of the gravel lag above # 12, the single Subway Tunnel was found. No other traces were found on this surface.

Based on the observations in the Cardinal and Ram II, Planolites, Paleophycus, and Skolithos are the least restricted ichnospecies. Teichichnus, Rosselia, and "Sc"-type Thalassinoides are the most restricted. Larger, more well defined traces are a feature most common in the Cardinal where Zoophycos, Rhizocorallium, and Subway Tunnels are best developed. Locally, these traces occur in high densities. Ophiomorpha and the Thalassinoid burrow systems are the largest features common in the Ram sections which are characterized more by smaller, worm produced burrows in general.

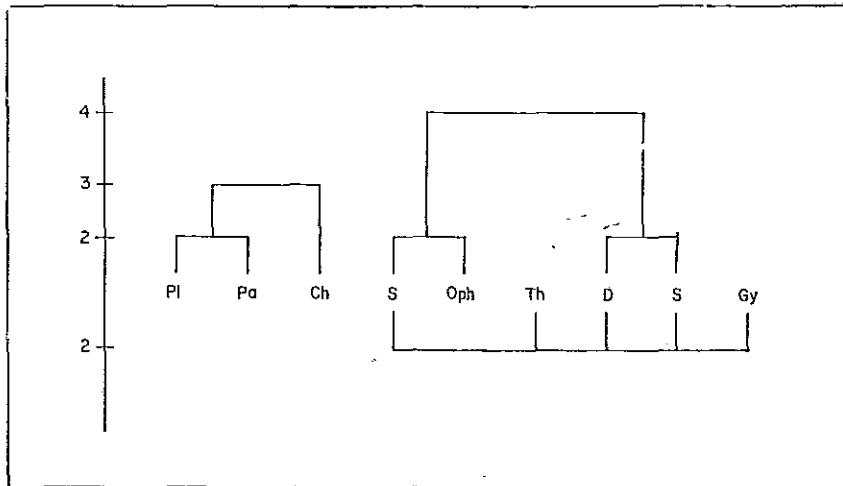
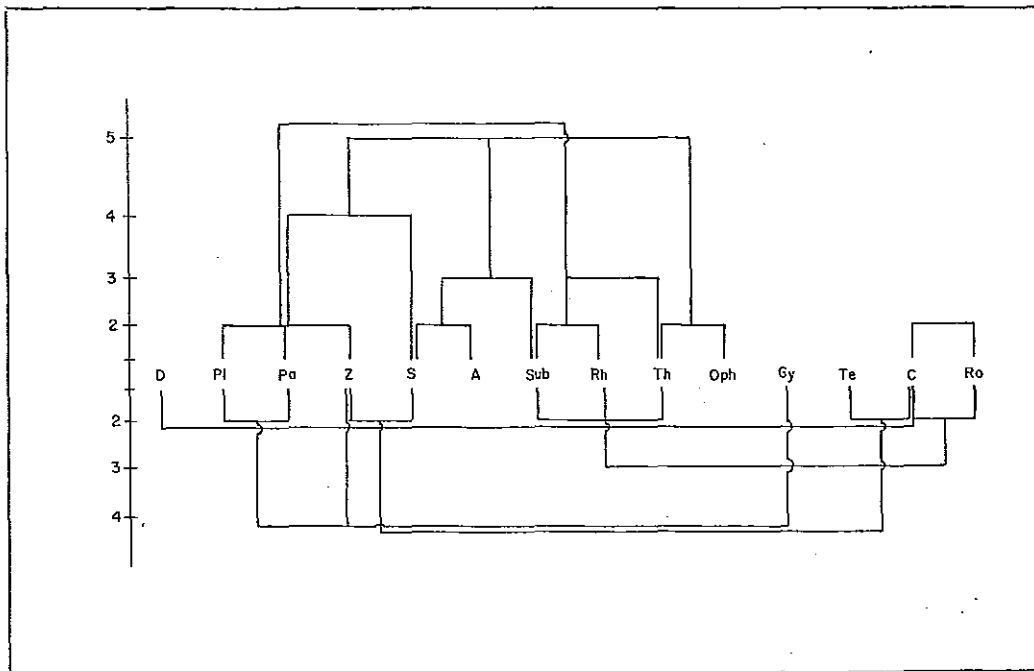

FIG. 9 RELATIONSHIPS BETWEEN SPECIES

The Cardinal surface shows more complex relationships (lower diagram) than does the Ram II surface (upper diagram). (These diagrams are not indicators of frequency of relationships but of type of inter-relationships).





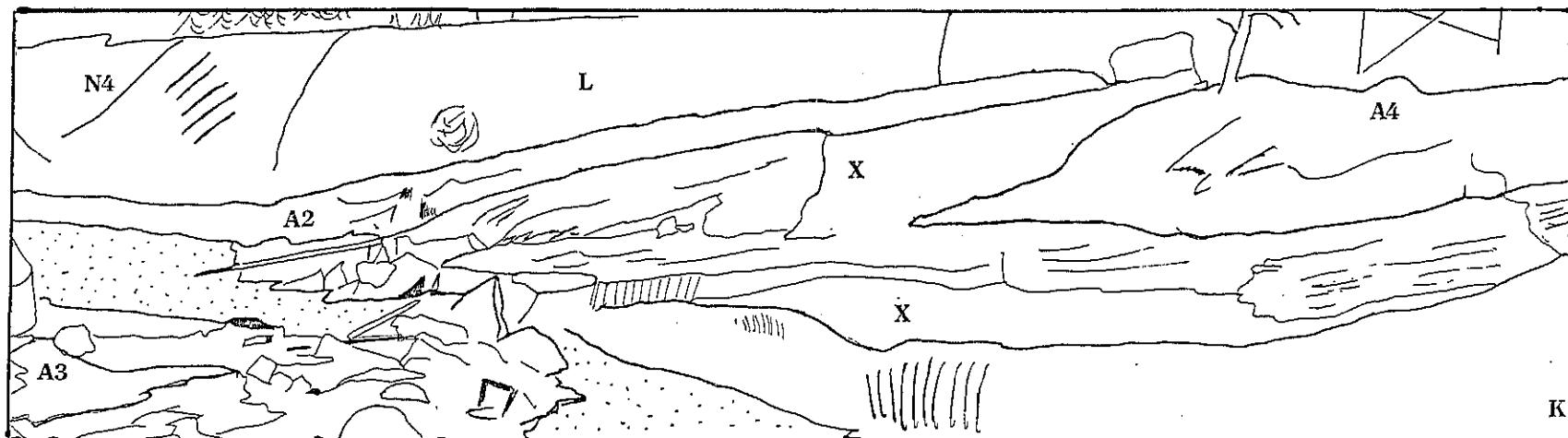
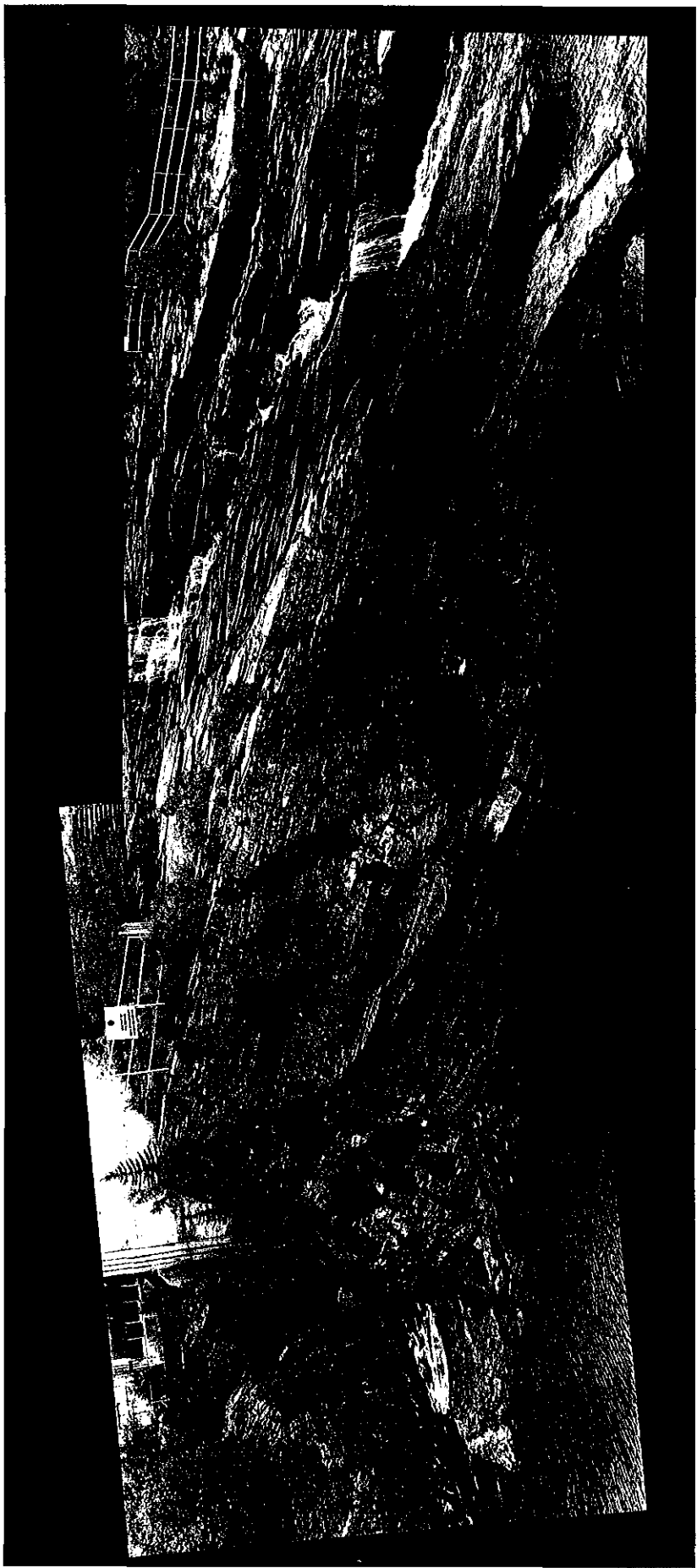

FIG. 10 STUDY AREAS - CARDINAL

L- Leyland, K- Kiska, N4- Fault (see Fig. 2),
A2, A3, A4- Cardinal study areas - see text for
details, X- No traces defined.



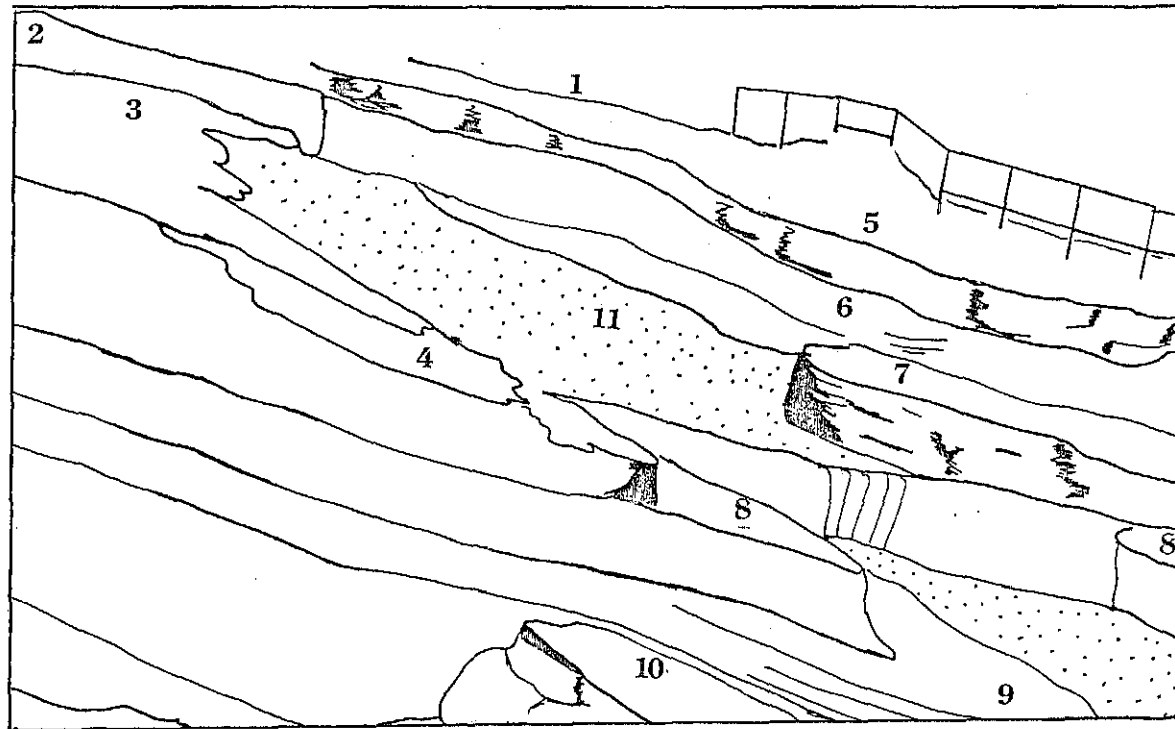

FIG.11 RAM II SPILLWAY SECTION

(Dots indicate areas normally covered by water);
see text for details of numbers.



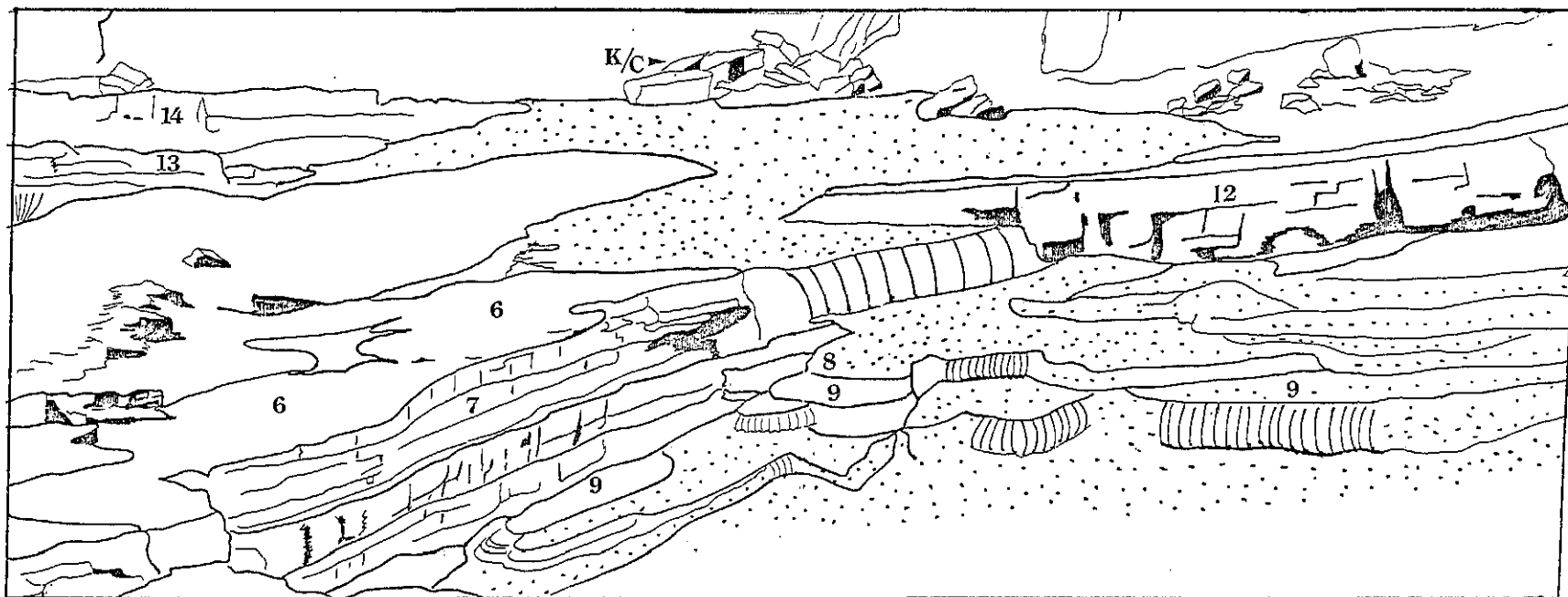

FIG. 12 RAM II LOWER SPILLWAY SECTION and GRAVEL LAG

K/C- Kiska/Cardinal fault blocks. See text for details of numbers.

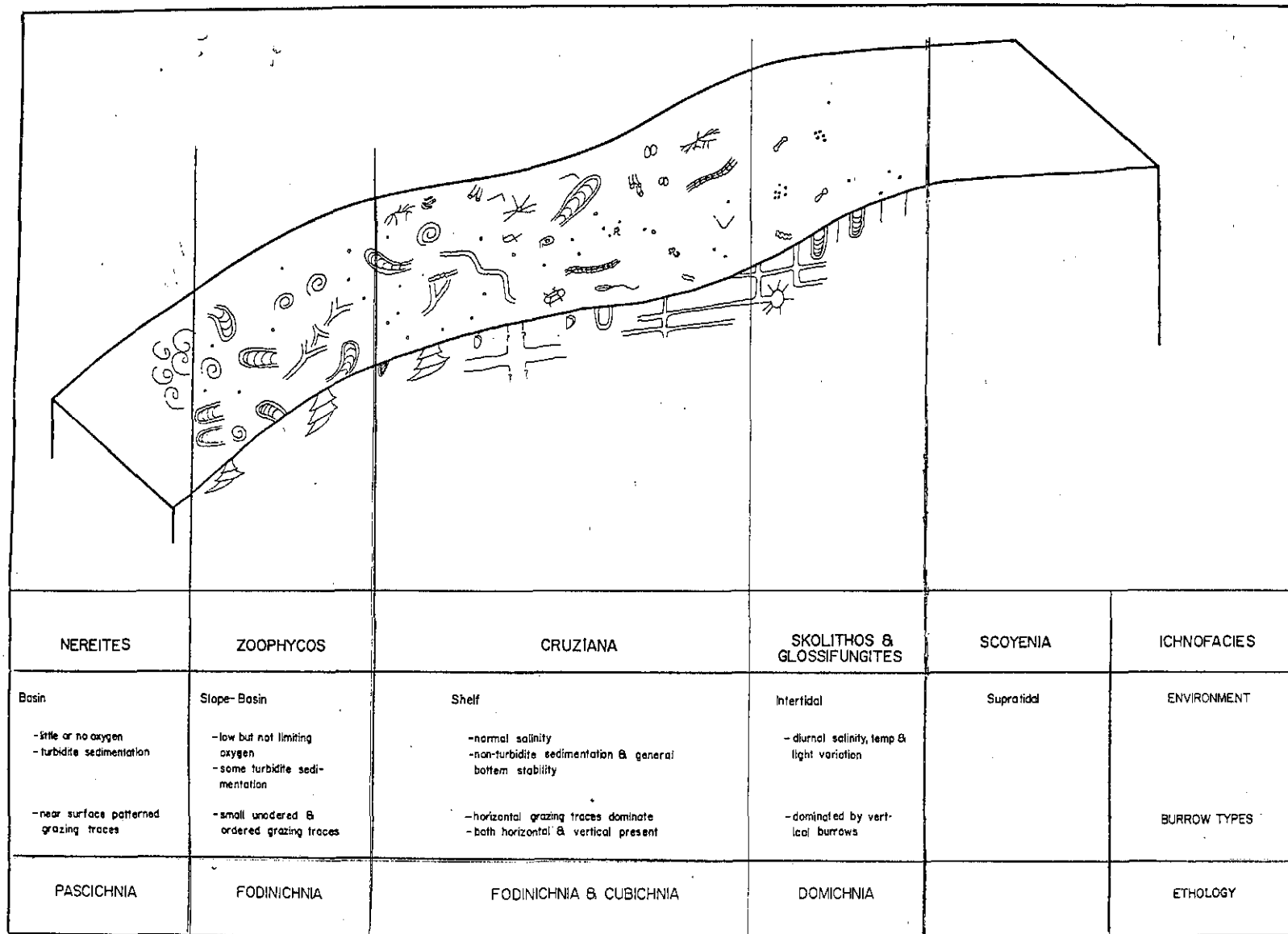

FIG. 13 ICHONOLOGICAL DIAGRAM OF SPECIES AT SEEBE

(See FIG. 14 for Legend and Symbols).

Figure 14Legend

h, v •, ¶	Skolithos	S
••, U	Arenicolites	A
~	Chondrites	Ch
P	Rosselia	Ro
U	Diplocraterion	D
∩(h)	Planolites	Pl
∩(h)	Paleophycos	Pa
⊙, ¶	Cylindrichnus	C
⊙, ¶	Zoophycos	Z
∩(h)	Rhizocorallium	Rh
∩(h)	Thalassinoides	Th
∩, ¶	Ophiomorpha	Oph
∩(v)	Subway Tunnels	Sub
∩(h)	Gyrochorte	Gy
7(h)	Scalarituba	Sc
∩(v)	Teichichnus	Te

TABLE 6 ; Trellis Diagram showing Species Relationships

Specimens	S	A	C	Ro	D ^{*2}	Pl	Pa	Ch	Z	Rh	Sub	Oph	Th	Gy	Sc	Te
S	-	+	+	+	+	-	-	-	+	+	+	+	+	+	+	+
A	4	+	+	-	-	-	-	-	+	+	-	-	+	-	-	-
C	8	1		+	-	-	-	-	+	-	+	-	-	-	-	+
Ro	2	-	1		-	-	-	-	+	+	-	-	-	-	-	-
D	1	-	-	-		-	-	-	-	-	-	+	+	-	+	-
Pl	-	-	-	-	-		+	+	+	+	+	+	+	-	-	-
Pa	-	-	-	-	-	5		+	+	-	-	+	-	-	-	-
Ch	-	-	-	-	-	1	7		-	-	-	-	-	-	-	-
Z	43	3	6	1	-	16 ^{*1}	2	-		+	+	+	+	+	-	+
Rh	31	2	-	1	-	7	-	-	28		+	+	+	-	-	-
Sub	27	-	1	-	-	3	-	-	13 ^{*3}	7		-	7	-	-	-
Oph	7	-	-	-	1	1	2	-	9	4	-		+	+	+	-
Th	4	1	-	-	1	-	-	-	14	9	5	9		+	+	-
Gy	3	-	-	-	-	1	-	-	1	-	-	1	1		-	-
Sc	1	-	-	-	1	-	-	-	-	-	-	1	2	-		-
Te	1	-	1	-	-	-	-	-	1	-	-	-	-	-	-	-

Observed
Associations

Number of Occurrences

LEGEND: *1- reflects association of tubes outside Zoophycos burrow.
 *2- horizontal section only.
 *3- 3 found in intimate association with burrow ends.
 +- indicates associations observed.

This graph is a Trellis Diagram showing species relationships. It is qualitative for the following reasons: 1) The number of observations of some species was limited, for example:

Teichichnus : 1
Scalaratuba : 4
Gyrochorte : 4
Arenicolites: 5

2) The relationships are more easily seen in horizontal than in vertical section.

CHAPTER 6

PALEOENVIRONMENTAL RECONSTRUCTION: A DISCUSSION

Uses of Trace Fossils

Traces have tremendous paleoecological value as environmental indicators. Widespread in space and time, and found in situ as a record of animal behavior, their interpretive value stems from the dependance of community structure on environmental factors (Seilacher, 1964, Rhoads, 1975). Biotic assemblages and modes of feeding may be implied from traces whose orientations are sensitive to such depth related variables as salinity, temperature and food supply (op. cit.) Traces which are used to separate species by feeding mode automatically distinguish deposit feeders from suspension feeders, but ichnology has not yet reached the state of refinement such that identification of trace originators at the species level is possible. However, traces are useful environmental indicators and general community structures may be implied (see Chapter 5).

Gradients of bioturbation may be used to reconstruct relative and absolute rates of sedimentation or erosion and interpretive environmental models are based on information

gained from relative abundance of body and trace fossils. Recent studies by Rhoads (1975) in Barnstable Harbour shows a 70% accuracy in environmental reconstruction if only dead matter is used which increases to 90% if traces are also included.

Traces are no longer used as reliable bathymetric indicators. For example, the mid-shelf Zoophycos species has been found in both shallow and deep waters and Skolithos, a previously defined shallow water indicator, is ubiquitous. Therefore, the current estimations of bathymetry are based on overall conditions as defined by trace morphology and ichnocoenoses. Even this presents difficulties since deposit feeders and suspension feeders cannot always be distinguished.

A word of caution is in order for those who rampantly over-classify species. McKee (1940) worked with lizards and amphibians in modern sediments under varying conditions of substrate water content, and slope, and noted considerable variation in trace morphology. This is obvious for those who have left footprints in the sand. How many species could be identified on a preserved beach surface at the end of a warm summer's day?

Seilacher's Classification

Trace identification was based on Seilacher's 1953 classification which has been subsequently modified by

Seilacher (1964) and Webby (1969). Figure 13 includes this classification of the environment at Seebe. Ethological changes are inferred from a primary transition of nearshore suspension feeders to offshore deposit feeders, observed in modern environments on the basis of food partitioning, physical instability of the bottom sediments, the degree of sediment reworking and oxygen concentration (Frey, 1977; Rhoads, 1970).

Seilacher stressed the importance of separating morphological features from those related to function. He recognized five ethologic classifications which are defined below.

- 1.- Repichnia: Trails or burrows left by vagile benthos during directed locomotion.
- 2.- Pascichnia: Winding trails or burrows of vagile mud eaters which are more or less efficiently grazing in search of food whilst avoiding double coverage.
3. Fodichnia: Burrows made by hemisessile deposit feeders which reflect a search for food but also the requirements of a permanent shelter.
- 4.- Domichnia: Permanent shelters dug by vagile or hemisessile animals procuring food from outside the sediment, as predators, scavengers or suspension feeders.

5.- Cubichnia: Shallow resting traces left by vagile animals which hide within the substrate and feed as scavengers of suspension feeders.

Fugichnia, escape structures identified by Simpson (1955, 1975) form a sixth ethological class.

The traces at Seebe fell into the first two classifications. Neither resting traces nor escape structures were found. "Cubichnia" could easily have been destroyed during subsequent diagenesis and weathering but lack of "fugichnia" remains a puzzle and suggests gaps in the sedimentary sequence. A total loss of these traces due to compaction weathering and diagenesis is unlikely; however, X-Ray analysis and close field observation revealed nothing.

Paleoenvironmental Reconstruction

Detailed reconstruction of the paleoenvironment at Seebe, requires the amalgamation of ichnological, geochemical and sedimentological evidence from the Cretaceous with modern ecological techniques. The zonation of traces as shown in Fig. 13, is the result of a literature search for the most common occurrence of traces and trace assemblages in various environments.

Traces similar to those at Seebe have been found in many sedimentologically different environments throughout the geologic

record (see Chamberlain, 1971, 1975; Frey, 1970, 1977; Crimes and Harper, 1970). The exceptions to this are the Subway Tunnels, first reported by Perkins et al. (1971) in the Cretaceous of Texas, and Cylindrichnus concentricus which is considered by Frey (1975) to be restricted to the Upper Cretaceous. Sixteen ichnogenera were recognized at Seebe. These are described in Chapter 4, and their interrelationships in Chapter 5. Currently, Pemberton and Frey are working with the little known decapod, Linuparus canadensis to further define the paleoenvironment at Seebe (Pemberton, 1981, pers. comm.).

Ethologically, the paleoenvironment at Seebe was offshore-marine within the Cruziana-Zoophycos assemblage as defined by Seilacher (1963). More specific correlations were found with general grain size and sediment type. Shales supported a poorly defined, less diverse deposit feeding fauna, while sands showed considerable variation in faunal diversity and abundance. The coarsest grained sands at Seebe, (0.15 mm) supported the most diverse fauna. Both trends within the sands are considered the result of the inferred sporadic sedimentation.

The totally bioturbated shales above 43 m and between 25 - 38 m (Fig. 3) contain poorly defined horizontal and vertical burrows. Field observations suggest that apart from upper and lower contacts, where a majority of horizontal

burrows were found, vertical burrows predominate. This observation is somewhat qualitative since small changes in lighting and surface moisture resulted in the appearance or disappearance of traces. The predominance of vertical burrows suggests rapid sedimentation, sediments low in organic content where filter feeders predominate or selective preservation of vertical burrows. Walker (1981, pers. comm.), rules out the former on the basis of a simple calculations of time and sedimentation rates and the latter ideas require more development. Selective preservation of vertical burrows in the thicker bioturbated shale units is the least speculative, though not necessarily the most accurate explanation at this time.

When sedimentation rates equal rates of reworking by organisms, total bioturbation results. In the modern, depths of reworking by eucaryotes on the shelf is between 0-5 cm/year (Risk, 1979, unpublished). If sedimentation rates exceed this, preservation of discrete traces may be expected; if less than or equal to this, total bioturbation results. Thus, at Seebe, shale interbeds record variations in sedimentation rates versus bioturbation rates. In terms of biological activity or percentage reworking, shales record apparent levels of 0 - 100 % within discrete interbeds in the Ram sections, and high activity (less than or equal to 100 %) in the mid-section of Leyland and Kiska shales. Chondrites, Planolites

and Paleophycos are well defined in the lowest Ram I shales⁹⁰ while Paleophycos and Planolites dominate in subsequent beds. In both Kiska and Leyland shales, upper and lower contacts showed good preservation of Paleophycos and Planolites. The mid sections contained general poorly defined vertical Skolithos and Ophiomorpha-type burrows.

Some sandstone beds in Ram I and Ram II showed no evidence of bioturbation. In fact, in some Ram II sands, parallel lamination is clearly defined. In contrast, areas of Ram II, sections 7, 8 and 9 show bioturbation which destroys most primary sedimentological features. The Cardinal, at about 40 m (at Seebe), and in sections on the north side of Horseshoe Dam is so totally bioturbated that vertical sections show very few individual burrows and no primary structures.

The most interesting ichnofauna was found in horizontal exposures at the top of Ram II and the Cardinal, (Horseshoe Dam and Seebe). Species relationships are detailed in Chapter 5. Interesting interfaunal relationships are seen on and near the surface of bioturbated sandstone beds. These include apparent truncation of surface burrows by subsurface burrows as in Thalassinoides by Ophiomorpha (Plate 6); preservation of hollow subway tunnels within 10 cm of transported shells in death assemblage, and cup form of Rosselia on the same bedding plane as the lower portion of subway tunnels.

Truncation of Thalassinoides by Ophiomorpha and the occurrence of Rosselia cups in the same plane as Subway Tunnels, indicates some preservational mechanism which prevented the destruction of surface traces in a biologically active zone during subsequent sedimentation. Rapid influx of sediment which hampered biological activity (probably by destroying the organisms) is the neatest way to do this. However, the shales were probably not deposited any faster than their modern sedimentary equivalent (Walker, 1981, pers. comm.), approximately 1 - 2 cm per year in a shelf environment (MacGinitie and MacGinitie, 1968).

I shall therefore propose a change in the biochemistry of the water concurrent with the return to normal deposition which killed off the remaining bioturbators and left the environment nonconducive to animal life. This idea cannot be supported with either biochemical or geochemical data at present.

Kauffman's (1967, 1973) studies of the Cretaceous deal with large scale environmental changes in the Western Interior sea which spanned North America, from the Northern extent of the Canadian Rocky Mountains to the Gulf of Mexico, during the Cretaceous (see Kauffman, 1967, text-fig. 1). He speculates about the correlation between Cretaceous transgressions and regressions and changes in water temperature, oxygen concentration, salinity changes and their effect on biomass.

The Cretaceous is one of the key periods from which

concepts in evolution, paleoecology, paleobiology and biostratigraphy have been developed (Kauffman, in Moore et al., 1969; Hallam, 1973). General trends in water temperature are known, based on Bowen's (1966) oxygen and carbon isotope analyses of benthonic invertebrates. Water temperature ranged from 10 - 17°C on the sea floor, to 15 -35°C on the surface. Broad temperature gradients resulted in sluggish water circulation, poor bottom oxygenation and high planktonic biomass leading to sediments with high organic content due to "organic rain". Although these trends are broad and inexactly defined, they may be applied in general to explain local conditions at Seebe.

Life at Seebe during the Turonian

The early Turonian transgression was a period of normal salinity and increased biological activity in the Western Interior Basin (Scholle & Kauffman, 1970). Prior to this, Kauffman (1975) hypothesizes a density stratified sea covered by a layer of brackish water due to river drainage. There was no incentive for daily, seasonal or long term variation, with the exception of unsettling events such as storms. Marine macro-and micro-fauna were depleted as a result of inadequate subsurface oxygenation (Frush & Eicher, 1975).

Normal communities were based on initial population by Inoceramids and ammonites on whose shells such taxa as

cranoid brachiopods, gastropods, bryozoans, cementing, tube-dwelling and boring worms existed as islands in a chemically inhospitable environment at the sediment/water interface (Kauffman, 1979). The source of the chemical inhospitability was not discussed, but was probably an anoxic layer of varying thickness. Thus, thin parallel laminated shale interbeds represent anoxic conditions at Seebe, while varying degrees of bioturbation are the result of reworking by euryhaline osmoregulatory or osmoconforming marine worms. The storm activity which resulted in offshore deposition of sand pods also turned over the stratified sea producing an oxygenated environment which was then rapidly colonized by larger organisms requiring higher oxygen levels. These included crustaceans and more stenohaline marine organisms.

The difference in extent of oxygenation would explain the diversity differences between the tops of Cycles 2 and 3. Cycle 3 ended in well oxygenated waters within which restricted euryhaline and stenohaline forms survived for a longer time than their counterparts in Cycle 2. As a result, the sands at the top of Cycle 3 are more bioturbated than those of Cycle 2. Whether this oxygenation occurred before or during the early stages of deposition of silt, has not yet been

investigated. If Linuparus is found to be tolerant of reduced oxygen levels then this idea helps to explain the preservation of surface traces at the sand/shale interface at the top of both cycles. A return to anoxic conditions concurrent with silt deposition destroyed salinity sensitive organisms while more tolerant ones survived.

Summary

The environment at Seebe may be defined by the ichnofauna as mid-shelf, normally populated by multicellular organisms with low oxygen requirements. Storm generated turbidity flows resulted in higher oxygen levels accompanying sediment influx. This allowed colonization of the newly deposited sands by (probably larger) organisms with a higher oxygen requirement.

Associated with the return to normal sedimentary conditions was a return to normal salinity. The timing of this is not certain. The animals responsible for the diverse ichnoassemblages subsequently left this environment or perhaps were killed off with the exception of the more tolerant (possibly Linuparus types) who burrowed beneath the s/w interface. The extent of bioturbation in the Cardinal sands relative to those of Ram II suggests a longer period of stability in an environment which could support a diverse deposit-feeding assemblage.

CHAPTER 7

CONCLUSIONS

- 1.- The Cardium Formation at Seebe may be subdivided into five ichnologically discrete facies. These are differentiated by sediment type, grain size and species present. Diversity of species is used to differentiate between the BSIT facies at the top cycles 2 and 3. These five facies show general correlation with the sedimentologically defined facies of Wright (1980) and define an offshore marine environment within the Cruziana- Zoophycos ichnofacies.

- 2.- Four facies represent discrete conditions of environmental stability. Totally bioturbated sands and shales suggest long periods of stability during which deposit feeders totally reworked the sediment so that no discrete traces remained. Bioturbated shales with identifiable traces imply shorter periods of stability resulting in partial reworking and thus preservation of discrete traces. Preservation differences within the shales may also be responsible for the difference in clarity of traces.

Bioturbated sands with identifiable traces contain two discrete communities whose development is a result of combined sedimentological and biological parameters. Primarily, these represent the effect of catastrophic influx of sediment into an environment which is chemically (in terms of PO_2 , salinity, etc.); biochemically (in terms of organic content of sediments and primary productivity of photosynthesizers) and sedimentologically (in terms of depositional rates) stable on a daily basis.

- 4.- Among the sixteen ichnogenera defined at Seebe, deposit feeders outnumber suspension feeders, (4:1). Obligate suspension feeders are Skolithos, Cylindrichnus, Arenicolites and possibly Diplocraterion.

- 5.- The Cardinal surface includes several subway tunnels which were most likely formed after the deposition of silt above the sand. Linuparus canadensis, a burrowing decapod crustacean is currently under investigation as the probable trace originator (Pemberton, 1981, pers. comm.) which would burrow down through the silt and create tunnels at the silt/sand interface.

6.- The Cardinal ichnofaunal community is more diverse than that of Ram II. This suggests a longer period of environmental stability during the early stages of normal sedimentation which followed the influx of sand due to storm activity and possibly beyond. This qualitative observation will be further investigated.

APPENDIX 1

X-Ray Analysis

Analysis of material was made possible through the aid of Mr. L. Zwicher who cut the required slabs and Mr. J. Cortes who provided instruction on the use of the Macrotank IV.

1.- Slabs were prepared by cutting to thickness between 0.5 and 1.8 cm. Surface grinding was found unnecessary, but thinner slabs gave better resolution.

2.- Experimentation with exposure time and X-Ray beam intensity showed best results on Kodak TRI-X Pan Professional Film, with 50 kv, 300 mA, for 10-20 minutes. Exposure time is dependent upon the thickness of the slab and the density of the rock. For example, Hamblin used 2 sec. and exposures at 35 kv and 30 mA for 3 mm thick slabs. This was neither possible nor beneficial for the fauna at Seebe because the fauna in general is on a large enough scale that sections this thin would reveal nothing that could not be seen in hand sample and would show only parts of traces.

Results

In general terms, the results indicate that there are no internal biogenic structures within the sandstones at Seebe

that cannot be seen in outcrop. This implies one of two things: either the nature of traces and bioturbation allows complete observation in the field or that at the resolution of the Macrotank, with the samples available, hidden internal structures remain hidden. I prefer the former implication.

PLATE X-1 shows the X-Ray of a 1.75 cm slab of sandstone from the Cardium at Seebe.

PLATES X-2 and X-3 show the equivalent black and white of both sides of the same slab. There are at least five recognizable traces on this slab (see arrows), which can be seen in both pictures.

PLATE X-4 shows the X-Ray picture of two 0.5 cm slabs which are thoroughly bioturbated.

PLATE X-5 shows the equivalent black and white. In this case bioturbation has reached the extent where the observer sees nonspecific bioturbation.

PLATE X-1: contact print of X-ray of Cardium
sample showing internal features.

PLATES X-2 & X-3: show photographed surface
of same slab, All photos life scale.



1

APPENDIX 2Acetate Peel Technique

This technique involved polishing surfaces of samples to remove saw marks. The polished samples were then etched in 50% HF for 2 to 20 minutes, observing all necessary precautions. Long etching times were required to remove sufficient silica cement for grain size measurement.

The etched surfaces were rinsed in distilled water and then allowed to dry completely, at least four hours.

Acetone was then spread over the entire etched surface, followed by a previously cut piece of acetate. Fewest air bubbles are collected under the acetate when the peel is applied to a completely wet surface, starting from one side and gently smoothing the sheet over the sample. The peel should dry for several hours before removal is attempted, Longer drying times ensure safe removal of the peel.

The peels were either enlarged and printed as photographs or observed under the microscope for grain size analysis.

REFERENCES

- Ager, D. V., and Wallace, P., 1970, The distribution and significance of trace fossils in the uppermost Jurassic rocks of the Boulonnais, Northern France; in: Crimes, T. P., and Harper, J. C. (eds.), Geol. Jour., Spec. Issue, No.3, p. 1-18.
- Ager, D. V., 1963, Principles of paleoecology, McGraw-Hill, New York, 371 p.
- Alpert, S., 1972, Systematic review of the genus Skolithos: J. Paleo., v. 48, p. 661-669.
- Basan, P. B., (ed.), 1978, Trace fossil concepts: S.E.P.M. Short Course 5, 191 p.
- Beach, F. K., 1955, Cardium, A turbidity current deposit: Jour. Alberta Soc. Petr. Geol., v. 3, # 8, p. 123-125.
- Becker, H. F., and Donn, W., 1952, A new occurrence and description of the fossil Arthropycus: Science, v. 115, no. 2982, p. 214-215, text-fig., 1, 2.
- Biffar, T. A., 1971, The genus Callianassa (Crustacea, Decapoda, Thalassinidea) in South Florida, with keys to the western Atlantic species: Bull. Marine Sci., v. 21, p. 637-715.
- Bischoff, B., 1968, Zoophycos, a polychaete annelid, Eocene of Greece: Jour. Paleont., v. 42, p. 1439-1443.
- Bradley, J., 1973, Zoophycos and Umbellula (Pennatulacea): their synthesis and identity: Palaeogeogr., Palaeoclimatol., Palaeoecol., v. 13, p. 103-128.

- Bromley, R.G., 1967, Some observations of burrows of thalassinoidean Crustacea in chalk hardgrounds: Geol. Soc. London, Quart. J., v. 123, p. 157-182.
- _____, & Asgaard, Ulla, 1972, Notes on Greenland trace fossils: 1. Freshwater Crúziana from the Upper Triassic of Jameson Land, East Greenland (p. 7-13). Report no. 49, p. 1-30, Grønlands Geol. Undersøgelse.
- _____, & Frey, R. W., 1974, Redescription of the trace fossil Gyrolithes and taxonomic evaluation of Thalassinoides, Ophiomorpha, and Spongeliomorpha, Bull. of Geol. Soc., Denmark, v. 23, p. 311-335.
- Bruce, C., ed., Canadian Soc. Petr. Geol. Student Industry Field Trip Guide Book: C.S.P.G., 1980.
- Caldwell, W. G. E., 1975, The Cretaceous System in the Western interior of North America, GSA Special Paper # 13, 666 p.
- Chamberlain, C. K., 1971, Morphology and ethology of trace fossils from the Ouachita Mountains, southeastern Oklahoma: J. Paleo., v. 45, p. 212-246, text-fig. 1-8, pl. 29-32.
- _____, 1975, Trace fossils in DSDP cores of the Pacific: J. Paleo., v. 49, p. 1074-1096.
- Chisholm, J. I., 1970, Teichichnus and related trace fossils in the lower Carboniferous at St. Monace, Scotland. Geol. Surv. G. B. Bull., v. 32, p. 21-51.
- Conkin, J. E., and Conkin, B. M., 1968, Scalarituba missouriensis and its stratigraphic distribution: Univ. Kansas Paleont. Contrib., Paper 31, p. 107, pl. 1-4.
- Crimes, T. P., & Harper, J. C. (eds.), 1970, Trace fossils: Geol. Jour. Special issue 3, 547 p.

- _____, 1970, The significance of trace fossils in sedimentology stratigraphy and paleoecology with examples from lower Paleozoic strata, in T.P. Crimes and J.C. Harper (eds.), Trace fossils: Geol. Jour., Special Issue no. 3, p. 101-126.
- _____, 1973, From limestones to distal turbidites: A facies and trace fossil analysis in the Zumaya flysch (Paleocene-Eocene), North Spain: Sedimentology, v. 20, p. 105-131.
- Dawson, W. C., Reaser, D. F., and Richardson, J. D., 1977, Trace fossils from the Pean Gap Fm. (U. Cretaceous), Northeastern Texas: Texas J. of Sci., v. 29, p. 175-186.
- De Weil, J. E. F., 1956, Viking and Cardium not Turbidity Current Deposits: Jour. Alta. Soc. Petr. Geol., v. 4, # 8, p. 173-174.
- Ekdale, A. A., 1978, Trace Fossils in leg 42 cores: Init. Repts. Deep Sea Drilling Project, v. 42, p. 821-827.
- Ewing, M. and Davis R. A., 1967, Lebensspuren photographed on the ocean floor. In J. B. Hersey (ed.) Deep-sea photography. Johns Hopkins Oceanogr. Stud. v. 3, p. 259-294 .
- Fenton, C. L. and Fenton, M. A., 1934, Scolithos as a fossil phoronid: Pan-Amer. Geol., v. 36, p. 1090-1107.
- Ferguson, L., 1965, A note on the emplacement of sediment in the trace fossil Chondrites: Geol. Soc. London Proc., v. 1622, p. 79-82.
- Fleming, C. A., 1973, Fossil "cuff-links": A new Miocene trace fossil of the genus Diplocraterion from New Zealand: Sci. Reports, Tohoky Univ., 2nd ser. (Geol.), spec. vol. 6, p. 415-418.
- Frey, R. W., 1970, Trace fossils of Fort Hays Limestone Member of Niabara Chalk (U. Cretaceous) west central Kansas: Univ. Kansas Paleo. Contrib. Art. 53 (Cret. 2), 41 p.

- _____, 1972, Paleoecology and depositional environment of Fort Hays Limestone Member, Niobara Chalk (U. Cretaceous), west central Kansas: Univ. Kansas Paleont. Contr., Art. 58, 72 p.
- _____, 1970, Comparison of Upper Cretaceous ichnofacies from siliceous sandstones and chalk, Western Interior Region, U.S.A., in Trace fossils, T.P. Crimes and J.C. Harper (eds.), Geol. Jour., special issue no. 3, p. 141-166, text-fig 1-8, table 1-3, Seel House Press, Liverpool.
- _____, (ed.), 1975, The study of Trace Fossils. A synthesis of Principles, Problems and Procedures in Ichnology: Springer-Verlag, New York, 562 p.
- _____, _____, and Pryor, W. A., 1978, Ophiomorpha: its morphologic, taxonomic and environmental significance: Paleogeogr. Paleoclimat. Palaeoecol., v. 23, p. 199-229.
- Fursich, F. T., 1974, Ichnogenus Rhizocorallium: Palaeont. Z., v. 48, p. 16-28.
- _____, 1974, On Diplocraterion and the significance of morphological features in vertical, spreiten-bearing U-shaped trace fossils: J. Paleo., v. 48, p. 952-962.
- Gernant, R. E. 1972, The Paleoenvironmental significance of Gyrolithes (Lebensspur). J. Paleont., v. 46, p. 735-742.
- Gregory, M. R., 1969, Trace fossils from the turbidite facies of the Waitemata Group, Whangaparaoa Peninsula, Auckland: Trans. Roy. Soc. New Zeal., Earth Sci. v. 7, p. 1-20.
- Hallam, A., 1970, Gyrochorte and other trace fossils in the Forest Marble (Bathonian) of Dorset, England; in T.P. Crimes and J.C. Harper (eds.): Geol. J., sp. issue 3, p. 189-200.

- _____, (ed.), 1977, Patterns of Evolution as illustrated by the Fossil Record (Dev. in Paleo and Stratigraphy 5); Elsevier, New York, 579 p.
- Hamblin, W. K., 1962, X-Ray Radiography in the study of structures in homogeneous sediments: Jour. Sed. Petr., v. 32, p. 201-210.
- _____, 1963, Radiography of rock structures, in Clark, G.L. (ed.), Encyclopedia of X-rays and Gamma rays, Reinhold Pub. Co. p. 940-942.
- _____, 1971, X-Ray photography, in Carber, R.C. (ed.), Procedures of Sedimentary Petrology, New York, Wiley Interscience, p. 251-284.
- _____, and Walker, R. G., 1979, Storm-dominated shallow marine deposits: The Fernie-Koosenay (Jurassic) Transition, Southern Rocky Mountains: Can. Jour. E. Sci., v. 16, no. 9, p. 1673-1690.
- Hancock, J. M., 1975, The sequence of facies in the Upper Cretaceous of Northern Europe compared with that in Western Europe, in GSA Spec. Paper 13, p. 82.
- Hantzschel, W., 1962, Trace fossils and Problematica: in Treatise on invertebrate paleontology, R. C. Moore (ed.), Pts. N & W, p. W177-W245, text-fig. 109-149: Geol. Sci. America and University of Kansas Press, New York and Lawrence, Kansas.
- Harms, J. C., Southard, J. B., Spearing, D. R., and Walker, R. G., 1975, Depositional environments as interpreted from primary sedimentary structures and stratification sequences: S.E.P.M. Short Course, No. 2, 161 p.
- Hayward, B. W., 1976, L. Miocene bathyal and submarine canyon ichnocoenoses from Northward New Zealand: Lethaia, v. 9, p. 149-162.
- Hedgepeth, J. W., 1964, Evolution of Community Structures, in Imbrie and

- Newell (eds.), Approaches to Paleoecology, John Wiley & Sons, New York
- _____, (ed.), 1957, Treatise on Marine Ecology and Paleoecology, v. 1, Ecology, Geol. Soc. Am. Mem. 67, 1296 pp.
- Heinberg, C., 1970, Some Jurassic trace fossils from Jameson land (East Greenland), in Trace Fossils, T.P. Crimes and J.C. Harper (eds.), Geol. Jour. Spec. Issue no. 3, p. 227-234.
- Howard, J. D., 1966, Characteristic trace fossils in Upper Cretaceous sandstones of the Book Cliffs and Watsatch Plateau: Uta Geol. Mineral. Survey, Central Utah, Coal Bull., v. 80, p. 35-53.
- _____, and Elders, C. A., 1970, Burrowing patterns of haustoriid amphipods from Sapelo Island, Georgia, in Trace Fossils, T.P. Crimes and J.C. Harper (eds.), Geol. Jour. Spec. Issue no. 3, p. 243-262.
- _____, Valentine J.W. and Warme, J. E., 1971, Trace fossils as paleoecological tools, in J.D. Howard et al., Recent advances in paleoecology and ichnology, Amer. Geol. Inst., Short Course Lect. Notes, p. 184-212.
- _____, 1972, Trace fossils as criteria for recognizing shorelines in the stratigraphic record: in Rigby, J.K. Rigby and W.K. Hamblin (eds.) Recognition of ancient sedimentary environments: S.E.P.M. Spec. Publ. No. 16, p. 215-225.
- Howell, B. F., 1943, Burrows of Skolithos and Planolites in the Cambrian Hardyston Sandstone at Reading, Pennsylvania: Wagner Free Inst. Sci. Publ., v. 3, p. 1-33.
- _____, 1945, Skolithos, Diplocraterion, and Sabellidites in the Cambrian Antietam Sandstone of Maryland: Wagner Free Inst. Scie. Bull., v. 20, p. 33-40.

Imbrie, J. and N. Newell, (eds.), 1964, Approaches to Paleocology, John Wiley & Sons, New York.

Ireland, R. J., Pollard, J. E., Steel, R. J., and Thompson, D. B., 1978, Intertidal sediments and trace fossils from the Waterstones (Scythian-Anisian?) at Daresbury, Cheshire: Proc. Yorkshire Geol. Soc., v. 41, p. 399-436.

James, J. F., 1893, Remarks on the genus Arthrophyucus (Hall): Cincinnati Soc. Nat. Hist. J., v. 14, p. 45-72.

Kauffman, E. G., 1973, Cretaceous Bivalvia; in Halam, A. (ed.), Atlas of Palaeobiogeography. Amsterdam, London, New York, Elsevier, p. 353-383.

_____, 1967, Coloradoan macroinvertebrate assemblages, central western interior U.S.A.; in Paleoenvironments of the Cretaceous Seaway - A symposium, Colorado School of Mines

Kay, M., 1945, Paleogeographic and Palenospastic Maps, Bull. Amer. Assoc. Petr. Geol., v. 29, p. 426-440.

Kennedy, W. J., Trace Fossils in the Chalk environment: in Trace Fossils, T.P. Crimes and J.C. Harper (eds.), Geol. Jour., Spec. Issue no. 3, p. 263-282.

Kern, J. P., and Warne, J. E., 1974, Trace fossils and bathymetry of Upper Cretaceous Point Loma Fm., San Diego, California: Geol. Soc. Amer. Bull., v. 85, p. 893-900.

Keunen, P. H., 1957, Review of marine sand-transporting mechanisms; in Cardium Symposium: J. Alta. Soc. Petr. Geol., v. 5, # 4, p. 82-87.

Kornicker, L. S. and Odum, H. T., 1958, Characterization of Modern and Ancient Environments by Species Diversity: Bull G. S. Am., v. 69, p. 1599.

- Ladd, H. S., 1957a (ed.), Treatise of Marine Ecology and Paleoeecology. Geol. Soc. Amer. Mem. 67, v. 2, 1077 p.
- _____, 1957b, Paleoeecological evidence, p. 31-66. In H. S. Ladd (ed.), Treatise of Marine Ecology and Paleoeecology, Geol. Soc. Amer. Mem. 67, v. 2, 1077 p.
- _____, 1959, Ecology, Paleontology and Stratigraphy: Science, v. 129, # 3341, p. 69-78.
- Levinton, J. S., 1972, Stability and trophic structure in deposit feeding and suspension feeding communities: Am. Nat., v. 106, p. 472-486.
- MacGinitie, G. E., and MacGinitie, N., 1968, Natural History of Marine Animals, Second Ed., McGraw Hill, N.Y. 523 p.
- McKee, E. D., 1947, Experiments on the Development of Tracks in fine cross-bedded sand. J. S. P. v. 17, p. 23-28.
- McMullin, B. R. and Van de Poll, H. W., 1979, Xeroradiography: an improved X-Ray method as applied in the study of unopened small diameter sediment cores. J. S. P., v. 49, # 2, June 1979.
- Michaelis, E. R., 1957, Cardium Sedimentation, Pembina River Area, in Cardium Symposium: Jour. Alta. Soc. Petr. Geol., v. 5, #4, p. 73-77.
- Moore, R. C., and Teichert, C., 1969, Treatise on Invertebrate Paleontology, G.S.A. and Univ. of Kansas Press, Part (N) Mollusca, Part (W) Miscellanea.
- Moussa, M. T., 1970, Nematode fossil trails from the Green River Formation (Eocene) in the Uinta Basin, Utah, Jour. Paleo, v. 44, # 2, p. 304-7.

- Nielsen, A. R., 1957, Cardium Stratigraphy, Pembina Field, in Cardium Symposium: Jour. Alta. Soc. Petr. Geol., v. 5, # 4, p. 64-72.
- Osgood, R. G., Jr. and Szmuc, 1970, Trace fossils of the Cincinnati Area, Palaeontographica Amer., v. 41, # 6, p. 281-444.
- _____, _____, 1972, The trace fossil Zoophycos as an indicator of water depth: Bull. Amer. Paleol., v. 62, p. 5-22.
- Passega, R., 1954, Turbidity Currents and Petroleum Exploration: Bull. Am. Ass. Petr. Geol., v. 37, # 2, P. 1871
- Pemberton, S. G., and Risk, M. J., 1978, Trace Fossils: Possible use in identifying hydrocarbon source rocks (Abstract): Geol. Soc. Amer., Abstracts with Programs, v. 10, p. 469.
- _____, 1979, Selected Studies in Lower Paleozoic Ichnology: PhD Thesis, McMaster University, Ham, Ontario.
- Perkins, B. F., (ed.), 1971, Trace Fossils, a field guide to selected localities in Pennsylvanian, Permian, Cretaceous and Tertiary Rocks of Texas and related papers: Louisiana State Univ., School Geosci., Misc. Publ., 71-1, p. 56-59.
- Plicka, M., 1968, Zoophycos, and a proposed classification of sabellid worms: Jour. Paleont., v. 42, p. 836-849.
- _____, 1970, Zoophycos and similar fossils, in Trace Fossils, T.P. Crimes and J.C. Harper (eds.), Geol. Jour., Spec. Issue No. 3, p.361-371.
- Raup, P. M., and Seilacher, Adolph, 1969, Fossil foraging behavior: computer simulation: Science, v.166, p. 944-995.

- Rhoads, D. C., et al., 1972, Trophic group analysis of Upper Cretaceous (Maestricatian) bivalve assemblages from South Dakota. A.A.P.G. Bull., v. 56, p. 1100-1113.
- Reyment, R. A., 1971, Introduction to Qualitative Paleoecology, Amsterdam, Elsevier, 226 p.
- Rossingh, H. K., 1957, Cardium between Athabasca River and Bow River, in Cardium Symposium, Jour. Alta. Soc. Petr. Geol., v. 5, # 4, p. 78-81.
- Schafer, W., 1972, Ecology and palaeoecology of marine environments. Edinburgh and Chicago, Oliver and Boyd and Univ. Chicago Press, 568 p.
- Schopf, T. J., 1980, Paleooceanography, Harvard University Press, 341 p.
- Seilacher, A., 1962, Paleontological studies on turbidite sedimentation and erosion, J. Geol. p. 227-234.
- _____, 1964, Biogenic sedimentary structures, in J. Imbrie and N. D. Newell (eds.), Approaches to paleoecology, John Wiley and Sons, Inc., N. Y. p. 296-316.
- _____, 1967, Fossil Behaviour: Sci. Amer., v. 217, p. 71-80.
- _____, 1967, Bathymetry of trace fossils: Mar. Geol., v. 5, p. 413-428.
- _____, 1970, Cruziana stratigraphy of "non-fossiliferous" Paleozoic sandstones, in T.P. Crimes and J.C. Harper (ed.), Trace Fossils: Geol. J. Spec. Issue no. 3, p. 447-476.

- _____, 1977, Evolution of Trace Fossil Communities, in A. Hallam (ed.) Patterns of Evolution as illustrated by the Fossil Record. Developments in Paleontology and Stratigraphy 5, Elsevier, N.Y. 547 p.
- Sellwood, B. W., 1971, A Thalassinoides burrow containig the crustacean Glyphaea udressieri (Meyer) from the Bathonian of Oxfordshire: Palaeontology, v. 14, p. 589-591.
- Selley, R. C., 1970, Ichnology of Palaeozoic sandstones in the Southern Desert of Jordan: a study of trace fossils in their sedimentologic context, in T.P. Crimes and J.C. Harper (eds.), Trace Fossils: Geol. J. Spec. Issue no. 3, p. 477-489.
- Simpson, Scott, 1957, On the trace fossil Chondrites: Geol. Soc. London, Quart. J. v. 112, p. 475-499.
- _____, 1970, Notes on Zoophycos and Spirophyton, in T.P. Crimes and J.C. Harper (eds.), Trace Fossils: Geol. J. Spec. Issue no. 3, p. 505-515.
- Showd , M. L., and Levin, M. L., 1976, Chondrites in the upper Platin subgroup (Middle Ordovician) of E. Missouri: J. Paleo., v. 50, p. 260-268.
- Stewart, D. J., 1978, Ophiomorpha: A marine indicator?: Proc. Geol. Assoc., v. 89, p. 33-41.
- Stott, D. F., 1963, The Cretaceous Alberta Group and equivalent rocks, Rocky Mountains Foothills, Alberta: Geol. Surv. Canada Mem. 317.
- Swagor, N. S., 1975, The Cardium Conglomerate of the Carrot Creek Field: M.Sc. Thesis, Univ. of Calgary, Calgary, Alberta.

- Taylor, B. J., 1967, Trace Fossils from the Fossil Bluff Series of Alexander Island: Brit. Antarctic Survey, Bull., v. 13, p. 1-30.
- Valentine, J. W., 1973, Evolutionary Paleocology of the Marine Biosphere, Prentice Hall, 511 p.
- Vokes, H. E., and B. Brown, 1944, Trails in the Cretaceous Mowry Shale of Montana, Report of Nat. Research Comm. Marine Ecology and Paleocology, # 4, p. 11-12.
- Walker, K. R., 1972, Trophic analysis: a method for studying the function of ancient communities, Jour. Paleont., v. 46, p. 82-93.
- Walker, R. G., (ed.), 1979, Facies Models: Reprint Series # 1.
- Weimer, R. J., and Hoyt J. H., 1964, Burrows of Callianasa major (Say), geologic indicators of littoral and shallow neritic environments: J. Paleo., v. 38, p. 761-767.
- Wilson, A. E., 1948, Miscellaneous classes of fossils, Ottawa Formation, Ottawa St. Lawrence Valley: Geol. Surv. Canada, Dept. Mines Res. Bull., v. 11, 116 p.
- Wright, M. E., 1979, Upper Cretaceous Cardium Formation at Seebe, Alberta, Shallow Marine Storm Deposits, B.Sc. Thesis, McMaster University, Hamilton, Ontario.
- Wright, M. E., and Walker, R. G., 1981, Cardium Formation (U. Cretaceous) at Seebe, Alberta -- storm transported sandstones and conglomerates in shallow marine depositional environments below fairweather wave base: C. J. E. S., v. 18 (in press)

