

Manhattan



User Guide

Plaza HD·T2

Freeview HD Receiver with Apps



WELCOME

Thanks for buying this Manhattan Plaza HD•T2 Freeview receiver, designed to provide you with the best in digital TV, radio and apps.

Connect to a suitable HD-ready television using HDMI for breathtaking high definition digital pictures and digital sound. To help make watching TV even more enjoyable, the Plaza HD•T2 is flexible and customisable:

- Create lists of your favourite channels and then use them to see only the channels you want to in the Programme Guide (see p22).
- Add reminders in the Guide with just the press of a button so you never miss your favourite shows (see p20).
- Catch up with the best of the week's TV using iPlayer and explore the largest collection of online video with YouTube.

Please take the time to read this user guide carefully before installing or using the unit, and keep it for future reference.

If you experience any difficulties connecting or using the Plaza HD•T2, please see the Troubleshooting section at the end of this guide and then if you still need help, contact us.

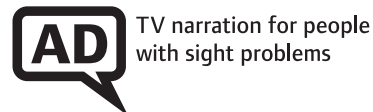

Manufactured under license from Dolby Laboratories.
Dolby and the double-D symbol are trademarks of Dolby Laboratories.

FURTHER INFORMATION

FREEVIEW

You can get more information and help from the Freeview website at:

www.freeview.co.uk

MANHATTAN

Please visit our website or call us for more information and help. We recommend you sign up to our mailing list to receive the latest information about your product including news of software updates.

Web: **www.manhattan-tv.com**

Phone: **020 8450 0005**

CONTENTS

1	In The Box	5	4	Advanced Use	21
	Your receiver	6		Using the favourites lists	21
	Remote control	8		The lock PIN	23
2	Preparation	10		Display mode	23
	The aerial	10		Changing the channel list	23
	Connecting your receiver	10		Using the setup menus	24
	Switching on	11		General menu section	24
	Tuning in	12		- Subtitles	25
3	Everyday Use	14		- Subtitle language	25
	Turning on the receiver	14		- Information	25
	Changing channels	14		Picture menu section	25
	Changing the volume	15		- Screen type	26
	Browsing bar	15		- Display mode	26
	Subtitles and Audio Description (AD)	16		- HDMI resolution	26
	Using the channel list	17		- SCART mode	26
	Searching for a channel	17		Sound menu section	27
	Using the programme guide	18		- Audio language	27
	Using Apps	20		- Audio description	27
	Interactive TV services	20		- Audio description volume	27
				- Dolby digital	27
				- Lip sync delay	28
				- Balance	28

continued...

CONTENTS

4 Advanced Use (continued)

Time menu section	28
- Auto standby	28
- Sleep timer	28
- Auto turn on	28
- Auto turn off	28
System menu section	29
- Retune	29
- Manual scan	29
- Network configuration	30
- 5V antenna power	30
- RF loopthrough in standby	30
- Parental guidance	30
- Set lock PIN	30
- Software update via OAD	31
- OAD software manual scan	31
- Software update via USB	31
- Restore factory default	31

5 Connecting To Your Network 32

Automatic (DHCP)	32
Manual (Static)	33

Appendix A Safety	34
Appendix B Troubleshooting	38
Appendix C Specifications	41
Guarantee & Legal	42

1 In The Box

In your Plaza HD•T2 Freeview receiver pack you should find the following items:



Quick Start Guide



Main User Guide



HDMI cable to connect to an HD-ready TV

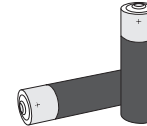

Batteries for the remote control

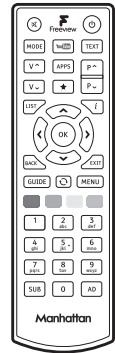

Remote control

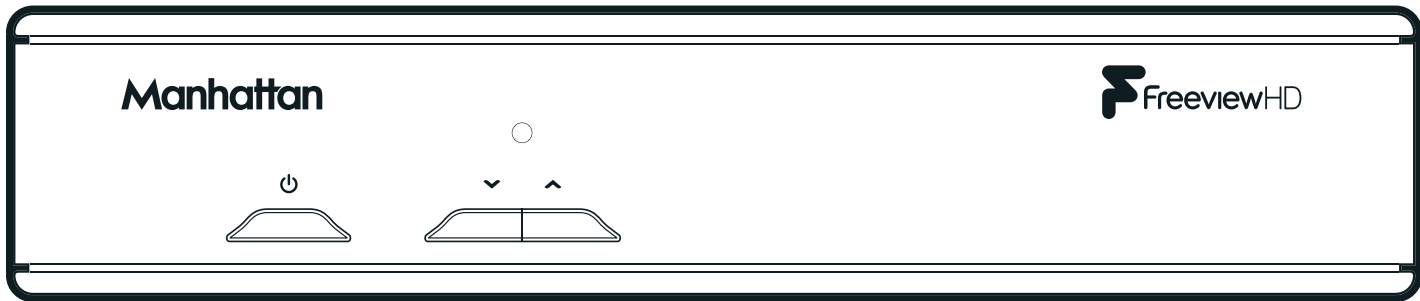

Plaza HD•T2 receiver

YOUR RECEIVER

Manhattan Plaza HD•T2

Front

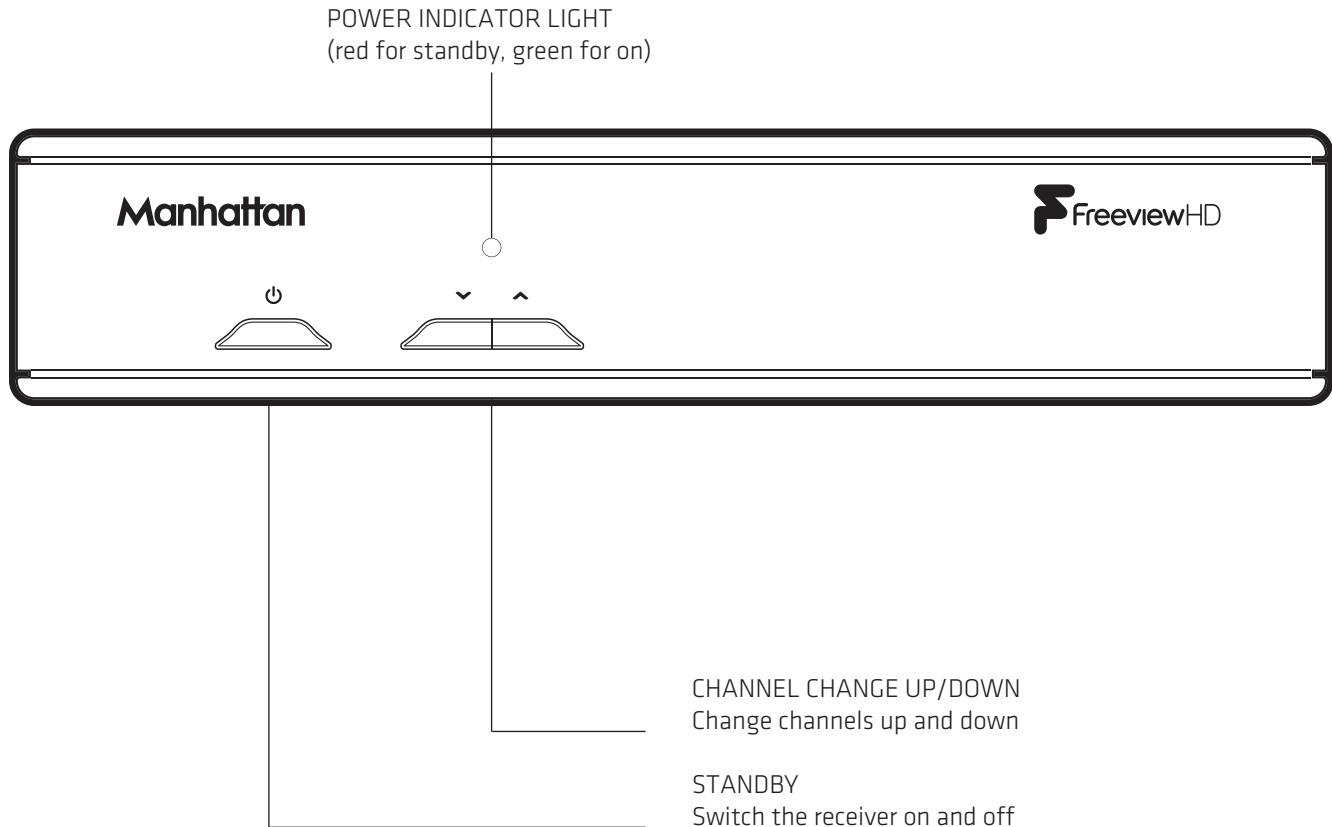

Manhattan Plaza HD•T2

Rear

ANTENNA IN

Input for connection to your aerial

AUDIO (L) & (R)

Analogue audio outputs for connection to a sound system

VIDEO

Composite video output for connection to a non-HD television

POWER CABLE

For connection to a mains plug socket

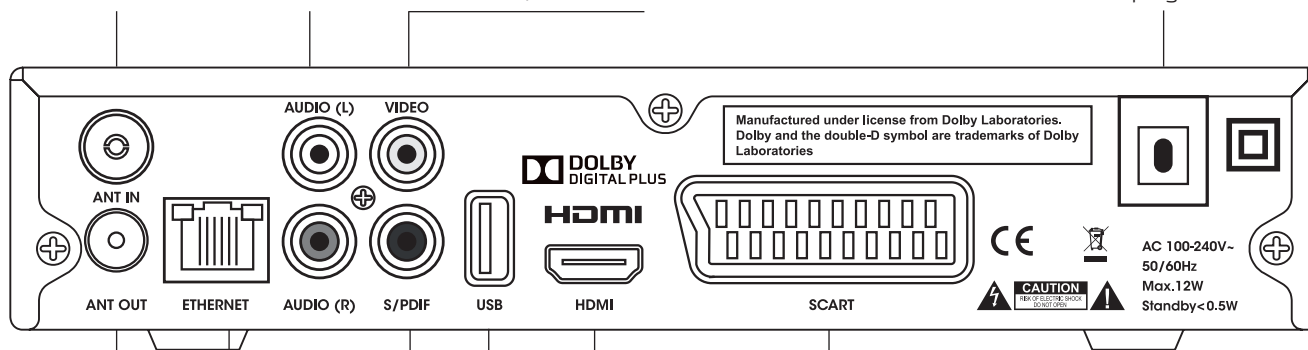

ANTENNA OUT

Output for connection to the RF input of your television

ETHERNET

Network socket for connection to your router & the internet

COAXIAL S/PDIF

Digital audio output for connection to a surround sound system

SCART

Output for connection to a non-HD television

HDMI

Output for connection to an HD-ready television

USB

Socket for upgrading the receiver's software

REMOTE CONTROL Plaza HD•T2



 Standby - switches the receiver on and off.

 Mute - silences the receiver's sound.

0, 1 ... 9 - buttons to directly select channels and enter numeric values in the set-up menus.

 Switches back to the last channel watched.

 Displays your favourites lists and adds channels to them in the channel list.

MENU Displays the main menu screen.

 Displays channel and programme information.

 Up, down, left, right - move the highlight bar in menus and in the programme guide, and allow you to browse the channels and programmes.

OK Selects the option in a menu.

LIST Displays the channel list.

GUIDE Displays the programme guide.

BACK Exits a menu and returns to the main menu.

EXIT Exits a menu and returns to normal TV viewing.

 Opens YouTube

APPS Open Apps menu.

V ^ Turns the volume up.

V v Turns the volume down.

P ^ P v Switches to the next or previous channel. Moves one page up or down in the channel list and programme guide.

AD Turns on or off audio description.

MODE Switches between available screen display modes.

SUB Turns on or off subtitles.

TEXT Displays interactive and digital text services (where available).



Red, green, yellow, blue
- Chooses options within menus.

2

Preparation

This section explains how to set up your Plaza HD•T2 to receive Freeview channels.

THE AERIAL

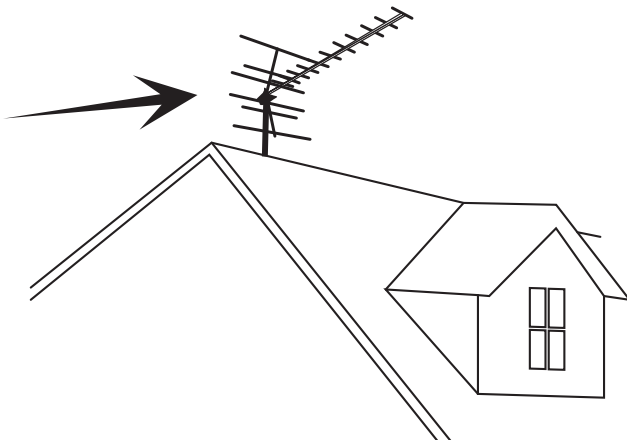

To receive Freeview, you must connect your Plaza HD•T2 receiver to an appropriate TV aerial that has been correctly installed. If your aerial is unable to provide adequate signal, it may need to be realigned. Please consult a professional.

CONNECTING YOUR RECEIVER

Place your Plaza HD•T2 receiver on a firm, level surface close to the television, a mains electricity socket, and the cable from the aerial.

(See Appendix A – Safety.)

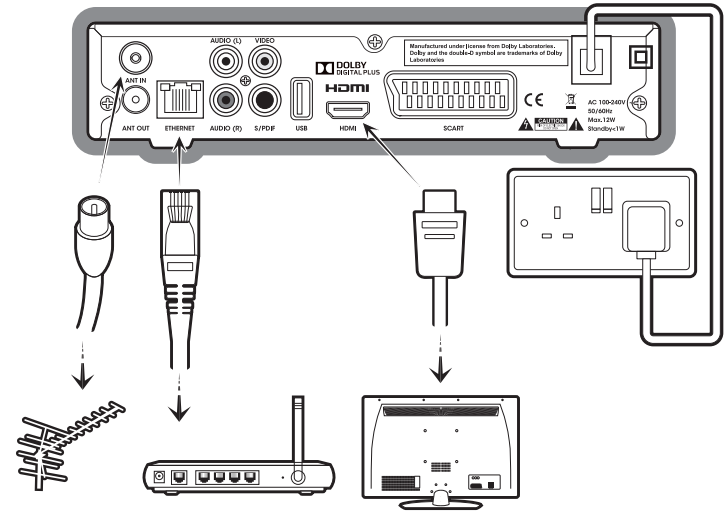

Connect the cable from your aerial to the ANT IN socket at the back of the Plaza HD•T2. If you also want to use your television's internal tuner, you can optionally connect a cable from the ANT OUT socket at the back of the Plaza HD•T2 to the appropriate input on your television. Please note that to conserve energy, by default this output is disabled when the Plaza HD•T2 is in standby. You can enable it in the System section of the Setup menu (please see page 30).

Ensure your television is turned off and connect the HDMI cable supplied between the HDMI socket at the back of your Plaza HD•T2 receiver and an HDMI socket on your television. There may be more than one HDMI socket on your television. If you are not sure which to use, check the television's manual.

HINT: If your television has no HDMI socket, then it must be connected to the receiver by SCART or RCA cable, and you will not be able to watch Freeview channels in high definition.

Plug the power cable from the rear of the Plaza HD•T2 into an available mains socket that is turned off.

You can also connect the Plaza HD•T2 receiver to a stereo or surround sound system, so that you can listen to the TV sound through the sound system instead of (or as well as) the television's speakers. If you connect a coaxial S/PDIF lead (not supplied) between the S/PDIF sockets on your receiver and digital sound system, you can listen to the TV sound in digital audio quality, or even in surround sound, depending on the broadcast and your sound system.

To use apps such as BBC iPlayer or YouTube, the Plaza HD•T2 must be connected to your internet router or hub using an ethernet cable (not supplied). Plug one end of the ethernet cable into the ETHERNET socket at the back of the Plaza HD•T2, and the other into your hub or router. Make sure the connections are fully pushed in - you'll hear a click as they lock into place. Consult your router or hub's documentation for further guidance.

If your receiver is not located near your hub or router, you could use HomePlug powerline adapters to extend your home network using the ring main of your house. Another option is to use a Wireless Ethernet Bridge to bridge the Ethernet socket of the Plaza HD•T2 to Wi-Fi, enabling it to connect wirelessly to your home network. For more information, please consult with your installer or retailer. If you require support for these devices, you will need to contact the manufacturer. The Plaza HD•T2 does not support USB Wi-Fi dongles.

SWITCHING ON

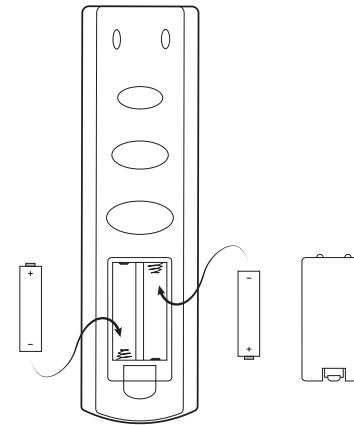

Take off the battery compartment cover from the back of the Plaza HD•T2 remote control by lifting it up while pushing the catch. Insert the two AAA batteries supplied, as shown on the inside of the compartment, and replace the compartment cover.

SWITCHING ON (continued)

Turn on your TV set and choose the HDMI input (see your television's manual for guidance).

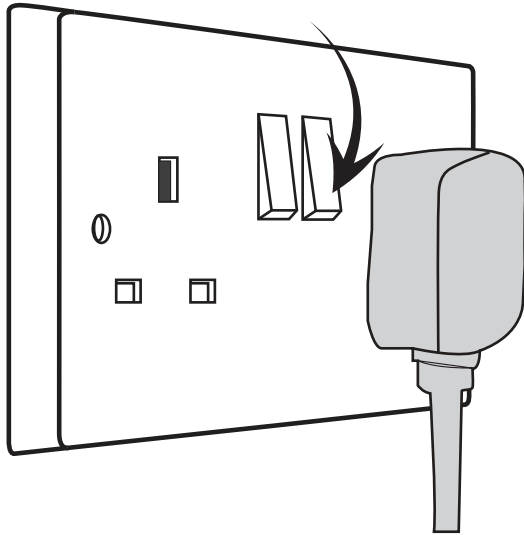

Switch on the mains socket the Plaza HD•T2 is connected to.

After a few seconds, the receiver's first Freeview installation screen shown below will appear on the television screen:

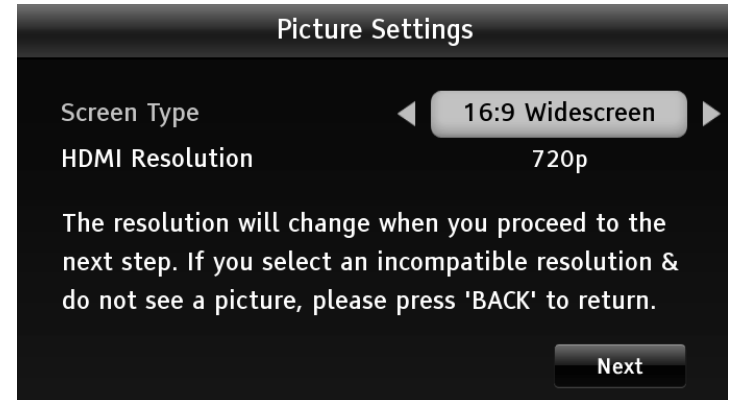

HINT: If you do not see this screen on your television, see 'Troubleshooting' on page 36.

TUNING IN

When the first installation step is displayed, use the **▶** or **◀** buttons to select the screen format of your television (16:9 Widescreen or the squarer 4:3 Traditional). Then press the **▼** button to highlight the HDMI Resolution selection box, and use the **▶** or **◀** buttons to select the correct resolution for your television. Press **▼** to select the "Next" button and then press **OK** to display the next installation step.

HINT: You should set the HDMI resolution to the highest that your television can display (see your television's manual). If in doubt, set the resolution to 720p.



Your Plaza HD•T2 receiver will scan for channels, displaying the total number of TV, radio and data channels found. When the scan is complete, press **OK** to proceed to the next step.

To use the receiver's parental guidance function, locked channels or restore to factory default, you need to create a PIN. Enter your choice of PIN by pressing the required number button **0, 1 ... 9** for each of the four PIN digits, then press **OK** to proceed.

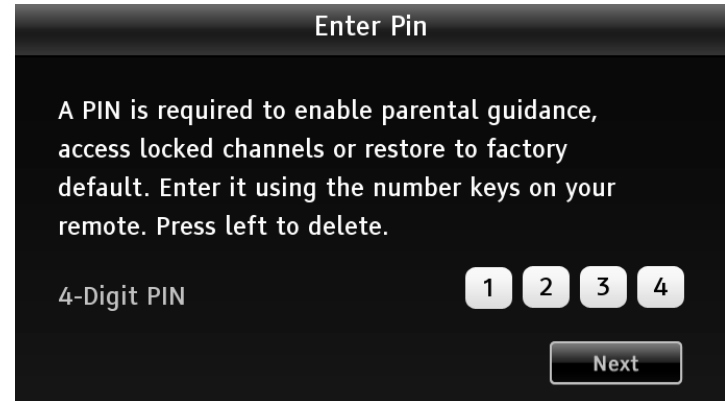





The setup completion screen confirms the lock PIN you have set. Press the **OK** button and your Plaza HD•T2 receiver is now ready for you to watch Freeview digital TV.



3 Everyday Use

This section describes the day-to-day use of your Plaza HD•T2 receiver – how to select the channels that you want to watch, view the programme schedules, and control the basic features.

TURNING ON THE RECEIVER



Press the  button on the remote control or the  button on the front of the receiver. The power light on the front panel changes from red to green when the receiver is powered up.

You can turn off the Plaza HD•T2, so it goes into standby, by pressing the  button on the remote control or the  button on the receiver. When the receiver is in standby, the power light on the front panel turns red. The Plaza HD•T2 uses less power when in standby.

HINT: You should leave the Plaza HD•T2 receiver plugged in with the socket switched on, at all times (except when there is lightning – see Appendix A). When you are not using the receiver, put it in standby by pressing the  button on the remote control or the  button on the front of the receiver.

HINT: To save power, the Plaza HD•T2 receiver will automatically switch to standby if it is not used for a long time. This feature can be disabled – see the Advanced Use section of this guide.

CHANGING CHANNELS

Step through the channels by pressing the **P[^]** or **P^v** buttons on the remote control or the  and  buttons on the front of the Plaza HD•T2 receiver.

If you know the channel's number, you can switch directly to the channel you want by using the number buttons on the remote control. As you enter a channel number, each digit appears at the top left of the screen to show the number button you have pressed.

Press the  button to switch from the channel you are currently watching to the channel you were watching before.

HINT: There are some channel numbers missing in the channel list because spaces are left for future channels to join Freeview.

HINT: If you enter a number that does not exist, the channel will not change.

There are other ways to change channel:

- Use the browsing bar at the bottom of the screen (see below)
- Use the on-screen channel list (see page 17)
- Use the programme guide (see page 18)

CHANGING THE VOLUME

You can increase or decrease the volume by using the **V ^** and **V v** buttons on the remote control. The sound is silenced by pressing the **X** button and restored to its previous level by pressing the **X** button again.

BROWSING BAR

Whenever you change channel, the Plaza HD•T2 briefly displays a browsing bar at the bottom of the screen that contains information about the current channel and programme. You can press the **i** button at anytime to display the bar again.

It shows:

- the name and number of the channel
- the name of the programme you are watching
- the start and finish time of the programme
- the progress through the programme
- the date and time



HINT: You can also display the browsing bar by pressing **^** or **v** on the remote control while you are watching TV.

The information bar may also display symbols to indicate:

- HD** The programme is in High Definition.
- SUB** Subtitles are available.
- AD** Audio Description is available.
- D** Dolby Digital audio is available.
- G** Parental guidance is advised as the programme contains language or scenes that may not be suitable for children (press **i** for further details).
- Y** The channel is locked (see the Advanced Use section).
- HD** An HD version is available on another channel (press **i** for further details).

While the bar is displayed, press the **▶** button to see details of the next programme, and the **◀** button to go back again. To see what is on another channel, press the **▲** or **▼** buttons. To change to this channel, press **OK** while the bar is still displayed. To remove the bar from the screen at anytime, press **EXIT**.

While the browsing bar is displayed, press **i** again to display more information about the selected programme, including a short summary. Pressing the **i** button once more removes the extra information from the screen.

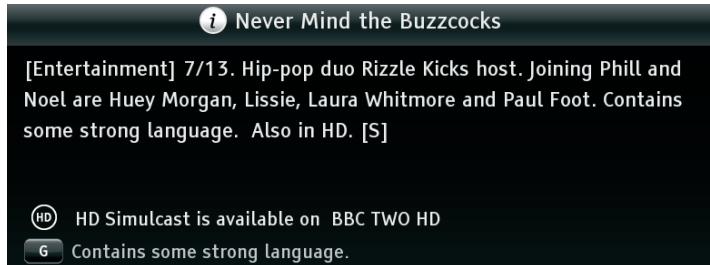

HINT: When the extra programme information is displayed, you can still press **◀** or **▶** to see what is on now or next and **▲** and **▼** to see what is on other channels.

SUBTITLES AND AUDIO DESCRIPTION

Many Freeview programmes are broadcast with subtitles for people who are deaf or hard of hearing. Channels with subtitles available show the **SUB** symbol in the information bar.

To turn on subtitles, press the **SUB** button. If subtitles are available for the current programme, a notification will be displayed showing "Subtitles On". If subtitles are not available for the current programme, the notification will show "Subtitles On but unavailable with this programme". When the next programme you watch has subtitles, they will then be displayed. To turn subtitles off, press the **SUB** button.

Some programmes have an extra soundtrack to tell people who are blind or partially sighted what is happening on screen. Channels with this audio description available show the **AD** symbol in the information bar.

To turn on audio description, press the **AD** button. If audio description is available for the current programme, a notification will be displayed showing "Audio Description On". If audio description is not available for the current programme, the notification will show "Audio Description On but unavailable with this programme". When the next programme you watch has audio description, it will then be heard. To turn audio description off, press the **AD** button.

USING THE CHANNEL LIST

Display the on-screen channel list by pressing the **LIST** button on the remote control. This lists the channels on the left-hand side of the screen, in number order, and displays a preview window of the currently selected channel on the right-hand side of the screen. You can return to watching TV at any time by pressing the **EXIT** button.

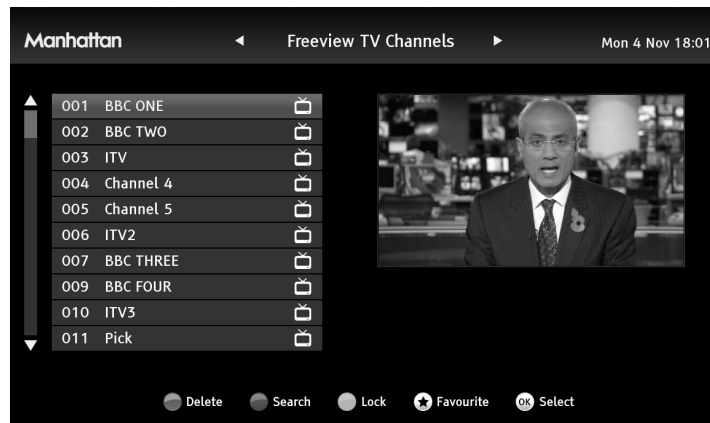

HINT: You can also display the channel list by pressing the **OK** button while watching TV.

Use the **▲** or **▼** buttons on the remote control to highlight a channel then press **OK** to view it in the preview window. Press **OK** again to exit the channel list and watch the channel full-screen.

HINT: Move a page at a time through the channel list by using the **P▲** and **P▼** buttons.

TV, radio and data channels are stored in separate lists. Switch between them by pressing the **◀** or **▶** buttons. The name of the list is displayed at the top of the screen.

SEARCHING FOR A CHANNEL

You can search for a channel by name, or a part of its name. Press the green button while on the channel list screen and enter the word that you want to search for using the on-screen keyboard.

The receiver shows a list of all channels with the search word within their name, for you to choose from in the normal way. You can press **◀** or **▶** to see the search results for the different channel lists. Press **↺** to clear the search.

USING THE PROGRAMME GUIDE



The Plaza HD•T2 guide is used to display details of all programmes on in the week ahead and to open Apps such as BBC iPlayer or YouTube.

Open the guide selection screen by pressing the **GUIDE** button on the remote control. You will see available apps and lists for All, TV, HD, Radio and Data channels as well as any favourites lists that you have created (see p22 for more about favourites lists).

To view the programmes on a channel list or open an App, use **▲**, **▼**, **◀**, **▶** to make your selection and then press **OK**.

HINT: Data channels are interactive channels that may require an Internet connection to function.



HINT: You can skip straight to the programme guide for all channels by pressing the **GUIDE** button a second time.

The programme guide shows a table of the programmes, with each page showing eight channels over a two-hour period

Information on the highlighted programme is shown above the table and you can read a full summary by pressing the **i** button. Press **i** again to remove the summary box.

The current date and time is displayed at the top right of the screen and a red line at the top of the table shows the present time in the schedule.

You look through the scheduled programmes using the **▲** and **▼** buttons to move through the channels and the **◀** and **▶** buttons to highlight programmes showing at different times.

HINT: You can jump through the list more quickly using the **P▲** or **P▼** buttons to move to the next or previous page. The green and red buttons move the highlight bar through the schedule two hours forward or back, and the blue and yellow buttons move a day forward or back.

As you move the highlight bar through the schedule, the programme summary shown above the list changes to reflect the programme highlighted.

Press **OK** to switch the receiver to the channel and programme highlighted. If the programme is on at the time, the receiver will switch to that channel immediately.

HINT: Programmes in standard definition that are also available on another channel in HD are labelled in the schedules with an **HD** symbol. You can see the time and channel that the HD version is broadcast by highlighting the programme and pressing **i**.

If the programme is scheduled for later on, a reminder is set so that when the programme is about to start, a message is displayed on-screen and, after a few seconds, the receiver automatically

switches to the relevant channel. In the programme guide a **🕒** is shown next to a programme with a reminder set.

83 Al Jazeera Eng	Newshour	News Live	The Stream
85 RT	SophieCo	Headline News	Cross Talk
87 COMMUNITY	Broadcasting 2am-8am and 24-hours on...		
101 BBC ONE HD	This Is BBC One HD	🕒 The One Show	Caught Red Handed
102 BBC TWO HD	Strictly Come Dan...	Celebrity Antiques Road Trip	
103 ITV HD	ITV News & Weat...	Emmerdale	Coronation Street

● -2 Hrs ● +2 Hrs ● -24 Hrs ● +24 Hrs 🕒 Reminders ⓘ In

You can see a list of all the programmes with reminders set by pressing the **🕒** button, and you can cancel a reminder by highlighting it and pressing the red button. Pressing **🕒** again or **BACK** leaves the reminder list and returns to the programme guide. You can also cancel a reminder by highlighting the programme in the programme guide and pressing **OK** again.

You can set as many reminders as you want but if you try to set a reminder on one channel for the same time as one you have already set on another channel, a warning is displayed on the screen.

You leave the programme guide and return to watching TV by pressing **BACK** or **EXIT** button.

HINT: If you have set a reminder for a program that comes on whilst you are using an App, the Plaza HD-T2 will exit the App and switch to that program automatically.

USING APPS

Your Plaza HD•T2 must have a working internet connection to use Apps (see pages 10 & 11 for how to connect the Plaza HD•T2 to your network). YouTube can be opened at anytime by pressing the **YouTube** button on the remote control. To open other Apps, press the **APPS** or **GUIDE** button, highlight the App you want to open and press **OK**. To exit an App, press the **EXIT** button.

Apps, even those from the same provider such as the BBC, all work slightly differently, and can be updated and changed by the provider at any time. Section 7 "Use Apps" of the Quick Start Guide has some basic help for iPlayer and YouTube that is correct at the time of printing. For further assistance, please visit our website (www.manhattan-tv.com) or the provider of the App.

A great feature of YouTube on the Plaza HD•T2 is that it can be controlled by the YouTube App on your smartphone or tablet. When using the YouTube App on a device that is connected to the same network as the Plaza HD•T2, the "Send to TV" icon will be displayed.



"Send to TV" icon

If you tap this icon, videos will playback via the Plaza HD•T2 on your TV instead of your device and you can use the video controls on your device to play, pause, stop or seek within the video. Please note that if using an iPhone, you may need to install YouTube first from the App Store.

INTERACTIVE TV SERVICES

Several Freeview channels broadcast a range of digital text and interactive services, such as news, weather, games, sports information and video, alongside normal TV. If interactive services are available, they will be indicated by an on-screen prompt - usually a red button in the top right-hand corner of the screen.

You can use the interactive options by pressing **TEXT** or the red button while watching the TV channel. This will display a menu of the services available.

When you have finished with the interactive services, return to watching normal TV by pressing **TEXT** again or the **EXIT** button.



4 Advanced Use

This section explains how to get the most out of your Plaza HD•T2 receiver.

USING THE FAVOURITES LISTS

The favourites lists make it easier for you to choose the channel that you want to watch, by limiting the on-screen list to just a few channels, such as those of a particular type, or that one member of the family watches the most.

The Plaza HD•T2 provides five favourites lists, and it only takes a short time to set up the lists before they can be used. First, display the channel list, by pressing the **LIST** button.

Highlight the channel that you want to include in a favourites list, and press the **★** button to show the five lists available. Highlight the list that you want to include the channel in and press **★** to add the channel to that list (a star will appear next to it). You can add a channel to as many lists as you like. Channels can be removed from favourites lists by highlighting a list and pressing the **★** button again. Press **OK** to store the changes to the lists, or press **BACK** to cancel.

You can rename the favourites lists to suit their contents (for example, the type of channels in the list, or the name of person who has chosen them). With the list highlighted, press the red button and enter the name that you want for that list using the on-screen keyboard.

Once favourites lists have had channels assigned to them, they can be used in three ways.

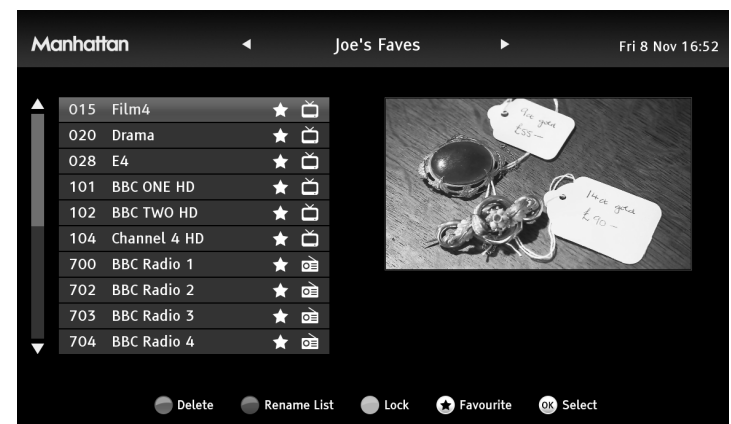
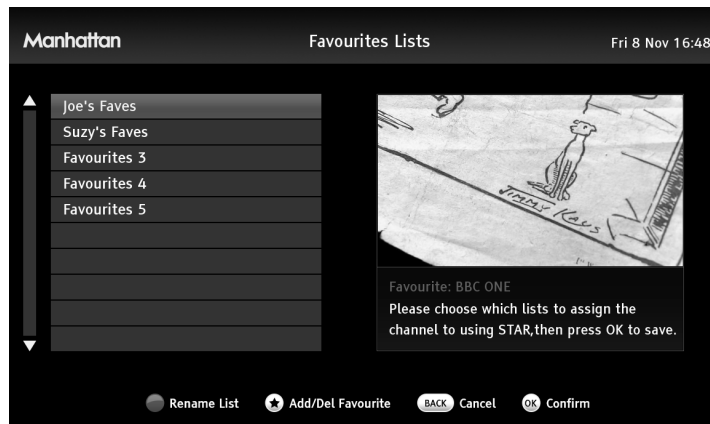

1. In the channel list, favourites lists can be selected in the same way as the Freeview TV, radio and data channel lists, by pressing the **◀** or **▶** buttons. Press **OK** to view a selected channel, **★** to change the favourites lists it is assigned to, or PIN lock it by pressing the yellow button. Red deletes the selected channel from the current favourites list and green renames the current list.
2. During normal TV viewing, you can quickly choose a channel from the favourites lists by pressing the **★** button. Use **◀** or **▶** to switch to the other lists, highlight the channel you want to watch, then press **OK**.



3. The programme guide can be filtered to only display the channels on a favourites list. Press **GUIDE** then highlight the list you want to choose, and press **OK**. Press **BACK** from the guide to choose a different list.



HINT: The channels in a favourites list appear in the same order as in the normal channel list, regardless of the order you added them.

THE LOCK PIN

Some of the Plaza HD•T2's menu functions can be locked to avoid accidental changes to the receiver's setup, and you can lock particular channels to prevent some family members, such as children, from watching them.

To use a locked menu function or watch a locked channel, you need to enter the four-digit PIN that you set when you first installed the Plaza HD•T2. You can change the lock PIN, without re-installing the receiver, as explained later in this section.

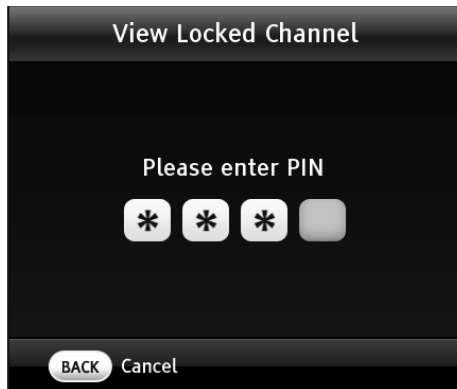

DISPLAY MODE

Most Freeview programmes are broadcast using a widescreen 16:9 format, designed for a widescreen TV. If you watch a widescreen broadcast on a squarer 4:3 television, or a 4:3 broadcast on a widescreen TV, the Plaza HD•T2 provides a choice of how the image is displayed. Pressing the **MODE** button will take you through the three available options.

If you have set up your receiver for a 16:9 Widescreen TV, the options are:

- Auto - the broadcaster chooses the best display format.
- Widescreen - a 4:3 broadcast is stretched to fill the 16:9 screen.
- Pillarbox - a 4:3 broadcast is shown unaltered with black bars on each side.

If you have set up your receiver for a 4:3 Traditional TV, the options are:

- Auto - the broadcaster chooses the best display format.
- Centre Cut-out - a 16:9 broadcast is cropped to show only the centre of the image.
- Letterbox - a 16:9 broadcast is shown unaltered with black bars above and below it.

CHANGING THE CHANNEL LIST

The channel list contains all the Freeview channels that the Plaza HD•T2 found when it was first installed, and may include some channels that you do not watch, do not want to include in the on-screen list, or do not want some members of your family to watch.

If you want to alter the channel list, first press the **LIST** button to display the channel list screen. To remove a channel, highlight it and press the red button to delete the channel. You need to confirm your choice to ensure you don't delete a channel accidentally.



You can lock a channel to prevent it being selected for viewing without first entering the lock PIN. Highlight the channel and press the yellow button to lock it. A padlock symbol is shown next to all locked channels in the channel list.

HINT: If you want to unlock a channel that you have locked before, highlight it in the channel list and press the yellow button. You will need to enter the PIN to complete the process.

USING THE SETUP MENUS

You display the Plaza HD•T2's setup menu by pressing the **MENU** button on the remote control. This shows the five sections in a bar across the top of the screen with the first section highlighted in red. The menu options for the highlighted section are listed below, along with a picture representing that section.

You can choose between the menu sections by pressing the **<** or **>** buttons to move the highlight along the section bar. You choose an option within the section shown by pressing the **▼** button to move the highlight bar through the option list. Some of the selections available from different menu sections are for advanced use of the Plaza HD•T2. We recommended that you take the time to read this section carefully before you make any changes.

GENERAL MENU SECTION

Highlight the option you want to alter using the **▲** and **▼** buttons. When you have finished making the changes you want, leave the menu system by pressing **BACK** or **EXIT**.

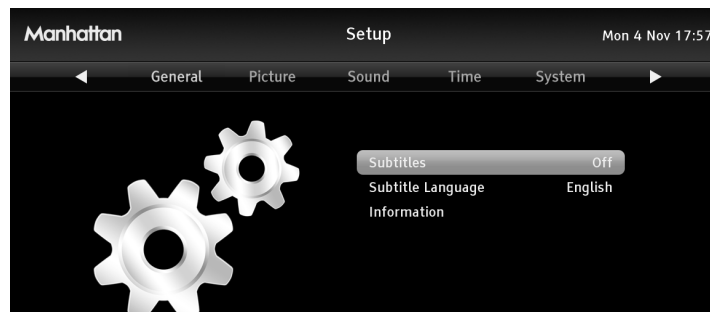

SUBTITLES

Press **OK** to switch on subtitles for all programmes that provide them. Switch subtitles off by pressing **OK** again.

You can toggle this setting quickly by pressing **AD** whilst watching TV.

SUBTITLE LANGUAGE

Programmes can be broadcast with subtitles available in a number of languages. The Plaza HD•T2 is set to English subtitles, but you can change this setting by pressing **OK** to show the subtitle language menu.

Use **▲** and **▼** to highlight the language you want for subtitles (if available) and press **OK**.

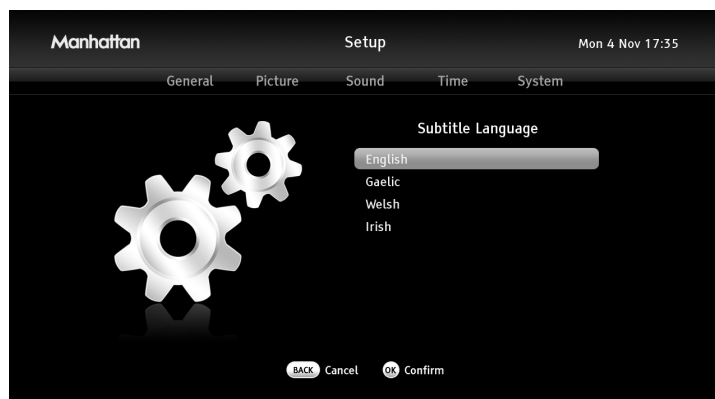

INFORMATION

Press **OK** to show technical information about your receiver, including the Helpline phone number, signal strength and quality readings.

HINT: We recommend that you have this screen displayed on your TV if you need to phone the Plaza HD•T2 helpline.



PICTURE MENU SECTION

Highlight the option you want to alter using the **▲** and **▼** buttons. When you have finished making the changes you want, leave the menu system by pressing **BACK** or **EXIT**.

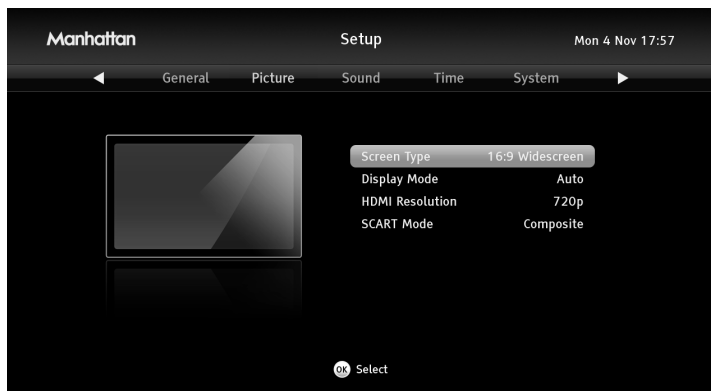

SCREEN TYPE

Press **OK** to show the screen type menu and use the **▲** and **▼** buttons to choose between 16:9 Widescreen and 4:3 Traditional. Press **OK** to confirm your choice.

HINT: This setting overrides the screen type you selected when you first installed the receiver.

DISPLAY MODE

Press **OK** to show the display mode menu and use the **▲** and **▼** buttons to choose between Auto, Centre Cut-Out, and Letterbox, if the screen type is set to 4:3 Traditional, or between Auto, Widescreen, and Pillarbox if the screen type is set to 16:9 Widescreen. Press **OK** to confirm your choice. See Advanced Use - Display Mode (page 23) for more information.

26

HINT: This menu option has the same effect as the **MODE** button.

HDMI RESOLUTION

Press **OK** to show the HDMI resolution menu and use the **▲** and **▼** buttons to choose the correct resolution for your TV. You should set the HDMI resolution to the highest that your television can display (see your television's manual). If in doubt, set the resolution to 720p. Press **OK** to confirm your choice.

HINT: If you set an incompatible resolution or move your receiver to a different TV that doesn't support the active resolution, ensure the receiver is turned on and then press and hold the **MODE** button for 10 seconds. The resolution will be changed to 720p, which is supported by all HD televisions.

SCART MODE

Press **OK** to show the SCART mode menu and use the **▲** and **▼** buttons to choose between Composite and RGB for the correct output for a television connected to the receiver's TV SCART output. Press **OK** to confirm your choice.

HINT: The RGB setting will usually produce the best quality SCART picture but a few televisions cannot accept this signal (see your TV manual). This setting has no effect on the receiver's HDMI output.

SOUND MENU SECTION

Highlight the option you want to alter using the **▲** and **▼** buttons. When you have finished making the changes you want, leave the menu system by pressing **BACK** or **EXIT**.

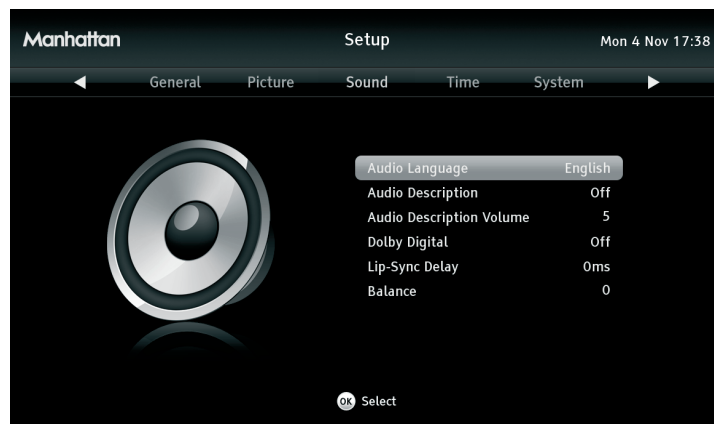

AUDIO LANGUAGE

The Freeview channels can broadcast in a number of languages. The Plaza HD•T2 is set to the English, but you can change this setting by pressing **OK** to show the audio language menu.

Use **▲** and **▼** to move the red highlight bar to the language you want for the soundtrack and press **OK**.

AUDIO DESCRIPTION

Press **OK** to switch on audio description for all programmes that provide it. Switch audio description off by pressing **OK** again.

You can toggle this setting quickly by pressing **AD** whilst watching TV.

AUDIO DESCRIPTION VOLUME

Press **OK** to show the audio description volume menu on top of the normal TV picture, then use the **◀** and **▶** buttons to adjust the volume of Audio Description in relation to the main audio track. Press **OK** to confirm your choice and return to the sound menu.

DOLBY DIGITAL

Press **OK** to switch on the Dolby Digital surround sound output from the S/PDIF and HDMI sockets, for all programmes that provide it (channels with Dolby Digital sound available show the **DD** symbol in the information bar). Switch off Dolby Digital by pressing **OK** again. Only turn this on if you have connected your Plaza HD•T2 to a product that supports Dolby Digital.

Warning! If you switch Dolby Digital on and your TV or sound system does not support it, you will not hear any audio on HD channels.

HINT: The volume level of Dolby Digital is fixed, therefore you cannot use the volume control buttons when you watch programming with Dolby Digital.

SOUND MENU SECTION (continued)

LIP-SYNC DELAY

If you are using the S/PDIF output with a sound system and find the sound and picture falling out of sync, you can delay the sound output by a small amount to compensate.

Press **OK** to show the lip-sync delay menu on top of the normal TV picture, then use the **◀** and **▶** buttons to adjust the amount of audio delay in 10ms steps from 0-250ms. Press **OK** to confirm your choice and return to the sound menu.

BALANCE

You can alter the volume balance between the left and right stereo sound outputs by pressing **OK** to show the balance menu and using the **◀** or **▶** buttons to alter the balance in favour of the right side (positive) or left side (negative). Press **OK** to confirm the setting.

TIME MENU SECTION

Highlight the option you want to alter using the **▲** and **▼** buttons. When you have finished making the changes you want, leave the menu system by pressing **BACK** or **EXIT**.



AUTO STANDBY

To conserve power, the Plaza HD•T2 will switch to standby after three hours if no buttons are pressed on the remote control or front panel. The Auto standby function is normally turned on, and can be turned off by pressing the **OK** button.

SLEEP TIMER

Press **OK** to show the sleep timer menu and use the **▲** and **▼** buttons to choose a time up to 90 minutes after which the receiver automatically switches itself to standby. Press **OK** to confirm your choice.

AUTO TURN ON

You can set the Plaza HD•T2 to switch on automatically at a particular time. Press **OK** to show the auto turn on menu and use the **◀** or **▶** buttons to set the timer to turn the receiver on once, every day, each week, on weekdays, weekends, or particular days of the week. Then use the **▲** and **▼** buttons, along with the **◀**, **▶** and the number buttons to set the switch-on time, the channel source (Freeview TV or radio), the channel number and the sound volume. Press **OK** to confirm.

AUTO TURN OFF

You can set the receiver to switch off automatically at a particular time. Press **OK** to show the auto turn off menu and use the **◀** or **▶** buttons to set the timer to turn the receiver off once, every day, each week, on weekdays, weekends, or particular days of the week. Then use the **▲** and **▼** buttons, along with the **◀**, **▶** and number buttons to set the switch-off time. Press **OK** to confirm.

SYSTEM MENU SECTION

Highlight the option you want to alter using the **▲** and **▼** buttons. When you have finished making the changes you want, leave the menu system by pressing **BACK** or **EXIT**.

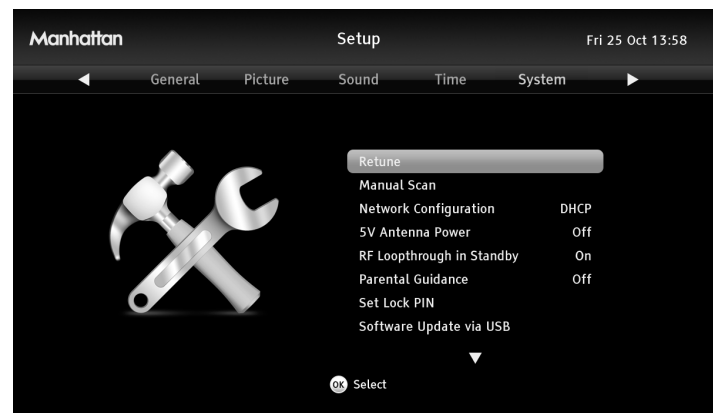

RETUNE

Press **OK** to retune all the Freeview channels. If you retune Freeview, you will lose all channels from the favourites lists (but not the lists' names), remove any channel locks you have set, and restore channels deleted from the channel list.

MANUAL SCAN

During installation or retune, the Plaza HD•T2 scans the entire TV spectrum for channels, which can take a while. The Manual Scan functionality is much quicker as it scans only a specific part of the spectrum.

SYSTEM MENU SECTION (continued)

Press **OK** to display the Manual Scan menu. Enter the UHF channel (21 - 68), frequency (474Mhz - 850Mhz) and bandwidth (7MHz or 8MHz) to be scanned. You can use the number buttons (0-9) to enter the channel and frequency, or use **◀** and **▶** to enter the channel, frequency and bandwidth. When ready, press **OK** to start scanning.

The Plaza HD•T2 will take a few seconds to complete the scan. Whilst scanning, it displays the services found so far, and when finished a list of all services found.

You can view a service from this list by highlighting it and then pressing the **OK** button. Channels that are not part of the default Freeview channel list for your region are added at the end of the main Freeview lists in the 800-range.

Please note that when browsing channels in the EPG that are on a different platform (e.g. Saorview in Ireland), you may find that programme data is unavailable, or unavailable until you select a channel from that platform.

NETWORK CONFIGURATION

See the Connecting to Your Network section (page 32) for full details on how to set up your Plaza HD-T2 to use Apps.

5V ANTENNA POWER

Some antennas that are installed with a signal amplifier need a power supply from the receiver because they do not have their own. If you have connected such a signal amplifier, the Plaza HD•T2 can supply it with a +5V DC supply. Press **OK** to turn this on or off.

HINT: Almost all normal aerial installations will not require this to be turned on. Only do so if instructed to by your aerial's user guide or your installer.

RF LOOPTHROUGH IN STANDBY

The ANT OUT output on the back of the Plaza HD•T2 is disabled in standby by default to reduce energy consumption. This means that if you have connected your TV to this output, it will not be able to get reception when the Plaza HD•T2 in standby. Press **OK** to turn on or off RF Loopthrough in Standby.

PARENTAL GUIDANCE

Press **OK** to turn on or off the parental guidance lock. This prevents watching any programme broadcast with a **G** parental guidance warning, or displaying the system menu, without first entering the lock PIN.

SET LOCK PIN

Press **OK** to show the set lock PIN menu. Change your PIN by first entering your current PIN and then entering and confirming your choice of new PIN.

SOFTWARE UPDATE VIA OAD

Press **OK** to turn on or off the automatic software update.

OAD SOFTWARE MANUAL SCAN

Press **OK** to immediately search for new software to download.

SOFTWARE UPDATE VIA USB

Press **OK** to load new software for the receiver from a storage device connected to the USB socket on the back of the receiver. The device must be formatted with the FAT32 file system. Please refer to the documentation from your operating system for more information.

We recommended you use a USB stick as many Hard Disks require more power than a single USB socket can provide. If using such a hard disk, please ensure it has an external power supply.

RESTORE FACTORY DEFAULT

Press **OK** to revert all the receiver settings to what they were when you first got your receiver and to start the installation procedure described in the Preparation section of this guide.

You must enter the lock PIN, and then confirm in another menu, to start the process because it will delete all channels, favourite channels, favourite channel list names, and the receiver configuration.

5 Connecting To Your Network

This section explains how to set up the Plaza HD•T2 to use Apps such as BBC iPlayer and YouTube. You must have a broadband Internet connection with a minimum sustained speed of 3Mbps for HD content.

AUTOMATIC (DHCP)

Ensure the ETHERNET socket at the back of the Plaza HD•T2 is connected to your router or hub. See the Connecting your receiver section (page 10) for more information.

HINT: If the receiver has made a connection with your modem or home network, one or both of the small green and orange lights immediately above the RJ-45 socket will light and/or flicker.

You can check that the receiver has successfully connected to the Internet from the information menu. Press **MENU** to display the General menu and use the **▼** button to highlight the “Information” option, then press **OK**.

If the IP address item shows a number in four sections separated by dots, then the receiver is connected to your local network. If online services still do not work, you should check your router’s connection to the internet. If “Not Connected” is shown, you should carefully check the broadband connection and the Network Configuration.

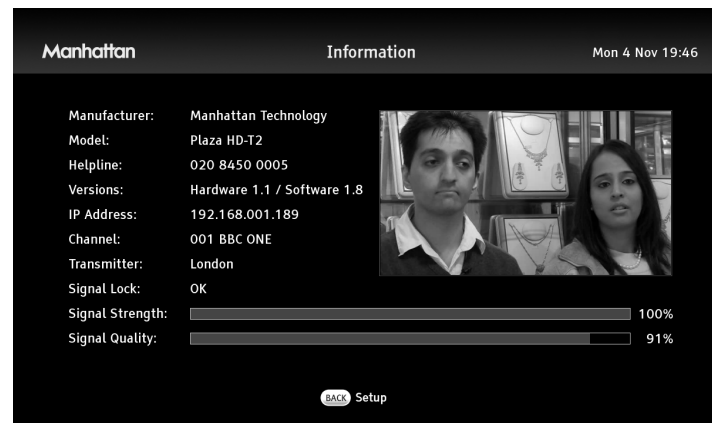

Press the **MENU** button on the remote control and then press **◀** to display the System menu. You should check that the Network Configuration menu option shows “DHCP” to automatically configure the network connection.

HINT: Consult the manual or supplier for your modem/ router or network for help choosing the correct addresses.

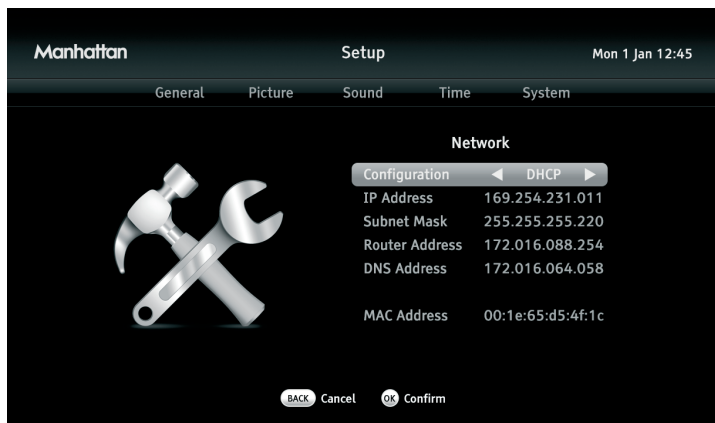

MANUAL (STATIC)

If your broadband modem/router is not compatible with DHCP (Dynamic Host Configuration Protocol), or you wish to manually configure the Network Configuration and IP address, press **OK** to select the Network Configuration option.

Use the **<** or **>** buttons to change the configuration to "Static" and for each of the addresses in turn (IP Address, Subnet Mask, Router Address, and DNS Address) press **▼** to highlight the address and then the red button to edit the address.

Highlight each of the four "octets" that is to be changed, enter the number required using the number buttons, and press **OK** to confirm that address. When all four addresses have been set correctly, press **OK** to set the configuration and return to the system menu page.

Appendix A – Safety

POWER

Your receiver requires a 100V to 240V AC ~ 50Hz mains supply and is fitted with a moulded plug. The mains plug is used as the disconnect device and shall remain readily operable. The USB port maximum load is 500mA under normal operation.

The rating label is located on the bottom surface of the receiver.

CABLES

Make sure all cables are positioned so they are not likely to be walked on, crushed or damaged by things placed on or against them. Pay particular attention to the power cable where it goes into the socket and where it comes out of the receiver. Do not connect or adjust cables to the receiver when it is plugged in.

TEMPERATURE AND MOISTURE

Use the apparatus only in moderate climates (not in tropical climates). Do not allow it to get wet as this is dangerous. Do not expose the apparatus to dripping or splashing. Do not place objects filled with liquids, such as vases, on the apparatus.

HEAT AND FLAMES

Do not place the apparatus near to naked flames or sources of intense heat, such as an electric fire. Do not place naked flame sources, such as lighted candles on the apparatus. Batteries shall not be exposed to excessive heat such as sunshine, fire or the like.

VENTILATION

Slots and openings in the receiver's cover are for ventilation. Ensure a minimum distance of 5cm around the apparatus for sufficient ventilation. Ensure the ventilation is not impeded by covering the ventilation opening with items such as newspapers, table-cloths, curtains, etc. Failure to follow these instructions could lead to the receiver overheating.

CLEANING

Unplug the receiver before you clean it with a lightly dampened cloth. Do not use liquid or aerosol cleaners.

LIGHTNING

If there is a storm or lightning, unplug the receiver.

SERVICING

Make sure that anyone who services your receiver is qualified to do so. Do not remove the cover yourself – you could get an electric shock.

REPLACEMENT PARTS

If your receiver needs repairing, make sure the person carrying out the repair uses parts which are specified by us or which have the same specifications as the original part. Other parts may cause a fire, electric shock or other dangers.

ELECTRICAL SAFETY

Your receiver requires a 100V to 240V AC ~ 50/60Hz mains supply and is fitted with a moulded plug. If the plug breaks or becomes damaged do not use it. If you change the fuse in the plug ensure you refit the fuse cover. If the plug requires replacement please follow these instructions. The wires in the mains lead are coloured in accordance with the following code:

BLUE - Neutral
BROWN - Live

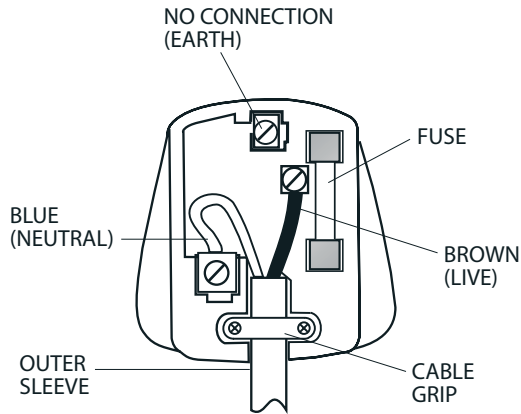





As the colours in the mains lead of this appliance may not correspond with the coloured markings identifying the terminals in your plug, proceed as follows:

The wire which is coloured blue or black must be connected to the terminal which is marked with the letter N or coloured Black. The wire which is coloured brown or red must be connected to the terminal which is marked with the letter L or coloured Red. No connection is to be made to the Earth terminal of the plug as this product is double insulated.

If a 13 Amp (BS1363) Plug is used, fit an ASTA approved (BS1362) 3 Amp fuse only. Your product is fitted with a moulded plug. If it requires replacement please cut off and dispose of safely, then rewire as shown opposite.

SYMBOLS

SYMBOLS	EXPLANATION
	Class II equipment
	AC voltage
	DC voltage
	This lightning flash with arrowhead symbol within an equilateral triangle is intended to alert the user to the presence of non-insulated “dangerous voltage” within the product’s enclosure that may be of sufficient magnitude to constitute a risk of electric shock.
	The exclamation point within an equilateral triangle is intended to alert the user to the presence of important operating and maintenance instructions in the literature accompanying the appliance.

PROTECTING THE ENVIRONMENT



If you one day find that your receiver or remote control needs replacing, or are of no further use to you, do not throw them out with your household waste. Under the Waste Electrical and Electronic Equipment (WEEE) regulations, your local council must provide a suitable recycling centre.



Do not throw batteries in the bin or on a fire. Make sure that you dispose of batteries safely at a local recycling centre. You can also recycle batteries at many supermarkets.

Appendix B – Troubleshooting

PROBLEM	POSSIBLE CAUSE	WHAT TO DO
Power light off	Power supply cable disconnected.	Check the power supply cable.
No set up screen	Receiver not switched on.	Check the mains power cable is plugged in and mains socket is turned on. Turn on receiver.
	HDMI/SCART cable disconnected.	Check HDMI/SCART cable connection to receiver and television.
	Television not switched to HDMI/SCART input.	Select television's HDMI/SCART input.
'Signal lock failed' or 'No signal' message	Cable from your aerial is disconnected.	Check the cable connections from your aerial. Consult a professional if necessary.
	Inadequate signal.	Reinstall or re-align your TV aerial. Consult your installer if necessary.
No channels were found when searching for channels, some channels are missing	Inadequate signal.	Your signal may be weak. Get a professional to check your installation; your aerial may provide a better signal if it is realigned or moved somewhere else. Please remember that older aerials and indoor aerials aren't as effective as new outdoor and roof aerials. As a last resort, try using a signal amplifier or booster to improve reception.
	Some TV channels are not available in every area.	Use the postcode checker on www.freeview.co.uk .
Full picture not visible	Mismatched screen format or that is how the programme is being broadcast.	Using the Picture menu, choose the correct screen type and display mode to suit your TV (see page 25).

PROBLEM	POSSIBLE CAUSE	WHAT TO DO
No picture or sound	HDMI/SCART cable disconnected.	Check HDMI/SCART cable connections at receiver and television.
	Television not switched to HDMI/SCART input.	Select television's HDMI/SCART input.
No picture via HDMI	Selected an incompatible HDMI resolution – many TVs don't support 1080p or 1080i, but only 720p.	Whilst the receiver is on, press and hold the MODE button for 10 seconds and the resolution will be changed to 720p.
The picture and sound keeps breaking up	Inadequate signal.	Your signal may be weak. Get a professional to check your installation; your aerial may provide a better signal if it is realigned or moved somewhere else. Please remember that older aerials and indoor aerials aren't as effective as new outdoor and roof aerials. As a last resort, try using a signal amplifier or booster to improve reception.
Channels are not working after I moved the Plaza HD•T2 to a different house	The house is in a different Freeview area and needs to be retuned.	Follow the retuning steps on p29.
Cannot view a channel	Wrong channel number used.	Choose the channel from Channel List.
	Channel locked.	Enter your PIN. If you have forgotten it, please contact us for the master PIN.

Appendix B – Troubleshooting (continued)

PROBLEM	POSSIBLE CAUSE	WHAT TO DO
TV picture not HD	Tuned to an SD channel.	Tune to an HD channel.
	TV not capable of HD.	Connect the receiver to an HD-Ready TV.
	TV connected by SCART.	Connect the TV with the HDMI lead.
No response with remote control	Receiver in standby.	Switch on the receiver.
	Remote control not aimed at the receiver correctly.	Aim the remote control at the receiver.
	Remote sensor on the front of the receiver is obstructed.	Check for obstructions in front of the receiver.
Receiver switches off after 3 Hrs	Auto Standby is on.	Turn off the Auto Standby in the Time menu.
No information for a channel in the programme guide	Information on the channel not downloaded.	Wait for the download.
No digital text or interactive services	Services not available on chosen channel.	Switch to a channel broadcasting interactive services.
Apps don't open	No connection to Internet.	Check broadband connection and network configuration in system menu.
Can't access System menu	You have forgotten your PIN.	Please contact us for the Master PIN.

Appendix C – Specifications

Tuner	Standard	DVB T / T2
	Input frequency	474~858 MHz
	Signal input level	-65dBm to -20 dBm
	Input connector	IEC 169-2 Female (PAL)
	Loop out connector	IEC 169-2 Male (PAL)
Video	HDMI output	Resolution 576i / 576p / 720p / 1080i /1080p
	SCART output	CVBS/RGB
	RCA output	CVBS
	Aspect ratio	4:3, 16:9 & Letterbox
Audio	SCART & RCA	Audio left and right
	Co-Axial S/PDIF output	Dolby Digital, Dolby Digital + & PCM
USB	Host	2.0 (5V@500mA max). For software upgrade only.
Internet Connectivity	Ethernet	RJ-45 10/100 Base-T
Power Requirements	Mains input voltage	100-240V AC~ 50/60Hz
	Power consumption	Max 12W (Standby Less than 0.5W)
Dimensions	Width x Depth x Height	210mm x 137mm x 41mm
Weight	Receiver only	550 grams

Appendix D - Guarantee & Legal

GUARANTEE

The product is guaranteed for 12 months from the date of original purchase. If there's any defect due to faulty materials or workmanship, please contact us and have your receipt of purchase available for reference. The guarantee is subject to the following provisions:

- It is only valid within the boundaries of the country of purchase.
- The product must be correctly installed and operated in accordance with the instructions contained in this user guide.
- The guarantee will be rendered invalid if the digital box is re-sold or has been damaged by inexpert repair.
- The manufacturer disclaims any liability for incidental or consequential damages.
- This guarantee is in addition to, and does not diminish, your statutory or legal rights.

DISCLAIMER

This product includes third party online services ("Apps") such as iPlayer and YouTube. To enjoy these services you may need to create an account with the third party service or use additional equipment and membership fees may apply. Your use of these services, and the content made available through them, will be governed by the third party provider's terms and conditions and privacy policy, so please make sure that you read them.

As we have no control over these services nor your Internet access, we cannot guarantee the availability of such services nor that your access to, or use of, such services will be uninterrupted or problem-free. We are neither responsible nor liable for any customer service or support relating to these third party services and any enquires should be made directly to the respective third party service providers.

Sometimes, these third parties may make changes to their Internet-based services which may require updates to the software installed in your product. Although we will make every effort to make these updates available during the life-cycle of this product, we may do so in a number of different ways e.g. they may be initiated automatically or require download from our website and manual installation by you.

EXCLUSIONS

In view of the above, there are certain things for which we exclude our liability and certain things for which we do not, as explained below.

We do not exclude or limit our liability for any of the following:

- death or personal injury caused by our negligence, fraud or fraudulent misrepresentation;
- defective products under the Consumer Protection Act 1987; or
- any other matter for which it would be illegal or unlawful for us to limit, exclude or attempt to exclude our liability.

What we do exclude:

Except as set out in the preceding paragraph, we exclude all liability for any losses, whether in contract or tort, for any direct, indirect, incidental, special or consequential damages (including any legal fees and expenses you incur and for any lost data, opportunity, goodwill, revenue or profits) or any other damages arising out of or in connection with:

- any information or data contained in the product;
- the use of the product; or
- any content or service accessed by you or any third party.

In view of the services which are outside our control as explained above, in particular we exclude all liability for any losses that you may suffer arising from any of the following:

- the availability (or unavailability), speed and quality of the Internet connection to your product;
- the availability (or unavailability), suspension, removal or termination of any third party content or service including of the language or the features supported by that service; and
- any change to third party content or services (including any associated APIs) that affects the functionality of the software installed in the product (e.g. Apps).

YOUR PRIVACY

We do not collect or process any of your personal data using this product nor do we store or access any 'cookies' on its hard drive. However, the third party services that you access using this product may collect, store and process personal information about you and may also use features such as cookies. Cookies are small data files sent to your product from a web server that are stored on your product's hard drive and can be read by the third party services that you access using the product.

We strongly recommend that you read the privacy and cookie policy of each service that you use as it will apply to the personal information collected and the cookies stored and accessed when you use those services through this product. The policies will also include details of the purposes for which your personal information and any cookies are used by the provider of the third party service you access.

Manhattan



For assistance, please call the
Manhattan helpline on

020 8450 0005

or visit our website at

www.manhattan-tv.com