



KONICA MINOLTA

bizhub 4020

User's Guide

2013. 8

A6WD-9560-00A

Contents

1—Safety information.....	7
2—Learning about the printer	11
Finding information about the printer	11
Selecting a location for the printer	12
Printer configurations	13
Understanding the basic functions of the scanner.....	14
Using the ADF and scanner glass	15
3—Understanding the printer control panel	16
Using the printer control panel.....	16
Understanding the colors of the indicator and Sleep button lights	17
Understanding the home screen.....	17
Using the touch-screen buttons	19
4—Setting up and using the home screen applications.....	21
Finding the IP address of the computer.....	21
Finding the IP address of the printer	22
Accessing the Embedded Web Server	22
Customizing the home screen	22
Understanding the different applications	23
Activating the home screen applications	24
Exporting and importing a configuration	27
5—Additional printer setup.....	29
Installing internal options	29
Installing hardware options	44
Setting up the printer software.....	48
Attaching cables	50
Networking.....	51
Verifying printer setup.....	59

User's Guide

6—Loading paper and specialty media..... 61

- Setting the paper size and type 61
- Configuring Universal paper settings..... 61
- Loading trays 61
- Loading the multipurpose feeder 66
- Linking and unlinking trays 70

7—Paper and specialty media guide 74

- Using specialty media 74
- Paper guidelines 76
- Supported paper sizes, types, and weights 79

8—Printing..... 83

- Printing forms and a document..... 83
- Printing from a flash drive 84
- Printing confidential and other held jobs..... 86
- Printing information pages 89
- Canceling a print job 89

9—Copying 91

- Making copies 91
- Copying photos 92
- Copying on specialty media 93
- Customizing copy settings 94
- Placing information on copies 99
- Canceling a copy job 100
- Understanding the copy options 100

10—E-mailing..... 105

- Setting up the printer to e-mail..... 105
- Creating an e-mail shortcut..... 106
- E-mailing a document 107
- Customizing e-mail settings 108
- Canceling an e-mail 109

User's Guide

Understanding the e-mail options.....	110
11—Faxing.....	113
Setting up the printer to fax.....	113
Sending a fax.....	125
Creating shortcuts.....	128
Customizing fax settings.....	129
Canceling an outgoing fax.....	130
Holding and forwarding faxes.....	131
Understanding the fax options.....	132
12—Scanning.....	135
Using Scan to Network.....	135
Scanning to an FTP address.....	136
Scanning to a computer or flash drive.....	138
Understanding the scan options.....	141
13—Understanding the printer menus.....	144
Menus list.....	144
Paper menu.....	145
Reports Menu.....	158
Network/Ports menu.....	159
Security menu.....	171
Settings menu.....	176
14—Saving the environment.....	238
Saving paper and toner.....	238
Saving energy.....	239
15—Securing the printer.....	243
Statement of Volatility.....	243
Erasing volatile memory.....	244
Erasing non-volatile memory.....	244
Erasing printer hard disk memory.....	244
Configuring printer hard disk encryption.....	245

16—Maintaining the printer	247
Cleaning the printer parts	247
Checking the status of parts and supplies	249
Estimated number of remaining pages	249
Ordering supplies	249
Storing supplies	251
Replacing supplies	252
Moving the printer	256
17—Managing the printer	258
Finding advanced networking and administrator information	258
Checking the virtual display	258
Setting up e-mail alerts	258
Viewing reports	259
Configuring supply notifications from the Embedded Web Server	259
Restoring factory default settings	260
18—Clearing jams	261
Avoiding jams	261
Understanding jam messages and locations	262
[x]-page jam, open front door. [20y.xx]	264
[x]-page jam, open rear door. [20y.xx]	267
[x]-page jam, clear standard bin. [20y.xx]	268
[x]-page jam, remove tray 1 to clear duplex. [23y.xx]	269
[x]-page jam, open tray [x]. [24y.xx]	270
[x]-page jam, clear manual feeder. [25y.xx]	271
[x]-page jam, open automatic feeder top cover. [28y.xx]	272
19—Troubleshooting	273
Understanding printer messages	273
Solving printer problems	289
Solving print problems	298
Solving copy problems	335

User's Guide

Solving fax problems	339
Solving scanner problems	348
Solving home screen applications problems	355
Embedded Web Server does not open	355
Contacting technical support	357
20—Notices	358
Copyright notice	358
Edition notice	358
Trademarks	358
Software License Agreement.....	358
Noise emission levels	359
Temperature information	360
For EU member states only	360
Product disposal	360
ENERGY STAR	361
Power consumption	362
Notice to users of the US telephone network: FCC requirements.....	363
Notice to users of the Canadian telephone network.....	365
Notice to users of the New Zealand telephone network.....	365
Using this product in Switzerland.....	366
Utilisation de ce produit en Suisse.....	366
Verwendung dieses Produkts in der Schweiz	366
Uso del prodotto in Svizzera	366
Modular component notice	366
Notice to users in Brazil	366
Taiwan NCC RF notice statement	367

1—Safety information

Connect the power cord to a properly grounded electrical outlet that is near the product and easily accessible.

Do not place or use this product near water or wet locations.

 **CAUTION—SHOCK HAZARD:** Do not use the fax feature during a lightning storm. Do not set up this product or make any electrical or cabling connections, such as the fax feature, power cord, or telephone, during a lightning storm.

Refer service or repairs, other than those described in the user documentation, to a service representative.

This product is designed, tested, and approved to meet strict global safety standards with the use of specific manufacturer's components. The safety features of some parts may not always be obvious. The manufacturer is not responsible for the use of other replacement parts.

 **CAUTION—SHOCK HAZARD:** Make sure that all external connections (such as Ethernet and telephone system connections) are properly installed in their marked plug-in ports.

 **CAUTION—POTENTIAL INJURY:** This product uses a laser. Use of controls or adjustments or performance of procedures other than those specified herein may result in hazardous radiation exposure.

This product uses a printing process that heats the print media, and the heat may cause the media to release emissions. You must understand the section in your operating instructions that discusses the guidelines for selecting print media to avoid the possibility of harmful emissions.

 **CAUTION—HOT SURFACE:** The inside of the printer might be hot. To reduce the risk of injury from a hot component, allow the surface to cool before touching.

 **CAUTION—POTENTIAL INJURY:** The lithium battery in this product is not intended to be replaced. There is a danger of explosion if a lithium battery is incorrectly replaced. Do not recharge, disassemble, or incinerate a lithium battery. Discard used lithium batteries according to the manufacturer's instructions and local regulations.

Use only the telecommunications (RJ-11) cord provided with this product or a 26 AWG or larger replacement when connecting this product to the public switched telephone network.

 **CAUTION—POTENTIAL INJURY:** Do not cut, twist, bind, crush, or place heavy objects on the power cord. Do not subject the power cord to abrasion or stress. Do not pinch the power cord between objects such as furniture and walls. If any of these things happen, a risk of fire or electrical shock results. Inspect the power cord regularly for signs of such problems. Remove the power cord from the electrical outlet before inspecting it.

 **CAUTION—POTENTIAL INJURY:** To reduce the risk of equipment instability, load each tray separately. Keep all other trays closed until needed.

 **CAUTION—SHOCK HAZARD:** To avoid the risk of electrical shock when cleaning the exterior of the printer, unplug the power cord from the electrical outlet and disconnect all cables from the printer before proceeding.

Use only the power cord provided with this product or the manufacturer's authorized replacement.



CAUTION—TIPPING HAZARD: Floor-mounted configurations require additional furniture for stability. You must use either a printer stand or printer base if you are using a high-capacity tray and an input option, or more than one input option. If you purchased a multifunction printer (MFP) that scans, copies, and faxes, you may need additional furniture.



CAUTION—SHOCK HAZARD: If you are accessing the controller board or installing optional hardware or memory devices sometime after setting up the printer, then turn the printer off, and unplug the power cord from the electrical outlet before continuing. If you have any other devices attached to the printer, then turn them off as well, and unplug any cables going into the printer.



CAUTION—POTENTIAL INJURY: The printer weight is greater than 18 kg (40 lb) and requires two or more trained personnel to lift it safely.





CAUTION—POTENTIAL INJURY: Before moving the printer, follow these guidelines to avoid personal injury or printer damage:

- Turn the printer off using the power switch, and then unplug the power cord from the electrical outlet.
- Disconnect all cords and cables from the printer before moving it.
- If an optional tray is installed, then remove it from the printer. To remove the optional tray, slide the latch on the right side of the tray toward the front of the tray until it *clicks* into place.
- Use the handholds located on both sides of the printer to lift it.
- Make sure your fingers are not under the printer when you set it down.
- Before setting up the printer, make sure there is adequate clearance around it.

SAVE THESE INSTRUCTIONS.

■ **Warning and Caution Symbols**

The labels and symbols used in this manual and on the printer help prevent injury to the operator and others around the printer as well as damage to property. Those labels and symbols have the following meanings:

 WARNING	Ignoring this warning could cause serious injury or even death.
 CAUTION	Ignoring this caution could cause injury or damage to property.

● **Meaning of Symbols**









△ indicates a danger against which you should take precaution.
The symbol shown to the left warns against possible electrical shock.

















⊘ indicates a prohibited course of action.
The symbol shown to the left warns against dismantling the device.



● indicates an imperative course of action.
The symbol shown to the left indicates that you must unplug the device.

 WARNING	
	<ul style="list-style-type: none"> Do not attempt to remove any of the covers and panels attached to the printer. Some printers have a high-voltage part or a laser beam source inside that could cause an electrical shock or blindness. Do not modify the printer, as a fire, electrical shock, or breakdown could result. If the printer employs a laser, the laser beam source could cause blindness.
	<ul style="list-style-type: none"> Use only the power cord supplied in the package. If a power cord is not supplied, use only the power cord and plug that are specified in the user documentation. Failure to use this cord could result in a fire or electrical shock. Use the power cord supplied in the package only with this printer; NEVER use it for another product. Failure to observe this precaution could result in a fire or electrical shock. Use only a power source of the specified voltage. Failure to do that could result in a fire or electrical shock.
	<ul style="list-style-type: none"> Do not use a multiple outlet adapter to connect any other products. Exceeding the rating of a power outlet could result in a fire or electrical shock. Do not use an extension cord, as this could cause a fire or electrical shock. Contact your authorized service provider if an extension cord is required. Do not scratch, rub, place a heavy object on, heat, twist, bend, pull on, or damage the power cord. Use of a damaged power cord (exposed core wire, broken wire, etc.) could result in a fire or breakdown. Should any of the described conditions have occurred, immediately turn off and unplug the printer, and then call your authorized service provider.
	Do not unplug and plug in the power cord with wet hands, as an electrical shock could result.
	Plug the power cord all the way into the power outlet. Failure to do this could result in a fire or electrical shock.

 WARNING	
	Connect the power cord to an electrical outlet that is equipped with a grounding terminal.
	Do not place metal clips, any other small metallic objects, or a container containing liquid on the printer. Liquid and metallic objects dropped inside the printer could result in a fire, electrical shock, or breakdown. Should liquid, a piece of metal, or any other foreign matter fall inside the printer, immediately turn off and unplug the printer, and then call your authorized service provider.
	<ul style="list-style-type: none"> Do not use your printer if it becomes excessively hot, emits smoke or an unusual odor, or makes an unusual noise. Immediately turn off and unplug the printer, and then call your authorized service provider. If you continue using the printer, a fire or electrical shock could result. Do not use this printer if it has been dropped or the cover has been damaged. Immediately turn off and unplug the printer, and then call your authorized service provider. If you continue using the printer, a fire or electrical shock could result.
	Do not burn toner cartridges or toner. The hot toner may scatter and cause burns or other damage.

 CAUTION	
	<ul style="list-style-type: none"> Do not expose the printer to dust, soot, or steam, or place it near a kitchen table, bath, or humidifier. A fire, electrical shock, or breakdown could result. Do not place the printer on an unstable or tilted table, or in a location subject to a lot of vibration and shock. The printer could fall, causing personal injury or mechanical breakdown.
	After installing this product, place it on a sturdy base. If the printer moves or falls, it may cause personal injury.
	Certain areas inside the printer may become very hot and cause burns. When checking the inside of the printer for malfunctions such as media jams, do not touch the locations (around the fusing unit, etc.) labeled "Caution HOT."
	<ul style="list-style-type: none"> Do not obstruct the printer's ventilation grilles. Heat could accumulate inside the printer, resulting in a fire or malfunction. Do not use flammable sprays, liquids, or gases near the printer, as a fire could result.
	<ul style="list-style-type: none"> Do not pull on the power cord when unplugging it. Pulling on the power cord could damage it, resulting in a fire or electrical shock. Do not place any objects around the power plug, as it may be difficult to unplug when an emergency occurs.
	<ul style="list-style-type: none"> Do not store toner cartridges and PC drum units near computer disks or watches that are susceptible to magnetism, as they could cause them to malfunction. Do not leave toner cartridges or PC drum units within reach of children. Ingesting toner could be harmful to your health.
	<ul style="list-style-type: none"> Whenever moving the printer, be sure to disconnect the power cord and other cables. Failure to do this could damage the cord or cable, resulting in a fire, electrical shock, or breakdown. Unplug the printer if you are not going to use it for a long period of time.
	<ul style="list-style-type: none"> When moving the printer, always hold it as specified in the user documentation. If the printer falls, it may cause severe personal injury and/or be damaged. Use the printer only in a well-ventilated location. Operating the printer in a poorly ventilated room for an extended period of time could be harmful to your health. Ventilate the room at regular intervals. Remove the power cord from the outlet more than once a year and clean between the plug terminals. Dust that accumulates between the plug terminals may cause a fire.

2—Learning about the printer

Finding information about the printer

What are you looking for?	Find it here
<p>Initial setup instructions:</p> <ul style="list-style-type: none"> • Connecting the printer • Installing the printer software 	<p>Setup documentation—The setup documentation came with the printer.</p>
<p>Additional setup and instructions for using the printer:</p> <ul style="list-style-type: none"> • Selecting and storing paper and specialty media • Loading paper • Configuring printer settings • Viewing and printing documents and photos • Setting up and using the printer software • Configuring the printer on a network • Caring for and maintaining the printer • Troubleshooting and solving problems 	<p><i>User's Guide</i> and <i>Quick Reference Guide</i>—The guides are available on the <i>Drivers and Documentation CD</i>.</p>
<p>Instructions for:</p> <ul style="list-style-type: none"> • Connecting the printer to an Ethernet network • Troubleshooting printer connection problems 	<p><i>Networking Guide</i>—Insert the <i>Drivers and Documentation CD</i>, and then click Documentation on the CD menu. On the left navigation pane, click User's Guide and other publications, and then click Networking Guide.</p>
<p>The latest supplemental information, updates, and technical support:</p> <ul style="list-style-type: none"> • Documentation • Driver downloads 	<p>KONICA MINOLTA Support Web site— http://www.konicaminolta.com</p> <p>Note: Record the following information (located on the store receipt and at the back of the printer), and have it ready when you contact technical support so that they may serve you faster:</p> <ul style="list-style-type: none"> • Machine Type number • Serial number • Date purchased • Store where purchased
<p>Warranty information</p>	<p>Warranty information varies by country or region.</p>

Selecting a location for the printer

⚠ CAUTION—POTENTIAL INJURY: The printer weight is greater than 18 kg (40 lb) and requires two or more trained personnel to lift it safely.

When selecting a location for the printer, leave enough room to open trays, covers, and doors. If you plan to install any options, then leave enough room for them also. It is important to:

- Set up the printer near a properly grounded and easily accessible electrical outlet.
- Make sure airflow in the room meets the latest revision of the ASHRAE 62 standard or the CEN Technical Committee 156 standard.
- Provide a flat, sturdy, and stable surface.
- Keep the printer:
 - Clean, dry, and free of dust.
 - Away from stray staples and paper clips.
 - Away from the direct airflow of air conditioners, heaters, or ventilators.
 - Free from direct sunlight and humidity extremes.
- Observe the recommended temperatures and avoid fluctuations:

Ambient temperature	15.6 to 32.2°C (60 to 90°F)
Storage temperature	-40 to 40°C (-40 to 104°F)

- Allow the following recommended amount of space around the printer for proper ventilation:

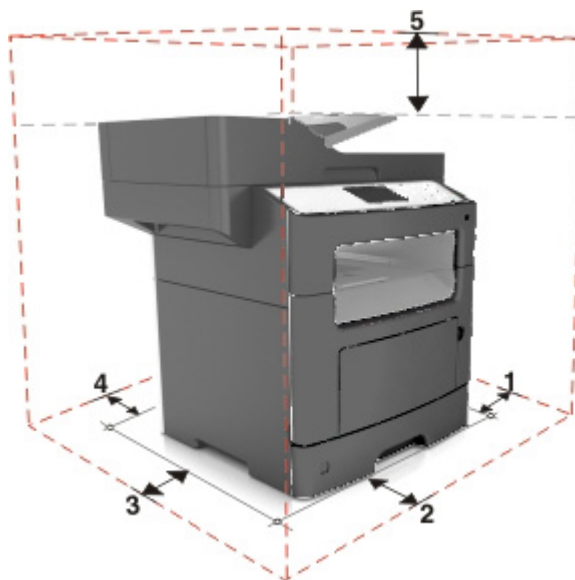

1	Right side	110 mm (4.33 in.)
2	Front	305 mm (12 in.)
3	Left side	65 mm (2.56 in.)
4	Rear	100 mm (3.94 in.)
5	Top	750 mm (29.53 in.)

Printer configurations

⚠ CAUTION—TIPPING HAZARD: Floor-mounted configurations require additional furniture for stability. You must use either a printer stand or printer base if you are using a high-capacity tray and an input option, or more than one input option. If you purchased a multifunction printer (MFP) that scans, copies, and faxes, you may need additional furniture.

You can configure your printer by adding an optional 250- or 550-sheet tray. For instructions on installing the optional tray, see [Installing optional trays](#).

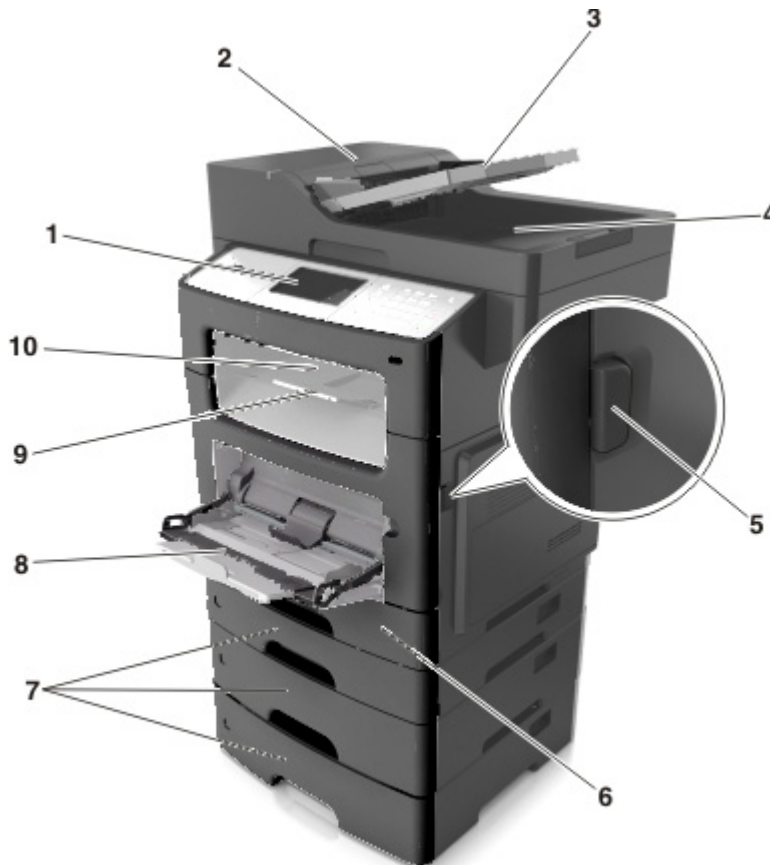



1	Printer control panel
2	Automatic document feeder (ADF)
3	ADF tray
4	ADF bin
5	Front door release button
6	Standard 250-sheet tray
7	Optional 250- or 550-sheet tray
8	100-sheet multipurpose feeder
9	Paper stop
10	Standard bin

Understanding the basic functions of the scanner

- Make quick copies or set the printer to perform specific copy jobs.
- Send a fax using the printer control panel.
- Send a fax to multiple fax destinations at the same time.
- Scan documents and send them to your computer, an e-mail address, or an FTP destination.
- Scan documents and send them to another printer (PDF through an FTP).

Using the ADF and scanner glass

Automatic document feeder (ADF)	Scanner glass
 <p data-bbox="188 720 634 774">Use the ADF for multiple-page documents including two-sided (duplex) pages.</p>	 <p data-bbox="703 795 1386 877">Use the scanner glass for single-page documents, book pages, small items (such as postcards or photos), transparencies, photo paper, or thin media (such as magazine clippings).</p>

Using the ADF

When using the ADF:

- Load the document into the ADF tray faceup, short edge first.
- Load up to 50 sheets of plain paper into the ADF tray.
- Scan size from 74–217 mm (2.9–8.5 inches) wide to 105–356 mm (4.1–14 inches) long.
- Scan media weights from 52 to 120 g/m² (14–32 lb).
- Do not load postcards, photos, small items, transparencies, photo paper, or thin media (such as magazine clippings) into the ADF tray. Place these items on the scanner glass.

Using the scanner glass

When using the scanner glass:

- Place a document facedown on the scanner glass in the corner with the green arrow.
- Scan or copy documents up to 216 x 356 mm (8.5 x 14 inches) long.
- Copy books up to 25 mm (1 inch) thick.

3—Understanding the printer control panel

Using the printer control panel

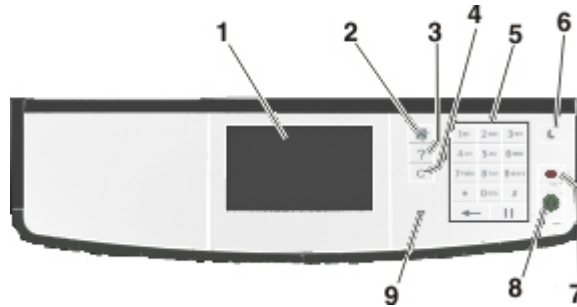

	Use the	To
1	Display	<ul style="list-style-type: none"> View the printer status and messages. Set up and operate the printer.
2	Home button	Go to the home screen.
3	Tips	Open a context-sensitive Help dialog.
4	Clear all / Reset button	Reset the default settings of a function, such as copying, faxing, or scanning.
5	Keypad	Enter numbers, letters, or symbols.
6	Sleep button	<p>Enable Sleep mode or Hibernate mode.</p> <p>Do one of the following to wake the printer from Sleep mode:</p> <ul style="list-style-type: none"> Press  (Sleep button). Send a print job from the computer. Perform a power-on reset with the main power switch. Receive a fax.
7	Stop or Cancel button	Stop all printer activity.
8	Submit button	Submit changes made in the printer settings.
9	Indicator light	Check the status of the printer.

Understanding the colors of the indicator and Sleep button lights

The colors of the indicator and Sleep button lights on the printer control panel signify a certain printer status or condition.

Indicator light color and its corresponding printer status

Indicator light	Printer status
Off	The printer is off or in Hibernate mode.
Blinking green	The printer is warming up, processing data, or printing.
Solid green	The printer is on, but idle.
Blinking red	The printer requires user intervention.

Sleep button light color and its corresponding printer status

Sleep button light	Printer status
Off	The printer is idle or in Ready state.
Solid amber	The printer is in Sleep mode.
Blinking amber	The printer is waking from or entering Hibernate mode.
Blinking amber for 0.1 second, then goes completely off for 1.9 seconds in pulsing pattern	The printer is in Hibernate mode.

Understanding the home screen

When the printer is turned on, the display shows a basic screen, referred to as the home screen. Use the home screen buttons and icons to initiate an action such as copying, faxing, or scanning; to open the menu screen; or respond to messages.

Note: Your home screen may vary depending on your home screen customization settings, administrative setup, and active embedded solutions.

User's Guide





Touch		To
1	Copy	Access the Copy menus and make copies.
2	Fax	Access the Fax menus and send fax.
3	E-mail	Access the E-mail menus and send e-mails.
4	FTP	Access the File Transfer Protocol (FTP) menus and scan documents directly to an FTP server.
5	Menu icon	Access printer menus. Note: The menus are available only when the printer is in ready state.
6	Status message bar	<ul style="list-style-type: none"> Show the current printer status such as Ready or Busy. Show printer supply conditions such as Imaging unit low or Cartridge Low. Show intervention messages and the instructions on how to clear them.
7	Status/Supplies	<ul style="list-style-type: none"> Show a printer warning or error message whenever the printer requires intervention to continue processing. View more information on the printer warning or message, and on how to clear it.

This may also appear on the home screen:

Touch	To
Search Held Jobs	Search current held jobs.

Touch	To
Jobs by user	Access print jobs saved by user.
Profiles and Solutions	Access profiles and solutions.

Features



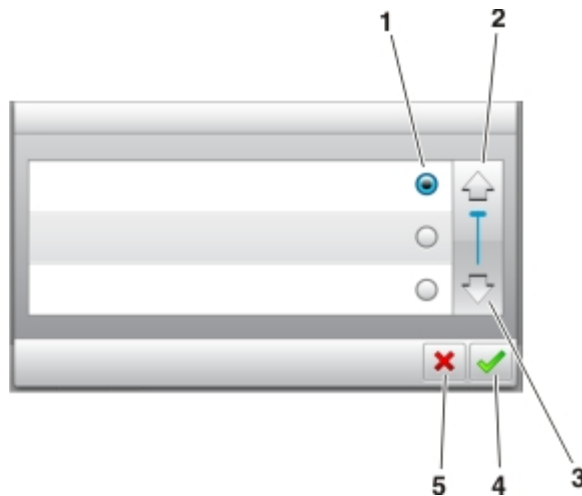

Feature	Description
Attendance message alert 	If an attendance message affects a function, then this icon appears and the red indicator light blinks.
Warning 	If an error condition occurs, then this icon appears.
Printer IP address Example: 123 . 123 . 123 . 123	The IP address of your printer is located at the top left corner of the home screen and appears as four sets of numbers separated by periods. You can use the IP address when accessing the Embedded Web Server to view and remotely configure printer settings even when you are not physically near the printer.

Using the touch-screen buttons



	Touch the	To
1	Radio button	Select or clear an item.
2	Up arrow	Scroll up.
3	Down arrow	Scroll down.
4	Accept button	Save a setting.
5	Cancel button	<ul style="list-style-type: none"> • Cancel an action or a selection. • Return to the previous screen.

Other touch-screen buttons

Touch	To
	Return to the home screen.
	Open a context-sensitive Help dialog on the printer control panel.
	Scroll to the left.
	Scroll to the right.

4—Setting up and using the home screen applications

Finding the IP address of the computer

Note: Make sure that you know how your printer and computer are connected to the network (Ethernet or wireless).

The computer IP address is required when setting up home screen applications, such as:

- Forms and Favorites
- Scan to Network

For Windows users

1. Open the command prompt.

In Windows 8

From the Search charm, type **run**, and then navigate to:

Apps list > **Run** > type **cmd** > **OK**

In Windows 7 or earlier

- a. Click , or click **Start** and then click **Run**.
 - b. In the Start Search or Run dialog, type **cmd**.
 - c. Press **Enter**, or click **OK**.
2. Type **ipconfig**, and then press **Enter**.

Note: Type **ipconfig /all** to see additional useful information.
 3. Look for **IP Address**.

The IP address appears as four sets of numbers separated by periods, such as 123.123.123.123.

For Macintosh users

Note: This is applicable only in Mac OS X version 10.5 or later.

1. From the Apple menu, navigate to:

System Preferences > Network
2. Click **Ethernet**, **Wi-Fi**, or **AirPort**.
3. Click **Advanced > TCP/IP**.

4. Look for **IPv4 Address**.

Finding the IP address of the printer

Note: Make sure your printer is connected to a network or to a print server.

You can find the printer IP address:

- From the top left corner of the printer home screen.
- From the TCP/IP section in the Network/Ports menu.
- By printing a network setup page or menu settings page, and then finding the TCP/IP section.

Note: An IP address appears as four sets of numbers separated by periods, such as 123.123.123.123.

Accessing the Embedded Web Server

The Embedded Web Server is the printer Web page that lets you view and remotely configure printer settings even when you are not physically near the printer.

1. Obtain the printer IP address:
 - From the printer control panel home screen
 - From the TCP/IP section in the Network/Ports menu
 - By printing a network setup page or menu settings page, and then finding the TCP/IP section

Note: An IP address appears as four sets of numbers separated by periods, such as 123.123.123.123.

2. Open a Web browser, and then type the printer IP address in the address field.
3. Press **Enter**.

Note: If you are using a proxy server, then temporarily disable it to load the Web page correctly.

Customizing the home screen

1. Open a Web browser, and then type the printer IP address in the address field.

Note: View the printer IP address on the printer home screen. The IP address appears as four sets of numbers separated by periods, such as 123.123.123.123.

2. Do one or more of the following:
 - Show or hide the icons of basic printer functions.
 1. Click **Settings >General Settings >Home screen customization**.

2. Select the check boxes to specify which icons appear on the home screen.

Note: If you clear a check box beside an icon, then the icon does not appear on the home screen.

3. Click **Submit**.
- Customize the icon for an application. For more information, see [Finding information about the home screen applications](#) or see the documentation that came with the application.

Understanding the different applications

Use	To
Card Copy	Scan and print both sides of a card on a single page. For more information, see Setting up Card Copy .
Fax	Scan a document, and then send it to a fax number. For more information, see Faxing .
Forms and Favorites	Quickly find and print frequently used online forms directly from the printer home screen. For more information, see Setting up Forms and Favorites .
MyShortcut	Create shortcuts directly on the printer home screen. For more information, see Using MyShortcut .
Scan to E-mail	Scan a document, and then send it to an e-mail address. For more information, see E-mailing .
Scan to Computer	Scan a document, and then save it to a predefined folder on a host computer. For more information, see Setting up Scan to Computer .
Scan to FTP	Scan documents directly to a File Transfer Protocol (FTP) server. For more information, see Scanning to an FTP address .
Scan to Network	Scan a document, and then send it to a network shared folder. For more information, see Setting up Scan to Network .

Activating the home screen applications

Finding information about the home screen applications

Your printer comes with preinstalled home screen applications.

Setting up Forms and Favorites

Use	To
	<p>Streamline work processes by letting you quickly find and print frequently used online forms directly from the printer home screen.</p> <p>Note: The printer must have permission to access the network folder, FTP site, or Web site where the bookmark is stored. From the computer where the bookmark is stored, use sharing, security, and firewall settings to allow the printer at least a <i>read</i> access. For help, see the documentation that came with your operating system.</p>

1. Open a Web browser, and then type the printer IP address in the address field.

Note: View the printer IP address on the printer home screen. The IP address appears as four sets of numbers separated by periods, such as 123.123.123.123.

2. Click **Settings >Apps >Apps Management >Forms and Favorites**.
3. Click **Add**, and then customize the settings.

Notes:

- See the mouse-over help beside each field for a description of the setting.
- To make sure the location settings of the bookmark are correct, type the correct IP address of the host computer where the bookmark is located. For more information on obtaining the IP address of the host computer, see [Finding the IP address of the computer](#).
- Make sure the printer has access rights to the folder where the bookmark is located.

4. Click **Apply**.

To use the application, touch **Forms and Favorites** on the printer home screen, and then navigate through form categories, or search for forms based on a form number, name, or description.

Setting up Card Copy

Use	To
	<p>Quickly and easily copy insurance, identification, and other wallet-size cards.</p> <p>You can scan and print both sides of a card on a single page, saving paper and showing the information on the card in a more convenient manner.</p>

1. Open a Web browser, and then type the printer IP address in the address field.

Note: View the printer IP address on the printer home screen. The IP address appears as four sets of numbers separated by periods, such as 123.123.123.123.

2. Click **Settings >Apps >Apps Management >Card Copy**.

3. Change the default scanning options, if necessary.

- **Default tray**—Select the default tray to be used for printing scan images.
- **Default number of copies**—Specify the number of copies that should automatically print when the application is used.
- **Default contrast setting**—Specify a setting to increase or decrease the level of contrast when a copy of the scanned card is printed. Select **Best for Content** if you want the printer to adjust the contrast automatically.
- **Default scale setting**—Set the size of the scanned card when printed. The default setting is 100% (full size).
- **Resolution setting**—Adjust the quality of the scanned card.

Notes:

- When scanning a card, make sure the scan resolution is not more than 200 dpi for color, and 400 dpi for black and white.
- When scanning multiple cards, make sure the scan resolution is not more than 150 dpi for color, and 300 dpi for black and white.
- **Print Borders**—Select the check box to print the scan image with a border around it.

4. Click **Apply**.

To use the application, touch **Card Copy** on the printer home screen, and then follow the instructions.

Using MyShortcut

Use	To
	<p>Create shortcuts on the printer home screen, with settings for up to 25 frequently used copy, fax, or e-mail jobs.</p>

To use the application, touch **MyShortcut**, and then follow the instructions on the printer display.

Setting up Scan to Network

Use	To
	<p>Scan a document and send it to a shared network folder. You can define up to 30 unique folder destinations.</p> <p>Notes:</p> <ul style="list-style-type: none"> • The printer must have permission to write to the destinations. From the computer where the destination is specified, use sharing, security, and firewall settings to allow the printer at least a <i>write</i> access. For help, see the documentation that came with your operating system. • The Scan to Network icon appears only when one or more destinations are defined.

1. Open a Web browser, and then type the printer IP address in the address field.

Note: View the printer IP address on the printer home screen. The IP address appears as four sets of numbers separated by periods, such as 123.123.123.123.

2. Click **Settings >Apps >Apps Management >Scan to Network**.
3. Specify the destinations, and then customize the settings.

Notes:

- See the mouse-over help beside some of the fields for a description of the setting.
- To make sure the location settings of the destination are correct, type the correct IP address of the host computer where the specified destination is located. For more information on obtaining the IP address of the host computer, see [Finding the IP address of the computer](#).
- Make sure the printer has access rights to the folder where the specified destination is located.

4. Click **Apply**.

To use the application, touch **Scan to Network** on the printer home screen, and then follow the instructions on the printer display.

Setting up Remote Operator Panel

This application shows the printer control panel on your computer screen and lets you interact with the printer control panel, even when you are not physically near the network printer. From your computer screen, you can view the printer status, release held print jobs, create bookmarks, and do other print-related tasks you might normally do while standing at the network printer.

1. Open a Web browser, and then type the printer IP address in the address field.

Note: View the printer IP address on the printer home screen. The IP address appears as four sets of numbers separated by periods, such as 123.123.123.123.

2. Click **Settings >Remote Operator Panel Settings**.
3. Select the **Enabled** check box, and then customize the settings.
4. Click **Submit**.

To use the application, click **Remote Operator Panel >Launch VNC Applet**.

Exporting and importing a configuration

You can export configuration settings into a text file, and then import the file to apply the settings to other printers.

1. Open a Web browser, and then type the printer IP address in the address field.

Note: View the printer IP address on the printer home screen. The IP address appears as four sets of numbers separated by periods, such as 123.123.123.123.

2. To export or import a configuration for one application, do the following:
 - a. Click **Settings >Apps >Apps Management**.
 - b. From the list of installed applications, click the name of the application you want to configure.
 - c. Click **Configure**, and then do either of the following:
 - To export a configuration to a file, click **Export**, and then follow the instructions on the computer screen to save the configuration file.

Notes:

- When saving the configuration file, you can type a unique file name or use the default name.
- If a "JVM Out of Memory" error occurs, then repeat the export process until the configuration file is saved.

- To import a configuration from a file, click **Import**, and then browse to the saved configuration file that was exported from a previously configured printer.

Notes:

- Before importing the configuration file, you can choose to preview it first or load it directly.
 - If a timeout occurs and a blank screen appears, then refresh the Web browser, and then click **Apply**.
3. To export or import a configuration for multiple applications, do the following:
- a. Click **Settings >Import/Export**.
 - b. Do either of the following:
 - To export a configuration file, click **Export Embedded Solutions Settings File**, and then follow the instructions on the computer screen to save the configuration file.
 - To import a configuration file, do the following:
 - a. Click **Import Embedded Solutions Settings File >Choose File**, and then browse to the saved configuration file that was exported from a previously configured printer.
 - b. Click **Submit**.

5—Additional printer setup

Installing internal options



CAUTION—SHOCK HAZARD: If you are accessing the controller board or installing optional hardware or memory devices sometime after setting up the printer, then turn the printer off, and unplug the power cord from the electrical outlet before continuing. If you have other devices attached to the printer, then turn them off as well, and unplug any cables going into the printer.

Available internal options

- Memory card
 - EM-P04 Expanded Memory Unit 1GB
 - EM-P03 Expanded Memory Unit 2G
 - UK-P01 Upgrade Kit 256MB User Flash
 - Font
 - UK-P06 Upgrade Kit Traditional Chinese Font Card
 - UK-P05 Upgrade Kit Simplified Chinese Font Card
 - UK-P04 Upgrade Kit Korean Font Card
 - UK-P07 Upgrade Kit Japanese Font Card
 - Firmware cards
 - UK-P10 Upgrade Kit Forms and Bar Code
 - UK-P11 Upgrade Kit IPSD eMMC Card
- HD-P05 Hard Disk
- Internal Solutions Ports (ISP)
 - EK-P02 Parallel 1284-B Interface
 - NC-P02 Network Interface Card Marknet 8350 Wireless
 - EK-P03 RS-232C Serial Interface Card

Accessing the controller board



CAUTION—SHOCK HAZARD: If you are accessing the controller board or installing optional hardware or memory devices sometime after setting up the printer, then turn the printer off, and unplug the power cord from the electrical outlet before continuing. If you have any other devices attached to the printer, then turn them off as well, and unplug any cables going into the printer.

1. Open the controller board access door.



2. Open the controller board shield using the green handle.

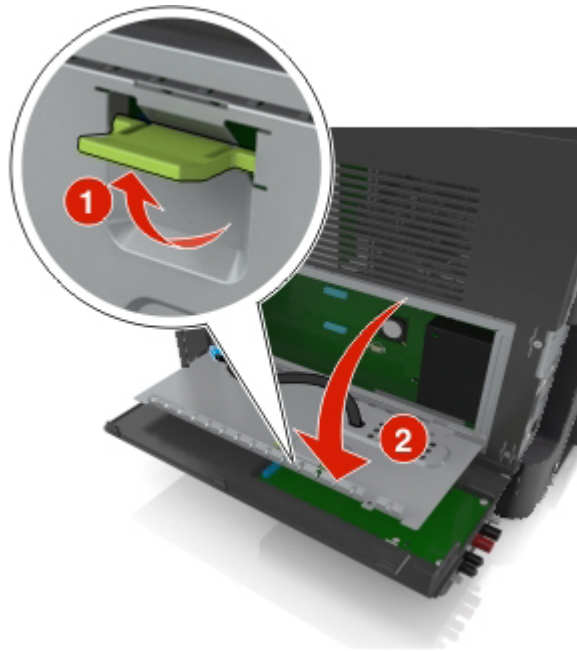

3. Use the following illustration to locate the appropriate connector.

Warning—Potential Damage: Controller board electronic components are easily damaged by static electricity. Touch something metal on the printer before touching any controller board electronic components or connectors.

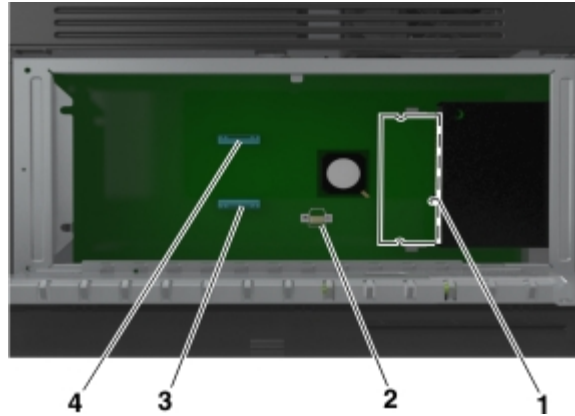

1	Memory card connector
2	Option card connector
3	Printer hard disk connector
4	Internal Solutions Port connector

4. Close the shield, and then the access door.

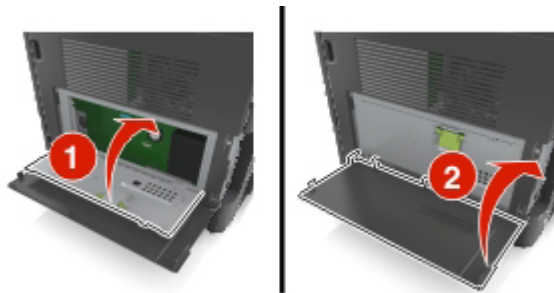

Installing a memory card

⚠ CAUTION—SHOCK HAZARD: If you are accessing the controller board or installing optional hardware or memory devices sometime after setting up the printer, then turn the printer off, and unplug the power cord from the electrical outlet before continuing. If you have any other devices attached to the printer, then turn them off as well, and unplug any cables going into the printer.

Warning—Potential Damage: Controller board electronic components are easily damaged by static electricity. Touch something metal on the printer before touching any controller board electronic components or connectors.

Note: An optional memory card can be purchased separately and attached to the controller board.

1. Access the controller board.

For more information, see [Accessing the controller board](#).

2. Unpack the memory card.

Warning—Potential Damage: Do not touch the connection points along the edge of the card. Doing so may cause damage.

3. Align the notch (1) on the memory card with the ridge (2) on the connector.

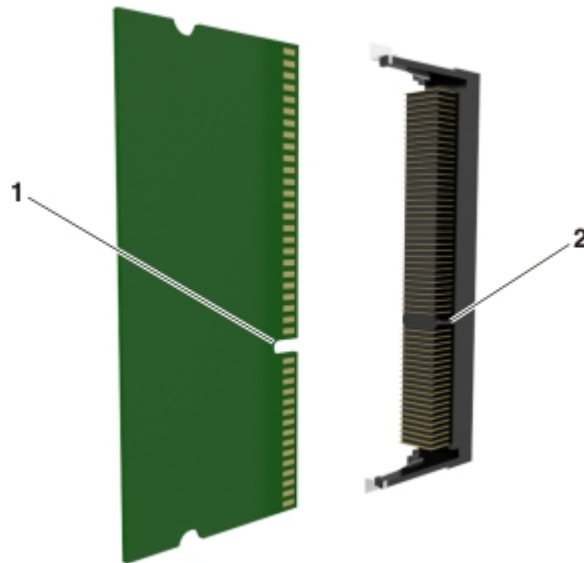

4. Push the memory card straight into the connector, and then push the card toward the controller board wall until it *clicks* into place.

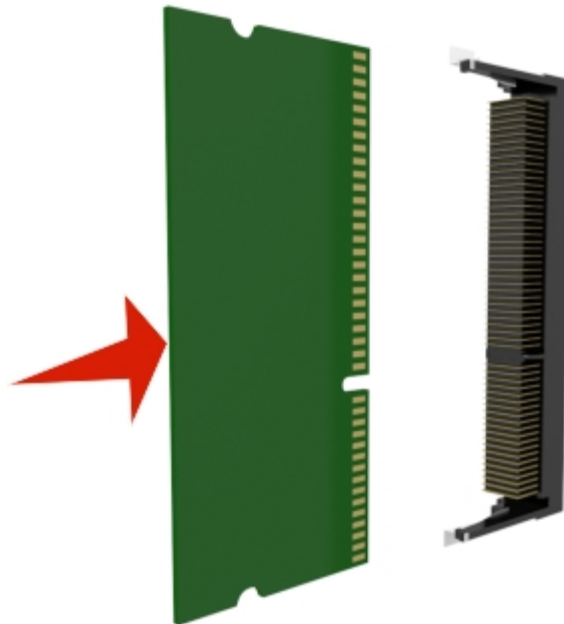

5. Close the controller board shield, and then the controller board access door.

Note: When the printer software and any hardware options are installed, you may need to manually add the options in the printer driver to make them available for print jobs. For more information, see [Updating available options in the printer driver](#).

Installing an optional card

⚠ CAUTION—SHOCK HAZARD: If you are accessing the controller board or installing optional hardware or memory devices sometime after setting up the printer, then turn the printer off, and unplug the power cord from the electrical outlet before continuing. If you have other devices attached to the printer, then turn them off as well, and unplug any cables going into the printer.

Warning—Potential Damage: Controller board electronic components are easily damaged by static electricity. Touch something metal on the printer before touching any controller board electronic components or connectors.

1. Access the controller board.

For more information, see [Accessing the controller board](#).

2. Unpack the optional card.

Warning—Potential Damage: Avoid touching the connection points along the edge of the card.

3. Holding the card by its sides, align the plastic pins (1) on the card with the holes (2) on the controller board.

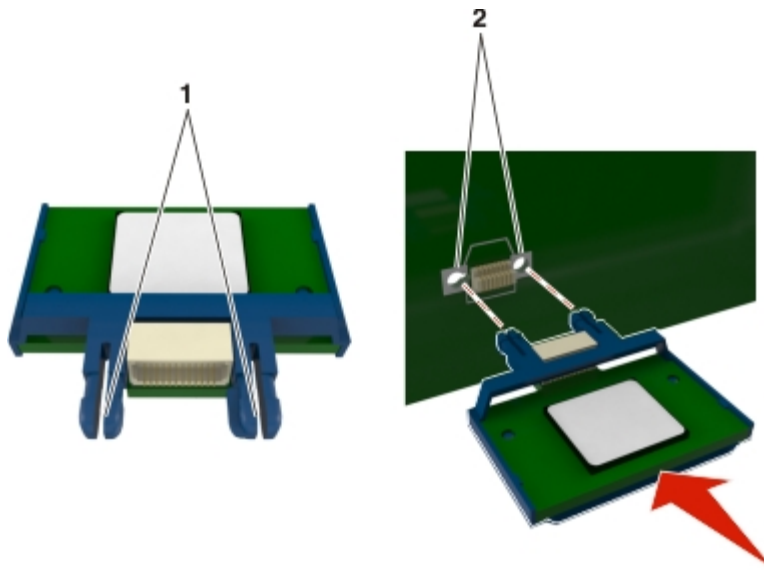

4. Push the card firmly into place as shown in the illustration.

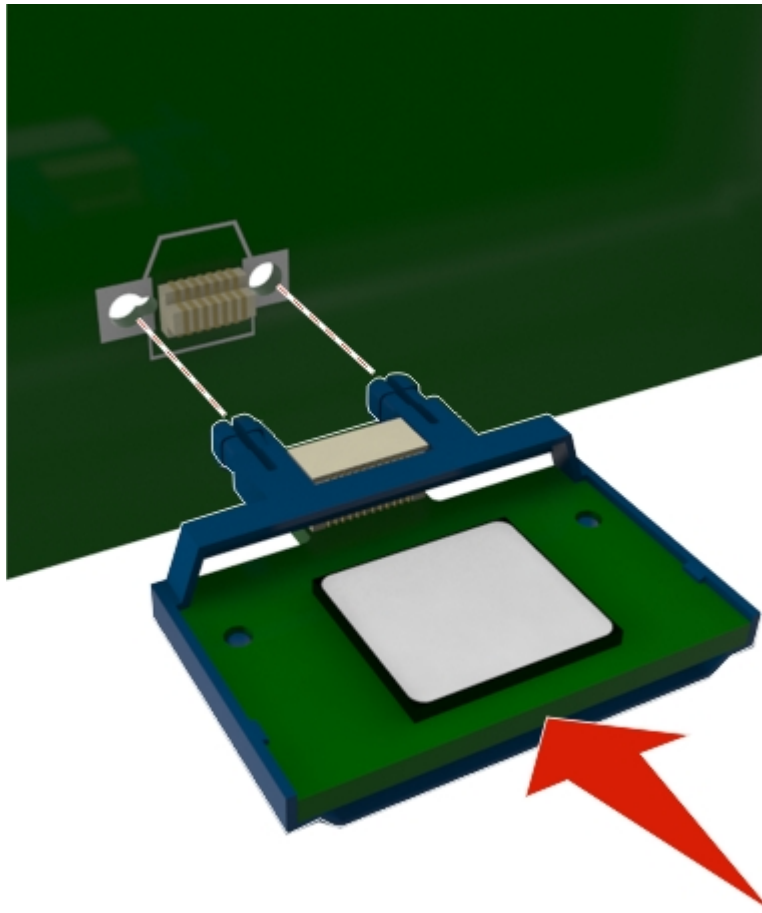

Warning—Potential Damage: Improper installation of the card may cause damage to the card and the controller board.

Note: The entire length of the connector on the card must touch and be flushed against the controller board.

5. Close the controller board shield, and then the controller board access door.

Note: When the printer software and any hardware options are installed, it may be necessary to manually add the options in the printer driver to make them available for print jobs. For more information, see [Updating available options in the printer driver](#).

Installing an Internal Solutions Port

The controller board supports one optional Internal Solutions Port (ISP).

Note: This task requires a flathead screwdriver.

 **CAUTION—SHOCK HAZARD:** If you are accessing the controller board or installing optional hardware or memory devices sometime after setting up the printer, then turn the printer off, and unplug

the power cord from the electrical outlet before continuing. If you have any other devices attached to the printer, then turn them off as well, and unplug any cables going into the printer.

Warning—Potential Damage: Controller board electronic components are easily damaged by static electricity. Touch something metal on the printer before touching any controller board electronic components or connectors.

1. Open the controller board access door.



2. Lightly press the stop on the left side of the controller board access door, and then slide the access door to remove.



3. Unpack the ISP kit.

Note: Make sure to remove and discard the small cable attached to the white connector.

User's Guide

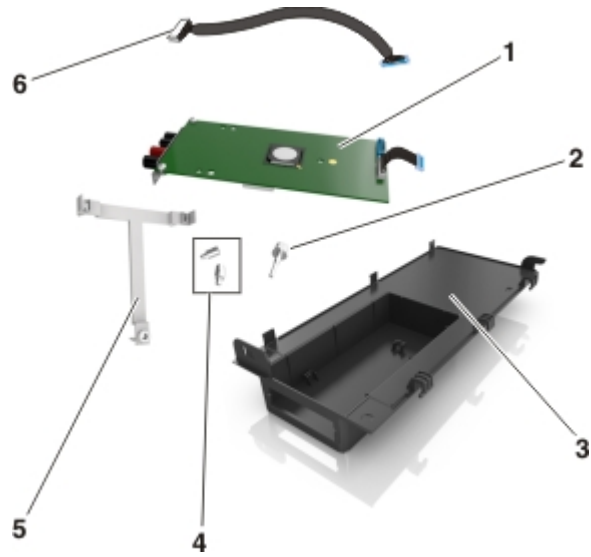

1	ISP solution
2	Screw to attach the ISP to the bracket
3	ISP exterior cover
4	Screws to attach the ISP metal bracket to the printer cage
5	Plastic bracket
6	Long ISP cable

4. Place the plastic bracket inside the ISP exterior cover until it *clicks* into place.

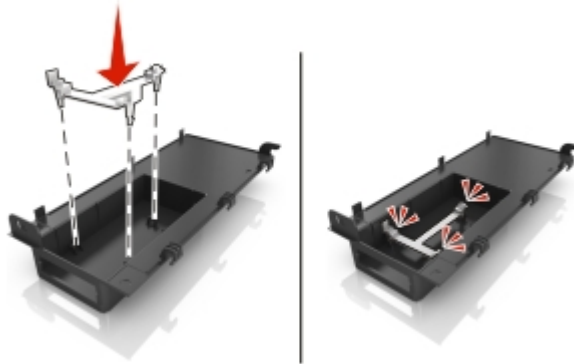

5. Slide and push the ISP solution into the plastic bracket.

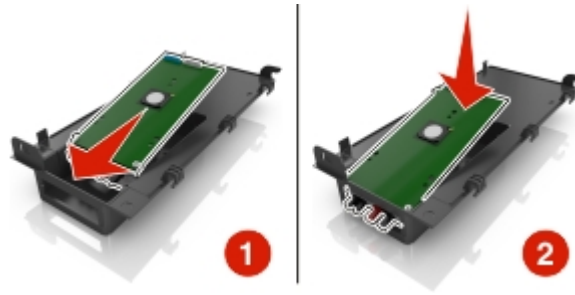

6. Secure the ISP solution to the plastic bracket using the long screw.

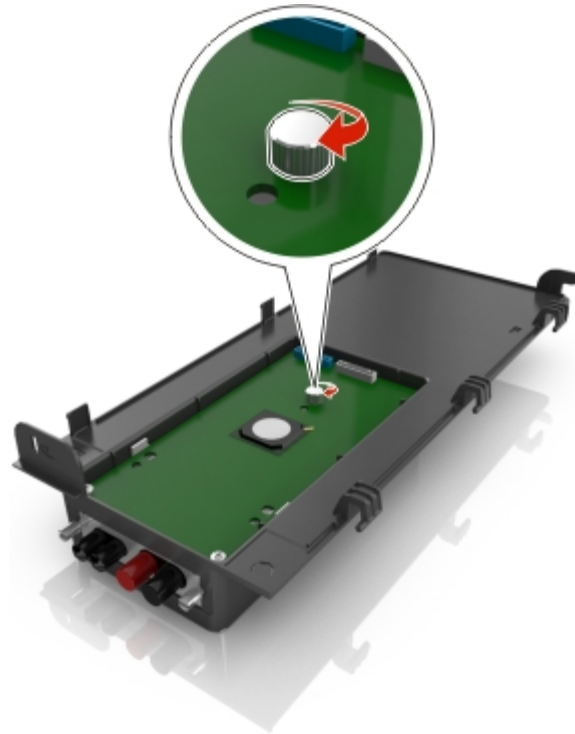

7. Tighten the two screws on the end of the ISP solution.

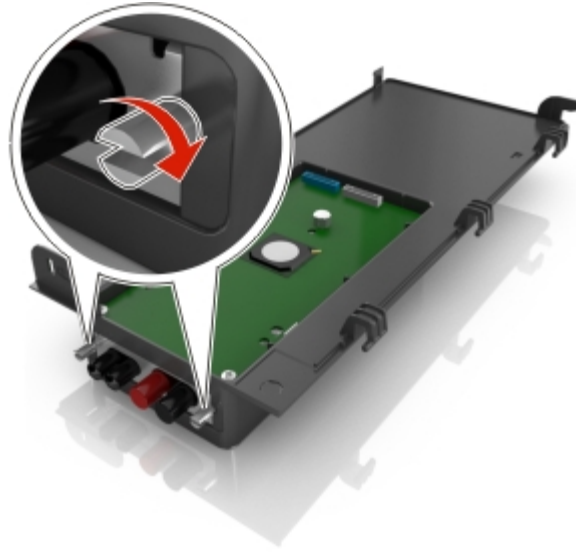

8. Attach the white plug of the ISP solution interface cable into the white receptacle on the ISP.

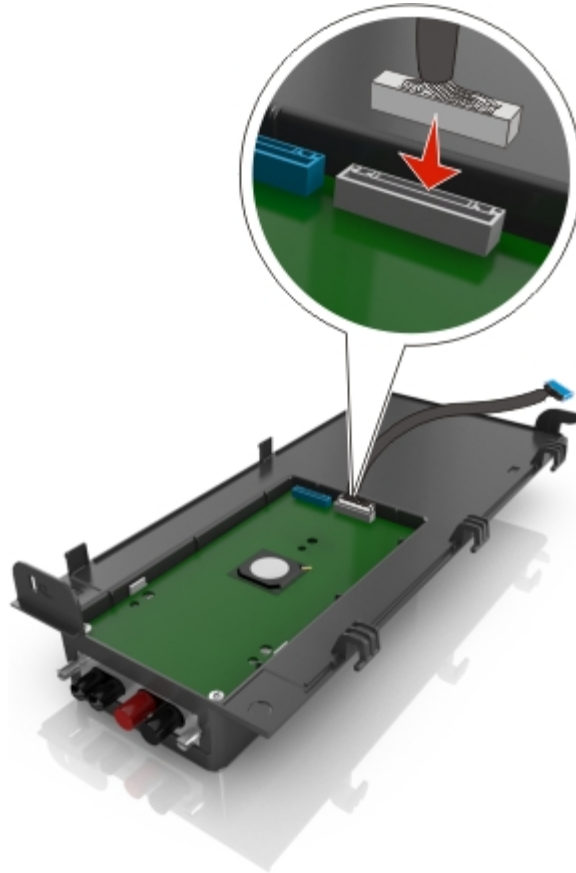

9. Slightly close the ISP exterior cover up to 65 degrees, and then slide the cover to attach.

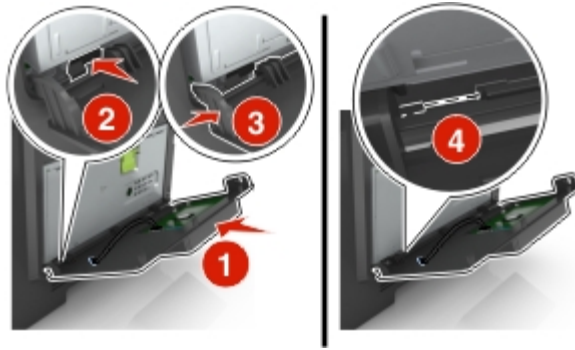

10. Run the ISP cable through the controller board shield.



11. Open the controller board shield using the green handle.

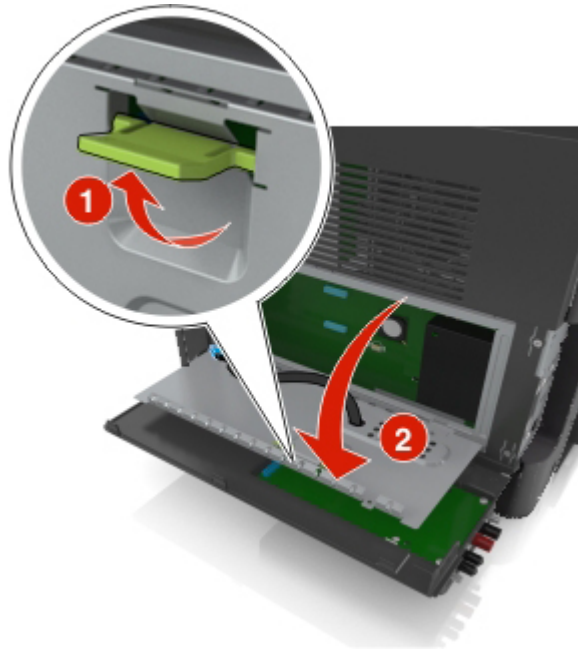

12. Attach the blue plug of the ISP solution interface cable into the blue receptacle on the controller board.

Note: If you have installed a printer hard disk, then you need to remove it. For more information, see [Removing a printer hard disk](#). To reinstall the printer hard disk, see [Installing a printer hard disk](#).

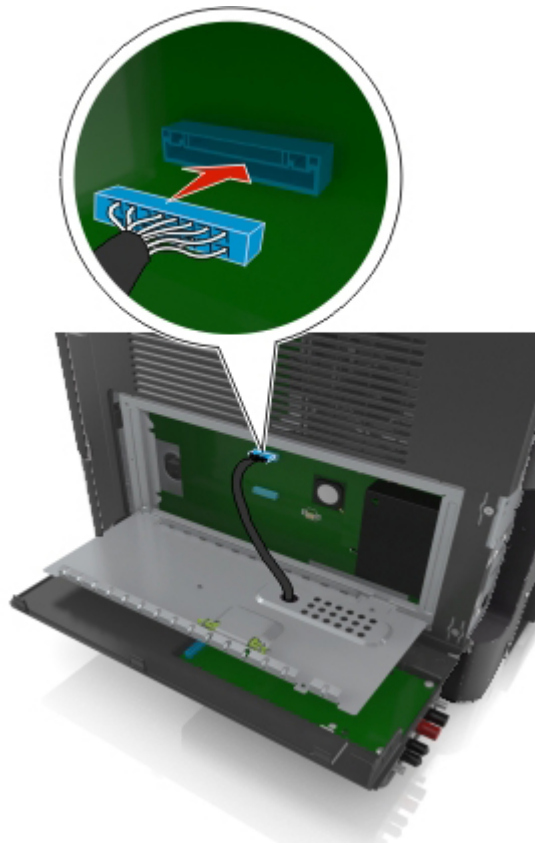

13. Close the controller board shield.

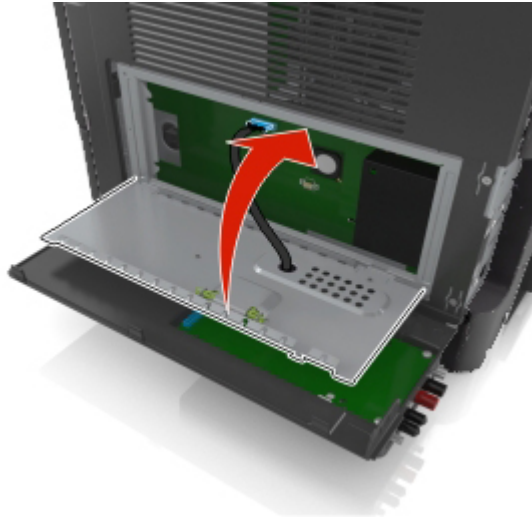

14. Close the ISP exterior cover.

Note: When the printer software and any hardware options are installed, it may be necessary to manually add the options in the printer driver to make them available for print jobs. For more information, see [Updating available options in the printer driver](#).

Installing a printer hard disk

CAUTION—SHOCK HAZARD: If you are accessing the controller board or installing optional hardware or memory devices sometime after setting up the printer, then turn the printer off, and unplug the power cord from the electrical outlet before continuing. If you have any other devices attached to the printer, then turn them off as well, and unplug any cables going into the printer.

Warning—Potential Damage: Controller board electronic components are easily damaged by static electricity. Touch something metal on the printer before touching any controller board electronic components or connectors.

1. Access the controller board.

For more information, see [Accessing the controller board](#).

2. Unpack the printer hard disk.
3. Install the printer hard disk on the controller board.

Warning—Potential Damage: Hold only the edges of the printed circuit board assembly. Do not touch or press on the center of the printer hard disk. Doing so may cause damage.

User's Guide

- a. Using a flathead screwdriver, loosen the screws.

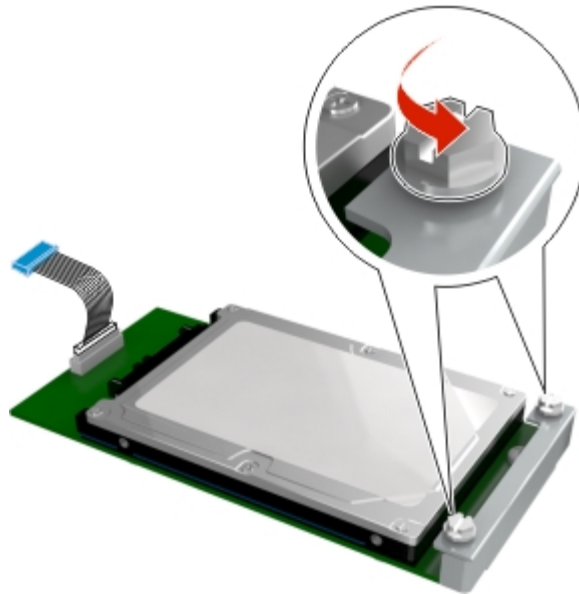

- b. Insert the plug of the printer hard disk interface cable into the receptacle of the controller board.

Note: The plug and the receptacle are color-coded blue.

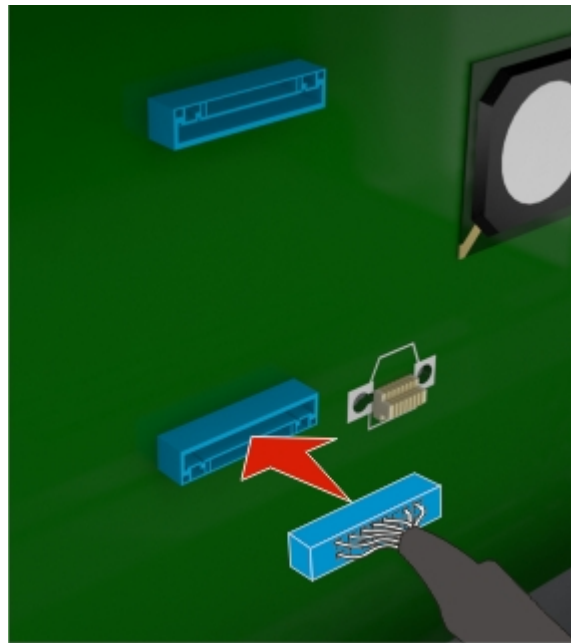

- c. Align the screws on the printer hard disk to the slots on the controller board bracket, and then slide the printer hard disk onto the brackets.

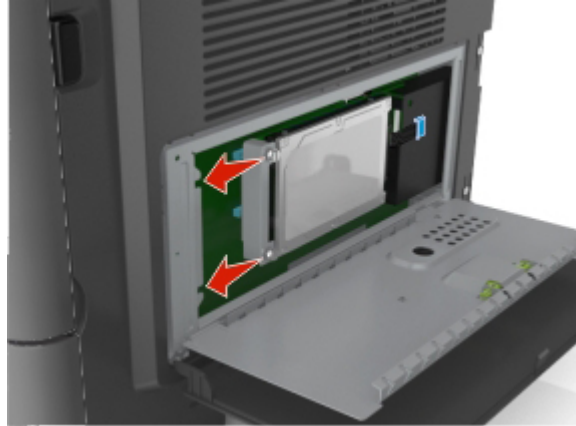

- d. Tighten the two screws.

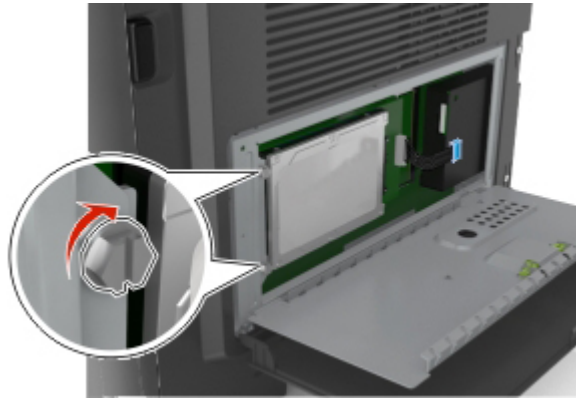

4. Close the controller board shield, and then close the controller board access door.

Note: When the printer software and any hardware options are installed, you may need to manually add the options in the printer driver to make them available for print jobs. For more information, see [Updating available options in the printer driver](#).

Removing a printer hard disk

Warning—Potential Damage: Controller board electronic components are easily damaged by static electricity. Touch something metal on the printer before touching any controller board electronic components or connectors.

1. Access the controller board.

For more information, see [Accessing the controller board](#).

Note: This task requires a flathead screwdriver.

2. Loosen the screws that connect the printer hard disk to the controller board bracket.

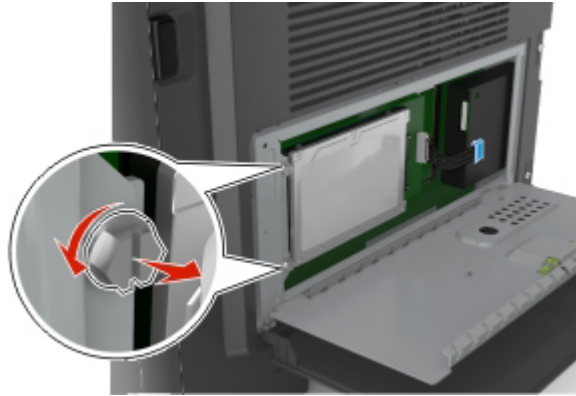

3. Unplug the printer hard disk interface cable from the receptacle in the controller board, leaving the cable attached to the printer hard disk. To unplug the cable, squeeze the paddle at the plug of the interface cable to disengage the latch before pulling the cable out.

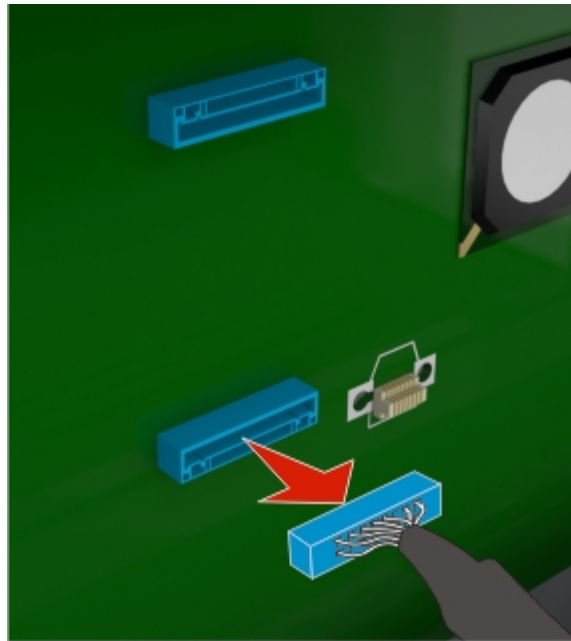

4. Hold the printer hard disk by the edges, and then remove it from the printer.
5. Close the controller board shield, and then close the access door.

Installing hardware options

Order of installation

⚠ CAUTION—POTENTIAL INJURY: The printer weight is greater than 18 kg (40 lb) and requires two or more trained personnel to lift it safely.

⚠ CAUTION—SHOCK HAZARD: If you are accessing the controller board or installing optional hardware or memory devices sometime after setting up the printer, then turn the printer off, and unplug the power cord from the electrical outlet before continuing. If you have any other devices attached to the printer, then turn them off as well, and unplug any cables going into the printer.

⚠ CAUTION—TIPPING HAZARD: Floor-mounted configurations require additional furniture for stability. You must use either a printer stand or printer base if you are using a high-capacity tray and an input option, or more than one input option. If you purchased a multifunction printer (MFP) that scans, copies, and faxes, you may need additional furniture.

Install the printer and any hardware options you have purchased in the following order:

- Printer stand
- Optional 250- or 550-sheet tray
- Printer

For more information on installing a printer stand, optional 250- or 550-sheet tray, or spacer, see the setup sheet that came with the option.

Installing optional trays

⚠ CAUTION—POTENTIAL INJURY: The printer weight is greater than 18 kg (40 lb) and requires two or more trained personnel to lift it safely.

⚠ CAUTION—SHOCK HAZARD: If you are accessing the controller board or installing optional hardware or memory devices sometime after setting up the printer, then turn the printer off, and unplug the power cord from the electrical outlet before continuing. If you have any other devices attached to the printer, then turn them off as well, and unplug any cables going into the printer.

⚠ CAUTION—TIPPING HAZARD: Floor-mounted configurations require additional furniture for stability. You must use either a printer stand or printer base if you are using a high-capacity tray and an input option, or more than one input option. If you purchased a multifunction printer (MFP) that scans, copies, and faxes, you may need additional furniture.

1. Turn off the printer using the power switch, and then unplug the power cord from the electrical outlet.



2. Unpack the tray, and then remove all packing material.
3. Pull out the tray from the base.

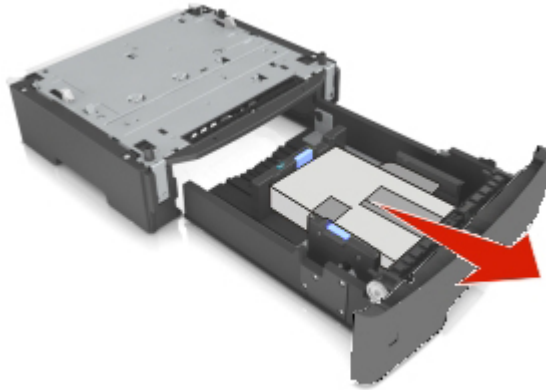

4. Remove any packing material from inside the tray.
5. Insert the tray into the base.
6. Place the tray near the printer.
7. Align the printer with the tray, and then slowly lower the printer into place.

Note: Optional trays lock together when stacked.



8. Connect the power cord to the printer, then to a properly grounded electrical outlet, and then turn on the printer.



Notes:

- When the printer software and any hardware options are installed, you may need to manually add the options in the printer driver to make them available for print jobs. For more information, see [Updating available options in the printer driver](#).

- To uninstall the optional trays, slide the latch on the right side of the printer toward the front of the printer until it *clicks* into place, and then remove stacked trays one at a time from the top to the bottom.

Setting up the printer software

Installing the printer driver

For Windows users

1. Insert the *Drivers and Documentation* CD in the CD/DVD drive of your PC.
2. Follow the instructions on the screen.

Note: The PostScript driver may not be installed to your PC which runs Windows Vista if it is connected to the printer via a USB cable. In that case, select USB port in the “Add a printer” wizard to install the printer driver.

3. Click Install, and then follow the instructions on the computer screen.

For Macintosh users

1. Insert the *Drivers and Documentation* CD in the CD drive of your Macintosh.
2. Double-click the CD icon on the desktop, the Drivers folder, and the Mac folder.

→ Mac OS X v10.3/v10.4: double-click bizhub_4020_3320_103104.pkg

→ Mac OS X v10.5: in the english (other) folder, double-click bizhub_4020_3320_105.pkg

→ Mac OS X v10.6/v10.7/v10.8: in the english (other) folder, double-click bizhub_4020_3320_106.pkg

3. The installer for the printer driver starts up.

Note: For OS X 10.6/10.7/10.8, the driver folder varies depending on the paper size. Select the appropriate driver folder for your environment.

- To use inch-based paper size (8 1/2 x 11 in letter size): Select a file in the english folder.
- To use metric-based paper size (A4 and the like): Select a file in the other folder.

Note: Double-click the package file appropriate for the application and version of operating system being used.

- bizhub_4020_3320_103104.pkg (for Mac OS X v10.3/v10.4)
- bizhub_4020_3320_105.pkg (for Mac OS X v10.5)
- bizhub_4020_3320_106.pkg (for Mac OS X v10.6/v10.7/v10.8)

4. Add the printer.

- a. (For Mac OS X v10.3/v10.4/v10.5/v10.6)
Apple menu > **System preferences** > **Print & Fax** > +
(For Mac OS X v10.7/v10.8)
Apple menu > **System preferences** > **Print & Scan** > +
- b. Select your printer.
- c. Click **Add**.

Updating available options in the printer driver

When any hardware options are installed, you may need to manually add the options in the printer driver to make them available for use.

For Windows users

1. Open the printers folder.

In Windows 8

From the Search charm, type **run**, and then navigate to:
Apps list > **Run** > type **control printers** > **OK**

In Windows 7 or earlier

- a. Click  , or click **Start** and then click **Run**.
 - b. In the Start Search or Run dialog, type **control printers**.
 - c. Press **Enter**, or click **OK**.
2. Select the printer.
 3. Right-click the printer, and then select **Printer properties**.
 4. Click the **Configure** tab.
 5. Do either of the following:
 - Click **Acquire Device Information**.
 - Under Device Option, manually add any installed hardware options.
 6. Click **Apply**.

For Macintosh users

1. From the Apple menu, navigate to either of the following:
 - (For Mac OS X v10.3/v10.4/v10.5/v10.6)
System Preferences > **Print & Fax** > select your printer > **Options & Supplies** > **Driver**

- (For Mac OS X v10.7/v10.8)

System Preferences >Print & Scan > select your printer >Options & Supplies >Driver

2. Add any installed hardware options, and then click **OK**.

Attaching cables

⚠ CAUTION—POTENTIAL INJURY: Do not use the fax feature during a lightning storm. Do not set up this product or make any electrical or cabling connections, such as the fax feature, power cord, or telephone, during a lightning storm.

Connect the printer to the computer using a USB cable or to the network using an Ethernet cable.

Make sure to match the following:

- The USB symbol on the cable with the USB symbol on the printer
- The appropriate Ethernet cable with the Ethernet port

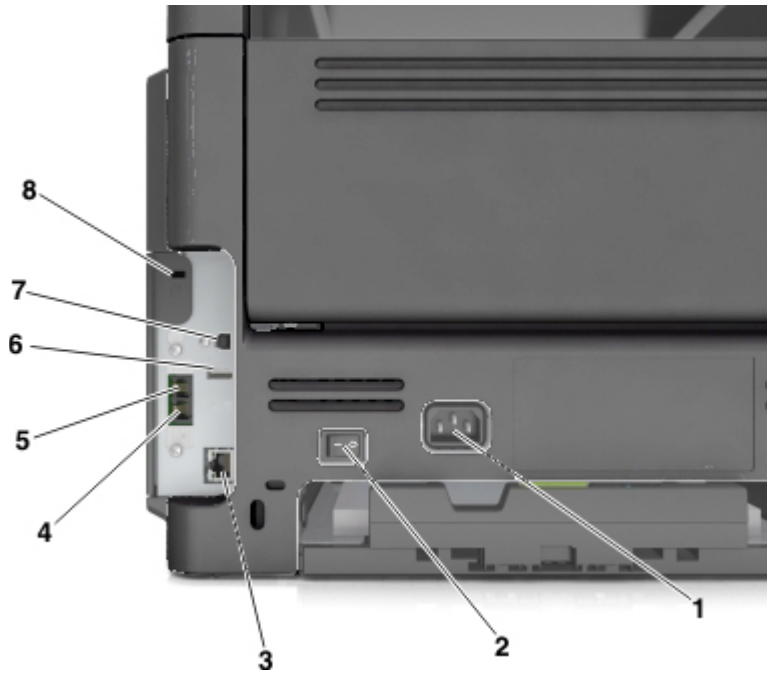

	Use the	To
1	Printer power cord socket	Connect the printer to a properly grounded electrical outlet.
2	Power switch	Turn the printer on or off.
3	Ethernet port	Connect the printer to an Ethernet network.

	Use the	To
4	EXT port	Connect additional devices (telephone or answering machine) to the printer and the telephone line. Use this port if you do not have a dedicated fax line for the printer and if this connection method is supported in your country or region. Note: Remove the plug to access the port.
5	LINE port	Connect the printer to an active telephone line through a standard wall jack (RJ-11), DSL filter, or VoIP adapter, or any other adapter that allows you to access the telephone line to send and receive faxes.
6	USB port	Do not use.
7	USB printer port	Connect the printer to a computer.
8	Security slot	Attach a lock that will secure the printer in place.

Networking

Notes:

- Purchase a wireless network adapter first before setting up the printer on a wireless network. For more information on installing the wireless network adapter, see the setup sheet that came with the adapter.
- A Service Set Identifier (SSID) is a name assigned to a wireless network. Wired Equivalent Privacy (WEP), Wi-Fi Protected Access (WPA), and WPA2 are types of security used on a network.

Preparing to set up the printer on an Ethernet network

To configure your printer to connect to an Ethernet network, organize the following information before you begin:

Note: If your network automatically assigns IP addresses to computers and printers, continue on to installing the printer.

- A valid, unique IP address for the printer to use on the network
- The network gateway
- The network mask
- A nickname for the printer (optional)

Note: A printer nickname can make it easier for you to identify your printer on the network. You can choose to use the default printer nickname, or assign a name that is easier for you to remember.

You will need an Ethernet cable to connect the printer to the network and an available port where the printer can physically connect to the network. Use a new network cable when possible to avoid potential problems caused by a damaged cable.

Installing the printer on an Ethernet network

For Windows users

1. Insert the *Drivers and Documentation* CD in the CD/DVD drive of your PC.
2. Follow the instructions on the screen.
3. A device is detected and it is displayed on a device list. Choose a device to install and click **Next**.
4. Choose the component to install and click **Next**.
5. Installation was completed.

For Macintosh users

1. Allow the network DHCP server to assign an IP address to the printer.
2. Obtain the printer IP address either:
 - From the printer control panel
 - From the TCP/IP section in the Network/Ports menu
 - By printing a network setup page or menu settings page, and then finding the TCP/IP section

Note: You will need the IP address if you are configuring access for computers on a different subnet than the printer.

3. Install the printer driver on the computer.
 - a. Insert the *Drivers and Documentation* CD in the CD drive of your Macintosh.
 - b. Double-click the CD icon on the desktop, the Drivers folder, and the Mac folder.
 - Mac OS X v10.3/v10.4: double-click bizhub_4020_3320_103104.pkg
 - Mac OS X v10.5: in the english (other) folder, double-click bizhub_4020_3320_105.pkg
 - Mac OS X v10.6/v10.7/v10.8: in the english (other) folder, double-click bizhub_4020_3320_106.pkg
 - c. The installer for the printer driver starts up.

Note: For OS X 10.6/10.7/10.8, the driver folder varies depending on the paper size. Select the appropriate driver folder for your environment.

- To use inch-based paper size (8 1/2 x 11 in letter size): Select a file in the english folder.
- To use metric-based paper size (A4 and the like): Select a file in the other folder.

Note: Double-click the package file appropriate for the application and version of operating system being used.

- bizhub_4020_3320_103104.pkg (for Mac OS X v10.3/v10.4)
- bizhub_4020_3320_105.pkg (for Mac OS X v10.5)

- bizhub_4020_3320_106.pkg (for Mac OS X v10.6/v10.7/v10.8)

4. Add the printer.

- For IP printing:

1. From the Apple menu, navigate to either of the following:

- (For Mac OS X v10.3/v10.4/v10.5/v10.6)

System preferences > Print & Fax

- (For Mac OS X v10.7/v10.8)

System preferences > Print & Scan

2. Click **+**.

3. Click the **IP** tab.

4. Type the printer IP address in the address field, and then click **Add**.

- For AppleTalk printing:

Notes:

- Make sure AppleTalk is activated on your printer.
- This feature is supported only in Mac OS X version 10.3/10.4/10.5.

1. From the Apple menu, navigate to:

System Preferences > Print & Fax

2. Click **+**, and then navigate to:

AppleTalk > select your printer > Add

For Linux users

Adding the Printer Using Printer configuration

1. Connect the machine to a computer or the network.
2. Insert the *Drivers and Documentation* CD in the CD/DVD drive of your computer.
3. From the System menu, select **Administration > Printing**.
4. Click **New Printer**.
5. Enter the Printer name, Description, and Location > **Forward**.
6. From the left pane of the dialog box, select the port for the machine to be installed.
7. Click **Forward**.
8. Select **Provide PPD file**.
9. Click the folder icon.

10. Select the PPD file.
11. Click **Open > Forward > Apply**.

Adding the Printer on the CUPS Administration Web page

1. Connect the machine to a computer or the network.
2. Start up the Web browser.
3. Enter the URL "http://localhost:631".
4. Click **Add Printer**.
5. Enter the Printer name, Location, and Description > **Continue**.
6. Select a Device Port from the Device list > **Continue**.
7. For a USB connection, skip to step 9.
Enter the device URI in the following form: "socket://<Printer IP or Printer Hostname>:port"
8. Click **Continue**.
9. Select **KONICA MINOLTA > Continue**.
10. Select **KM4020X.ppd > Add Printer**.
11. Enter the user name and password for using root privileges > **OK**.

Preparing to set up the printer on a wireless network

Notes:

- Make sure your wireless network adapter is installed in your printer and working properly. For more information, see the instruction sheet that came with the wireless network adapter.
- Make sure your access point (wireless router) is turned on and is working properly.

Make sure you have the following information before setting up the printer on a wireless network:

- **SSID**—The SSID is also referred to as the network name.
- **Wireless Mode (or Network Mode)**—The mode is either infrastructure or ad hoc.
- **Channel (for ad hoc networks)**—The channel defaults to automatic for infrastructure networks.

Some ad hoc networks will also require the automatic setting. Check with your system support person if you are not sure which channel to select.

- **Security Method**—There are four basic options for Security Method:
 - WEP key

If your network uses more than one WEP key, then enter up to four in the provided spaces. Select the key currently in use on the network by selecting the default WEP transmit key.

- WPA or WPA2 preshared key or passphrase

WPA includes encryption as an additional layer of security. The choices are AES or TKIP. Encryption must be set for the same type on the router and on the printer, or the printer will not be able to communicate on the network.

- 802.1X–RADIUS

If you are installing the printer on an 802.1X network, then you may need the following:

- Authentication type
- Inner authentication type
- 802.1X user name and password
- Certificates

- No security

If your wireless network does not use any type of security, then you will not have any security information.

Note: We do not recommend using an unsecured wireless network.



Notes:

- If you do not know the SSID of the network that your computer is connected to, then launch the wireless utility of the computer network adapter, and then look for the network name. If you cannot find the SSID or the security information for your network, then see the documentation that came with the access point, or contact your system support person.
- To find the WPA/WPA2 preshared key or passphrase for the wireless network, see the documentation that came with the access point, see the Embedded Web Server associated with the access point, or consult your system support person.

Connecting the printer using the Wireless Setup Wizard

Before you begin, make sure that:

- A wireless network adapter is installed in the printer and is working properly. For more information, see the instruction sheet that came with the wireless network adapter.
- An Ethernet cable is disconnected from the printer.
- Active NIC is set to Auto. To set this to Auto, navigate to:

 >Network/Ports >Active NIC >Auto > 

Note: Make sure to turn off the printer, then wait for at least five seconds, and then turn the printer back on.

1. From the printer control panel, navigate to:

 >Network/Ports >Network [x] >Network [x] Setup >Wireless >Wireless Connection Setup

2. Select a wireless connection setup.

Use	To
Search for networks	Show available wireless connections. Note: This menu shows all broadcast secured or unsecured SSIDs.
Enter a network name	Manually type the SSID. Note: Make sure to type the correct SSID.
Wi-Fi Protected Setup	Connect the printer to a wireless network using Wi-Fi Protected Setup.

3. Follow the instructions on the printer display.

Connecting the printer to a wireless network using Wi-Fi Protected Setup

Before you begin, make sure that:

- The access point (wireless router) is Wi-Fi Protected Setup (WPS) certified or WPS-compatible. For more information, see the documentation that came with your access point.
- A wireless network adapter installed in your printer is attached and working properly. For more information, see the instruction sheet that came with the wireless network adapter.

Using the Push Button Configuration method

1. From the printer control panel, navigate to:



>**Network/Ports** >**Network [x]** >**Network [x] Setup** >**Wireless** >**Wi-Fi Protected Setup** >**Start Push Button Method**

2. Follow the instructions on the printer display.

Using the Personal Identification Number (PIN) method

1. From the printer control panel, navigate to:



>**Network/Ports** >**Network [x]** >**Network [x] Setup** >**Wireless** >**Wi-Fi Protected Setup** >**Start PIN Method**

2. Copy the eight-digit WPS PIN.
3. Open a Web browser, and then type the IP address of your access point in the address field.

Notes:

- The IP address appears as four sets of numbers separated by periods, such as 123.123.123.123.
 - If you are using a proxy server, then temporarily disable it to load the Web page correctly.
4. Access the WPS settings. For more information, see the documentation that came with your access point.

5. Enter the eight-digit PIN, and then save the setting.

Connecting the printer to a wireless network using the Embedded Web Server

Before you begin, make sure that:

- Your printer is connected temporarily to an Ethernet network.
 - A wireless network adapter is installed in your printer and working properly. For more information, see the instruction sheet that came with the wireless network adapter.
1. Open a Web browser, and then type the printer IP address in the address field.

Notes:

- View the printer IP address on the printer control panel. The IP address appears as four sets of numbers separated by periods, such as 123.123.123.123.
- If you are using a proxy server, then temporarily disable it to load the Web page correctly.

2. Click **Settings >Network/Ports >Wireless**.
3. Modify the settings to match the settings of your access point (wireless router).

Note: Make sure to enter the correct SSID, security method, preshared key or passphrase, network mode, and channel.

4. Click **Submit**.
5. Turn off the printer, and then disconnect the Ethernet cable. Then wait for at least five seconds, and then turn the printer back on.
6. To verify if your printer is connected to the network, print a network setup page. Then in the Network Card [x] section, see if the status is Connected.

Changing port settings after installing a new network Internal Solutions Port

When a new Internal Solutions Port (ISP) is installed in the printer, the printer configurations on computers that access the printer must be updated since the printer will be assigned a new IP address. All computers that access the printer must be updated with this new IP address.

Notes:

- If the printer has a static IP address, then you do not need to make any changes to the computer configurations.
- If the computers are configured to use the network name, instead of an IP address, then you do not need to make any changes to your computer configurations.
- If you are adding a wireless ISP to a printer previously configured for an Ethernet connection, then make sure the printer is disconnected from the Ethernet network when you configure the printer to operate wirelessly. If the printer is connected to the Ethernet network, then the wireless configuration completes, but the wireless ISP is inactive. To activate the wireless ISP, disconnect the printer from the Ethernet network, turn off the printer, and then turn it back on.

- Only one network connection is active at a time. To switch between Ethernet and wireless connection types, turn off the printer, connect the cable (to switch to an Ethernet connection) or disconnect the cable (to switch to a wireless connection), and then turn the printer back on.

For Windows users

1. Open a Web browser, and then type the printer IP address in the address field.

Notes:

- View the printer IP address on the printer control panel. The IP address appears as four sets of numbers separated by periods, such as 123.123.123.123.
- If you are using a proxy server, then temporarily disable it to load the Web page correctly.

2. Open the printers folder.

In Windows 8

From the Search charm, type **run**, and then navigate to:
Apps list > **Run** > type **control printers** > **OK**

In Windows 7 or earlier

- a. Click , or click **Start** and then click **Run**.
 - b. In the Start Search or Run dialog, type **control printers**.
 - c. Press **Enter**, or click **OK**.
3. Select the printer that has changed.
Note: If there is more than one copy of the printer, then update all of them with the new IP address.
 4. Right-click the printer, and then select **Printer properties** or **Properties**.
 5. Click the **Ports** tab.
 6. Select the port from the list, and then click **Configure Port**.
 7. Type the new IP address in the "Printer Name or IP Address" field.
 8. Click **OK >Close**.

For Macintosh users

1. Open a Web browser, and then type the printer IP address in the address field.

Notes:

- View the printer IP address on the printer control panel. The IP address appears as four sets of numbers separated by periods, such as 123.123.123.123.
- If you are using a proxy server, then temporarily disable it to load the Web page correctly.

2. Add the printer.

- For IP printing:

1. From the Apple menu, navigate to either of the following:

- (For Mac OS X v10.3/v10.4/v10.5/v10.6)

System preferences > Print & Fax

- (For Mac OS X v10.7/v10.8)

System preferences > Print & Scan

2. Click **+**.

3. Click the **IP** tab.

4. Type the printer IP address in the address field, and then click **Add**.

- For AppleTalk printing:

Notes:

- Make sure AppleTalk is activated on your printer.
- This feature is supported only in Mac OS X version 10.3/10.4/10.5.

1. From the Apple menu, navigate to:

System Preferences > Print & Fax

2. Click **+**, and then navigate to:

AppleTalk > select the printer >Add

Verifying printer setup

When all hardware and software options are installed and the printer is turned on, verify that the printer is set up correctly by printing the following:

- **Menu settings page**—Use this page to verify that all printer options are installed correctly. If an option you installed is not listed, then it is not installed correctly. Remove the option, and then install it again.
- **Network setup page**—If your printer has networking support, then use this page to verify that the network connection is working. This page also provides important information that aids network printing configuration.

Printing a menu settings page

From the home screen, navigate to:

 > **Reports > Menu Settings Page**

Printing a network setup page

If the printer is attached to a network, then print a network setup page to verify the network connection. This page also provides important information that aids network printing configuration.

1. From the home screen, navigate to:



> **Reports > Network Setup Page**

2. Check the first section of the network setup page, and confirm that the status is **Connected**.



If the status is **Not Connected**, then the LAN drop may not be active, or the network cable may be malfunctioning. Consult a system support person for a solution, and then print another network setup page.

6—Loading paper and specialty media

The selection and handling of paper and specialty media can affect how reliably documents print. For more information, see [Avoiding jams](#) and [Storing paper](#).

Setting the paper size and type

From the home screen navigate to:

 > **Paper Menu** > **Paper Size/Type** > select a tray > select the paper size or type > 

Configuring Universal paper settings

The Universal paper size is a user-defined setting that lets you print on paper sizes that are not preset in the printer menus.

Notes:

- The smallest supported Universal size is 76.2 x 127 mm (3 x 5 inches).
- The largest supported Universal size is 215.9 x 355.6 mm (8.5 x 14 inches).

1. From the home screen, navigate to:

 > **Paper Menu** > **Universal Setup** > **Units of Measure** > select the unit of measure > 

2. Touch **Portrait Width** or **Portrait Height**.

3. Select the width or height, and then touch .

Loading trays



CAUTION—POTENTIAL INJURY: To reduce the risk of equipment instability, load each tray separately. Keep all trays closed until needed.

1. Pull out the tray completely.

Note: Do not remove trays while a job prints or while **Busy** appears on the printer display. Doing so may cause a jam.

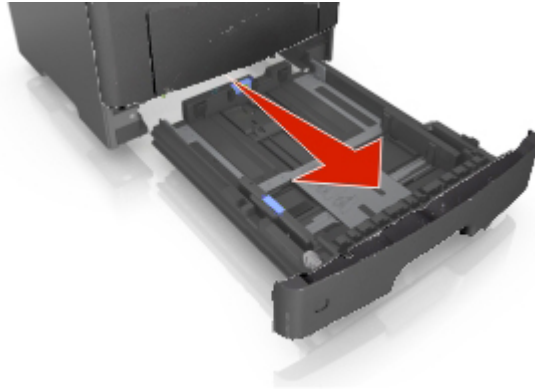

2. Squeeze, and then slide the width guide tab to the correct position for the size of the paper you are loading.

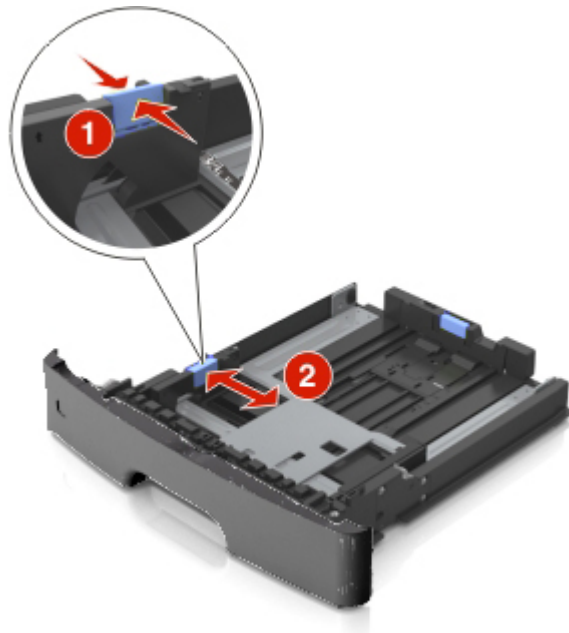

3. Unlock the length guide. Squeeze, and then slide the length guide tab to the correct position for the size of the paper you are loading.

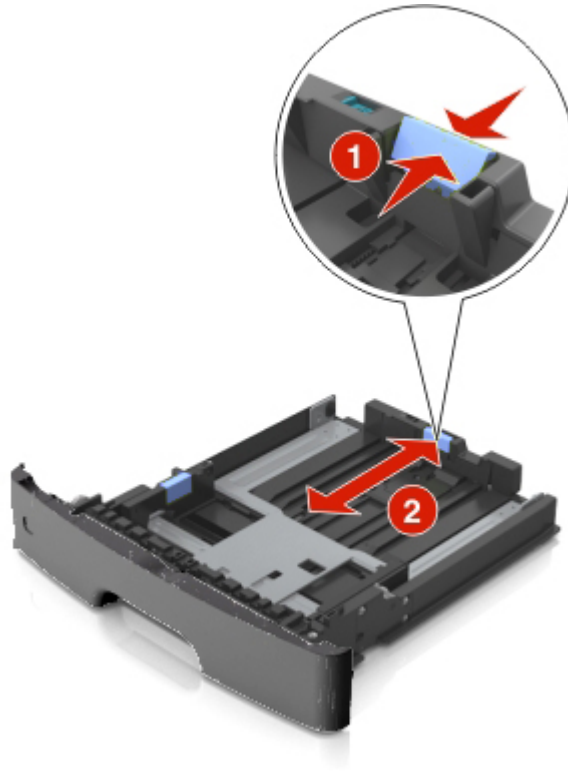

Notes:

- For some paper sizes like letter, legal, and A4, squeeze and slide the length guide tab backward to accommodate their length.
- When loading legal-size paper, the length guide extends beyond the base leaving the paper exposed to dust. To protect the paper from dust, you can purchase a dust cover separately. For more information, contact technical support.
- If you are loading A6-size paper in the standard tray, then squeeze and then slide the length guide tab toward the center of the tray to the A6-size position.
- Make sure the width and length guides are aligned with the paper size indicators on the bottom of the tray.

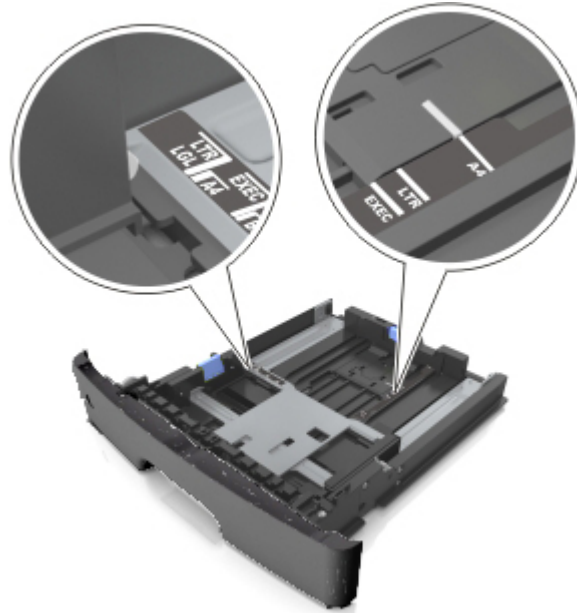

4. Flex the sheets back and forth to loosen them, and then fan them. Do not fold or crease the paper. Straighten the edges on a level surface.

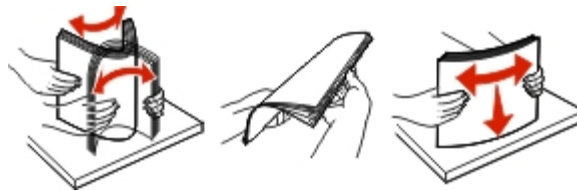

5. Load the paper stack.

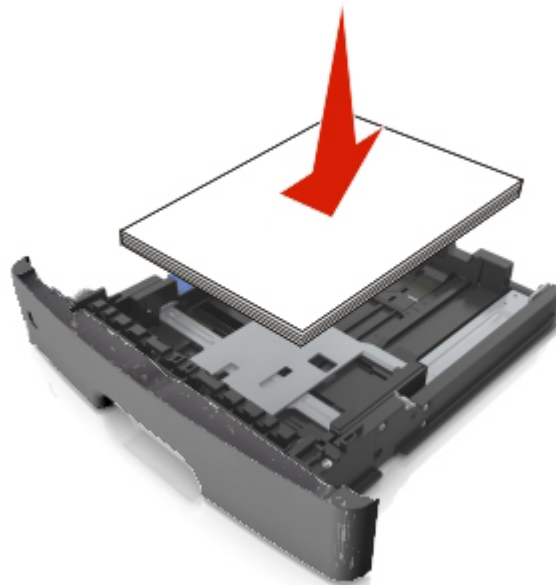

Notes:

- Load with the printable side facedown when using recycled or preprinted paper.
- Load prepunched paper with the holes on the top edge toward the front of the tray.
- Load letterhead facedown, with the top edge of the sheet toward the front of the tray. For two-sided printing, load letterhead faceup with the bottom edge of the sheet toward the front of the tray.
- Make sure the paper is below the maximum paper fill indicator located on the side of the width guide.

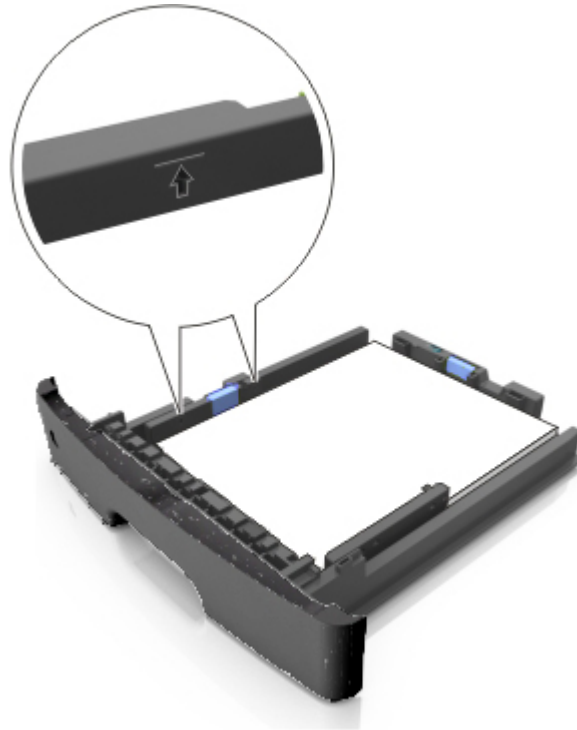

6. Insert the tray.



7. From the printer control panel, set the paper size and paper type in the Paper menu to match the paper loaded in the tray.

Note: Set the correct paper size and type to avoid paper jams and print quality problems.

Loading the multipurpose feeder

Use the multipurpose feeder when printing on different paper sizes and types or specialty media, such as card stock, transparencies, paper labels, and envelopes. You can also use it for single-page print jobs on letterhead.

1. Open the multipurpose feeder.



- a. Pull the multipurpose feeder extender.

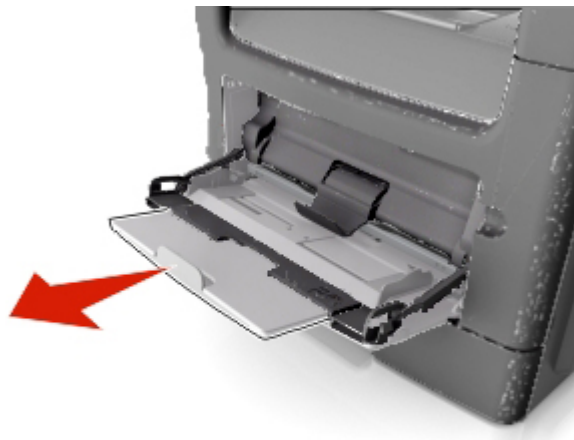

- b. Pull the extender gently so that the multipurpose feeder is fully extended and open.

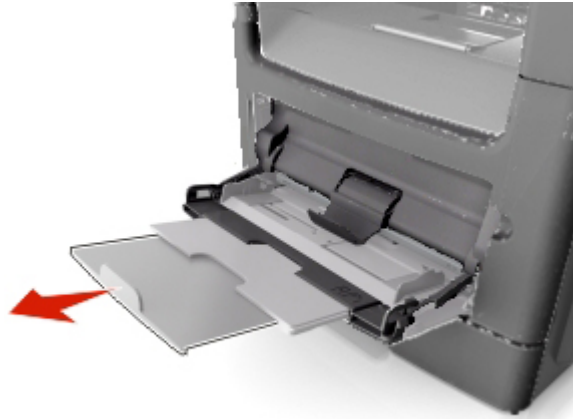

2. Squeeze the tab on the left width guide, and then move the guides for the paper you are loading.



3. Prepare the paper or specialty media for loading.

- Flex sheets of paper back and forth to loosen them, and then fan them. Do not fold or crease the paper. Straighten the edges on a level surface.



User's Guide

- Hold transparencies by the edges. Flex the stack of transparencies back and forth to loosen them, and then fan them. Straighten the edges on a level surface.

Note: Avoid touching the printable side of the transparencies. Be careful not to scratch them.



- Flex the stack of envelopes back and forth to loosen them, and then fan them. Straighten the edges on a level surface.



4. Load the paper or specialty media.

Notes:

- Do not force paper or specialty media into the multipurpose feeder.
- Make sure the paper or specialty media is below the maximum paper fill indicator located on the paper guides. Overfilling may cause paper jams.



User's Guide

- Load paper, transparencies, and card stock with the recommended printable side faceup and the top edge entering the printer first. For more information on loading transparencies, see the packaging that the transparencies came in.



Note: When loading A6-size paper, make sure the multipurpose feeder extender rests lightly against the edge of the paper so that the last few sheets of paper remain in place.

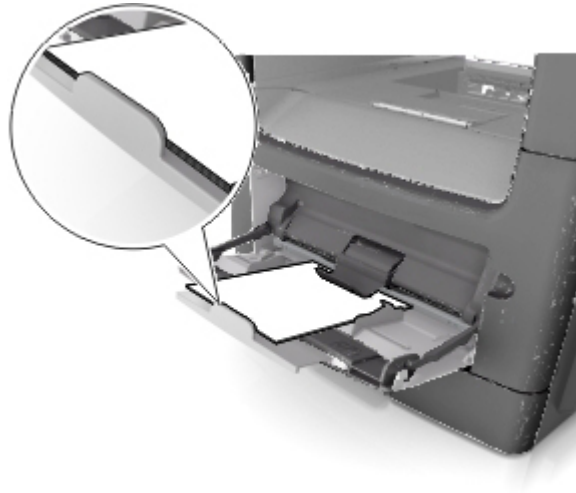

- Load letterhead faceup with the top edge entering the printer first. For two-sided (duplex) printing, load letterhead facedown with the bottom edge entering the printer first.



- Load envelopes with the flap on the left side facedown.



Warning—Potential Damage: Never use envelopes with stamps, clasps, snaps, windows, coated linings, or self-stick adhesives. These envelopes may severely damage the printer.

5. From the printer control panel, set the paper size and paper type in the Paper menu to match the paper or specialty media loaded in the multipurpose feeder.

Linking and unlinking trays

When one linked tray becomes empty, paper feeds from the next linked tray. We recommend giving all custom paper, such as letterhead and different colored plain papers, a different custom type name so that the trays they are in do not automatically link.

Linking and unlinking trays

1. Open a Web browser, and then type the printer IP address in the address field.

Notes:

- View the printer IP address on the printer home screen. The IP address appears as four sets of numbers separated by periods, such as 123.123.123.123.
- If you are using a proxy server, then temporarily disable it to load the Web page correctly.

2. Click **Settings >Paper Menu**.

3. Change the paper size and type settings for the trays you are linking.

- To link trays, make sure the paper size and type for the tray match that of the other tray.
- To unlink trays, make sure the paper size or type for the tray does *not* match that of the other tray.

4. Click **Submit**.

Note: You can also change the paper size and type settings using the printer control panel. For more information, see [Setting the paper size and type](#).

Warning—Potential Damage: Paper loaded in the tray should match the paper type name assigned in the printer. The temperature of the fuser varies according to the specified paper type. Printing issues may occur if settings are not properly configured.

Creating a custom name for a paper type

Using the Embedded Web Server

1. Open a Web browser, and then type the printer IP address in the address field.

Notes:

- View the printer IP address on the printer home screen. The IP address appears as four sets of numbers separated by periods, such as 123.123.123.123.
- If you are using a proxy server, then temporarily disable it to load the Web page correctly.

2. Click **Settings >Paper Menu >Custom Names**.

3. Select a custom name, and then type a custom paper type name.

4. Click **Submit**.

5. Click **Custom Types**, and then verify if the new custom paper type name has replaced the custom name.

Using the printer control panel

1. From the home screen, navigate to:



>Paper Menu >Custom Names

2. Select a custom name, and then type a custom paper type name.

3. Touch .
4. Touch **Custom Types**, and then verify that the new custom paper type name has replaced the custom name.

Assigning a custom paper type

Using the Embedded Web Server

Assign a custom paper type name to a tray when linking or unlinking trays.

1. Open a Web browser, and then type the printer IP address in the address field.

Notes:

- View the printer IP address on the printer home screen. The IP address appears as four sets of numbers separated by periods, such as 123.123.123.123.
- If you are using a proxy server, then temporarily disable it to load the Web page correctly.

2. Click **Settings >Paper Menu >Custom Types**.
3. Select a custom paper type name, and then select a paper type

Note: Paper is the factory default paper type for all user-defined custom names.

4. Click **Submit**.

Using the printer control panel

1. From the home screen, navigate to:



>Paper Menu >Custom Types

2. Select a custom paper type name, and then select a paper type

Note: Paper is the factory default paper type for all user-defined custom names.

3. Touch .

Configuring a custom name

Using the Embedded Web Server

1. Open a Web browser, and then type the printer IP address in the address field.

Notes:

- View the printer IP address on the printer home screen. The IP address appears as four sets of numbers separated by periods, such as 123.123.123.123.
- If you are using a proxy server, then temporarily disable it to load the Web page correctly.

2. Click **Settings >Paper Menu >Custom Types**.

3. Select a custom name you want to configure, then select a paper or specialty media type, and then click **Submit**.

Using the printer control panel

1. From the home screen, navigate to:



>**Paper Menu** >**Custom Types**

2. Select a custom name you want to configure, and then touch .

7—Paper and specialty media guide

Using specialty media

Tips on using letterhead

- Use letterhead designed specifically for laser printers.
- Print samples on the letterhead being considered for use before buying large quantities.
- Before loading letterhead, flex, fan, and straighten the stack to prevent sheets from sticking together.
- Page orientation is important when printing on letterhead. For information on how to load letterhead, see:
 - [Loading trays](#)
 - [Loading the multipurpose feeder](#)

Tips on using transparencies

- Print a test page on the transparencies being considered for use before buying large quantities.
- Feed transparencies from the standard tray, or the multipurpose feeder.
- Use transparencies designed specifically for laser printers. Transparencies must be able to withstand temperatures up to 185°C (365°F) without melting, discoloring, offsetting, or releasing hazardous emissions.
Note: If the transparency weight is set to Heavy and the transparency texture is set to Rough in the Paper menu, then transparencies can be printed at a temperature up to 195°C (383°F).
- Avoid getting fingerprints on the transparencies to prevent print quality problems.
- Before loading transparencies, flex, fan, and straighten the stack to prevent sheets from sticking together.

Tips on using envelopes

Print samples on the envelopes being considered for use before buying large quantities.

- Use envelopes designed specifically for laser/LED printers. Check with the manufacturer or vendor to ensure that the envelopes can withstand temperatures up to 220°C (446°F) without sealing, wrinkling, curling excessively, or releasing hazardous emissions.
- For best performance, use envelopes made from 90 g/m² (24 lb bond) paper or 25% cotton. All-cotton envelopes must not exceed 70 g/m² (20 lb bond) weight.
- Use only new envelopes from undamaged packages.

- To optimize performance and minimize jams, do not use envelopes that:
 - Have excessive curl or twist
 - Are stuck together or damaged in any way
 - Have windows, holes, perforations, cutouts, or embossing
 - Have metal clasps, string ties, or folding bars
 - Have an interlocking design
 - Have postage stamps attached
 - Have any exposed adhesive when the flap is in the sealed or closed position
 - Have bent corners
 - Have rough, cockle, or laid finishes

- Adjust the width guides to fit the width of the envelopes.

Note: A combination of high humidity (over 60%) and the high printing temperature may wrinkle or seal envelopes.

Tips on using labels

Print samples on the labels being considered for use before buying large quantities.

Note: Use only paper label sheets. Vinyl, pharmacy, and two-sided labels are not supported.

When printing on labels:

- Use labels designed specifically for laser printers. Check with the manufacturer or vendor to verify that:
 - The labels can withstand temperatures up to 230°C (446°F) without sealing, excessive curling, wrinkling, or releasing hazardous emissions.
 - Label adhesives, face sheet (printable stock), and topcoats can withstand up to 25-psi (172-kPa) pressure without delaminating, oozing around the edges, or releasing hazardous fumes.
- Do not use labels with slick backing material.
- Use full label sheets. Partial sheets may cause labels to peel off during printing, resulting in a jam. Partial sheets also contaminate the printer and the cartridge with adhesive, and could void the printer and toner cartridge warranties.
- Do not use labels with exposed adhesive.
- Do not print within 1 mm (0.04 inches) of the edge of the label, of the perforations, or between die-cuts of the label.
- Make sure the adhesive backing does not reach to the edge of the sheet. Zone coating of the adhesive should be at least 1 mm (0.04 inches) away from edges. Adhesive material contaminates the printer and could void the warranty.

- If zone coating of the adhesive is not possible, then remove a 2-mm (0.06-inches) strip on the leading and driver edge, and use a non-oozing adhesive.
- Portrait orientation is recommended, especially when printing bar codes.

Tips on using card stock

Card stock is heavy, single-ply specialty media. Many of its variable characteristics, such as moisture content, thickness, and texture, can significantly impact print quality. Print samples on the card stock being considered for use before buying large quantities.

- From the Paper menu, set the Paper Type to Card Stock.
- Select the appropriate Paper Texture setting.
- Be aware that preprinting, perforation, and creasing may significantly affect the print quality and cause jams or other paper handling problems.
- Check with the manufacturer or vendor to ensure the card stock can withstand temperatures up to 220°C (446°F) without releasing hazardous emissions.
- Do not use preprinted card stock manufactured with chemicals that may contaminate the printer. Preprinting introduces semi-liquid and volatile components into the printer.
- Use grain short card stock when possible.

Paper guidelines

Selecting the correct paper or specialty media reduces printing problems. For the best print quality, try a sample of the paper or specialty media before buying large quantities.

Paper characteristics

The following paper characteristics affect print quality and reliability. Consider these characteristics when evaluating new paper stock.

Weight

The standard printer trays can automatically feed paper weights up to 120-g/m² (32-lb) bond grain long paper. The optional trays can automatically feed paper weights up to 120-g/m² (32-lb) bond grain long paper. The multipurpose feeder can automatically feed paper weights up to 163-g/m² (43-lb) bond grain long paper. Paper lighter than 60 g/m² (16 lb) might not be stiff enough to feed properly, causing jams. For best performance, use 75-g/m² (20-lb) bond grain long paper. For paper smaller than 182 x 257 mm (7.2 x 10.1 inches), it is recommended to use 90 g/m² (24 lb) or heavier paper.

Note: Two-sided printing is supported only for 60–90-g/m² (16–24-lb) bond paper.

Curl

Curl is the tendency for paper to curl at its edges. Excessive curl can cause paper feeding problems. Curl can occur after the paper passes through the printer, where it is exposed to high temperatures. Storing

paper unwrapped in hot, humid, cold, or dry conditions, even in the trays, can contribute to paper curling prior to printing and can cause feeding problems.

Smoothness

Paper smoothness directly affects print quality. If paper is too rough, toner cannot fuse to it properly. If paper is too smooth, it can cause paper feeding or print quality issues. Always use paper between 100 and 300 Sheffield points; smoothness between 150–250 Sheffield points produces the best print quality.

Moisture content

The amount of moisture in paper affects both print quality and the ability of the printer to feed the paper correctly. Leave paper in its original wrapper until it is time to use it. This limits the exposure of paper to moisture changes that can degrade its performance.

Condition paper before printing by storing it in its original wrapper in the same environment as the printer for 24–48 hours before printing. Extend the time to several days if the storage or transportation environment is very different from the printer environment. Thick paper may also require a longer conditioning period.

Grain direction

Grain refers to the alignment of the paper fibers in a sheet of paper. Grain is either *grain long*, running the length of the paper, or *grain short*, running the width of the paper.

For 60–90-g/m² (16–24-lb) bond paper, grain long paper is recommended.

Fiber content

Most high-quality xerographic paper is made from 100% chemically treated pulped wood. This content provides the paper with a high degree of stability resulting in fewer paper feeding problems and better print quality. Paper containing fibers such as cotton can negatively affect paper handling.

Unacceptable paper

The following paper types are not recommended for use with the printer:

- Chemically-treated papers used to make copies without carbon paper, also known as carbonless papers, carbonless copy paper (CCP), or no carbon required (NCR) paper
- Preprinted papers with chemicals that may contaminate the printer
- Preprinted papers that can be affected by the temperature in the printer fuser
- Preprinted papers that require a registration (the precise print location on the page) greater than ±2.4 mm (±0.9 inch), such as optical character recognition (OCR) forms

In some cases, registration can be adjusted with a software application to successfully print on these forms:

- Coated papers (erasable bond), synthetic papers, thermal papers
- Rough-edged, rough or heavily textured surface papers, or curled papers

- Recycled papers that fail EN12281:2002 (European)
- Paper weighing less than 60 g/m² (16 lb)
- Multiple-part forms or documents

Selecting paper

Using the appropriate paper prevents jams and helps ensure trouble-free printing.

To help avoid paper jams and poor print quality:

- *Always* use new, undamaged paper.
- Before loading paper, know the recommended printable side of the paper. This information is usually indicated on the paper package.
- *Do not* use paper that has been cut or trimmed by hand.
- *Do not* mix paper sizes, types, or weights in the same tray; mixing results in jams.
- *Do not* use coated papers unless they are specifically designed for electrophotographic printing.

Selecting preprinted forms and letterhead

Use these guidelines when selecting preprinted forms and letterhead:

- Use grain long for 60 to 90 g/m² (16 to 24 lb) weight paper.
- Use only forms and letterhead printed using an offset lithographic or engraved printing process.
- Avoid papers with rough or heavily textured surfaces.

Use papers printed with heat-resistant inks designed for use in xerographic copiers. The ink must be able to withstand temperatures up to 190°C (374°F) without melting or releasing hazardous emissions. Use inks that are not affected by the resin in toner. Inks that are oxidation-set or oil-based generally meet these requirements; latex inks might not. When in doubt, contact the paper supplier.

Preprinted papers such as letterhead must be able to withstand temperatures up to 190°C (374°F) without melting or releasing hazardous emissions.

Storing paper

Use these paper storage guidelines to help avoid jams and uneven print quality:

- For best results, store paper where the temperature is 21°C (70°F) and the relative humidity is 40 percent. Most label manufacturers recommend printing in a temperature range of 18–24°C (65–75°F) with relative humidity between 40 and 60 percent.
- Store paper in cartons, on a pallet or shelf, rather than on the floor.
- Store individual packages on a flat surface.
- Do not store anything on top of individual paper packages.

- Take paper out of the carton or wrapper only when you are ready to load it in the printer. The carton and wrapper help keep the paper clean, dry, and flat.

Supported paper sizes, types, and weights

Supported paper sizes

Paper size and dimension	Standard 250-sheet tray	Optional 250- or 550-sheet tray	Multipurpose feeder	ADF	Scanner glass	Duplex mode
Business card	X	X	X	X	✓	X
3 x 5 in.	X	X	✓	X	✓	X
4 x 6 in.	X	X	✓	X	✓	X
A4 210 x 297 mm (8.27 x 11.7 in.)	✓	✓	✓	✓	✓	✓
A5 148 x 210 mm (5.83 x 8.27 in.)	✓	✓	✓	✓	✓	X
A6 105 x 148 mm (4.13 x 5.83 in.)	✓	X	✓	✓	✓	X
JIS B5 182 x 257 mm (7.17 x 10.1 in.)	✓	✓	✓	✓	✓	X
Letter 215.9 x 279.4 mm (8.5 x 11 in.)	✓	✓	✓	✓	✓	✓
Legal 215.9 x 355.6 mm (8.5 x 14 in.)	✓	✓	✓	✓	✓	✓
Executive 184.2 x 266.7 mm (7.25 x 10.5 in.)	✓	✓	✓	✓	✓	X

User's Guide

Paper size and dimension	Standard 250-sheet tray	Optional 250- or 550-sheet tray	Multipurpose feeder	ADF	Scanner glass	Duplex mode
Oficio (México) 215.9 x 340.4 mm (8.5 x 13.4 in.)	✓	✓	✓	✓	X	✓
Folio 215.9 x 330 mm (8.5 x 13 in.)	✓	✓	✓	✓	X	✓
Statement 139.7 x 215.9 mm (5.5 x 8.5 in.)	✓	✓	✓	✓	✓	X
Universal* 76.2 x 127 mm to 215.9 x 355.6 mm (3 x 5 in. to 8.5 x 14 in.)	✓	✓	✓	✓	✓	✓
7 3/4 Envelope (Monarch) 98.4 x 190.5 mm (3.875 x 7.5 in.)	X	X	✓	X	X	X
9 Envelope 98.4 x 225.4 mm (3.875 x 8.9 in.)	X	X	✓	X	X	X
10 Envelope 104.8 x 241.3 mm (4.12 x 9.5 in.)	X	X	✓	X	X	X
DL Envelope 110 x 220 mm (4.33 x 8.66 in.)	X	X	✓	X	X	X
C5 Envelope 162 x 229 mm (6.38 x 9.01 in.)	X	X	✓	X	X	X

Paper size and dimension	Standard 250-sheet tray	Optional 250- or 550-sheet tray	Multipurpose feeder	ADF	Scanner glass	Duplex mode
B5 Envelope 176 x 250 mm (6.93 x 9.84 in.)	X	X	✓	X	X	X
Other Envelope 85.7 x 165 mm to 215.9 x 355.6 mm (3.375 x 6.50 in. to 8.5 x 14 in.)	X	X	✓	X	X	X
* To support two-sided (duplex) printing, the Universal width must be between 139.7 mm (5.5 in.) and 215.9 mm (8.5 in.); the Universal length must be between 210 mm (8.27 in.) and 355.6 mm (14 in.).						

Supported paper types and weights

The standard tray supports 60–120-g/m² (16–32-lb) paper weights. The optional tray supports 60–120-g/m² (16–32-lb) paper weights. The multipurpose feeder supports 60–163-g/m² (16–43-lb) paper weights.

Paper type	250- or 550-sheet tray	Multipurpose feeder	Duplex mode	ADF	Scanner glass
Plain paper	✓	✓	✓	✓	✓
Card stock	X	✓	X	✓	✓
Transparencies	✓ ¹	✓	X	✓	✓
Recycled	✓	✓	✓	✓	✓
Paper labels ²	✓	✓	X	✓	✓
Bond	✓	✓	✓	✓	✓
Envelope ³	X	✓	X	X	✓
Rough envelope	X	✓	X	X	✓
Letterhead	✓	✓	✓	✓	✓
Preprinted	✓	✓	✓	✓	✓

User's Guide

Paper type	250- or 550-sheet tray	Multipurpose feeder	Duplex mode	ADF	Scanner glass
Colored paper	✓	✓	✓	✓	✓
Light paper	✓	✓	✓	✓	✓
Heavy paper	✓	✓	✓	✓	✓
Rough/Cotton	✓	✓	x	✓	✓
Custom Type [x]	✓	✓	✓	✓	✓

¹ Transparencies are supported only in 250-sheet tray.

² One-sided paper labels designed for laser printers are supported for occasional use. We recommend printing only up to 20 pages of paper labels per month. Vinyl, pharmacy, and two-sided labels are not supported.

³ Use envelopes that lie flat when individually placed on a table facedown.

8—Printing



Printing forms and a document

Printing forms

Use the Forms and Favorites application to quickly and easily access frequently used forms or other information that is regularly printed. Before you can use this application, first set it up on the printer. For more information, see [Setting up Forms and Favorites](#).

1. From the printer home screen, navigate to:

Forms and Favorites > select the form from the list > enter the number of copies > adjust other settings

2. Depending on your printer model, touch , , or **Submit**.

Printing a document

1. From the Paper menu on the printer control panel, set the paper type and size to match the paper loaded.
2. Send the print job:

For Windows users

- a. With a document open, click **File >Print**.
- b. Click **Properties**, **Preferences**, **Options**, or **Setup**.
- c. Adjust the settings, if necessary.
- d. Click **OK >Print**.

Note: For details on the Printing Preferences settings, refer to the Help for the Driver.

For Macintosh users

- a. Customize the settings in the Page Setup dialog:
 1. With a document open, choose **File >Page Setup**.
 2. Choose a paper size or create a custom size to match the paper loaded.
 3. Click **OK**.
- b. Customize the settings in the Print dialog:
 1. With a document open, choose **File >Print**.

If necessary, click the disclosure triangle to see more options.

2. From the Print dialog and pop-up menus, adjust the settings if necessary.

Note: To print on a specific paper type, adjust the paper type setting to match the paper loaded, or select the appropriate tray or feeder.

3. Click **Print**.

Adjusting toner darkness

Using the Embedded Web Server

1. Open a Web browser, and then type the printer IP address in the address field.

Notes:

- View the printer IP address on the printer home screen. The IP address appears as four sets of numbers separated by periods, such as 123.123.123.123.
- If you are using a proxy server, then temporarily disable it to load the Web page correctly.

2. Click **Settings >Print Settings >Quality Menu >Toner Darkness**.
3. Adjust the setting, and then click **Submit**.

Using the printer control panel

1. From the home screen, navigate to:



>Settings >Print Settings >Quality Menu >Toner Darkness

2. Adjust the setting, and then touch .

Printing from a flash drive

Printing from a flash drive

Notes:

- Before printing an encrypted PDF file, you will be prompted to type the file password from the printer control panel.
- You cannot print files for which you do not have printing permissions.

1. Insert a flash drive into the USB port.

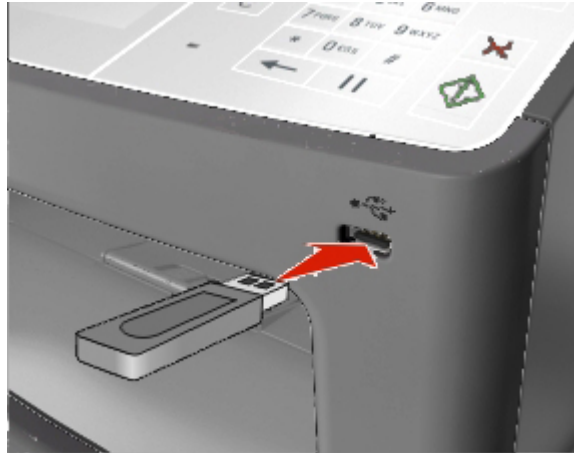



Notes:

- A flash drive icon appears on the printer home screen when a flash drive is inserted.
- If you insert the flash drive when the printer requires attention, such as when a jam has occurred, then the printer ignores the flash drive.
- If you insert the flash drive while the printer is processing other print jobs, then **Busy** appears on the printer display. After these print jobs are processed, you may need to view the held jobs list to print documents from the flash drive.

Warning—Potential Damage: Do not touch the USB cable, any wireless network adapter, any connector, the memory device, or the printer in the areas shown while actively printing, reading, or writing from the memory device. Loss of data can occur.



2. From the printer control panel, touch the document you want to print.
3. Touch the arrows to get a preview of the document.

- Use  or  to specify the number of copies to be printed, and then touch **Print**.

Notes:

- Do not remove the flash drive from the USB port until the document has finished printing.
- If you leave the flash drive in the printer after leaving the initial USB menu screen, then touch **Held Jobs** on the home screen to print files from the flash drive.

Supported flash drives and file types

Notes:

- High-speed USB flash drives must support the full-speed standard. Low-speed USB devices are not supported.
- USB flash drives must support the File Allocation Table (FAT) system. Devices formatted with New Technology File System (NTFS) or any other file system are not supported.

Recommended flash drives	File type
<ul style="list-style-type: none"> • Lexar JumpDrive FireFly (512MB and 1GB) • SanDisk Cruzer Micro (512MB and 1GB) • Sony Micro Vault Classic (512MB and 1GB) 	<p>Documents:</p> <ul style="list-style-type: none"> • .pdf • .xps <p>Images:</p> <ul style="list-style-type: none"> • .dcx • .gif • .jpeg or .jpg • .bmp • .pcx • .tiff or .tif • .png

Printing confidential and other held jobs

Storing print jobs in the printer

- From the home screen, navigate to:



>**Security** >**Confidential Print** > select a print job type

Use	To
Max Invalid PIN	Limit the number of times an invalid PIN can be entered. Note: When the limit is reached, the print jobs for that user name and PIN are deleted.
Confidential Job Expiration	Hold print jobs in the computer until you enter the PIN from the printer control panel. Note: The PIN is set from the computer. It must be four digits, using the numbers 0–9.
Repeat Job Expiration	Print and store print jobs in the printer memory.
Verify Job Expiration	Print one copy of a print job and hold the remaining copies. It lets you examine if the first copy is satisfactory or not. The print job is automatically deleted from the printer memory when all copies are printed.
Reserve Job Expiration	Store print jobs for printing at a later time. Note: The print jobs are held until deleted from the Held Jobs menu.
<p>Notes:</p> <ul style="list-style-type: none"> • Confidential, Verify, Reserve, and Repeat print jobs may be deleted if the printer requires extra memory to process additional held jobs. • You can set the printer to store print jobs in the printer memory until you start the print job from the printer control panel. • All print jobs that can be initiated by the user at the printer are called <i>held jobs</i>. 	

2. Touch .

Printing confidential and other held jobs

Note: Confidential and Verify print jobs are automatically deleted from memory after printing. Repeat and Reserve jobs are *held* in the printer until you delete them.

For Windows users

1. With a document open, click **File >Print**.
2. Click **Properties** or **Preferences, Basic** tab.
3. Click **Job Retention**.
4. Select the print job type (Confidential, Repeat, Reserve, or Verify), For a confidential print job, enter a four-digit PIN.
5. Click **OK** or **Print**.

6. From the printer home screen, release the print job.
 - For confidential print jobs, navigate to:
Held Jobs > select your user name >**Confidential** > enter the PIN >Print
 - For other print jobs, navigate to:
Held Jobs > select your user name > select the print job > specify the number of copies >Print

For Macintosh users

1. With a document open, choose **File >Print**.
If necessary, click the disclosure triangle to see more options.
2. From the print options or Copies & Pages pop-up menu, choose **Job Retention**.
3. Select the print job type (Confidential, Repeat, Reserve, or Verify), For a confidential print job, enter a four-digit PIN.
4. Click **OK** or **Print**.
5. From the printer home screen, release the print job.
 - For confidential print jobs, navigate to:
Held Jobs > select your user name >**Confidential** > enter the PIN >Print
 - For other print jobs, navigate to:
Held Jobs > select your user name > select the print job > specify the number of copies >Print

Modifying confidential print settings

Note: This feature is available only in network printers or printers connected to print servers.

1. Open a Web browser, and then type the printer IP address in the address field.
Notes:
 - View the printer IP address on the printer home screen. The IP address appears as four sets of numbers separated by periods, such as 123.123.123.123.
 - If you are using a proxy server, then temporarily disable it to load the Web page correctly.
2. Click **Settings >Other Settings** tab >**Security >Confidential Print Setup**.
3. Modify the settings:
 - Set a maximum number of PIN entry attempts. When a user exceeds that number, all of the jobs for that user are deleted.
 - Set an expiration time for confidential print jobs. When a user has not printed the jobs within that time, all of the jobs for that user are deleted.
4. Save the modified settings.

Printing information pages

Printing a font sample list

1. From the home screen, navigate to:

 > **Reports** > **Print Fonts**

2. Touch **PCL Fonts** or **PostScript Fonts**.

Printing a directory list



A directory list shows the resources stored in a flash memory or in the printer hard disk.

From the home screen, navigate to:

 > **Reports** > **Print Directory**

Canceling a print job

Canceling a print job from the printer control panel

1. From the home screen, touch **Cancel Jobs**, or press  on the keypad.
2. Touch the job you want to cancel, and then touch .
3. Press  on the keypad to return to the home screen.

Canceling a print job from the computer

For Windows users

1. Open the printers folder.

In Windows 8

From the Search charm, type **run**, and then navigate to:

Apps list > **Run** > type **control printers** > **OK**

In Windows 7 or earlier



- a. Click , or click **Start** and then click **Run**.
 - b. In the Start Search or Run dialog, type **control printers**.
 - c. Press **Enter**, or click **OK**.
2. Double-click the printer icon.

3. Select the print job you want to cancel.
4. Click **Delete**.

For Macintosh users

1. From the Apple Menu, navigate to either of the following:
 - (For Mac OS X v10.3/v10.4/v10.5/v10.6)
System Preferences >Print & Fax > select a printer >Open Print Queue
 - (For Mac OS X v10.7/v10.8)
System Preferences >Print & Scan > select a printer >Open Print Queue
2. From the printer window, select the print job you want to cancel, and then click **Delete**.

9—Copying

ADF	Scanner glass
 <p data-bbox="188 747 636 804">Use the ADF for multiple-page documents including two-sided (duplex) pages.</p>	 <p data-bbox="703 825 1390 909">Use the scanner glass for single-page documents, book pages, small items (such as postcards or photos), transparencies, photo paper, or thin media (such as magazine clippings).</p>

Making copies

Making a quick copy

1. Load an original document faceup, short edge first into the ADF tray or facedown on the scanner glass.

Notes:

- Do not load postcards, photos, small items, transparencies, photo paper, or thin media (such as magazine clippings) into the ADF tray. Place these items on the scanner glass.
- The ADF indicator light comes on when the paper is loaded properly.

2. If you are loading a document into the ADF tray, then adjust the paper guides.

Note: To avoid a cropped image, make sure the size of the original document and the size of the copy paper are the same.

3. From the printer control panel, press .

Copying using the ADF

1. Load an original document faceup, short edge first into the ADF tray.

Notes:

- Do not load postcards, photos, small items, transparencies, photo paper, or thin media (such as magazine clippings) into the ADF tray. Place these items on the scanner glass.
- The ADF indicator light comes on when the paper is loaded properly.

2. Adjust the paper guides.
3. From the home screen, navigate to:
Copy > specify the copy settings > **Copy It**

Copying using the scanner glass

1. Place an original document facedown on the scanner glass in the upper left corner.
2. From the home screen, navigate to:
Copy > specify the copy settings > **Copy It**
If you have more pages to scan, then place the next document on the scanner glass, and then touch **Scan the next page**.
3. Touch **Finish the Job**.

Copying photos

1. Place a photo facedown on the scanner glass in the upper left corner.
2. From the home screen, navigate to:
Copy > **Content** > **Photo** > 
3. From the Content Source menu, navigate to:

Photo/Film >  > **Copy It**

Note: If you have more photos to copy, then place the next photo on the scanner glass, and then touch **Scan the next page**.

4. Touch **Finish the Job**.

Copying on specialty media

Copying on transparencies

1. Load an original document faceup, short edge first into the ADF tray or facedown on the scanner glass.

Notes:

- Do not load postcards, photos, small items, transparencies, photo paper, or thin media (such as magazine clippings) into the ADF tray. Place these items on the scanner glass.
- The ADF indicator light comes on when the paper is loaded properly.

2. From the home screen, navigate to:

Copy >Copy from > select the size of the original document

3. Navigate to:

Copy to > select the tray that contains transparencies >**Copy It**

If there are no trays that support transparencies, then navigate to:

Multipurpose Feeder > select the size of the transparencies >**Transparency**

4. Load transparencies into the multipurpose feeder, and then touch **Copy It**.

Copying on letterhead

1. Load an original document faceup, short edge first into the ADF tray or facedown on the scanner glass.

Notes:

- Do not load postcards, photos, small items, transparencies, photo paper, or thin media (such as magazine clippings) into the ADF tray. Place these items on the scanner glass.
- The ADF indicator light comes on when the paper is loaded properly.

2. From the home screen, navigate to:

Copy >Copy from > select the size of the original document

3. Touch **Copy to > Multipurpose Feeder**.

4. Place the letterhead faceup, top edge first into the multipurpose feeder.

5. Select the size of the letterhead, and then touch **Letterhead >Copy It**.

Customizing copy settings

Copying to a different size

1. Load an original document faceup, short edge first into the ADF tray or facedown on the scanner glass.

Notes:

- Do not load postcards, photos, small items, transparencies, photo paper, or thin media (such as magazine clippings) into the ADF tray. Place these items on the scanner glass.
- The ADF indicator light comes on when the paper is loaded properly.

2. If you are loading a document into the ADF tray, then adjust the paper guides.
3. From the home screen, navigate to:

Copy >Copy from > select the size of the original document

4. Navigate to:

Copy to > select a new size for the copy >**Copy It**

Note: If the selected paper size is different from the “Copy from” size, then the printer scales the size automatically.

Making copies using paper from a selected tray

1. Load an original document faceup, short edge first into the ADF tray or facedown on the scanner glass.

Notes:

- Do not load postcards, photos, small items, transparencies, photo paper, or thin media (such as magazine clippings) into the ADF tray. Place these items on the scanner glass.
- The ADF indicator light comes on when the paper is loaded properly.

2. If you are loading a document into the ADF tray, then adjust the paper guides.
3. From the home screen, navigate to:

Copy >Copy from > select the size of the original document

4. Touch **Copy to**, and then select the tray that contains the paper type you want to use.
5. Touch **Copy It**.

Copying different paper sizes

Use the ADF to copy original documents with different paper sizes. Depending on the paper sizes loaded and the “Copy to” and “Copy from” settings, each copy is either printed on mixed paper sizes (Example 1) or scaled to fit a single paper size (Example 2).

Example 1: Copying on mixed paper sizes

1. Load an original document faceup, short edge first into the ADF tray or facedown on the scanner glass.

Notes:

- Do not load postcards, photos, small items, transparencies, photo paper, or thin media (such as magazine clippings) into the ADF tray. Place these items on the scanner glass.
 - The ADF indicator light comes on when the paper is loaded properly.
2. If you are loading a document into the ADF tray, then adjust the paper guides.
 3. From the home screen, navigate to:

Copy >Copy from >Mixed Sizes >Copy to >Auto Size Match >Copy It

The scanner identifies the different paper sizes as they are scanned. Copies are printed on mixed paper sizes corresponding to the paper sizes of the original document.

Example 2: Copying on a single paper size

1. Load an original document faceup, short edge first into the ADF tray or facedown on the scanner glass.

Notes:

- Do not load postcards, photos, small items, transparencies, photo paper, or thin media (such as magazine clippings) into the ADF tray. Place these items on the scanner glass.
 - The ADF indicator light comes on when the paper is loaded properly.
2. If you are loading a document into the ADF tray, then adjust the paper guides.
 3. From the home screen, navigate to:

Copy >Copy from >Mixed Sizes >Copy to >Letter >Copy It

The scanner identifies the different paper sizes as they are scanned, and then scales the mixed paper sizes to fit on the paper size selected.

Copying on both sides of the paper (duplexing)

1. Load an original document faceup, short edge first into the ADF tray or facedown on the scanner glass.

Notes:

- Do not load postcards, photos, small items, transparencies, photo paper, or thin media (such as magazine clippings) into the ADF tray. Place these items on the scanner glass.
 - The ADF indicator light comes on when the paper is loaded properly.
2. If you are loading a document into the ADF tray, then adjust the paper guides.
 3. From the home screen, navigate to:

Copy >Sides (Duplex) > select the preferred duplexing method

Note: For the preferred duplexing method, the first number represents sides of the original documents while the second number represents sides of the copy. For example, select “2 sided to 2 sided” if you have two-sided original documents and you want two-sided copies.

4. Touch  >Copy It.

Reducing or enlarging copies

Copies can be scaled from 25% to 400% of the original document size.



1. Load an original document faceup, short edge first into the ADF tray or facedown on the scanner glass.

Notes:

- Do not load postcards, photos, small items, transparencies, photo paper, or thin media (such as magazine clippings) into the ADF tray. Place these items on the scanner glass.
- The ADF indicator light comes on when the paper is loaded properly.

2. If you are loading a document into the ADF tray, then adjust the paper guides.

3. From the home screen, touch **Copy**.

4. From the Scale area, touch  or  to enlarge or reduce your copies.

Notes:

- The factory default setting for Scale is Auto.
- If you leave Scale set to Auto, then the content of your original document will be scaled to fit the size of the paper onto which you are copying.
- Touching **Copy to** or **Copy from** after setting Scale manually changes the scale value back to Auto.

5. Touch **Copy It**.

Adjusting copy quality

1. Load an original document faceup, short edge first into the ADF tray or facedown on the scanner glass.



Notes:

- Do not load postcards, photos, small items, transparencies, photo paper, or thin media (such as magazine clippings) into the ADF tray. Place these items on the scanner glass.
- The ADF indicator light comes on when the paper is loaded properly.

2. If you are loading a document into the ADF tray, then adjust the paper guides.

3. From the home screen, navigate to:

Copy >Content

4. Touch the button that best represents the content type of the document you are copying.
 - **Text**—The content of the original document is mostly text or line art.
 - **Text/Photo**—The original document is a mixture of text, graphics, and photos.
 - **Photo**—The original document is mostly a photo or an image.
 - **Graphics**—The original document is mostly business-type graphics, such as pie charts, bar charts, and animations.
5. Touch .
6. Touch the button that best represents the content source of the document you are copying.
 - **Color Laser**—The original document was printed using a color laser printer.
 - **Inkjet**—The original document was printed using an inkjet printer.
 - **Magazine**—The original document is from a magazine.
 - **Press**—The original document was printed using a printing press.
 - **Black/White Laser**—The original document was printed using a mono laser printer.
 - **Photo/Film**—The original document is a photo from a film.
 - **Newspaper**—The original document is from a newspaper.
 - **Other**—The original document was printed using an alternate or unknown printer.
7. Touch  >Copy It.

Collating copies

If you print multiple copies of a document, then you can choose to print the copies as a set (collated) or to print the copies as groups of pages (not collated).

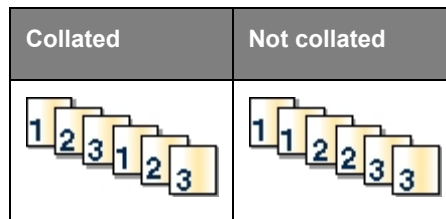

1. Load an original document faceup, short edge first into the ADF tray or facedown on the scanner glass.

Notes:

- Do not load postcards, photos, small items, transparencies, photo paper, or thin media (such as magazine clippings) into the ADF tray. Place these items on the scanner glass.
- The ADF indicator light comes on when the paper is loaded properly.

2. If you are loading a document into the ADF tray, then adjust the paper guides.
3. From the home screen, navigate to:

Copy > enter the number of copies > **Collate** > select the preferred order of pages >  > **Copy It**

Placing separator sheets between copies

1. Load an original document faceup, short edge first into the ADF tray or facedown on the scanner glass.

Notes:

- Do not load postcards, photos, small items, transparencies, photo paper, or thin media (such as magazine clippings) into the ADF tray. Place these items on the scanner glass.
 - The ADF indicator light comes on when the paper is loaded properly.
2. If you are loading a document into the ADF tray, then adjust the paper guides.
 3. From the home screen, navigate to:

Copy > **Separator Sheets**

Note: Set Collate to “1,2,3 - 1,2,3” to place separator sheets between copies. If Collate is set to “1,1,1 - 2,2,2,” then the separator sheets are added to the end of the copy job. For more information, see [Collating copies](#).

4. Select one of the following:

- **Between Copies**
- **Between Jobs**
- **Between Pages**
- **Off**

5. Touch  > **Copy It**.

Copying multiple pages onto a single sheet

In order to save paper, you can copy either two or four consecutive pages of a multiple-page document onto a single sheet of paper.

Notes:

- Make sure to set the paper size to letter, legal, A4, or JIS B5.
- Make sure to set the copy size to 100%.

1. Load an original document faceup, short edge first into the ADF tray or facedown on the scanner glass.

Notes:

- Do not load postcards, photos, small items, transparencies, photo paper, or thin media (such as magazine clippings) into the ADF tray. Place these items on the scanner glass.
- The ADF indicator light comes on when the paper is loaded properly.

2. If you are loading a document into the ADF tray, then adjust the paper guides.
3. From the home screen, navigate to:

Copy >Paper Saver > select the output you want >  **>Copy It**

Note: If Paper Saver is set to Off, then the Print Page Borders option is unavailable.

Placing information on copies

Placing a header or footer on pages





1. Load an original document faceup, short edge first into the ADF tray or facedown on the scanner glass.

Notes:

- Do not load postcards, photos, small items, transparencies, photo paper, or thin media (such as magazine clippings) into the ADF tray. Place these items on the scanner glass.
- The ADF indicator light comes on when the paper is loaded properly.

2. If you are loading a document into the ADF tray, then adjust the paper guides.
3. From the home screen, navigate to:

Copy >Header/Footer

4. Select **Header** or **Footer**, and then touch .
5. Select where you want to insert the header or footer, then select a text option, and then touch .
6. Select where you want to print the header or footer, and then touch .
7. From the Header/Footer menu, touch  **>Copy It**.

Placing an overlay message on each page

1. Load an original document faceup, short edge first into the ADF tray or facedown on the scanner glass.

Notes:

- Do not load postcards, photos, small items, transparencies, photo paper, or thin media (such as magazine clippings) into the ADF tray. Place these items on the scanner glass.
- The ADF indicator light comes on when the paper is loaded properly.

2. If you are loading a document into the ADF tray, then adjust the paper guides.
3. From the home screen, navigate to:

Copy > **Overlay** > select an overlay message > .

Note: The message choices are Urgent, Confidential, Copy, Custom, and Draft.

4. Touch **Copy It**.

Canceling a copy job

Canceling a copy job while the original document is in the ADF



When the ADF begins processing a document, touch **Cancel Job** on the printer control panel.

Canceling a copy job while copying pages using the scanner glass

From the home screen, touch **Cancel Job**.

Canceling appears on the display. When the job is canceled, the Copy screen appears.

Canceling a copy job while pages are being printed

1. From the printer control panel, press .
2. Touch the job you want to cancel, and then touch .
3. Press  to return to the home screen.

Understanding the copy options

Copy from

This option opens a screen where you can select the paper size of the original document.

- Touch the paper size that matches the original document.

- To copy an original document that contains mixed paper sizes with the same width, touch **Mixed Sizes**.
- To set the printer to automatically detect the size of the original document, touch **Auto Size Sense**.



Copy to

This option opens a screen where you can enter the paper size and type on which your copies will be printed.

- Touch the paper size and type that matches the paper loaded.
- If the settings for “Copy from” and “Copy to” are different, then the printer automatically adjusts the Scale setting to accommodate the difference.
- If the paper type or size that you want to copy onto is not loaded in one of the trays, then touch **Multipurpose Feeder**, and manually load the paper in the multipurpose feeder.
- When “Copy to” is set to Auto Size Match, each copy matches the paper size of the original document. If a matching paper size is not in one of the trays, then **Paper size not found** appears and prompts to load a paper in a tray or multipurpose feeder.

Scale

This option lets you scale the document from 25% to 400% of the original document size. You can also set automatic scaling.

- When copying to a different paper size, such as from legal-size to letter-size paper, set the “Copy from” and “Copy to” paper sizes automatically to scale the scan image to fit the size of the paper onto which you are copying.
- To decrease or increase the value by 1%, touch  or  on the printer control panel. To make a continuous decrease or increase in value, hold the button for two seconds or more.

Darkness

This option lets you adjust how light or dark the copies are in relation to the original document.

Sides (Duplex)

This option lets you make one- or two-sided copies from one- or two-sided original documents.

Collate

This option keeps the pages of a print job stacked in sequence when printing multiple copies of the document.

Copies

This option lets you set the number of copies to be printed.

Content

This option lets you set the original document type and source.

Select from the following content types:

- **Graphics**—The original document is mostly business-type graphics such as pie charts, bar charts, and animations.
- **Photo**—The original document is mostly a photo or an image.
- **Text**—The content of the original document is mostly text or line art.
- **Text/Photo**—The original document is a mixture of text, graphics, and photos.

Select from the following content sources:

- **Black/White Laser**—The original document was printed using a mono laser printer.
- **Color Laser**—The original document was printed using a color laser printer.
- **Inkjet**—The original document was printed using an inkjet printer.
- **Magazine**—The original document is from a magazine.
- **Newspaper**—The original document is from a newspaper.
- **Other**—The original document was printed using an alternate or unknown printer.
- **Photo/Film**—The original document is a photo from film.
- **Press**—The original document was printed using a printing press.

Advanced Duplex

This option lets you specify the document orientation, whether documents are one-sided or two-sided, and how documents are bound.



Save As Shortcut

This option lets you save the current settings by assigning a shortcut name.

Note: Selecting this option automatically assigns the next available shortcut number.

Margin Shift

This option lets you increase or reduce the size of the margin of a page by shifting the scanned image.

Touch  or  to set the margin you want. If the additional margin is too large, then the copy will be cropped.

Edge Erase

This option lets you remove smudges or marks around the edges of a document. You can choose to remove an equal area around all four sides of the paper, or pick a particular edge. Edge Erase also removes whatever is within the area selected, leaving nothing on that portion of the scan.

Overlay

This option lets you create a watermark (or message) that overlays the content of your copy. You can choose from Confidential, Copy, Draft, Urgent, and Custom. You can type a custom message in the "Enter the Custom Text Overlay and press OK" field. The message will appear, faintly, in large print across each page.

Cover Page Setup

This option lets you set up the cover page of copies and booklets.

Separator Sheets

This option lets you place a blank sheet of paper between copies, prints, pages, print jobs or copy jobs. The separator sheets can be drawn from a tray that contains a type or color of paper that is different from the paper your copies are printed on.

Header/Footer

This option lets you insert a header or footer and specify its location on a page.

Select one of the following:

- **Bates number**
- **Custom text**
- **Date/Time**
- **Page number**

Paper Saver

This option lets you print two or more pages of an original document on the same page. Paper Saver is also called *N-up* printing where *N* stands for the number of pages. For example, 2-up would print two pages of your document on a single page, and 4-up would print four pages of your document on a single page.

Advanced Imaging

This option lets you adjust the Auto Center, Background Removal, Color Dropout, Contrast, Mirror Image, Negative Image, Scan Edge to Edge, Shadow Detail, Sharpness, and Temperature settings before you copy the document.

Create Booklet

This option lets you create a sequence of printed and collated pages that, when folded, forms a booklet half the page size of the original document and with all the pages in order. You can choose between one-sided and two-sided.

Note: This option appears only when a printer hard disk is installed.



Custom Job

This option lets you combine multiple scan jobs into a single job and appears only when a working printer hard disk is installed.

Fix Scan Skew

This option lets you straighten scanned images that are slightly skewed when received from the ADF tray.

10—E-mailing

Automatic document feeder (ADF)	Scanner glass
 <p data-bbox="188 747 513 800">Use the ADF for multiple-page documents.</p>	 <p data-bbox="626 825 1406 905">Use the scanner glass for single pages, small items (such as postcards or photos), transparencies, photo paper, or thin media (such as magazine clippings).</p>

You can use the printer to e-mail scanned documents to one or more recipients. There are three ways to send an e-mail from the printer. You can type the e-mail address, use a shortcut number, or use the address book.

Setting up the printer to e-mail

Setting up the e-mail function

1. Open a Web browser, and then type the printer IP address in the address field.

Notes:

- View the printer IP address on the printer home screen. The IP address appears as four sets of numbers separated by periods, such as 123.123.123.123.
- If you are using a proxy server, then temporarily disable it to load the Web page correctly.

2. Click **Settings >E-mail/FTP Settings >E-mail Settings**.
3. Enter the appropriate information, and then click **Submit**.

Creating an e-mail shortcut

Creating an e-mail shortcut using the Embedded Web Server

1. Open a Web browser, and then type the printer IP address in the address field.

Notes:

- View the printer IP address on the printer home screen. The IP address appears as four sets of numbers separated by periods, such as 123.123.123.123.
- If you are using a proxy server, then temporarily disable it to load the Web page correctly.



2. Click **Settings**.
3. From the Other Settings column, click **Manage Shortcuts >E-mail Shortcut Setup**.
4. Type a unique name for the e-mail recipient, and then type the e-mail address. If you are entering multiple addresses, then separate each address with a comma.
5. Click **Add**.

Creating an e-mail shortcut using the printer control panel

1. From the home screen, navigate to:

E-mail >Recipient(s) > type the recipient's e-mail address > 

Note: To create a group of recipients, touch , and then type the next recipient's e-mail address.

2. Touch **Subject** > type the e-mail subject > .
3. Touch **Message** > type your message > .
4. Adjust the e-mail settings.

Note: If you change the settings after the e-mail shortcut has been created, then the settings are not saved.

5. Touch **Save As Shortcut**.
6. Type a unique name for the shortcut, and then touch .
7. Verify that the shortcut name is correct, and then touch **OK**.

If the shortcut name is incorrect, then touch **Cancel**, and then reenter the information.

Notes:

- The shortcut name appears in the E-mail Shortcuts icon on the printer home screen.
- You can use the shortcut when e-mailing another document using the same settings.

E-mailing a document

You can use the printer to e-mail scanned documents to one or more recipients in a number of ways. You can type the e-mail address, use a shortcut number, or use the address book. You can also use the Multi Send or MyShortcut application from the printer home screen. For more information, see the "Activating the home screen applications" section.

Sending an e-mail using the printer control panel

1. Load an original document faceup, short edge first into the ADF tray or facedown on the scanner glass.

Notes:

- Do not load postcards, photos, small items, transparencies, photo paper, or thin media (such as magazine clippings) into the ADF tray. Place these items on the scanner glass.
- The ADF indicator light comes on when the paper is loaded properly.

2. If you are loading a document into the ADF tray, then adjust the paper guides.

Note: To avoid a cropped image, make sure that the size of the original document and the copy paper size are the same.

3. From the home screen, navigate to:

E-mail >Recipient(s)

4. Type the e-mail address, or press # and then enter the shortcut number.

To enter additional recipients, touch , and then enter the e-mail address or shortcut number that you want to add.

Note: You can also enter an e-mail address using the address book.

5. Touch  >**E-mail It.**

Sending an e-mail using a shortcut number

1. Load an original document faceup, short edge first into the ADF tray or facedown on the scanner glass.

Notes:

- Do not load postcards, photos, small items, transparencies, photo paper, or thin media (such as magazine clippings) into the ADF tray. Place these items on the scanner glass.
- The ADF indicator light comes on when the paper is loaded properly.

2. If you are loading a document into the ADF tray, then adjust the paper guides.

3. Press #, then enter the shortcut number using the keypad, and then touch .

To enter additional recipients, touch , and then enter the e-mail address or shortcut number that you want to add.

4. Touch  >E-mail It.

Sending an e-mail using the address book

1. Load an original document faceup, short edge first into the ADF tray or facedown on the scanner glass.

Notes:

- Do not load postcards, photos, small items, transparencies, photo paper, or thin media (such as magazine clippings) into the ADF tray. Place these items on the scanner glass.
- The ADF indicator light comes on when the paper is loaded properly.

2. If you are loading a document into the ADF tray, then adjust the paper guides.
3. From the home screen, navigate to:

E-mail >**Recipient(s)** >  > type the name of the recipient > 

4. Touch the name of the recipient.

To search for additional recipients, touch **New Search**, and then type the name of the next recipient.

5. Touch  >E-mail It.

Customizing e-mail settings

Adding e-mail subject and message information

1. Load an original document faceup, short edge first into the ADF tray or facedown on the scanner glass.

Notes:

- Do not load postcards, photos, small items, transparencies, photo paper, or thin media (such as magazine clippings) into the ADF tray. Place these items on the scanner glass.
- The ADF indicator light comes on when the paper is loaded properly.

2. If you are loading a document into the ADF tray, then adjust the paper guides.
3. From the home screen, navigate to:

E-mail >**Recipient(s)** > type the e-mail address > 

4. Touch **Subject** > type the e-mail subject > .

5. Touch **Message** > type your message > .

Changing the output file type

1. Load an original document faceup, short edge first into the ADF tray or facedown on the scanner glass.

Notes:

- Do not load postcards, photos, small items, transparencies, photo paper, or thin media (such as magazine clippings) into the ADF tray. Place these items on the scanner glass.
 - The ADF indicator light comes on when the paper is loaded properly.
2. If you are loading a document into the ADF tray, then adjust the paper guides.
 3. From the home screen, navigate to:

E-mail > **Recipient(s)** > type the e-mail address >  > **Send as**

4. Touch the button that represents the file type you want to send.
 - **PDF**—Use this to create a single file with multiple pages, viewable with Adobe Reader. Adobe Reader is provided free by Adobe at www.adobe.com.
 - **Secure PDF**—Use this to create an encrypted PDF file that protects the file contents from unauthorized access.
 - **TIFF**—Use this to create multiple files or a single file. If Multi-page TIFF is turned off in the Settings menu of the Embedded Web Server, then TIFF saves one page in each file. The file size is usually larger than an equivalent JPEG.
 - **JPEG**—Use this to create and attach a separate file for each page of your original document, viewable by most Web browsers and graphics programs.
 - **XPS**—Use this to create a single XML Paper Specification (XPS) file with multiple pages, viewable using an Internet Explorer-hosted viewer and the .NET Framework, or by downloading a third-party standalone viewer.
5. Touch  > **E-mail It**.

Note: If you selected **Secure PDF**, then you will be prompted to enter your password twice.

Canceling an e-mail

- When using the ADF, touch **Cancel Job** while **Scanning** appears.
- When using the scanner glass, touch **Cancel Job** while **Scanning** appears, or while **Scan the Next Page / Finish the Job** appears.

Understanding the e-mail options

Recipient(s)

This option lets you enter the recipient of your e-mail. You may enter multiple e-mail addresses.

Subject

This option lets you type a subject line for your e-mail.

Message

This option lets you type a message that will be sent with your scanned attachment.

File Name

This option lets you customize the attachment file name.

Save As Shortcut

This option lets you save the current settings as a shortcut by assigning a shortcut name.

Note: Selecting this option automatically assigns the next available shortcut number.

Original Size

This option lets you set the paper size of the documents you are going to e-mail. When Original Size is set to Mixed Sizes, you can scan an original document that contains mixed paper sizes (letter- and legal-size pages).

Darkness

This option lets you adjust how light or dark your scanned documents are in relation to the original document.

Resolution

This option lets you adjust the output quality of your e-mail. Increasing the image resolution increases the e-mail file size and the time needed to scan your original document. Decreasing the image resolution reduces the file size.

Send As

This option lets you set the output type for the scan image.

Select one of the following:

- **PDF**—Use this to create a single file with multiple pages.
Note: PDF is the factory default setting.
- **Secure PDF**—Use this to create an encrypted PDF file that protects the file contents from unauthorized access.
- **TIFF**—Use this to create multiple files or a single file. If Multi-page TIFF is turned off in the Settings menu of the Embedded Web Server, then TIFF saves one page in each file. The file size is usually larger than an equivalent JPEG.
- **JPEG**—Use this to create and attach a separate file for each page of your original document.
- **XPS**—Use this to create a single XPS file with multiple pages.

Content

This option lets you set the original document type and source.

Select from the following content types:

- **Graphics**—The original document is mostly business-type graphics, such as pie charts, bar charts, and animations.
- **Photo**—The original document is mostly a photo or an image.
- **Text**—The content of the original document is mostly text or line art.
- **Text/Photo**—The original document is a mixture of text, graphics, and photos.

Select from the following content sources:

- **Black/White Laser**—The original document was printed using a mono laser printer.
- **Color Laser**—The original document was printed using a color laser printer.
- **Inkjet**—The original document was printed using an inkjet printer.
- **Magazine**—The original document is from a magazine.
- **Newspaper**—The original document is from a newspaper.
- **Other**—The original document was printed using an alternate or unknown printer.
- **Photo/Film**—The original document is a photo from film.
- **Press**—The original document was printed using a printing press.

Page Setup

This option lets you change the following settings:

- **Sides (Duplex)**—This specifies if the original document is printed on only one side or on both sides of the paper. This also identifies what needs to be scanned for inclusion in the e-mail.

- **Orientation**—This specifies the orientation of the original document, and then changes the Sides (Duplex) and Binding settings to match the orientation.
- **Binding**—This specifies if the original document is bound on the long-edge or short-edge side.

Custom Job

This option lets you combine multiple scan jobs into a single job and appears only when a working printer hard disk is installed.

Scan Preview

This option lets you view the first page of the image before it is included in the e-mail. When the first page is scanned, the scanning is paused and a preview image appears.

Note: This option appears only when a working printer hard disk is installed.

Transmission Log

This option lets you print the transmission log or transmission error log.

Edge Erase

This option lets you remove smudges or any mark around the edges of a document. You can remove an equal area around all four sides of the paper, or you can pick a particular edge. Edge Erase also removes whatever is within the area selected, leaving nothing on that portion of the scan.

Advanced Imaging



This option lets you adjust the Background Removal, Color Balance, Color Dropout, Contrast, JPEG Quality, Mirror Image, Negative Image, Scan Edge to Edge, Shadow Detail, Sharpness, and Temperature settings before you e-mail the document.

Fix Scan Skew

This option lets you straighten scanned images that are slightly skewed when received from the ADF tray.

11—Faxing

Note: The fax function is available only in select printer models.

Automatic document feeder (ADF)	Scanner glass
 <p data-bbox="188 810 636 863">Use the ADF for multiple-page documents including two-sided (duplex) pages.</p>	 <p data-bbox="703 884 1390 963">Use the scanner glass for single-page documents, book pages, small items (such as postcards or photos), transparencies, photo paper, or thin media (such as magazine clippings).</p>

Setting up the printer to fax

 **CAUTION—SHOCK HAZARD:** Do not use the fax feature during a lightning storm. Do not set up this product or make any electrical or cabling connections, such as the fax feature, power cord, or telephone, during a lightning storm.

Note: The following connection methods are applicable only in select countries or regions.

During the initial printer setup, clear the Fax function and any other function you plan to set up later, and then press **Continue**.

Note: The indicator light may blink red if the fax function is enabled and not fully set up.

Warning—Potential Damage: Do not touch cables or the printer in the area shown while actively sending or receiving a fax.



Initial fax setup

Many countries and regions require outgoing faxes to contain the following information in a margin at the top or bottom of each transmitted page, or on the first page of the transmission: fax name (identification of the business, other entity, or individual sending the message) and fax number (telephone number of the sending fax machine, business, other entity, or individual).

To enter your fax setup information, use the printer control panel, or use your browser to access the Embedded Web Server and then enter the Settings menu.

Note: If you do not have a TCP/IP environment, then you must use the printer control panel to enter your fax setup information.

Using the printer control panel for fax setup

When the printer is turned on for the first time, a series of start-up screens appear. If the printer has fax capabilities, then the Fax Name and Fax Number screens appear.

1. When the Fax Name screen appears, do the following:
 - a. Enter the name to be printed on all outgoing faxes.
 - b. Enter the fax name, and then touch **Submit**.
2. When the Fax Number screen appears, enter the fax number, and then touch **Submit**.

Using the Embedded Web Server for fax setup

1. Open a Web browser, and then type the printer IP address in the address field.

Notes:

- View the printer IP address on the printer home screen. The IP address appears as four sets of numbers separated by periods, such as 123.123.123.123.
 - If you are using a proxy server, then temporarily disable it to load the Web page correctly.
2. Click **Settings >Fax Settings >Analog Fax Setup**.
 3. In the Fax Name field, type the name to be printed on all outgoing faxes.

4. In the Fax Number field, enter the printer fax number.
5. Click **Submit**.

Choosing a fax connection

Scenario 1: Standard telephone line

Setup 1: Printer is connected to a dedicated fax line

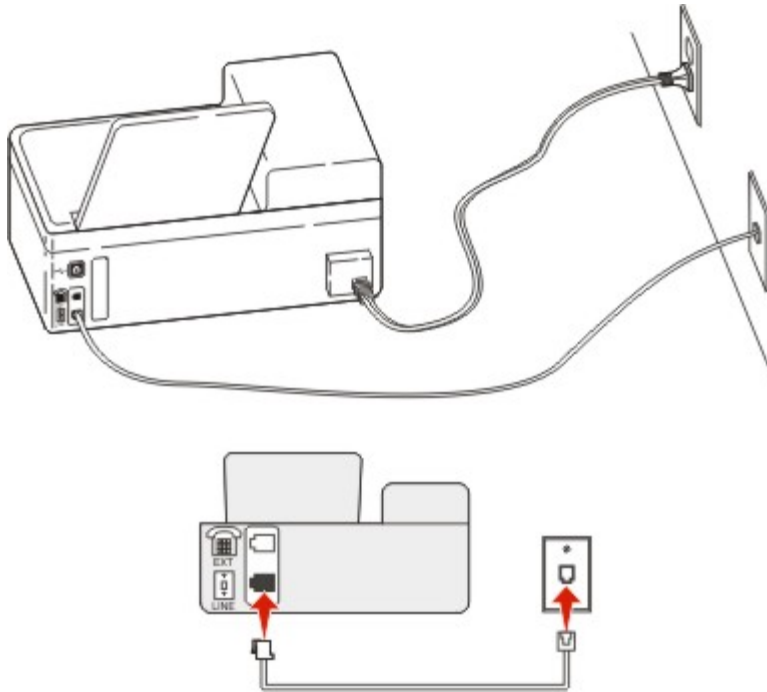

To connect:

1. Connect one end of the telephone cable that came with the printer to the  port of the printer.
2. Connect the other end of the telephone cable to an active analog wall jack.

Tips for this setup:



- You can set the printer to receive faxes automatically (Auto Answer On) or manually (Auto Answer Off).
- If you want to receive faxes automatically (Auto Answer On), then set the printer to pick up on any number of rings that you want.

Setup 2: Printer is sharing the line with an answering machine

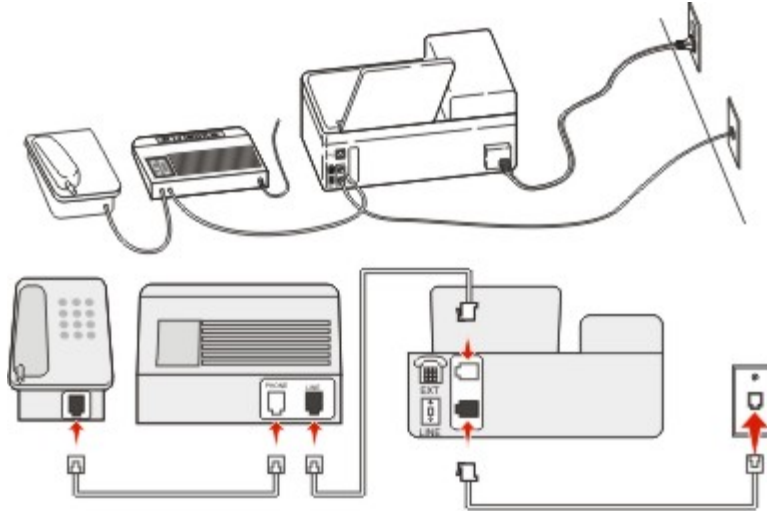
Connected to the same telephone wall jack



To connect:

1. Connect one end of the telephone cable that came with the printer to the  port of the printer.
2. Connect the other end of the telephone cable to an active analog wall jack.
3. Connect the answering machine to the  port of the printer.

Connected to different wall jacks

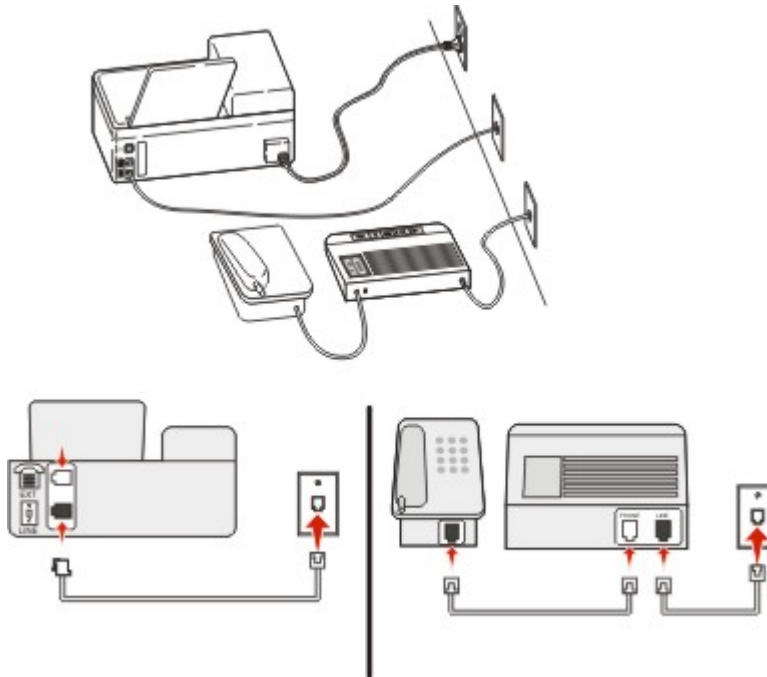

To connect:

1. Connect one end of the telephone cable that came with the printer to the  port of the printer.
2. Connect the other end of the telephone cable to an active analog wall jack.



Tips for this setup:

- If you have only one telephone number on your line, then you need to set the printer to receive faxes automatically (Auto Answer On).
- Set the printer to pick up calls two rings after the answering machine. For example, if the answering machine picks up calls after four rings, then set the printer to pick up after six rings. This way, the answering machine picks up calls first and your voice calls are received. If the call is a fax, then the printer detects the fax signal on the line and takes over the call.
- If you subscribe to a distinctive ring service provided by your telephone company, then make sure that you set the correct ring pattern for the printer. Otherwise, the printer does not receive faxes even if you have set it to receive faxes automatically.

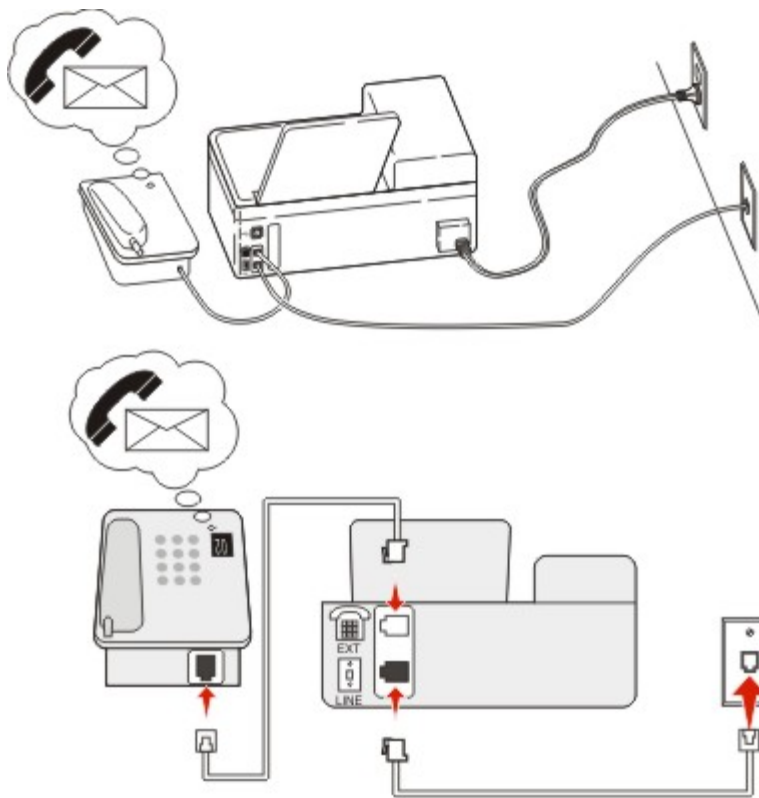
Setup 3: Printer is sharing the line with a telephone subscribed to voice mail service



To connect:

1. Connect one end of the telephone cable that came with the printer to the  port of the printer.
2. Connect the other end of the telephone cable to an active analog wall jack.
3. Connect the telephone to the  port of the printer.

Tips for this setup:

- This setup works best if you subscribe to a distinctive ring service. If you have distinctive ring service, then make sure that you set the correct ring pattern for the printer. Otherwise, the printer does not receive faxes even if you have set it to receive faxes automatically.

- If you have only one telephone number on your line, then you need to set the printer to receive faxes manually (Auto Answer Off).

When you answer the telephone and you hear fax tones, press *9* or the manual answer code on the telephone to receive the fax.

- You can also set the printer to receive faxes automatically (Auto Answer On), but you need to turn off the voice mail service when you are expecting a fax. This setting works best if you are using voice mail more often than fax.

Scenario 2: Digital Subscriber Line (DSL)

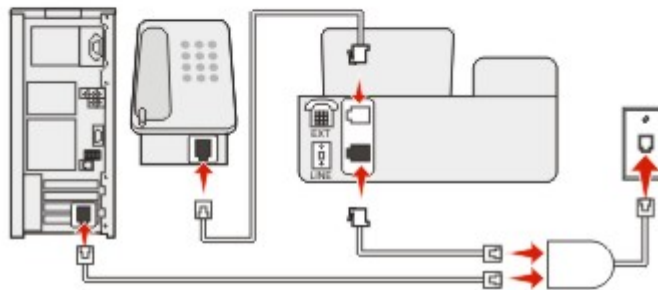
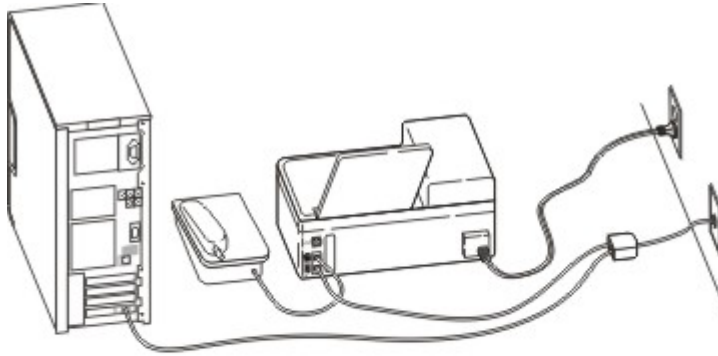

A Digital Subscriber Line splits your regular telephone line into two channels: voice and Internet. Telephone and fax signals travel through the voice channel, and Internet signals pass through the other channel. This way, you can use the same line for analog voice calls (including faxes) and digital Internet access.

To minimize interference between the two channels and ensure a quality connection, you need to install a DSL filter for the analog devices (fax machine, telephone, answering machine) in your network. Interference causes noise and static on the telephone, failed and poor quality faxes for the printer, and slow Internet connection on your computer.

To install a filter for the printer:

1. Connect the line port of the DSL filter to the wall jack.
2. Connect one end of the telephone cable that came with your printer to the  port of the printer. Connect the other end to the phone port on the DSL filter.

3. To continue using a computer for Internet access, connect the computer to the DSL HPN port on the DSL filter.
4. To connect a telephone to the printer, remove any installed adapter plug from the  port of the printer, and then connect the telephone to the port.

Scenario 3: VoIP telephone service

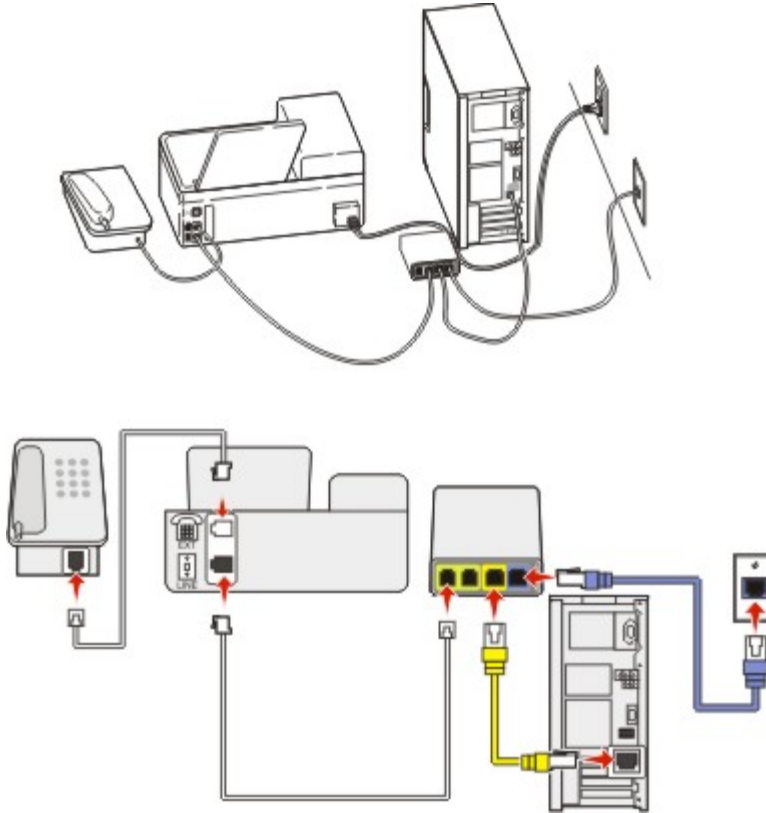

To connect:

1. Connect one end of the telephone cable that came with the printer to the  port of the printer.
2. Connect the other end of the cable to the port labeled **Phone Line 1** or **Phone Port** on the VoIP adapter.

Note: The port labeled **Phone Line 2** or **Fax Port** is not always active. VoIP providers may charge additional cost for activation of the second phone port.

3. Connect the telephone to the  port of the printer.

Tips for this setup:

- To make sure that the phone port on the VoIP adapter is active, plug an analog telephone into the phone port, and then listen for a dial tone. If you hear a dial tone, then the port is active.

- If you need two phone ports for your devices, but do not want to pay additional cost, then do not plug the printer into the second phone port. You can use a phone splitter. Plug the phone splitter into the port labeled **Phone Line 1** or **Phone Port**, and then plug the printer and telephone into the splitter.

Note: Make sure you use a phone splitter, *not* a line splitter. To make sure that you are using the correct splitter, plug an analog telephone into the splitter and then listen for a dial tone.

Scenario 4: Digital telephone service through a cable provider

Setup 1: Printer is connected directly to a cable modem

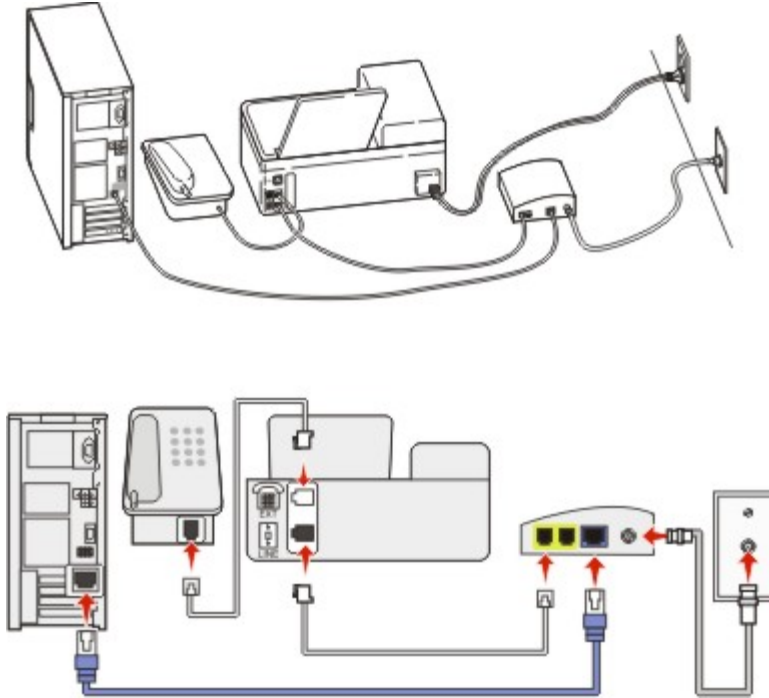

1. Connect one end of the telephone cable that came with your printer to the  port of the printer.
2. Connect the other end of the cable to the port labeled **Phone Line 1** or **Phone Port** on the cable modem.

Note: The port labeled **Phone Line 2** or **Fax Port** is not always active. VoIP providers may charge additional cost for activation of the second phone port.



3. Connect your analog telephone phone to the  port of the printer.

Notes:

- To make sure that the telephone port on the cable modem is active, plug an analog telephone into the telephone port, and then listen for a dial tone. If you hear a dial tone, then the port is active.
- If you need two telephone ports for your devices, but do not want to pay additional cost, then do not plug the printer into the second telephone port. You can use a phone splitter. Plug the phone splitter into the **Phone Line 1** or **Phone Port**, and then plug the printer and telephone into the splitter.
- Make sure you use a phone splitter, *not* a line splitter. To make sure that you are using the correct splitter, plug an analog telephone into the splitter and then listen for a dial tone.

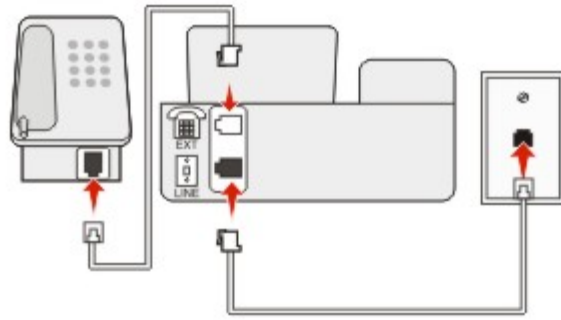
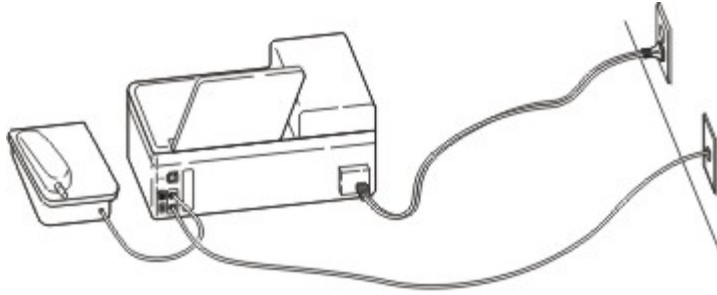
Setup 2: Printer is connected to a wall jack; cable modem is installed elsewhere in the facility





1. Connect one end of the telephone cable that came with your printer to the  port of the printer.
2. Connect the other end of the telephone cable to an active analog telephone wall jack.
3. Connect your analog telephone to the  port of the printer.

Scenario 5: Countries or regions with different telephone wall jacks and plugs

Some countries or regions may have different types of telephone wall jack connectors than those that came with the printer. The standard wall jack adopted by most countries or regions is RJ-11. Your printer comes with the RJ-11 jack and a telephone cable with the RJ-11 plug.

If the wall jack or equipment in your facility is not compatible with this type of connection, then you need to use a telephone adapter. An adapter for your country or region may not come with your printer, and you may need to purchase it separately.



There may be an adapter plug installed in the  port of the printer. If you are using a telephone adapter or a facility that has a cascaded or serial wiring scheme, then do not remove the adapter plug from the  port of the printer.

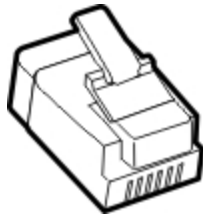

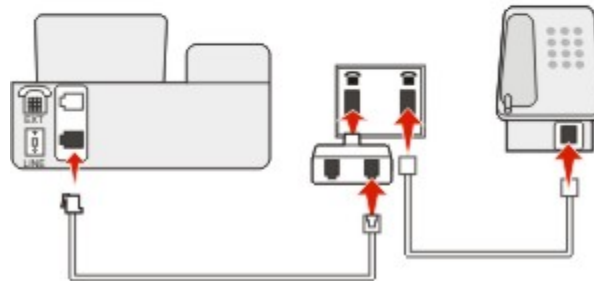
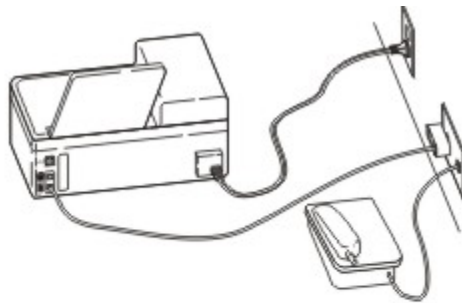

Connecting the printer to a non-RJ-11 wall jack



1. Connect one end of the telephone cable that came with printer to the  port of the printer.
2. Connect the other end of the cable to the RJ-11 adapter, and then connect the adapter to the wall jack.
3. If you want to connect another device (telephone or answering machine) to the same wall jack, and if the device has a non-RJ-11 connector, then connect it directly to the telephone adapter.

Notes:

- The  port of the printer may have an adapter plug for use with the adapter. Do *not* remove the plug from the  port of the printer.
- In some countries or regions, the printer may not come with a telephone adapter or an adapter plug.

Connecting the printer to a wall jack in Germany

The German wall jack has two kinds of ports. The N ports are for fax machines, modems, and answering machines. The F port is for telephones.

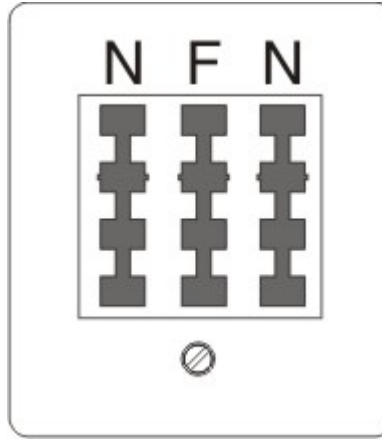

Connect the printer to any of the N ports.

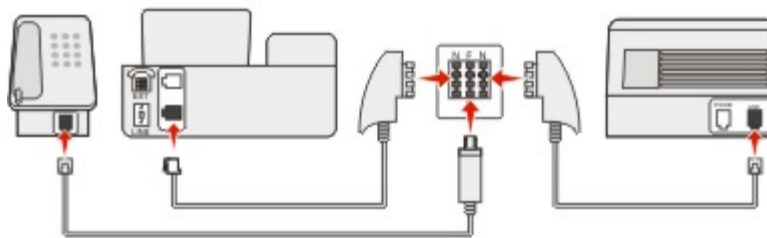
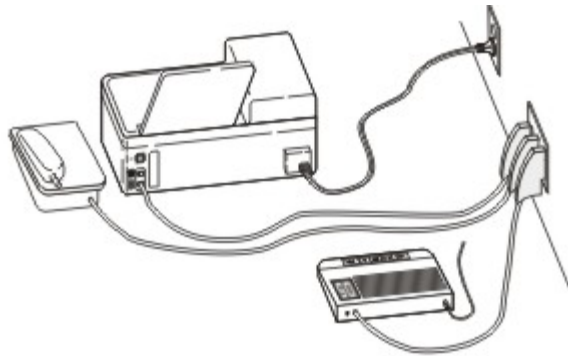

1. Connect one end of the telephone cable that came the printer to the  port of the printer.
2. Connect the other end of the telephone cable to the RJ-11 adapter, and then connect the adapter to an N port.
3. If you want to connect a telephone and answering machine to the same wall jack, then connect the devices as shown.

Note: Do *not* remove the adapter plug from the  port of the printer if you are connecting to a serial or cascaded telephone system.

Connecting to a distinctive ring service

A distinctive ring service may be available from your telephone company. This service lets you have multiple telephone numbers on one telephone line, with each telephone number having a different ring pattern. This may be useful for distinguishing between fax and voice calls. If you subscribe to a distinctive ring service, then follow these steps to connect the equipment:

1. Connect one end of the telephone cable that came with the printer to the printer LINE port .
2. Connect the other end of the telephone cable to an active analog telephone wall jack.

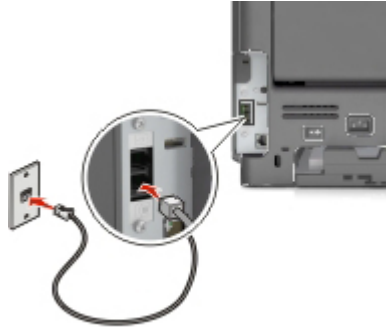

3. Change the distinctive rings setting to match the setting you want for the printer to answer.

Note: The factory default setting for distinctive rings is On. This sets the printer to answer single, double, and triple ring patterns.

- a. From the home screen, navigate to:

 **>Settings >Fax Settings >Analog Fax Setup >Answer On**

- b. Select the pattern setting you want to change, and then touch .

Setting the outgoing fax name and number

1. Open a Web browser, and then type the printer IP address in the address field.

Notes:

- View the printer IP address on the printer home screen. The IP address appears as four sets of numbers separated by periods, such as 123.123.123.123.
- If you are using a proxy server, then temporarily disable it to load the Web page correctly.

2. Click **Settings >Fax Settings >Analog Fax Setup**.
3. In the Fax Name field, type the name to be printed on all outgoing faxes.
4. In the Fax Number field, enter the printer fax number.
5. Click **Submit**.

Setting the date and time

You can set the date and time so that they are printed on every fax you send.

1. Open a Web browser, and then type the printer IP address in the address field.

Notes:

- View the printer IP address on the printer home screen. The IP address appears as four sets of numbers separated by periods, such as 123.123.123.123.
- If you are using a proxy server, then temporarily disable it to load the Web page correctly.

2. Click **Security >Set Date and Time**.
3. In the Manually Set Date & Time field, enter the current date and time.
4. Click **Submit**.

Note: It is recommended to use the network time.

Configuring the printer to observe daylight saving time

The printer can be set to automatically adjust for daylight saving time:

1. Open a Web browser, and then type the printer IP address in the address field.

Notes:

- View the printer IP address on the printer home screen. The IP address appears as four sets of numbers separated by periods, such as 123.123.123.123.
- If you are using a proxy server, then temporarily disable it to load the Web page correctly.

2. Click **Security >Set Date and Time**.
3. Select the **Automatically Observe DST** check box, and then enter the DST start and end dates in the Custom Time Zone Setup section.
4. Click **Submit**.

Sending a fax

You can use the printer to send a fax to one or more recipients in a number of ways. You can type the e-mail address, use a shortcut number, or use the address book. You can also use the MyShortcut application from the printer home screen. For more information, see the "Activating the home screen applications" section of the *User's Guide*.

Sending a fax using the printer control panel

1. Load an original document faceup, short edge first into the ADF tray or facedown on the scanner glass.

Notes:

- Do not load postcards, photos, small items, transparencies, photo paper, or thin media (such as magazine clippings) into the ADF tray. Place these items on the scanner glass.
- The ADF indicator light comes on when the paper is loaded properly.

2. If you are loading a document into the ADF tray, then adjust the paper guides.
3. From the home screen, touch **Fax**.
4. From the printer control panel keypad, enter the fax number or the shortcut number.

Note: To add recipients, touch , and then enter the recipient's telephone number or shortcut number, or search the address book.

5. Touch **Fax It**.

Sending a fax using the computer

The printer driver fax option lets you send a print job to the printer, which sends the job as a fax. The fax option works as a normal fax machine, but is controlled through the printer driver instead of the printer control panel.

1. With a document open, click **File >Print**.
2. Select the printer, and then navigate to:

Properties >Fax tab >Enable fax

3. Enter the recipient fax number or numbers in the "Fax number(s)" field.

Note: Fax numbers can be entered manually or by using the Phone Book feature

4. If necessary, enter a prefix in the "Dialing prefix" field.
5. Select the appropriate paper size and page orientation.
6. If you want to include a cover page with the fax, then select **Include cover page with fax**, and then enter the appropriate information.
7. Click **OK**.

Notes:

- For information on installing these drivers, see the *Drivers and Documentation CD*.
- If the **Always display settings prior to faxing** check box is selected, then you are prompted to verify the recipient information before the fax is sent. If this check box is cleared, then the queued document is sent automatically as a fax when you click **OK** on the Fax tab.

Sending a fax using a shortcut number

Fax shortcuts are like the speed dial numbers on a telephone or a fax machine. A shortcut number (1–999) can contain a single recipient or multiple recipients.

1. Load an original document faceup, short edge first into the ADF tray or facedown on the scanner glass.

Notes:

- Do not load postcards, photos, small items, transparencies, photo paper, or thin media (such as magazine clippings) into the ADF tray. Place these items on the scanner glass.
- The ADF indicator light comes on when the paper is loaded properly.

2. If you are loading a document into the ADF tray, then adjust the paper guides.
3. From the printer control panel, press **#**, and then enter the shortcut number using the keypad.
4. Touch **Fax It**.

Sending a fax using the address book

The address book feature lets you search for bookmarks and network directory servers.

Note: If the address book feature is not enabled, then contact your system support person.

1. Load an original document faceup, short edge first into the ADF tray or facedown on the scanner glass.

Notes:

- Do not load postcards, photos, small items, transparencies, photo paper, or thin media (such as magazine clippings) into the ADF tray. Place these items on the scanner glass.
- The ADF indicator light comes on when the paper is loaded properly.

2. If you are loading a document into the ADF tray, then adjust the paper guides.
3. From the home screen, navigate to:

Fax >  > type the name of the recipient > 

Note: You can only search for one name at a time.

4. Touch the name of the recipient, and then touch **Fax It**.

Sending a fax at a scheduled time

1. Load an original document faceup, short edge first into the ADF tray or facedown on the scanner glass.

Notes:

- Do not load postcards, photos, small items, transparencies, photo paper, or thin media (such as magazine clippings) into the ADF tray. Place these items on the scanner glass.
- The ADF indicator light comes on when the paper is loaded properly.

2. If you are loading a document into the ADF tray, then adjust the paper guides.
3. From the home screen, navigate to:

Fax > enter the fax number >**Options** >**Delayed Send**

Note: If Fax Mode is set to Fax Server, then the Delayed Send button does not appear. Faxes waiting for transmission are listed in the fax queue.

4. Specify the time the fax will be transmitted, and then touch .
5. Touch **Fax It**.

Note: The document is scanned, and then faxed at the scheduled time.

Creating shortcuts

Creating a fax destination shortcut using the Embedded Web Server

Assign a shortcut number to a single fax number or a group of fax numbers.

1. Open a Web browser, and then type the printer IP address in the address field.

Notes:

- View the printer IP address on the printer home screen. The IP address appears as four sets of numbers separated by periods, such as 123.123.123.123.
- If you are using a proxy server, then temporarily disable it to load the Web page correctly.

2. Click **Settings** > **Manage Shortcuts** > **Fax Shortcut Setup**.

Note: A password may be required. If you do not have an ID and password, then contact your system support person.

3. Type a name for the shortcut, and then enter the fax number.

Notes:

- To create a multiple-number shortcut, enter the fax numbers for the group.
- Separate each fax number in the group with a semicolon (;).

4. Assign a shortcut number.

Note: If you enter a number that is already in use, then you are prompted to select another number.

5. Click **Add**.

Creating a fax destination shortcut using the printer control panel

1. From the home screen, touch **Fax**, and then enter the fax number.

To create a group of fax numbers, touch , and then enter the other fax number.

2. Touch .

3. Type a unique name for the shortcut, and then touch .

4. Verify that the shortcut name and number are correct, and then touch **OK**.

If the name or number is incorrect, then touch **Cancel**, and then reenter the information.

Customizing fax settings

Changing the fax resolution



1. Load an original document faceup, short edge first into the ADF tray or facedown on the scanner glass.

Notes:

- Do not load postcards, photos, small items, transparencies, photo paper, or thin media (such as magazine clippings) into the ADF tray. Place these items on the scanner glass.
- The ADF indicator light comes on when the paper is loaded properly.

2. If you are loading a document into the ADF tray, then adjust the paper guides.

3. From the home screen, touch **Fax**, and then enter the fax number.

4. From the Resolution area, touch  or  to change to the resolution you want.

Note: Settings range from Standard (fastest speed) to Ultra Fine (best quality at a reduced speed).



5. Touch **Fax It**.

Making a fax lighter or darker

1. Load an original document faceup, short edge first into the ADF tray or facedown on the scanner glass.

Notes:

- Do not load postcards, photos, small items, transparencies, photo paper, or thin media (such as magazine clippings) into the ADF tray. Place these items on the scanner glass.

- The ADF indicator light comes on when the paper is loaded properly.
- 2. If you are loading a document into the ADF tray, then adjust the paper guides.
- 3. From the home screen, touch **Fax**, and then enter the fax number.
- 4. From the Darkness area, touch  or  to adjust the darkness setting of the fax.
- 5. Touch **Fax It**.

Viewing a fax log

1. Open a Web browser, and then type the printer IP address in the address field.

Notes:

- View the printer IP address on the printer home screen. The IP address appears as four sets of numbers separated by periods, such as 123.123.123.123.
 - If you are using a proxy server, then temporarily disable it to load the Web page correctly.
2. Click **Settings > Reports**.
 3. Click **Fax Job Log** or **Fax Call Log**.

Blocking junk faxes

1. Open a Web browser, and then type the printer IP address in the address field.

Notes:

- View the printer IP address on the printer home screen. The IP address appears as four sets of numbers separated by periods, such as 123.123.123.123.
 - If you are using a proxy server, then temporarily disable it to load the Web page correctly.
2. Click **Settings > Fax Settings > Analog Fax Setup > Block No Name Fax**.

Notes:

- This option blocks all incoming faxes that have a private caller ID or have no fax name.
- In the Banned Fax List field, enter the phone numbers or type the fax names of specific fax callers you want to block.

Canceling an outgoing fax

Canceling a fax while the original documents are still scanning

- When using the ADF, touch **Cancel Job** on the printer control panel while **Scanning** appears.
- When using the scanner glass, touch **Cancel Job** on the printer control panel while **Scanning** appears or while **Scan the Next Page** and **Finish the Job** appear.

Canceling a fax after the original documents have been scanned to memory

1. On the home screen, touch **Cancel Jobs**.

The Cancel Jobs screen appears.

2. Touch the job or jobs you want to cancel.

Only three jobs appear on the screen; touch the down arrow until the job you want appears, and then touch the job you want to cancel.

3. Touch **Delete Selected Jobs**.

The Deleting Selected Jobs screen appears, the selected jobs are deleted, and then the home screen appears.

Holding and forwarding faxes

Holding faxes

This option lets you hold received faxes from printing until they are released. Held faxes can be released manually or at a scheduled day or time.

1. Open a Web browser, and then type the printer IP address in the address field.

Notes:

- View the printer IP address on the printer home screen. The IP address appears as four sets of numbers separated by periods, such as 123.123.123.123.
- If you are using a proxy server, then temporarily disable it to load the Web page correctly.

2. Click **Settings >Fax Settings >Analog Fax Setup >Holding Faxes**.

3. From the Held Fax Mode menu, select one of the following:

- **Off**
- **Always On**
- **Manual**
- **Scheduled**

4. If you selected Scheduled, then continue with the following steps:

- a. Click **Fax Holding Schedule**.
- b. From the Action menu, select **Hold faxes**.
- c. From the Time menu, select the time you want the held faxes released.
- d. From the Day(s) menu, select the day you want the held faxes released.

5. Click **Add**.

Forwarding a fax

This option lets you print and forward received faxes to a fax number, e-mail address, FTP site, or LDSS.

1. Open a Web browser, and then type the printer IP address in the address field.

Notes:

- View the printer IP address on the printer home screen. The IP address appears as four sets of numbers separated by periods, such as 123.123.123.123.
- If you are using a proxy server, then temporarily disable it to load the Web page correctly.

2. Click **Settings >Fax Settings**.
3. From the Fax Forwarding menu, select **Print, Print and Forward, or Forward**.
4. From the "Forward to" menu, select **Fax, E-mail, FTP, LDSS, or eSF**.
5. In the "Forward to Shortcut" field, enter the shortcut number where you want the fax forwarded.
Note: The shortcut number must be valid for the setting selected in the "Forward to" menu.
6. Click **Submit**.

Understanding the fax options

Content

This option lets you specify the content type and source of the original document.

Select from the following content types:

- **Graphics**—The original document is mostly business-type graphics, such as pie charts, bar charts, and animations.
- **Photo**—The original document is mostly a photo or an image.
- **Text**—The content of the original document is mostly text or line art.
- **Text/Photo**—The original document is a mixture of text, graphics, and photos.

Select from the following content sources:

- **Black/White Laser**—The original document was printed using a mono laser printer.
- **Color Laser**—The original document was printed using a color laser printer.
- **Inkjet**—The original document was printed using an inkjet printer.
- **Magazine**—The original document is from a magazine.
- **Newspaper**—The original document is from a newspaper.
- **Other**—The original document was printed using an alternate or unknown printer.

- **Photo/Film**—The original document is a photo from film.
- **Press**—The original document was printed using a printing press.

Resolution

This option lets you adjust the quality of the fax output. Increasing the image resolution increases the file size and the time needed to scan your original document. Decreasing the image resolution reduces the file size.

Select one of the following:

- **Standard**—Use this when faxing most documents.
- **Fine 200 dpi**—Use this when faxing documents with small prints.
- **Super fine 300 dpi**—Use this when faxing documents with fine details.
- **Ultra fine 600 dpi**—Use this when faxing documents with pictures or photos.

Darkness

This option lets you adjust how light or dark the faxes are in relation to the original document.

Page Setup

This option lets you change the following settings:

- **Sides (Duplex)**—This specifies if the original document is printed on one side or on both sides of the page (duplex). This also identifies what needs to be scanned for inclusion in the fax.
- **Orientation**—This specifies the orientation of the original document, and then changes the Sides (Duplex) and Binding settings to match the orientation.
- **Binding**—This specifies if the original document is bound on the long-edge or short-edge side.

Custom Job

This option lets you combine multiple scan jobs into a single job and appears only when a working printer hard disk is installed.

Scan Preview

This option lets you view the first page of the image before it is included in the fax. When the first page is scanned, the scanning is paused and a preview image appears.

Note: This option appears only when a working printer hard disk is installed.

Delayed Send

This option lets you send a fax at a later time or date.

Advanced Imaging

This option lets you adjust the Background Removal, Color Balance, Color Dropout, Contrast, Mirror Image, Negative Image, Scan Edge to Edge, Shadow Detail, Sharpness, and Temperature settings before you fax the document.

Edge Erase

This option lets you remove smudges or any mark around the edges of a document. You can remove an equal area around all four sides of the paper, or you can pick a particular edge. Edge Erase also removes whatever is within the area selected, leaving nothing on that portion of the scan.



Transmission Log

This option lets you print the transmission log or transmission error log.

Fix Scan Skew

This option lets you straighten scanned images that are slightly skewed when received from the ADF tray.

12—Scanning



Automatic document feeder (ADF)	Scanner glass
	
<p>Use the ADF for multiple-page documents.</p>	<p>Use the scanner glass for single pages, small items (such as postcards or photos), transparencies, photo paper, or thin media (such as magazine clippings).</p>

The scanner lets you scan documents directly to a computer or a flash drive. The computer does not have to be directly connected to the printer for you to receive Scan to PC images. You can scan the document back to the computer over the network by creating a scan profile on the computer and then downloading the profile to the printer.

Using Scan to Network

Scan to Network lets you scan your documents to network destinations specified by your system support person. After the destinations (shared network folders) have been established on the network, the setup process for the application involves installing and configuring the application on the appropriate printer using its Embedded Web Server. For more information, see [Setting up Scan to Network](#).

Scanning to an FTP address

Automatic document feeder (ADF)	Scanner glass
	
<p>Use the ADF for multiple-page documents including two-sided (duplex) pages.</p>	<p>Use the scanner glass for single-page documents, book pages, small items (such as postcards or photos), transparencies, photo paper, or thin media (such as magazine clippings).</p>

The scanner lets you scan documents directly to a File Transfer Protocol (FTP) server. Only one FTP address may be sent to the server at a time.

When an FTP destination has been configured by your system support person, the name of the destination becomes available as a shortcut number, or it is listed as a profile under the Held Jobs icon. An FTP destination could also be another PostScript printer; for example, a color document can be scanned and then sent to a color printer.

Creating shortcuts

Instead of entering the entire FTP site address on the printer control panel each time you want to send a document to an FTP server, you can create a permanent FTP destination and assign a shortcut number. There are two methods for creating shortcut numbers: using the Embedded Web Server and using the printer control panel.

Creating an FTP shortcut using the Embedded Web Server

1. Open a Web browser, and then type the printer IP address in the address field.

Notes:

- View the printer IP address on the printer home screen. The IP address appears as four sets of numbers separated by periods, such as 123.123.123.123.
- If you are using a proxy server, then temporarily disable it to load the Web page correctly.

2. Navigate to:

Settings > Other Settings area > Manage Shortcuts > FTP Shortcut Setup

3. Enter the appropriate information.

Note: A password may be required. If you do not have an ID and password, then contact your system support person.

4. Enter a shortcut number.

Note: If you enter a number that is already in use, then you are prompted to select another number.

5. Click **Add**.

Creating an FTP shortcut using the printer control panel

1. From the home screen, navigate to:

FTP >FTP Address > type the FTP address >  >  > type a name for the shortcut > 

2. Verify that the shortcut name and number are correct, and then touch **OK**.

If the name or number is incorrect, then touch **Cancel**, and then reenter the information. If you enter a number that is already in use, then you will be prompted to select another number.

Scanning to an FTP address

You can use the printer to send scanned documents to an FTP address in a number of ways. You can type the FTP address, use a shortcut number, or use the address book. You can also use the Multi Send, Scan to Network, or MyShortcut application from the printer home screen. For more information, see the "Activating the home screen applications" section of the *User's Guide*.

Scanning to an FTP address using the printer control panel

1. Load an original document faceup, short edge first into the ADF tray or facedown on the scanner glass.

Notes:

- Do not load postcards, photos, small items, transparencies, photo paper, or thin media (such as magazine clippings) into the ADF tray. Place these items on the scanner glass.
- The ADF indicator light comes on when the paper is loaded properly.

2. If you are loading a document into the ADF tray, then adjust the paper guides.

3. From the home screen, navigate to:

FTP >FTP Address > type the FTP address >  >**Scan It**



Scanning to an FTP address using a shortcut number

1. Load an original document faceup, short edge first into the ADF tray or facedown on the scanner glass.

Notes:

- Do not load postcards, photos, small items, transparencies, photo paper, or thin media (such as magazine clippings) into the ADF tray. Place these items on the scanner glass.
 - The ADF indicator light comes on when the paper is loaded properly.
2. If you are loading a document into the ADF tray, then adjust the paper guides.
 3. From the printer control panel, press # on the keypad, and then enter the FTP shortcut number.
 4. Touch **Scan It**.

Scanning to a computer or flash drive

Automatic Document Feeder (ADF)	Scanner glass
	
Use the ADF for multiple-page documents.	Use the scanner glass for single pages, small items (such as postcards or photos), transparencies, photo paper, or thin media (such as magazine clippings).

The scanner lets you scan documents directly to a computer or a flash drive. The computer does not have to be directly connected to the printer for you to receive Scan to PC images. You can scan the document back to the computer over the network by creating a scan profile on the computer and then downloading the profile to the printer.

Scanning to a computer using the Embedded Web Server

1. Open a Web browser, and then type the printer IP address in the address field.

Notes:

- View the printer IP address on the printer home screen. The IP address appears as four sets of numbers separated by periods, such as 123.123.123.123.
- If you are using a proxy server, then temporarily disable it to load the Web page correctly.

2. Click **Scan Profile >Create Scan Profile**.

3. Select your scan settings, and then click **Next**.

4. Select a location on your computer where you want to save the scan image.

5. Type a scan name, and then a user name.

Note: The scan name is the name that appears in the Scan Profile list on the display.

6. Click **Submit**.

Note: Clicking **Submit** automatically assigns a shortcut number. You can use this shortcut number when you are ready to scan your documents.

7. Review the instructions on the Scan Profile screen.

- a. Load an original document faceup, short edge first into the ADF tray or facedown on the scanner glass.

Notes:

- Do not load postcards, photos, small items, transparencies, photo paper, or thin media (such as magazine clippings) into the ADF tray. Place these items on the scanner glass.
 - The ADF indicator light comes on when the paper is loaded properly.
- b. If you are loading a document into the ADF tray, then adjust the paper guides.
 - c. Do either of the following:

- Press **#**, and then enter the shortcut number using the keypad.
- From the home screen, navigate to:

Held Jobs >Profiles > select your shortcut on the list

Note: The scanner scans and sends the document to the directory you specified.

8. View the file from the computer.

Note: The output file is saved in the location or launched in the program you specified.

Setting up Scan to Computer

Notes:

- This feature is supported only in Windows Vista or later.
 - Make sure that your computer and printer are connected to the same network.
1. Open the printers folder.

In Windows 8

From the Search charm, type **run**, and then navigate to:

Apps list > **Run** > type **control printers** > **OK**

In Windows 7 or earlier

- a. Click , or click **Start** and then click **Run**.
 - b. In the Start Search or Run dialog, type **control printers**.
 - c. Press **Enter**, or click **OK**.
2. Depending on your operating system, click **Add a device** or **Add a printer**.
 3. Select your printer from the list.
Note: To identify your printer, print a network setup page, and then look for “Fully Qualified Domain Name” in the TCP/IP section.
 4. Click **Next** > **Close**.
 5. From the printers folder, right-click the printer, and then click **Scan Properties** or **Properties** to configure the scan settings.
 6. From the printer control panel, touch **Scan to Computer** > **Options**.
 7. Select from the following options:
 - **Scan**—Scan and save the document directly to a selected location on the computer.
 - **Scan for Print**—Scan and automatically print the document.
 - **Scan for E-mail**—Attach a scanned document to an e-mail.
 - **Scan for Fax**—Attach a scanned document to be sent through fax.
 - **Scan for OCR**—Scan the document using an optical character recognition (OCR) software that turns your printed documents into various electronic formats, including Microsoft Word, Microsoft Excel, and searchable PDF. For help, see the documentation that came with the OCR software.
 8. Touch **Send It**.

Remote scan in progress appears on the printer display. The scanned image opens automatically on the computer screen.

Scanning to a flash drive

1. Load an original document faceup, short edge first into the ADF tray or facedown on the scanner glass.

Notes:

- Do not load postcards, photos, small items, transparencies, photo paper, or thin media (such as magazine clippings) into the ADF tray. Place these items on the scanner glass.
- The ADF indicator light comes on when the paper is loaded properly.

2. If you are loading a document into the ADF tray, then adjust the paper guides.
3. Insert the flash drive into the USB port on the front of the printer.

Note: The USB Drive home screen appears.

4. Select the destination folder, and then touch **Scan to USB drive**.

Note: The printer goes back to the home screen after 30 seconds of inactivity.

5. Adjust the scan settings, and then touch **Scan It**.

Understanding the scan options

FTP Address

This option lets you enter the IP address for the FTP destination.

Note: An IP address appears as four sets of numbers separated by periods, such as 123.123.123.123.

File Name

This option lets you type a file name for the scan image.

Save As Shortcut

This option lets you save the current settings as a shortcut by assigning a shortcut name.

Note: Selecting this option automatically assigns the next available shortcut number.

Original Size

This option lets you set the paper size of the documents you are going to scan. When Original Size is set to Mixed Sizes, you can scan an original document that contains mixed paper sizes (letter- and legal-size pages).

Darkness

This option lets you adjust how light or dark the scanned documents are in relation to the original document.

Resolution

This option lets you adjust the output quality of your file. Increasing the image resolution increases the file size and the time needed to scan your original document. Decreasing the image resolution reduces the file size.

Send As

This option lets you set the output type for the scan image.

Select one of the following:

- **PDF**—Use to create a single file with multiple pages.
- **Secure PDF**—Use to create an encrypted PDF file that protects the file contents from unauthorized access.
- **TIFF**—Use to create multiple files or a single file. If Multi-page TIFF is turned off in the Settings menu, then TIFF saves one page in each file. The file size is usually larger than an equivalent JPEG.
- **JPEG**—Use to create and attach a separate file for each page of the original document.
- **XPS**—Use to create a single XPS file with multiple pages.

Content

This option lets you set the original document type and source.

Select from the following content types:

- **Graphics**—The original document is mostly business-type graphics, such as pie charts, bar charts, and animations.
- **Photo**—The original document is mostly a photo or an image.
- **Text**—The content of the original document is mostly text or line art.
- **Text/Photo**—The original document is a mixture of text, graphics, and photos.

Select from the following content sources:

- **Black/White Laser**—The original document was printed using a mono laser printer.
- **Color Laser**—The original document was printed using a color laser printer.
- **Inkjet**—The original document was printed using an inkjet printer.
- **Magazine**—The original document is from a magazine.
- **Newspaper**—The original document is from a newspaper.
- **Other**—The original document was printed using an alternate or unknown printer.
- **Photo/Film**—The original document is a photo from film.

- **Press**—The original document was printed using a printing press.

Page Setup

This option lets you change the following settings:

- **Sides (Duplex)**—This specifies if the original document is printed on only one side or on both sides of the paper.
- **Orientation**—This specifies the orientation of the original document, and then changes the Sides (Duplex) and Binding settings to match the orientation.
- **Binding**—This specifies if the original document is bound on the long-edge or short-edge side.

Transmission Log

This option lets you print the transmission log or transmission error log.

Scan Preview

This option lets you view the first page of the image before it is included in the file. When the first page is scanned, the scanning is paused and a preview image appears.

Note: This option appears only when a formatted, working printer hard disk is installed.

Edge Erase

This option lets you remove smudges or any mark around the edges of a document. You can remove an equal area around all four sides of the paper, or you can pick a particular edge. Edge Erase also removes whatever is within the area selected, leaving nothing on that portion of the scan.

Advanced Imaging

This option lets you adjust the Background Removal, Color Balance, Color Dropout, Contrast, JPEG Quality, Mirror Image, Negative Image, Scan Edge to Edge, Shadow Detail, Sharpness, and Temperature settings before you scan the document.

Custom Job

This option lets you combine multiple scan jobs into a single job and appears only when a working printer hard disk is installed.

Fix Scan Skew

This option lets you straighten scan images that are slightly skewed when received from the ADF tray.

13—Understanding the printer menus

Menus list

Paper Menu	Reports	Network/Ports	Security	Settings
Default Source	Menu Settings Page	Active NIC	Miscellaneous Security Setting	General Settings
Paper Size/Type	Device Statistics	Standard Network ²	Confidential Print	Copy Settings
Configure MP	Network Setup Page ¹	Standard USB	Disk Wiping	Fax Settings
Substitute Size	Shortcut List	SMTP Setup	Security Audit Log	E-mail Settings
Paper Texture	Fax Job Log		Set Date and Time	FTP Settings
Paper Weight	Fax Call Log			Flash Drive Menu
Paper Loading	Copy Shortcuts			Print Settings
Custom Types	E-mail Shortcuts			
Custom Names	Fax Shortcuts			
Custom Scan Sizes	FTP Shortcuts			
Universal Setup	Profiles List			
	Print Fonts			
	Print Directory			
	Asset Report			
	Event Log Summary			

Manage Shortcuts

Fax Shortcuts

E-mail Shortcuts

FTP Shortcuts

Copy Shortcuts

Profile Shortcuts

¹ Depending on the printer setup, this menu item appears as Network Setup Page or Network [x] Setup Page.

² Depending on the printer setup, this menu item appears as Standard Network or Network [x].

Paper menu

Default Source menu

Use	To
<p>Default Source</p> <ul style="list-style-type: none"> Tray [x] Multipurpose Feeder Manual Paper Manual Envelope 	<p>Set a default paper source for all print jobs.</p> <p>Notes:</p> <ul style="list-style-type: none"> • Tray 1 (standard tray) is the factory default setting. • From the Paper menu, set Configure MP to “Cassette” for MP Feeder to appear as a menu setting. • If the same size and type of paper are in two trays and the paper size and paper type settings match, then the trays are automatically linked. When one tray is empty, the print job continues using the linked tray.

Paper Size/Type menu

Use	To
<p>Tray [x] Size</p> <ul style="list-style-type: none"> A4 A5 A6 JIS B5 Letter Legal Executive Oficio (Mexico) Folio Statement Universal 	<p>Specify the size of the paper loaded in each tray.</p> <p>Notes:</p> <ul style="list-style-type: none"> • A4 is the factory default setting. • If the same size and type of paper are loaded in two trays and the tray settings for paper size and type match, then the trays are automatically linked. The multipurpose feeder may also be linked. When one tray is empty, the job prints using paper from the linked tray. • A6 is supported only in Tray 1 and in the multipurpose feeder.

Use	To
<p>Tray [x] Type</p> <ul style="list-style-type: none"> Plain Paper Transparency Recycled Labels Bond Letterhead Preprinted Colored Paper Light Paper Heavy Paper Rough/Cotton Custom Type [x] 	<p>Specify the type of the paper loaded in each tray.</p> <p>Notes:</p> <ul style="list-style-type: none"> • Plain Paper is the factory default setting for Tray 1. Custom Type [x] is the factory default setting for all other trays. • If available, a user-defined name will appear instead of Custom Type [x]. • Use this menu to configure automatic tray linking.
<p>MP Feeder Size</p> <ul style="list-style-type: none"> A4 A5 A6 JIS B5 Letter Legal Executive Oficio (Mexico) Folio Statement Universal 7 3/4 Envelope 9 Envelope 10 Envelope DL Envelope C5 Envelope B5 Envelope Other Envelope 	<p>Specify the size of the paper loaded in the multipurpose feeder.</p> <p>Notes:</p> <ul style="list-style-type: none"> • A4 is the factory default setting. • From the Paper menu, set Configure MP to “Cassette” for MP Feeder Size to appear as a menu item. • The multipurpose feeder does not automatically detect paper size. The paper size value must be set.

User's Guide

Use	To
<p>MP Feeder Type</p> <ul style="list-style-type: none"> Plain Paper Card Stock Transparency Recycled Labels Bond Envelope Rough Envelope Letterhead Preprinted Colored Paper Light Paper Heavy Paper Rough/Cotton Custom Type [x] 	<p>Specify the type of the paper loaded in the multipurpose feeder.</p> <p>Notes:</p> <ul style="list-style-type: none"> • Plain Paper is the factory default setting. • From the Paper menu, set Configure MP to “Cassette” in order for MP Feeder Type to appear as a menu item.
<p>Manual Paper Size</p> <ul style="list-style-type: none"> A4 A5 A6 JIS B5 Letter Legal Executive Oficio (Mexico) Folio Statement Universal 	<p>Specify the size of the paper being manually loaded.</p> <p>Note: A4 is the factory default setting.</p>

Use	To
<p>Manual Paper Type</p> <ul style="list-style-type: none"> Plain Paper Card Stock Transparency Recycled Labels Bond Letterhead Preprinted Colored Paper Light Paper Heavy Paper Rough/Cotton Custom Type [x] 	<p>Specify the type of the paper being manually loaded.</p> <p>Notes:</p> <ul style="list-style-type: none"> • Plain Paper is the factory default setting. • From the Paper menu, set Configure MP to “Manual” in order for Manual Paper Type to appear as a menu item.
<p>Manual Envelope Size</p> <ul style="list-style-type: none"> 7 3/4 Envelope 9 Envelope 10 Envelope DL Envelope C5 Envelope B5 Envelope Other Envelope 	<p>Specify the size of the envelope being manually loaded.</p> <p>Note: DL Envelope is the factory default setting.</p>
<p>Manual Envelope Type</p> <ul style="list-style-type: none"> Envelope Rough Envelope Custom Type [x] 	<p>Specify the type of the envelope being manually loaded.</p> <p>Note: Envelope is the factory default setting.</p>
<p>Note: Only installed trays and feeders are listed in this menu.</p>	

Configure MP menu

Use	To
<p>Configure MP</p> <p>Cassette</p> <p>Manual</p> <p>First</p>	<p>Determine when the printer selects paper from the multipurpose feeder.</p> <p>Notes:</p> <ul style="list-style-type: none"> • Cassette is the factory default setting. Cassette configures the multipurpose feeder as the automatic paper source. • Manual sets the multipurpose feeder only for manual-feed print jobs. • First configures the multipurpose feeder as the primary paper source.

Substitute Size menu

Use	To
<p>Substitute Size</p> <p>Off</p> <p>Statement/A5</p> <p>Letter/A4</p> <p>All Listed</p>	<p>Substitute a specified paper size if the requested paper size is not available.</p> <p>Notes:</p> <ul style="list-style-type: none"> • All Listed is the factory default setting. All available substitutions are allowed. • Off indicates that no size substitutions are allowed. • Setting a size substitution lets the print job continue without Change Paper appearing.

Paper Texture menu

Use	To
<p>Plain Texture</p> <p>Smooth Normal Rough</p>	<p>Specify the relative texture of the plain paper loaded.</p> <p>Note: Normal is the factory default setting.</p>
<p>Card Stock Texture</p> <p>Smooth Normal Rough</p>	<p>Specify the relative texture of the card stock loaded.</p> <p>Notes:</p> <ul style="list-style-type: none"> • Normal is the factory default setting. • The options appear only if card stock is supported.
<p>Transparency Texture</p> <p>Smooth Normal Rough</p>	<p>Specify the relative texture of the transparencies loaded.</p> <p>Note: Normal is the factory default setting.</p>
<p>Recycled Texture</p> <p>Smooth Normal Rough</p>	<p>Specify the relative texture of the recycled paper loaded.</p> <p>Note: Normal is the factory default setting.</p>
<p>Labels Texture</p> <p>Smooth Normal Rough</p>	<p>Specify the relative texture of the labels loaded.</p> <p>Note: Normal is the factory default setting.</p>
<p>Bond Texture</p> <p>Smooth Normal Rough</p>	<p>Specify the relative texture of the bond paper loaded.</p> <p>Note: Rough is the factory default setting.</p>
<p>Envelope Texture</p> <p>Smooth Normal Rough</p>	<p>Specify the relative texture of the envelopes loaded.</p> <p>Note: Normal is the factory default setting.</p>
<p>Rough Envelope Texture</p> <p>Rough</p>	<p>Specify the relative texture of the rough envelopes loaded.</p>

User's Guide

Use	To
<p>Letterhead Texture</p> <p>Smooth Normal Rough</p>	<p>Specify the relative texture of the letterhead loaded.</p> <p>Note: Normal is the factory default setting.</p>
<p>Preprinted Texture</p> <p>Smooth Normal Rough</p>	<p>Specify the relative texture of the preprinted paper loaded.</p> <p>Note: Normal is the factory default setting.</p>
<p>Colored Texture</p> <p>Smooth Normal Rough</p>	<p>Specify the relative texture of the colored paper loaded.</p> <p>Note: Normal is the factory default setting.</p>
<p>Light Texture</p> <p>Smooth Normal Rough</p>	<p>Specify the relative texture of the paper loaded.</p> <p>Note: Normal is the factory default setting.</p>
<p>Heavy Texture</p> <p>Smooth Normal Rough</p>	<p>Specify the relative texture of the paper loaded.</p> <p>Note: Normal is the factory default setting.</p>
<p>Rough/Cotton Texture</p> <p>Rough</p>	<p>Specify the relative texture of the cotton paper loaded.</p>
<p>Custom [x] Texture</p> <p>Smooth Normal Rough</p>	<p>Specify the relative texture of the custom paper loaded.</p> <p>Notes:</p> <ul style="list-style-type: none"> • Normal is the factory default setting. • The options appear only if the custom type is supported.

Paper Weight menu

Use	To
<p>Plain Weight</p> <p>Light Normal Heavy</p>	<p>Specify the relative weight of the plain paper loaded.</p> <p>Note: Normal is the factory default setting.</p>
<p>Card Stock Weight</p> <p>Light Normal Heavy</p>	<p>Specify the relative weight of the card stock loaded.</p> <p>Note: Normal is the factory default setting.</p>
<p>Transparency Weight</p> <p>Light Normal Heavy</p>	<p>Specify the relative weight of the transparencies loaded.</p> <p>Note: Normal is the factory default setting.</p>
<p>Recycled Weight</p> <p>Light Normal Heavy</p>	<p>Specify the relative weight of the recycled paper loaded.</p> <p>Note: Normal is the factory default setting.</p>
<p>Labels Weight</p> <p>Light Normal Heavy</p>	<p>Specify the relative weight of the labels loaded.</p> <p>Note: Normal is the factory default setting.</p>
<p>Bond Weight</p> <p>Light Normal Heavy</p>	<p>Specify the relative weight of the bond paper loaded.</p> <p>Note: Normal is the factory default setting.</p>
<p>Envelope Weight</p> <p>Light Normal Heavy</p>	<p>Specify the relative weight of the envelope loaded.</p> <p>Note: Normal is the factory default setting.</p>

User's Guide

Use	To
<p>Rough Envelope Weight</p> <p>Light Normal Heavy</p>	<p>Specify the relative weight of the rough envelope loaded.</p> <p>Note: Normal is the factory default setting.</p>
<p>Letterhead Weight</p> <p>Light Normal Heavy</p>	<p>Specify the relative weight of the letterhead loaded.</p> <p>Note: Normal is the factory default setting.</p>
<p>Preprinted Weight</p> <p>Light Normal Heavy</p>	<p>Specify the relative weight of the preprinted paper loaded.</p> <p>Note: Normal is the factory default setting.</p>
<p>Colored Weight</p> <p>Light Normal Heavy</p>	<p>Specify the relative weight of the colored paper loaded.</p> <p>Note: Normal is the factory default setting.</p>
<p>Light Weight</p> <p>Light</p>	<p>Specify that the relative weight of the paper loaded is light.</p>
<p>Heavy Weight</p> <p>Heavy</p>	<p>Specify the relative weight of the paper loaded is heavy.</p>
<p>Rough/Cotton Weight</p> <p>Light Normal Heavy</p>	<p>Specify the relative weight of the cotton or rough paper loaded.</p> <p>Note: Normal is the factory default setting.</p>
<p>Custom [x] Weight</p> <p>Light Normal Heavy</p>	<p>Specify the relative weight of the custom paper loaded.</p> <p>Notes:</p> <ul style="list-style-type: none"> • Normal is the factory default setting. • The options appear only when the custom type is supported.

Paper Loading menu

Use	To
<p>Recycled Loading</p> <p>Duplex</p> <p>Off</p>	<p>Determine and set two-sided printing for all print jobs that specify Recycled as the paper type.</p>
<p>Bond Loading</p> <p>Duplex</p> <p>Off</p>	<p>Determine and set two-sided printing for all print jobs that specify Bond as the paper type.</p>
<p>Letterhead Loading</p> <p>Duplex</p> <p>Off</p>	<p>Determine and set two-sided printing for all print jobs that specify Letterhead as the paper type.</p>
<p>Preprinted Loading</p> <p>Duplex</p> <p>Off</p>	<p>Determine and set two-sided printing for all print jobs that specify Preprinted as the paper type.</p>
<p>Colored Loading</p> <p>Duplex</p> <p>Off</p>	<p>Determine and set two-sided printing for all print jobs that specify Colored as the paper type.</p>
<p>Light Loading</p> <p>Duplex</p> <p>Off</p>	<p>Determine and set two-sided printing for all print jobs that specify Light as the paper type.</p>
<p>Heavy Loading</p> <p>Duplex</p> <p>Off</p>	<p>Determine and set two-sided printing for all print jobs that specify Heavy as the paper type.</p>
<p>Custom [x] Loading</p> <p>Duplex</p> <p>Off</p>	<p>Determine and set two-sided printing for all print jobs that specify Custom [x] as the paper type.</p> <p>Note: Custom [x] Loading is available only if the custom type is supported.</p>
<p>Notes:</p> <ul style="list-style-type: none"> • Duplex sets two-sided printing as the default for all print jobs unless one-sided printing is set from Printing Preferences or Print dialog. • If Duplex is selected, then all print jobs are sent through the duplex unit, including one-sided jobs. • Off is the factory default setting for all the menus. 	

Custom Types menu

Use	To
<p>Custom Type [x]</p> <ul style="list-style-type: none"> Paper Card Stock Transparency Rough/Cotton Labels Envelope 	<p>Associate a paper or specialty media type with a factory default Custom Type [x] name or a user-defined custom name created in the Embedded Web Server or MarkVision™ Professional. The user-defined name appears instead of Custom Type [x].</p> <p>Notes:</p> <ul style="list-style-type: none"> • Paper is the factory default setting for Custom Type [x]. • The custom media type must be supported in the selected tray or feeder in order to print from that source.
<p>Recycled</p> <ul style="list-style-type: none"> Paper Card Stock Transparency Rough/Cotton Labels Envelope 	<p>Specify a paper type when the Recycled setting is selected in other menus.</p> <p>Notes:</p> <ul style="list-style-type: none"> • Paper is the factory default setting. • The Recycled paper type must be supported in the selected tray or feeder in order to print from that source.

Custom Names menu

Use	To
<p>Custom Name [x]</p>	<p>Specify a custom name for a paper type. This name replaces Custom Type [x] in the printer menus.</p>

Custom Scan Sizes menu

Use	To
<p>Custom Scan Size [x]</p> <ul style="list-style-type: none"> Scan Size Name Width Height Orientation <ul style="list-style-type: none"> Portrait Landscape 2 scans per side <ul style="list-style-type: none"> Off On 	<p>Specify a custom scan size name and page orientation.</p> <p>Notes:</p> <ul style="list-style-type: none"> • The custom scan size name replaces Custom Scan Size [x] in the printer menus. • ADF Media Type is the factory default setting for custom scan sizes 3, 4, 5, and 6. • 210 millimeters is the factory default setting for Width. • 297 millimeters is the factory default setting for Height. • Portrait is the factory default setting for Orientation. • Off is the factory default setting for “2 scans per side.”

Universal Setup menu

Use	To
<p>Units of Measure</p> <p>Inches</p> <p>Millimeters</p>	<p>Identify the units of measure.</p> <p>Note: Millimeters is the factory default setting.</p>
<p>Portrait Width</p> <p>3–8.5 inches</p> <p>76–216 mm</p>	<p>Set the portrait width.</p> <p>Notes:</p> <ul style="list-style-type: none"> • If the width exceeds the maximum, then the printer uses the maximum width allowed. • You can increase the width in 0.01-inch increments. • 216 mm is the factory default setting. You can increase the width in 1-mm increments.
<p>Portrait Height</p> <p>3–14.17 inches</p> <p>76–360 mm</p>	<p>Set the portrait height.</p> <p>Notes:</p> <ul style="list-style-type: none"> • If the height exceeds the maximum, then the printer uses the maximum height allowed. • You can increase the height in 0.01-inch increments. • 360 mm is the factory default setting. You can increase the height in 1-mm increments.
<p>Feed Direction</p> <p>Short Edge</p> <p>Long Edge</p>	<p>Specify the feed direction if the paper can be loaded in either direction.</p> <p>Notes:</p> <ul style="list-style-type: none"> • Short Edge is the factory default setting. • Long Edge appears only when the longest edge is shorter than the maximum width supported in the tray.

Reports Menu

Reports menu

Use	To
Menu Settings Page	Print a report containing information about the paper loaded in trays, installed memory, total page count, alarm settings, timeouts, printer control panel language, TCP/IP address, status of supplies, status of the network connection, and other information.
Device Statistics	Print a report containing printer statistics such as supply information and number of printed pages.
Network Setup Page	Print a report containing information about the network printer settings, such as the TCP/IP address information. Note: This menu item appears only in network printers or printers connected to print servers.
Network [x] Setup Page	Print a report containing information about the network settings of the printer, such as the TCP/IP address information. Note: This menu item appears only in network printers or printers connected to print servers, and when there is more than one network option installed.
Shortcut List	Print a report containing information about configured shortcuts.
Fax Job Log	Print a report containing information about the last 200 completed faxes. Notes: <ul style="list-style-type: none"> • This menu item appears only when Enable Job Log is set to On in the Fax Settings menu. • This menu is supported only in select printer models.
Fax Call Log	Print a report containing information about the last 100 attempted, received, and blocked calls. Notes: <ul style="list-style-type: none"> • This menu item appears only when Enable Job Log is set to On in the Fax Settings menu. • This menu is supported only in select printer models.
Copy Shortcuts	Print a report containing information about copy shortcuts.
E-mail Shortcuts	Print a report containing information about e-mail shortcuts.
Fax Shortcuts	Print a report containing information about fax shortcuts.

Use	To
FTP Shortcuts	Print a report containing information about FTP shortcuts.
Profiles List	Print a list of profiles stored in the printer.
Print Fonts	Print a report of all the fonts available for the printer language currently set in the printer.
Print Directory	<p>Print a list of all the resources stored in an optional flash memory card or printer hard disk.</p> <p>Notes:</p> <ul style="list-style-type: none"> • Job Buffer Size must be set to 100%. • Make sure the optional flash memory or printer hard disk is working and installed correctly.
Asset Report	Print a report containing asset information including the printer serial number and model name. The report contains text and UPC bar codes that can be scanned into an asset database.

Network/Ports menu

Active NIC menu

Use	To
<p>Active NIC</p> <p>Auto</p> <p>[list of available network cards]</p>	<p>Notes:</p> <ul style="list-style-type: none"> • Auto is the factory default setting. • This menu item appears only when an optional network card is installed.

Standard Network or Network [x] menu

Note: Only active ports appear in this menu. All inactive ports are omitted.

Use	To
<p>PCL SmartSwitch</p> <p>On Off</p>	<p>Set the printer to automatically switch to PCL emulation when a print job requires it, regardless of the default printer language.</p> <p>Notes:</p> <ul style="list-style-type: none"> On is the factory default setting. If PCL SmartSwitch is disabled, then the printer does not examine incoming data and it uses the default printer language specified in the Setup menu.
<p>PS SmartSwitch</p> <p>On Off</p>	<p>Set the printer to automatically switch to PS emulation when a print job requires it, regardless of the default printer language.</p> <p>Notes:</p> <ul style="list-style-type: none"> On is the factory default setting. If PS SmartSwitch is disabled, then the printer does not examine incoming data and uses the default printer language specified in the Setup menu.
<p>NPA Mode</p> <p>Off Auto</p>	<p>Set the printer to perform the special processing required for bidirectional communication following the conventions defined by the NPA protocol.</p> <p>Notes:</p> <ul style="list-style-type: none"> Auto is the factory default setting. Changing this setting from the printer control panel and then exiting the menus causes the printer to restart. The menu selection is then updated.
<p>Network Buffer</p> <p>Auto 3KB to [maximum size allowed]</p>	<p>Set the size of the network input buffer.</p> <p>Notes:</p> <ul style="list-style-type: none"> Auto is the factory default setting. The value can be changed in 1KB increments. The maximum size allowed depends on the amount of memory in the printer, the size of the other link buffers, and whether Resource Save is set to On or Off. To increase the maximum size range for the Network Buffer, disable or reduce the size of the parallel, serial, and USB buffers. Changing this setting from the printer control panel, and then exiting the menus causes the printer to restart. The menu selection is then updated.

Use	To
<p>Mac Binary PS</p> <p>On</p> <p>Off</p> <p>Auto</p>	<p>Set the printer to process Macintosh binary PostScript print jobs.</p> <p>Notes:</p> <ul style="list-style-type: none"> • Auto is the factory default setting. • Off filters print jobs using the standard protocol. • On processes raw binary PostScript print jobs.
<p>Standard Network Setup or Network [x] Setup</p> <p>Reports</p> <p>Network Card</p> <p>TCP/IP</p> <p>IPv6</p> <p>Wireless</p> <p>AppleTalk</p>	<p>Display and set the printer network settings.</p> <p>Note: The Wireless menu appears only when the printer is connected to a wireless network.</p>

Reports menu

To access the menu, navigate to either of the following:

- **Network/Ports >Standard Network >Standard Network Setup >Reports**
- **Network/Ports >Network [x] >Network [x] Setup >Reports**

Use	To
<p>Print Setup Page</p>	<p>Print a report containing information about the network printer settings, such as the TCP/IP address.</p>

Network Card menu

To access the menu, navigate to either of the following:

- **Network/Ports >Standard Network >Standard Network Setup >Network Card**
- **Network/Ports >Network [x] >Network [x] Setup >Network Card**

Use	To
View Card Status Connected Disconnected	View the connection status of the network card.
View Card Speed	View the speed of an active network card.
Network Address UAA LAA	View the network addresses.
Job Timeout 0–255 seconds	Set the amount of time it takes for a network print job to be canceled. Notes: <ul style="list-style-type: none"> • 90 seconds is the factory default setting. • A setting value of 0 disables the timeout. • If a value of 1–9 is selected, then the setting is saved as 10.

TCP/IP menu

To access the menu, navigate to either of the following:

- **Network/Ports >Standard Network >Standard Network Setup >TCP/IP**
- **Network/Ports >Network [x] >Network [x] Setup >TCP/IP**

Note: This menu is available only in network printers or printers attached to print servers.

Use	To
Set Hostname	Set the current TCP/IP host name. Note: This can be changed only from the Embedded Web Server.
IP Address	View or change the current TCP/IP address. Note: Manually setting the IP address sets the Enable DHCP and Enable Auto IP settings to Off. It also sets Enable BOOTP and Enable RARP to Off on systems that support BOOTP and RARP.

User's Guide

Use	To
Netmask	View or change the current TCP/IP netmask.
Gateway	View or change the current TCP/IP gateway.
Enable DHCP On Off	Specify the DHCP address and parameter assignment. Note: On is the factory default setting.
Enable RARP On Off	Specify the RARP address assignment setting. Note: Off is the factory default setting.
Enable BOOTP On Off	Specify the BOOTP address assignment setting. Note: On is the factory default setting.
Enable AutoIP Yes No	Specify the Zero Configuration Networking setting. Note: Yes is the factory default setting.
Enable FTP/TFTP Yes No	Enable the built-in FTP server, which lets you send files to the printer using File Transfer Protocol. Note: Yes is the factory default setting.
Enable HTTP Server Yes No	Enable the built-in Web server (Embedded Web Server). When enabled, the printer can be monitored and managed remotely using a Web browser. Note: Yes is the factory default setting.
WINS Server Address	View or change the current WINS server address.
Enable DDNS Yes No	View or change the current DDNS setting. Note: Yes is the factory default setting.
Enable mDNS Yes No	View or change the current mDNS setting. Note: Yes is the factory default setting.

Use	To
DNS Server Address	View or change the current DNS server address.
Backup DNS Server Address	View or change the backup DNS server addresses.
Backup DNS Server Address 2	
Backup DNS Server Address 3	
Enable HTTPS Yes No	View or change the current HTTPS setting. Note: Yes is the factory default setting.

IPv6 menu

To access the menu, navigate to either of the following:

- **Network/Ports >Standard Network >Standard Network Setup >IPv6**
- **Network/Ports >Network [x] >Network [x] Setup >IPv6**

Note: This menu is available only in network printers or printers that are attached to print servers.

Use	To
Enable IPv6 On Off	Enable IPv6 in the printer. Note: On is the factory default setting.
Auto Configuration On Off	Specify whether or not the wireless network adapter accepts the automatic IPv6 address configuration entries provided by a router. Note: On is the factory default setting.
View Hostname	Set the host name. Note: These settings can be changed only from the Embedded Web Server.
View Address	
View Router Address	
Enable DHCPv6 On Off	Enable DHCPv6 in the printer. Note: On is the factory default setting.

Wireless menu

Note: This menu is available only in printers connected to an Ethernet network and printers with a wireless network adapter attached.

To access the menu, navigate to either of the following:

- **Network/Ports >Standard Network >Standard Network Setup >Wireless**
- **Network/Ports >Network [x] >Network [x] Setup >Wireless**

Use	To
<p>Wi-Fi Protected Setup (WPS)</p> <p>Start Push Button Method Start PIN Method</p>	<p>Establish a wireless network connection and enable network security.</p> <p>Notes:</p> <ul style="list-style-type: none"> • Start Push Button Method connects the printer to a wireless network when buttons on both the printer and the access point (wireless router) are pressed within a given period of time. • Start PIN Method connects the printer to a wireless network when a PIN on the printer is entered into the wireless settings of the access point.
<p>Enable/Disable WPS Auto-detection</p> <p>Enable Disable</p>	<p>Automatically detect the connection method that an access point with WPS uses—Start Push Button Method or Start PIN Method.</p> <p>Note: Disable is the factory default setting.</p>
<p>Network Mode</p> <p>BSS Type</p> <p>Infrastructure Ad hoc</p>	<p>Specify the network mode.</p> <p>Notes:</p> <ul style="list-style-type: none"> • Infrastructure is the factory default setting. This lets the printer access a network using an access point. • Ad hoc configures a wireless connection directly between the printer and a computer.
<p>Compatibility</p> <p>802.11b/g 802.11b/g/n</p>	<p>Specify the wireless standard for the wireless network.</p> <p>Note: The 802.11b/g/n is the factory default setting.</p>
<p>Choose Network</p>	<p>Select an available network for the printer to use.</p>
<p>View Signal Quality</p>	<p>View the quality of the wireless connection.</p>
<p>View Security Mode</p>	<p>View the encryption method for the wireless network.</p>

AppleTalk menu

Note: This menu is available only in printer models connected to a wired network or when an optional network card is installed.

To access the menu, navigate to any of the following:

- **Network/Ports >Standard Network >Standard Network Setup >AppleTalk**
- **Network/Ports >Network Setup [x] >AppleTalk**

Use	To
Activate Yes No	Enable or disable AppleTalk support. Note: Yes is the factory default setting.
View Name	Show the assigned AppleTalk name. Note: The name can be changed only from the Embedded Web Server.
View Address	Show the assigned AppleTalk address. Note: The address can be changed only from the Embedded Web Server.
Set Zone [list of zones available on the network]	Provide a list of AppleTalk zones available on the network. Note: The factory default setting is the default zone for the network. If no default zone exists, then the zone marked with an asterisk (*) is the default setting.

Standard USB menu

Use	To
<p>PCL SmartSwitch</p> <p>On</p> <p>Off</p>	<p>Set the printer to automatically switch to PCL emulation when a print job received through a USB port requires it, regardless of the default printer language.</p> <p>Notes:</p> <ul style="list-style-type: none"> • On is the factory default setting. • When set to Off, the printer does not examine incoming data. The printer uses PostScript emulation if the PS SmartSwitch is set to On. It uses the default printer language specified in the Setup menu if the PS SmartSwitch is set to Off.
<p>PS SmartSwitch</p> <p>On</p> <p>Off</p>	<p>Set the printer to automatically switch to PS emulation when a print job received through a USB port requires it, regardless of the default printer language.</p> <p>Notes:</p> <ul style="list-style-type: none"> • On is the factory default setting. • When set to Off, the printer does not examine incoming data. The printer uses PCL emulation if the PCL SmartSwitch is set to On. It uses the default printer language specified in the Setup menu if the PCL SmartSwitch is set to Off.
<p>NPA Mode</p> <p>On</p> <p>Off</p> <p>Auto</p>	<p>Set the printer to perform the special processing required for bidirectional communication following the conventions defined by the NPA protocol.</p> <p>Notes:</p> <ul style="list-style-type: none"> • Auto is the factory default setting. Auto sets the printer to examine data, determine the format, and then process it appropriately. • The printer automatically restarts when changing the setting from the printer control panel. The menu selection is then updated.

User's Guide

Use	To
<p>USB Buffer</p> <p>Disabled</p> <p>Auto</p> <p>3K to [maximum size allowed]</p>	<p>Set the size of the USB input buffer.</p> <p>Notes:</p> <ul style="list-style-type: none"> • Auto is the factory default setting. • Disabled turns off job buffering. Any jobs already buffered on the printer hard disk are printed before normal processing resumes. • The USB buffer size value can be changed in 1-K increments. • The maximum size allowed depends on the amount of memory in the printer, the size of the other link buffers, and whether Resource Save is set to On or Off. • To increase the maximum size range for the USB Buffer, disable or reduce the size of the parallel, serial, and network buffers. • The printer automatically restarts when the setting is changed from the printer control panel. The menu selection is then updated.
<p>Job Buffering</p> <p>Off</p> <p>On</p> <p>Auto</p>	<p>Temporarily store print jobs in the printer hard disk before printing.</p> <p>Notes:</p> <ul style="list-style-type: none"> • Off is the factory default setting. • On buffers jobs on the printer hard disk. • Auto buffers print jobs only if the printer is busy processing data from another input port. • Changing this setting from the printer control panel and then exiting the menus causes the printer to restart. The menu selection is then updated.
<p>Mac Binary PS</p> <p>On</p> <p>Off</p> <p>Auto</p>	<p>Set the printer to process Macintosh binary PostScript print jobs.</p> <p>Notes:</p> <ul style="list-style-type: none"> • Auto is the factory default setting. • On processes raw binary PostScript print jobs. • Off filters print jobs using the standard protocol.
<p>ENA Address</p> <p>yyy.yyy.yyy.yyy</p>	<p>Set the network address information for an external print server.</p> <p>Note: This menu is available only when the printer is attached to an external print server through the USB port.</p>
<p>ENA Netmask</p> <p>yyy.yyy.yyy.yyy</p>	<p>Set the netmask information for an external print server.</p> <p>Note: This menu is available only when the printer is attached to an external print server through the USB port.</p>

Use	To
ENA Gateway yyy.yyy.yyy.yyy	Set the gateway information for an external print server. Note: This menu is available only when the printer is attached to an external print server through the USB port.

SMTP Setup menu

Use	To
Primary SMTP Gateway	Specify SMTP server gateway and port information. Note: 25 is the default SMTP gateway port.
Primary SMTP Gateway Port	
Secondary SMTP Gateway	
Secondary SMTP Gateway Port	
SMTP Timeout 5–30	Specify the amount of time in seconds before the server stops trying to send an e-mail. Note: 30 is the factory default setting.
Reply Address	Specify a reply address of up to 128 characters in the e-mail sent by the printer.
Use SSL Disabled Negotiate Required	Set the printer to use SSL for increased security when connecting to the SMTP server. Notes: <ul style="list-style-type: none"> • Disabled is the factory default setting. • When the Negotiate setting is used, the SMTP server determines if SSL will be used.
SMTP Server Authentication No authentication required Login/Plain CRAM-MD5 Digest-MD5 NTLM Kerberos 5	Specify the type of user authentication required for scan to e-mail privileges. Note: “No authentication required” is the factory default setting.

User's Guide

Use	To
<p>Device-Initiated E-mail</p> <p>None</p> <p>Use Device SMTP Credentials</p>	<p>Specify what credentials will be used when communicating to the SMTP server.</p> <p>Notes:</p> <ul style="list-style-type: none"> • None is the factory default setting for Device-Initiated E-mail and User-Initiated E-mail. • “Device Userid” and “Device password” are used to log in to the SMTP server when Use Device SMTP Credentials is selected.
<p>User-Initiated E-mail</p> <p>None</p> <p>Use Device SMTP Credentials</p> <p>Use Session User ID and Password</p> <p>Use Session E-mail address and Password</p> <p>Prompt user</p>	
<p>Device Userid</p>	
<p>Device password</p>	
<p>Kerberos 5 Realm</p>	
<p>NTLM Domain</p>	

Security menu

Miscellaneous Security Settings menu

Use	To
<p>Login Restrictions</p> <ul style="list-style-type: none"> Login Failures Failure Time Frame Lockout Time Panel Login Timeout Remote Login Timeout 	<p>Limit the number and time frames of failed login attempts from the printer control panel before <i>all</i> users are locked out.</p> <p>Notes:</p> <ul style="list-style-type: none"> • Login Failures specifies the number of failed login attempts before users are locked out. Settings range from 1–10. 3 attempts is the factory default setting. • Failure Time Frame specifies the time frame during which failed login attempts can be made before users are locked out. Settings range from 1–60 minutes. 5 minutes is the factory default setting. • Lockout Time specifies how long users are locked out after exceeding the login failures limit. Settings range from 1–60 minutes. 5 minutes is the factory default setting. 1 indicates the scanner does not impose a lockout time. • Panel Login Timeout specifies how long the scanner remains idle on the home screen before automatically logging the user off. Settings range from 1–900 seconds. 30 seconds is the factory default setting. • Remote Login Timeout specifies how long a remote interface remains idle before automatically logging the user off. Settings range from 1–120 minutes. 10 minutes is the factory default setting.
<p>Minimum PIN Length</p> <p>1–16</p>	<p>Limit the digit length of the PIN.</p> <p>Note: 4 is the factory default setting.</p>

Confidential Print menu

Use	To
<p>Max Invalid PIN</p> <p>Off 2-10</p>	<p>Limit the number of times an invalid PIN can be entered.</p> <p>Notes:</p> <ul style="list-style-type: none"> • This menu appears only when a formatted, non-defective printer hard disk is installed. • Once the limit is reached, the print jobs for that user name and PIN are deleted.
<p>Confidential Job Expiration</p> <p>Off 1 hour 4 hours 24 hours 1 week</p>	<p>Limit the amount of time a confidential print job stays in the printer before it is deleted.</p> <p>Notes:</p> <ul style="list-style-type: none"> • If the “Confidential Job Expiration” setting is changed while confidential print jobs reside in the printer RAM or printer hard disk, then the expiration time for those print jobs does not change to the new default value. • If the printer is turned off, then all confidential jobs held in the printer RAM are deleted.
<p>Repeat Job Expiration</p> <p>Off 1 hour 4 hours 24 hours 1 week</p>	<p>Set a time limit on how long the printer stores print jobs.</p>
<p>Verify Job Expiration</p> <p>Off 1 hour 4 hours 24 hours 1 week</p>	<p>Set a time limit on how long the printer stores print jobs needing verification.</p>
<p>Reserve Job Expiration</p> <p>Off 1 hour 4 hours 24 hours 1 week</p>	<p>Set a time limit on how long the printer stores print jobs for printing at a later time.</p>

Use	To
Note: Off is the factory default setting.	

Disk Wiping menu

Disk Wiping erases *only* print job data on the printer hard disk that *are not* currently in use by the file system. All permanent data on the printer hard disk are preserved, such as downloaded fonts, macros, and held jobs.

Note: This menu appears only when a formatted, non-defective printer hard disk is installed.

Use	To
Wiping Mode Auto	Specify the mode for disk wiping.
Automatic Method Single pass Multiple pass	Mark all disk space used by a previous print job. This method does not permit the file system to reuse this space until it has been cleared. Notes: <ul style="list-style-type: none"> • “Single pass” is the factory default setting. • Only automatic wiping enables users to activate disk wiping without having to turn the printer off for an extended amount of time. • Highly confidential information should be wiped using <i>only</i> the Multiple pass method.

Security Audit Log menu

Use	To
<p>Export Log</p>	<p>Let an authorized user export the audit log.</p> <p>Notes:</p> <ul style="list-style-type: none"> • To export the audit log from the printer control panel, a flash drive must be attached to the printer. • The audit log can be downloaded from the Embedded Web Server and saved on a computer.
<p>Delete Log</p> <p>Yes No</p>	<p>Specify whether or not audit logs are deleted.</p> <p>Note: Yes is the factory default setting.</p>
<p>Configure Log</p> <p>Enable Audit Yes No</p> <p>Enable Remote Syslog No Yes</p> <p>Remote Syslog Facility 0–23</p> <p>Severity of events to log 0–7</p>	<p>Specify how and whether or not audit logs are created.</p> <p>Notes:</p> <ul style="list-style-type: none"> • Enable Audit determines if events are recorded in the secure audit log and remote syslog. No is the factory default setting. • Enable Remote Syslog determines if logs are sent to a remote server. No is the factory default setting. • Remote Syslog Facility determines the value used to send logs to the remote syslog server. 4 is the factory default setting. • If the security audit log is activated, then the severity value of each event is recorded. 4 is the factory default setting.

Set Date and Time menu

Use	To
Current Date and Time	View the current date and time settings for the printer.
Manually Set Date and Time [input date/time]	Enter the date and time. Notes: <ul style="list-style-type: none"> • Manually setting the date and time sets Enable NTP to No. • The wizard lets you set the date and time in YYYY-MM-DD-HH:MM format.
Time Zone [list of time zones]	Select the time zone. Note: GMT is the factory default settings.
Automatically observe DST On Off	Set the printer to use the applicable daylight saving time (DST) start and end times associated with the printer Time Zone setting. Note: On is the factory default setting.
Enable NTP On Off	Enable Network Time Protocol, which synchronizes the clocks of devices on a network. Notes: <ul style="list-style-type: none"> • On is the factory default setting. • This setting is turned off if you manually set the date and time.

Settings menu

General Settings menu

Use	To
<p>Display Language</p> <ul style="list-style-type: none"> English Francais Deutsch Italiano Espanol Dansk Norsk Nederlands Svenska Portuguese Suomi Russian Polski Greek Magyar Turkce Cesky Simplified Chinese Traditional Chinese Korean Japanese 	<p>Set the language of the text appearing on the printer display.</p> <p>Note: Not all languages are available for all printers, and you may need to install special hardware for those languages to appear.</p>
<p>Show Supply Estimates</p> <ul style="list-style-type: none"> Show estimates Do not show estimates 	<p>Display the estimates of the supplies on the printer control panel, Web page, menu settings, and device statistics reports.</p> <p>Note: “Show estimates” is the factory default setting.</p>

User's Guide

Use	To
<p>Eco-Mode</p> <p>Off Energy Energy/Paper Paper</p>	<p>Minimize the use of energy, paper, or specialty media.</p> <p>Notes:</p> <ul style="list-style-type: none"> • Off is the factory default setting. This resets the printer to its factory default settings. • Energy minimizes the power used by the printer. Performance may be affected, but print quality is not. • Energy/Paper minimizes the use of power and of paper and specialty media. • Paper minimizes the amount of paper and specialty media needed for a print job. Performance may be affected, but print quality is not.
<p>ADF Loaded Beep</p> <p>Enabled Disabled</p>	<p>Specify whether or not the ADF sounds a beep when paper is loaded.</p> <p>Note: Enabled is the factory default setting.</p>
<p>Quiet Mode</p> <p>Off On</p>	<p>Reduce the amount of noise produced by the printer.</p> <p>Notes:</p> <ul style="list-style-type: none"> • Off is the factory default setting. This supports the performance specifications for your printer. • On configures the printer to produce as little noise as possible. This is best suited for printing text and line art. • Selecting Photo from the printer driver may disable Quiet Mode and provide better print quality and full-speed printing.
<p>Run Initial setup</p> <p>Yes No</p>	<p>Run the setup wizard.</p> <p>Notes:</p> <ul style="list-style-type: none"> • Yes is the factory default setting. • After completing the setup wizard by selecting Done at the country or region selection screen, the default becomes No.

Use	To
<p>Keyboard</p> <p>Keyboard Type</p> <ul style="list-style-type: none"> English Francais Francais Canadien Deutsch Italiano Espanol Greek Dansk Norsk Nederlands Svenska Suomi Portuguese Russian Polski Swiss German Swiss French Korean Magyar Turkish Czech Simplified Chinese Traditional Chinese Japanese Custom Key [x] 	<p>Specify a language and custom key information for the printer control panel keyboard. The additional tabs enable access to accent marks and symbols.</p> <p>Note: Customer Key 1 is the factory default setting.</p>
<p>Paper Sizes</p> <ul style="list-style-type: none"> US Metric 	<p>Specify the unit of measurement for paper sizes.</p> <p>Notes:</p> <ul style="list-style-type: none"> • US is the factory default setting. • The initial setting is determined by your country or region selection in the initial setup wizard.
<p>Scan to PC Port Range</p> <p>[port range]</p>	<p>Specify a valid port range for printers behind a port blocking firewall. The valid ports are specified by two sets of numbers separated by a semicolon.</p> <p>Note: 9751:12000 is the factory default setting.</p>

User's Guide

Use	To
<p>Displayed Information</p> <p>Left side</p> <p>Right side</p> <p>Custom Text [x]</p>	<p>Specify what is displayed on the upper left and right corners of the home screen.</p> <p>For the “Left side” and “Right side” options, select from the following options:</p> <ul style="list-style-type: none"> None IP Address Hostname Contact Name Location Date/Time mDNS/DDNS Service Name Zero Configuration Name Custom Text [x] Model Name <p>Notes:</p> <ul style="list-style-type: none"> • IP Address is the factory default setting for Left side. • Date/Time is the factory default setting for Right side.
<p>Displayed Information (continued)</p> <p>Black Toner</p> <p>PC Kit</p>	<p>Customize the displayed information for Black Toner and PC Kit.</p> <p>Select from the following options:</p> <ul style="list-style-type: none"> When to display <ul style="list-style-type: none"> Do not display Display Message to display <ul style="list-style-type: none"> Default Alternate Default <ul style="list-style-type: none"> [text entry] Alternate <ul style="list-style-type: none"> [text entry] <p>Notes:</p> <ul style="list-style-type: none"> - “Do not display” is the factory default setting for “When to display.” - Default is the factory default setting for “Message to display.”

User's Guide

Use	To
<p>Displayed Information (continued)</p> <p>Paper Jam</p> <p>Load Paper</p> <p>Service Errors</p>	<p>Customize the displayed information for Paper Jam, Load Paper, and Service Errors.</p> <p>Select from the following options:</p> <p>Display</p> <p> Yes</p> <p> No</p> <p>Message to display</p> <p> Default</p> <p> Alternate</p> <p>Default</p> <p> [text entry]</p> <p>Alternate</p> <p> [text entry]</p> <p>Notes:</p> <ul style="list-style-type: none">• No is the factory default setting for Display.• Default is the factory default setting for "Message to display."

Use	To
<p>Home screen customization</p> <ul style="list-style-type: none"> Change Language Copy Copy shortcuts Fax Fax shortcuts E-mail E-mail shortcuts FTP FTP shortcuts Search held jobs Held jobs USB Drive Profiles and Solutions Bookmarks Jobs by user Forms and Favorites Basic Card Copy Scan to Network My Shortcuts 	<p>Change the icons and buttons that appear on the home screen.</p> <p>For each icon or button, select from the following options:</p> <ul style="list-style-type: none"> Display Do not display <p>Notes:</p> <ul style="list-style-type: none"> • Display is the factory default setting for Copy, Fax, E-mail, FTP, Search Held Jobs, Held jobs, USB Drive, Forms and Favorites, Basic Card Copy, Scan to Network, and My Shortcuts. • “Do not display” is the factory default setting for Change language, Copy shortcuts, Fax shortcuts, E-mail shortcuts, FTP shortcuts, Profiles and Solutions, Bookmarks, and Jobs by user.
<p>Date Format</p> <ul style="list-style-type: none"> MM-DD-YYYY DD-MM-YYYY YYYY-MM-DD 	<p>Format the printer date.</p> <p>Note: DD-MM-YYYY is the factory default setting.</p>
<p>Time Format</p> <ul style="list-style-type: none"> 12 hour A.M./P.M. 24 hour clock 	<p>Format the printer time.</p> <p>Note: “12 hour A.M./P.M.” is the factory default setting.</p>
<p>Screen Brightness</p> <ul style="list-style-type: none"> 20–100 	<p>Set the brightness of the printer display.</p> <p>Note: 100 is the factory default setting.</p>
<p>One Page Copy</p> <ul style="list-style-type: none"> Off On 	<p>Set copies from the scanner to only one page at a time.</p> <p>Note: Off is the factory default setting.</p>

User's Guide

Use	To
<p>Output Lighting</p> <p>Off</p> <p>Dim</p> <p>Bright</p>	<p>Set the lighting for the standard output bin.</p> <p>Off: The lighting turns off when paper remains in the standard bin.</p> <p>Dim: The lighting turns on with a dim light when paper remains in the standard bin.</p> <p>Bright: The lighting turns on with a bright light when paper remains in the standard bin.</p> <p>Notes:</p> <ul style="list-style-type: none"> • This menu item appears only when lighting is installed in the standard output bin. • When Eco-Mode is set to Off or Plain Paper, Bright is the default setting. When Eco-Mode is set to Energy or Energy/Paper, Dim is the default setting.
<p>Audio Feedback</p> <p>Button Feedback</p> <p>On</p> <p>Off</p> <p>Volume</p> <p>1–10</p>	<p>Specify whether icons and buttons have audio feedback.</p> <p>Notes:</p> <ul style="list-style-type: none"> • On is the factory default setting for Button Feedback. • 5 is the factory default setting for Volume.
<p>Show Bookmarks</p> <p>Yes</p> <p>No</p>	<p>Specify whether bookmarks are displayed from the Held Jobs area.</p> <p>Note: Yes is the factory default setting. When Yes is selected, bookmarks appear in the Held Jobs area.</p>
<p>Allow Background Removal</p> <p>On</p> <p>Off</p>	<p>Specify whether image background removal is allowed in copy, fax, e-mail, FTP, or scan-to-flash-drive jobs.</p> <p>Note: On is the factory default setting. The background of the image will be removed.</p>
<p>Allow Custom Job Scans</p> <p>On</p> <p>Off</p>	<p>Scan multiple jobs to one file.</p> <p>Note: On is the factory default setting. If On is selected, then Allow Custom Job Scans can be enabled for specific jobs.</p>
<p>Scanner Jam recovery</p> <p>Job Level</p> <p>page Level</p>	<p>Specify how a scan job should be reloaded if a paper jam occurs in the ADF.</p> <p>Note: Job Level is the factory default setting.</p>

User's Guide

Use	To
<p>Web Page Refresh Rate</p> <p>30–300</p>	<p>Specify the number of seconds between Embedded Web Server refreshes.</p> <p>Note: 120 is the factory default setting.</p>
<p>Contact Name</p>	<p>Specify a contact name for the printer.</p> <p>Note: The contact name will be stored on the Embedded Web Server.</p>
<p>Location</p>	<p>Specify the location of the printer.</p> <p>Note: The location will be stored on the Embedded Web Server.</p>
<p>Alarms</p> <p>Alarm Control</p> <p>Cartridge Alarm</p>	<p>Set an alarm to sound when the printer requires user intervention. When activated, Alarm Control lets you set the number of times that the alarm sounds, while Cartridge Alarm lets you stop printing when a cartridge-low condition occurs.</p> <p>For each alarm type, select from the following options:</p> <p>Off</p> <p>Single</p> <p>Continuous</p> <p>Notes:</p> <ul style="list-style-type: none"> - Single is the factory default setting for Alarm Control. This sounds three quick beeps. - Off is the factory default setting for Cartridge Alarm. This means no alarm will sound. - Continuous repeats three beeps every 10 seconds.
<p>Timeouts</p> <p>Standby Mode</p> <p>Disabled</p> <p>1–240</p>	<p>Specify the number of minutes of inactivity before the printer enters a lower power state.</p> <p>Note: 15 is the factory default setting.</p>

Use	To
<p>Timeouts</p> <p>Sleep Mode</p> <p> Disabled</p> <p> 1–120</p>	<p>Set the amount of time in minutes the printer waits after a job is printed before it goes into a reduced power state.</p> <p>Notes:</p> <ul style="list-style-type: none"> • 30 is the factory default setting. • Disabled appears only when Energy Conserve is set to Off. • Lower settings conserve more energy, but may require longer warm-up times. • Select a high setting if the printer is in constant use. Under most circumstances, this keeps the printer ready to print with minimum warm-up time.
<p>Timeouts</p> <p>Timeout</p> <p> Disabled</p> <p> 1 hour</p> <p> 2 hours</p> <p> 3 hours</p> <p> 6 hours</p> <p> 1 day</p> <p> 2 days</p> <p> 3 days</p> <p> 1 week</p> <p> 2 weeks</p> <p> 1 month</p>	<p>Set the amount of time the printer waits before it goes to Hibernate mode.</p> <p>Notes:</p> <ul style="list-style-type: none"> • Disabled is the factory default setting for printers except in European Union countries and Switzerland. • “3 days” is the factory default setting for Class B printers in European Union countries and Switzerland.
<p>Hibernate Timeout on Connection</p> <p>Hibernate</p> <p>Do Not Hibernate</p>	<p>Set the printer to hibernate mode even when there is an active Ethernet or fax connection.</p> <p>Notes:</p> <ul style="list-style-type: none"> • Do Not Hibernate is the factory default setting. • The fax function is available only in select printer models.
<p>Timeouts</p> <p>Screen Timeout</p> <p> 15–300</p>	<p>Set the amount of time in seconds the printer waits before returning the display to the Ready state.</p> <p>Note: 30 is the factory default setting.</p>

User's Guide

Use	To
<p>Timeouts</p> <p>Prolong Screen Timeout</p> <p>On</p> <p>Off</p>	<p>Show a message that lets you reset the screen timeout timer instead of returning to the home screen.</p> <p>Note: Off is the factory default setting.</p>
<p>Timeouts</p> <p>Print Timeout</p> <p>Disabled</p> <p>1–255</p>	<p>Set the amount of time in seconds the printer waits to receive an end-of-job message before canceling the remainder of the print job.</p> <p>Notes:</p> <ul style="list-style-type: none"> • 90 is the factory default setting. • When the timer expires, any partially printed page still in the printer is printed, and then the scanner checks to see if any new print jobs are waiting. • Print Timeout is available only when using PCL emulation. This has no effect on PostScript emulation print jobs.
<p>Timeouts</p> <p>Wait Timeout</p> <p>Disabled</p> <p>15–65535</p>	<p>Set the amount of time in seconds the printer waits for additional data before canceling a print job.</p> <p>Notes:</p> <ul style="list-style-type: none"> • 40 is the factory default setting. • Wait Timeout is available only when the scanner is using PostScript emulation. This has no effect on PCL emulation print jobs.
<p>Timeouts</p> <p>Job Hold Timeout</p> <p>5–255</p>	<p>Set the amount of time the printer waits for user intervention before it holds jobs that require unavailable resources and continues to print other jobs in the print queue.</p> <p>Notes:</p> <ul style="list-style-type: none"> • 30 is the factory default setting. • This menu item appears only when a printer hard disk is installed.
<p>Error Recovery</p> <p>Auto Reboot</p> <p>Reboot when idle</p> <p>Reboot always</p> <p>Reboot never</p>	<p>Automatically reboot the printer.</p> <p>Note: “Reboot when idle” is the factory default setting.</p>

User's Guide

Use	To
<p>Error Recovery</p> <p>Max Auto Reboots 1–20</p>	<p>Determine the number of automatic reboots the printer can perform.</p> <p>Note: 5 is the factory default setting.</p>
<p>Print Recovery</p> <p>Auto Continue Disabled 5–255</p>	<p>Let the printer automatically continue printing from certain offline situations when these are not resolved within the specified time period.</p> <p>Note: Disabled is the factory default setting.</p>
<p>Print Recovery</p> <p>Jam Recovery On Off Auto</p>	<p>Specify whether the printer reprints jammed pages.</p> <p>Notes:</p> <ul style="list-style-type: none"> • Auto is the factory default setting. The printer reprints jammed pages unless the memory required to hold the pages is needed for other printer tasks. • On sets the printer to always reprint jammed pages. • Off sets the printer to never reprint jammed pages.
<p>Print Recovery</p> <p>Jam Assist On Off</p>	<p>Set the printer to automatically check for jammed paper.</p> <p>Note: On is the factory default setting.</p>
<p>Print Recovery</p> <p>Page Protect Off On</p>	<p>Let the printer successfully print a page that may not have printed otherwise.</p> <p>Notes:</p> <ul style="list-style-type: none"> • Off is the factory default setting. This prints a partial page when there is not enough memory to print the whole page. • On sets the printer to process the whole page so that the entire page prints.
<p>Press Sleep Button</p> <p>Do nothing Sleep Hibernate</p>	<p>Determine how the printer, while in idle state, reacts to a short press of the Sleep button.</p> <p>Note: Sleep is the factory default setting.</p>
<p>Press and Hold Sleep Button</p> <p>Do nothing Sleep Hibernate</p>	<p>Determine how the printer, while in idle state, reacts to a long press of the Sleep button.</p> <p>Note: “Do nothing” is the factory default setting.</p>

User's Guide

Use	To
Factory Defaults Do Not Restore Restore Now	Restore the printer settings to the factory default settings. Notes: <ul style="list-style-type: none">• Do Not Restore is the factory default setting. This keeps the user-defined settings.• Restore Now returns all scanner settings to the factory default settings except Network/Ports menu settings. All downloads stored in the RAM are deleted. Downloads stored in the flash memory or in the printer hard disk are not affected.
Export Configuration Package	Export the printer configuration package to a flash drive. Note: The configuration package cannot be exported unless a flash drive is attached to the printer.
Export Compressed Logs File	Export the compressed logs file to a flash drive. Note: The configuration package cannot be exported unless a flash drive is attached to the printer.

Copy Settings menu

Use	To
<p>Content Type</p> <ul style="list-style-type: none"> Text Graphics Text/Photo Photo 	<p>Specify the content of the original document.</p> <p>Note: Text/Photo is the factory default setting.</p>
<p>Content Source</p> <ul style="list-style-type: none"> Black/White Laser Color Laser Inkjet Photo/Film Magazine Newspaper Press Other 	<p>Specify how the original document was produced.</p> <p>Note: Black/White Laser is the factory default setting.</p>
<p>Sides (Duplex)</p> <ul style="list-style-type: none"> 1 sided to 1 sided 1 sided to 2 sided 2 sided to 1 sided 2 sided to 2 sided 	<p>Specify whether an original document is two-sided (duplex) or one-sided, and then specify whether the copy should be two-sided or one-sided.</p> <p>Notes:</p> <ul style="list-style-type: none"> • 1 sided to 1 sided—The original document has print on one side and the copy will also have print on one side. • 1 sided to 2 sided—The original document has print on one side, while the copy will have print on both sides. • 2 sided to 1 sided—The original document has print on both sides, while the copy will have print on just one side. • 2 sided to 2 sided—The original document has print on both sides, and the copy will also have print on both sides.
<p>Paper Saver</p> <ul style="list-style-type: none"> Off 2-up Portrait 4-up Portrait 2-up Landscape 4-up Landscape 	<p>Copy two or four sheets of a document on one page.</p> <p>Note: Off is the factory default setting.</p>

User's Guide

Use	To
<p>Print Page Borders</p> <p>On Off</p>	<p>Specify whether or not a border is printed.</p> <p>Note: Off is the factory default setting.</p>
<p>Collate</p> <p>1,1,1 - 2,2,2 1,2,3 - 1,2,3</p>	<p>Keep the pages of a print job stacked in sequence when printing multiple copies.</p> <p>Note: "1,2,3 - 1,2,3" is the factory default setting.</p>
<p>Original Size</p> <p>Letter Legal Executive Folio Statement Oficio (Mexico) Universal Auto Size Sense Mixed Sizes A4 A5 A6 JIS B5 Custom Scan Size [x] Book Original Business Card 3 x 5 in. 4 x 6 in. ID Card</p>	<p>Specify the paper size of the original document.</p> <p>Note: A4 is the factory default setting.</p>
<p>Copy To Source</p> <p>Tray [x] Auto Size Match Multipurpose Feeder</p>	<p>Specify the paper source for copy jobs.</p> <p>Note: Tray 1 is the factory default setting.</p>
<p>Transparency Separators</p> <p>On Off</p>	<p>Place a sheet of paper between transparencies.</p> <p>Note: On is the factory default setting.</p>

User's Guide

Use	To
<p>Separator Sheets</p> <p>Off</p> <p>Between Copies</p> <p>Between Jobs</p> <p>Between Pages</p>	<p>Place a sheet of paper between pages, copies, or jobs.</p> <p>Note: Off is the factory default setting.</p>
<p>Separator Sheet Source</p> <p>Tray [x]</p>	<p>Specify the separator sheet source.</p> <p>Note: Tray 1 is the factory default setting.</p>
<p>Darkness</p> <p>1–9</p>	<p>Specify the level of darkness for the copy job.</p> <p>Note: 5 is the factory default setting.</p>
<p>Number of Copies</p> <p>1–999</p>	<p>Specify the number of copies for the copy job.</p> <p>Note: 1 is the factory default setting.</p>
<p>Header/Footer</p> <p>[Location]</p> <p>Off</p> <p>Date/Time</p> <p>Page number</p> <p>Custom text</p> <p>Print on</p> <p>All pages</p> <p>First page only</p> <p>All but first page</p> <p>Custom text</p>	<p>Specify the header or footer information and its location on the page.</p> <p>For the location, select from the following options:</p> <ul style="list-style-type: none"> • Top left • Top middle • Top right • Bottom left • Bottom middle • Bottom right <p>Notes:</p> <ul style="list-style-type: none"> • Off is the factory default setting for the location. • “All pages” is the factory default setting for “Print on.”
<p>Overlay</p> <p>Confidential</p> <p>Copy</p> <p>Draft</p> <p>Urgent</p> <p>Custom</p> <p>Off</p>	<p>Specify the overlay text printed on each page of the copy job.</p> <p>Note: Off is the factory default setting.</p>

User's Guide

Use	To
<p>Custom Overlay</p>	<p>Specify the custom overlay text.</p> <p>Note: A maximum of 64 characters is allowed.</p>
<p>Allow priority copies</p> <p>On Off</p>	<p>Allow interruption of a print job to copy a page or document.</p> <p>Note: On is the factory default setting.</p>
<p>Custom Job scanning</p> <p>On Off</p>	<p>Scan a document that contains mixed paper sizes into a single copy job.</p> <p>Notes:</p> <ul style="list-style-type: none"> • Off is the factory default setting. • This menu item appears only when a formatted, working printer hard disk is installed.
<p>Allow Save as Shortcut</p> <p>On Off</p>	<p>Save custom copy settings as shortcuts.</p> <p>Note: On is the factory default setting.</p>
<p>Background Removal</p> <p>-4 to 4</p>	<p>Adjust the amount of background visible on a copy.</p> <p>Note: 0 is the factory default setting.</p>
<p>Auto Center</p> <p>Off On</p>	<p>Automatically align the content at the center of the page.</p> <p>Note: Off is the factory default setting.</p>
<p>Contrast</p> <p>0–5 Best for content</p>	<p>Specify the contrast used for the copy job.</p> <p>Note: “Best for content” is the factory default setting.</p>
<p>Mirror Image</p> <p>Off On</p>	<p>Create a mirror image of the original document.</p> <p>Note: Off is the factory default setting.</p>
<p>Negative Image</p> <p>Off On</p>	<p>Create a negative image of the original document.</p> <p>Note: Off is the factory default setting.</p>
<p>Shadow Detail</p> <p>-4 to 4</p>	<p>Adjust the amount of shadow detail visible on a copy.</p> <p>Note: 0 is the factory default setting.</p>

Use	To
<p>Fix Scan Skew</p> <p>Auto</p> <p>Off</p> <p>On</p>	<p>Correct slight skew in the scanned image.</p> <p>Note: Off is the factory default setting.</p>
<p>Scan edge to edge</p> <p>Off</p> <p>On</p>	<p>Specify if the original document is scanned edge-to-edge prior to faxing.</p> <p>Note: Off is the factory default setting.</p>
<p>Sharpness</p> <p>1–5</p>	<p>Adjust the amount of sharpness of a copy.</p> <p>Note: 3 is the factory default setting.</p>
<p>Sample Copy</p> <p>Off</p> <p>On</p>	<p>Create a sample copy of the original document.</p> <p>Note: Off is the factory default setting.</p>

Fax Settings menu

Fax Mode (Analog Fax Setup) menu

Analog Fax Setup mode sends the fax job through a telephone line.

Note: The fax function is available only in select printer models.

User's Guide

Use	To
Fax Name	Specify the name of the fax in the printer.
Fax Number	Specify the number assigned to the fax.
Fax ID Fax Name Fax Number	Specify how the fax is identified.
Enable Manual Fax On Off	Set the printer to fax manually, which requires a line splitter and a telephone handset. Notes: <ul style="list-style-type: none"> • Off is the factory default setting. • Use a regular telephone to answer an incoming fax job and to dial a fax number. • Press # 0 on the numeric keypad to go directly to the Manual Fax function.
Memory Use All receive Mostly receive Equal Mostly send All send	Define the allocation of non-volatile memory between sending and receiving fax jobs. Notes: <ul style="list-style-type: none"> • Equal is the factory default setting. This splits the memory for sending and receiving fax jobs into equal amounts. • “Mostly send” specifies that most of the memory is set to send fax jobs. • “All send” specifies that all the memory is set to send fax jobs. • “All receive” specifies that all the memory is set to receive fax jobs. • “Mostly receive” specifies that most of the memory is set to receive fax jobs.
Cancel Faxes Allow Don't Allow	Specify whether or not the printer cancels fax jobs. Note: Allow is the factory default setting.
Caller ID Off Primary Alternate	Specify the type of caller ID being used.

User's Guide

Use	To
<p>Fax number masking</p> <p>Off</p> <p>From left</p> <p>From right</p>	<p>Specify the direction from where digits are masked in an outgoing fax number.</p> <p>Notes:</p> <ul style="list-style-type: none"> • Off is the factory default setting. • The number of characters masked is determined by the “Digits to mask” setting.
<p>Digits to Mask</p> <p>0–58</p>	<p>Specify the number of digits to mask in an outgoing fax number.</p> <p>Note: 0 is the factory default setting.</p>
<p>Fax Cover Page</p> <p>Fax Cover Page</p> <p>Off by default</p> <p>On by default</p> <p>Never use</p> <p>Always use</p> <p>Include to Field</p> <p>On</p> <p>Off</p> <p>Include from Field</p> <p>On</p> <p>Off</p> <p>From</p> <p>Include Message Field</p> <p>On</p> <p>Off</p> <p>Message</p> <p>Include Logo</p> <p>On</p> <p>Off</p> <p>Include Footer [x]</p> <p>On</p> <p>Off</p> <p>Footer [x]</p>	<p>Configure the fax cover page.</p> <p>Notes:</p> <ul style="list-style-type: none"> • “Off by default” is the factory default setting for Fax Cover Page option. • Off is the factory default setting for the “Include to Field,” “Include from Field,” “Include Message Field,” “Include Logo,” and “Include Footer [x]” options. • A maximum of 255 characters is allowed for the “From” option. • A maximum of 80 characters is allowed for the “Footer [x]” option.

Fax Send Settings menu items and their descriptions

Use	To
<p>Resolution</p> <p>Standard Fine 200 dpi Super Fine 300 dpi</p>	<p>Specify quality in dots per inch (dpi). A higher resolution gives better print quality, but increases the fax transmission time for outgoing faxes.</p> <p>Note: Standard is the factory default setting.</p>
<p>Original Size</p> <p>Letter Legal Executive Folio Statement Oficio (Mexico) Universal Auto Size Sense Mixed Sizes A4 A5 A6 JIS B5 Custom Scan Size [x] Book Original Business Card 3 x 5 in. 4 x 6 in.</p>	<p>Specify the paper size of the original document.</p> <p>Note: A4 is the factory default setting.</p>
<p>Sides (Duplex)</p> <p>Off Long edge Short edge</p>	<p>Specify the page orientation of text and graphics.</p> <p>Notes:</p> <ul style="list-style-type: none"> • Off is the factory default setting. • Long edge assumes binding along the long edge of the page (left edge for portrait and top edge for landscape). • Short edge assumes binding along the short edge of the page (top edge for portrait and left edge for landscape).

User's Guide

Use	To
<p>Content Type</p> <p>Text Graphics Text/Photo Photo</p>	<p>Specify the content of the original document.</p> <p>Note: Text is the factory default setting.</p>
<p>Content Source</p> <p>Black/White Laser Color Laser Inkjet Photo/Film Magazine Newspaper Press Other</p>	<p>Specify how the original document was produced.</p> <p>Note: Black/White Laser is the factory default setting.</p>
<p>Darkness</p> <p>1–9</p>	<p>Lighten or darken the output.</p> <p>Note: 5 is the factory default setting.</p>
<p>Dial Prefix</p>	<p>Enter a dialing prefix, such as 99. A numeric entry field is provided.</p>
<p>Dialing Prefix Rules</p> <p>Prefix Rule [x]</p>	<p>Establish a dialing prefix rule.</p>
<p>Automatic Redial</p> <p>0–9</p>	<p>Specify the number of times the printer tries to send the fax to a specified number.</p> <p>Note: 5 is the factory default setting.</p>
<p>Redial frequency</p> <p>1–200</p>	<p>Specify the number of minutes between redials.</p> <p>Note: 3 is the factory default setting.</p>
<p>Behind a PABX</p> <p>Yes No</p>	<p>Enable or disable switchboard blind dialing without a dial tone.</p> <p>Note: No is the factory default setting.</p>
<p>Enable ECM</p> <p>Yes No</p>	<p>Enable or disable Error Correction Mode for fax jobs.</p> <p>Note: Yes is the factory default setting.</p>

User's Guide

Use	To
<p>Enable Fax Scans</p> <p>On Off</p>	<p>Fax files that are scanned at the printer.</p> <p>Note: On is the factory default setting.</p>
<p>Driver to fax</p> <p>Yes No</p>	<p>Allow the printer driver to send fax jobs.</p> <p>Note: Yes is the factory default setting.</p>
<p>Allow Save as Shortcut</p> <p>On Off</p>	<p>Save fax numbers as shortcuts in the printer.</p> <p>Note: On is the factory default setting.</p>
<p>Dial Mode</p> <p>Tone Pulse</p>	<p>Specify the dialing sound, either as a tone or as a pulse.</p> <p>Note: Tone is the factory default setting.</p>
<p>Max Speed</p> <p>2400 4800 9600 14400 33600</p>	<p>Specify the maximum speed in baud at which faxes are sent.</p> <p>Note: 33600 is the factory default setting.</p>
<p>Custom Job scanning</p> <p>On Off</p>	<p>Scan a document that contains mixed paper sizes into a single file.</p> <p>Notes:</p> <ul style="list-style-type: none"> • Off is the factory default setting. • This menu item appears only when a formatted, working printer hard disk is installed.
<p>Scan Preview</p> <p>On Off</p>	<p>Specify whether a preview will appear on the display for scan jobs.</p> <p>Notes:</p> <ul style="list-style-type: none"> • Off is the factory default setting. • This menu item appears only when a formatted, working printer hard disk is installed.
<p>Background Removal</p> <p>-4 to 4</p>	<p>Adjust the amount of background visible on a scanned image.</p> <p>Note: 0 is the factory default setting.</p>

User's Guide

Use	To
<p>Contrast</p> <p>0–5</p> <p>Best for content</p>	<p>Specify the contrast in the scanned image.</p> <p>Note: “Best for content” is the factory default setting.</p>
<p>Mirror Image</p> <p>Off</p> <p>On</p>	<p>Create a mirror image of the original document.</p> <p>Note: Off is the factory default setting.</p>
<p>Negative Image</p> <p>Off</p> <p>On</p>	<p>Create a negative image of the original document.</p> <p>Note: Off is the factory default setting.</p>
<p>Shadow Detail</p> <p>-4 to 4</p>	<p>Adjust the amount of shadow detail visible.</p> <p>Note: 0 is the factory default setting.</p>
<p>Fix Scan Skew</p> <p>Auto</p> <p>Off</p> <p>On</p>	<p>Correct the slight skew in the scanned image.</p> <p>Notes:</p> <ul style="list-style-type: none"> • Off is the factory default setting. • This menu item is supported only in select printer models.
<p>Scan edge to edge</p> <p>Off</p> <p>On</p>	<p>Specify if the original document is scanned edge-to-edge prior to faxing.</p> <p>Note: Off is the factory default setting.</p>
<p>Sharpness</p> <p>1–5</p>	<p>Adjust the sharpness of a fax.</p> <p>Note: 3 is the factory default setting.</p>
<p>Temperature</p> <p>-4 to 4</p>	<p>Specify “warm” or “cool” outputs. “Cool” values generate a bluer output than the default while “warm” values generate a redder output than the default.</p> <p>Note: 0 is the factory default setting.</p>
<p>Auto Convert Color Faxes to Mono Faxes</p> <p>On</p> <p>Off</p>	<p>Convert all outgoing faxes to black and white.</p> <p>Note: On is the factory default setting.</p>

Fax Receive Settings menu items and their descriptions

Use	To
<p>Enable Fax Receive</p> <p>On Off</p>	<p>Allow the printer to receive fax jobs.</p> <p>Note: On is the factory default setting.</p>
<p>Fax Job Waiting</p> <p>None Toner Toner and Supplies</p>	<p>Remove fax jobs from the print queue when the job requires specific unavailable resources.</p> <p>Note: None is the factory default setting.</p>
<p>Rings to Answer</p> <p>1–25</p>	<p>Specify the number of rings before answering an incoming fax job.</p> <p>Note: 3 is the factory default setting.</p>
<p>Auto Reduction</p> <p>On Off</p>	<p>Scale an incoming fax job so that it fits the size of the paper loaded in the designated fax source.</p> <p>Note: On is the factory default setting.</p>
<p>Paper Source</p> <p>Auto Tray [x] Multi-Purpose Feeder</p>	<p>Specify the paper source for printing incoming fax jobs.</p> <p>Note: Auto is the factory default setting.</p>
<p>Sides (Duplex)</p> <p>Off On</p>	<p>Enable two-sided (duplex) printing for incoming fax jobs.</p> <p>Notes:</p> <ul style="list-style-type: none"> • Off is the factory default setting. • This menu item appears only when a print duplexer is installed.
<p>Separator Sheets</p> <p>Off Before Job After Job</p>	<p>Enable the printer to include separator sheets for incoming fax jobs.</p> <p>Note: Off is the factory default setting.</p>
<p>Separator Sheet Source</p> <p>Tray [x] Multipurpose Feeder</p>	<p>Specify where the printer will pick the separator sheet.</p> <p>Note: Tray 1 is the factory default setting.</p>

User's Guide

Use	To
<p>Fax Footer</p> <p>On Off</p>	<p>Print the transmission information at the bottom of each page from a received fax.</p> <p>Note: Off is the factory default setting.</p>
<p>Max Speed</p> <p>2400 4800 9600 14400 33600</p>	<p>Specify the maximum speed in baud at which faxes are received.</p> <p>Note: 33600 is the factory default setting.</p>
<p>Fax Forwarding</p> <p>Print Print and Forward Forward</p>	<p>Enable forwarding of received faxes to another recipient.</p> <p>Note: Print is the factory default setting.</p>
<p>Forward to</p> <p>Fax E-mail FTP LDSS eSF</p>	<p>Specify the type of recipient to which faxes will be forwarded.</p> <p>Notes:</p> <ul style="list-style-type: none"> • Fax is the factory default setting. • This menu item is available only from the Embedded Web Server.
<p>Forward to Shortcut</p>	<p>Enter the shortcut number which matches the recipient type (Fax, E-mail, FTP, LDSS, or eSF).</p> <p>Note: You can enter up to 16 characters.</p>
<p>Block No Name Fax</p> <p>Off On</p>	<p>Enable blocking of incoming faxes sent from devices with no station ID or fax ID specified.</p> <p>Note: Off is the factory default setting.</p>
<p>Banned Fax List</p>	<p>Enable the list of blocked fax numbers stored in the printer.</p> <p>Note: You can enter up to 512 characters.</p>

Fax Log Settings menu items and their descriptions

Use	To
<p>Transmission Log</p> <p>Print log Do not print log Print only for error</p>	<p>Enable printing of a transmission log after each fax job.</p> <p>Note: "Print log" is the factory default setting.</p>
<p>Receive Error Log</p> <p>Print Never Print on Error</p>	<p>Enable printing of a receive error log following a receive error.</p> <p>Note: Print Never is the factory default setting.</p>
<p>Auto Print Logs</p> <p>On Off</p>	<p>Enable automatic printing of fax logs.</p> <p>Notes:</p> <ul style="list-style-type: none"> • On is the factory default setting. • Logs print after every 200 fax jobs.
<p>Log Paper Source</p> <p>Tray [x] Multipurpose Feeder</p>	<p>Specify the source of the paper used for printing logs.</p> <p>Note: Tray 1 is the factory default setting.</p>
<p>Logs Display</p> <p>Remote Station Name Dialed Number</p>	<p>Specify whether printed logs display the dialed number or the station name or fax name returned.</p> <p>Note: Remote Station Name is the factory default setting.</p>
<p>Enable Job Log</p> <p>On Off</p>	<p>Enable access to the Fax Job log.</p> <p>Note: On is the factory default setting.</p>
<p>Enable Call Log</p> <p>On Off</p>	<p>Enable access to the Fax Call log.</p> <p>Note: On is the factory default setting.</p>

Speaker Settings menu items and their descriptions

Use	To
<p>Speaker Mode</p> <p>Always Off On until Connected Always On</p>	<p>Specify the mode of the speaker.</p> <p>Notes:</p> <ul style="list-style-type: none"> • On until Connected is the factory default setting. A sound is issued until the fax connection is made. • Always On turns the speaker on. • Always Off turns the speaker off.
<p>Speaker Volume</p> <p>High Low</p>	<p>Control the volume setting.</p> <p>Note: High is the factory default setting.</p>
<p>Ringer Volume</p> <p>Off On</p>	<p>Control the fax speaker ringer volume.</p> <p>Note: On is the factory default setting.</p>

Answer On menu items and their descriptions

Use	To
<p>All Rings Single Ring Only Double Ring Only Triple Ring Only Single or Double Rings Only Single or Triple Rings Only Double or Triple Rings Only</p>	<p>Specify ring patterns when the printer is answering calls.</p> <p>Note: All Rings is the factory default setting.</p>

E-mail Settings menu

Use	To
<p>E-mail Server Setup</p> <p>Subject Message File Name</p>	<p>Specify e-mail server information.</p> <p>Notes:</p> <ul style="list-style-type: none"> You can enter up to 255 characters in the Subject field. You can enter up to 512 characters in the Message field. You can enter up to 53 characters in the File Name field.
<p>E-mail Server Setup</p> <p>Send me a copy Never appears On by default Off by default Always On</p>	<p>Send a copy of the e-mail to the sender.</p> <p>Note: "Never appears" is the factory default setting.</p>
<p>E-mail Server Setup</p> <p>Max E-mail size 0–65535 KB</p>	<p>Specify the maximum e-mail size in kilobytes.</p> <p>Note: E-mails above the specified size are not sent.</p>
<p>E-mail Server Setup</p> <p>Size Error Message</p>	<p>Send a message when an e-mail is greater than the configured size limit.</p> <p>Note: You can enter up to 1024 characters.</p>
<p>E-mail Server Setup</p> <p>Limit destinations</p>	<p>Specify a domain name, such as a company domain name, and then limit e-mail destinations only to that domain name.</p> <p>Note: You can specify only one domain.</p>
<p>E-mail Server Setup</p> <p>Web Link Setup Server Login Password Path File Name Web Link</p>	<p>Define the e-mail server path name, for example: <code>/directory/path</code>.</p> <p>Notes:</p> <ul style="list-style-type: none"> The characters * : ? < > are invalid entries for a path name. You can enter up to 128 characters for Server, Login, Password, Path, and Web Link. You can enter up to 53 characters for File Name.

User's Guide

Use	To
<p>Format</p> <ul style="list-style-type: none"> PDF (.pdf) Secure PDF TIFF (.tif) JPEG (.jpg) XPS (.xps) 	<p>Specify the format of the scanned file.</p> <p>Note: "PDF (.pdf)" is the factory default setting.</p>
<p>PDF Version</p> <ul style="list-style-type: none"> 1.2–1.6 A–1a 	<p>Set the version of the PDF file that will be scanned for e-mailing.</p> <p>Note: 1.5 is the factory default setting.</p>
<p>Content Type</p> <ul style="list-style-type: none"> Graphics Text Text/Photo Photo 	<p>Specify the content of the original document.</p> <p>Note: Text/Photo is the factory default setting.</p>
<p>Content Source</p> <ul style="list-style-type: none"> Black/White Laser Color Laser Inkjet Photo/Film Magazine Newspaper Press Other 	<p>Specify how the original document was produced.</p> <p>Note: Black/White Laser is the factory default setting.</p>
<p>Resolution</p> <ul style="list-style-type: none"> 75 dpi 150 dpi 200 dpi 300 dpi 400 dpi 600 dpi 	<p>Specify the resolution of the scan in dots per inch.</p> <p>Note: "150 dpi" is the factory default setting.</p>
<p>Darkness</p> <ul style="list-style-type: none"> 1–9 	<p>Lighten or darken the output.</p> <p>Note: 5 is the factory default setting.</p>

User's Guide

Use	To
<p>Orientation</p> <p>Portrait Landscape</p>	<p>Specify the page orientation of the scanned image.</p> <p>Note: Portrait is the factory default setting.</p>
<p>Original Size</p> <p>Letter Legal Executive Folio Statement Oficio (Mexico) Universal Auto Size Sense Mixed Sizes A4 A5 A6 JIS B5 Custom Scan Size [x] Book Original Business Card 3 x 5 in. 4 x 6 in.</p>	<p>Specify the paper size of the document being scanned.</p> <p>Note: A4 is the factory default setting.</p>
<p>Sides (Duplex)</p> <p>Off Long edge Short edge</p>	<p>Specify the page orientation of text and graphics.</p> <p>Notes:</p> <ul style="list-style-type: none"> • Off is the factory default setting. • “Long edge” assumes binding along the long edge of the page (left edge for portrait and top edge for landscape). • “Short edge” assumes binding along the short edge of the page (top edge for portrait and left edge for landscape).

User's Guide

Use	To
<p>JPEG Quality</p> <p>Best for content</p> <p>5–90</p>	<p>Set the quality of a JPEG photo image in relation to file size and quality of the image.</p> <p>Notes:</p> <ul style="list-style-type: none"> • “Best for content” is the factory default setting. • 5 reduces the file size and quality of the image. • 90 provides the best image quality, but the file size is very large. • This menu item applies to all scan functions.
<p>Text Default</p> <p>5–90</p>	<p>Set the quality of a text image in relation to file size and quality of the image.</p> <p>Note: 75 is the factory default setting.</p>
<p>Text/Photo Default</p> <p>5–90</p>	<p>Set the quality of a text or photo image in relation to file size and the quality of the image.</p> <p>Note: 75 is the factory default setting.</p>
<p>Photo Default</p> <p>5–90</p>	<p>Set the quality of a photo image in relation to file size and the quality of the image.</p> <p>Note: 50 is the factory default setting.</p>
<p>E-mail images sent as</p> <p>Attachment</p> <p>Web Link</p>	<p>Specify how the images are sent.</p> <p>Note: Attachment is the factory default setting.</p>
<p>Use Multi-Page Tiff</p> <p>On</p> <p>Off</p>	<p>Provide a choice between single-page TIFF files and multiple-page TIFF files. For a multiple-page scan-to-e-mail job, either one TIFF file is created containing all the pages, or multiple TIFF files are created with one file for each page of the job.</p> <p>Notes:</p> <ul style="list-style-type: none"> • On is the factory default setting. • This menu item applies to all scan functions.
<p>Transmission Log</p> <p>Print log</p> <p>Do not print log</p> <p>Print only for error</p>	<p>Specify whether or not the transmission log prints.</p> <p>Note: “Print log “is the factory default setting.</p>
<p>Log Paper Source</p> <p>Tray [x]</p> <p>Multipurpose Feeder</p>	<p>Specify the paper source for printing e-mail logs.</p> <p>Note: Tray 1 is the factory default setting.</p>

User's Guide

Use	To
<p>E-mail Bit Depth</p> <p>1 bit 8 bit</p>	<p>Enable the Text/Photo mode to produce smaller file sizes by using 1-bit images.</p> <p>Note: "8 bit" is the factory default setting.</p>
<p>Custom Job scanning</p> <p>On Off</p>	<p>Copy a document that contains mixed paper sizes.</p> <p>Notes:</p> <ul style="list-style-type: none"> • Off is the factory default setting. • This menu item appears only when a formatted, working printer hard disk is installed.
<p>Scan Preview</p> <p>On Off</p>	<p>Specify whether or not a preview will appear on the display for scan jobs.</p> <p>Notes:</p> <ul style="list-style-type: none"> • Off is the factory default setting. • This menu item appears only when a formatted, working printer hard disk is installed.
<p>Allow Save as Shortcut</p> <p>On Off</p>	<p>Save e-mail addresses as shortcuts.</p> <p>Notes:</p> <ul style="list-style-type: none"> • On is the factory default setting. • When set to Off, the Save as Shortcut button does not appear on the e-mail Destination screen.
<p>Background Removal</p> <p>-4 to 4</p>	<p>Adjust the amount of background visible on a scanned image.</p> <p>Note: 0 is the factory default setting.</p>
<p>Contrast</p> <p>0–5 Best for content</p>	<p>Specify the contrast of the output.</p> <p>Note: "Best for content" is the factory default setting.</p>
<p>Mirror Image</p> <p>Off On</p>	<p>Create a mirror image of the original document.</p> <p>Note: Off is the factory default setting.</p>
<p>Negative Image</p> <p>Off On</p>	<p>Create a negative image of the original document.</p> <p>Note: Off is the factory default setting.</p>

User's Guide

Use	To
<p>Shadow Detail</p> <p>-4 to 4</p>	<p>Adjust the amount of shadow detail visible on a scanned image.</p> <p>Note: 0 is the factory default setting.</p>
<p>Fix Scan Skew</p> <p>Auto</p> <p>Off</p> <p>On</p>	<p>Correct slight skew in the scanned image.</p> <p>Notes:</p> <ul style="list-style-type: none"> • Off is the factory default setting. • This menu item appears only in select printer models.
<p>Scan edge to edge</p> <p>Off</p> <p>On</p>	<p>Specify whether the original document is scanned edge-to-edge.</p> <p>Note: Off is the factory default setting.</p>
<p>Sharpness</p> <p>1–5</p>	<p>Adjust the amount of sharpness on a scanned image.</p> <p>Note: 3 is the factory default setting.</p>
<p>Temperature</p> <p>-4 to 4</p>	<p>Enable the user to specify “warm” or “cool” outputs. “Cool” values generate a bluer output than the default, while “warm” values generate a redder output than the default.</p> <p>Note: 0 is the factory default setting.</p>
<p>Use cc:/bcc:</p> <p>Off</p> <p>On</p>	<p>Enable the use of the cc and bcc fields.</p> <p>Note: Off is the factory default setting.</p>

FTP Settings menu

Use	To
<p>Format</p> <ul style="list-style-type: none"> PDF (.pdf) Secure PDF (.pdf) TIFF (.tif) JPEG (.jpg) XPS (.xps) 	<p>Specify the format of the file for FTP sending.</p> <p>Note: PDF (.pdf) is the factory default setting.</p>
<p>PDF Version</p> <ul style="list-style-type: none"> 1.2–1.6 A–1a 	<p>Set the version level of the PDF file for FTP sending.</p> <p>Note: 1.5 is the factory default setting.</p>
<p>Content Type</p> <ul style="list-style-type: none"> Text Graphics Text/Photo Photo 	<p>Specify the content of the original document.</p> <p>Note: Text/Photo is the factory default setting.</p>
<p>Content Source</p> <ul style="list-style-type: none"> Black/White Laser Color Laser Inkjet Photo/Film Magazine Newspaper Press Other 	<p>Specify how the original document was produced.</p> <p>Note: Black/White Laser is the factory default setting.</p>
<p>Resolution</p> <ul style="list-style-type: none"> 75 dpi 150 dpi 200 dpi 300 dpi 400 dpi 600 dpi 	<p>Specify the quality of the scan in dots per inch (dpi).</p> <p>Note: “150 dpi” is the factory default setting.</p>
<p>Darkness</p> <ul style="list-style-type: none"> 1–9 	<p>Lighten or darken the output.</p> <p>Note: 5 is the factory default setting.</p>

User's Guide

Use	To
<p>Orientation</p> <p>Portrait Landscape</p>	<p>Specify the page orientation of the scanned image.</p> <p>Note: Portrait is the factory default setting.</p>
<p>Original Size</p> <p>Letter Legal Executive Folio Statement Oficio (Mexico) Universal Auto Size Sense Mixed Sizes A4 A5 A6 JIS B5 Custom Scan Size [x] Book Original Business Card 3 x 5 in. 4 x 6 in.</p>	<p>Specify the paper size of the original document.</p> <p>Note: A4 is the factory default setting.</p>
<p>Sides (Duplex)</p> <p>Off Long edge Short edge</p>	<p>Specify the page orientation of text and graphics.</p> <p>Notes:</p> <ul style="list-style-type: none"> • Off is the factory default setting. • “Long edge” assumes binding along the long edge of the page (left edge for portrait and top edge for landscape). • “Short edge” assumes binding along the short edge of the page (top edge for portrait and left edge for landscape).

User's Guide

Use	To
<p>JPEG Quality</p> <p>Best for content</p> <p>5–90</p>	<p>Set the quality of a JPEG photo image in relation to the file size and quality of the image.</p> <p>Notes:</p> <ul style="list-style-type: none"> • “Best for content” is the factory default setting. • 5 reduces the file size, but the quality of the image is lessened. • 90 provides the best image quality, but the file size is very large. • This menu item applies to all scan functions.
<p>Text Default</p> <p>5–90</p>	<p>Set the quality of the text in relation to the file size and quality of the image.</p> <p>Note: 75 is the factory default setting.</p>
<p>Text/Photo Default</p> <p>5–90</p>	<p>Set the quality of a text/photo image in relation to the file size and quality of the image.</p> <p>Note: 75 is the factory default setting.</p>
<p>Photo Default</p> <p>5–90</p>	<p>Set the quality of a photo image in relation to the file size and quality of the image.</p> <p>Note: 50 is the factory default setting.</p>
<p>Use Multi-Page TIFF</p> <p>On</p> <p>Off</p>	<p>Provide a choice between single-page TIFF files and multiple-page TIFF files. For a multiple-page scan-to-FTP job, either one TIFF file is created containing all the pages, or multiple TIFF files are created with one file for each page of the job.</p> <p>Notes:</p> <ul style="list-style-type: none"> • On is the factory default setting. • This menu item applies to all scan functions.
<p>Transmission Log</p> <p>Print log</p> <p>Do not print log</p> <p>Print only for error</p>	<p>Specify whether the transmission log prints.</p> <p>Note: “Print log” is the factory default setting.</p>
<p>Log Paper Source</p> <p>Tray [x]</p> <p>Multipurpose Feeder</p>	<p>Specify a paper source when printing FTP logs.</p> <p>Note: Tray 1 is the factory default setting.</p>
<p>FTP bit Depth</p> <p>1 bit</p> <p>8 bit</p>	<p>Enable the Text/Photo mode to have smaller file sizes by using 1-bit images.</p> <p>Note: 8 bit is the factory default setting.</p>

User's Guide

Use	To
<p>File Name</p>	<p>Type a base file name.</p> <p>Note: You can enter up to 53 characters.</p>
<p>Custom Job Scanning</p> <p>On Off</p>	<p>Copy a document that contains mixed paper sizes into a single scan job.</p> <p>Note: Off is the factory default setting.</p>
<p>Scan Preview</p> <p>On Off</p>	<p>Specify whether a preview will appear on the display for scan jobs.</p> <p>Notes:</p> <ul style="list-style-type: none"> • Off is the factory default setting. • This menu item appears only when a formatted, working printer hard disk is installed.
<p>Allow Save as Shortcut</p> <p>On Off</p>	<p>Enable shortcut creation for FTP addresses.</p> <p>Note: On is the factory default setting.</p>
<p>Background Removal</p> <p>-4 to 4</p>	<p>Adjust the amount of background visible on a copy.</p> <p>Note: 0 is the factory default setting.</p>
<p>Contrast</p> <p>0–5 Best for content</p>	<p>Specify the contrast of the output.</p> <p>Note: “Best for content” is the factory default setting.</p>
<p>Mirror Image</p> <p>Off On</p>	<p>Create a mirror image of the original document.</p> <p>Note: Off is the factory default setting.</p>
<p>Negative Image</p> <p>Off On</p>	<p>Create a negative image of the original document.</p> <p>Note: Off is the factory default setting.</p>
<p>Shadow Detail</p> <p>-4 to 4</p>	<p>Adjust the amount of shadow detail visible on a scanned image.</p> <p>Note: 0 is the factory default setting.</p>

User's Guide

Use	To
<p>Fix Scan Skew</p> <p>Auto Off On</p>	<p>Correct slight skew in the scanned image.</p> <p>Notes:</p> <ul style="list-style-type: none"> • Off is the factory default setting. • This menu item is supported only in select printer models.
<p>Scan edge to edge</p> <p>Off On</p>	<p>Specify whether the original document is scanned edge-to-edge.</p> <p>Note: Off is the factory default setting.</p>
<p>Sharpness</p> <p>1–5</p>	<p>Adjust the amount of sharpness of a scanned image.</p> <p>Note: 3 is the factory default setting.</p>
<p>Temperature</p> <p>-4 to 4</p>	<p>Enable the user to specify “warm” or “cool” outputs. “Cool” values generate a bluer output than the default while “warm” values generate a redder output than the default.</p> <p>Note: 0 is the factory default setting.</p>

Flash Drive menu

Scan Settings

Use	To
<p>Format</p> <ul style="list-style-type: none"> PDF (.pdf) Secure PDF TIFF (.tif) JPEG (.jpg) XPS (.xps) 	<p>Specify the format of the file to be sent through FTP.</p> <p>Note: "PDF (.pdf)" is the factory default setting.</p>
<p>PDF Version</p> <ul style="list-style-type: none"> 1.2–1.6 A-1a 	<p>Set the version of the PDF file to be sent through FTP.</p> <p>Note: 1.5 is the factory default setting.</p>
<p>Content Type</p> <ul style="list-style-type: none"> Text Graphics Text/Photo Photo 	<p>Specify the content of the original document.</p> <p>Note: Text/Photo is the factory default setting.</p>
<p>Content Source</p> <ul style="list-style-type: none"> Black/White Laser Color Laser Inkjet Photo/Film Magazine Newspaper Press Other 	<p>Specify how the original document was produced.</p> <p>Note: Black/White Laser is the factory default setting.</p>
<p>Resolution</p> <ul style="list-style-type: none"> 75 dpi 150 dpi 200 dpi 300 dpi 400 dpi 600 dpi 	<p>Specify the resolution of the scan in dots per inch (dpi).</p> <p>Note: "150 dpi" is the factory default setting.</p>

User's Guide

Use	To
<p>Darkness</p> <p>1–9</p>	<p>Lighten or darken the output.</p> <p>Note: 5 is the factory default setting.</p>
<p>Orientation</p> <p>Portrait</p> <p>Landscape</p>	<p>Specify the orientation of the scanned image.</p> <p>Note: Portrait is the factory default setting.</p>
<p>Original Size</p> <p>Letter</p> <p>Legal</p> <p>Executive</p> <p>Folio</p> <p>Statement</p> <p>Oficio (Mexico)</p> <p>Universal</p> <p>Auto Size Sense</p> <p>Mixed Sizes</p> <p>A4</p> <p>A5</p> <p>A6</p> <p>JIS B5</p> <p>Custom Scan Size [x]</p> <p>Book Original</p> <p>Business Card</p> <p>3 x 5 in.</p> <p>4 x 6 in.</p>	<p>Specify the paper size of the original document.</p> <p>Note: A4 is the factory default setting.</p>
<p>Sides (Duplex)</p> <p>Off</p> <p>Long edge</p> <p>Short edge</p>	<p>Specify the page orientation of text and graphics.</p> <p>Notes:</p> <ul style="list-style-type: none"> • Off is the factory default setting. • “Long edge” assumes binding along the long edge of the page (left edge for portrait and top edge for landscape). • “Short edge” assumes binding along the short edge of the page (top edge for portrait and left edge for landscape).

User's Guide

Use	To
<p>JPEG Quality</p> <p>Best for content</p> <p>5–90</p>	<p>Set the quality of a JPEG photo image in relation to file size and quality.</p> <p>Notes:</p> <ul style="list-style-type: none"> • “Best for content” is the factory default setting. • 5 reduces the file size, but the quality of the image is lessened. • 90 provides the best image quality, but the file size is very large. • This menu setting applies to all scan functions.
<p>Text Default</p> <p>5–90</p>	<p>Set the quality of the text in relation to file size and the quality of the image.</p> <p>Note: 75 is the factory default setting.</p>
<p>Text/Photo Default</p> <p>5–90</p>	<p>Set the quality of a text or photo image in relation to file size and quality.</p> <p>Note: 75 is the factory default setting.</p>
<p>Photo Default</p> <p>5–90</p>	<p>Set the quality of a photo image in relation to file size and quality.</p> <p>Note: 50 is the factory default setting.</p>
<p>Use Multi-Page TIFF</p> <p>On</p> <p>Off</p>	<p>Provide a choice between single-page TIFF files and multiple-page TIFF files. For a multiple-page scan-to-FTP job, either one TIFF file is created containing all the pages, or multiple TIFF files are created with one file for each page.</p> <p>Notes:</p> <ul style="list-style-type: none"> • On is the factory default setting. • This menu setting applies to all scan functions.
<p>Scan Bit Depth</p> <p>1 bit</p> <p>8 bit</p>	<p>Enable the Text/Photo mode to have smaller file sizes by using 1-bit images.</p> <p>Note: “8 bit” is the factory default setting.</p>
<p>File Name</p>	<p>Type a base file name.</p> <p>Note: You can enter a maximum of 53 characters.</p>
<p>Custom Job Scanning</p> <p>On</p> <p>Off</p>	<p>Copy a document containing mixed paper sizes in a single copy job.</p> <p>Note: Off is the factory default setting.</p>

User's Guide

Use	To
<p>Scan Preview</p> <p>On Off</p>	<p>Specify whether a preview appears on the display for scan jobs.</p> <p>Notes:</p> <ul style="list-style-type: none"> • Off is the factory default setting. • This menu item appears only when a formatted, working printer hard disk is installed.
<p>Background Removal</p> <p>-4 to 4</p>	<p>Adjust the amount of background visible on a copy.</p> <p>Note: 0 is the factory default setting.</p>
<p>Contrast</p> <p>0–5 Best for content</p>	<p>Specify the contrast of the scanned image.</p> <p>Note: “Best for content” is the factory default setting.</p>
<p>Mirror Image</p> <p>Off On</p>	<p>Create a mirror image of the original document.</p> <p>Note: Off is the factory default setting.</p>
<p>Negative Image</p> <p>Off On</p>	<p>Create a negative image of the original document.</p> <p>Note: Off is the factory default setting.</p>
<p>Shadow Detail</p> <p>-4 to 4</p>	<p>Adjust the amount of shadow detail visible on a scanned image.</p> <p>Note: 0 is the factory default setting.</p>
<p>Fix Scan Skew</p> <p>Auto Off On</p>	<p>Specify whether or not to fix slight skew on the scanned image.</p> <p>Notes:</p> <ul style="list-style-type: none"> • Off is the factory default setting • This menu item appears only in select printer models.
<p>Scan edge to edge</p> <p>Off On</p>	<p>Specify whether the original document is scanned edge-to-edge.</p> <p>Note: Off is the factory default setting.</p>
<p>Sharpness</p> <p>1–5</p>	<p>Adjust the amount of sharpness on a scanned image.</p> <p>Note: 3 is the factory default setting.</p>

User's Guide

Use	To
<p>Temperature</p> <p style="padding-left: 20px;">-4 to 4</p>	<p>Enable the user to specify “warm” or “cool” outputs. “Cool” values generate a bluer output than the default while “warm” values generate a redder output than the default.</p> <p>Note: 0 is the factory default setting.</p>

Print Settings menu items and their descriptions

Use	To
<p>Copies</p> <p style="padding-left: 20px;">1–999</p>	<p>Specify a default number of copies for each print job.</p> <p>Note: 1 is the factory default setting.</p>
<p>Paper Source</p> <p style="padding-left: 20px;">Tray [x] MP Feeder Manual Paper Manual Envelope</p>	<p>Set a default paper source for all print jobs.</p> <p>Note: Tray 1 is the factory default setting.</p>
<p>Collate</p> <p style="padding-left: 20px;">1,1,1 - 2,2,2 1,2,3 - 1,2,3</p>	<p>Stack the pages of a print job in sequence when printing multiple copies.</p> <p>Note: “1,2,3 - 1,2,3” is the factory default setting.</p>
<p>Sides (Duplex)</p> <p style="padding-left: 20px;">1 sided 2 sided</p>	<p>Specify whether prints are on one side or on both sides of the page.</p> <p>Note: “1 sided” is the factory default setting.</p>
<p>Duplex Binding</p> <p style="padding-left: 20px;">Long Edge Short Edge</p>	<p>Define binding for duplexed pages in relation to the page orientation of the printed document.</p> <p>Notes:</p> <ul style="list-style-type: none"> • Long Edge is the factory default setting. This assumes binding along the long edge of the page (left edge for portrait and top edge for landscape). • Short Edge assumes binding along the short edge of the page (top edge for portrait and left edge for landscape).
<p>Paper Saver Orientation</p> <p style="padding-left: 20px;">Auto Landscape Portrait</p>	<p>Specify the orientation of a multiple-page document.</p> <p>Note: Auto is the factory default setting. The printer chooses between portrait and landscape.</p>

User's Guide

Use	To
<p>Paper Saver</p> <p>Off 2-Up 3-Up 4-Up 6-Up 9-Up 12-Up 16-Up</p>	<p>Specify that multiple-page images be printed on one side of a paper.</p> <p>Notes:</p> <ul style="list-style-type: none"> • Off is the factory default setting. • The number selected is the number of page images that will print per side.
<p>Paper Saver Border</p> <p>None Solid</p>	<p>Print a border on each page image.</p> <p>Note: None is the factory default setting.</p>
<p>Paper Saver Ordering</p> <p>Horizontal Reverse Horizontal Reverse Vertical Vertical</p>	<p>Specify the positioning of multiple-page images.</p> <p>Notes:</p> <ul style="list-style-type: none"> • Horizontal is the factory default setting. • Positioning depends on the number of page images and whether they are in portrait or in landscape orientation.
<p>Separator Sheets</p> <p>Off Between Copies Between Jobs Between Pages</p>	<p>Specify whether blank separator sheets are inserted.</p> <p>Notes:</p> <ul style="list-style-type: none"> • Off is the factory default setting. • Between Copies inserts a blank sheet between each copy of a print job if Collate is set to "1,2,3 - 1,2,3". If Collate is set to "1,1,1 - 2,2,2", then a blank page is inserted between each set of printed pages, such as after all page 1's and after all page 2's. • Between Jobs inserts a blank sheet between print jobs. • Between Pages inserts a blank sheet between each page of the print job. This setting is useful when printing transparencies or when inserting blank pages in a document .
<p>Separator Sheet Source</p> <p>Tray [x] Multipurpose Feeder</p>	<p>Specify the paper source for separator sheets.</p> <p>Note: Tray 1 is the factory default setting.</p>
<p>Blank Pages</p> <p>Do Not Print Print</p>	<p>Specify whether blank pages are inserted in a print job.</p> <p>Note: Do Not Print is the factory default setting.</p>

Print Settings

Setup menu

Use	To
<p>Printer Language</p> <p>PCL Emulation</p> <p>PS Emulation</p>	<p>Set the printer language.</p> <p>Notes:</p> <ul style="list-style-type: none"> • PCL Emulation is the factory default setting. • Setting a printer language as the default does not prevent a software program from sending print jobs that use another printer language.
<p>Job Waiting</p> <p>On</p> <p>Off</p>	<p>Specify that print jobs be removed from the print queue if they require unavailable printer options or custom settings.</p> <p>Print jobs removed from the print queue are stored in a separate print queue, so other jobs print normally. When the missing information or options are obtained, the stored jobs print.</p> <p>Notes:</p> <ul style="list-style-type: none"> • Off is the factory default setting. • This menu setting appears only when a formatted, working printer hard disk is installed. This requirement ensures that stored jobs are not deleted if the printer loses power.
<p>Print Area</p> <p>Normal</p> <p>Whole Page</p>	<p>Set the logical and physical printable area.</p> <p>Notes:</p> <ul style="list-style-type: none"> • Normal is the factory default setting. When attempting to print data in the non-printable area defined by the Normal setting, the printer clips the image at the boundary. • Whole Page allows the image to be moved into the non-printable area defined by the Normal setting, but the printer will clip the image at the Normal setting boundary. This affects only pages printed using a PCL 5e interpreter. This has no effect on pages printed using the PCL XL or PostScript interpreter.

User's Guide

Use	To
<p>Download Target</p> <p>RAM</p> <p>Flash</p> <p>Disk</p>	<p>Set the storage location for downloads.</p> <p>Notes:</p> <ul style="list-style-type: none"> • RAM is the factory default setting. Storing downloads in the RAM is temporary. • Storing downloads in flash memory or on a printer hard disk places them in permanent storage. Downloads remain in flash memory or on the printer hard disk even when the printer is turned off. • This menu setting appears only when a formatted, working flash drive or printer hard disk is installed.
<p>Resource Save</p> <p>On</p> <p>Off</p>	<p>Specify how the printer handles temporary downloads, such as fonts and macros stored in the RAM, when the printer receives a job that requires more memory than is available.</p> <p>Notes:</p> <ul style="list-style-type: none"> • Off is the factory default setting. This sets the printer to retain the downloads only until memory is needed. Downloads are deleted in order to process print jobs. • On retains the downloads during language changes and printer resets. If the printer runs out of memory, then Memory Full [38] appears, and downloads are not deleted.
<p>Print All Order</p> <p>Alphabetical</p> <p>Oldest First</p> <p>Newest First</p>	<p>Specify the order in which held and confidential jobs are printed when Print All is selected.</p> <p>Note: Alphabetical is the factory default setting. Print jobs always appear in alphabetical order on the printer control panel.</p>

Finishing menu

Use	To
<p>Sides (Duplex)</p> <p>1 sided 2 sided</p>	<p>Specify whether two-sided (duplex) printing is set as the user default setting for all print jobs.</p> <p>Notes:</p> <ul style="list-style-type: none"> • “1 sided” is the factory default setting. • You can set two-sided printing from the software program. <p>For Windows users: Click File >Print, and then click Properties, Preferences, Options, or Setup.</p> <p>For Macintosh users: Choose File >Print, and then adjust the settings from the print dialog and pop-up menus.</p>
<p>Duplex Binding</p> <p>Long Edge Short Edge</p>	<p>Define the way two-sided pages are bound and printed.</p> <p>Notes:</p> <ul style="list-style-type: none"> • Long Edge is the factory default setting. This assumes binding along the long edge of the page (left edge for portrait and top edge for landscape). • Short Edge assumes binding along the short edge of the page (top edge for portrait and left edge for landscape).
<p>Copies</p> <p>1–999</p>	<p>Specify the default number of copies for each print job.</p> <p>Note: 1 is the factory default setting.</p>
<p>Blank Pages</p> <p>Do Not Print Print</p>	<p>Specify whether or not blank pages are inserted in a print job.</p> <p>Note: Do Not Print is the factory default setting.</p>
<p>Collate</p> <p>(1,1,1) (2,2,2) (1,2,3) (1,2,3)</p>	<p>Stack the pages of a print job in sequence when printing multiple copies.</p> <p>Note: “(1,2,3) (1,2,3)” is the factory default setting.</p>

User's Guide

Use	To
<p>Separator Sheets</p> <p>Off</p> <p>Between Copies</p> <p>Between Jobs</p> <p>Between Pages</p>	<p>Specify whether or not blank separator sheets are inserted.</p> <p>Notes:</p> <ul style="list-style-type: none"> • Off is the factory default setting. • Between Copies inserts a blank sheet between each copy of a print job if Collate is set to “(1,2,3) (1,2,3).” If Collate is set to “(1,1,1) (2,2,2),” then a blank page is inserted between each set of printed pages, such as after all page 1's and after all page 2's. • Between Jobs inserts a blank sheet between print jobs. • Between Pages inserts a blank sheet between each page of a print job. This setting is useful when printing transparencies or when inserting blank pages in a document.
<p>Separator Source</p> <p>Tray [x]</p> <p>Multipurpose Feeder</p>	<p>Specify the paper source for separator sheets.</p> <p>Notes:</p> <ul style="list-style-type: none"> • Tray 1 (standard tray) is the factory default setting. • From the Paper menu, set Configure MP to “Cassette” for Multipurpose Feeder to appear as a menu setting.
<p>Paper Saver</p> <p>Off</p> <p>2-Up</p> <p>3-Up</p> <p>4-Up</p> <p>6-Up</p> <p>9-Up</p> <p>12-Up</p> <p>16-Up</p>	<p>Print multiple pages on one sheet of paper.</p> <p>Notes:</p> <ul style="list-style-type: none"> • Off is the factory default setting. • When the number of pages per sheet is selected, each page is scaled so that the number of pages you want can be displayed on the sheet.
<p>Paper Saver Ordering</p> <p>Horizontal</p> <p>Reverse Horizontal</p> <p>Reverse Vertical</p> <p>Vertical</p>	<p>Specify the order in which pages are printed on a single sheet when using Paper Saver.</p> <p>Notes:</p> <ul style="list-style-type: none"> • Horizontal is the factory default setting. • Positioning depends on the number of pages and whether they are in portrait or landscape orientation.

User's Guide

Use	To
Paper Saver Orientation Auto Landscape Portrait	Specify the orientation in which pages are printed on a single sheet. Note: Auto is the factory default setting. The printer chooses between portrait and landscape.
Paper Saver Border None Solid	Print a border when using Paper Saver. Note: None is the factory default setting.

Quality menu

Use	To
<p>Print Resolution</p> <p>300 dpi 600 dpi 1200 dpi 1200 Image Q 2400 Image Q</p>	<p>Specify the printed output resolution in dots per inch.</p> <p>Note: 600 dpi is the factory default setting.</p>
<p>Pixel Boost</p> <p>Off Fonts Horizontally Vertically Both directions Isolated</p>	<p>Enable more pixels to print in clusters for clarity, in order to enhance images horizontally or vertically, or to enhance fonts.</p> <p>Note: Off is the factory default setting.</p>
<p>Toner Darkness</p> <p>1–10</p>	<p>Lighten or darken the printed output.</p> <p>Notes:</p> <ul style="list-style-type: none"> • 8 is the factory default setting. • Selecting a smaller number can help conserve toner.
<p>Enhance Fine Lines</p> <p>On Off</p>	<p>Enable a print mode preferable for files such as architectural drawings, maps, electrical circuit diagrams, and flow charts.</p> <p>Notes:</p> <ul style="list-style-type: none"> • Off is the factory default setting. • You can set this option from the printer software. For Windows users, click File >Print, and then click Properties, Preferences, Options, or Setup. For Macintosh users, choose File >Print, and then adjust the settings from the Print dialog and pop-up menus. • To set this option using the Embedded Web Server, type the network printer IP address in the Web browser address field.
<p>Gray Correction</p> <p>Auto Off</p>	<p>Automatically adjust the contrast enhancement applied to images.</p> <p>Note: Auto is the factory default setting.</p>

Use	To
Brightness -6 to 6	Adjust the printed output either by lightening or darkening it. You can conserve toner by lightening the output. Note: 0 is the factory default setting.
Contrast 0–5	Adjust the contrast of printed objects. Note: 0 is the factory default setting.

Job Accounting menu

Notes:

- This menu appears only when Upgrade Kit (256MB User Flash/Font Card) or Hard Disk is installed.
- You can maintain the statistics on Job Account by using PageScope Account Manager. PageScope Account Manager (charged) must be installed to be able to maintain the statistics on Job Account, and this machine must be specified as the target device.
- We recommend that you set the administrator password on the Embedded Web Server if you are using the Job Accounting menu.

Use	To
Job Accounting Log On Off	Specify whether to record a received print job. Note: Off is the factory default setting.
Job Accounting Utilities	Print and delete log files or export them to a flash drive.
Accounting Log Frequency Daily Weekly Monthly	Specify the cycle to update the log file. Notes: <ul style="list-style-type: none"> • Monthly is the factory default setting. • Weekly begins on Monday at 12:00 AM and ends on Sunday at 11:59 PM. • Monthly begins at 12:00 AM on the first day of the month and ends at 11:59 PM on the last day of the month.

User's Guide

Use	To
<p>Log Action at End of Frequency</p> <ul style="list-style-type: none"> None Email Current Log Email & Delete Current Log Post Current Log Post & Delete Current Log 	<p>Specify how the printer operates at the end of the log file update cycle.</p> <p>Note: None is the factory default setting.</p>
<p>Log Near Full Level</p> <ul style="list-style-type: none"> Off 1-49 	<p>Specify the numeric value by which the printer judges that the log storage area is reaching the upper limit.</p> <p>Note: The upper limit of the log storage area is 50 MB.</p>
<p>Log Action at Near Full</p> <ul style="list-style-type: none"> None Email Current Log Email & Delete Current Log Email & Delete Oldest Log Post Current Log Post & Delete Current Log Post & Delete Oldest Log Delete Current Log Delete Oldest Log Delete All But Current Delete All Logs 	<p>Specify how the printer operates when the log storage area is reaching the upper limit.</p> <p>Note: None is the factory default setting.</p>
<p>Log Action at Full</p> <ul style="list-style-type: none"> None Email & Delete Current Log Email & Delete Oldest Log Post & Delete Current Log Post & Delete Oldest Log Delete Current Log Delete Oldest Log Delete All But Current Delete All Logs 	<p>Specify how the printer operates when the log storage area has reached the upper limit.</p> <p>Note: None is the factory default setting.</p>
<p>URL to Post Logs</p> <p>[user-defined string]</p>	<p>Specify the folder in which to save the job accounting logs.</p> <p>Note: This option is available when "Post Current Log", "Post & Delete Current Log", or "Post & Delete Oldest Log" is selected in Log Action at Near Full/Log Action at Full.</p>

User's Guide

Use	To
<p>E-mail Address to Send Logs</p> <p>[user-defined string]</p>	<p>Specify the E-mail address to use to send the job accounting logs.</p> <p>Note: This option is available when "E-mail Current Log", "E-mail & Delete Current Log", or "E-mail & Delete Oldest Log" is selected in Log Action at Near Full/Log Action at Full.</p>
<p>Log File Prefix</p> <p>[user-defined string]</p>	<p>Change Prefix of the log file.</p> <p>Notes:</p> <ul style="list-style-type: none"> • The log file has two naming rules. Ongoing log files appear as "jal_[value of Log File Prefix setting]_current.csv" . Closed log files appear as "jal_[value of Log File Prefix setting]_[time stamp in appropriate Date Format for first day of jobs included in the log].csv" . • Current host name string in TCP/IP menu is the factory default setting.
<p>Delete Logs</p> <p>Select All</p> <p>Unselect All</p> <p>Delete</p>	<p>Select the desired log file from the displayed list, and then delete it.</p> <p>Note: This option is displayed only when Job Accounting Log is enabled.</p>
<p>Print/Export Logs</p> <p>Print</p> <p style="padding-left: 20px;">Detailed</p> <p style="padding-left: 20px;">User ID Summary</p> <p style="padding-left: 20px;">Account Code Summary</p> <p>Export</p>	<p>Specify processing of the job accounting log file.</p> <p>Note: This option is displayed only when Job Accounting Log is enabled.</p>

Utilities menu

Use	To
<p>Remove Held Jobs</p> <p>Confidential Held Not Restored All</p>	<p>Delete confidential and held jobs from the printer hard disk.</p> <p>Notes:</p> <ul style="list-style-type: none"> • Selecting a setting affects only print jobs that are resident in the printer. Bookmarks, print jobs on flash drives, and other types of held jobs are not affected. • Not Restored removes all Print and Hold jobs that are <i>not</i> restored from the printer hard disk or memory.
<p>Format Flash</p> <p>Yes No</p>	<p>Format the flash memory.</p> <p>Warning—Potential Damage: Do not turn off the printer while the flash memory is being formatted.</p> <p>Notes:</p> <ul style="list-style-type: none"> • Yes deletes all data stored in flash memory. • No cancels the format request. • Flash memory refers to the memory added by installing a flash memory card in the printer. • The flash memory option card must not be read/write- or write-protected. • This menu item appears only when a non-defective flash memory card is installed.
<p>Delete Downloads on Disk</p> <p>Delete Now Do Not Delete</p>	<p>Delete downloads from the printer hard disk, including all held jobs, buffered jobs, and parked jobs.</p> <p>Notes:</p> <ul style="list-style-type: none"> • Delete Now sets the printer to delete the downloads and allows the display to return to the originating screen after the deletion. • Do Not Delete sets the printer display to return to the main Utilities menu for touch-screen printer models. When selected in non-touch-screen printer models, Do Not Delete sets the printer to return to the originating screen after the deletion.
<p>Activate Hex Trace</p>	<p>Assist in isolating the source of a print job problem.</p> <p>Notes:</p> <ul style="list-style-type: none"> • When activated, all data sent to the printer is printed in hexadecimal and character representation, and control codes are not executed. • To exit or deactivate Hex Trace, turn off or reset the printer.

Use	To
Coverage Estimator Off On	Provide an estimate of the percentage coverage of toner on a page. The estimate is printed on a separate page at the end of each print job. Note: Off is the factory default setting.

XPS menu

Use	To
Print Error Pages Off On	Print a page containing information on errors, including XML markup errors. Note: Off is the factory default setting.

PDF menu

Use	To
Scale to Fit Yes No	Scale page content to fit the selected paper size. Note: No is the factory default setting.
Annotations Do Not Print Print	Print annotations in a PDF. Note: Do Not Print is the factory default setting.

PostScript menu

Use	To
<p>Print PS Error</p> <p>On Off</p>	<p>Print a page containing the PostScript error.</p> <p>Note: Off is the factory default setting.</p>
<p>Lock PS Startup Mode</p> <p>On Off</p>	<p>Disable the SysStart file.</p> <p>Note: Off is the factory default setting.</p>
<p>Font Priority</p> <p>Resident Flash/Disk</p>	<p>Establish the font search order.</p> <p>Notes:</p> <ul style="list-style-type: none"> • Resident is the factory default setting. • This menu item is available only when a formatted flash memory option card or printer hard disk is installed and operating properly. • Make sure the flash memory option or printer hard disk is not read/write-, write-, or password-protected. • Job Buffer Size must not be set to 100%.

PCL Emul menu

Use	To
<p>Font Source</p> <p>Resident Download All</p>	<p>Specify the set of fonts used in the Font Name menu.</p> <p>Notes:</p> <ul style="list-style-type: none"> • “Resident” is the factory default setting. It shows the factory default set of fonts downloaded in the RAM. • “Download” shows all the fonts downloaded in the RAM. • “All” shows all fonts available to any option.
<p>Font Name</p> <p>Courier 10</p>	<p>Identify a specific font and where it is stored.</p> <p>Note: Courier 10 is the factory default setting.</p>
<p>Symbol Set</p> <p>10U PC-8 12U PC-850</p>	<p>Specify the symbol set for each font name.</p> <p>Notes:</p> <ul style="list-style-type: none"> • 12U PC-850 is the factory default setting. • A symbol set is a set of alphabetical and numeric characters, punctuation, and special symbols. Symbol sets support the different languages or specific programs, such as math symbols for scientific text. Only the supported symbol sets are shown.
<p>PCL Emulation Settings</p> <p>Point Size 1.00–1008.00</p>	<p>Change the point size for scalable typographic fonts.</p> <p>Notes:</p> <ul style="list-style-type: none"> • 12 is the factory default setting. • Point size refers to the height of the characters in the font. One point equals approximately 0.014 of an inch. This can be increased or decreased in 0.25-point increments.
<p>PCL Emulation Settings</p> <p>Pitch 0.08–100.00</p>	<p>Specify the font pitch for scalable monospaced fonts.</p> <p>Notes:</p> <ul style="list-style-type: none"> • 10 is the factory default setting. • Pitch refers to the number of fixed-space characters per inch (cpi). This can be increased or decreased in 0.01-cpi increments. • For non-scalable monospaced fonts, the pitch appears on the display but cannot be changed.

User's Guide

Use	To
<p>PCL Emulation Settings</p> <p>Orientation</p> <p>Portrait</p> <p>Landscape</p>	<p>Specify the orientation of text and graphics on a page.</p> <p>Notes:</p> <ul style="list-style-type: none"> • Portrait is the factory default setting. It prints text and graphics parallel to the short edge of the page. • Landscape prints text and graphics parallel to the long edge of the page.
<p>PCL Emulation Settings</p> <p>Lines per Page</p> <p>1–255</p>	<p>Specify the number of lines that print on each page.</p> <p>Notes:</p> <ul style="list-style-type: none"> • 64 is the default setting. • The printer sets the amount of space between each line based on the Lines per Page, Paper Size, and Orientation settings. Select the paper size and orientation before setting Lines per Page.
<p>PCL Emulation Settings</p> <p>A4 Width</p> <p>198 mm</p> <p>203 mm</p>	<p>Set the printer to print on A4-size paper.</p> <p>Notes:</p> <ul style="list-style-type: none"> • 198 mm is the factory default setting. • The 203-mm setting sets the width of the page to allow the printing of eighty 10-pitch characters.
<p>PCL Emulation Settings</p> <p>Auto CR after LF</p> <p>On</p> <p>Off</p>	<p>Specify whether the printer automatically performs a carriage return (CR) after a line feed (LF) control command.</p> <p>Note: Off is the factory default setting.</p>
<p>PCL Emulation Settings</p> <p>Auto LF after CR</p> <p>On</p> <p>Off</p>	<p>Specify whether the printer automatically performs a line feed (LF) after a carriage return (CR) control command.</p> <p>Note: Off is the factory default setting.</p>

User's Guide

Use	To
<p>Tray Renumber</p> <p>Assign MP Feeder</p> <p>Off</p> <p>None</p> <p>0–199</p> <p>Assign Tray [x]</p> <p>Off</p> <p>None</p> <p>0–199</p> <p>Assign Manual Paper</p> <p>Off</p> <p>None</p> <p>0–199</p> <p>Assign Manual Envelope</p> <p>Off</p> <p>None</p> <p>0–199</p>	<p>Configure the printer to work with printer software or programs that use different source assignments for trays and feeders.</p> <p>Notes:</p> <ul style="list-style-type: none"> • “Off” is the factory default setting. • “None” ignores the Select Paper Feed command. This option appears only when it is selected by the PCL 5e interpreter. • “0–199” allows a custom setting to be assigned.
<p>Tray Renumber</p> <p>View Factory Defaults</p> <p>MPF Default = 8</p> <p>T1 Default = 1</p> <p>T2 Default = 4</p> <p>T3 Default = 5</p> <p>T4 Default = 20</p> <p>T5 Default = 21</p> <p>Env Default = 6</p> <p>MPaper Default = 2</p> <p>MEnv Default = 3</p>	<p>Show the factory default setting assigned to each tray or feeder.</p>
<p>Tray Renumber</p> <p>Restore Defaults</p> <p>Yes</p> <p>No</p>	<p>Restore all tray and feeder assignments to the factory default settings.</p>

HTML menu

Use		To
Font Name	Joanna MT	Set the default font for HTML documents. Note: The Times font is used in HTML documents that do not specify a font.
Albertus MT	Letter Gothic	
Antique Olive	Lubalin Graph	
Apple Chancery	Marigold	
Arial MT	Monalisa Recut	
Avant Garde	Monaco	
Bodoni	New CenturySbk	
Bookman	New York	
Chicago	Optima	
Clarendon	Oxford	
Cooper Black	Palatino	
Copperplate	StempelGaramond	
Coronet	Taffy	
Courier	Times	
Eurostile	TimesNewRoman	
Garamond	Univers	
Geneva	Zapf Chancery	
Gill Sans	NewSansMTCS	
Goudy	NewSansMTCT	
Helvetica	New SansMTJA	
Hoefler Text	NewSansMTKO	
Intl CG Times		
Intl Courier		
Intl Univers		

User's Guide

Use	To
<p>Font Size</p> <p>1–255 pt</p>	<p>Set the default font size for HTML documents.</p> <p>Notes:</p> <ul style="list-style-type: none"> • 12 pt is the factory default setting. • Font size can be increased in 1-point increments.
<p>Scale</p> <p>1–400%</p>	<p>Scale the default font for HTML documents.</p> <p>Notes:</p> <ul style="list-style-type: none"> • 100% is the factory default setting. • Scaling can be increased in 1% increments.
<p>Orientation</p> <p>Portrait Landscape</p>	<p>Set the page orientation for HTML documents.</p> <p>Note: Portrait is the factory default setting.</p>
<p>Margin Size</p> <p>8–255 mm</p>	<p>Set the page margin for HTML documents.</p> <p>Notes:</p> <ul style="list-style-type: none"> • 19 mm is the factory default setting. • Margin size can be increased in 1-mm increments.
<p>Backgrounds</p> <p>Do Not Print Print</p>	<p>Specify whether to print backgrounds on HTML documents.</p> <p>Note: Print is the factory default setting.</p>

Image menu

Use	To
<p>Auto Fit</p> <p>On</p> <p>Off</p>	<p>Select the optimal paper size, scaling, and orientation.</p> <p>Note: On is the factory default setting. It overrides scaling and orientation settings for some images.</p>
<p>Invert</p> <p>On</p> <p>Off</p>	<p>Invert bitonal monochrome images.</p> <p>Notes:</p> <ul style="list-style-type: none"> • Off is the factory default setting. • This setting does not apply to GIF or JPEG images.
<p>Scaling</p> <p>Anchor Top Left</p> <p>Best Fit</p> <p>Anchor Center</p> <p>Fit Height/Width</p> <p>Fit Height</p> <p>Fit Width</p>	<p>Scale the image to fit the selected paper size.</p> <p>Notes:</p> <ul style="list-style-type: none"> • Best Fit is the factory default setting. • When Auto Fit is set to On, Scaling is automatically set to Best Fit.
<p>Orientation</p> <p>Portrait</p> <p>Landscape</p> <p>Reverse Portrait</p> <p>Reverse Landscape</p>	<p>Set the image orientation.</p> <p>Note: Portrait is the factory default setting.</p>

14—Saving the environment

Saving paper and toner

Studies show that as much as 80% of the carbon footprint of a printer is related to paper usage. You can significantly reduce your carbon footprint by using recycled paper and the following printing suggestions, such as printing on both sides of the paper and printing multiple pages on one side of a single sheet of paper.

For information on how you can quickly save paper and energy using one printer setting, see "Using Eco-Mode".

Using recycled paper

As an environmentally conscious company, KONICA MINOLTA supports the use of recycled office paper produced specifically for use in laser printers.

Conserving supplies

There are a number of ways you can reduce the amount of paper and toner you use when printing. You can:

Use both sides of the paper

If your printer model supports duplex printing, then you can control whether print appears on one or two sides of the paper by selecting **2-sided printing** from the Print dialog.

Place multiple pages on one sheet of paper

You can print up to 16 consecutive pages of a multiple-page document onto one side of a single sheet of paper by selecting a setting from the Multipage printing (N-Up) section of the Print dialog screen.

Check your first draft for accuracy

Before printing or making multiple copies of a document:

- Print one copy of the document to check its content and format for accuracy.

Avoid paper jams

Carefully select and load paper to avoid paper jams. For more information, see [Avoiding jams](#).

Saving energy

Using Eco-Mode

1. Open a Web browser, and then type the printer IP address in the address field.

Notes:

- View the printer IP address on the printer home screen. The IP address appears as four sets of numbers separated by periods, such as 123.123.123.123.
- If you are using a proxy server, then temporarily disable it to load the Web page correctly.

2. Click **Settings >General Settings >Eco-Mode >** select a setting

Use	To
Off	Use the factory default settings for all settings associated with Eco-Mode. Off supports the performance specifications of the printer.
Energy	Reduce energy use, especially when the printer is idle. <ul style="list-style-type: none"> • Printer engine motors do not start until it is ready to print. You may notice a short delay before the first page is printed. • The printer enters Sleep mode after one minute of inactivity.
Energy/Paper	Use all the settings associated with Energy and Paper modes.
Plain Paper	<ul style="list-style-type: none"> • Enable the automatic two-sided (duplex) feature. • Turn off print log features.

3. Click **Submit**.

Reducing printer noise

Enable Quiet Mode to reduce printer noise.

1. Open a Web browser, and then type the printer IP address in the address field.

Notes:

- View the printer IP address on the printer home screen. The IP address appears as four sets of numbers separated by periods, such as 123.123.123.123.
- If you are using a proxy server, then temporarily disable it to load the Web page correctly.

- Click **Settings >General Settings >Quiet Mode** > select a setting

Use	To
On	<p>Reduce printer noise.</p> <p>Notes:</p> <ul style="list-style-type: none"> Print jobs are processed at a reduced speed. Printer engine motors do not start until a document is ready to print. There will be a short delay before the first page is printed.
Off	<p>Use factory default settings.</p> <p>Note: This setting supports the performance specifications of the printer.</p>

- Click **Submit**.

Adjusting Sleep mode

To save energy, decrease the number of minutes the printer waits before it enters Sleep mode. Select from 1 to 120. The factory default setting is 30 minutes.

Note: The printer still accepts print jobs when in Sleep mode.

Using the Embedded Web Server

- Open a Web browser, and then type the printer IP address in the address field.

Notes:

- View the printer IP address on the printer home screen. The IP address appears as four sets of numbers separated by periods, such as 123.123.123.123.
- If you are using a proxy server, then temporarily disable it to load the Web page correctly.

- Click **Settings >General Settings >Timeouts**.
- In the Sleep Mode field, enter the number of minutes you want for the printer to wait before it enters Sleep mode.
- Click **Submit**.

Using the printer control panel

- From the home screen, navigate to:



>Settings >General Settings >Timeouts >Sleep Mode

- In the Sleep Mode field, select the number of minutes you want for the printer to wait before it enters Sleep mode.

3. Touch .

Using Hibernate Mode

Hibernate is an ultra-low power operating mode. When operating in Hibernate mode, the printer is essentially off, and all other systems and devices are powered down safely.

Note: The Hibernate and Sleep modes can be scheduled.

Using the Embedded Web Server

1. Open a Web browser, and then type the printer IP address in the address field.

Notes:

- View the printer IP address on the printer home screen. The IP address appears as four sets of numbers separated by periods, such as 123.123.123.123.
- If you are using a proxy server, then temporarily disable it to load the Web page correctly.

2. Click **Settings >General Settings >Sleep Button Settings**.
3. From the Press Sleep Button or Press and Hold Sleep Button drop-down menu, select **Hibernate**.
4. Click **Submit**.

Using the printer control panel

1. From the home screen, navigate to:



>**Settings > General Settings**

2. Touch **Press Sleep Button** or **Press and Hold Sleep Button**.
3. Touch **Hibernate** > .

Adjusting the brightness of the display

To save energy, or if you are have trouble reading your display, adjust the brightness of the display.

Available settings range from 20–100. The factory default setting is 100.

Using the Embedded Web Server

1. Open a Web browser, and then type the printer IP address in the address field.

Notes:

- View the printer IP address on the home screen. The IP address appears as four sets of numbers separated by periods, such as 123.123.123.123.
- If you are using a proxy server, then temporarily disable it to load the Web page correctly.

2. Click **Settings >General Settings**.
3. In the Screen Brightness field, enter the brightness percentage you want for the display.

4. Click **Submit**.

Using the printer control panel

1. From the home screen, navigate to:

 **>Settings >General Settings >Screen Brightness**

2. In the Screen Brightness field, enter the brightness percentage you want for the display.
3. Touch .

15—Securing the printer

Statement of Volatility

Your printer contains various types of memory that can store device and network settings, and user data.

Types of memory	Description
Volatile memory	Your printer uses standard <i>Random Access Memory</i> (RAM) to temporarily buffer user data during simple print and copy jobs.
Non-volatile memory	Your printer may use two forms of non-volatile memory: EEPROM and NAND (flash memory). Both types are used to store the operating system, device settings, network information, scanner and bookmark settings, and embedded solutions.
Hard disk memory	Some printers have a hard disk drive installed. The printer hard disk is designed for device-specific functionality. This lets the device retain buffered user data from complex scan, print, copy, and fax jobs, as well as form data, and font data.

Erase the content of any installed printer memory in the following circumstances:

- The printer is being decommissioned.
- The printer hard disk is being replaced.
- The printer is being moved to a different department or location.
- The printer is being serviced by someone from outside your organization.
- The printer is being removed from your premises for service.
- The printer is being sold to another organization.

Disposing of a printer hard disk

Note: Some printer models may not have a printer hard disk installed.

In high-security environments, it may be necessary to take additional steps to make sure that confidential data stored in the printer hard disk cannot be accessed when the printer—or its hard disk—is removed from your premises.

- **Degaussing**—Flushes the hard disk with a magnetic field that erases stored data
- **Crushing**—Physically compresses the hard disk to break component parts and render them unreadable
- **Milling**—Physically shreds the hard disk into small metal bits

Note: Most data can be erased electronically, but the only way to guarantee that all data is completely erased is to physically destroy each hard disk where data is stored.

Erasing volatile memory

The volatile memory (RAM) installed in your printer requires a power source to retain information. To erase the buffered data, simply turn off the printer.

Erasing non-volatile memory

- **Individual settings, device and network settings, security settings, and embedded solutions—** Erase information and settings by selecting **Erase Printer Memory** in the Configuration menu.
- **Fax data—**Erase fax settings and data by selecting **Erase Printer Memory** in the Configuration menu.

1. Turn off the printer.
2. Hold down **2** and **6** while turning the printer on. Release the buttons only when the screen with the progress bar appears.

The printer performs a power-on sequence, and then the Configuration menu appears. When the printer is fully powered up, the touch screen displays a list of functions, instead of the standard home screen icons.

3. Touch **Restore Factory Defaults > Erase Printer Memory**.

The printer will restart several times during this process.

Note: Wipe All Settings securely removes device settings, solutions, jobs, faxes, and passwords from the printer memory.

4. Touch **Back > Exit Config Menu**.

The printer will perform a power-on reset, and then return to normal operating mode.

Erasing printer hard disk memory

Note: Some printer models may not have a printer hard disk installed.

Configuring Disk Wiping in the printer menus lets you remove residual confidential material left by print jobs by securely overwriting files that have been marked for deletion.

Using the printer control panel

1. Turn off the printer.
2. Hold down **2** and **6** while turning the printer on. Release the buttons only when the screen with the progress bar appears.

The printer performs a power-on sequence, and then the Configuration menu appears. When the printer is fully turned on, the touch screen displays a list of functions.

3. Touch **Restore Factory Defaults > Erase Hard Disk**, and then touch one of the following:
 - **Single Pass Erase**—This lets you overwrite the disk with all zeroes in a single pass.
 - **Multiple Pass Erase**—This lets you overwrite the disk with random bit patterns several times, followed by a verification pass. A secure overwrite is compliant with the DoD 5220.22-M standard for securely erasing data from a hard disk. Highly confidential information should be wiped using this method.
4. Touch **Yes** to proceed with disk wiping.

Notes:

- A status bar will indicate the progress of the disk wiping task.
- Disk wiping can take from several minutes to more than an hour, during which the printer will be unavailable for other user tasks.

5. Touch **Back > Exit Config Menu**.

The printer will perform a power-on reset, and then return to normal operating mode.

Configuring printer hard disk encryption

Enable hard disk encryption to prevent loss of sensitive data in the event the printer or its hard disk is stolen.

Note: Some printer models may not have a printer hard disk installed.

Using the Embedded Web Server

1. Open a Web browser, and then type the printer IP address in the address field.

Notes:

- View the printer IP address on the printer home screen. The IP address appears as four sets of numbers separated by periods, such as 123.123.123.123.
- If you are using a proxy server, then temporarily disable it to load the Web page correctly.

2. Click **Settings > Security > Disk Encryption**.

Note: Disk Encryption appears in the Security Menu only when a formatted, non-defective printer hard disk is installed.

3. From the Disk encryption menu, select **Enable**.

Notes:

- Enabling disk encryption will erase the contents of the printer hard disk.
- Disk encryption can take from several minutes to more than an hour, during which the printer will be unavailable for other user tasks.

4. Click **Submit**.

Using the printer control panel

1. Turn off the printer.
2. Hold down **2** and **6** while turning the printer on. Release the buttons only when the screen with the progress bar appears.

The printer performs a power-on sequence, and then the Configuration menu appears. When the printer is fully turned on, a list of functions appears on the printer display.

3. Touch **Disk Encryption >Enable**.

Note: Enabling disk encryption will erase the contents of the printer hard disk.

4. Touch **Yes** to proceed with disk wiping.

Notes:

- Do not turn off the printer during the encryption process. Doing so may result in loss of data.
- Disk encryption can take from several minutes to more than an hour, during which the printer will be unavailable for other user tasks.
- A status bar will indicate the progress of the disk wiping task. After the disk has been encrypted, the printer will return to the Enable/Disable screen.

5. Touch **Back >Exit Config Menu**.

The printer will perform a power-on reset, and then return to normal operating mode.

16—Maintaining the printer

Warning—Potential Damage: Failure to maintain optimum printer performance, or to replace parts and supplies, may cause damage to your printer.

Cleaning the printer parts

Cleaning the printer

Note: You may need to perform this task after every few months.

Warning—Potential Damage: Damage to the printer caused by improper handling is not covered by the printer warranty.

1. Make sure that the printer is turned off and unplugged from the electrical outlet.



CAUTION—SHOCK HAZARD: To avoid the risk of electrical shock when cleaning the exterior of the printer, unplug the power cord from the electrical outlet and disconnect all cables from the printer before proceeding.

2. Remove paper from the standard bin and multipurpose feeder.
3. Remove any dust, lint, and pieces of paper around the printer using a soft brush or vacuum.
4. Dampen a clean, lint-free cloth with water, and use it to wipe the outside of the printer.

Warning—Potential Damage: Do not use household cleaners or detergents to prevent damage to the exterior of the printer.

5. Make sure all areas of the printer are dry before sending a new print job.

Cleaning the scanner glass

Clean the scanner glass if you encounter print quality problems, such as streaks on copied or scanned images.

1. Slightly dampen a soft, lint-free cloth or paper towel with water.

2. Open the scanner cover.



3. Clean all the areas shown, and then let them dry.



1	White underside of the scanner cover
2	Scanner glass
3	ADF glass
4	White underside of the ADF cover

4. Close the scanner cover.

Checking the status of parts and supplies

Checking the status of parts and supplies on the printer control panel

From the home screen, touch **Status/Supplies > View Supplies**.

Checking the status of parts and supplies from the Embedded Web Server

Note: Make sure the computer and the printer are connected to the same network.

1. Open a Web browser, and then type the printer IP address in the address field.

Notes:

- View the printer IP address on the home screen. The IP address appears as four sets of numbers separated by periods, such as 123.123.123.123.
- If you are using a proxy server, then temporarily disable it to load the Web page correctly.

2. Click **Device Status >More Details**.

Estimated number of remaining pages

The estimated number of remaining pages is based on the recent printing history of the printer. Its accuracy may vary significantly and is dependent on many factors, such as actual document content, print quality settings, and other printer settings.

The accuracy of the estimated number of remaining pages may decrease when the actual printing consumption is different from the historical printing consumption. Consider the variable level of accuracy before purchasing or replacing supplies based on the estimate. Until an adequate print history is obtained on the printer, initial estimates assume future supplies consumption based on the International Organization for Standardization* test methods and page content.

* Average continuous black declared cartridge yield in accordance with ISO/IEC 19752.

Ordering supplies

Using genuine KONICA MINOLTA parts and supplies

Your KONICA MINOLTA printer is designed to function best with genuine KONICA MINOLTA supplies and parts. Use of third-party supplies or parts may affect the performance, reliability, or life of the printer and its imaging components. Use of third-party supplies or parts can affect warranty coverage. Damage caused by the use of third-party supplies or parts is not covered by the warranty. All life indicators are designed to function with KONICA MINOLTA supplies and parts, and may deliver unpredictable results if third-party supplies or parts are used. Imaging component usage beyond the intended life may damage your KONICA MINOLTA printer or its associated components.

Ordering toner cartridges

Notes:

- Estimated cartridge yield is based on the ISO/IEC 19752 standard.
- Extremely low print coverage for extended periods of time may negatively affect actual yield.

Part name	Part number
For the UnitedState, latin America (120V) and Taiwan	
Toner Cartridge 20K for bizhub 4020 (Use and Return)	A6WN01F
Toner Cartridge 20K for bizhub 4020	A6WN01W
For Europe	
Toner Cartridge 20K for bizhub 4020 (Use and Return)	A6WN01H
Toner Cartridge 20K for bizhub 4020	A6WN01W
For the Asia Pacific, Africa, Middle East, Latin America (220V), Australia and New Zealand	
Toner Cartridge 20K for bizhub 4020 (Use and Return)	A6WN01K
Toner Cartridge 20K for bizhub 4020	A6WN01W
For China	
Toner Cartridge 20K for bizhub 4020 (Use and Return)	A6WN01K
Toner Cartridge 20K for bizhub 4020	A6WN01R

Ordering an imaging unit

Extremely low print coverage for extended periods of time may cause imaging unit parts to fail prior to exhaustion of toner from toner cartridge.

For more information on replacing the imaging unit, see the instruction sheet that came with the supply.

Part name	Destination	Part number
Imaging unit 60K for bizhub 4020/3320 (Use and Return)	For World wide	A6W903V
Imaging unit 60K for bizhub 4020/3320	For World wide	A6W903W

Ordering a maintenance kit

Notes:

- Using certain types of paper may require more frequent replacement of the maintenance kit.
- The separator roller, fuser, pick rollers, transfer roller, and redrive assembly are all included in the maintenance kit and can be individually ordered and replaced if necessary.
- Contact your service representative to replace the maintenance kit.

Recommended maintenance kits

Maintenance kit
100-V maintenance kit [*]
110-V maintenance kit
220-V maintenance kit
* This is available only in Japan.

Ordering an ADF separator roller

Order an ADF separator roller when the ADF fails to pick paper or picks more than one sheet of paper at a time.

For information on replacing the ADF separator roller, see the instruction sheet that came with the part.

Recommended part numbers

Part name
Separator roller

Storing supplies

Choose a cool, clean storage area for the printer supplies. Store supplies right side up in their original packing until you are ready to use them.

Do not expose supplies to:

- Direct sunlight
- Temperatures above 35°C (95°F)

- High humidity above 80%
- Salty air
- Corrosive gases
- Heavy dust

Replacing supplies

Replacing the toner cartridge

1. Press the button on the right side of the printer, and then open the front door.

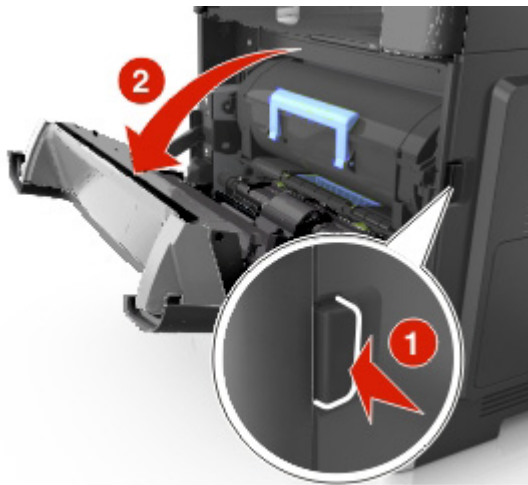

2. Pull the toner cartridge out using the handle.

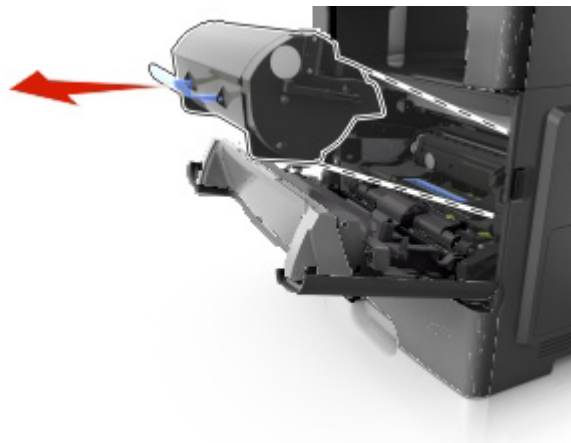

3. Unpack the toner cartridge, and then remove all packing materials.

4. Shake the new cartridge to redistribute the toner.

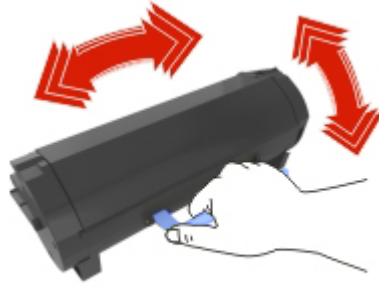

5. Insert the toner cartridge into the printer by aligning the side rails of the cartridge with the arrows on the side rails inside the printer.

Warning—Potential Damage: Do not expose the imaging unit to direct light for more than 10 minutes. Extended exposure to light may cause print quality problems.

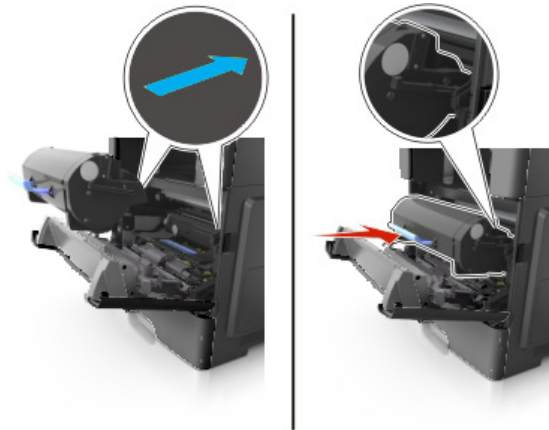

6. Close the front door.

Note: Dispose of the empty toner cartridge according to your local regulations. Do not burn the toner cartridge.

CAUTION: If you get toner in your eyes, wash it out immediately with cool water and consult a doctor.

Replacing the imaging unit

1. Press the button on the right side of the printer, and then open the front door.

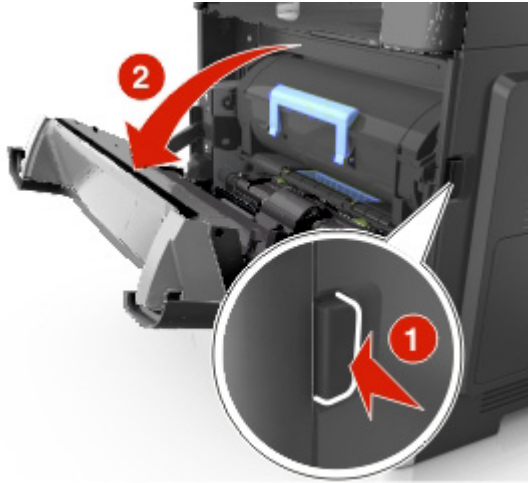

2. Pull the toner cartridge out using the handle.

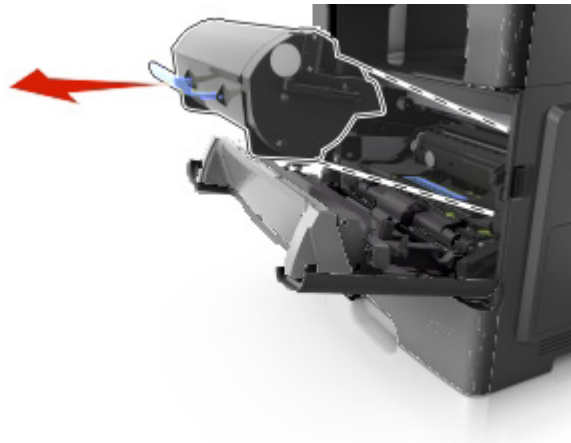

3. Lift the blue handle, and then pull the imaging unit out of the printer.

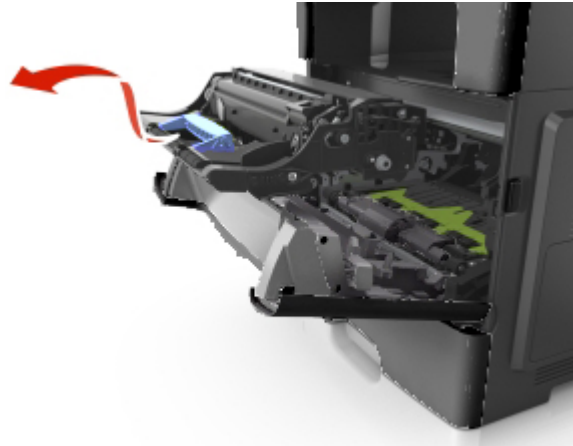

4. Unpack the new imaging unit, and then shake it.

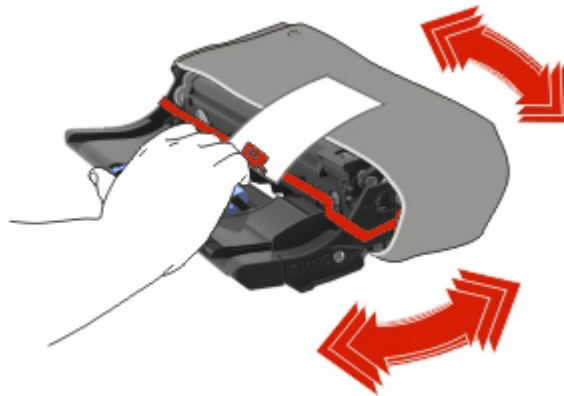

5. Remove all packing materials from the imaging unit.

Warning—Potential Damage: Do not expose the imaging unit to direct light for more than 10 minutes. Extended exposure to light may cause print quality problems.

Warning—Potential Damage: Do not touch the photoconductor drum. Doing so may affect the print quality of future print jobs.

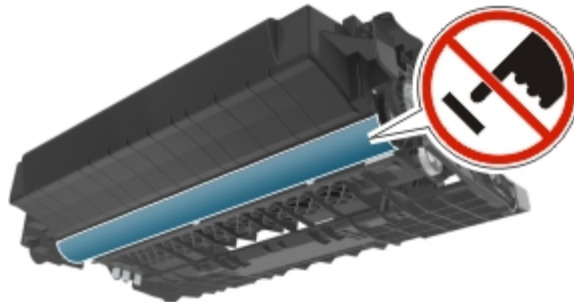

6. Insert the imaging unit into the printer by aligning the arrows on the side rails of the imaging unit with the arrows on the side rails inside the printer.

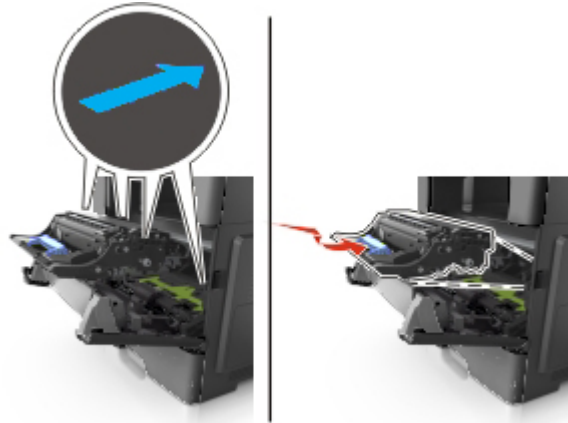

7. Insert the toner cartridge into the printer by aligning the side rails of the cartridge with the arrows on the side rails inside the printer.

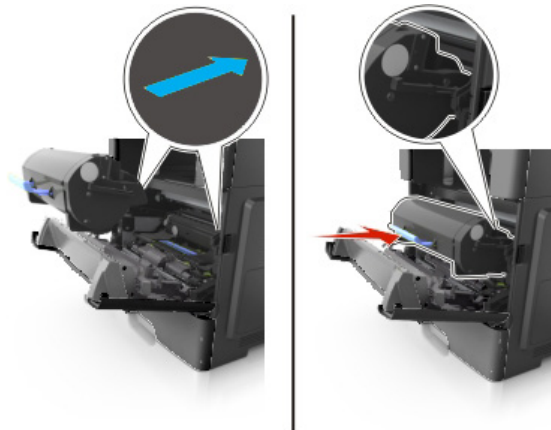

8. Close the front door.

Note: Dispose of the used imaging unit according to your local regulations. Do not burn the imaging unit.

Moving the printer

⚠ CAUTION—POTENTIAL INJURY: The printer weight is greater than 18 kg (40 lb) and requires two or more trained personnel to lift it safely.

Before moving the printer

⚠ CAUTION—POTENTIAL INJURY: Before moving the printer, follow these guidelines to avoid personal injury or printer damage:

- Turn the printer off using the power switch, and then unplug the power cord from the electrical outlet.
- Disconnect all cords and cables from the printer before moving it.

- If an optional tray is installed, then remove it from the printer. To remove the optional tray, slide the latch on the right side of the tray toward the front of the tray until it *clicks* into place.



- Use the handholds located on both sides of the printer to lift it.
- Make sure your fingers are not under the printer when you set it down.
- Before setting up the printer, make sure there is adequate clearance around it.

Use only the power cord provided with this product or the manufacturer's authorized replacement.

Warning—Potential Damage: Damage to the printer caused by improper moving is not covered by the printer warranty.

Moving the printer to another location

The printer and its hardware options can be safely moved to another location by following these precautions:

- Any cart used to move the printer must have a surface able to support the full footprint of the printer.
- Any cart used to move the hardware options must have a surface able to support the dimensions of the hardware options.
- Keep the printer in an upright position.
- Avoid severe jarring movements.

Shipping the printer

When shipping the printer, use the original packaging.

17—Managing the printer

Finding advanced networking and administrator information

This chapter covers basic administrative support tasks using the Embedded Web Server. For more advanced system support tasks, see the *Networking Guide* on the *Drivers and Documentation CD*.

Checking the virtual display

1. Open a Web browser, and then type the printer IP address in the address field.

Notes:

- View the printer IP address on the printer home screen. The IP address appears as four sets of numbers separated by periods, such as 123.123.123.123.
- If you are using a proxy server, then temporarily disable it to load the Web page correctly.

2. Check the virtual display that appears at the top left corner of the screen.

The virtual display works as an actual display would work on a printer control panel.

Setting up e-mail alerts

Configure the printer to send you e-mail alerts when the supplies are getting low or when the paper needs to be changed or added, or when there is a paper jam.

1. Open a Web browser, and then type the printer IP address in the address field.

Notes:

- View the printer IP address on the printer home screen. The IP address appears as four sets of numbers separated by periods, such as 123.123.123.123.
- If you are using a proxy server, then temporarily disable it to load the Web page correctly.

2. Click **Settings**.
3. From the Other Settings menu, click **E-mail Alert Setup**.
4. Select the items you want to be notified on, and then type the e-mail addresses.
5. Click **Submit**.

Note: For information on setting up the e-mail server, contact your system support person.

Viewing reports

You can view some reports from the Embedded Web Server. These reports are useful for assessing the status of the printer, network, and supplies.

1. Open a Web browser, and then type the printer IP address in the address field.

Notes:

- View the printer IP address on the printer home screen. The IP address appears as four sets of numbers separated by periods, such as 123.123.123.123.
- If you are using a proxy server, then temporarily disable it to load the Web page correctly.

2. Click **Reports**, and then click the type of report you want to view.

Configuring supply notifications from the Embedded Web Server

You can determine how you would like to be notified when supplies run nearly low, low, very low, or reach their end-of-life by setting the selectable alerts.

Notes:

- Selectable alerts can be set on the toner cartridge, imaging unit, and maintenance kit.
- All selectable alerts can be set for nearly low, low, and very low supply conditions. Not all selectable alerts can be set for the end-of-life supply condition. E-mail selectable alert is available for all supply conditions.
- The percentage of estimated remaining supply that prompts the alert can be set on some supplies for some supply conditions.

1. Open a Web browser, and then type the printer IP address in the address field.

Notes:

- View the printer IP address on the printer home screen. The IP address appears as four sets of numbers separated by periods, such as 123.123.123.123.
- If you are using a proxy server, then temporarily disable it to load the Web page correctly.

2. Click **Settings >Print Settings >Supply Notifications**.

3. From the drop-down menu for each supply, select one of the following notification options:

Notification	Description
Off	The normal printer behavior for all supplies occurs.
E-mail Only	The printer generates an e-mail when the supply condition is reached. The status of the supply appears on the menus page and status page.

Notification	Description
Warning	The printer displays the warning message and generates an e-mail about the status of the supply. The printer does not stop when the supply condition is reached.
Continuable Stop ¹	The printer stops processing jobs when the supply condition is reached, and the user needs to press a button to continue printing.
Non Continuable Stop ^{1,2}	The printer stops processing jobs when the supply condition is reached. The supply must be replaced to continue printing.
¹ The printer generates an e-mail about the status of the supply when supply notification is enabled. ² The printer stops when some supplies become empty to prevent damage.	

4. Click **Submit**.

Restoring factory default settings

If you want to keep a list of the current menu settings for reference, then print a menu settings page before restoring the factory default settings. For more information, see [Printing a menu settings page](#).

If you want a more comprehensive method of restoring the printer factory default settings, then perform the Wipe All Settings option. For more information, see [Erasing non-volatile memory](#).

Warning—Potential Damage: Restoring factory defaults returns most printer settings to the original factory default settings. Exceptions include the display language, custom sizes and messages, and network/port menu settings. All downloads stored in the RAM are deleted. Downloads stored in the flash memory or in a printer hard disk are not affected.

From the home screen, navigate to:

 >Settings >General Settings >Factory Defaults >Restore Now > 

18—Clearing jams

By carefully selecting paper and specialty media and loading it properly, you should be able to avoid most jams. If jams occur, then follow the steps outlined in this chapter.

Warning—Potential Damage: Never use any tool to remove a jam. Doing so could permanently damage the fuser.

Avoiding jams

Load paper properly

- Make sure paper lies flat in the tray.

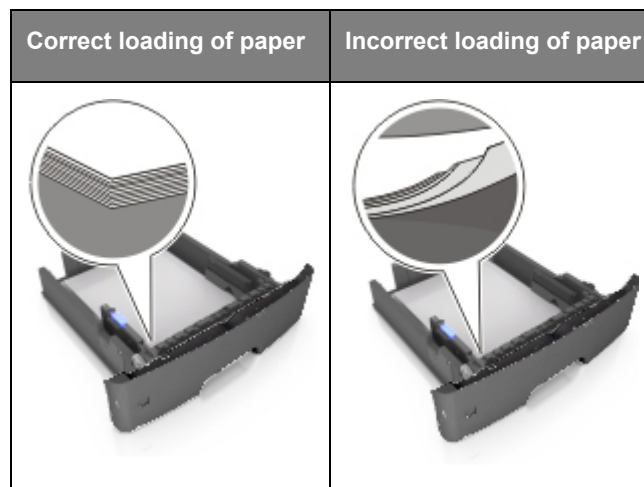

- Do not remove a tray while the printer is printing.
- Do not load a tray while the printer is printing. Load it before printing, or wait for a prompt to load it.
- Do not load too much paper. Make sure the stack height is below the maximum paper fill indicator.

- Do not slide the paper into the tray. Load paper as shown in the illustration.

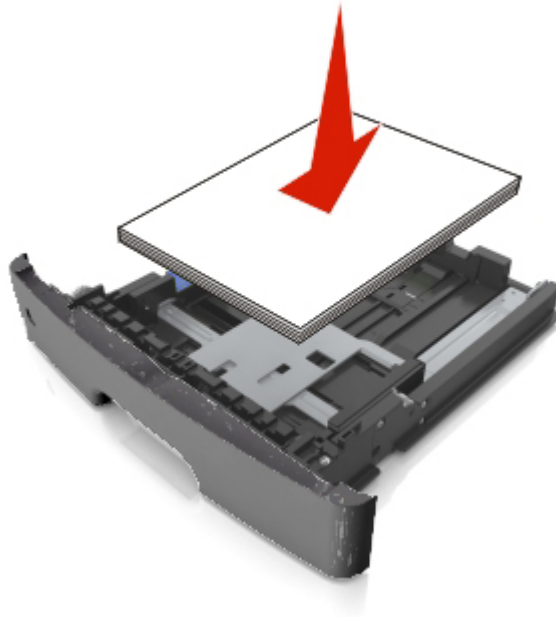

- Make sure the guides in the tray or the multipurpose feeder are properly positioned and are not pressing tightly against the paper or envelopes.
- Push the tray firmly into the printer after loading paper.

Use recommended paper

- Use only recommended paper or specialty media.
- Do not load wrinkled, creased, damp, bent, or curled paper.
- Flex, fan, and straighten paper before loading it.



- Do not use paper that has been cut or trimmed by hand.
- Do not mix paper sizes, weights, or types in the same tray.
- Make sure the paper size and type are set correctly on the computer or printer control panel.
- Store paper according to manufacturer recommendations.

Understanding jam messages and locations

When a jam occurs, a message indicating the jam location and information to clear the jam appears on the printer display. Open the doors, covers, and trays indicated on the display to remove the jam.

Notes:

- When Jam Assist is set to On, the printer automatically flushes blank pages or pages with partial prints to the standard bin after a jammed page has been cleared. Check your printed output stack for discarded pages.
- When Jam Recovery is set to On or Auto, the printer reprints jammed pages. However, the Auto setting does not guarantee that the page will reprint.

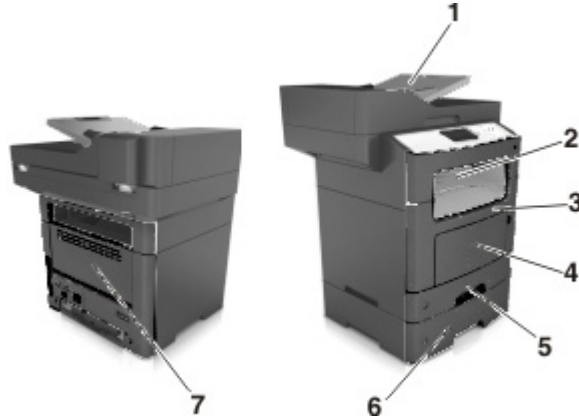

	Jam access area	Printer control panel message	What to do
1	Automatic document feeder (ADF)	[x]-page jam, open automatic feeder top cover. [28y.xx]	Remove all paper from the ADF tray, and then remove the jammed paper.
2	Standard bin	[x]-page jam, clear standard bin. [20y.xx]	Remove the jammed paper.
3	Front door	[x]-page jam, open front door. [20y.xx]	Open the front door, then remove the toner cartridge and imaging unit, and then the jammed paper.
4	Multipurpose feeder	[x]-page jam, clear manual feeder. [25y.xx]	Remove all paper from the multipurpose feeder, and then remove the jammed paper.
5	Tray 1	[x]-page jam, remove tray 1 to clear duplex. [23y.xx]	Pull out tray 1 completely, then push the front duplex flap down, and then remove the jammed paper. Note: You may need to open the rear door to clear some 23y.xx paper jams.
6	Tray [x]	[x]-page jam, remove tray [x]. [24y.xx]	Pull out the indicated tray, and then remove the jammed paper.
7	Rear door	[x]-page jam, open rear door. [20y.xx]	Open the rear door, and then remove the jammed paper.

[x]-page jam, open front door. [20y.xx]

 **CAUTION—HOT SURFACE:** The inside of the printer might be hot. To reduce the risk of injury from a hot component, allow the surface to cool before touching it.

1. Press the button on the right side of the printer, and then open the front door.

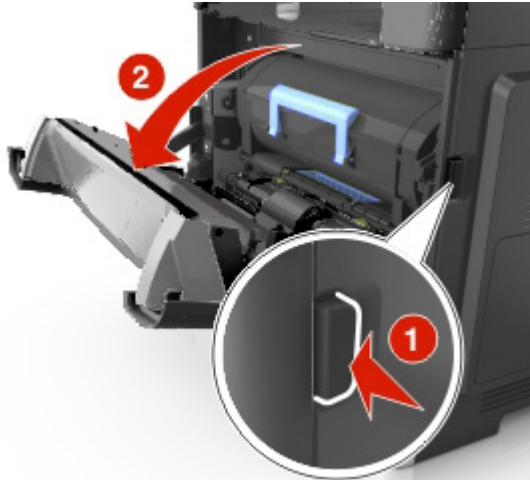

2. Pull the toner cartridge out using the handle.

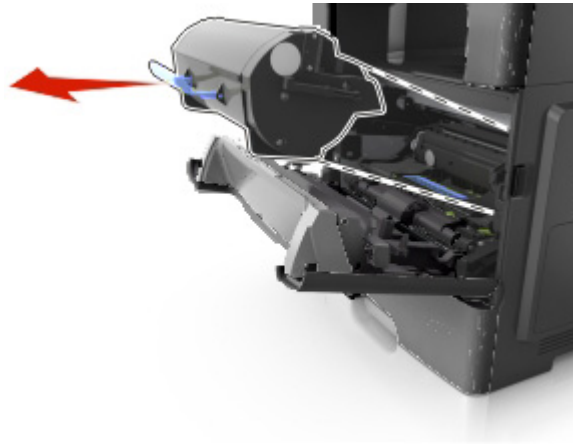

3. Lift the blue handle, and then pull the imaging unit out of the printer.

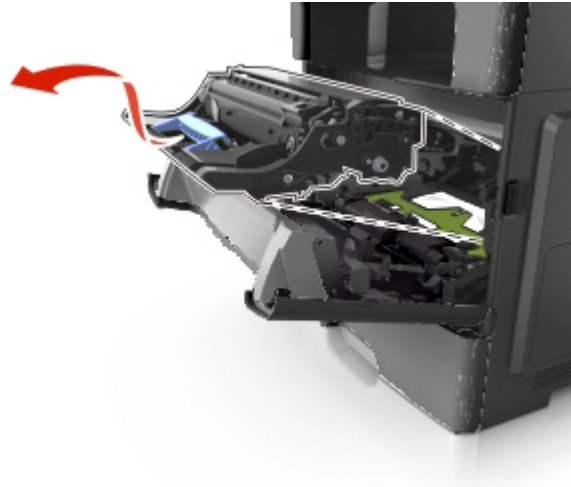

Warning—Potential Damage: Do not touch the shiny blue photoconductor drum under the imaging unit. Doing so may affect the quality of future print jobs.

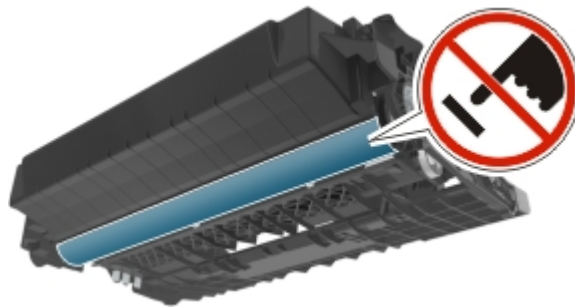

4. Place the imaging unit aside on a flat, smooth surface.

Warning—Potential Damage: Do not expose the imaging unit to direct light for more than 10 minutes. Extended exposure to light may cause print quality problems.

5. Lift the green flap in front of the printer.

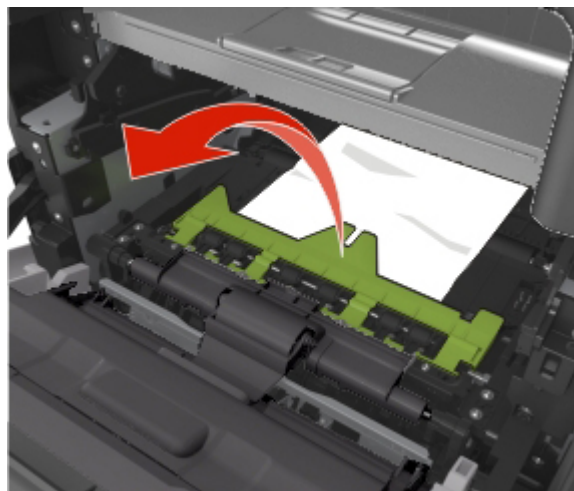

6. Firmly grasp the jammed paper on each side, and then gently pull it out.

Note: Make sure all paper fragments are removed.

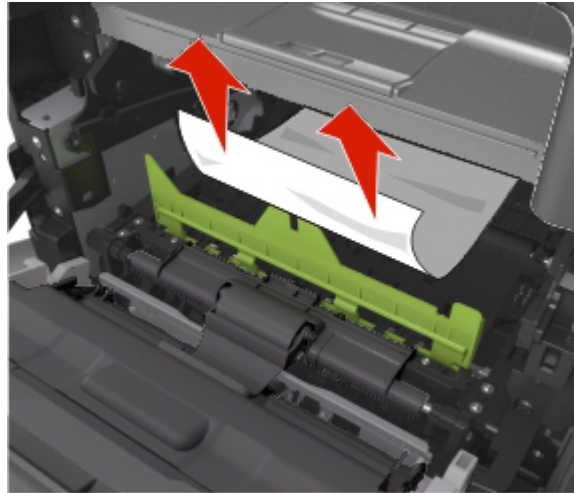

7. Insert the imaging unit by aligning the arrows on the side rails of the unit with the arrows on the side rails inside the printer, and then insert the imaging unit into the printer.

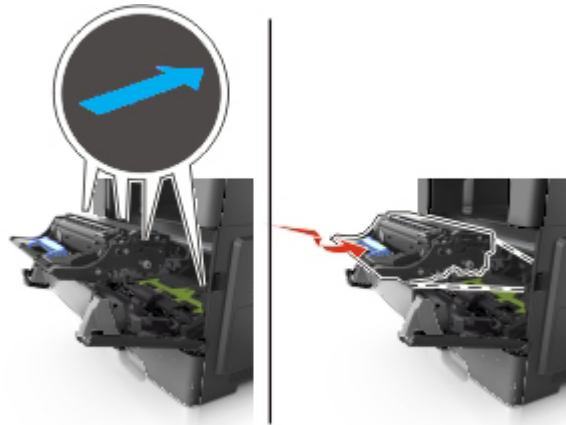

8. Insert the toner cartridge by aligning the side rails of the cartridge with the arrows on the side rails inside the printer, and then insert the cartridge into the printer.

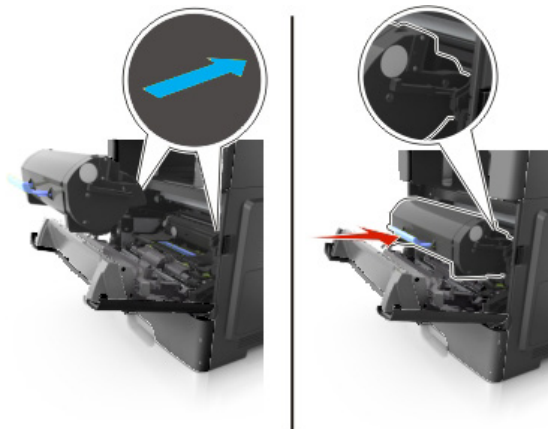

9. Close the front door.

[x]-page jam, open rear door. [20y.xx]

1. Open the front door to loosen the jammed paper in the rear door.

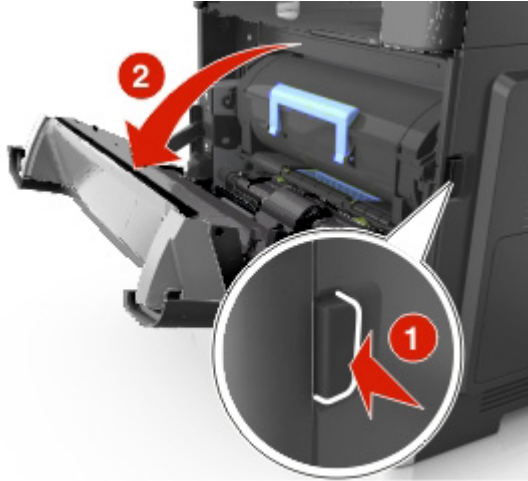

2. Gently pull down the rear door.

 **CAUTION—HOT SURFACE:** The inside of the printer might be hot. To reduce the risk of injury from a hot component, allow the surface to cool before touching it.

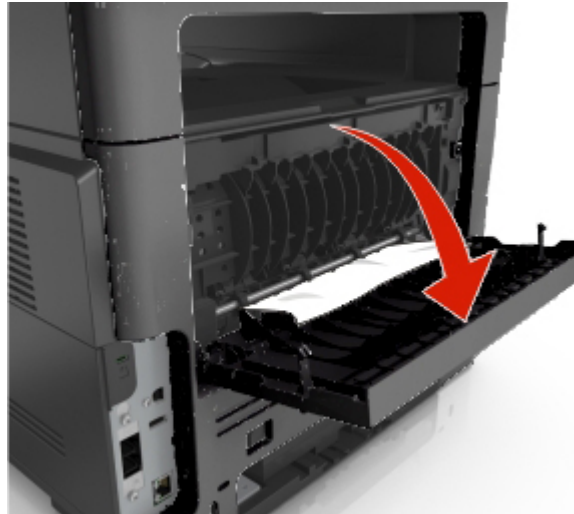

3. Firmly grasp the jammed paper on each side, and then gently pull it out.

Note: Make sure all paper fragments are removed.



4. Close the rear door, and then the front door.

[x]-page jam, clear standard bin. [20y.xx]

1. Firmly grasp the jammed paper on each side, and then gently pull it out.

Note: Make sure all paper fragments are removed.



[x]-page jam, remove tray 1 to clear duplex. [23y.xx]

 **CAUTION—HOT SURFACE:** The inside of the printer might be hot. To reduce the risk of injury from a hot component, allow the surface to cool before touching it.

1. Pull the tray completely out of the printer.



2. Locate the green lever, and then pull it down to release the jam.

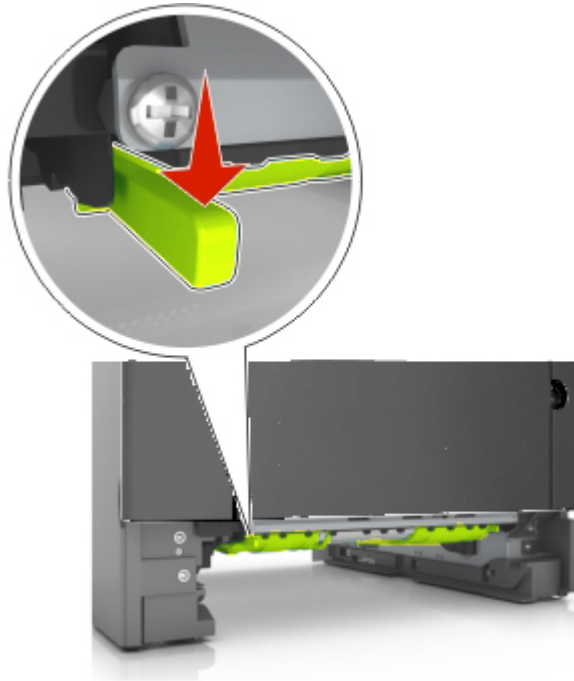

3. Firmly grasp the jammed paper on each side, and then gently pull it out.

Note: Make sure all paper fragments are removed.

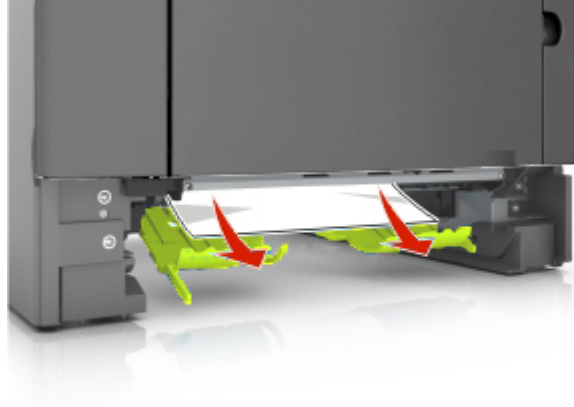

4. Insert the tray.

[x]-page jam, open tray [x]. [24y.xx]

1. Pull the tray completely out of the printer.

Note: The message on the printer display indicates the tray where the jammed paper is located.



2. Firmly grasp the jammed paper on each side, and then gently pull it out.

Note: Make sure all paper fragments are removed.

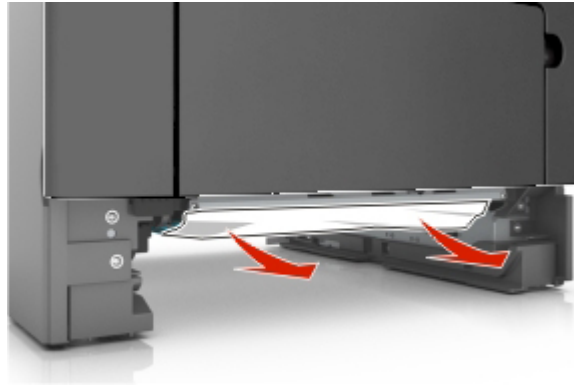

3. Insert the tray.

[x]-page jam, clear manual feeder. [25y.xx]

1. From the multipurpose feeder, firmly grasp the jammed paper on each side, and then gently pull it out.

Note: Make sure all paper fragments are removed.



2. Flex the sheets of paper back and forth to loosen them, and then fan them. Do not fold or crease the paper. Straighten the edges on a level surface.



3. Reload paper into the multipurpose feeder.

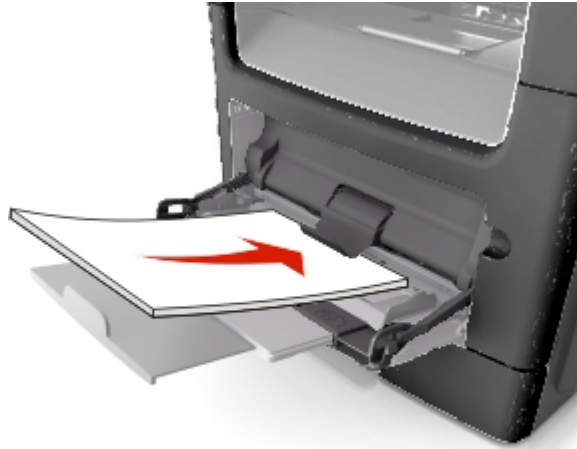

Note: Make sure the paper guide lightly rests against the edge of the paper.

[x]-page jam, open automatic feeder top cover. [28y.xx]

1. Remove all original documents from the ADF tray.

Note: The message is cleared when the pages are removed from the ADF tray.

2. Open the ADF cover.

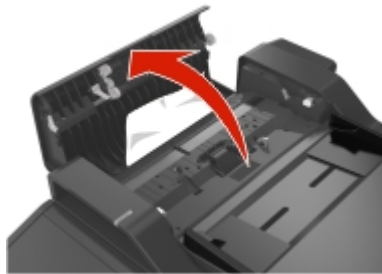

3. Firmly grasp the jammed paper on each side, and then gently pull it out.

Note: Make sure all paper fragments are removed.

4. Close the ADF cover.
5. Straighten the edges of the original documents, then load the original documents into the ADF, and then adjust the paper guide.

19—Troubleshooting

Understanding printer messages

Cartridge low [88.xy]

You may need to order a toner cartridge. If necessary, select **Continue** on the printer control panel to clear the message and continue printing. For non-touch-screen printer models, press **OK** to confirm.

Cartridge nearly low [88.xy]

If necessary, select **Continue** on the printer control panel to clear the message and continue printing. For non-touch-screen printer models, press **OK** to confirm.

Cartridge very low, [x] estimated pages remain [88.xy]

You may need to replace the toner cartridge very soon. For more information, see the “Replacing supplies” section of the *User's Guide*.

If necessary, select **Continue** on the printer control panel to clear the message and continue printing. For non-touch-screen printer models, press **OK** to confirm.

Change [paper source] to [custom string] load [paper orientation]

Try one or more of the following:

- Load the correct size and type of paper in the tray, then verify that the paper size and type settings are specified in the Paper menu on the printer control panel, and then select **Finished changing paper**. For non-touch-screen printer models, press **OK** to confirm.
- Cancel the print job.

Change [paper source] to [custom type name] load [orientation]

Try one or more of the following

- Load the correct paper size and type in the tray, verify the paper size and type settings are specified in the Paper menu on the printer control panel, and then select **Finished changing paper**. For non-touch-screen printer models, press **OK** to confirm.
- Cancel the print job.

Change [paper source] to [paper size] load [orientation]

Try one or more of the following:

- Load the correct paper size and type in the tray, verify the paper size and type settings are specified in the Paper menu on the printer control panel, and then select **Finished changing paper**. For non-touch-screen printer models, press **OK** to confirm.
- Cancel the print job.

Change [paper source] to [paper type] [paper size] load [orientation]

Try one or more of the following:

- Load the correct paper size and type in the tray, verify the paper size and type settings are specified in the Paper menu on the printer control panel, and then select **Finished changing paper**. For non-touch-screen printer models, press **OK** to confirm.
- Cancel the print job.

Close flatbed cover and load originals if restarting job [2yy.xx]

From the printer control panel, try one or more of the following:

- Select **Scan from automatic feeder** to continue scanning from the ADF immediately after the last successful scan job.
- Select **Scan from flatbed** to continue scanning from the scanner glass immediately after the last successful scan job.
- Select **Finish job without further scanning** to end the last successful scan job.

Note: This does not cancel the scan job. All successfully scanned pages will be processed further for copying, faxing, or e-mailing.

- Select **Cancel job** to clear the message and cancel the scan job.
- For non-touch-screen printer models, press **OK** to confirm.

Close door

Make sure the right side cover is installed, and then close the front and top doors to clear the message.

Configuration change, some held jobs were not restored [57]

Held jobs are invalidated because of any of the following possible changes in the printer:

- The printer firmware has been updated.
- The tray for the print job is removed.

- The print job is sent from a flash drive that is no longer attached to the USB port.
- The printer hard disk contains print jobs that were stored when the hard disk was installed in a different printer model.

From the printer control panel, select **Continue** to clear the message. For non-touch-screen printer models, press **OK** to confirm.

Complex page, some data may not have printed [39]

Try one or more of the following:

- From the printer control panel, select **Continue** to ignore the message and continue printing. For non-touch-screen printer models, press **OK** to confirm.
- Cancel the current print job. For non-touch-screen printer models, press **OK** to confirm.
- Install additional printer memory.

Defective flash detected [51]

Try one or more of the following:

- Replace the defective flash memory card.
- From the printer control panel, select **Continue** to ignore the message and continue printing. For non-touch-screen printer models, press **OK** to confirm.
- Cancel the current print job.

Disk must be formatted for use in this device

From the printer control panel, select **Format disk** to format the printer hard disk and clear the message. For non-touch-screen printer models, press **OK** to confirm.

Note: Formatting deletes all the files stored in the printer hard disk.

Error reading USB drive. Remove USB.

An unsupported USB device is inserted. Remove the USB device, and then insert a supported one.

Error reading USB hub. Remove hub.

An unsupported USB hub has been inserted. Remove the USB hub, and then install a supported one.

Fax partition inoperative. Contact system administrator.

Try either of the following:

- From the printer control panel, select **Continue** to clear the message. For non-touch-screen printer models, press **OK** to confirm.
- Turn the printer off, and then turn it back on. If the message appears again, then contact your system support person or see the “Setting up the printer to fax” section of the *User's Guide*.

Fax server 'To Format' not set up. Contact system administrator.

Try either of the following:

- From the printer control panel, select **Continue** to clear the message. For non-touch-screen printer models, press **OK** to confirm.
- Complete the Fax Server setup. If the message appears again, then contact your system support person.

Fax Station Name not set up. Contact system administrator.

Try either of the following:

- From the printer control panel, select **Continue** to clear the message. For non-touch-screen printer models, press **OK** to confirm.
- Complete the Analog Fax Setup. If the message appears again after completing the setup, then contact your system support person.

Fax Station Number not set up. Contact system administrator.

Try either of the following:

- From the printer control panel, select **Continue** to clear the message. For non-touch-screen printer models, press **OK** to confirm.
- Complete the Analog Fax Setup. If the message appears again after completing the setup, then contact your system support person.

Imaging unit low [84.xy]

You may need to order an imaging unit. If necessary, select **Continue** on the printer control panel to clear the message and continue printing. For non-touch-screen printer models, press **OK** to confirm.

Imaging unit nearly low [84.xy]

If necessary, select **Continue** on the printer control panel to clear the message and continue printing. For non-touch-screen printer models, press **OK** to confirm.

Imaging unit very low, [x] estimated pages remain [84.xy]

You may need to replace the imaging unit very soon. For more information, see the "Replacing supplies" section of the *User's Guide*.

If necessary, select **Continue** on the printer control panel to clear the message and continue printing. For non-touch-screen printer models, press **OK** to confirm.

Incorrect paper size, open [paper source] [34]

Try one or more of the following:

- Load the correct size of paper in the tray.
- From the printer control panel, select **Continue** to clear the message and print using a different tray. For non-touch-screen printer models, press **OK** to confirm.
- Check the tray length and width guides and make sure the paper is loaded properly in the tray.
- Make sure the correct paper size and type are specified in the Printing Preferences or in the Print dialog.
- Make sure the paper size and type are specified in the Paper menu on the printer control panel.
- Make sure that the paper size is correctly set. For example, if MP Feeder Size is set to Universal, then make sure the paper is large enough for the data being printed.
- Cancel the print job.

Insufficient memory, some Held Jobs were deleted [37]

The printer deleted some held jobs in order to process current jobs.

Select **Continue** to clear the message. For non-touch-screen printer models, press **OK** to confirm.

Insufficient memory, some held jobs will not be restored [37]

Try one or more of the following:

- From the printer control panel, select **Continue** to clear the message. For non-touch-screen printer models, press **OK** to confirm.
- Delete other held jobs to free up additional printer memory.

Insufficient memory for Flash Memory Defragment operation [37]

Try one or more of the following:

- From the printer control panel, select **Continue** to stop the defragmentation and continue printing. For non-touch-screen printer models, press **OK** to confirm.
- Delete fonts, macros, and other data from the printer memory.
- Install additional printer memory.

Insufficient memory to collate job [37]

Try one or more of the following:

- From the printer control panel, select **Continue** to print the part of the job already stored and begin collating the rest of the print job. For non-touch-screen printer models, press **OK** to confirm.
- Cancel the current print job.

Insufficient memory to support Resource Save feature [35]

Install additional printer memory or select **Continue** on the printer control panel to disable Resource Save, clear the message, and continue printing. For non-touch-screen printer models, press **OK** to confirm.

Load manual feeder with [custom string] [paper orientation]

Try one or more of the following:

- Load the feeder with the correct size and type of paper.
- Depending on your printer model, touch **Continue** or press **OK** to clear the message and continue printing.

Note: If no paper is loaded in the feeder when **Continue** or **OK** is selected, then the printer automatically overrides the request, and then prints from an automatically selected tray.

- Cancel the current job.

Load manual feeder with [custom type name] [paper orientation]

Try one or more of the following:

- Load the multipurpose feeder with the correct size and type of paper.

- Depending on your printer model, touch **Continue** or press  to clear the message and continue printing.

Note: If no paper is loaded in the feeder when **Continue** or  is selected, then the printer manually overrides the request, and then prints from an automatically selected tray.

- Cancel the current job.

Load manual feeder with [paper size] [paper orientation]

Try one or more of the following:

- Load the multipurpose feeder with the correct size of paper.
- Depending on your printer model, touch **Continue** or press  to clear the message and continue printing.

Note: If no paper is loaded in the feeder when **Continue** or  is selected, then the printer manually overrides the request, and then prints from an automatically selected tray.

- Cancel the current job.

Load manual feeder with [paper type] [paper size] [paper orientation]

Try one or more of the following:

- Load the multipurpose feeder with the correct size and type of paper.
- Depending on your printer model, touch **Continue** or press  to clear the message and continue printing.

Note: If no paper is loaded in the feeder when **Continue** or  is selected, then the printer manually overrides the request, and then prints from an automatically selected tray.

- Cancel the current job.

Load [paper source] with [custom string] [paper orientation]

Try one or more of the following:

- Load the tray or feeder with the correct size and type of paper.
- To use the tray that has the correct size or type of paper, select **Finished loading paper** on the printer control panel. For non-touch-screen printer models, press  to confirm.

Note: If the printer finds a tray that has the correct size and type of paper, then it feeds from that tray. If the printer cannot find a tray that has the correct size and type of paper, then it prints from the default paper source.

- Cancel the current job.

Load [paper source] with [custom type name] [paper orientation]

Try one or more of the following:

- Load the tray or feeder with the correct size and type of paper.
- To use the tray that has the correct size or type of paper, select **Finished loading paper** on the printer control panel. For non-touch-screen printer models, press **OK** to confirm.

Note: If the printer finds a tray that has the correct size and type of paper, then it feeds from that tray. If the printer cannot find a tray that has the correct size and type of paper, then it prints from the default paper source.

- Cancel the current job.

Load [paper source] with [paper size] [paper orientation]

Try one or more of the following:

- Load the tray or feeder with the correct size of paper.
- To use the tray or feeder that has the correct size of paper, select **Finished loading paper** on the printer control panel. For non-touch-screen printer models, press **OK** to confirm.

Note: If the printer finds a tray that has the correct size and type of paper, then it feeds from that tray. If the printer cannot find a tray that has the correct size and type of paper, then it prints from the default paper source.

- Cancel the current job.

Load [paper source] with [paper type] [paper size] [paper orientation]

Try one or more of the following:

- Load the tray or feeder with the correct size and type of paper.
- To use the tray or feeder that has the correct size and type of paper, select **Finished loading paper** on the printer control panel. For non-touch-screen printer models, press **OK** to confirm.

Note: If the printer finds a tray that has the correct size and type of paper, then it feeds from that tray. If the printer cannot find a tray that has the correct size and type of paper, then it prints from the default paper source.

- Cancel the current job.

Maintenance kit low [80.xy]

You may need to order a maintenance kit. For more information, contact technical support. If necessary, select **Continue** to clear the message and continue printing. For non-touch-screen printer models, press **OK** to confirm.

Maintenance kit nearly low [80.xy]

For more information, contact technical support. If necessary, select **Continue** to clear the message and continue printing. For non-touch-screen printer models, press **OK** to confirm.

Maintenance kit very low, [x] estimated pages remain [80.xy]

You may need to replace the maintenance kit very soon. For more information, contact technical support. If necessary, select **Continue** on the printer control panel to clear the message and continue printing. For non-touch-screen printer models, press **OK** to confirm.

Memory full [38]

Try one or more of the following:

- From the printer control panel, select **Cancel job** to clear the message. For non-touch-screen printer models, press **OK** to confirm.
- Install additional printer memory.

Memory full, cannot print faxes

From the printer control panel, select **Continue** to clear the message without printing. For non-touch-screen printer models, press **OK** to confirm.

Note: Held faxes will attempt to print after the printer restarts.

Memory full, cannot send faxes

1. From the printer control panel, select **Continue** to clear the message and cancel the fax job. For non-touch-screen printer models, press **OK** to confirm.
2. Do either of the following:
 - Reduce the fax resolution, and then resend the fax job.
 - Reduce the number of pages in the fax, and then resend fax job.

Network [x] software error [54]

Try one or more of the following:

- From the printer control panel, select **Continue** to continue printing. For non-touch-screen printer models, press  to confirm.
- Turn off the printer, wait for about 10 seconds, and then turn the printer back on.
- Update the network firmware in the printer or print server. For more information, contact technical support.

No analog phone line connected to modem, fax is disabled.

Connect the printer to an analog phone line.

Non-Printer Manufacturer [supply type], see User's Guide [33.xy]

Note: The supply type can be toner cartridge or imaging unit.



The printer has detected a Non-Printer Manufacturer supply or part installed in the printer.

Your KONICA MINOLTA printer is designed to function best with genuine Printer Manufacturer supplies and parts. Use of third-party supplies or parts may affect the performance, reliability, or life of the printer and its imaging components.

All life indicators are designed to function with Printer Manufacturer supplies and parts and may deliver unpredictable results if third-party supplies or parts are used. Imaging component usage beyond the intended life may damage your KONICA MINOLTA printer or associated components.

Warning—Potential Damage: Use of third-party supplies or parts can affect warranty coverage. Damage caused by the use of third-party supplies or parts may not be covered by the warranty.

To accept any and all of these risks and to proceed with the use of non-genuine supplies or parts in your printer, press and hold  and the # button on the printer control panel simultaneously for 15 seconds.

For non-touch-screen printer models, press  and  on the printer control panel simultaneously for 15 seconds to clear the message and continue printing.

If you do not wish to accept these risks, then remove the third-party supply or part from your printer, and then install a genuine Printer Manufacturer supply or part.

Note: For a list of supported supplies, see the “Ordering supplies” section of the *User's Guide*.

Not enough free space in flash memory for resources [52]



Try one or more of the following:

- From the printer control panel, select **Continue** to clear the message and continue printing. For non-touch-screen printer models, press  to confirm.
- Delete fonts, macros, and other data stored in the flash memory.

- Upgrade to a larger capacity flash memory card.

Note: Downloaded fonts and macros that are not previously stored in the flash memory are deleted.

Printer had to restart. Last job may be incomplete.

From the printer control panel, touch  to clear the message and continue printing. For non-touch-screen printer models, press  to confirm.

For more information, contact technical support.

Reinstall defective or unresponsive cartridge [31.xy]

Remove and reinstall the toner cartridge. For more information, see the instruction sheet that came with the supply.

Reinstall missing or unresponsive cartridge [31.xy]

Try one or more of the following:

- Check if the toner cartridge is missing. If missing, install the toner cartridge.

For information on installing the cartridge, see the “Replacing supplies” section of the *User's Guide*.

- If the toner cartridge is installed, then remove the unresponsive toner cartridge, and then reinstall it.

Note: If the message appears after reinstalling the supply, then the cartridge is defective. Replace the toner cartridge.

Remove paper from standard output bin

Remove the paper stack from the standard bin. The printer automatically detects paper removal and resumes printing.

If removing the paper does not clear the message, then select **Continue** on the printer control panel. For non-touch-screen printer models, press  to confirm.

Replace all originals if restarting job.

From the printer control panel, try one or more of the following:

- Select **Cancel job** to clear the message and cancel the scan job.
- Select **Scan from automatic feeder** to continue scanning from the ADF immediately after the last successful scan job.
- Select **Scan from flatbed** to continue scanning from the scanner immediately after the last successful scan job.
- Select **Finish job without further scanning** to end the last successful scan job.

- Select **Restart job** to restart the scan job with the same settings from the previous scan job.
- For non-touch-screen printer models, press  to confirm.

Replace cartridge, 0 estimated pages remain [88.xy]

Replace the toner cartridge to clear the message and continue printing. For more information, see the instruction sheet that came with the supply or see the “Replacing supplies” section of the *User’s Guide*.

Note: If you do not have a replacement cartridge, then see the “Ordering supplies” section of the *User’s Guide*.

Replace cartridge, printer region mismatch [42.xy]

Install a toner cartridge that matches the region number of the printer. x indicates the value of the printer region. y indicates the value of the cartridge region. x and y can have the following values:

List of printer and toner cartridge regions

Region number	Region
0	Global
1	United States, Canada
2	European Economic Area (EEA), Switzerland
3	Asia Pacific, Australia, New Zealand
4	Latin America
5	Africa, Middle East, rest of Europe
9	Invalid

Notes:

- The x and y values are the .xy of the error code shown on the printer control panel.
- The x and y values must match for printing to continue.

Replace defective imaging unit [31.xy]

Replace the defective imaging unit to clear the message. For more information, see the instruction sheet that came with the supply.

Note: If you do not have a replacement imaging unit, then see the “Ordering supplies” section of the *User’s Guide*.

Replace jammed originals if restarting job.

From the printer control panel, try one or more of the following:

- Select **Cancel job** to clear the message and cancel the scan job. For non-touch-screen printer models, press **OK** to confirm.
- Select **Scan from automatic feeder** to continue scanning from the ADF immediately after the last successful scan job. For non-touch-screen printer models, press **OK** to confirm.
- Select **Scan from flatbed** to continue scanning from the scanner immediately after the last successful scan job. For non-touch-screen printer models, press **OK** to confirm.
- Select **Finish job without further scanning** to end the last successful scan job. For non-touch-screen printer models, press **OK** to confirm.
- Select **Restart job** to restart the scan job with the same settings from the previous scan job. For non-touch-screen printer models, press **OK** to confirm.

Replace imaging unit, 0 estimated pages remain [84.xy]

Replace the imaging unit to clear the message and continue printing. For more information, see the instruction sheet that came with the supply or see the “Replacing supplies” section of the *User's Guide*.

Note: If you do not have a replacement imaging unit, then see the “Ordering supplies” section of the *User's Guide*.

Replace maintenance kit, 0 estimated pages remain [80.xy]

Contact technical support or your service representative, and then report the message. The printer is scheduled for maintenance.

Reinstall missing or unresponsive imaging unit [31.xy]

Try one or more of the following:

- Check if the imaging unit is missing. If missing, install the imaging unit.

For information on installing the imaging unit, see the “Replacing supplies” section of the *User's Guide*.

- If the imaging unit is installed, then remove the unresponsive imaging unit, and then reinstall it.

Note: If the message appears after reinstalling the supply, then the imaging unit is defective. Replace the imaging unit.

Replace unsupported cartridge [32.xy]

Remove the toner cartridge, and then install a supported one to clear the message and continue printing. For more information, see the instruction sheet that came with the supply or see the “Replacing supplies” section of the *User's Guide*.

Note: If you do not have a replacement cartridge, then see the “Ordering supplies” section of the *User's Guide*.

Replace unsupported imaging unit [32.xy]

Remove the imaging unit, and then install a supported one to clear the message and continue printing. For more information, see the instruction sheet that came with the supply or see the “Replacing supplies” section of the *User's Guide*.

Note: If you do not have a replacement imaging unit, then see the “Ordering supplies” section of the *User's Guide*.

Restore held jobs?

Try one or more of the following:

- From the printer control panel, select **Restore** to restore all held jobs stored in the printer hard disk.
For non-touch-screen printer models, press **OK** to confirm.
- From the printer control panel, select **Do not restore** if you do not want any print jobs to be restored.
For non-touch-screen printer models, press **OK** to confirm.

Scanner automatic feeder cover open

Close the ADF cover.

Scanner disabled by admin [840.01]

Print without the scanner, or contact your system support person.

Scanner disabled. Contact system administrator if problem persists. [840.02]

From the printer control panel, try one or more of the following:

- Select **Continue with scanner disabled** to return to the home screen, and then contact your system support person.
- Select **Reboot and automatically enable scanner** to cancel the job.
Note: This attempts to enable the scanner.
- For non-touch-screen printer models, press **OK** to confirm.

Scanner jam, remove all originals from the scanner [2yy.xx]

Remove the jammed paper from the scanner.

Scanner jam, remove jammed originals from the scanner [2yy.xx]

Remove the jammed paper from the scanner.

Serial option [x] error [54]

Try one or more of the following:

- Make sure that the serial cable is properly connected and is the correct one for the serial port.
- Make sure that the serial interface parameters (protocol, baud, parity, and data bits) are set correctly on the printer and computer.
- From the printer control panel, select **Continue** to continue printing. For non-touch-screen printer models, press **OK** to confirm.
- Turn off the printer, and then turn it back on.

SMTP server not set up. Contact system administrator.

From the printer control panel, select **Continue** to clear the message. For non-touch-screen printer models, press **OK** to confirm.

Note: If the message appears again, then contact your system support person.

Some held jobs were not restored

From the printer control panel, select **Continue** to delete the specified job. For non-touch-screen printer models, press **OK** to confirm.

Note: Held jobs that are not restored stay in the printer hard disk and are inaccessible.

Standard network software error [54]

Try one or more of the following:

- From the printer control panel, select **Continue** to continue printing. For non-touch-screen printer models, press **OK** to confirm.
- Turn off the printer and then turn it back on.
- Update the network firmware in the printer or print server. For more information, contact technical support.

Standard USB port disabled [56]

From the printer control panel, select **Continue** to clear the message. For non-touch-screen printer models, press **OK** to confirm.

Notes:

- The printer discards any data received through the USB port.
- Make sure the USB Buffer menu is not set to Disabled.

Supply needed to complete job

Do either of the following:

- Install the missing supply to complete the job.
- Cancel the current job.

Too many flash options installed [58]

1. Turn off the printer.
2. Unplug the power cord from the electrical outlet.
3. Remove the extra flash memory.
4. Connect the power cord to a properly grounded electrical outlet.
5. Turn the printer back on.

Too many trays attached [58]

1. Turn off the printer.
2. Unplug the power cord from the electrical outlet.
3. Remove the extra trays.
4. Connect the power cord to a properly grounded electrical outlet.
5. Turn the printer back on.

Unformatted flash detected [53]

Try one or more of the following:

- From the printer control, select **Continue** to stop the defragmentation and continue printing. For non-touch-screen printer models, press **OK** to confirm.
- Format the flash memory.

Note: If the error message remains, then the flash memory may be defective and need to be replaced.

Weblink server not set up. Contact system administrator.

Select **Continue** to clear the message. For non-touch-screen printer models, press  to confirm.

Note: If the message appears again, then contact your system support person.

Solving printer problems

[Basic printer problems](#)

[Hardware and internal option problems](#)

[Paper feed problems](#)

Basic printer problems

The printer is not responding

Action	Yes	No
<p>Step 1</p> <p>Make sure the printer is turned on.</p> <p>Is the printer turned on?</p>	<p>Go to step 2.</p>	<p>Turn on the printer.</p>
<p>Step 2</p> <p>Check if the printer is in Sleep mode or Hibernate mode.</p> <p>Is the printer in Sleep mode or Hibernate mode?</p>	<p>Press the Sleep button to wake the printer from Sleep mode or Hibernate mode.</p>	<p>Go to step 3.</p>
<p>Step 3</p> <p>Check if one end of the power cord is plugged into the printer and the other to a properly grounded electrical outlet.</p> <p>Is the power cord plugged into the printer and a properly grounded electrical outlet?</p>	<p>Go to step 4.</p>	<p>Plug one end of the power cord into the printer and the other to a properly grounded electrical outlet.</p>

User's Guide

Action	Yes	No
<p>Step 4</p> <p>Check other electrical equipment plugged into the electrical outlet.</p> <p>Does other electrical equipment work?</p>	<p>Unplug the other electrical equipment, and then turn on the printer. If the printer does not work, then reconnect the other electrical equipment.</p>	<p>Go to step 5.</p>
<p>Step 5</p> <p>Check if the cables connecting the printer and the computer are inserted in the correct ports.</p> <p>Are the cables inserted in the correct ports?</p>	<p>Go to step 6.</p>	<p>Make sure to match the following:</p> <ul style="list-style-type: none"> • The USB symbol on the cable with the USB symbol on the printer • The appropriate Ethernet cable with the Ethernet port
<p>Step 6</p> <p>Make sure the electrical outlet is not turned off by a switch or breaker.</p> <p>Is the electrical outlet turned off by a switch or breaker?</p>	<p>Turn on the switch or reset the breaker.</p>	<p>Go to step 7.</p>
<p>Step 7</p> <p>Check if the printer is plugged into any surge protectors, uninterruptible power supplies, or extension cords.</p> <p>Is the printer plugged into any surge protectors, uninterruptible power supplies, or extension cords?</p>	<p>Connect the printer power cord directly to a properly grounded electrical outlet.</p>	<p>Go to step 8.</p>
<p>Step 8</p> <p>Check if one end of the printer cable is plugged into a port on the printer and the other to the computer, print server, option, or other network device.</p> <p>Is the printer cable securely attached to the printer and the computer, print server, option, or other network device?</p>	<p>Go to step 9.</p>	<p>Connect the printer cable securely to the printer and the computer, print server, option, or other network device.</p>

User's Guide

Action	Yes	No
<p>Step 9</p> <p>Make sure to install all hardware options properly and remove any packing material.</p> <p>Are all hardware options properly installed and all packing material removed?</p>	Go to step 10.	Turn off the printer, remove all packing materials, then reinstall the hardware options, and then turn on the printer.
<p>Step 10</p> <p>Check if you have selected the correct port settings in the printer driver.</p> <p>Are the port settings correct?</p>	Go to step 11.	Use correct printer driver settings.
<p>Step 11</p> <p>Check the installed printer driver.</p> <p>Is the correct printer driver installed?</p>	Go to step 12.	Install the correct printer driver.
<p>Step 12</p> <p>Turn off the printer, then wait for about 10 seconds, and then turn the printer back on.</p> <p>Is the printer working?</p>	The problem is solved.	Contact technical support .

Printer display is blank

Action	Yes	No
<p>Step 1</p> <p>Press the Sleep button on the printer control panel.</p> <p>Does Ready appear on the printer display?</p>	The problem is solved.	Go to step 2.

Action	Yes	No
<p>Step 2</p> <p>Turn off the printer, then wait for about 10 seconds, and then turn the printer back on.</p> <p>Do Please wait and Ready appear on the printer display?</p>	<p>The problem is solved.</p>	<p>Turn off the printer, and then contact technical support.</p>

Hardware and internal option problems

Cannot detect internal option

Action	Yes	No
<p>Step 1</p> <p>Turn off the printer, then wait for about 10 seconds, and then turn on the printer.</p> <p>Does the internal option operate correctly?</p>	<p>The problem is solved.</p>	<p>Go to step 2.</p>
<p>Step 2</p> <p>Check if the internal option is properly installed in the controller board.</p> <ol style="list-style-type: none"> 1. Turn off the printer using the power switch, and then unplug the power cord from the electrical outlet. 2. Make sure the internal option is installed in the appropriate connector in the controller board. 3. Connect the power cord to the printer, then to a properly grounded electrical outlet, and then turn on the printer. <p>Is the internal option properly installed in the controller board?</p>	<p>Go to step 3.</p>	<p>Connect the internal option to the controller board.</p>
<p>Step 3</p> <p>Print a menu settings page, and then check to see if the internal option is listed in the Installed Features list.</p> <p>Is the internal option listed in the menu settings page?</p>	<p>Go to step 4.</p>	<p>Reinstall the internal option.</p>

Action	Yes	No
<p>Step 4</p> <p>1. Check if the internal option is selected.</p> <p>It may be necessary to manually add the internal option in the printer driver to make it available for print jobs. For more information, see Updating available options in the printer driver.</p> <p>2. Resend the print job.</p> <p>Does the internal option operate correctly?</p>	<p>The problem is solved.</p>	<p>Contact technical support.</p>

Internal Solutions Port does not operate correctly

Action	Yes	No
<p>Step 1</p> <p>Make sure the Internal Solutions Port (ISP) is installed.</p> <p>1. Install the ISP. For more information, see Installing an Internal Solutions Port.</p> <p>2. Print a menu settings page, and then check if the ISP is listed in the Installed Options list.</p> <p>Is the ISP listed in the Installed Options list?</p>	<p>Go to step 2.</p>	<p>Check if you have a supported ISP.</p> <p>Note: An ISP from another printer may not work on this printer.</p>
<p>Step 2</p> <p>Check the cable and the ISP connection.</p> <p>1. Use the correct cable, and then make sure it is securely connected to the ISP.</p> <p>2. Check if the ISP solution interface cable is securely connected into the receptacle of the controller board.</p> <p>Note: The ISP solution interface cable and the receptacle on the controller board are color-coded.</p> <p>Does the Internal Solutions Port operate correctly?</p>	<p>The problem is solved.</p>	<p>Contact technical support.</p>

Tray problems

Action	Yes	No
<p>Step 1</p> <p>1. Pull out the tray, and then do one or more of the following:</p> <ul style="list-style-type: none"> - Check for paper jams or misfeeds. - Check if the paper size indicators on the paper guides are aligned with the paper size indicators on the tray. - If you are printing on custom-size paper, then make sure that the paper guides rest against the edges of the paper. - Make sure the paper is below the maximum paper fill indicator. - Make sure paper lies flat in the tray. <p>2. Check if the tray closes properly.</p> <p>Is the tray working?</p>	<p>The problem is solved.</p>	<p>Go to step 2.</p>
<p>Step 2</p> <p>1. Turn off the printer, then wait about 10 seconds, and then turn the printer back on.</p> <p>2. Resend the print job.</p> <p>Is the tray working?</p>	<p>The problem is solved.</p>	<p>Go to step 3.</p>

Action	Yes	No
<p>Step 3</p> <p>Check if the tray is installed and recognized by the printer.</p> <p>Print a menu settings page, and then check if the tray is listed in the Installed Features list.</p> <p>Is the tray listed in the menu settings page?</p>	<p>Go to step 4.</p>	<p>Reinstall the tray. For more information, see the setup documentation that came with the tray.</p>
<p>Step 4</p> <p>Check if the tray is available in the printer driver.</p> <p>Note: If necessary, manually add the tray in the printer driver to make it available for print jobs. For more information, see Updating available options in the printer driver.</p> <p>Is the tray available in the printer driver?</p>	<p>The problem is solved.</p>	<p>Contact technical support.</p>

USB/parallel interface card does not operate correctly

Action	Yes	No
<p>Step 1</p> <p>Make sure the USB or parallel interface card is installed.</p> <ol style="list-style-type: none"> 1. Install the USB or parallel interface card. For more information, see Installing an Internal Solutions Port. 2. Print a menu settings page, and then check if the USB or parallel interface card is listed in the Installed Options list. <p>Is the USB or parallel interface card listed in the Installed Options list?</p>	<p>Go to step 2.</p>	<p>Check if you have a supported USB or parallel interface card.</p> <p>Note: A USB or parallel interface card from another printer may not work on this printer.</p>

Action	Yes	No
<p>Step 2</p> <p>Check if you are using the correct cable and if it is connected securely to the USB or parallel interface card.</p> <p>Is the correct cable securely connected to the USB or parallel interface card?</p>	<p>Contact technical support.</p>	<p>Connect the cable to the USB or parallel interface card connector.</p>

Paper feed problems

Paper frequently jams

Action	Yes	No
<p>Step 1</p> <ol style="list-style-type: none"> Pull out the tray, and then do one or more of the following: <ul style="list-style-type: none"> Make sure paper lies flat in the tray. Check if the paper size indicators on the paper guides are aligned with the paper size indicators on the tray. Check if the paper guides are aligned against the edges of the paper. Make sure the paper is below the maximum paper fill indicator. Check if you are printing on a recommended paper size and type. Insert the tray properly. <p>If jam recovery is enabled, then the print jobs will reprint automatically.</p> <p>Do paper jams still occur frequently?</p>	<p>Go to step 2.</p>	<p>The problem is solved.</p>
<p>Step 2</p> <ol style="list-style-type: none"> Load paper from a fresh package. <p>Note: Paper absorbs moisture due to high humidity. Store paper in its original wrapper until you use it.</p> Resend the print job. <p>Do paper jams still occur frequently?</p>	<p>Go to step 3.</p>	<p>The problem is solved.</p>

Action	Yes	No
<p>Step 3</p> <ol style="list-style-type: none"> 1. Review the tips on avoiding jams. For more information, see Avoiding jams. 2. Follow the recommendations, and then resend the print job. <p>Do paper jams still occur frequently?</p>	Contact technical support .	The problem is solved.

Paper jam message remains after jam is cleared

Action	Yes	No
<p>Check the entire paper path for jammed paper.</p> <ol style="list-style-type: none"> 1. Remove any jammed paper. 2. From the printer control panel, touch Continue to clear the message. <p>Does the paper jam message remain?</p>	Contact technical support .	The problem is solved.

Jammed pages are not reprinted

Action	Yes	No
<p>Turn on Jam Recovery.</p> <ol style="list-style-type: none"> 1. From the home screen, navigate to: <ul style="list-style-type: none">  >Settings >General Settings >Print Recovery 2. From the Jam Recovery menu, touch the arrows to scroll to On or Auto. 3. Touch Submit. <p>Do pages reprint after a jam?</p>	The problem is solved.	Contact technical support .

Solving print problems

Printing problems

Multiple-language PDF files do not print

Action	Yes	No
<p>Step 1</p> <ol style="list-style-type: none"> 1. Check if the print options for the PDF output are set to embed all fonts. <p>For more information, see the documentation that came with Adobe Acrobat.</p> <ol style="list-style-type: none"> 2. Generate a new PDF file, and then resend the print job. <p>Do the files print?</p>	<p>The problem is solved.</p>	<p>Go to step 2.</p>
<p>Step 2</p> <ol style="list-style-type: none"> 1. Open the document you want to print in Adobe Acrobat. 2. Click File >Print >Advanced >Print As Image >OK >OK. <p>Do the files print?</p>	<p>The problem is solved.</p>	<p>Contact technical support.</p>

Error message about reading the flash drive appears

Action	Yes	No
<p>Step 1</p> <p>Check if the flash drive is inserted into the front USB port.</p> <p>Note: The flash drive will not work if it is inserted into the rear USB port.</p> <p>Is the flash drive inserted into the front USB port?</p>	<p>Go to step 2.</p>	<p>Insert the flash drive into the front USB port.</p>

User's Guide

Action	Yes	No
<p>Step 2</p> <p>Check if the indicator light on the printer control panel is blinking green.</p> <p>Note: A green blinking light indicates that the printer is busy.</p> <p>Is the indicator light blinking green?</p>	<p>Wait until the printer is ready, then view the held jobs list, and then print the documents.</p>	<p>Go to step 3.</p>
<p>Step 3</p> <ol style="list-style-type: none"> 1. Check for an error message on the display. 2. Clear the message. <p>Does the error message still appear?</p>	<p>Go to step 4.</p>	<p>The problem is solved.</p>
<p>Step 4</p> <p>Check if the flash drive is supported.</p> <p>For more information on tested and approved USB flash drives, see Supported flash drives and file types.</p> <p>Does the error message still appear?</p>	<p>Go to step 5.</p>	<p>The problem is solved.</p>
<p>Step 5</p> <p>Check if the USB port is disabled by the system support person.</p> <p>Does the error message still appear?</p>	<p>Contact technical support.</p>	<p>The problem is solved.</p>

Print jobs do not print

Action	Yes	No
<p>Step 1</p> <ol style="list-style-type: none"> 1. From the document you are trying to print, open the Print dialog and check if you have selected the correct printer. <p>Note: If the printer is not the default printer, then you must select the printer for each document that you want to print.</p> <ol style="list-style-type: none"> 2. Resend the print job. <p>Do the jobs print?</p>	The problem is solved.	Go to step 2.
<p>Step 2</p> <ol style="list-style-type: none"> 1. Check if the printer is plugged in and turned on, and if Ready appears on the printer display. 2. Resend the print job. <p>Do the jobs print?</p>	The problem is solved.	Go to step 3.
<p>Step 3</p> <p>If an error message appears on the printer display, then clear the message.</p> <p>Note: The printer continues to print after clearing the message.</p> <p>Do the jobs print?</p>	The problem is solved.	Go to step 4.
<p>Step 4</p> <ol style="list-style-type: none"> 1. Check if the ports (USB, serial, or Ethernet) are working and if the cables are securely connected to the computer and the printer. <p>Note: For more information, see the setup documentation that came with the printer.</p> <ol style="list-style-type: none"> 2. Resend the print job. <p>Do the jobs print?</p>	The problem is solved.	Go to step 5.

User's Guide

Action	Yes	No
<p>Step 5</p> <ol style="list-style-type: none"> 1. Turn off the printer, then wait for about 10 seconds, and then turn the printer back on. 2. Resend the print job. <p>Do the jobs print?</p>	The problem is solved.	Go to step 6.
<p>Step 6</p> <ol style="list-style-type: none"> 1. Remove, and then reinstall the printer software. For more information, see Installing the printer driver. 2. Resend the print job. <p>Do the jobs print?</p>	The problem is solved.	Contact technical support .

Confidential and other held jobs do not print

Note: Confidential, Verify, Reserve, and Repeat print jobs may be deleted if the printer requires extra memory to process additional held jobs.

Action	Yes	No
<p>Step 1</p> <p>Open the held jobs folder on the printer display, and then verify that your print job is listed.</p> <p>Is your print job listed in the held jobs folder?</p>	Go to step 2.	Select one of the Print and Hold options, and then resend the print job. For more information, see Printing confidential and other held jobs .

User's Guide

Action	Yes	No
<p>Step 2</p> <p>The print job may contain a formatting error or invalid data.</p> <ul style="list-style-type: none"> • Delete the print job, and then send it again. • For PDF files, generate a new PDF, and then print it again. <p>Does the job print?</p>	<p>The problem is solved.</p>	<p>Go to step 3.</p>
<p>Step 3</p> <p>Free up additional printer memory by deleting some of the held jobs.</p> <p>Does the job print?</p>	<p>The problem is solved.</p>	<p>Add additional printer memory.</p>

Print job takes longer than expected

Action	Yes	No
<p>Step 1</p> <p>Change the environmental settings of the printer.</p> <ol style="list-style-type: none"> 1. From the printer control panel, navigate to: <ul style="list-style-type: none"> Settings >General Settings 2. Select Eco-Mode or Quiet Mode, and then select Off. <p>Note: Disabling Eco-Mode or Quiet Mode may increase the consumption of energy or supplies, or both.</p> <p>Did the job print?</p>	<p>The problem is solved.</p>	<p>Go to step 2.</p>
<p>Step 2</p> <p>Reduce the number and size of fonts, the number and complexity of images, and the number of pages in the print job, and then resend the job</p> <p>Did the job print?</p>	<p>The problem is solved.</p>	<p>Go to step 3.</p>

Action	Yes	No
<p>Step 3</p> <ol style="list-style-type: none"> 1. Remove held jobs stored in the printer memory. 2. Resend the print job. <p>Did the job print?</p>	<p>The problem is solved.</p>	<p>Go to step 4.</p>
<p>Step 4</p> <ol style="list-style-type: none"> 1. Disable the Page Protect feature. From the printer control panel, navigate to: Settings >General Settings >Print Recovery >Page Protect >Off 2. Resend the print job. <p>Did the job print?</p>	<p>The problem is solved.</p>	<p>Go to step 5.</p>
<p>Step 5</p> <ol style="list-style-type: none"> 1. Check if the cable connections to the printer and print server are secure. For more information, see the setup documentation that came with the printer. 2. Resend the print job. <p>Did the job print?</p>	<p>The problem is solved.</p>	<p>Go to step 6.</p>
<p>Step 6</p> <p>Install additional printer memory, and then resend the print job.</p> <p>Did the job print?</p>	<p>The problem is solved.</p>	<p>Contact technical support.</p>

Printing slows down

Notes:

- When printing using narrow paper, the printer prints at a reduced speed to prevent damage to the fuser.
- The printer speed may be reduced when printing for long periods of time, or printing at elevated temperatures.

User's Guide

Action	Yes	No
<p>Step 1</p> <ol style="list-style-type: none"> 1. Make sure the size of the paper loaded in the tray matches the fuser type. <p>Note: Use a 110-volt fuser for printing on letter-size paper and a 220-volt fuser for printing on A4-size paper.</p> <ol style="list-style-type: none"> 2. Resend the print job. <p>Does the print speed increase?</p>	The problem is solved.	Go to step 2.
<p>Step 2</p> <ol style="list-style-type: none"> 1. Replace the fuser. For more information on installing the fuser, see the instruction sheet that came with the part. 2. Resend the print job. <p>Does the print speed increase?</p>	The problem is solved.	Contact technical support .

Job prints from the wrong tray or on the wrong paper

Action	Yes	No
<p>Step 1</p> <ol style="list-style-type: none"> 1. Check if you are printing on paper that is supported by the tray. 2. Resend the print job. <p>Did the job print from the correct tray or on the correct paper?</p>	The problem is solved.	Go to step 2.
<p>Step 2</p> <ol style="list-style-type: none"> 1. From the Paper menu on the printer control panel, set the paper size and type to match the paper loaded in the tray. 2. Resend the print job. <p>Did the job print from the correct tray or on the correct paper?</p>	The problem is solved.	Go to step 3.

Action	Yes	No
<p>Step 3</p> <ol style="list-style-type: none"> 1. Depending on your operating system, open Printing Preferences or the Print dialog, and then specify the paper type. 2. Resend the print job. <p>Did the job print from the correct tray or on the correct paper?</p>	The problem is solved.	Go to step 4.
<p>Step 4</p> <ol style="list-style-type: none"> 1. Check if the trays are not linked. 2. Resend the print job. <p>Did the job print from the correct tray or on the correct paper?</p>	The problem is solved.	Contact technical support .

Incorrect characters print

Action	Yes	No
<p>Step 1</p> <p>Make sure the printer is not in Hex Trace mode.</p> <p>Note: If Ready Hex appears on the printer display, then turn off the printer, and then turn it back on to deactivate Hex Trace mode.</p> <p>Is the printer in Hex Trace mode?</p>	Deactivate Hex Trace mode.	Go to step 2.
<p>Step 2</p> <ol style="list-style-type: none"> 1. From the printer control panel, select Standard Network or Network [x], and then set SmartSwitch to On. 2. Resend the print job. <p>Do incorrect characters print?</p>	Contact technical support .	The problem is solved.

Tray linking does not work

Notes:

- The trays can detect paper length.
- The multipurpose feeder does not automatically detect the paper size. You must set the size from the Paper Size/Type menu.

Action	Yes	No
<p>Step 1</p> <ol style="list-style-type: none"> 1. Open the trays, and then check if they contain paper of the same size and type. <ul style="list-style-type: none"> - Check if the paper guides are in the correct positions for the size of the paper loaded in each tray. - Check if the paper size indicators on the paper guides are aligned with the paper size indicators on the tray. 2. Resend the print job. <p>Do the trays link correctly?</p>	<p>The problem is solved.</p>	<p>Go to step 2.</p>
<p>Step 2</p> <ol style="list-style-type: none"> 1. From the printer control panel, set the paper size and type in the Paper menu to match the paper loaded in the trays to be linked. <p>Note: The paper size and type must match for trays to be linked.</p> 2. Resend the print job. <p>Do the trays link correctly?</p>	<p>The problem is solved.</p>	<p>Contact technical support.</p>

Large jobs do not collate

Action	Yes	No
<p>Step 1</p> <ol style="list-style-type: none"> From the Finishing menu on the printer control panel, set Collate to "(1,2,3) (1,2,3)." Resend the print job. <p>Did the job print and collate correctly?</p>	<p>The problem is solved.</p>	<p>Go to step 2.</p>
<p>Step 2</p> <ol style="list-style-type: none"> From the printer software, set Collate to "(1,2,3) (1,2,3)." <p>Note: Setting Collate to "(1,1,1) (2,2,2)" in the software overrides the setting in the Finishing menu.</p> <ol style="list-style-type: none"> Resend the print job. <p>Did the job print and collate correctly?</p>	<p>The problem is solved.</p>	<p>Go to step 3.</p>
<p>Step 3</p> <p>Reduce the complexity of the print job by eliminating the number and size of fonts, the number and complexity of images, and the number of pages in the job.</p> <p>Did the job print and collate correctly?</p>	<p>The problem is solved.</p>	<p>Contact technical support.</p>

Unexpected page breaks occur

Action	Yes	No
<p>Increase the printing timeout.</p> <ol style="list-style-type: none"> From the home screen, navigate to:  >Settings >General Settings >Timeouts Increase the Print Timeout setting, and then touch Submit. Resend the print job. <p>Did the file print correctly?</p>	<p>The problem is solved.</p>	<p>Check the original file for manual page breaks.</p>

Print quality problems

Characters have jagged or uneven edges

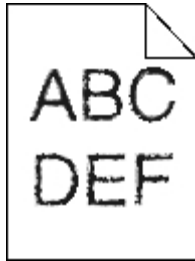

Action	Yes	No
<p>Step 1</p> <ol style="list-style-type: none"> 1. Print a font sample list to check if the fonts you are using are supported by the printer. <ol style="list-style-type: none"> a. From the printer control panel, navigate to: <div style="margin-left: 20px;">  >Reports >Print Fonts </div> b. Touch PCL Fonts or PostScript Fonts. 2. Use a font that is supported by the printer or install the font that you want to use. For more information, contact your system support person. 3. Resend the print job. <p>Do prints still contain characters that have jagged or uneven edges?</p>	<p>Go to step 2.</p>	<p>The problem is solved.</p>
<p>Step 2</p> <ol style="list-style-type: none"> 1. Use a font that is supported by the printer or install the font that you want to use on your computer. For more information, contact your system support person. 2. Resend the print job. <p>Do prints still contain characters that have jagged or uneven edges?</p>	<p>Contact technical support.</p>	<p>The problem is solved.</p>

Printer is printing blank pages

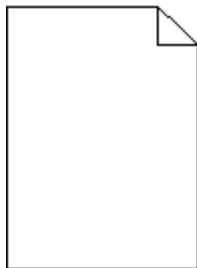

User's Guide

Action	Yes	No
<p>Step 1</p> <ol style="list-style-type: none"> 1. Check if there is packing material left on the imaging unit. <ol style="list-style-type: none"> a. Remove the toner cartridge, and then the imaging unit. b. Check if the packing material is properly removed from the imaging unit. <p>Warning—Potential Damage: Do not expose the imaging unit to direct light for more than 10 minutes. Extended exposure to light may cause print quality problems.</p> c. Reinstall the imaging unit, and then the cartridge. 2. Resend the print job. <p>Is the printer still printing blank pages?</p>	Go to step 2.	The problem is solved.
<p>Step 2</p> <ol style="list-style-type: none"> 1. Redistribute the toner in the imaging unit. <ol style="list-style-type: none"> a. Remove the toner cartridge, and then the imaging unit. b. Firmly shake the imaging unit. <p>Warning—Potential Damage: Do not expose the imaging unit to direct light for more than 10 minutes. Extended exposure to light may cause print quality problems.</p> c. Reinstall the imaging unit, and then the cartridge. 2. Resend the print job. <p>Is the printer still printing blank pages?</p>	Go to step 3.	The problem is solved.
<p>Step 3</p> <p>Replace the imaging unit, and then resend the print job.</p> <p>Is the printer still printing blank pages?</p>	Contact technical support .	The problem is solved.

Clipped pages or images

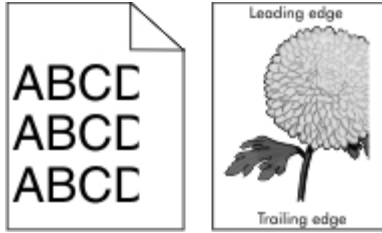

Action	Yes	No
<p>Step 1</p> <ol style="list-style-type: none"> 1. Move the width and length guides in the tray to the correct positions for the paper loaded. 2. Resend the print job. <p>Is the page or image clipped?</p>	Go to step 2.	The problem is solved.
<p>Step 2</p> <p>From the printer control panel, set the paper size and type in the Paper menu to match the paper loaded in the tray.</p> <p>Do the paper size and type match the paper loaded in the tray?</p>	Go to step 3.	<p>Do one or more of the following:</p> <ul style="list-style-type: none"> • Specify the paper size from the tray settings to match the paper loaded in the tray. • Change the paper loaded in the tray to match the paper size specified in the tray settings.
<p>Step 3</p> <ol style="list-style-type: none"> 1. Depending on your operating system, specify the paper size from Printing Preferences or from the Print dialog. 2. Resend the print job. <p>Is the page or image clipped?</p>	Go to step 4.	The problem is solved.

Action	Yes	No
<p>Step 4</p> <ol style="list-style-type: none"> 1. Reinstall the imaging unit. <ol style="list-style-type: none"> a. Remove the toner cartridge. b. Remove the imaging unit. <p>Warning—Potential Damage: Do not expose the imaging unit to direct light for more than 10 minutes. Extended exposure to light may cause print quality problems.</p> <ol style="list-style-type: none"> c. Install the imaging unit, and then the cartridge. 2. Resend the print job. <p>Is the page or image clipped?</p>	<p>Contact technical support.</p>	<p>The problem is solved.</p>

Compressed images appear on prints

Note: Printing on letter-size paper using a 220-volt fuser compresses images.

Action	Yes	No
<p>Step 1</p> <ol style="list-style-type: none"> 1. Make sure the size of the paper loaded in the tray matches the fuser type. <p>Note: Use a 110-volt fuser for printing on letter-size paper and a 220-volt fuser for printing on A4-size paper.</p> 2. Resend the print job. <p>Do compressed images still appear?</p>	<p>The problem is solved.</p>	<p>Go to step 2.</p>
<p>Step 2</p> <ol style="list-style-type: none"> 1. Replace the fuser. For more information on installing the fuser, see the instruction sheet that came with the part. 2. Resend the print job. <p>Do compressed images still appear?</p>	<p>The problem is solved.</p>	<p>Contact technical support.</p>

Shadow images appear on prints

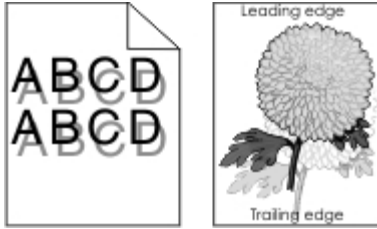

Action	Yes	No
<p>Step 1</p> <p>Load paper with the correct paper type and weight in the tray.</p> <p>Is paper with the correct paper type and weight loaded in the tray?</p>	Go to step 2.	Load paper with the correct paper type and weight in the tray.
<p>Step 2</p> <p>From the printer control panel, set the paper type and weight in the Paper menu to match the paper loaded in the tray.</p> <p>Is the tray set to the type and weight of the paper loaded?</p>	Go to step 3.	Change the paper loaded in the tray to match the paper type and weight specified in the tray settings.
<p>Step 3</p> <ol style="list-style-type: none"> Depending on your operating system, specify the paper type and weight from Printing Preferences or from the Print dialog. Resend the print job. <p>Do shadow images still appear on prints?</p>	Go to step 4.	The problem is solved.

Action	Yes	No
<p>Step 4</p> <p>Replace the imaging unit, and then resend the print job.</p> <p>Do shadow images still appear on prints?</p>	Contact technical support .	The problem is solved.

Gray background on prints

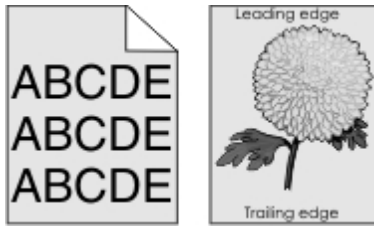

Action	Yes	No
<p>Step 1</p> <p>Check if Allow Background Removal is set to Off.</p> <ol style="list-style-type: none"> From the General Settings menu, set Allow Background Removal to On. Resend the print job. <p>Did the background disappear from the prints?</p>	The problem is solved.	Go to step 2.
<p>Step 2</p> <p>Adjust the toner darkness to a lighter setting.</p> <ol style="list-style-type: none"> From the Quality Menu, select a lower value to reduce toner density. <ul style="list-style-type: none"> 4 is the factory default setting. If Print Mode is set to Black Only, then a setting of 5 increases toner density and darkness for all print jobs. Resend the print job. <p>Did the background disappear from the prints?</p>	The problem is solved.	Go to step 3.

Action	Yes	No
<p>Step 3</p> <p>Reinstall the toner cartridge.</p> <ol style="list-style-type: none"> 1. Remove the cartridge. 2. Install the cartridge. 3. Resend the print job. <p>Did the background disappear from the prints?</p>	<p>The problem is solved.</p>	<p>Go to step 4.</p>
<p>Step 4</p> <p>Check if off-white background is selected.</p> <ol style="list-style-type: none"> 1. Depending on your operating system, set off-white background from Print Properties or the Print dialog. 2. Resend the print job. <p>Did the background disappear from the prints?</p>	<p>The problem is solved.</p>	<p>Contact technical support.</p>

Incorrect margins on prints



Action	Yes	No
<p>Step 1</p> <ol style="list-style-type: none"> 1. Move the width and length guides in the tray to the correct positions for the paper size loaded. 2. Resend the print job. <p>Are the margins correct?</p>	<p>The problem is solved.</p>	<p>Go to step 2.</p>

User's Guide

Action	Yes	No
<p>Step 2</p> <p>From the printer control panel, set the paper size in the Paper menu to match the paper loaded in the tray.</p> <p>Does the paper size match the paper loaded in the tray?</p>	Go to step 3.	<p>Do one or more of the following:</p> <ul style="list-style-type: none"> • Specify the paper size from the tray settings to match the paper loaded in the tray. • Change the paper loaded in the tray to match the paper size specified in the tray settings.
<p>Step 3</p> <ol style="list-style-type: none"> 1. Depending on your operating system, specify the paper size from Printing Preferences or from the Print dialog. 2. Resend the print job. <p>Are the margins correct?</p>	The problem is solved.	Contact technical support .

Paper curl

Action	Yes	No
<p>Step 1</p> <p>Move the width and length guides in the tray to the correct positions for the size of the paper loaded.</p> <p>Are the width and length guides positioned correctly?</p>	Go to step 2.	Adjust the width and length guides.
<p>Step 2</p> <p>From the printer control panel, set the paper type and weight in the Paper menu to match the paper loaded in the tray.</p> <p>Do the paper type and weight match the type and weight of the paper in the tray?</p>	Go to step 3.	Specify the paper type and weight from the tray settings to match the paper loaded in the tray.

Action	Yes	No
<p>Step 3</p> <ol style="list-style-type: none"> 1. Depending on your operating system, specify the paper type and weight from Printing Preferences or from the Print dialog. 2. Resend the print job. <p>Is the paper still curled?</p>	Go to step 4.	The problem is solved.
<p>Step 4</p> <ol style="list-style-type: none"> 1. Remove the paper from the tray, and then turn it over. 2. Resend the print job. <p>Is the paper still curled?</p>	Go to step 5.	The problem is solved.
<p>Step 5</p> <ol style="list-style-type: none"> 1. Load paper from a fresh package. <p>Note: Paper absorbs moisture due to high humidity. Store paper in its original wrapper until you use it.</p> <ol style="list-style-type: none"> 2. Resend the print job. <p>Is the paper still curled?</p>	Contact technical support .	The problem is solved.

Print irregularities

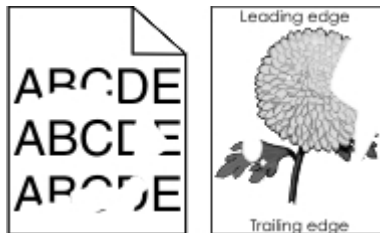

User's Guide

Action	Yes	No
<p>Step 1</p> <p>1. Move the width and length guides in the tray to the correct positions for the size of the paper loaded in the tray.</p> <p style="text-align: center;">Resend the print job.</p> <p>Do print irregularities still appear?</p>	<p>Go to step 2.</p>	<p>The problem is solved.</p>
<p>Step 2</p> <p>From the printer control panel, set the paper size and type in the Paper menu to match the paper loaded in the tray.</p> <p>Do the printer settings match the type and weight of the paper loaded in the tray?</p>	<p>Go to step 3.</p>	<p>Specify the paper size and type from the tray settings to match the paper loaded in the tray.</p>
<p>Step 3</p> <p>Depending on your operating system, specify the paper type and weight from Printing Preferences or from the Print dialog.</p> <p>Resend the print job.</p> <p>Do print irregularities still appear?</p>	<p>Go to step 4.</p>	<p>The problem is solved.</p>
<p>Step 4</p> <p>Check if the paper loaded in the tray has texture or rough finishes.</p> <p>Are you printing on textured or rough paper?</p>	<p>From the printer control panel, set the paper texture in the Paper menu to match the paper loaded in the tray.</p>	<p>Go to step 5.</p>

Action	Yes	No
<p>Step 5</p> <p>Load paper from a fresh package.</p> <p>Note: Paper absorbs moisture due to high humidity. Store paper in its original wrapper until you use it.</p> <p>Resend the print job.</p> <p>Do print irregularities still appear?</p>	<p>Go to step 6.</p>	<p>The problem is solved.</p>
<p>Step 6</p> <p>Replace the imaging unit, and then resend the print job.</p> <p>Do print irregularities still appear?</p>	<p>Contact technical support.</p>	<p>The problem is solved.</p>

Repeating defects appear on prints

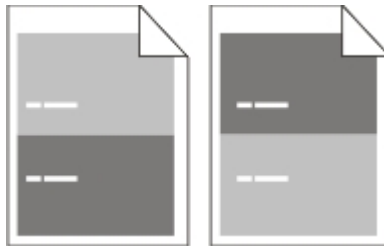

Action	Yes	No
<p>Step 1</p> <p>Measure the distance between the defects.</p> <p> Check for a distance between the defects that equals:</p> <p>97 mm (3.82 in.)</p> <p>47 mm (1.85 in.)</p> <p>38 mm (1.5 in.)</p> <p>Is the distance between defects equal to one of the listed measurements?</p>	<p>Go to step 2.</p>	<ol style="list-style-type: none"> 1. Check if the distance between the defects equal to 80 mm (3.15 in.) 2. Take note of the distance, and then contact technical support.
<p>Step 2</p> <p>Replace the imaging unit, and then resend the print job.</p> <p>Do the repeating defects still appear?</p>	<p>Contact technical support.</p>	<p>The problem is solved.</p>

Print is too dark

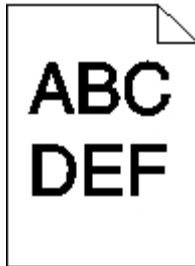

User's Guide

Action	Yes	No
<p>Step 1</p> <p>From the Quality menu on the printer control panel, reduce the toner darkness.</p> <p>Note: 8 is the factory default setting.</p> <p>Resend the print job.</p> <p>Is the print still too dark?</p>	<p>Go to step 2.</p>	<p>The problem is solved.</p>
<p>Step 2</p> <p>From the printer control panel, set the paper type, texture and weight in the Paper menu to match the paper loaded in the tray.</p> <p>Resend the print job.</p> <p>Is the tray set to the type, texture, and weight of the paper loaded?</p>	<p>Go to step 3.</p>	<p>Do one or more of the following:</p> <p>Specify the paper type, texture, and weight from the tray settings to match the paper loaded in the tray.</p> <p>Change the paper loaded in the tray to match the paper type, texture and weight specified in the tray settings.</p>
<p>Step 3</p> <p>Depending on your operating system, specify the paper type, texture and weight from Printing Preferences or from the Print dialog.</p> <p>Resend the print job.</p> <p>Is the print still too dark?</p>	<p>Go to step 4.</p>	<p>The problem is solved.</p>
<p>Step 4</p> <p>Check if the paper loaded in the tray has texture or rough finishes.</p> <p>Are you printing on textured or rough paper?</p>	<p>From the printer control panel, change the texture settings in the Paper Texture menu to match the paper you are printing on.</p>	<p>Go to step 5.</p>

User's Guide

Action	Yes	No
<p>Step 5</p> <p>Load paper from a fresh package.</p> <p>Note: Paper absorbs moisture due to high humidity. Store paper in its original wrapper until you use it.</p> <p>Resend the print job.</p> <p>Is the print still too dark?</p>	Go to step 6.	The problem is solved.
<p>Step 6</p> <p>Replace the imaging unit, and then resend the print job.</p> <p>Is the print still too dark?</p>	Contact technical support .	The problem is solved.

Print is too light



Action	Yes	No
<p>Step 1</p> <p>From the Quality menu on the printer control panel, increase the toner darkness.</p> <p>Note: 8 is the factory default setting.</p> <p>Resend the print job.</p> <p>Is the print still too light?</p>	Go to step 2.	The problem is solved.

User's Guide

Action	Yes	No
<p>Step 2</p> <p>From the printer control panel, set the paper type, texture, and weight in the Paper menu to match the paper loaded in the tray.</p> <p>Is the tray set to the type, texture, and weight of the paper loaded?</p>	Go to step 3.	Change the paper type, texture, and weight to match the paper loaded in the tray.
<p>Step 3</p> <p>Depending on your operating system, specify the paper type, texture, and weight from Printing Preferences or from the Print dialog.</p> <p>Resend the print job.</p> <p>Is the print still too light?</p>	Go to step 4.	The problem is solved.
<p>Step 4</p> <p>Make sure that the paper has no texture or rough finishes.</p> <p>Are you printing on textured or rough paper?</p>	From the printer control panel, change the texture settings in the Paper Texture menu to match the paper you are printing on.	Go to step 5.
<p>Step 5</p> <p>Load paper from a fresh package.</p> <p>Note: Paper absorbs moisture due to high humidity. Store paper in its original wrapper until you use it.</p> <p>Resend the print job.</p> <p>Is the print still too light?</p>	Go to step 6.	The problem is solved.

Action	Yes	No
<p>Step 6</p> <p>Redistribute the toner in the imaging unit.</p> <p>Remove the toner cartridge, and then the imaging unit.</p> <p>Firmly shake the imaging unit.</p> <p>Warning—Potential Damage: Do not expose the imaging unit to direct light for more than 10 minutes. Extended exposure to light may cause print quality problems.</p> <p>Install the imaging unit, and then the cartridge.</p> <p>Resend the print job.</p> <p>Is the print still too light?</p>	<p>Go to step 7.</p>	<p>The problem is solved.</p>
<p>Step 7</p> <p>Replace the imaging unit, and then resend the print job.</p> <p>Is the print still too light?</p>	<p>Contact technical support.</p>	<p>The problem is solved.</p>

Skewed print



Action	Yes	No
<p>Step 1</p> <p>Move the width and length guides in the tray to the correct positions for the size of the paper loaded.</p> <p>Resend the print job.</p> <p>Is the print still skewed?</p>	Go to step 2.	The problem is solved.
<p>Step 2</p> <p>Check if you are printing on a paper that is supported by the tray.</p> <p>Resend the print job.</p> <p>Is the print still skewed?</p>	Contact technical support .	The problem is solved.

Printer is printing solid black pages

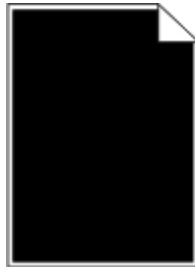

Action	Yes	No
<p>Step 1</p> <p>Reinstall the imaging unit.</p> <p>Remove the toner cartridge, and then the imaging unit.</p> <p>Warning—Potential Damage: Do not expose the imaging unit to direct light for more than 10 minutes. Extended exposure to light may cause print quality problems.</p> <p>Install the imaging unit, and then the cartridge.</p> <p>Resend the print job.</p> <p>Is the printer printing solid black pages?</p>	Go to step 2.	The problem is solved.

Action	Yes	No
<p>Step 2</p> <p>Replace the imaging unit, and then resend the print job.</p> <p>Is the printer printing solid black pages?</p>	<p>Contact technical support.</p>	<p>The problem is solved.</p>

Transparency print quality is poor

Action	Yes	No
<p>Step 1</p> <p>From the printer control panel, set the paper type in the Paper menu to match the paper loaded in the tray.</p> <p>Is the paper type for the tray set to Transparency?</p>	<p>Go to step 2.</p>	<p>Set the paper type to Transparency.</p>
<p>Step 2</p> <p>Check if you are using a recommended type of transparency.</p> <p>Resend the print job.</p> <p>Is the print quality still poor?</p>	<p>Contact technical support.</p>	<p>The problem is solved.</p>

Streaked horizontal lines appear on prints



User's Guide

Action	Yes	No
<p>Step 1</p> <p>Depending on your operating system, specify the tray or feeder from Printing Preferences or the Print dialog.</p> <p>Resend the print job.</p> <p>Do streaked horizontal lines appear on prints?</p>	<p>Go to step 2.</p>	<p>The problem is solved.</p>
<p>Step 2</p> <p>From the printer control panel, set the paper type and weight in the Paper menu to match the paper loaded in the tray.</p> <p>Do the paper type and weight match the type and weight of the paper in the tray?</p>	<p>Go to step 3.</p>	<p>Change the paper type and weight to match the paper loaded in the tray.</p>
<p>Step 3</p> <p>Load paper from a fresh package.</p> <p>Note: Paper absorbs moisture due to high humidity. Store paper in its original wrapper until you use it.</p> <p>Resend the print job.</p> <p>Do streaked horizontal lines appear on prints?</p>	<p>Go to step 4.</p>	<p>The problem is solved.</p>
<p>Step 4</p> <p>Reinstall the imaging unit.</p> <p>Remove the toner cartridge, and then the imaging unit.</p> <p>Warning—Potential Damage: Do not expose the imaging unit to direct light for more than 10 minutes. Extended exposure to light may cause print quality problems.</p> <p>Install the imaging unit, and then the cartridge.</p> <p>Resend the print job.</p> <p>Do streaked horizontal lines appear on prints?</p>	<p>Go to step 5.</p>	<p>The problem is solved.</p>

Action	Yes	No
<p>Step 5</p> <p>Replace the imaging unit, and then resend the print job.</p> <p>Do streaked horizontal lines appear on prints?</p>	<p>Contact technical support.</p>	<p>The problem is solved.</p>

Streaked vertical lines appear on prints

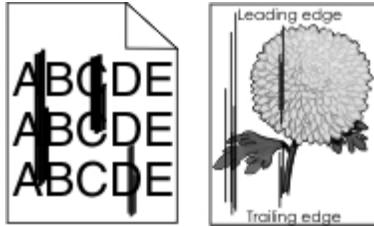

Action	Yes	No
<p>Step 1</p> <p>Depending on your operating system, specify the paper type, texture, and weight from Printing Preferences or from the Print dialog.</p> <p>Resend the print job.</p> <p>Do streaked vertical lines appear on prints?</p>	<p>Go to step 2.</p>	<p>The problem is solved.</p>
<p>Step 2</p> <p>From the printer control panel, set the paper texture, type, and weight in the Paper menu to match the paper loaded in the tray.</p> <p>Do the paper texture, type, and weight match the paper in the tray?</p>	<p>Go to step 3.</p>	<p>Do one or more of the following:</p> <p>Specify the paper texture, type, and weight from the tray settings to match the paper loaded in the tray.</p> <p>Change the paper loaded in the tray to match the paper texture, type, and weight specified in the tray settings.</p>

Action	Yes	No
<p>Step 3</p> <p>Load paper from a fresh package.</p> <p>Note: Paper absorbs moisture due to high humidity. Store paper in its original wrapper until you use it.</p> <p>Resend the print job.</p> <p>Do streaked vertical lines appear on prints?</p>	Go to step 4.	The problem is solved.
<p>Step 4</p> <p>Reinstall the imaging unit.</p> <p>Remove the toner cartridge, and then the imaging unit.</p> <p>Warning—Potential Damage: Do not expose the imaging unit to direct light for more than 10 minutes. Extended exposure to light may cause print quality problems.</p> <p>Install the imaging unit, and then the cartridge.</p> <p>Resend the print job.</p> <p>Do streaked vertical lines appear on prints?</p>	Go to step 5.	The problem is solved.
<p>Step 5</p> <p>Replace the imaging unit, and then resend the print job.</p> <p>Do streaked vertical lines appear on prints?</p>	Contact technical support .	The problem is solved.

Horizontal voids appear on prints



User's Guide

Action	Yes	No
<p>Step 1</p> <p>Make sure your software program is using a correct fill pattern.</p> <p>Resend the print job.</p> <p>Do horizontal voids appear on prints?</p>	Go to step 2.	The problem is solved.
<p>Step 2</p> <p>Load the specified tray or feeder with a recommended type of paper.</p> <p>Resend the print job.</p> <p>Do horizontal voids appear on prints?</p>	Go to step 3.	The problem is solved.
<p>Step 3</p> <p>Redistribute the toner in the imaging unit.</p> <p>Remove the toner cartridge, and then the imaging unit.</p> <p>Firmly shake the imaging unit.</p> <p>Warning—Potential Damage: Do not expose the imaging unit to direct light for more than 10 minutes. Extended exposure to light may cause print quality problems.</p> <p>Reinstall the imaging unit, and then the cartridge.</p> <p>Resend the print job.</p> <p>Do horizontal voids appear on prints?</p>	Go to step 4.	The problem is solved.
<p>Step 4</p> <p>Replace the imaging unit, and then resend the print job.</p> <p>Do horizontal voids appear on prints?</p>	Contact technical support .	The problem is solved.

Vertical voids appear on prints



Action	Yes	No
<p>Step 1</p> <p>Make sure your software program is using a correct fill pattern.</p> <p>Resend the print job.</p> <p>Do vertical voids appear on prints?</p>	<p>Go to step 2.</p>	<p>The problem is solved.</p>
<p>Step 2</p> <p>From the printer control panel, set the paper type and weight in the Paper menu to match the paper loaded in the tray.</p> <p>Resend the print job.</p> <p>Do vertical voids appear on prints?</p>	<p>Go to step 3.</p>	<p>The problem is solved.</p>
<p>Step 3</p> <p>Check if you are using a recommended type of paper.</p> <p>Load the specified tray or feeder with a recommended type of paper.</p> <p>Resend the print job.</p> <p>Do vertical voids appear on prints?</p>	<p>Go to step 4.</p>	<p>The problem is solved.</p>

Action	Yes	No
<p>Step 4</p> <p>Redistribute the toner in the imaging unit.</p> <p>Remove the toner cartridge, and then the imaging unit.</p> <p>Firmly shake the imaging unit.</p> <p>Warning—Potential Damage: Do not expose the imaging unit to direct light for more than 10 minutes. Extended exposure to light may cause print quality problems.</p> <p>Reinstall the imaging unit, and then the cartridge.</p> <p>Resend the print job.</p> <p>Do vertical voids appear on prints?</p>	<p>Go to step 5.</p>	<p>The problem is solved.</p>
<p>Step 5</p> <p>Replace the imaging unit, and then resend the print job.</p> <p>Do vertical voids appear on prints?</p>	<p>Contact technical support.</p>	<p>The problem is solved.</p>

Toner specks appear on prints

Action	Yes	No
<p>Replace the imaging unit, and then resend the print job.</p> <p>Do toner specks appear on prints?</p>	<p>Contact technical support.</p>	<p>The problem is solved.</p>

Toner fog or background shading appears on prints

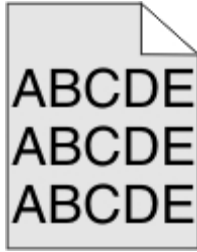

Action	Yes	No
<p>Step 1</p> <p>Reinstall the imaging unit.</p> <p>Remove, and then install the imaging unit.</p> <p>Resend the print job.</p> <p>Does fog or shading appear on prints?</p>	<p>Go to step 2.</p>	<p>The problem is solved.</p>
<p>Step 2</p> <p>Replace the imaging unit, and then resend the print job.</p> <p>Does fog or shading appear on prints?</p>	<p>Contact technical support.</p>	<p>The problem is solved.</p>

Toner rubs off

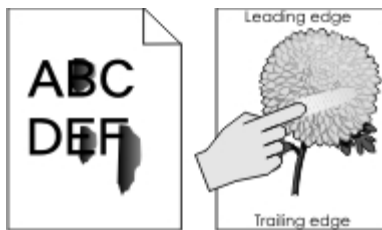

User's Guide

Action	Yes	No
<p>Step 1</p> <p>From the Paper menu on the printer control panel, check the paper type and weight.</p> <p>Do the paper type and texture match the paper loaded in the tray?</p>	Go to step 2.	Specify the paper type and weight from the tray settings to match the paper loaded in the tray.
<p>Step 2</p> <p>Check if you are printing on paper with texture or rough finishes.</p> <p>Are you printing on textured or rough paper?</p>	From the Paper menu on the printer control panel, set the paper texture.	Contact technical support .

Uneven print density



Action	Yes	No
<p>Replace the imaging unit, and then resend the print job.</p> <p>Is the print density uneven?</p>	Contact technical support .	The problem is solved.

Solving copy problems

[Copier does not respond](#)

[Scanner unit does not close](#)

[Poor copy quality](#)

[Partial document or photo copies](#)

Copier does not respond

Action	Yes	No
<p>Step 1</p> <p>Check if an error or status message appears on the display.</p> <p>Does an error or status message appear?</p>	<p>Clear the error or status message.</p>	<p>Go to step 2.</p>
<p>Step 2</p> <p>Check if the power cord is plugged into the printer and a properly grounded electrical outlet.</p> <p>Is the power cord plugged into the printer and a properly grounded electrical outlet?</p>	<p>Go to step 3.</p>	<p>Connect the power cord to the printer and a properly grounded electrical outlet.</p>
<p>Step 3</p> <p>Turn off the printer, then wait for about 10 seconds, and then turn it back on.</p> <p>Did Performing Self Test and Ready appear?</p>	<p>The problem is solved.</p>	<p>Contact technical support.</p>

Scanner unit does not close

Action	Yes	No
<p>Check if there are no obstructions between the scanner unit and the printer.</p> <p>Lift the scanner unit.</p> <p>Remove any obstruction that keeps the scanner unit open.</p> <p>Lower the scanner unit.</p> <p>Did the scanner unit close properly?</p>	<p>The problem is solved.</p>	<p>Contact technical support.</p>

Poor copy quality

Action	Yes	No
<p>Step 1</p> <p>Check if an error or status message appears on the display.</p> <p>Does an error or status message appear?</p>	<p>Clear the error or status message.</p>	<p>Go to step 2.</p>
<p>Step 2</p> <p>Check the quality of the original document.</p> <p>Is the quality of the original document satisfactory?</p>	<p>Go to step 3.</p>	<p>Increase the scan resolution setting for a higher-quality output.</p>
<p>Step 3</p> <p>If dark marks appear on prints, then clean the scanner glass and the ADF glass using a clean, lint-free cloth dampened with water.</p> <p>Is the scanner glass clean?</p>	<p>Go to step 4.</p>	<p>See Cleaning the scanner glass.</p>

User's Guide

Action	Yes	No
<p>Step 4</p> <p>Send a print job, and then check for print quality problems.</p> <p>From the General Settings menu, adjust the Eco-Mode settings.</p> <p>From the Copy menu, adjust the Darkness setting.</p> <p>If the print remains faded, then replace the toner cartridge.</p> <p>Is the print quality satisfactory?</p>	Go to step 5.	See Print quality problems .
<p>Step 5</p> <p>Check the placement of the document or photo.</p> <p>Make sure the document or photo is loaded facedown on the scanner glass in the upper left corner.</p> <p>Is the document or photo loaded correctly?</p>	Go to step 6.	Place the document or photo facedown on the scanner glass in the upper left corner.
<p>Step 6</p> <p>Check the copy settings.</p> <p>From the Copy screen, check if the Content Type and Content Source settings are correct for the document being scanned.</p> <p>Are the Content Type and Content Source settings correct for the document being scanned?</p>	Go to step 7.	Change the Content Type and Content Source settings to match the document being scanned.
<p>Step 7</p> <p>Check for patterns on print.</p> <p>From the printer control panel, navigate to:</p> <p>Copy >Sharpness > select a lower setting</p> <p>Note: Make sure no scaling is being selected.</p> <p>Resend the copy job.</p> <p>Do patterns appear on prints?</p>	Go to step 8.	The problem is solved.

User's Guide

Action	Yes	No
<p>Step 8</p> <p>Check for missing or faded text on prints.</p> <p>From the Copy screen, adjust the settings of the following:</p> <p>Sharpness—Increase the sharpness setting.</p> <p>Contrast—Increase the contrast setting.</p> <p>Resend the copy job.</p> <p>Do prints have missing or faded text?</p>	<p>Go to step 9.</p>	<p>The problem is solved.</p>
<p>Step 9</p> <p>Check for washed-out or overexposed output.</p> <p>From the Copy screen, adjust the settings of the following:</p> <p>Background Removal—Reduce the current setting.</p> <p>Darkness—Increase the current setting.</p> <p>Resend the copy job.</p> <p>Do pages show washed-out or overexposed prints?</p>	<p>Contact technical support.</p>	<p>The problem is solved.</p>

Partial document or photo copies

Action	Yes	No
<p>Step 1</p> <p>Check the placement of the document or photo.</p> <p>Make sure the document or photo is loaded facedown on the scanner glass in the upper left corner.</p> <p>Is the document or photo loaded correctly?</p>	<p>Go to step 2.</p>	<p>Place the document or photo facedown on the scanner glass in the upper left corner.</p>

Action	Yes	No
<p>Step 2</p> <p>Check if the paper size setting matches the size of the paper loaded in the tray.</p> <p>From the Paper menu on the printer control panel, check the Paper Size setting.</p> <p>Does the paper size setting match the size of the paper loaded in the tray.</p>	<p>Go to step 3.</p>	<p>Change the paper size setting to match the paper loaded in the tray, or load the tray with paper that matches the paper size setting.</p>
<p>Step 3</p> <p>Specify the paper size. Depending on your operating system, specify the paper size in Printing Preferences or the Print dialog.</p> <p>Resend the print job.</p> <p>Do copies print properly?</p>	<p>The problem is solved.</p>	<p>Contact technical support.</p>

Solving fax problems

[Fax and e-mail functions are not set up](#)

[Caller ID is not shown](#)

[Cannot send or receive a fax](#)

[Can send but not receive faxes](#)

[Can receive but not send faxes](#)



[Received fax has poor print quality](#)

Fax and e-mail functions are not set up

Notes:

Before you troubleshoot, check if the fax cables are connected.

The indicator light is blinking red until you set up fax and e-mail.

Action	Yes	No
<p>From the home screen, navigate to:</p> <p> >Settings >General Settings >Run initial setup >Yes >Submit</p> <p>Turn off the printer, and then turn it back on.</p> <p>The “Select your language” screen appears on the printer display.</p> <p>Select a language, and then touch .</p> <p>Select a country or region, and then touch Next.</p> <p>Select a time zone, and then touch Next.</p> <p>Select Fax and E-mail, and then touch Next.</p> <p>Are fax and e-mail functions set up?</p>	<p>The problem is solved.</p>	<p>Contact technical support.</p>

Caller ID is not shown

Action	Yes	No
<p>Contact your telephone company to check if your telephone line is subscribed to the caller ID service.</p> <p>Notes:</p> <p>If your region supports multiple caller ID patterns, then you may have to change the default setting. There are two settings available: FSK (pattern 1) and DTMF (pattern 2).</p> <p>The availability of these settings in the Fax menu depends on whether your country or region supports multiple caller ID patterns.</p> <p>Contact your telephone company to determine which pattern or switch setting to use.</p> <p>Does the caller ID appear?</p>	<p>The problem is solved.</p>	<p>Contact technical support.</p>

Cannot send or receive a fax

Action	Yes	No
<p>Step 1</p> <p>Check if an error or status message appears on the display.</p> <p>Is there an error or status message on the display?</p>	<p>Clear the error or status message.</p>	<p>Go to step 2.</p>
<p>Step 2</p> <p>Check if the power cord is plugged into the printer and a properly grounded electrical outlet.</p> <p>Is the power cord plugged into the printer and a properly grounded electrical outlet?</p>	<p>Go to step 3.</p>	<p>Connect the power cord to the printer and a properly grounded electrical outlet.</p>
<p>Step 3</p> <p>Check the power.</p> <p> Check if the printer is plugged in and turned on, and if Ready appears on the display.</p> <p>Is the printer turned on, and does Ready appear on the display?</p>	<p>Go to step 4.</p>	<p>Turn on the printer, and then wait until Ready appears on the display.</p>
<p>Step 4</p> <p>Check the printer connections.</p> <p> If applicable, check if the cable connections for the following equipment are secure:</p> <p>Telephone</p> <p>Handset</p> <p>Answering machine</p> <p>Are the cable connections secure?</p>	<p>Go to step 5.</p>	<p>Securely connect the cables.</p>

User's Guide

Action	Yes	No
<p>Step 5</p> <p>Check the telephone wall jack.</p> <p>Plug the telephone cable into the wall jack.</p> <p>Listen for a dial tone.</p> <p>If you do not hear a dial tone, then plug a different telephone cable into the wall jack.</p> <p>If you still do not hear a dial tone, then plug the telephone cable into a different wall jack.</p> <p>If you hear a dial tone, then connect the printer to that wall jack.</p> <p>Try sending or receiving a fax.</p> <p>Can you send or receive a fax?</p>	<p>The problem is solved.</p>	<p>Go to step 6.</p>
<p>Step 6</p> <p>Check if the printer is connected to an analog phone service or the correct digital connector.</p> <p style="padding-left: 40px;">The fax modem is an analog device. Certain devices can be connected to the printer so that digital telephone services can be used.</p> <p>If you are using an ISDN telephone service, then connect the printer to an analog telephone port (an R-interface port) on an ISDN terminal adapter. For more information and to request an R-interface port, contact your ISDN provider.</p> <p>If you are using DSL, then connect to a DSL filter or router that will support analog use. For more information, contact your DSL provider.</p> <p>If you are using a PBX telephone service, then make sure you are connecting to an analog connection on the PBX. If none exists, then consider installing an analog telephone line for the fax machine.</p> <p>Is the printer connected to an analog phone service or the correct digital connector?</p>	<p>Go to step 7.</p>	<p>Connect the printer to an analog phone service or the correct digital connector.</p>

User's Guide

Action	Yes	No
<p>Step 7</p> <p>Check for a dial tone.</p> <p>Did you hear a dial tone?</p>	<p>Go to step 8.</p>	<p>Try calling the fax number to make sure that it is working properly.</p> <p>If the telephone line is being used by another device, then wait until the other device is finished before sending a fax.</p> <p>If you are using the On Hook Dial feature, then turn up the volume to check if you hear a dial tone.</p>
<p>Step 8</p> <p>Temporarily disconnect other equipment (such as answering machines, computers with modems, or telephone line splitters) between the printer and the telephone line, and then try sending or receiving a fax.</p> <p>Can you send or receive a fax?</p>	<p>The problem is solved.</p>	<p>Go to step 9.</p>
<p>Step 9</p> <p>Temporarily disable call waiting. Contact your telephone company to obtain the keypad sequence for temporarily disabling call waiting.</p> <p>Try sending or receiving a fax.</p> <p>Can you send or receive a fax?</p>	<p>The problem is solved.</p>	<p>Go to step 10.</p>
<p>Step 10</p> <p>Temporarily disable voice mail service. For more information, contact your telephone company.</p> <p>Note: If you want to use both voice mail and the printer, then consider adding a second telephone line for the printer.</p> <p>Try sending or receiving a fax.</p> <p>Can you send or receive a fax?</p>	<p>The problem is solved.</p>	<p>Go to step 11.</p>

Action	Yes	No
<p>Step 11</p> <p>Scan the original document one page at a time.</p> <p>Dial the fax number.</p> <p>Scan the document one page at a time.</p> <p>Can you send or receive a fax?</p>	<p>The problem is solved.</p>	<p>Contact technical support.</p>

Can send but not receive faxes

Action	Yes	No
<p>Step 1</p> <p>Check the tray or feeder.</p> <p style="padding-left: 40px;">If empty, then load paper in the tray or feeder.</p> <p>Can you receive faxes?</p>	<p>The problem is solved.</p>	<p>Go to step 2.</p>
<p>Step 2</p> <p>Check the ring count delay settings.</p> <p>Open a Web browser, and then type the printer IP address in the address field.</p> <p>Notes:</p> <p>View the printer IP address on the printer home screen. The IP address appears as four sets of numbers separated by periods, such as 123.123.123.123.</p> <p>If you are using a proxy server, then temporarily disable it to load the Web page correctly.</p> <p>Click Settings >Fax Settings >Analog Fax Setup.</p> <p>In the "Rings to Answer" field, enter the number of times you want the phone to ring before the printer answers.</p> <p>Click Submit.</p> <p>Can you receive faxes?</p>	<p>The problem is solved.</p>	<p>Go to step 3.</p>

Action	Yes	No
<p>Step 3</p> <p>Replace the toner cartridge. For more information, see the instruction sheet that came with the supply.</p> <p>Can you receive faxes?</p>	<p>The problem is solved.</p>	<p>Contact technical support.</p>

Can receive but not send faxes

Action	Yes	No
<p>Step 1</p> <p>Check if the printer is in Fax mode.</p> <p>From the home screen, touch Fax to put the printer in Fax mode, and then send the fax.</p> <p>Note: The Multi Send application does not support the XPS output type. To use XPS, use the regular faxing method.</p> <p>Can you send faxes?</p>	<p>The problem is solved.</p>	<p>Go to step 2.</p>
<p>Step 2</p> <p>Load the original document properly.</p> <p>Load the original document faceup, short edge first into the ADF tray or facedown on the scanner glass in the upper left corner.</p> <p>Note: Do not load postcards, photos, small items, transparencies, photo paper, or thin media (such as magazine clippings) into the ADF tray. Place these items on the scanner glass.</p> <p>Can you send faxes?</p>	<p>The problem is solved.</p>	<p>Go to step 3.</p>

User's Guide

Action	Yes	No
<p>Step 3</p> <p>Set up the shortcut number properly.</p> <p>Check if the shortcut number has been set for the telephone number that you want to dial.</p> <p>Dial the telephone number manually.</p> <p>Can you send faxes?</p>	<p>The problem is solved.</p>	<p>Contact technical support.</p>

Received fax has poor print quality

Action	Yes	No
<p>Step 1</p> <p>Ask the person who sent you the fax to:</p> <p>Check if the quality of the original document is satisfactory.</p> <p>Increase the fax scan resolution, if possible.</p> <p>Resend the fax.</p> <p>Is the fax print quality satisfactory?</p>	<p>The problem is solved.</p>	<p>Go to step 2.</p>

User's Guide

Action	Yes	No
<p>Step 2</p> <p>Decrease the incoming fax transmission speed.</p> <p>Open a Web browser, and then type the printer IP address in the address field.</p> <p>Notes:</p> <p>View the printer IP address on the printer home screen. The IP address appears as four sets of numbers separated by periods, such as 123.123.123.123.</p> <p>If you are using a proxy server, then temporarily disable it to load the Web page correctly.</p> <p>Print a network setup page or menu settings page, and then locate the IP address in the TCP/IP section.</p> <p>Click Settings >Fax Settings >Analog Fax Setup.</p> <p>In the Max Speed menu, click one of the following:</p> <p>2400</p> <p>4800</p> <p>9600</p> <p>14400</p> <p>33600</p> <p>Click Submit, and then resend the fax.</p> <p>Is the fax print quality satisfactory?</p>	<p>The problem is solved.</p>	<p>Go to step 3.</p>
<p>Step 3</p> <p>Replace the toner cartridge.</p> <p>When Cartridge low [88.xy] appears, replace the cartridge, and then resend the fax.</p> <p>Is the fax print quality satisfactory?</p>	<p>The problem is solved.</p>	<p>Contact technical support.</p>

Solving scanner problems

[The scanner does not respond](#)

[Scan job was not successful](#)

[Scanner unit does not close](#)

[Scanning takes too long or freezes the computer](#)

[Poor scanned image quality](#)

[Partial document or photo scans](#)

[Cannot scan from a computer](#)

The scanner does not respond

Action	Yes	No
<p>Step 1</p> <p>Check if the printer is turned on.</p> <p>Is the printer turned on?</p>	Go to step 2.	Turn on the printer.
<p>Step 2</p> <p>Check if the printer cable is securely attached to the printer and the computer, print server, option, or other network device.</p> <p>Is the printer cable securely attached to the printer and the computer, print server, option, or other network device?</p>	Go to step 3.	Connect the printer cable securely to the printer and the computer, print server, option, or other network device.
<p>Step 3</p> <p>Check if the power cord is plugged into the printer and a properly grounded electrical outlet.</p> <p>Is the power cord plugged into the printer and a properly grounded electrical outlet?</p>	Go to step 4.	Connect the power cord to the printer and a properly grounded electrical outlet.

User's Guide

Action	Yes	No
<p>Step 4</p> <p>Check if the electrical outlet is turned off by a switch or breaker.</p> <p>Is the electrical outlet turned off by a switch or breaker?</p>	<p>Turn on the switch or reset the breaker.</p>	<p>Go to step 5.</p>
<p>Step 5</p> <p>Check if the printer is plugged into any surge protectors, uninterruptible power supplies, or extension cords.</p> <p>Is the printer plugged into any surge protectors, uninterruptible power supplies, or extension cords?</p>	<p>Connect the printer power cord directly to a properly grounded electrical outlet.</p>	<p>Go to step 6.</p>
<p>Step 6</p> <p>Check other electrical equipment plugged into the outlet.</p> <p>Are the other electrical equipment working?</p>	<p>Unplug the other electrical equipment and turn on the printer. If the printer does not work, then reconnect the other electrical equipment and then go to step 6.</p>	<p>Go to step 7.</p>
<p>Step 7</p> <p>Turn off the printer, then wait for about 10 seconds, and then turn the printer back on.</p> <p>Are the printer and scanner working?</p>	<p>The problem is solved.</p>	<p>Contact technical support.</p>

Scan job was not successful

Action	Yes	No
<p>Step 1</p> <p>Check the cable connections.</p> <p>Make sure the Ethernet or USB cable is securely connected to the computer and the printer.</p> <p>Are the cables securely connected?</p>	Go to step 2.	Connect the cables properly.
<p>Step 2</p> <p>Check if the file name is already in use.</p> <p>Is the file name already in use?</p>	Change the file name.	Go to step 3.
<p>Step 3</p> <p>Check if the document or photo you want to scan is open in another application or being used by another user.</p> <p>Is the file you want to scan open in another application or being used by another user?</p>	Close the file you are scanning.	Go to step 4.
<p>Step 4</p> <p>Check if either the Append time stamp or the Overwrite existing file check box is selected in the destination configuration settings.</p> <p>Is the Append time stamp or Overwrite existing file check box selected in the destination configuration settings?</p>	Go to step 5.	Select the Append time stamp or Overwrite existing file check box in the destination configuration settings.

User's Guide

Action	Yes	No
<p>Step 5</p> <p>From the Flash Drive menu, reduce the scan resolution settings, and then resend the scan job.</p> <p>Does the job scan?</p>	The problem is solved.	Go to step 6.
<p>Step 6</p> <p>Check the scan settings.</p> <p>From the Scan screen, make sure the Content Type and Content Source settings are correct for the document being scanned.</p> <p>Are the Content Type and Content Source settings correct for the document being scanned?</p>	The problem is solved.	Change the Content Type and Content Source settings to match the document being scanned.

Scanner unit does not close

Action	Yes	No
<p>Check if there are obstructions in the scanner unit.</p> <p>Lift the scanner unit.</p> <p>Remove any obstruction keeping the scanner unit open.</p> <p>Lower the scanner unit.</p> <p>Did the scanner unit close correctly?</p>	The problem is solved.	Contact technical support .

Scanning takes too long or freezes the computer

Action	Yes	No
<p>Step 1</p> <p>Check if other applications are interfering with the scan.</p> <p>Close all applications that are not being used.</p> <p>Does scanning still take too long or freeze the computer?</p>	Go to step 2.	The problem is solved.
<p>Step 2</p> <p>Select a lower scan resolution.</p> <p>Does scanning still take too long or freeze the computer?</p>	Contact technical support .	The problem is solved.

Poor scanned image quality

Action	Yes	No
<p>Step 1</p> <p>Check if an error message appears on the display.</p> <p>Is there an error message on the printer display?</p>	Clear the error message.	Go to step 2.
<p>Step 2</p> <p>Check the quality of the original document.</p> <p>Is the quality of the original document satisfactory?</p>	Go to step 3.	Increase the scan resolution settings for a higher-quality output.
<p>Step 3</p> <p>Clean the scanner glass and the ADF glass using a clean, lint-free cloth dampened with water.</p> <p>Is the scanner glass clean?</p>	Go to step 4.	See Cleaning the scanner glass .

User's Guide

Action	Yes	No
<p>Step 4</p> <p>Check the placement of the document or photo.</p> <p style="padding-left: 40px;">Make sure the document or photo is loaded facedown on the scanner glass in the upper left corner.</p> <p>Is the document or photo loaded correctly?</p>	Go to step 5.	Place the document or photo facedown on the scanner glass in the upper left corner.
<p>Step 5</p> <p>Send a print job, and then check for print quality problems.</p> <p>From the General Settings menu, adjust the Eco-Mode settings.</p> <p>From the Copy menu, adjust the toner darkness.</p> <p>When the print becomes faded, replace the toner cartridge.</p> <p>Is the print quality satisfactory?</p>	Go to step 6.	See Print quality problems .
<p>Step 6</p> <p>Increase the scan resolution settings for a higher-quality output.</p> <p>Did the increased resolution produce a higher-quality output?</p>	Problem solved.	Go to step 7.
<p>Step 7</p> <p>Check the scan settings.</p> <p style="padding-left: 40px;">From the Scan screen, make sure the Content Type and Content Source settings are correct for the document being scanned.</p> <p>Are the Content Type and Content Source settings correct for the document being scanned?</p>	Contact technical support .	Change the Content Type and Content Source settings to match the document being scanned.

Partial document or photo scans

Action	Yes	No
<p>Check the placement of the document or photo.</p> <p>Make sure the document or photo is loaded facedown on the scanner glass in the upper left corner.</p> <p>Is the document or photo loaded correctly?</p>	<p>Contact technical support.</p>	<p>Load the document or photo facedown on the scanner glass in the upper left corner.</p>

Cannot scan from a computer

Action	Yes	No
<p>Step 1</p> <p>Make sure the printer is turned on and that Ready appears on the printer display before scanning a job.</p> <p>Does Ready appear before scanning the job?</p>	<p>Go to step 3.</p>	<p>Go to step 2.</p>
<p>Step 2</p> <p>Turn off the printer, then wait for about 10 seconds, and then turn the printer back on.</p> <p>Is there an error message on the printer display?</p>	<p>Clear the error message.</p>	<p>Go to step 3.</p>
<p>Step 3</p> <p>Check the cable connections between the printer and the print server to make sure they are secure.</p> <p>For more information, see the setup documentation that came with the printer.</p> <p>Are the cable connections between the printer and the print server secure?</p>	<p>Contact technical support.</p>	<p>Tighten the cable connections.</p>

Solving home screen applications problems

An application error has occurred

Action	Yes	No
<p>Step 1</p> <p>Check the system log for relevant details.</p> <p>Open a Web browser, and then type the printer IP address in the address field.</p> <p>If you do not know the IP address of the printer, then you can:</p> <p>View the IP address on the printer home screen.</p> <p>Print a network setup page or the menu settings pages, and then locate the IP address in the TCP/IP section.</p> <p>Note: An IP address appears as four sets of numbers separated by periods, such as 123.123.123.123.</p> <p>Click Settings >Apps >Apps Management >System tab >Log.</p> <p>From the Filter menu, select an application status.</p> <p>From the Application menu, select an application, and then click Submit.</p> <p>Does an error message appear in the log?</p>	Go to step 2.	Contact technical support .
<p>Step 2</p> <p>Resolve the error.</p> <p>Is the application working now?</p>	The problem is solved.	Contact technical support .

Embedded Web Server does not open

Action	Yes	No
<p>Step 1</p> <p>Turn on the printer.</p> <p>Open a Web browser, and then type the printer IP address.</p> <p>Press Enter.</p> <p>Does the Embedded Web Server open?</p>	The problem is solved.	Go to step 2.

User's Guide

Action	Yes	No
<p>Step 2</p> <p>Make sure the printer IP address is correct.</p> <p>View the printer IP address:</p> <p>From the TCP/IP section in the Network/Ports menu</p> <p>By printing a network setup page or menu settings page, and then finding the TCP/IP section</p> <p>Note: An IP address appears as four sets of numbers separated by periods, such as 123.123.123.123.</p> <p>Open a Web browser, and then type the IP address.</p> <p>Note: Depending on the network settings, you may need to type "https://" instead of "http://" before the printer IP address to access the Embedded Web Server.</p> <p>Press Enter.</p> <p>Does the Embedded Web Server open?</p>	<p>The problem is solved.</p>	<p>Go to step 3.</p>
<p>Step 3</p> <p>Check if the network is working.</p> <p>Print a network setup page.</p> <p>Check the first section of the network setup page and confirm that the status is Connected.</p> <p>Note: If the status is Not Connected, then the connection may be intermittent, or the network cable may be defective. Contact your system support person for a solution, and then print another network setup page.</p> <p>Open a Web browser, and then type the printer IP address.</p> <p>Press Enter.</p> <p>Does the Embedded Web Server open?</p>	<p>The problem is solved.</p>	<p>Go to step 4.</p>

Action	Yes	No
<p>Step 4</p> <p>Check if the cable connections to the printer and print server are secure.</p> <p>Connect the cables properly. For more information, see the setup documentation that came with the printer.</p> <p>Open a Web browser, and then type the printer IP address.</p> <p>Press Enter.</p> <p>Does the Embedded Web Server open?</p>	<p>The problem is solved.</p>	<p>Go to step 5.</p>
<p>Step 5</p> <p>Temporarily disable the Web proxy servers.</p> <p>Proxy servers may block or restrict you from accessing certain Web sites including the Embedded Web Server.</p> <p>Does the Embedded Web Server open?</p>	<p>The problem is solved.</p>	<p>Contact your system support person.</p>

Contacting technical support

When you contact technical support, you will need to be able to describe the problem you are experiencing, the message on the printer display, and the troubleshooting steps you have already taken to find a solution.

You need to know your printer model type and serial number. For more information, see the label at the back of the printer. The serial number is also listed on the menu settings page.

KONICA MINOLTA Web site at <http://www.konicaminolta.com>.

20—Notices

Copyright notice

Copyright © 2013 KONICA MINOLTA, INC., JP Tower, 2-7-2 Marunouchi, Chiyoda-ku, Tokyo, 100-7014, Japan. All Rights Reserved. This document may not be copied, in whole or part, nor transferred to any other media or language, without written permission of KONICA MINOLTA, INC.

Edition notice

KONICA MINOLTA, INC. reserves the right to make changes to this guide and to the equipment described herein without notice. Considerable effort has been made to ensure that this guide is free of inaccuracies and omissions. However, KONICA MINOLTA, INC. makes no warranty of any kind including, but not limited to, any implied warranties of merchantability and fitness for a particular purpose with regard to this guide. KONICA MINOLTA, INC. assumes no responsibility for, or liability for, errors contained in this guide or for incidental, special, or consequential damages arising out of the furnishing of this guide, or the use of this guide in operating the equipment, or in connection with the performance of the equipment when so operated.

Trademarks

KONICA MINOLTA and the KONICA MINOLTA logo are trademarks or registered trademarks of KONICA MINOLTA, INC.

bizhub and PageScope are trademarks or registered trademarks of KONICA MINOLTA, INC.

Mac and the Mac logo are trademarks of Apple Inc., registered in the U.S. and other countries.

PCL® is a registered trademark of the Hewlett-Packard Company. PCL is Hewlett-Packard Company's designation of a set of printer commands (language) and functions included in its printer products. This printer is intended to be compatible with the PCL language. This means the printer recognizes PCL commands used in various application programs, and that the printer emulates the functions corresponding to the commands.

All other trademarks are the property of their respective owners.

Software License Agreement

This package contains the following materials provided by KONICA MINOLTA, INC. (KM): software included as part of the printing system ("Printing Software"), the digitally-encoded machine-readable outline data encoded in the special format and in the encrypted form ("Font Programs"), other software which runs on a computer system for use in conjunction with the Printing Software ("Host Software"), and related explanatory written materials ("Documentation"). The term "Software" shall be used to describe Printing Software, Font Programs and/or Host Software and also include any upgrades, modified versions, additions, and copies of the Software. The Software is being licensed to you under the terms of this Agreement. KM grants to you a non-exclusive sublicense to use the Software and Documentation, provided that you agree to the following:

1. You may use the Software and accompanying Font Programs for imaging to the licensed output device(s), solely for your own internal business purposes.

2. In addition to the license for Font Programs set forth in Section 1 above, you may use Roman Font Programs to reproduce weights, styles, and versions of letters, numerals, characters and symbols ("Typefaces") on the display or monitor for your own internal business purposes.
3. You may make one backup copy of the Host Software, provided your backup copy is not installed or used on any computer. Notwithstanding the above restrictions, you may install the Host Software on any number of computers solely for use with one or more printing systems running the Printing Software.
4. You may assign its rights under this Agreement to an assignee of all of Licensee's right and interest to such Software and Documentation ("Assignee") provided you transfer to Assignee all copies of such Software and Documentation Assignee agrees to be bound by all of the terms and conditions of this Agreement.
5. You agree not to modify, adapt or translate the Software and Documentation.
6. You agree that you will not attempt to alter, disassemble, decrypt, reverse engineer or decompile the Software.
7. Title to and ownership of the Software and Documentation and any reproductions thereof shall remain with KM and its licensor.
8. Trademarks shall be used in accordance with accepted trademark practice, including identification of the trademark owner's name. Trademarks can only be used to identify printed output produced by the Software. Such use of any trademark does not give you any rights of ownership in that trademark.
9. You may not rent, lease, sublicense, lend or transfer versions or copies of the Software Licensee does not use, or Software contained on any unused media, except as part of the permanent transfer of all Software and Documentation as described above.
10. IN NO EVENT WILL KM OR ITS LICENSOR BE LIABLE TO YOU FOR ANY CONSEQUENTIAL, INCIDENTAL INDIRECT, PUNITIVE OR SPECIAL DAMAGES, INCLUDING ANY LOST PROFITS OR LOST SAVING, EVEN IF KM HAS BEEN ADVISED OF THE POSSIBILITY OF SUCH DAMAGES, OR FOR ANY CLAIM BY ANY THIRD PARTY. KM OR ITS LICENSOR DISCLAIMS ALL WARRANTIES WITH REGARD TO THE SOFTWARE, EXPRESS OR IMPLIED, INCLUDING, WITHOUT LIMITATION IMPLIED WARRANTIES OF MERCHANTABILITY, FITNESS FOR A PARTICULAR PURPOSE, TITLE AND NON-INFRINGEMENT OF THIRD PARTY RIGHTS. SOME STATES OR JURISDICTIONS DO NOT ALLOW THE EXCLUSION OR LIMITATION OF INCIDENTAL, CONSEQUENTIAL OR SPECIAL DAMAGES, SO THE ABOVE LIMITATIONS MAY NOT APPLY TO YOU.
11. Notice to Government End Users: The Software is a "commercial item," as that term is defined at 48 C.F.R.2.101, consisting of "commercial computer software" and "commercial computer software documentation," as such terms are used in 48 C.F.R. 12.212. Consistent with 48 C.F.R. 12.212 and 48 C.F.R. 227.7202-1 through 227.7202-4, all U.S. Government End Users acquire the Software with only those rights set forth herein.
12. You agree that you will not export the Software in any form in violation of any applicable laws and regulations regarding export control of any countries.

Noise emission levels

The following measurements were made in accordance with ISO 7779 and reported in conformance with ISO 9296.

Note: Some modes may not apply to your product.

1-meter average sound pressure, dBA	
Printing (Simplex / Duplex)	56 dBA / 54 dBA
Scanning	55 dBA
Copying	56 dBA
Ready	N/A

Temperature information

Ambient operating temperature	15.6 to 32.2°C (60 to 90°F)
Shipping and storage temperature	-40 to 40°C (-40 to 104°F)

For EU member states only

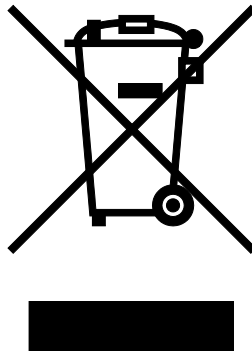

This symbol means: **Do not dispose of this product together with your household waste!**

Please contact the Local Authority for appropriate disposal instructions. In the case of a new device being purchased, the used one can also be given to our dealer for appropriate disposal. Recycling of this product will help to conserve natural resources and prevent potential negative consequences for the environment and human health caused by inappropriate waste handling.

This product complies with RoHS (2002/95/EC) directive.

Product disposal

Do not dispose of the printer or supplies in the same manner as normal household waste. Consult your local authorities for disposal and recycling options.

ENERGY STAR



As an ENERGY STAR® Partner, we have determined that this machine meets the ENERGY STAR Guidelines for energy efficiency.

What is an ENERGY STAR product?

An ENERGY STAR product has a special feature that allows it to automatically switch to a “low-power mode” after a period of inactivity. An ENERGY STAR product uses energy more efficiently, saves you money on utility bills and helps protect the environment.

Power consumption

Product power consumption

The following table documents the power consumption characteristics of the product.

Note: Some modes may not apply to your product.

Mode	Description	Power consumption (Watts)
Printing	The product is generating hard-copy output from electronic inputs.	600 W
Copy	The product is generating hard-copy output from hard-copy original documents.	620 W
Scan	The product is scanning hard-copy documents.	30 W
Ready	The product is waiting for a print job.	14 W
Sleep Mode	The product is in a high-level energy-saving mode.	7 W
Hibernate	The product is in a low-level energy-saving mode.	0.4 W
Off	The product is plugged into an electrical outlet, but the power switch is turned off.	0 W

The power consumption levels listed in the previous table represent time-averaged measurements. Instantaneous power draws may be substantially higher than the average.

Sleep Mode

This product is designed with an energy-saving mode called *Sleep Mode*. The Sleep Mode saves energy by lowering power consumption during extended periods of inactivity. The Sleep Mode is automatically engaged after this product is not used for a specified period of time, called the *Sleep Mode Timeout*.

Factory default Sleep Mode Timeout for this product (in minutes):	30
---	----

By using the configuration menus, the Sleep Mode Timeout can be modified between 1 minute and 120 minutes. Setting the Sleep Mode Timeout to a low value reduces energy consumption, but may increase the response time of the product. Setting the Sleep Mode Timeout to a high value maintains a fast response, but uses more energy.

Hibernate Mode

This product is designed with an ultra-low power operating mode called *Hibernate mode*. When operating in Hibernate Mode, all other systems and devices are powered down safely.

The Hibernate mode can be entered in any of the following methods:

- Using the Hibernate Timeout
- Using the Schedule Power modes
- Using the Sleep/Hibernate button

Factory default Hibernate Timeout for this product in all countries or regions except for EU countries and Switzerland	Disabled
Factory default value for this product in EU countries or regions and Switzerland	3 days

The amount of time the printer waits after a job is printed before it enters Hibernate mode can be modified between one hour and one month.

Off mode

If this product has an off mode which still consumes a small amount of power, then to completely stop product power consumption, disconnect the power supply cord from the electrical outlet.

Total energy usage

It is sometimes helpful to calculate the total product energy usage. Since power consumption claims are provided in power units of Watts, the power consumption should be multiplied by the time the product spends in each mode in order to calculate energy usage. The total product energy usage is the sum of each mode's energy usage.

Notice to users of the US telephone network: FCC requirements

This equipment complies with Part 68 of the FCC rules and the requirements adopted by the Administrative Council for Terminal Attachments (ACTA). On the back of this equipment is a label that contains, among other information, a product identifier in the format US:AAAEQ##TXXXX. If requested, this number must be provided to your telephone company.

This equipment uses the RJ-11C Universal Service Order Code (USOC) jack.

A plug and jack used to connect this equipment to the premises' wiring and telephone network must comply with the applicable FCC Part 68 rules and requirements adopted by the ACTA. A compliant telephone cord and modular plug is provided with this product. It is designed to be connected to a compatible modular jack that is also compliant. See your setup documentation for more information.

User's Guide

The Ringer Equivalence Number (REN) is used to determine the number of devices that may be connected to a telephone line. Excessive RENs on a telephone line may result in the devices not ringing in response to an incoming call. In most but not all areas, the sum of RENs should not exceed five (5.0). To be certain of the number of devices that may be connected to a line, as determined by the total RENs, contact your local telephone company. For products approved after July 23, 2001, the REN for this product is part of the product identifier that has the format US:AAAEQ##TXXXX. The digits represented by ## are the REN without a decimal point (for example, 03 is a REN of 0.3). For earlier products, the REN is shown separately on the label.

If this equipment causes harm to the telephone network, the telephone company will notify you in advance that temporary discontinuance of service may be required. If advance notice is not practical, the telephone company will notify the customer as soon as possible. You will also be advised of your right to file a complaint with the FCC.

The telephone company may make changes in its facilities, equipment, operations or procedures that could affect the operation of this equipment. If this happens, the telephone company will provide advance notice in order for you to make necessary modifications to maintain uninterrupted service.

If you experience trouble with this equipment, for repair or warranty information, contact KONICA MINOLTA, INC. at <http://www.konicaminolta.com> or your KONICA MINOLTA representative. If the equipment is causing harm to the telephone network, the telephone company may request that you disconnect the equipment until the problem is resolved.

This equipment contains no user serviceable parts. For repair and warranty information, contact KONICA MINOLTA, INC. See the previous paragraph for contact information.

Connection to party line service is subject to state tariffs. Contact the state public utility commission, public service commission, or corporation commission for information.

If your home has specially wired alarm equipment connected to the telephone line, ensure the installation of this equipment does not disable your alarm equipment. If you have questions about what will disable alarm equipment, consult your telephone company or a qualified installer.

Telephone companies report that electrical surges, typically lightning transients, are very destructive to customer terminal equipment connected to AC power sources. This has been identified as a major nationwide problem. It is recommended that the customer install an appropriate AC surge arrester in the AC outlet to which this device is connected. An appropriate AC surge arrester is defined as one that is suitably rated, and certified by UL (Underwriter's Laboratories), another NRTL (Nationally Recognized Testing Laboratory), or a recognized safety certification body in the country/region of use. This is to avoid damage to the equipment caused by local lightning strikes and other electrical surges.

The Telephone Consumer Protection Act of 1991 makes it unlawful for any person to use a computer or other electronic device, including fax machines, to send any message unless said message clearly contains in a margin at the top or bottom of each transmitted page or on the first page of the transmission, the date and time it is sent and an identification of the business or other entity, or other individual sending the message, and the telephone number of the sending machine or such business, other entity, or individual. (The telephone number provided may not be a 900 number or any other number for which charges exceed local or long-distance transmission charges.)

See your user documentation in order to program this information into your fax machine.

Notice to users of the Canadian telephone network

This product meets the applicable Industry Canada technical specifications. The Ringer Equivalence Number (REN) is an indication of the maximum number of terminals allowed to be connected to a telephone interface. The terminus of an interface may consist of any combination of devices, subject only to the requirement that the sum of the RENs of all the devices does not exceed five. The modem REN is located on the rear of the equipment on the product labeling.

Telephone companies report that electrical surges, typically lightning transients, are very destructive to customer terminal equipment connected to AC power sources. This has been identified as a major nationwide problem. It is recommended that the customer install an appropriate AC surge arrester in the AC outlet to which this device is connected. An appropriate AC surge arrester is defined as one that is suitably rated, and certified by UL (Underwriter's Laboratories), another NRTL (Nationally Recognized Testing Laboratory), or a recognized safety certification body in the country/region of use. This is to avoid damage to the equipment caused by local lightning strikes and other electrical surges.

This equipment uses CA11A telephone jacks.

Avis réservé aux utilisateurs du réseau téléphonique du Canada

Ce produit est conforme aux spécifications techniques d'Industrie Canada. Le numéro REN (ringer equivalence number : numéro d'équivalence de sonnerie) fournit une indication du nombre maximum de terminaux pouvant être connectés à l'interface téléphonique. En bout de ligne, le nombre d'appareils qui peuvent être connectés n'est pas directement limité, mais la somme des REN de ces appareils ne doit pas dépasser cinq. Le numéro REN du modem est indiqué sur l'étiquette produit située à l'arrière de l'équipement.

Les compagnies de téléphone constatent que les surtensions électriques, en particulier celles dues à la foudre, entraînent d'importants dégâts sur les terminaux privés connectés à des sources d'alimentation CA. Il s'agit-là d'un problème majeur d'échelle nationale. En conséquence, il vous est recommandé de brancher un parasurtenseur dans la prise de courant à laquelle l'équipement est connecté. Utilisez un parasurtenseur répondant à des caractéristiques nominales satisfaisantes et certifié par le laboratoire d'assureurs UL (Underwriter's Laboratories), un autre laboratoire agréé de type NRTL (Nationally Recognized Testing Laboratory) ou un organisme de certification agréé dans votre région ou pays. Ceci prévient tout endommagement de l'équipement causé par les orages et autres surtensions électriques.

Cet équipement utilise des prises de téléphone CA11A.

Notice to users of the New Zealand telephone network

The following are special conditions for the Facsimile User Instructions. The grant of a telepermit for any item of terminal equipment indicates only that Telecom has accepted that the item complies with minimum conditions for connection to its network. It indicates no endorsement of the product by Telecom, nor does it provide any sort of warranty. Above all, it provides no assurance that any item will work correctly in all respects with another item of telepermitted equipment of a different make or model, nor does it imply that any product is compatible with all of Telecom's network services.

This equipment shall not be set up to make automatic calls to the Telecom's 111 Emergency Service.

This equipment may not provide for the effective hand-over of a call to another device connected to the same line.

This equipment should not be used under any circumstances that may constitute a nuisance to other Telecom customers.

Some parameters required for compliance with Telecom's telepermit requirements are dependent on the equipment associated with this device. The associated equipment shall be set to operate within the following limits for compliance to Telecom's specifications:

- There shall be no more than 10 call attempts to the same number within any 30 minute period for any single manual call initiation, and
- The equipment shall go on-hook for a period of not less than 30 seconds between the end of one attempt and the beginning of the next call attempt.
- The equipment shall be set to ensure that automatic calls to different numbers are spaced such that there is not less than 5 seconds between the end of one call attempt and the beginning of another.

Using this product in Switzerland

This product requires a Swiss billing tone filter (part number 80D1877) to be installed on any line which receives metering pulses in Switzerland. The filter must be used, as metering pulses are present on all analog telephone lines in Switzerland.

Utilisation de ce produit en Suisse

Cet appareil nécessite l'utilisation d'un filtre de tonalité de facturation suisse (n° de référence : 80D1877) devant être installé sur toute ligne recevant des impulsions de comptage en Suisse. Ce filtre doit être utilisé pour toute installation car ces impulsions existent sur toutes les lignes téléphoniques suisses.

Verwendung dieses Produkts in der Schweiz

Für dieses Produkt muss ein schweizerischer Billing Tone Filter zur Zählzeichenübertragung (Teilenummer 80D1877) für jede Leitung installiert werden, über die in der Schweiz Zeitsteuertakte übertragen werden. Die Verwendung des Filters ist obligatorisch, da in allen analogen Telefonleitungen in der Schweiz Zeitsteuertakte vorhanden sind.

Uso del prodotto in Svizzera

Questo prodotto richiede un filtro toni Billing svizzero, (codice 80D1877) da installare su tutte le linee che ricevono impulsi remoti in Svizzera. È necessario utilizzare il filtro poiché gli impulsi remoti sono presenti su tutte le linee analogiche in Svizzera.

Modular component notice

Wireless-equipped models contain the following modular component(s):

Regulatory Type/Model LEX-M01-005; FCC ID:IYLLLEXM01005; IC:2376A-M01005

Notice to users in Brazil

Este equipamento opera em caráter secundário, isto é, não tem direito a proteção contra interferência prejudicial, mesmo de estações do mesmo tipo, e não pode causar interferência a sistemas operando em caráter primário. (Res.ANATEL 282/2001).

Taiwan NCC RF notice statement

NCC型式認證設備注意事項 台灣低功率射頻電機設備之使用注意事項

經型式認證合格之低功率射頻電機，非經許可，公司、商號或使用者均不得擅自變更頻率、加大功率或變更原設計之特性及功能。

低功率射頻電機之使用不得影響飛航安全及干擾合法通信；經發現有干擾現象時，應立即停用，並改善至無干擾時方得繼續使用。前項合法通信，指依電信規定作業之無線電信。低功率射頻電機須忍受合法通信或工業、科學及醫療用電波輻射性電機設備之干擾。