



TECHBOOK.



DT SWISS

DTSWISS.COM

2014

WHEELS // COMPONENTS // SUSPENSION // ACCESSORIES.



CONTENT

TECHBOOK 2014

DT SWISS



CONTENT

DT SWISS

DT SWISS symbols	4 – 7
DT SWISS naming	8 – 9

WHEELS

Wheels mountain	12 – 27
Wheels road	28 – 37

COMPONENTS

Rims mountain	40 – 45
Rims road	46 – 49
Hubs	50 – 58
Spokes	59 – 61
Nipples	62 – 63
RWS	64 – 65

SUSPENSION

Forks	68 – 71
Shocks	72 – 73

ACCESSORIES

Axle conversion kits	76 – 77
Rotor kits	78 – 79
Tubeless solutions	80
Proline	81 – 85

DT SWISS SYMBOLS

D

E

F

I

ONE PIECE MAG



Die One Piece Mag Tauchrohreinheit wird im Magnesium-Spritzgussverfahren hergestellt. Wandstärken und Formen können sehr präzise und frei gestaltet werden, dadurch lässt sich ein ideales Verhältnis von Gewicht zu Steifigkeit erreichen. DT Swiss verwendet modernste Konstruktionsmethoden um diese Möglichkeiten auszureizen.

The One Piece Mag lower unit is made using a magnesium injection-molding process. This process allows our engineers to precisely define wall thicknesses and complex shapes. The advanced engineering processes DT Swiss employs for its One Piece Mag lowers make for an ideal strength to weight ratio of the final product.

Les fourreaux One Piece Mag sont fabriqués en utilisant un processus de moulage par injection de magnésium. Ainsi, tous les volumes et formes peuvent être définis très librement et contrôlés avec une très haute précision. Ceci permet de créer un équilibre idéal entre poids et rigidité. DT Swiss emploie les méthodes de construction les plus avancées pour utiliser au mieux ces possibilités.

I nuovi foderi One Piece Mag sono fusi a getto in magnesio. Questo processo lascia la massima libertà nel dimensionamento delle sezioni e nella scelta delle forme. DT Swiss applica i più moderni metodi di costruzione per usufruire queste possibilità al massimo. Il risultato è un prodotto con una relazione ideale tra peso e rigidità.

TORSION BOX



Durch die zweiteilige, hohle Konstruktion der Gabelbrücke ist die Magnesium Tauchrohreinheit sehr leicht und steif.

The two piece, hollow construction of the arch creates a very light and stiff magnesium lower.

Grâce à une construction à deux pièces creuses de l'arceau, les fourreaux en magnésium sont très légers et rigides.

La costruzione cava, in due pezzi, dell'archetto in magnesio dà rigidità e leggerezza al profilo.

HOLLOW ARCH



Der Hollow arch (hohle Carbon Gabelbrücke) sorgt für eine extrem steife und leichte Tauchrohreinheit.

The hollow carbon arch makes an extremely stiff and light lower.

Hollow arch (arceau creux en carbone) pour des fourreaux extrêmement rigides et légers.

L'archetto vuoto in carbonio garantisce la massima rigidità e pesi contenuti.

ABS



Auto Balancing Spring. Hochleistungs Luftfederung. Positiv- und Negativluftkammer werden über ein einziges Ventil optimal auf das Fahrergewicht eingestellt.

Auto Balancing Spring – a high performance air spring system. Both the positive and negative air chamber are set up to the rider weight via a single valve.

Auto Balancing Spring. Ressort à air haute performance, dont les pressions dans la chambre positive et négative sont ajustées au poids du pilote par une seule valve.

Auto Balancing Spring – molla d'aria ad alte prestazioni. Le camere d'aria positiva e negativa vengono regolata seguente il peso del pilota con una sola valvola.

NCS



Negative Coil Spring. NCS ist ein Hochleistungs-Luftfederungssystem mit einer Stahl-Negativfeder. Diese ist so ausgelegt, dass unabhängig vom Fahrergewicht eine ideale Kennlinie erreicht wird.

Negative Coil Spring. NCS is a high performance air spring system featuring a negative coil spring. It is designed to achieve a perfect spring rate, and therefore performance, irrespective of the rider weight.

Negative Coil Spring. NCS est une suspension à air avec un ressort négatif en acier. Sa conception permet d'offrir une courbe, et donc une performance idéale indépendante du poids du pilote.

Negative Coil Spring. NCS è un sistema di sospensione ad aria con una molla negativa in acciaio. La sua concezione permette di ottenere una caratteristica della molla ideale, indipendente dal peso del pilota.

SINGLE SHOT



Zwei Fahrmodi: Open mode und Lockout. Geringes Gewicht und Dämpfungsperformance sind perfekt kombiniert.

Two ride settings: Open mode and lockout. Low weight and high performance are perfectly combined. Adjustable rebound.

Deux positions de roulage: Open mode et blocage. Hautes performances et légèreté sont combinés à la perfection. Détente réglable.

Due possibilità di funzionamento: Modalità aperta o bloccata. Una combinazione di peso contenuto e prestazioni di altissimo livello. Estensione regolabile.

TWIN SHOT



Drei Fahrmodi: Open mode, climb mode und Lockout. Geringes Gewicht, Verstellbarkeit und Dämpfungsperformance sind perfekt kombiniert. Einstellbare Zug- und Druckstufe.

Three ride settings: Open mode, climb mode and lockout. Low weight, adjustability and high performance are perfectly combined. Adjustable rebound and compression.

Trois positions de roulage: Open mode, climb mode et blocage. Hautes performances, réglages et légèreté sont combinés à la perfection. Détente et compression réglable.

Tre possibilità di funzionamento: Modalità aperta, salita o bloccata. Una combinazione di peso contenuto, regolabilità e prestazioni di altissimo livello. Estensione e compressione regolabile.

LAUNCH CONTROL



Diese Funktion schliesst die Zugstufe, die Gabel federt nach dem Komprimieren nur bis zu einem definierten Punkt aus. Dadurch lässt sich die Front des Bikes für Anstiege absenken. Wird die einstellbare Auslösekraft (threshold) durch einem Schlag überschritten, deaktiviert sich das Launch Control und die Gabel arbeitet wieder normal.

This function closes the rebound circuit, so the fork compresses but does not extend. By pushing the Launch Control button, the fork can be lowered for climbing. If the adjustable release threshold is exceeded by an impact, the Launch Control deactivates automatically and the fork immediately returns to full travel mode.

En activant cette fonction, le circuit de rebond est bloqué et la fourche ne travaille plus qu'en compression. La hauteur peut être ajusté en appuyant sur l'avant du vélo. Si, lors d'un impact, le seuil de déclenchement ajustable est dépassé, le Launch Control se désactive et la fourche retourne au débattement standard.

Questa funzione permette di chiudere il circuito d'estensione. Premere il pulsante Launch Control per abbassare la forcella durante la salita. In caso di superamento della soglia di sblocco regolabile, in seguito ad urto, il Launch Control si disattiva automaticamente e la forcella ritorna immediatamente all'estensione piena.

D

REMOTE CONTROL



Das Remote control ermöglicht die Bedienung der Federelemente vom Lenker aus.

E

The Remote control allows the manipulation of the suspension from the handlebar.

F

Le Remote control permet le réglage des suspensions au guidon.

I

Il Remote control consente di azionare la sospensione dal manubrio.

CARBON CROWN



Gabelkrone und -schaft sind eine Einheit aus high modulus UD Carbon. Die Rippenverstärkungen im Inneren sorgen für erhöhte Steifigkeit und Sicherheit.

Crown and steerer are a unit of high modulus UD carbon. The internal rib reinforcements make it safe and stiff.

Té et pivot forment une unité en carbone haut module UD. Les nervures à l'intérieur augmentent la rigidité et la sécurité.

Il tubo sterzo e la corona sono formati da carbonio UD dal alto modulo. Le nervature di rinforzo la rendono sicura e rigida.

TUBULAR



Tubular Reifen sind für den Wettkampfeinsatz auf der Strasse und im Cross Country Bereich das Nonplus-ultra. Mit Kontaktkleber auf die speziell geformten Felgen aufgeklebt, punkten sie mit sehr geringem Rollwiderstand und Gewicht bei maximalem Grip.

Tubular tires are every road and XC racers dream. They are glued onto the specifically shaped rim using a contact glue. While being super light, they offer a lot of grip and very little rolling resistance.

Les boyaux sont le choix préféré des coureurs sur route ou en XC. Ils sont collés sur une jante à la forme adaptée avec une colle spécifique et offrent un rendement et une adhérence optimale pour un poids très faible.

Tubolari sono la scelta perfetta per un uso agonistico e vengono incollati su cerchi a forma specifica con una colla speciale. La resistenza al rotolamento e il peso sono minimali sempre offrendo un grip senza pari.

TUBELESS



Ein geschlossenes Felgenbett ermöglicht die Montage von standard tubeless Reifen.

Closed rim bed allows the installation of standard tubeless tires.

Jante non percée permettant le montage de pneus tubeless standard.

La base del cerchio priva di fori consente di installare pneumatici tubeless standard.

TUBELESS READY



Tubeless ready Felgen sind auf den Einsatz von tubeless Kits und Reifen ausgelegt. Sie ermöglichen einen korrekten Sitz des tubeless Felgenbandes (passendes Modell verwenden!) und des tubeless Reifens.

Tubeless ready rims are designed for use with tubeless kits and tubeless compatible tires. With the correct kit and tubeless compatible tires, the tubeless ready rims make for simple and quick tubeless setups.

Les jantes tubeless ready sont conçues pour l'utilisation avec un kit tubeless et des pneus soit tubeless, soit tubeless ready. Elles permettent un maintien correct du fond de jante tubeless (attention à utiliser le bon modèle!) et du pneu tubeless.

I cerchi tubeless ready sono concepiti per l'uso di un kit tubeless e copertoni sia tubeless ready o tubeless. Permettono un alloggiamento corretto del copertone e del nastro tubeless (usare il modello adeguato!).

CARBON



Als High-Tech Verbundmaterial aus Fasern und Harz lässt sich Carbon genau entsprechend der auftretenden Belastungen einsetzen. Dadurch können konkurrenzlos leichte und widerstandsfähige Teile konstruiert werden.

Being a high-tech composite material consisting of fibres and resin, carbon can be used to resist the exact forces it is subjected to. This enables engineers to design parts with an unmatched strength to weight ratio.

Matériel composite constitué de fibres et de résine, le carbone peut être parfaitement adapté aux forces auxquelles il doit résister. Cela permet de construire des pièces ayant un rapport entre résistance et poids inégalable.

Essendo un materiale composito consistente di fibre e di una resina, il carbonio può essere impiegato per resistere esattamente alle forze presenti. Questo permette di costruire componenti con un rapporto tra leggerezza e resistenza senza paragone.

QUICK RELEASE



Der Schnellspanner ist das gebräuchlichste Laufradbefestigungssystem. Es wurde 1922 vom Rennfahrer Tullio Campagnolo erfunden und ist seitdem der Standard für Rennräder und Mountainbikes.

A wheelmounting system developed by Tullio Campagnolo in 1922. Originally designed for road bicycles, it became the standard for road- and mountain bikes.

Le blocage rapide développé en 1922 par Tullio Campagnolo pour les vélos de route, est aujourd'hui le standard pour tous types de vélos.

Un sistema di montaggio della ruota sviluppato da Tullio Campagnolo nel 1922. Progettato originariamente per le biciclette su strada, è diventato lo standard per le bici su strada e le mountain-bike.

DT SWISS THRU BOLT



Das DT Swiss Thru Bolt System ist zu 100% mit Standard Ausfallenden kompatibel. Durch die Verwendung von durchgehenden 9mm Achsen vorne und 10mm Achsen hinten wird eine wesentlich festere Lauftradverbinding erreicht. Dadurch erhöht sich sowohl die Systemsteifigkeit als auch die Sicherheit.

The DT Swiss Thru Bolt system is 100% compatible with standard quick release dropouts. It uses 9mm front and 10mm rear alloy axles, making the connection between the wheel and the frame/fork substantially stronger and safer than a standard quick release.

Le système DT Swiss Thru Bolt est compatible à 100% avec les pattes standard pour blocage rapide. A la place d'un axe en diamètre de 5mm, le DT Swiss thru bolt utilise un axe en aluminium de 9mm à l'avant et de 10mm à l'arrière.

Il sistema DT Swiss Thru Bolt è compatibile al 100% con i forcellini a sgancio rapido standard. Utilizza perni in alluminio anteriori da 9 mm e posteriori da 10mm, rendendo il collegamento tra la ruota e telaio/forcella sostanzialmente più forte e sicuro di uno sgancio rapido standard.

THRU AXLE



Steckachs-Lauftradverbindungen sind nicht mit Ausfallenden für Schnellspanner kompatibel. Die Steckachse ist immer Bestandteil des Rahmens oder der Gabel. Der Durchmesser der Achse beträgt 20mm oder 15mm vorne und 12mm hinten.

A thru axle connection is not compatible with the quick release standard. Thru axles are always an integrated part of the frame or fork. The diameter of the axle is generally 20 or 15mm at the front and 12mm at the rear.

Le thru axle n'est pas compatible avec les pattes standard pour blocages rapides. Le thru axle (axe traversant) fait toujours partie intégrante du cadre ou de la fourche. Le diamètre de ces axes est généralement de 20 ou 15mm à l'avant et 12mm à l'arrière.

Il perno passante non è compatibile con lo standard a sgancio rapido. I perni passanti sono sempre parte integrante del telaio o della forcella. Il diametro del perno è generalmente 20 o 15 mm sulla ruota anteriore e 12 mm sulla ruota posteriore.

DT SWISS SYMBOLS

D

E

F

I

LEFTY



Lefty Federgabeln verwenden einen eigenen Nabenstandard. Das Laufrad wird mit einer Inbusschraube direkt mit der Gabelachse verschraubt. Alle DT Swiss Lefty Naben verfügen über eine IS 6-bolt Bremsscheibenaufnahme.

Lefty forks use a proprietary axle system. The wheel is bolted directly to the fork axle via an Allen bolt. All DT Swiss Lefty hubs feature an IS 6-bolt disc mount.

Les fourches Lefty utilisent un standard d'axe spécifique. La roue est vissée directement sur l'axe de la fourche par une vis hexagonale. Sur tous les moyeux DT Swiss Lefty le disque du frein se monte par le standard IS 6-bolt.

Le forcelle Lefty utilizzano uno standard d'asse specifico. La ruota si monta con una vite esagonale direttamente sull'asse della forcella. Tutti i mozzi DT Swiss Lefty corrispondono allo standard IS 6-bolt per montare il disco.

X-12



Das X-12 System vereint die überlegene Steifigkeit einer Steckachse mit der Anwendungsfreundlichkeit und dem Leichtgewicht des konventionellen Schnellspanners.

The X-12 system is as stiff as a normal thru axle but at the same time as user friendly and lightweight as a conventional quick release.

Le système X-12 possède la rigidité d'un axe traversant normal tout en étant aussi rapide en utilisation et léger qu'un blocage rapide conventionnel.

Il sistema X-12 ha la rigidità di un perno passante convenzionale, sempre offrendo però la semplicità e la leggerezza di uno sgancio rapido.

BOLT ON



Beim Bolt on System verwendet man zwei Schrauben um das Laufrad mit dem Rahmen oder der Gabel zu verschrauben. Man findet diese Verbindung oft an BMX und Single Speed Rahmen mit horizontalen Ausfallenden.

The bolt on system is mainly found on BMX and single speed frames using horizontal dropouts. Two independent bolts which thread into the axle are used to connect the wheel to the frame or the fork.

Le système bolt on (vissé) est surtout utilisé en BMX et sur des vélos single speed. Deux vis indépendantes sont vissées directement sur l'axe du moyeu.

Il sistema bolt on è utilizzato principalmente su BMX e su bici single speed che utilizzano forcellini orizzontali. Due bulloni indipendenti che si inseriscono nell'asse servono a collegare la ruota al telaio o alla forcella.

DT SWISS RATCHET SYSTEM®



Das patentierte Freilauf-System mit hochpräzisen Zahnscheiben garantiert höchste Belastbarkeit und Zuverlässigkeit. Dank dem no-tool-Konzept ist das System sehr einfach und schnell zu warten.

This patented freewheel system uses precision Ratchets, featuring extremely high load capacity and reliability. The no tool concept allows for an easy execution of routine maintenance.

Le système de roue libre breveté DT Swiss utilise deux disques dentés. Il garantit une fiabilité et une résistance à l'usure très élevée. Grâce au concept no tool il est très facile à entretenir.

Questo sistema di ruota libera, brevettato, utilizza dei cricchetti di precisione, caratterizzati da capacità di carico ed affidabilità estremamente elevate. Il concetto no tool permette la semplice esecuzione della manutenzione di routine.

PAWL SYSTEM



Ein bewährtes Freilaufsystem mit Klinken (pawls), zuverlässig und sicher.

A proven freewheel system with pawls, reliable and safe.

Le système éprouvé de roue libre à cliquets offre fiabilité et sécurité.

Un sistema a ruota libera, consolidato, con cricchetti affidabile e sicuro.

CENTER LOCK®



Von Shimano Inc. lizenzierte Bremsscheibenaufnahme.

Brake rotor mounting system licensed by Shimano Inc.

Système de fixation centrale pour disques, licencié de Shimano Inc.

Il sistema di montaggio del rotore del freno su licenza Shimano Inc.

IS (6-BOLT)



Internationaler Standard zur Bremsscheibenmontage mit 6 Schrauben.

International rotor mounting standard using 6 bolts.

Standard international pour montage du disque de frein à 6 trous.

Standard internazionale di montaggio del rotore che utilizza 6 viti.

RWS



Patentiertes Laufrad-Befestigungssystem. Steifer, sicherer und leichter zu bedienen als ein Schnellspanner. 100 % Scheibenbremsen tauglich.

Patented wheelmounting system. Stiffer, safer and more user friendly than conventional quick releases. 100 % disc brake compatible.

Système de montage de roue breveté. Plus rigide, sur, et plus facile à utiliser que les serrages rapides conventionnels. 100 % compatible frein à disque.

Sistema di montaggio della ruota brevettato. Più rigido, sicuro e facile da usare rispetto agli sganci rapidi tradizionali. Compatibile al 100 % con i freni a disco.

WELDED



Das Schweißverfahren erzeugt die präziseste, leichteste und stabilste Felgenverbindung. Nach dem Schweißen wird die Verbindungsstelle verputzt um einen nahtlosen Übergang zu erreichen.

The welding process creates the most precise, lightweight and strong rim connection possible. After welding, the seam is smoothed to guarantee a perfect tire fit.

La soudure permet d'obtenir la connection de la jante la plus précise, légère et durable. Après la soudure le joint est ébavuré et poncé pour obtenir un siège parfait pour le pneu.

I cerchi saldati possiedono il giunto più preciso, leggero e durabile. Dopo la saldatura il raccordo viene pulito con massima precisione per garantire un alloggiamento perfetto del copertone.

SLEEVED



Bei diesem Verfahren wird ein Formteil (sleeve) gleichmässig in beide Enden des Profils gepresst. Die Sleeve Joint Verbindung ist die beste Alternative zu den geschweißten Felgen.

A precise sleeve connects the profile. This guarantees optimum resistance against all occurring loads. The sleeve joint connection is the best alternative to welded rims.

Chaque extrémité du profil de la jante est pressé sur un manchon de précision. La connection sleeve joint garantit une parfaite résistance à la torsion et une fiabilité à toute épreuve.

Un manicotto di precisione chiude il profilo e garantisce dunque una resistenza ottima a tutti i carichi. Il giunto a manicotto è la migliore alternativa ai cerchi saldati.

	D	E	F	I	
PIN JOINT		Zwei Stahl Inserts werden formschlüssig in die Enden des Profils eingepresst. Die so entstandene Verbindung ist präzise, haltbar und wirtschaftlich.	Two steel inserts are press fitted into both ends of the profile. The achieved pin joint connection is precise, strong and economic.	Deux pièces en acier sont pressées dans le profil de la jante. La connection ainsi obtenue est précise, durable et économique.	Due manicotti in acciaio vengono pressati in entrambi i lati del profilo. Il raccordo così ottenuto è preciso, durabile ed economico.
NO TOOL		Für die normale Wartung wird kein Spezialwerkzeug benötigt.	No special tools needed for routine maintenance.	Aucun outil spécifique n'est nécessaire pour l'entretien régulier.	Per la manutenzione di routine non occorre alcun utensile speciale.
DOUBLE BUTTED		Einfach reduzierte Speichen verfügen über einen verjüngten Mittelteil. Dies wird durch ein von DT Swiss eigens entwickeltes Kaltschmiedeverfahren erreicht, welches sowohl das Verhältnis von Festigkeit zu Gewicht als auch die Elastizität der Speiche verbessert.	Double butted spokes are thinner in the middle than at the ends. This is achieved through DT Swiss' unique cold forging technology, which reduces the diameter of the spoke for better strength to weight performance and improved elasticity.	Le diamètre sur la partie centrale des rayons «double butted» est réduit par un processus de forgeage à froid propre à DT Swiss qui améliore considérablement le rapport poids / résistance et l'élasticité du rayon.	I raggi a doppio spessore sono più sottili al centro che alle estremità. Questo è permesso dalla tecnologia unica DT Swiss di forgiatura a freddo, che risulta in un miglior rapporto tra resistenza e peso e una migliore elasticità.
TRIPLE BUTTED		Diese Speichen haben drei verschiedene Durchmesser. So können sie noch besser an die auftretenden Kräfte angepasst werden. Auch hier kommt das Kaltschmiedeverfahren, um die mechanischen Qualitäten der Speichen zu perfektionieren, zum Einsatz.	These spokes have three different diameters to adapt even further to the occurring loads. Again we use a cold forging process to achieve these qualities.	Ces rayons ont trois diamètres différents pour encore mieux s'adapter aux contraintes qui apparaissent tout en étant très léger. Ils sont bien entendu également forgés à froid.	Questi raggi hanno tre diversi diametri per adattarsi ancora meglio ai carichi. Di nuovo, ci avvaliamo di un processo di forgiatura a freddo per ottenere queste proprietà.
BLADED		Ein flacher Mittelteil ermöglicht bessere Aerodynamik. Wie bei unseren reduzierten Speichen wird auch diese Umformung per Kaltschmiedeverfahren erreicht.	These spokes have a flat bladed central section for improved aerodynamics. As with our butted spokes, cold forging is used to produce the aero section and to optimize mechanical properties.	Les rayons bladed sont plats pour une meilleure aérodynamique. Comme sur les rayons «butted», le forgeage s'effectue à froid pour améliorer les propriétés mécaniques.	Questi raggi presentano una sezione centrale piatta per una migliore aerodinamica. Come con i nostri raggi a spessore variabile, la forgiatura a freddo serve a realizzare la sezione aero e ad ottimizzare le proprietà meccaniche.
DT SWISS PRO LOCK®		Das in die Nippel eingespritzte Schraubensicherungssystem ermöglicht den Bau von extrem haltbaren Laufrädern.	A patented liquid injected into the nipple thread allows for extremely durable wheel builds.	Une colle adhésive à deux composants injectée dans le filet permet le montage de roues extrêmement fiables.	Un liquido brevettato, iniettato nel filetto dei nipples, consente di realizzare ruote estremamente durevoli.
DT SWISS WEAR CONTROL®		DT Swiss Felgen für Felgenbremsen sind mit Verbrauchsanzeigen versehen. Diese zeigen den Abnutzungsgrad der Bremsfläche an. Die DT Swiss Wear Control® ist EN konform.	The DT Swiss Wear Control® shows the extent of rim wear. It is compliant to the European standard.	Des témoins d'usure indiquent l'état d'usure de la jante. Le DT Swiss Wear Control® est conforme aux normes européennes.	Il DT Swiss Wear Control® evidenzia lo stato di usura del cerchio. È conforme allo standard europeo.
STRAIGHT PULL		Straight pull Speichen kommen ohne Speichenbogen aus und eliminieren so einen Schwachpunkt konventioneller Speichen. Trotzdem sind sie mit Standardwerkzeugen zentrier- und ersetzbar.	Straight pull spokes have no spoke elbow, which eliminates the biggest weakpoint of conventional spokes. They are still true- and replaceable with conventional tools.	Les rayons straight pull ont une tête de rayon non coudée, éliminant le point le plus faible de tous les rayons. Ils restent toujours ajustables et remplaçables avec des outils conventionnels.	I raggi straight pull hanno una testa dritta, eliminando così un punto debole dei raggi convenzionali. Rimangono sempre centrabili e scambiabili con attrezzi convenzionali.
CERAMIC CARTRIDGE BEARINGS		Diese gedichteten Lager verwenden Kugeln aus Keramik und Laufflächen aus rostfreiem Stahl. Neben dem niedrigeren Gewicht sind diese Lager haltbarer als rostfreie und rollen Dank sehr harten Keramikugeln noch leichter.	These sealed bearings use ceramic balls running on stainless steel races. Due to the hardness of the ceramic balls, they feature less rolling resistance and longer life time at a lower weight than any stainless steel bearing.	Ces roulements utilisent des billes en céramique, des cages en acier inoxydable et des joints étanches. Ils ont une résistance au roulement encore plus faible tout en étant plus légers et plus solides.	Questi cuscinetti sigillati utilizzano delle sfere in ceramica che rotolano in guide di scorrimento in acciaio inox. Data la durezza delle sfere in ceramica, essi sono caratterizzati da una minor resistenza al rotolamento e da una maggior durata nonché da una maggiore leggerezza rispetto a qualsiasi cuscinetto in acciaio inox.

D

E

F

I

RR

road race



Geschwindigkeit ist es, was Rennradfahrer antreibt. Vorwärts kommen und schnell sein. Die Komponenten der RR Serie werden deshalb für möglichst effiziente Kraftübertragung konstruiert. Sie sind je nach Einsatzbereich hinsichtlich Aerodynamik, Gewicht oder Steifigkeit optimiert.

The RR product range meets road riders' need for speed with lightweight parts featuring great stiffness, aerodynamics and reliability.

La vitesse est primordiale pour les coureurs sur route, c'est pourquoi les composants RR sont conçus pour une transmission optimale de la puissance. En fonction de leur utilisation ils sont optimisés en aérodynamique, rigidité ou en poids.

La serie di prodotti RR soddisfa l'esigenza di velocità dei ciclisti su strada con parti ultraleggere, caratterizzate da grande rigidità, aerodinamica ed affidabilità.

R

road



Über den Asphalt fliegen, den Rythmus finden, Landschaften genießen. Die Teile der R Serie verfügen über die zentralen DT Swiss Technologien und sind so konzipiert, dass der Rennradgenuss garantiert ist: Zuverlässig, leicht und stabil.

Fly over the tarmac, find the rythm, enjoy landscapes. R category components feature the main DT Swiss technologies and are designed with the warrants of road riding enjoyment in mind: reliability, lightweight and durability.

Survoler le bitume, trouver le rythme, apprécier les paysages. Les composants de la série R disposent des technologies éprouvées DT Swiss et sont construits pour garantir le plaisir en vélo: fiables, légers et durables.

Sorvolare l'asfalto, trovare il ritmo, godersi il paesaggio. I componenti della serie R sono dotati delle più importanti tecnologie DT Swiss e creati per permettere il massimo piacere in bici: Affidabili, leggeri e duraturi.

XR

CROSS race



Cross Country Fahrer wollen sportliche Höchstleistungen erbringen und sich dabei in der Natur bewegen. Genauso wie hartes Training die Beine schneller macht, ist DT Swiss ständig bestrebt die XR Produkte leichter und steifer zu bauen.

Cross Country riders demand maximum performance from their bodies and the bike parts that take them through the countryside they enjoy. Just like constant training leads to improved results, DT Swiss is constantly improving the XR product line to make it lighter, stiffer and faster.

Ceux qui roulent en Cross Country aiment combiner les performances physiques et les expériences dans la nature. Tout comme l'entraînement intensif fait progresser le pilote, DT Swiss ne recule devant aucun effort pour rendre les produits XR plus légers, plus rigides et plus performants.

I ciclisti cross country richiedono la massima prestazione dal loro corpo e dalle parti della bici che li accompagnano attraverso il fuoristrada. Proprio come un allenamento costante porta a risultati migliori, DT Swiss sta costantemente migliorando la linea di prodotti XR allo scopo di renderla più leggera, rigida e veloce.

X

CROSS



Cross Country bedeutet sportliche Leistung, Spass an der Natur und am Entdecken. Alle Komponenten der X Kategorie sind mit DT Swiss Schlüsseltechnologien ausgestattet, so dass man sich auf das Wichtigste konzentrieren kann: Biken und Erleben.

Cross Country stands for for physical effort, enjoying nature and discovering new places. All the parts in the X category come with DT Swiss core technologies so the rider can focus on the main thing: mountainbiking and exploring.

Cross Country, ça veut dire effort physique, profiter de la nature et découvrir. Tout les composants de la série X sont dotés des technologies spécifiques DT Swiss permettant de se concentrer sur l'essentiel: rouler et vivre le vélo.

Cross Country significa attività sportiva nella natura e scoprire nuovi luoghi. Tutti i prodotti della categoria X sono equipaggiati delle tecnologie chiave DT Swiss che consentono di concentrarsi sull'essenziale: Pedalare e divertirsi.

XM

cross mountain



XM Komponenten richten sich an Biker, die den Bikesport in all seinen Varianten betreiben wollen. Ob Alpenüberquerung, Feierabendrunde oder Marathon: Vielseitigkeit und Zuverlässigkeit sind für den Cross Mountain Fahrer ebenso wichtig wie Komfort und geringes Gewicht.

XM components are designed for the rider who wants to do it all. Whether it's riding across the Alps, the weekend group ride or competing in a bike marathon: To a Cross Mountain rider product versatility and reliability are as important as weight and comfort.

Les composants XM s'adressent à tous ceux qui veulent pratiquer le VTT sous toutes ses formes. A travers les Alpes, autour du monde ou lors d'une épreuve marathon. Polyvalence et fiabilité sont particulièrement importantes en Cross Mountain, tout comme le confort et le poids.

I componenti XM sono progettati per il biker che desidera praticare questo sport in tutte le sue varianti: attraversando le Alpi, andando in bici in gruppo durante il weekend oppure gareggiando in una marathon. Per un biker cross mountain, la versatilità ed affidabilità del prodotto sono tanto importanti quanto il peso e il comfort.

D

E

F

I

M

mountain



Mountainbiken in seinem ursprünglichen Sinn: Freunde, Natur und Spass. Die Produkte der M Serie setzen dabei kaum Grenzen: Mit Muskelkraft hoch und mit Spass in die Abfahrt. Bewährte Technologien und solide Konstruktion machen es möglich.

Mountainbiking with its original values in mind: friends, nature and fun. The M series products leave the rider with virtually no limits: pedal up and and hammer the descents. Proven technology and solid engineering are the backbone of these components.

Le VTT comme dans ses origines: des amis, la nature et du plaisir. Les produits M n'y posent pas de limites: monter en pédalant et prendre le maximum de plaisir en descente. Une construction solide et des technologies éprouvées le permettent.

Il mountainbike nella versione originale: amici, natura e divertimento. Le parti della gamma M non mettono limiti: salire pedalando e massimo piacere in discesa. Tecnologie provate e costruzione intelligente lo permettono.

EX

enduro cross



Endurobiker suchen Abenteuer, die Geschwindigkeit ist dabei zweitrangig. Für die ultimative, anspruchsvolle Singletrail Abfahrt nehmen sie auch lange Anstiege in Kauf. Gelegentliche Ausritte in den Bikepark müssen EX Komponenten ebenso überstehen. Enduro Produkte sind deshalb stabil, zuverlässig und trotzdem leicht.

For Enduro riders it's all about adventure. They suffer through long uphill to reach that ultimate, untouched singletrack, loaded with roots, rocks and flowing corners. A day in the local bike park? No problem, EX parts are strong, reliable and lightweight to do the job perfectly.

En Enduro la vitesse est vraiment secondaire, le plus important étant la sortie elle-même. Les riders sont à la recherche des singles les plus techniques, ludiques et longs. Une session au bikepark local n'est jamais refusée non plus. Pour être performant dans cette utilisation, les produits Enduro sont solides, fiables et pourtant légers.

Per l'endurista tutto è avventura. Soffre percorrendo lunghe salite per raggiungere la cima, singletrack incotaminati, che abbondano di radici, rocce e cascate. Una giornata nel bikepark locale? Nessun problema: le parti EX sono forti, affidabili e leggere, perfettamente all'altezza del compito.

E

enduro



Das Material darf Enduro Piloten keine Grenzen setzen. Bergab gehen sie ans Limit und auch bergauf soll es leicht gehen. Mit bewährten Materialien und DT Swiss Technologie erfüllen die Komponenten der E Kategorie diese Wünsche problemlos.

The equipment of all mountain riders must not set them any limits. When the trail points downwards, they push the boundaries but still want to ride up comfortably. E category components easily stand up to these demands with proven materials and all the key DT Swiss technologies.

Le matériel ne doit pas limiter les pilotes en enduro. Ils cherchent les limites en descente mais veulent monter avec aise. Des matériaux haute qualité et des technologies exclusives DT Swiss résistent à ces exigences sans problème.

Il materiale non deve limitare i piloti enduro. In discesa cercano i limiti e salendo non vogliono disperdere troppe energie. Con materiali di alta qualità e tecnologie esclusive DT Swiss, i componenti della categoria E sono perfettamente adattati a queste esigenze.

FR

freeride



Freerider interpretieren ihre Umgebung immer wieder anders. Aus einem Fels, einem Baumstamm oder einem Treppengeländer wird ein Drop, ein Skinnie oder eine Gelegenheit zum Grinden. Die FR Produkte sind in erster Linie robust, um all dem zu widerstehen, was Natur und Fahrer dem Bike abverlangen können.

Freeriding is about interpreting your surroundings. For freeriders big rocks, fallen trees and creeks become drops, skinnies and gaps. FR products have to be tough and reliable to handle misjudged landings and emergency ejections mid-air.

En Freeride les pilotes considèrent leur environnement comme un énorme terrain de jeu. Un rocher, un arbre déraciné ou un escalier deviennent un drop, un passage en équilibre ou une possibilité pour grinder. Les produits FR doivent avant tout être fiables pour résister à tout ce que le pilote fait avec son vélo.

Il freeriding interpreta l'ambiente circostante. Per il freerider, grandi rocce, alberi caduti e ruscelli diventano salti, dislivelli e rampe. I prodotti FR devono essere resistenti ed affidabili per gestire atterraggi mal riusciti e distacchi d'emergenza a mezz'aria dalla bici.

TK/E-BIKE

trekking/touring



Das Fahrrad als Reisemittel, Alltagsfahrt oder einfach um am Wochenende in die Natur zu radeln. Egal ob auf dem E-bike oder dem reiseerprobten Drahtesel, die TK/E-bike Komponenten von DT Swiss bestechen durch Zuverlässigkeit und rundum-sorglos Technik.

The bicycle can serve for touring, commuting or simply for a quiet ride through the countryside. Equally at home on E-bikes, touring bikes, or commuters the DT Swiss TK/E-bike components ensure reliable wheels thanks to their proven technology and materials.

Qu'on utilise son vélo pour voyager, comme moyen de transport quotidien ou tout simplement pour une ballade en pleine nature le weekend. Sur un e-bike moderne ou sur un vélo de ville, les composants TK/E-bike DT Swiss se distinguent par leur fiabilité grâce à une technologie et des matériaux éprouvés.

La bici come mezzo da trasporto, per l'uso quotidiano o semplicemente per pedalare nella natura il fine settimana. Su una e-bike moderna o sulla bici da viaggio, i componenti TK/E-bike DT Swiss stupiscono con l'affidabilità e la meccanica provata.





WHEELS

MOUNTAIN || ROAD

WHEELS MTB **OVERVIEW**



XR 1501 SPLINE®



XM 1501 SPLINE®



EX 1501 SPLINE®



XRC 1250 SPLINE®



XR 1450 SPLINE®



X 1900 SPLINE®



M 1700 SPLINE®



M 1900 SPLINE®

WHEELS MTB **OVERVIEW**



EX 1750 SPLINE®



E 1900 SPLINE®



XM 1550 TRICON®



M 1700 TRICON®



FX 1950 TRICON®



XRC 950 T



EXC 1550



EX 1750

WHEELS MTB SPLINE ONE

Model	Width	Weight	Rim																Hub																				
			Built-in width [mm]	± 5% [g]	Rim dimension	Clincher	Tubular	Tubeless	Valve hole Presta ø 6.5 mm	Valve hole Schrader ø 8.5 mm	Material					Rim color						Hub axle system										Free wheel		Rotor body system			Disc mount		Hub color
											Carbon	Aluminium	Black	White	Carbon	5/100 mm RWS / Quick release	9/100 mm DT Swiss Thru bolt	15/100 mm Thru axle	20/110 mm Thru axle	Lefty	5/130 mm RWS / Quick release	5/135 mm RWS / Quick release	5/145 mm RWS / Quick release	10/135 mm DT Swiss Thru bolt	12/135 mm Thru axle	12/142 mm / X-12 Thru axle	12/150 mm Thru axle	bolt on	DT Swiss Ratchet System®	Pawl system	Shimano 9 / 10 and Sram 9 / 10	Shimano 11 Road*	Campagnolo 9 / 10 / 11	Sram MTB XD	Center Lock®	IS (6-bolt)			
																																					Carbon	Aluminium	
XR 1501 SPLINE® 26 black	100	655	559 x 20	●			●				●	●			○	○	●							○	○	○	●				●	●	○	●	●	●	black / silver		
XR 1501 SPLINE® 26 black	142	755	559 x 20	●			●				●	●											○	○	○	○	●				○	○	○	●	●	●	black / silver		
XR 1501 SPLINE® 26 black	142	745	559 x 20	●			●				●	●											○	○	○	○	●				●	○	○	○	○	●	●	●	black / silver
XR 1501 SPLINE® 27.5 black	100	680	584 x 20	●			●				●	●			○	○	●																			●	●	●	black / silver
XR 1501 SPLINE® 27.5 black	142	790	584 x 20	●			●				●	●											○	○	○	○	●				●	○	○	○	○	●	●	●	black / silver
XR 1501 SPLINE® 27.5 black	142	780	584 x 20	●			●				●	●											○	○	○	○	●				●	○	○	○	○	●	●	●	black / silver
XR 1501 SPLINE® 29 black	100	710	622 x 20	●			●				●	●			○	○	●																			●	●	●	black / silver
XR 1501 SPLINE® 29 black	142	810	622 x 20	●			●				●	●											○	○	○	○	●				●	○	○	○	○	●	●	●	black / silver
XR 1501 SPLINE® 29 black	142	800	622 x 20	●			●				●	●											○	○	○	○	●				●	○	○	○	○	●	●	●	black / silver
XM 1501 SPLINE® 26 black	100	725	559 x 22.5	●			●				●	●			○	○	●																			●	●	●	black / silver
XM 1501 SPLINE® 26 black	142	820	559 x 22.5	●			●				●	●											○	○	○	○	●				●	○	○	○	○	●	●	●	black / silver
XM 1501 SPLINE® 26 black	142	810	559 x 22.5	●			●				●	●											○	○	○	○	●				●	○	○	○	○	●	●	●	black / silver
XM 1501 SPLINE® 27.5 black	100	745	584 x 22.5	●			●				●	●			○	○	●																			●	●	●	black / silver
XM 1501 SPLINE® 27.5 black	142	845	584 x 22.5	●			●				●	●											○	○	○	○	●				●	○	○	○	○	●	●	●	black / silver
XM 1501 SPLINE® 27.5 black	142	835	584 x 22.5	●			●				●	●											○	○	○	○	●				●	○	○	○	○	●	●	●	black / silver
XM 1501 SPLINE® 29 black	100	795	622 x 22.5	●			●				●	●			○	○	●																			●	●	●	black / silver
XM 1501 SPLINE® 29 black	142	885	622 x 22.5	●			●				●	●											○	○	○	○	●				●	○	○	○	○	●	●	●	black / silver
XM 1501 SPLINE® 29 black	142	875	622 x 22.5	●			●				●	●											○	○	○	○	●				●	○	○	○	○	●	●	●	black / silver

WHEELS MTB SPLINE ONE





Nipples		Nipple color	No. of spokes	Spokes				Spoke color	Lacing	Intended use	Tubeless solution	Technical data				Recommended system weight max. [kg]	Accessories included												
DT Pro Lock® aluminium	DT Pro Lock® brass			Spoke type		Length						Tire dimension	Axle clamping force (min./max.) 4000N / 8000N	Max. tire pressure [bar]	RWS Ratchet wheelmounting system		Quick release wheelmounting system	5 mm Endcaps / Axle	15 mm Endcaps	Tubeless ready tape	Tubeless valve	Rim tape	Wheel bag	Centering tools	Center Lock® / IS (6-bolt) adapter				
				Left	Right	Left cross [mm]	Left radial [mm]																			Right cross [mm]	Right radial [mm]		
		silver	28	DT competition	DT competition	274	273	black	3-cross	XR	○	26" x 1.7" - 2.4"	●	3.5	100			●	●	●	●								
●		silver	28	DT competition	DT competition	275	274	black	3-cross	XR	○	26" x 1.7" - 2.4"	●	3.5	100	●		●	●	●	●								
●		silver	28	DT competition	DT competition	275	274	black	3-cross	XR	○	26" x 1.7" - 2.4"	●	3.5	100	●		●	●	●	●								
●		silver	28	DT competition	DT competition	287	288	black	3-cross	XR	○	27.5" x 1.7" - 2.4"	●	3.5	100	●		●	●	●	●								
●		silver	28	DT competition	DT competition	288	287	black	3-cross	XR	○	27.5" x 1.7" - 2.4"	●	3.5	100	●		●	●	●	●								
●		silver	28	DT competition	DT competition	288	287	black	3-cross	XR	○	27.5" x 1.7" - 2.4"	●	3.5	100	●		●	●	●	●								
●		silver	28	DT competition	DT competition	305	306	black	3-cross	XR	○	29" x 1.7" - 2.4"	●	3.5	100	●		●	●	●	●								
●		silver	28	DT competition	DT competition	307	305	black	3-cross	XR	○	29" x 1.7" - 2.4"	●	3.5	100	●		●	●	●	●								
●		silver	28	DT competition	DT competition	307	305	black	3-cross	XR	○	29" x 1.7" - 2.4"	●	3.5	100	●		●	●	●	●								
●		silver	28	DT competition	DT competition	272	274	black	3-cross	XM	○	26" x 1.9" - 2.5"	●	3	110	●		●	●	●	●								
●		silver	28	DT competition	DT competition	274	273	black	3-cross	XM	○	26" x 1.9" - 2.5"	●	3	110	●		●	●	●	●								
●		silver	28	DT competition	DT competition	274	273	black	3-cross	XM	○	26" x 1.9" - 2.5"	●	3	110	●		●	●	●	●								
●		silver	28	DT competition	DT competition	285	286	black	3-cross	XM	○	27.5" x 1.9" - 2.5"	●	3	110	●		●	●	●	●								
●		silver	28	DT competition	DT competition	286	285	black	3-cross	XM	○	27.5" x 1.9" - 2.5"	●	3	110	●		●	●	●	●								
●		silver	28	DT competition	DT competition	286	285	black	3-cross	XM	○	27.5" x 1.9" - 2.5"	●	3	110	●		●	●	●	●								
●		silver	28	DT competition	DT competition	303	304	black	3-cross	XM	○	29" x 1.9" - 2.5"	●	3	110	●		●	●	●	●								
●		silver	28	DT competition	DT competition	304	303	black	3-cross	XM	○	29" x 1.9" - 2.5"	●	3	110	●		●	●	●	●								
●		silver	28	DT competition	DT competition	304	303	black	3-cross	XM	○	29" x 1.9" - 2.5"	●	3	110	●		●	●	●	●								

● = Standard ○ = Convertible with included accessories ○ = Option * incl. washer for 10 speed

WHEELS MTB **SPLINE ONE**

Model	Width	Weight	Rim														Hub																					
			Built-in width [mm]	± 5% [g]	Rim dimension	Clincher	Tubular	Tubeless	Valve hole Presta ø 6.5 mm	Valve hole Schrader ø 8.5 mm	Material		Rim color		Hub axle system										Free wheel	Rotor body system		Disc mount										
											Carbon	Aluminium	Black	White	Carbon	5/100 mm RWS / Quick release	9/100 mm DT Swiss Thru bolt	15/100 mm Thru axle	20/110 mm Thru axle	Lefty	5/130 mm RWS / Quick release	5/135 mm RWS / Quick release	5/145 mm RWS / Quick release	10/135 mm DT Swiss Thru bolt		12/135 mm Thru axle	12/142 mm / X-12 Thru axle	12/150 mm Thru axle	bolt on	DT Swiss Ratchet System®	Pawl system	Shimano 9 / 10 and Sram 9 / 10	Shimano 11 Road*	Campagnolo 9 / 10 / 11	Sram MTB XD	Center Lock®	IS (6-bolt)	Hub color
EX 1501 SPLINE® 26 black	100	790	559 x 25	●			●																												●	black / silver		
EX 1501 SPLINE® 26 black	142	870	559 x 25	●			●																												●	black / silver		
EX 1501 SPLINE® 26 black	142	860	559 x 25	●			●																												●	black / silver		
EX 1501 SPLINE® 27.5 black	100	815	584 x 25	●			●																												●	black / silver		
EX 1501 SPLINE® 27.5 black	142	915	584 x 25	●			●																												●	black / silver		
EX 1501 SPLINE® 27.5 black	142	905	584 x 25	●			●																												●	black / silver		





WHEELS MTB SPLINE ONE

DT Pro Lock® aluminium		DT Pro Lock® brass		Nipples		Spokes				Technical data						Accessories included												
Nipple type		Nipple color		No. of spokes	Spoke type		Length				Spoke color	Lacing	Intended use	Tubeless solution	Tire dimension	Axle clamping force (min./max.) 4000N / 8000N	Max. tire pressure [bar]	Recommended system weight max. [kg]	RWS Ratchet wheelmounting system	Quick release wheelmounting system	5 mm Endcaps / Axle	15 mm Endcaps	Tubeless ready tape	Tubeless valve	Rim tape	Wheel bag	Centering tools	Center Lock® / IS (6-bolt) adapter
					Left	Right	Left cross [mm]	Left radial [mm]	Right cross [mm]	Right radial [mm]																		
																												
●		silver		28	DT competition	DT competition	271	273		black	3-cross	EX	○	26" x 2.1" – 2.8"	●	3	110	●		●			●					
●		silver		28	DT competition	DT competition	273	271		black	3-cross	EX	○	26" x 2.1" – 2.8"	●	3	110	●		●			●	●				
●		silver		28	DT competition	DT competition	273	271		black	3-cross	EX	○	26" x 2.1" – 2.8"	●	3	110	●		●			●	●				
●		silver		28	DT competition	DT competition	284	285		black	3-cross	EX	○	27.5" x 2.1" – 2.8"	●	3	110	●		●			●					
●		silver		28	DT competition	DT competition	285	284		black	3-cross	EX	○	27.5" x 2.1" – 2.8"	●	3	110	●		●			●	●				
●		silver		28	DT competition	DT competition	285	284		black	3-cross	EX	○	27.5" x 2.1" – 2.8"	●	3	110	●		●			●	●				

● = Standard ○ = Convertible with included accessories ○ = Option * incl. washer for 10 speed





WHEELS MTB SPLINE®

Model	Width	Weight	Rim dimension	Rim						Hub																												
				Clincher	Tubular	Tubeless	Valve hole Presta ø 6.5 mm	Valve hole Schrader ø 8.5 mm	Material		Rim color		Hub axle system											Free wheel	Rotor body system			Disc mount		Hub color								
									Carbon	Aluminium	Black	White	Carbon	5/100 mm RWS / Quick release	9/100 mm DT Swiss Thru bolt	15/100 mm Thru axle	20/110 mm Thru axle	Lefty	5/130 mm RWS / Quick release	5/135 mm RWS / Quick release	5/145 mm RWS / Quick release	10/135 mm DT Swiss Thru bolt	12/135 mm Thru axle	12/142 mm / X-12 Thru axle	12/150 mm Thru axle	bolt on	DT Swiss Ratchet System®	Pawl system	Shimano 9 / 10 and Sram 9 / 10		Shimano 11 Road*	Campagnolo 9 / 10 / 11	Sram MTB XD	Center Lock®	IS (6-bolt)			
XRC 1250 SPLINE® 27.5	100	635	584 x 21.5	●			●					●				○	○	●																		●	○	black
XRC 1250 SPLINE® 27.5	142	725	584 x 21.5	●			●					●									○			○	○	●			●					○	●	○	black	
XRC 1250 SPLINE® 29	100	695	622 x 21.5	●			●					●																							●	○	black	
XRC 1250 SPLINE® 29	142	780	622 x 21.5	●			●					●												○	○	●			●				○	●	○	black		
XR 1450 SPLINE® 26 white	100	660	559 x 18	●			●		●		●																								●	○	white	
XR 1450 SPLINE® 26 white	142	800	559 x 18	●			●		●		●																							○	●	○	white	
XR 1450 SPLINE® 29 white	100	723	622 x 18	●			●		●		●																								●	○	white	
XR 1450 SPLINE® 29 white	142	832	622 x 18	●			●		●		●																							○	●	○	white	
X 1900 SPLINE® 26 black	100	800	559 x 18	●			●		●	●																										●	○	black
X 1900 SPLINE® 26 black	142	940	559 x 18	●			●		●	●																									●	○	black	
X 1900 SPLINE® 29 black	100	870	622 x 18	●			●		●	●																										●	○	black
X 1900 SPLINE® 29 black	142	1015	622 x 18	●			●		●	●																										●	○	black

Nipples		Nipple color	No. of spokes	Spokes		Length				Spoke color	Technical data			Accessories included											
DT Pro Lock® aluminium	DT Pro Lock® brass			Left	Right	Left cross [mm]	Left radial [mm]	Right cross [mm]	Right radial [mm]		Lacing	Intended use	Tubeless solution	Tire dimension	Axle clamping force (min./max.) 4000N / 8000N	Max. tire pressure [bar]	Recommended system weight max. [kg]	RWS Ratchet wheelmounting system	Quick release wheelmounting system	5 mm Endcaps / Axle	15 mm Endcaps	Tubeless ready tape	Tubeless valve	Rim tape	Wheel bag
																									
●		black	24	DT aero comp	DT aero comp	280	282	white	2-cross	XR	○	27.5" x 1.9" – 2.4"	●	3	100	●		●		●		●	●	●	●
●		black	24	DT aero comp	DT aero comp	281	278	white	2-cross	XR	○	27.5" x 1.9" – 2.4"	●	3	100	●		●		●		●	●	●	●
●		black	28	DT aero comp	DT aero comp	303	304	white	3-cross	XR	○	29" x 1.9" – 2.4"	●	3	100	●		●		●		●	●	●	●
●		black	28	DT aero comp	DT aero comp	304	303	white	3-cross	XR	○	29" x 1.9" – 2.4"	●	3	100	●		●		●		●	●	●	●
●		black	28	DT aerolite	DT aerolite	274	275	black	3-cross	XR	○	26" x 1.5" – 2.25"	●	4	100	●		●		●					●
●		black	28	DT aerolite	DT aerolite	276	275	black	3-cross	XR	○	26" x 1.5" – 2.25"	●	4	100	●		●		●					●
●		black	28	DT aerolite	DT aerolite	305	306	black	3-cross	XR	○	29" x 1.5" – 2.25"	●	4	100	●		●		●					●
●		black	28	DT aerolite	DT aero comp	306	305	black	3-cross	XR	○	29" x 1.5" – 2.25"	●	4	100	●		●		●					●
	●	black	28	DT champion	DT champion	273	274	black	3-cross	X	○	26" x 1.5" – 2.25"	●	4	110		●	●		●					
	●	black	28	DT champion	DT champion	274	273	black	3-cross	X	○	26" x 1.5" – 2.25"	●	4	110		●	●		●					
	●	black	28	DT champion	DT champion	305	306	black	3-cross	X	○	29" x 1.5" – 2.25"	●	4	110		●	●		●					
	●	black	28	DT champion	DT champion	306	305	black	3-cross	X	○	29" x 1.5" – 2.25"	●	4	110		●	●		●					

WHEELS MTB SPLINE®

Model	Width	Weight	Rim										Hub													Hub color												
			Rim dimension	Clincher	Tubular	Tubeless	Valve hole Presta ø 6.5 mm	Valve hole Schrader ø 8.5 mm	Material		Rim color		Hub axle system										Free wheel	Rotor body system			Disc mount											
									Carbon	Aluminium	Black	White	Carbon	5/100 mm RWS / Quick release	9/100 mm DT Swiss Thru bolt	15/100 mm Thru axle	20/110 mm Thru axle	Lefty	5/130 mm RWS / Quick release	5/135 mm RWS / Quick release	5/145 mm RWS / Quick release	10/135 mm DT Swiss Thru bolt		12/135 mm Thru axle	12/142 mm / X-12 Thru axle		12/150 mm Thru axle	bolt on	DT Swiss Ratchet System®	Pawl system	Shimano 9 / 10 and Sram 9 / 10	Shimano 11 Road*	Campagnolo 9 / 10 / 11	Sram MTB XD	Center Lock®	IS (6-bolt)		
M 1700 SPLINE® 26 black	100	790	559 x 19.5	●				●	●				○	●																					●	●	●	white
M 1700 SPLINE® 26 black	142	925	559 x 19.5	●				●	●												○							●		●				○		●	●	white
M 1700 SPLINE® 27.5 black	100	820	584 x 19.5	●				●	●				○	●																						●	●	white
M 1700 SPLINE® 27.5 black	142	955	584 x 19.5	●				●	●												○		○	○	●			●		●			○		●	●	white	
M 1700 SPLINE® 29 black	100	860	622 x 19.5	●				●	●				○	●																						●	●	white
M 1700 SPLINE® 29 black	142	995	622 x 19.5	●				●	●												○		○	○	●			●		●			○		●	●	white	
M 1900 SPLINE® 26 black	100	825	559 x 19	●				●	●				○	●																						●	●	black
M 1900 SPLINE® 26 black	142	965	559 x 19	●				●	●												○		○	○	●			●		●					●	●	black	
M 1900 SPLINE® 27.5 black	100	845	584 x 19	●				●	●				○	●																						●	●	black
M 1900 SPLINE® 27.5 black	142	985	584 x 19	●				●	●												○		○	○	●			●		●						●	●	black
M 1900 SPLINE® 29 black	100	900	622 x 19	●				●	●				○	●																						●	●	black
M 1900 SPLINE® 29 black	142	1045	622 x 19	●				●	●												○		○	○	●			●		●						●	●	black

Nipples		No. of spokes	Spokes				Technical data										Accessories included										
DT Pro Lock® aluminium	DT Pro Lock® brass		Nipple color	Spoke type		Length				Spoke color	Lacing	Intended use	Tubeless solution	Tire dimension	Axle clamping force (min./max.) 4000N / 8000N	Max. tire pressure [bar]	Recommended system weight max. [kg]	RWS Ratchet wheelmounting system	Quick release wheelmounting system	5 mm Endcaps / Axle	15 mm Endcaps	Tubeless ready tape	Tubeless valve	Rim tape	Wheel bag	Centering tools	Center Lock® / IS (6-bolt) adapter
				Left	Right	Left cross [mm]	Left radial [mm]	Right cross [mm]	Right radial [mm]																		
																											
●		black	28	DT competition	DT competition	273	274	black	3-cross	M	○	26" x 1.7" - 2.4"	●	4	110		●	●			●						
●		black	28	DT competition	DT competition	274	273	black	3-cross	M	○	26" x 1.7" - 2.4"	●	4	110		●	●			●	●					
●		black	28	DT competition	DT competition	284	285	black	3-cross	M	○	27.5" x 1.7" - 2.4"	●	4	110		●	●			●						
●		black	28	DT competition	DT competition	286	285	black	3-cross	M	○	27.5" x 1.7" - 2.4"	●	4	110		●	●			●	●					
●		black	28	DT competition	DT competition	304	305	black	3-cross	M	○	29" x 1.7" - 2.4"	●	4	110		●	●			●						
●		black	28	DT competition	DT competition	305	304	black	3-cross	M	○	29" x 1.7" - 2.4"	●	4	110		●	●			●	●					
	●	black	28	DT champion	DT champion	273	274	black	3-cross	M	○	26" x 1.7" - 2.4"	●	4	110		●	●			●						
	●	black	28	DT champion	DT champion	274	273	black	3-cross	M	○	26" x 1.7" - 2.4"	●	4	110		●	●			●	●					
	●	black	28	DT champion	DT champion	285	286	black	3-cross	M	○	27.5" x 1.7" - 2.4"	●	4	110		●	●			●						
	●	black	28	DT champion	DT champion	286	285	black	3-cross	M	○	27.5" x 1.7" - 2.4"	●	4	110		●	●			●	●					
	●	black	28	DT champion	DT champion	304	305	black	3-cross	M	○	29" x 1.7" - 2.4"	●	4	110		●	●			●						
	●	black	28	DT champion	DT champion	305	304	black	3-cross	M	○	29" x 1.7" - 2.4"	●	4	110		●	●			●	●					

● = Standard ○ = Convertible with included accessories ○ = Option * incl. washer for 10 speed

WHEELS MTB SPLINE®

Model	Width	Weight	Rim											Hub																												
			Rim dimension	Clincher	Tubular	Tubeless	Valve hole Presta ø 6.5 mm	Valve hole Schrader ø 8.5 mm	Material		Rim color		Hub axle system										Free wheel	Rotor body system		Disc mount																
									Carbon	Aluminium	Black	White	Carbon	5/100 mm RWS / Quick release	9/100 mm DT Swiss Thru bolt	15/100 mm Thru axle	20/110 mm Thru axle	Lefty	5/130 mm RWS / Quick release	5/135 mm RWS / Quick release	5/145 mm RWS / Quick release	10/135 mm DT Swiss Thru bolt	12/135 mm Thru axle	12/142 mm / X-12 Thru axle	12/150 mm Thru axle	bolt on	DT Swiss Ratchet System®	Pawl system	Shimano 9 / 10 and Sram 9 / 10	Shimano 11 Road*	Campagnolo 9 / 10 / 11	Sram MTB XD	Center Lock®	IS (6-bolt)	Hub color							
																																				Carbon	Aluminium	Black	White	Carbon	5/100 mm RWS / Quick release	9/100 mm DT Swiss Thru bolt
Built-in width [mm]	± 5% [g]																																									
EX 1750 SPLINE® 26 black	110	780	559 x 21	●	●	●	●	●	●	○	●	●	●	●	○	○	○	○	○	○	○	○	○	○	○	○	○	○	○	○	○	○	○	●	white							
EX 1750 SPLINE® 26 black	142	875	559 x 21	●	●	●	●	●	●	○	●	●	●	●	○	○	○	○	○	○	○	○	○	○	○	○	○	○	○	○	○	○	○	○	●	white						
EX 1750 SPLINE® 26 black	150	915	559 x 21	●	●	●	●	●	●	○	●	●	●	●	○	○	○	○	○	○	○	○	○	○	○	○	○	○	○	○	○	○	○	○	○	●	white					
EX 1750 SPLINE® 27.5 black	110	825	584 x 21	●	●	●	●	●	●	○	●	●	●	●	○	○	○	○	○	○	○	○	○	○	○	○	○	○	○	○	○	○	○	○	○	●	white					
EX 1750 SPLINE® 27.5 black	142	915	584 x 21	●	●	●	●	●	●	○	●	●	●	●	○	○	○	○	○	○	○	○	○	○	○	○	○	○	○	○	○	○	○	○	○	○	●	white				
EX 1750 SPLINE® 27.5 black	150	955	584 x 21	●	●	●	●	●	●	○	●	●	●	●	○	○	○	○	○	○	○	○	○	○	○	○	○	○	○	○	○	○	○	○	○	○	●	white				
E 1900 SPLINE® 26 black	100	885	559 x 22	●	●	●	●	●	●	○	●	●	●	●	○	○	○	○	○	○	○	○	○	○	○	○	○	○	○	○	○	○	○	○	○	○	●	black				
E 1900 SPLINE® 26 black	110	985	559 x 22	●	●	●	●	●	●	○	●	●	●	●	○	○	○	○	○	○	○	○	○	○	○	○	○	○	○	○	○	○	○	○	○	○	○	●	black			
E 1900 SPLINE® 26 black	142	1030	559 x 22	●	●	●	●	●	●	○	●	●	●	●	○	○	○	○	○	○	○	○	○	○	○	○	○	○	○	○	○	○	○	○	○	○	○	○	●	black		
E 1900 SPLINE® 27.5 black	100	910	584 x 22	●	●	●	●	●	●	○	●	●	●	●	○	○	○	○	○	○	○	○	○	○	○	○	○	○	○	○	○	○	○	○	○	○	○	○	●	black		
E 1900 SPLINE® 27.5 black	110	1010	584 x 22	●	●	●	●	●	●	○	●	●	●	●	○	○	○	○	○	○	○	○	○	○	○	○	○	○	○	○	○	○	○	○	○	○	○	○	○	●	black	
E 1900 SPLINE® 27.5 black	142	1050	584 x 22	●	●	●	●	●	●	○	●	●	●	●	○	○	○	○	○	○	○	○	○	○	○	○	○	○	○	○	○	○	○	○	○	○	○	○	○	○	●	black

Nipples		No. of spokes	Spokes				Spoke color	Lacing	Intended use	Tubeless solution	Technical data				Accessories included										
DT Pro Lock® aluminium	DT Pro Lock® brass		Nipple color	Spoke type		Length					Tire dimension	Axle clamping force (min./max.) 4000N / 8000N	Max. tire pressure [bar]	Recommended system weight max. [kg]	RWS Ratchet wheelmounting system	Quick release wheelmounting system	5 mm Endcaps / Axle	15 mm Endcaps	Tubeless ready tape	Tubeless valve	Rim tape	Wheel bag	Centering tools	Center Lock® / IS (6-bolt) adapter	
				Left	Right	Left cross [mm]																			Left radial [mm]
●		black	28	DT aerolite	DT aerolite	272	273	black	3-cross	EX	○	26" x 1.9" – 2.5"	●	3	130										
●		black	28	DT aerolite	DT aero comp	273	272	black	3-cross	EX	○	26" x 1.9" – 2.5"	●	3	130		●		●	●					
●		black	28	DT aero comp	DT aero comp	273	273	black	3-cross	EX	○	26" x 1.9" – 2.5"	●	3	130				●	●					
●		black	28	DT aero comp	DT aerolite	285	286	black	3-cross	EX	○	27.5" x 1.9" – 2.5"	●	3	130			●		●					
●		black	28	DT aero comp	DT aero comp	286	285	black	3-cross	EX	○	27.5" x 1.9" – 2.5"	●	3	130	●		●		●	●				
●		black	28	DT aero comp	DT aero comp	285	285	black	3-cross	EX	○	27.5" x 1.9" – 2.5"	●	3	130				●	●					
	●	black	28	DT champion	DT champion	272	273	black	3-cross	E	○	26" x 1.9" – 2.5"	●	3	130					●					
	●	black	28	DT champion	DT champion	274	274	black	3-cross	E	○	26" x 1.9" – 2.5"	●	3	130					●					
	●	black	28	DT champion	DT champion	273	272	black	3-cross	E	○	26" x 1.9" – 2.5"	●	3	130		●	●		●	●				
	●	black	28	DT champion	DT champion	284	285	black	3-cross	E	○	27.5" x 1.9" – 2.5"	●	3	130					●					
	●	black	28	DT champion	DT champion	286	286	black	3-cross	E	○	27.5" x 1.9" – 2.5"	●	3	130					●					
	●	black	28	DT champion	DT champion	285	284	black	3-cross	E	○	27.5" x 1.9" – 2.5"	●	3	130		●	●		●	●				

WHEELS MTB TRICON®

Model	Width Built-in width [mm]	Weight ± 5% [g]	Rim							Hub															Hub color								
			Rim dimension	Clincher	Tubular	Tubeless	Valve hole Presta ø 6.5 mm	Valve hole Schrader ø 8.5 mm	Material		Rim color		Hub axle system										Free wheel	Rotor body system		Disc mount							
									Carbon	Aluminium	Black	White	Carbon	5/100 mm RWS / Quick release	9/100 mm DT Swiss Thru bolt	15/100 mm Thru axle	20/110 mm Thru axle	Lefty	5/130 mm RWS / Quick release	5/135 mm RWS / Quick release	5/145 mm RWS / Quick release	10/135 mm DT Swiss Thru bolt	12/135 mm Thru axle	12/142 mm / X-12 Thru axle		12/150 mm Thru axle	bolt on	DT Swiss Ratchet System®	Pawl system	Shimano 9 / 10 and Sram 9 / 10	Shimano 11 Road*	Campagnolo 9 / 10 / 11	Sram MTB XD
XM 1550 TRICON® 26 black	100	720	559 x 19.5	●	●	●	●	●	●	●	○	●	○																		●	○	black/gun metal
XM 1550 TRICON® 26 black	100	730	559 x 19.5	●	●	●	●	●	●	●	○	○	●																		●	○	black/gun metal
XM 1550 TRICON® 26 black	135	855	559 x 19.5	●	●	●	●	●	●	●								○	●	○	○		●	●				○	●	○	black/gun metal		
XM 1550 TRICON® 26 black	142	850	559 x 19.5	●	●	●	●	●	●	●									○	○	○	●	●	●				○	●	○	black/gun metal		
XM 1550 TRICON® 29 black	100	835	622 x 19.5	●	●	●	●	●	●	●	○	●	○																		●	○	black/gun metal
XM 1550 TRICON® 29 black	100	845	622 x 19.5	●	●	●	●	●	●	●	○	○	●																		●	○	black/gun metal
XM 1550 TRICON® 29 black	135	970	622 x 19.5	●	●	●	●	●	●	●									○	●	○	○	●	●	●			○	●	○	black/gun metal		
XM 1550 TRICON® 29 black	142	965	622 x 19.5	●	●	●	●	●	●	●									○	○	○	●	●	●			○	●	○	black/gun metal			
M 1700 TRICON® 26 black	100	800	559 x 19.5	●	●	●	●	●	●	●	●																				●	○	black
M 1700 TRICON® 26 black	100	780	559 x 19.5	●	●	●	●	●	●	●	○		●																		●	○	black
M 1700 TRICON® 26 black	135	900	559 x 19.5	●	●	●	●	●	●	●									●	○	○	○	●	●	●			○	●	○	black		
M 1700 TRICON® 26 black	142	895	559 x 19.5	●	●	●	●	●	●	●									○	○	○	●	●	●			○	●	○	black			
FX 1950 TRICON® 26 black	100	965	559 x 23	●	●	●	●	●	●	●	○	○	●	○																	●	green	
FX 1950 TRICON® 26 black	110	960	559 x 23	●	●	●	●	●	●	●	○	○	○	●																	●	green	
FX 1950 TRICON® 26 black	135	1035	559 x 23	●	●	●	●	●	●	●									○	●	○	○	●	●	●			○	●	green			
FX 1950 TRICON® 26 black	142	1040	559 x 23	●	●	●	●	●	●	●									○	○	○	●	●	●			○	●	green				
FX 1950 TRICON® 26 black	150	1070	559 x 23	●	●	●	●	●	●	●												●	●	●			○	●	green				

Nipples		Nipple color	No. of spokes	Spokes		Length				Spoke color	Technical data			Axle clamping force (min./max.) 4000N / 8000N	Max. tire pressure [bar]	Recommended system weight max. [kg]	Accessories included												
DT Pro Lock® aluminium	DT Pro Lock® brass			Left	Right	Left cross [mm]	Left radial [mm]	Right cross [mm]	Right radial [mm]		Lacing	Intended use	Tubeless solution				Tire dimension	RWS Ratchet wheelmounting system	Quick release wheelmounting system	5 mm Endcaps / Axle	15 mm Endcaps	Tubeless ready tape	Tubeless valve	Rim tape	Wheel bag	Centering tools	Center Lock® / IS (6-bolt) adapter		
●		black	24	DT aerolite	DT aerolite	256	247	258	248	white	open crowfoot	XM	●	26" x 1.7" - 2.4"	●	4	110	●					●	●					●
●		black	24	DT aerolite	DT aerolite	256	247	258	248	white	open crowfoot	XM	●	26" x 1.7" - 2.4"	●	4	110					●	●						●
●		black	24	DT aerolite	DT new aero	257	248	255	243	white	open crowfoot	XM	●	26" x 1.7" - 2.4"	●	4	110	●					●	●					●
●		black	24	DT aerolite	DT new aero	257	248	255	243	white	open crowfoot	XM	●	26" x 1.7" - 2.4"	●	4	110					●	●						●
●		black	30	DT aerolite	DT aerolite	284	277	286	280	white	open crowfoot	XM	●	29" x 1.7" - 2.4"	●	4	110	●					●	●					●
●		black	30	DT aerolite	DT aerolite	284	277	286	280	white	open crowfoot	XM	●	29" x 1.7" - 2.4"	●	4	110					●	●						●
●		black	30	DT aerolite	DT new aero	286	279	283	274	white	open crowfoot	XM	●	29" x 1.7" - 2.4"	●	4	110	●					●	●					●
●		black	30	DT aerolite	DT new aero	286	279	283	274	white	open crowfoot	XM	●	29" x 1.7" - 2.4"	●	4	110					●	●						●
●		silver	24	DT new aero	DT new aero	256	247	258	249	black	open crowfoot	M	●	26" x 1.7" - 2.4"	●	4	120	●					●	●					●
●		silver	24	DT new aero	DT new aero	256	247	258	249	black	open crowfoot	M	●	26" x 1.7" - 2.4"	●	4	120					●	●						●
●		silver	24	DT new aero	DT new aero	257	249	255	244	black	open crowfoot	M	●	26" x 1.7" - 2.4"	●	4	120	●					●	●					●
●		silver	24	DT new aero	DT new aero	257	249	255	244	black	open crowfoot	M	●	26" x 1.7" - 2.4"	●	4	120					●	●						●
●		black	30	DT aero comp	DT aero comp	251	243	252	244	white	open crowfoot	FR	●	26" x 1.9" - 2.7"	●	3	130					●	●						
●		black	30	DT aero comp	DT aero comp	251	243	252	244	white	open crowfoot	FR	●	26" x 1.9" - 2.7"	●	3	130					●	●						
●		black	30	DT aero comp	DT aero comp	253	245	252	243	white	open crowfoot	FR	●	26" x 1.9" - 2.7"	●	3	130	●					●	●					
●		black	30	DT aero comp	DT aero comp	253	245	252	243	white	open crowfoot	FR	●	26" x 1.9" - 2.7"	●	3	130					●	●						
●		black	30	DT aero comp	DT aero comp	253	245	253	244	white	open crowfoot	FR	●	26" x 1.9" - 2.7"	●	3	130					●	●						

● = Standard

○ = Convertible with included accessories

○ = Option

* incl. washer for 10 speed

WHEELS MTB CLASSIC

Model	Width	Weight	Rim										Hub										Hub color							
			Rim dimension	Clincher	Tubular	Tubeless	Valve hole Presta ø 6.5 mm	Valve hole Schrader ø 8.5 mm	Material		Rim color		Hub axle system											Free wheel	Rotor body system		Disc mount			
									Carbon	Aluminium	Black	White	Carbon	5/100 mm RWS / Quick release	9/100 mm DT Swiss Thru bolt	15/100 mm Thru axle	20/110 mm Thru axle	Lefty	5/130 mm RWS / Quick release	5/135 mm RWS / Quick release	5/145 mm RWS / Quick release	10/135 mm DT Swiss Thru bolt			12/135 mm Thru axle	12/142 mm / X-12 Thru axle	12/150 mm Thru axle	bolt on	DT Swiss Ratchet System®	Pawl system
Built-in width [mm]	± 5% [g]	TUBULAR		TUBELESS		CARBON				15		20		12		X-12		12		RATCHET SYSTEM		Pawl		9		15				
XRC 950 T 26	100	510	571 x 26	●	●	●			●	●	○																	●	●	black / carbon
XRC 950 T 26	100	525	571 x 26	●	●	●			●	○	○	●															●	●	black / carbon	
XRC 950 T 26	135	610	571 x 26	●	●	●			●						●		○	○	○		●		●			○	●	●	black / carbon	
XRC 950 T 26	142	605	571 x 26	●	●	●			●						○		○	○	●		●		●			○	●	●	black / carbon	
XRC 950 T 29	100	580	633 x 26	●	●	●			●	●	○																●	●	black / carbon	
XRC 950 T 29	100	595	633 x 26	●	●	●			●	○	○	●															●	●	black / carbon	
XRC 950 T 29	135	680	633 x 26	●	●	●			●						●		○	○	○		●		●			○	●	●	black / carbon	
XRC 950 T 29	142	675	633 x 26	●	●	●			●						○		○	○	●		●		●			○	●	●	black / carbon	
EXC 1550 26	100	715	559 x 21	●	●	●			●	○	○	●	○														●		black	
EXC 1550 26	110	715	559 x 21	●	●	●			●	○	○	○	●														●		black	
EXC 1550 26	135	815	559 x 21	●	●	●			●						○		●	○	○		●		●			○	●		black	
EXC 1550 26	142	815	559 x 21	●	●	●			●						○		○	○	●		●		●			○	●		black	
EX 1750 26	100	830	559 x 21	●	●	●	●		●		○	○	●	○													●		white	
EX 1750 26	110	830	559 x 21	●	●	●	●	●	●		○	○	○	●													●		white	
EX 1750 26	135	930	559 x 21	●	●	●	●	●	●						○		●	○	○		●		●			○	●		white	
EX 1750 26	142	930	559 x 21	●	●	●	●	●	●						○		○	○	●		●		●			○	●		white	
EX 1750 26	150	955	559 x 21	●	●	●	●	●	●								●				●		●			○	●		white	

Nipples		No. of spokes	Spokes				Technical data										Accessories included										
DT Pro Lock® aluminium	DT Pro Lock® brass		Spoke type		Length		Spoke color	Lacing	Intended use	Tubeless solution	Tire dimension	Axle clamping force (min./max.) 4000N / 8000N	Max. tire pressure [bar]	Recommended system weight max. [kg]	RWS Ratchet wheelmounting system	Quick release wheelmounting system	5 mm Endcaps / Axle	15 mm Endcaps	Tubeless ready tape	Tubeless valve	Rim tape	Wheel bag	Centering tools	Center Lock® / IS (6-bolt) adapter			
			Left	Right	Left cross [mm]	Left radial [mm]																			Right cross [mm]	Right radial [mm]	
DT Pro Lock® aluminium	DT Pro Lock® brass	Nipple color	Left	Right	Left cross [mm]	Left radial [mm]	Right cross [mm]	Right radial [mm]	Spoke color	Lacing	Intended use	Tubeless solution	Tire dimension	Axle clamping force (min./max.) 4000N / 8000N	Max. tire pressure [bar]	Recommended system weight max. [kg]	RWS Ratchet wheelmounting system	Quick release wheelmounting system	5 mm Endcaps / Axle	15 mm Endcaps	Tubeless ready tape	Tubeless valve	Rim tape	Wheel bag	Centering tools	Center Lock® / IS (6-bolt) adapter	
●	●	black	28	DT aerolite	DT aerolite	257	260	white	3-cross	XR	-	26" x 1.95" – 2.2"	●	4	95	●							●		●	●	
●	●	black	28	DT aerolite	DT aerolite	257	260	white	3-cross	XR	-	26" x 1.95" – 2.2"	●	4	95									●		●	●
●	●	black	28	DT aerolite	DT aerolite	257	255	white	3-cross	XR	-	26" x 1.95" – 2.2"	●	4	95	●								●	●	●	●
●	●	black	28	DT aerolite	DT aerolite	257	255	white	3-cross	XR	-	26" x 1.95" – 2.2"	●	4	95									●	●	●	●
●	●	black	32	DT aerolite	DT aerolite	284	286	white	3-cross	XR	-	29" x 1.95" – 2.2"	●	4	95	●								●		●	●
●	●	black	32	DT aerolite	DT aerolite	284	286	white	3-cross	XR	-	29" x 1.95" – 2.2"	●	4	95									●		●	●
●	●	black	32	DT aerolite	DT aerolite	284	282	white	3-cross	XR	-	29" x 1.95" – 2.2"	●	4	95	●								●	●	●	●
●	●	black	32	DT aerolite	DT aerolite	284	282	white	3-cross	XR	-	29" x 1.95" – 2.2"	●	4	95									●	●	●	●
●	●	red	32	DT aerolite	DT aerolite	259	260	white	3-cross	EX	-	26" x 1.9" – 2.5"	●	3	120								●	●			
●	●	red	32	DT aerolite	DT aerolite	259	260	white	3-cross	EX	-	26" x 1.9" – 2.5"	●	3	120									●	●		
●	●	red	32	DT aerolite	DT aerolite	260	260	white	3-cross	EX	-	26" x 1.9" – 2.5"	●	3	120	●								●	●	●	
●	●	red	32	DT aerolite	DT aerolite	260	260	white	3-cross	EX	-	26" x 1.9" – 2.5"	●	3	120									●	●	●	
●	●	red	32	DT aerolite	DT aerolite	260	262	black	3-cross	EX	○	26" x 1.9" – 2.5"	●	3	130									●			
●	●	red	32	DT aerolite	DT aerolite	260	262	black	3-cross	EX	○	26" x 1.9" – 2.5"	●	3	130									●			
●	●	red	32	DT aerolite	DT aerolite	261	261	black	3-cross	EX	○	26" x 1.9" – 2.5"	●	3	130	●								●			
●	●	red	32	DT aerolite	DT aerolite	261	261	black	3-cross	EX	○	26" x 1.9" – 2.5"	●	3	130									●			
●	●	red	32	DT aerolite	DT aerolite	261	261	black	3-cross	EX	○	26" x 1.9" – 2.5"	●	3	130									●			

WHEELS ROAD **OVERVIEW**



RRC 32 DICUT® C



RRC 46 DICUT® C



RRC 66 DICUT® C



RRC disc DICUT® C



RRC 32 DICUT® T



RRC 46 DICUT® T



RRC 66 DICUT® T



RRC disc DICUT® T



RRC 46 DICUT® H



RR 21 DICUT® white



RR 21 DICUT® black

WHEELS ROAD **OVERVIEW**



RC 28 SPLINE® C



RC 28 SPLINE® C db



RC 38 SPLINE® C



RC 38 SPLINE® T



RC 38 SPLINE® C db



RC 38 SPLINE® T db



RC 55 SPLINE® C



RC 55 SPLINE® T



RC 46 SPLINE® H



R 23 SPLINE® black



R 23 SPLINE® white



R 28 SPLINE®



RR 1450 TRICON® black



RR 1450 TRICON® white











R 1700 TRICON®





WHEELS ROAD **DICUT®**

Model	Width	Weight	Rim										Hub										Hub color													
			Rim dimension	Clincher	Tubular	Tubeless	Valve hole Presta ø 6.5 mm	Valve hole Schrader ø 8.5 mm	Material		Rim color		Hub axle system											Free wheel	Rotor body system		Disc mount									
									Carbon	Aluminium	Black	White	Carbon	5/100 mm RWS / Quick release	9/100 mm DT Swiss Thru bolt	15/100 mm Thru axle	20/110 mm Thru axle	Lefty	5/130 mm RWS / Quick release	5/135 mm RWS / Quick release	5/145 mm RWS / Quick release	10/135 mm DT Swiss Thru bolt			12/135 mm Thru axle	12/142 mm / X-12 Thru axle	12/150 mm Thru axle	bolt on	DT Swiss Ratchet System®	Pawl system	Shimano 9 / 10 and Sram 9 / 10	Shimano 11 Road*	Campagnolo 9 / 10 / 11	Sram MTB XD	Center Lock®	IS (6-bolt)
Built-in width [mm]	± 5% [g]	Rim dimension	Clincher	Tubular	Tubeless	Valve hole Presta ø 6.5 mm	Valve hole Schrader ø 8.5 mm	Carbon	Aluminium	Black	White	Carbon	5/100 mm RWS / Quick release	9/100 mm DT Swiss Thru bolt	15/100 mm Thru axle	20/110 mm Thru axle	Lefty	5/130 mm RWS / Quick release	5/135 mm RWS / Quick release	5/145 mm RWS / Quick release	10/135 mm DT Swiss Thru bolt	12/135 mm Thru axle	12/142 mm / X-12 Thru axle	12/150 mm Thru axle	bolt on	DT Swiss Ratchet System®	Pawl system	Shimano 9 / 10 and Sram 9 / 10	Shimano 11 Road*	Campagnolo 9 / 10 / 11	Sram MTB XD	Center Lock®	IS (6-bolt)	Hub color		
RRC 32 DICUT® C	100	600	622 x 15	●	●	●	●	●				●	●	●	●	●	●	●	●	●	●	●	●	●	●	●	●	●	●	●	●	●	●	●	●	black
RRC 32 DICUT® C	130	750	622 x 15	●		●	●	●				●						●								●	○	●	○						black	
RRC 32 DICUT® T	100	470	633 x 20.5		●	●	●	●				●	●																						black	
RRC 32 DICUT® T	130	620	633 x 20.5		●	●	●	●				●															●	○	●	○					black	
RRC 46 DICUT® C	100	640	622 x 15	●		●	●	●				●	●																						black	
RRC 46 DICUT® C	130	790	622 x 15	●		●	●	●				●															●	○	●	○					black	
RRC 46 DICUT® T	100	530	633 x 20.5		●	●	●	●				●	●																						black	
RRC 46 DICUT® T	130	680	633 x 20.5		●	●	●	●				●															●	○	●	○					black	
RRC 66 DICUT® C	100	735	622 x 15	●		●	●	●				●	●																						black	
RRC 66 DICUT® C	130	880	622 x 15	●		●	●	●				●															●	○	●	○					black	
RRC 66 DICUT® T	100	635	633 x 20.5		●	●	●	●				●	●																						black	
RRC 66 DICUT® T	130	780	633 x 20.5		●	●	●	●				●															●	○	●	○					black	
RRC DISC C	130	1200	622 x 15	●		●	●	●				●	●																						black	
RRC DISC T	130	1050	633 x 20.5		●	●	●	●				●															●	○	●	○					black	
RRC 46 DICUT® H	100	725	622 x 16	●		●	●	●				●	●																						black	
RRC 46 DICUT® H	130	860	622 x 16	●		●	●	●				●															●	○	●	○					black	
RR 21 DICUT®	100	660	622 x 16	●		●		●		●		●																							white	
RR 21 DICUT®	130	810	622 x 16	●		●		●		●		●															●	○	●	○					white	
RR 21 DICUT®	100	655	622 x 16	●		●		●		●		●																							black	
RR 21 DICUT®	130	805	622 x 16	●		●		●		●		●															●	○	●	○					black	









Nipples		Nipple color	No. of spokes	Spokes				Spoke color	Lacing	Intended use	Tubeless solution	Technical data				Recommended system weight max. [kg]	Accessories included												
DT Pro Lock® aluminium	DT Pro Lock® brass			Spoke type		Length						Tire dimension	Axle clamping force (min./max.) 4000N / 8000N	Max. tire pressure [bar]	RWS Ratchet wheelmounting system		Quick release wheelmounting system	5 mm Endcaps / Axle	15 mm Endcaps	Tubeless ready tape	Tubeless valve	Rim tape	Wheel bag	Centering tools	Center Lock® / IS (6-bolt) adapter				
				Left	Right	Left cross [mm]	Left radial [mm]																			Right cross [mm]	Right radial [mm]		
		silver	20	DT aerolite	DT aerolite		280	280	white	radial	RR -	700 x 19C – 23C	●	9	100														
●		silver	24	DT aerolite	DT aero comp	283	277		white	2-cross	RR -	700 x 19C – 23C	●	9	100	●													
●		silver	20	DT aerolite	DT aerolite		280	280	white	radial	RR -	700 X 19T – 23T	●	14	100	●													
●		silver	24	DT aerolite	DT aero comp	283	277		white	2-cross	RR -	700 X 19T – 23T	●	14	100	●													
●		silver	20	DT aerolite	DT aerolite		266	266	white	radial	RR -	700 x 19C – 23C	●	9	100	●													
●		silver	24	DT aerolite	DT aero comp	270	262		white	2-cross	RR -	700 x 19C – 23C	●	9	100	●													
●		silver	20	DT aerolite	DT aerolite		266	266	white	radial	RR -	700 X 19T – 23T	●	14	100	●													
●		silver	24	DT aerolite	DT aero comp	270	262		white	2-cross	RR -	700 X 19T – 23T	●	14	100	●													
●		silver	16	DT aerolite	DT aerolite		248	248	white	radial	RR -	700 x 19C – 23C	●	9	100	●													
●		silver	20	DT aerolite	DT aero comp	254	246		white	2-cross	RR -	700 x 19C – 23C	●	9	100	●													
●		silver	16	DT aerolite	DT aerolite		248	248	white	radial	RR -	700 X 19T – 23T	●	14	100	●													
●		silver	20	DT aerolite	DT aero comp	254	247		white	2-cross	RR -	700 X 19T – 23T	●	14	100	●													
-	-	-	-	-	-	-	-	-	-	-	RR -	700 x 19C – 23C	●	9	100	●													
-	-	-	-	-	-	-	-	-	-	-	RR -	700 X 19T – 23T	●	14	100	●													
●		silver	20	DT aerolite	DT aerolite		268	268	white	radial	RR ○	700 x 19C – 25C	●	9	110	●													
●		silver	24	DT aerolite	DT aero comp	272	264		white	2-cross	RR ○	700 x 19C – 25C	●	9	110	●													
●		black	20	DT aerolite	DT aerolite		281	281	black	radial	RR ○	700 x 19C – 32C	●	9	110	●													
●		black	24	DT aerolite	DT aero comp	286	279		black	2-cross	RR ○	700 x 19C – 32C	●	9	110	●													
●		black	20	DT aerolite	DT aerolite		281	281	white	radial	RR ○	700 x 19C – 32C	●	9	110	●													
●		black	24	DT aerolite	DT aero comp	286	279		white	2-cross	RR ○	700 x 19C – 32C	●	9	110	●													



WHEELS ROAD **SPLINE®**

Model	Width	Weight	Rim												Hub												Hub color									
			Rim dimension	Clincher	Tubular	Tubeless	Valve hole Presta ø 6.5 mm	Valve hole Schrader ø 8.5 mm	Material		Rim color		Hub axle system												Free wheel	Rotor body system		Disc mount								
									Carbon	Aluminium	Black	White	Carbon	5/100 mm RWS / Quick release	9/100 mm DT Swiss Thru bolt	15/100 mm Thru axle	20/110 mm Thru axle	Lefty	5/130 mm RWS / Quick release	5/135 mm RWS / Quick release	5/145 mm RWS / Quick release	10/135 mm DT Swiss Thru bolt	12/135 mm Thru axle	12/142 mm / X-12 Thru axle		12/150 mm Thru axle		bolt on	DT Swiss Ratchet System®	Pawl system	Shimano 9 / 10 and Sram 9 / 10	Shimano 11 Road*	Campagnolo 9 / 10 / 11	Sram MTB XD	Center Lock®	IS (6-bolt)
RC 28 SPLINE® C	100	585	622 x 15	●			●																											white		
RC 28 SPLINE® C	130	800	622 x 15	●			●																											white		
RC 28 SPLINE® C db	100	655	622 x 15	●			●																										●	○	white	
RC 28 SPLINE® C db	135	775	622 x 15	●			●																										●	○	white	
RC 38 SPLINE® T	100	565	633 x 21		●		●																												white	
RC 38 SPLINE® T	130	745	633 x 21		●		●																												white	
RC 38 SPLINE® C	100	630	622 x 15	●			●																												white	
RC 38 SPLINE® C	130	845	622 x 15	●			●																												white	
RC 38 SPLINE® T db	100	635	633 x 21		●		●																										●	○	white	
RC 38 SPLINE® T db	135	755	633 x 21		●		●																											●	○	white
RC 38 SPLINE® C db	100	700	622 x 15	●			●																											●	○	white
RC 38 SPLINE® C db	135	820	622 x 15	●			●																											●	○	white
RC 55 SPLINE® T	100	615	633 x 21		●		●																													white
RC 55 SPLINE® T	130	825	633 x 21		●		●																													white
RC 55 SPLINE® C	100	710	622 x 15	●			●																													white
RC 55 SPLINE® C	130	920	622 x 15	●			●																													white
RC 46 SPLINE® H	100	760	622 x 16	●			●																													white
RC 46 SPLINE® H	130	940	622 x 16	●			●																													white

Nipples		No. of spokes	Spokes				Technical data										Accessories included										
DT Pro Lock® aluminium	DT Pro Lock® brass		Nipple color	Spoke type		Length				Spoke color	Lacing	Intended use	Tubeless solution	Tire dimension	Axle clamping force (min./max.) 4000N / 8000N	Max. tire pressure [bar]	Recommended system weight max. [kg]	RWS Ratchet wheelmounting system	Quick release wheelmounting system	5 mm Endcaps / Axle	15 mm Endcaps	Tubeless ready tape	Tubeless valve	Rim tape	Wheel bag	Centering tools	Center Lock® / IS (6-bolt) adapter
				Left	Right	Left cross [mm]	Left radial [mm]	Right cross [mm]	Right radial [mm]																		
																											
●		silver	20	DT aerolite	DT aerolite		290		290	black	radial	RR -	700 x 19C - 25C	●	9	100	●									●	●
●		silver	24	DT aero comp	DT aero comp	302		300		black	2-cross	RR -	700 x 19C - 25C	●	9	100	●								●	●	
●		silver	24	DT aerolite	DT aerolite	303		302		black	2-cross	RR -	700 x 19C - 28C	●	9	110	●								●	●	●
●		silver	24	DT aerolite	DT aerolite	302		300		black	2-cross	RR -	700 x 19C - 28C	●	9	110	●								●	●	●
●		silver	20	DT aerolite	DT aerolite		281		281	black	radial	RR -	700 X 19T - 25T	●	14	100	●									●	
●		silver	24	DT aerolite	DT aerolite	293		291		black	2-cross	RR -	700 X 19T - 25T	●	14	100	●									●	
●		silver	20	DT aerolite	DT aerolite		281		281	black	radial	RR -	700 x 19C - 25C	●	9	100	●								●	●	
●		silver	24	DT aero comp	DT aero comp	293		291		black	2-cross	RR -	700 x 19C - 25C	●	9	100	●								●	●	
●		silver	24	DT aerolite	DT aerolite	291		293		black	2-cross	RR -	700 X 19T - 27T	●	14	110	●								●	●	
●		silver	24	DT aerolite	DT aerolite	292		291		black	2-cross	RR -	700 X 19T - 27T	●	14	110	●								●	●	
●		silver	24	DT aerolite	DT aerolite	291		293		black	2-cross	RR -	700 x 19C - 28C	●	9	110	●								●	●	●
●		silver	24	DT aerolite	DT aerolite	292		291		black	2-cross	RR -	700 x 19C - 28C	●	9	110	●								●	●	●
●		silver	20	DT aerolite	DT aerolite		265		265	black	radial	RR -	700 X 19T - 25T	●	14	100	●									●	
●		silver	24	DT aero comp	DT aero comp	276		274		black	2-cross	RR -	700 X 19T - 25T	●	14	100	●									●	
●		silver	20	DT aerolite	DT aerolite		265		265	black	radial	RR -	700 x 19C - 25C	●	9	100	●								●	●	
●		silver	24	DT aero comp	DT aero comp	276		274		black	2-cross	RR -	700 x 19C - 25C	●	9	100	●								●	●	
●		silver	20	DT aero comp	DT aero comp		275		275	black	radial	RR -	700 x 19C - 25C	●	9	110	●								●	●	
●		silver	24	DT aero comp	DT aero comp	285		283		black	2-cross	RR -	700 x 19C - 25C	●	9	110	●								●	●	

WHEELS ROAD **SPLINE®**

Model	Width	Weight	Rim dimension	Rim			Material		Rim color		Hub axle system												Free wheel		Rotor body system			Disc mount		Hub color											
				Built-in width [mm]	± 5% [g]	Clincher	Tubular	Tubeless	Valve hole Presta ø 6.5 mm	Valve hole Schrader ø 8.5 mm	Carbon	Aluminium	Black	White	Carbon	5/100 mm RWS / Quick release	9/100 mm DT Swiss Thru bolt	15/100 mm Thru axle	20/110 mm Thru axle	Lefty	5/130 mm RWS / Quick release	5/135 mm RWS / Quick release	5/145 mm RWS / Quick release	10/135 mm DT Swiss Thru bolt	12/135 mm Thru axle	12/142 mm / X-12 Thru axle	12/150 mm Thru axle	bolt on	DT Swiss Ratchet System®		Pawl system	Shimano 9 / 10 and Sram 9 / 10	Shimano 11 Road*	Campagnolo 9 / 10 / 11	Sram MTB XD	Center Lock®	IS (6-bolt)				
																																						Hub axle system	Free wheel	Rotor body system	Disc mount
R 23 SPLINE®	100	660	622 x 15	●			●																																	white	
R 23 SPLINE®	130	860	622 x 15	●			●		●											●										●		○	●	○							white
R 23 SPLINE®	100	660	622 x 15	●			●	●							●															●		○	●	○							white
R 23 SPLINE®	130	860	622 x 15	●			●	●							●															●		○	●	○							white
R 28 SPLINE®	100	790	622 x 14	●			●	●						●																											black
R 28 SPLINE®	130	1100	622 x 14	●			●	●						●																●	○	●	○								black

DT Pro Lock® aluminium		DT Pro Lock® brass		Nipples		Spokes				Technical data			Accessories included													
Nipple type	Nipple color	No. of spokes	Spoke type		Length				Spoke color	Lacing	Intended use	Tubeless solution	Tire dimension	Axle clamping force (min./max.) 4000N / 8000N	Max. tire pressure [bar]	Recommended system weight max. [kg]	RWS Ratchet wheelmounting system	Quick release wheelmounting system	5 mm Endcaps / Axle	15 mm Endcaps	Tubeless ready tape	Tubeless valve	Rim tape	Wheel bag	Centering tools	Center Lock® / IS (6-bolt) adapter
PROLOCK	PROLOCK		Left	Right	Left cross [mm]	Left radial [mm]	Right cross [mm]	Right radial [mm]																		
●	●	black	20	DT aerolite	DT aerolite		286		286	black	radial	RR -	700 x 19C - 28C	●	9	110										
●		black	24	DT aerolite	DT aero comp	296		294		black	2-cross	RR -	700 x 19C - 28C	●	9	110										
●		black	20	DT aerolite	DT aerolite		286		286	black	radial	RR -	700 x 19C - 28C	●	9	110										
●		black	24	DT aerolite	DT aero comp	296		294		black	2-cross	RR -	700 x 19C - 28C	●	9	110										
	●	black	20	DT aero comp	DT aero comp		280		280	black	radial	R -	700 x 19C - 28C	●	9	110										
	●	black	24	DT aero comp	DT aero comp	286		284		black	2-cross	R -	700 x 19C - 28C	●	9	110										





















● = Standard

○ = Convertible with included accessories

○ = Option

* incl. washer for 10 speed

WHEELS ROAD **TRICON®**

Model	Width	Weight	Rim dimension	Rim						Hub																													
				Clincher	Tubular	Tubeless	Valve hole Presta ø 6.5 mm	Valve hole Schrader ø 8.5 mm	Material		Rim color		Hub axle system										Free wheel	Rotor body system		Disc mount													
									Carbon	Aluminium	Black	White	Carbon	5/100 mm RWS / Quick release	9/100 mm DT Swiss Thru bolt	15/100 mm Thru axle	20/110 mm Thru axle	Lefty	5/130 mm RWS / Quick release	5/135 mm RWS / Quick release	5/145 mm RWS / Quick release	10/135 mm DT Swiss Thru bolt		12/135 mm Thru axle	12/142 mm / X-12 Thru axle	12/150 mm Thru axle	bolt on	DT Swiss Ratchet System®	Pawl system	Shimano 9 / 10 and Sram 9 / 10	Shimano 11 Road*	Campagnolo 9 / 10 / 11	Sram MTB XD	Center Lock®	IS (6-bolt)	Hub color			
RR 1450 TRICON®	100	665	622 x 15	●			●			●	●																									pearl white			
RR 1450 TRICON®	130	835	622 x 15	●			●			●										●																			pearl white
RR 1450 TRICON®	100	665	622 x 15	●			●		●	●																													black/gun metal
RR 1450 TRICON®	130	835	622 x 15	●			●		●	●																													black/gun metal
R 1700 TRICON®	100	750	622 x 15	●			●		●	●																													black
R 1700 TRICON®	130	950	622 x 15	●			●		●	●																													black

DT Pro Lock® aluminium		DT Pro Lock® brass		Nipples		Spokes				Technical data				Accessories included												
Nipple type	Nipple color	No. of spokes	Spoke type		Length				Spoke color	Lacing	Intended use	Tubeless solution	Tire dimension	Axle clamping force (min./max.) 4000N / 8000N	Max. tire pressure [bar]	Recommended system weight max. [kg]	RWS Ratchet wheelmounting system	Quick release wheelmounting system	5 mm Endcaps / Axle	15 mm Endcaps	Tubeless ready tape	Tubeless valve	Rim tape	Wheel bag	Centering tools	Center Lock® / IS (6-bolt) adapter
PROLOCK	PROLOCK		Left	Right	Left cross [mm]	Left radial [mm]	Right cross [mm]	Right radial [mm]																		
●	black	18	DT aerolite	DT aerolite	294	280	294	280	black	open crowfoot	RR	●	700 x 19C – 32C	●	9	100	●				●	●				
●	black	24	DT aerolite	DT new aero	289	279	284	272	black	open crowfoot	RR	●	700 x 19C – 32C	●	9	100	●				●	●				
●	black	18	DT aerolite	DT aerolite	294	280	294	280	black	open crowfoot	RR	●	700 x 19C – 32C	●	9	100	●				●	●				
●	black	24	DT aerolite	DT new aero	289	279	284	272	black	open crowfoot	RR	●	700 x 19C – 32C	●	9	100	●				●	●				
●	black	18	DT new aero	DT new aero	293	279	293	279	black	open crowfoot	R	●	700 x 19C – 32C	●	9	120	●				●	●				
●	black	24	DT new aero	DT new aero	287	279	283	272	black	open crowfoot	R	●	700 x 19C – 32C	●	9	120	●				●	●				

● = Standard

○ = Convertible with included accessories

○ = Option

* incl. washer for 10 speed





COMPONENTS

RIMS || HUBS || SPOKES || NIPPLES || RWS

RIMS MTB **OVERVIEW**



XRC 320



XR 331



XR 400



X 430



X 470



XMC 350



XM 401



XM 450

RIMS MTB OVERVIEW



XM 490



M 480



M 520



EX 471



EX 500



E 530



533d



FR 600



F 630

RIMS MTB

Model	Dimension				Weight ± 5% [g]	Riding style						Rim joint				Brake		Holes					Eyelets			Color		Valve hole		Technical data			
	Rim dimension	ERD [mm]	Outer width [mm]	Height [mm]		Road race	Touring	Cross race	Cross mountain	Enduro cross	Free ride	Carbon	Welded	Sleeve joint	Pin joint	Disc brake	Rim brake	20 holes	24 holes	28 holes	32 holes	36 holes	None	Single	Double	UD Carbon	Black	White	Presta ø 6.5 mm	Schrader ø 8.5 mm	Tire dimension	Max. tire pressure** [bar]	Recommended system weight max. [kg]
XR-Rims																																	
XR 331 26	559 x 20	543*	24	18	340			●			●			●					●						●	●			26" x 1.7" – 2.4"	3.5	100		
XR 331 27.5	584 x 20	568*	24	18	355			●			●			●					●						●	●			27.5" x 1.7" – 2.4"	3.5	100		
XR 331 29	622 x 20	606*	24	18	380			●			●			●					●						●	●			29" x 1.7" – 2.4"	3.5	100		
XM-Rims																																	
XM 401 26	559 x 22.5	540*	27	19.5	410				●		●			●					●						●	●			26" x 1.9" – 2.5"	3	110		
XM 401 27.5	584 x 22.5	565*	27	19.5	430				●		●			●					●						●	●			27.5" x 1.9" – 2.5"	3	110		
XM 401 29	622 x 22.5	603*	27	19.5	460				●		●			●					●						●	●			29" x 1.9" – 2.5"	3	110		
EX-Rims																																	
EX 471 26	559 x 25	537*	30	21	475					●		●		●					●						●	●			26" x 2.1" – 2.8"	3	110		
EX 471 27.5	584 x 25	562*	30	21	500					●		●		●					●						●	●			27.5" x 2.1" – 2.8"	3	110		

	Max. spoke tension [N]	Spoke tension & recommendations								Accessories		
		DT aerolite	DT aero comp	DT new aero	DT aero speed	DT supercomp	DT competition	DT alpine III	DT revolution	DT champion	Rim tape	Tubeless solution
	1200	●	●			●	●				559 x 22	○
	1200	●	●			●	●				584 x 22	○
	1200	●	●			●	●				622 x 22	○
	1200	●	●					●			559 x 22	○
	1200	●	●					●			584 x 22	○
	1200	●	●					●			622 x 22	○
	1200	●	●					●			559 x 25	○
	1200	●	●					●			584 x 25	○

RIMS MTB

Model	Dimension			Weight ± 5% [g]	Riding style						Rim joint				Brake		Holes					Eyelets			Color		Valve hole		Technical data				
	Rim dimension	ERD [mm]	Outer width [mm]		Height [mm]	Road race	Touring	Cross race	Cross mountain	Enduro cross	Free ride	Carbon	Welded	Sleeve joint	Pin joint	Disc brake	Rim brake	20 holes	24 holes	28 holes	32 holes	36 holes	None	Single	Double	UD Carbon	Black	White	Presta ø 6.5 mm	Schrader ø 8.5 mm	Tire dimension	Max. tire pressure** [bar]	Recommended system weight max. [kg]
XR/X-Rims																																	
XRC 320 26	559 x 19	540	26	20	325			●			●			●				●				●				●		26" x 1.7" – 2.35"	3	100			
XRC 320 29	622 x 19	602	26	20	370			●			●			●				●				●				●		29" x 1.7" – 2.35"	3	100			
XR 400 26	559 x 18	544	23.8	17.8	400			●			●			●			●	●	●			●		●		●		26" x 1.5" – 2.25"	4	110			
XR 400 white	559 x 18	544	23.8	17.8	400			●			●			●				●	●			●		●	●	●		26" x 1.5" – 2.25"	4	110			
XR 400 29	622 x 18	606	23.8	17.8	450			●			●			●				●	●			●		●		●		29" x 1.5" – 2.25"	4	110			
X 430 26	559 x 18	545	23.8	17.8	430			●			●			●				●	●			●		●		●		26" x 1.5" – 2.25"	4	110			
X 470 29	622 x 18	606	23.8	17.8	470			●			●			●				●	●			●		●		●		29" x 1.5" – 2.25"	4	110			
XM/M-Rims																																	
XMC 350 27.5	584 x 21.5	566	28	20	370			●			●			●				●				●		●		●		27.5" x 1.9" – 2.5"	3	110			
XMC 350 29	622 x 21.5	604	28	20	395			●			●			●				●				●		●		●		29" x 1.9" – 2.5"	3	110			
XM 450 26	559 x 19.5	541	26	18.7	450			●			●			●				●	●			●		●		●		26" x 1.7" – 2.4"	4	120			
XM 490 29	622 x 19.5	603	26	18.7	500			●			●			●				●	●			●		●		●		29" x 1.7" – 2.4"	4	120			
M 480 26	559 x 19.5	541	26	18.7	470			●			●			●				●	●			●		●		●		26" x 1.7" – 2.4"	4	110			
M 480 27.5	584 x 19.5	566	26	18.7	490			●			●			●				●	●			●		●		●		27.5" x 1.7" – 2.4"	4	110			
M 520 29	622 x 19.5	604	26	18.7	520			●			●			●				●	●			●		●		●		29" x 1.7" – 2.4"	4	110			
EX/E-Rims																																	
EX 500 26	559 x 21	540	27.8	19.8	500			●			●			●				●	●			●		●		●		26" x 1.9" – 2.5"	3	130			
E 530 26	559 x 21	541	27.8	19.8	530			●			●			●				●	●			●		●		●		26" x 1.9" – 2.5"	3	130			
533d 26	559 x 22	539	27.7	20.3	520			●			●			●				●	●			●		●		●		26" x 1.9" – 2.5"	3	130			
533d 27.5	584 x 22	564	27.7	20.3	540			●			●			●				●	●			●		●		●		27.5" x 1.9" – 2.5"	3	130			
533d 29	622 x 22	602	27.7	20.3	575			●			●			●				●	●			●		●		●		29" x 1.9" – 2.5"	3	130			
FR/F-Rims																																	
FR 600 26	559 x 25	538	32	21.7	600			●			●			●				●	●			●		●		●		26" x 2.1" – 3"	3	140			
F 630 26	559 x 25	536	32.5	22	630			●			●			●				●	●			●		●		●		26" x 2.1" – 3"	3	140			

	Max. spoke tension [N]	Spoke tension & recommendations										Accessories	
		DT aerolite	DT aero comp	DT new aero	DT aero speed	DT supercomp	DT competition	DT alpine III	DT revolution	DT champion	Rim tape	Tubeless solution	
	1200	●	●			●	●				559 x 22	○	
	1200	●	●			●	●				622 x 22	○	
	1200	●	●			●	●				559 x 22	○	
	1200	●	●			●	●				559 x 22	○	
	1200	●	●			●	●				622 x 22	○	
	1200	●	●			●	●				559 x 22	○	
	1200	●	●			●	●				622 x 22	○	
	1200	●	●			●	●				559 x 22	○	
	1200	●	●			●	●				622 x 22	○	
	1200	●	●			●	●				559 x 22	○	
	1200	●	●			●	●			●	559 x 22	○	
	1200	●	●			●	●			●	584 x 22	○	
	1200	●	●			●	●			●	622 x 22	○	
	1200	●	●			●	●				559 x 22	○	
	1200		●			●	●			●	559 x 22	○	
	1200		●			●	●			●	559 x 22	○	
	1200		●			●	●			●	584 x 22	○	
	1200		●			●	●			●	622 x 22	○	
	1200		●			●	●				559 x 25	○	
	1200					●	●		●		559 x 25	○	

** or like posted on the tire

RIMS ROAD **OVERVIEW**



RR 440



RR 440 asymmetric



RR 585



R 450

RIMS TREKKING / E-BIKE **OVERVIEW**



TK 540



TK 540 disc



535



535 700c



545d



545d 700c

RIMS ROAD / TREKKING / E-BIKE

Model	Dimension				Weight ± 5% [g]	Riding style							Rim joint				Brake		Holes					Eyelets			Color		Valve hole		Technical data			
	Rim dimension	ERD [mm]	Outer width [mm]	Height [mm]		Road race	Touring	Cross race	Cross mountain	Enduro cross	Free ride	Carbon	Welded	Sleeve joint	Pin joint	Disc brake	Rim brake	20 holes	24 holes	28 holes	32 holes	36 holes	None	Single	Double	UD Carbon	Black	White	Presta ø 6.5 mm	Schrader ø 8.5 mm	Tire dimension	Max. tire pressure** [bar]	Recommended system weight max. [kg]	
Road Rims																																		
RR 440	622 x 16	599	21	21	450	●						●			●	●	●	●	●			●			●	●			700 x 19C – 35C	9	110			
RR 440 asymmetric	622 x 16	599	21	21	450	●						●			●	●	●	●	●			●			●	●			700 x 19C – 35C	9	110			
RR 585	622 x 15	582	19.5	30.3	580	●						●			●	●	●	●	●		●			●	●			700 x 19C – 35C	9	130				
R 450	622 x 15	596	19.8	22.5	445	●							●		●		●	●	●		●			●	●			700 x 19C – 28C	9	100				
Trekking / E-Bike																																		
TK 540	622 x 19	600	23.6	20.2	545	●						●			●				●	●			●		●	●			28" x 1" – 2.35"	6	130			
TK 540 disc	622 x 19	600	23.6	20.2	545	●						●			●				●				●		●	●			28" x 1" – 2.35"	6	130			
535	559 x 19	540	25.2	20	540	●								●	●				●	●			●		●*	●			26" x 1" – 2.35"	5	140			
535 700c	622 x 19	603	25.2	20	600	●								●	●				●	●			●		●*	●			28" x 1" – 2.35"	5	140			
545d	559 x 21	542	26.7	19	530	●								●	●				●	●			●		●*	●			26" x 1.35" – 2.4"	4	140			
545d 700c	622 x 21	605	26.7	19	605	●								●	●				●	●			●		●*	●			28" x 1.35" – 2.4"	4	140			

	Spoke tension & recommendations									Accessories		
	Max. spoke tension [N]	DT aerolite	DT aero comp	DT new aero	DT aero speed	DT supercomp	DT competition	DT alpine III	DT revolution	DT champion	Rim tape	Tubeless solution
	1200	●	●				●		●		20 x 622	
	1200	●	●				●		●		20 x 622	
	1200		●	●	●		●				18 x 622	
	1200	●	●				●				18 x 622	
	1200		●				●				22 x 622	
	1200		●				●				22 x 622	
	1200		●				●	●		●	22 x 559	
	1200		●				●	●		●	22 x 622	
	1200		●				●	●		●	22 x 559	
	1200		●				●	●		●	22 x 622	

HUBS OVERVIEW



180 carbon ceramic



180 carbon ceramic XD



240s straightpull



240s straightpull XD



240s



240s XD

HUBS OVERVIEW



350 straightpull



350 straightpull XD



350



350 XD



540 tandem

HUBS 180 CARBON CERAMIC

180 Carbon Ceramic		Model	Built-in dimension [mm]	Width	Weight	Hub axle system				Spoke holes						Color		Disc mount		Rotor body system			Hub dimension			Technical data			Accessories																
180 Carbon Ceramic		Model	Built-in dimension [mm]	Width	Weight	5/100 mm RWS / Quick release	9/100 mm DT Swiss Thru bolt	15/100 mm Thru axle	20/110 mm Thru axle	Lefty	5/130 mm RWS / Quick release	5/135 mm RWS / Quick release	5/145 mm RWS / Quick release	10/135 mm DT Swiss Thru bolt	12/135 mm Thru axle	12/142 mm / X-12 Thru axle	12/150 mm Thru axle	bolt on	20 holes	24 holes	28 holes	32 holes	36 holes	40 holes	Black	White	Center Lock®	IS (6-bolt)	Shimano 9 / 10 and Sram 9 / 10	Shimano 11 Road**	Campagnolo 9 / 10 / 11	Sram MTB XD	Flange distance (L/R) [mm]	Pitch circle diameter (L/R) [mm]	Spoke hole ø [mm]	Optimized spoke ø [mm]	Spoke tension radial lacing max. 1000N	Spoke tension crossed max. 1200N	Axle clamping force (min./max) 4000N/8000N	Maintenance	RWS Ratchet wheelmounting system	Center Lock® / IS (6-bolt) adapter			
Non disc																																													
Front	100	100	●															●	●	●					●										●	●	●	●							
Rear	130	183			●													●	●	●	●					○	●	○												●					
	130	190																	●	●	●	●					○	○	●											●					
Center Lock®																																													
Front fifteen	100	126	●	○	○															●	●			●	●	○												●	●	●			●		
	100	123	○	○	●															●	●			●	●	○													●	●	●			●	
Rear	135	207											●	○	○	○				●	●			●	●	○	●			○	○									●	●	●			●
	142	202											○	○	○	●				●	●			●	●	○	●			○	○									●	●	●			●
	142	195											○	○	○	●				●	●			●	●	○	○			●	●									●	●	●			●

HUBS 240S STRAIGHTPULL

Model	Width		Weight	Hub axle system	Spoke holes	Color	Disc mount	Rotor body system	Hub dimension	Technical data		Accessories	
	Built-in dimension [mm]	± 5% [g]*								Spoke tension radial lacing max. 1000N	Spoke tension crossed max. 1200N		Spoke clamping force (min./max) 4000N/8000N
240s Straightpull				5/100 mm RWS / Quick release 9/100 mm DT Swiss Thru bolt 15/100 mm Thru axle*** 20/110 mm Thru axle Lefty 5/130 mm RWS / Quick release 5/135 mm RWS / Quick release 5/145 mm RWS / Quick release 10/135 mm DT Swiss Thru bolt 12/135 mm Thru axle 12/142 mm / X-12 Thru axle 12/150 mm Thru axle bolt on 20 holes 24 holes 28 holes 32 holes 36 holes 40 holes Black White Center Lock® IS (6-bolt) Shimano 9 / 10 and Sram 9 / 10 Shimano 11 Road** Campagnolo 9 / 10 / 11 Sram MTB XD Flange distance (L/R) [mm] Pitch circle diameter (L/R) [mm] Spoke hole ø [mm] Optimized spoke ø [mm]									
Non disc													
Front	100	107	●						75.8(37.9/37.9)	30.0/30.0	2.5 2.0	● ● ●	
Rear	130	212		●				○ ● ○	49.3(33.3/16.0)	39.0/46.0	2.5 2.0	● ● ●	
Center Lock®													
Front fifteen	100	122	● ○ ○						56.7(21.7/35.0)	38.5/36.5	2.5 2.0	● ● ●	
	100	118	○ ○ ●						56.7(21.7/35.0)	38.5/36.5	2.5 2.0	● ● ●	
Rear	135	231		● ○ ○ ○				○ ● ○ ●	53.2(33.0/20.2)	38.5/45.5	2.5 2.0	● ● ●	
	142	227		○ ○ ○ ●				○ ● ○ ●	53.2(33.0/20.2)	38.5/45.5	2.5 2.0	● ● ●	
	142	216		○ ○ ○ ●				● ○ ○ ○	53.2(33.0/20.2)	38.5/45.5	2.5 2.0	● ● ●	
Disc brake IS													
Front fifteen	100	130	● ○ ○						57.2(22.3/34.9)	38.5/36.5	2.5 2.0	● ● ●	
	100	127	○ ○ ●						57.2(22.3/34.9)	38.5/36.5	2.5 2.0	● ● ●	
Front oversize	110	164	○ ○ ○ ●						53.0(22.5/30.5)	48.0/48.0	2.5 2.0	● ● ●	
Rear	135	237		● ○ ○ ○				○ ● ○ ●	55.1(34.6/20.5)	38.5/45.5	2.5 2.0	● ● ●	
	142	232		○ ○ ○ ●				○ ● ○ ●	55.1(34.6/20.5)	38.5/45.5	2.5 2.0	● ● ●	
	142	222		○ ○ ○ ●				● ○ ○ ○	55.1(34.6/20.5)	38.5/45.6	2.5 2.0	● ● ●	
	150	276						○ ● ● ●	54.8(27.4/27.4)	47.0/47.0	2.5 2.0	● ● ●	

● = Standard

○ = Option

* Weight without cl adapter or quick release or thru axle

** incl. washer for 10 speed

*** for 240s CL front hub you will need the 15 mm locking

HUBS 240S

240s	Model		Width		Weight		Hub axle system							Spoke holes				Color		Disc mount		Rotor body system			Hub dimension			Technical data			Accessories										
	Built-in dimension [mm]	± 5% [g]*	5/100 mm RWS / Quick release	9/100 mm DT Swiss Thru bolt	15/100 mm Thru axle***	20/110 mm Thru axle	Lefty	5/130 mm RWS / Quick release	5/135 mm RWS / Quick release	5/145 mm RWS / Quick release	10/135 mm DT Swiss Thru bolt	12/135 mm Thru axle	12/142 mm / X-12 Thru axle	12/150 mm Thru axle	bolt on	20 holes	24 holes	28 holes	32 holes	36 holes	40 holes	Black	White	Center Lock®	IS (6-bolt)	Shimano 9 / 10 and Sram 9 / 10	Shimano 11 Road**	Campagnolo 9 / 10 / 11	Sram MTB XD	Flange distance (L/R) [mm]	Pitch circle diameter (L/R) [mm]	Spoke hole ø [mm]	Optimized spoke ø [mm]	Spoke tension radial lacing max. 1000N	Spoke tension crossed max. 1200N	Axle clamping force (min./max) 4000N/8000N	Maintenance	RWS Ratchet wheelmounting system	Center Lock® / IS (6-bolt) adapter		
	Non disc																																								
	Front	100	105	●											●	●	●	●			●								74.8(37.4/37.4)	39.0/39.0	2.4	2.0	●	●	●						
		100	105	●														●				●							74.8(37.4/37.4)	39.0/39.0	2.4	2.0	●	●	●						
	Rear	130	209				●									●	●	●			●			○	●	○			50.2(33.2/17.0)	45.0/45.0	2.4	2.0		●	●	●					
		130	209				●										●	●	●			●			○	○	●		50.2(33.2/17.0)	45.0/45.0	2.4	2.0		●	●	●					
		130	209				●											●				●			○	●	○		50.2(33.2/17.0)	45.0/45.0	2.4	2.0		●	●	●					
		130	209				●											●				●			○	○	●		50.2(33.2/17.0)	45.0/45.0	2.4	2.0		●	●	●					
	Rear MTB	135	219				●			○	○	○						●			●					○		54.7(35.3/19.4)	45.0/45.0	2.4	2.0		●	●	●						
	Center Lock®																																								
	Front fifteen	100	130	●	○	○											●	●		●	●	○							58.1(22.5/35.6)	44.0/42.0	2.5	2.0		●	●						
		100	130	●	○	○												●	●		●	●	○						58.1(22.5/35.6)	44.0/42.0	2.5	2.0		●	●						
		100	126	○	○	●												●	●		●	●	○						58.1(22.5/35.6)	44.0/42.0	2.5	2.0		●	●						
		100	126	○	○	●												●	●		●	●	○						58.1(22.5/35.6)	44.0/42.0	2.5	2.0		●	●						
	Rear	135	233				●			○	○	○					●	●		●	●	○				○		52.4(33.0/19.4)	44.0/47.5	2.5	2.0		●	●	●						
		135	233				●				○	○	○				●	●		●	●	○				○		52.4(33.0/19.4)	44.0/47.5	2.5	2.0		●	●	●						
		135	230				○			●	○	○	●				●	●		●	●	○				○		52.4(33.0/19.4)	44.0/47.5	2.5	2.0		●	●	●	●					
		142	228				○			○	○	○	●				●	●		●	●	○				○		52.4(33.0/19.4)	44.0/47.5	2.5	2.0		●	●	●						
		142	218				○			○	○	○	●				●	●		●	●	○				●		52.4(33.0/19.4)	44.0/47.6	2.5	2.0		●	●	●						

HUBS 240S

Model	Width		Weight		Hub axle system												Spoke holes				Color		Disc mount		Rotor body system				Hub dimension				Technical data				Accessories						
	Built-in dimension [mm]	± 5% g *	5/100 mm RWS / Quick release	9/100 mm DT Swiss Thru bolt	15/100 mm Thru axle	20/110 mm Thru axle	Lefty	5/130 mm RWS / Quick release	5/135 mm RWS / Quick release	5/145 mm RWS / Quick release	10/135 mm DT Swiss Thru bolt	12/135 mm Thru axle	12/142 mm / X-12 Thru axle	12/150 mm Thru axle	bolt on	20 holes	24 holes	28 holes	32 holes	36 holes	40 holes	Black	White	Center Lock®	IS (6-bolt)	Shimano 9 / 10 and Sram 9 / 10	Shimano 11 Road**	Campagnolo 9 / 10 / 11	Sram MTB XD	Flange distance (L/R) [mm]	Pitch circle diameter (L/R) [mm]	Spoke hole ø [mm]	Optimized spoke ø [mm]	Spoke tension radial lacing max. 1000N	Spoke tension crossed max. 1200N	Axle clamping force (min./max) 4000N/8000N	Maintenance	RWS Ratchet wheelmounting system	Center Lock® / IS (6-bolt) adapter				
240s																						Black	White																				
Disc brake IS																																											
Front	100	145	●	○																																							
Front oversize	110	165	○	○	○	●																																					
Rear	135	244						●			○	○	○															○	53.4(34.0/19.4)	57.0/47.5	2.5	2.0			●	●	●						
	135	242						○			●	○	○															○	53.4(34.0/19.4)	57.0/47.5	2.5	2.0			●	●	●	●					
	142	240						○			○	○	●															○	53.4(34.0/19.4)	57.0/47.5	2.5	2.0			●	●	●	●					
	142	230						○			○	○	●															●	53.4(34.0/19.4)	57.0/47.6	2.5	2.0			●	●	●	●					
	150	275												●														○	53.0(26.5/26.5)	57.0/57.0	2.5	2.0			●	●	●	●					
Lefty																																											
Front	Lefty	124				●																																					
	Lefty	124				●																																					
Single speed																																											
Rear	135	243						●																					67.4(33.0/34.4)	45.0/45.0	2.5	2.0			●	●	●						
	135	308												●															67.4(33.0/34.4)	45.0/45.0	2.5	2.0			●	●	●						
BMX																																											
Front	100	103												●															74.8(37.4/37.4)	39.0/39.0	2.5	2.0			●	●	●						
Rear	112	204												●															45.6(22.8/22.8)	45.0/45.0	2.5	2.0			●	●	●	●					

● = Standard

○ = Option

◐ = Convertible with included accessories

* Weight without cl adapter or quick release or thru axle

** incl. washer for 10 speed

HUBS 350 STRAIGHTPULL

350 Straightpull		Model	Width	Weight	Hub axle system										Spoke holes					Color		Disc mount		Rotor body system			Hub dimension				Technical data			Accessories										
			Built-in dimension [mm]	± 5% [g]*	5/100 mm RWS / Quick release	9/100 mm DT Swiss Thru bolt	15/100 mm Thru axle***	20/110 mm Thru axle	Lefty	5/130 mm RWS / Quick release	5/135 mm RWS / Quick release	5/145 mm RWS / Quick release	10/135 mm DT Swiss Thru bolt	12/135 mm Thru axle	12/142 mm / X-12 Thru axle	12/150 mm Thru axle	bolt on	20 holes	24 holes	28 holes	32 holes	36 holes	40 holes	Black	White	Center Lock®	IS (6-bolt)	Shimano 9 / 10 and Sram 9 / 10	Shimano 11 Road**	Campagnolo 9 / 10 / 11	Sram MTB XD	Flange distance (L/R) [mm]	Pitch circle diameter (L/R) [mm]	Spoke hole Ø [mm]	Optimized spoke Ø [mm]	Spoke tension radial lacing max. 1000N	Spoke tension crossed max. 1200N	Axle clamping force (min./max) 4000N/8000N	Maintenance	RWS Ratchet wheelmounting system	Center Lock® / IS (6-bolt) adapter			
	Non disc																																											
	Front	100	110	●													●						●												●	●								
	Rear	130	264						●										●					●			○	●	○									●	●	●				
	Center Lock®																																											
	Front	100	151	●															●				●	○																				
		100	130	○	●															●				●	○																			
	Rear	135	271							●		○	○	○					●					●	○	●			○															
		142	257							○		○	○	●					●					●	○	○		●																
		142	267							○		○	○	●					●					●	○	●		○																
	Disc brake IS																																											
	Front	100	151	●															●					●																				
		100	130	○	●														●					●																				
		110	239		●														●					●																				
	Rear	135	279							●		○	○	○					●					●	●				○															
		142	274							○		○	○	●					●					●	●				○															
		142	264							○		○	○	●					●					●	○	●			●															

● = Standard ○ = Option

* Weight without cl adapter or quick release or thru axle

** incl. washer for 10 speed

*** for 240s CL front hub you will need the 15 mm locking

HUBS 350

Model	Width	Weight	Hub axle system										Spoke holes				Color		Disc mount	Rotor body system		Hub dimension				Technical data			Accessories											
	Built-in dimension [mm]	± 5% [g]*	5/100 mm RWS / Quick release	9/100 mm DT Swiss Thru bolt	15/100 mm Thru axle***	20/110 mm Thru axle	Lefty	5/130 mm RWS / Quick release	5/135 mm RWS / Quick release	5/145 mm RWS / Quick release	10/135 mm DT Swiss Thru bolt	12/135 mm Thru axle	12/142 mm / X-12 Thru axle	12/150 mm Thru axle	bolt on	20 holes	24 holes	28 holes	32 holes	36 holes	40 holes	Black	White	Center Lock®	IS (6-bolt)	Shimano 9 / 10 and Sram 9 / 10	Shimano 11 Road**	Campagnolo 9 / 10 / 11	Sram MTB XD	Flange distance (L/R) [mm]	Pitch circle diameter (L/R) [mm]	Spoke hole ø [mm]	Optimized spoke ø [mm]	Spoke tension radial lacing max. 1000N	Spoke tension crossed max. 1200N	Axle clamping force (min./max) 4000N/8000N	Maintenance	RWS Ratchet wheelmounting system	Center Lock® / IS (6-bolt) adapter	
350																																								
Non disc																																								
Front	100	149	●														●	●			●								74.8(37.4/37.4)	39.0/39.0	2.6	2.0	●	●	●					
Rear	130	265					●										●	●			●			○	●	○			50.3(33.5/16.8)	46.0/46.0	2.6	2.0		●	●	●				
	130	252					●										●	●			●			○	○	●			50.3(33.5/16.8)	46.0/46.0	2.6	2.0		●	●	●				
Rear MTB	135	267					●										●	●			●			●		○			50.3(31.0/19.3)	46.0/46.0	2.6	2.0		●	●	●				
Center Lock®																																								
Front	100	156	●														●	●			●		○						57.4(22.4/35.0)	44.0/42.0	2.6	2.0		●	●					
	100	136	○	●													●	●			●		○						57.4(22.4/35.0)	44.0/42.0	2.6	2.0		●	●					
Rear	135	272					●			○	○	○					●	●			●		○	●		○			53.2(33.0/20.2)	46.0/46.0	2.6	2.0		●	●	●		●		
	135	266					○			●	○	○					●	●			●		○	●		○			53.2(33.0/20.2)	46.0/46.0	2.6	2.0		●	●	●		●		
	135	265					○			○	●	○					●	●			●		○	●		○			53.2(33.0/20.2)	46.0/46.0	2.6	2.0		●	●	●		●		
	142	267					○			○	○	●					●	●			●		○	●		○			53.2(33.0/20.2)	46.0/46.0	2.6	2.0		●	●	●		●		
	142	257					○			○	○	●					●	●			●		○	○		●			53.2(33.0/20.2)	46.0/46.1	2.6	2.0		●	●	●		●		
Disc brake IS																																								
Front	100	194	●														●	●			●		●						57.4(22.4/35.0)	58.0/52.0	2.6	2.0		●	●					
	100	172	○	●													●	●			●		●						57.4(22.4/35.0)	58.0/52.0	2.6	2.0		●	●					
	110	239			●												●	●			●		●						55.5(23.3/32.2)	58.0/58.0	2.6	2.0		●	●					
Rear	135	305					●			○	○	○					●	●			●		●	●		○			54.0(33.6/20.3)	58.0/52.0	2.6	2.0		●	●	●		●		
	142	300					○			○	○	●					●	●			●		●	●		○			54.0(33.6/20.3)	58.0/52.0	2.6	2.0		●	●	●		●		
	142	290					○			○	○	●					●	●			●		●	○		●			54.0(33.6/20.3)	58.0/52.0	2.6	2.0		●	●	●		●		
	150	344										●					●	●			●		●	●		○			53.4(26.7/26.7)	58.0/58.0	2.6	2.0		●	●	●		●		

● = Standard

○ = Option

* Weight without cl adapter or quick release or thru axle

** incl. washer for 10 speed

*** for 240s CL front hub you will need the 15 mm locking

HUBS 540 TANDEM

540 Tandem		Model		Width		Weight		Hub axle system		Spoke holes		Color		Disc mount		Rotor body system		Hub dimension		Technical data		Accessories																								
		Built-in dimension [mm]	± 5% [g]*			5/100 mm RWS / Quick release	9/100 mm DT Swiss Thru bolt	15/100 mm Thru axle	20/110 mm Thru axle	Lefty	5/130 mm RWS / Quick release	5/135 mm RWS / Quick release	5/145 mm RWS / Quick release	10/135 mm DT Swiss Thru bolt	12/135 mm Thru axle	12/142 mm / X-12 Thru axle	12/150 mm Thru axle	bolt on	20 holes	24 holes	28 holes	32 holes	36 holes	40 holes	Black	White	Center Lock®	IS (6-bolt)	Shimano 9 / 10 and Sram 9 / 10	Shimano 11 Road**	Campagnolo 9 / 10 / 11	Sram MTB XD	Flange distance (L/R) [mm]	Pitch circle diameter (L/R) [mm]	Spoke hole ø [mm]	Optimized spoke ø [mm]	Spoke tension radial lacing max. 1000N	Spoke tension crossed max. 1200N	Axle clamping force (min./max) 4000N/8000N	Maintenance	RWS Ratchet wheelmounting system	Center Lock® / IS (6-bolt) adapter				
Tandem																																														
Front	100	242	●																																											
Rear	135	477								●																																				
	145	510									●																																			

SPOKES OVERVIEW

DT champion® straightpull



DT champion®



DT competition® straightpull



DT competition®



DT super comp®



DT revolution®



DT alpine®



DT alpine III®



DT aerolite® straightpull



DT aerolite®



DT aero speed®



DT new aero®



















DT aero comp® straightpull



DT aero comp®



SPOKES COLLECTION

Model	Thread (DIN 79012)			Length (L) Range [mm]	Shape			Length of thread (G) 9 – 10 mm	Height of head (H) [mm]	Diameters			Width bladed (B) [mm]	Thickness bladed (S) [mm]	Angle (A) 90 – 95°	Gauges	Color				Weight ± 5% for 64 spokes, length 264 mm [g]	E-Bike use
	1.8 mm FG 2.0	2.0 mm FG 2.3	2.34 mm FG 2.6		Double butted	Triple butted	Bladed			Diameter 1 [mm] (D1)	Diameter 2 [mm] (D2)	Diameter 3 [mm] (D3)					Diameters	Silver	Black	White		
 DT champion®	●			140 – 315				●	6.0	1.8	1.8	1.8		●	15	●				359		
 DT champion®		●		140 – 315				●	6.2	2.0	2.0	2.0		●	14	●	●			444		
 DT champion®			●	140 – 315				●	7.8	2.34	2.34	2.34		●	13	●				591	●	
 DT champion® straightpull		●		140 – 315				●		2.0	2.0	2.0			14	●	●			440		
 DT competition®	●			238 – 300	●			●	6.0	1.8	1.6	1.8		●	15 16 15	●				311		
 DT competition®		●		238 – 300	●			●	6.2	2.0	1.8	2.0		●	14 15 14	●	●	●	●	382		
 DT competition® straightpull		●		238 – 300	●			●		2.0	1.8	2.0			14 15 14	●	●			378		
 DT super comp®	●			247 – 308		●		●	6.2	1.8	1.7	2.0		●		●	●			318		
 DT revolution®		●		247 – 308	●			●	6.2	2.0	1.5	2.0		●	14 17 14	●	●			283		
 DT alpine®		●		260 – 305	●			●	7.8	2.0	2.34	2.34		●	14 13	●	●			586	●	
 DT alpine III®		●		260 – 305		●		●	7.8	2.0	1.8	2.34		●	14 15 13	●	●			418	●	
 DT aerolite®		●		238 – 300	●		●	●	6.2	2.0		2.0	2.3	0.9	●		●	●	●	●	278	
 DT aerolite® straightpull		●		238 – 300	●		●	●		2.0		2.0	2.3	0.9			●	●			274	
 DT aero speed®	●			215 – 305			●	●	6.0	1.8		1.8	2.3	1.2	●		●	●			355	
 DT new aero®		●		215 – 305			●	●	6.2	2.0		2.0	3.3	1.1	●		●	●			437	
 DT aero comp®		●		238 – 300	●		●	●	6.2	2.0		2.0	2.3	1.2	●		●	●			380	
 DT aero comp® straightpull		●		238 – 300	●		●	●		2.0		2.0	2.3	1.2			●	●			376	

SPOKES TECHSPECS



J-bend



straight pull



butted



bladed

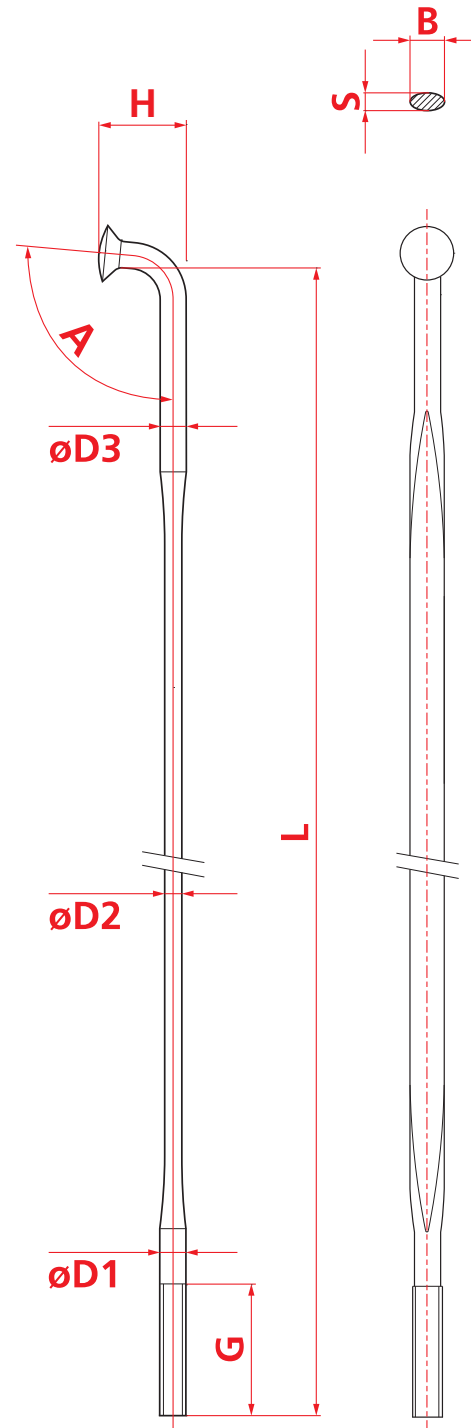

NIPPLES **OVERVIEW**



NIPPLES COLLECTION

Model	Thread (DIN 79012)			Length					Thread coating		Color								Weight E-Bike		
	1.8 mm FG 2.0	2.0 mm FG 2.3	2.34 mm FG 2.6	12 mm	14 mm	15 mm	16 mm	14.5 mm	Without DT Swiss Pro Lock®	DT Swiss Pro Lock®	Silver	Black	Gold	Green	Blue	Turquoise	Violet	Red		+ 5% for 64 nipples [g]	E-Bike use
DT standard brass	•			•					•	•	•								64		
	•				•				•	•	•								73		
	•						•		•	•	•								84		
		•							•	•	•								62	•	
			•						•	•	•								71	•	
				•					•	•	•								82	•	
DT Pro Lock® standard brass									•	•	•								56	•	
									•	•	•								112	•	
	•								•	•	•								64		
	•								•	•	•								73		
	•								•	•	•								84		
		•							•	•	•								62	•	
DT standard aluminium									•	•	•								71	•	
									•	•	•								82	•	
	•								•	•	•								21		
	•								•	•	•								24		
	•								•	•	•								27		
		•							•	•	•								20		
DT Pro Lock® standard aluminium									•	•	•								23		
									•	•	•								26		
	•								•	•	•								21		
	•								•	•	•								24		
		•							•	•	•								27		
			•						•	•	•								20		
DT (Pro Lock®) Pro Head® brass									•	•	•								23		
									•	•	•								26		
	•								•	•	•								61		
	•								•	•	•								70		
		•							•	•	•								59	•	
			•						•	•	•								68	•	
DT Pro Lock® hexagonal aluminium								•	•	•								74	•		
DT (Pro Lock®) hidden aluminium								•	•	•								•	27		
DT (Pro Lock®) squorx Pro Head® aluminium								•	•	•									22		
DT (Pro Lock®) squorx Pro Head® aluminium	•							•	•	•									27		
DT (Pro Lock®) squorx Pro Head® aluminium		•						•	•	•									•	26	
DT (Pro Lock®) squorx Pro Head® brass		•						•	•	•									79	•	

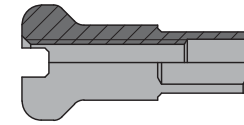

DT Pro Lock® standard aluminium
DT standard aluminium
DT Pro Lock® standard brass
DT standard brass

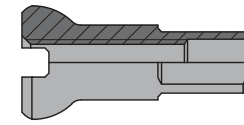

DT Pro Lock® Pro Head® brass
DT Pro Head® brass

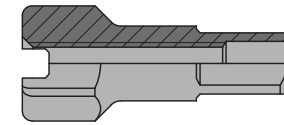

DT Pro Lock® hexagonal aluminium

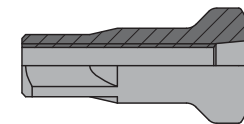

DT Pro Lock® hidden aluminium
DT hidden aluminium

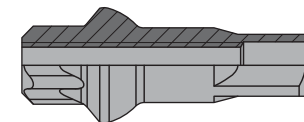

DT Pro Lock® squorx Pro Head® aluminium
DT squorx Pro Head® aluminium
DT Pro Lock® squorx Pro Head® brass
DT squorx Pro Head® brass

RWS OVERVIEW



RWS ROAD titan with aluminium lever



RWS ROAD steel with aluminium lever



RWS MTB titan with aluminium lever



RWS MTB steel with aluminium lever



RWS Thru axle 15 mm with aluminium lever



RWS Thru bolt with aluminium lever



RWS for X-12 with aluminium lever



RWS E-Thru Thru axle with aluminium lever

Model	Weight ± 5% [g]	Hub axle system										Axle material		Lever material			
		5/100 mm RWS / Quick release	9/100 mm DT Swiss Thru bolt	15/100 mm Thru axle	20/110 mm Thru axle	5/130 mm RWS / Quick release	5/135 mm RWS / Quick release	5/145 mm RWS / Quick release	10/135 mm DT Swiss Thru bolt	12/135 mm Thru axle	12/142 mm / X-12 Thru axle	12/150 mm Thru axle	AL6V4 grade 5 titanium	High-strength steel	7075 Aluminium	Alloy	Synthetic
ROAD																	
RWS Road titan	45	●											●			●	
	46					●							●			●	
	47						●						●			●	
RWS Road steel	50	●											●			●	
	54					●							●			●	
	55						●						●			●	
MTB																	
RWS MTB titan	44	●											●			●	
	47						●						●			●	
RWS MTB steel	50	●											●			●	
	54						●						●			●	
	55							●					●			●	
RWS Thru bolt	58		●												●	●	
	70							●							●	●	
RWS for X-12	65									●					●	●	
RWS E-Thru	65									●					●	●	
RWS 15 mm	72			●											●	●	





SUSPENSION

FORKS || SHOCKS

FORKS OVERVIEW



XRC 100



XMM 26 Torsion Box



XMM 29 Torsion Box



EXM 26 Torsion Box



XMM 26 One piece Mag



XMM 27.5 One piece Mag



XMM 29 One piece Mag

FORKS XRC/TORSION BOX

Model	Weight	Travel				Dropout		Color dropout / Fork slider		Material forks / slider			Spring		Damping			Remote		Diameter stanchions		Crown		Diameter steerer		Material steerer		Hose guide		Ride height (A) ± 3 mm [mm]		Fork offset (B) [mm]		Tire diameter max. (C) [mm]		Max. diameter (D) at tire width (E) [mm]		Max. tire width (E) [mm]		Recommended system weight max. [kg]		Disc mount
		± 3% [g] *	100 mm	120 mm	140 mm	150 mm	9 mm	15 mm	W = White (RAL 9010)	S = Black	Torsion box magnesium	One piece Magnesium	Hollow arch carbon UD-finish	NCS	ABS	SS II = Single shot II	TS = Twin shot	LC = Launch control II	Yes	No	ø 28.6 mm	ø 32 mm	C = Carbon UD-finish	A = Aluminium black-painted	ø 1 1/8"	Tapered 1.5 – 1 1/8"	C = Carbon UD-finish	A = Aluminium (black anodize)														
XRC 100	1270	●				●		●		●			●							●		●	●				●	●	475	41	686	662	59	95	PM6" max. 185 mm							
XMM 100 Torsion Box	1550	●				●		●		●			●						○	●	●	●	●			●	●	475	40	690	670	65	110	PM6" max. 210 mm								
XMM 100 Torsion Box	1550	●				●		●		●			●						○	●	●	●	●			●	●	475	40	690	670	65	110	PM6" max. 210 mm								
XMM 100 Torsion Box	1480	●				●		●		●			●						○	●	●	●	●			●	●	475	40	690	670	65	110	PM6" max. 210 mm								
XMM 120 Torsion Box	1650	●	●			●		●		●			●						○	●	●	●	●			●	●	495	40	690	670	65	110	PM6" max. 210 mm								
XMM 120 Torsion Box	1650	●	●			●		●		●			●						○	●	●	●	●			●	●	495	40	690	670	65	110	PM6" max. 210 mm								
XMM 120 Torsion Box	1570	●				●		●		●			●						○	●	●	●	●			●	●	495	40	690	670	65	110	PM6" max. 210 mm								
XMM 140 Torsion Box	1675		●			●		●		●			●						○	●	●	●	●			●	●	515	40	690	670	65	110	PM6" max. 210 mm								
XMM 140 Torsion Box	1570		●			●		●		●			●						○	●	●	●	●			●	●	515	40	690	670	65	110	PM6" max. 210 mm								
XMM 150 Torsion Box	1685			●		●		●		●			●						○	●	●	●	●			●	●	525	40	690	670	65	110	PM6" max. 210 mm								
XMM 150 Torsion Box	1590			●		●		●		●			●						○	●	●	●	●			●	●	525	40	690	670	65	110	PM6" max. 210 mm								
XMM 100 29 Torsion Box	1660	●				●		●		●			●						○	●	●	●	●			●	●	503	45	756	733	62	110	PM6" max. 210 mm								
XMM 100 29 Torsion Box	1535	●				●		●		●			●						○	●	●	●	●			●	●	503	45	756	733	62	110	PM6" max. 210 mm								
XMM 100 29 Torsion Box	1675	●				●		●		●			●						○	●	●	●	●			●	●	503	45	756	733	62	110	PM6" max. 210 mm								
XMM 100 29 Torsion Box	1560	●				●		●		●			●						○	●	●	●	●			●	●	503	45	756	733	62	110	PM6" max. 210 mm								
XMM 120 29 Torsion Box	1550	●	●			●		●		●			●						○	●	●	●	●			●	●	523	45	756	733	62	110	PM6" max. 210 mm								
XMM 120 29 Torsion Box	1690	●	●			●		●		●			●						○	●	●	●	●			●	●	523	45	756	733	62	110	PM6" max. 210 mm								
XMM 120 29 Torsion Box	1575	●	●			●		●		●			●						○	●	●	●	●			●	●	523	45	756	733	62	110	PM6" max. 210 mm								
EXM 150 Torsion Box	1675			●	●	●		●		●			●						○	●	●	●	●			●	●	525	40	690	670	65	110	PM6" max. 210 mm								
EXM 150 Torsion Box	1700			●	●	●		●		●			●						○	●	●	●	●			●	●	525	40	690	670	65	110	PM6" max. 210 mm								
EXM 150 Torsion Box	1700			●	●	●		●		●			●						○	●	●	●	●			●	●	525	40	690	670	65	110	PM6" max. 210 mm								
EXM 150 Torsion Box	1590			●	●	●		●		●			●						○	●	●	●	●			●	●	525	40	690	670	65	110	PM6" max. 210 mm								

● = Standard

○ = Option

* Weight without RWS

FORKS ONE PIECE MAG

Model	Weight		Travel				Dropout		Color dropout / Fork slider		Material forks slider			Spring		Damping			Remote		Diameter stanchions		Crown		Diameter steerer		Material steerer		Hose guide		Ride height (A) ± 3 mm [mm]		Fork offset (B) [mm]		Tire diameter max. (C) [mm]		Max. diameter (D) at tire width (E) [mm]		Max. tire width (E) [mm]		Recommended system weight max. [kg]		Disc mount
	± 3% [g]*		100 mm	120 mm	140 mm	150 mm	9 mm	15 mm	W = White (RAL 9010)	S = Black	Torsion box magnesium	One piece Magnesium	Hollow arch carbon UD-finish	NCS	ABS	SS II = Single shot II	TS = Twin shot	LC = Launch control II	Yes	No	ø 28.6 mm	ø 32 mm	C = Carbon UD-finish	A = Aluminium black painted	ø 1 1/8"	Tapered 1.5 – 1 1/8"	C = Carbon UD-finish	A = Aluminium (black anodize)															
XMM 100 26 OPM	1510	●					●	●			●		●		●				○	●	●	●	●	●	●	●	●	●	●	●	●	478	41	690	670	65	110	PM6" max. 210 mm					
XMM 120 26 OPM	1515		●				●	●			●		●		●				○	●	●	●	●	●	●	●	●	●	●	●	498	41	690	670	65	110	PM6" max. 210 mm						
XMM 140 26 OPM	1570			●			●	●			●		●		●				○	●	●	●	●	●	●	●	●	●	●	●	518	41	690	670	65	110	PM6" max. 210 mm						
XMM 150 26 OPM	1570				●		●	●			●		●		●				○	●	●	●	●	●	●	●	●	●	●	●	528	41	690	670	65	110	PM6" max. 210 mm						
XMM 100 27.5 OPM	1525	●					●	●			●		●		●				○	●	●	●	●	●	●	●	●	●	●	●	488	41	718	698	65	110	PM6" max. 210 mm						
XMM 120 27.5 OPM	1530		●				●	●			●		●		●				○	●	●	●	●	●	●	●	●	●	●	●	508	41	718	698	65	110	PM6" max. 210 mm						
XMM 140 27.5 OPM	1570			●			●	●			●		●		●				○	●	●	●	●	●	●	●	●	●	●	●	528	41	718	698	65	110	PM6" max. 210 mm						
XMM 150 27.5 OPM	1570				●		●	●			●		●		●				○	●	●	●	●	●	●	●	●	●	●	●	538	41	718	698	65	110	PM6" max. 210 mm						
XMM 100 29 OPM	1555	●					●	●			●		●		●				○	●	●	●	●	●	●	●	●	●	●	●	505	45	756	733	62	110	PM6" max. 210 mm						
XMM 120 29 OPM	1610		●				●	●			●		●		●				○	●	●	●	●	●	●	●	●	●	●	●	525	45	756	733	62	110	PM6" max. 210 mm						

FORKS TECH SPECS

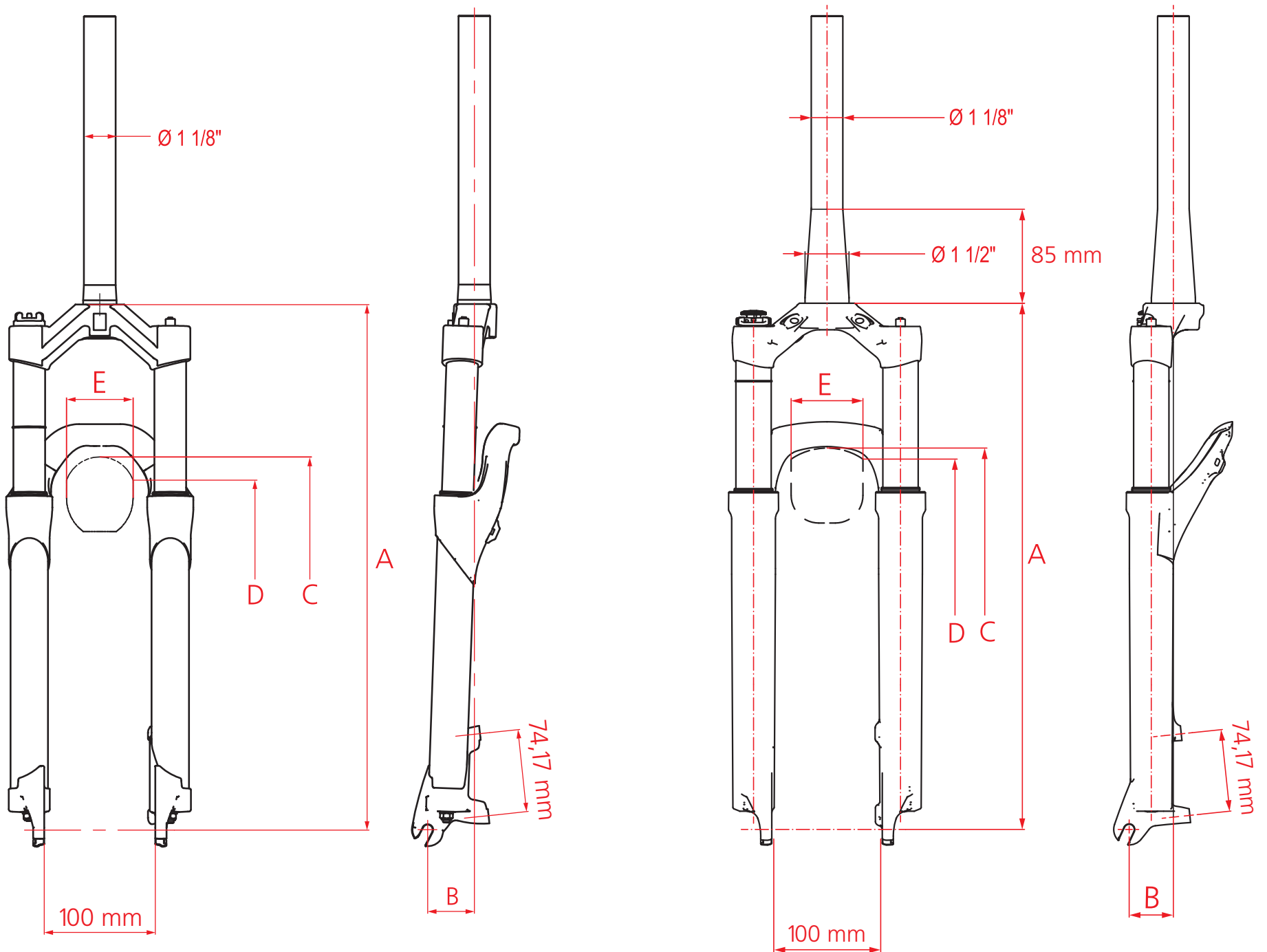

SHOCKS OVERVIEW



X 313 Carbon



X 313



M 212



X 313 Carbon Remote



X 313 Remote



M 212 Remote

Model	Weight ± 3% [g] *	Eye-to-eye x travel [mm] (A) x (D)				Air chamber, finish		Spring system	Damping			Adjustments			Remote		Mounting system	Standard hardware sizes [mm]
		165x37.5	190x50	200x50	200x55	Carbon fiber	Aluminium white RAL 9010		Aluminium black anodized	ABS	Superlight, factory tuned hydraulic damping circuit lockout	HS & LS rebound	HS & LS compression lockout	Rebound Lockout	Rebound	Drive mode Lockout		
X 313 Carbon	145	●	●	●	●	●		●	●	●				●	●	●	●	●
X 313 Carbon Remote	165 incl. lever	●	●	●	●	●		●	●	●				●	●	●	●	●
X 313	198	●	●	●	●		●	●	●	●				●	●	●	●	●
X 313 Remote	218 incl. lever	●	●	●	●		●	●	●	●				●	●	●	●	●
M 212	198	●	●	●	●			●	●		●		●		●	●	●	●
M 212 Remote	218 incl. lever	●	●	●	●			●	●		●		●		●	●	●	●

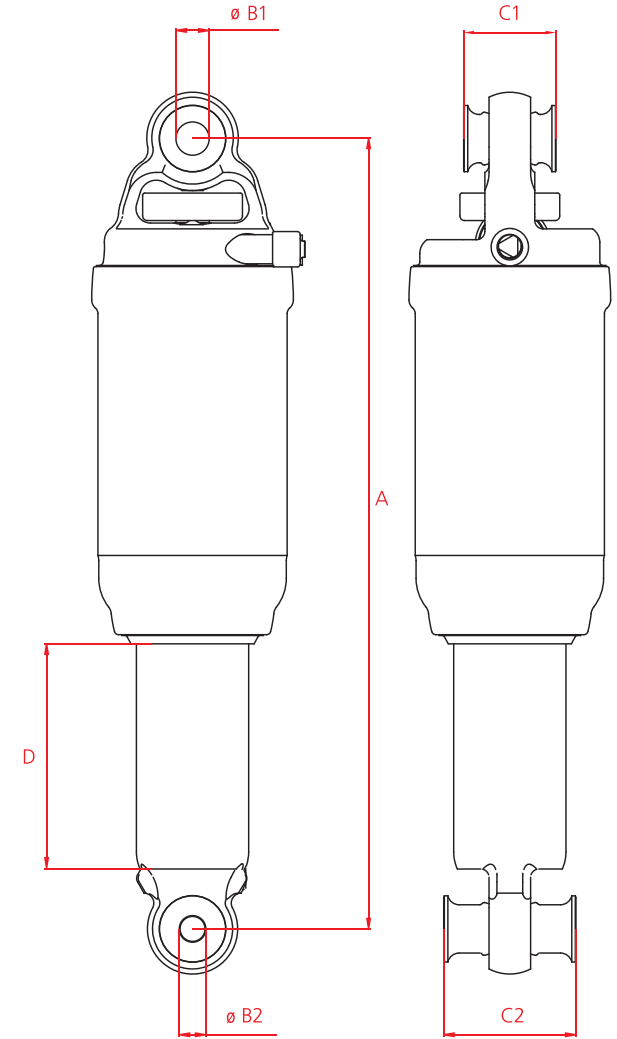

● = Standard

○ = Option

















* @ 165 mm e-t-e















The background features a complex geometric design. A large, dark red triangle points upwards from the bottom left towards the center. A white line starts from the left edge, descends diagonally, then turns horizontal, and finally ascends diagonally to the right edge. At the top, there are several horizontal bands: a solid dark red band, a band with a fine white diagonal hatching pattern, and another solid dark red band. The word "ACCESSORIES" is centered in a white, outlined, sans-serif font, with a thin red horizontal line underneath it.

ACCESSORIES

AXLE CONVERSION KITS **FRONT**

Model	Kit Art. No.	Conversion kits contain		Convertible hubs							Convertible wheels																	
		Endcaps	Axle	RWS	180 Center Lock® fifteen front	240s straightpull Center Lock® fifteen front	240s Center Lock® fifteen front	240s disc brake IS oversize front	240s disc brake IS front	350	XRC 1250 SPLINE® front (27.5, 29)	XR 1450 SPLINE® front (26, 29)	XR 1501 SPLINE® front (26, 27.5, 29)	X 1900 SPLINE® front (26, 29)	XM 1501 SPLINE® front (26, 27.5, 29)	M 1700 SPLINE® front (26, 27.5, 29)	M 1900 SPLINE® front (26, 27.5, 29)	EX 1501 SPLINE® front (26, 27.5)	EX 1750 SPLINE® front (26, 27.5)	E 1900 SPLINE® front (26, 27.5)	XM 1550 TRICON® front (26, 29)	M 1700 TRICON® front	FX 1950 TRICON® front	XRC 950T front (26, 29)	EXC 1550 front	EX 1750 front		
Convert into 5 mm quick release 																												
5 / 100 mm fifteen / TRICON® QR front	HWGXXX0002328S	●			○	○	○				○	○	○		○			○			○				○		○	
5 / 100 mm oversize QR front	HWYXXX00S2479S	●					○											○				○				○		○
Adapter 15mm /QR für 350	HRCXXX00N4369S		●							○			○		○	○			○			○						
Convert into 9 mm thru bolt 																												
9 / 100 mm disc brake TB front	HWGXXX0001919S	●							○																	○		
9 / 100 mm fifteen / TRICON® TB front	HWGXXX0002326S	●			○	○	○				○	○	○		○							○				○		
9 / 100 mm oversize TB front	HWGXXX0002478S	●					○												○				○			○		○
Convert into 15 mm thru axle 																												
15 / 100 mm fifteen / TRICON® TA front	HWGXXX0002149S	●			○	○	○				○	○	○		○							○				○		
15 / 100 mm oversize TA front	HWYXXX00S2477S	●					○																○			○		○
Convert into 20 mm thru axle 																												
20 / 110 mm oversize TA front	HWYXXX00S2480S	●					○																		○		○	

AXLE CONVERSION KITS REAR

Model	Kit Art. No.	Conversion kits contain			Convertible hubs													Convertible wheels															
		Endcaps	Axle	RWS	180 Center Lock® rear	240s straightpull Center Lock® rear	240s straightpull IS rear	240s Center Lock® rear	240s disc brake IS rear	350 straightpull Center Lock® rear	350 straightpull IS rear	350 Center Lock® rear	350 disc brake IS rear	XRC 1250 SPLINE® rear (27.5, 29)	XR 1450 SPLINE® rear (26, 29)	XR 1501 SPLINE® rear (26, 27.5, 29)	X 1900 SPLINE® rear (26, 29)	XM 1501 SPLINE® rear (26, 27.5, 29)	M 1700 SPLINE® rear (26, 27.5)	M 1900 SPLINE® rear (26, 27.5, 29)	EX 1501 SPLINE® rear (26, 27.5)	EX 1750 SPLINE® rear (26, 27.5)	E 1900 SPLINE® rear (26, 27.5)	XM 1550 TRICON® rear (26, 29)	M 1700 TRICON® rear	FX 1950 TRICON® rear (except 150mm)	XRC 950T rear (26, 29)	EXC 1550 rear	EX 1750 rear (except 150mm)				
Convert into 5 mm quick release 																																	
5/135 mm QR rear	HWGXXX0001528S	●			○	○	○	○	○	○	○	○	○	○	○	○	○	○	○	○	○	○	○	○	○	○	○	○	○	○	○	○	
5/135 mm QR rear for Sram XD	HWGXXX00S3115S	●			○	○	○	○	○	○	○	○	○	○	○	○	○	○	○	○	○	○	○	○	○	○	○	○	○	○	○	○	
Convert into 10 mm thru bolt 																																	
10/135 mm TB rear	HWGXXX0001803S	●			○	○	○	○	○	○	○	○	○	○	○	○	○	○	○	○	○	○	○	○	○	○	○	○	○	○	○	○	
10/135 mm TB rear for Sram XD	HWGXXX00S3218S	●			○	○	○	○	○	○	○	○	○	○	○	○	○	○	○	○	○	○	○	○	○	○	○	○	○	○	○	○	
Convert into 12 mm thru axle  																																	
12/135 mm TA rear	HWGXXX0002218S	●			○	○	○	○	○	○	○	○	○	○	○	○	○	○	○	○	○	○	○	○	○	○	○	○	○	○	○	○	
12/135 mm TA rear for Sram XD	HWGXXX00S3382S	●			○	○	○	○	○	○	○	○	○	○	○	○	○	○	○	○	○	○	○	○	○	○	○	○	○	○	○	○	
12/142 mm TA rear	HWGXXX0002193C	●			○	○	○	○	○	○	○	○	○	○	○	○	○	○	○	○	○	○	○	○	○	○	○	○	○	○	○	○	
12/142 mm TA rear	HWYXXX0002216S	●	●		○	○	○	○	○	○	○	○	○	○	○	○	○	○	○	○	○	○	○	○	○	○	○	○	○	○	○	○	
12/142 mm X-12 rear	HWYXXX0002877C	●	●	●	○	○	○	○	○	○	○	○	○	○	○	○	○	○	○	○	○	○	○	○	○	○	○	○	○	○	○	○	
12/142 mm TA rear for Sram XD	HWGXXX00S3188S	●			○	○	○	○	○	○	○	○	○	○	○	○	○	○	○	○	○	○	○	○	○	○	○	○	○	○	○	○	

● = Standard ○ = Optionally convertible

ROTOR KITS **ROAD**



Rotor kit road
Shimano ceramic
9/10 speed



Rotor kit road
Shimano
9/10 speed



Rotor kit road
Campagnolo
10/11 speed



Rotor kit road
Shimano
11 speed



Rotor kit road
Shimano
11 speed SL

Convert into Shimano 9/10 speed	Art. No.
Rotor kit road Shimano ceramic 9/10 speed	HWYCBX00S1239S
Rotor kit road Shimano 9/10 speed	HWYABX00S1239S
Convert into Campagnolo 10/11 speed	Art. No.
Rotor kit road Campagnolo 10/11 speed	HWYABX00S1296S

- D.** Kompatibilität siehe tech. Specs der Laufräder / Naben.
- E.** For compatibility see tech specs wheels / hubs.
- F.** Concernant la compatibilité voyez les spécifications techniques des roues / moyeux.
- I.** Per la compatibilità vedere i dati tecnici delle ruote / dei mozzi.

Convert into Shimano 11 speed	Art. No.
Rotor kit road Shimano 11 speed	HWYABX00S2775S
Rotor kit road Shimano 11 speed SL	HWYABX00S3184S

- D.** Alle DT Swiss Ratchet System® Naben können mit den oben aufgeführten rotor kits auf Shimano 11-fach umgerüstet werden.
- E.** All DT Swiss Ratchet System® hubs can be converted to Shimano 11 speed using the rotor kits listed above.
- F.** Tous les moyeux DT Swiss Ratchet System® peuvent être convertis en Shimano 11-vitesses en utilisant les kits rotor listés ci-dessus.
- I.** Tutti i mozzi DT Swiss Ratchet System® possono essere convertiti nel sistema Shimano 11-rapporti utilizzando i rotor kit indicati in alto.

ROTOR KITS **MTB**



**Rotor kit MTB
Sram XD
5/135 mm QR**



**Rotor kit MTB
Sram XD
10/135 mm TB**



**Rotor kit MTB
Sram XD
12/135 mm TA**



**Rotor kit MTB
Sram XD
12/142 mm TA**

- D.** Mit den folgenden Umrüstkits ist es möglich, alle existierenden DT Swiss Ratchet System® MTB Laufräder und Naben auf das Sram XD 11-fach System umzurüsten:
- E.** Using the following conversion kits, it is possible to convert all existing DT Swiss Ratchet System® based MTB wheels and hubs to the Sram XD 11 speed system:
- F.** En utilisant les kits de conversion suivants, il est possible de convertir les roues et les moyeux DT Swiss de VTT basés sur le Ratchet System®, dans le système Sram XD 11-vitesses:
- I.** Utilizzando i kit di conversione seguenti è possibile di convertire tutte le ruote e i mozzi DT Swiss MTB che usano il Ratchet System® al sistema Sram XD 11-rapporti:

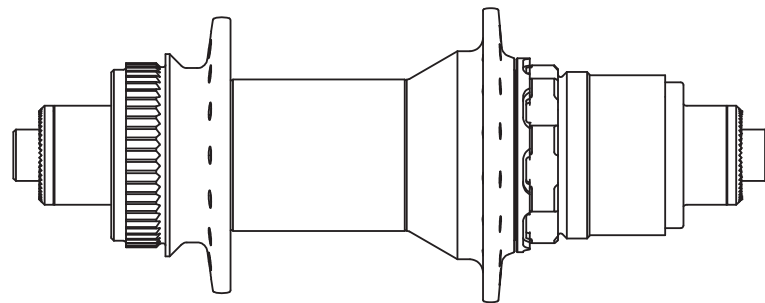

Convert into Sram 11 speed	Art. No.
Rotor kit MTB Sram XD 5/135 mm QR	HWYAA00S3115S
Rotor kit MTB Sram XD 10/135 mm TB	HWYAA00S3218S
Rotor kit MTB Sram XD 12/135 mm TA	HWYAA00S3382S
Rotor kit MTB Sram XD 12/142 mm TA	HWYAA00S3188S

- D.** Kompatibilität siehe tech. Specs der Laufräder / Naben.
- E.** For compatibility see tech specs wheels / hubs.
- F.** Concernant la compatibilité voyez les spécifications techniques des roues / moyeux.
- I.** Per la compatibilità vedere i dati tecnici delle ruote / dei mozzi.

TUBELESS SOLUTIONS

Model	Art. No.	Wheels										Rims																	
		XRC 1250 SPLINE® (27.5, 29)	XR 1450 SPLINE® (26, 29)	XR 1501 SPLINE® (26, 27.5, 29)	X 1900 SPLINE® (26, 29)	XM 1501 SPLINE® (26, 27.5, 29)	M 1700 SPLINE® (26, 27.5, 29)	M 1900 SPLINE® (26, 27.5, 29)	EX 1501 SPLINE® (26, 27.5)	EX 1750 SPLINE® (26, 27.5)	E 1900 SPLINE® (26, 27.5)	EX 1750 (26)	XRC 320 (26, 29)	XR 331 (26, 27.5, 29)	XR 400 (26, 29)	X 430 (26)	X 470 (29)	XMC 350 (27.5, 29)	XM 401 (26, 27.5, 29)	XM 450 (26)	XM 490 (29)	M 480 (26, 27.5)	M 520 (29)	EX 471 (26, 27.5)	EX 500 (26)	E 530 (26)	533d (26, 27.5, 29)	FR 600 (26)	F 630 (26)
DT Swiss tubeless ready tape																													
DT tubeless ready tape 23 mm/10 m black ¹⁾	TVX2310S29812S		○	○	○		○					○	○	○	○	○													
DT tubeless ready tape 25 mm/10 m black ¹⁾	TVX2510S29809S	○				○	○		○		○						○	○	○	○	○	○			○	○			
DT tubeless ready tape 27 mm/10 m black ¹⁾	TVX2710S29813S									○														○				○	○
DT Swiss tubeless ready kits																													
DT tubeless ready kit 23 mm/10 m black ²⁾	TVK2310S29812S		●	●	●		●					○	○	○	○	○													
DT tubeless ready kit 25 mm/10 m black ²⁾	TVK2510S29809S	●				●	●		●		●						○	○	○	○	○	○			○	○			
DT tubeless ready kit 27 mm/10 m black ²⁾	TVK2710S29813S									●		●												○			○	○	○
Tubeless kits																													
XR/X 26 tubeless kit ³⁾	TVXXXXXNKIT41S		○		○									○	○														
XM/M 26 tubeless kit ³⁾	TVXXX26NKITXMS							○	○										○		○								
EX/E 26 tubeless kit ³⁾	TVXXXXXNKIT51S									○		○													○	○			
XM/M 27.5 tubeless kit ³⁾	TVXX650NKITXMS							○	○													○							
XR/X 29 tubeless kit ³⁾	TVXXX29NKITXRS		○		○								○		○														
XM/M 29 tubeless kit ³⁾	TVXXX29NKITXMS							○	○											○		○							

¹⁾ Only tubeless ready tape

²⁾ Tubeless ready tape, 2x tubeless valves M, manual

³⁾ Red tubeless tape, 1x tubeless valves M, tire sealant, double sided tape, manual

D

DT TRUING STAND



Der DT truing stand ist der ultimative Zentrierständer! Das Profigerät besteht aus geschliffenem, anodisiertem Aluminium mit oberflächengehärteten Stahlführungen und Aufnahmen.

- Höchste Qualität, einfachste Bedienung
- Spart Zeit beim Laufradbau
- Kompatibel mit allen gängigen Fahrradlaufrädern (12" – 29") mit Schnellspann- oder Steckachse
- Dank drei präzisen Multilink-Armen sind die Messpunkte frei wählbar
- Genaue, spielfreie Taster für Höhen- und Seitenschlag
- Höchste Steifigkeit und feste Klemmung
- Laufrad kann auch mit Bereifung zentriert werden
- Zum verschrauben, aufstellen oder im Schraubstock einklemmen
- Optionen: Analoge Messuhren inklusive Messeinsatz mit Kugel, spezielle Messeinsätze mit gerundetem Teller oder kugelgelagerter Stahlrolle, Zentrieradapter für alle Achsvarianten.

E

The DT Swiss truing stand is the ultimate stand used by professionals. It is made of precision machined, polished and anodized aluminium with hardened steel guides and mounts.

- High-end quality and easy handling
- Quicker wheel building
- Compatible with all current bicycle wheels (12" – 29") with quick release or thru axle
- Three precision multilink arms providing a wide range of contact points
- Playfree precision gauges to measure lateral and vertical dish
- Extremely stiff and solid clamping
- Wheel can be trued with tires
- Can be installed on a table or clamped into a vice
- Upgrades: Analog gauges including measuring insert with ball, special measuring inserts with rounded washers or ball bearing steel roll, truing adapters for all axle configurations.

F

Le centreur de roue DT Swiss est l'arme ultime des monteurs professionnels. Usiné en aluminium poli et anodisé et doté des pattes de fixation en acier.

- Qualité de fabrication extraordinaire, utilisation facile
- Gain de temps lors du montage de roue
- Compatible avec toutes les roues vélo (12" – 29")
- Trois bras articulés multiposition
- Capteurs de précision pour le saut et le voile
- Fixation de la roue optimale
- Le pneu ne doit pas être démonté pour le dévoilage
- Peut être serré dans un étau ou vissé sur un banc
- Options: Indicateurs analogues de saut et de voile, adaptateurs pour tout type d'axe.

I

Il centraruote DT Swiss è il meglio che può essere utilizzato dai professionisti. È realizzato in alluminio lucidato ed anodizzato, lavorato a macchina di precisione con guide ed attacchi in acciaio temprato.

- Massima qualità e facilità di utilizzo
- Montaggio ruota più rapido
- Compatibile con tutte le ruote per bici disponibili in commercio (12" – 29") provviste di sgancio rapido o perno passante
- Tre braccia di precisione che offrono numerosi punti di contatto
- Indicatori di precisione per misurare il cerchio lateralmente e verticalmente
- Serraggio estremamente rigido e solido
- La ruota può essere centrata con i pneumatici
- Può essere installata su un tavolo oppure serrata in una morsa
- Upgrades: indicatori analogici comprensivi di inserto di misurazione a sfera, gli inserti di misurazione speciali con rondelle arrotondate oppure rullo in acciaio su cuscinetto a sfere, adattatori di centraggio per tutte le misure di perno.

DT TENSIO (ANALOG)



Der analoge Tensiometer DT tensio ist ein Präzisionsinstrument zum Messen der Speichenspannungen im Laufrad. Diese DT Swiss Entwicklung, 100 % Swiss made, ist für das schrittweise Vorspannen der Speichen während des Laufradbbaus sowie der Kontrolle der Speichenspannung bestimmt. Für jeden professionellen Laufradbauer unerlässlich, ist es mit allen Speichentypen kompatibel, einschliesslich Flachspeichen. Der Tensiometer wird im praktischen Handkoffer geliefert.

The analog tensiometer is a high-precision tool to measure spoke tensions. Developed by DT Swiss and 100 % Swiss made, it is used to precisely measure the spoke tension step by step during the wheel building process. The DT Swiss tensiometer is a necessity for any professional wheel builder. Can be used with all spoke types including flat spokes. Includes case.

Le tensiometre analogique est un instrument de précision pour mesurer la tension de rayon. Cet outil développé par DT Swiss et fabriqué à 100 % en Suisse, vous permet de contrôler la tension des rayons pendant le montage de la roue. Indispensable à tous les monteurs professionnels et compatible avec tous types de rayons (rayons plats inclus). Il est livré dans une boîte protectrice.

Il tensiometro analogico è un utensile di alta precisione per misurare la tensionatura del raggio. Sviluppato da DT Swiss e realizzato al 100 % in Svizzera, è utilizzato per misurare accuratamente la tensionatura del raggio passo a passo durante il processo di montaggio della ruota. Il tensiometro DT Swiss è indispensabile per qualunque costruttore professionista di ruote. Può essere utilizzato con tutti i tipi di raggi, inclusi i raggi piatti. Involo in dotazione.

DT TENSIO (DIGITAL)



Die digitale Messuhr erlaubt ein schnelles und präzises Ablesen der Werte. Über den Opto-RS232 Datenausgang lassen sich die Messwerte via Verbindungskabel auf einen PC oder Drucker übertragen. Anwendbar für alle Speichentypen, einschliesslich Flachspeichen. Lieferung inklusive Koffer. 100 % Swiss made.

The digital tensiometer is equipped with a digital gauge, allowing fast and easy reading of measurements. Using its Opto-RS232 data output device, the measured values can be transmitted directly to a PC or printer via connecting cable. Suitable for all spoke types, including flat spokes. Includes case. 100 % Swiss made.

Le tensiometre digital vous permet de voir facilement et rapidement les valeurs de tension, grâce à son compteur Opto-RS232. Les informations peuvent être transmises directement sur un ordinateur ou imprimées à l'aide d'un câble de connexion. Il est compatible avec tous types de rayons (rayons plats inclus) et 100 % Swiss made. Il est livré dans une boîte protectrice.

Il tensiometro digitale è dotato di un indicatore digitale che consente di leggere le misurazioni velocemente ed agevolmente. L'utilizzo del dispositivo di uscita dati Opto-RS232 consente di trasmettere i valori misurati direttamente a un PC oppure a una stampante tramite un cavo di connessione. Adatto per tutti i tipi di raggi, inclusi i raggi piatti. Involo in dotazione. Realizzato al 100 % in Svizzera.

SHOCK PUMP



- Pumpe für alle DT Swiss Suspension Produkte, 20bar / 300PSI Maximaldruck
- Platzsparend dank abnehmbarer Druckanzeige
- Anti Air-Loss Kupplung gegen Luftverlust beim Entfernen der Pumpe
- Geeignet für Links- und Rechtshänder dank drehbarer Anzeige
- Luftblasknopf zur Feineinstellung
- Griffiger Gummischutz für die Druckanzeige

- Fits all DT Swiss suspension forks and shocks 20bar/300PSI max. pressure
- Minimal packing size thanks to removable gauge and foldable hose
- Anti air-loss coupler for precise set-ups (no air loss when removing pump from valve)
- Suitable for right- and left-handed people
- Air bleeder for fine tuning
- Rubber padded gauge housing

- Pression maximale de 20 bar/300 PSI, suffisante pour les fourches et les amortisseurs DT Swiss.
- Indicateur de pression amovible pour un transport simplifié
- Pas de perte d'air lors du montage et démontage sur la valve d'air
- S'adapte aux droitiers et gauchers en tournant le manomètre
- Ajustage de la pression facile grâce à la valve de réglage
- Manomètre protégé pendant le transport

- Si monta su tutte le forcelle e gli ammortizzatori DT Swiss, pressione max. 20bar/300PSI
- Dimensioni di imballo minime grazie all'indicatore amovibile e al tubo ripiegabile
- Attacco con valvola anti perdita per impostazioni precise (nessuna perdita d'aria durante l'asportazione della pompa dalla valvola)
- Adatto per destrimani e mancini
- Valvola di scarico dell'aria per regolazioni più precise
- Involo indicatore imbottito di gomma

ACCESSORIES PROLINE

D

DT NIPPLE WRENCHES



Der passende Nippelspanner für DT Swiss Nippel mit innenliegendem Antrieb. Erhältlich für DT Swiss Nippel in Sechskant (blauer Griff **1**), Torx (schwarzer Griff **2**) oder Vierkant (roter Griff **3**) Ausführung.

- Kleinere Handkräfte beim Vorspannen der Speichen
- Erleichtert die Arbeit mit Flachspeichen
- Entwickelt von DT Swiss
- Auch für Hochprofilfelgen geeignet (max. 100 mm)

E

The matching nipple wrench for DT Swiss nipples with an internal drive. Available for DT Swiss nipples with hexagonal (blue handle **1**), torx (black handle **2**) or square (red handle **3**) heads.

- Less hand force needed
- Facilitates work with bladed spokes
- Developed by DT Swiss
- Also suitable for high profile rims (max. 100 mm)

F

La clé correcte pour les écrous DT Swiss avec empreinte à l'interno de la jante. Disponible pour les écrous DT Swiss en version hexagonale (poignée bleue **1**), torx (poignée noire **2**) ou carrée (poignée rouge **3**).

- Force nécessaire à la tension des rayons réduite
- Facilite le travail avec les rayons plats
- Développé par DT Swiss
- Convient aussi pour les jantes à profil haut (max. 100 mm)

I

La chiave adatta per i nipples DT Swiss con un innesto all'interno del cerchio. Disponibile per i nipples DT Swiss in versione esagonale (manico blu **1**), torx (manico nero **2**) o quadrata (manico rosso **3**).

- Richiede meno forza manuale
- Facilita il lavoro con i raggi piatti
- Sviluppato da DT Swiss
- Idoneo anche per cerchi ad alto profile (max. 100 mm)

SPOKEY



Professionelles Werkzeug für ein passgenaues Umfassen der Nippel.

Professional tool for a precise fit onto the nipple.

Outil professionnel garantissant une prise précise de l'écrou.

Utensile professionale per una presa precisa dei nipples.

DT AERO SPOKE HOLDER



0.8 – 1.0 mm / 1.0 – 1.3 mm

Diese Speichenhalter verhindern das Verdrehen von Flachspeichen (z.B. DT aerolite) beim Zentrieren oder Laufradbau. Durch ihre Konstruktion kann die Speiche so nah wie möglich beim Nippel gehalten, und somit das Verdrehen verhindert werden. Kompatibel mit allen DT Swiss Zentrierwerkzeugen.

This spoke holders effectively eliminate spoke twist when truing or building wheels with bladed spokes (e.g. DT aerolite). Thanks to their design, the spoke can be held close to the nipple, which eliminates twisting. Compatible with all DT Swiss nipple wrenches.

Empêchent la torsion des rayons plats lors de la mise en tension ou du dévoilage. La forme spécifique permet le maintien du rayon très proche de l'écrou pour faciliter le travail. Compatibles avec tous les clés de rayon DT Swiss.

Questi porta-raggi eliminano efficacemente la torsione del raggio durante la centratura o realizzazione della ruota con raggi bladed (per es. DT aerolite). Grazie alla loro progettazione, il raggio può essere tenuto vicino al nipple, con conseguente eliminazione del rischio di torsione. Compatibili con tutte le chiavi nipples DT Swiss.

MULTI TOOL



Nippelspanner für DT Swiss Torx und Vierkant Nippel sowie für das Halten von Aerospeichen.

Nipple wrench for DT Swiss torx and square nipples as well as for holding bladed spokes.

Une clé soit pour les écrous DT Swiss torx soit pour les écrous carrés et pour la prise des rayons plats.

Chiave sia per i nipples DT Swiss torx che per i nipples quadrati e per tenere i raggi piatti.

NIPPLE DRIVER



Erleichtert und beschleunigt das Aufschrauben der Nippel auf die Speichen.

Makes screwing the nipple onto the spoke quicker and easier.

Permet un vissage de l'écrou facile et rapide.

Velocizza e facilita l'avvitatura del nipple sul raggio.

NIPPLE GUIDE



Erleichtert das Positionieren und Fixieren der Nippel in Hochprofilfelgen.

Facilitates the insertion of nipples into deep section rims.

Facilite l'insertion de l'écrou dans les jantes à profil haut ou celles sans double oeillets.

Facilita l'inserimento del nipple nei cerchi a profilo alto.

SPOKE HEAD PUNCH



Durchschlag mit konkaver Spitze, passend auf DT Swiss Speichenköpfe. Verbessert den Sitz des Speichenkopfes im Nabenflansch.

Punch with concave head, fitting DT Swiss spoke heads. Improves seating of the spoke head in the hub flange.

Enfonceur avec pointe concave, fonctionne avec toutes les têtes de rayon DT Swiss. Optimise la position de la tête dans le flasque.

Punzone a testa concava, adatto per le teste dei raggi DT Swiss. Migliora l'alloggiamento della testa del raggio nella flangia del mozzo.

SPOKE RULER



Zum Messen von Speichenlängen und Speichendurchmessern.

For measuring spoke lengths and diameters.

Pour mesurer la longueur et le diamètre des rayons.

Per misurare le lunghezze e i diametri dei raggi.

D

DT SWISS SPOKE FREEZE



Speziell entwickelte Schraubensicherung für den Laufradbau. Verhindert ein Lösen der Speichen-Nippel Verbindung.

E

Threadlock solution to prevent loosening of the spoke-nipple connection.

F

Conçu pour éliminer le risque de desserrage de l'écrou et du rayon.

I

Soluzione threadlock per prevenire l'allentamento del collegamento raggio - nipple.

SOLDER TIN



Lötzinn mit Bindefähigkeit auf rostfreiem Stahl 18/10. Die Lötstelle bleibt dauerhaft glänzend. Bleifrei! Spule à 15.8m

Solder tin with bonding capacity on 18/10 stainless steel. The soldered joint stays permanently shiny. Lead-free! Spool of 15.8m.

Etain de soudure. Compatible avec l'acier inoxydable 18/10. La soudure reste parfaitement brillante. Bobine de 15.8m. Sans plomb!

Stagno per saldatura con capacità legante sull'acciaio inox 18/10. Il giunto saldato resta lucido permanentemente. Senza piombo! Bobina da 15,8m.

SPOKE HEAD WASHERS



Unterlagsscheiben aus Messing. Diese werden benötigt wenn zwischen Speiche und Speichenloch Spiel besteht. Erhältlich in den Durchmessern 2.2 und 2.5mm.

Brass washers for the use between spoke head and hub flange. Necessary if there's play between the spoke and spokehole. Available in 2.2 and 2.5mm diameters.

Permettent de stabiliser la tête du rayon dans le flasque. Nécessaires lorsque il y a du jeu entre rayon et trou de flasque. Existe en 2.2 mm et 2.5 mm.

Rondelle in ottone da utilizzarsi tra la testa del raggio e la flangia del mozzo. Necessarie in presenza di gioco tra il raggio e il foro del raggio. Disponibili nei diametri da 2,2 e 2,5 mm.

TYING WIRE



Spezialdraht für das Binden von Speichenkreuzungen. Die verzinnnte Drahtoberfläche dient als Temperaturindikator beim Löten. Spule à 100m.

Special wire for tying and soldering spoke crossings. The tin-plated wire surface also acts as a temperature indicator when soldering. Available in spools of 100m.

Fil pour ligaturer les croisements des rayons. Disponible en bobine de 100 m.

Filo speciale per legare e saldare gli incroci dei raggi. La superficie del filo, stagnata, funge da indicatore della temperatura durante la saldatura. Disponibile nelle bobine da 100m.

APRON



Für den Laufradbau oder den Werkstattgebrauch. 100 % Baumwolle, Gesamtlänge ca. 95 cm, Nacken- und Beckentaschen zum Binden und zwei praktische Fronttaschen. Gesticktes DT Swiss Logo.

For wheelbuilding or general wrenching. Made of 100% cotton, total length 95 cm, with straps for neck and waist and two handy front pockets. Embroidered DT Swiss logo.

Le montage professionnel des roues peut devenir une affaire huileuse. Ce tablier est en 100% coton, longueur totale 95 cm, serrage par la nuque et par la taille, avec deux poches frontales, logo DT Swiss brodé.

Per i costruttori di ruote oppure per l'officina in generale. Realizzato in cotone al 100%, lungo 95 cm in tutto, con lacci per il collo e la vita e due comode tasche anteriori. Il logo DT Swiss è ricamato.

Ölabweisend.

Oil proof.

Etanche à l'huile.

Impermeabile all'olio.

SPOKE LENGTH CHART



Zur exakten Berechnung von Speichenlängen bei Verwendung von Felgen mit einem ERD von 390 bis 630 mm, Nieder- und Hochflanschnaben (24 bis 48 Loch) und den Kreuzungsarten radial bis 4-fach.

Genauigkeit ± 0.5 mm. Format 70 x 52 cm.

Benutzen Sie auch unser Gratisprogramm «spokes calc» auf www.dtswiss.com. Hier lassen sich Speichenlängen einfach und rasch ermitteln.

Allows for precise spoke length calculation. Works when using rims with an ERD from 390 to 630 mm, low- and high-flanged hubs (24 to 48 holes), radial to 4-cross lacing patterns.

Precision ± 0.5 mm, Size 70 x 52 cm.

Also check out our free program «spokes calc» on www.dtswiss.com – an easy and fast way to calculate your spoke lengths.

Pour un calcul de longueur de rayon précis, utilisant des jantes au diamètre de 390 à 630 mm, des moyeux à flasque haut ou compact de 24 à 48 trous.

Précision ± 0.5 mm. Dimensions 70 x 52 cm.

Consultez le site www.dtswiss.com, rubrique «spokes calc», pour un calcul facile et rapide de la longueur de rayon.

Consente di calcolare con precisione la lunghezza del raggio. Funziona quando si utilizzano i cerchi con un ERD compreso tra 390 e 630 mm, mozzi a flangia bassa e alta (da 24 a 48 fori), schemi di incrocio da radiale ad incrocio quadruplo.

Precisione ± 0.5 mm, Dimensione 70 x 52 cm.

Verificare anche il nostro programma gratuito «spokes calc» sul sito www.dtswiss.com – un modo facile e rapido per calcolare le lunghezze dei raggi.

SERVICE TOOL CASE



DT Swiss bietet verschiedene Reparaturkoffer, Service- und Wartungskits an.

Weitere Angaben finden Sie unter www.dtswiss.com.

Several service and maintenance tool kits are available for DT Swiss products.

For more information check out www.dtswiss.com.

Plusieurs kits de maintenance DT Swiss sont disponibles.

Consultez le site www.dtswiss.com pour une liste complète.

Sono numerosi gli attrezzi per la manutenzione e l'assistenza disponibili per i prodotti DT Swiss.

Per maggiori informazioni consultare il sito www.dtswiss.com.

ACCESSORIES PROLINE

D

E

F

I

DVD



Mastering the Wheel: Gerd Schraner (DT Swiss) and Alex Roussel (UCI) erklären den Laufradbau in all seinen Facetten. Anleitung zum Bau von Laufrädern für Strasse, MTB, Bahn und BMX. Umfassend und verständlich für Anfänger und Profis. PC und Mac kompatibel, PAL oder NTSC Versionen verfügbar, Laufzeit 120 min.

Sprachen: Deutsch, Englisch, Französisch, Spanisch und Portugiesisch.

Mastering the Wheel: Gerd Schraner (DT Swiss) and Alex Roussel (UCI) show all the secrets of wheelbuilding, be it MTB, road, track or BMX wheels. Comprehensive for beginners and professionals. PC and Mac compatible, NTSC and PAL versions available, run time 120 min.

Languages: English, French, German, Spanish and Portuguese.

Maîtriser la Roue: A l'atelier avec Gerd Schraner (DT Swiss) et Alex Roussel (UCI). Un cours pratique pour apprendre tout sur la roue (route, VTT, BMX). A la portée des monteurs professionnels et des amateurs. Compatible PC et Mac, disponible en version PAL ou NTSC, durée 120 min.

Langues: Allemand, Anglais, Français, Portugais, Espagnol.

Mastering the Wheel: Gerd Schraner (DT Swiss) e Alex Roussel (UCI) illustrano tutti i segreti riguardanti la realizzazione di una ruota, sia che si tratti di ruote MTB, su strada, su pista oppure BMX. Adatto per i principianti e i professionisti. Compatibile con PC e Mac, disponibile nella versione NTSC e PAL, durata 120 min.

Lingue: inglese, francese, tedesco, spagnolo e portoghese.

BOOK



Gerd Schraner zeigt in seinem Buch sämtliche Tricks und Kniffe, die für handgebaute, hochwertige Laufräder entscheidend sind. Das für Anfänger sowie für Profisgedachte Buch ist eine exakte Anleitung zum Bau von Laufrädern für Mountainbikes, Touren- und Rennräder.

In his book, Gerd Schraner reveals all his tricks and secrets about high-quality, hand-built wheels. Clearly written for beginners and professionals, this book is a precise guide for wheelbuilding, be it mountain, touring or road wheels.

Dans son livre Gerd Schraner nous révèle tous ses secrets du montage de roue. A la portée des monteurs professionnels et des amateurs. Un guide précis expliquant le montage de tout type de roue (route, VTT, BMX, touring).

Nel suo libro, Gerd Schraner rivela tutti i trucchi e i segreti sulle ruote di alta qualità realizzate a mano. Scritto in modo chiaro per principianti e professionisti, questo libro è una guida precisa per la realizzazione delle ruote, siano esse per il ciclismo mountain, touring oppure su strada.

DT SWISS TUBELESS KIT



Mit dem DT Swiss Tubeless Kit verwandeln Sie Ihre DT Swiss Felge in ein Tubeless-System! Die Felge wird mittels Spezial-Klebeband gegen Luftverlust abgedichtet, eine Gummilösung dichtet den Reifen und wirkt im Falle kleinerer Einstiche selbstreparierend. Das Set besteht aus spezial Klebeband, Felgenband, Gummilösung und Ventil. Achtung: Nur für UST Tubeless-Reifen!

Kompatibilität siehe tech. Specs der Laufräder / Felgen und Seite 80.

The DT Swiss tubeless kit converts your DT Swiss rim into a tubeless system! The specially developed rim tape makes the rim airtight while the tire sealant seals the tire from the inside and automatically fixes small punctures. The set consists of tire sealant, adhesive tape, rim tape and valve. Attention: Only for UST tubeless tires!

For compatibility see tech specs wheels / rims and page 80.

Transformez vos roues DT Swiss en roues tubeless avec le DT Swiss tubeless kit. Le kit comprend: Un fond de jante étanche (flap), un kit valve spécifique, un liquide anticrevaision préventif et une bande adhésive. Le flap rend la jante étanche à l'air et le liquide préventif répare les petites crevaisons. Seulement pour les pneus tubeless UST!

Concernant la compatibilité voyez les spécifications techniques des roues / jantes et page 80.

Il kit tubeless DT Swiss converte il cerchio DT Swiss in un sistema tubeless! Il flap, sviluppato specificamente, rende il cerchio a tenuta d'aria mentre il lattice antiforatura sigilla il pneumatico dall'interno, riparando automaticamente piccole forature. Il set è costituito dal lattice antiforatura, dal nastro adesivo, dal flap e della valvola. Attenzione: solo per i pneumatici tubeless UST!

Per la compatibilità vedere i dati tecnici delle ruote / dei cerchi e pagina 80.

DT SWISS TUBELESS READY KIT



Das DT Swiss tubeless ready Kit macht aus einem tubeless ready Laufrad ein tubeless Laufrad. Einfach das Felgenband und das Tubeless Ventil installieren, Dichtflüssigkeit* begeben und los geht's!

*Dichtflüssigkeit nicht inbegriffen

The DT Swiss tubeless ready kit transforms your tubeless ready wheel into a tubeless wheel. Simply install the rim tape and the tubeless valve, add some tire sealant* on off you go!

*tire sealant not included

Le DT Swiss tubeless ready kit fait d'une roue tubeless ready une roue tubeless. Il suffit d'installer le fond de jante, la valve tubeless et d'ajouter un peu de liquide préventif* et c'est parti!

*liquide préventif non inclus

Il DT Swiss tubeless ready kit trasforma ogni ruota tubeless ready in una ruota tubeless. Basta montare il nastro e la valvola tubeless e aggiungere un poco di lattice antiforatura* e si parte!

*lattice antiforatura venduto separatamente

DT SWISS TUBELESS READY TAPE



Das DT Swiss tubeless ready Tape dichtet die Felge ab und funktioniert gleichzeitig als Felgenband.

The DT Swiss tubeless ready tape seals the rim and works as a rim tape.

Le DT Swiss tubeless ready tape rend la jante étanche à l'air et sert comme fond de jante.

Il DT Swiss tubeless ready tape sigilla il cerchio e serve da nastro paranipples.

DT SWISS TUBELESS MILK



Die DT Swiss tubeless Milk dichtet tubeless ready Reifen ab und repariert kleine Einstiche automatisch.

The DT Swiss tubeless milk seals tubeless ready tires and automatically repairs small punctures.

Le liquide préventif DT Swiss tubeless milk rend les pneus tubeless ready étanches à l'air et répare les petites crevaisons automatiquement.

Il lattice antiforatura DT Swiss tubeless milk sigilla i copertoni tubeless ready e ripara automaticamente le piccole forature.

D

E

F

I

TUBELESS VALVE MOUNTAIN



Ventil für die tubeless Konversion von geeigneten DT Swiss MTB Laufrädern.

Valve to convert compatible DT Swiss MTB wheels to tubeless.

Valve pour transformer les roues DT Swiss VTT compatibles en tubeless.

Valvola per convertire le ruote DT Swiss MTB adatte in tubeless.

RIM TAPE



Felgenbänder zu DT Swiss Felgen und Laufräder.

Rim tapes for DT Swiss rims and wheels.

Fond de jante pour les roues et les jantes DT Swiss.

Nastri per cerchi e ruote DT Swiss.

Kompatibilität siehe tech. Specs der Felgen und unter www.dtswiss.com.

For compatibility see tech specs rims and check out our website www.dtswiss.com.

Concernant la compatibilité voyez les spécifications techniques des jantes et sur www.dtswiss.com.

Per la compatibilità vedere i dati tecnici dei cerchi e www.dtswiss.com.

BRAKE PADS



Bremsbeläge für DT Swiss Carbonfelgen.
Black Prince: Neue, verbesserte Gummimischung für kontrolliertes lineares Bremsverhalten.

Brakepads for DT Swiss carbon rims.
Black Prince: New pad compound offering linear and controlled braking.

Patins de frein pour les roues DT Swiss carbone.
Black Prince: nouvelle composition du patin pour un freinage contrôlé et linéaire.

Pastiglie di freno per le ruote DT Swiss in carbonio.
Black Prince: nuova composizione della pastiglia per una frenata controllata e lineare.

CENTER LOCK® CAP



Abdeckung für Shimano Center Lock® Aufnahmen.

Cover for Shimano Center Lock® interfaces.

Protège le Center Lock® si la roue est utilisée avec des freins à jante.

Coperchio per l'interface Center Lock® Shimano.

CENTER LOCK® – IS (6-BOLT) ADAPTOR



Dieser Adapter von DT Swiss ermöglicht die Montage von Sechs-Loch Bremsscheiben auf allen Center Lock® Naben.

With this adaptor from DT Swiss you can mount any 6 bolt rotor onto any Center Lock® hub.

Grâce à cet adaptateur, vous pouvez monter n'importe quel disque à six trous sur votre moyeu Center Lock®.

Questo adattatore DT Swiss consente di montare qualsiasi rotore a 6 bulloni su qualsiasi mozzo Center Lock®.

- Schnelle und einfache Montage
- Nur 29.5 g (± 5%)
- Erhältlich für QR und Steckachs-naben

- Quick and easy installation
- Lightweight at only 29.5 g (± 5%)
- Available for QR and thru axle hubs

- Le montage est très rapide et sûr
- Pèse seulement 29.5 g (± 5%)
- Disponible pour moyeux QR et axe traversant

- Installazione rapida e veloce
- Leggero: pesa appena 29.5 g (± 5%)
- Disponibile per mozzi QR e perno passante

CENTER LOCK LOCKRING



- für 15 mm Vorderrad-Achsen
- für 12/142 mm Hinterrad-Achsen

- for 15 mm front axles
- for 12/142 mm rear axles

- pour axes 15 mm antérieurs
- pour axes 12/142 mm postérieurs

- per perni da 15 mm anteriori
- per perni da 12/142 mm posteriori

LOCKRING



- Shimano 12er Zahnkranz, Aluminium
- Campagnolo 11er Zahnkranz, Stahl
- Campagnolo 12/13er Zahnkranz, Stahl

- Shimano 12 T, aluminium
- Campagnolo 11 T, steel
- Campagnolo 12/13 T, steel

- Shimano, pignon 12 T, aluminium
- Campagnolo pignon 11 T, acier
- Campagnolo pignon 12/13 T, acier

- Shimano 12 T, alluminio
- Campagnolo 11 T, acciaio
- Campagnolo 12/13 T, acciaio

DT SWISS

DT SWISS AG

Längfeldweg 101
CH - 2504 Biel/Bienne
info.ch@dtswiss.com

DT SWISS (ASIA) LTD.

No. 26, 21st Road, Industrial Park
Taichung City
Taiwan R.O.C.
info.tw@dtswiss.com

DT SWISS, INC.

2493 Industrial Blvd.
USA - Grand Junction/CO 81505
info.us@dtswiss.com

DT SWISS (FRANCE) S.A.S.

Parc d'Activites de la Sarrée
Route de Gourdon
F - 06620 Le Bar sur Loup
info.fr@dtswiss.com

DTSWISS.COM