

# Housing and Equipment for Sheep

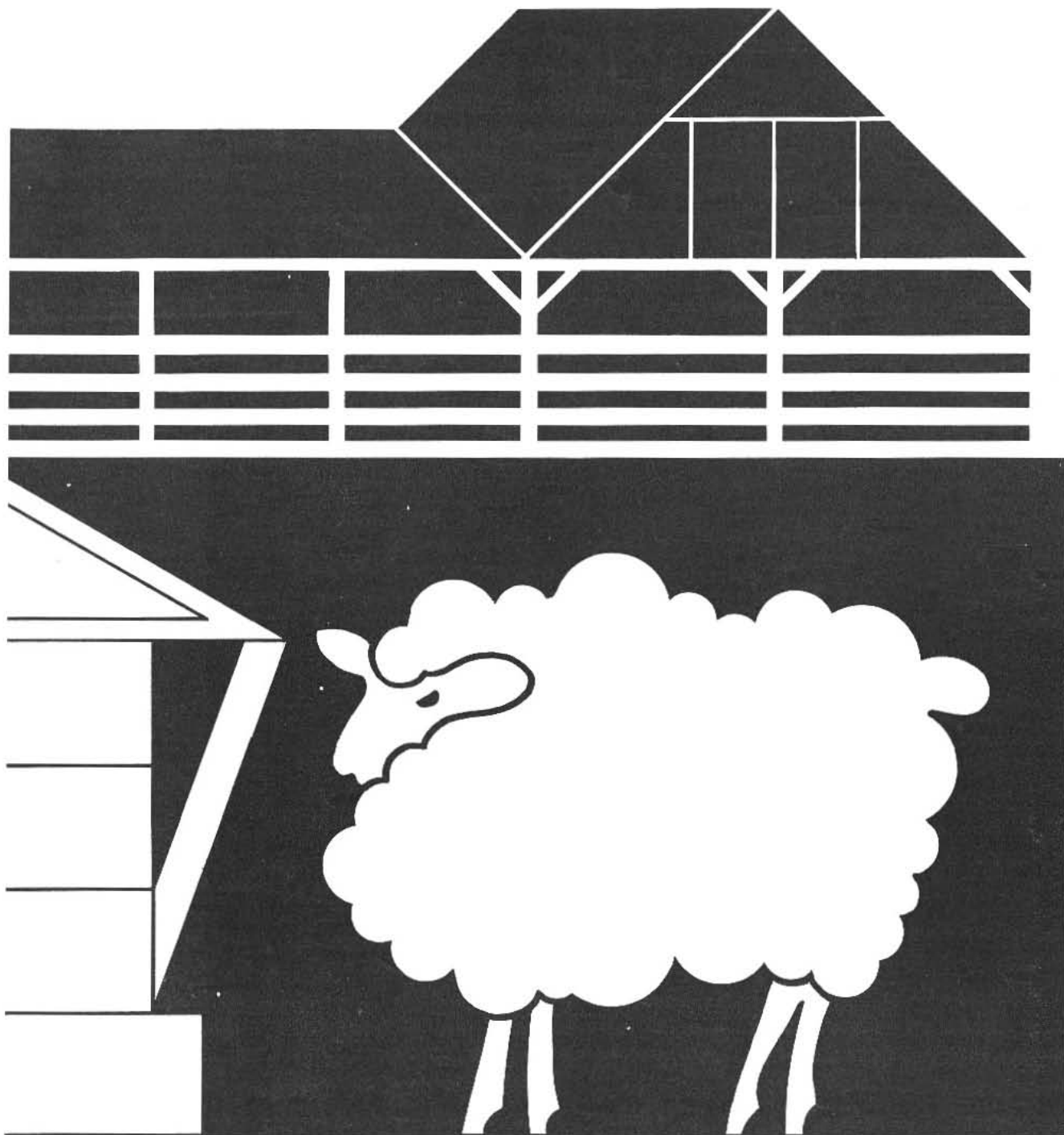

UNITED STATES  
DEPARTMENT OF  
AGRICULTURE

FARMERS'  
BULLETIN  
NUMBER 2242

PREPARED BY  
SCIENCE AND  
EDUCATION  
ADMINISTRATION

# CONTENTS

	Page
Shelters .....	3
Conventional shelters .....	3
Slatted floor housing .....	4
Feeding equipment .....	5
Feed racks .....	5
Feed troughs .....	5
Self-feeders .....	6
Mineral feeders .....	6
Water troughs .....	7
Feedlots .....	7
Panels .....	8
Fences .....	8
Chutes .....	8
Cutting chutes .....	8
Loading chutes .....	8
Squeezes .....	8
Scales .....	9
Corrals .....	9
Dipping vats .....	9
Shipping crates .....	10
Shearing equipment .....	10
Tools .....	12
Plans for sheep facilities .....	13

Revised July 1978

---

For sale by the Superintendent of Documents, U.S. Government Printing Office

Washington, D.C. 20402

Stock No. 001-000-03816-8

# HOUSING AND EQUIPMENT FOR SHEEP

You can build most of the housing and equipment illustrated or described in this bulletin with readily available tools and materials. Before you build your own equipment, compare the cost of the materials you will need with the cost of buying ready-made equipment. Even if the original cost of readymade equipment is higher, it may be cheaper to use if it is more durable and has built-in conveniences.

Your county agricultural agent or State extension specialist can give you additional information about the tools and materials you will need for making your own equipment. If necessary, he can also help you modify the plans to suit your climate and soil. Consult local sheep raisers, too, before you buy or build shelters and equipment. They may be able to offer helpful suggestions.

## SHELTERS

### Conventional Shelters

A small flock of sheep can be housed in a barn with other stock. A flock of 100 or more ewes needs separate housing, however, such as the all-purpose unit illustrated in fig-

ure 1. In mild climates, shelters need to do little more than provide shade for the animals (fig. 2). Even in places where winters are severe, sheep should not be shut in, except during storms and when they are lambing.

The complete unit in figure 1 can house 30 to 36 ewes. It can be closed in during storms. The pen panels, feed racks, creep, and trough can be rearranged for lambing, shearing, fattening lambs, and other operations. If there is electricity at the barn, you can equip the lambing pens ("jugs") with heat lamps to warm newborn lambs in cold weather.

Directions for building the housing in figure 1 are in USDA Plan 5919, and for figure 2, in USDA Plan 5926. You will find plans for another permanent sheep shed in USDA Plan 5874.

Here are some points to keep in mind when you are planning a shelter:

- Allow 8 square feet of floorspace for each lamb; 14 square feet for a small ewe; and 20 square feet for a large ewe.
- Build the shelter or barn on well-drained land. It should face away from the wind.
- Locate windows and doors where they will let in plenty of light

and air and make the shelter cool in summer. Be sure that windows and doors fit tight to prevent drafts.

- Clay floors should slope toward the front of the building.
- Roofing should be sound and resistant to wind damage.
- Place troughs on eaves for rain runoff.
- Pole-type sheds are generally cheaper to build than those on concrete or masonry foundations. Poles

and lumber that are in contact with the ground should be pressure-treated with a preservative. It is best to use a nonstaining preservative.

## Slatted Floor Housing

You may want to use slatted floor housing if you are going to practice intensive sheep raising.

Use expanded metal or 2- by 2-inch lumber to build a slatted floor. If you

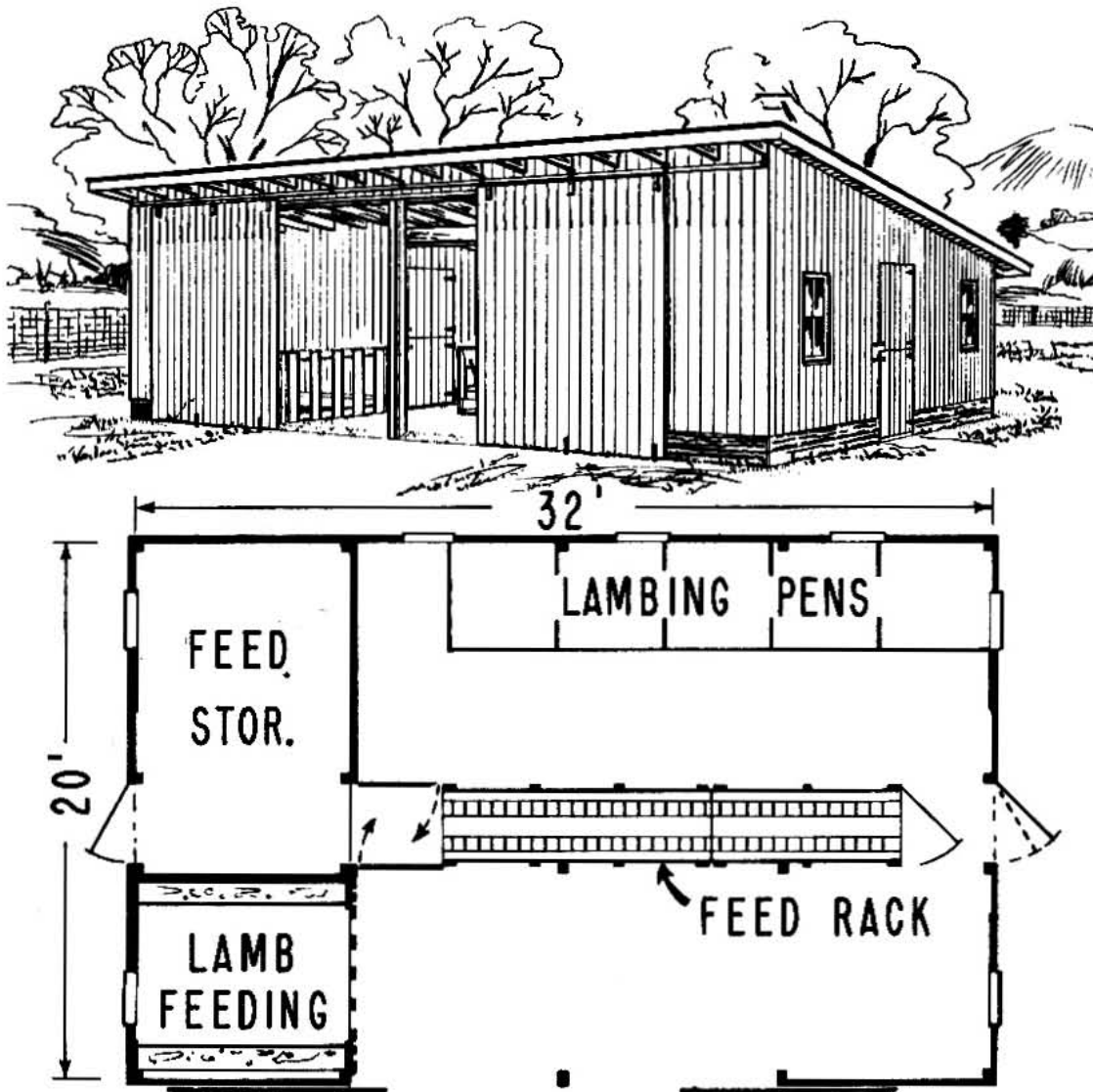

Figure 1.—Above, complete unit for a small flock of sheep; below, dimensions and interior arrangement. (USDA Plan 5919)

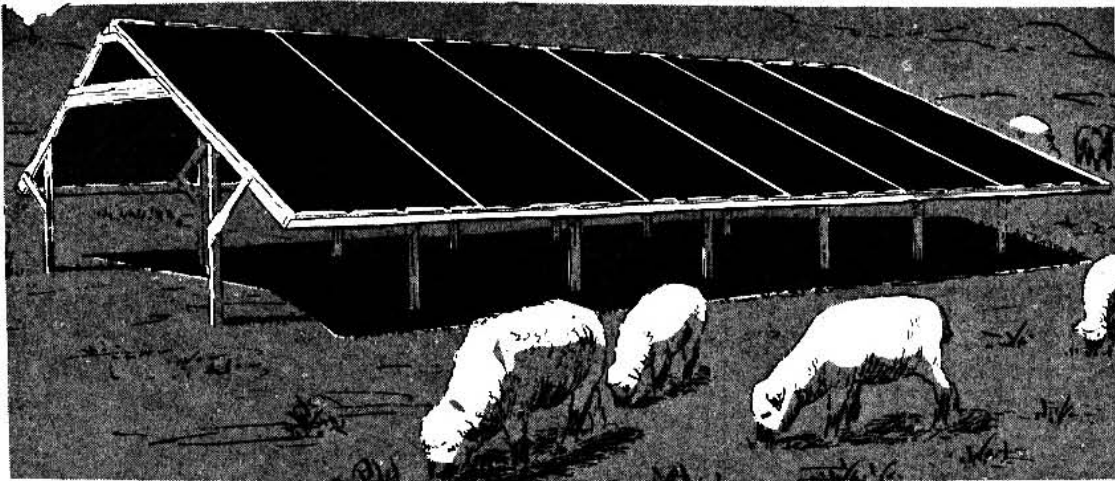

Figure 2.—Lightweight, temporary sheep shed. (USDA Plan 5926)

use expanded metal, use 1/8-inch sheets, rolled flat, with 9/16-inch by 1-5/8-inch diamond-shaped holes. Fasten the metal to treated, 2- by 6-inch wooden frames with cross supports every 4 feet.

If you use lumber, trim the lower edges of the 2- by 2-inch pieces so that there is 5/8 inch between the upper edges and 3/4 inch between the lower edges of each pair of slats. Support the slats every 18 inches.

The floor should be 2 to 3 feet above ground. This allows for a year's accumulation of manure. The floor can be removed for cleaning once a year. Provide 10 to 14 square feet of floorspace for each ewe. Bedding is not necessary.

To use slatted floor housing, move lambs and ewes from the lambing area to the slatted floor 4 or 5 days after lambing. Wean lambs at about 60 days and finish them by themselves on the slatted floor. These lambs usually gain weight at a very good rate. In addition, lambs raised on a slatted floor will be practically free of parasites.

## FEEDING EQUIPMENT

Build and locate feeders where you can fill them easily. Keep them clean; sheep may refuse to eat from a dirty feeder. Keep feed dry and free from insects.

### Feed Racks

Combination hay and grain racks are best for small flocks. When weather permits, feed hay outdoors in portable racks. You will find racks suitable for outdoor use in USDA Plans 5910 and 5913. If the racks are inside the shelter (figs. 3 and 4), be sure that you can fill them without entering the pen. USDA Plan 5913 also shows another indoor feed rack.

### Feed Troughs

Feed troughs are generally made of wood. Although troughs may be V-shaped, flat-bottomed troughs are more stable and easier to keep clean, especially if they can be reversed.

For small farms, portable feed troughs are more practical than stationary ones. They can be used in the

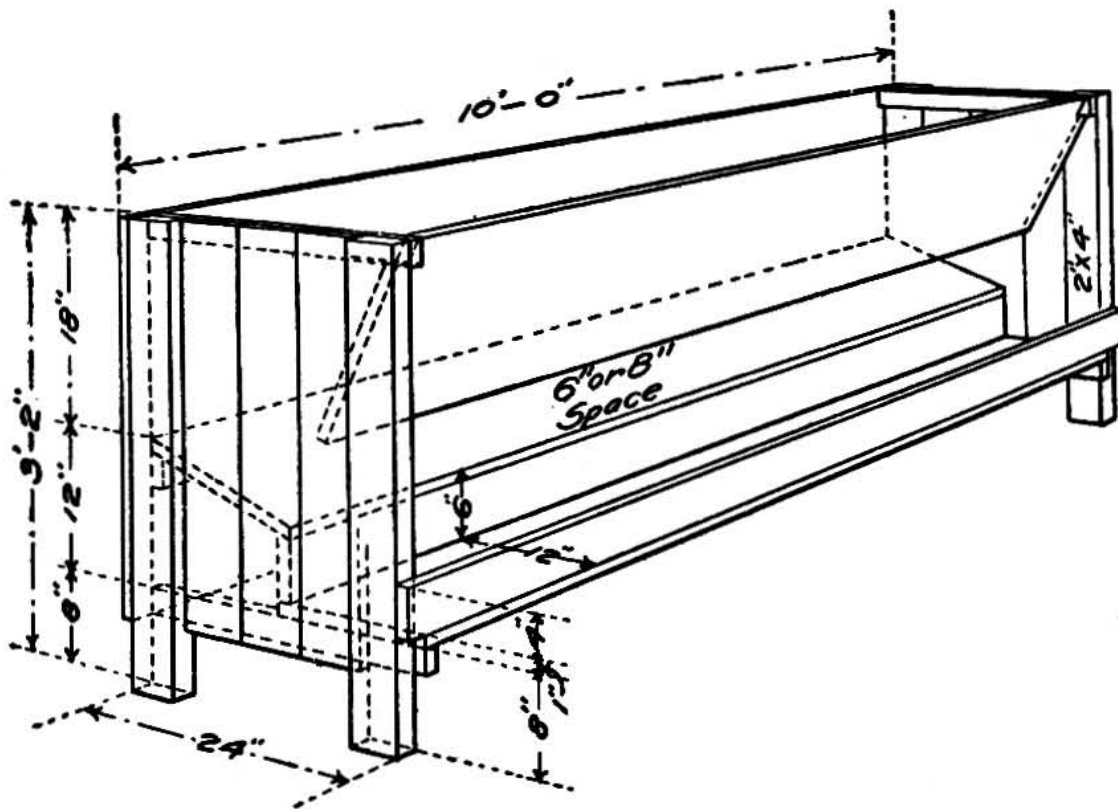

Figure 3.—Combination hay and grain rack.

field, as well as near the barn. Brace them on the ends with metal straps and build them at least 8 inches wide. Instructions for making portable feed troughs are in USDA Plan 5918.

Use heavy, seasoned lumber. If you cannot get well-cured lumber for the bottom, line the trough with tempered hardboard to help prevent cracks and make the trough more durable.

In a combination hay and grain trough, provide 10 to 12 inches of trough space for each lamb and as much as 18 inches for each ewe weighing 140 pounds or more.

### Self-Feeders

Self-feeders can save you time and labor in feeding young sheep. They generally hold 6 to 10 days' supply of

pelleted feed or grain. Do not self-feed pellets or grain to mature sheep.

The self-feeder shown on the front cover is weatherproof. It is 15 feet long (30 feet of trough space), but it can be built in other lengths. It has a capacity of 3,000 pounds (50 bushels) and will feed pellets to 100 lambs for about 10 days. You will find directions for building it in USDA Plan 5861.

### Mineral Feeders

Make salt and other mineral supplements available to the flock at all times. Set a block of salt on a post or in an open box. If you use granulated salt, put it in a small feeder to keep it dry and clean.

If internal parasites are a problem, you can partially control them by mixing phenothiazine with the salt.

Here is a good phenothiazine mixture: 6 parts salt with trace minerals, 3 parts dicalcium phosphate, and 1 part phenothiazine.

USDA Plan 5916 tells how to build a self-feeding, weather-tight salt feeder for 50 to 100 ewes.

## Water Troughs

Water troughs may be made of galvanized iron or concrete. Iron is usually cheaper, but concrete is more durable. Round troughs require less material than square or rectangular troughs. Make sure that the troughs are easy to clean.

Allow 1 foot of trough space for every 10 sheep. One sheep will drink about 2-1/2 gallons of water per day.

Use a float valve connected to a reservoir or water hydrant to control the water level in the trough.

For good drainage be sure that the ground slopes away from the tank. A paved surface that extends 8 to 10 feet

around the tank prevents mudholes from forming.

In cold regions, locate the tanks in protected places, such as behind a windbreak or in a shed, to reduce the danger of freezing.

A single tank in a fence line or in a corner can serve two or more lots.

If you use galvanized tanks without bottoms, seal the earth inside the tank wall with bentonite.

If you use an automatic waterer, you will not have to haul water, and the sheep will have a constant supply of fresh water.

## Feedlots

Many sheep raisers, especially those who fatten sheep for market, confine their flocks in feedlots.

Locate lots in well-drained areas, close to feed storage facilities. Allow about 30 square feet per head. The shortest part of the lot should run downhill.

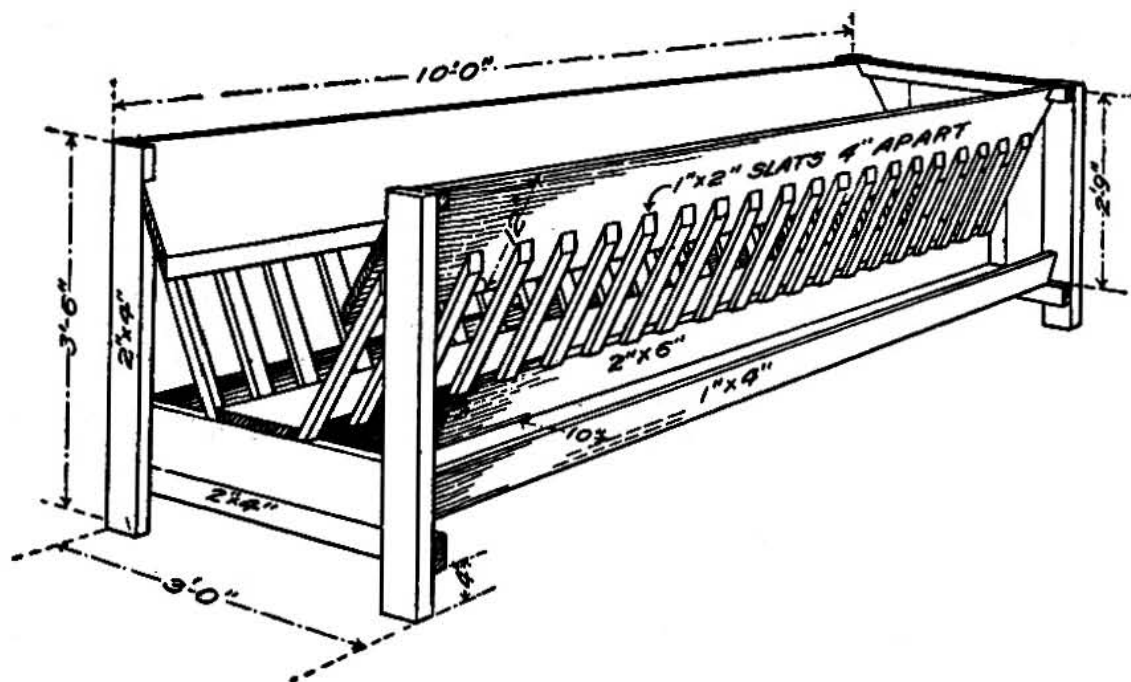

Figure 4.—Combination hay and grain rack.

Pave the feedlot to prevent mud-holes. If you do not want to pave an entire feedlot, pave only around feeders and waterers.

Make sure that runoff from the feedlot does not pollute streams. Consult your local county agent or Soil Conservation Service office for advice as to the need for pollution control facilities.

## PANELS

Use panels to separate fattening lambs by age, to control sheep at shearing time, and to form temporary feeding fences and lambing pens for ewes and newborn lambs.

Build 10-foot panels of 1- by 8-inch boards. You can stack hinged or single panels for storage. USDA Plan 5917 gives instructions for building fencing, feeding, and creep panels.

## FENCES

Build outside fences 5 feet high—7-1/2-foot posts driven 2-1/2 feet into the ground. Stretch one strand of barbed wire close to the ground. Run 4-foot rectangular-mesh wire fencing above it. Run two strands of barbed wire above the mesh.

Build cross fences at least 40 inches high. They need not be equipped with barbed wire.

If you use homemade gates, make sure they are strong. They should be as high as the fence.

Fence in enough pastures to allow sheep to move frequently to fresh ground. This is necessary to preserve the pastures and to control internal parasites.

Electric fences are showing promise of being effective for protecting sheep against predators and dogs.

## CHUTES

### Cutting Chutes

A cutting chute can help separate the flock into smaller groups for breeding, lambing, shearing, or culling. To keep sheep from turning around, make the chutes about 18 inches wide.

USDA Plan 5859 gives directions for building a portable chute. It has removable hinge pins that allow the gates to open from either side. With this chute, you can separate sheep moving in either direction into three groups. To separate the flock into more than three groups, install more than one chute, and build small pens opposite each gate.

### Loading Chutes

Locate a loading chute in or near the corral. Leave enough room around it for a truck. Build the chute at least 18 feet long and 1-1/2 feet wide.

You will find directions for building a variable-height loading chute in USDA Plan 5924. This chute permits easy loading into any type of truck body. It has a concrete counterweight to counterbalance part of the chute, so that one man can raise and lower it. There is a 3-foot-long entrance fence that is taller than the chute walls, to keep sheep from jumping out. A permanent fence can be attached to it.

### Squeezes

A sheep squeeze is convenient for examining or treating an animal, but a sheep may be held by hand easily, if necessary. Consult local sheep raisers for easy ways to handle and hold



## CORRALS

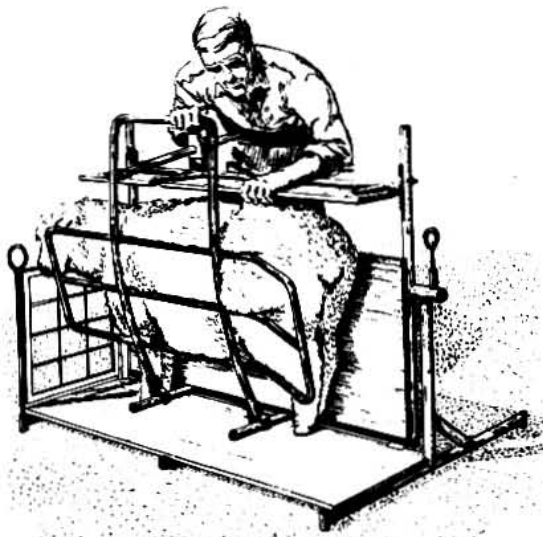

Figure 5.—Tilting squeeze for sheep. (USDA Plan 6006)

sheep. Figure 5 shows a tilting squeeze that keeps the sheep in a prone position and permits regular inspection and trimming of the feet. Directions for building the squeeze are in USDA Plan 6006.

## SCALES

You should weigh sheep and fleeces to keep your production records accurate and to form a basis for selecting breeding stock.

Use a small milk scale to weigh fleeces and newborn lambs. For larger sheep, on a small farm where sheep can be weighed one at a time, use portable scales with a 500-pound capacity.

On a large farm you may need a permanent scale that can weigh several sheep at a time. Locate it near feeding pens or corrals. Place the scales on a platform with sides. This keeps the sheep from crowding against the sides of the pen and causing errors in the readings.

A well-built and well-located system of corrals can save you a lot of work. USDA Plan 6019 shows the details of three basic corral designs.

Equip your corral system with a squeeze chute, a cutting chute, holding pens, a water trough, scales, spray area, and loading facilities. Locate it on well-drained ground.

The cutting area should form enough pens that lead to the cutting gate for all the cuts you need to make.

A shallow trough in the cutting chute can be used for a footbath. Sheep can walk through it for treatment of foot ailments.

## DIPPING VATS

Dipping is the most effective way to treat sheep for control of lice, ticks, and mites. Vats for dipping are usually made of concrete or galvanized iron.

The permanent vat in figure 6 is made of concrete, which is more durable than iron. It rests on well-tamped earth. The bottom and sides are 4 to 6 inches thick. The low roof over the front keeps the sheep from jumping into the vat and splashing the liquid. The rear of the vat slopes 20 to 25 degrees and is fitted with slats to help the sheep climb out. For more details, see USDA Plan 5390.

NOTE: You can use a high-pressure sprayer (at least 25 pounds pressure per square inch) instead of a vat. If you use a sprayer, be sure to spray the entire surface of each animal.

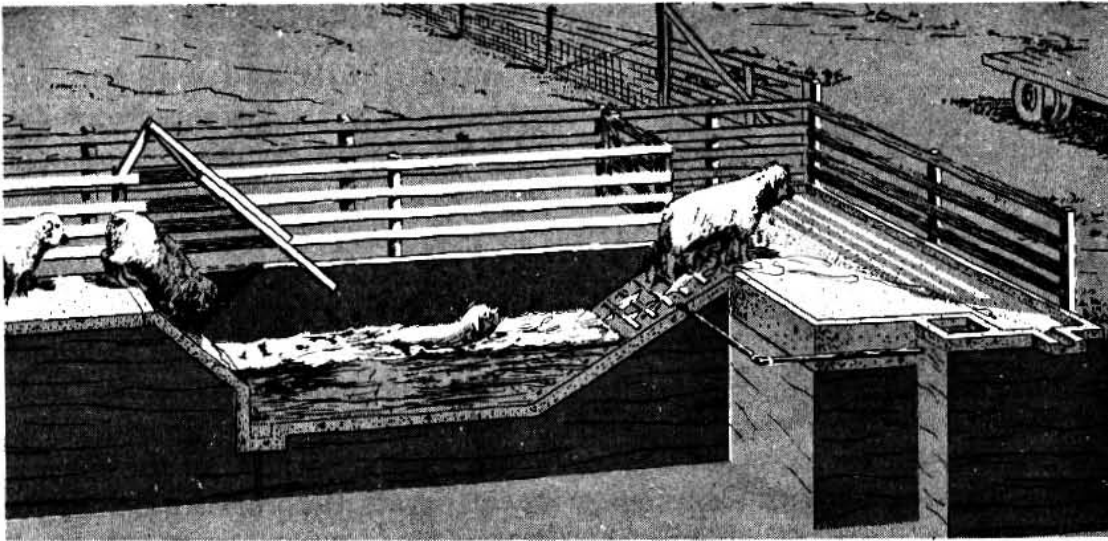

Figure 6.—Permanent concrete dipping vat. (USDA Plan 5390)

## SHIPPING CRATES

Strong crates help prevent accidents when sheep are shipped to exhibitions or to breeders. Use well-seasoned pine boards 1 inch thick. Fasten troughs for water and feed to one end of each crate.

Collapsible crates cost more to construct than noncollapsible crates, but they can be folded for easy return to the shipper.

USDA Plan 5867 tells how to build both collapsible and noncollapsible crates. These crates weigh 50 to 75 pounds and will hold a sheep weighing up to 300 pounds. Crates should be about 1 foot longer and 1 foot wider than the animals. Increase these clearances by about 50 percent for ewes in advanced stages of pregnancy.

## SHEARING EQUIPMENT

A shearing room should include room for holding sheep while they are

sheared and facilities for keeping the wool clean afterward.

If a shearing room with sacking racks (fig. 7) is not practical for you, use 200-pound-capacity paper or plastic-lined wool bags in a packing rack. USDA Plan 5911 gives instructions for building a hinged rack that folds flat for easy moving and storage. It also has a ring-type bag clamp on a removable top.

A rack without hinges or a special clamp is shown in the same set of plans. This type of rack is less expensive to build. It can be taken apart and reassembled.

Tie fleeces into compact bundles with paper twine. If you have only a few sheep you may want to use a hinged tying box. Directions for making a box are in USDA Plan 5805. If you have a larger flock, however, you should learn to tie fleeces without using the box. After you practice a little, you will find that this is faster than using a box.

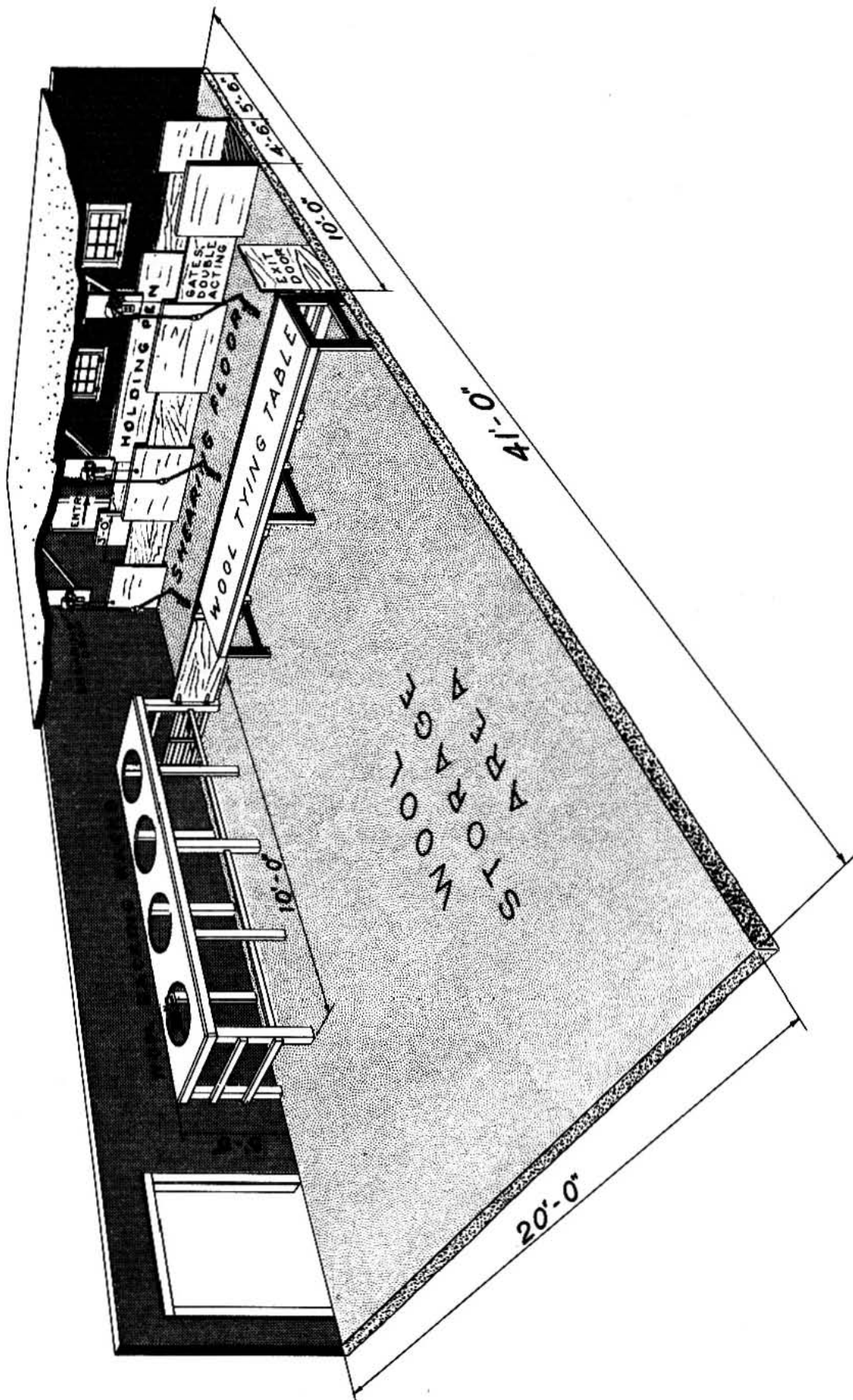

Figure 7.—Shearing and wool storage room.

## TOOLS

Here are some small tools needed for raising sheep:

- Docking stool; and docking chisel, sharp knife, elastrator, or all-in-one tool for severing tails and castrating the male lambs.
- Pruning knife, pruning shears, or commercial foot-rot shears for trimming feet.
- Punch, dies, and metal tags for numbering sheep.
- Graduated nursing bottle with nipple for measuring medicines and raising orphaned and disowned lambs.
- Hand shears for trimming fleeces and removing tags.
- One power-operated shearing machine for a small flock is adequate.

# PLANS FOR SHEEP FACILITIES

<i>Plan No.</i>	<i>Title</i>
5019	Sheep shed - 16' x 24'
5733	Sheep shed - 30' x 60'
5808	Self feeder for sheep - 2'8" W, 8' L, 4' H
5809	Parting chutes for sheep - 15" x 24' and 16" x 36'
5811	Sheep shed - 20' x 72'
5813	Sheep shed - 24' x 92'
6058	Three-way cutting gates - 2'4" x 5'7"
5861	Self feeder for sheep - 15' long, 30' trough
5863	Combination lamb brooder and ewe feeder - 2' x 8'
5867	Shipping crates for sheep - 1'9" W, 4' L, 3' H
5874	Sheep shed - 26' x 120'
5877	Weighing crate for sheep - 27" W, 42" L, 34" H
5905	Sheep equipment - feeder 16' L, lamb shelter 16' L
5910	Hay and grain feeder - for 10 sheep
5911	Wool packing racks
5912	Ewe stanchion - 2'10" x 3'
5913	Sheep feeders - 3' W, 6' L, 2'6" H and 1'6" W, 8' L, 3'4" H
5914	Portable self-feeder for sheep - 8' L, 16' trough
5915	Lamb feeder - 1'6" W, 8' L, and mineral box at each end
5916	Mineral feeder for sheep - 1'4" W, 5'5" L
5917	Fencing and feeding panels for sheep - 3' x 10' sections
5918	Sheep equipment - grain troughs - 10' long
5919	Sheep and lambing shed - 20' x 32'
5924	Variable height loading chute for sheep - 1'6" x 18'
5926	Shelter for sheep - 28' x 48'
5999	Portable dipping vat for sheep - trailer unit
6006	Tilting squeeze for sheep
6019	Corrals for sheep
6043	Sheep corral
6047	Sheep chair
6096	Shearing shed and corral for sheep
6142	Portable foot bath for sheep

## **HOW TO ORDER WORKING DRAWINGS**

Complete working drawings may be obtained from the extension agricultural engineer at your State university. There may be a small charge to cover cost of printing.

If you do not know the location of your State university, send your

request to Agricultural Engineer, Science and Education Administration-Extension, U.S. Department of Agriculture, Washington, D.C. 20250. He will forward your request to the correct university.

## **PRECAUTION**

Do not use paint containing lead on sheep equipment or on parts of building accessible to sheep. Poisoning may result when animals lick or chew objects covered with paint containing lead.