

Contour | Roughness | Roundness | Straightness | Thread measurement | Gearing | Stylus tips | Accessories

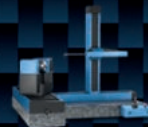

optacom  
Measurement technology - Made in Germany

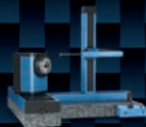
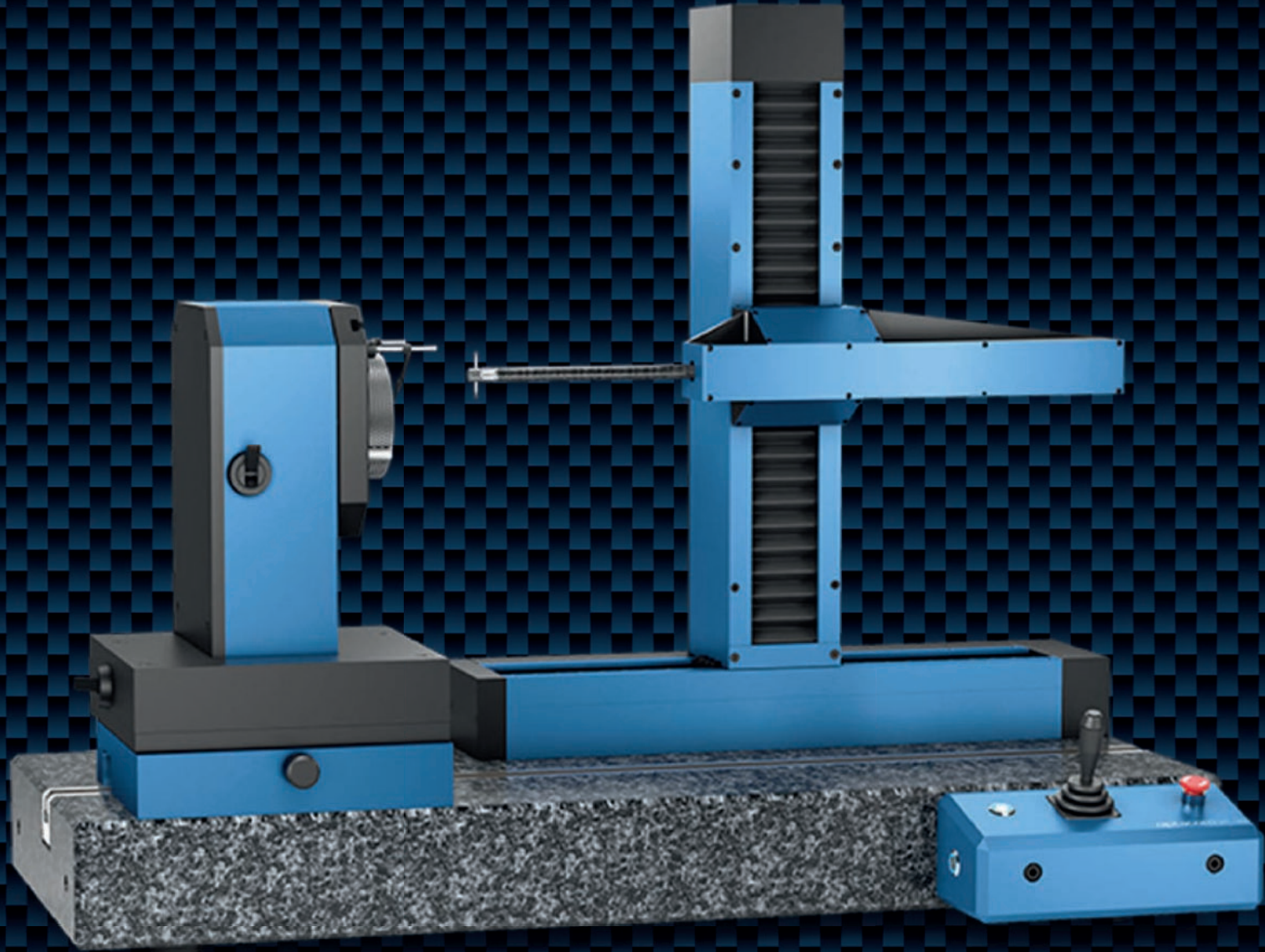

### optacom GmbH & Co. KG

Abonnieren

Startseite Videos Playlists Diskussion Über uns

Uploads



optacom GmbH & Co. KG hat ein Video hochgeladen:



#### Vergleich von Tastspitzen

vor 2 Wochen • 13 Aufrufe

Ein Vergleich von Tastspitzen beim Messen von Spindeln. Die Wahl des falschen Typs kann die Messung um bis zu 20% verfälschen!



optacom GmbH & Co. KG hat ein Video hochgeladen:



#### Our measurement philosophy

vor 2 Wochen • 23 Aufrufe

Through our two-axis measuring procedure, the complete movement range conforms automatically the usable measuring range. Therefore the contour and roughness even of ...



optacom GmbH & Co. KG hat ein Video hochgeladen:

#### The rotary-swiveling table RSY 240-25

**20th ANNIVERSARY**

**Hurra, schon wieder Erster!**  
 Wir feiern unser 20-jähriges Jubiläum mit 19 1/2 ...  
 System für mehr als 600 x 600 mm  
 Die 10-18 Achslänge erhöht auf 220 mm Messung in der Z-Achse!  
 90 Prozent aus auf der Glas-Saite mit Bronze!

2014 2015 2016 2017

optacom  
 Oberflächenmesstechnik - Made in Germany

New products and training videos can be seen at our youtube-channel <http://www.youtube.com/user/optacom1>.



optacom youtube-channel	2	optacom stylus tip – coating, time of delivery & digital pocket scale	38
Table of Contents	3	optacom stylus tips - standard	39
optacom measurement technology	4	optacom conical - stylus tips	42
The advantages of optacom measuring systems	5	optacom roughness - stylus tips	44
optacom product overview	6	optacom roughness - stylus tips with optaDiamond coating	45
optacom LC-10	8	optacom double stylus tips conical	46
optacom VC-series	10	optacom double stylus tips	47
optacom VC-10-EL	12	optacom disc stylus systems	48
optacom VC-10-UL	13	optacom quick-release fastener, miniature- and cross- and diamond stylus arms	50
optacom VC-series overview	14	optacom special stylus tips	52
optacom VC-10-UL-RDY	16	optacom ceramic stylus tips and straight ruby stylus	53
optacom VC-10-UL-RDSY	18	optacom trapezoidal thread stylus tips	54
optacom VC-10-ring gauge edition	20	optacom thread stylus tips	55
optacom VC-10-EL-thread edition	21	optacom thread sensing arms, thread receptive and quick release fasteners	56
optacom zeropoint clamping system	22	optacom special stylus tips	57
optacom thread equipment	24	Mahr-compatible stylus tips - standard and conical	58
optacom tailstock	26	Hommel-compatible stylus tips - standard and conical	60
optacom Y-tables	28	Taylor Hobson-compatible stylus tips	61
optacom centric clamping vise	29	Mitutoyo-compatible stylus tips - standard and conical	62
optacom rotary-swivel table RSY 240-25	30	Zeiss-compatible stylus tips - standard and conical	64
optacom rotary-swivel table RSY 240-25-29	31	optacom contour	66
optacom automatic 4-way swival table	32	optacom contour - topdown	70
optacom rotary-swivel table RSY 240-25 /-29 & 4-way swival table intermediate plates	33	optacom rough - roughness in its best shape	72
optacom topdown	34	optacom round - completes the product range with precision	74
optacom wooden box for topdown-module	35	optacom thread software	76
optacom vises	36	optacom - The best at last	82
optacom rotating swivel vises	37	Distributors worldwide	83

**Your investment in optacom is protected for years thanks to:**

- ▶ **Lifetime free software updates**
- ▶ **Modular expansion of our machines**
- ▶ **Subsequent expansion via options**
- ▶ **Certification according to DIN EN ISO 9001:2015**

### **Made in Germany**

optacom develops, manufactures and distributes world-class surface measurement systems since its founding in 1999. These measurement systems allow evaluation of contour, roughness, and roundness in a single pass. A foolproof, fully automatic and extremely rapid calibration as well as an equally rapid, uncomplicated stylus tip replacement constitute the hallmarks of carefully crafted precision systems.

Thanks to a broad range of special tracing arms and machine options, e. g. the newly developed rotary-swivel table, even composite or other complicated measuring tasks on complex parts become almost child's play. Our products have convinced numerous manufacturers and measurement laboratories worldwide of the quality, robustness and efficiency of our measurement systems.

optacom's young and enthusiastic team takes care of all customer concerns. The emphasized partnership with the customer ensures the rapid realization of individual needs and special measurement requirements. Anyone who has ever worked with an optacom system is reluctant to change. "Follow-up orders are fortunately very common in our daily business. And also the confirmation of our customers that shows we are on the right track with our concept," says founder and CEO Diana Hubert. Now, let us show you and win you over.

### **Innovations made by optacom**







### The advantages of our mechanics

- ▶ Additional options may be added at any time
- ▶ Lowest follow-up costs
- ▶ Nearly wear-free parts
- ▶ All measurement systems are incremental, optical, and contactless
- ▶ Very low usage of stylus tips thanks to optacom soft-touch
- ▶ Stylus tip breakage is almost impossible
- ▶ The machine protects stylus tips and tracing arms via collision-detect feature
- ▶ All machines measure as you manufacture without stylus arm-pivot
- ▶ Our guides have a maintenance interval of 50 km
- ▶ Measuring range up to 595 x 425 mm are standard
- ▶ Simple machine operation via built-in joystick
- ▶ On all our machines the measuring range is identical to the movement range

### The advantages of our software

- ▶ Single software interface for all modules
- ▶ Intuitive software solution, resulting in low training requirements
- ▶ Software is multi-language and allows customization
- ▶ Industrial PC with modular plug-in card concept
- ▶ Integrated online diagnostic tool
- ▶ Contour, roughness and roundness evaluation is possible in one single evaluation
- ▶ Free software updates
- ▶ Clearly arranged element list with red-green evaluation
- ▶ Fully automatic calibration of the stylus tips
- ▶ Red-green evaluation using a percentage tolerance display
- ▶ Automated export to Q-DAS
- ▶ Print manager for meaningful and conclusive reporting
- ▶ Evaluation and print views are saved separately
- ▶ Fewer operating errors thanks to automatic program selection via barcode scanner



	LC-10	VC-10	VC-10-EL	VC-10-UL
Resolution in X and Z axis	0.02 µm / 0.79 µin	0.002 µm / 0.079 µin	0.002 µm / 0.079 µin	0.002 µm / 0.079 µin
Measuring range (X axis)	225 mm / 8.86 inch	225 mm / 8.86 inch	325 mm / 12.80 inch	425 mm / 16.73 inch
Measuring range (Z axis)	225 mm / 8.86 inch	225 mm / 8.86 inch	325 mm / 12.80 inch	425 mm / 16.73 inch
Straightness	+/- (1.5 + L/100) µm	+/- (0.5 + L/100) µm	+/- (0.5 + L/100) µm	+/- (0.5 + L/100) µm
L in mm / in	+/- (59 + L x 10) µin	+/- (20 + L x 10) µin	+/- (20 + L x 10) µin	+/- (20 + L x 10) µin
Accuracy	+/- (1.5 + L/100) µm	+/- (0.5 + L/100) µm	+/- (0.5 + L/100) µm	+/- (0.5 + L/100) µm
L in mm / in	+/- (59 + L x 10) µin	+/- (20 + L x 10) µin	+/- (20 + L x 10) µin	+/- (20 + L x 10) µin
optacom contour (p. 68)	✓	✓	✓	✓
optacom rough (p. 74)	■	■	■	■
Y-table YTA-25 / YTM-25 (p. 28)	■	■	■	■
Y-table YTA-100 (p. 28)	■	■	■	■
RSY 240-25 (p. 30)	□	■	■	■
RSY 240-25-29 (p. 31)	□	■	■	■
4-way swivel table (p. 32)	□	■	■	■
topdown (p. 34)	■	■	■	■
Basis with zeropoint clamping (p. 22)	□	■	■	■
Quick exchange basis for basis with zeropoint clamping (p. 24 & 25)	□	■	■	■
Basis without zerop. camplng incl. quick exchange basis (p. 25)	□	■	■	■
Tailstock (p. 26)	□	□	■	■
optacom Thread Software Light (p. 76)	■	■	■	■
optacom Thread Software Standard (p. 76)	■	■	■	■
optacom Thread Software Professional (p. 76)	□	■	■	■



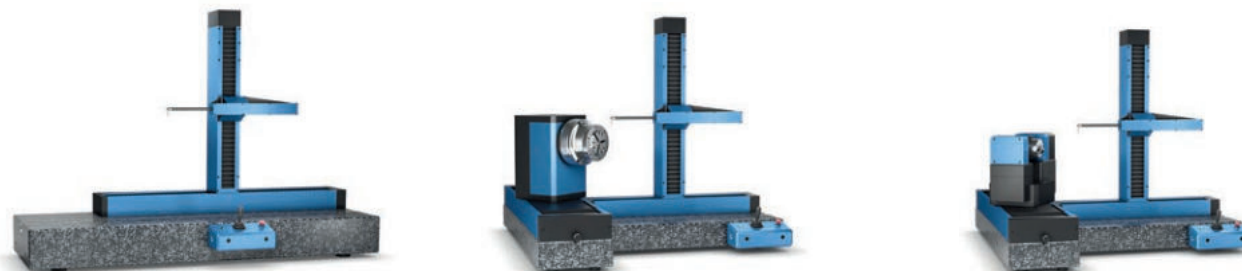

	<b>VC-10-XXL</b>	<b>VC-10-UL-RDY</b>	<b>VC-10-UL-RDSY</b>
Resolution in X and Z axis	0.002 µm / 0.079 µin	0.002 µm / 0.079 µin	0.002 µm / 0.079 µin
Measuring range (X axis)	595 mm / 23.43 inch	425 mm / 16.73 inch	425 mm / 16.73 inch
Measuring range (Z axis)	425 mm / 16.73 inch	425 mm / 16.73 inch	425 mm / 16.73 inch
Straightness	+/- (2.0 + L/100) µm	+/- (0.5 + L/100) µm	+/- (0.5 + L/100) µm
L in mm / in	+/- (79 + L x 10) µin	+/- (20 + L x 10) µin	+/- (20 + L x 10) µin
Accuracy	+/- (2.0 + L/100) µm	+/- (0.5 + L/100) µm	+/- (0.5 + L/100) µm
L in mm / in	+/- (79 + L x 10) µin	+/- (20 + L x 10) µin	+/- (20 + L x 10) µin
optacom contour (p. 68)	✓	✓	✓
optacom rough (p. 74)	■	■	■
Y-table YTA-25 / YTM-25 (p. 28)	■	□	□
Y-table YTA-100 (p. 28)	■	□	□
RSY 240-25 (p. 30)	■	□	✓
RSY 240-25-29 (p. 31)	■	□	■
4-way swivel table (p. 32)	■	□	■
topdown (p. 34)	■	■	■
Basis with zeropoint clamping (p. 22)	■	□	□
Quick exchange basis for basis with zeropoint clamping (p. 24 & 25)	■	□	□
Basis without zeropoint campling incl. quick exchange basis (p. 25)	■	□	□
Tailstock (p. 26)	■	□	□
optacom Thread Software Light (p. 76)	■	■	■
optacom Thread Software Standard (p. 76)	■	■	■
optacom Thread Software Professional (p. 76)	■	■	■

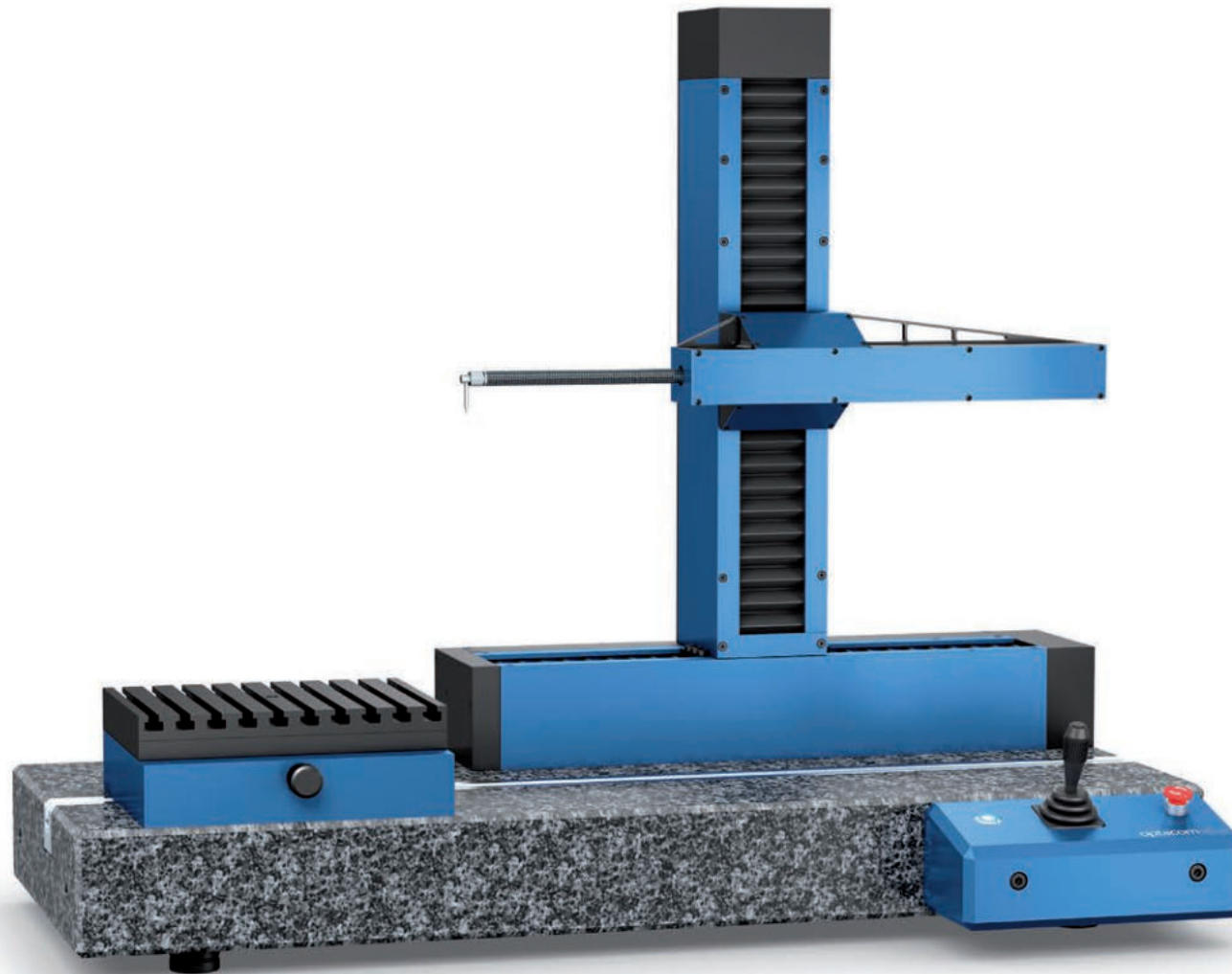

The optacom LC-10 represents the perfect entry model. Especially in cases where the entire scope of service of a modern universal measuring machine is needed, but the high precision of a VC-10 is not needed, the LC-10 is the most suitable product. It covers the measuring range and features the technical refinements of our all-round machine VC-10, thus provides an outstanding measuring accuracy.

Therefore the LC-10 combines a perfect measurement quality and an attractive price.

The LC-10 is a real optacom measuring machine in every detail. It uses a high-precision linear axis with an integrated drive and wear-free, linear incremental system.

It's body is made of high-strength aircraft aluminium. The operation and the software modules used are identical to those found in other optacom measuring machines.

However, the LC-10 cannot be extended to a universal measuring machine with the optional rotary-swivel table.



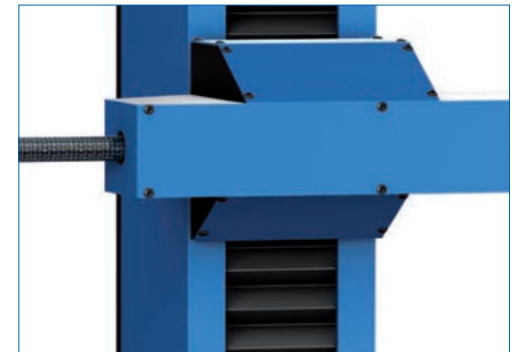

Resolution in X and Z axis:	0.02 µm	Maximum measuring force:	10 - 150 mN
Resolution at the stylus tip:	0.03 µm	Measuring speed:	0.1 - 2 mm / sec (optimized automatically)
Measuring range (X axis , Z axis):	225 mm	Radius of the stylus tip:	from 0.002 to 1 mm
Measuring system:	optical, incremental and contactless in all axes (X, Z, T)	Angle measurement:	78° upwards; 87° downwards
Accuracy and Straightness:	+/- (1.5 + L/100) µm	Dimensions (W x D x H):	950 x 490 x 760 mm
Measurement uncertainty regarding roughness:	10%	Weight:	150 kg

- ▶ The entry-level system for the entire variety of contour measuring tasks
- ▶ Contour and roughness in one single measurement with the optional roughness module
- ▶ Very good resolution of 30 nm directly at the stylus tip
- ▶ Y-table optional
- ▶ Body made of high-strength aircraft aluminium
- ▶ Axis guide and head integrally made from one workpiece
- ▶ X axis permanently and absolutely backlash free connected to the Z axis
- ▶ Contactless and absolutely wear-free linear-incremental measuring system
- ▶ Machine calibration (including stylus tip calibration) in less than 3 minutes
- ▶ Quick stylus tip replacement with optacom quick-release fastener. No tools required and no accuracy loss
- ▶ High-precision linear axes with integrated drive

### Scope of delivery:

Measuring machine optacom LC-10, including calibration standard with machine calibration certificate, industrial PC, TFT monitor and optacom contour software module, one quick-release fastener and one stylus tip 33 mm

<b>optacom LC-10</b>	
horizontal / vertical (X axis/Z axis)	225 mm
Order no.:	101-206-001

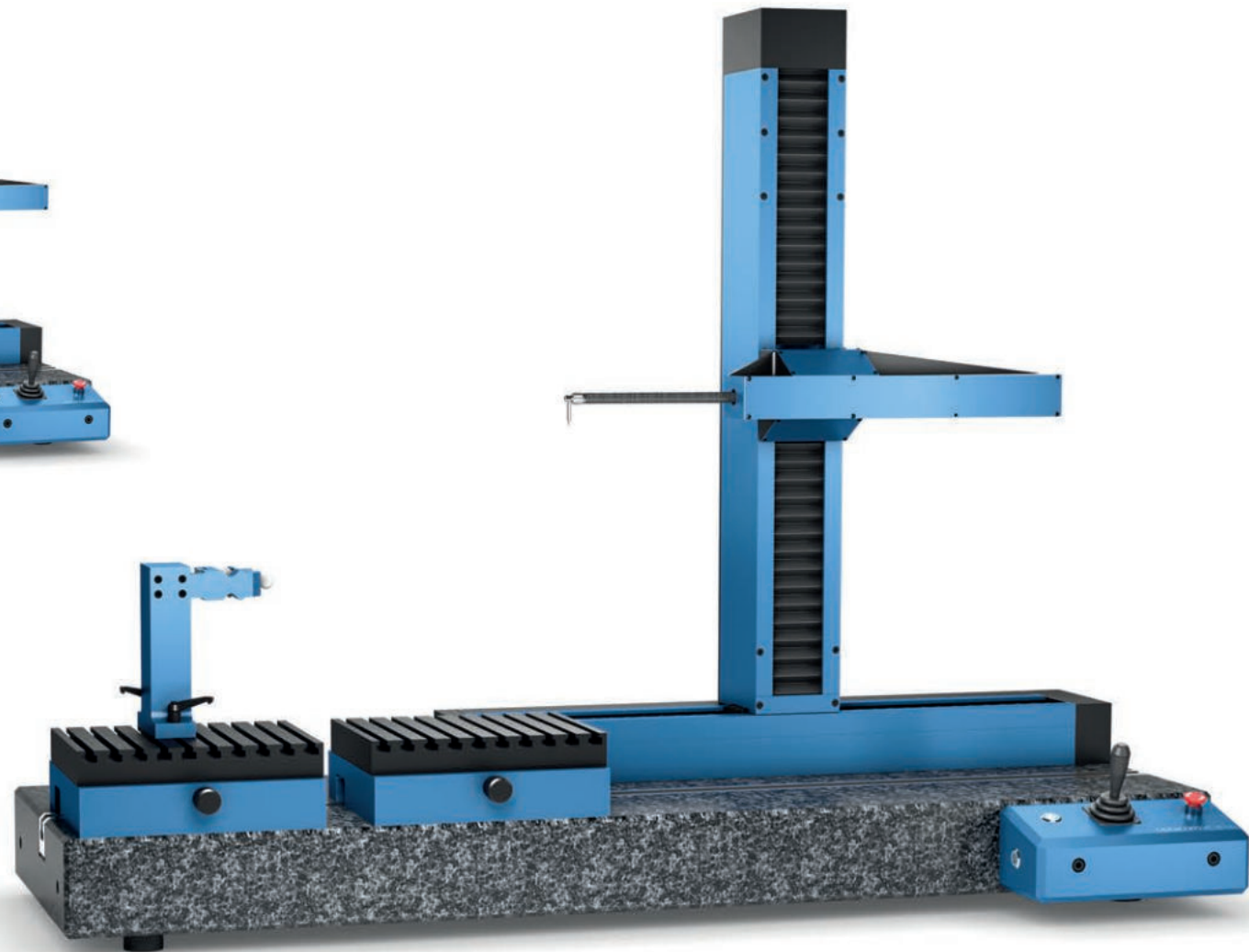
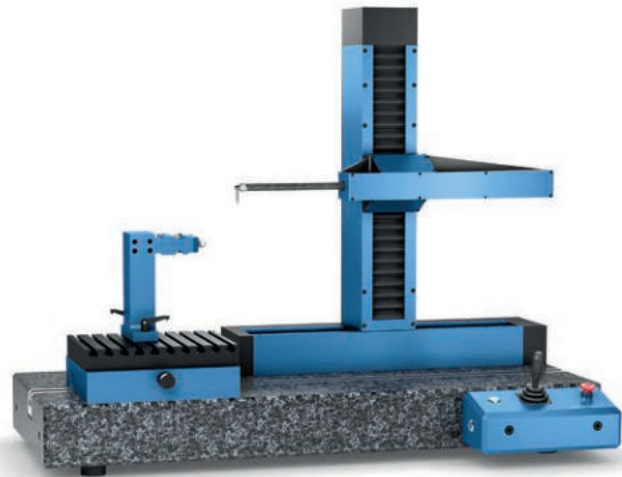

Illustrations may differ

Are you looking for an all-round system to take care of the whole variety of contour measurement tasks with outstanding accuracy? If so, the optacom VC-10 may be the right solution for you. It performs contour measurements alone or in combination with roughness simultaneously as well as roundness measurements or composite measurements (e. g., with the new rotary-swivel table).

Even complicated measurement tasks of complex formed objects will be easy to handle. The VC-10-EL/-UL was specifically designed for extension with our rotary-swivel table.

Through the extension of the measuring range in X and Z axis up to 370 mm, we can fully leverage the possibilities of the rotary-swivel table.

The VC-10 also convinces because of its ease-to-use nature and outstanding precision.

At the stylus tip it reaches a genuine - not just simply calculated - resolution of 3 nm over the entire measuring range.



Resolution in X and Z axis:	0.002 $\mu\text{m}$
Resolution at stylus tip:	0.003 $\mu\text{m}$
Measurement system:	optical incremental and contactless in all axis (X, Z, T)
Accuracy:	+/- (0.5 + L/100) $\mu\text{m}$
Straightness:	+/- (0.5 + L/100) $\mu\text{m}$
Maximum measuring force:	10 - 150 mN
Measuring speed:	0.1 – 2 mm/sec (optimized automatically)
Radius of the stylus tip:	0.002 – 1 mm
Measurable gradients:	78° upwards; 87° downwards
Measurement uncertainty regarding roughness:	5%

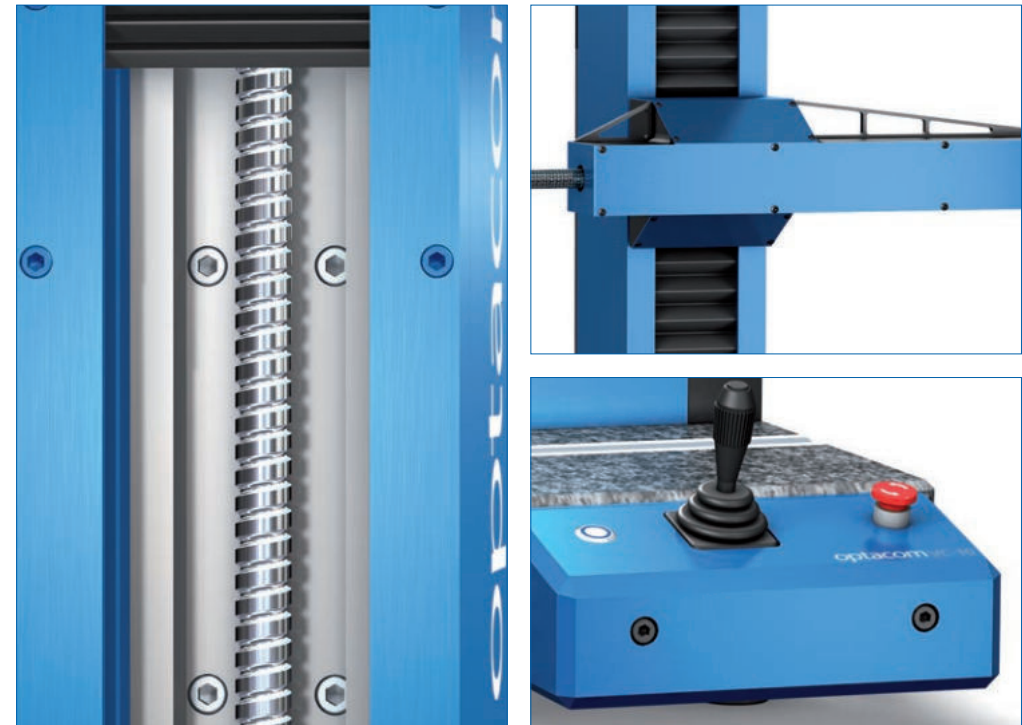

- ▶ The powerful all-round system for the entire variety of contour measurement tasks
- ▶ Contour and roughness in one measurement with the optional roughness module
- ▶ Roundness measurements and composite measurements with optional rotary-swivel table
- ▶ Outstanding genuine resolution of 3 nm direct at the stylus tip
- ▶ Y-table optional
- ▶ Axis guide and head integrally made from one workpiece
- ▶ X axis permanently and absolutely backlash free connected to the Z axis
- ▶ High-precision linear axes with integrated drive
- ▶ Body made of high-strength aircraft aluminium
- ▶ Contactless and absolutely wear-free linear-incremental measuring system
- ▶ Machine calibration (including stylus tip calibration) in less than 3 minutes
- ▶ Quick stylus tip replacement with optacom quick-release fastener. No tools required and no accuracy loss
- ▶ Fully equipped basic system, including calibration standard, industrial PC with TFT monitor, printer and optacom contour software module

<b>optacom VC-10</b>	
horizontal / vertical (X axis/Z axis)	225 mm
Order no.:	101-204-010

### Delivery scope:

Measuring machine optacom VC-10, industrial PC with TFT monitor, mouse and keyboard, Windows operating system, optacom contour software, calibration standard with certificate (for machine calibration purposes), two quick-release fasteners and two stylus tips

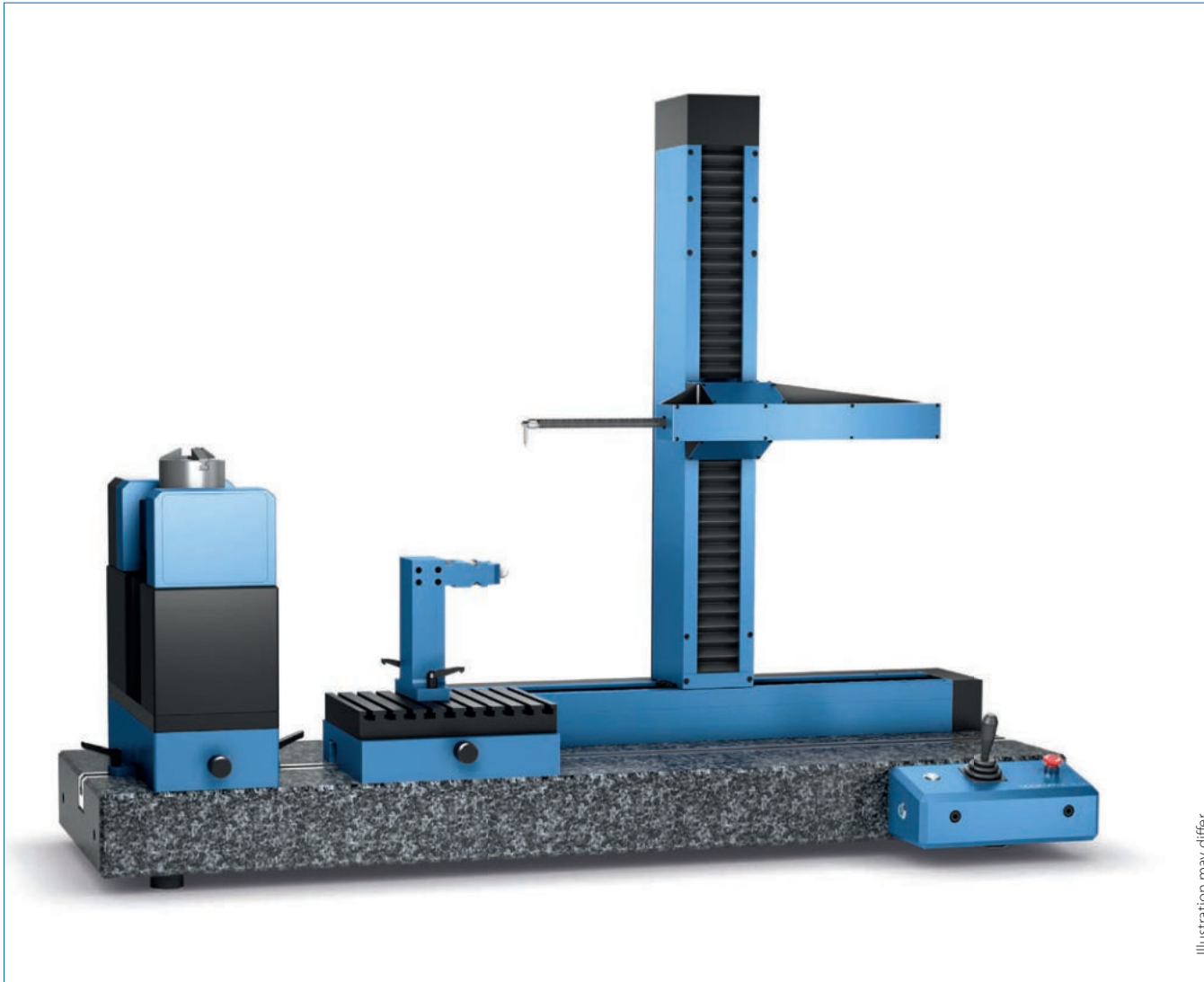

Illustration may differ

Measuring range (X axis):	325 mm
Measuring range (Z axis):	325 mm
Accuracy:	+/- (0.5 + L/100) µm
Straightness:	+/- (0.5 + L/100) µm
Dimensions (W x D x H):	1200 x 490 x 960 mm
Weight (ca.):	180 kg
Resolution in X and Z axis:	0.002 µm
Resolution at stylus tip:	0.003 µm
Measurement uncertainty regarding roughness:	5 %
Maximum measuring force:	10 - 150 mN
Measuring speed:	0.1 – 2 mm/sec (optimized automatically)
Radius of the stylus tip:	0.002 – 1 mm
Measurable gradients:	78° upwards; 87° downwards

**Scope of delivery:** Measuring machine optacom VC-10-EL, industrial PC, minimum 21" TFT monitor, mouse and keyboard, Windows-Software, optacom contour software, calibration standard with certificate (for machine calibration purposes), two quick-release fasteners and two stylus tips

<b>VC-10-EL</b>	
horizontal/vertical (X axis/Z axis) / Y axis	325 mm
Order no.:	101-204-325

### Let's go round...

Are you looking for an all-round system to control the whole variety of contour measurement tasks with outstanding accuracy? If so, the optacom VC-10-EL may be the right solution for you. It performs contour measurements alone or in combination with roughness simultaneously as well as roundness mea-

surements or composite measurements (e.g., with the new rotary-swivel table). Thus, even complicated measurement tasks of complex formed objects will be easy to handle. The VC-10-EL as specifically designed for extension with our rotary-swivel table.

Through the extension of the measuring range in X and Z axis up to 325 mm, we can fully leverage the possibilities of the rotary-swivel table. The VC-10-EL also convinces because of its ease-to-use nature and outstanding precision.



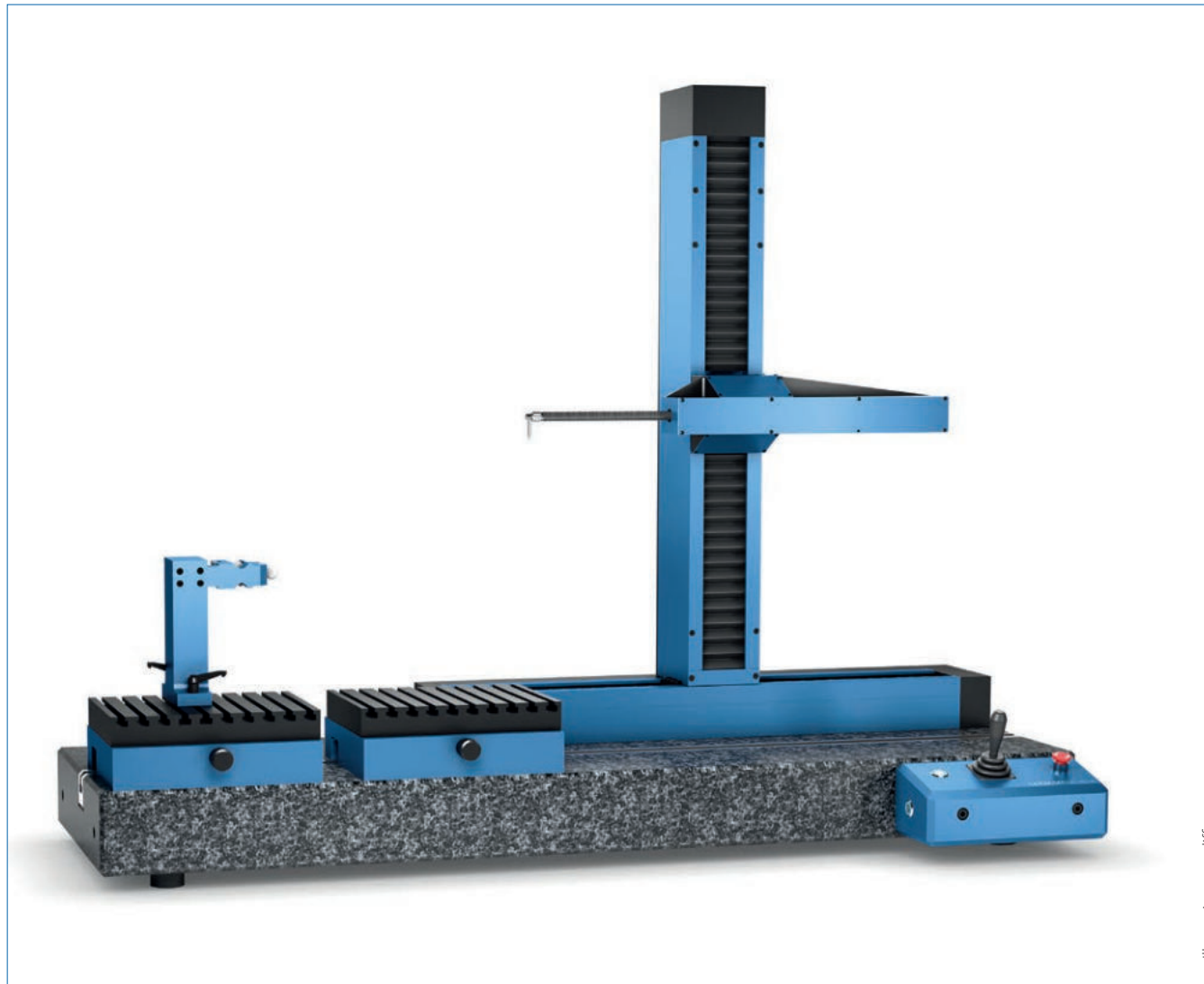

Illustration may differ

Measuring range (X axis):	425 mm
Measuring range (Z axis):	425 mm
Accuracy:	+/- (0.5 + L/100) µm
Straightness:	+/- (0.5 + L/100) µm
Dimensions (W x D x H):	1200 x 490 x 960 mm
Weight (ca.):	200 kg
Resolution in X and Z axis:	0.002 µm
Resolution at stylus tip:	0.003 µm
Measurement uncertainty regarding roughness:	5 %
Maximum measuring force:	10 - 150 mN
Measuring speed:	0.1 – 2 mm/sec (optimized automatically)
Radius of the stylus tip:	0.002 – 1 mm
Measurable gradients:	78° upwards; 87° downwards

**Scope of delivery:** Measuring machine optacom VC-10-UL, industrial PC with TFT monitor, mouse and keyboard, Windows operating system, optacom contour software, calibration standard with certificate (for machine calibration purposes), two quick-release fasteners and two stylus tips

<b>optacom VC-10-UL</b>	
horizontal/vertical (X axis/Z axis) / Y axis	425 mm
Order no.:	101-204-425

## The ultimate benchmark - our all-round solution for high-precision measurement

Are you looking for an all-round system to control the whole variety of contour measurement tasks with outstanding accuracy? If so, the optacom VC-10-UL may be the right solution for you. It performs contour measurements alone or in combination with roughness simultaneously as well as roundness

measurements or composite measurements (e.g., with the new rotary-swivel table). Thus, even complicated measurement tasks of complex formed objects will be easy to handle. The VC-10-UL was specifically designed for extension with our rotary-swivel table.

Through the extension of the measuring range in X and Z axis up to 425 mm, we can fully leverage the possibilities of the rotary-swivel table. The VC-10-UL also convinces because of its ease-to-use nature and outstanding precision.

## VC-10

The measure of all things ...

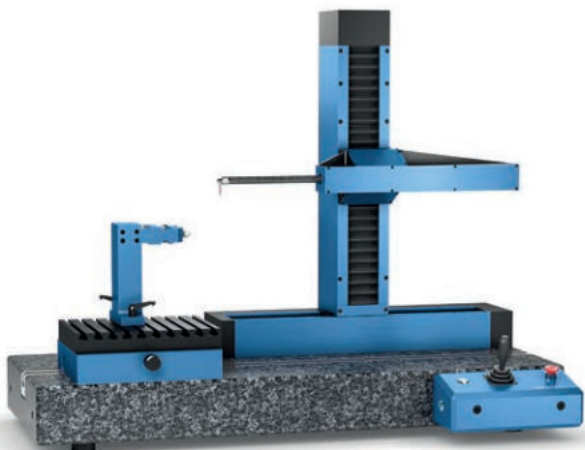
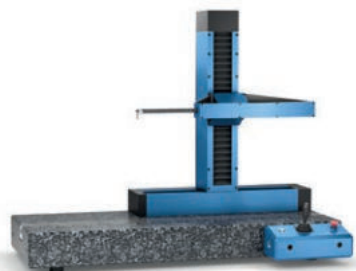

## VC-10-EL

And round and round it goes ...

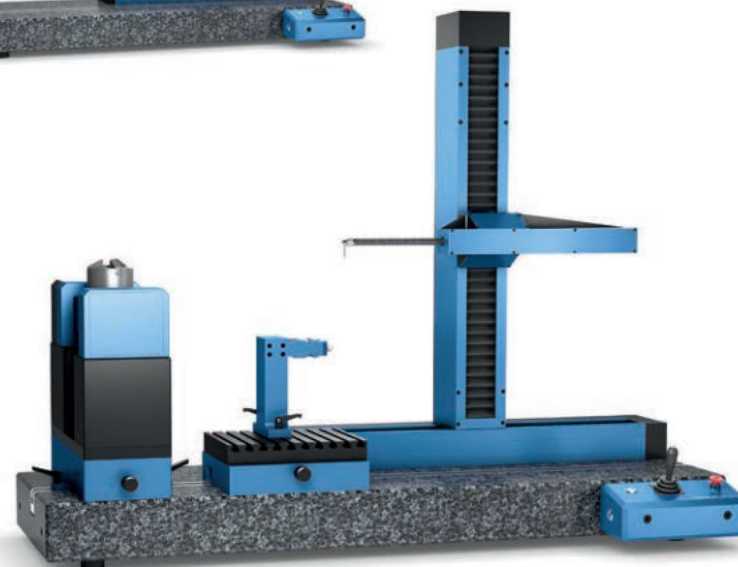
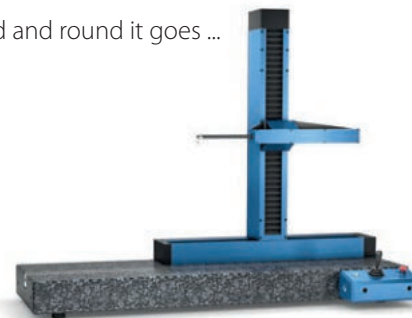

Illustrations may differ

Measuring range horizontal (X axis):	225 mm
Measuring range vertical (Z axis):	225 mm
Accuracy:	+/- (0.5 + L/100) µm
Straightness:	+/- (0.5 + L/100) µm
Dimensions (W x D x H):	950 x 490 x 760 mm
Weight (ca.):	150 kg

<b>optacom VC-10</b>	
horizontal/vertical (X axis/ Z axis):	225 mm
Order no.:	101-204-010

Measuring range horizontal (X axis):	325 mm
Measuring range vertical (Z axis):	325 mm
Accuracy:	+/- (0.5 + L/100) µm
Straightness:	+/- (0.5 + L/100) µm
Dimensions (W x D x H):	1200 x 490 x 960 mm
Weight (ca.):	180 kg

<b>optacom VC-10-EL</b>	
horizontal/vertical (X axis/ Z axis):	325 mm
Order no.:	101-204-325

## VC-10-UL

Size does matter ...

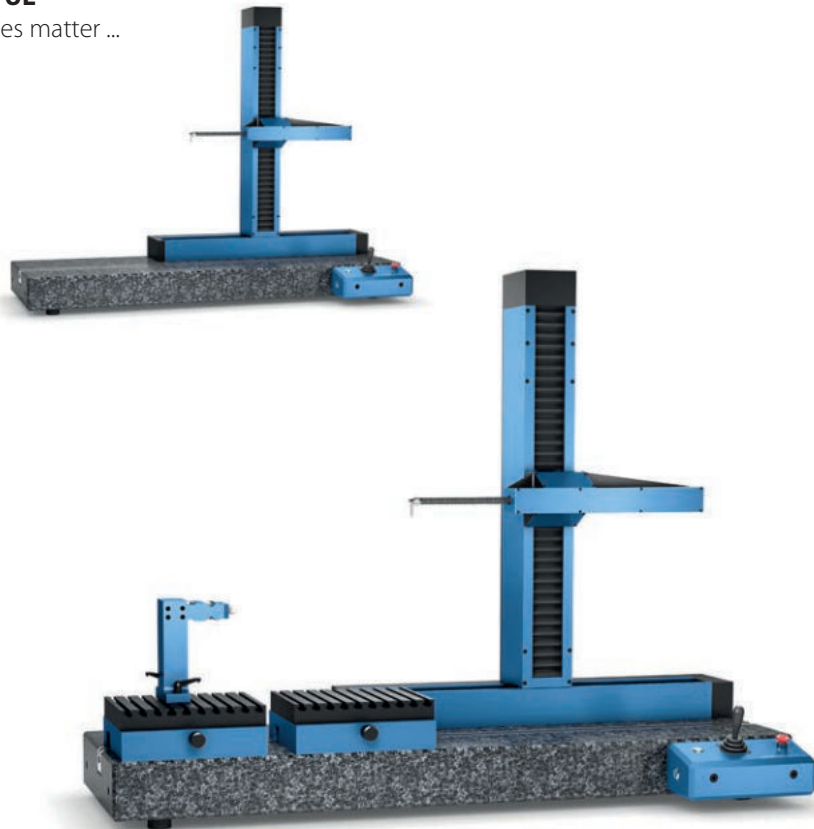

Illustrations may differ

## VC-10-XXL

Probably the longest measuring machine in the world...

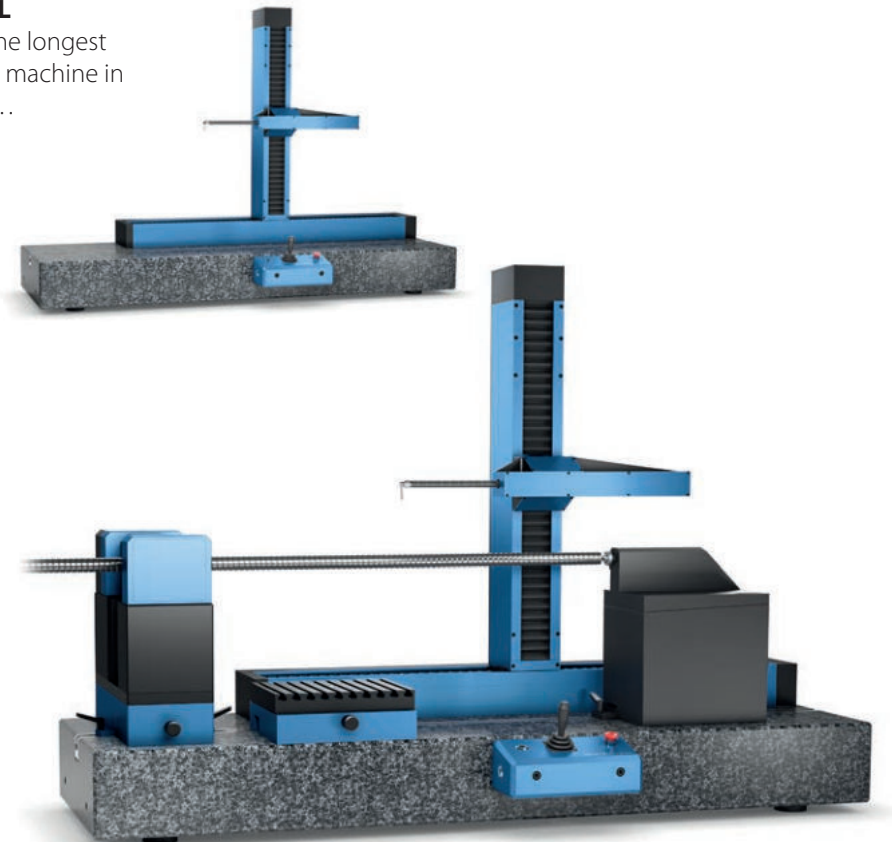

Measuring range horizontal (X axis):	425 mm
Measuring range vertical (Z axis):	425 mm
Accuracy:	+/- (0.5 + L/100) µm
Straightness:	+/- (0.5 + L/100) µm
Dimensions (W x D x H):	1200 x 490 x 960 mm
Weight (ca.):	200 kg

<b>optacom VC-10-UL</b>	
horizontal/vertical (X axis/ Z axis):	425 mm
Order no.:	101-204-425

Measuring range horizontal (X axis):	595 mm
Measuring range vertical (Z axis):	425 mm
Accuracy:	+/- (2 + L/100) µm
Straightness:	+/- (2 + L/100) µm
Dimensions (W x D x H):	1450 x 550 x 1050 mm
Weight (ca.):	325 kg

<b>optacom VC-10-XXL</b>	
horizontal/vertical (X axis/ Z axis):	595/425 mm
Order no.:	101-204-595



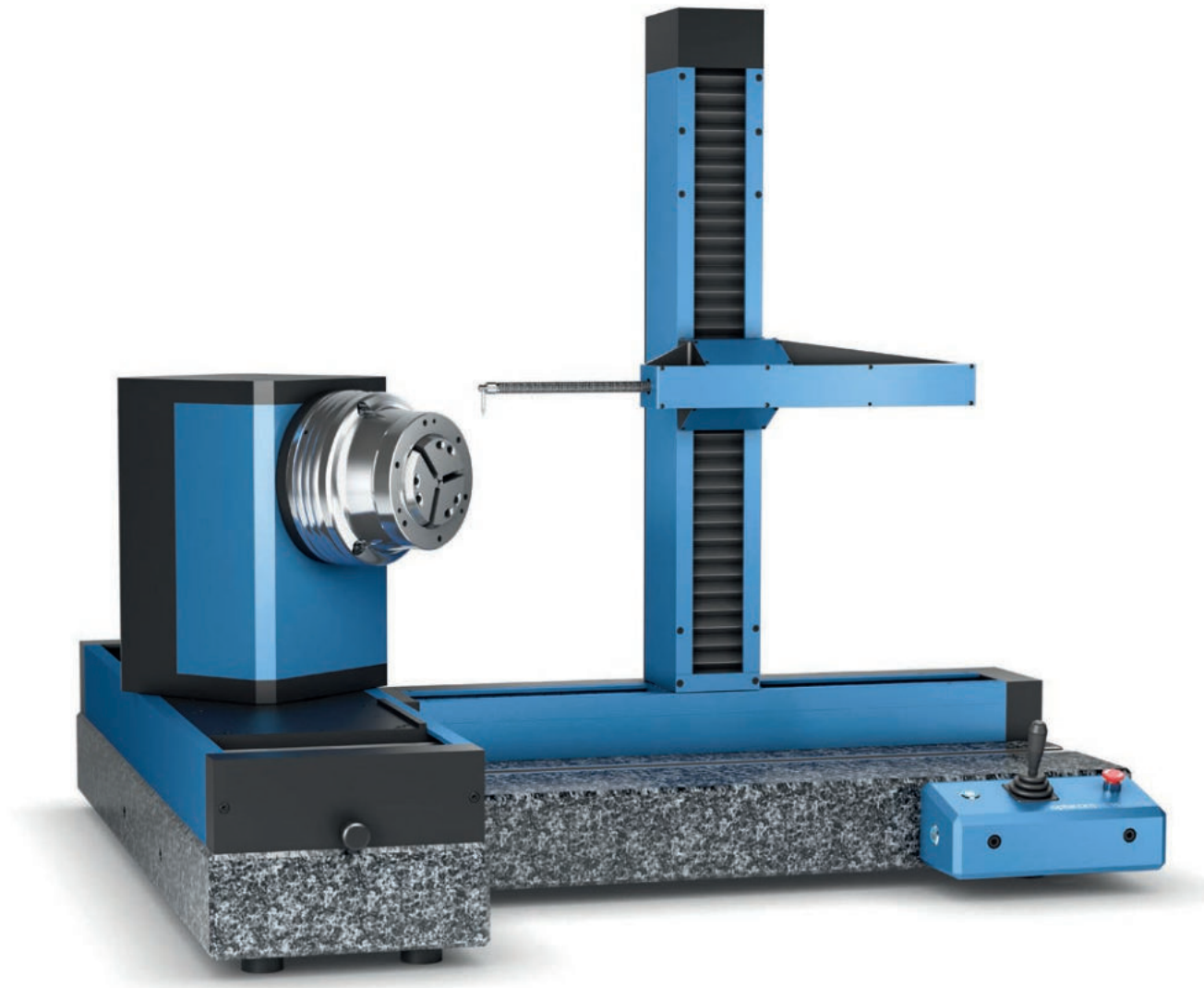

**Are you looking for a universal measuring station that not only replaces your contour, roughness and roundness, but also your gear measuring machine?**

Then you will definitely like our optacom VC-10-UL-RDY. Consisting of 6 measuring axes it does contour measurements automatically or in combination with a simultaneous roughness measurement in a perfect manner.

Next to these qualities, it does roundness measurements or composed measurements with an integrated swivel table, which is placed on an installed rotary axis. This leads to the fact that even complicated measuring tasks of complexly formed objects become very easy.

At the stylus tip it reaches a true, not only simply calculated resolution of less than 3 nm and can do this over the entire measuring range.

Resolution in X and Z axis:	0.002 $\mu\text{m}$
Resolution at stylus tip:	0.003 $\mu\text{m}$
Measurement system:	optical incremental and contactless (X, Z, T, R, D, Y)
Accuracy:	+/- (0.5 + L/100) $\mu\text{m}$
Straightness:	+/- (0.5 + L/100) $\mu\text{m}$
Dimensions (W x D x H):	1065 x 1060 x 980 mm
Measuring speed:	0.1 – 2 mm/sek (optimized automatically)
Measurable gradients:	78° upwards; 87° downwards
Maximum measuring force:	10 - 150 mN
Measuring range (X + Z axis):	425 mm
Measuring range (Y axis):	530 mm
Rotation angle (D):	210°
Weight (ca.):	275 kg

<b>optacom VC-10-UL-RDY</b>	
horizontal/vertical (X axis/Z axis) / Y axis	425 mm / 425 mm / 530 mm
Order no.:	101-227-425

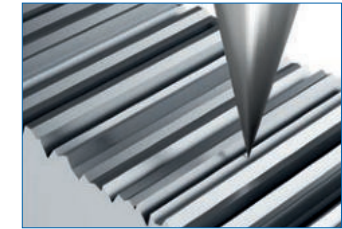
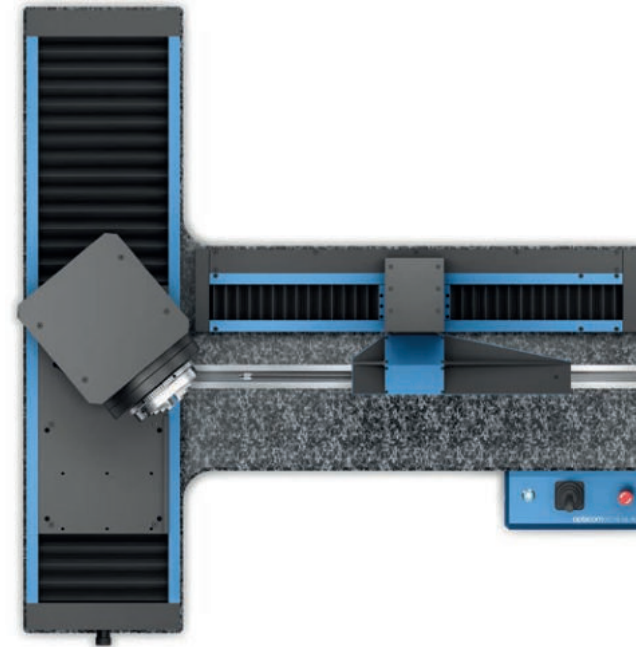

- ▶ The most powerful all-round system for the entire variety of contour measuring tasks
- ▶ Contour and roughness in one measurement with the integrated roughness module
- ▶ Roundness measurements and gear measurements with the integrated rotary table
- ▶ Y-table with 530 mm travel
- ▶ Rotary axis with a rotation angle of 210°
- ▶ High-precision linear axis with an integrated drive
- ▶ Contact-free, linear incremental measuring systems, absolutely wear free
- ▶ Various chucks available
- ▶ Machine calibration (including stylus tips calibration) in less than 3 minutes
- ▶ Rapid stylus tips change with optacom quick-release fastener
- ▶ Body made of high-strength aircraft aluminium

**Delivery scope:** Measuring machine optacom VC-10-UL-RDY, industrial PC with TFT monitor, mouse and keyboard, Windows operating system, optacom Suite 2 complete software, calibration standard with certificate (for machine calibration purposes), two quick-release fasteners and two stylus tips

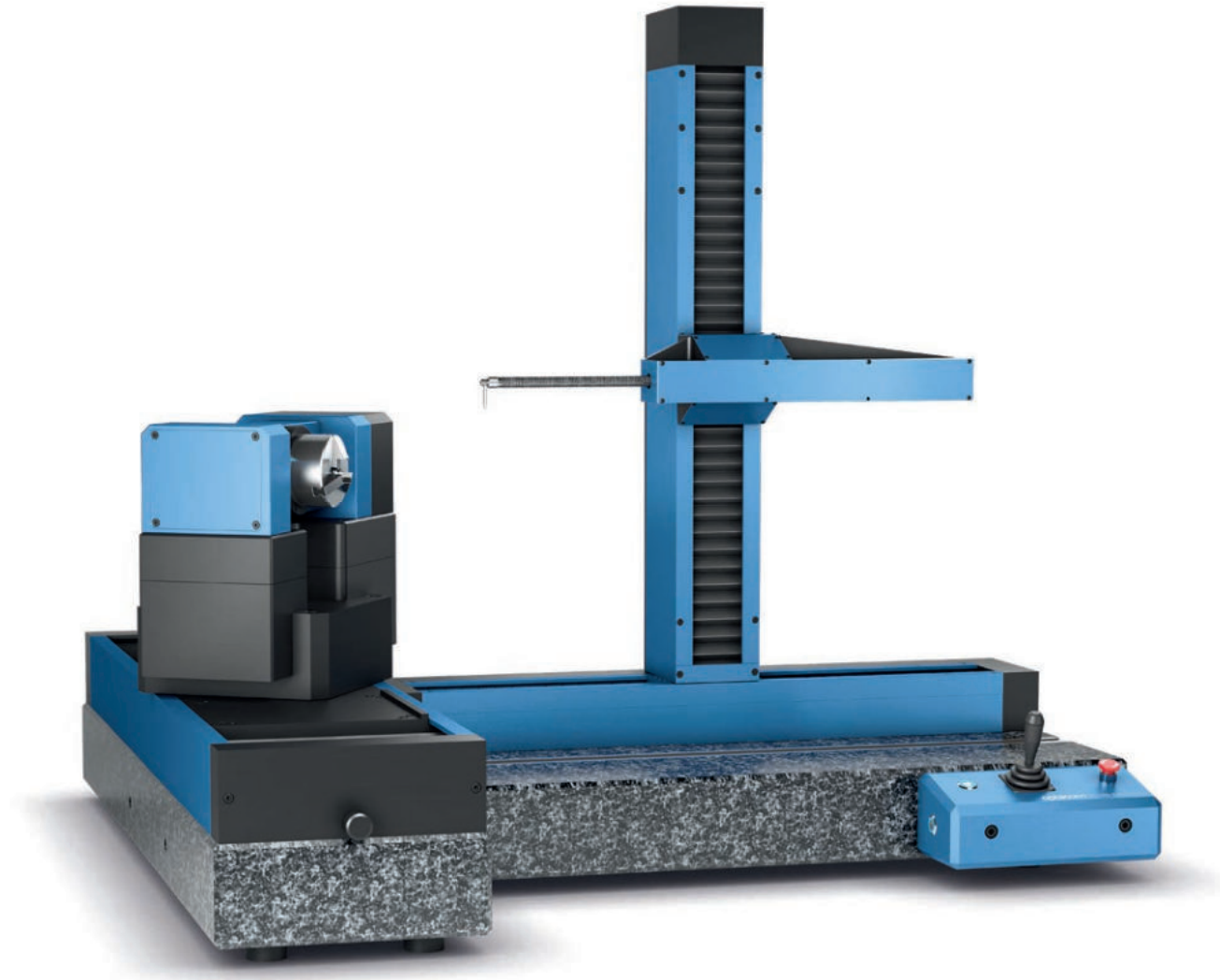

**Are you looking for a multi-functional measuring station that not only replaces your contour, roughness and roundness, but also your form measuring instrument?**

Then you will definitely like our optacom VC-10-UL-RDSY. This extraordinary instrument has 7 measuring axes that does contour measurements automatically or in combination with simultaneous roughness measurement in a perfect manner.

Next to these qualities, it does roundness measurements or composed measurements with an integrated swivel table, which is placed on an installed rotary axis. This leads to the fact that even complicated measuring tasks of complexly formed objects become very easy.

At the probe tip it reaches a true, not only simply calculated resolution of less than 3 nm and can do this over the entire measuring range.



Resolution in X and Z axis:	0.002 $\mu\text{m}$
Resolution at stylus tip:	0.003 $\mu\text{m}$
Measurement system:	optical incremental and contactless (X, Z, T, R, S, D, Y)
Accuracy:	+/- (0.5 + L/100) $\mu\text{m}$
Straightness:	+/- (0.5 + L/100) $\mu\text{m}$
Dimensions (W x D x H):	1065 x 1060 x 980 mm
Measuring speed:	0.1 – 2 mm/sek (optimized automatically)
Measurable gradients:	78° upwards; 87° downwards
Measuring range (X + Z axis):	425 mm
Measuring range (Y axis):	530 mm
Rotation angle (D):	210°
Swivel angle (S):	240°
Weight (ca.):	275 kg

<b>optacom VC-10-UL-RDSY</b>		
horizontal/vertical (X axis/Z axis) / Y axis	425 mm / 425 mm / 530 mm	
Order no.:	101-228-425	

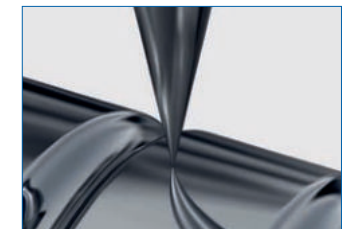
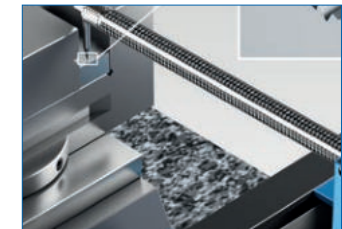
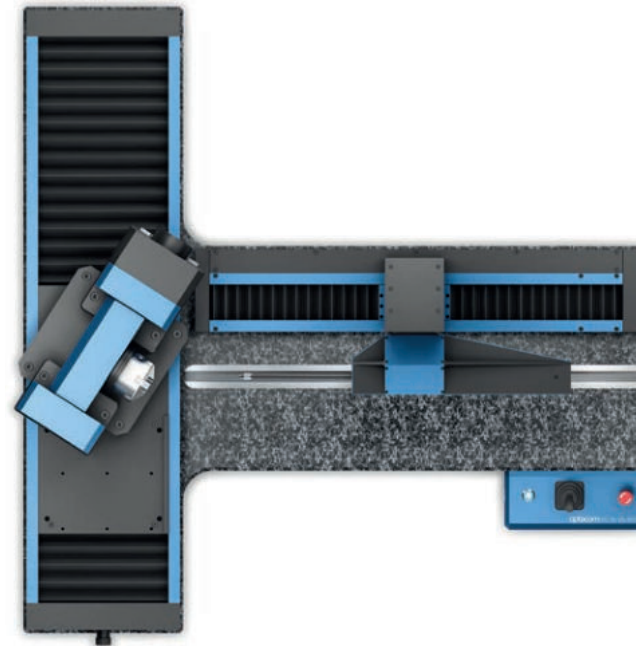

- ▶ The most powerful all-round system for the entire variety of contour measuring tasks
- ▶ Contour and roughness in one measurement with the integrated roughness module
- ▶ Roundness measurements and consolidated measurements with the integrated swiveling table
- ▶ Y-table with 530 mm travel
- ▶ Rotary axis with a rotation angle of 210°
- ▶ Swivel axis with an angle of 240°
- ▶ High-precision linear axis with an integrated drive
- ▶ Body made out of high-strength aircraft aluminium
- ▶ Contact-free, linear incremental measuring systems, absolutely wear free
- ▶ Machine calibration (including unilaterally stylus tips calibration) in less than 3 minutes
- ▶ Rapid stylus tips change with optacom quick-release fastener

**Delivery scope:** Measuring machine optacom VC-10-UL-RDSY, industrial PC with TFT monitor, mouse and keyboard, Windows operating system, optacom Suite 2 complete software, calibration standard with certificate (for machine calibration purposes), two quick-release fasteners and two stylus tips

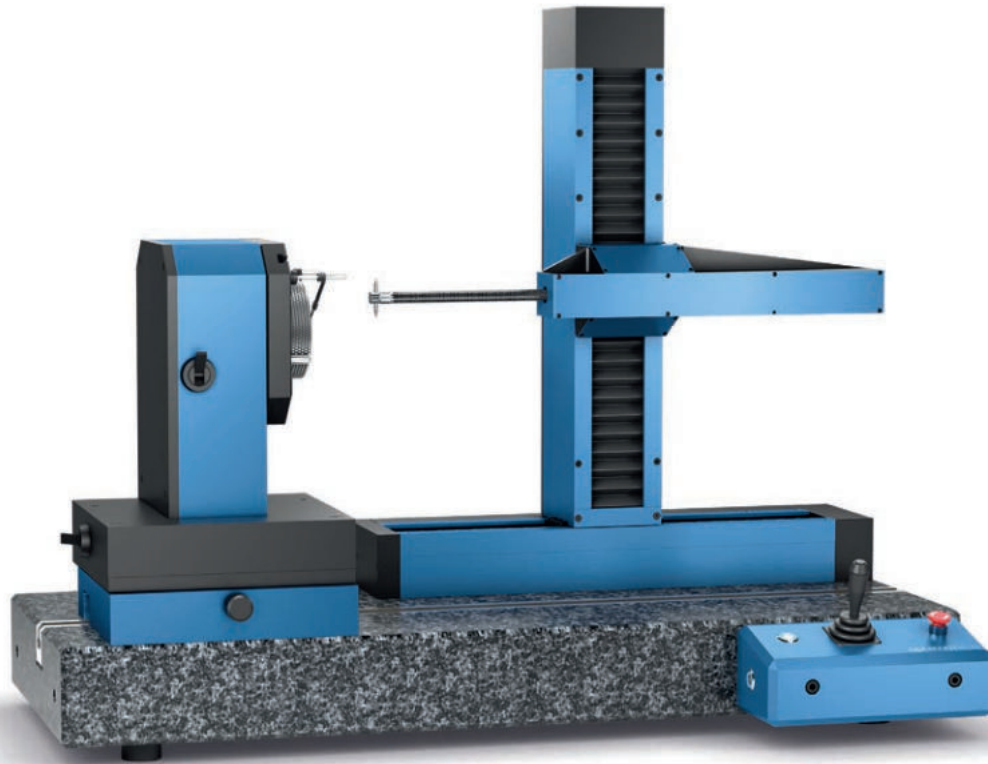

**Scope of delivery:** VC-10, industrial PC with TFT monitor, mouse, keyboard, Windows OS, optacom contour software, calibration standard with certificate, two quick-release fasteners and two stylus tips YTA, quick exchange basis, basis without zero tension, stud bolt set, set of threaded t nut set, set of threaded receptacle plates (M2.5 – M120), top down module, incl. thread software 'Professional'. Stylus tips not included.

Illustration may differ

#### VC-10-ring gauge-edition

Order no.:

101-207-225

#### Are you looking for a measurement equipment for quick and easy thread ring gauges (normal and smooth) from M2.5 to M120?

The VC-10-ring gauge-edition features all options required for reliable measurement in modern production environment: An integrated quick-exchange system and three receptacle plates allow adaptation to different diameters in no time.

As the exchange precision amounts to less than 0.01 mm repeatability when clamping, a recalibration or alignment is not needed. It is sufficient to mount the required receptacle plate, to clamp the ring gauge and to start the program.

The entire measuring sequence is performed by the optacom software automatically, together with a specialized program and the integrated motorized Y table.

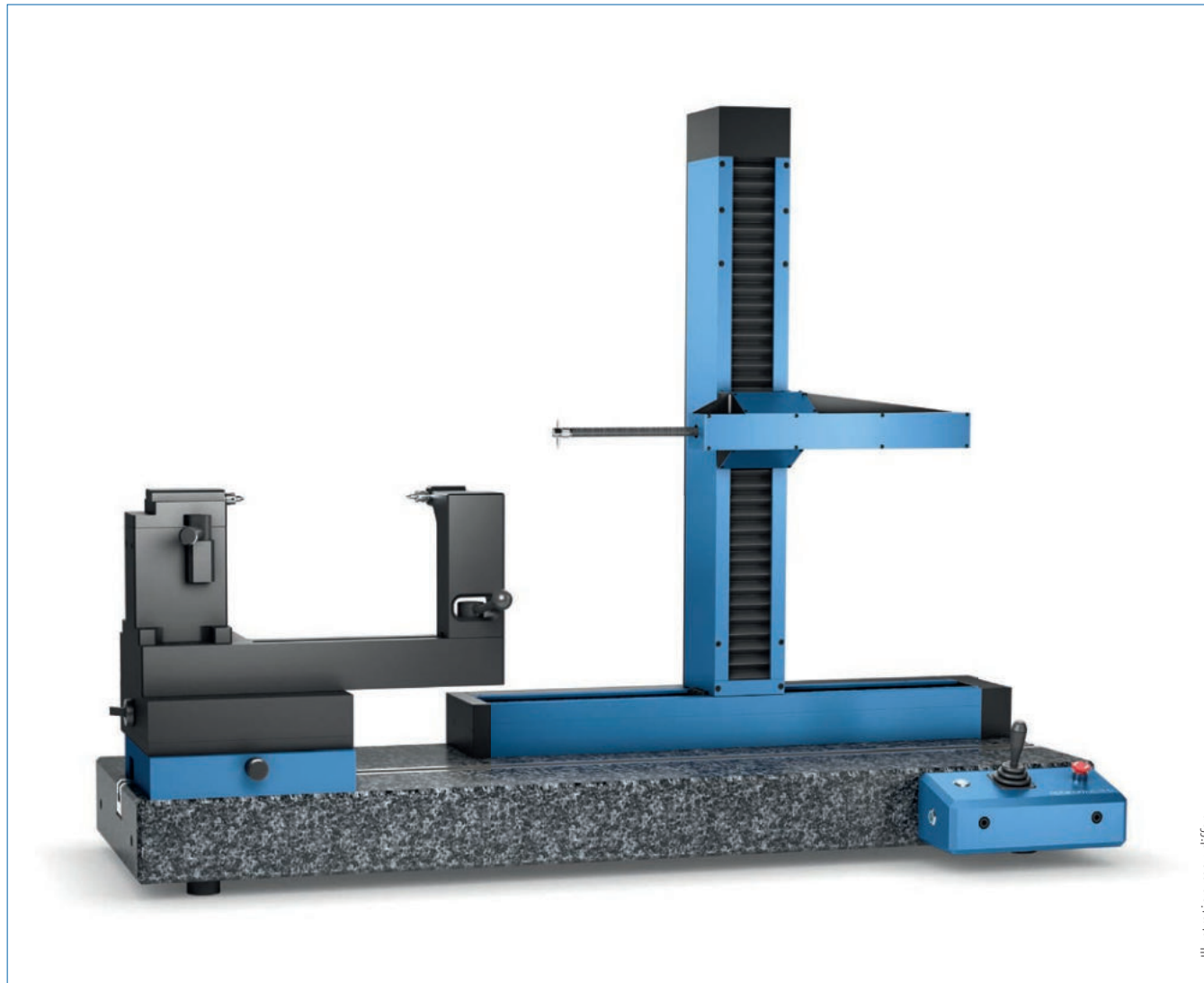

**Scope of delivery:** VC-10-EL, industrial PC with TFT monitor, mouse, keyboard, Windows OS, optacom contour software, calibration standard with certificate, two quick-release fasteners and two stylus tips, YTA, quick exchange basis, basis with zero tension, stud bolt set, threaded t nut set, set of threaded receptacle plates (M2.5 – M120), top down module and tailstock, incl. thread software 'Professional'. Stylus tips not included.

### VC-10-EL-thread-edition

Also available as VC-10-UL-thread-edition upon request.

Order no.: 101-207-325

Illustration may differ

## Are you looking for a test assembly for quick and easy measurement of smooth and threaded plug gauges?

The VC-10-EL-thread-edition features all options required for reliable measurement in modern production environment: A tailstock mounted on an easy-click with cross roller guides of an accuracy of 2 µm and two locating centers allow adaptation to different diameters and lengths in no time.

As the exchange precision amounts to less than 0.01 mm repeatability when clamping, a recalibration or alignment is not needed. It is sufficient to select to desired length, to clamp the plug gauge between the locating centers and to start the program.

The entire measuring sequence is performed by the optacom software automatically, together with a particular program and the integrated motorized Y table. The integrated Click-it system enables users to proceed afterwards with ring gauge measurement without delay.



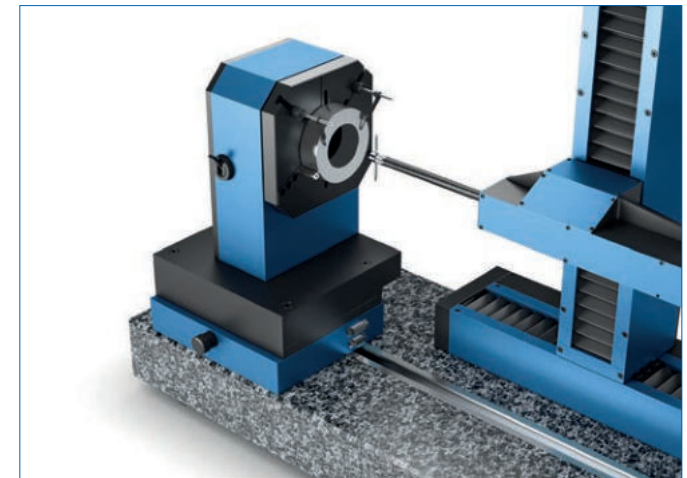
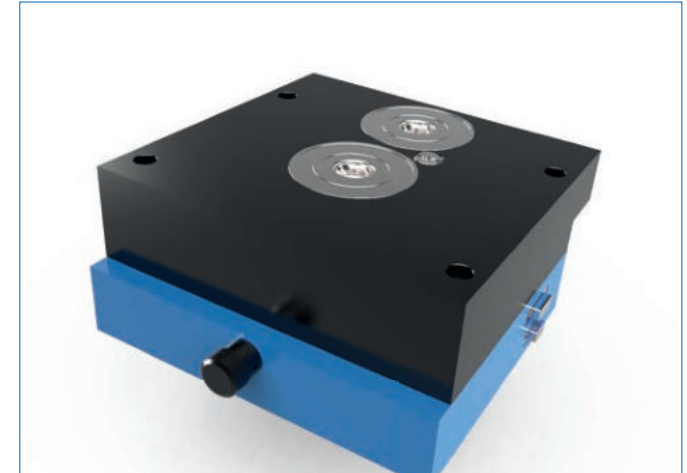
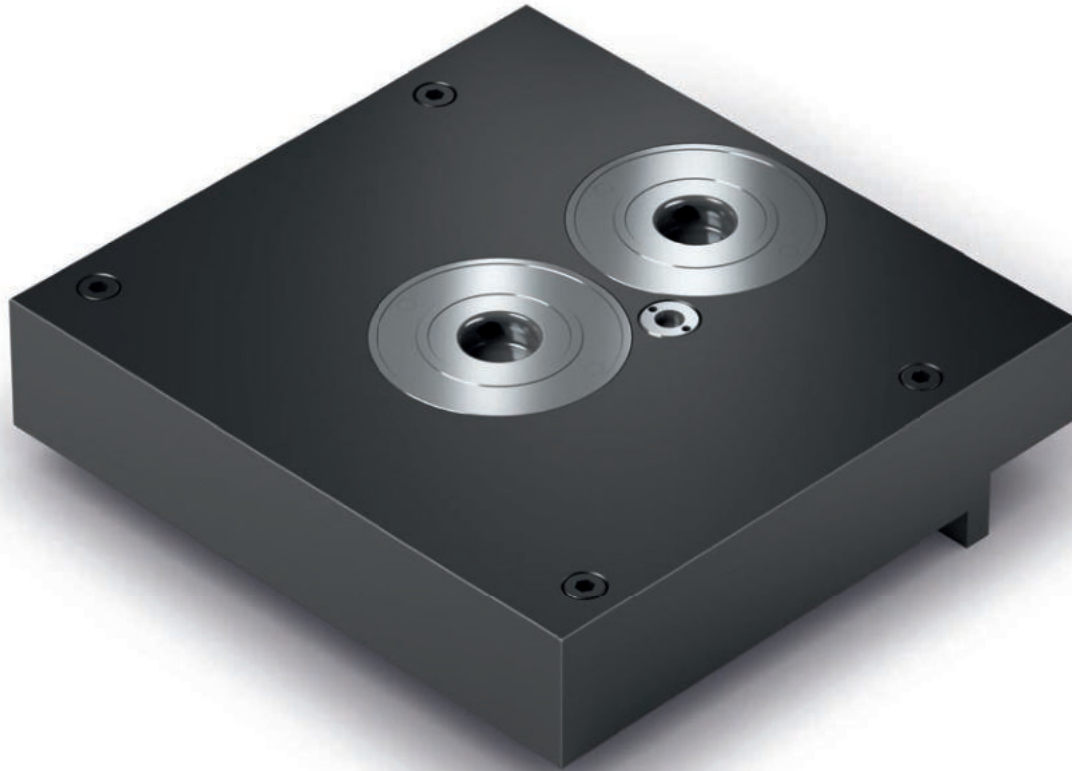

### optacom Quick Exchange System for Zero Point

Are you looking for a method of speeding up your measurement at maximum repeatability?

The quick exchange system for zero point represents an extremely sophisticated solution for this challenge: On the one hand, the exchange precision amounts to less than 0.01 mm at highest repeatability, on the other hand the whole exchange procedure even does not take 10 seconds.

This way, interruptions of the measuring sequence itself become negligible. Tension is generated by simple pressing in. Tension force amounts to 5.000, retention force to 10.000 N.

Clamping force:	5.000 N
Holding force:	10.000 N
Pressure to release:	3 - 8 bar
Repeat accuracy:	< 0,01 mm
Set-up & release time	< 0,1

### Zeropoint clamping system

Order no.: 101-207-011



### Automatic Y table YTA-25

Y-movement range: 25 mm

#### Automatic Y table YTA-25

Order no.: 101-204-007



### Zeropoint clamping Centric Clamping Vise

Incl. 2x Compensation Nipple

#### Zeropoint clamping Centric Clamping Vise

Order no.: 101-202-105



### Zeropoint clamping Standard Clamping Vise A25

Incl. 2x Compensation Nipple

#### Zeropoint clamping Standard Clamping Vise A25

Order no.: 101-202-106



### Zeropoint clamping topdown Standard

Incl. 2x Compensation Nipple

#### Zeropoint clamping topdown Standard

Order no.: 101-202-107



### Zeropoint clamping T Slot Plate

Incl. 2x Compensation Nipple

#### Zeropoint clamping T Slot Plate

Order no.: 101-202-108



### Compensation Nipples

Clamping nipple "Easy Click" with compensation

#### Compensation Nipples

Order no.: 101-208-007

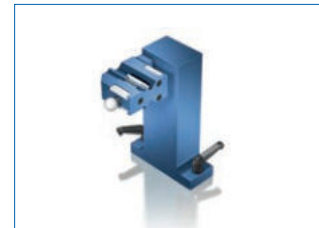

### topdown Module for Quick Exchange Basis

#### topdown Module for Quick Exchange Basis

Order no.: 101-207-008



### Undersize Nipple

Two items required for each receptacle plate

#### Undersize Nipple

Order no.: 101-208-001



### Centric Clamping Vise

#### Centric Clamping Vise

Order no.: 101-202-100

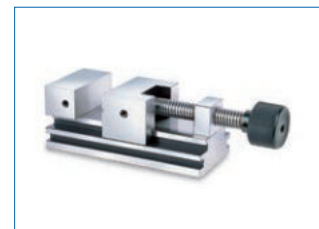

### Standard Clamping Vise A-25

#### Standard Clamping Vise A-25

Order no.: 101-202-020

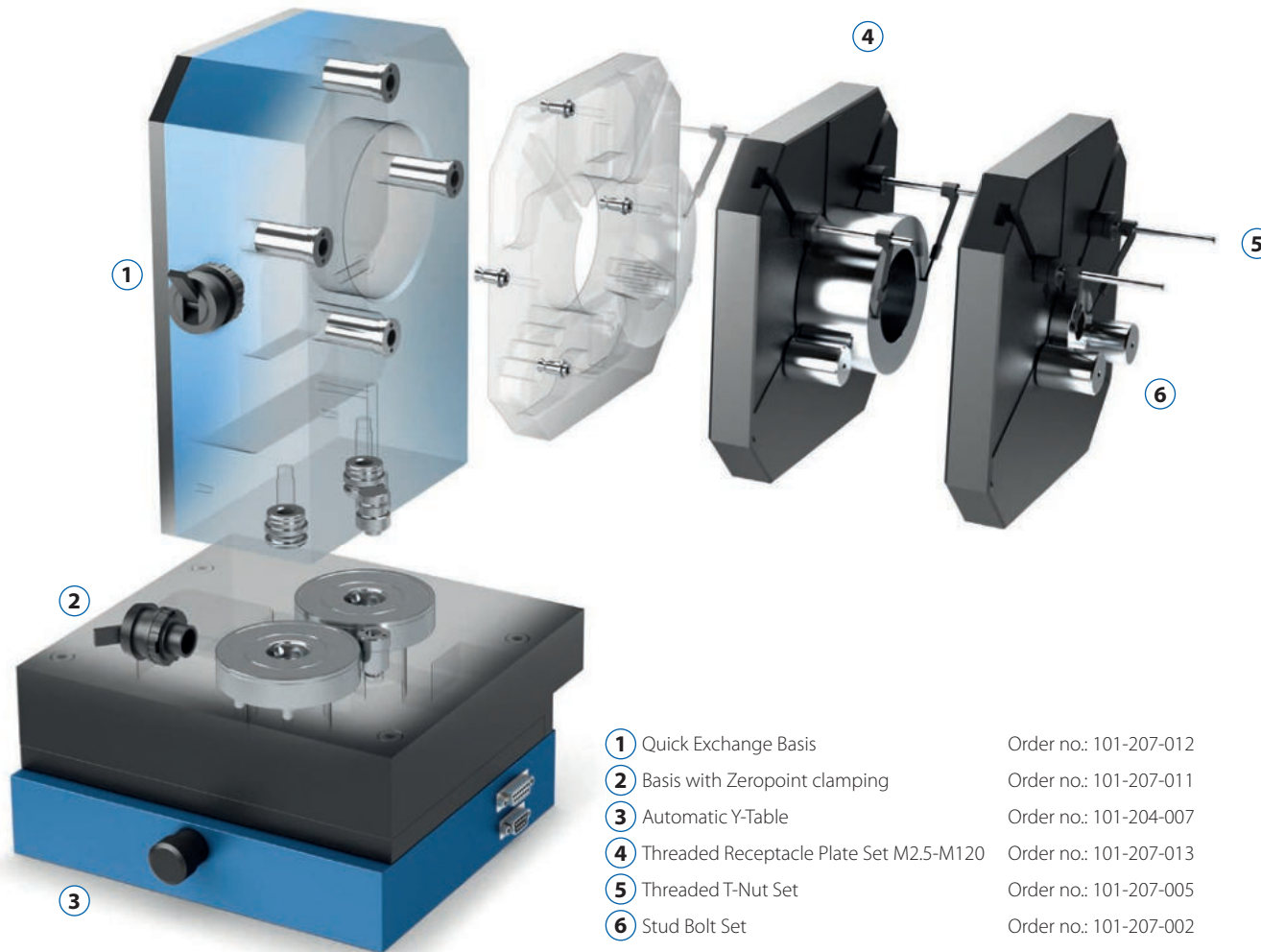

- |   |                        |
|---|------------------------|
| ① Quick Exchange Basis                    | Order no.: 101-207-012 |
| ② Basis with Zeropoint clamping           | Order no.: 101-207-011 |
| ③ Automatic Y-Table                       | Order no.: 101-204-007 |
| ④ Threaded Receptacle Plate Set M2.5-M120 | Order no.: 101-207-013 |
| ⑤ Threaded T-Nut Set                      | Order no.: 101-207-005 |
| ⑥ Stud Bolt Set                           | Order no.: 101-207-002 |

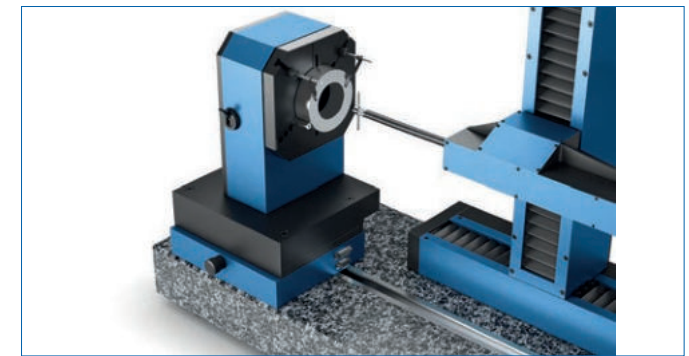

### Are you looking for convenient measurement equipment for smooth and threaded ring gauges from M2.5 to M120?

An integrated quick-exchange system and three receptacle plates allow adaptation to different diameters in no time. As the exchange precision amounts to less than 0.01 mm repeatability when clamping, a recalibration or alignment is not needed. It is sufficient to mount the required receptacle plate, to clamp the ring gauge and to start the program.

The entire measuring sequence is performed by the optacom software automatically, together with a particular program and the integrated motorized Y table.

The zero point quick exchange system is released by air pressure of 6 bar within 0.1 s. Tension is generated by simple pressing in. Tension force amounts to 5.000, retention force to 10.000 N.

#### Thread Software Professional

available only combined with optacom thread testing equipment

Order no.: 101-006-MPRO

#### Thread Software Standard

available only combined with optacom contour measuring machine

Order no.: 101-006-MSTA

#### Thread Software Light

available only combined with optacom contour measuring machine

Order no.: 101-006-MLIG





**Basis without zeropoint clamping  
incl. Quick Exchange Basis**

Only combined with automatic Y-table Order no.: 101-204-007

**Basis without zeropoint clamping  
incl. Quick Exchange Basis**  
Order no.: 101-207-009



**Quick Exchange Basis**

For basis with zeropoint clamping, order no.: 101-207-011 and automatic Y-table, order no.:101-204-007

**Quick Exchange Basis**  
Order no.: 101-207-012

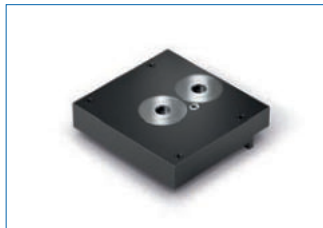

**Basis with zeropoint clamping**

Only combined with automatic Y table  
Order no.: 101-204-007

**Basis with zeropoint clamping**  
Order no.: 101-207-011



**Automatic Y-Table YTA-25**

Y-movement range: 25 mm

**Automatic Y-Table YTA-25**  
Order no.: 101-204-007



**Threaded Receptacle Plates M2.5-M120<sup>1/2</sup>**

contains threaded receptacle plates M2.5-M15, M16-M50 and M52-M120

**Threaded Receptacle Plate M2,5-M120<sup>1/2</sup>**  
Order no.: 101-207-013



**Set for threaded t nuts 6x each<sup>2</sup>**

Incl. holding-down clamp, threaded nut, threaded shaft and t nuts

**Set for threaded t nuts 6x each<sup>2</sup>**  
Order no.: 101-207-005



**Stud bolt set<sup>2</sup>**

Each bolt 2x

**Stud bolt set<sup>2</sup>**  
Order no.: 101-207-002

1) Delivery contains holding-down clamp option 1, threaded nut, threaded shaft and t nuts.  
2) All items are also separately available.

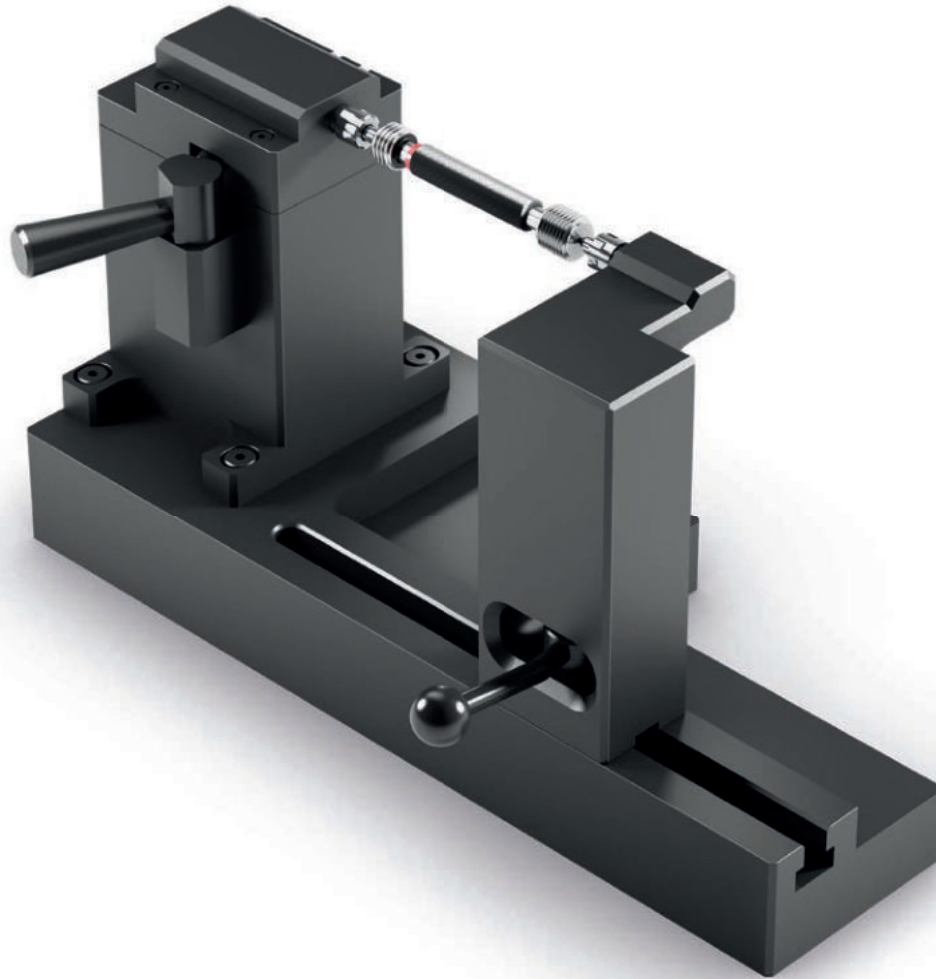

### Measurement of threaded plug gauges optacom Tailstock

Do you intend to simplify your measuring method for threaded plug gauges?

The optacom tailstock is perfectly suited to meet this requirement. On the one hand, the exchange precision amounts to less than 0.01 mm at highest repeatability, on the other hand

the whole exchange procedure even does not take 10 seconds. Threaded plug gauges of a length of up to 200 mm and a diameter of up to 250 mm may be examined.



### Tailstock

Only combined with basis with zero tension, order no.: 101-207-011 and automatic Y table, order no.:101-204-007

### optacom Tailstock

Order no.:

101-203-900

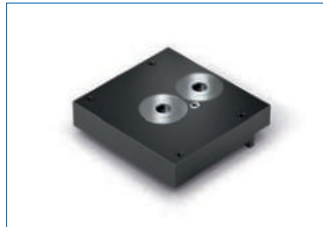

**Basis with zero tension**

Only combined with automatic Y table Order no.: 101-204-007

**Basis with zero tension**

Order no.: 101-207-011



**Automatic Y table YTA-25**

Y-movement range: 25 mm

**Automatic Y table YTA-25**

Order no.: 101-204-007

**Carrying Case Stylus Tips M Thread**

101-730-M2,5, 101-730-M03, 101-730-M04, 101-730-M5-8, 101-730-M8-10, 101-730-M10-30/L8, 101-730-M14-30/L10, 101-730-M30, 101-730-M40, 101-730-M100

All stylus tips are supplied with the appropriate quick-release fastener

**Carrying Case Stylus Tips M Thread**

Order no.: 101-207-003

**Carrying case with styli for trapezoidal threads**

101-731-T08, 101-731-T16, 101-731-T22/D1,1, 101-731-T22/D2

All stylus tips are supplied with the appropriate quick-release fastener

**Carrying Case Stylus Tips Trapezoid Thread**

Order no.: 101-207-014

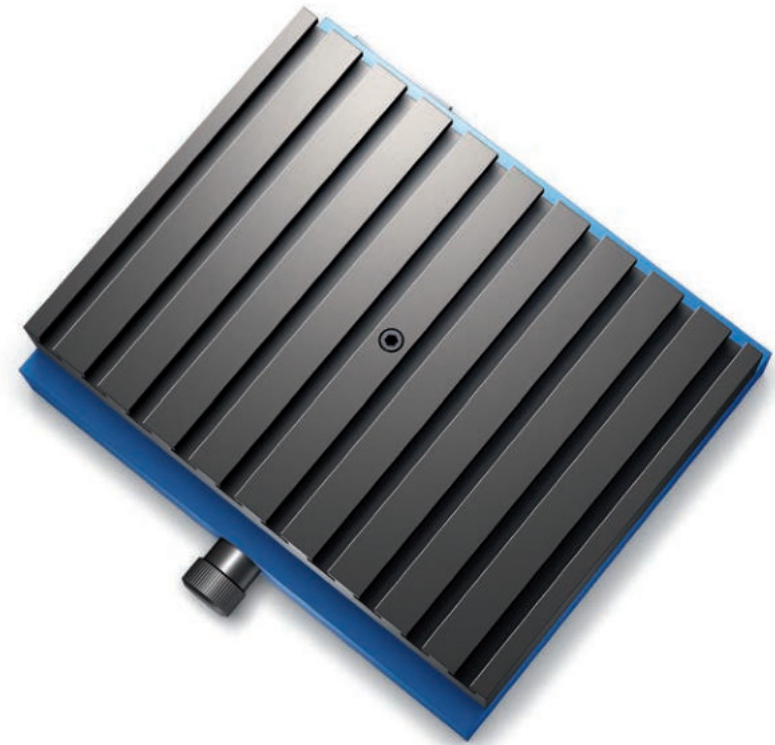
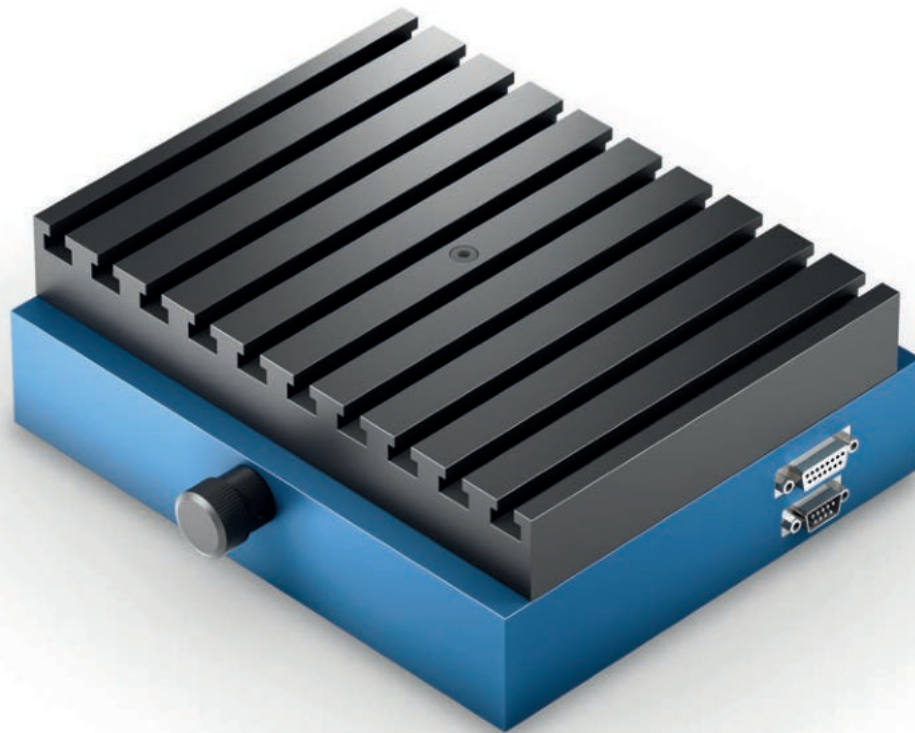

Tough, universal, accurate - optacom Y-tables - the perfect addition to your measuring machine.

Y-tables from optacom are universal, flexible, tough and highly accurate. All in all typical optacom components.

They are compact and their linear guides and ball screw drives allow a play-free and accurate movement.

The automatic Y-table also features a stepper motor and an optical, incremental and contactless measuring system.

optacom offers you the following three different versions:

**Y-table manual YTM**

to manually search for the highest / lowest point

**Y-table automatic YTA-25 or YTA-100**

to automatically search for the highest / lowest point

For the extension of automated CNC programmes on the Y axis to obtain user-independent, reproducible topdown measurements in the micrometer range.

When ordering items 101-207-009 or 101-207-011, the T-slot plate is removed from the Y-table.

The following specifications apply to all Y-tables:

YTA-25/YTM-25 length:	185 mm
YTA-100 length:	375 mm
Width:	250 mm
Height:	85 mm
Y-movement range:	25 mm or 100 mm
Spindle pitch:	3 mm
YTA-25 YTM-25 weight:	11 kg
YTA-100 weight:	17 kg
Table load:	500 kg

<b>Automatic Y-table YTA-25</b> with 25 mm movement range	
Order no.:	101-204-007

<b>Automatic Y-table YTA-100</b> with 100 mm movement range	
Order no.:	101-204-107

<b>Manual Y-table YTM-25</b> with 25 mm movement range	
Order no.:	101-204-004



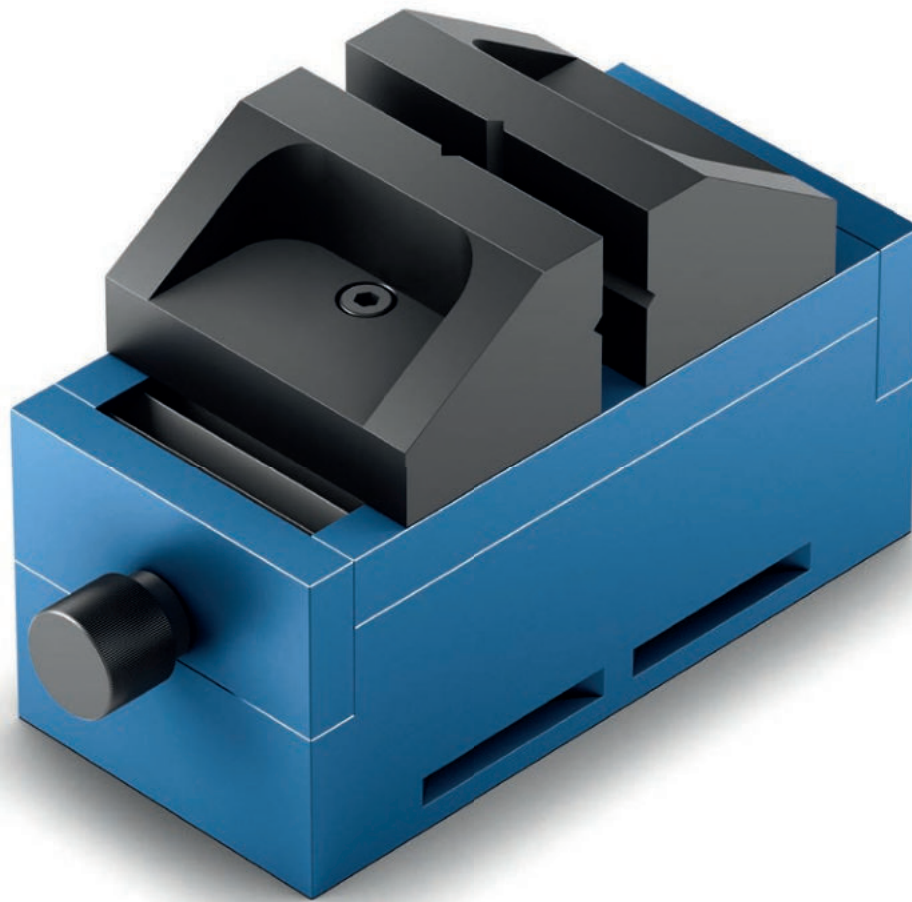

Dimensions (W x D x H):	145 x 70 x 64 mm
Clamping range w.clamp. jaws for ring clamp.:	max. 140 mm
Jaw width:	70 mm
Jaw height (standard):	35 mm
Material:	high-strength aircraft aluminium

<b>Centre clamping vice with flat clamping jaws</b>	
Order no.:	101-202-100

<b>Clamping jaws for spindle clamping</b>	
Set	
Order no.:	101-202-101

<b>Clamping jaws for ring clamping</b>	
Set	
Order no.:	101-202-102

<b>Flat clamping jaws</b>	
Set	
Order no.:	101-202-103

## Are you looking for a possible way to clamp components easily and centrally?

Then you will definitely like our completely encapsulated optacom centric clamping vice made out of high-strengthen aluminium. Through the optional available, different, quick to change, hard anodised clamping jaws the widely varying components until 50 mm can be clamped perfectly centrally.

Even thermal expansion is ensured through the centric spindle bearing. In most cases, due to the high centring and repetition accuracy a zenith search after changing parts is not necessary anymore. Our centric clamping vice is equipped standardly with the optacom quick-change system.

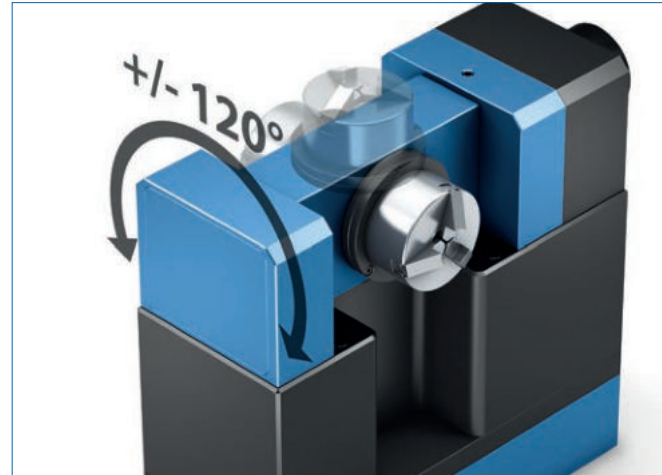

The rotary swiveling table RSY-240-25 from optacom combines the advantages of a round table with the advantages of a swiveling holder. In Addition to roundness measurements, the table focuses especially on the automated and metrologically exact comprehensible swiveling of components. For the first time, it is possible to measure consistently under clearly defined conditions. Components with deep grooves and 90° insertions capture flatness and roundness values that require multiple measurement passes and combine the results of these individual measurements in an error free overall measurement report. Therefore the measurement is entirely simplified and more precise. The results are noticeably reduced by monitoring and evaluation.

The optacom RSY-240-25 works ultra-precisely, like all our components. The default concentricity is achieved through a mechanical accuracy of 2.5 microns which can be increased by using special chucks to a value below 0.5 micron.

By default the RSY 240-25 is delivered with a special developed motorized Y-table with a measuring system and movement range of 25 mm.

The integrated Y-table provides the ability to automatically search for the highest / lowest point and allows the expansion of the CNC mode on the Y Axis.

#### Rotary-swiveling table RSY 240-25

Max. asymmetrical work piece weight depends on geometry.

Order no.: 101-710-010

The standard RSY 240-25 is delivered with a manual 3-jaw chuck

- ▶ Fully integrated in the optacom software
- ▶ Easy roundness measurement
- ▶ Absolute torsion resistant
- ▶ In-Out clamping
- ▶ Swing diameter over granite base of 190 mm
- ▶ Roughness fully measurable on the diameter at circumference
- ▶ Fully CNC programmable
- ▶ Movement controllable via machine console provided with buttons and joystick
- ▶ Three integrated optical, incremental and contactless measuring systems

Length:	365 mm
Width:	145 mm
Height:	255 mm
Y-movement range:	25 mm
Swivel angle:	+ / -120°
Weight:	30 kg
Maximum symm. work piece weight w/o gear:	10 kg
Maximum symm. work piece weight with gear:	15 kg

#### Rotary-swiveling table RSY 240-25 with gear drive

Max. asymmetrical work piece weight depends on geometry.

Order no.: 101-710-010-G



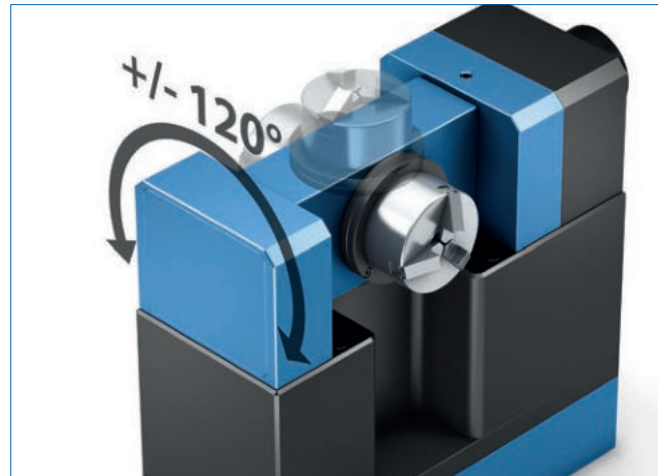

The rotary swiveling table RSY-240-25-29 from optacom combines the advantages of a round table with the advantages of a swiveling holder. In Addition to roundness measurements, the table focuses especially on the automated and metrologically exact comprehensible swiveling of components. For the first time, it is possible to measure consistently under clearly defined conditions. Components with deep grooves and 90° insertions capture flatness and roundness values that require multiple measurement passes and combine the results of these individual measurements in an error free overall measurement report. Therefore the measurement is entirely simplified and more precise. The results are noticeably reduced by monitoring and evaluation.

The optacom RSY-240-25-29 works ultra-precisely, like all our components. The default concentricity is achieved through a mechanical accuracy of 2.5 microns which can be increased by using special chucks to a value below 0.5 micron.

By default the RSY 240-25-29 is delivered with a special developed motorized Y-table with a measuring system and movement range of 25 mm.

The integrated Y-table provides the ability to automatically search for the highest / lowest point and allows the expansion of the CNC mode on the Y Axis.

The standard RSY 240-25-29 is delivered with a manual 3-jaw chuck

- ▶ Fully integrated in the optacom software
- ▶ Easy roundness measurement
- ▶ Absolute torsion resistant
- ▶ In-Out clamping
- ▶ Swing diameter over granite base of 190 mm
- ▶ Roughness fully measurable on the diameter at circumference
- ▶ Fully CNC programmable
- ▶ Movement controllable via machine console provided with buttons and joystick
- ▶ Three integrated optical, incremental and contactless measuring systems

Length:	365 mm
Width:	145 mm
Height:	255 mm
Y-movement range:	25 mm
Swivel angle:	+ / -120°
Weight:	30 kg
Max. sym. workpiece weight without transmission:	10 kg
Max. sym. workpiece weight with transmission:	15 kg

**Rotary-swiveling table RSY 240-25-29**

Max. asymmetrical work piece weight depends on geometry.  
Order no.: 101-710-029

**Rotary-swiveling table RSY 240-25-29 with gear drive**

Max. asymmetrical work piece weight depends on geometry.  
Order no.: 101-710-029-G

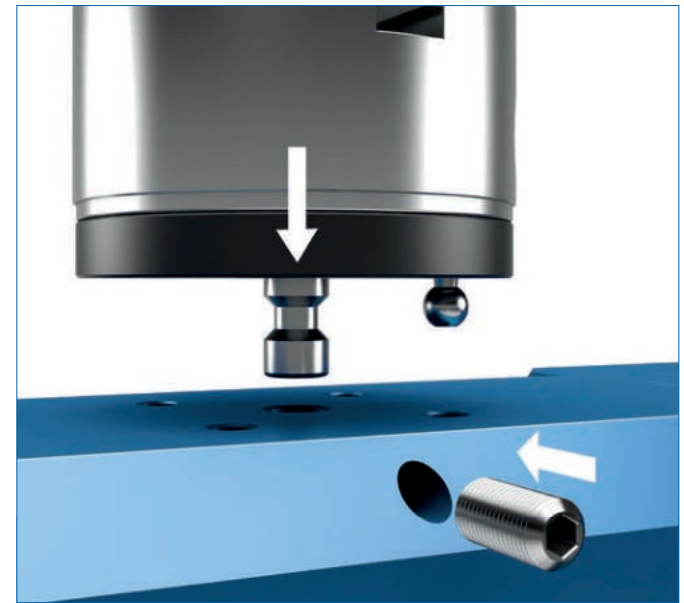
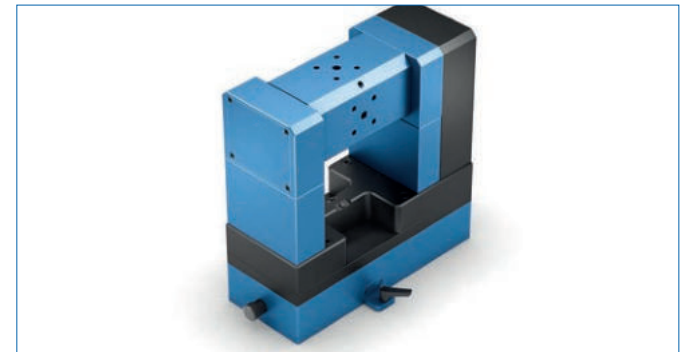
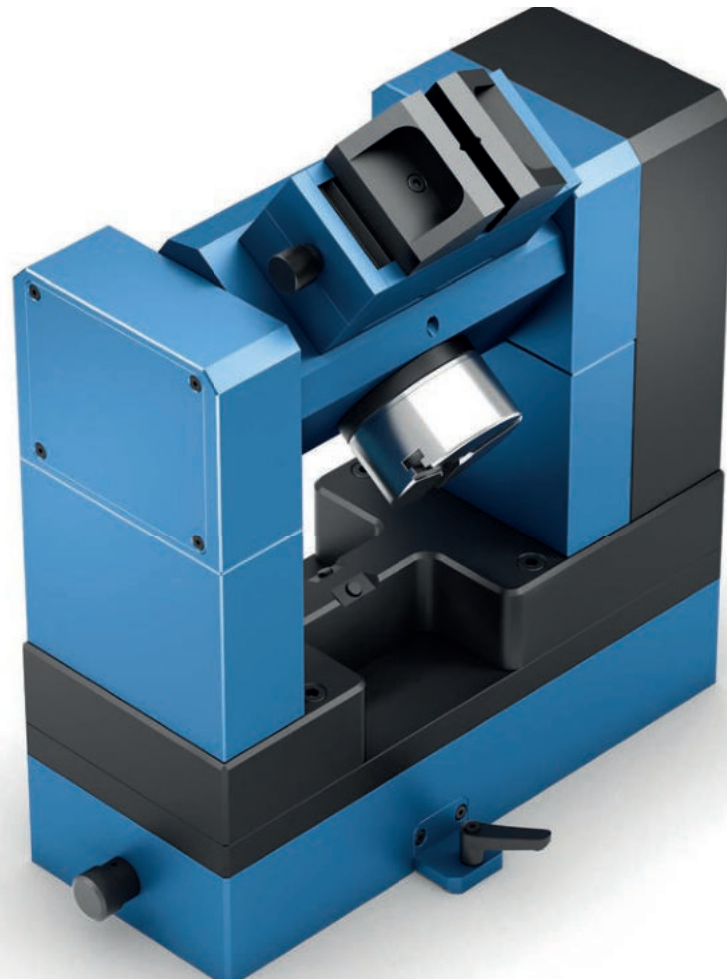

### Are you looking for a possible way to clamp several different components simultaneously with your measuring machine?

Then you will definitely like the automatic 4-way swivel table from optacom. With the 4-way swivel table you can realise up to four different ways of clamping at the same time with your machine. Naturally, all clamping adapters are equipped with the optacom quick-change system.

Due to the CNC controlled swivel axis with rotating, contact-free incremental measuring systems, the automatic 4-way swivel table offers the possibility to travel to any measuring point fully automatic. Despite the structuring through its unique construction you can reach any position.

Thanks to the motorised Y-table with a measuring system, a fully automatic zenith search is possible. The 4-way swivel table is fully integrated into the optacom Software Suite 2.

Resolution of the swivel axis (S):	0.00004°
Resolution in Y axis (Y):	0.002 µm
Measurement syst.: optical incremental and contactless (S, Y)	
Measuring range (Y):	25 mm
Clamping options:	4

#### 4-way swivel table

Order no.: 101-715-000



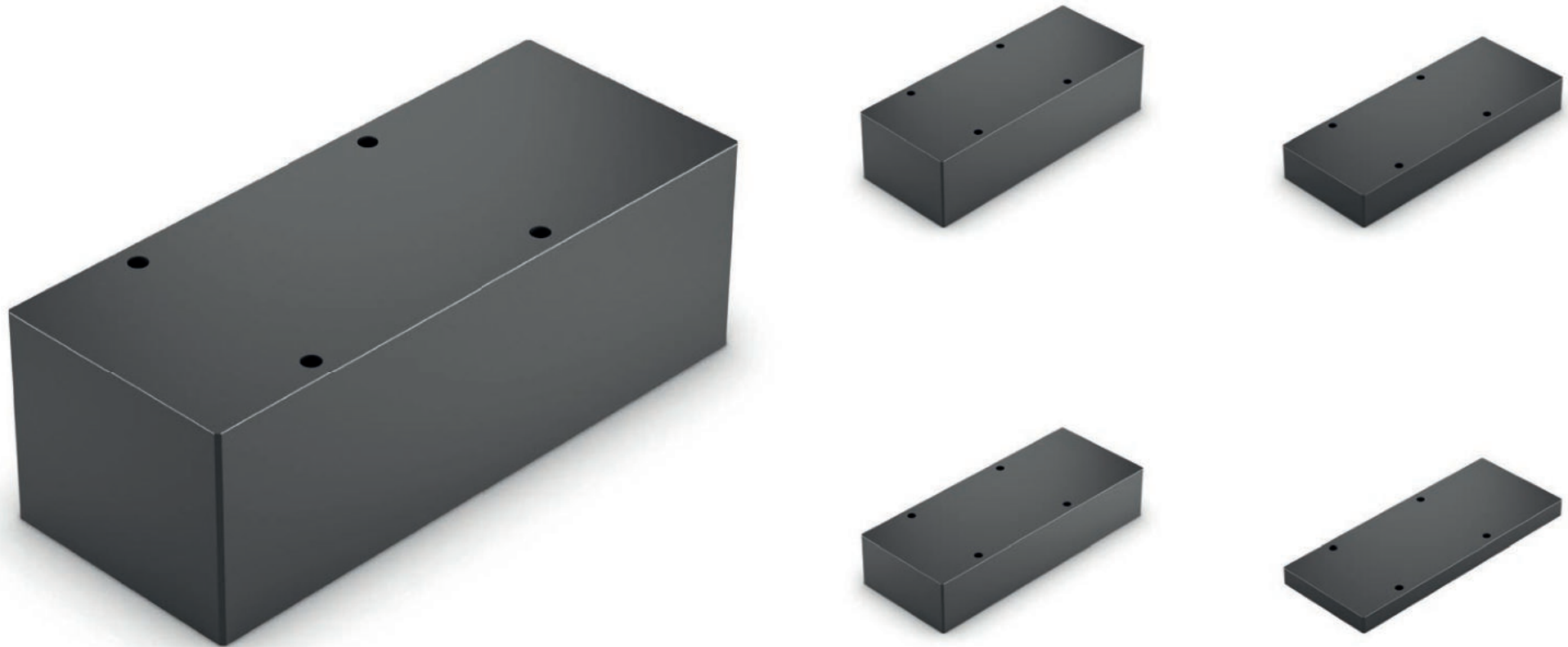

<b>Intermediate plate height 125 mm</b> for RSY 240-25/-29 & 4-way swivel table Order no.: 101-710-125
--

<b>Intermediate plate height 100 mm</b> for RSY 240-25/-29 & 4-way swivel table Order no.: 101-710-100
--

<b>Intermediate plate height 75 mm</b> for RSY 240-25/-29 & 4-way swivel table Order no.: 101-710-075
---

<b>Intermediate plate height 50 mm</b> for RSY 240-25/-29 & 4-way swivel table Order no.: 101-710-050
---

<b>Intermediate plate height 25 mm</b> for RSY 240-25/-29 & 4-way swivel table Order no.: 101-710-025
---

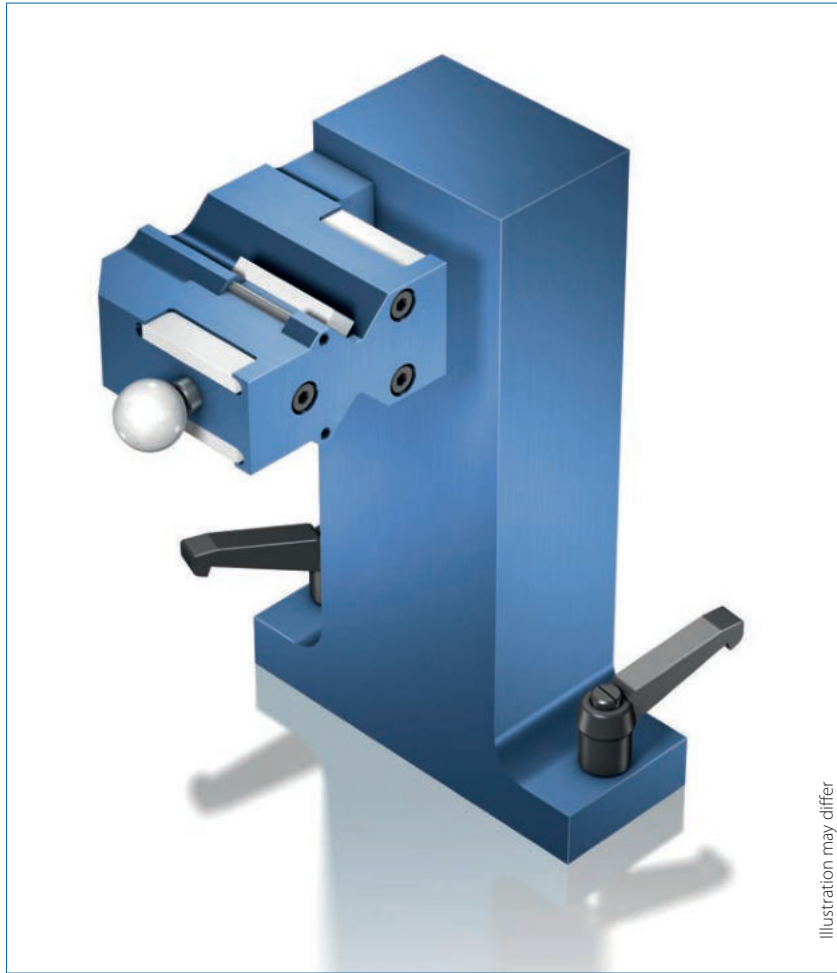
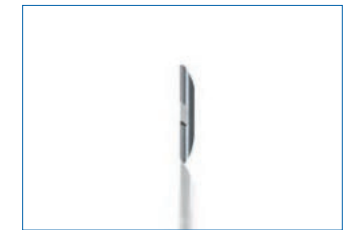
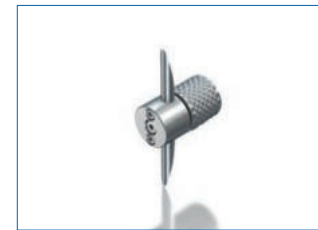
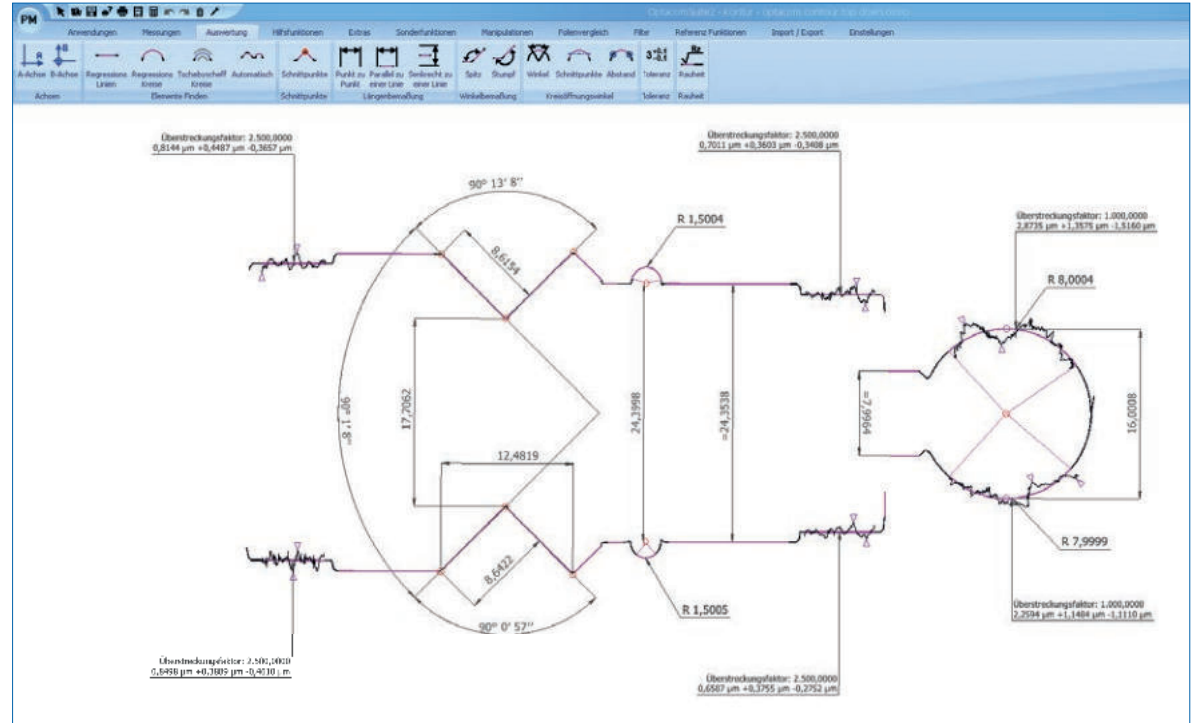

Illustration may differ



Of course, valuable knowledge on the dimensional stability of a component e. g. thickness, angle or radii and their relation, can be gained by checking the upper and lower contour. But so far, the problem was that both contours had to be analysed in two different measurement runs and subsequently had to be more or less correlated. Using optacom topdown, this task will be fixed comfortably and precisely to your entire satisfaction – that you are used to at optacom.

Given that contour measurements obtained through our machines stand in precise dimensional relation with each other based on absolute coordinates from the very beginning, you can use optacom topdown to combine two (or more) sub-measurements in a straightforward and automatic fashion.

**Scope of delivery:**

optacom topdown software, double-sided calibration standard with certificate (for machine calibration purposes), a double stylus tip quick-release fastener and two 20.5 mm stylus tips

<b>topdown module</b>	
when ordering with machine	
Order no.:	101-600-001

<b>topdown module</b>	
retrofit kit	
Order no.:	101-610-001

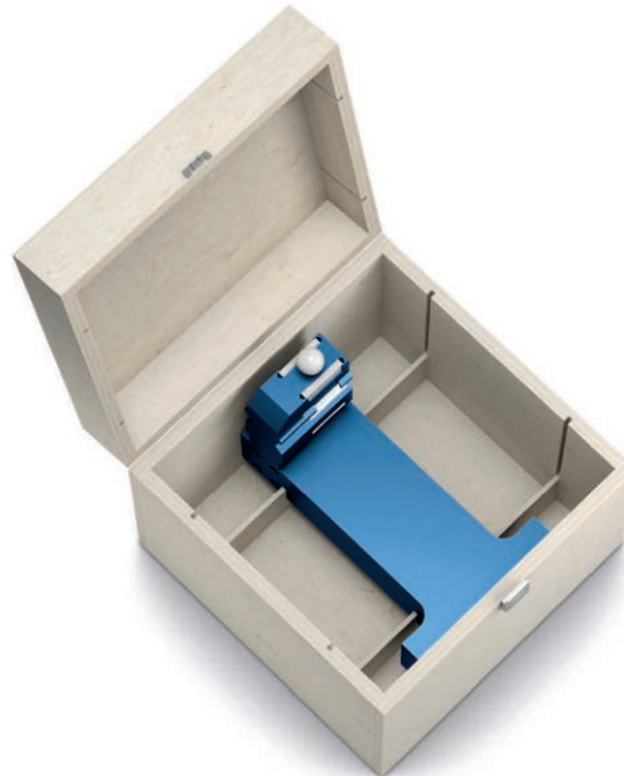

Illustration may differ

### Wooden box with hinged lid

Upper parts beveled at the upper corners, corner joint stitched and sanded, natural box incl. Optacom logo print on the box.

Height distribution:	30/140 mm
Body made of birch plywood:	8 mm
Floor and cover made of birch plywood:	3 mm
Lower parts 47 mm high with cut-out:	about 61 x 22 mm
Upper parts 122 mm high with cut-out:	about 61 x 21 mm

### Scope of delivery:

optacom wooden box for topdown-module, incl. 2 hinges (180 degrees) nickel plated or brass plated, incl. 1 lock nickel plated or brass plated, incl. 2 guillotines made of birch plywood 3 mm

### Wooden box for topdown-module

205 mm x 205 mm x 175 mm

Order no.:

101-600-030

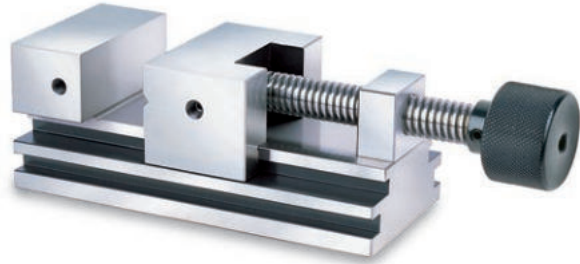

#### Standard vise A-25

- ▶ Made out of high-quality alloy steel, hardened and grinded
- ▶ Very precise, closes absolutely gap-free
- ▶ Two integrated side clamping slots

Length:	140 mm
Width:	63 mm
Span:	85 mm
Height:	69 mm
Parallelism:	3 µm / 100 mm
Perpendicularity:	4 µm / 100 mm
Material:	1.1654
Hardened:	56° - 58° HRC
Weight:	4.6 kg

#### Standard vise A-25

Order no.: 101-202-020

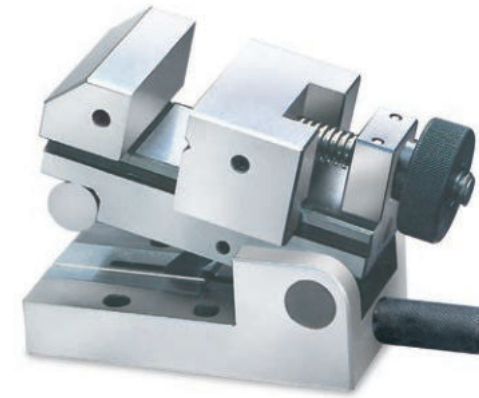

#### Sine angle vise SA-100

- ▶ Made out of high-quality alloy steel, hardened and grinded
- ▶ Angle adjustment via gauge blocks
- ▶ Clamping system at the lower part allows a secure angle adjustment

Length:	130 mm
Width:	73 mm
Span:	45 mm
Height:	93 mm
Swivel adjustment:	45°
Parallelism:	3 µm / 100 mm
Perpendicularity:	5 µm / 100 mm
Material:	1.1654
Hardened:	58° - 62° HRC
Weight:	6 kg

#### Sine angle vise SA-100

Order no.: 101-202-010



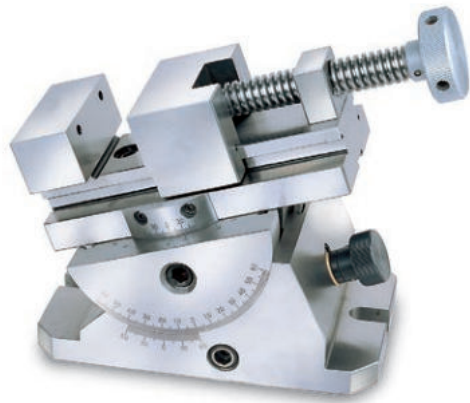

## Rotating swivel vise CHM-80

- ▶ Angle adjustment via a 3'-Nonius
- ▶ Adjustment screw to allow precise angle adjustment
- ▶ Form-fitted clamping in any desired angle position via locking screws

Length:	160 mm
Width:	110 mm
Jaw width:	75 mm
Span:	80 mm
Height:	137 mm
Horizontal adjustment:	360°
Swivel adjustment:	+/- 60°
Parallelism:	3 µm / 100 mm
Perpendicularity:	4 µm / 100 mm
Material:	1.1654
Hardened:	56° - 60° HRC
Weight:	14 kg



## Rotating swivel vise CHM-SC04

- ▶ Angle adjustment via a 3'-Nonius
- ▶ Adjustment screw to allow precise angle adjustment
- ▶ Form-fitted clamping in any desired angle position via locking screws

Length:	178 mm
Width:	75 mm
Chuck-Diameter:	112 mm
Chuck-Height:	58 mm
Inside-Clamping:	∅ 32 - 84 mm
Outside-Clamping:	∅ 3 - 90 mm
Height:	181 mm
Horizontal adjustment:	360°
Swivel adjustment:	+/- 60°
Material:	1.1654
Hardened:	56° - 60° HRC
Weight:	13 kg

### Rotating swivel vise CHM-80







Order no.: 101-202-003

### Rotating swivel vise CHM-SC04

Order no.: 101-202-005



## optacom stylus tip icons -finding instead of searching!

-  **Angle:** This stylus tip is well suited to measure threads and parts with a pitch.
-  **Thread:** This stylus tip is well suited to measure threads, ball screws and parts with a pitch.
-  **Track:** This stylus tip is well suited to measure parts with symmetric contour. For example - ball screws.
-  **Roughness:** This stylus tip is well suited to measure roughness
-  **Top/down external:** This stylus tip is best used for top/down measurement.
-  **Top/down internal:** This stylus tip is best used for top/down measurements within drill holes.
-  **Gear:** This stylus tip is well suited for measurements of geometries in combination with our RSY 240-25. For example – gear wheels.

### Coated stylus tips:

Additionally to our normal stylus tips, models with special coating are available:

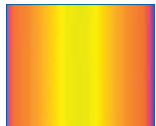

#### optaDiamond:

Reduces sliding friction in case of steel surfaces  
 Considerably saves cost compared with conventional diamond tips  
 Layer thickness: <math>< 3 \mu\text{m}</math>  
 Hardness: 6,000 - 8,000 HV

Upon request, all of our stylus tips can be coated as desired

### Digital pocket scale

Digital pocket scale made of sturdy plastic for checking the tactile force of a stylus tip. The scale has an auto-off function for battery saving (function can be switched off). Blue LCD display with digit height 9 mm. Easy operation via 2 buttons.

2x AAA batteries (micro) are already included.



Illustration may differ

Readability:	0,1g
Weighing range:	max. 150 g
Weighing plate:	60 x 64 mm
Dimensions:	67 x 100 x 22 mm
Weight:	100 g

Digital pocket scale	
Order no.:	101-010-WAG



**Stylus tip 59.5 mm** Order no.: 101-010-595  
made of carbide,  $\varnothing$  3.5 mm / R: 25  $\mu$ m / A: 12°

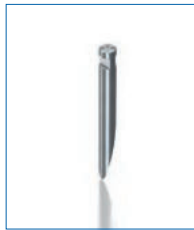

**Stylus tip 33 mm** Order no.: 101-010-330  
made of carbide,  $\varnothing$  3.5 mm / R: 25  $\mu$ m / A: 12°



**Stylus tip 33 mm** Order no.: 101-011-330  
made of carbide,  $\varnothing$  3.5 mm / R: 25  $\mu$ m / A: 12°  
with optaDiamond coating



**Stylus tip 20.5 mm** Order no.: 101-010-205  
made of carbide,  $\varnothing$  3.5 mm / R: 25  $\mu$ m / A: 12°

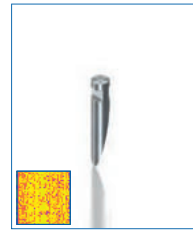

**Stylus tip 20.5 mm** Order no.: 101-011-205  
made of carbide,  $\varnothing$  3.5 mm / R: 25  $\mu$ m / A: 12°  
with optaDiamond coating



**Stylus tip 13 mm** Order no.: 101-030-130  
made of carbide,  $\varnothing$  1 mm / R: 25  $\mu$ m / A: 19°

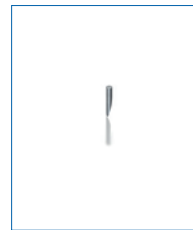

**Stylus tip 7 mm** Order no.: 101-010-070  
made of carbide,  $\varnothing$  1 mm / R: 25  $\mu$ m / A: 19°

**Stylus tip 7 mm** Order no.: 101-010-070-E  
Glued (the existing tracing arm is required)



**Stylus tip 6 mm** **Order no.: 101-010-060**  
made of carbide,  $\varnothing$  1 mm / R: 25  $\mu$ m / A: 19°

**Stylus tip 6 mm** **Order no.: 101-010-060-E**  
Glued (the existing tracing arm is required)

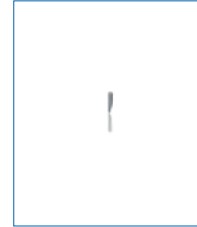

**Stylus tip 2.5 mm** **Order no.: 101-010-025**  
made of carbide,  $\varnothing$  0.5 mm / R: 25  $\mu$ m / A: 19°

**Stylus tip 2.5 mm** **Order no.: 101-010-025-E**  
Glued (the existing tracing arm is required)



**Stylus tip 4.5 mm** **Order no.: 101-010-045**  
made of carbide,  $\varnothing$  1 mm / R: 25  $\mu$ m / A: 19°

**Stylus tip 4.5 mm** **Order no.: 101-010-045-E**  
Glued (the existing tracing arm is required)



**Stylus tip 3.5 mm** **Order no.: 101-030-035**  
made of carbide,  $\varnothing$  0.5 mm / R: 25  $\mu$ m / A: 19°

**Stylus tip 3.5 mm** **Order no.: 101-030-035-E**  
Glued (the existing tracing arm is required)





**Stylus tip 105 mm** **Order no.: 101-010-105**  
made of carbide,  $\varnothing$  3.5 mm / R: 25  $\mu$ m / A: 12°



**Stylus tip 90 mm** **Order no.: 101-010-900**  
made of carbide,  $\varnothing$  3.5 mm / R: 25  $\mu$ m / A: 12°



**Stylus tip 10 mm** **Order no.: 101-010-100**  
made of carbide,  $\varnothing$  1 mm / R: 25  $\mu$ m / A: 19°



**Stylus tip 20.5 mm  
conical**

**Order no.: 101-134-005**

made of carbide,  $\varnothing$  3.5 mm, R: 0,05 mm / A: 24°



**Stylus tip 20.5 mm  
conical**

**Order no.: 101-134-010**

made of carbide,  $\varnothing$  3.5 mm, R: 0,1 mm / A: 24°



**Stylus tip 14,45 mm  
conical**

**Order no.: 101-110-14,45**

made of carbide,  $\varnothing$  3,5 mm, R: 25  $\mu$ m / A: 24°



**Stylus tip 10 mm  
conical**

**Order no.: 101-110-100**

made of carbide,  $\varnothing$  1 mm, R: 25  $\mu$ m / A: 24°



**Stylus tip 4,8 mm  
conical**

**Order no.: 101-110-048**

made of carbide,  $\varnothing$  1,0 mm, R: 25  $\mu$ m / A: 24°



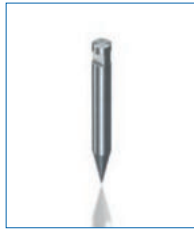

**Stylus tip 59.5 mm conical**    **Order no.: 101-110-595**  
made of carbide,  $\varnothing$  3.5 mm / R: 25  $\mu$ m / A: 24°



**Stylus tip 33 mm conical**    **Order no.: 101-110-330**  
made of carbide,  $\varnothing$  3.5 mm / R: 25  $\mu$ m / A: 24°



**Stylus tip 33 mm conical**    **Order no.: 101-111-330**  
made of carbide,  $\varnothing$  3.5 mm / R: 25  $\mu$ m / A: 24°  
with optaDiamond coating



**Stylus tip 20.5 mm conical**    **Order no.: 101-110-205**  
made of carbide,  $\varnothing$  3.5 mm / R: 25  $\mu$ m / A: 24°

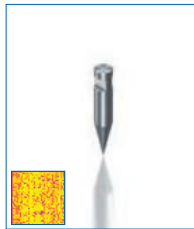

**Stylus tip 20.5 mm conical**    **Order no.: 101-111-205**  
made of carbide,  $\varnothing$  3.5 mm / R: 25  $\mu$ m / A: 24°  
with optaDiamond coating

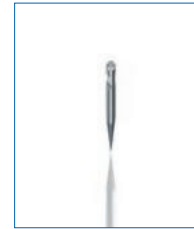

**Stylus tip 6 mm conical**    **Order no.: 101-110-060**  
made of carbide,  $\varnothing$  1 mm / R: 25  $\mu$ m / A: 24°



**Roughness stylus tip**  
**33 mm conical**

**Order no.: 101-430-335**

made of carbide,  $\varnothing$  3.5 mm / A: 24° with diamond /  
R: 5  $\mu$ m / A: 90°



**Roughness stylus tip**  
**33 mm conical**

**Order no.: 101-430-332**

made of carbide,  $\varnothing$  3.5 mm / A: 24° with diamond /  
R: 2  $\mu$ m / A: 90°

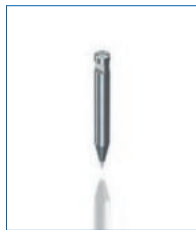

**Roughness stylus tip**  
**33 mm conical**

**Order no.: 101-431-332**

made of carbide,  $\varnothing$  3.5 mm / A: 24° with diamond /  
R: 2  $\mu$ m / A: 60°

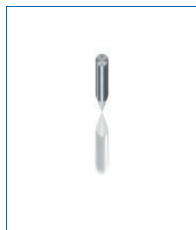

**Roughness stylus tip**  
**13 mm conical**

**Order no.: 101-430-130**

made of carbide,  $\varnothing$  1 mm / A: 24° with diamond /  
R: 5  $\mu$ m / A: 90°

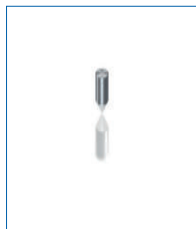

**Roughness stylus tip**  
**6 mm conical**

**Order no.: 101-430-060**

made of carbide,  $\varnothing$  1 mm / A: 24° with diamond /  
R: 2  $\mu$ m / A: 90°

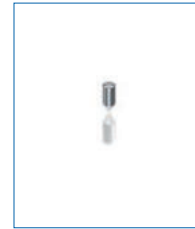

**Roughness stylus tip**  
**3 mm conical**

**Order no.: 101-430-035**

made of carbide,  $\varnothing$  1 mm / A: 24° with diamond /  
R: 5  $\mu$ m / A: 90°

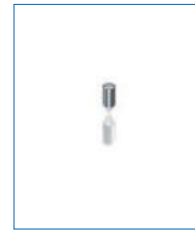

**Roughness stylus tip**  
**3 mm conical**

**Order no.: 101-430-032**

made of carbide,  $\varnothing$  1 mm / A: 24° with diamond /  
R: 2  $\mu$ m / A: 90°

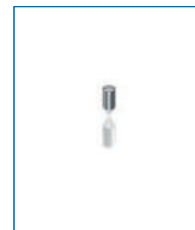

**Roughness stylus tip**  
**3 mm conical**

**Order no.: 101-431-032**

made of carbide,  $\varnothing$  1 mm / A: 24° with diamond /  
R: 2  $\mu$ m / A: 60°



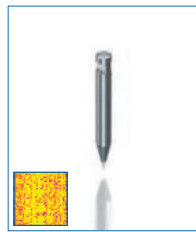

**Roughness stylus tip**  
**33 mm conical** **Order no.: 101-133-330**  
 made of carbide,  $\varnothing$  3,5 mm / A: 24°  
 R: 2  $\mu$ m / A: 90° / with optaDiamond coating

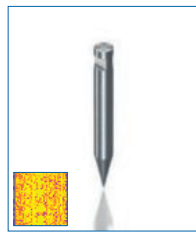

**Roughness stylus tip**  
**33 mm conical** **Order no.: 101-133-331**  
 made of carbide,  $\varnothing$  3,5 mm / A: 24°  
 R: 5  $\mu$ m / A: 90° / with optaDiamond coating



**Roughness stylus tip**  
**33 mm conical** **Order no.: 101-133-332**  
 made of carbide,  $\varnothing$  3,5 mm / A: 24°  
 R: 2  $\mu$ m / A: 60° / with optaDiamond coating



**Roughness stylus tip**  
**33 mm conical** **Order no.: 101-133-333**  
 made of carbide,  $\varnothing$  3,5 mm / A: 24°  
 R: 5  $\mu$ m / A: 60° / with optaDiamond coating



**Roughness stylus tip**  
**33 mm conical** **Order no.: 101-133-334**  
 made of carbide,  $\varnothing$  3,5 mm / A: 24°  
 R: 2  $\mu$ m / A: 45° / with optaDiamond coating



**Roughness stylus tip**  
**33 mm conical** **Order no.: 101-133-335**  
 made of carbide,  $\varnothing$  3,5 mm / A: 24°  
 R: 5  $\mu$ m / A: 45° / with optaDiamond coating

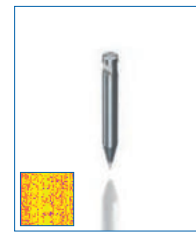

**Roughness stylus tip**  
**20,5 mm conical** **Order no.: 101-133-205**  
 made of carbide,  $\varnothing$  3,5 mm / A: 24°  
 R: 2  $\mu$ m / A: 90° / with optaDiamond coating



**Roughness stylus tip**  
**14 mm conical** **Order no.: 101-133-140**  
 made of carbide,  $\varnothing$  3,5 mm / A: 24°  
 R: 2  $\mu$ m / A: 47° / with optaDiamond coating



**Roughness stylus tip**  
**13 mm conical** **Order no.: 101-133-130**  
 made of carbide,  $\varnothing$  1 mm / A: 24°  
 R: 5  $\mu$ m / A: 90° / with optaDiamond coating



**Roughness stylus tip**  
**12 mm conical** **Order no.: 101-133-120**  
 made of carbide,  $\varnothing$  1 mm / A: 24°  
 R: 2  $\mu$ m / A: 90° / with optaDiamond coating

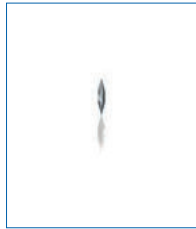

### Double-Stylus tip 25 mm conical

**Order no.: 101-330-250**

made of carbide,  $\varnothing$  2 mm / R: 25  $\mu$ m / A: 2 x 24°  
for topdown measurements

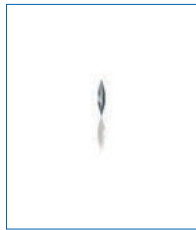

### Double-Stylus tip 18 mm conical

**Order no.: 101-330-180**

made of carbide,  $\varnothing$  2 mm / R: 25  $\mu$ m / double-sided cone 24°

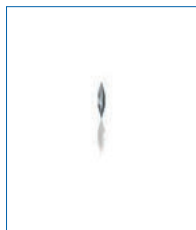

### Double-Stylus tip 13 mm conical

**Order no.: 101-330-130**

made of carbide,  $\varnothing$  2 mm / R: 25  $\mu$ m / double-sided cone 24°

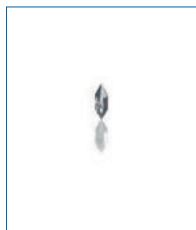

### Double-Stylus tip 12 mm conical

**Order no.: 101-330-120**

made of carbide,  $\varnothing$  3.5 mm / R: 0.1 mm / with double-sided cone 48°

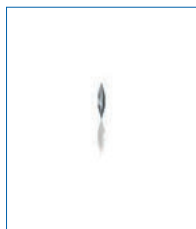

### Double-Stylus tip 9 mm conical

**Order no.: 101-330-090**

made of carbide,  $\varnothing$  1 mm / R: 25  $\mu$ m / A: 2 x 24°  
for topdown measurements

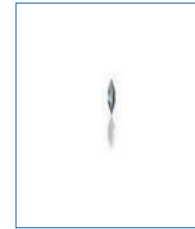

### Double-Stylus tip 6 mm conical

**Order no.: 101-330-060**

made of carbide,  $\varnothing$  1 mm / R: 25  $\mu$ m / A: 2 x 24°  
for topdown measurements



### Double-Stylus tip 4.4-24°-0.7 conical

**Order no.: 101-330-044**

made of carbide,  $\varnothing$  1 x 4.4 mm / R: 25  $\mu$ m / with double-sided cone 24° x 0.7 mm long

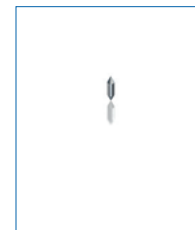

### Double-Stylus tip 4.4-48°-0.7 conical

**Order no.: 101-330-144**

made of carbide,  $\varnothing$  1 x 4.4 mm / R: 25  $\mu$ m / with double-sided cone 48° x 0.7 mm long



**Double-Stylus tip 34 mm** **Order no.: 101-230-340**  
made of carbide,  $\varnothing$  3,5 mm / R: 25  $\mu$ m / A: 2 x 12°  
for topdown measurements



**Double-Stylus tip 28 mm** **Order no.: 101-230-280**  
made of carbide,  $\varnothing$  3,5 mm / R:25  $\mu$ m / A: 2 x 15,5°  
for topdown measurements



**Double-Stylus tip 22 mm** **Order no.: 101-230-220**  
made of carbide,  $\varnothing$  3,5 mm / R: 25  $\mu$ m / A: 2 x 19°  
for topdown measurements



**Double-Stylus tip 25 mm** **Order no.: 101-230-250**  
made of carbide,  $\varnothing$  1 mm / R:25  $\mu$ m / A: 2 x 19°  
for topdown measurements.

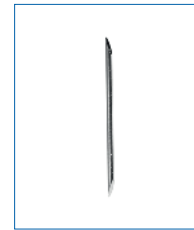

**Double-Stylus tip 9 mm** **Order no.: 101-230-090**  
made of carbide,  $\varnothing$  1 mm / R: 25  $\mu$ m / A: 2 x 19°  
for topdown measurements

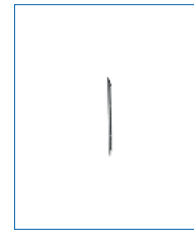

**Double-Stylus tip 6 mm** **Order no.: 101-230-060**  
made of carbide,  $\varnothing$  1 mm / R: 25  $\mu$ m / A: 2 x 24°  
for topdown measurements



**Disc stylus system 10 mm**      **Order no.: 101-530-10K**  
 Disc stylus (see below) and arm extension, including quick-release fastener (QRF), length 51 mm from front edge of QRF

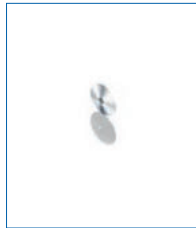

**Disc stylus 10 mm**      **Order no.: 101-530-100**  
 single item, made of carbide,  
 $\varnothing$  10 mm / R: 25  $\mu$ m / A: 2 x 12°

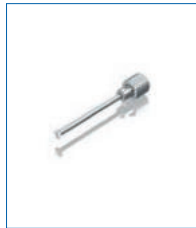

**Disc stylus system 6 mm**      **Order no.: 101-530-06K**  
 Disc stylus (see below) and arm extension, including quick-release fastener (QRF), length 51 mm from front edge of QRF

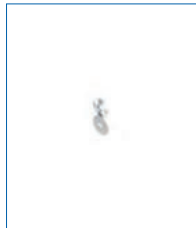

**Disc stylus 6 mm**      **Order no.: 101-530-060**  
 single item, made of carbide,  
 $\varnothing$  6 mm / R: 25  $\mu$ m / A: 2 x 12°



**Disc stylus system 4 mm**      **Order no.: 101-530-04K**  
 Disc stylus (see below) and arm extension, including quick-release fastener (QRF), length 100 mm from front edge of QRF

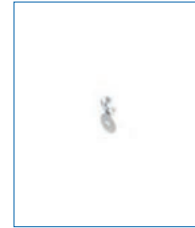

**Disc stylus 4 mm**      **Order no.: 101-530-040**  
 single item, made of carbide,  
 $\varnothing$  4 mm / R: 25  $\mu$ m / A: 2 x 12°

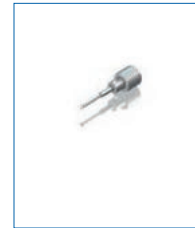

**Disc stylus system 3 mm**      **Order no.: 101-530-03K**  
 Disc stylus (see below) and arm extension, including quick-release fastener (QRF), length 25 mm from front edge of QRF



**Disc stylus 3 mm**      **Order no.: 101-530-030**  
 single item, made of carbide,  
 $\varnothing$  3 mm / R: 25  $\mu$ m / A: 2 x 12°

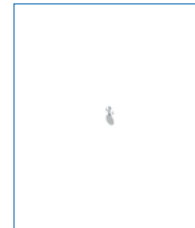

**Measuring plate 3 mm**      **Order no.: 101-530-03T**  
 Measuring plate made of VHM,  $\varnothing$  3 x 0.36 x  $\varnothing$  0.5 mm  
 single-sided slope 24° / R: 25  $\mu$ m / rounded and polished





**Disc stylus system 1 mm**      **Order no.: 101-530-01K**

Disc stylus (see below) incl. quick-release fastener (QRF)



**Disc stylus 1 mm**      **Order no.: 101-530-010**

single item,  $\varnothing$  1 mm / R: 25  $\mu$ m / A: 2 x 12°, including extension  
(made of one piece - carbide), length 25 mm from front edge  
of quick-release fastener

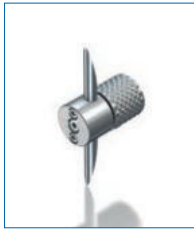

**topdown-Quick-release fastener** **Order no.: 101-630-0TD**  
for stylus tips with diameters 3.5 mm for topdown measurements; delivery without stylus tips!



**Quick-release fastener** **Order no.: 101-630-035**  
for stylus tips with diameters of 3.5 mm



**Quick-release fastener** **Order no.: 101-630-040**  
for stylus tips and absorption for dial test indicator with  $\varnothing$  4 mm



**Horizontal-Quick-release fastener** **Order no.: 101-630-030**  
for horizontal extension for stylus tips with  $\varnothing$  3 mm



**Quick-release fastener M2** **Order no.: 101-630-M20**  
for ball probe M2 thread



**Quick-release fastener M3** **Order no.: 101-630-M30**  
for ball probe M3 thread

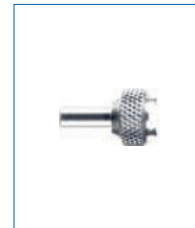

**Clamping shaft for dial test indicator  $\varnothing$  4 mm H7** **Order no.: 101-631-065**  
needs Quick-release fastener Order no.: 101-630-040



**Miniature stylus arm for removable stylus tip  $\varnothing$  3,5 mm incl. allen key** **Order no.: 101-631-250**  
including QRF, standard length 250 mm (other lengths upon request); delivery without stylus tips!



**Miniature stylus arm for removable stylus tip  $\varnothing$  2 mm incl. allen key** **Order no.: 101-631-062**  
including QRF, standard length 150 mm (other lengths upon request); delivery without stylus tips!



**Miniature stylus arm for removable stylus tip  $\varnothing$  2 mm incl. allen key** **Order no.: 101-631-100**  
including QRF, standard length 100 mm (other lengths upon request); delivery without stylus tips!



**Miniature stylus arm for removable stylus tip ø 1 mm  
incl. allen key** **Order no.: 101-631-150**

including QRF, standard length 150 mm  
(other lengths upon request);  
delivery without stylus tips!

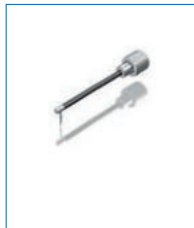

**Miniature stylus arm for removable stylus tip ø 1 mm  
incl. allen key** **Order no.: 101-631-060**

including QRF, standard length 50 mm  
(other lengths upon request);  
delivery without stylus tips!



**Miniature stylus arm with glued ø 0.5 mm  
stylus tip / length 3.5 mm** **Order no.: 101-631-035**

including QRF, standard length 35 mm  
(other lengths upon request)

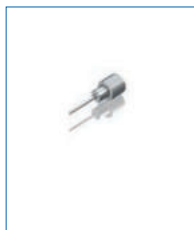

**Miniature stylus arm with glued ø 0.5 mm  
stylus tip / length 2.5 mm** **Order no.: 101-631-025**

including QRF, standard length 35 mm  
(other lengths upon request)



**Miniature stylus arm for flush-bonded  
stylus tip ø 1 mm** **Order no.: 101-631-010**

including QRF, standard length 50 mm;  
delivery without stylus tips!



**Miniature stylus arm for flush-bonded  
stylus tip ø 1 mm** **Order no.: 101-631-011**

including QRF, standard length 100 mm;  
delivery without stylus tips!



**Miniature stylus arm with stylus tip ø 1 mm  
incl. allen key** **Order no.: 101-631-QA1**

including QRF, standard length 25 mm, length of cross arm 25  
mm; delivery without stylus tips!



**Miniature stylus arm with stylus tip ø 3.5 mm  
incl. allen key** **Order no.: 101-631-QA3,5**

including QRF, standard length 50 mm, length of cross arm 25  
mm; delivery without stylus tips!



**Small diamond stylus arm** **Order no.: 101-633-OKL**

Clamping ø 3 mm, measurement length 5 mm, shaft ø 1 mm;  
for topdown roughness measurements in slots and cut-ins  
min. width of 2 mm.  
Stylus tip L: 1,2 mm / R: 5 µm / A: 90°



**Small diamond stylus arm** **Order no.: 101-633-00D**

Clamping ø 3 mm, measurement length 5 mm, shaft ø 0,8  
mm; for roughness measurements in slots and cut-ins min.  
width of 2 mm.  
Stylus tip ø: 0,5 mm / R: 5 µm / A: 90°

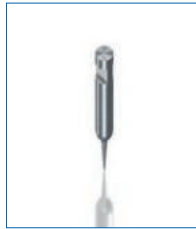

**Special-Stylus tip  
20.5 mm conical** Order no.: 101-130-120  
made of carbide,  $\varnothing$  3.5 mm / R: 100  $\mu$ m / L: 5 mm /  
A: 10°

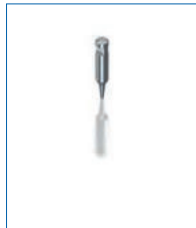

**Special-Stylus tip  
20.5 mm conical** Order no.: 101-130-420  
made of carbide,  $\varnothing$  3.5 mm / R: 450  $\mu$ m / L: 5 mm /  
A: 10°



**Special-Stylus tip  
16.35 mm conical** Order no.: 101-030-16,35  
made of carbide,  $\varnothing$  3.5 mm / R: 25  $\mu$ m / A: 16°



**Special-Stylus tip 20.5 mm** Order no.: 101-030-820  
made of carbide,  $\varnothing$  3.5 mm / R: 25  $\mu$ m / A: 8° / L: 10 mm



**Special-Stylus tip 20.5 mm** Order no.: 101-030-628  
made of carbide,  $\varnothing$  3.5 mm / R: 25  $\mu$ m



**Special-Stylus tip 20.5 mm** Order no.: 101-030-620  
made of carbide,  $\varnothing$  3.5 mm / R: 25  $\mu$ m / A: 6° / L: 3 mm



**Special-Stylus tip 13 mm** Order no.: 101-830-130  
made of carbide,  $\varnothing$  2 x  $\varnothing$  1\* mm / R: 25  $\mu$ m / A: 12°  
\* suitable for mounting 1 mm (Order no.: 101-631-060)



**Special-Stylus tip  
9 mm conical** Order no.: 101-130-090  
made of carbide,  $\varnothing$  1 mm / R: 5  $\mu$ m / L: 9 mm / A: 37,5°



**Special-Double-Stylus tip  
9 mm conical** Order no.: 101-330-091  
made of carbide,  $\varnothing$  1 mm / R: 5  $\mu$ m / L: 9 mm / A: 2x37,5°





**Ceramic Stylus tip 33 mm** Order no.: 101-640-330  
made of ceramics,  $\varnothing$  3.5 mm / R: 25  $\mu$ m / A: 12°



**Ceramic Stylus tip 33 mm conical** Order no.: 101-641-330  
made of ceramics,  $\varnothing$  3.5 mm / R: 0,5 mm / A: 24°



**Ceramic Stylus tip 20.5 mm conical** Order no.: 101-641-205  
made of ceramics,  $\varnothing$  3.5 mm / R: 0,5 mm / A: 24°



**Ceramic Stylus tip 20.5 mm conical** Order no.: 101-642-205  
made of ceramics,  $\varnothing$  3.5 mm / R: 25  $\mu$ m / A: 24°



**Ceramic Stylus tip 14 mm conical** Order no.: 101-641-140  
made of ceramics,  $\varnothing$  3.5 mm / R: 500  $\mu$ m / A: 24°

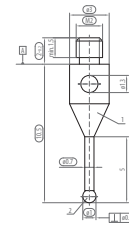

①

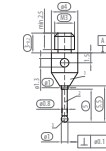

②

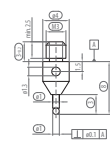

③

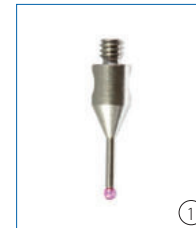

**Straight ruby stylus with M2 thread** Order no.: 101-178-000  
with ruby ball  $\varnothing$  1 mm / L: 10.5 mm / shaft -  $\varnothing$  0.8 mm / M2 = 6.5 mm / DG = 3 mm

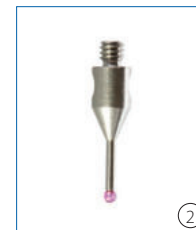

**Straight ruby stylus with M3 thread** Order no.: 101-178-001  
with ruby ball  $\varnothing$  1 mm / L: 10.5 mm / shaft -  $\varnothing$  0.8 mm / 1 mm / ML + ML 1 = 5.0/5.5 mm / DG = 4 mm

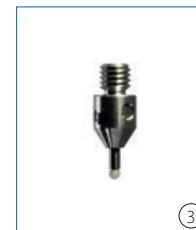

**Straight ruby stylus with M3 thread** Order no.: 101-178-002  
with ruby ball  $\varnothing$  1 mm / L = 8 mm / shaft -  $\varnothing$  1 mm / ML = 3 mm / DG = 4 mm

**Stylus tip for trapezoidal threads****8x1.5 - 14x3****Order no.: 101-731-T08**made of carbide,  $\varnothing$  0.6 / R: 50  $\mu$ m / A: 2 x 22.5° /  
length 6 mm, for topdown measurements**Stylus tip for trapezoidal threads****16x2 - 20x4****Order no.: 101-731-T16**made of carbide,  $\varnothing$  1.1 / R: 50  $\mu$ m / A: 2 x 22.5° /  
length 11 mm, for topdown measurements**Stylus tip for trapezoidal threads****22x3 - 60x9****Order no.: 101-731-T22/D1,1**made of carbide,  $\varnothing$  1.1 / R: 50  $\mu$ m / A: 2 x 22.5° /  
length 17 mm, for topdown measurements**Stylus tip for trapezoidal threads****22x3 - 60x9****Order no.: 101-731-T22/D2**made of carbide,  $\varnothing$  2 / R: 50  $\mu$ m / A: 2 x 22.5° /  
length 17 mm, for topdown measurements



**Stylus tip for M2.5 threads** Order no.: 101-730-M2,5

made of carbide,  $\varnothing$  0.5 h6 / R: 50  $\mu$ m / A: 2 x 50° /  
length 2 mm, for topdown measurements



**Stylus tip for M3 threads** Order no.: 101-730-M03

made of carbide,  $\varnothing$  0.6 h6 / R: 50  $\mu$ m / A: 2 x 45° /  
length 2.2 mm, for topdown measurements



**Stylus tip for M4 threads** Order no.: 101-730-M04

made of carbide,  $\varnothing$  0.6 h6 / R: 50  $\mu$ m / A: 2 x 37.5° /  
length 3 mm, for topdown measurements



**Stylus tip for M5-M8 threads** Order no.: 101-730-M5-8

made of carbide,  $\varnothing$  0.6 h6 / R: 50  $\mu$ m / A: 2 x 37.5° /  
length 3.5 mm, for topdown measurements



**Stylus tip for M8-M10 threads** Order no.: 101-730-M8-10

made of carbide,  $\varnothing$  0.8 h6 / R: 50  $\mu$ m / A: 2 x 37.5° /  
length 5 mm, for topdown measurements



**Stylus tip for M10-M30 threads** Order no.: 101-730-M10-30/L8

made of carbide,  $\varnothing$  1.1 h6 / R: 50  $\mu$ m / A: 2 x 37.5° /  
length 8 mm, for topdown measurements



**Stylus tip for M14-M30 threads** Order no.: 101-730-M14-30/L10

made of carbide,  $\varnothing$  1.1 h6 / R: 50  $\mu$ m / A: 2 x 37.5° /  
length 10 mm, for topdown measurements



**Stylus tip for > M30 threads** Order no.: 101-730-M30

made of carbide,  $\varnothing$  3.5 h6 / R: 50  $\mu$ m / A: 2 x 37.5° /  
length 22 mm, for topdown measurements



**Stylus tip for > M40 threads** Order no.: 101-730-M40

made of carbide,  $\varnothing$  3.5 h6 / R: 50  $\mu$ m / A: 2 x 37.5° /  
length 30 mm, for topdown measurements

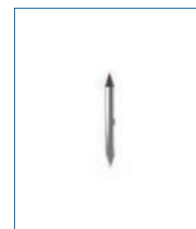

**Stylus tip for > M100 threads** Order no.: 101-730-M100

made of carbide,  $\varnothing$  5 h6 / R: 50  $\mu$ m / A: 2 x 37.5° /  
length 50 mm, for topdown measurements



**Stylus arm for thread styli for M2.5**      **Order no.: 101-632-M2,5**

Stylus tip with  $\varnothing$  0.5, includes quick-release fastener, total length 42.5 mm, delivery without stylus tips!



**Stylus arm for thread styli for M3**      **Order no.: 101-632-M03**

Stylus tip with  $\varnothing$  0.6, includes quick-release fastener, total length 42.5 mm, delivery without stylus tips! for thread styli M3

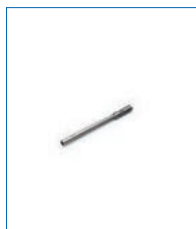

**Stylus arm for thread styli for M4**      **Order no.: 101-632-M04**

Stylus tip with  $\varnothing$  0.6, includes quick-release fastener, total length 42.5 mm, delivery without stylus tips! for thread styli M4

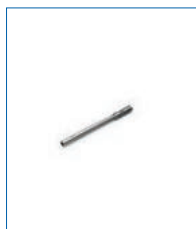

**Stylus arm for thread styli for M5-M8**      **Order no.: 101-632-5M8**

Stylus tip with  $\varnothing$  0.6, includes quick-release fastener, total length 42.5 mm, stylus tip delivery without stylus tips! for thread styli M5 - M8



**Stylus arm for thread styli for M8-M10**      **Order no.: 101-632-8M10**

Stylus tip with  $\varnothing$  0.8, includes quick-release fastener, total length 51 mm, delivery without stylus tips!



**Stylus arm for thread styli for M10-M30**      **Order no.: 101-632-10M30**

Stylus tip with  $\varnothing$  1.1, includes quick-release fastener, total length 70 mm, delivery without stylus tips!



**Stylus arm for thread styli for M14-M30**      **Order no.: 101-632-10M30**

Stylus tip with  $\varnothing$  1.1, includes quick-release fastener, total length 70 mm, delivery without stylus tips!



**Stylus arm for trapezoidal thread styli  $\varnothing$  2.0**      **Order no.: 101-632-TSD2**

incl. quick-release fastener, total length 70 mm delivery without stylus tips!



**Quick-release fastener for double stylus tips > M30**      **Order no.: 101-632-M30**

for double-stylus tips with  $\varnothing$  3.5 mm



**Quick-release fastener for double stylus tips > M30**      **Order no.: 101-632-M100**

for double-stylus tips with  $\varnothing$  5.0 mm





Miniature stylus arm, angled 90° for 6 mm stylus tip glued at a 45° angle

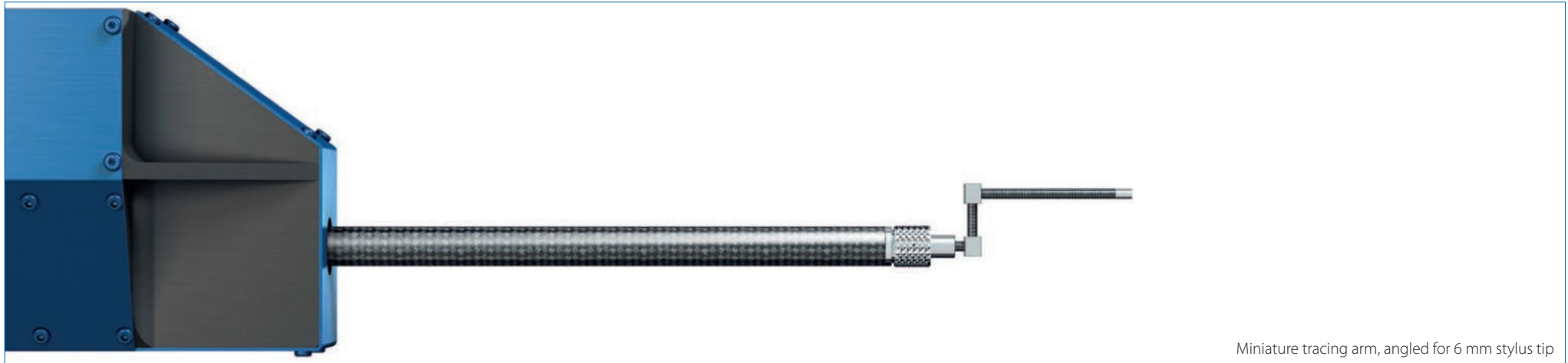

Miniature tracing arm, angled for 6 mm stylus tip

A chain is only as strong as its weakest link - a measurement system is only as good as its tracing arm and stylus tip. Thus, we pay serious attention to this detail – as we do to our machines. All stylus systems are manufactured with the same care as optacom's measurement systems.

Our practice oriented and cost reducing system of various stylus tips, disc styli, and miniature tracing arms can be replaced in seconds using the practical optacom quick-release fastener.

This is shown in the daily business of calibration and measuring labs in factories worldwide.

With your input we develop and manufacture effective solutions to meet your specific measurement requirements.

**We are looking forward to receive your inquiry.**

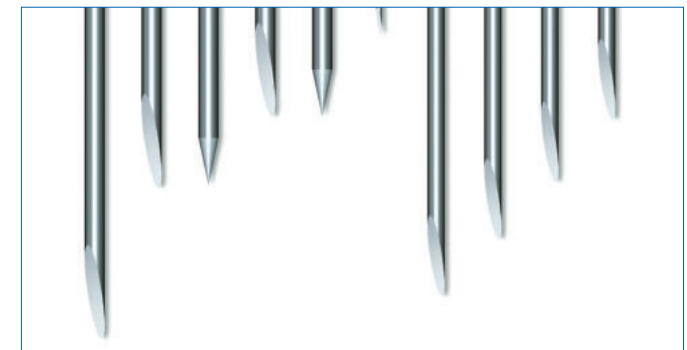



**Stylus tip 59.5 mm** **Order no.: 101-010-595**  
made of carbide,  $\varnothing$  3.5 mm / R: 25  $\mu$ m / A: 12°  
Mahr-compatible (6851517)



**Stylus tip 33 mm** **Order no.: 101-010-330**  
made of carbide,  $\varnothing$  3.5 mm / R: 25  $\mu$ m / A: 12°  
Mahr-compatible (6850286)



**Stylus tip 20.5 mm** **Order no.: 101-010-205**  
made of carbide,  $\varnothing$  3.5 mm / R: 25  $\mu$ m / A: 12°  
Mahr-compatible (6850289)



**Stylus tip 7 mm** **Order no.: 101-010-070**  
made of carbide,  $\varnothing$  1 mm / R: 25  $\mu$ m / A: 19°  
Mahr-compatible vor tracing arm LD C 7-15-25

**Stylus tip 7 mm** **Order no.: 101-010-070-E**  
Glued (the existing tracing arm is required)



**Stylus tip 6 mm** **Order no.: 101-010-060**  
made of carbide,  $\varnothing$  1 mm / R: 25  $\mu$ m / A: 19°  
Mahr-compatible (6851527)

**Stylus tip 6 mm** **Order no.: 101-010-060-E**  
Glued (the existing tracing arm is required)

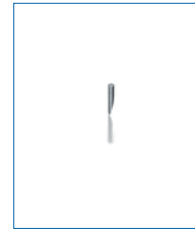

**Stylus tip 4.5 mm** **Order no.: 101-010-045**  
made of carbide,  $\varnothing$  1 mm / R: 25  $\mu$ m / A: 19°  
Mahr-compatible

**Stylus tip 4.5 mm** **Order no.: 101-010-045-E**  
Glued (the existing tracing arm is required)

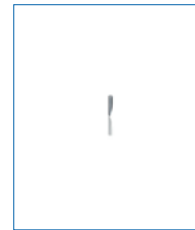

**Stylus tip 2.5 mm** **Order no.: 101-010-025**  
made of carbide,  $\varnothing$  0.5 mm / R: 25  $\mu$ m / A: 19°  
Mahr-compatible

**Stylus tip 2.5 mm** **Order no.: 101-010-025-E**  
Glued (the existing tracing arm is required)

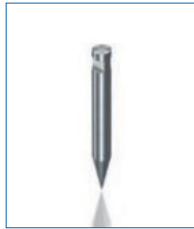

**Stylus tip 59.5 mm conical**    **Order no.: 101-110-595**

made of carbide,  $\varnothing$  3.5 mm / R: 25  $\mu$ m / A: 24°  
Mahr-compatible



**Stylus tip 33 mm conical**    **Order no.: 101-110-330**

made of carbide,  $\varnothing$  3.5 mm / R: 25  $\mu$ m / A: 24°  
Mahr-compatible (6851534)



**Stylus tip 20.5 mm conical**    **Order no.: 101-110-205**

made of carbide,  $\varnothing$  3.5 mm / R: 25  $\mu$ m / A: 24°  
Mahr-compatible

**Stylus tip 52 mm** **Order no.: 101-020-520**

made of carbide,  $\varnothing$  3 mm / R: 20  $\mu$ m / A: 11°  
Hommel-compatible (compatible to 232633)

**Stylus tip 42 mm** **Order no.: 101-020-420**

made of carbide,  $\varnothing$  3 mm / R: 20  $\mu$ m / A: 11°  
Hommel-compatible (compatible to 232586)

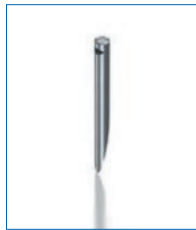
**Stylus tip 32 mm** **Order no.: 101-020-320**

made of carbide,  $\varnothing$  3 mm / R: 20  $\mu$ m / A: 11°  
Hommel-compatible (compatible to 284039)

**Stylus tip 21 mm** **Order no.: 101-020-210**

made of carbide,  $\varnothing$  3 mm / R: 20  $\mu$ m / A: 11°  
Hommel-compatible

**Stylus tip 6 mm** **Order no.: 101-020-060**

made of carbide,  $\varnothing$  1 mm / R: 20  $\mu$ m / A: 22°  
Hommel-compatible

**Stylus tip 6 mm** **Order no.: 101-020-060-E**

Glued (the existing tracing arm is required)

**Stylus tip 52 mm conical** **Order no.: 101-120-520**

made of carbide,  $\varnothing$  3 mm / R: 20  $\mu$ m / A: 30°  
Hommel-compatible

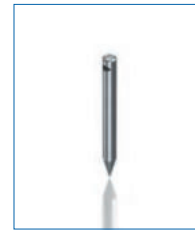
**Stylus tip 32 mm conical** **Order no.: 101-120-320**

made of carbide,  $\varnothing$  3 mm / R: 20  $\mu$ m / A: 30°  
Hommel-compatible

**Stylus tip 20 mm conical** **Order no.: 101-120-200**

made of carbide,  $\varnothing$  1 mm / R: 20  $\mu$ m / A: 30°  
Hommel-compatible

**Stylus tip 20 mm conical** **Order no.: 101-120-200-E**

Glued (the existing tracing arm is required)





**Stylus tip 26.7 mm**      **Order no.: 101-060-267**  
made of carbide,  $\varnothing$  1.6 mm / R: 20  $\mu$ m / A: 15°  
Taylor Hobson-compatible (232633)



**Stylus tip 26.7 mm conical**      **Order no.: 101-160-267**  
made of carbide,  $\varnothing$  1.6 mm / R: 10  $\mu$ m / A: 30°  
Taylor Hobson-compatible

**Stylus tip 50 mm** Order no.: 101-050-500

made of carbide,  $\varnothing$  3 mm / R: 25  $\mu$ m / A: 11°  
Mitutoyo-compatible (354886)

**Stylus tip 38 mm** Order no.: 101-050-380

made of carbide,  $\varnothing$  3 mm / R: 25  $\mu$ m / A: 11°  
Mitutoyo-compatible (354885)

**Stylus tip 28 mm** Order no.: 101-050-280

made of carbide,  $\varnothing$  3 mm / R: 25  $\mu$ m / A: 11°  
Mitutoyo-compatible (354884)

**Stylus tip 28 mm** Order no.: 101-050-280-0,035

made of carbide,  $\varnothing$  3 mm / R: 35  $\mu$ m / A: 11°  
Mitutoyo-compatible

**Stylus tip 28 mm** Order no.: 101-050-280-0,045

made of carbide,  $\varnothing$  3 mm / R: 45  $\mu$ m / A: 11°  
Mitutoyo-compatible

**Stylus tip 28 mm** Order no.: 101-050-280-0,075

made of carbide,  $\varnothing$  3 mm / R: 75  $\mu$ m / A: 11°  
Mitutoyo-compatible

**Stylus tip 28 mm** Order no.: 101-050-280-0,100

made of carbide,  $\varnothing$  3 mm / R: 100  $\mu$ m / A: 11°  
Mitutoyo-compatible

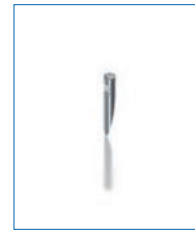
**Stylus tip 20 mm** Order no.: 101-050-200

made of carbide,  $\varnothing$  3 mm / R: 25  $\mu$ m / A: 11°  
Mitutoyo-compatible (354883)

**Stylus tip 14 mm** Order no.: 101-050-140

made of carbide,  $\varnothing$  3 mm / R: 25  $\mu$ m / A: 11°  
Mitutoyo-compatible (354882)



**Stylus tip 50 mm conical**      **Order no.: 101-150-500**  
made of carbide,  $\varnothing$  3 mm / R: 25  $\mu$ m / A: 24°  
Mitutoyo-compatible



**Stylus tip 38 mm conical**      **Order no.: 101-150-380**  
made of carbide,  $\varnothing$  3 mm / R: 25  $\mu$ m / A: 24°  
Mitutoyo-compatible



**Stylus tip 28 mm conical**      **Order no.: 101-150-280**  
made of carbide,  $\varnothing$  3 mm / R: 25  $\mu$ m / A: 24°  
Mitutoyo-compatible



**Stylus tip 20 mm conical**      **Order no.: 101-150-200**  
made of carbide,  $\varnothing$  3 mm / R: 25  $\mu$ m / A: 24°  
Mitutoyo-compatible

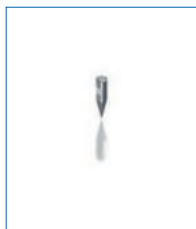

**Stylus tip 14 mm conical**      **Order no.: 101-150-140**  
made of carbide,  $\varnothing$  3 mm / R: 25  $\mu$ m / A: 24°  
Mitutoyo-compatible



**Stylus tip 60 mm** **Order no.: 101-040-600**  
made of carbide,  $\varnothing$  3 mm / R: 25  $\mu$ m / A: 11°  
Zeiss-compatible (DT 45501)



**Stylus tip 34 mm** **Order no.: 101-040-340**  
made of carbide,  $\varnothing$  3 mm / R: 25  $\mu$ m / A: 11°  
Zeiss-compatible (DT 45502)



**Stylus tip 21 mm** **Order no.: 101-040-210**  
made of carbide,  $\varnothing$  2 mm / R: 25  $\mu$ m / A: 11°  
Zeiss-compatible (DT 45503)



**Stylus tip 12 mm** **Order no.: 101-040-120**  
made of carbide,  $\varnothing$  2 mm / R: 25  $\mu$ m / A: 12°  
Zeiss-compatible (DT 45510 / DT 45081)

**Stylus tip 12 mm** **Order no.: 101-040-120-E**  
Glued (the existing tracing arm is required)



**Stylus tip 12 mm** **Order no.: 101-040-121**  
made of carbide,  $\varnothing$  1 h6 / R: 25  $\mu$ m / A: 10°  
Zeiss-compatible-/Stk.



**Stylus tip 8 mm** **Order no.: 101-040-080**  
made of carbide,  $\varnothing$  1.2 mm / R: 25  $\mu$ m / A: 12°  
Zeiss-compatible (DT 45510 / DT 45081)

**Stylus tip 8 mm** **Order no.: 101-040-080-E**  
Glued (the existing tracing arm is required)

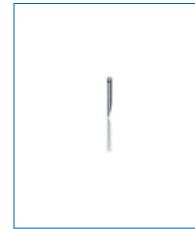

**Stylus tip 4.5 mm** **Order no.: 101-040-045**  
made of carbide,  $\varnothing$  0.8 mm / R: 25  $\mu$ m / A: 12°  
Zeiss-compatible (DT 45512 / DT 45083)

**Stylus tip 4.5 mm** **Order no.: 101-040-045-E**  
Glued (the existing tracing arm is required)



**Stylus tip 60 mm conical**      **Order no.: 101-140-600**  
 made of carbide,  $\varnothing$  3 mm / R: 25  $\mu$ m / A: 24°  
 Zeiss-compatible (DT 45504)



**Stylus tip 34 mm conical**      **Order no.: 101-140-340**  
 made of carbide,  $\varnothing$  3 mm / R: 25  $\mu$ m / A: 24°  
 Zeiss-compatible (DT 45505)



**Stylus tip 21 mm conical**      **Order no.: 101-140-210**  
 made of carbide,  $\varnothing$  2 mm / R: 25  $\mu$ m / A: 24°  
 Zeiss-compatible (DT 45506)



**Stylus tip 12 mm conical**      **Order no.: 101-140-120**  
 made of carbide,  $\varnothing$  2 mm / R: 25  $\mu$ m / A: 24°  
 Zeiss-compatible (DT 45513 / DT 45084)

**Stylus tip 12 mm conical**      **Order no.: 101-140-120-E**  
 Glued (the existing tracing arm is required)



**Stylus tip 12 mm conical**      **Order no.: 101-140-121**  
 made of carbide,  $\varnothing$  1 mm / R: 25  $\mu$ m / A: 20°

**Stylus tip 12 mm conical**      **Bestell-Nr.: 101-140-121-E**  
 Glued (the existing tracing arm is required)



**Stylus tip 4,5 mm conical**      **Order no.: 101-140-045**  
 made of carbide,  $\varnothing$  0.8 mm / R: 25  $\mu$ m / A: 24°  
 Zeiss-compatible (DT 45515)

**Stylus tip 4,5 mm conical**      **Order no.: 101-140-045-E**  
 Glued (the existing tracing arm is required)



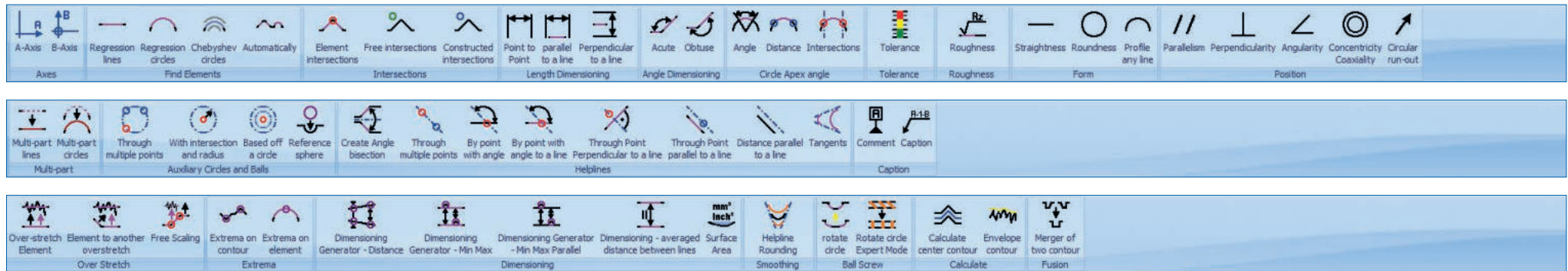

### The software for contour measurements

The operation of our machines and software was originally designed to ensure stability and ease-of-use. The functional scope is considerably bigger, compared to similar machines with reduction of training. This also applies to our various software modules.

Using the optional optacom topdown module, an unlimited number of contours can be evaluated within a single representation and without loss of reference.

Using the optional roughness module optacom rough Contour, roughness and waviness can be recorded and evaluated in one single measuring run.

Thanks to our available optional software module optacom round, you can now, for the first time, measure contour, roundness, co-axiality and roughness in one single clamping.

One of the most striking arguments for all our software is the lifetime free software update.

### optacom contour: functional overview

- ▶ Semi-automatic search of all elements with a single mouse-click
- ▶ Manual or automatic element adjustment and optimization
- ▶ Evaluation of radii, distances and angles
- ▶ Creation of intersection points between any elements
- ▶ Regression lines or regression circles
- ▶ Regression adjustment with specified Gaussian or Chebyshev circles
- ▶ Multi-part regression lines or regression circles
- ▶ Fitting of test balls with a given radius and a definable direction angle
- ▶ Auxiliary lines: Parallel, perpendicular, straight lines with definable angle and distance
- ▶ Auxiliary circles: Through several points at intersections with given diameter
- ▶ Auxiliary points: Coordinate points, contour points, contour intersections, etc.
- ▶ Finding the highest / lowest point of contours and elements with respect to a reference
- ▶ Numeric and graphical determination of form deviations on lines and circles
- ▶ Numerical and graphical straightness and profile depth of lines
- ▶ Circular opening angle for regression circles
- ▶ Ordinate guideline for regression circle and regression line
- ▶ Automatic dimensioning with tolerance assessment for repeat measurements
- ▶ Zoom from 1:1 to 5000:1 for the evaluation, independent from printing
- ▶ Comments and texts
- ▶ Export function to Q-DAS
- ▶ Export function to Excel
- ▶ Newly developed printing functions with various output options
- ▶ Multi-contour printout supports multiple contours on a sheet
- ▶ Flexible representation of your company data, company logo, part numbers, etc.
- ▶ Segmented measurements in the entire measuring range without loss of reference
- ▶ Stylus tips compensation for all stylus directions
- ▶ Fully automatic calibration of stylus tips
- ▶ Newly developed tools for evaluating ball screws
- ▶ DXF import and sheet comparison
- ▶ Reference part database Q-DAS compatible
- ▶ All reports can display the reference system
- ▶ Extensive element list displays all element details
- ▶ Part comparison can also be done with modified measurement conditions or lengths
- ▶ Simple red-green evaluation with tolerances

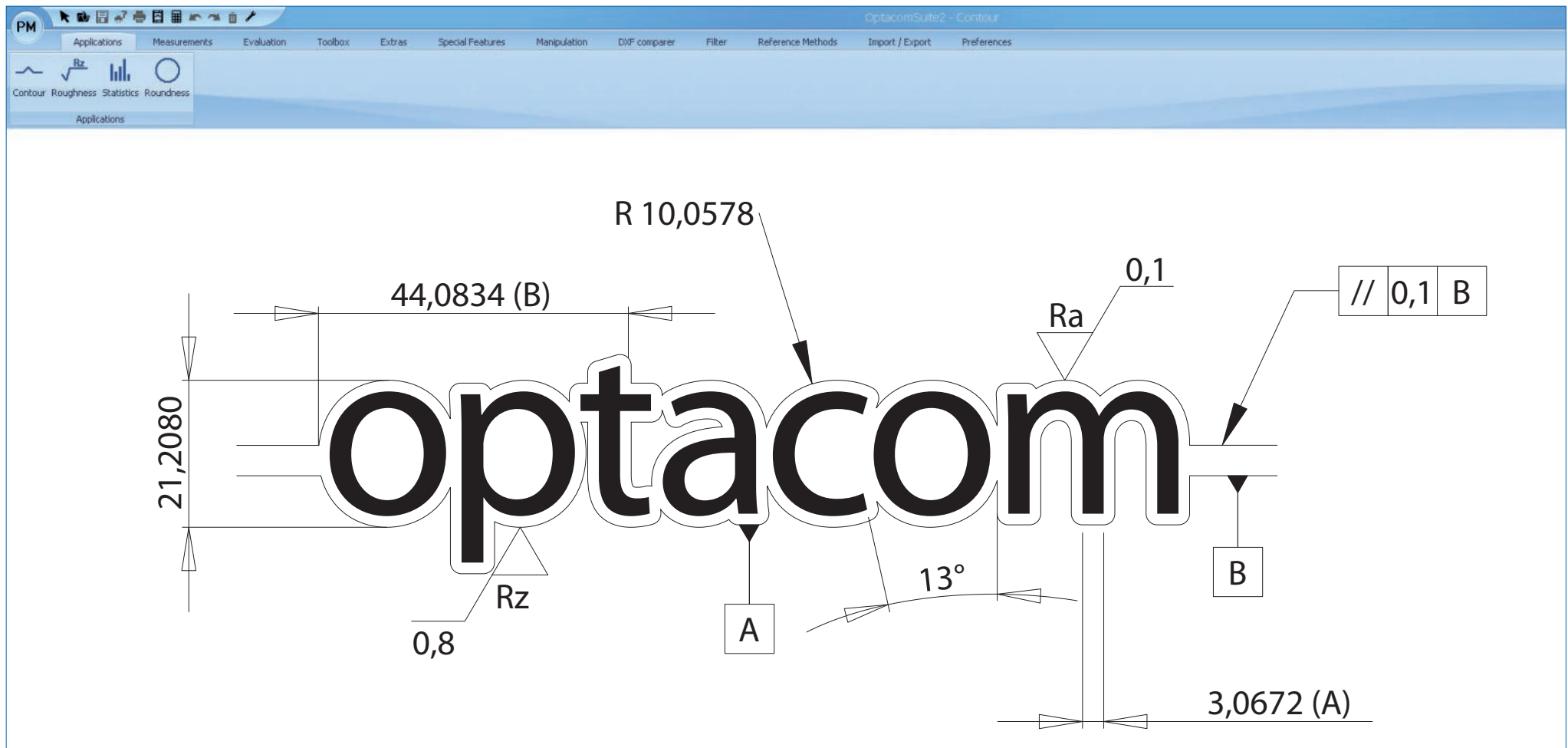

- ▶ Lifetime free software updates
- ▶ If required, software updates work fully automatic
- ▶ Single software interface for all modules
- ▶ Intuitive software solution, interface in low training requirements
- ▶ Using our roughness automation all incorrect measurements are excluded
- ▶ Q-Stat export interface also works with reference parts
- ▶ Integrated database fully compatible with Q-DAS
- ▶ New fault-tolerant reference part automation

- ▶ Fully automatic stylus tip calibration in less than 3 minutes
- ▶ Significant time savings through automatic element detection
- ▶ New algorithm for measuring ball screws and threads
- ▶ Due to our intelligent automatic functions, the evaluation time is reduced
- ▶ Integrated foil comparison with various integrations
- ▶ Well arranged list of elements
- ▶ References can be shown/hidden
- ▶ DXF import

- ▶ Very simple red-green tolerance comparison
- ▶ Contour, roughness and roundness analysis in a single evaluation
- ▶ Integrated form and position tolerances according to DIN ISO 1101
- ▶ User-customizable software interface
- ▶ Interface language can be changed during runtime
- ▶ Integrated online diagnosis tool in the event of problems
- ▶ Software includes statistical functions

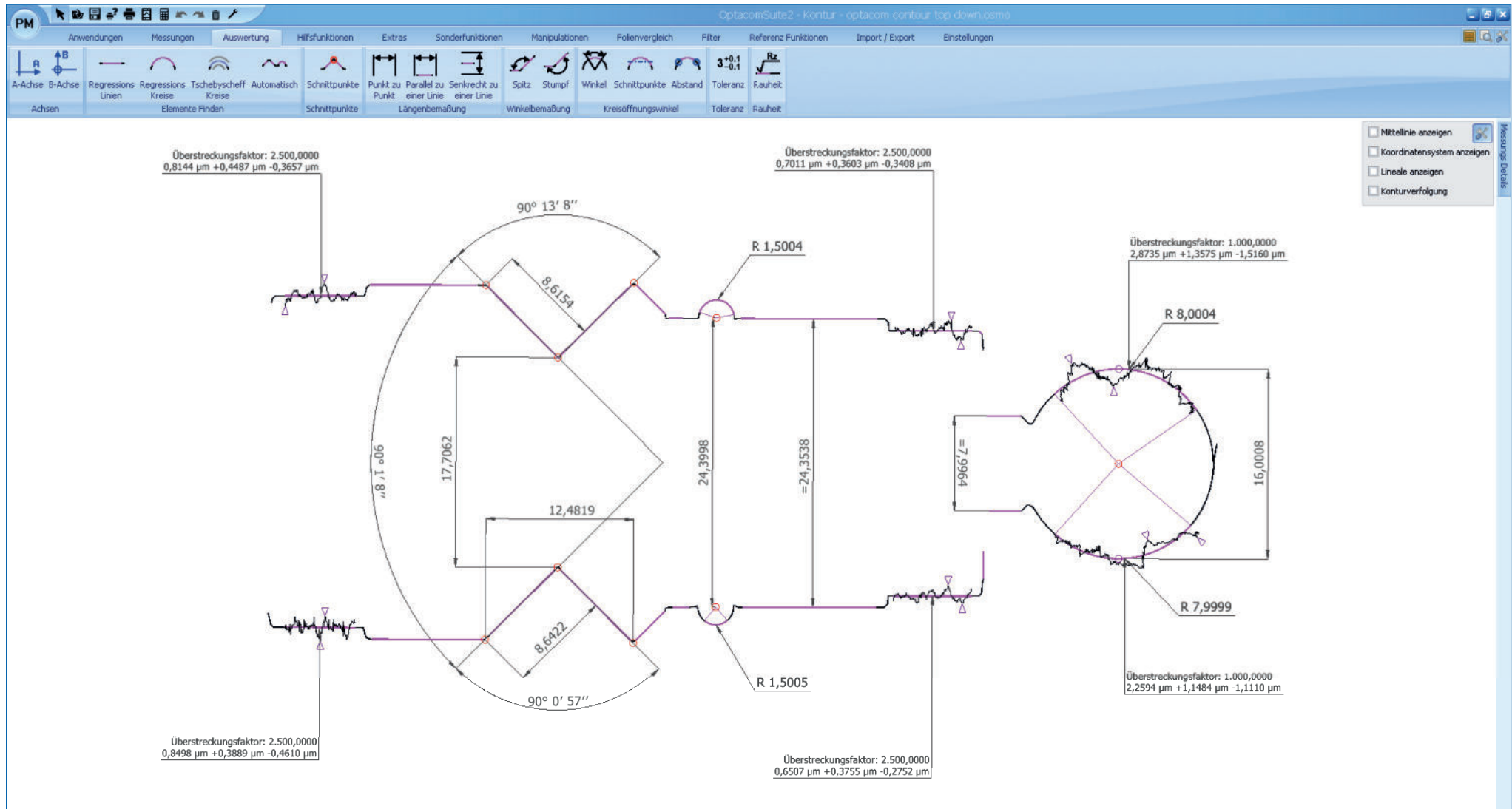

### Evaluation made easy

Any number of contours can be evaluated with absolute dimensional reference to each other. After one or more measurements, the measured contours appear on the analysis screen. At this point, there are several possibilities available to search for elements on the measurement. For example, you can search for elements in a semi-automatic fashion using your

own criteria. Moreover, you may create elements by double-clicking at any position. Should you require regression radii, you can calculate them according to the Gaussian or Chebyshev specification. As shown in the upper evaluation screen, you can graphically overextend the form deviation and display the numeric Pt value. In addition, you can create angles for any

quadrant with just two clicks. As shown by the evaluation above, you can evaluate angles as well as distances between all measured contours. Using the extrema function, it is possible to determine the greatest or smallest distances of evaluated elements or contours.

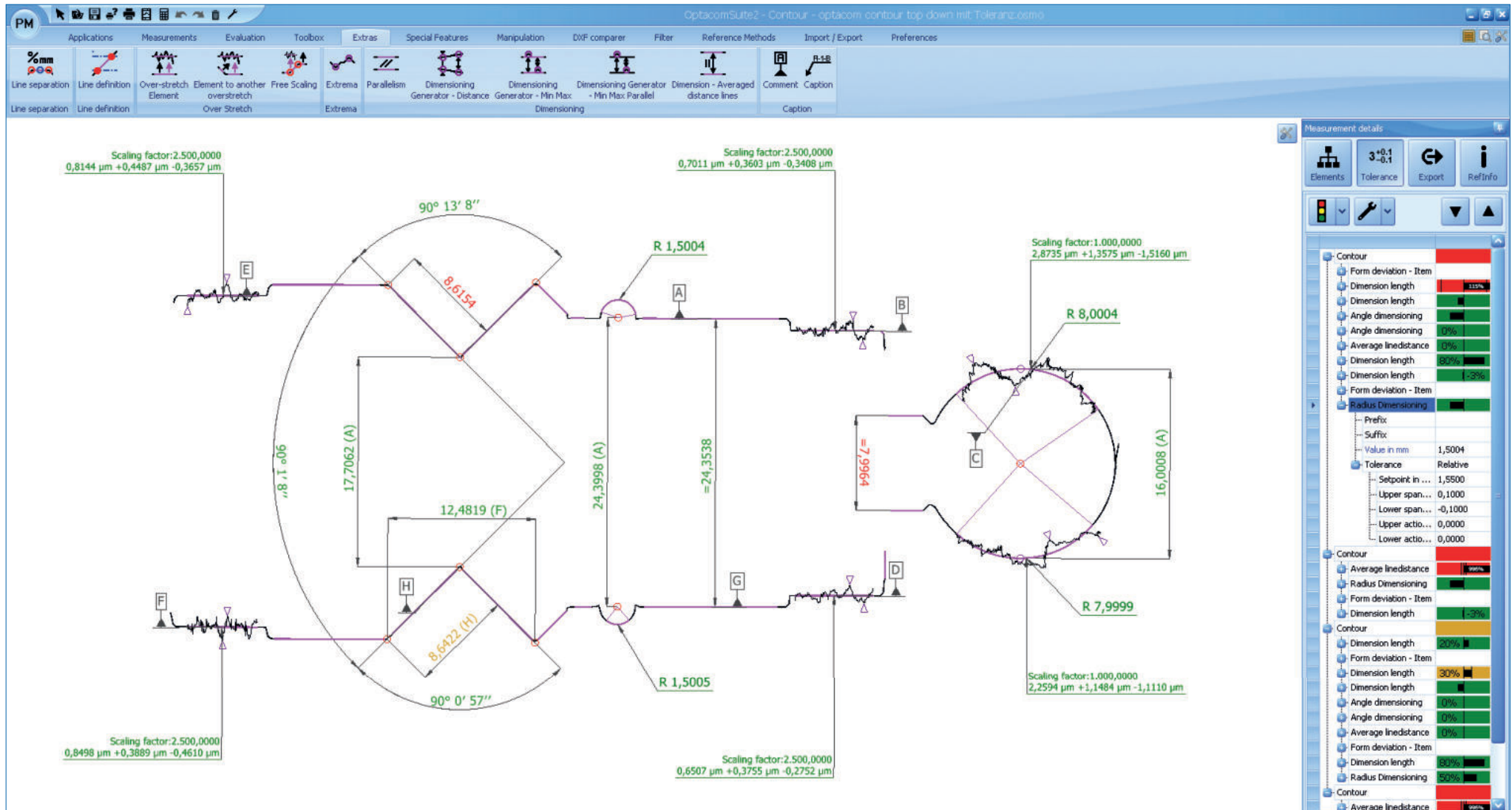

## Good to know that everything fits

When evaluating serial parts, you have the possibility of indicating tolerances. After a fully automatic evaluation through our unique reference run, you can immediately find out whether your part is OK or not. The advantage of the element list is in the display of the existing tolerance percentage, in addition to the red-green evaluation. This indicates the exhausted and re-

maining tolerance. This feature prevents unwelcome surprises, as you can immediately see whether you need to counteract the process, thereby avoiding late interventions associated with the usual red-green evaluation. Furthermore, our tolerance evaluation allows defining intervention limits. These limits are shown in yellow colour when it is time to act. It is possible

to assign a tolerance value to any elements. This works naturally across contours. Simply click on the desired value and type the reference and tolerance value.



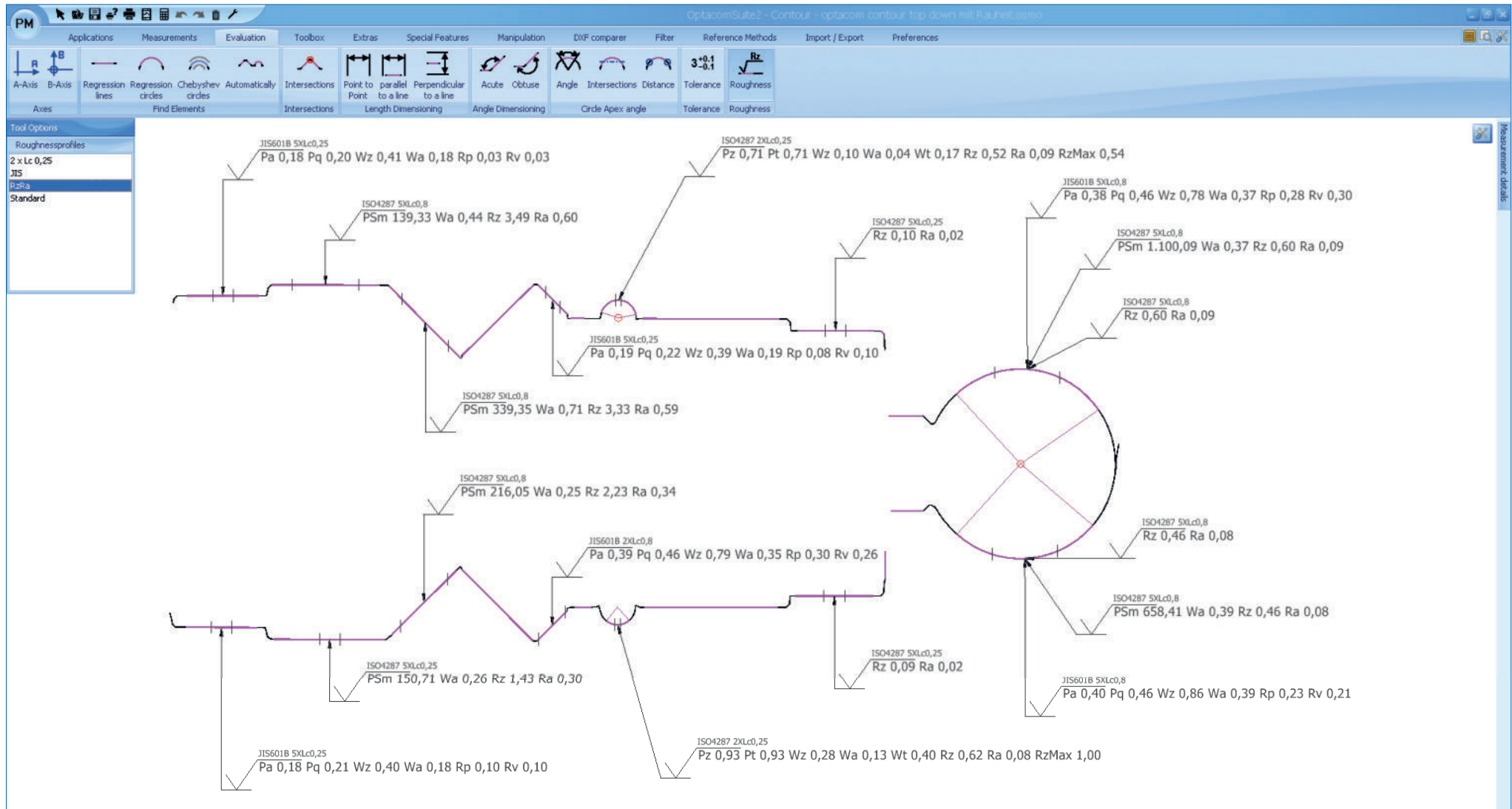

### Roughness easy as pie with optacom rough

With our newly developed software algorithms, inexperienced operators are capable to create DIN ISO-compliant measurements for the first time. Our intelligent algorithms analyse the contour underlying and automatically calculate the proper cut-off and the compliant cut-off counts. Just another priceless advantage is the permanent horizontal position of our tracing

arm, which allows roughness measurements on all elements without restrictions to the stylus movement. You may find various examples of falling and rising contours and radii in the example above. Needless to say, unrestricted overhead roughness evaluations are also supported.

Furthermore, the roughness evaluation is completely integrated in the reference run. A further advantage is the possibility of performing different evaluations on one and the same line or radius. In that respect, the ball evaluation above provides an interesting example.



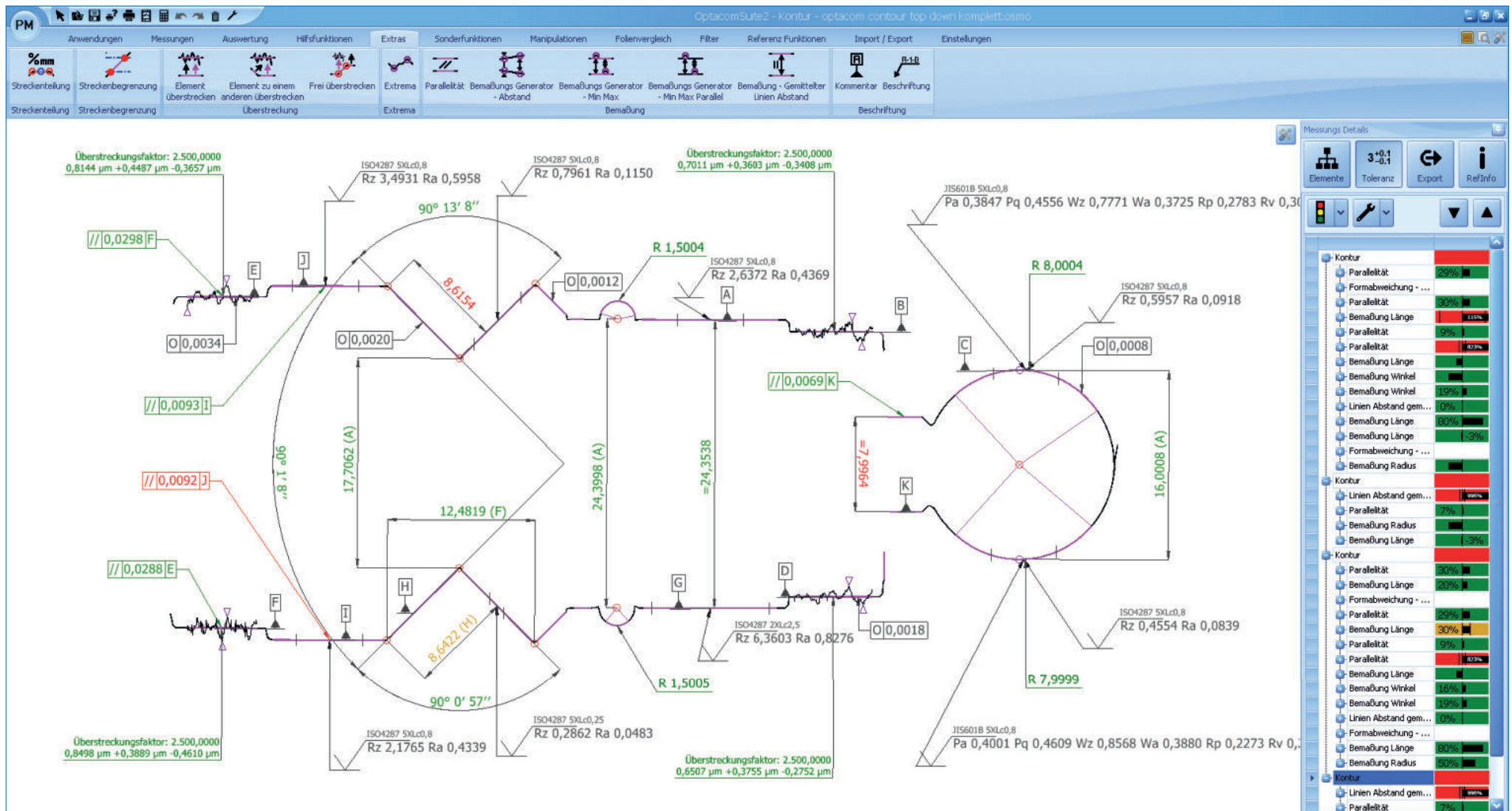

## Contour, roughness, roundness, topdown - one software fits all

Our optacom rough and optacom round software modules allow you to create multiple profiles. Upon creation, you define uniquely to which norms they should evaluate. These profiles can then easily be used in our software optacom contour – simply by mouse click. This means that you do not need to adjust any settings when evaluating roughness and roundness. Moreover,

all evaluations will be created DIN-compliant and fully automatic. To top this function off, you not only have a large time-saving, but also the reassuring feeling that possible failures cannot happen anymore. In the same easy and trouble-free way in which you create roughness and roundness evaluations, you can obtain form, orientation and position evaluations,

which are already integrated in the optacom contour software module. After having analyzed all required evaluations, you can then focus on printing. Thanks to our print processor, which has an integrated user database as well as customer profiles, you are able to save your reports as a PDF document and to send it via email – and this with just a few clicks.



- ▶ Significant time savings
- ▶ Contour and roughness evaluations in a single measurement run
- ▶ No incorrect evaluations because of cut-off and filtering automatic
- ▶ Due to profiles, technical knowledge is not needed
- ▶ Several different standards on a single evaluation profile
- ▶ Significant cost savings through the use of carbide stylus tips instead of usual diamond stylus tips
- ▶ Roughness evaluation on lines, radii and on inclined surfaces; also on topdown and roundness measurements
- ▶ Graphical and numerical representation of all reports
- ▶ Fully automatic calibration of carbide and diamond stylus tips
- ▶ Overhead evaluation of roughness
- ▶ Factory calibration of roughness makes on-site calibration unnecessary
- ▶ Roughness automatic facilitates DIN-compliant evaluations
- ▶ Roughness evaluation is automatically integrated in reference run



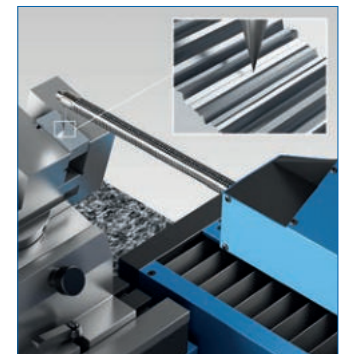
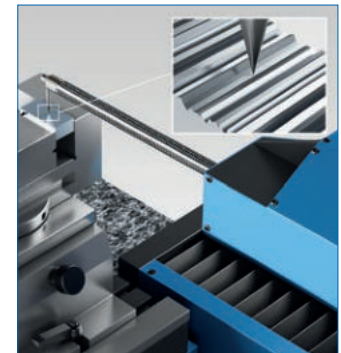
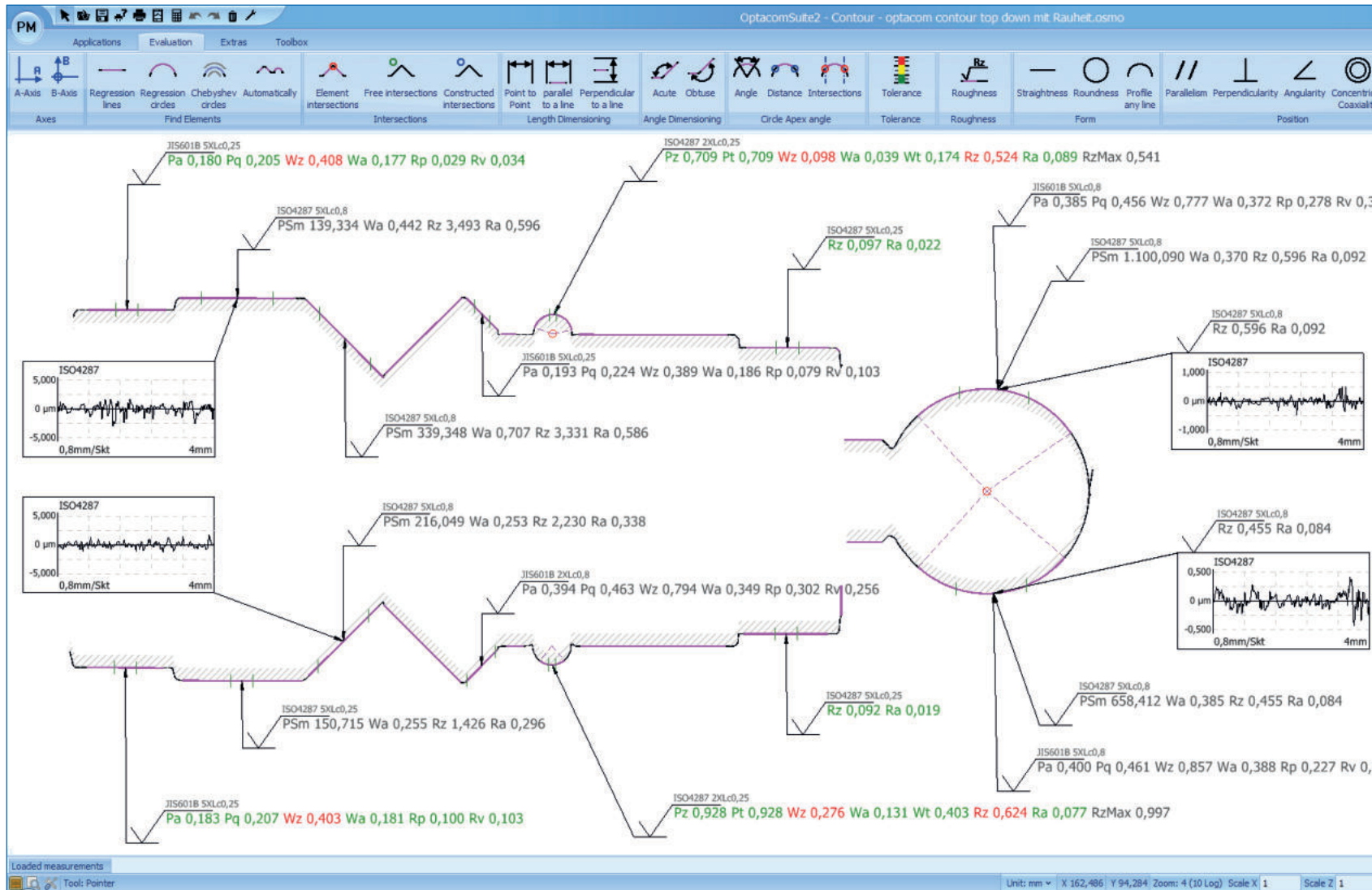

### EN ISO 4287/ JIS B 0601

Pp	Pv	Pz	Pc	Pa	Pq	Psm	Pdq	Pdc	Pt	Pku	Psk	Pmr
Wp	Wv	Wz	Wc	Wa	Wq	Wsm	Wdq	Wdc	Wt	Wku	Wsk	Wmr
Rp	Rv	Rz	Rc	Ra	Rq	Rsm	Rdq	Rdc	Rt	Rku	Rsk	Rmr

### EN ISO 12085 (Motif)

AW	W	Wx	Wt
AR	R	Rx	

### EN ISO 13565 – 2

Mr1	Mr2	A1	A2	Rpk	Rvk	Rk
-----	-----	----	----	-----	-----	----

### Scope of delivery for optacom rough software:

Software package only

### Scope of delivery for optacom rough complete:

Software package, one diamond stylus tip, roughness standard, Quick-release fastener

### optacom rough Software

Order no.: 101-203-020

### optacom rough complete

Order no.: 101-203-001

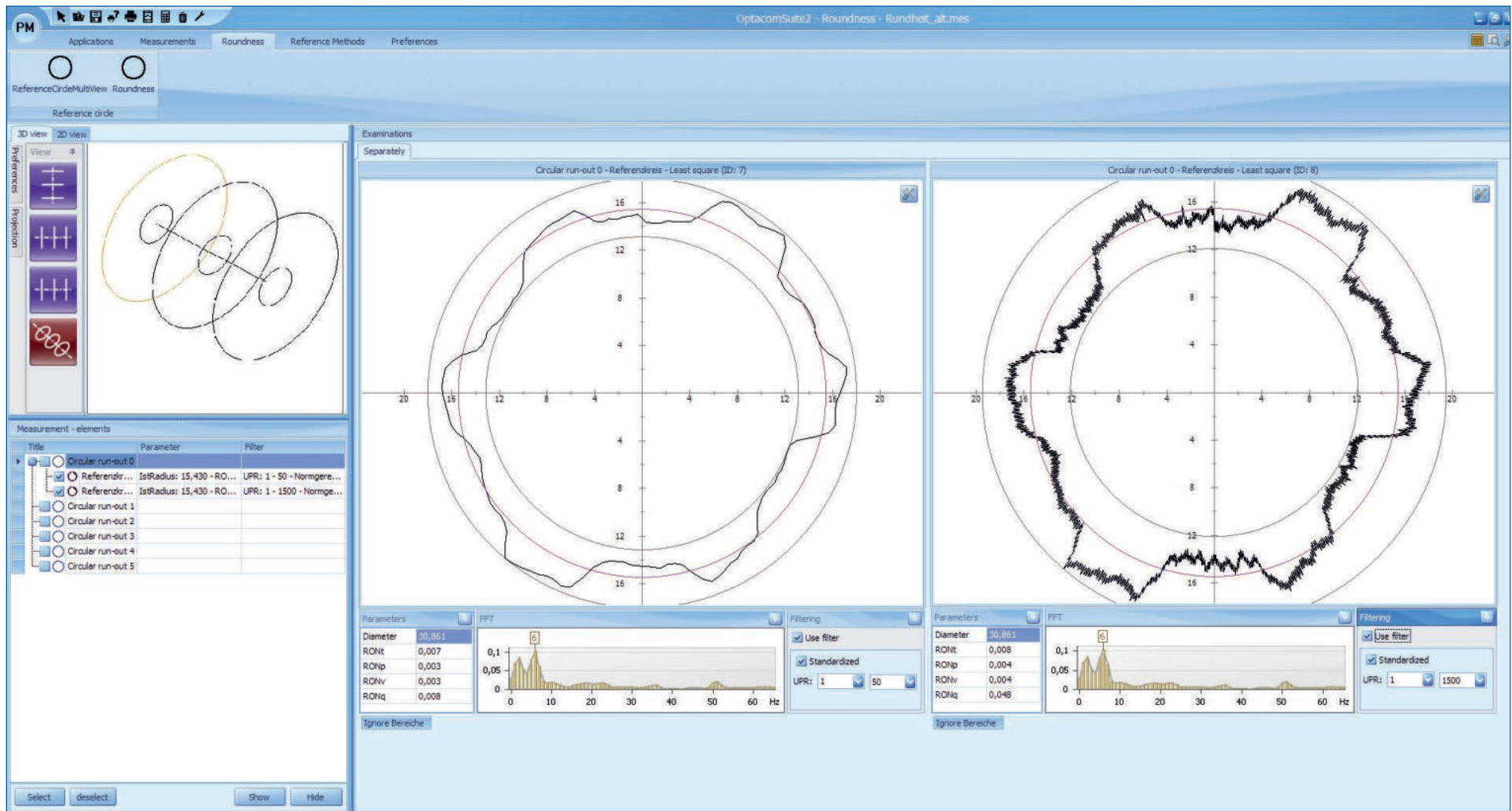

- ▶ Contour, roughness and roundness evaluation in a single measurement run
- ▶ Increased accuracy because the workpiece needs no reclamping
- ▶ Software based calibration and alignment of the workpiece holder
- ▶ Significant time savings thanks to our 4 in 1 concept
- ▶ Extremely reduced footprint
- ▶ Extremely simple operation through the joystick integrated in machine console
- ▶ Accurate, quick, and reproducible measurements possible without technical knowledge
- ▶ Customizable graphical interface to increase efficiency
- ▶ Quick and practically oriented evaluations
- ▶ Automatic filter adjustment
- ▶ Display of evaluable characteristics
- ▶ Illustration of evaluable features, according to DIN ISO 1101
- ▶ User-selectable evaluations of local form deviations

## Form tolerances:

—	Straightness
▭	Flatness
○	Roundness
∅	Cylindricity
⌒	Line form
⌒	Surface form

## without reference specification

## Position tolerances

//	Parallelism
⊥	Perpendicularity
∠	Angularity
◎	Coaxiality, Concentricity
≡	Symmetry
↑	Circular run-out
↗	Total run-out

## with reference specification

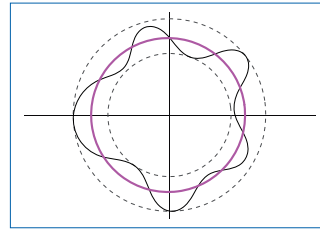

**LSCI:**  
**Least Square Circle**

Regression circle such that the sum of the squares of the local roundness deviations is a minimum

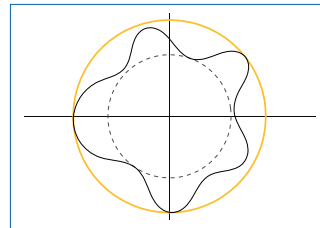

**MCCI:**  
**Minimum Circumscribed Circle**

Smallest circle circumscribing the roundness profile

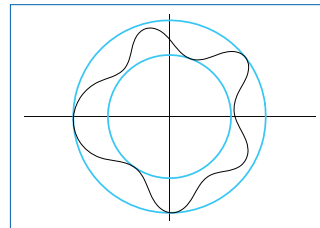

**MZCI:**  
**Minimum Zone Circle**

Two concentric circles enclosing the roundness profile and having the least radial separation

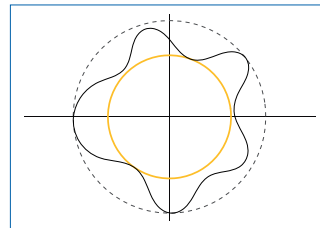

**MICI:**  
**Maximum Inscribed Circle**

Largest inscribed circle in the roundness profile

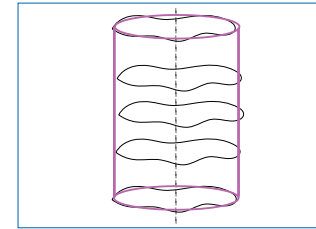

**LSCY:**  
**Least Square Cylinder**

Regression cylinder such that the sum of the squares of the local roundness deviations is a minimum

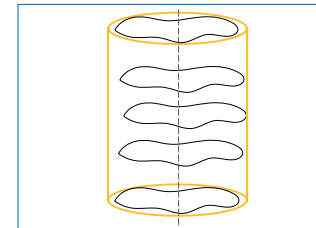

**MCCY:**  
**Minimum Circumscribed Cylinder**

Cylinder with the smallest possible diameter encompassing the measured cylinder surface

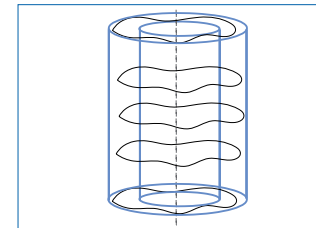

**MZCY:**  
**Minimum Zone Cylinder**

Two concentric cylinder enclosing the roundness profile and having the least radial separation

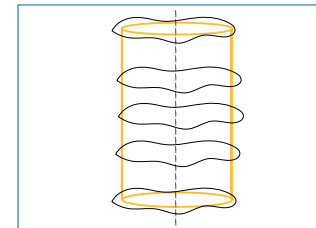

**MICY:**  
**Maximum Inscribed Cylinder**

Cylinder with the largest possible diameter inscribed in the measured cylinder surface

## Complete the product range with precision

The extension module for roundness measurements.

Your measuring programme can be perfectly rounded up with our software optacom round and our rotary-swivel table. In this combination it is possible to evaluate and measure contour, roughness and roundness simultaneously (if roughness module optacom rough is installed).

**Easy, fast, and comfortable measurements based on a high-precision, program-based operation.**

## Filtering method for roundness evaluation

Filter definition according to DIN EN ISO 11562: Cut-off numbers: 15, 50, 150, 500, 1500 W/U, arbitrary

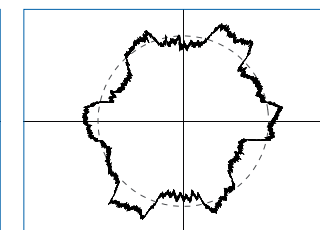
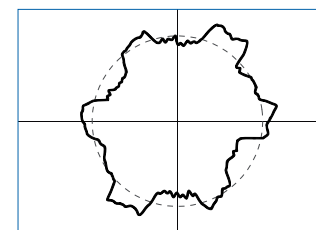
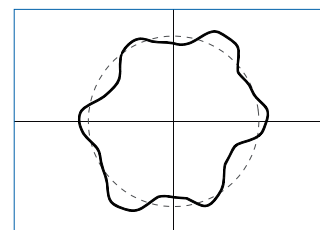



## Thread Evaluation by optacom

A further analysis option has been added to our well known optacom suite 2, so that additional tasks in production and test laboratories can be performed.

Even complex geometries on workpieces and thread gauges can quickly be assessed at maximum precision, and features for data logging and export are provided.

The user may select between three software configurations, according to their particular needs with respect to measurements: Light, Standard and Professional.

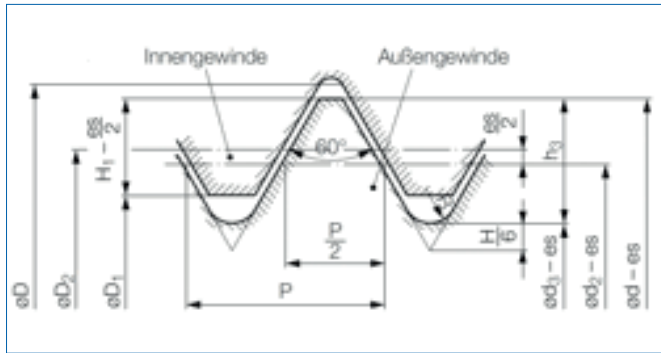

### optacom Thread Software Light

All basic tasks in thread measurement are already offered by the Light Version. Even users without particular knowledge may execute thread measurements on workpieces with respect to flank, outer and core diameter, as well as of flank angle and slope.

A meaningful choice of functions is included to simplify work, like automatic range insulation, this way considerably contributing to establish fast and repeatable measuring sequences. Tolerances may be assigned to averages, minimum and maximum limits. Even the smallest edition is able to simultaneously evaluate inner and outer threads.

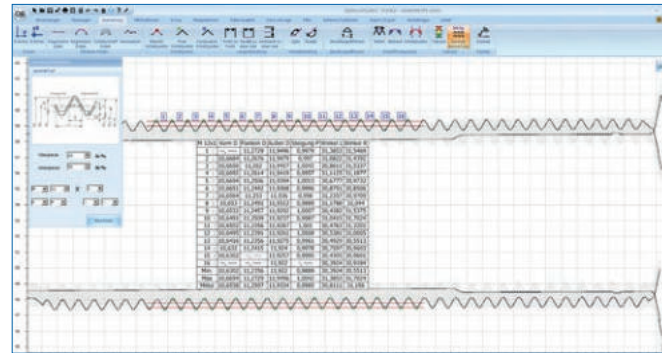

### optacom Thread Software Standard

The standard version has been developed for users examining a large variance of thread types. Additionally to basic thread parameters, further variables are supported, like flank diameter, single flank diameter, paired flank diameter, accumulated slope deviation, partition, conicity, profile shape deviation, straightness etc., easily to be selected from different thread or factory standards.

The analysis features of the Light version are completed by an optimized window for thread display with enhanced logging possibilities.

Each pass may distinctly be evaluated and presented. All common international standards are supported. Numerous evaluation methods, including the usual three-ball method, are provided. Further benefits of this software edition are easy handling and a high degree of automation.

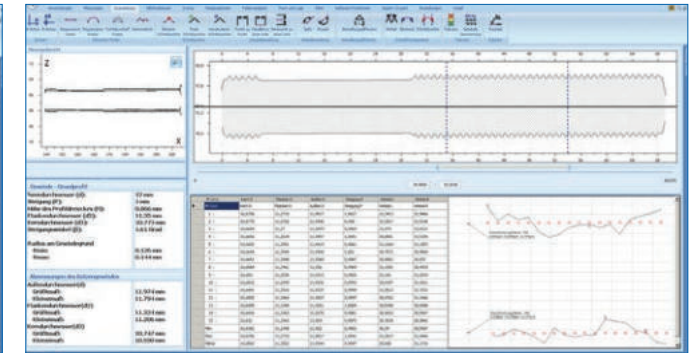

### optacom Thread Software Professional

Not only threads of workpieces, but also of thread gauges may be assessed at utmost accuracy by means of this software package. For this reason, hardware items developed in-house and intended for safe stretching of ring and plug gauges, are supported.

A software extension for a large quantity of international standards, valid for threaded gauges, is comprised as well, so that users are enabled to perform quick comparison of nominal values and real results.

Detected parameters as well as customized data logging can automatically be exported any time.

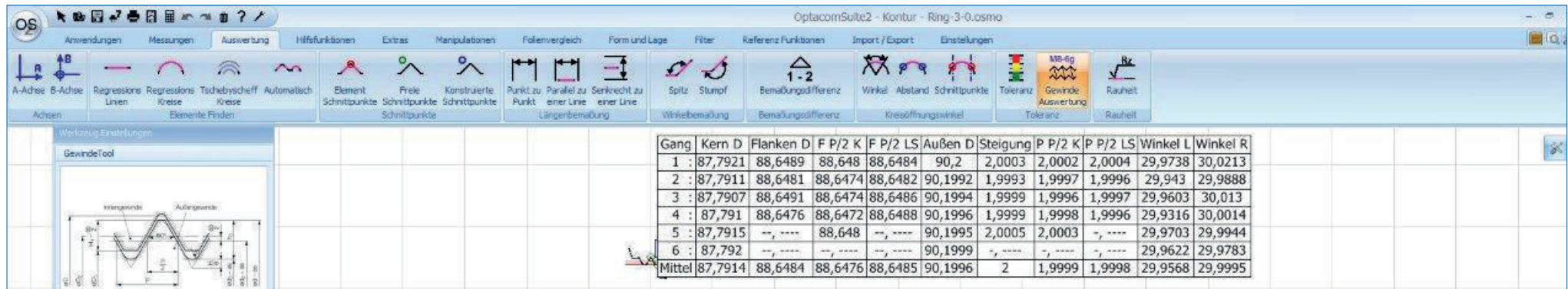

## optacom Thread Software: Functions offered by the distinct versions

Function	Light	Standard	Professional
Assessment of basic thread parameters for workpieces	✓	✓	✓
Assessment of all thread parameters for workpieces		✓	✓
Assessment of all thread parameters for gauges			✓
Evaluation by means of three ball method with nominal diameter of measuring wire	✓		
Free selection of measuring method		✓	✓
Free assignment of tolerances, independent of standards	✓	✓	✓
Comparison of nominal thread parameters and real results acc. to international standards		✓	✓
Comparison of nominal thread parameters and real results acc. to international standards (for gauges)			✓
Support for automatic mode (reference run)	✓	✓	✓
Support for supplementary thread module of optacom			✓
Automatic range insulation	✓	✓	✓
Test possible also for users without particular knowledge	✓	✓	✓
Extended display of thread profile		✓	✓
Logging in total view	✓	✓	✓
Extended logging (all passes, resp. adaptable)		✓	✓
Userinterface optimized for gauge measurement			✓
Quick Start Bar for automatic sequences and evaluations on the basis of measurement programs			✓

Type of Thread (Distinguishing Letter)	Thread acc. to standards	Gauges acc. to standards
Metric thread (M, MF, MJ, UNM, M STI, MJ STI)	ISO 68-1 / ISO 965-1 bis 5 / ISO 1501 / ISO 5855-1 DIN 13-1 to 52 / DIN 14 / DIN 2510-2 / DIN 8140 ASME 1.13M / ANSI B1.10M / BS 4377 / SAE MA1567	ISO 1502 ANSI B1.16M
Cylindrical ISO Pipe Thread	ISO 228-1	ISO 228-2
Conical ISO Pipe Thread (R-Rp-Rc, Rp STI, Rc STI)	ISO 7-1 EN 10226-1, -2	ISO 7-2 / DIN 2999 B.S. 21 (A, B)
Round Thread (Rd)	DIN 405-1, -2 / DIN 20400 /	DIN 405-3
Unity Inch Thread (UNC, UNF, UNEF, UN, UNS, UNRC, UNRF, UNREF, UNR, UNRS, UNJC, UNJF, UNJEF, UNJ, UNJS)	ANSI B1.1 / ANSI B1.15	ANSI B1.2 BS 919-1
Whitword Thread (BSW, BSF, Whit.S., Whit., BSW STI, BSF STI, BSP STI)	B.S. 84	BS 919-2
Metric Trapezoid Thread (Tr, ACME, STUB ACME)	ISO 2901 / DIN 103-1 to 8 / DIN 380 ANSI B1.5 / ANSI B1.8	DIN 103-9 ANSI B1.5 / ANSI B1.8
Metric Serrate Thread 33° / 45° (S), 52° (BUTT)	DIN 513-1 to 3 / DIN 20401 / DIN 2781 ANSI B1.9 / B.S. 1657	ISO 1502 / DIN 103-9 ANSI B1.9
Gas Bottles Conical ISO Thread	ISO 11363-1	ISO 11363-2
ANSI Universal Pipe Thread (NPT, NPSC, NPTR, NPSM, NPSL, NPT STI, NPSC STI, ANPT STI))	ANSI B1.20.1 SAE AS71051	ANSI B1.20.1 SAE AS71051
ANSI Dry-Sealing Pipe Thread (NPTF, PTF-SAE Short, NPSF, NPSI, F-PTF)	ANSI B1.20.3	ANSI B1.20.5
API Thread for Oil Industry (LP, CSG, LCSG, TBG, UPTBG, UPLTBG, IJTBG, BCSG, XCSG, LTC )	API Spec. 5B	API Spec. 5B / API Spec. 5B1
ANSI Hose Coupling Thread (NPSH, NH, NHR)	ANSI B1.20.7	ANSI B1.20.7
NFPA Hose Coupling Thread for Fire Brigades (NH)	NFPA 1963	NFPA 1963
NC Interference Fit Thread Class 5 (NC) (HF/IF; CSF/IF; ONF/INF)	ANSI B1.12	ANSI B1.12
EC Inch Thread (UN STI, UNJ STI, 8 UN STI, 16UN STI)	ASME B18.29.1 / ANSI B1.1 NASM 33537 / BS 3409	ANSI B1.2 BS 919-1
B.A. Thread (BA)	B.S. 93	BS 919-2

OptacomSuite2 - Kontur - Gewinderohr.osmo

Anwendungen Messungen Auswertung Hilfsfunktionen Extras Manipulationen Folienvergleich Form und Lage Filter Referenz Funktionen Import / Export Einstellungen Undef

A-Achse B-Achse Regressions Linien Regressions Kreise Tschebyscheff Kreise Automatisch Elemente Finden Element Schnittpunkte Freie Schnittpunkte Konstruierte Schnittpunkte Punkt zu Punkt Parallel zu einer Linie Senkrecht zu einer Linie Winkelmessung Bemaßungsdifferenz Winkel Abstand Schnittpunkte Toleranz M8-6g Gewinde Auswertung Rauheit

Messungsübersicht

Gewinde - Grundprofil

Nenndurchmesser (d): 12 mm  
 Steigung (P): 1 mm  
 Höhe des Profildreiecks (H): 0.866 mm  
 Flankendurchmesser (d2): 11.35 mm  
 Kerndurchmesser (d3): 10.773 mm  
 Steigungswinkel (β): 1.61 Grad

Radius am Gewindegrund  
 Rmin: 0.126 mm  
 Rmax: 0.144 mm

Abmessungen des Bolzensgewindes

Außendurchmesser (d)  
 Größtmaß: 11.974 mm  
 Kleinstmaß: 11.794 mm

Flankendurchmesser (d2)  
 Größtmaß: 11.324 mm  
 Kleinstmaß: 11.206 mm

Kerndurchmesser (d3)  
 Größtmaß: 10.747 mm  
 Kleinstmaß: 10.590 mm

M 12x1	Kern D	Flanken D	Außen D	Steigung P	Winkel L	Winkel R
M 12x1	Kern D	Flanken D	Außen D	Steigung P	Winkel L	Winkel R
1 :	10,6786	11,2733	11,9517	1,0027	31,3413	31,9466
2 :	10,6775	11,2726	11,9496	0,998	31,3817	31,5196
3 :	10,6684	11,27	11,9479	0,9969	31,079	31,4121
4 :	10,6656	11,2634	11,9457	1,0041	30,8581	31,5185
5 :	10,6692	11,2581	11,9419	0,9961	31,1064	31,1853
6 :	10,6694	11,2544	11,9394	1,001	30,7572	30,9869
7 :	10,6651	11,2498	11,9368	0,9987	30,8852	30,837
8 :	10,6564	11,2461	11,936	0,9989	31,1091	30,9433
9 :	10,653	11,2536	11,9313	0,9903	31,181	31,0293
10 :	10,6532	11,2439	11,9292	0,9993	30,4397	31,3421
11 :	10,6491	11,2516	11,9237	0,9999	31,0512	31,7022
12 :	10,6502	11,2464	11,9267	0,9997	30,4762	31,1466
13 :	10,6495	11,2348	11,9261	1,0009	30,5348	30,9988
14 :	10,6416	11,2363	11,9275	0,9961	30,4923	30,5407
15 :	10,632	11,2416	11,924	0,9975	30,7635	30,9542
Min:	10,6302	11,2348	11,922	0,9903	30,39	30,5407
Max:	10,6786	11,2733	11,9517	1,0041	31,3817	31,9466
Mittel:	10,6562	11,2522	11,9344	0,9987	30,838	31,1716

Überstreckungsfaktor: 250  
 5,864µm +6,403µm -0,744µm

Überstreckungsfaktor: 250  
 5,558µm +5,706µm -0,147µm



Abbreviation	Country	Flank Angle	German	English
ISO		60°	Internationale Vereinigung der Standardisierungsgremien	International Organization for Standardization
UN	USA	60°	Amerikanisches Einheitsgewinde mit konstanter Steigung	Unified National 8-, 12- and 16 pitch series
UNC	USA	60°	Amerikanisches Einheitsgewinde, grob	Unified National Coarse
UNEF	USA	60°	Amerikanisches Einheitsgewinde, extra fein	Unified National Extra Fine
UNF	USA	60°	Amerikanisches Einheitsgewinde, fein	Unified National Fine
UNJ	USA	60°	Amerikanisches Einheitsgewinde mit Maßangaben für den Grundradius des Außendurchmessers, vergrößerter Kerndurchmesser des Innengewindes	Unified National thread series with external thread controlled root radius
UNJC	USA	60°	Amerikanisches Einheitsgewinde, grob, mit Maßangaben für den Grundradius des Außendurchmessers, vergrößerter Kerndurchmesser des Innengewindes	Unified National Coarse thread series with external thread controlled root radius
UNJEF	USA	60°	Amerikanisches Einheitsgewinde, extrafein, mit Maßangaben für den Grundradius des Außendurchmessers, vergrößerter Kerndurchmesser des Innengewindes	Unified National Extra Fine thread series with external thread controlled root radius
UNJF	USA	60°	Amerikanisches Einheitsgewinde, fein, mit Maßangaben für den Grundradius des Außendurchmessers, vergrößerter Kerndurchmesser des Innengewindes	Unified National Fine thread series with external thread controlled root radius
UNJS	USA	60°	Amerikanisches Einheitsgewinde, mit speziellen Durchmessern, Steigungen und Einschraubtlängen, mit Maßangaben für den Grundradius des Außendurchmessers, vergrößerter Kerndurchmesser des Innengewindes	Unified National Special thread series with external thread controlled root radius
UNR	USA	60°	Amerikanisches Einheitsgewinde mit konstanter Steigung und Maßangaben für den Grundradius	Unified National thread series with external thread controlled root radius
UNRC	USA	60°	Amerikanisches Einheitsgewinde, grob und Maßangaben für den Grundradius	Unified National Coarse thread series with external thread controlled root radius
UNREF	USA	60°	Amerikanisches Einheitsgewinde, extrafein und Maßangaben für den Grundradius	Unified National Extra Fine thread series with external thread controlled root radius
UNRF	USA	60°	Amerikanisches Einheitsgewinde, fein und Maßangaben für den Grundradius	Unified National Fine thread series with external thread controlled root radius
UNRS	USA	60°	Amerikanisches Einheitsgewinde mit speziellen Durchmessern, Steigungen und Einschraubtlängen und Maßangaben für den Grundradius	Unified National Special thread series with external thread controlled root radius



Abbreviation	Country	Flank Angle	German	English
UNS	USA	60°	Amerikanisches Einheitsgewinde mit speziellen Durchmessern, Steigungen und Einschraub­längen	Unified National Special
NPT	USA	60°	Amerikanisches, kegeliges Standard Rohrgewinde, 1:16	National Pipe Taper 1:16
NPTF	USA	60°	Amerikanisches, kegeliges Standard Rohrgewinde, trocken dichtend, 1:16	National Pipe Taper Fuel and Oil Dryseal 1:16
NPTR	USA	60°	Amerikanisches, kegeliges Standard Rohrgewinde, Schienenfahrzeuge	National Pipe Taper Railing Fittings
NPSC	USA	60°	Amerikanisches, kegeliges Standard Rohrgewinde, Kupplungen	National Pipe StraightCoupling
NPSF	USA	60°	Amerikanisches, zylindrisches Standard Rohrgewinde, innen, trocken dichtend	National Pipe Straight Fuel
NPSG	USA	60°	Amerikanisches, zylindrisches Standard Rohrgewinde für Schmiernippel	National Pipe StraightGrease
NPSH	USA	60°	Amerikanisches, zylindrisches Standard Rohrgewinde, Schlauchverbindungen	National Pipe Straight Hose
NPSI	USA	60°	Amerikanisches, zylindrisches Standard Rohrgewinde für Rohrzwischenstücke	National Pipe StraightIntermediate
NPSL	USA	60°	Amerikanisches, zylindrisches Standard Rohrgewinde, für mechanische Verbindungen mit Abdichtmutter	National Pipe StraightLoose
NPSM	USA	60°	Amerikanisches, zylindrisches Standard Rohrgewinde, für mechanische Verbindungen	National Pipe StraightMechanical
BSW	GB	55°	British Standard Whitworth Grobgewinde	British Standard Withworth Coarse
BSF	GB	55°	British Standard Feingewinde	British Standard Fine
BSPP	GB	55°	Zylindrisches British Standard Gasgewinde	British Strandard PipeParallel
BSPT	GB	55°	Kegeliges British Standard Gasgewinde	British Standard Pipe Taper
BA	GB	47°	British Association Standard Gewinde	British StandardAssociation
NC	USA	60°	National Grobgewinde, 1948 ersetzt durch UNC	National Coarse
NF	USA	60°	National Feingewinde, 1948 ersetzt durch UNF	National Fine

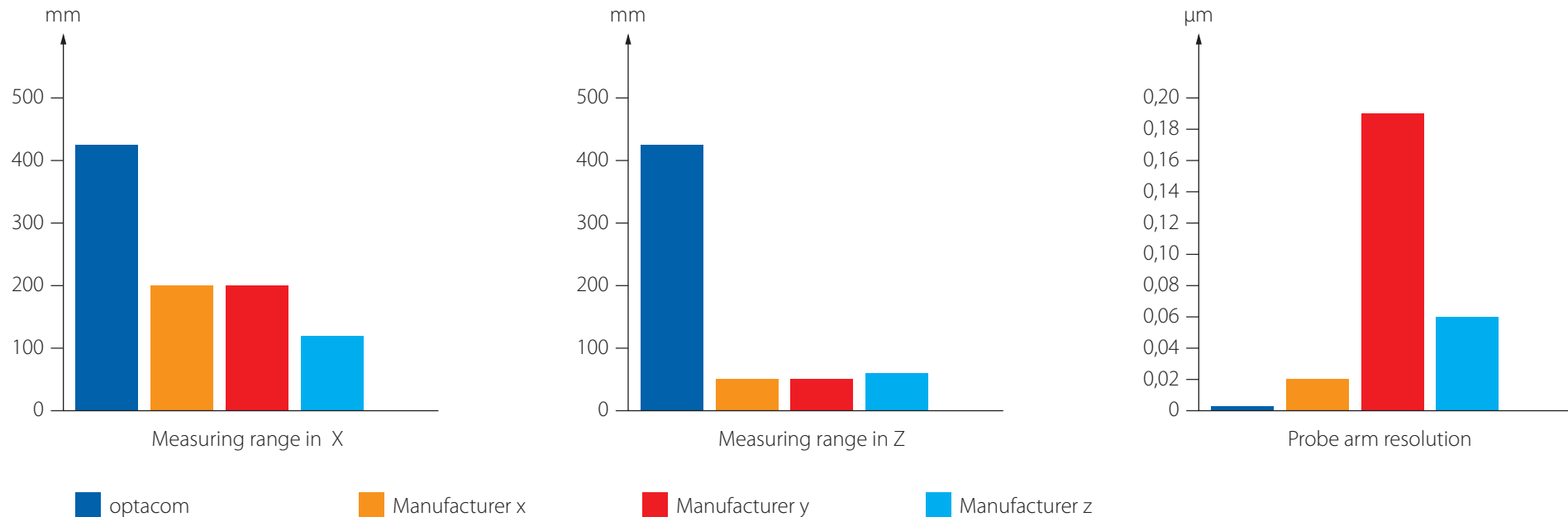

### Overview of the operation-relevant standards embedded in our software:

DIN EN ISO 1101 Geometrical Product Specifications (GPS) - Geometrical tolerancing - Tolerances of form, orientation, location and run-out

EN ISO 4287 Geometrical Product Specifications (GPS) - Surface texture: Profile method - Terms, definitions and surface texture parameters

EN ISO 4288 Geometrical Product Specifications (GPS) - Surface texture: Profile method - Rules and procedures for the assessment of surface texture

EN ISO 12085 Geometrical Product Specifications (GPS) - Surface texture: Profile method - Motif parameters

EN ISO 12562 Geometrical Product Specifications (GPS) - Surface texture: Profile method - Metrological characteristics of phase correct filters

EN ISO 13565-1 Geometrical Product Specifications (GPS) - Surfaces having stratified functional properties-Filtering and general measurement conditions

EN ISO 13565-2 Geometrical Product Specifications (GPS) - Surfaces having stratified functional properties - Height characterization using the linear material ratio curve

JIS B 0601 Surface texture: Profile method - Terms, definitions and surface texture parameters

DIN EN ISO 12180-1 Geometrical product specifications (GPS) - Cylindricity - Part 1: Vocabulary and parameters of cylindrical form

DIN EN ISO 12181-1 Geometrical Product Specifications (GPS) - Roundness - Part 1: Vocabulary and parameters of roundness

DIN EN ISO 12780-1 Geometrical Product Specifications (GPS) - Straightness - Part 1: Vocabulary and parameters of straightness

DIN EN ISO 12781-1 Geometrical product specifications (GPS) - Flatness - Part 1: Vocabulary and parameters of flatness

VDI / VDE 2631 Sheet 1 Form measurement - Principles for the determination of form and position deviations

VDI / VDE 2631 Sheet 2 Form measurement - Determination of the sensitivity of signal-transmission chain

VDI / VDE 2631 Sheet 3 Form measurement - Characteristics and selection of filters

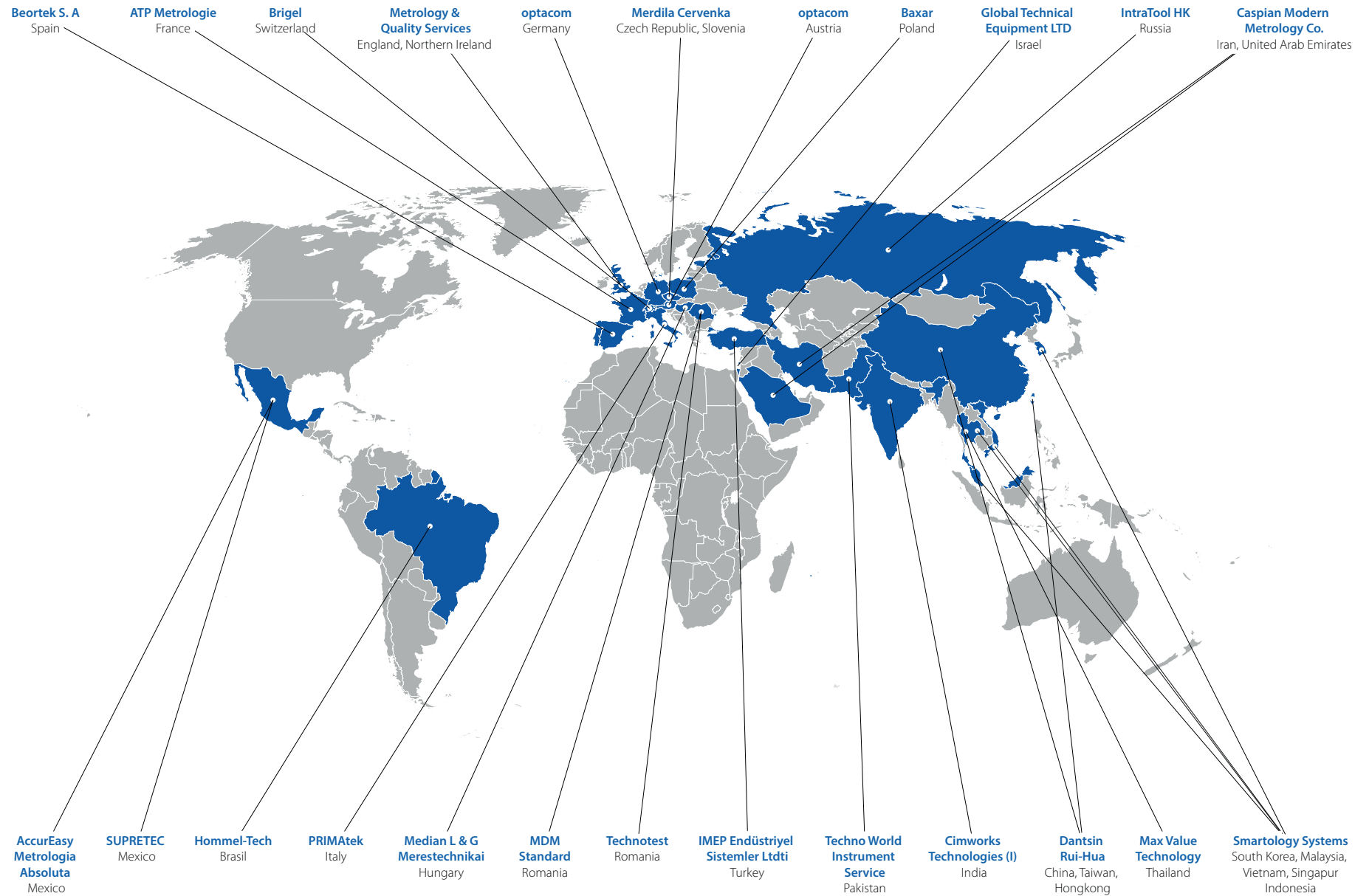

Contour | Roughness | Roundness | Straightness | Thread measurement | Gearing | Stylus tips | Accessories

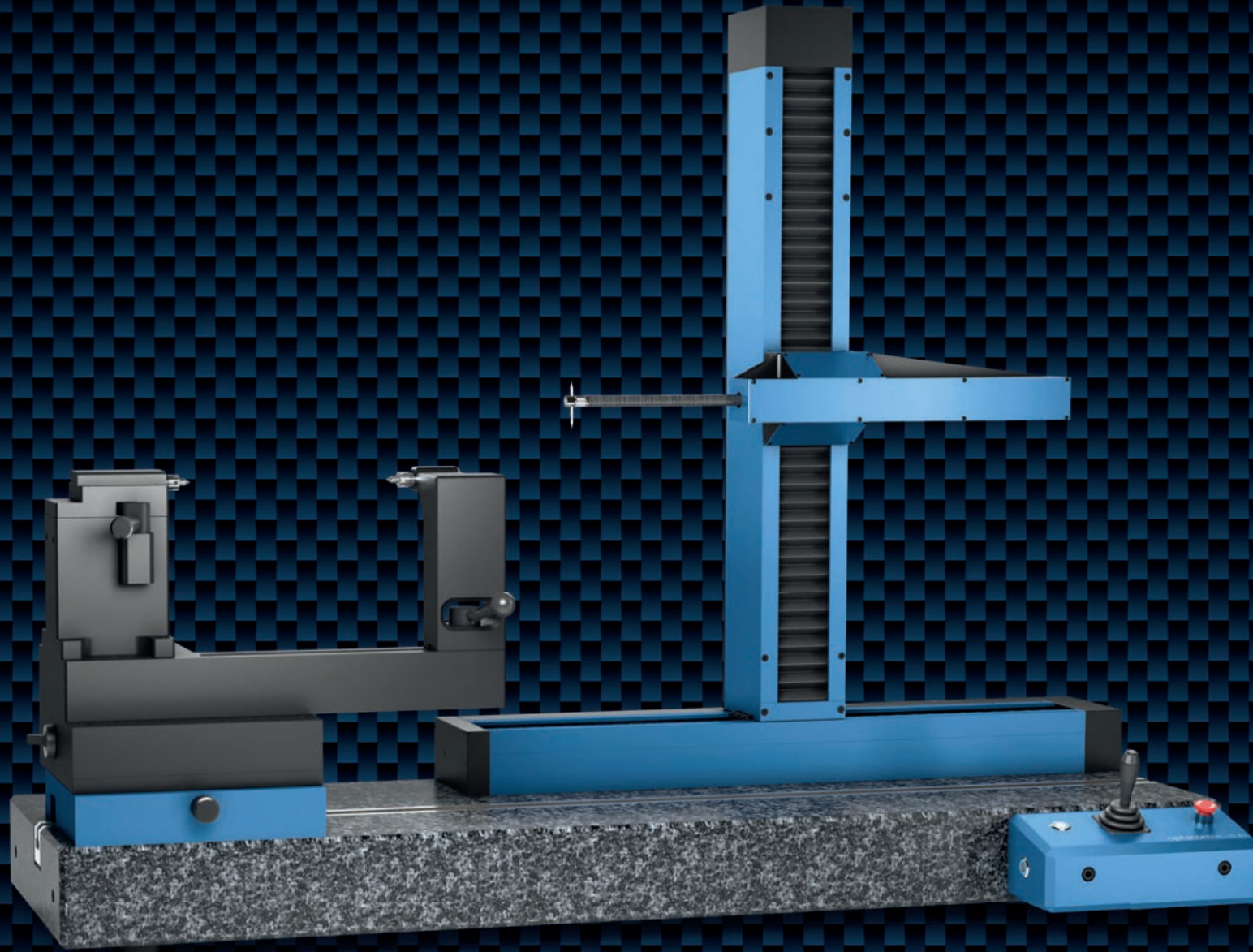

**optacom GmbH & Co. KG**

Dürrfelder Straße 18 • 97508 Obereuerheim • Phone: +49 (0)9729 90971-0 • Fax: +49 (0)9729 90971-29 • office@optacom.com • www.optacom.com

**optacom**  
Measurement technology - Made in Germany