

Metal Composite Power Choke Coils

AEC-Q200 Compliant
For Automotive & Industrial
Use in Harsh Environments

- Vibration Resistance up to 50G (5Hz - 2kHz)
- Maximum Operating Temperature of 180°C
- Up to 50% smaller compared to ferrite technologies
- Thermal shock up to -55°C~155°C
- Metal Composite Core with Magnetic Shielding Structure
- Non-Hard Saturation



IN Your Future



IN Your Innovation



Index

Introduction	3
Applications	3

Automotive Application

Automotive Application	4
------------------------	---

Features and Benefits

Performance Benchmark	5
Unique Terminal Structure and Mechanical Robustness	6
Low Leakage Flux	6
AEC-Q200 Compliant for Use in Harsh Environments	7
Miniaturization in Design	7
Acoustic Noise Reduction	8
Excellent Withstanding Voltage Characteristics	8

Technical Information

Robust design for Vibration proof body and terminal structure	9
10.0 x 10.7 x H 5.4 max. // ETQP5M2R5YFC	10

Explanation of Part Numbers

Panasonic ETQP Series Part Number Breakdown	11
---	----

Comparison

Panasonic ETQP Series Vs. Alternative Products	12
--	----

Selection Guide

Panasonic ETQP High Performance Series Selection Guide	13
Panasonic ETQP Low Profile / LE Series Selection Guide	14
Panasonic ETQP High Frequency / High Vibration Resistance / Large Current Series Selection Guide	15

DC / DC Converter Application Example

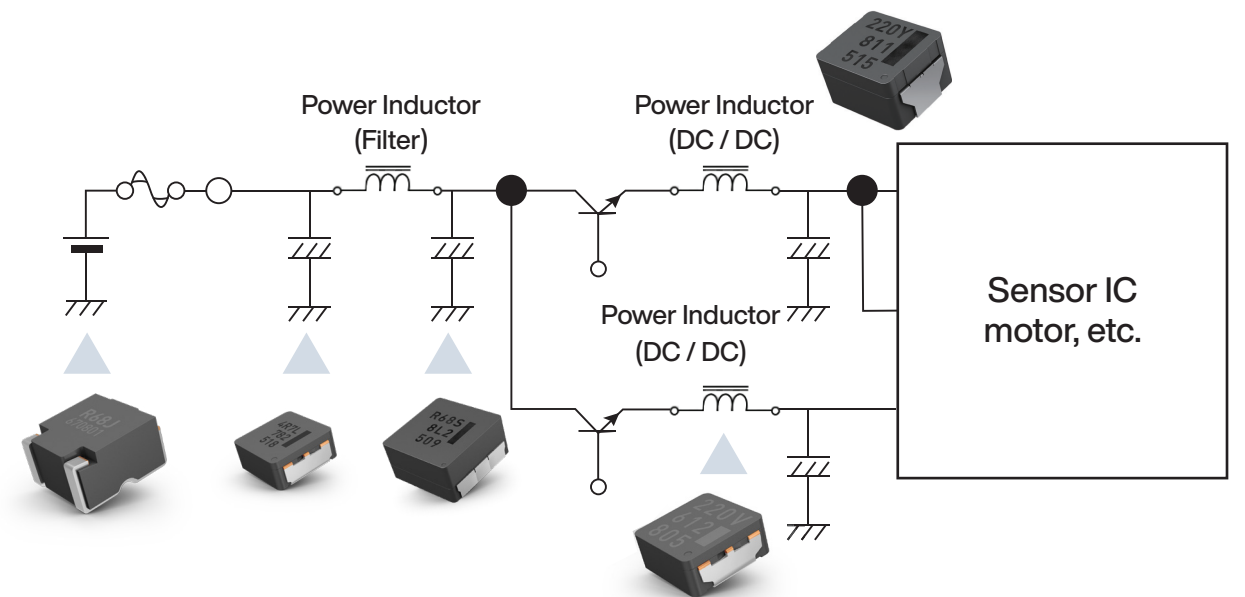

Applications



Circuit Function

- Noise Filter For Drive Circuits
- DC/DC Converter
- Voltage Regulator
- Buck/Boost Converters



Automotive

- HEV/EV
- Engine ECU
- ADAS
- Powertrain
- Lighting
- Autonomous Driving

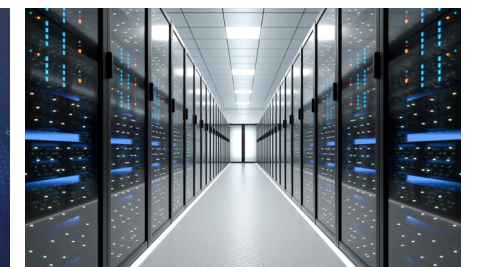

Industrial

- Automation
- Server
- LED Driver
- Power Supply Module

Automotive Application

By Series



Series	PCC-MC High Perform	PCC-LP Low Profile	PCC-LE LE type	PCC-1280/-1510 Large Current
Temperature range	-40 ~ +150°C	-55 ~ +155°C	-40 ~ +150°C	-40 ~ +160°C
Inductance range	0.33~100μH	0.33~47μH	3.3~47μH	0.33~4.7μH
Rated current	1.9~39.7A	2.1~23.9A	2.9~9.2A	20.2 ~ 83A
Package size (mm)	□5.5x5.0x3.0~ □0.9x10.0x6.0	□5.5x5.0x3.0~ □10.7x10.0x4.0	□6.4x6.0x4.8 □7.4x7.0x4.8	□13.2x12.6x8.0 □15.6x17.2x10.5
Benefit	<ul style="list-style-type: none"> High performance Robust & high stability High saturation Low AC-power loss 	<ul style="list-style-type: none"> Low profile design Max 3.0 & 4.0mm height. Low DCR Pin layout compatible with IHLP series. 	<ul style="list-style-type: none"> Lower DCR Pin to pin compatible with Ferrite type 	<ul style="list-style-type: none"> High current Lower DCR 30G Vibration ½ package size

By Application

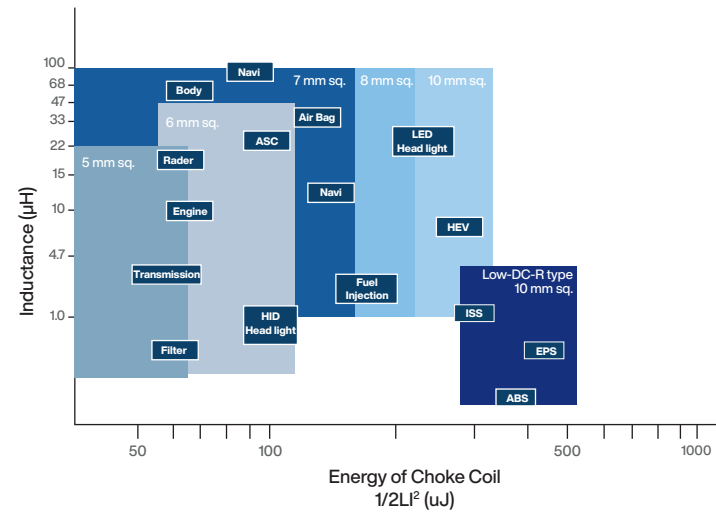

Line-up for Application

Automotive Application Examples

Engine ECU	Autonomous Driving	EPS	Transmission ECU	Start & Stop
ABS/ESP	Navigation System			Battery ECU
Panel/HUD	On-board Charger			Camera
Radar				Lidar
Fan motor driver	Domain Controller		Gateway	Monitor
LED headlamp	Electrical pump	48V/EV Inverter	Body controller	Door motor controller

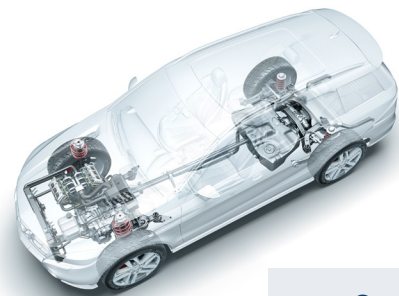

Panasonic's Metal Composite inductors can be used for a variety of application and functional circuit.

- PCC-MC; Power-Train, Engine, Brake, Lighting, ADAS, Battery management and more.
- PCC-LP/LE, Body Control, Human Interface, Interior, Audio, Telematics and more.

Features and Benefits

High Current, High Heat Resistance and Excellent Thermal Stability

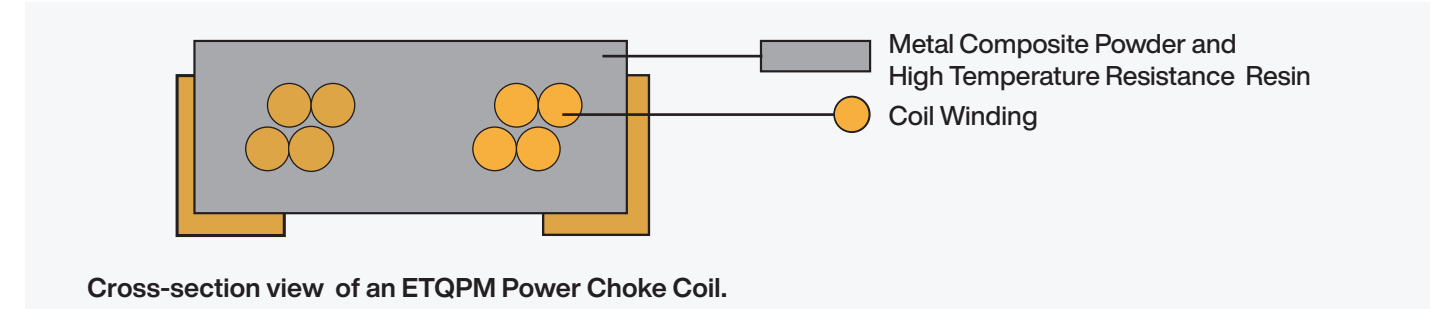

- The ETQP Power Inductor consists of metal powder, Binding & Coating resin and coil winding. The magnetic material, which is created from Fe-based powder, enables high current, high heat resistance and excellent thermal stability.
- Excellent magnetic saturation characteristics (i.e. Ferrite core = 0.4T vs. Metal Composite Type=above 1.5T) make it difficult to magnetically saturate, resulting in good inductance vs. current performance without substantial drop off.
- By using a high temperature capable resin material, an operating temperature up to 180°C is achievable for several hours.

- *Low Profile Series 155°C
- *High Performance Series 150°C



* 180°C under Special Conditions

Frequency Characteristics of AC Resistance

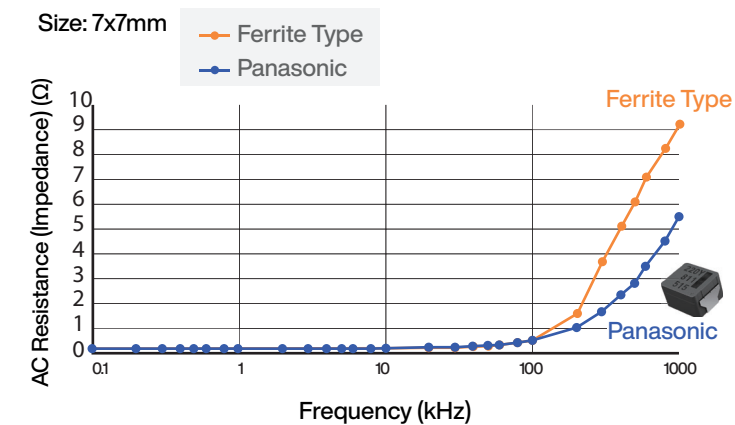

The metal composite molded structure has a distributed gap rather than a discrete gap resulting in low AC resistance (impedance) at higher frequencies.

Effect of DC Bias Current on Inductance

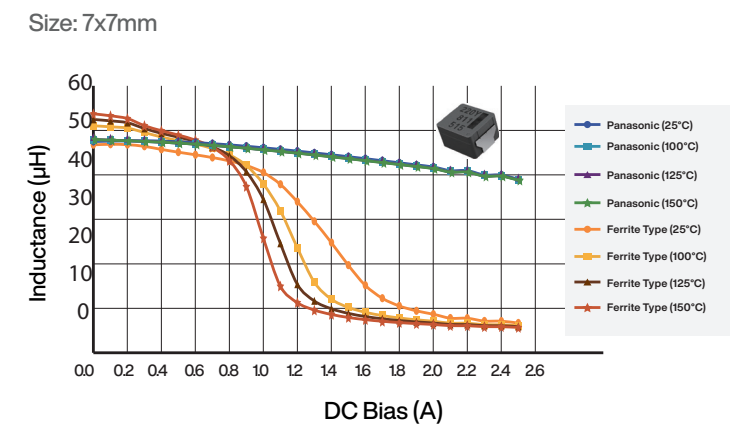

The ETQP Inductor allows for large currents. The inductance levels do not drop significantly as the current increases regardless of the temperature.

Comparison of Panasonic vs. Ferrite Type (at the same inductance)

Manufacturer	Panasonic Metal Composite	Ferrite (Alternative Product)
Series	ETQP4M470YFN	Ferrite Type
Size (mm)	6.5 × 6.0	7.4 × 6.9
Height (mm)	4.5 max	4.7 max
Volume (mm) ³	187	240
Core Material	Metal Composite	Ferrite
L1 (μH) at 100kHz	47.0 (0.8A)	47.0 (0.7A)
ISAT (A) at 125°C, L-10%	1.3	0.7
DCR (mΩ)	210	158
Performance Index Per Volume	100%	60%
Max Operating Temperature	150°C (180°C for several hours)	125°C

Achieved 22% downsizing
85% higher saturation current

Temperature condition 125°C

40% higher performance
Up to +180°C in short time
Stable characteristics in high temp.

Unique Terminal Structure

The copper wire of the internal coil is brought out directly to the terminal mounting part to ensure the reliability of mounting to the PCB. Other products make the connection inside the Metal Composite, thus it is hard to verify the connection condition and long-term reliability issues may occur with environmental stresses.

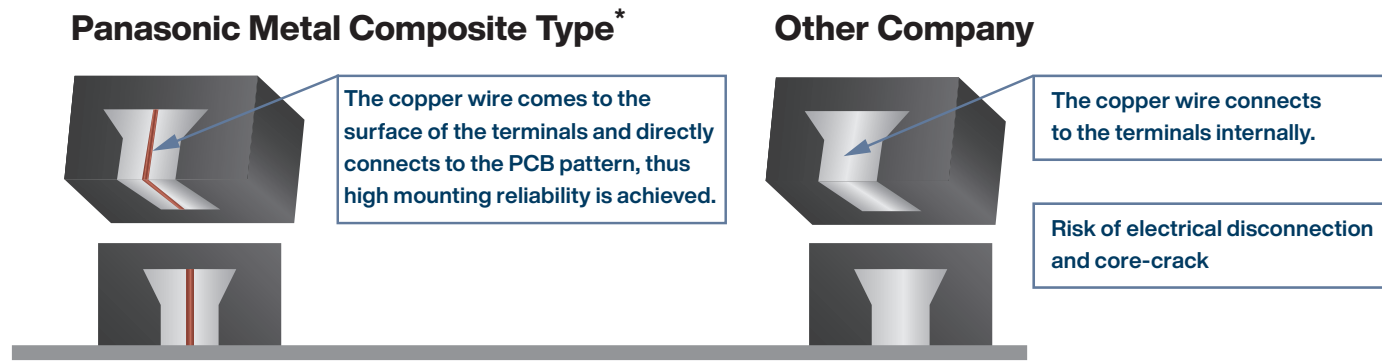

*For the actual product, dip solder is applied on the copper wire part and terminal to keep good mountability. The corresponding part numbers are included in the Selection Guide on page 13 of this document.

Low Leakage Flux

The integrated molded and magnetic shielded structure of the Metal Composite Type with its distributed gap has low leakage flux from the core resulting in noise and interference reduction, facilitating high density layouts.

AEC-Q200 Compliant For Use In Harsh Environments

Through the previously mentioned improvements, the ETQP Series product provides 150°C temperature and excellent vibration resistance characteristics.

Reliability Results for AEC-Q200 Compliance (Example)

Item	Condition	Time	Remark
Thermal Shock	-40 ~ +150°C (Each for 10 minutes)	2000 cycles	<ul style="list-style-type: none"> Inductance is ±10% from initial value DCR is ±10% from initial value Insulation resistance is above 10KΩ Nothing abnormal on appearance and structures
Vibration Resistance	10G to 30G, up to 50G (5Hz-2kHz, Sine)	XYZ (each for 2 hours)	
Heat Resistance	150°C	2000 hours	
High Temperature Lifetime	150°C (Rated current applied)		
Anti-Humidity	85°C, 85%RH	2000 hours	
Anti-Humidity Lifetime Test	85°C, 85%RH (Rated current applied)		
Low Temperature Test	-40°C	2000 hours	No open wire or mechanical damage

Miniaturization in Design

Panasonic Metal Composite Core Types facilitate smaller designs compared with Ferrite Type Choke Coils. Up to 50% downsize and 5-25% down in weight.

Size Down: Volume/Weight Reduction Effect

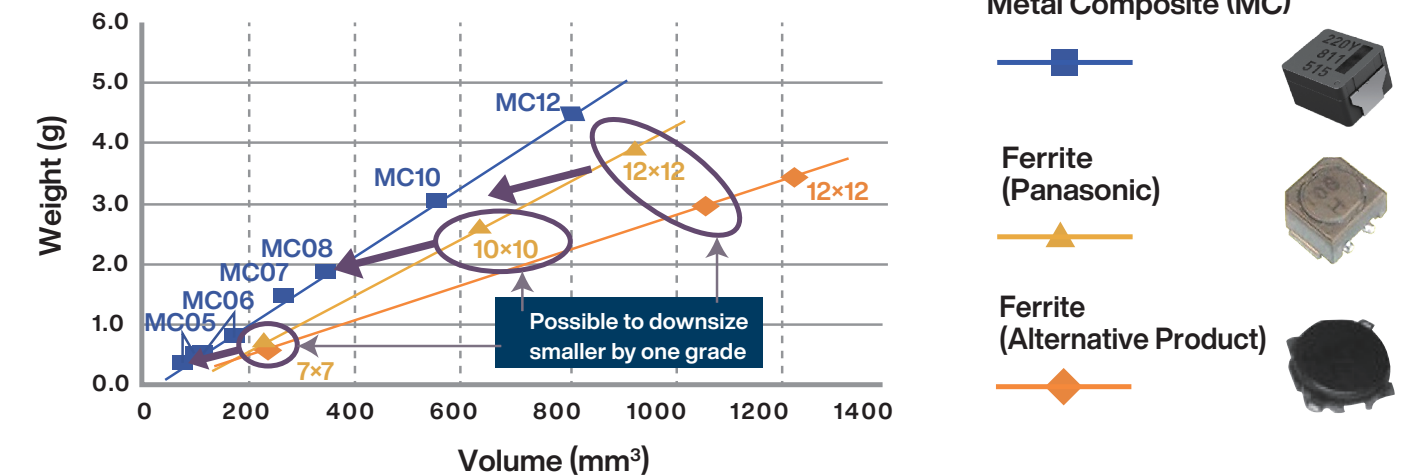

Acoustic Noise Reduction

Troublesome acoustic noise at audible frequencies is reduced by having a distributed gap structure where the resin replaces the air gap. This enables a large reduction of acoustic noise compared to Ferrite Types.

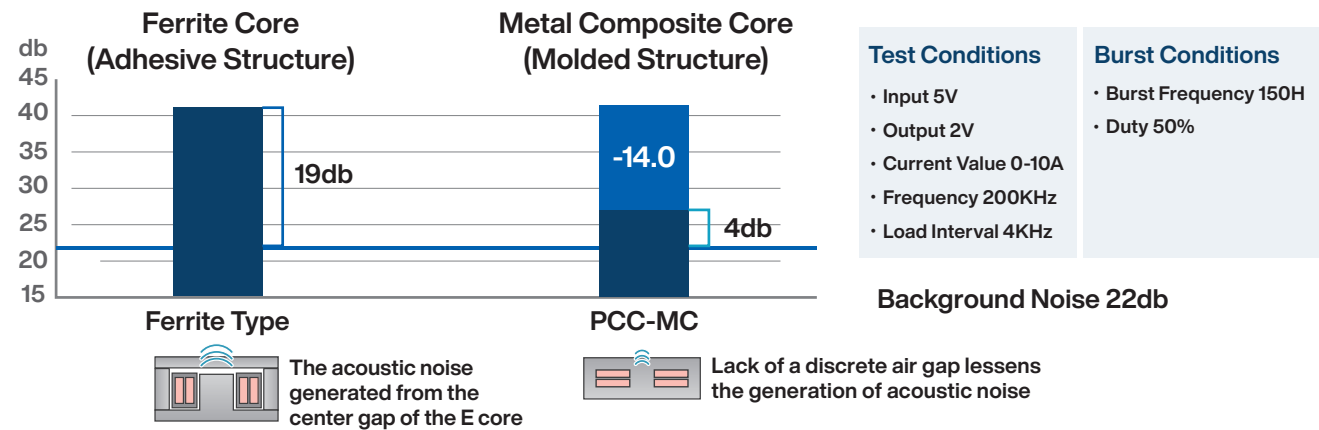

Excellent Withstanding Voltage Characteristics

ETQP Series Metal Composite Type achieves excellent withstanding voltage characteristics that can be used in various applications.

Maximum operation voltage target

PCC Series	Size	Existing spec.	Upgraded Voltage (please contact us for conditions)												
			0.68μH	1.0μH	1.5μH	2.2μH	3.3μH	4.7μH	10μH	15μH	22μH	33μH	47μH	68μH	100μH
M1280	13.2x12.6x8.0mm	35V	50V												
M1060L	10.9x10.0x6.0mm	35V	70V												
M1050L	10.9x10.0x5.0mm	35V	70V												
M1054M	10.7x10.0x5.4mm	35V	70V											65V	
M1040LP	10.7x10.0x4.0mm	35V	65V												60V
M0854M	8.5x8.0x5.4mm	35V	70V										65V		
M0840LP	8.5x8.0x4.0mm	35V	65V												
M0754M	7.5x7.0x5.4mm	35V	65V								60V				
M0645M	6.5x6.0x4.5mm	25V	60V						55V						
M0630M	6.5x6.0x3.0mm	25V	60V												
M0630LP	6.4x6.0x3.0mm	25V	60V						55V						
M0540M	5.5x5.0x4.0mm	20V									55V				
M0530M	5.5x5.0x3.0mm	20V							55V						
M0530LP	5.5x5.0x3.0mm	25V	55V						50V						

*please contact Panasonic for detailed specification.

Robust design for Vibration proof body and terminal structure

Ferrite Type // PCC-MC Type // PCC-MC MS Type

Ferrite Type	PCC-MC Type	PCC-MC MS Type
<p>Parts assembly structure by adhesive Less resistant to shock and vibration</p> <p>Disadvantages: Risk of crack and disassembly by mechanical stress 4G to 10G max.</p>	<p>Monolithic Molded structure</p> <p>Full mold with Core & Coil</p> <p>Special terminal design with gap clearance</p> <p>Hard coated wire</p>	<p>Lower position Terminal design Lower center of gravity, less movement</p> <p>PCC 10x10mm <50G 5-2,000Hz 108/axis</p>
4G to 10G	10G to 30G	30 to 50G

- Suitable for tough and harsh vibration
- Mechanical stress-resistant to dumper terminal
- Long life stability

High Current Series Features; ETQP8M__JFA (12x12mm Core Size)

THD Type

• Mounting area 361 mm² (19 x 19 mm)

• Electrical characteristics 2.5 μH / 2.8 mΩ

PCC-M 1280MF series for large current, in 12 x 12mm size

SMD Mounting ▲ 50-60%

SMD Type

• Mounting area 161 mm² (13.2x12.8mm)

• Electrical characteristic 2.5 μH / 2.5 mΩ

THD → SMD

Disadvantages of THD Power Inductor types:

- Larger space consumption on PCB
- Additional assembly process required with manual insertion
- Additional anti vibration measures such as glue, adhesives or cramps required

Panasonic solution

ETQP8M__JFA series

- Large current in compact size as 13.2x12.8mm SMD.
- Excellent heat resistance and vibration resistance
- SMD type enables automatic mounting on PCB, contributing to customer's process cost reduction

* Panasonic conventional products Choke coil (ELC18E-L type)

Technical Information

Design Information

Temperature Measurement

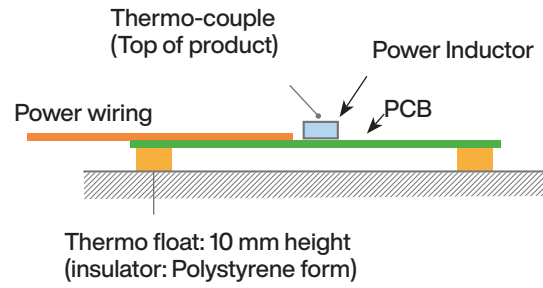

Land Patterns

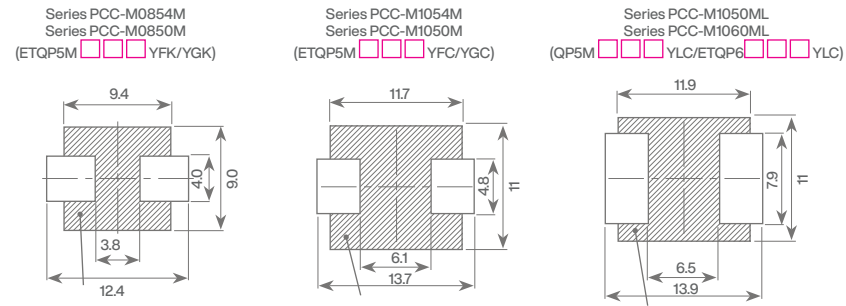

PCB specification:

- 1.6mm, FR4 / 4layers or Multi-layer PCB
- PCB with high heat dissipation performance
 - PCB size: 110 × 80 × T1.6 mm
 - Land pattern; Using Panasonic recommendation pattern by series (shown in WEB catalog)

Panasonic's Suggestions for Design

- Temperature rise may differ, depending on measurement method and land pattern.
- PCB, wiring condition and design may cause temperature rise.
- Please note that rated current shown here is only a reference. Actual temperature rise is dependent on your application and product usage. Please ask Panasonic representative in your area for a consultation.

Specification of rated current (e.g. ETQP5M2R5YFC)

Item	Inductance	RDC	Rated Current	
Condition	100 kHz, DC0A	20°C	$\Delta L/L = -30\%$	$\Delta T = 40K^*$
Value	2.5 μH (+/-20%)	5.3 m Ω (+/-10%)	27.2 A	18.1 A (15.1 A)*

*Temperature can be applied up to +150°C max

DC-Bias Characteristic

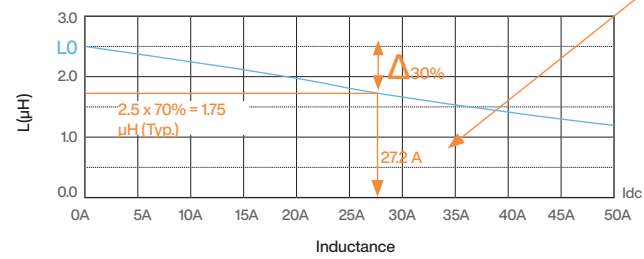

Temperature-rise Characteristics

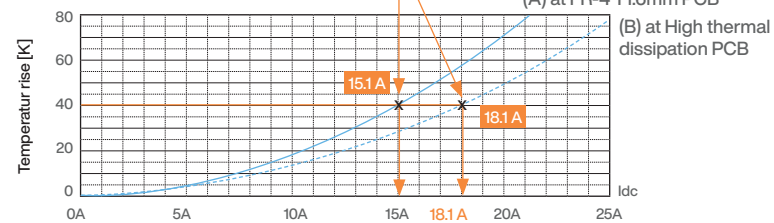

*T rated current is DC current, which causes temperature rise by 40K. Within a suitable application, the part's temperature depends on circuit design and certain heat dissipation conditions. This should be double checked in a worst case operation mode. Maximum standard operating temperature should not exceed 150 °C.

I_{dc} (A)	0	25	50
Inductance (μH)	2.50	1.99	1.25
$\Delta L/L$ (%)	0 %	-26.1 %	-50.2 %

Saturation rated current:

*Saturation rated current is DC current, which causes $L_0(0A)$ to drop by 30%.

Explanation of Part Numbers

Panasonic's ETQP Series Part Number Breakdown

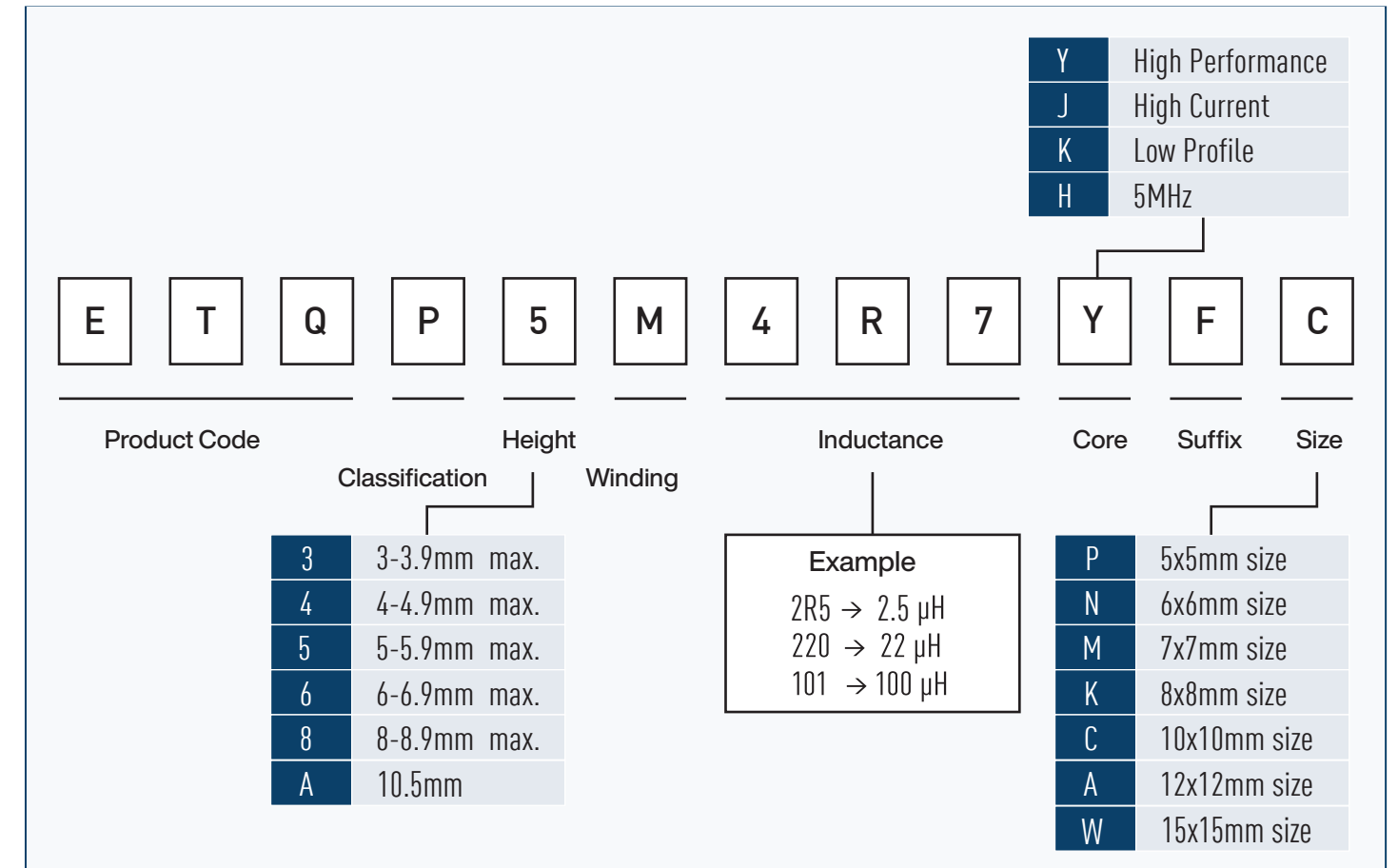

Comparison

Panasonic's ETQP Series Vs. Alternative Products

With unique metal magnetic material technology, the ETQP Series displays low loss and downsizing compared with alternative products.

Panasonic vs. Alternative Products

Manufacturer	22μH		47μH			
	Panasonic		Alternative Products	Panasonic		Alternative Products
Power Inductor	8 × 8.5 × 5.4 ETQP5M220YFK	10 × 10.7 × 5.4 ETQP5M220YFC	10 × 10.7 × 4.0 22μH	8 × 8.5 × 5.4 ETQP5M470YFK	10 × 10.7 × 5.4 ETQP5M470YFC	10 × 10.7 × 4.0 47μH
Frequency	400kHz	400kHz	400kHz	400kHz	400kHz	400kHz
DCR 20°C	63mΩ	45mΩ	70mΩ	125mΩ	96mΩ	165mΩ
ACR	1190mΩ	861mΩ	1254mΩ	2416mΩ	2171mΩ	2805mΩ
Rated Current	4.8A	6.2A	4.33A	3.4A	4.2A	2.47A
Iac (Ripple)	1.11A	1.11A	1.11A	0.52A	0.52A	0.52A
Idc RMS	4.42A	4.42A	4.42A	2.51A	2.51A	2.51A
Iac RMS	0.64A	0.64A	0.64A	0.30A	0.30A	0.30A
DC Loss	1.65W	1.18W	1.83W	1.06W	0.81W	1.39W
AC Loss	0.46W	0.34W	0.52W	0.22W	0.20W	0.25W
Total Loss	2.11W	1.51W	2.35W	1.27W	1.01W	1.65W
ΔT (Top)	78.1K	49.9K	80.9K	47.1K	33.2K	56.8K
ΔT (Terminal)	58.0K	35.5K	58.6K	35.0K	23.6K	41.1K

Selection Guide

Panasonic's ETQP Series Selection Guide

High Performance Series

Type	5x5 ETQP*M__YFP		6x6 ETQP*M__YFN		7x7 ETQP5M__YFM		8x8 ETQP5M__Y*K		10x10 ETQP5M__Y*C		10x10 (Low DCR) ETQP*M__YLC	
(Size) WxLxT Height=t	5.5x5.0mm t=3.0mm (<4.7μH) t=4.0mm (≥4.7μH)		6.5x6.0mm t=3.0mm (<2.2μH) t=4.5mm (≥2.2μH)		7.5x7.0mm t=5.4mm (<95μH) t=5.0mm (≥95μH)		8.5x8.0mm t=5.4mm (<95μH) t=5.0mm (≥95μH)		10.7x10.0mm t=5.4mm (<95μH) t=5.0mm (≥95μH)		10.9x10.0mm t=5.0mm (<1.5μH) t=6.0mm (≥1.5μH)	
LO (μH)	Rated Current (A)	DCR (mΩ)	Rated Current (A)	DCR (mΩ)	Rated Current (A)	DCR (mΩ)	Rated Current (A)	DCR (mΩ)	Rated Current (A)	DCR (mΩ)	Rated Current (A)	DCR (mΩ)
100					1.9 (*1)	348	2.1	302	2.7(*5)	208		
68					2.3	251			3.6 (*7)	136		
47			2.2	210	2.9 (*3)	156	3.4 (*3)	125	4.2	99		
33			2.5	172	3.3	120			5.0	68.5		
22	2.3	163	2.9	126	3.7	92.0	4.8	63.0	6.2	45.0		
15							5.5	48.2	7.0	35.6	7.9 (*8)	28.0
10			4.5	54.2	5.7	37.6	6.7	33.4	8.5	23.8		
6.8			5.2	39.3	6.9	26.7						
4.7	4.8	36.0			8.0	20.4			13.1	10.2	14.1	8.7
3.3	5.0	31.3	8.2	16.1	10.4	11.9	12.5	9.5	15.7	7.1	17.0	6.0
2.2	5.8	22.6	10.2	10.4			14.0 (*4)	7.6	18.1(*4)	5.3	19.6(*9)	4.55
1.5									21.4	3.8	23.3	3.2
1.0			10.7	7.9							27.5	2.3
0.68			12.0	6.3							31.5	1.75
0.33											39.7	1.1

*Other part numbers available upon request

Note: Current value (Rated Current) is the typical value when overall temperature rise is 40K up with multi-layer PWB (high-heat dissipation)
(*1) 95μH (*2) 97μH (*3) 48μH (*4) 2.5μH (*5) 97.0μH (*6) 3.2μH (*7) 66μH (*8) 14.0μH (*9) 2.5μH

Selection Guide

Panasonic's ETQP Series Selection Guide

Low Profile Series // LE Series

Type	5x5 ETQP3M__KVP		6x6 ETQP3M__KVN		8x8 ETQP4M__KVK		10x10 ETQP4M__KVC		6x6 ETQP4M__KFN		7x7 ETQP4M__KFM	
(Size) WxLxT Height=t	5.5x5.0mm t=3.0mm		6.4x6.0mm t=3.0mm		8.5x8.0mm t=4.0mm		10.7x10.0mm t=4.0mm		6.4x6.0mm t=4.8mm		7.4x7.0mm t=4.8mm	
LO (μH)	Rated Current (A)	DCR (mΩ)	Rated Current (A)	DCR (mΩ)	Rated Current (A)	DCR (mΩ)	Rated Current (A)	DCR (mΩ)	Rated Current (A)	DCR (mΩ)	Rated Current (A)	DCR (mΩ)
47							3.4	132.0			2.9	148.6
33			2.1	206	3.1	118	4.2	84.6				
22			2.7	128	3.8	78.4	5.0	60.0			3.9	84.1
15			3.0	99.2	4.5	55	6.3	37.0	4.2	63.8		
10	2.9	96	3.6	71.0	5.2	41.6	7.6	25.4	5.2	40.4	6.0	36.0
6.8	3.5	65.7	4.5	45.6	6.9	23.5	8.9	18.5	5.9	32.1		
4.7	4.1	45.6	5.6	29.0	8.3	16.1	11.2	12.3	7.3	20.7	8.8	16.8
3.3	5.4	27.3	6.1	24.1	8.9	14.1	12.6	9.4	9.2	13.1		
2.2	6.3	20.0	7.9	14.5	11.4	8.5	14.8	6.8				
1.5	8.1	12.0	9.1	11.0	15.1	4.9	17.4	4.9				
1.0	9.0	9.6	12.1	6.2	17.3	3.7	23.9	2.6				
0.68	10.2	7.6	13.2	5.2	19.5	2.92						
0.47	11.6	5.8										
0.33	12.7	4.85										

*please contact Panasonic for availability

Note: Current value (Rated Current) is the typical value when overall temperature rise is 40K up with multi-layer PWB (high-heat dissipation)

Panasonic's ETQP Series Selection Guide

High Frequency Series // High Vibration Resistance Series // Large Current Series





Type	5x5 ETQP3M__HFP		6x6 ETQP3M__HFN		8x8 ETQP5M__YSK		10x10 ETQP5M__YSC		12x12 ETQP*M__JFA	
(Size) WxLxT Height=t	5.5x5.0mm t=3.0mm		6.5x6.0mm t=3.0mm		8.5x8.0mm t=5.4mm		10.9x10.0mm t=5.0mm		13.2x12.8mm t=8.0mm	
LO (μH)	Rated Current (A)	DCR (mΩ)	Rated Current (A)	DCR (mΩ)	Rated Current (A)	DCR (mΩ)	Rated Current (A)	DCR (mΩ)	Rated Current (A)	DCR (mΩ)
47							4.1 (*5)	102		
33										
22			2.5	144			6.2 (*4)	45.5		
15										
10			3.7	68						
6.8										
4.7									20.2	4.9
3.3									23.6	3.6
2.2	6.3	19.5			14.1 (*1)	7.4	19.7 (*2)	4.48	27.7 (*1)	2.6
1.5							29.8 (*3)	19.8	33.3	1.8
1.0									38.3	1.36
0.68							32.3	1.66	42.6	1.1
0.47										
0.33									53.5	0.7



*please contact Panasonic for availability

Note: Current value (Rated Current) is the typical value when overall temperature rise is 40K up with multi-layer PWB (high-heat dissipation)
(*1) 2.45μH (*2) 2.5μH (*3) 1.9μH (*4) 20.0μH (*5) 44.0μH

Panasonic's ETQP Design & Sales Support

Panasonic offers many tools to help with your circuit designs. Follow the links below for a device library for circuit simulators, CAD data and further information.

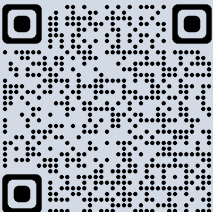
Simulation Data Libraries	Industrial & Automotive use LC filter simulator	Power Inductor Loss Simulator	CAD Data
Equivalent circuit models and S-parameter data can be downloaded for each individual item number.	The Industrial & Automotive use LC filter simulator enables the simulation of attenuation amounts when configuring a filter using Panasonic's power inductor and aluminum electrolytic capacitor suitable for industrial & automotive use.	The Power Inductor loss simulator for automotive application enables the simulation of losses and temperature rises according to the current for Panasonic's power inductors designed for automotive use.	Find inductor CAD data for download (3D STEP, 3D PDF)
 Start Selection	 Start Simulation	 Start Simulation	 Start Selection

Characteristic Viewer	Inductor	Local Technical Support
Characteristic Viewer is the tool which represent various characteristics of a selected part by means of a graph of the frequency axis and temperature axis, etc.		Our Business Development Team as well as our respective Product Managers are available for technical on-site support. Or if you have any further inquiries, you can contact them at Inductor@eu.panasonic.com
 Start Simulation		

Panasonic
INDUSTRY

Panasonic Industry Europe GmbH
Caroline-Herschel-Str. 100 · 85521 Ottobrunn · Germany
Inductor@eu.panasonic.com
<http://industry.panasonic.eu>

