

A Taxonomic Review of Indo-Pacific Didemnid Ascidians and Descriptions of Twenty-three Central Pacific Species¹

L. G. ELDRIDGE

College of Guam

ABSTRACT

Twenty-three didemnid ascidian species, eight of them new, are described from central Pacific waters. The taxonomic position of each is considered with reference to other related Indo-Pacific species. The bases for generic and specific determinations are evaluated; spicule occurrence is too variable to be the sole basis for distinguishing a species, whereas occurrence of algae is shown to be diagnostically significant because of the discovery that algae can be transmitted by the larvae. The family authorship, heretofore variously credited, is attributed to Milne Edwards in accordance with the International Code of Zoological Nomenclature.

In *Trididemnum* the complex of eleven similarly spiculate species is divided into three species groups, some members of which have been synonymized differently by various authors. The "aspicular" *T. profundum* is discovered to infrequently have small clusters of minute spicules at the surface.

Didemnum is defined *sensu stricto* to contain no subgenera. Members of species complexes originally described as *Didemnum* but recently placed elsewhere are maintained according to their original descriptions. The six varieties of *D. psammatodes* are no longer maintained separately.

Leptoclinides rufus is found to be either spiculate or completely aspicular, and its confused synonymy is discussed.

Diplosoma (*nom. cons. pro Leptoclinum*) is defined to comprise two subgenera—*D. (Diplosoma)* and *D. (Lissoclinum)*, which are differentiated on the constancy of spicule occurrence. The monotypic *Echinoclinum* is tentatively reduced to a species of *D. (Lissoclinum)*. The homonyms created by this reclassification are resolved by two suggested *nomina nova*. In *D. (Diplosoma)* the former species *D. rayneri*, *D. macdonaldi*, *D. mitsukurii*, and *D. pizoni* are shown to be indistinguishable and are synonymized with *D. (D.) macdonaldi* (*nom. cons. pro D. rayneri*). The value of the algal pouches discovered in the larvae of *D. (D.) virens* is discussed. The complicated taxonomic status of *D. (L.) fragile* is discussed.

The appendix provides tabularized information concerning the distributions of the species identified and a summary of pertinent Indo-Pacific records. A key to Oahu, Hawaii, species is included.

¹ Contribution No. 254, Hawaii Institute of Marine Biology, the major portion of a dissertation submitted to the Graduate School of the University of Hawaii in partial fulfillment of the requirements for the Ph.D. degree, June, 1965.

Acknowledgments

The author is very much indebted to those many persons whose assistance has made accomplishing this study possible. The work could not have been undertaken without reference to the extensive ascidian literature, and special thanks are due those authors cited who provided reprints of their own current publications and those persons who loaned copies of some of the older references—Dr. A. G. Huntsman and the staff of the Toronto Great Lakes Fisheries Library and Dr. D. J. Zinn, University of Rhode Island. The author is also indebted to those who contributed to the scope of the research by having made collecting at the various central Pacific sites possible or by having provided specimens otherwise unobtainable: Drs. A. H. Banner, H. W. Frings, and R. W. Hiatt, University of Hawaii, for travel to Palmyra, Midway and Kure Islands, and Eniwetok Atoll; Dr. D. P. Abbott, Hopkins Marine Station, for his gift of numerous didemnids collected at Ifaluk and Kapingamarangi Atolls and Hawaii, Dr. A. M. Clark and Mr. F. W. E. Rowe for the loan of several specimens from the British Museum (Natural History); Dr. D. Pawson for the loan of U.S. National Museum specimens; Mr. A. Ross for the use of facilities at the American Museum of Natural History; Mrs. M. L. King, Honolulu, for didemnids dredged off Oahu by the "Pele"; and several fellow students for incidental specimens. The author is particularly grateful to Dr. and Mrs. N. J. Berrill for their enthusiastic encouragement during the completion of the study and to Drs. D. P. Abbott and R. H. Millar for their comments on the finished dissertation. And to his most severe critic, his wife Joann, is extended deep appreciation for her assistance and never-ending interest.

Genera Reviewed and Species Described

Trididemnum Della Valle

Trididemnum profundum

Trididemnum banneri n. sp.

Trididemnum savignii

Trididemnum cyclops

Trididemnum sp.

Didemnum Savigny

Didemnum grande

Didemnum spongioides

Didemnum quincunciale

Didemnum pele n. sp.

Didemnum sp.

Didemnum psammatodes

Didemnum elikapekae n. sp.

Didemnum gintonicum n. sp.

Didemnum edmondsoni n. sp.

Didemnum moseleyi

Didemnum candidum

Polysyncraton Nott

? *Sinecloaca* Carlisle and Carlisle*Leptoclinides* Bjerkan*Leptoclinides rufus**Askonides* Kott*Diplosoma* Macdonald*Diplosoma* (*Diplosoma* Macdonald)*Diplosoma* (*Diplosoma*) *virens**Diplosoma* (*Diplosoma*) *macdonaldi**Diplosoma* (*Diplosoma*) *hiatti* n. sp.*Diplosoma* (*Diplosoma*) *handi* n. sp.*Diplosoma* (*Lissoclinum* Verrill)*Diplosoma* (*Lissoclinum*) *abbotti* n. sp.*Diplosoma* (*Lissoclinum*) *fragile*

Collection: Specimens were collected in the littoral (intertidal) and sublittoral zones from various areas, described below, throughout the central Pacific—30°N, 0°, 150°W, and 140°E—including the Hawaiian Chain, Line Islands, Marshall Islands, and Caroline Islands. The region is used for convenience and is not meant to establish a new faunal area (see Map 1).

Hawaiian Chain

Leeward Islands—collections made under auspices of Research Grant Nonr (g)-00033-62, Project Nr 310 661 to H. W. Frings

Midway Islands (Map 2)

Kure [Ocean] Island (Map 3)

Main Islands

Oahu (Map 4)—specimens from off Barber's Point and Waikiki dredged by the "Pele" from 40 to 120 meters

Auau Channel (between Lanai and Maui)—two specimens taken from 55 meters by a SCUBA diver

Line Islands

Kingman Reef (6°25'N, 162°24'W)—one specimen taken during BCF-HBL Cruise CHG-50 by R. B. T. Iversen

Palmyra Island (Map 5)—collections made under auspices of AEC Contract No. AT (14-2)-235 to A. H. Banner

Marshall Islands

Eniwetok Atoll (Map 6)—collections made under auspices of the Eniwetok Marine Biological Laboratory

Caroline Islands

Ifaluk Atoll (Map 7)—collections made under auspices of the Pacific Science Board Ifaluk Expedition, 1953, by D. P. Abbott, R. R. Rofen, and F. M. Bayer

Kapingamarangi Atoll (Map 8)—collections made under auspices of the Pacific Science Board Kapingamarangi Expedition, 1954, by C. H. Hand

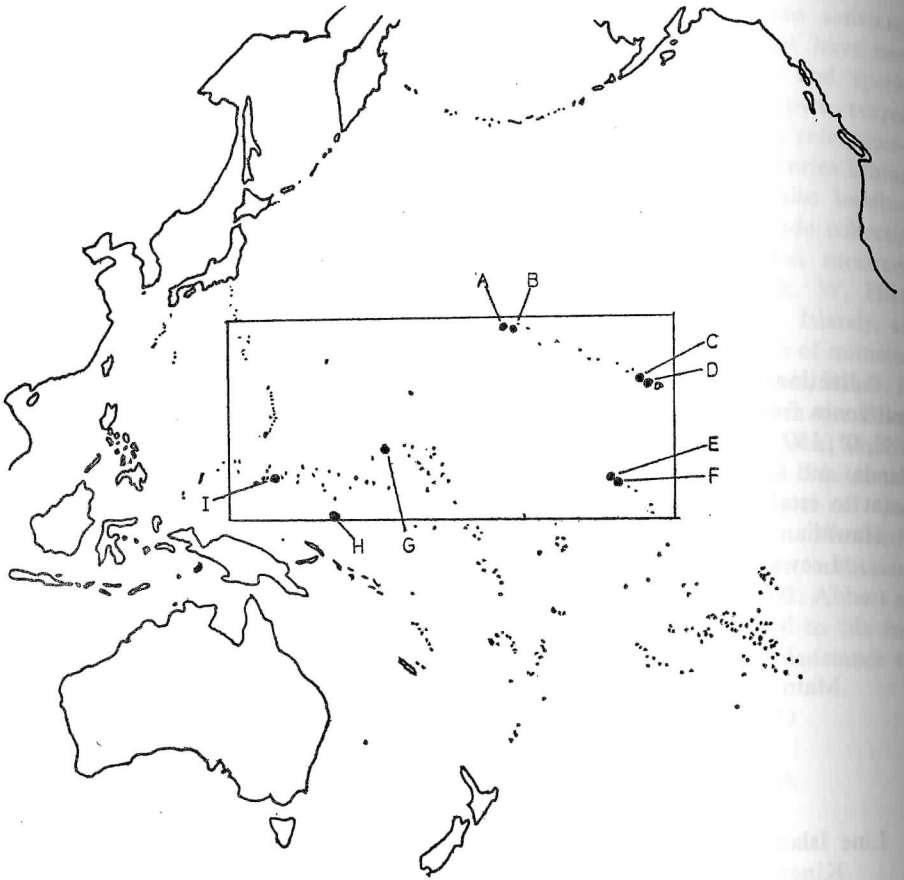

Map 1. The "Central Pacific." Collection sites:

A—Kure Island B—Midway Islands C—Oahu, Hawaii D—Auau Channel
 E—Kingman Reef F—Palmyra Island G—Eniwetok Atoll H—Kapingama-
 rangi Atoll I—Ifaluk Atoll

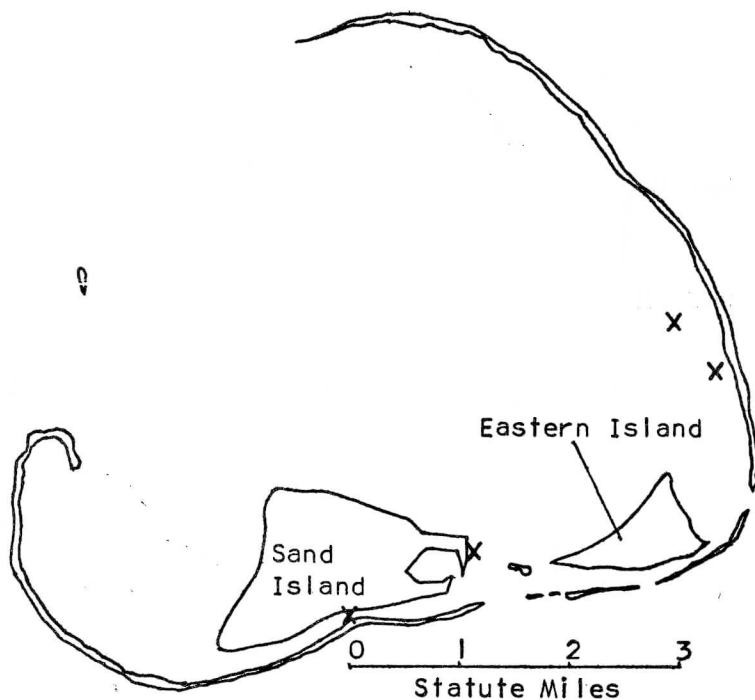

Map 2. Collection sites at Midway Islands ($128^{\circ}12'N$, $177^{\circ}22'W$).

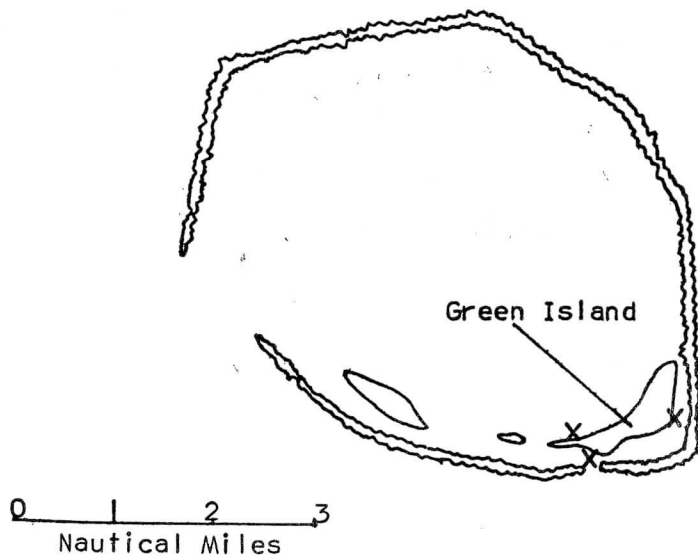

Map 3. Collection sites at Kure Island ($28^{\circ}25'N$, $178^{\circ}25'W$).

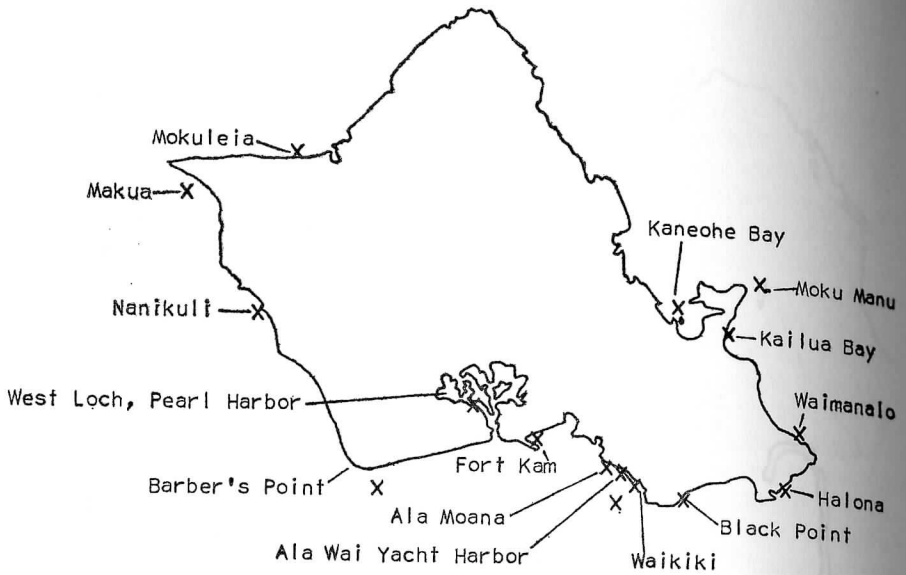

Map 4. Collection sites at Oahu, Hawaii ($21^{\circ}30'N$, $158^{\circ}30'W$).

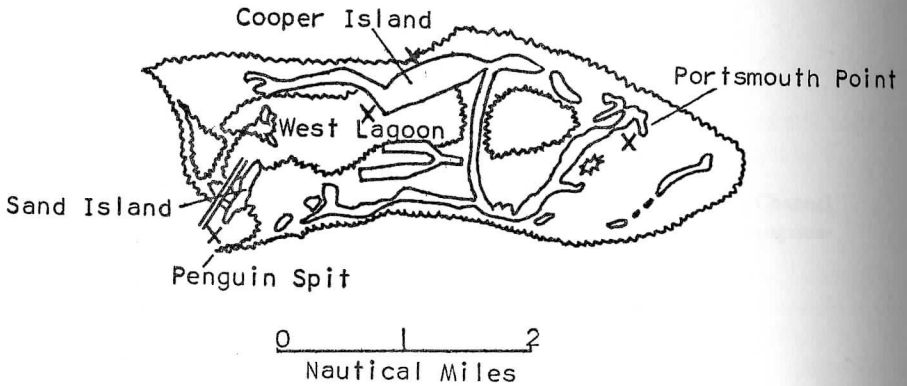

Map 5. Collection sites at Palmyra Island, Line Islands ($5^{\circ}52'N$, $162^{\circ}06'W$).

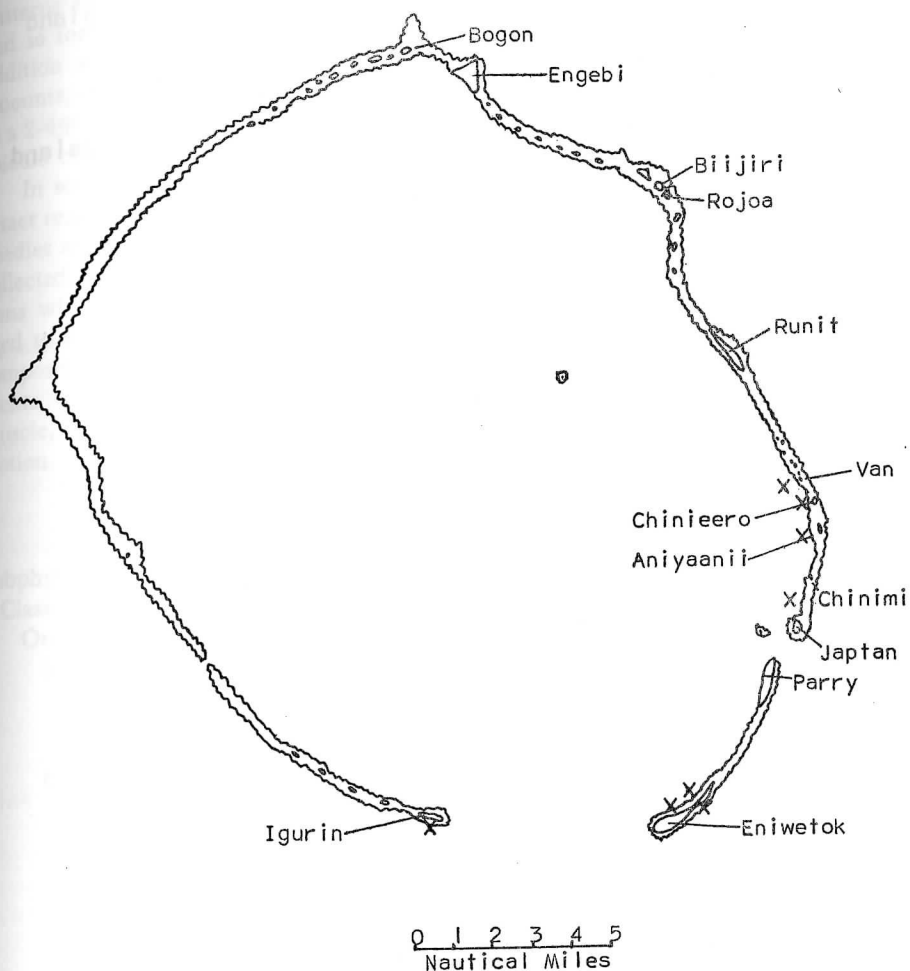

Map 6. Collection sites at Eniwetok Atoll, Marshall Islands ($11^{\circ}21'N$, $162^{\circ}20'E$).

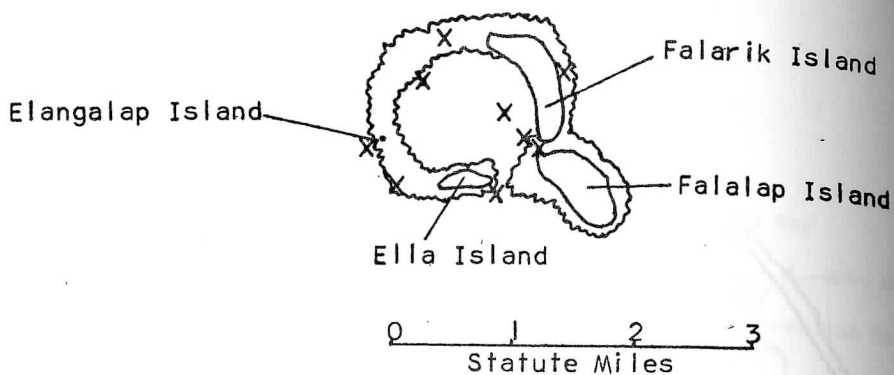

Map 7. Collection sites at Ifaluk Atoll, Western Caroline Islands ($7^{\circ}15'N$, $144^{\circ}27'E$).

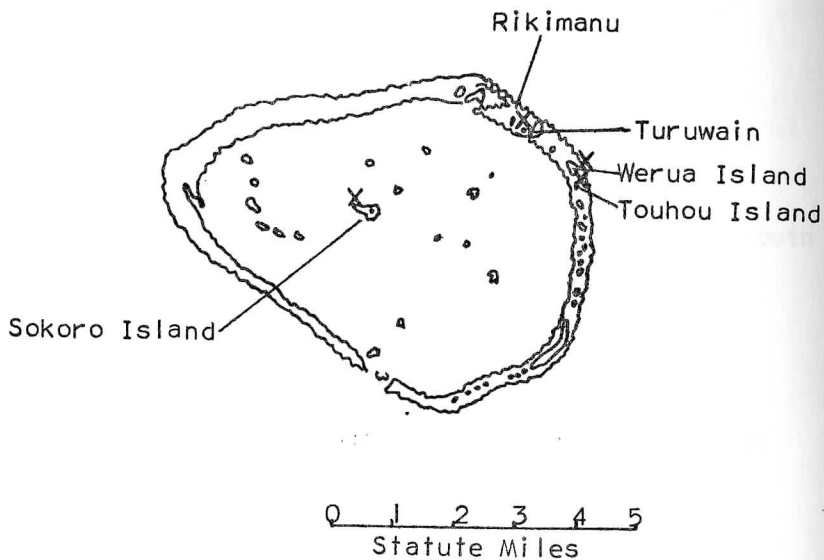

Map 8. Collection sites at Kapingamarangi Atoll, Eastern Caroline Islands ($1^{\circ}04'N$, $154^{\circ}48'E$).

Observation and Preservation: Notes were made on live specimens—on color patterns and surface configurations, numbers of branchial lobes and of stigmata, and so forth. After observation, specimens were relaxed for 8-15 hours by the addition to the natural seawater of the colony of magnesium sulfate in varying amounts, depending on the number of specimens. Specimens were then preserved in a 2-4% formalin solution buffered with additional magnesium sulfate to prevent spicule erosion.

In some colonies the individuals could be removed easily. In others, however, intact removal was impossible, and the common tunic was torn apart with minute needles and/or forceps until a sufficient number of thoraces and abdomens were collected. Several individuals from each colony were examined to observe variations within the colony itself. A dilute solution of aqueous methylene blue was used to stain the outer portions of individuals with indistinct characteristics. A composite drawing was made for the individuals of most colonies, and measurements were taken of such pertinent features as the thorax, abdomen, retractor muscle, atrial siphon, and so forth. Spicule rays were counted at the optical section.

Synopsis of Classification

- Subphylum Tunicata Lamarck, 1816
 - Class Ascidiacea Blainville, 1825
 - Order Enterogona Perrier, 1898
 - Suborder Aplousobranchiata Lahille, 1886
 - Family Didemnidae Milne Edwards, 1841
 - Didemnum* Savigny, 1816
 - Diplosoma* Macdonald
 - Diplosoma (Diplosoma)* Macdonald, 1859
 - Diplosoma (Lissoclinum)* Verrill, 1871
 - Trididemnum* Della Valle, 1881
 - Coelocormus* Herdman, 1886
 - Polysyncraton* Nott, 1892
 - Leptoclinides* Bjerkan, 1905
 - ? *Sinecloaca* Carlisle and Carlisle, 1954
 - †? *Micrascidites* Deflandre and Deflandre-Rigaud, 1956
 - Askonides* Kott, 1962

DIDEMNIDAE Milne Edwards

- SYNONYMY: Didemniens unistellés Milne Edwards, 1841
 Didemnidae + Diplosomidae Giard, 1872, and Coelocormidae Herdman, 1886
 Oligosomidae Jourdain, 1885
- TYPE GENUS: *Didemnum* Savigny, 1816

Definition

Colonial ascidians with zooids situated around a common cloaca; zooids

divided into thorax and abdomen; atrial apertures variable from almost complete exposure of thorax to long siphon, some zooids with atrial languet; vas deferens either coiled or straight, originating from testicular lobe(s); stellate calcareous spicules frequently in tunic; pyloric budding; larvae with antero-median adhesive disks, usually three, and with variable numbers of paired lateral ampullae.

Family Authorship

The question arises as to the correct authorship and date of the family name, Didemnidae. Giard (1872), having used Didemnidae to describe a tribe, is generally cited as the author, but Van Name (1918, 1945) credited Verrill (1871), who used the formal spelling, Didemnidae, without giving the familial characteristics. Earlier in the same year Gill (1871) used the formal spelling in a list without providing any descriptive material. However, if Article 11e(iii) of the International Code of Zoological Nomenclature (1961, p. 11) is followed,

A family-group name published before 1900 . . . , but not itself fully latinized, is available with its original date and authorship, provided that it has been latinized by later authors and that it has been generally accepted by zoologists interested in the group concerned as dating from its first publication in vernacular form.

then the family name should be attributed to Milne Edwards (1841), who first used the vernacular form in describing the tribe Didemniens [after Savigny's (1816) genus *Didemnum*].

Generic Scheme

The generic scheme used herein is that employed by Huus (1937) with four modifications:

1. The subgenus *Didemnum* (*Polysyncraton*) is considered the distinct and valid genus *Polysyncraton*.
2. *Lissoclinum* is reclassified as a subgenus of *Diplosoma* (*nom. cons. pro Leptoclinum*).
3. *Echinoclinum verrilli*, the only published species in that genus, is questionably reclassified as *Diplosoma* (*Lissoclinum*) *verrilli*.
4. ? *Sinecloaca* and *Askonides*, two genera not known by Huus, are also included.

Deposition of Type Material

Syntypic series will be deposited in the Smithsonian Institution (U.S. National Museum), Washington, D. C., and in the B. P. Bishop Museum, Honolulu, Hawaii. Representatives of the larger series will be retained in the author's collection, and portions of each series collected by D. P. Abbott will be sent to him at the Hopkins Marine Station, Pacific Grove, California.

Bases for Generic and Specific Determinations

Primary generic determinants are, in the order of their diagnostic importance, the nature of the vas deferens, the number of stigmata rows, the structure of the

testis, the structure of the atrial opening, and the extent of the cloacal system. Each of these features is outstandingly diagnostic of a particular genus. Of secondary value are combinations of these determinants and such variations thereof as ranges in the number of testicular lobes and degree of cloacal-system development. Larval characteristics, such as precocious budding and numbers of lateral ampullae, are also valuable; however, the larvae are not well known in each genus.

Specific determinants of primary importance are actually variations of the features by which the genera are diagnosed and differ according to the genus being considered. In general, the most reliable specific determinants are the numbers of stigmata per half row and of vas deferens coils, the particular appearance of the atrial aperture or siphon, the depth and extent of the cloacal canals, and the frequency of larval precocious budding. Of secondary importance when constant and best considered in conjunction with primary determinants, or at least in combination, are such features as colony size, surface appearance (including frequency of cloacal apertures and papillae), presence of algae, presence and distribution of bladder cells, distribution of pigment granules, spicule occurrence (including diameter, number of rays, and distribution), lateral organs, zooid arrangement (whether systematic or random), variations in branchial lobes, occurrence of a retractor muscle, and numbers of tentacles. Of doubtful diagnostic value are those features which are easily distorted in preserved specimens such as color of pigment and shape of stigmata.

Re-evaluation of Spicules and Algae as Determinants

Although spicules—absence or presence, diameter, ray-count, and distribution—are often considered primary generic diagnostic criteria, they should not be so valued (Berrill, 1950; Carlisle, 1953). Even when considered in conjunction with other features, spicule occurrence may not be specifically significant diagnostically. For example, they have been found to occur in species which are normally completely aspicular—by Carlisle (1953) in *Diplosoma* (*Diplosoma*) *listerianum* and herein in *Trididemnum profundum*. Conversely, they may be entirely absent from species which should, by generic definition, be spiculate—*Didemnum pacificum* and *D. flagellatum* (Tokioka, 1953a) and *Didemnum elikapekae*.

Even less reliable than occurrence are spicule distribution and density, which may vary widely not only within a given species but also occasionally within the same colony. Van Name (1952), who indicated that spicules are zooid products, has suggested that inconstant distribution and density dissimilarities occur because the colony undergoes a certain amount of regression during unfavorable periods. At such times the spicules remain fixed within the tunic while the zooids degenerate and are added to when new zooids develop. This phenomenon creates distribution peculiarities, and the spicule density of such a colony thus becomes much greater than that of another in the same species.

Other unreliable aspects of spicules may be ray-counts and diameters, which are easily reduced in specimens preserved in unbuffered formalin.

Furthermore, the diagnostic value of spicules *per se* is difficult to evaluate because their origin is not yet understood. They may develop independently of

of the zooid [Loewig and Koelliker (1846), Giard (1872), Herdman (1886), Woodland (1907), and Prenant (1925)]. On the other hand, they may originate in the lateral organs [Michaelsen (1919) and Pérès (1947)]. Although research in this area has not been conclusive, it is suspected that the lateral organs may have something to do with the development of spicules, in spite of their calcareous nature. The spicules therein are often smaller than those in the surrounding tunic and usually appear in greater profusion. It is noted that the aspicular *Diplosoma* (*Diplosoma*) is also partly diagnosed on the basis of the constant absence of these organs. However, not all spiculate didemnids seem to have them.

Descriptions of several species from time to time have noted the presence of algae, or of bleached algal cells, in the common cloacal systems; however, this condition has not been regarded as diagnostically valuable. The discovery herein of distinct pouches containing algae in the larvae of *Diplosoma* (*Diplosoma*) *virens* is therefore an important one, not only because the pouch itself is of value as a specific determinant for that species but also because it suggests that algae found constantly in colonies of other species should perhaps also be considered of taxonomic importance pending re-examination of the respective larvae.

Key to Didemnid Genera and Subgenera, Based on World-wide Records

[*Coelocormus* Herdman, 1886—a monotypic, aberrant, deepwater, Atlantic form recorded only once—is not included in this key. *Askonides*, *Polysyncraton*, and *Sinecloaca* are not represented in the following study.]

- | | | |
|------|--|---|
| 1 | Proximal part of vas deferens coiled; three or four stigmata rows | 2 |
| | Proximal part of vas deferens straight; always four stigmata rows..... | 7 |
| 2(1) | Four rows of stigmata; spicules almost always present | 3 |
| | Three rows of stigmata; spicules present or absent; no atrial languet; single testis | <i>Trididemnum</i> |
| 3(2) | Atrial aperture..... | 4 |
| | Atrial siphon..... | 5 |
| 4(3) | Atrial languet, when present, very small; usually single testis, occasionally two lobes, rarely three, never four | <i>Didemnum</i> |
| | Atrial languet large flap anterior to atrial aperture; multiple (4-10) testicular lobes | <i>Polysyncraton</i> |
| 5(3) | Cloacal system either postabdominal and/or thoracic canals or postzooid chamber..... | 6 |
| | Cloacal system absent | ? <i>Sinecloaca</i> |
| 6(5) | Smooth-lipped atrial siphon, usually posteriorly directed; distinct cloacal canals, often postabdominal; 1-24 testicular lobes | <i>Leptoclinides</i> |
| | Five-lobed atrial siphon; common cloacal chamber; 4-10 testicular lobes..... | <i>Askonides</i> |
| 7(1) | Spicules absent; no lateral organs; never with atrial languet | <i>Diplosoma</i> (<i>Diplosoma</i>) |
| | Spicules present; usually lateral organs; occasionally small atrial languet..... | <i>Diplosoma</i> (<i>Lissoclinum</i>) |

***Trididemnum* Della Valle**

SYNONYMY:

(*non*) *Didemnum* Savigny, 1816
 (*non*) *Didemnum* Milne Edwards, 1841
Lissoclinum Verrill, 1871 (part)
Trididemnum Della Valle, 1881, *auct. mult.*
Didemnum Giard, 1872 (part)
Didemnum Drasche, 1883 (part)
 (*non*) *Didemnoides* Drasche, 1883
Didemnum Herdman, 1886 (part)
Didemnoides Lahille, 1890
Didemnopsis Hartmeyer, 1903

TYPE SPECIES:

Trididemnum tenerum (Verrill)
 (= *Lissoclinum tenerum* Verrill, 1871)

DEFINITION: Branchial sac with 3 stigmata rows; atrial aperture sometimes extended into short siphon; usually spiculate; vas deferens coiled on single testis; larvae usually with 3 median adhesive disks and 4 (variable—three to many) pairs lateral ampullae.

SPECIES described from or known to occur in Indo-Pacific or western North American (*) waters:

Trididemnum areolatum (Herdman, 1906)
aurantiacum (Herdman, 1886)
auriculatum Michaelsen, 1919
banneri n. sp.
cerebri forme Hartmeyer, 1913
coeruleum (Gottschaldt, 1898)
cyclops Michaelsen, 1921
decipiens (Gottschaldt, 1898)
erythraeum Michaelsen, 1923
globuliferum (Sluiter, 1913)
granosum Sluiter, 1909
luderitzi Michaelsen, 1919
microzoa (Redikorzev, 1913)
natalense Michaelsen, 1920
 **opacum* (Ritter, 1907)
planum Sluiter, 1909
profundum (Sluiter, 1909)
ramosum (Gottschaldt, 1898)
sansibaricum (Michaelsen, 1920)
savignii (Herdman, 1886)
sluiteri Brewin, 1958
spiculatum Kott, 1962
 **strangulatum* Ritter, 1901
symbioticum Pérès, 1962
tenerum (Verrill, 1871)

REMARKS: Members of this genus are distinctive in that all have only three rows of stigmata. The species are differentiated principally by the shape of the

atrial aperture, the number of vas deferens coils, and the absence or presence of spicules (and spicule distribution). That spicules are the least reliable of these criteria is shown by the discovery of tiny, sparsely scattered, spicule clusters in the upper portions of a few *Trididemnum profundum* colonies, a species normally diagnosed as being completely aspicular. Therefore, the use of spicule presence or absence as a primary specific determinant in this genus should be avoided, and the aspicular "trididemnum" forms for which the genus *Didemnopis* was established (Hartmeyer, 1903) are herein treated as species of *Trididemnum*, as indeed they are by most current ascidiologists.

The definitions of many *Trididemnum* species overlap, and descriptions of the twenty Indo-Pacific forms published to date contain a much-confused "complex" of eleven similarly spiculate species. In this "complex" can be seen three distinct groups—the "savignii" group, the "cerebriforme" group, and the "cyclops" group—in each of which the zooid features usually used as major taxonomic indicators so closely resemble one another that making identifications is extremely difficult. The confusion is compounded because some of the specific names have been synonymized differently by various authors. Although the problems are recognized in the present study, no formal specific revisions can be attempted because the specimens collected represent only two of the species heretofore involved and add two more forms to the entire "complex." (See remarks under *T. savignii*, *T. cyclops*, *T. banneri*, and *Trididemnum* sp., as well as Tables I and II for detailed discussions.)

Key to *Trididemnum* Species Described

- 1 Numerous cloacal apertures per colony; colony directly attached along entire basal surface; without algal cells.....2
 - Single cloacal aperture per colony; colony attached by peripheral strands; algal cells in cloacal canals.....4
- 2(1) Cloacal canals thoracic; 7-9 vas deferens coils; always spiculate3
 - Cloacal canals thoracic and postabdominal; 6-7 vas deferens coils; usually aspicular—very infrequently small clusters of tiny spicules at surface*T. profundum*
- 3(2) Branchial sac with 10-13 stigmata per half row; colony dark brown; spicules in thin distinct layer above or in streaks just below thorax.....*T. banneri*
 - Branchial sac with 6-9 stigmata per half row; colony always light (white or tan); spicules in various concentrations throughout tunic*T. savignii*
- 4(1) Atrial aperture narrowly incut to middle of branchial sac; dark endostylar cap; spicules dense throughout tunic, diameter to 35 μ*T. cyclops*
 - Short atrial siphon; no endostylar cap; spicules dense only in uppermost and basal tunic, diameter to 50 μ *Trididemnum* sp.

Trididemnum profundum (Sluiter)

SYNONYMY:

Didemnoposis profundus Sluiter, 1909, Siboga-Exped. Monogr. 56b:44.

Trididemnum aspiculatum Kott, 1957, John Murray Exped. 1933-34 Sci. Rep. 10(4):139.

[*T. profundus* Kott, 1962, Aust. J. Mar. Freshw. Res. 13(3): 275.]

DISTRIBUTION:

Malaya (Sluiter, 1909)

South Arabia (Kott, 1957)

Oahu—Leeward Sand Island, Kaneohe Bay; 1-VIII-63; 1 colony.

Coconut Island, Kaneohe Bay; 30-VII-64; 2 colonies.

Kapingamarangi—Reef between Turuaimu and Rikimana Islets; 9-VIII-54 (Coll. C. H. Hand); 6 colonies.

Ifaluk—Lagoon Station D, *Halimeda*-covered knoll at 12 m.; 3-X-53 (Coll. D. P. Abbott & F. M. Bayer); 1 colony.

Southwest end of Falarik Islet; 9-X-53 (Coll. D. P. Abbott); 19 colonies.

Channel between Falarik and Falalap Islets; 26-X-53 (Coll. D. P. Abbott & F. M. Bayer); 20 colonies.

Substrates: coral (*Porites* sp., *Stylophora* sp.), calcareous algae (*Halimeda* sp., *H. stupeosa*)

DESCRIPTION: (See Figure 1)

Colony—Shape variable—longest axis to 3 cm., thickness to 1 cm.; color alive (Oahu specimens) and preserved (all specimens) dark brown throughout; cloacal apertures numerous, indistinct; cloacal canals shallow, thoracic with occasional thin postabdominal extensions; spicules found only rarely, scattered in tiny clusters below very thin surface bladder-cell layer; spicule diameter 10-25 μ , innumerable flat-tipped rays giving spheroidal appearance; zooids scattered.

Zooid—Height to 1.5 mm., thorax height one-third to one-half height of abdomen; thorax preserved opaque except, in some, for dark neural complex and dark endostylar cap; extremely short branchial siphon with 6 short lobes; branchial sac with 3 stigmata rows, 10 stigmata per half row; short midthoracic atrial siphon; retractor muscle one-half to three times thorax height; no lateral organs observed; stomach nearly spherical; intestine without recurved loop and with distinct divisions; single testis, 6-7 vas deferens coils.

Larva—3 adhesive disks; usually 5 pairs lateral ampullae (in same colony also some larvae with extra ampulla on left side, others with 4 lateral pairs and single median-ventral ampulla); ampullae long, thin, darkly pigmented and broadened at tips; length without tail to 1.3 mm.; thorax with atrial siphon; branchial sac with 3 stigmata rows.

REMARKS: The specimens studied differ somewhat from Sluiter's (1909) original description. A minor deviation is that they all have a greater number of stigmata per half row. Sluiter described six or seven in his single specimen, whereas ten are seen constantly in the zooids of the numerous colonies examined. This difference, however, corresponds well to Kott's broadened definition of the species, for she (1962) questionably synonymized with *T. profundus* [*sic*] her (1957) *T. aspiculatum*, which is characterized in part by having between eight and ten stigmata per half row. Because Kott's reclassification appears only incidentally in a specific key, unaccompanied by either a description of new rec-

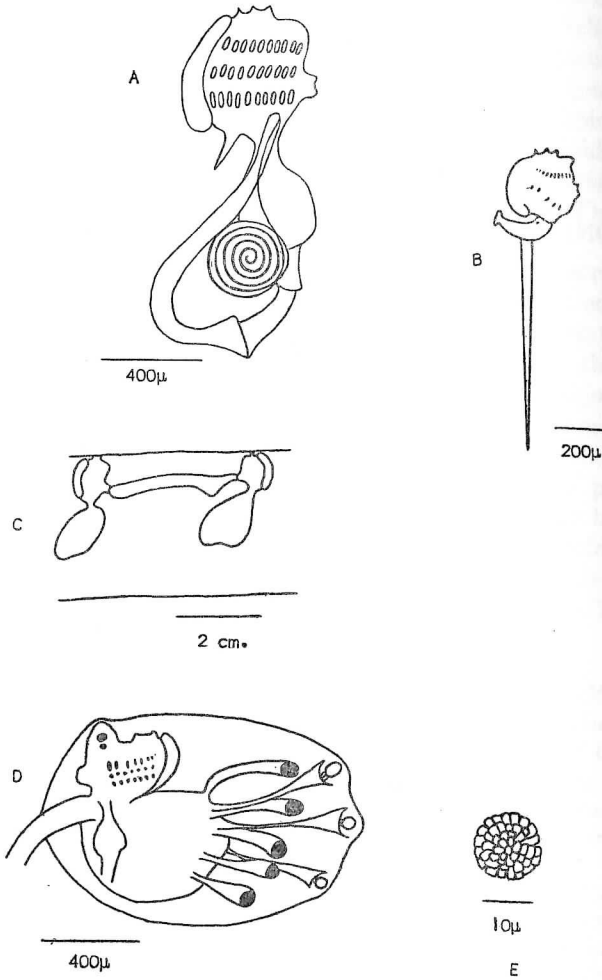

Fig. 1. *Trididemnum profundum*: A. zooid; B. thorax with long retractor muscle; C. colony cross section showing shallow thoracic portion of common cloacal canal; D. larva; E. typical spicule.

ords or by a discussion, the 1962 reference appears in the above synonymy in brackets.

More significant is the discovery, upon extremely close examination, of sparsely scattered, very small clusters of tiny (diameter 10–25 μ) spheroidal spicules just below the thin surface bladder-cell layer in a few of the colonies examined. *T. profundum* can no longer be maintained as a completely aspicular species. Although spicule presence or absence alone should not be used as a primary taxonomic indicator for this species, the infrequent occurrence of scattered clusters can be considered of some secondary diagnostic value.

Neither Sluiter (1909) nor Kott (1957) recorded larvae for this species. The description herein is important taxonomically, for the arrangement of the lateral

ampullae in five, rather than the usual four, pairs is unique. Also, the dark pigmentation of the ampullae is unusual.

Trididemnum banneri n. sp.

DIAGNOSIS: 10-13 stigmata per half row; 7-9 vas deferens coils; large spicules in thin layer above or in streaks just below thorax; larvae with 3 pairs lateral ampullae.

DISTRIBUTION: (*Type Locality)

Kure—20-VI-63; 15 colonies.

Palmyra—Offshore Sand Island; 10-V-62; 4 colonies.

*Penguin Spit; 13-V-62; 4 colonies.

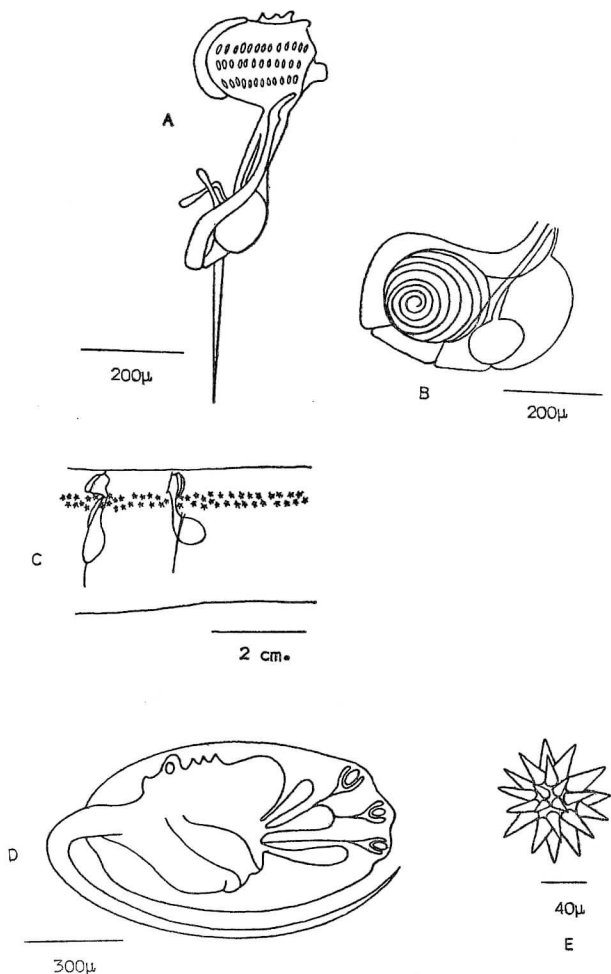

Fig. 2. *Trididemnum banneri*: A. immature zooid with two stolons; B. mature abdomen with testis, vas deferens, and small ovary; C. colony cross section; D. larva; E. typical spicule.

Substrate: coral (*Montipora* sp.)

DESCRIPTION: (See Figure 2)

Colony—Surface smooth, shape variable—longest axis to 4 cm., thickness to 4 mm.; color alive dark brown to velvety black, preserved translucent tan; cloacal apertures numerous, indistinct; cloacal canals shallow, thoracic; large spicules either in continuous layer not more than three spicules thick just under bladder cells at level of thorax anterior or in thin streaks just below thorax, and in bases of cloacal canals; spicule diameter to 120 μ , 12-15 pointed conical rays at optical section; thick (to 750 μ) bladder-cell layer at surface; zooids scattered.

Zooid—Height to 1 mm.; thoracic pigmentation light tan to overall dark brown; short branchial siphon with 6 lobes; branchial sac with 3 stigmata rows, 10-13 stigmata per half row; short atrial siphon at level between second and third stigmata rows; retractor muscle as long as 1 mm.; no lateral organs observed; (in same colony) abdomen either in straight line with or perpendicular to thorax; single testis, 7-9 vas deferens coils; stolons projected anteriorly in some colonies.

Larva—(Seen only in one colony from Penguin Spit, Palmyra) 3 adhesive disks; 3 pairs lateral ampullae—long, slender, broad-tipped; length without tail to 975 μ .

REMARKS: Except for being superficially like the nonconvoluted form of *Trididemnum cerebriforme* [Kott's (1957) *T. luderitzi*], these specimens bear no significant resemblance to any *Trididemnum* species described to date. They are considered closely related to *T. cerebriforme* (see Table I) but distinct from that species. The zooids exhibit a greater number of stigmata per half row; the larvae have three, rather than four, pairs of lateral ampullae; and the colonies contain larger spicules distributed in a much more restricted pattern. These specimens represent a new species, the name *Trididemnum banneri* being chosen because travel to the type locality was provided by Dr. A. H. Banner.

Trididemnum savignii (Herdman)

SYNONYMY: *Didemnum savignii* Herdman, 1886, Rep. Sci. Res. Voy. H. M. S. Challenger, Zool., 14(38):261.

D. atrocantum, *D. lucidum*, *D. porites*, *D. savignii* Van Name, 1902, Trans. Conn. Acad. Arts Sci. 11:359, 360, 360, 358.

?*D. areolatum* Herdman, 1906, Ceylon Pearl Oyster Fish., 5 (suppl. 39):337.

Didemnoposis jolense Van Name, 1918, Bull. U. S. Natl. Mus. 100, 1(2):147.

Trididemnum savignii + *T. s.* form *porites* Van Name, 1921, Bull. Am. Mus. Nat. Hist. 44:314, 317.

T. savignii Van Name, 1924, Bijdr. Dierk. 23:25.

T. savignii Sluiter, 1929, Bull. Soc. Sci. Nat. Maroc 9(7-8):116.

T. savignii Van Name, 1930, Sci. Surv. Porto Rico Virgin Is. 10 (4):428.

T. savignii Hastings, 1931, Great Barrier Reef Exped. 1928-1929 Sci. Rep. 4(3):91.

T. savignii Berrill, 1932, Biol. Bull. 62(1):77.

T. savignii Van Name, 1945, Bull. Am. Mus. Nat. Hist. 84:100.

T. savignii Pérès, 1949, Bull. Inst. Franc. Afr. Noire 11(1-2):184.

- T. savignii* Pérès, 1951, Bull. Inst. Franc. Afr. Noire 13(4):1056.
T. savignii Tokioka, 1953, Ascidians of Sagami Bay, p. 197.
T. savignii Tokioka, 1958, Encyclopaedia Zoologica Illustrated in Colours 2:377.
T. savignii Tokioka, 1962, Pub. Seto Mar. Biol. Lab. 10(1):3.
T. sp. aff. savignii var. *jolense* Tokioka, 1962, Pub. Seto Mar. Biol. Lab. 10(2):271.

DISTRIBUTION: Extensive throughout tropical and subtropical Atlantic and Indo-Pacific (see Map 9)

Oahu—Coconut Island, Kaneohe Bay; 2-VIII-61, 29-XI-61, 13-XII-61, 21-XI-62, 1-VIII-63; approximately 20 colonies.
 Substrates: wood (floating dock), glass (test panel), sabellid worm tubes, barnacles, solitary ascidians (*Herdmania momas*), bivalve mollusks (*Ostrea* sp.)

DESCRIPTION: (See Figure 3)

Colony—Growth extensive, shape irregular—no real axis, thickness variable to 3 mm., depending on irregularities of substrate; color alive and preserved pure (spicule) white, some with dull tan effect from darkly pigmented thoraces; cloacal apertures numerous, indistinct, round or oval; cloacal canals thoracic (anastomotic secondary canals in one colony); spicules infrequent at branchial lobes, in dense layer just below thin surface bladder-cell layer, in sparse layer around zooids, scattered in basal tunic; spicule diameter to 50 μ , usually 12 blunted rays at optical section; zooids scattered.

Zooid—Height less than 1 mm.; thoracic pigmentation (preserved) variable from none to dark circumbranchial ring and dark endostylar cap (developing thoraces most often without pigment); branchial siphon to 100 μ with 6 distinct lobes; branchial sac with 3 stigmata

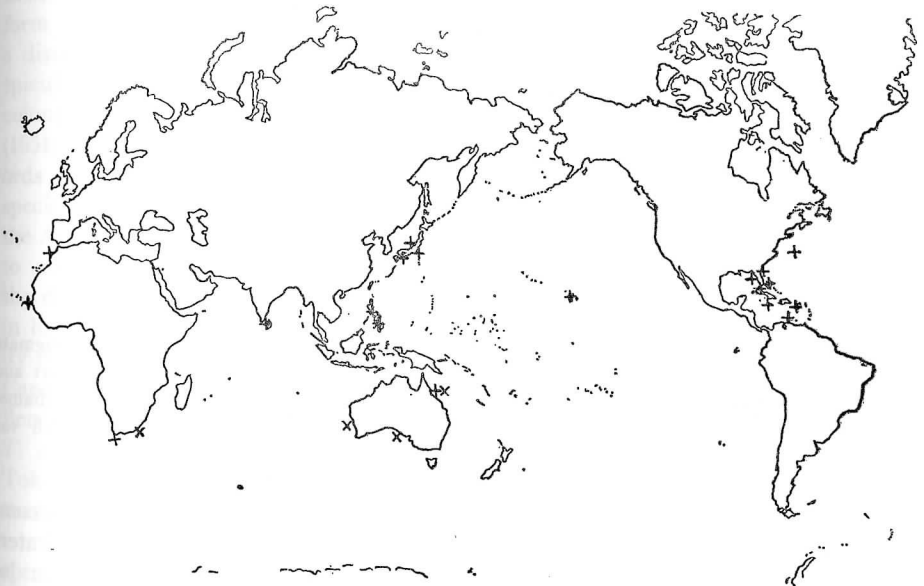

Map 9. Distribution of *Trididemnum savignii* (+), including present records, and of *T. natalense* (x).

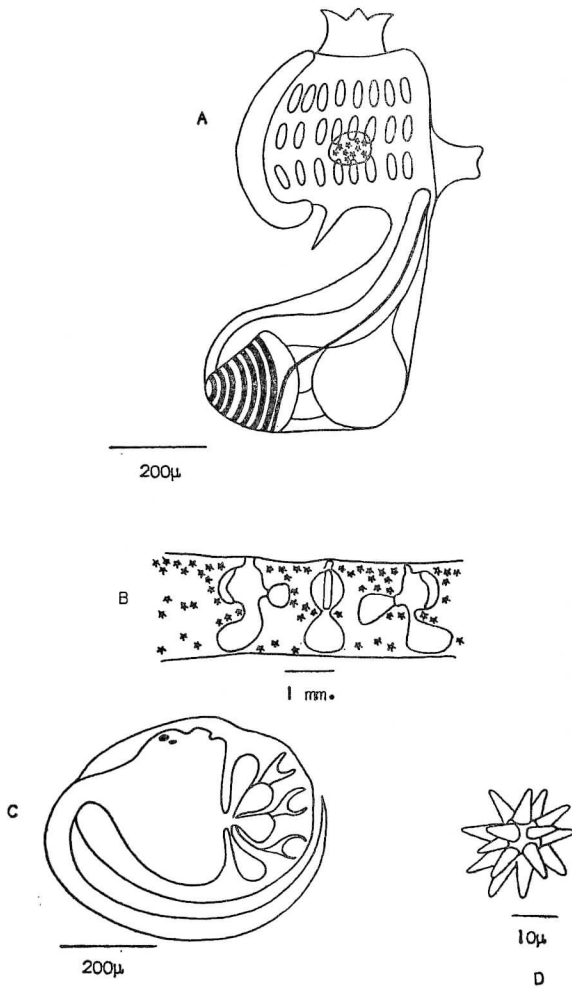

Fig. 3. *Trididemnum savignii*: A. zooid with spicule-filled lateral organ; B. colony cross section; C. larva; D. typical spicule.

rows, 6-9 stigmata per half row; atrial siphon at level between second and third stigmata rows—short in some, longer and posteriorly directed in others; retractor muscle short and blunt, often equal to height of branchial siphon; lateral organs (when present) large (diameter to $100\ \mu$), containing 3-20 spicules; stomach somewhat square; single testis, 7-8 vas deferens coils.

Larva—3 adhesive disks; 4 pairs lateral ampullae; length without tail to $500\ \mu$.

REMARKS: Were it not for Tokioka's (1953a) excellent description, accompanied by detailed figures, of *Trididemnum savignii* occurring in Japanese waters and for his (in press) record of this species from Hawaii and other Pacific localities, identification of the specimens collected would have had to be tentative. They vary widely in spicule distribution and in thoracic pigmentation, and the

numbers of stigmata per half row and of vas deferens coils fall somewhat below the maximums noted by Van Name (1945). However, the counts and variations are consistent with those described by Tokioka (1953a), and in all other respects the specimens examined correspond very closely to previous *T. savignii* descriptions.

A species extremely similar to *T. savignii* is *T. natalense*, which is differentiated primarily by the somewhat irregular distribution of (layered) spicules (with greater concentration in the basal tunic), by a more constantly dark thoracic pigmentation, by one less vas deferens coil, and to a lesser degree by a slightly longer atrial siphon and retractor muscle. However, these differences are of reasonably minor importance; indeed, if the two species were united, the "differences" would no doubt constitute reasonable ranges of variations within the single species useful diagnostically in separating that species from other members of the genus. Specifically, both *T. savignii* and *T. natalense* have been characterized by various authors as having spicules of similar diameter with 12 rays at the optical section distributed in rather distinct layers throughout the colony, thoracic cloacal canals, variably pigmented thoraces (sometimes with dark endostylar caps) within the same colony, atrial siphons rather than apertures, and similar numbers of stigmata per half row and of vas deferens coils. Neither has been described as containing algae, as have some other members of this genus.

Recognition of the confusingly close relationship between *T. savignii* and *T. natalense* was noted as early as Michaelsen's original description (1920) of *T. natalense*, in which he specifically separated these species on the basis of their different spicule distributions. Van Name at first (1921) listed *T. natalense* as a doubtful synonym for *T. savignii* but later (1945) considered it a distinct old-world form closely related to *T. savignii*. Hastings (1931) also treated *T. natalense* as a distinct species, differentiated from *T. savignii* primarily by its (clustered) spicule distribution and lack of thoracic pigmentation, and described a single colony of each from the Great Barrier Reef. Kott (1962) disallowed Hastings' (1931) separation on the bases of such variable characteristics, treated both records as descriptions of *T. natalense*, and herself discriminated between the two species by their separate geographic confinement. *T. savignii* she relegated to the Atlantic Ocean only, and *T. natalense*, its "counterpart" (Kott, 1962, p. 275), to northern Australia, the East Indies, and the Indian Ocean. Interestingly, she did not include Tokioka's earlier (1953a) record of the Japanese *T. savignii* in her synonymy for *T. natalense*. Nor did she discuss the doubtful type locality of the original *T. savignii*, which Herdman (1886) gave as probably off the Cape of Good Hope and which Van Name (1945) suggested as perhaps being Bermuda because the description closely corresponded to those given later for *T. savignii* specimens from Bermuda and Florida waters. On the other hand, Tokioka (1953a, 1958b) preferred the Cape of Good Hope type locality, stating that *T. savignii* enjoys a world-wide tropical and subtropical distribution.

In view of the above disagreements and because the type specimen of each species has yet to be examined, *T. natalense* is not herein synonymized with *T. savignii*, in spite of the anatomical similarities apparent from the literature. Rather, it is preferred at this time to simply identify the present specimens as

T. savignii.

It may be noted that *T. areolatum* appears above as a questionable synonym for *T. savignii*. It is so included because Hastings (1931) synonymized it in this manner following her examinations of the respective type specimens. (See Table I for a diagrammatic sketch of the interrelationships of the "savignii" species.)

Trididemnum cyclops Michaelsen

SYNONYMY:

Trididemnum cyclops Michaelsen, 1921, Ark. Zool. 13(23):19.
T. cyclops Hastings, 1931, Great Barrier Reef Exped. 1928-1929 Sci. Rep. 4(3):89.
T. cyclops Kott, 1962, Aust. J. Mar. Freshw. Res. 13(3):281.

DISTRIBUTION:

Australia (Hastings, 1931; Kott, 1962)
 Madagascar (Michaelsen, 1921)
 Eniwetok—Channel between Rojoa and Biijiri Islets; 22-VIII-62; 13 colonies.
 Substrates: coral (unidentifiable), bivalve mollusks (*Tridacna squamosa*)

DESCRIPTION: (See Figure 4)

Colony—Surface smooth, somewhat convex, shape round or oval—longest axis less than 1 cm., thickness about 1 mm.; indirectly attached by peripheral strands; color alive (spicule) white and green, preserved tan with (bleached) algal cells (7–10 μ in diameter) in cloacal canal; small, single cloacal aperture (largest specimen only with two); single shallow thoracic cloacal canal; spicules concentrated at cloacal aperture, in thin layer below slight surface bladder-cell layer, dense in central and basal tunic; spicule diameter 20–35 μ , 13–15 short conical rays at optical section; zooids scattered.

Zooid—Height to 600 μ ; thorax about as wide as high with distinct dark endostylar cap; short branchial siphon with 6 stout lobes; branchial sac with 3 stigmata rows, 5–6 stigmata per half row; atrial aperture narrowly incut to middle of branchial sac; retractor muscle almost as long as thorax height; no lateral organs observed; stomach elongate; single testis, 7 vas deferens coils.

Larva—2 adhesive disks at right angles to one another; 2 lateral ampullary ridges; length without tail 450 μ , body height to 375 μ .

REMARKS: The specimens examined correspond exactly to Michaelsen's (1921) description of *Trididemnum cyclops* except for the structure of the atrial aperture. In the present specimens the aperture was slightly incut over a portion of the branchial sac, whereas the original record of this species described a very short siphon. However, Hastings (1931) and Kott (1962) have also reported *T. cyclops* as having a small incut aperture. The distribution of spicules in the specimens examined is nearly identical to that in Hasting's photograph (1931, Plate IIB).

The larva description herein is the first offered for this species. Of particular interest is the presence of only two median adhesive disks, a peculiarity previously noted for didemnids only in the larvae of *T. aurantiacum* [Herdman (1886, Plate XXXIII, Fig. 8)], *T. alleni* [Berrill (1947)], of some *Didemnum candidum* [Carlisle (1954); Tokioka (1954c)], and of some *D. maculosum* [Millar (1949)].

There is some possibility that the *T. cyclops* larvae studied are immature. The thorax is indistinct and does not appear to be fully developed. Whether

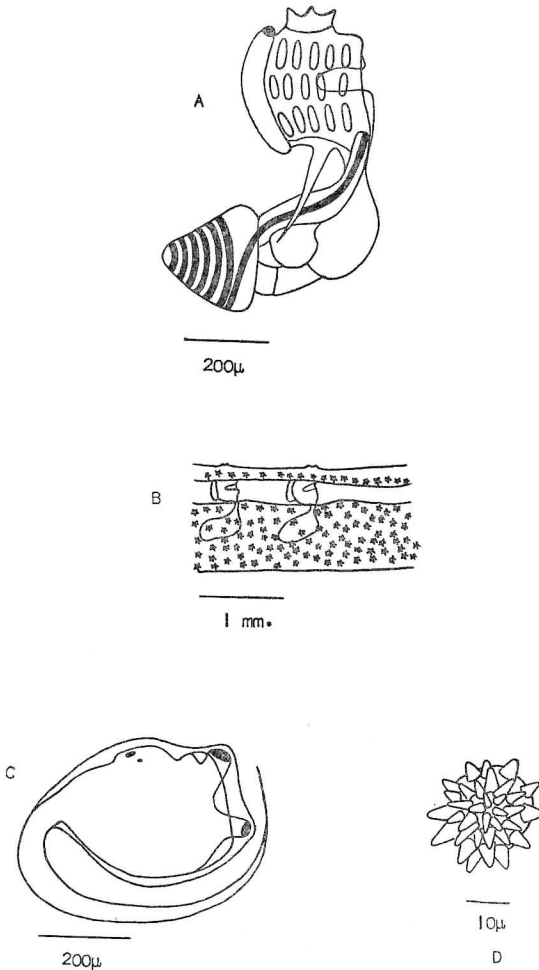

Fig. 4. *Trididemnum cyclops*: A. zooid; B. colony cross section; C. larva (note two adhesive disks and ampullary ridge); D. typical spicule.

lateral ampullary ridges represent merely one phase of ampullar development is not known; nevertheless, this feature is constant among the dozen larvae examined from different colonies.

No algae-filled pouches, such as those described below for the larvae of *Diplosoma* (*Diplosoma*) *virens*, were discernible. However, algae were observed in slide-squashed larvae, and the outlines of intact larvae, more rounded than usual at the posterior ends, strongly suggest that algal pouches are present.

Millar (1961) proposed that the western Indian Ocean forms of *T. cyclops* and *T. natalense* might well be united under the *T. cerebri forme* from the same area. This step should not be taken. Only *T. cyclops* is known to contain algae. It is easily distinguished from the massive convoluted *T. cerebri forme* by the small nonconvoluted colony, the incut atrial aperture, and the unusual

structure of the larvae. Furthermore, *T. cyclops* is much more closely related to species of the "cyclops" group (see *Trididemnum* sp. remarks). *T. natalense* is related to the thin-colonied members of the "savignii" group (see *T. savignii* remarks and Table I).

***Trididemnum* sp.**

DISTRIBUTION: Eniwetok—Channel between Rojoa and Biihiri Islets; 22-VIII-62; approximately 150 colonies.

Substrate: coral (unidentifiable)

DESCRIPTION: (See Figure 5)

Colony—Surface smooth, shape round or oval—longest axis less than 1 cm., thickness about 1 mm.; indirectly attached by peripheral strands; color alive greenish tan, preserved tan

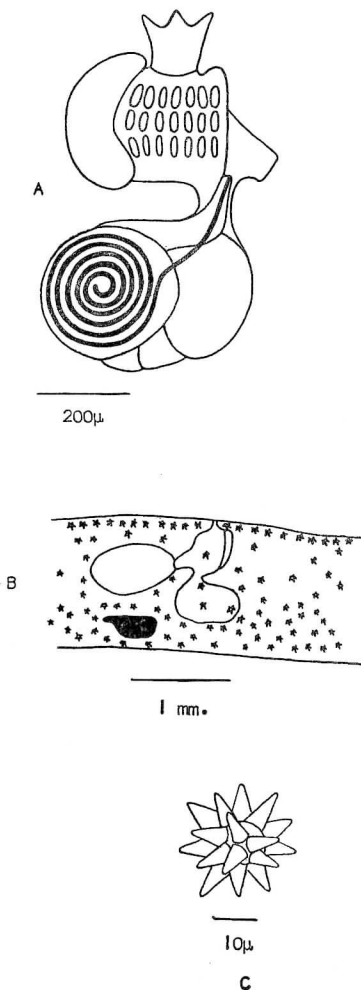

Fig. 5. *Trididemnum* sp. A. zooid; B. colony cross section; C. typical spicule.

with (bleached) algal cells in cloacal canal and (green) algal cells in large rounded mass in basal tunic; single, wide, oval cloacal aperture; single thoracic cloacal canal; spicules in continuous layer at upper surface, scattered in central tunic, dense in thick basal tunic; spicule diameter 30-50 μ , 10-12 short irregularly conical rays at optical section; bladder cells rare at surface; zooids scattered.

Zooid—Height to 1 mm.; thorax wider (500 μ) than high (375 μ) with no pigment or indication of pigment; long branchial siphon with 6 long pointed lobes; branchial sac with 3 stigmata rows, 7 stigmata per half row; long atrial siphon near thorax base, almost always posteriorly directed; no retractor muscle observed; no lateral organs observed; stomach flattened at posterior; intestine without recurved loop; single testis, 6-6½ vas deferens coils.

Larva—None observed.

REMARKS: Although the reproductive systems seen in these specimens are well developed, there is, of course, a possibility that the colonies may not be fully mature. However, it is unlikely that such a large number of colonies would all be in exactly the same stage of development at the same time, and the absence of larvae from them may be significant diagnostically. At least fifty were examined specifically for larvae; none was found. It is interesting to note that the colonies were collected at the same time and from the same vicinity as were the *Trididemnum cyclops* specimens identified above, which did contain larvae.

The specific determination of these colonies cannot be made at this time, for they resemble several interrelated *Trididemnum* species, as Table I indicates.

Table 1. Relationship of *Trididemnum* sp. to some other members of the genus.

[Interrelationships noted herein indicated by dotted curves; synonymies, all questionable, indicated by solid-arrow-curves within a group, by dash-curves across groups—(1) Hastings (1931), (2) Kott (1962), (3) Millar (1961), (4) Tokioka (1953a)].

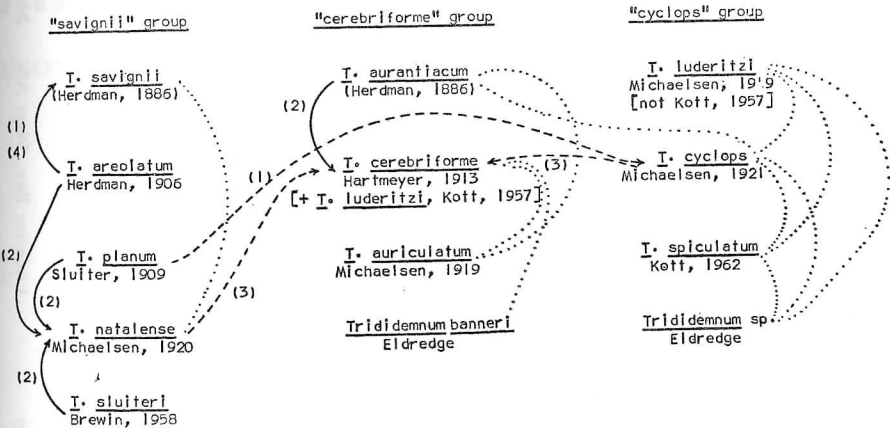

These species form two "complexes": (1) the "cerebriforme" group, in which *T. aurantiacum*, *T. auriculatum*, and Kott's (1957) *T. luderitzi* have in common massive algae-free colonies with extensive cloacal systems, large few-rayed spicules generally restricted to the upper tunic, and tall zooids with numerous

Table II. Characteristics of species constituting the "cyclops" group.

Original Diagnostic Characteristics	<i>T. luderitzi</i> Michaelsen, 1919 [(+1930)]	<i>T. cyclops</i> Michaelsen, 1921	<i>T. spiculatum</i> Kott, 1962	<i>Trididemnum</i> sp.
Colony appearance	small—diameter to 1.2 cm., thickness to 1.5 mm., color [preserved?] white	small—diameter to 1 cm., thickness to 1 mm.; color [preserved?] muddy gray	diameter not given, thickness to 1.5 cm.; color [alive?] green	small—diameter less than 1 cm., thickness to 1 mm.; color alive greenish tan
Cloacal system	single aperture; canals not described	usually single aperture, 2–3 in some large colonies; thoracic canals [single shallow canal in present specimens]	apertures rare; canals thoracic, occasionally also postabdominal	single aperture; single thoracic canal
Spicules	in layer at upper surface; diameter 30 μ (to 42 μ), 8–10 rays at optical section	in layer at upper surface, thick in central and basal tunic; diameter 35–45 μ , 16 rays at optical section	in branchial lobes, more dense at surface than throughout colony; diameter 20–40 μ —most with 14 rays at optical section [from Fig. 12], some smaller forms burr-like	thin continuous layer at upper surface, scattered in central tunic, dense in basal tunic; diameter 30–50 μ , 10–12 rays at optical section
Algae	none	spherical bodies [bleached algal cells in present specimens] in cloacal canals	in cloacal canals	in cloacal canal and in clump in basal tunic
Zooid height	750 μ	900 μ	not given	to 1 mm.
Thoracic pigmentation	not mentioned [none?]	dark endostylar cap	not mentioned [none?]	none
Number stigmata/half row	5, possibly 6 [(7)]	5–7	5	7
Atrial aperture	siphon—somewhat longer than branchial siphon	very short siphon [small aperture?—see <i>T. cyclops</i> remarks]	small aperture, may expose large part of branchial sac	long siphon, almost always posteriorly directed
Lateral organs	small, bowl-shaped	small, plain	not mentioned	none observed
Retractor muscle	very short	long	present [length not given]	none
Number vas deferens coils	8	7	5½–7½	6–6½
Larva	not described	not described [present specimens with 2 adhesive disks, 2 lateral ampullary ridges; length without tail to 450 μ]	3 adhesive disks, 5 (4–6) pairs lateral ampullae; length [without tail?] 700 μ	none observed
Type locality	Lüderitz Bay, West Africa	Madagascar [present specimens from Eniwetok]	Rottnest Island, West Australia	[Collected from Eniwetok]

stigmata per half row; and (2) the "cyclops" group, in which the original *T. luderitzi*, *T. spiculatum*, and *T. cyclops* all have smaller colonies with less extensive cloacal systems, small several-rayed spicules distributed in layers throughout the tunic, and relatively short zooids with few stigmata per half row. In addition, *T. spiculatum* and *T. cyclops* contain algal cells in the cloacal canals.

The two groups are interrelated through the "cerebriforme" *T. aurantiacum*, which corresponds well in colony and zooid features to *T. cerebriforme* and whose larvae closely resemble those of *T. cyclops* in having only two median adhesive disks. As the arrows indicate, the synonymies of *T. cerebriforme* and *T. cyclops* have each included one member of the "savignii" group, which is herein considered distinct (the colonies of those various species are intermediate in size with spicules distributed evenly throughout the tunic) and perhaps more closely related to the "cerebriforme" species than to the "cyclops" group.

No reclassifications are made at this time other than to disallow Millar's (1961) suggestion that the western Indian Ocean forms of *T. cyclops* be united with those of *T. cerebriforme* and to maintain the original *T. luderitzi* as a valid "cyclops" species while reaffirming Kott's (1962) synonymization of her (1957) *T. luderitzi* only with *T. cerebriforme* (see also *T. cyclops* remarks).

The colonies examined fit well within the "cyclops" group; however, they are clearly not members of any one of the species therein. As can be seen in Table II, they correspond to none in all features. Rather, their features resemble some of those of each of the species involved. These specimens may eventually prove to be part of a series which will unite the "cyclops" species; without larvae they cannot serve such a purpose in themselves. They certainly do not present so unique a structure as to warrant being classified as a separate species. Therefore, they are identified at this time only as *Trididemnum* sp.

Didemnum Savigny (*sensu stricto*)

- SYNONYMY: *Didemnum* Savigny, 1816, *auct. mult.*
 (non) *Eucoelium* Savigny, 1816
Leptoclinum Milne Edwards, 1841 (part)
Leptoclinum Forbes and Hanley, 1848 (part)
 ?*Lacinia* Selenka, 1865
Lioclinum Verrill, 1871 (part)
Leptoclinum Giard, 1872 (part)
Eucoelium Giard, 1872
Astellium Giard, 1872 (part)
Leptoclinum Della Valle, 1877
Tetradidemnum Della Valle, 1877
Didemnoides Drasche, 1883
Leptoclinum Drasche, 1883 (part)
 (non) *Didemnoides* Lahille, 1890
Sarcodidemnoides Oka and Willey, 1892
 ?*Lepidium* Hurst, 1896
Hypurgon Sollas, 1903
 (non) *Didemnum* (*Polysyncraton*) Van Name, 1921

(non) *Didemnum* (*Leptoclinides*) Carlisle and Carlisle, 1954

(non) *Didemnum* (*Polysyncrator*) Carlisle and Carlisle, 1954

TYPE SPECIES: *Didemnum candidum* Savigny, 1816

DEFINITION: Branchial sac with 4 stigmata rows; atrial aperture either wide or narrow, never with languet or as siphon; coiled vas deferens usually originating from single (from bilobed in some) testis; usually spiculate; cloacal canals usually thoracic, only occasionally postabdominal; larvae with 2 or 3 median adhesive disks and 4 pairs lateral ampullae.

SPECIES described from or known to occur in Indo-Pacific and western North American (*) waters:

Didemnum albidum (Verrill, 1871)

albopunctatum Sluiter, 1909

areolatum Tokioka, 1953

aspersum Tokioka, 1953

asteropum (Sluiter, 1895)

augusti Michaelsen, 1920

bistratum (Sluiter, 1905)

bisyncrator Michaelsen, 1920

braueri Michaelsen, 1920

caesium Sluiter, 1909

candidum Savigny, 1816

**carnulentum* Ritter and Forsyth, 1917

cerebrale Michaelsen, 1920

ceylonicum (Herdman, 1906)

chartaceum Sluiter, 1909

**chilense* Ärnäck-Christie-Linde, 1929

conglomerans Michaelsen, 1920

cuspidatum Sluiter, 1909

dealbatum Sluiter, 1909

densipunctatum (Gottschaldt, 1898)

digestum Sluiter, 1909

dispersum Sluiter, 1909

dorotubu Tokioka, 1963

(nom. nov. pro *Hypurgon fuscum* Oka, 1931)

edmondsoni n. sp.

edwardsi (Herdman, 1886)

elikapekæ n. sp.

elongatum Sluiter, 1909

flagellatum Tokioka, 1953

fragilis Sluiter, 1909

fraternum Sluiter, 1909

frondescens Hartmeyer, 1909

(nom. nov. pro *Leptoclinium ramosum* Herdman, 1906)

fuscum Sluiter, 1909

giganteum (Gottschaldt, 1898)

gintonicum n. sp.

gottschaldti Hartmeyer, 1909

(nom. nov. pro *Leptoclinium asperum* Gottschaldt, 1898)

- Didemnum grande* (Herdman, 1886)
graveli Das, 1949
jacksoni (Herdman, 1886)
japonicum (Herdman, 1886)
jedanensis Sluiter, 1909
karlae Michaelsen, 1920
kelleri Michaelsen, 1923
laeve (Gottschaldt, 1898)
lambitum (Sluiter, 1900)
lithostrotum Brewin, 1956
maeandrium Sluiter, 1909
makropnous Sluiter, 1909
membranaceum Sluiter, 1909
misakiense (Oka and Willey, 1892)
montosum Sluiter, 1909
moseleyi (Herdman, 1886)
neglectum (Herdman, 1886)
octogesimum (Hartmeyer, 1905)
okudai Tokioka, 1951
pacificum Tokioka, 1953
pantherinum (Sluiter, 1895)
pardale Hartmeyer, 1909
 (nom. nov. pro *Didemnoides maculatum* Gottschaldt, 1898)
pardum Tokioka, 1962
partitum Tokioka, 1953
patella (Gottschaldt, 1898)
patulum (Herdman, 1899)
pele n. sp.
psammatodes (Sluiter, 1895)
pseudodiplosoma Kott, 1962
pustulosum (Sluiter, 1895)
quincunciale Michaelsen, 1920
recurvatum Sluiter, 1909
roberti Michaelsen, 1930
rottnesti Kott, 1962
 **santaelenae* Van Name, 1945
semifusum Sluiter, 1909
siphoniatum (Sluiter, 1895)
spongioides Sluiter, 1909
stilense Michaelsen, 1934
sycon Michaelsen, 1920
tabulatum Sluiter, 1909
tenebricosum Sluiter, 1909
ternatanum (Gottschaldt, 1898)
thomsoni (Herdman, 1886)
tigrinoides Tokioka, 1953

- Didemnum tonga* (Herdman, 1886)
torresii (Sluiter, 1895)
translucidum Tokioka, 1953
tuberatum (Nott, 1892)
turritum Michaelsen, 1930
 **vanderhorsti* Van Name, 1945
velans Michaelsen, 1920
viride (Herdman, 1906)
voeltzkowi Michaelsen, 1920

REMARKS: The genus *Didemnum* is partly defined, *sensu stricto*, by the simple atrial aperture, the usually single testis, and by the "typical" larvae. Therefore, the subgenera sometimes included—*D. (Leptoclinides)*, in which all members have a long atrial siphon and often multiple testicular lobes, and *D. (Polysyncraton)*, in which they have an atrial languet, several testicular lobes, and larvae with many pairs of lateral ampullae—are herein maintained as separate but closely related genera (see respective generic remarks).

Although numerous *Didemnum* species have been recorded, many descriptions are insufficient and/or vague and lack figures. Several very similar species are known solely from their respective type localities, having been collected only once, and it is agreed—as Michaelsen (1934), Van Name (1945), and Millar (1962a) have suggested—that this genus should probably contain fewer species than it does at present. Although no interspecific synonymies can be made at this time (too few of the apparently similar species are represented in the present collection), the varieties of *D. psammatoles* are herein united under that undivided species.

Several *Didemnum* "complexes" have been recognized. The genus appears to be somewhat related to *Diplosoma* (*Lissoclinum*) through the hooked-vas-deferens "complex"—*D. patella*, *D. cerebrale*, *D. voeltzkowi*, and *D. conglomerans*—three of which have been placed in that subgenus. *D. patella* was therein reclassified by Tokioka (1955a), *D. cerebrale* by Kott (1962), who at the same time synonymized Hastings' (1931) specimens of the algae-containing *D. voeltzkowi* with the algae-free *Leptoclinum* [= *Diplosoma*] (*Lissoclinum*) *molle*. However, these species are herein maintained as distinct members of *Didemnum*. The genus *Diplosoma* itself is well defined as comprising species in which the vas deferens is always straight at the proximal end, whereas the degree of coiling varies greatly among the *Didemnum* and has been described at every stage between the half-coil and figure "6" of the above species to a dozen or more turns. Breaking-off points in this continuum have not yet been investigated in conjunction with the constancy of such other features as larval characteristics and algal occurrence.

Another particularly distinct group consists of members which have both thoracic and postabdominal cloacal canals (see *D. spongioides* remarks). A third comprises those species with two or three testicular lobes (see *D. grande* remarks). The genus has always been defined as one whose members contain spicules; however, three aspicular species have been recorded from Japanese waters (Tokioka, 1951, 1953a), and a fourth is described herein from Hawaii (see *Didemnum elikapaka*).

Key to *Didemnum* Species Described

- 1 Single testis, infrequently divided 2
 Always two testicular lobes *D. grande*
- 2(1) Cloacal canals thoracic only, either shallow or deep 3
 Cloacal canals thoracic with constant postabdominal extensions *D. spongioides*
- 3(2) Zooids irregularly scattered 4
 Zooids arranged in rows along each side of cloacal canals .. *D. quincunciale*
- 4(3) Thorax shape "typical"; stigmata rows equal in height 5
 Thorax distorted; first stigmata row $2\frac{1}{2}$ times taller than other rows *D. pele*
- 5(4) Numerous vas deferens coils; abdomen outline approximately round 6
 $1\frac{1}{2}$ vas deferens coils; abdomen outline oval (twice as wide as high) *Didemnum* sp.
- 6(5) Atrial aperture wide, deeply incut 7
 Atrial aperture small oval, narrow slit, or wide but only partially incut 8
- 7(6) Spiculate; more stigmata per half row than vas deferens coils [dark ovoid bodies frequently embedded throughout tunic] *D. psammatodes*
 Aspicular; fewer stigmata per half row than vas deferens coils [white pigment granules scattered throughout deeper portions of colony] *D. elikapekae*
- 8(6) Thoracic cloacal canals extensive with deep interabdominal depressions; spicules usually of same diameter 9
 Thoracic cloacal canals shallow and only at level of atrial aperture; spicules of two distinctly different diameters arranged in separate areas *D. gintonicum*
- 9(8) Branchial lobes at colony surface with occasional spicules 10
 Branchial lobes raised above colony surface, densely spiculate [living colony dark and velvety with distinct white branchial lobes] *D. edmondsoni*
- 10(9) Atrial aperture wide, partially incut; surface often with solid papillae near branchial siphons; spicule diameter 25-40 μ , few rays *D. moseleyi*
 Atrial aperture short narrow slit; surface never papillose; spicule diameter 15-20 μ , numerous rays *D. candidum*

Didemnum grande (Herdman)

SYNONYMY:

- Leptoclinium albidum* var. *grande* Herdman, 1886, Rep. Sci. Res. Voy. H.M.S. Challenger, Zool., 14(38):291.
L. densum Nott, 1892, Trans. N. Z. Inst. 24:311.
Didemnum grande Van Name, 1918, Bull. U. S. Natl. Mus. 100, 1(2):148.

- D. albidum* Michaelsen, 1924, Vidensk. Medd. Dansk Naturhist. Foren. København 77:354.
D. grande Harant and Tuzet, 1932, Mém. Mus. Roy. Hist. Nat., Belgique, hors ser., 3(11):6.
D. (Didemnum) albidum Tokioka, 1951, Pub. Akkeshi Mar. Biol. Sta. 1:2.
D. albidum Brewin, 1951, Trans. Roy. Soc. N. Z. 79(1):107.
D. albidum Kott, 1954, B. A. N. Z. Antarct. Res. Exped. 1929-31 Rep., Ser. B, 1(4):160.
D. candidum Kott, 1957, John Murray Exped. 1933-34 Sci. Rep. 10(4):138.
D. grande Kott, 1962, Aust. J. Mar. Freshw. Res. 13(3):325.

DISTRIBUTION: Japan (Tokioka, 1951)
 Philippines (Herdman, 1886; Van Name, 1918)
 Malaya (Harant and Tuzet, 1932)
 Australia (Kott, 1962)
 Tasmania (Kott, 1954)
 New Zealand (Nott, 1892; Michaelsen, 1924; Brewin, 1951)
 South Arabia (Kott, 1957)
 Palmyra—Portsmouth Point; 15-V-62; 40 colonies.
 Eniwetok—Channel between Roja and Biijiri Islets; 22-VIII-62; 17 colonies.
 Substrate: coral (unidentifiable rubble)

DESCRIPTION: (See Figure 6)

Colony—Growth extensive, shape elongated oval with irregular periphery—longest axis variable, thickness to about 2 mm.; color alive rose-pink to cedar-orange in center, white near periphery; color preserved tan or white, streaked with irregularly dark pigment; cloacal apertures distinct, randomly scattered; cloacal canals shallow, thoracic; spicules in layers—evenly dense above cloacal canals, thick and solid in basal tunic; spicule diameter 15-40 μ , shape spheroidal with innumerable minute rays (or sculptured surface?) all of same length—flat or evenly rounded at distal ends; zooids scattered.

Zooid—Height to 1 mm., opaque thorax and abdomen about same size; short or long branchial siphon with 6 short lobes; branchial sac with 4 stigmata rows, 6-8 stigmata per half row; atrial aperture mid-thoracic narrow slit (small oval in developing thoraces); retractor muscle attached near short esophageal pedicle, length variable to two times thorax height; in some, lateral organs thorax-wall depressions; intestinal tract without distinct recurved loop; 2 testicular lobes, 5-6½ vas deferens coils; variable thoracic buds quite different from mature thoraces (more elongated and very transparent).

Larva—None observed.

REMARKS: The spicules in the specimens examined are somewhat more spheroidal than those described by Van Name (1918) but are generally the same in diameter. The three-dimensionally contiguous rays are most easily seen after the spicules have been broken apart.

The numerous buds and absence of larvae suggest that these colonies may not be fully mature. However, the zooids are well developed, and the specimens are readily identifiable as *Didemnum grande*, one of four *Didemnum* species characterized in part by constantly having at least two testicular lobes. In addition to other differences, *D. grande* has a different number of vas deferens coils than

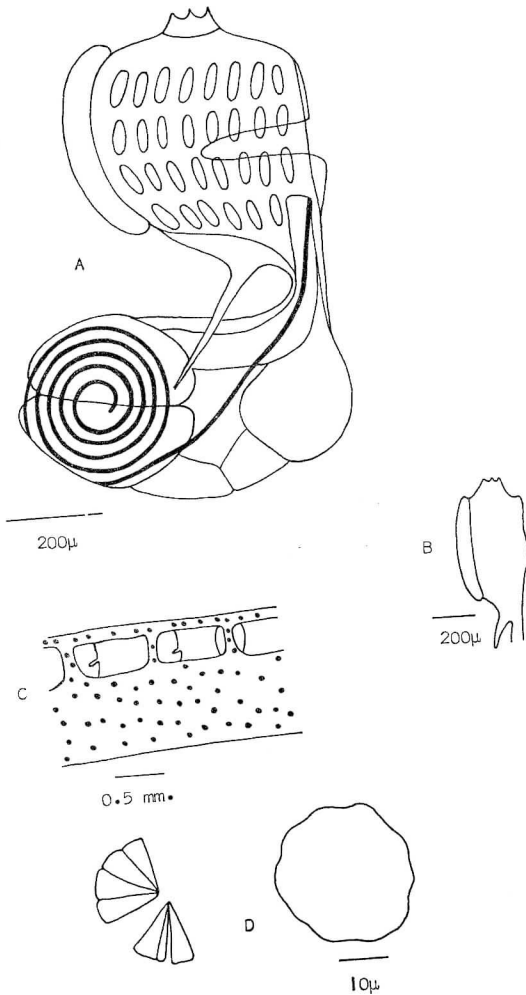

Fig. 6. *Didemnum grande*: A. mature zooid with divided testis; B. thorax of budded zooid with small simple atrial aperture; C. colony cross section; D. typical spicule—section of crushed spicule and entire spheroid.

do the other three—fewer than *D. conchylatum* and *D. studeri* and more than *D. biglans*.

The synonymy for this species includes several records of what were originally other species but which have been found (Kott, 1962) to belong to *D. grande* because the descriptions mention bilobed testes in the various specimens.

Didemnum spongioides Sluiter

SYNONYMY:

Didemnum spongioides Sluiter, 1909, Siboga-Exped. Monogr. 56b:67.

D. spongioides Kott, 1962, Aust. J. Mar. Freshw. Res. 13(3):318.

DISTRIBUTION: Malayan region (Sluiter, 1909)
 Australia and Tasmania (Kott, 1962)
 Ifaluk—Patch reef southwest of Falarik Islet; 28-IX-53 (Coll. D. P. Abbott); 1 colony.
 Lagoon Station D; 3-X-53 (Coll. D. P. Abbott & F. M. Bayer); 4 colonies.

DESCRIPTION: Substrate: ?calcareous algae (*Halimeda* sp. found in bottle)
 (See Figure 7)

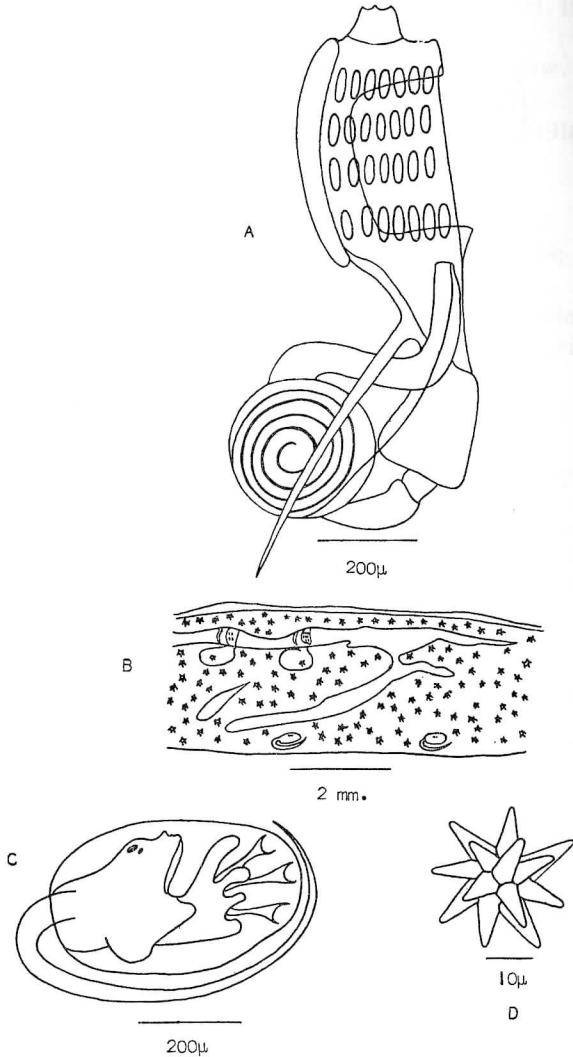

Fig. 7. *Didemnum spongioides*: A. zooid; B. colony cross section showing thoracic and postabdominal cloacal canals and larvae in basal tunic; C. larva; D. typical spicule.

Colony—Surface irregularly uneven, shape variable—longest axis to 2.5 cm., thickness to 3 mm.; color alive purple and black (collectors' note), preserved uneven brown with dark irregularly elongated pigment granules at surface; scattered cloacal apertures raised above surface; cloacal canals shallow, thoracic with thin postabdominal extensions; spicules evenly dense throughout tunic; spicule diameter to $53\ \mu$ (usually $24\text{--}35\ \mu$), usually 8 blunted rays at optical section; zooids scattered.

Zooid—Height to 1 mm.; color preserved translucent tan; short branchial siphon with 6 short pointed lobes; branchial sac with 4 stigmata rows, 7 stigmata per half row; atrial aperture wide, deeply incut; retractor muscle long (to $900\ \mu$), originating from esophageal pedicle; no lateral organs observed; stomach elongated, flattened at each end; single testis, 6 vas deferens coils.

Larva—3 adhesive disks; 4 pairs lateral ampullae along raised ridge, some (immature?) with indented ridge only; length without tail to $625\ \mu$.

REMARKS: These specimens are identical to *Didemnum spongioides* in all zooidal features. However, Sluiter (1909) originally diagnosed this species partly on its unusual growth in many high, irregularly cylindrical tubules marked on the inner surfaces with "trabeculae and ridges" (p. 67). He apparently used the name "spongioides" because his specimens resembled sponges in the surrounding waters, not because he discovered them actually growing over sponges. However, in his figure (Plate VI, Fig. 9) the hollow area under the central portion of the colony corresponds to what could have been the external surface of a sponge. Van Name (1918, 1945) noted similar forms for *D. grande* and *D. candidum* and decided that some ascidians simply smother a living substrate, not collapsing after the substrate disintegrates.

The specimens examined are flat, and were it not for Van Name's (1945) having doubted the diagnostic validity of growth form and for Kott's (1962) having described a *D. spongioides* colony as "embracing a small stone basally" (p. 319), the identification herein would have had to be questionable.

D. spongioides belongs to a loose "complex" of six species in which the members have both thoracic and postabdominal cloacal canals—*D. ceylonicum*, *D. lambitum*, *D. pacificum*, *D. roberti*, *D. spongioides*, and *D. sycon*. It is distinguished from the group by its different number of stigmata per half row and by its (usually) fewer vas deferens coils in conjunction with its large, few-rayed spicules.

Didemnum quincunciale Michaelsen

SYNONYMY: *Didemnum quincunciale* Michaelsen, 1920, Mitt. Zool. Mus. Hamburg 37:19.

DISTRIBUTION: Zanzibar (Michaelsen, 1920)
Eniwetok—Coral knoll, lagoonward Chinieero Islet, 19-VIII-62; 8 colonies.
Substrates: solitary ascidians (*Herdmania momas*) coral (*Acropora* sp.)

DESCRIPTION: (See Figure 8)

Colony—Growth somewhat extensive, shape irregular—longest axis variable, thickness 1.5–2 mm.; color alive mottled maroon and white, preserved dark with darker pigment granules in irregular elongated strands on surface; cloacal apertures few, scattered (single in smallest

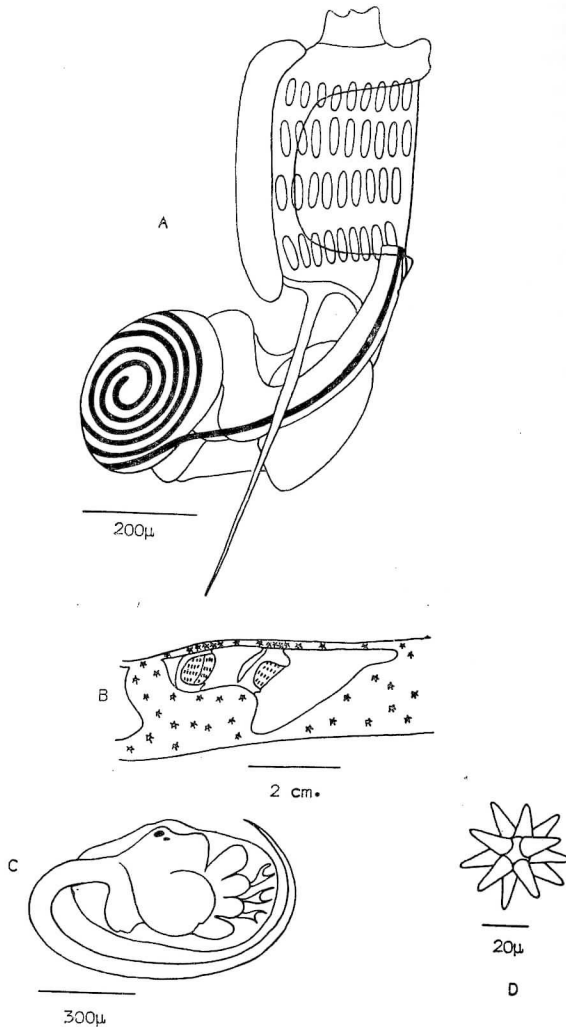

Fig. 8. *Didemnum quincunciale*: A. zooid; B. colony cross section; C. larva; D. typical spicule.

colony); cloacal canals thoracic and extensive, radiating from apertures throughout colony and extending laterally toward abdomens of zooids unevenly arranged in rows on either side; spicules concentrated at branchial lobes, absent from cloacal apertures, evenly dense throughout tunic; spicule diameter 40–60 μ , usually 11–12 somewhat blunted rays at optical section.

Zooid—Height to 1.3 mm.; transparent when preserved; short branchial siphon with 6 minute lobes; branchial sac with 4 stigmata rows, 9 stigmata per half row; atrial aperture wide, deeply incut; retractor muscle as long as 1.6 mm. (often more than twice thorax height); no lateral organs observed; stomach flattened at posterior; single testis, 5–5½ vas deferens coils.

Larva—3 adhesive disks; 4 pairs broad lateral ampullae; length without tail to 600 μ .

REMARKS: These specimens differ from the original description in having three more stigmata per half row and slightly larger (by $4\ \mu$) spicules. However, the double-row positioning of the zooids along the sides of the cloacal canals is unique and is an important diagnostic characteristic for this species. Although Michaelsen (1920) originally questioned its taxonomic value, it is a constant condition in all the colonies examined.

Didemnum pele n. sp.

DIAGNOSIS: Colony surface irregularly papillose; thorax distorted—width at anterior more than four times that at base; first third to half of endostyle lies along broad anterior surface; stigmata rows of inwardly sloping branchial sac visible through anterior surface as ovals of posteriorly decreasing circumferences; stigmata in first row about twice as wide as and much taller ($125\ \mu$) than those of other rows ($50\ \mu$), 6 stigmata per half row; single testis, 5 vas deferens coils.

DISTRIBUTION: (Type locality) Oahu—off Waikiki; 5-IX-63; ("Pele" dredge at 120 m.); 8 colonies.

Substrate: coral (unidentifiable)

DESCRIPTION: (See Figure 9)

Colony—Many solid papillae scattered along otherwise smooth surface except around cloacal apertures, shape oval—longest axis to 2 cm., thickness less than 1 mm.; color alive light lemon-yellow, darker around cloacal apertures; color preserved white; cloacal apertures scattered; cloacal canals thoracic; spicules dense in papillae and in layer at surface, in nearly solid layer below abdomens; spicule diameter to $30\ \mu$, usually 9 blunted rays at optical section; zooids scattered.

Zooid—Height to $500\ \mu$; transparent when preserved; thorax distorted—height to $250\ \mu$, anterior width to $500\ \mu$, posterior width about $100\ \mu$; very short branchial siphon with 6 short pointed lobes; branchial sac with 4 stigmata rows, 6 stigmata per half row—stigmata in first row about twice as wide as and much taller ($125\ \mu$) than those in other rows ($50\ \mu$); atrial aperture wide, deeply incut; retractor muscle as long as $500\ \mu$ (often equal to or longer than anterior thorax width); no lateral organs observed; abdomen generally smaller than thorax, very fragile; single testis, 5 vas deferens coils.

Larva—3 very small adhesive disks; 4 pairs very wide lateral ampullae with sides contiguous so as to give appearance of grooved ampullary ridge; length without tail to $375\ \mu$.

REMARKS: Although some *Didemnum* species have been described with as few as five vas deferens coils in conjunction with only six or seven stigmata per half row, none has been so noted in which the stigmata of the first are distinctly larger than those of the other rows. This condition, seen in all of these specimens, apparently results from the unique distortion of the thorax. The unusual shape is not an artifact of preservation, as one might suspect. The impression remaining in the densely spiculate tunic exactly matches that of the thorax after its removal, and no other distortions, such as wrinkled stigmata or endostyle, are present. The condition is considered a basis sufficient to warrant identification of these colonies as a new species, *Didemnum pele*, named for the vessel from which these specimens were collected.

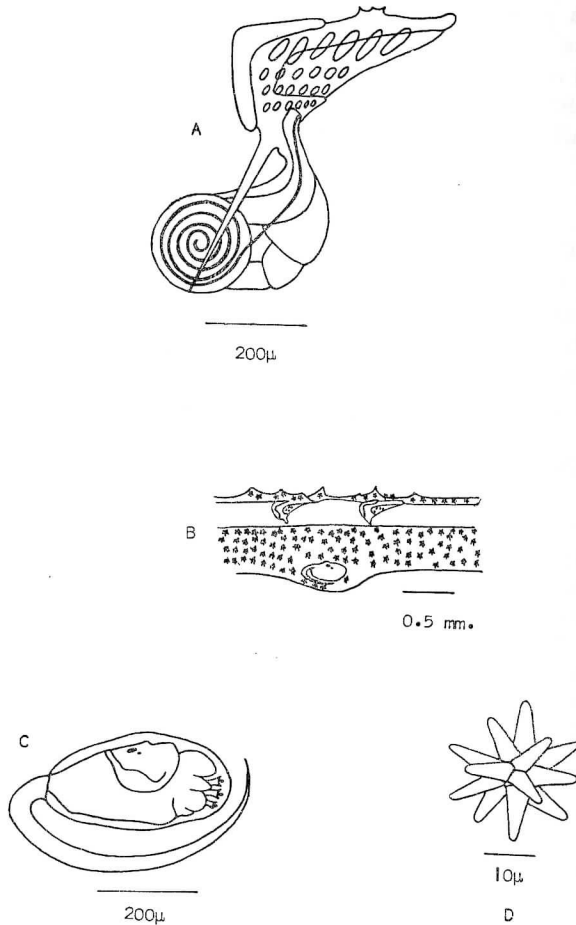

Fig. 9. *Didemnum pele*: A. zooid; B. colony cross section with larva in basal tunic; C. larva; D. typical spicule.

Didemnum sp.

DISTRIBUTION: Ifaluk—Ship pass between Falalap and Ella Islets; 3-X-53 (Coll. R. Rofen); 2 colonies.

Substrate: coral (*Porites* sp.)

DESCRIPTION: (See Figure 10)

Colony—[Immature specimens] Surface smooth, shape irregular—longest axis about 1 cm., thickness to 1 mm.; color alive blackish (collector's note), preserved overall tan with darkly pigmented zooids showing through as small dark dots; many indistinct cloacal apertures; cloacal canals thoracic; spicules rare at surface, moderately dense in central and basal tunic; spicule diameter 15–40 μ , burr-like with innumerable short conical rays; bladder cells dense throughout tunic; zooids scattered.

Zooid—Height to 1 mm.; color preserved overall brown; (usually) long branchial siphon with

6 lobes, branchial sac with 4 stigmata rows, 9 stigmata per half row; atrial aperture incut over portion of branchial sac—narrow slit in smaller zooids, wide opening in larger; retractor muscle about as long as thorax height; no lateral organs observed; abdomen usually at right angle (toward endostyle) to thorax, height ($375\ \mu$) about half of width ($750\ \mu$); stomach elongated, intestinal tract very long and narrow without recurved loop; single testis, $1\frac{1}{2}$ vas deferens coils seen in only one zooid (all others without gonads); many pyloric buds in various stages of development.

Larva—None observed.

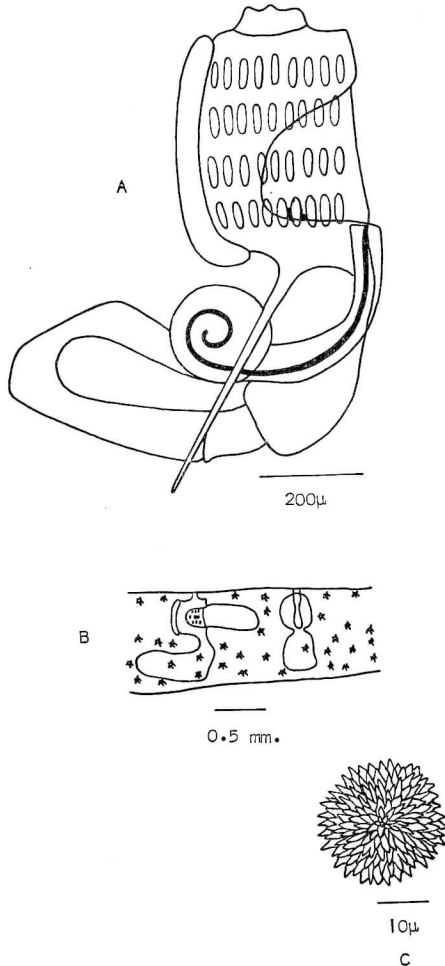

Fig. 10. *Didemnum* sp.: A. zooid with atrial aperture of larger form; B. colony cross section; C. typical spicule.

REMARKS: These two colonies are immature. Neither contained larvae. Almost every zooid was examined: many were found with pyloric buds; gonads

were seen only once, in which the vas deferens was coiled one and a half times. A few *Didemnum* species have been described as having only one or two coils, but their other features do not in any way correspond to those of these colonies. Nor do the colonies resemble any members of the hooked-vas-deferens "complex" closely enough to fall even loosely within that group.

The relatively tall zooid and the low number of vas deferens coils in conjunction with the elongated abdomen so peculiarly positioned at right angles to the thorax in these thin colonies might be considered sufficient to warrant identifying them as a new *Didemnum* species. However, since only two colonies are available for examination, and since they are both so obviously immature, such a classification is withheld at this time. Rather, it is preferred to identify them simply as *Didemnum* sp.

***Didemnum psammatodes* (Sluiter)**

SYNONYMY:

- Leptoclinium maculatum* Nott, 1892, Trans. N. Z. Inst. 24:316.
L. psammatodes [also *psamathodes*] Sluiter, 1895, Denkschr. Med.-Naturwiss. Ges. 8(2):11.
L. ianthinum Sluiter, 1898, Zool. Jahrb., Syst., 11:38.
Hypurgon skeati Sollas, 1903, Quart. J. Microscop. Sci., N. S., 46:729.
Leptoclinium psammatodes Sluiter, 1905, Mém. Soc. Zool. France 18:20.
Hypurgon skeati Herdman, 1906, Ceylon Pearl Oyster Fish., 5(suppl. 39):337.
Didemnum psammatodes, ?+ *D. fucatus*, ?+ *D. timorensis*, ?+ *D. ramosum* Sluiter, 1909, Siboga-Exped. Monogr. 56b:46, 47, 51, 63.
? *D. sibogae* [nom. nov. pro *D. ramosum*] Hartmeyer, 1910, In Klassen und Ordnungen des Tier-Reichs 3, suppl., (88):1489.
D. (Leptoclinium) psammatodes, ?+ *D. (L.) siphoniatum*, ?+ *D. (L.) sibogae*, ?+ *D. (L.) fucatum*, ?+ *D. (L.) venosum* Sluiter, 1913, Abhandl. Senckenb. Naturforsch. Ges. 35(1):75, 73, 74, 75, 75.
Leptoclininides africanus Michaelsen, 1915 (part), Beitr. Kenntn. Meeresfauna Westafrikas 1:488.
Didemnum psammatodes var. *guinense* + *D. p.* ? var. *skeati* Michaelsen, 1919, Abhandl. Geb. Naturwiss. Ver. Hamburg 21(1): 14, 17.
D. psammatodes + *D. p.* var. *skeati* + var. *intermedium* + var. *typicum* + var. *seychellense* + var. *ianthinum* Michaelsen, 1920, Mitt. Zool. Mus. Hamburg 37:22, 27, 28, 28, 29.
D. psammatodes var. *maculatum* + var. *intermedium* Michaelsen, 1924, Vidensk. Medd. Dansk Naturhist. Foren. København 77:341, 342.
D. psamathodes var. *skeati* Hastings, 1931, Great Barrier Reef Exped. 1928-1929 Sci. Rep. 4(3):95.
D. psammatodes var. *maculatum* Brewin, 1946, Trans. Roy. Soc.

N. Z. 76(2):97.

D. psammotodes Brewin, 1950, Trans. Roy. Soc. N. Z. 78(2-3): 345.

D. ?psammotodes Millar, 1956, Ann. Mag. Nat. Hist., Ser. 12, 9:922.

D. psammotodes var. *maculatum* Brewin, 1957, Trans. Roy. Soc. N. Z. 84(3):577.

D. psammotodes var. *ianthinum* Kott, 1957, John Murray Exped. 1933-34 Sci. Rep. 10(4):137.

D. psammotodes var. *maculatum* Brewin, 1958, Trans. Roy. Soc. N. Z. 85(3):439.

D. psammotodes f. *maculatum* + f. *intermedium* + f. *skeati* Kott, 1962, Aust. J. Mar. Freshw. Res. 13(3):325, 326.

DISTRIBUTION:

Malayan region (Sluiter, 1895, 1909, 1913; Sollas, 1903)
Australia (Hastings, 1931; Kott, 1962)

New Zealand (Nott, 1892; Michaelsen, 1924; Brewin, 1946, 1950, 1957, 1958)

Ceylon (Herdman, 1906)

Red Sea, Suez, Seychelles (Sluiter, 1905; Michaelsen, 1920; Kott, 1957)

Mozambique (Sluiter, 1898; Michaelsen, 1920; Millar, 1956)

Zanzibar (Michaelsen, 1920)

West Africa (Michaelsen, 1914, 1915, 1919)

Ifaluk—Southwest end of Falarik Islet; 9-X-53 (Coll. D. P. Abbott); 11 colonies.

Sand delta west of channel between Falarik and Falalap Islets; 26-X-53 (Coll. D. P. Abbott & F. M. Bayer); 2 colonies.

Lagoon shelf southwest of Falarik Islet; 27-X-53 (Coll. D. P. Abbott); 14 colonies.

Substrates: calcareous algae (*Halimeda* sp., *H. opuntia*), turtle grass (*Thalassia* sp.)

DESCRIPTION: (See Figure 11)

Colony—Growth not extensive, shape irregular—longest axis variable, thickness to 1 mm.; color preserved gray; several indistinct cloacal apertures; cloacal canals thoracic, about as deep as thorax height; spicules few at branchial lobes, scattered throughout tunic among ovoid bodies (fecal pellets?); spicule diameter 23-50 μ , usually 18 unevenly conical or parallel-sided flat-tipped rays at optical section; bladder cells distinct in tunic along endostyles of scattered zooids, obscured in other areas.

Zoid—Height less than 1 mm.; color preserved overall dark tan; long branchial siphon flared at 6 lobes; branchial sac with 4 stigmata rows, 9 stigmata per half row; atrial aperture deeply incut from half of first to below third stigmata row; retractor muscle about as long as thorax height; no lateral organs observed; single testis, 7 vas deferens coils.

Larva—3 long slender adhesive disks; 4 pairs broad-tipped lateral ampullae; length without tail to 425 μ .

REMARKS: Dark ovoid bodies embedded throughout the tunic in some didemnids have long puzzled ascidiologists. Sollas (1903) first noted their presence

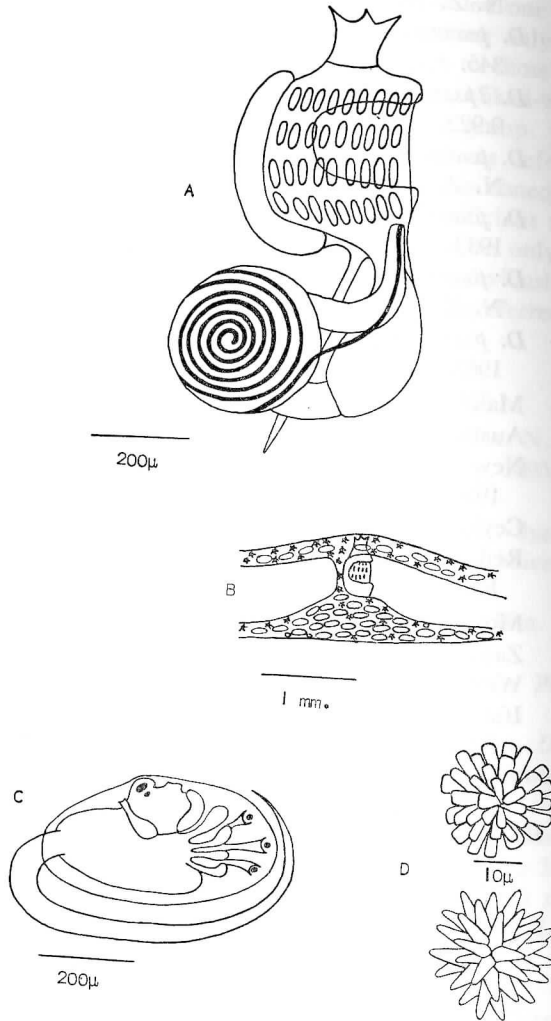

Fig. 11. *Didemnum psammatores*: A. zooid; B. colony cross section with distribution of ovoid bodies; C. larva; D. typical spicules of two types.

and described in detail her unsuccessful attempts to identify them by dissolving them with various boiling acids. She concluded that they are actually an organic material encased in an impenetrable though crushable inorganic shell, perhaps silica, and described them as fecal pellets. Kott (1962) suggested that the pellets are actually completely inorganic, being made of mud accumulated from the area around the substrate. The bodies in the specimens examined are herein identified questionably as fecal pellets. They are not mud balls, but although they are identical in superficial appearance and in fibrillose structure to the pellets found in the rectums, they are not affected by methylene blue stain, as are the latter.

Sollas (1903) considered this condition so rare as to be diagnostic for her genus *Hyphurgon*, the type species of which became one of the six varieties of *Didemnum psammatoedes*, originally separated (Michaelsen, 1919, 1920) as follows:

Variety	Fecal pellets	Spicule diameter	No. of tentacles	Lateral organs	No. stigmata per half row
<i>skeati</i>	dense	23-27 μ (max. 42 μ)	24	indistinct	6(5?)
<i>guinense</i>	scarce	23 μ (max. 33 μ)	32?	internal	8
<i>typicum</i>	present	[?]	24	superficial thorax-wall cups—small	4-5
<i>maculatum</i>	none	18 μ (max. 27 μ)	16	superficial thorax-wall cups—small	about 8
<i>intermedium</i>	none	27 μ (max. 45 μ)	12-16	superficial thorax-wall cups—small	about 9
<i>seychellense</i>	none	23 μ (max. 42 μ)	24	superficial thorax-wall cups—small	8

These varieties are otherwise identical, and the slight deviation(s) by which each one has been maintained for some forty-odd years exist in other species simply as ranges of variations. The few recent varietal descriptions contain nothing to warrant their being further maintained separately; in fact, these descriptions actually overlap so as to present ranges of variations with respect to a few of the supposed differences. The varieties might be reduced to two—*D. p.* var. *skeati*, in which fecal pellets occur, and *D. p.* var. *maculatum*, from which they are absent. However, this variation is essentially no different from the spiculate-aspicular condition known in several other undivided species and should not be considered varietally diagnostic in this species. Reasonably then, *D. psammatoedes* is considered an undivided species characterized in part by generally small spicules, small thorax-wall-depression lateral organs, usually six to eight stigmata per half row, and by the occasional occurrence of fecal pellets in varying densities. Other diagnostic features include colony thickness from one to two millimeters, fairly deep thoracic cloacal canals, bladder cells throughout the tunic, a wide mid-thoracic atrial aperture, five to eight (usually eight) vas deferens coils, and larvae with three median adhesive disks and either four lateral pairs (Millar, 1956; herein) or a single median-ventral and three lateral pairs (Kott, 1962) of ampullae. The specimens examined correspond well to this diagnosis.

The above synonymy includes as questionable all those records which Michaelsen (1919, 1920) gave as uncertain except for *D. japonicum*, a species maintained as distinct by Tokioka (1953a).

D. dorotubu, another species described (Oka, 1931) with fecal pellets, may properly belong to *D. psammatoedes*. Recent records (Tokioka, 1953a, 1963) indicate that it has a closer relationship than Oka originally thought.

Didemnum elikapekae n. sp.

DIAGNOSIS: Extensive thoracic cloacal canals with interabdominal depressions; zooid tall; branchial sac with 6 stigmata per half row; wide atrial aperture; abdomen often on either side at angle to thorax; long retractor muscle originating from posterior portion of esophageal pedicle; single testis, 9-10 vas deferentia; colony aspicular.

DISTRIBUTION: (Type locality) Oahu—Coconut Island, Kaneohe Bay; 21-XI-62; 1 colony.

Substrate: wood (floating dock)

DESCRIPTION: (See Figure 12)

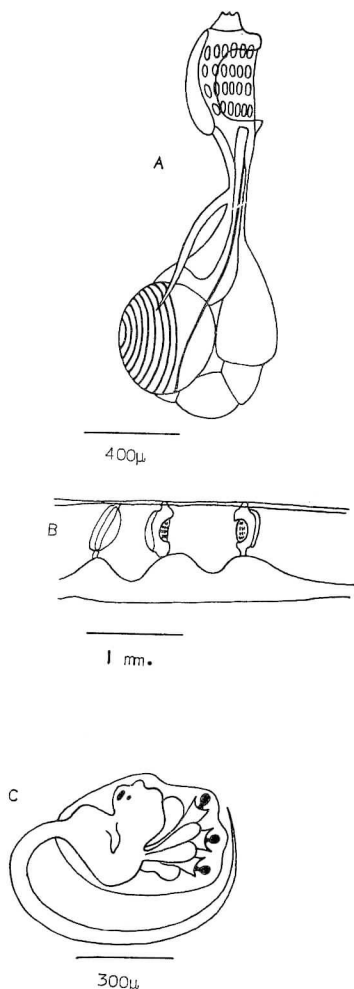

Fig. 12. *Didemnum elikapekae*: A. zooid; B. colony cross section; C. larva.

Colony—Surface smooth, shape elongated oval (6 cm. by 1.5 cm.), thickness to 1.5 mm.; color alive black throughout with few white pigment granules (diameter 50μ) which look like

Table III. Characteristics of aspicular *Didemnum* species.

Original Diagnostic Characteristics	<i>D. okudai</i> Tokioaka, 1951	<i>D. flagellatum</i> Tokioaka, 1953	<i>D. pacificum</i> Tokioaka, 1953	<i>D. elikapekae</i> n. sp.
Colony appearance	transparent milky-white; thickness 1 mm.; sand grains throughout tunic	semitransparent milky-white; thickness 1.5-2 mm.	milky-white with pale yellow zooids; thickness 4-5 mm.	black with white pigment granules scattered throughout basal tunic; thickness 1-1.2 mm.
Arrangement of zooids	not given	scattered	irregular aggregations along cloacal canals	scattered along cloacal canals
Cloacal system	aperture[s?] indistinct; canals not described [probably thoracic and shallow—atrial aperture very small]	aperture[s?] not described; canals inconspicuous [presumably thoracic and very shallow]	apertures rounded, large (diameter 2.5 mm.); canals extensive—thoracic and hypoabdominal [secondary]	apertures numerous, small, indistinct, round; canals extensive—thoracic with interabdominal depressions
Branchial siphon	long, 6 distinct lobes [from Fig. 2]	long, 6 distinct lobes [from Text Fig. 4]	short, 6 small pointed lobes [from Plate 13]	short, 6 very low indistinct lobes
Number stigmata/half row	approximately 10 [from Fig. 2]	not described	1st and 2nd—6, 3rd—5, 4th—4	6
Atrial aperture	small, only slightly incut	small, partially incut [from Text Fig. 4]	wide, deeply incut over most of branchial sac	wide, deeply incut over most of branchial sac
Lateral organs	fan-shaped	none described	none described	none observed
Retractor muscle	somewhat longer than thorax height [from Fig. 2]	very long—about 3½ times thorax height	apparently none [from Plate 13]	length equal to thorax height
Testis; vas deferens coils	? (zooids immature)	single; 7-8 coils	single?; 4 coils	single; 9-10 coils
Larva	none described	3 adhesive disks; 4 pairs lateral ampullae; length without tail 413 μ	none described	3 adhesive disks; 4 pairs lateral ampullae; length without tail 550 μ

spicules scattered in tunic, preserved even dull brown; cloacal apertures numerous, indistinct, round; cloacal canals thoracic and extensive with interabdominal depressions; aspicular; zooids scattered.

Zooid—Height to 1.6 mm.; thorax height and lengths of retractor muscle and esophageal pedicle about same (375–500 μ); color preserved light tan; short branchial siphon with 6 very low nearly indistinct lobes; branchial sac with 4 stigmata rows, 6 stigmata per half row; atrial aperture wide, deeply incut; retractor muscle (to 500 μ) originating from posterior portion of esophageal pedicle; no lateral organs observed; abdomen often on either side at angle to thorax; long esophageal pedicle; stomach not much wider than remainder of intestinal tract; intestinal tract with very slight recurved loop; single testis, 9–10 vas deferens coils.

Larva—3 large adhesive disks; 4 pairs lateral ampullae; length without tail 550 μ .

REMARKS: The features of this *Didemnum* colony do not correspond at all well to those of the other members of this genus collected from the same floating dock during a three-year period. Therefore, it is not possibly an aspicular form of one of these species. The colony also does not seem to be an aspicular variant of any other spiculate *Didemnum*. Nor do its features correspond closely to those of the three aspicular species described to date, although some features are similar to one or two characters of each. Table III shows the contrasts among the aspicular *Didemnum*. It can be seen that this single, unusually pigmented, mature colony is unique in having extensive thoracic cloacal canals with interabdominal depressions and a constant number of stigmata in each half row in conjunction with numerous vas deferens coils. Furthermore, the frequent positioning of the abdomen at right angles to the thorax has not been described for the other aspicular species. Therefore, in spite of the fact that the classification is based on an examination of only one colony, this specimen is identified as the new species *Didemnum elikapekae*, named in gratitude for Dr. E. A. Kay's continued interest in the completion of this research.

Didemnum gintonicum n. sp.

DIAGNOSIS: Shallow thoracic cloacal canals; spicules of two distinct forms and diameters (burr-like less than 24 μ ; "typical" 55–85 μ) found in separate areas of tunic; 10 stigmata per half row; small oval atrial aperture very slightly protrusible; single testis, 8–10 (usually 8) vas deferens coils.

DISTRIBUTION: (Type locality) Eniwetok—Coral knoll, Chinieero Islet; 19-VIII-62; 5 colonies.

Substrate: coral (unidentifiable)

DESCRIPTION: (See Figure 13)

Colony—Surface smooth, shape irregular—longest axis variable to 2 cm., thickness to 1 mm.; color alive crystalline coal-black with (spicule) white branchial lobes and periphery, preserved uneven gray with minute (diameter 3 μ) darker pigment granules arranged either in small clusters or in long strands over surface; cloacal apertures indistinct, scattered; cloacal canals thoracic, shallow; spicules of two distinct diameters and forms seldom intermingled—(1) small form (diameter to 24 μ , burr-like with innumerable short rays) at branchial lobes, in dense at-surface clusters, and scattered from surface throughout central tunic, (2) large form (diameter 55–85 μ , 18 broad conical rays at optical section) thinly scattered in lower central tunic, dense in basal tunic, and thinly "lining" cloacal canals; bladder cells interspersed among spicules throughout colony; zooids scattered.

Zooid—Height about 800 μ , abdomen generally somewhat larger than thorax; color preserved

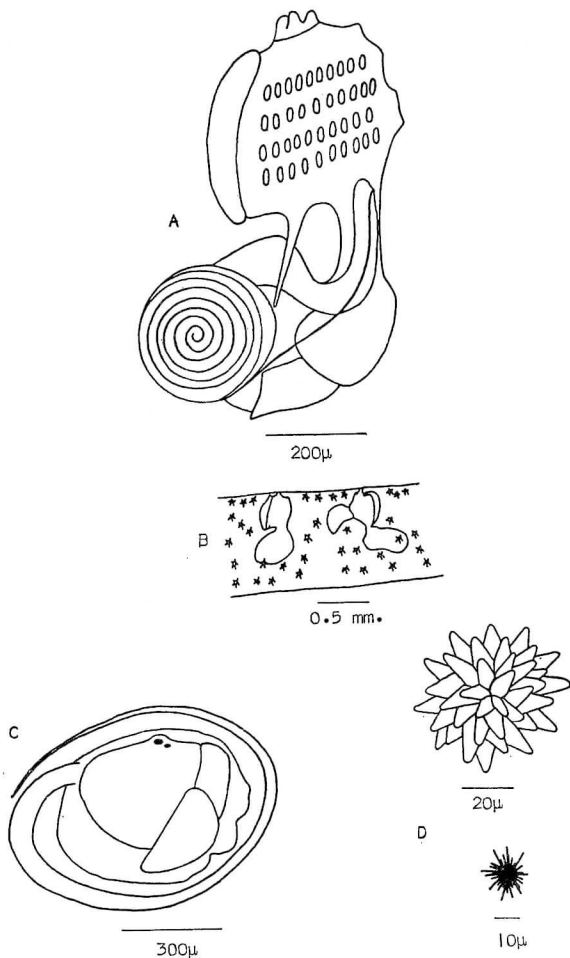

Fig. 13. *Didemnum gintonicum*: A. zooid; B. colony cross section; C. larva (mature?) with adhesive disk elevations and ampullary ridge with fold; D. typical spicules—large typical form and small burr-like form.

tan, some (more mature?) with dark circumbranchial ring and dark line from posterior end of endostyle across thorax to posterior margin of atrial aperture; very short branchial siphon with 6 large rounded lobes; branchial sac with 4 stigmata rows, 10 unusually small stigmata per half row; atrial aperture small oval, very slightly protrusible at level of third and fourth stigmata rows; retractor muscle short and blunt; no lateral organs observed; stomach ovoid with blunted posterior; poststomach posterior wide, distinctly flattened; single testis, 8-10 (usually 8) vas deferens coils.

Larva—Perhaps somewhat immature—some enveloped in long (750 μ) wide (ovarian?) sheath; all with parts of sensory vesicle discernable; 3 rounded median elevations (developing adhesive disks?); low undivided lateral ampullary ridge; length without tail to 525 μ ; in some, few "typical" spicules scattered on body surface (within larval sheath).

REMARKS: The larvae examined from these colonies may be immature; however, not all the larvae were ensheathed, and yet the three median elevations,

rather than the usual disks, and the undivided low ampullary ridge were seen constantly. Mature or not, the larvae are unique in having spiculate surfaces.

The peculiar spicule occurrence seen constantly throughout these five colonies is of some secondary diagnostic value. Few didemnid species are known to contain spicules of two different diameters (of these, fewer still have spicules of disparate ray-counts), and in all cases the spicules are intermixed, the larger ones occurring far more frequently. The arrangement in the present specimens is unique, not only because the two sizes are distinctly separated but also because they are equally abundant.

More significant than the unusual spicule condition is that these specimens differ from other *Didemnum* species in having numerous vas deferens coils as well as numerous stigmata per half row. These features in conjunction with the extremely small atrial aperture warrant their being identified as the new species *Didemnum gintonicum*, a name my wife suggested.

***Didemnum edmondsoni* n. sp.**

DIAGNOSIS: Color alive purplish black or maroon with distinct, white, (densely spiculate) raised branchial lobes; spicules below surface totally obscured by dark pigment; extensive thoracic cloacal canals with interabdominal depressions; 8-9 stigmata per half row; single testis, 5-9 (usually 6-8) vas deferens coils.

DISTRIBUTION: (*Type locality)

Oahu—*Coconut Island, Kaneohe Bay; 21-VI-61, 9-VIII-61, 29-XI-61, 13-XII-63, 1-VIII-63, 16-XI-63; approximately 50 colonies.

Bouy No. 8 Reef, Kaneohe Bay; 29-XII-61; 7 colonies.

Sand Island, Kaneohe Bay; 1-VIII-63; 1 colony.

Kaimalino, Kailua Bay; 7-VIII-63; 1 colony.

Sand Island, Honolulu; ?-XI-64 (Coll. D. K. Young); 1 colony.

Substrates: wood (floating dock, test panel), glass (test panel), serpulid worm tubes, solitary ascidians (*Herdmania momas* + spp.), bivalve mollusks (*Ostrea* sp.), sponges, calcareous algae (*Porolithon* sp.)

DESCRIPTION: (See Figure 14)

Colony—Growth extensive, surface smooth, shape irregular—longest axis variable, thickness to 1 mm. (usually 775 μ); color alive velvety purplish black or maroon with (spicule) white branchial lobes, preserved white throughout; tunic at branchial siphons raised, formed into 3 prominent and 3 less distinct lobes; cloacal apertures slightly raised; cloacal canals thoracic and very extensive with interabdominal depressions; spicules dense at branchial lobes, absent from cloacal apertures, scattered throughout tunic with greater density in lower portions (uppermost spicules obscured by surface pigment); spicule diameter 18-31 μ , 14-16 flat-tipped or pointed rays at optical section; bladder cells scattered throughout tunic; zooids scattered.

Zooid—Height less than 1 mm.; color preserved opaque white; short branchial siphon with 6 minute lobes; branchial sac with 4 stigmata rows, 8-9 stigmata per half row; narrow atrial aperture incut over portion of third stigmata row; retractor muscle length equal to thorax height, originating from esophageal pedicle; no lateral organs observed; abdomen in some at right angle to thorax; posterior of stomach blunter than anterior; single testis (one zooid

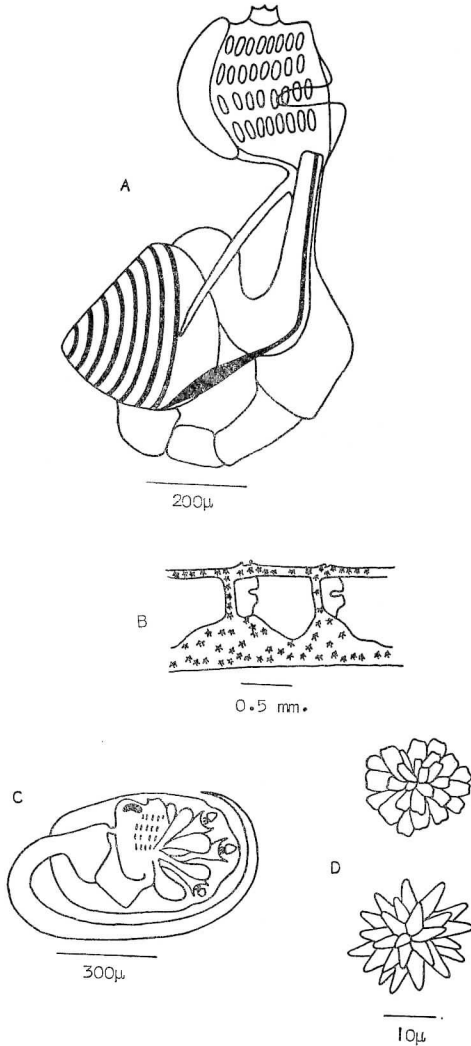

Fig. 14. *Didemnum edmondsoni*: A. zooid; B. colony cross section; C. larva; D. typical spicules of two forms.

with 2 lobes), 5-9 (usually 6-8) vas deferens coils; pyloric buds present in some.

Larva—3 large adhesive disks; 4 pairs broad lateral ampullae; length without tail to 625 μ .

REMARKS: When alive, these colonies were readily distinguishable from other didemnids because of their striking coloration. Preservation, however, bleached the purplish black pigment, and the resultant white surface easily blends with the white of the heavily spiculate branchial lobes. The preserved specimens bear a superficial resemblance to several (preserved) *Didemnum* species. In some respects they correspond rather well to the overlapping descriptions of *D. moseleyi* and *D. candidum*: in all three groups the thin but extensive colonies have deep thoracic cloacal canals with interabdominal depressions, and the zooids

have fairly short branchial siphons, retractor muscles of similar lengths, several vas deferens coils, and nearly identical larvae. In other respects, however, the specimens examined differ from *D. moseleyi* and *D. candidum* to such a degree that they can neither serve to unite those two species nor can they be identified as a darkly pigmented variant of either. The thoracic portions of the cloacal canals extend more deeply over the anteriors of the abdomens; the densely spiculate tunic at the branchial lobes protrudes unevenly above the colony surface; slightly more stigmata per half row appear in the branchial sac; the retractor muscle originates from the esophageal pedicle rather than from the thorax; and the spicules differ somewhat in distribution, diameter, and ray-count. This combination of features presents a reasonably unusual structure. In conjunction with the unique appearance of the living colony, it provides the basis for classifying these specimens as a new species, *Didemnum edmondsoni*. The specific name is chosen in recognition of Dr. C. H. Edmondson's extensive contributions to the knowledge of Hawaiian invertebrates.

***Didemnum moseleyi* (Herdman)**

SYNONYMY:

- Leptoclinium moseleyi* Herdman, 1886, Rep. Sci. Res. Voy. H. M. S. Challenger, Zool., 14(38):272.
- L. incanum* Herdman, 1899, Aust. Mus. Cat. 17:90.
- Didemnum moseleyi* Sluiter, 1909, Siboga-Exped. Monogr. 56b:45.
- Leptoclinium incanum* Herdman and Riddell, 1913, Mem. Aust. Mus. 4:888.
- Didemnum (Leptoclinium) moseleyi* Sluiter, 1913, Abhandl. Senckenb. Naturforsch. Ges. 35(1):74.
- D. moseleyi* Van Name, 1918, Bull. U.S. Natl. Mus. 100, 1(2):151.
- Leptoclinium album* Oka, 1927, Figuraro de Japanaj Bestoj, p. 499.
- Didemnum moseleyi* Tokioka, 1949, Pub. Seto Mar. Biol. Lab. 1(2):43.
- D. (Didemnum) moseleyi* Tokioka, 1953, Ascidiens of Sagami Bay, p. 185.
- D. (D.) moseleyi* + *D. (D.) m. f. granulatum* + *f. punici-color* Tokioka, 1954, Pub. Seto Mar. Biol. Lab. 3(3):243, 244, 245.
- D. (D.) moseleyi* Tokioka, 1954, Pub. Seto Mar. Biol. Lab. 4(1):77.
- D. (D.) moseleyi* Tokioka, 1955, Pub. Seto Mar. Biol. Lab. 4(2-3):212.
- D. (D.) moseleyi* Tokioka, 1955, Pub. Seto Mar. Biol. Lab. 5(1):44.
- D. moseleyi* Kott, 1957, John Murray Exped. 1933-34 Sci. Rep. 10(4):136.
- D. (D.) moseleyi* Tokioka, 1958, Encyclopaedia Zoologica Illustrated in Colours 2:379.

- D. (D.) moseleyi* Tokioka, 1959, Pub. Seto Mar. Biol. Lab. 7(2):226.
D. (D.) moseleyi Tokioka, 1961, Pub. Seto Mar. Biol. Lab. 9(1):106.
D. (D.) moseleyi Utinomi, 1961, Coloured Illustrations of Sea Shore Animals of Japan, p. 127.
D. moseleyi Kott, 1962, Aust. J. Mar. Freshw. Res. 13(3):328.

DISTRIBUTION:

- Japan (Tokioka, 1949, 1953, 1954, 1959)
 Philippines (Herdman, 1886; Van Name, 1918)
 Palau Islands (Tokioka, 1955)
 Malayan region (Sluiter, 1909, 1913; Tokioka, 1955)
 Australia (Herdman, 1899; Kott, 1962)
 Tasmania (Kott, 1962)
 New Caledonia (Tokioka, 1961)
 South Arabia (Kott, 1957)
 Oahu—Coconut Island, Kaneohe Bay; 14-X-61, 13-XII-61; 6 colonies.
 Kingman Reef—East end; 19-XII-60 (Coll. R. B. T. Iversen); 1 colony.
 Palmyra—Leeward Channel; 12-V-62; 2 colonies.
 Off Penguin Spit; 13-V-62; 1 colony.
 Eniwetok—Coral knoll lagoonward Aniyaanii Islet; 17-VIII-62; 1 colony.
 Channel between Japtan and Chinimi Islets; 17-VIII-62; 40 colonies.
 Coral knoll lagoonward Chinieero Islet; 19-VIII-62; 4 colonies.
 Channel between Rojoa and Biijiri Islets; 22-VIII-62; 17 colonies.
 Ifaluk—Channel between Elangalap and Falarik Islets; 19-X-53 (Coll. D. P. Abbott & R. Rofen); 7 colonies.
 West shore Elangalap Islet; 25-X-53 (Coll. D. P. Abbott & R. Rofen); 1 colony.
 Ship pass between Falalap and Ella Islets; 25-X-53 (Coll. R. Rofen); 4 colonies.
 Channel between Falarik and Falalap Islets; 26-X-53 (Coll. D. P. Abbott & F. M. Bayer); 45 colonies.
 ?Southwest end of Falarik Islet; 29-X-53 (Coll. D. P. Abbott); 2 colonies.
 North end of Falalap Islet; 27-X-53 (Coll. D. P. Abbott); 6 colonies.
 ?East of south end of Falarik Islet; 31-X-53 (Coll. D. P. Abbott & F. M. Bayer); 10 colonies.
 Lagoon Station D; 3-X-53 (Coll. D. P. Abbott & F. M. Bayer); 1 colony.
 Substrates: coral (*Acropora* sp., *Leptastrea* sp., *Montipora* sp., *Stylophora* sp.), bivalve mollusks (*Tridacna squammosa*), calcareous and green algae (*Halimeda* sp., *Microdictyon* sp.)

DESCRIPTION: (See Figure 15)

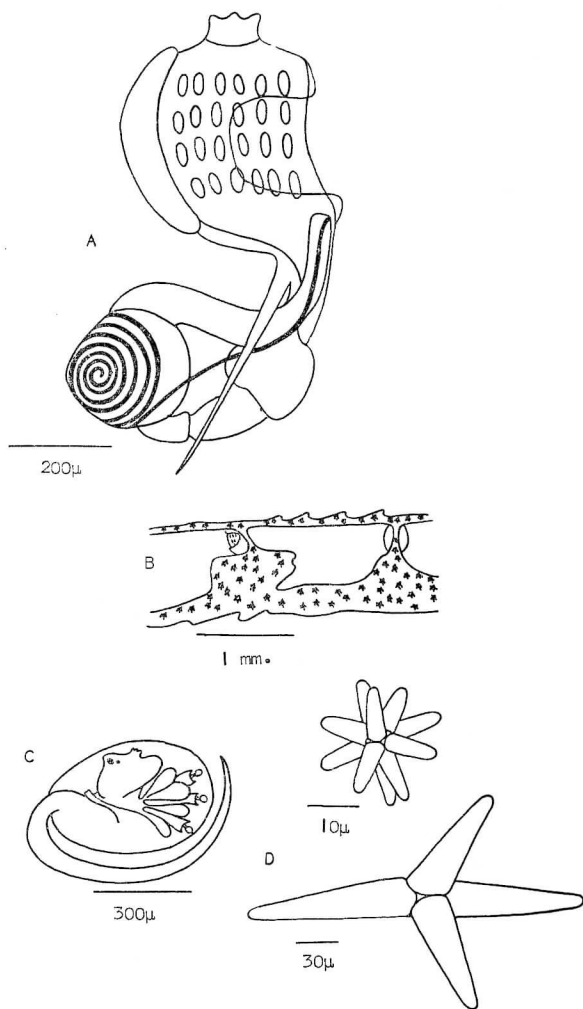

Fig. 15. *Didemnum moseleyi*: A. zooid; B. colony cross section; C. larva; D. typical spicule and a typical tetrahedral spicule.

Colony—Surface smooth, often with a few solid papillae (usually) near branchial siphons, shape extremely variable—longest axis 1–8 cm., thickness to 1 mm.; color alive variable—white, uneven pink, yellow, or shades of orange—preserved white to brown, depending on original pigment; cloacal apertures indistinct; cloacal canals thoracic and extensive with interabdominal depressions (one Oahu specimen with anastomotic secondary canals); spicules infrequent at cloacal apertures, quite dense throughout tunic, sometimes less dense in basal tunic; spicule diameter usually 25–40 μ (largest 66 μ), 5–11 blunted or flat-tipped rays at optical section (few unusually slender-rayed tetrahedral spicules, diameter 80–100 μ , scattered among “typical” form in one Eniwetok specimen); zooids scattered.

Zooid—Height usually 750 μ (largest 1.1 mm.); color preserved opaque white or transparent,

with dark pigment granules on thorax wall; short branchial siphon with 6 pointed lobes; branchial sac with 4 stigmata rows, 5-8 stigmata (usually 6) per half row; atrial aperture wide, partially incut; retractor muscle usually equal to thorax height (300-500 μ); a few round large (diameter 125 μ) lateral organs observed; single testis, 5-8 (usually 6 or 7) vas deferens coils; often pyloric buds in various stages of development.

Larva—3 adhesive disks; 4 pairs broad lateral ampullae; length without tail usually 500 μ (largest 1 mm.).

REMARKS: Two sets of specimens from Ifaluk are questionably identified because they do not correspond in all features to descriptions given for *Didemnum moseleyi*. The first has four, rather than five or more, vas deferens coils, and the abdomens are densely covered with large, dark pigment cells not seen in the other specimens. It is possible that these cells so obscured the vas deferens that the coil count is too low. The second set includes several specimens which have two more stigmata per half row and spicules with eight more rays at the optical section than do the other colonies examined.

Descriptions for *D. moseleyi* are quite similar to those for *D. candidum*, *D. moseleyi* being differentiated by its larger fewer-rayed spicules (Tokioka, 1954c; Kott, 1962) and by its fewer vas deferens coils (Kott, 1962). The *D. moseleyi* specimens examined are identical to these descriptions; the *D. candidum* specimens are not (see *D. candidum* remarks). Two other differences previously described but not especially noted as such are that *D. moseleyi* has a wider, farther incut atrial aperture and frequently a papillose, rather than a constantly smooth, surface.

Didemnum candidum Savigny

SYNONYMY:

- Didemnum candidum* Savigny, 1816, Mém. animaux sans vertèbres 2(1):194.
- Leptoclinium speciosum* + *L. s.* var. *asperum*, *L. annectens*, *L. tenue* (part), *L. albidum* + *L. a.* var. *luteolum* Herdman, 1886, Rep. Sci. Res. Voy. H.M.S. Challenger, Zool., 14(38):274, 277, 280, 281, 287, 290.
- L. candidum* Lahille, 1890, Recherches sur les Tuniciers, p. 92.
- L. niveum* Nott, 1892, Trans. N. Z. Inst. 24:308.
- ?*L. cineraceum*, *L. tenue* Sluiter, 1897, Mém. Soc. Zool. France 11:30, 31.
- L. cretaceum*, *L. speciosum* var. *aspera* Sluiter, 1898, Zool. Jahrb., Syst., 11:36, 39.
- L. speciosum* var. *bermudense* + var. *pageti* + var. *hamiltoni* + var. *harringtonense* + var. *acutilobatum* + var. *somersi* Van Name, 1902, Trans. Conn. Acad. Arts Sci. 11:363-366.
- Didemnum novae-seelandiae* [nom. nov. pro *D. niveum* Nott] Hartmeyer, 1909, Klassen und Ordnungen des Tier-Reichs 3, suppl., (86):1450.
- D. lutarium* Van Name, 1910, Proc. Boston Soc. Nat. Hist. 34(1):371.
- D. candidum* Alder and Hancock, 1912, The British Tunicata 3:35.

- Leptoclinides africanus* var. *typica* Michaelsen, 1914, Mitt. Zool. Mus. Hamburg 31:78.
- L. africanus* f. *typica* + *L. a.* var. *trigonostoma* Michaelsen, 1915, Beitr. Kenntn. Meeresfauna Westafrikas 1:488, 495.
- Didemnum candidum* Michaelsen, 1919, Abhandl. Geb. Naturwiss. Ver. Hamburg 21(1):18.
- D. candidum* Michaelsen, 1920, Mitt. Zool. Mus. Hamburg 37:19.
- D. candidum*, *D. fusiferum*, *D. annectens*, *D. cineraceum* Van Name, 1921, Bull. Am. Mus. Nat. Hist. 44:323, 331, 484, 484.
- D. candidum* Michaelsen, 1924, Vidensk. Medd. Dansk Naturhist. Foren København 77:358.
- D. candidum* Van Name, 1924, Bijdr. Dierk. 23:25.
- D. candidum* Sluiter, 1929, Bull. Soc. Sci. Nat. Maroc 9(7-8):113.
- D. candidum* Van Name, 1930, Sci. Surv. Porto Rico Virgin Is. 10(4):435.
- D. candidum* Hastings, 1931, Great Barrier Reef Exped. 1928-1929 Sci. Rep. 4(3):94.
- D. candidum* Harant, 1931, Ann. Inst. Océano., N. S., 8(4):277.
- D. candidum* Berrill, 1932, Biol. Bull. 62(1):77.
- D. candidum*, *D. c. lutarium*, *D. c. fusiferum* Van Name, 1945, Bull. Am. Mus. Nat. Hist. 84:83, 86, 88.
- D. candidum* Van Name, 1945, Fish. Bull. 89:496.
- D. candidum* Brewin, 1946, Trans. Roy. Soc. N. Z. 76(2):98.
- ?*Trididemnum alleni* Berrill, 1947, J. Mar. Biol. Ass. U. K. 26:609.
- Didemnum candidum* Pérès, 1948, Bull. Mus. Natl. Hist. Nat., Ser. 2, 20(1):91.
- D. candidum* var. *africana* Pérès, 1949, Bull. Inst. Franc. Afr. Noire 11(1-2):189.
- D. candidum* Brewin, 1950, Trans. Roy. Soc. N. Z. 78(1):55.
- D. candidum* Brewin, 1950, Trans. Roy. Soc. N. Z. 78(2-3):345.
- D. candidum* Brewin, 1951, Trans. Roy. Soc. N. Z. 79(1):104.
- D. candidum* Pérès, 1951, Bull. Inst. Franc. Afr. Noire 13(4):1056.
- D. candidum* Brewin, 1952, Trans. Roy. Soc. N. Z. 80(2):188.
- D. candidum* Van Name, 1952, Bull. Brit. Mus. (Nat. Hist.), Zool., 1(8):215.
- D. candidum* var. *africana* Millar, 1953, Proc. Zool. Soc. London 123(2):297.
- D. (Didemnum) candidum* Tokioka, 1954, Pub. Seto Mar. Biol. Lab. 3(3):246.
- ?*D. candidum* [= *D. maculosum* Milne Edwards, 1841 (part)] Car-

- lisle, 1954, J. Mar. Biol. Ass. U. K. 33:313.
D. candidum Pérès, 1954, Bull. Sta. Océano. Salammbo 49:13.
D. candidum Kott, 1954, B.A.N.Z. Anarct. Res. Exped. 1929-31 Rep., Ser. B, 1(4):162.
D. (D.) candidum Tokioka, 1955, Pub. Seto Mar. Biol. Lab. 5(1):45.
D. candidum Brewin, 1956, Trans. Roy. Soc. N. Z. 84(1):122.
D. candidum Pérès, 1956, Ann. Inst. Océano. 32:279.
D. candidum Brewin, 1957, Trans. Roy. Soc. N. Z. 84(3):577.
(non) *D. candidum* Kott, 1957, John Murray Exped. 1933-34 Sci. Rep. 10(4):138.
D. candidum Brewin, 1958, Trans. Roy. Soc. N. Z. 85(3):439.
D. candidum Pérès, 1958, Bull. Res. Counc. Israel 7B(3-4):156.
D. (D.) candidum Tokioka, 1958, Encyclopaedia Zoologica Illustrated in Colours 2:379.
D. candidum Brewin, 1960, Trans. Roy. Soc. N. Z. 88(1):119.
D. candidum Millar, 1960, Fauna of the Clyde Sea Area, p. 6.
D. candidum Kott, 1962, Aust. J. Mar. Freshw. Res. 13(3):327.
D. c. lutarium Zinn and Abbott, 1964, Keys to marine invertebrates of the Woods Hole region, pp. 194, 198.

DISTRIBUTION: Extensive between north and south 15°C isotheres (Carlisle, 1954) except for western North America; see Map 10.
Oahu—Coconut Island, Kaneohe Bay; (?) 4-X-61, 15-XI-61, 29-XI-61, (?) 13-XII-61, 11-V-63, 1-VIII-63, 26-X-63, 16-XI-63; approximately 60 colonies.
Ala Wai Yacht Harbor; 15-I-63; 10 colonies.
West Loch, Pearl Harbor; 31-X-61; 10 colonies.
Off Barber's Point; 25-III-62 ("Pele" dredge at 40 m.); 2 colonies.
Ifaluk—West shore of Elangalap Islet; (?) 25-VIII-53 (Coll. D. P. Abbott & R. Rofen); 2 colonies.
Channel between Falarik and Falalap Islets; 26-VIII-53 (Coll. D. P. Abbott & F. M. Bayer); 1 colony.
Substrates: wood (floating dock), sabellid and serpulid worm tubes, barnacles, solitary ascidians (*Herdmania momas*), bi-valve mollusks (*Ostrea* sp., *Tridacna squamosa*), sponges, calcareous algae (*Halimeda* sp.)

DESCRIPTION: (See Figure 16)

Colony—Shape variable, depending on substrate—often "cylindrical" over worm tubes—growth usually extensive, thickness to 1.5 mm.; color alive uneven white or off-white, preserved pure white; cloacal apertures scattered; cloacal canals thoracic and extensive with inter-abdominal depressions and also (in rare thicker colonies) with finger-like postabdominal extensions; spicules concentrated at surface over zooids and around cloacal apertures, evenly dense throughout tunic; spicule diameter 15-20 μ , numerous blunted rays ("sculptured sphere" in one colony); zooids scattered.

Zooid—Height to 1 mm.; color alive transparent tan, preserved opaque tan; short branchial

siphon with 6 blunt lobes; branchial sac with 4 stigmata rows, 6 stigmata per half row; atrial aperture short narrow slit, longer in some larger zooids; retractor muscle pointed, length to $550\ \mu$; no lateral organs observed, though small concentrations of spicules some-
times seen at sides of thorax; single testis, 6 vas deferens coils.

Larva—3 adhesive disks; 4 pairs lateral ampullae; length without tail to $625\ \mu$.

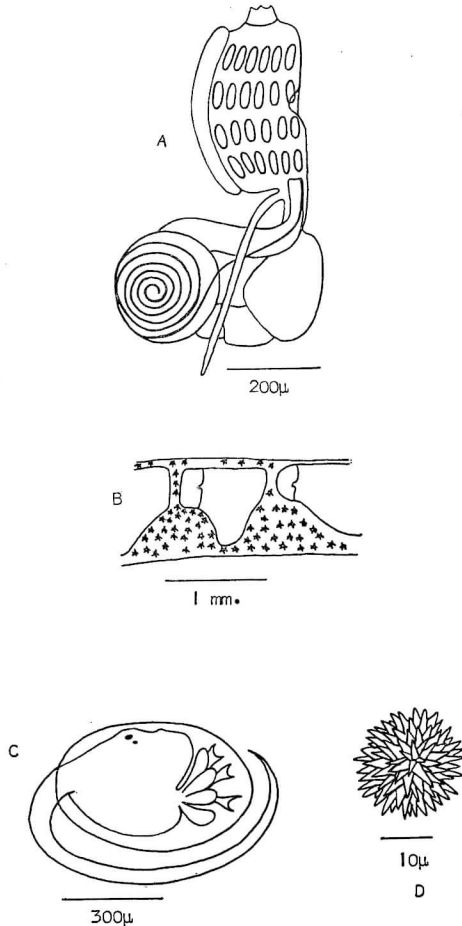

Fig. 16. *Didemnum candidum*: A. zooid; B. colony cross section; C. larva; D. typical spicule.

REMARKS: Several identifications are questionable: the larvae of two colonies from Cononut Island, Oahu, are atypical—one has five pairs of lateral ampullae, and the other, six; and the zooids of the single Elangalap, Ifaluk, colony are darkly pigmented when preserved (the collector had noted purple pigmentation on the unembedded thoraces of the living colony). In all other respects these specimens correspond very well to Van Name's (1945) description for *Didemnum candidum*.

This type species enjoys a nearly world-wide distribution, having been recorded frequently for many years. It contains two Atlantic subspecies (Van

Name, 1945)—*D. c. fusiferum*, a Florida form in which the spicules often consist of two cones fused at their bases, and *D. c. lutarium*, a southern New England form having smaller zooids with shorter branchial lobes and often an additional vas deferens coil—as well as a west African variant (Pérès, 1949). As the name suggests, the colony color is solid white; however, pink forms have also been recorded (Hastings, 1931; Tokioka, 1958b) from Pacific waters.

This species is the most confusing of the *Didemnum*, for it is the most typical representative of the genus and lacks any unique feature which might readily facilitate its differentiation from the other species. Indeed, the generalized nature of its features presents so composite a structure that *D. candidum* has at times encompassed more than a single group, several species having passed in and out of its synonymy.



Map 10. Distribution of *Didemnum candidum*, including present records.

Two such species are *D. maculosum* and *Trididemnum alleni*, which Carlisle (1954) has included in *D. candidum* because the number of rows of stigmata may be three or four. He synonymized part of *D. maculosum* on the basis of this condition in conjunction with its two larval median adhesive disks. He also synonymized *T. alleni* on the same bases, stating that *T. alleni* is actually a dwarf form of *D. candidum* produced by larvae from its three-rowed marginal zooids which settle in a crowded environment. Upon removal to more nutritive conditions, these colonies metamorphose, their zooids actually developing a fourth stigmata row.

Another such species is Sluiter's (1897) *D. conchyliatum*, which was synonymized (Van Name, 1945) with *D. candidum* and later (Millar, 1962b) re-established as a valid species on the basis of its bilobed, rather than single, testis in con-

junction with the three median adhesive disks of the larvae. Interestingly, the classic *D. candidum* description (Van Name, 1945) noted that the zooids of the same colony may vary in having either a single or a bilobed testis. Furthermore, the infrequent descriptions of the larvae disagree considerably. Tokioka (1954c) described most of his larvae as having the usual three disks, although he did report only one or two in some from the same colonies. Kott (1962) recorded a constant three for her specimens, as does the present description. On the other hand, Carlisle (1954) recorded a constant two, and because of this deviation, his *D. candidum* record and the *Trididemnum alleni* it included appear in the above synonymy as questionable.

Another "standard" feature described very differently by the various authors is the number of vas deferens coils. Tokioka (1954c) noted *D. candidum* from Japanese waters as having four or five, from Palau with three and a half to seven; the classic descriptions noted six to eight; and Kott (1962) recorded eight to ten in her Australian specimens. Six were seen constantly in the present specimens.

Polysyncraton Nott

- SYNONYMY: *Leptoclinum* Giard, 1872 (part)
Leptoclinum Drasche, 1883 (part)
 (non) *Diplosomoides* Herdman, 1886
Diplosomoides Lahille, 1890
Polysyncraton Nott, 1892, *auct. mult.*
Didemnum (Polysyncraton) Van Name, 1921, *auct. mult.*
Didemnum (Polysyncraton) Carlisle and Carlisle, 1954 (part)

TYPE SPECIES: *Polysyncraton paradoxum* Nott, 1892

DEFINITION: Branchial sac with 4 stigmata rows; atrial aperture with flap-like languet; vas deferens seldom coiled more than 5 times on several (4-10) testicular lobes; usually spiculate; larvae with 3 median adhesive disks, numerous pairs lateral ampullae.

SPECIES described from or known to occur in Indo-Pacific waters (none known from western North American waters):

- Polysyncraton arafurensis* (Tokioka, 1952)
aspiculatum (Tokioka, 1949)
chondrilla (Michaelsen, 1924)
chuni Hartmeyer, 1912
circulum Kott, 1962
crassum (Redikorzev, 1913)
dobense Sluiter, 1913
discoides Kott, 1962
fimbriatum (Herdman, 1899)
hartmeyeri Michaelsen, 1923
magnetae (Hastings, 1931)
magnilarvum (Millar, 1962)
mortenseni (Michaelsen, 1924)
orbiculum Kott, 1962

paradoxum Nott, 1892
sagamiana (Tokioka, 1953)
schillingi Michaelsen, 1920
spongioides Hartmeyer, 1912
tubiporae Michaelsen, 1920

REMARKS: Members of *Polysyncraton* are widely distributed throughout the Indo-Pacific region, and their absence from the present collection is interesting and somewhat surprising.

Polysyncraton is sometimes considered a subgenus of *Didemnum*. Although its members are very closely related to those of *Didemnum*, *Polysyncraton* comprises a single, well-defined species complex and should be maintained as a valid genus on the basis of the atrial-aperture structure in conjunction with the characteristics of the male gonad. Its status is further stabilized by the constancy of lateral-ampullae arrangement among the larvae of the various species. (See also ?*Sinecloaca* and *Leptoclinides* remarks.)

?*Sinecloaca* Carlisle and Carlisle

SYNONYMY: *Leptoclinides* Bjerkan, 1905 (part)
Sinecloaca Carlisle and Carlisle, 1954

TYPE SPECIES: *Sinecloaca glauerti* (Michaelsen)
 (= *Leptoclinides glauerti* Michaelsen, 1930)

DEFINITION: Branchial sac with 4 stigmata rows; elongated atrial siphon opening directly to exterior through basal tunic [no common cloacal system]; thorax with distinct longitudinal muscle bands; spiculate.

REMARKS: This monotypic genus was established by Carlisle and Carlisle (1954) to contain the Australian *Sinecloaca glauerti*, a species they separated from the genus *Leptoclinides* because it lacks a cloacal system. Although the Carlisles' reclassification of the remaining *Leptoclinides* species as two subgenera of *Didemnum* and their abandonment of the genus *Leptoclinides* cannot be accepted (see *Leptoclinides* and *Didemnum* remarks), their *Sinecloaca* is recognized on a tentative basis. Further research may indicate whether the acloacal condition of this species, known only from the original description of a single colony with immature zooids, warrants its establishment under a distinct genus.

Leptoclinides Bjerkan

SYNONYMY: *Leptoclinides* Bjerkan, 1905 (part), *auct. mult.*
Polysyncraton Sluiter, 1909 (part)
Didemnum (Leptoclinides) Carlisle and Carlisle, 1954
Didemnum (Polysyncraton) Carlisle and Carlisle, 1954 (part)

TYPE SPECIES: *Leptoclinides faerøensis* Bjerkan, 1905

DEFINITION: Branchial sac with 4 stigmata rows; atrial siphon usually posteriorly directed; thorax often with several distinct longitudinal muscle bands; vas deferens usually coiled more than 5 times on several (1-24) testicular lobes; cloacal canals thoracic and often postabdominal; usually spiculate.

SPECIES described from or known to occur in Indo-Pacific waters (none known

from western North American waters):

- Leptoclinides auranticus* Brewin, 1956
capensis Michaelsen, 1934
diemenensis Michaelsen, 1924
dubius (Sluiter, 1909)
echinatus Tokioka, 1954
komaii Tokioka, 1949
lissus Hastings, 1931
madara Tokioka, 1953
marmoratus (Sluiter, 1909)
marmoreus Brewin, 1956
multilobatus Kott, 1954
nigropunctatus (Sluiter, 1909)
nigrothorax Tokioka, 1954
novaezealandiae Brewin, 1958
ocellatus (Sluiter, 1909)
reticulatus (Sluiter, 1909)
rufus (Sluiter, 1909)
rugosus Tokioka, 1962
sluiteri Brewin, 1950
sparsus Michaelsen, 1924

REMARKS: This genus has previously been defined as one whose members are invariably spiculate. The definition is herein modified by the discovery of an aspicular colony among the *Leptoclinides rufus* specimens. The anatomical features of the various *Leptoclinides* species are otherwise quite constant. The group is readily distinguished from the genus *Polysyncraton*, to which it is most closely related, not only by the multiplicity of testicular lobes, as Brewin (1956) stated, but also by the extensive postabdominal cloacal canals, the long atrial siphon, and the numerous vas deferens coils.

Carlisle and Carlisle (1954) reclassified what they considered the six-species genus *Leptoclinides* (fifteen species had actually been described to that date) by removing the acloacal *L. glauerti* to their monotypic genus *Sinecloaca* and by placing the remaining species in the genus *Didemnum* in two subgenera. Their *D. (Leptoclinides)* contained only two of these species, whereas their *D. (Polysyncraton)* contained the other three as well as the species from the separate genus *Polysyncraton*. Even though their separation of *S. glauerti* is warranted on a tentative basis, the Carlisles' definition of the other species as *Didemnum* subgenera cannot be accepted (see appropriate generic remarks). The *Leptoclinides* species can be distinguished as a homogenous group by the atrial siphon in conjunction with the several testicular lobes. Tokioka (1954b), Millar (1960), and Kott (1962) have also maintained *Leptoclinides* as a valid genus, to which eight more species have been added since the Carlisles' work.

***Leptoclinides rufus* (Sluiter)**

SYNONYMY: *Polysyncraton rufum* Sluiter, 1909, Siboga-Expd. Monogr. 56b: 72.

P. rufum Sluiter, 1913, Abhandl. Senckenb. Naturforsch. Ges. 35(1):77.

?*Leptoclinides rufus* Tokioka, 1952, Pub. Seto Mar. Biol. Lab. 2(2):92.

L. rufus Kott, 1962 (part), Aust. J. Mar. Freshw. Res. 13(3):286.

DISTRIBUTION: Malayan region (Sluiter, 1909, 1913; Tokioka, 1952)
 Tasmania and southern Australia (Kott, 1962)
 Oahu—Offshore Diamond Head; 11-III-62 (“Pele” dredge at 20 m.); 5 colonies.
 Offshore Barber’s Point; 25-III-62 (“Pele” dredge at 40 m.); 8 colonies.
 Moku Manu, ?-XI-62 (Coll. R. W. Grigg, at 45 m.); 2 colonies.
 Auau Channel; ?-II-63 (Coll. R. W. Grigg, at 55 m.); 1 colony.

Substrates: coral (unidentifiable rubble), black coral (*Antipathes grandis*)

DESCRIPTION: (See Figure 17)

Colony—Growth extensive, shape variable, periphery often irregularly lobed—longest axis variable, thickness to 3 mm.; color alive variable, tan (sometimes with orange streaks across surface) or gray; color preserved white with clusters (240 μ in diameter) in basal tunic of dark pigment granules (each about 10 μ in diameter); tunic at branchial siphons level, formed into 3 prominent and 3 less distinct lobes; cloacal apertures raised above surface; cloacal canals thoracic and of varying widths, few extensions toward colony periphery; colony from Auau Channel with thin at-surface bladder-cell layer and aspicular, in all others no bladder cells and spicules usually in thin row at margins of the 3 more prominent branchial lobes, in dense layer at surface, scattered throughout tunic; spicule diameter 50–60 μ (to 80 μ in some), 10–11 (straight-sided and slightly elongated at tip) rays at optical section; zooids scattered.

Zooid—Positioned at angle with atrial siphon extending to cloacal canals; height to 1.5 mm.; color alive black or dark olive, preserved solid white; very long (to 425 μ) branchial siphon with 6 lobes; branchial sac with 4 stigmata rows, 8–12 (usually 10–11) stigmata per half row; atrial siphon posteriorly directed in most specimens, about as long as branchial siphon, with wide bulb at distal end; usually 7–9 distinct longitudinal thoracic muscles; no retractor muscle observed; oval lateral organs at third stigmata row or between third and fourth rows; stomach somewhat oval; intestinal tract without recurved loop; 3–6 (usually 4 or 5) testicular lobes, 5–6 vas deferens coils.

Larva—3 adhesive disks; 4 pairs very broad-tipped lateral ampullae; length without tail to 725 μ .

REMARKS: The aspicular Auau Channel colony is the first record of a completely aspicular member of any *Leptoclinides* species; however, *L. rufus* has been described as lacking spicules at the large distal lobes of the colony. The Auau Channel colony also contains bladder cells in a thin at-surface layer, a condition which has been noted occasionally for this species. The zooids and larvae of this specimen are indistinguishable from those of the other specimens, all of which are essentially identical to Sluiter’s (1909) description for this species (the spicules are somewhat larger in diameter than those originally described).

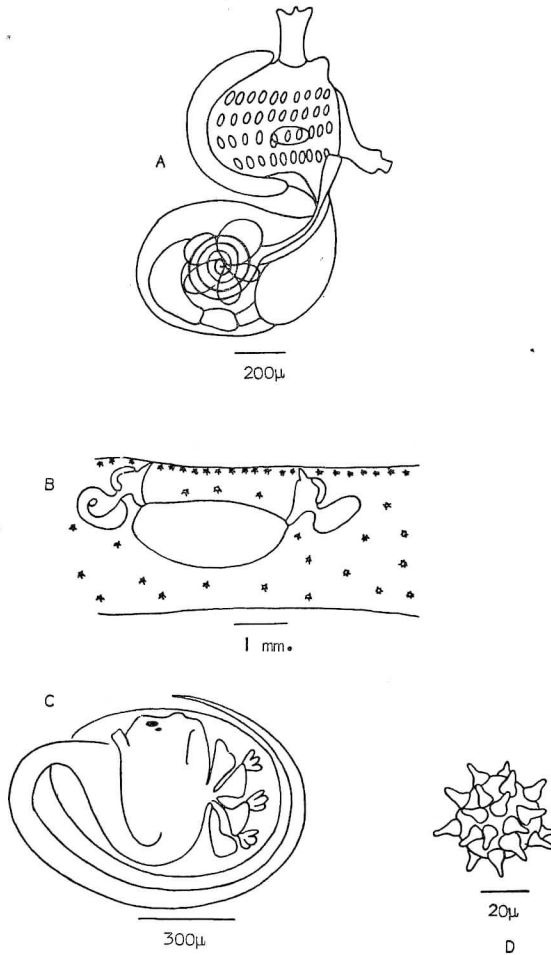

Fig. 17. *Leptoclinides rufus*: A. zooid; B. colony cross section; C. larva; D. typical spicule.

The specimens examined correspond well to Kott's (1962) description but poorly to that of Tokioka's (1952) single colony, which did not have the dense at-surface spicule layer and in which the zooids had rather short atrial siphons and in which the tunic at the branchial lobes was not formed into uneven lobes. His diagnosis for this species probably differed from the classic description because he had questionably synonymized with *L. rufus* two other species which are herein considered distinct. Therefore, his record is given in the above synonymy as questionable.

Several closely related *Leptoclinides* species have been variously synonymized with *L. rufus*: *L. diemenensis*, *L. lissus*, *L. auranticus*, *L. sluiteri*, and *L. novaezealandiae*. *L. lissus* and *L. diemenensis* were questionably included by Tokioka (1952). Brewin (1957, 1958b), however, presented new *L. diemenensis* records,

and Millar (1960) also described as distinct *L. diemenensis* and specifically maintained it as well as the somewhat similar *L. auranticus* and *L. sluiteri*, known only from original records, as individually valid because of their apparently divergent features pending investigations of the respective diagnostic-characteristic variations. He did remark that Australasian investigations might reduce the number of species in Sluiter's (1909) Indonesian *Leptoclinides* series, to which *L. rufus* belongs.

Kott (1962) synonymized with *L. rufus* not only *L. lissus* and *L. diemenensis* positively but also *L. auranticus*, *L. sluiteri*, and *L. novaezealandiae* questionably. Her reason for having done so is confusing: "Like Tokioka (1952) and Millar (1960) the present author can find no grounds on which to separate the suggested synonyms" (p. 288).

Apparently, Millar's (1963) description of a new record for the distinct species *L. lissus* was "in press" before Kott's (1962) publication became available. He did not cite her paper, nor did he discuss the synonymic status of *L. lissus* or that of any other species which has become involved with *L. rufus*.

Since only *L. rufus* is represented in the present collection, and since the description herein does not significantly overlap those of the other species involved, none of them are included in the above synonymy.

Askonides Kott

SYNONYMY: *Askonides* Kott, 1962

TYPE SPECIES: *Askonides coelenteratus* Kott, 1962

DEFINITION: Branchial sac with 4 stigmata rows; 5-lobed atrial siphon; spicules lining atrial lobes and present throughout tunic; vas deferens coiled on several testicular lobes; large "domed" colony with postzoid cloacal chambers connected by basal canals; larvae with 3 median adhesive disks, 3-4 pairs lateral ampullae.

SPECIES described from or known to occur in Indo-Pacific waters (known only from Australian waters):

Askonides coelenteratus Kott, 1962

imperfectus Kott, 1962

REMARKS: This genus, which somewhat resembles *Leptoclinides*, is not represented in the present collection.

Diplosoma Macdonald (*nomen conservandum*)

SYNONYMY: *Leptoclinium* Milne Edwards, 1841 (part)

Diplosoma Macdonald, 1859, *auct. mult.*

Lissoclinium Verrill, 1871 (part), *auct. mult.*

[see separate subgeneric synonymies below]

DEFINITION: Branchial sac with 4 stigmata rows, 6-12 stigmata per half row; atrial aperture usually wide and deeply incut, infrequently small opening; with or without lateral organs; with or without spicules; 1-5 testicular lobes (usually 2), vas deferens straight; cloacal canals postabdominal and/or thoracic, larvae usually with 3 median adhesive disks, 4 pairs lateral ampullae, and with or

without precocious thorax bud.

SPECIES described: (See subgenera below)

REMARKS: *Diplosoma* Macdonald (1859) is used herein as *nomen conservandum* for *Leptoclinium* Milne Edwards (1841). *Leptoclinium* in the classic sense has been used, with the exception of *Diplosoma* (*Diplosoma*) *listerianum* (= *L. listerianum*), for those spiculate didemnids which have coiled vas deferens and which are presently classified as members of *Didemnum* (Hartmeyer, 1909a, 1909b). *Diplosoma* has always comprised those aspicular forms with straight vas deferens (Hartmeyer, 1915) and is used currently by most ascidiologists for these forms.

The genus *Lissoclinium* is herein regarded as a subgenus of *Diplosoma*, a rearrangement suggested by many authors, used currently by only two. The close relationship between the two groups was first noted by Van Name (1921), who differentiated them on the basis of spicule presence or absence. Placing a lesser value on the taxonomic importance of spicule occurrence, Berrill (1950) proposed that *Lissoclinium* be a subgenus of *Diplosoma*. Carlisle (1953) declared that *Lissoclinium* should be absorbed entirely by *Diplosoma*, in the type species of which he discovered a few minute spicules. Since then the various authors have disagreed as to the proper taxonomic relationship between the two genera.

Tokioka (1955a, 1958b) has used *Lissoclinium* as a subgenus of *Leptoclinium* [= *Diplosoma*] but also (1958a, 1963) has considered it a distinct genus. None of his "diplosoma" *Leptoclinium* species (1955c, 1958b, 1962a, 1963) have been described as *Leptoclinium* (*Leptoclinium*).

Kott (1957) did consider *Lissoclinium* and *Diplosoma* distinct genera but more recently (1962) has described new records subgenerically as *Leptoclinium* (*Lissoclinium*) and *Leptoclinium* (*Leptoclinium*).

Millar (1955, 1956, 1960, 1962a, 1962b, 1963), Pérès (1956, 1958a, 1958b), and Brewin (1958a, 1958b, 1960) have each continued to describe species in the separate genera *Diplosoma* and *Lissoclinium*. Utinomi (1961) has also considered the genera distinct, for he described a species as being in the undivided genus *Leptoclinium*.

As can readily be seen in Table IV, Part A, the characteristics by which these genera are diagnosed do not differ to any significant degree except with respect to the presence or absence of spicules and lateral organs. Although the occurrences of lateral organs and spicules may be helpful in making specific determinations, the features themselves are not primarily important in making generic distinctions. Furthermore, since spicules may possibly originate within lateral organs, these differences may actually involve only one criterion rather than two separate characteristics. The few known larvae of *Diplosoma* and *Lissoclinium* are similar except for the extreme infrequency of precocious budding among the *Lissoclinium* species.

Table IV, Part B, presents other "generic" characteristics which do not usually appear in generic definitions. Again it can be seen that these groups are essentially identical. The only dissimilarity is that the "lissoclinium" zooid is more often supported in tunic strands than by being abdominally embedded.

Therefore, the two groups are considered subgenera of equal rank comprised by the genus *Diplosoma*. (Part C merely indicates the general distributions and numbers of species involved.)

Table IV. Characteristics of *Diplosoma* subgenera.

<i>Part A</i> , Diagnostic Characteristics	<i>Diplosoma</i> Macdonald, 1859 [= <i>Diplosoma</i> (<i>Diplosoma</i>)]	<i>Lissoclinum</i> Verrill, 1871 [= <i>Diplosoma</i> (<i>Lissoclinum</i>)]
Cloacal canals	usually extensive, postabdominal and/or thoracic	usually extensive, postabdominal and/or thoracic
Spicules	absent [rare in type species]	present in varying sizes and densities
Stigmata	4 rows, 6-12 per half row	4 rows, 6-12 per half row
Atrial aperture	wide, deeply incut; no languet	usually wide and deeply incut, sometimes small opening; with or without small languet in same species
Lateral organs	absent	frequently present
Testis and vas deferens	1-5 (usually 2) lobes; vas deferens straight	1-5 (usually 2) lobes; vas deferens straight
Larva	usually with 3 median adhesive disks, 4 pairs lateral ampullae, precocious thorax bud	usually with 3 median adhesive disks, 4 pairs lateral ampullae, precocious thorax bud rare
<i>Part B</i> , Other Characteristics:		
Nature of colony	very thin to very thick; tunic gelatinous or tough; cloacal apertures single or multiple	very thin to very thick; tunic gelatinous or tough; cloacal apertures single or multiple
Zoid arrangement	usually scattered, rarely systematically placed; abdomen usually embedded in basal tunic; zoid sometimes suspended in tunic strands	usually scattered, rarely systematically placed; abdomen sometimes embedded in basal tunic; zoid usually suspended in tunic strands
Branchial siphon	6 lobes	6 lobes
Retractor muscle	absent or present	absent or present
<i>Part C</i> , Miscellaneous:		
Distribution	Atlantic, Pacific, and Indian Oceans; Antarctic	Atlantic, Pacific, and Indian Oceans; Arctic
Number of species	23 (19 Indo-Pacific)	24 (16 Indo-Pacific)

The homonyms created by this reclassification heretofore have not been noted. Two *nomina nova* must be established:

1. *Diplosoma* (*Diplosoma*) *molle* Gottschaldt, 1898 (= *Diplosoma molle* Gottschaldt, 1898) is preoccupied by *Diplosoma* (*Lissoclinum*) *molle* (Herdman, 1886) (= *Diplosomoides molle* Herdman, 1886). Therefore, Herdman's species is maintained as *D. (L.) molle* (Herdman, 1886). The name suggested for Gottschaldt's newer "molle" is *D. (D.) berrilli*, the specific name being offered in recognition of Dr. Berrill's first having suggested that

spicule occurrence alone is not a valid generic determinant.

2. Both *Diplosoma (Lissoclinum) circumscriptum* (Gottschaldt, 1898) (= *Diplosomoides circumscriptum* Gottschaldt, 1898) and *Diplosoma (Diplosoma) circumscriptum* Gottschaldt, 1898 (= *Diplosoma circumscriptum* Gottschaldt, 1898) were originally described in the same publication. The selection of the *nomen novum* being left to the redescrber under such circumstances (International Code of Zoological Nomenclature, Article 24(a), p. 25), it is preferred to maintain the "diplosoma" species as *D. (D.) circumscriptum* Gottschaldt, 1898, in spite of the fact that the description appears on a later page, because that species was originally described within the genus *Diplosoma*. The name suggested for the "lissoclinum" species is *D. (L.) tokiokai*, the specific name being offered in recognition of Dr. Tokioka's first having used *Lissoclinum* subgenerically.

Another homonymic situation occurs with *D. (D.) gelatinosum* (Milne Edwards, 1841) and *D. (L.) gelatinosum* (Gottschaldt, 1898). No *nomen novum* is suggested at this time for Gottschaldt's species, however, because the status of each is subject to some question. *D. (D.) gelatinosum* is not currently regarded as a distinct species by most ascidiologists [see *D. (Diplosoma)* remarks], and *D. (L.) gelatinosum* is possibly synonymous with *D. (L.) fragile* [see *D. (L.) fragile* remarks].

Members of this genus are among the more simply constructed species in the family. The two subgenera are differentiated by the presence or absence of lateral organs and spicules. Although zooids of the different species are often nearly indistinguishable, those groups are separated by the presence or absence of algae, the nature of the tunic, the complexity of the cloacal system, the placement of the zooids, and the various aspects of the spicules, such as distribution and diameter.

Diplosoma (Diplosoma) Macdonald

SYNONYMY:

Polyclinum Lister, 1834
Leptoclinum Milne Edwards, 1841 (part)
Leptoclinum Forbes and Hanley, 1848 (part)
Diplosoma Macdonald, 1859, *auct. mult.*
Lioclinum Verrill, 1871 (part)
Lissoclinum Verrill, 1871 (part)
Astellium Giard, 1872 (part)
 (non) *Leptoclinum* Giard, 1872
Pseudodidemnum Giard, 1872
Brevistellium Jourdain, 1885
Diplosomoides Herdman, 1886 (part)
Leptoclinum Hartmeyer, 1909a (part)
Leptoclinum (Leptoclinum) Kott, 1962

TYPE SPECIES:

Diplosoma (Diplosoma) listerianum (Milne Edwards)
 (= *Leptoclinum listerianum* Milne Edwards, 1841)

DIAGNOSIS: Aspicular; no lateral organs; atrial aperture without languet; most larvae with precocious thorax bud.

SPECIES described from or known to occur in Indo-Pacific and western North American (*) waters:

- Diplosoma (Diplosoma) berrilli* Eldredge, herein
 (nom. nov. pro *D. molle* Gottschaldt, 1898)
calificiforme (Sluiter, 1909)
circumscriptum Gottschaldt, 1898
 ?*discrepans* (Sluiter, 1909)
globulare (Gottschaldt, 1898)
handi n. sp.
hiatti n. sp.
 **macdonaldi* Herdman, 1886
 (nom. cons. pro *D. rayneri* Macdonald, 1859)
 (= *D. mitsukurii* Oka, 1892)
 (= *Leptoclinum macrolobium* Tokioka, 1949)
 (= *Leptoclinum okai* Tokioka, 1949)
 *(= *D. pizoni* Ritter & Forsyth, 1917)
marmoratum (Sluiter, 1909)
midori (Tokioka, 1954)
modestum Michaelsen, 1920
multifidum (Sluiter, 1909)
papyraceum (Sluiter, 1909)
simile (Sluiter, 1909)
spongiforme (Giard, 1872)
subviridis (Sluiter, 1909)
takeharai (Tokioka, 1951)
ternatanum [ternatum] Gottschaldt, 1898
translucidum (Hartmeyer, 1910)
 (nom. nov. pro *Leptoclinum perspicuum* Sluiter, 1909)
varium (Sluiter, 1909)
virens (Hartmeyer, 1909)
 (nom. nov. pro *D. viride* Herdman, 1906)

REMARKS: Several species of *Diplosoma (Diplosoma)* have been variously synonymized by different authors. The status of the type species itself is subject to question, for it has not always been maintained as distinct. Harant (1931) considered *Leptoclinum* [= *Diplosoma (Diplosoma)*] *listerianum* a variety of *D. gelatinosum*, in the synonymy of which he also included *D. rayneri*. He further synonymized under another *D. gelatinosum* variety the species *D. spongiforme*. On the other hand, Carlisle (1953) maintained *D. listerianum* as a valid species comprising, in the fashion of Lahille (1890), essentially the "gelatinosum" varieties, among which he synonymized *D. gelatinosum*, *D. rayneri*, and *D. spongiforme*. The confusion is further compounded by the existence of several other "gelatinosum" species which have also been variously synonymized and even classified by some in another genus. A solution has not yet been provided. One is not offered herein because neither have the respective type specimens been examined nor is enough of the extensive literature pertaining to this essentially European problem available at this time. With regard to the two Indo-Pacific species which have been involved in this confusion, *D. (D.) spongi-*

forme is herein considered distinct, and *D. (D.) rayneri* is synonymized with *D. (D.) macdonaldi*.

As the specific name suggests, Sluiter's (1909) *Leptoclinium* [= *Diplosoma* (*Diplosoma*)] *discrepans* presents a classification problem. Among his seven aspicular colonies, he found only a few zooids with discernible male gonads, and he described the [lobed?] structures as having straight vas deferens. At the same time, he also described the zooids as having only three stigmata rows. Perhaps, as Kott (1962) suggested, these colonies represent a new genus. It is equally likely that they are actually immature *Trididemnum* forms, for they correspond well to the definition of that genus in such respects as the cushion-like colony appearance, the small oval atrial aperture, and the numerous stigmata per half row. Furthermore, although the number of stigmata rows is nearly always a constant feature, the only known exceptions being Carlisle's (1954) *Didemnum candidum* and Carlisle and Carlisle's (1954) *Leptoclinides faerøensis*, the degree of vas-deferens coiling may vary greatly. Perhaps the few structures Sluiter observed were not well enough developed for any coiling to have been evident. Because of these uncertainties, this species is only questionably included in *Diplosoma* (*Diplosoma*).

Key to *Diplosoma* (*Diplosoma*) Species Described

- 1 Colony larger than 1 cm. in diameter; numerous cloacal apertures; zooids usually suspended in tunic strands 2
- Colony smaller than 1 cm. in diameter; single central cloacal aperture; zooids not suspended in tunic strands 3
- 2(1) Algae present in cloacal canals; live colony dark green with at-surface tourquoise ring around or crescent at dorsal side of branchial opening; zooids usually unpigmented *D. (D.) virens*
- Colony algae-free; live colony tan or gray with white pigment granules scattered over surface; zooid abdomens tan- or gray-orange *D. (D.) macdonaldi*
- 3(1) Colony attached by peripheral strands; thickness to 1 mm.; colony algae-free; live colony white with yellow pigment granules scattered around cloacal aperture *D. (D.) hiatti*
- Colony attached along entire basal surface; thickness to 4 mm.; algae present in cloacal canals; live colony green *D. (D.) handi*

Diplosoma (*Diplosoma*) *virens* (Hartmeyer)

- SYNONYMY: (*non*) *Leptoclinium viride* Herdman, 1906, Ceylon Pearl Oyster Fish. 5(suppl. 39):340.
- Diplosoma viride* Herdman, 1906, Ceylon Pearl Oyster Fish. 5(suppl. 39):341.
- Leptoclinium virens* [*nom. nov. pro Diplosoma viride*] Hartmeyer, 1909, Klassen und Ordnungen des Tier-Reichs 3, suppl., (86-87):1456.
- Diplosoma virens* Hastings, 1931, Great Barrier Reef Exped. 1928-1929 Sci. Rep. 4(3):102.

Leptoclinum virens Tokioka, 1942, Palao Trop. Biol. Sta. Stud. 2(3):500.

DISTRIBUTION: Palau (Tokioka, 1942)
Great Barrier Reef (Hastings, 1931)
Ceylon (Herdman, 1906)
Oahu—Checker Reef, Kaneohe Bay; 10-XI-61, 30-VII-64;
approximately 10 colonies.
Palmyra—Penguin Spit; 13-V-62; 2 colonies.
Eniwetok—Eniwetok quarry tide pool; 15-VIII-62, 18-VIII-62; approximately 20 colonies.
Ebon Atoll, Marshall Islands; 5-VII-49 (Coll. M. W. de Laubenfels; USNM 11541); 1 colony.
Substrates: coral (*Pocillopora meandrina*), calcareous algae (*Porolithon* sp.)

DESCRIPTION (See Figure 18)

Colony—Growth usually extensive, shape variable, depending on substrate—longest axis often several cm., thickness to 4 mm.; color alive dark green with turquoise flecks scattered over surface, at-surface iridescent turquoise ring around branchial opening (Oahu specimens) or turquoise crescent over neural complexes (Eniwetok specimens); color preserved opaque white (all specimens); cloacal apertures few and transparent, most often raised; cloacal canals extensive, thoracic and postabdominal, with basal accumulations of algal cells; zooids scattered, suspended in tunic strands at center, abdomens partially embedded in basal tunic at periphery.

Zooid—Height to 1.1 mm., thorax height to 500 μ , abdomen slightly shorter (375 μ) and quite wide in zooids with mature testes; zooid usually not pigmented, occasionally abdomen dark brown or black even when preserved; short branchial siphon with 6 pointed lobes; branchial sac with 4 stigmata rows, 6 stigmata per half row; atrial aperture wide, deeply incut; retractor muscle variable—short to as long as thorax height; 2 testicular lobes, straight vas deferens; thoracic buds in varying stages of development; frequent stolons, some upturned anteriorly.

Larva—3 adhesive disks; 2 pairs small lateral ampullae; length without tail to 772 μ ; large, somewhat spheroidal posterolateral algal pouch (not part of intestinal tract)—when preserved, presence of bleached algal cells in pouch difficult to determine; no precocious buds observed; larval body surface covered with bladder cells.

REMARKS: Although ascidiologists have long noted that some didemnid species characteristically contain algae in the cloacal canals or in the adjacent tunic, ascidian-algae associations have generally been considered accidental, coincidental, and diagnostically insignificant. Smith (1935), the only author to have speculated on the origin of such associations, noted that the few didemnids known to contain algae occurred only in tropical coral-reef waters. He theorized that some of the algae from ingested coral planulae passed unaffected into the cloacal systems, where cells remained. At the same time, he did not offer to explain why the numerous other didemnids occurring in the same waters were known not to contain algae.

Perhaps algae do occasionally settle out of zooid waste products. However, the discovery of algal pouches in the dozen or so larvae examined from the present *Diplosoma* (*Diplosoma*) *virens* colonies is of particular interest. This aspect of larval anatomy would certainly have gone unnoticed among these specimens

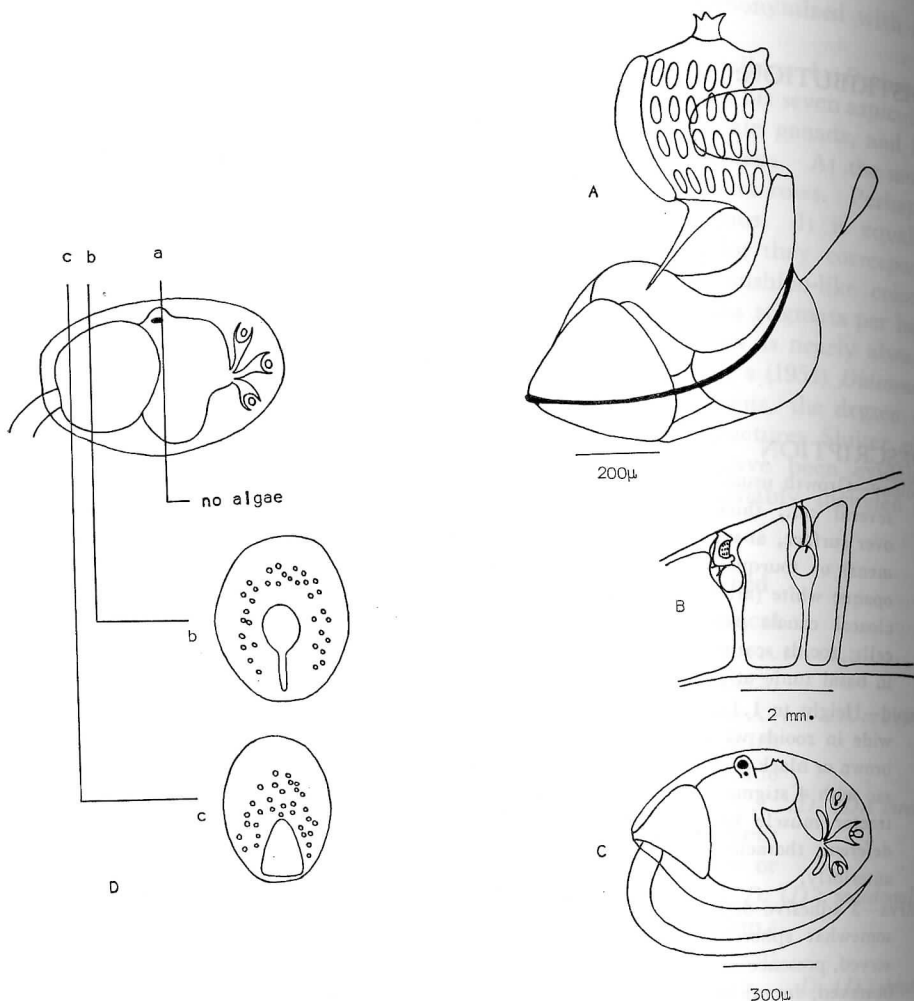

Fig. 18. *Diplosoma* (*Diplosoma*) *virens*: A. zooid; B. colony cross section; C. larva; D. diagrammatic sketch of larva showing cross sections (b-c) through algal pouch.

had not a green larva swum through the field of observation while live-colony color notes were being made. The captured larva and others taken from the colony were immediately relaxed and examined. Each was seen to have, at the origin of the tail, a somewhat spheroidal transparent pouch in which closely packed algal cells were discernible. A later cross section [at 10μ, larva stained with hemotoxylin and eosin] revealed that the pouch actually envelops the origin of the tail and rests against the posterior margin of the larval abdomen. In the separate cross sections the algae appear to be arranged in a "horseshoe," the open end being at the ventral portion of the pouch. It is thought that some of the algae were lost during the cross section preparation, for the

bleached cells were not as abundant as they had seemed to be in the living larvae. In the unstained, intact, preserved larvae, the pouches are nearly indistinguishable from the remainder of the larval body.

A curious condition, which may or may not be coincidental, is the absence of precocious budding among these larvae, some of which were otherwise quite well developed and were actually in the process of leaving the colonies. Whether or not the presence of the algal pouch precludes such budding could not be determined; however, the pouch itself does not intrude into the area normally occupied by the precocious bud. The condition is perhaps even more singular because the lateral ampullae are much smaller than normal and consist of only two pairs (most *Diplosoma* have four). Ampullae usually closely resemble the stolons found in the colony. Because of their proximity to the adhesive disks, they are automatically positioned at the base of the settled larva, a location corresponding to that of stolon buds. Thus, it is suspected that these structures actually function "stolonically" during the first stages of colony formation. It is further surmised that the *D. (D.) virens* colony enjoys a remarkable degree of developmental potency, for its apparently unrestricted growth is far more extensive than such meager larvae would seem likely to generate.

A species perhaps even more closely related to *D. (D.) virens* than the equivalent specific names suggest is *D. (D.) midori*, zooidally distinguishable from *D. (D.) virens* only by the more rectangular stomach outline. In general colony structure the two species are apparently identical. Moreover, Tokioka (1954c) has described *D. (D.) midori* not only as being algal green but also as having a circumbranchial blue pigmentation. The Hawaiian specimens resemble *D. (D.) midori* very closely in this respect, and the Eniwetok specimens are also algal green but with turquoise-blue crescents over the neural complexes. *D. (D.) midori* may well be synonymous with *D. (D.) virens*. However, never has the larva of either previously been described, and the atypical structure of the *D. (D.) virens* larva is of critical value diagnostically. When the larval characteristics of *D. (D.) midori* are known, it can be determined whether or not that species should be maintained as distinct.

***Diplosoma (Diplosoma) macdonaldi* Herdman (*nomen conservandum*)**

- SYNONYMY: [For clarity, records of the newly incorporated species appear individually in chronological order]
- Diplosoma rayneri* Macdonald, 1859, Trans. Linn. Soc. London 22(4):373.
- Leptoclinium (Leptoclinium) rayneri* Kott, 1962, Aust. J. Mar. Freshw. Res. 13(3):305.
- Diplosoma macdonaldi* Herdman, 1886, Rep. Sci. Res. Voy. H.M.S. Challenger, Zool., 14(38):315.
- D. macdonaldi* Gottschaldt, 1898, Abhandl. Senckenb. Naturforsch. Ges. 24(4):657.
- D. macdonaldi* + *D. lacteum* + *D. atropunctatum* Van Name, 1902, Trans. Conn. Acad. Arts Sci. 11:368, 369, 370.
- Leptoclinium macdonaldi* Van Name, 1918, Bull. U. S. Natl.

- Mus. 100, 1(2):159.
- L. macdonaldi* Van Name, 1921, Bull. Am. Mus. Nat. Hist. 44:335.
- L. macdonaldi* Van Name, 1924, Bijdr. Dierk. 23:26.
- Diplosoma macdonaldi* Van Name, 1930, Sci. Surv. Porto Rico Virgin Is. 10(4):440.
- Leptoclinum macdonaldi* Berrill, 1932, Biol. Bull. 62(1):77.
- Diplosoma macdonaldi* Van Name, 1945, Bull. Am. Mus. Nat. Hist. 84:109.
- D. macdonaldi* Brewin, 1946, Trans. Roy. Soc. N. Z. 76(2):100.
- D. macdonaldi* Brewin, 1950, Trans. Roy. Soc. N. Z. 78(2-3):345.
- D. macdonaldi* Brewin, 1951, Trans. Roy. Soc. N. Z. 79(1):104.
- D. macdonaldi* Brewin, 1952, Trans. Roy. Soc. N. Z. 80(2):188.
- D. macdonaldi* Brewin, 1958, Trans. Roy. Soc. N. Z. 85(3):439.
- D. macdonaldi* Brewin, 1960, Trans. Roy. Soc. N. Z. 88(1):119.
- Diplosoma mitsukurii* Oka, 1892, Biol. Centr. 12(9):265.
- D. mitsukurii* Oka, 1927, Figuraro de Japanaj Bestoj, p. 500.
- Leptoclinum okai* Tokioka, 1949, Pub. Seto Mar. Biol. Lab. 1(1):5.
- L. macrolobium* Tokioka, 1949, Pub. Seto Mar. Biol. Lab. 1(2):44.
- L. mitsukurii* Tokioka, 1953, Ascidians of Sagami Bay, p. 201.
- L. mitsukurii* Tokioka, 1954, Pub. Seto Mar. Biol. Lab. 3(3):249.
- L. mitsukurii* Tokioka, 1958, Encyclopaedia Zoologica Illustrated in Colours 2:377.
- L. mitsukurii* Utinomi, 1961, Coloured Illustrations of Sea Shore Animals of Japan, p. 127.
- L. mitsukurii* Tokioka, 1962, Pub. Seto Mar. Biol. Lab. 10(1):7.
- Diplosoma pizoni* Ritter and Forsyth, 1917, Univ. Calif. Pub. Zool. 16(24):474.
- D. pizoni* Van Name, 1945, Bull. Am. Mus. Nat. Hist. 84:110.
- ?*Diplosoma* sp. Millar, 1963, Proc. Zool. Soc. London 141(4):705.

DISTRIBUTION: Extensive throughout tropical and subtropical Atlantic and Pacific, including west coast of North America; also known from Malayan and western Australian waters; not known from Indian Ocean proper (see Map 11)

Midway—Sandy Point; 23-VI-63; 1 colony.

Oahu—Coconut Island, Kaneohe Bay; 9-VIII-61, 4-X-61, 11-X-61, 11-XI-61, 29-XI-61, 21-XI-62, 11-V-63, 1-VII-63, 30-VII-64; approximately 100 colonies.

West Loch, Pearl Harbor; 31-X-61; 10 colonies.

Pearl Harbor; no date (Coll. D. P. Abbott); 1 colony.

Pearl Harbor (Hull of U. S. S. Dobin); ?-VII-40 (Coll. D. P.



Map 11. Distribution of *Diplosoma* (*Diplosoma*) *macdonaldi*, including present records and indicating locations of species synonymized herein: *D. (D.) macdonaldi* (×), *D. (D.) mitsukurii* (+), *D. (D.) pizoni* (⊙), *D. (D.) rayneri* (●), *Diplosoma* sp. (⊖).

Abbott); 5 colonies.

Sand Island, Honolulu; 9-VII-64; 1 colony.

Honolulu Harbor; 18-III-41 (Coll. D. P. Abbott & C. B. Mills); 1 colony.

Honolulu; 18-V-00 (Coll. L. Miller); 5 colonies.

Honolulu; 3-VII-02 (Coll. U. S. Fish Comm. Albatross Hawaiian Expedition, from tug boat); 5 colonies.

Halona Blowhole; 27-II-46 (Coll. D. P. Abbott); 1 colony.

Queens Beach; 19-IV-42 (Coll. D. P. Abbott); 3 colonies.

Palmyra—Central lagoon; 10-V-62; 1 colony.

Eniwetok—Eniwetok quarry tide pool; 15-VIII-62; 5 colonies.

Eniwetok atoll lagoon; 20-VIII-62; 2 colonies.

Kapingamarangi—Touhou Island “microatoll”; 2-VII-54 (Coll. C. H. Hand); 2 colonies.

Ifaluk—Reef between Ella and Elangalap Islets; 30-IX-53 (Coll. D. P. Abbott); 1 colony.

Lagoon station D; 3-X-53 (Coll. D. P. Abbott & F. M. Bayer); 2 colonies.

? Falarik Islet; 17-X-53 (Coll. F. M. Bayer); 1 colony.

Falalap and Ella Islets ship pass; 25-X-53 (Coll. R. Rofen); 1 colony.

California—Carmel Cove, Monterey County; 19-VII-47 (Coll. D. P. Abbott); 1 colony.

San Diego Rowing Club floats; 28-XII-47 (Coll. D. P. Abbott, C. H. Hand, & B. McConnaughey); 1 colony.

Berkeley Yacht Harbor, San Francisco Bay; 5-III-48 (Coll. D. P. Abbott); 1 colony.

Alamitos Bay, Long Beach; 8-VIII-60 (Coll. D. L. Reish); 1 colony.

Substrates: wood (floating dock, pilings), sabellid and serpulid worm tubes, barnacles, coral (unidentifiable), bivalve mollusks (*Ostrea* sp.), sponges—externally and internally, green algae (live?), calcareous algae (*Halimeda* sp., *Porolithon gardineri*), solitary ascidians (*Ascidia sydneiensis*, *Ciona intestinalis*)

Additional Specimens Examined:

California—San Diego Bay; 1899 (Coll. S. J. Holmes); approx. 5 colonies. [Ident. as *D. pizoni* by W. E. Ritter]

Kerkoff Marine Laboratory, Corona Del Mar; ?-IV or V-36 (Coll. G. E. MacGinitie); 1 colony. [AMNH 1298 as *D. pizoni* (label reads “changed from *D. macdonaldi*” by W. G. Van Name, Feb., 1943)]

Mussel Point (rocky point near laboratory), Pacific Grove; 19-VII-39 (Coll. W. G. Van Name); 1 colony. [Ident. as *D. pizoni* by W. G. Van Name]

Canada—Tschum Harbor wharf (near Sidney, Vancouver Is., Br. Columbia); 8-V-60 (Coll. Mrs. J. F. L. Carl); 2 colonies. [Ident. as *D. pizoni* by D. P. Abbott]

Sooke (near Victoria), Vancouver Is., Br. Columbia; 11-VI-60 (Coll. Mrs. J. F. L. Carl); 7 colonies. [Ident. as *D. pizoni* by D. P. Abbott]

Philippines—Jolo Light; date unknown; (Coll. unknown); 1 colony. [AMNH 653, Ident. as *D. macdonaldi* by W. G. Van Name]

Jolo; 15-II-08 (Coll. U. S. Bureau of Fisheries Albatross Philippine Expedition, Stat. 5145, 23 fms.); 2 colonies. [On carapace of dromid crab; USNM 5957, Ident. as *Leptoclinum macdonaldi* by W. G. Van Name in 1912]

Australia—Outer Harbor, Adelaide; date unknown (Coll. Chittleborough); approx. 5 colonies. [British Museum (Nat. Hist.) Reg. No. 1951.9.10.9 as *D. listerianum*, redetermined as *D. rayneri* by F. W. E. Rowe]

Port Jackson, New South Wales; date unknown (Coll. unknown—presented to British Museum by Australian Museum); 1 colony. [British Museum (Nat. Hist.) Reg. No. 31.5.12.7 as *D. spongiforme* var., redetermined as *D. rayneri* by F. W. E. Rowe]

Caribbean—Dry Tortugas, Fort Jefferson, West Side; 15-VI-31 (Tandy-Colman Coll. No. 85); 8 small colonies. [British Museum (Nat. Hist.) Reg. No. 31.12.25.5 as *D. macdonaldi*, Ident. by A. Hastings]

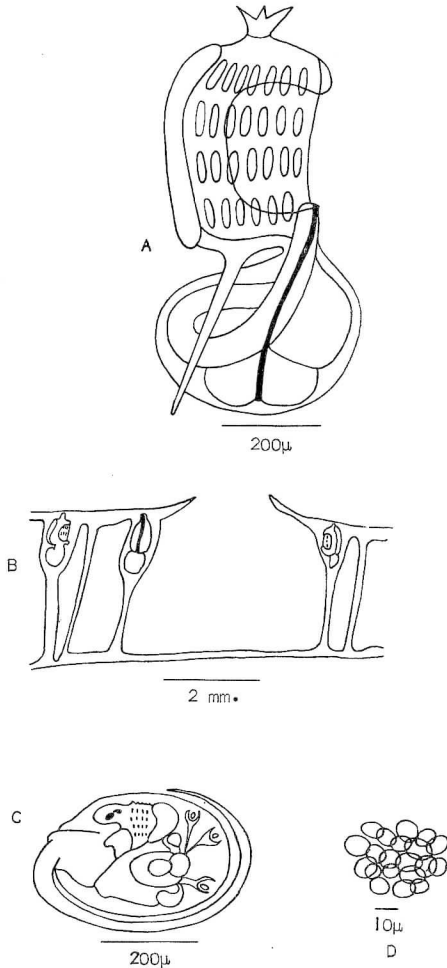

Fig. 19. *Diplosoma* (*Diplosoma*) *macdonaldi*: A. zooid; B. colony cross section; C. larva; D. outline of white pigment cells in colony surface.

DESCRIPTION: (See Figure 19)

Colony—Shape variable, outline irregular—longest axis often several cm., thickness less than 1 cm.; color alive transparent gray to tan with white pigment granules (12–13 μ in diameter) easily mistaken for spicules over surface, more concentrated around branchial openings; white granules transparent when preserved with distinct cell outlines; cloacal apertures usually transparent and often raised, not outlined; cloacal canals extensive, thoracic and postabdominal; zooids scattered—suspended in tunic strands at center, abdomens partially embedded in basal tunic at periphery.

Zooid—Height to 1.5 mm.; thorax usually transparent, some with occasional dark circum-branchial pigment even when preserved; stomach and testicular lobes almost always with dark tan or gray-orange pigment, even when preserved; branchial siphon with 6 distinctly

pointed lobes; branchial sac with 4 stigmata rows, 6-9 (usually 7-8) stigmata per half row; atrial aperture wide, deeply incut; retractor muscle length variable from short to as long as thorax height; intestinal tract with slight recurved loop; 2 testicular lobes, straight vas deferens; female gonads present in all stages of development; pyloric buds present in different quantities in most specimens; frequent stolons oriented both anteriorly and posteriorly. Larva—3 adhesive disks; 4 pairs lateral ampullae, often obscured by precocious thorax bud; length without tail to 500 μ ; precocious buds found in almost all specimens.

REMARKS: The single colony from Falarik Islet, Ifaluk is questionably identified as *Diplosoma (Diplosoma) macdonaldi*. It contained no larvae. In structure it is identical to the other specimens, and no (bleached) algal cells were discovered in the preserved colony. However, the collector had noted that this colony

Table V. Characteristics of species synonymy

Original Diagnostic Characteristics	<i>Diplosoma macdonaldi</i> Herdman, 1886 [+Van Name, 1945]	<i>Diplosoma rayneri</i> Macdonald, 1859 [+Kott, 1962]
Colony appearance	growth extensive; very soft, flexible; pale yellow cells in tunic	thin; delicate; small cells in tunic [presumably bleached pigment cells]
Cloacal system	apertures not described; canals very extensive	apertures not described; canals extensive
Zooid support	in tunic strands	in tunic strands
Zooid appearance	transparent, stomach pigmented in some; height 1.5 mm.	pigmented, sometimes only on abdomen; height about 1 mm.
Branchial siphon	not lobed [?—lobes described and illustrated (Van Name, 1918, 1945)]	lobes distinct
Number stigmata/half row	9-10	not described
Atrial aperture	transverse oval, large when expanded	wide, deeply incut
Retractor muscle	not described [present in BM(NH) specimens]	present
Testicular lobes	2	2
Vas deferens	straight	not described [presumably straight]
Stolons	vascular processes [=stolons]	basal stolons
Larva	not described	3 adhesive disks, 4 pairs lateral ampullae, precocious budding
Type locality	Bahia, Brazil	Sidney Harbour, Australia

was found "with zoochlorellae," and had algal cells been found, this specimen might have been identified as *D. (D.) virens*.

The superficial variations of this species have resulted in its having been given different names from geographically isolated areas. Table V summarizes these identifications, and it can readily be seen that in spite of one or two minor deviations, the "species" involved are essentially identical.

Although some of the earlier descriptions would not so indicate, these species are all characterized by small pigment granules scattered over the upper surface and concentrated at the branchial openings. For example, in the original description of *D. rayneri*, Macdonald (1859) illustrated "cells and in-

mized with *Diplosoma (Diplosoma) macdonaldi*.

<i>Diplosoma mitsukurii</i> Oka, 1892 [from Tokioka, 1953a]	<i>Diplosoma pizoni</i> Ritter and Forsyth, 1917	Specimens Examined Herein
growth extensive; soft, gelatinous; semi- to transparent with white spherical cells on surface	growth extensive; exceptionally soft; apparently pigmented at surface	growth extensive; thin; delicate, gelatinous; color alive transparent gray to tan with white pigment granules on surface
apertures not described; canals deep, extensive	apertures few, large, and raised; canals extensive	apertures transparent, raised; canals extensive, thoracic and postabdominal
in tunic strands	in tunic strands	in tunic strands
stomach with brownish purple cells; height 1.2 mm.	stomach and intestine pigmented; height 1.5 mm.	stomach and testicular lobes distinctly tan- or gray-orange; height to 1.5 mm.
lobes distinct	lobes distinct	lobes distinct
7-11	7-8	6-9 (usually 7-8)
wide, deeply incut	wide, deeply incut	wide, deeply incut
present—very short	present	present—very short to equal thorax height
2	2	2
not described [presumably straight]	not described [presumably straight]	straight
none described	ectodermal vessels [=stolons]	basal stolons frequent
3 adhesive disks, number lateral ampullae not described, precocious budding	not described	3 adhesive disks, 4 pairs lateral ampullae, precocious budding
Honshu, Japan	San Diego, California	[from Midway, Oahu, Palmyra, Eniwetok, Ifaluk, Kapingamarangi]

tercellular corpuscles of connecting substance" (p. 375 and Tab. LXV, Div. I, Fig. 6). The structures are identical to the at-surface bleached pigment granules seen in specimens of *D. macdonaldi* collected from the Dry Tortugas granules Museum (Natural History) Reg. No. 31.12.25.5] which were examined for purposes of comparison. [Although she did not publish the description, these specimens were identified by Dr. Hastings (A. M. Clark, BM(NH), pers. comm.).] According to various (later) descriptions of all of the species, these granules are quite light in color—very pale yellow or white. Such pigmentation was constant among the present (living) specimens; in fact, the granules were at first mistaken for spicules. After the colonies were preserved, the color completely disappeared, leaving only the cell outlines.

As the table indicates, the name *D. (D.) rayneri* Macdonald (1859) technically has priority over *D. (D.) macdonaldi* Herdman (1886). However, the former should be suppressed in favor of *D. (D.) macdonaldi* as *nomen conservandum* for several reasons. *D. (D.) rayneri* is known virtually only from a single record. Kott (1962), in presenting the second record in its one-hundred-odd-year history, stated, "nothing can be added to previous descriptions . . ." (p. 305). (Although she indicated that more than one description exists, only Macdonald's original description is listed in her synonymy, and it is apparently the only other one ever to have been published.) Furthermore, the name *D. (D.) macdonaldi* is far better known, for that species has been recorded frequently from numerous areas for approximately seventy-five years. That species has also been the subject of several ecological, physiological, and larval studies. In accordance with Article 23(b) of the International Code of Zoological Nomenclature (1961, p. 23), the name *D. (D.) macdonaldi* is therefore selected.

This species enjoys an extensive, nearly cosmopolitan, tropical and subtropical distribution. A range such as this one is not unusual, for many ascidians are found both in the western Atlantic and in the Indo-Pacific and are not present in (cooler) European waters (Huus, 1927; Tokioka, 1963). Notable in the above synonymy, however, is the inclusion of *D. pizoni* from California, thus making *D. (D.) macdonaldi* the first didemnid species known to be distributed across Ekman's "East Pacific Barrier." This synonymic step is prompted by Van Name's (1945, p. 111) statement that *D. pizoni* "is even more closely related to [the original] *D. macdonaldi* than Ritter and Forsyth's description indicates." The five colonies identified by Ritter from San Diego Bay may possibly be part or all of a type series or even the fragmented holotype of *D. pizoni*. At the very least they are topotypic material. These and the other western North American specimens examined for comparison purposes are indistinguishable from the other members of the collection.

A record which no doubt definitely belongs in *D. (D.) macdonaldi* is the Australian *Diplosoma* sp. described by Millar (1963). It is included only questionably at the present time, however, because even though the figure of the zooid is nearly identical to that for *D. (D.) macdonaldi*, the description of the two larvaless colonies is sketchy and makes no mention of such pertinent features as the number of stigmata per half row, testicular structure, and extent of cloacal system.

Although the brief descriptions of some of Gottschaldt's (1898) and Sluiter's

(1909, 1913) species from the Malayan area suggest that these might be incorporated into *D. (D.) macdonaldi*, they are not included at this time because the descriptions are incomplete and lack type figures.

The European *D. (D.) listerianum* is apparently the northern counterpart of *D. (D.) macdonaldi*, distinguished by the dark colony pigmentation, the somewhat more extensive cloacal canals, and the vertically narrower atrial aperture. The geographic range of *D. (D.) listerianum* is not known to overlap that of *D. (D.) macdonaldi* except possibly for Millar's (1955) doubtful record of the former from South Africa. Further investigations may perhaps prove these two species to be synonymous.

Diplosoma (Diplosoma) hiatti n. sp.

DIAGNOSIS: Colony small, attached only by peripheral strands; color alive even (pigmented) white with brilliant lemon-yellow pigment granules surrounding single cloacal aperture; 6-8 stigmata per half row; abdomen on ventral side at angle to thorax.

DISTRIBUTION: (Type locality) Eniwetok—Reef between Japtan and Chinimi Islets; 17-VIII-62; 14 colonies.

Substrate: coral (unidentifiable)

DESCRIPTION: (See Figure 20)

Colony—Surface smooth, shape irregularly round—longest axis less than 5 mm., thickness less than 1 mm.; indirectly attached by several (7-10) peripheral tunic strands; color alive even (pigmented) white with lemon-yellow pigment granules scattered immediately around cloacal aperture, preserved tan with some granules retaining pigment; single nearly round cloacal aperture at colony center; cloacal canal thoracic, extensive; bladder cells very dense throughout tunic; few zooids per colony, oriented dorsally toward cloacal aperture.

Zooid—Height to 650 μ —thorax to 475 μ , abdomen to 175 μ ; color preserved opaque tan; short branchial siphon with 6 very short pointed lobes; branchial sac with 4 stigmata rows, 6-8 (usually 6) stigmata per half row; atrial aperture wide, deeply incut; retractor muscle very short and fragile; esophageal pedicle short; abdomen on ventral side at angle to thorax; stomach oval; intestinal tract without recurved loop; single testis, straight vas deferens; pyloric budding thoracic and abdominal; stolons abundant at colony periphery.

Larva—None observed.

REMARKS: These algae-free specimens do not conform to the diagnoses of any previously described *Diplosoma (Diplosoma)* species. The active pyloric budding and frequency of stolons and the total absence of larvae indicate that these colonies are not fully mature. However, the peculiar peripheral-strand attachment in conjunction with the single cloacal aperture and the unusual orientation of the abdomen presents a unique structure which warrants identifying these specimens as a new species, *D. (Diplosoma) hiatti*, named for Dr. R. W. Hiatt, under whose auspices these specimens were collected.

Diplosoma (Diplosoma) handi n. sp.

DIAGNOSIS: High (to 4 mm.), solid, unusually tough, dome-like colony distinctly layered—(1) thick bladder-cell-filled upper tunic separated by (2) extensive, algae-filled, thoracic and slightly abdominal cloacal canal from (3) unusually thick

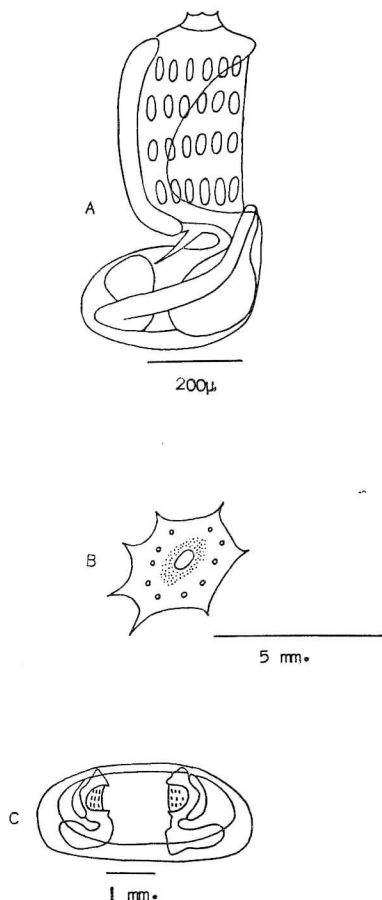

Fig. 20. *Diplosoma* (*Diplosoma*) *hiatti*: A. zooid; B. general surface view of entire colony, yellow pigment represented by stippled area around cloacal aperture; C. colony cross section.

(2 mm.) basal tunic containing numerous particularly distinct stolon buds; single cloacal aperture protrusible as high as 1.5 mm. above colony surface; zooid with abdomen on either side at angle to thorax, branchial sac with 6 stigmata per half row, single testis, straight vas deferens.

DISTRIBUTION: (Type locality) Kapingamarangi—Channel between Touhou and Werua Islets; 10-VII-54 (Coll. C. H. Hand); 70 colonies.
Substrates: "algae and rocks" (collector's note)

DESCRIPTION: (See Figure 21)

Colony—Upper surface smooth, at peripheral areas a few papillae each with single stolon bud; shape dome-like, round or slightly oval—longest axis to 1.5 cm., thickness (through center) to 4 mm.; color alive green (collector's note), preserved even dark gray with numerous (bleached) algal cells in cloacal canal; single smooth-lipped cloacal aperture protrusible as high as 1.5 mm. above surface; single cloacal canal very extensive (depth 500–700 μ), thoracic and somewhat abdominal (not truly postabdominal); heavy concentration of blad-

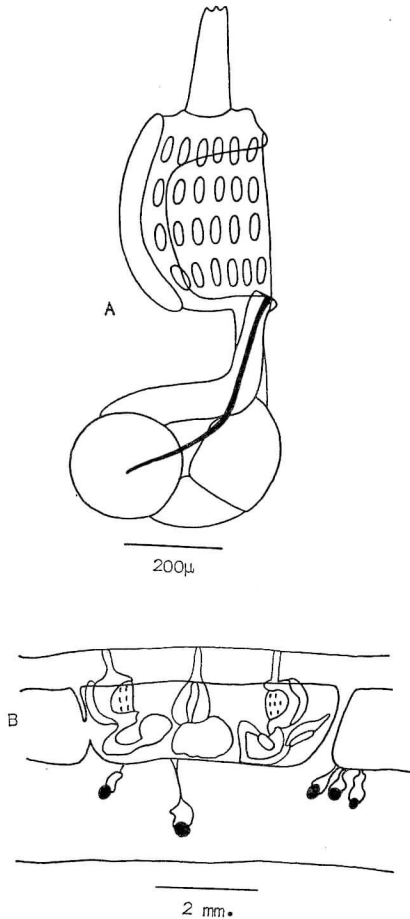

Fig. 21. *Diplosoma (Diplosoma) handi*: A. zooid; B. colony cross section showing layers and stolons in basal tunic.

der cells throughout thick (to $375\ \mu$) uppermost tunic layer ending directly on thoraces of zooids densely packed in cloacal canal; occasional thin tunic "columns" continuing through canal to very thick (to 2 mm.) basal tunic; tunic unusually tough and solid.

Zooid—Height less than 1 mm.; transparent when preserved; very long branchial siphon (one-third to one-half thorax height) with 6 short lobes; branchial sac with 4 stigmata rows, 6 oval stigmata per half row; atrial aperture wide, deeply incut; very short retractor muscle, arising from short esophageal pedicle, extending only barely below zooid to upper part of basal tunic; abdomen on either side at angle to thorax; single testis, straight vas deferens; very distinct large stolons distally pigmented, extending deep into (zooid-free) basal tunic.

Larva—None observed.

REMARKS: In addition to being thick, tough, and solid, these specimens are unique in the layered colony structure and extensive cloacal canal leading to the unusual, single, high aperture. The location of the large stolon buds is also unusual. These features in conjunction with the algal cells in the cloacal canal, the oddly angled abdomen, and the single testis warrant identifying

these colonies as a new species, the name *Diplosoma (Diplosoma) handi* being given for the collector.

Diplosoma (Lissoclinum) Verrill

SYNONYMY: *Lissoclinum* Verrill, 1871 (part), *auct. mult.*
Diplosomoides Herdman, 1886 (part)
 ?*Echinoclinum* Van Name, 1902
Leptoclinum Hartmeyer, 1909a (part)
 ?*Lissoclinum (Echinoclinum)* Harant, 1931
Leptoclinum (Lissoclinum) Tokioka, 1955a

TYPE SPECIES: *Diplosoma (Lissoclinum) aureum* (Verrill)
 (= *Lissoclinum aureum* Verrill, 1871)

DIAGNOSIS: Spiculate; frequently with lateral organs; atrial aperture sometimes with small languet; few larvae with precocious thorax bud.

SPECIES described from or known to occur in Indo-Pacific and western North American (*) waters:

Diplosoma (Lissoclinum) abbotti n. sp.
bilobatum (Millar, 1955)
capense (Hartmeyer, 1912)
 **caulleryi* (Ritter and Forsyth, 1917)
cavum (Millar, 1962)
cuculliferum (Sluiter, 1909)
fragile (Van Name, 1902)
gelatinosum (Gottschaldt, 1898)
japonicum (Tokioka, 1958)
molle (Herdman, 1886)
notti (Brewin, 1958)
ostrearium (Michaelsen, 1930)
perspicuum (Gottschaldt, 1898)
pulvinum (Tokioka, 1954)
 (nom. nov. pro *Didemnum gottschaldti* Tokioka, 1950)
tokiokai Eldredge, herein
 (nom. nov. pro *Diplosomoides circumscriptum* Gottschaldt, 1898)
triangulum (Sluiter, 1909)
triforme (Sluiter, 1909)
tropicum (Sluiter, 1909)
 ?*verrilli* (Van Name, 1902)

REMARKS: The monotypic genus *Echinoclinum* is herein questionably reclassified under the subgenus *Diplosoma (Lissoclinum)*. The status of *D. (L.) verrilli* (= *E. verrilli*), the only published species involved, has been subject to question since Van Name's (1902) original description, for he established it under a separate genus solely on the basis of the tetrahedral spicule structure. In all other features, however, the species is similar to other members of *D. (Lissoclinum)*, and the tetrahedral spicule form is merely a simplification of the usual multiradiate

structure seen in other species of this subgenus. It is not a deviation significant enough to warrant separate subgeneric status under *Diplosoma*, as Berrill (1950) proposed, and under the circumstances of reclassifying *Lissoclinum* itself as a subgenus of *Diplosoma*, Harant's (1931) synonymic step (cf. synonymy above), which was never used by other ascidiologists, cannot be taken in quite the same way as it was originally made. The reclassification is questionable because:

1. Although the species is known from Japanese (Tokioka, 1958a) and Australian (Kott, 1962) waters, it is not represented in the present collection, nor has the type specimen been examined.
2. Tokioka (in press) is to record a second *Echinoclinum* species, the description of which is not yet available. Unless his new record presents a basis more solid than that of spicule structure only (for example, the larval structure is unknown) for continuing *Echinoclinum* as a separate genus, or perhaps as a separate subgenus of *Diplosoma*, it is felt that the resemblance to *D. (Lissoclinum)* is too close to warrant any other than the distinct specific status accorded *D. (L.) verrilli* herein.

D. (Lissoclinum) is partly defined by the straight vas deferens. Therefore, the *Didemnum* species having hooked vas deferens which were classified by Tokioka (1955a, 1958b) and Kott (1962) as *Leptoclinum (Lissoclinum)* species are regarded as distinct members of the genus *Didemnum* (see *Didemnum* remarks).

Key to *Diplosoma (Lissoclinum)* Species Described

- Colony high (zooids in tunic strands radiating from central core);
 algal cells in cloacal canals; 10 stigmata per half row *D. (L.) abbotti*
 Colony flat, encrusting; algae-free; 6-9 stigmata per half row *D. (L.) fragile*

Diplosoma (Lissoclinum) abbotti n. sp.

DIAGNOSIS: Colony shape "ampulloid"—high (to 1.4 cm.) with very small area of attachment; single cloacal aperture central at uppermost surface; tunic strands radiating perpendicularly from solid central tunic core suspending zooids so that branchial siphons open on "sides" of colony; algae in cloacal canals; zooid with 10 stigmata per half row, single testis; colony spiculate.

DISTRIBUTION: (Type locality) Kapingamarangi—Sokoro; 26-VII-54 (Coll. C. H. Hand); 12 colonies.

Substrate: (unknown)

DESCRIPTION: (See Figure 22)

Colony—Surface smooth, shape generally "ampulloid"—small attaching area, colony as high as 1.4 cm. (usually 1.0 cm.) with solid central tunic core from which zooids radiate in tunic strands in all degrees; color alive "gray, green inside" (collector's note), preserved uneven grayish lavender; algal cells in cloacal canals; single cloacal aperture central at uppermost surface; cloacal canals extensively ramiform and anastomotic, thoracic and post-abdominal; spicules absent from area around cloacal aperture and branchial siphons but otherwise dense in outer-surface layer, rare in zooid-supporting tunic strands, scattered in central tunic core; spicule diameter to 20 μ (usually 15 μ), burr-like with innumerable short blunted rays; bladder cells scattered throughout tunic.

Zooid—Height to 1 mm., thorax to 550 μ ; extremely short branchial siphon with 6 short pointed

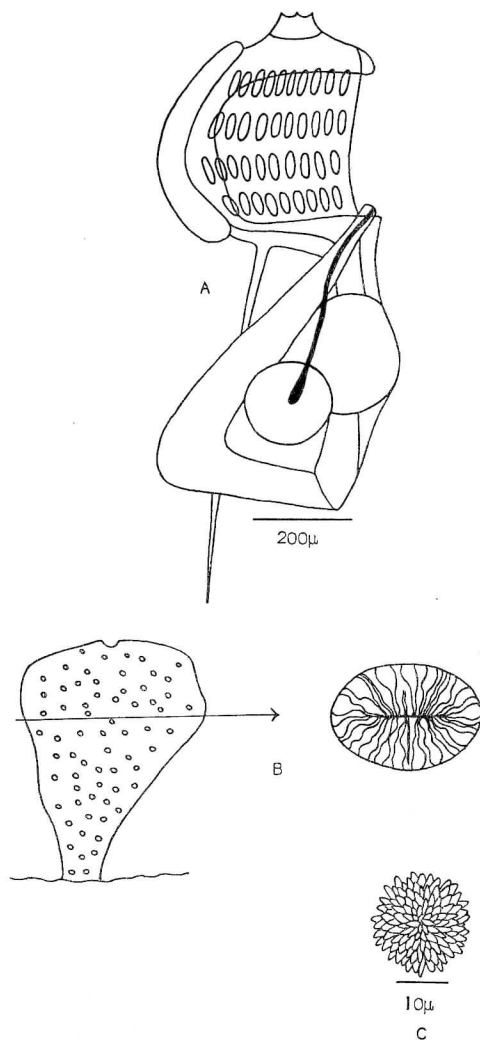

Fig. 22. *Diplosoma (Lissoclinium) abbotti*: A. zooid; B. general view of colony and colony cross section showing central core with radiating zooid-supporting tunic strands; C. typical spicule.

lobes; branchial sac with 4 stigmata rows, 10 elongated stigmata per half row; atrial aperture wide, deeply incut; no languet observed; no lateral organs observed; retractor muscle long, thin; esophageal pedicle short; stomach nearly spheroidal; intestine without recurved loop; single small testis, straight vas deferens; few pyloric buds.

Larva—None observed.

REMARKS: The zooids of these specimens bear a close resemblance to those of other *D. (Lissoclinium)* species, except perhaps for their greater number of stigmata per half row. However, other members of the subgenus are always described as flat and encrusting, and the characteristic zooid-supporting tunic

strands have never been described as lying in the same plane as the upper and basal surfaces. The structure of these colonies is so unique that it and the occurrence of algae, a condition as yet known in only one other *D. (Lissoclinum)* species, constitute a legitimate basis for diagnosing this new species. The name *D. (L.) abbotti* is selected in recognition of Dr. D. P. Abbott's gift of numerous specimens to the author.

***Diplosoma (Lissoclinum) fragile* (Van Name)**

- SYNONYMY:** *Diplosomoides fragile* Van Name, 1902, Trans. Conn. Acad. Arts Sci. 11:370.
D. molle Sluiter, 1909 (part), Siboga-Exped. Monogr. 56b:
Lissoclinum fragile Van Name, 1921, Bull. Am. Mus. Nat. Hist. 44:338.
L. fragile Van Name, 1924, Bijdr. Dierk. 23:26.
L. fragile Van Name, 1930, Sci. Surv. Porto Rico Virgin Is. 10(4):442.
L. fragile Berrill, 1932, Biol. Bull. 62(1):77.
L. fragile Van Name, 1945, Bull. Am. Mus. Nat. Hist. 84:113.
L. fragile Tokioka, 1954, Pub. Seto Mar. Biol. Lab. 3(3):248.
L. fragile Millar, 1962, Studies on the fauna of Curacao and other Caribbean Islands 13:67.
- DISTRIBUTION:** Japan (Tokioka, 1954)
 Malayan waters (Sluiter, 1909)
 Bermuda and West Indian waters (Van Name, 1902, 1921, 1924, 1930, 1945; Berrill, 1932; Millar, 1962)
 Kure—Lagoon; 20-VI-63; 1 colony.
 Oahu—Coconut Island, Kaneohe Bay; 21-XI-62, 26-X-63; 6 colonies.
 Palmyra—Western reef flat; 11-V-62, 12-V-62; 2 colonies.
 Eniwetok—Eniwetok quarry tide pool; 13-VIII-62; 2 colonies.
 Ifaluk—West of north end of Falalap Islet; 27-X-53 (Coll. D. P. Abbott); 1 colony.
 Substrates: wood (floating dock), coral (unidentifiable), calcareous algae (unidentified)
- DESCRIPTION:** (See Figure 23)
- Colony—Surface usually smooth (occasional mounds over zooids in some), shape irregular—longest axis variable (to 5 cm.), thickness less than 5 mm.; color alive white (sometimes uneven), preserved white; cloacal apertures scattered; cloacal canals extensive, thoracic and postabdominal; spicules in dense layer at upper surface, infrequent in scattered (zooid-supporting) tunic strands, less dense in central and basal tunic; spicule diameter 10–25 μ (usually 15–20 μ), burr-like with 15–24 slightly flared flat-tipped rays at optical section; zooids scattered—most in tunic strands, sometimes abdominally embedded.
- Zooid—Height to 1.2 mm.; color alive orange or tan, preserved translucent white; branchial siphon with 6 distinct lobes; branchial sac with 4 stigmata rows, 6–9 stigmata per half row; atrial aperture wide, deeply incut, occasionally with very small languet; retractor muscle usually either absent or very short (to basal surface in Ifaluk specimen); often small flap-like lateral organs at ventral margin of atrial aperture; single or bilobed testis

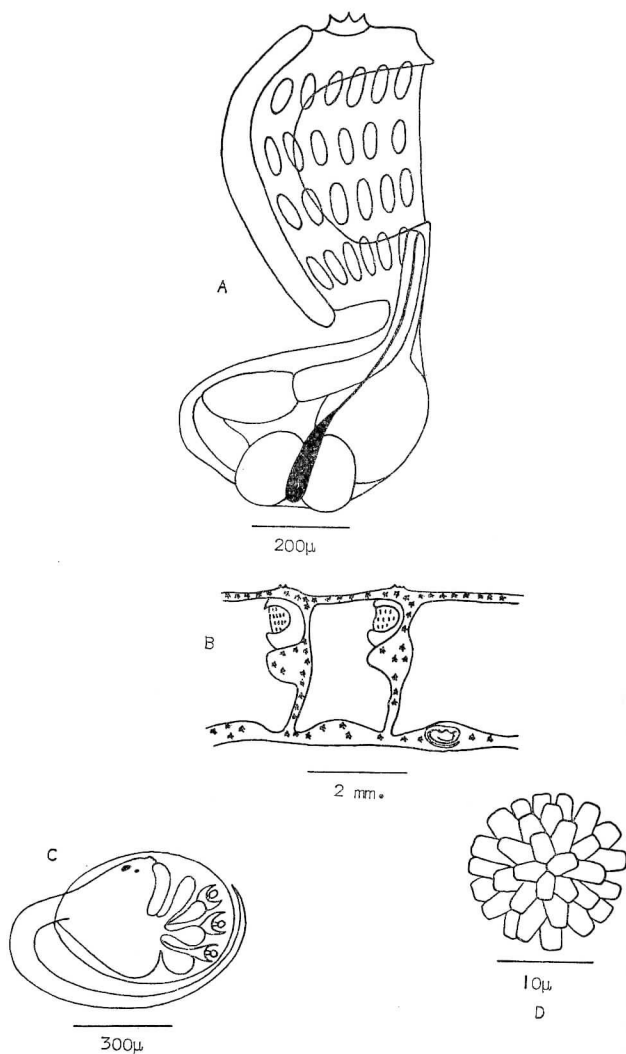

Fig. 23. *Diplosoma (Lissoclinum) fragile*: A. zooid; B. colony cross section with larva in basal tunic; C. larva; D. typical spicule.

(in same colony), vas deferens straight.

Larva—3 adhesive disks; 4 pairs lateral ampullae; length without tail to 525 μ ; in some, dense layer of (bladder?) cell bodies about 15 μ in diameter over entire sheath surface except in areas over sensory vesicle and adhesive disks.

REMARKS: The specimens examined correspond well to previous descriptions of *Diplosoma (Lissoclinum) fragile*, although the colonies are generally thinner. A few of the larvae are covered with ovoid cells, the distribution of which is the same as that of the small spicules described from the larvae of *D. (L.) ostrearium* by Kott (1962). However, since the cells examined picked up the methylene blue stain used to detail the indistinct larval anatomy, it is assumed

that they are actually bladder cells, for spicules are not affected by this stain.

A problem of interrelationships exists with some *D. (Lissoclinum)* species similar to that of the *D. (D.) macdonaldi* complex synonymized above. Several species named from widely separated geographic areas are almost indistinguishable. Table VI summarizes these identifications. Possibly three of Gottschaldt's (1898) Ternate species—*D. (L.) tokiokai* [*nom. nov. pro Diplosomoides circumscriptum*], *D. (L.) gelatinosum*, and *D. (L.) perspicuum*—should also be compared here, but they are not because the vague descriptions lack type figures. Unfortunately, none of them has been recorded a second time, and there is some indication that the type specimens may no longer exist (Gersch, Zoologisches Institut, Jena, pers. comm.). Another species which perhaps might be included is *D. (L.) caulleryi* from the western coast of North America, which Tokioka (1958a) noted as being very similar to his *D. (L.) japonicum*.

Kott (1962) apparently "synonymized" *D. (L.) marpum*, *D. (L.) bilobatum*, *D. (L.) japonicum*, and *D. (L.) notti* with *D. (L.) fragile* by way of simply declaring them indistinguishable and including their respective distributions in her *Leptoclinium* [= *Diplosoma*] (*Lissoclinum*) specific key. Paradoxically, she considered all but *D. (L.) japonicum* distinct in her discussion of *D. (L.) ostrearium*, which she would maintain as valid solely on the basis of its "long, delicate, and rectangular" (p. 308) stigmata. Those of *D. (L.) fragile* she described as "long and oval" (p. 308). Unfortunately, she provided no illustration, and a pictorial comparison with Hastings' (1931, p. 104, Fig. 17) clear figure, in which the stigmata of *D. (L.) ostrearium* are quite definitely pointed at each end, is impossible. Furthermore, Van Name (1945, p. 113, Fig. 53) depicted *D. (L.) fragile* with rather rectangular stigmata.

Kott's (1962) perplexing synonymy is herein disregarded, and no other synonymy, even of part of this complex, is attempted at this time because *D. (L.) ostrearium* is known from only three records, and the other four species have been described only once each. In spite of the strong indications apparent in the table that these species ought not be individually maintained, it is noted that none of the larvae are well known. The description above is the first for *D. (L.) fragile*, and further investigations of larvae from the other species should be evaluated lest a premature synonymy of so many species unnecessarily complicate the literature.

Diplosoma (Lissoclinum) sp. aff. fragile

Two colonies collected from Eniwetok (Van Islet; 19-VIII-62) correspond well in colony structure, spicule occurrence, and zooid anatomy to the above description. However, they contain algal cells in the cloacal canals, a condition not previously known for this species or for any of the species compared in Table VI. Neither of these colonies contained larvae; thus any deviations in larval structure which might explain the presence of the algae, such as the algal pouch which occurs in the larvae of *D. (D.) virens*, could not be used to separate them from the other specimens. Had a unique structure been discovered, the colonies would have had to be identified as a new species. Without definitive evidence, and lacking exhaustive "proof" that algae occurrence is usually dependent upon

Table VI. Characteristics of species closely

Original Diagnostic Characteristics	<i>D. (L.) fragile</i> (Van Name, 1902) [from Van Name, 1945]	<i>D. (L.) ostrearium</i> (Michaelsen, 1930)
Colony appearance	color alive snowy white without least tinge of yellow; fragile; flat and very thin—2–3 mm.	when alive with gray pigment cells over surface; thickness to 2 mm.
Spicules	dense throughout tunic; diameter 20–23 μ ; some "typical," some burr-like with numerous rays	dense throughout tunic; diameter 35 μ ; 9–16 rays at optical section
Branchial siphon	6 lobes	6 lobes
Number stigmata/half row	10 (or 11?)	8
Atrial aperture	wide and incut; languet absent or very small	wide, deeply incut
Retractor muscle	none	none
Lateral organs	sometimes present	internal
Testis	2 lobes—large, oval	2 lobes
Larva	not described [in present specimens—3 adhesive disks, 4 pairs lateral ampullae, length without tail 525 μ ; in some most of sheath surface covered with bladder (?) cells	not described [Kott (1962)—3 adhesive disks, 4 pairs lateral ampullae, length 700 μ ; larval test with dense small-spicule layer]
Type locality	Bermuda	Oyster Harbour, West Australia

larval transmission, these colonies are identified only tentatively as members of *D. (L.) fragile*.

APPENDIX

Summaries of Distributions

Table VII compares the central Pacific distribution of the species identified herein with their respective distributions known from previous records. The Malayan region includes the Philippines; the West Indies, Bermuda. It will be

related to *Diplosoma (Lissoclinum) fragile*.

<i>D. (L.) marpum</i> Millar, 1953	<i>D. (L.) bilobatum</i> Millar, 1955	<i>D. (L.) japonicum</i> Tokioka, 1958	<i>D. (L.) notti</i> Brewin, 1958
color alive white; thin and flat with numerous cloacal apertures	color alive white, preserved pale buff; rather brittle and easily torn	color alive grayish purple on surface and pure white inside; thickness 2.5-3 mm.	color (alive?) violet or brown; thickness to 2 mm.
dense in upper tunic, less dense in lower; diameter 10-30 μ ; some "typical" (14-24 rays at optical section), some burr-like or spherical (numerous rays)	present in all parts of tunic; diameter 15-25 μ ; 12+ rays at optical section	evenly dense throughout tunic; diameter 21-33 μ ; 15-20 rays at optical section	in layer with pigment granules just below surface, dense in lower tunic; diameter 10-40 μ
6 lobes	without prominent lobes	6 small lobes	6 short lobes
6-8	8	10, 10, 8, 7 for four rows, respectively	8-9
wide, deeply incut; languet absent or very small	wide, deeply incut	wide, deeply incut; languet not observed	wide with short languet
none observed	none observed	none observed	none observed
small when present	appendages at level of third stigmata row	very large, roundish, at level of third stigmata row	not described
2 lobes—ovoid or globular	2 lobes—ovoid or spherical	2 lobes	single but with faint indication of division
not described	not described	not described	3 adhesive disks, 4 pairs lateral ampullae
Pram Pram, Gold Coast, West Africa	Durban Bay, South Africa	Sirahama, Kii, Japan	Rangitoto Islands, Hauraki Gulf, New Zealand

noted that the distributions of only five species are not confined to Indo-Pacific waters: *Didemnum candidum*, *Didemnum psammatoades*, *Diplosoma (Diplosoma) macdonaldi*, *Diplosoma (Lissoclinum) fragile*, and *Trididemnum savignii*. Furthermore, *D. (D.) macdonaldi*, as synonymized herein, is the most nearly cosmopolitan didemnid, it being the only species whose Pacific distribution crosses Ekman's East Pacific Barrier. Questionable identifications are appropriately indicated.

Table VIII shows the breakdown of the central Pacific distribution of the species identified, including those questionably identified, according to respective collecting sites.

Table VIII. Breakdown of central Pacific distribution of species identified.

Species	Oahu	Palmyra	Eniwetok	Ifaluk	Kapinga- marangi	Midway	Kure
<i>DIDEMNUM</i>							
<i>candidum</i>	+, ?			+, ?			
<i>grande</i>		+	+				
<i>moseleyi</i>	+	+	+	+, ?			
<i>psammatodes</i>				+			
<i>quincunciale</i>			+				
<i>spongioides</i>				+			
<i>elikapekae</i>	+						
<i>pele</i>	+						
<i>gintonicum</i>			+				
<i>edmondsoni</i>	+						
sp.				+			
<i>DIPLOSOMA (DIPLOSOMA)</i>							
<i>macdonaldi</i>	+	+	+	+, ?	+	+	
<i>virens</i>	+	+	+				
<i>hiatti</i>			+				
<i>handi</i>					+		
<i>DIPLOSOMA (LISSOCLINUM)</i>							
<i>fragile</i>	+	+	+	+, ?			+
<i>abbotti</i>					+		
<i>LEPTOCLINIDES</i>							
<i>rufus</i>	+						
<i>TRIDIDEMNUM</i>							
<i>cyclops</i>			+				
<i>profundum</i>	+			+	+		
<i>savignii</i>	+						
<i>banneri</i>		+					
sp.			+				+

Table IX. Summary of pertinent didemnid records, listed chronologically by geographic areas.

References		Collecting Area	No. Species Recorded Ascid./Did./New Did.		
NEW ZEALAND and CHATHAM ISLAND					
1892	Nott	North Shore Reef	8	6	6
1900	Sluiter	D'Urville and Pitt Islands	36	3	2
1924	Michaelsen	Chatham, Stewart, North and South Islands	31+6	12+4	4
1946	Brewin	Otago Harbour	19	3	0
1948	„	Hauraki Gulf	18	2	0
1950a	„	Otago coastal waters	9	1	0
1950b	„	Christchurch	21	3	0
1950c	„	Great Barrier Island	15	2	1
1951	„	Hauraki Gulf	23	3	0
1952	„	East Cape	23	3	0
1956	„	Chatham Island; Chatham Rise	43	9	3
1957	„	North Auckland	33	5	0
1958a	„	Stewart Island	58	13	2
1958b	„	Hauraki Gulf	6	2	1
1960	„	Cook Strait	26	3	0
AUSTRALIA					
1859	Macdonald	Sydney Harbour	1	1	1
1886	Herdman	Southeast Australia	9	1	1
1899	„	Australia	74	12	3
1913	Herdman and Riddell	New South Wales	25	2	1
1930	Michaelsen	Southwest Australia	21	7	4
1931	Hastings	Great Barrier Reef	36	14	2
1954	Kott	Tasmania; West Australia	32	8	1
1962	„	Australia	34+5	34+5	8
1963	Millar	Australia	60	7	0
INDIAN OCEAN					
1816	Savigny	Red Sea; Gulf of Suez	25	3	0
1886	Herdman	Cape of Good Hope	8	2	1
1898	Sluiter	South Africa	32	3	2
1905	Hartmeyer	Mauritius	8	1	1
1905	Sluiter	Somaliland	18	3	1
1906	Herdman	Ceylon	64+1	9+1	6+1
1912	Hartmeyer	Cape of Good Hope; Kerguelen	44	4	3
1916	„	Gulf of Suez	7	1	0
1920	Michaelsen	West Indian Ocean	22+4	22+4	15+3
1921	„	West Indian Ocean	9	9	1
1923	„	Red Sea	14	5	3
1934	„	South Africa	18	4	2
*1949	Das	South India	1	1	1
1952	Van Name	Gulf of Aqaba	12	1	0
1954	Kott	Kerguelen	24	2	1
1955	Millar	South Africa	35	4	1

References		Collecting Area	No. Species Recorded Ascid./Did./New Did.		
1956	Millar	Mozambique	19	3	0
1957	Kott	Red Sea; Gulf of Aden; southern Arabia	24	7	1
1961	Millar	Mozambique	21	2	0
1962a	„	South Africa	(5?)69	6	2
*1962	Pérès	Red Sea	?	5	1
MALAYAN ARCHIPELAGO					
1886	Herdman	Malayan region	12	2	1
1895	Sluiter	Malaya	24	6	6
1898	Gottschaldt	Ternate	26	21	18
1903	Sollas	Malaya	1	1	1
1908	Pizon	Amboina	10	2	0
1909	Sluiter	Malayan region	95	51	46
1913	„	Aru Island	37	22	3
1932	Harant and Tuzet	Malaya	4	1	0
1952	Tokioka	Arafura Sea	27	3	1
1955b	„	Arafura Sea	5	1	0
PHILIPPINE ISLANDS					
[1856	Gould]	Sulu Sea	4	2	0
1886	Herdman	Sulu Sea	3	1	1
1909	Sluiter	Sulu Sea	15	7	5
1918	Van Name	Philippines	46	7	1
1919	Hartmeyer	Sulu Sea; Borneo	34	3	0
CHINESE WATERS					
[1934	Chin]	Amoy	12	1	0
JAPANESE WATERS					
1886	Herdman	Southern Japan	1	1	1
1892	Oka	Japan	1	1	1
*1892	Oka and Willey	Japan	1	1	1
1913	Redikorzev	Northern Japan	6	2	2
1927	Oka	Japan	36	4	0
1931	„	Sagami Bay	1	1	1
1949a	Tokioka	Haka, Matoya, and Nanao Bays	19	4	4
1949b	„	Kii Peninsula	16	2	2
1951	„	Akkeshi Bay	20	3	2
1953a	„	Sagami Bay	81	15	8
1953b	„	Inland Sea	16	1	1
1954a	„	Honshu	3	1	0
1954b	„	Osaka Bay	30	4	2
1954c	„	Tokara Islands	25+2	8+2	1+2
1955b	„	East China Sea	3	1	0
1955c	„	Japan	36	4	0
1958a	„	Sirahama and Sagami Bays	5	2	1
1958b	„	Japan	90	11	0
1959	„	Tanabe and Wakasa Bays	23	1	0
1961	Utinomi	Japan	26	2	0

References	Collecting Area	No. Species Recorded		
		Ascid./	Did./	New Did.
1962a Tokioka	Sado Island; Sagami Bay	21	3	1
1962b „	Osaka and Sagami Bays	(2?)12+1	(2?)4+1	1
1963 „	Japan	308	43	0
PACIFIC WATERS				
[1856 Gould]	Fiji	3	1	0
1886 Herdman	Tonga	1	1	1
[1903 Sherlock]	Fiji	1	1	0
1942 Tokioka	Palau	2	1	0
1950 „	Palau	25	2	1
1955a „	Palau	9	3	0
1961 „	New Caledonia	14	1	0
In Press „	Hawaii and	6	3	1
(Pers. Comm.)	Pacific waters	112?	?	?
Herein Eldredge	Central Pacific	(2?)23	(2?)23	8
PACIFIC COAST—NORTH, CENTRAL, and SOUTH AMERICA				
1901 Ritter	Alaska	15	1	1
1907 „	California coast	14	1	1
*1912 Huntsman	Canada	?	3	0
1917 Ritter and Forsyth	California coast	29+1	4+1	4+1
1920 Hartmeyer	Juan Fernandez Islands	4	1	0
1929 Ärnäck-Christie- Linde	Guaitecas Islands	7	2	1
1945 Van Name	Pacific North and South America	161	15	1
1954 „	Chile	13	2	0
1959 Trason	Gulf of California	4	1	0
1963 McLaughlin	East Bering Sea	12	2	0
1964 Trason	Canadian Arctic	27	2	0

Explanation of symbols:

[] Indicates those early records in which the descriptions are so unsatisfactory as to place in question the validities of certain species.

* Indicates those unavailable records which apparently include Indo-Pacific didemnids; the numbers of species are approximated from various second sources.

+ Indicates varieties, as 31+6 means 31 species and 6 varieties.

(?) Indicates questionable or provisional identifications, as (5?)69 means that 5 of the 69 species are questionably identified.

Key to Didemnids Described from Oahu

- 1 Vas deferens coiled; 3 or 4 stigmata rows 2
 Vas deferens straight; always 4 stigmata rows [*DIPLOSONA*] 9
- 2(1) 3 stigmata rows [*TRIDIDEMNUM*] 3
 4 stigmata rows 4
- 3(2) Cloacal canals thoracic and postabdominal; 6-7 vas deferens
 coils; color alive and preserved dark brown; usually aspicular
 (very rarely tiny scattered clusters only on surface, spicule
 diameter 10-25 μ) *T. profundum*

- Cloacal canals thoracic; 7-9 vas deferens coils; color alive and preserved light (white or tan); spiculate, spicule diameter to $50\ \mu$ *T. savignii*
- 4(2) Atrial siphon, posteriorly directed; multiple testicular lobes [*LEPTOCLINIDES*] (zooids dark, 8-12 stigmata per half row, 5-6 vas deferens coils) *L. rufus*
- Atrial aperture, usually incut over at least part of branchial sac; usually single testis [*DIDEMNUM*] 5
- 5(4) Thorax shape "typical"—stigmata rows equal in height 6
- Thorax distorted—first stigmata row at least twice as tall as other rows *D. pele*
- 6(5) Atrial aperture small oval, narrow slit, or wide but only partially incut over branchial sac; spiculate 7
- Atrial aperture wide, deeply incut over most of branchial sac; aspicular (white pigment granules scattered throughout deeper portions of colony) *D. elikapekae*
- 7(6) Branchial lobes level with colony surface with occasional spicules 8
- Branchial lobes raised above colony surface, densely spiculate (living colony dark and velvety with distinct white branchial lobes) *D. edmondsoni*
- 8(7) Atrial aperture wide, partially incut; surface often with solid papillae near branchial siphons; spicule diameter $25-40\ \mu$, few rays *D. moseleyi*
- Atrial aperture short narrow slit; surface never papillose; spicule diameter $20\ \mu$, numerous rays *D. candidum*
- 9(1) Aspicular; without lateral organs [*D. (DIPLOSOMA)*] 10
- Spiculate; usually with lateral organs [*D. (LISSOCLINUM)*] (dense small spicules; 6-9 stigmata per half row) *D. (L.) fragile*
- 10(9) Algae present in cloacal canals; color alive dark green with at-surface circumbranchial ring *D. (D.) virens*
- Colony algae-free; color alive tan or gray with white pigment granules scattered over surface *D. (D.) macdonaldi*

LITERATURE CITED

[Unavailable references indicated by asterisks]

- ÄRNBACK-CHRISTIE-LINDE, A. 1929. Chilean tunicates. Ascidiens from the Guaitucas Islands. Ark. Zool. **21A**(6):1-27.
- BERRILL, N. J. 1947. The ascidians *Trididemnum alleni* and *Distaplia garstangi*, new species from the Plymouth area. J. Mar. Biol. Ass. U. K. **26**:609-615.
- 1950. The Tunicata, with an account of British species. Ray Soc. London **133**: 1-354.
- BJERKAN, P. 1905. Ascidiens von dem norwegischen Fischereidampfer "Michael Sars" in den Jahren 1900-1904 gesammelt. Bergens Mus. Aarbog **1905**(5):4-29.
- BLAINVILLE, H. M. D., de. 1825. Manuel de Malacologie et de Conchologie. F. G. Levrault Libraire, Paris. 664 p.

- BREWIN, B. I.** 1946. Ascidiens in the vicinity of the Porto Bello Marine Biological Station, Otago Harbour. *Trans. Roy. Soc. N. Z.* **76**(2):87-131.
- 1948. Ascidiens of the Hauraki Gulf (I). *Trans. Roy. Soc. N. Z.* **77**(1):115-138.
- 1950a. Ascidiens from Otago coastal waters. *Trans. Roy. Soc. N. Z.* **78**(1):54-63.
- 1950b. Ascidiens of New Zealand. Part IV. Ascidiens in the vicinity of Christchurch. *Trans. Roy. Soc. N. Z.* **78**(2-3):344-353.
- 1950c. Ascidiens of New Zealand. Part V. Ascidiens from the east coast of Great Barrier Island. *Trans. Roy. Soc. N. Z.* **78**(2-3):354-362.
- 1951. Ascidiens of New Zealand. Part VI. Ascidiens of the Hauraki Gulf (II). *Trans. Roy. Soc. N. Z.* **79**(1):104-113.
- 1952. Ascidiens of New Zealand. Part VIII. Ascidiens of the East Cape region. *Trans. Roy. Soc. N. Z.* **80**(2):187-195.
- 1956. Ascidiens from the Chatham Islands and the Chatham Rise. *Trans. Roy. Soc. N. Z.* **84**(1):121-137.
- 1957. Ascidiens of New Zealand. Part X. Ascidiens from North Auckland. *Trans. Roy. Soc. N. Z.* **84**(3):577-580.
- 1958a. Ascidiens of New Zealand. Part XI. Ascidiens of the Stewart Island region. *Trans. Roy. Soc. N. Z.* **85**(3):439-453.
- 1958b. Ascidiens of New Zealand. Part XII. Ascidiens of the Hauraki Gulf (III). *Trans. Roy. Soc. N. Z.* **85**(3):455-458.
- 1960. Ascidiens of New Zealand. Part XIII. Ascidiens of the Cook Strait region. *Trans. Roy. Soc. N. Z.* **88**(1):119-120.
- CARLISLE, D. B.** 1953. Presenza di spicole in *Diplosoma listerianum* (Milne Edwards). Contributo alla sistematica degli Ascidiacea, Didemnidae. *Pubbl. Staz. Zool. Napoli* **24**(1):61-67.
- 1954. Notes on the Didemnidae (Ascidiacea). III. A comparison of *Didemnum maculosum*, *D. candidum*, *D. helgolandicum*, and *Trididemnum alleni*. *J. Mar. Biol. Ass. U. K.* **33**:313-324.
- CARLISLE, D. B., AND A. I. CARLISLE.** 1954. Notes on the Didemnidae (Ascidiacea). I. The presence of *Didemnum (Leptoclinides) faerøense* (Bjerkan) in the Plymouth area. *J. Mar. Biol. Ass. U. K.* **33**:21-25.
- CHIN, T. G.** 1934. A preliminary report on Amoy Tunicata. *Lingnan Sci. J. Canton* **13**(3):487-491.
- ***DAS, S. M.** 1949. On *Didemnum graveli* n. sp., a new synascidien from South India seas. *Proc. Indian Sci. Cong.* **1946**(4):8.
- DEFLANDRE, G., AND M. DEFLANDRE-RIGAUD.** 1956. *Micrascidites* manip. nov., sclérites de Didemnides (Ascidiens, Tuniciers) fossiles du Lutétien du Bassin parisien et du Balcombien d'Australie. *C.-R. Som. Soc. Géol. France* **4**:47-48.
- ***DELLA VALLE, A.** 1877. Contribuzioni alla storia naturale delle ascidie composte del Golfo di Napoli. Naples [pages unknown].
- 1881. Nuove contribuzioni alla storia naturale delle ascidie composte del Golfo di Napoli. *Atti. Accad. Lincei, Ser. 3*, **10**:431-498.
- ***DRASCHE, R., VON.** 1883. Die Synascidien der Bucht von Rovigno (Istrien). Ein Beitrag zur Fauna der Adria. Vienna. 41 p.
- ***FORBES, E., AND S. C. T. HANLEY.** 1848. A history of British Mollusca, and their shells, vol. I [p. 341 ?].
- GIARD, A. M.** 1872. Recherches sur les Ascidiens composées ou Synascidies. *Arch. Zool. Expér.* **1**:501-709.
- GILL, T. N.** 1871. Arrangement of the families of mollusks. *Smith. Misc. Coll.* **227**:1-49.

- GOTTSCHALDT, R.** 1898. Synascidien von Ternate. Abhandl. Senckenb. Naturforsch. Ges. **24**(4):641-660.
- GOULD, A. A.** 1856. Atlas to Mollusca and shells, U. S. Exploring Expedition during the years 1838 till 1842 under C. Wilkes, vol. 12. 16 p.
- HARANT, H.** 1931. Contribution a l'histoire naturelle des ascidies et de leurs parasites. Ann. Inst. Océano., N. S., **8**(4):231-389.
- HARANT, H., AND O. TUZET.** 1932. Ascidies résultats scientifiques du voyage aux Indes Orientales Néerlandaises. Mém. Mus. Roy. Hist. Nat., Belgique, hors ser., **3**(11):1-6.
- HARTMEYER, R.** 1903. Die Ascidien der Arktis. Fauna Arctica **3**(2):93-412.
- 1905. Ascidien von Mauritius. Zool. Jahrb., Syst., **8**(suppl.):383-406.
- 1909a. Ascidien. Tunicata (Manteltiere). In H. G. Bronn, Klassen und Ordnungen des Tier-Reichs 3, suppl., (81-87):1281-1488.
- 1909b. Zur terminologie der Didemnidae. Sitzber. Ges. Naturforsch. Freunde Berlin **1909**:575-581.
- 1910. Ascidien. Tunicata (Manteltiere). In H. G. Bronn, Klassen und Ordnungen des Tier-Reichs 3, suppl., (88-94):1489-1680.
- 1912. Ascidien. Wiss. Ergeb. Deutsch. Tiefsee-Exped. ("Valdivia") **16**(3):223-392.
- * ——— 1913. Tunicata. Denkschr. Med.-Naturwiss. Ges. **17**:125-144.
- 1915. Ascidiarium nomina conservanda. Sitzber. Ges. Naturforsch. Freunde Berlin **1915**:247-258.
- 1916. Über einige ascidien aus dem Golfe von Suez. Sitzber. Ges. Naturforsch. Freunde Berlin **1915**:397-430.
- 1919. Ascidien. Results of Dr. E. Mjörbergs Swedish Scientific Expeditions to Australia 1910-13 (XXV). Kungl. Svenska Vetenskap. Handl. **60**(4):1-150.
- 1920. Ascidien von Juan Fernandez. In C. Skottsberg, Natural history of Juan Fernandez and Easter Island **3**:131-136.
- HASTINGS, A. B.** 1931. Tunicata. Great Barrier Reef Exped. 1928-1929 Sci. Rep. **4**(3):69-109.
- HERDMAN, W. A.** 1886. Report on the Tunicata collected during the voyage of the H.M.S. Challenger during the years 1873-76. Part II. Ascidiæ compositæ. Rep. Sci. Res. Voy. H.M.S. Challenger, Zool., **14**(38):1-432.
- 1899. Descriptive catalogue of the Tunicata in the Australian Museum, Sydney, N. S. W. Aust. Mus. Sydney Cat. **17**:1-139.
- 1906. On the Tunicata. Ceylon Pearl Oyster Fish. 5(suppl. 39):295-348.
- HERDMAN, W. A., AND W. RIDDELL.** 1913. The Tunicata of the "Thetis" Expedition. Scientific results of the trawling expedition of H.M.C.S. "Thetis" off the coast of New South Wales (17). Mem. Aust. Mus. **4**:873-889.
- ***HUNTSMAN, A. G.** 1912. Holostomatous ascidians from the coast of western Canada. Contrib. Canadian Biol. **10**:103-185.
- ***HURST, C. H.** 1896. Fauna of Belfast Lough. Irish Naturalist **5**:271-272.
- HUUS, J.** 1927. Über die Ausbreitungshindernisse der Meerestiefen und die geographische Verbreitung der Ascidien. Nyt Mag. Naturvidensk. **65**:153-174.
- 1937. Ascidiaceæ. In W. Kükenthal [T. Krumbach, ed.], Handbuch der Zoologie **5**(2):545-692.
- INTERNATIONAL COMMISSION ON ZOOLOGICAL NOMENCLATURE.** 1961. International code of zoological nomenclature. Int. Trust Zool. Nomen., London. 176 p.
- JOURDAIN, S.** 1885. Sur les ascidies composées de la tribu des Diplosomidae. C.-R. Acad. Sci. **100**:1512-1514.
- KOTT, P.** 1954. Ascidiens. In Tunicata. B.A.N.Z. Antarct. Res. Exped. 1929-31 Rep., Ser. B, **1**(4):121-182.
- 1957. The sessile Tunicata. John Murray Exped. 1933-34 Sci. Rep. **10**(4):129-149.

- KOTT, P.** 1962. The ascidians of Australia. III. Aplousobranchiata Lahille: Didemnidae. *Giard. Aust. J. Mar. Freshw. Res.* **13**(3):265-334.
- LAHILLE, F.** 1886. Sur la classification des tuniciers. *C.-R. Acad. Sci.* **102**:1573-1575.
- 1890. Recherches sur les Tuniciers, contributions a l'etude anatomique et taxonomique des Tuniciers. Toulouse, 328 p.
- LAMARCK, J. B.** 1816. Les Tuniciers [Tunicata]. Histoire naturelle des animaux sans vertèbres. Verdière Libraire, Paris. **3**:80-130.
- ***LISTER, J. J.** 1834. Some observations on the structure and functions of tubular and cellular polypi, and of Ascidiae. *Phil. Trans. Roy. Soc. London* **1834** [124] (2):365-388.
- ***LOEWIG, C., AND R. A. VON KOELLIKER.** 1846. Observations sur l'existence d'une substance terneite, identique avec la cellulose dans une classe d'animaux sans vertèbres, les Tuniciers. *C.-R. Acad. Sci.* **22**:38-40.
- MACDONALD, J. D.** 1859. On the anatomical characters of a remarkable form of compound Tunicata. *Trans. Linn. Soc. London* **22**(4):373-375.
- McLAUGHLIN, P. A.** 1963. Survey of the benthic invertebrate fauna of the eastern Bering Sea. *U.S. Fish Wild. Ser., Sp. Rep., Fish.* **401**:1-75.
- MICHAELSEN, W.** 1919. Zur kenntnis der Didemniden. *Abhandl. Geb. Naturwiss. Ver. Hamburg* **21**(1):1-44.
- 1920. Die Krikobranchen Ascidiën des westlichen Indischen Ozeans: Didemniden. *Mitt. Zool. Mus. Hamburg* **37**:1-74.
- 1921. Ascidiën vom westlichen Indischen Ozean aus dem Reichsmuseum zu Stockholm. *Ark. Zool.* **13**(23):1-25.
- 1923. Neue und altbekannte Ascidiën aus dem Reichsmuseum zu Stockholm. *Mitt. Zool. Staatsinst. Zool. Mus. Hamburg* **40**:1-60.
- 1924. Ascidiæ Krikobranchiæ von Neuseeland, den Chatham- und den Auckland-Inseln. *Vidensk. Medd. Dansk Naturhist. Foren. Kjøbenhavn* **77**:263-434.
- 1930. Ascidiæ Krikobranchiæ. *Fauna Südwest-Aust.* **5**(7):461-558.
- 1934. The ascidians of the Cape Province of South Africa. *Trans. Roy. Soc. South Africa* **22**:129-163.
- MILLAR, R. H.** 1949. The larva of a didemnid ascidian, with notes on the structure of the colony and the adult. *J. Mar. Biol. Ass. U. K.* **28**:583-586.
- 1953. On a collection of ascidians from the Gold Coast. *Proc. Zool. Soc. London* **123**(2):277-325.
- 1955. On a collection of ascidians from South Africa. *Proc. Zool. Soc. London* **125**(1):169-221.
- 1956. Ascidians from Mozambique, East Africa. *Ann. Mag. Nat. Hist., Ser. 12,* **9**:913-932.
- 1960. Ascidiacea. *Discovery Rep.* **30**: 1-160.
- 1961. Ascidians from Mozambique. *Ann. Mag. Nat. Hist., Ser. 13,* **4**:11-16.
- 1962a. Further descriptions of South African ascidians. *Ann. South African Mus.* **46**(7):113-221.
- 1962b. Some ascidians from the Caribbean. *Studies on the fauna of Curacao and other Caribbean Islands* (59) **13**:61-77.
- 1963. Australian ascidians in the British Museum (Natural History). *Proc. Zool. Soc. London* **141**(4):689-746.
- MILNE EDWARDS, H.** 1841. Observations sur les ascidies composées des côtes de la Manche. *Mém. Acad. Roy. Sci. Inst. France* **18**:217-326.
- NOTT, J. T.** 1892. On the composite ascidians of the North Shore Reef. *Trans. N. Z. Inst.* **24**:305-334.

- OKA, A.** 1892. Die periodische Regeneration der oberen Körperhälfte bei den Diplosomiden. Biol. Centr. **12**(9):265-268.
- 1927. Ascidiens. Figuraro de Japanoj Bestoj, or Illustrated Encyclopedia of the Fauna of Japan [Dobutu Zukan; in Japanese]. 1 vol. Hokuryukwan & Co.
- 1931. Ueber eine neue Art von der merkwürdigen Synascidien-Gattung *Hypurgon*. Proc. Imp. Acad. Tokyo **7**(7):287-290.
- ***OKA, A., AND A. WILLEY.** 1892. On a new genus of synascidians from Japan. Quart. J. Microscop. Sci. **33**(2):313-324.
- PÉRÈS, J. M.** 1947. Note sur le genre *Trididemnum* dans le région de Dinard, accompagnée de remarques sur les organes latéraux des Didemnidae. Bull. Inst. Océan. Monaco **91A**: 1-15.
- 1949. Contribution a l'étude des ascidies de la côte occidentale. Bull. Inst. Franc. Afr. Noire **11**(1-2):159-207.
- 1956. Ascidies. Res. Sci. Comp. "Calypso" **2**:265-304.
- 1958a. Ascidies de la Baie de Haifa collectées par E. Gottlieb. Bull. Res. Council. Israel, Sect. B: Zool., **7B**(3-4):151-164.
- 1958b. Ascidies recoltées sur les côtes mediterranéennes d'Israël. Bull. Res. Council. Israel, Sect. B: Zool., **7B**(3-4):143-150.
- 1962. Sur une collection d'ascidies de la côte israelienne de la mer Rouge et de la Peninsule du Sinai. Bull. Sea Fish. Res. Sta. Israel **30**:39-47.
- PERRIER, E.** 1898. Note sur la classification des Tuniciers. C.-R. Acad. Sci. **126**:1758-1762.
- PIZON, A.** 1908. Ascidies d'Amboine. Rev. Suisse Zool. **16**:195-240.
- PRENANT, M.** 1925. Contribution à l'étude cytologique du calcaire. II. Sur les conditions de formation des spicules chez les didemnides. Bull. Biol. France Belgique **59**:403-435.
- REDIKORZEV, V. V.** 1913. Neue Ascidien. Zool. Anz. **43**(5):204-213.
- RITTER, W. E.** 1901. The ascidians. Proc. Wash. Acad. Sci. **3**:225-266.
- 1907. The ascidians collected by the U.S. Fisheries Steamer "Albatross" on the coast of California during the summer of 1904. Univ. Calif. Pub. Zool. **4**(1):1-52.
- RITTER, W. E., AND R. A. FORSYTH.** 1917. Ascidians of the littoral zone of southern California. Univ. Calif. Pub. Zool. **16**(24):439-512.
- SAVIGNY, M. J. C. L., de.** 1816. Recherches anatomiques sur les Ascidies composeés et sur les Ascidies simples. Mémoires sur les animaux sans vertèbres **2**(1):1-240.
- ***SELENKA, E.** 1865. Über einige neue Schwämme aus der Südsee. Zeit. Wiss. Zool. 17 [pages unknown].
- SHERLOCK, R. L.** 1903. The foraminifera and other organisms in the raised reefs of Fiji. Bull. Mus. Comp. Zool. **38**[Geol. Ser. 5](8):349-365.
- SLUITER, C. P.** 1895. Tunicaten. Denkschr. Med.-Naturwiss. Ges. **8**(2):3-26.
- 1897. Tuniciers recueillis en 1896 par la "Chazalie" dans la Mer des Antilles. Mém. Soc. Zool. France **11**:5-34.
- 1898. Tunicaten von Süd-Afrika. Beiträge zur Kenntniss der Fauna von Süd-Afrika (II). Zool. Jahrb., Syst., **11**:1-64.
- 1900. Tunicaten aus dem Stillen Ozean. Zool. Jahrb., Syst., **13**:1-35.
- 1905. Tuniciers recueillis en 1904 par M. Ch. Gravier, dans le Golfe de Tadjourah (Somalie Française). Mém. Soc. Zool. France **18**:5-21.
- 1909. Die Tunicaten der Siboga-Expedition. II. Die merosomen ascidien. Siboga-Exped. Monogr. **56b**:1-112.
- 1913. Ascidien von den Aru-Inseln. Abhandl. Senckenb. Naturforsch. Ges. **35**(1): 65-78.
- SMITH, H. G.** 1935. On the presence of algae in certain Ascidiacea. Ann. Mag. Nat. Hist., Ser. 10, **15**(90):615-626.

- SOLLAS, I. B. J.** 1903. On *Hypurgon skeati*, a new genus and species of compound ascidians. Quart. J. Microscop. Sci., N. S., **46**:729-735.
- TOKIOKA, T.** 1942. Ascidians found on the mangrove trees in Iwayama Bay, Palao. Palao Trop. Biol. Sta. Stud. **2**(3):497-506.
- 1949a. Contributions to the Japanese ascidian fauna. I. Ascidians collected by Prof. Miyadi and Mr. Masui during the Bottom Survey 1939-1940. Pub. Seto Mar. Biol. Lab. **1**(1):1-17.
- 1949b. Contribution to Japanese ascidian fauna. II. Notes on some ascidians collected chiefly along the coast of Kii Peninsula. Pub. Seto Mar. Biol. Lab. **1**(2):39-64.
- 1950. Ascidians from the Palao Islands (I). Pub. Seto Mar. Biol. Lab. **1**(3):115-150.
- 1951. The fauna of Akkeshi Bay. XVIII. Ascidia. (Contributions to Japanese ascidian fauna III). Pub. Akkeshi Mar. Biol. Sta. **1**:1-22.
- 1952. Ascidians collected by Messrs. Renzi Wada and Seizi Wada from the pearl-oyster bed in the Arafura Sea in 1940. Pub. Seto Mar. Biol. Lab. **2**(2):91-142.
- 1953a. Ascidians of Sagami Bay, collected by His Majesty the Emperor of Japan [H. Hattori, ed.; in Japanese, English translation]. Iwanami Shoten, Tokyo. 315 p., 79 Pl.
- 1953b. Contributions to Japanese ascidian fauna. V. Ascidians collected near the Marine Biological Laboratory of Hiroshima University in the Inland Sea (1). Pub. Seto Mar. Biol. Lab. **3**(1):1-25.
- 1954a. Contributions to Japanese ascidian fauna. IX. Re-descriptions of Oka's species found in "Figuraro de Japanaj Bestoj" [Dobutu Zukan]. Pub. Seto Mar. Biol. Lab. **4**(1):69-74.
- 1954b. Contributions to Japanese ascidian fauna. X. Notes on some ascidians collected in Osaka Bay (2). Pub. Seto Mar. Biol. Lab. **4**(1):67-98.
- 1954c. Invertebrate fauna of the intertidal zone of the Tokara Islands. VII. Ascidians. (Contributions to Japanese ascidian fauna VII). Pub. Seto Mar. Biol. Lab. **3**(3):239-264.
- 1955a. Ascidians from the Palao Islands (II). Pub. Seto Mar. Biol. Lab. **5**(1):43-57.
- 1955b. Contributions to Japanese ascidian fauna. XI. Sporadic memoranda (2). Pub. Seto Mar. Biol. Lab. **4**(2-3):205-218.
- 1955c. Revision of ascidians described and illustrated in Japanese "Dobutu Zukan" [in Japanese, English résumé]. Dobutsugaku Zasshi [Zool. Mag.] **64**(1):20-23.
- 1958a. Contributions to Japanese ascidian fauna. XII. Sporadic memoranda (3). Pub. Seto Mar. Biol. Lab. **6**(3):313-325.
- 1958b. Prochordata. In Encyclopaedia Zoologica Illustrated in Colours [in Japanese]. Hokuryukan Co., Tokyo. **2**:343-392.
- 1959. Contributions to Japanese ascidian fauna. XIII. Sporadic memoranda (4). Pub. Seto Mar. Biol. Lab. **7**(2):223-236.
- 1961. Ascidians collected during the Melanesia Expedition of the Osaka Museum of Natural History. I. Ascidians presented by Dr. R. L. A. Catala of the Aquarium of Noumea. Pub. Seto Mar. Biol. Lab. **9**(1):103-137.
- 1962a. Contributions to Japanese ascidian fauna. XVIII. Ascidians from Sado Island and some records from Sagami Bay. Pub. Seto Mar. Biol. Lab. **10**(1):1-20.
- 1962b. Contributions to Japanese ascidian fauna. XIX. Additions to Japanese ascidian fauna, with notes on two already known species. Pub. Seto Mar. Biol. Lab. **10**(2):259-282.
- 1963. Contributions to Japanese ascidian fauna. XX. The outline of Japanese ascidian fauna as compared with that of the Pacific coasts of North America. Pub. Seto Mar. Biol. Lab. **11**(1):131-156.

- TOKIOKA, T.** In press. Pacific Tunicata in the U. S. National Museum. Bull. U. S. Natl. Mus.
- TRASON, W. B.** 1959. Brief notes on interesting ascidians. *Veliger* **2**(1):19.
- 1964. Ascidians of the Canadian Arctic waters. *J. Fish. Bd. Canada* **21**(6):1505-1517.
- UTINOMI, H.** 1961. Coloured Illustrations of Sea Shore Animals of Japan [in Japanese]. Hoikusha, Japan. 167 p.
- VAN NAME, W. G.** 1902. The ascidians of the Bermuda Islands. *Trans. Conn. Acad. Arts Sci.* **11**:325-412.
- 1918. Ascidians of the Philippines and adjacent waters. *Bull. U. S. Natl. Mus.* **100**, **1**(2):49-174.
- 1921. Ascidians of the West Indian region and southeastern United States. *Bull. Am. Mus. Nat. Hist.* **44**(16):283-494.
- 1945. The North and South American ascidians. *Bull. Am. Mus. Nat. Hist.* **84**:1-476.
- 1952. Tunicata. The "Manihine" Expedition to the Gulf of Aqaba (VIII). *Bull. Brit. Mus. (Nat. Hist.), Zool.*, **1**(8):215-220.
- 1954. Ascidians (Asciacea). Reports of the Lund University Chile Expedition 1948-1949 (14). *Lunds Univ. Arrskr. N. F. Avd. 2*, **50**(1):1-20.
- VERRILL, A. E.** 1871. Descriptions of some imperfectly known and new ascidians from New England. *Am. J. Sci., Ser. 3*, **1**:443-446.
- ***WOODLAND, W. N. F.** 1907. Studies in spicule formation. VI. The scleroblastic development of the spicules in some Mollusca and in one genus of colonial ascidian (*Leptoclinum*). *Quart. J. Microscop. Sci.* **51**:45-53.