



ISSN NO. 2320-5407

Journal homepage: <http://www.journalijar.com>

INTERNATIONAL JOURNAL
OF ADVANCED RESEARCH

REVIEW ARTICLE

CHEMICAL ANALYSIS AND THERAPEUTIC USES OF CITRONELLA OIL FROM *CYMBOPOGON WINTERIANUS*: A SHORT REVIEW

Aakanksha Wany¹, Shivesh Jha², Vinod Kumar Nigam¹ and Dev Mani Pandey¹

1. Department of Biotechnology, Birla Institute of Technology, Mesra, Ranchi, Jharkhand-835215, India.

2. Department of Pharmaceutical Sciences, Birla Institute of Technology, Mesra, Ranchi, Jharkhand-835215, India.

Manuscript Info

Manuscript History:

Received: 12 July 2013
Final Accepted: 25 July 2013
Published Online: August 2013

Key words:

Citronella oil,
Ceylon chemotype,
GLC, HPTLC,
Java chemotype,
Supercritical fluid extraction,
Therapeutic uses

Abstract

Citronella grass is mainly grown for its commercial essential oils and the systematic study of its chemical composition resulted in several other benefits apart from the development of analytical methods for quality assessment. This quality assessment of the oil gives a basic insight into the chemical composition and the extent to which the main constituents varies in proportion. The studies enabled the systematic monitoring using GLC and Supercritical fluid extraction process, the formulation of ideas on the correct methods of preparation of the plant material and the optimum time for harvesting of the grass. For instance, it was found that immature grass had a higher content of terpene hydrocarbons than the mature ones and that the wilting process was also necessary for the production of good quality oil. Seasonal variations also existed. There are many literatures that demonstrated the therapeutic use of Citronella oil and also analyzed the constituents of its oil simultaneously. The advanced therapeutic studies enabled the systematic and controlled use of Citronella oil as an antifungal agent, anti-parasitic agent, a potent mosquito repellent and antibacterial agent. In addition, the expertise and techniques developed led to the discovery of several possible varieties of Citronella which consistently gave oils of composition different to either Ceylon type or Java type.

Copy Right, IJAR, 2013.. All rights reserved.

Introduction

1. Introduction

It is an aromatic grass belonging to the Poaceae family which gives essential oils upon steam distillation. One of the important essential oils extracted from aromatic grasses is citronella oil obtained from citronella grass. This oil is used extensively as a source of important perfumery chemicals like citronellal, citronellal and geraniol, which finds its extensive use in soap, perfumery, cosmetic and flavoring industries throughout the world. It is classified in trade into two types -Ceylon citronella oil, obtained from *Cymbopogon nardus* (inferior type), while Java type citronella oil obtained from *Cymbopogon winterianus* (superior type). The use of active secondary chemical compounds such as

alkaloids and terpenoids in the medicinal plants holds a great promise in the field of medicine in ancient as well as modern era. In Jharkhand, where diseases like Malaria and Kala-azar prevail, Citronella, a perennial multi-crop of industrial importance will be a boon for its treatment and cure.

It is cultivated in parts of tropical and subtropical areas of Asia, Africa and America (Shasany et al. 2000). Java citronella is mainly produced by Taiwan, Guatemala, Honduras, Malaya, Brazil, Ceylon, India, Argentina, Ecuador, Madagascar, Mexico and West Indies. Presently, 300-350 tonnes of oil are produced in the India for the last 6-8 years in the states of Assam, Karnataka, U.P, M.P, Maharashtra, Tamil Nadu, and West Bengal. Areas receiving good and distributed rainfalls throughout the year are suitable for cultivation of Citronella (Katiyar et al. 2011).

1.1 Propagation and Harvesting

Java citronella flowers copiously in South India and at higher altitudes in the hills of North Eastern India. Due to irregularities in meiosis and chromosome polyploidy viable seeds, however, are not formed and therefore, the species can be propagated only vegetatively. The entire clump of grass is splitted into a number of slips and each slip contains 1-3 tillers. Each slip is a unit of propagation and on planting establishes itself as plants or bushes. Before planting, leaves should be trimmed off from the slips. Monsoon is the best time for plantation of Java citronella and can be initiated any time during the year. If there are no rains within next 24 hours the field should be irrigated immediately after plantation.

As a whole, all the plant parts contain oil but leaves contain the maximum amount of oil. Furthermore, the oil from other parts is of inferior quality. Only its leaves, therefore, should be harvested. The number of harvests always depends upon the growth of the plants and in favourable climatic conditions; four (approx.) harvests can be obtained per year. The plantation can remain for consecutive five-six years but the yield decreases after second and third years. Therefore, after 3-4 years the plantation should be uprooted and rotated with some legume crop species. Cowpea or sun hemp is a good alternative for rotational crop recommended for north Indian plains and horse gram for South Indian plains.

1.2 Extraction and Yield

For the extraction of oil from any specific species of *Cymbopogon*, the plants have to be identified and authenticated by a plant taxonomist (Setiawati et al. 2011). The leaves of Citronella are collected, transported in plastic bags to the laboratory and dried at room temperature (28°C) until brittle. The leaves are then chopped before extraction as they provide maximum surface area so as to increase the amount of essential oil. The oil content of the leaves is affected by various factors, such as the soil, climate, age of the plantation and method of efficiency of distillation. The conventional distillation procedures can be taken up for the extraction of essential oils such as steam distillation and hydro-distillation. The essential oil obtained is a natural source of important perfumery chemicals like citronellol, geraniol etc., which finds extensive uses in soaps, perfumery, cosmetic and flavouring industry throughout the world.

In the literature, some studies of oil extraction by steam and hydrodistillation (Cassel and Vargas, 2006) have been reported. The average oil content is about 1% on the basis of fresh leaves

within 2-3 hours of distillation. The yield of leaves may range from 15-20 tonnes per hectare in the first year and 20-25 tonnes per hectare in the second and third year. The yield of oil obtained during the first year is about 100-150 kg per hectare and, in subsequent years about 200 kg per hectare of oil of citronella may be obtained.

Reis et al. (2006) studied the composition of essential oil of citronella extracted by hydro-distillation at different temperatures (323.15, 333.15 and 343.15 K) and approximately 9.4% yield of oil was obtained. According to Reverchon and De Marco (2006), and other published scientific papers, the most widely studied application of extracting oils from natural sources is supercritical fluid extraction (SFE). It has many advantages over conventional extraction techniques such that it is flexible, allows modulation of solvent selectivity, eliminates polluting organic solvents and expensive post-processing cost of solvent elimination from the extracts.

1.3 Active Constituents

The industrial interest in essential oils is due to their application as fragrances in perfumes, as flavour additives in food products or as pharmaceutical products and desirable repellent characteristics against mosquitoes (Katz et al. 2008; Simic et al. 2008; Silva et al. 2011).

C. winterianus essential oil is rich in citronellal, geraniol and citronellol (Katiyar et al. 2011) but consists of other constituents like citronellyl acetate, L-limonene, elemol and other sesquiterpene alcohols. It also consists of monoterpene constituents like citral, citronellol, citronellal, linalool, elemol, 1, 8-cineole, limonene, geraniol, b-carophyllene, methyl heptenone, geranyl acetate and geranyl formate. Citral is one of the important components of the oil present in several species of *Cymbopogon* with wide industrial uses such as raw material for perfumery, confectionery and vitamin A (Khanuja et al. 2005). Among all the active constituents the following four are considered to be the most important essential oils of commercial interest (Figure 1):

- a. **Citronellal** or rhodinol or 3, 7-dimethyloct-6-en-1-al ($C_{10}H_{18}O$) is a monoterpene, responsible for its distinctive lemony scent.
- b. **Citral**, or 3, 7-dimethyl-2, 6-octadienal or lemonal, ($C_{10}H_{16}O$) is a mixture of, a pair of terpenoids. The two compounds are double bond isomers. The E-isomer is known as geranial or citral A. The Z-isomer is known as neral or citral B.
- c. **Geraniol** or 3, 7-dimethylocta-2, 6-dien-1-ol, ($C_{10}H_{18}O$) is a monoterpene and an alcohol. It is the primary part of rose oil, palmarosa oil,

and citronella oil (Java type), appears as a clear to pale-yellow oil, insoluble in water, but soluble in most organic solvents.

d. **Nerol** or 3, 7-dimethyl-2, 6-octadien 1-ol, molecular formula $C_{10}H_{18}O$ is a monoterpenoid and an alcohol.

1.4 Cymbopogon genus- various species and their Domestication

The genus *Cymbopogon* (Poaceae) is known to include about 140 species, of which more than 52 have been reported to occur in Africa, 45 in India, six each in Australia and South America, four in Europe, two in North America and the remaining are distributed in South Asia (Table-1). *Cymbopogons* are highly stress-tolerant plants which adapt easily to diverse edapho-climatic conditions, occurring widely throughout the tropics and subtropics (Sangwan et al. 1994; Sangwan et al. 1993). *C. flexuosus*, *C. pendulus*, *C. winterianus* and *C. martini* are commercially cultivated as modern cash crops for essential oil production. Few commercial cultivars such as Pragati, Krishna and Cauvery of *C. flexuosus*, Manjusha, Mandakini and Bio-13 of *C. winterianus*, Trishna, Tripta and PRC-1 of *C. martinii*, Praman of *C. pendulus* and interspecific hybrid (*C. pendulus* × *C. khasianus*) CKP are popular in the Indian subcontinent. Morphologically, there are least differences between them at the intra-species level but these cultivars differ in oil content and quality at the intra- and inter-species levels (Sangwan et al. 2001). The brief description of different cultivars of *Cymbopogon* species and their yield is shown in Table-2.

1.5 Medicinal activities and Therapeutic uses

The essential oils are natural products that exhibit a variety of biological properties, such as analgesic anticonvulsant and anxiolytic (Almeida et al. 2001, 2003 and 2004). The steam volatile essential oils extracted from its leaves are used in perfumery, cosmetics, pharmaceuticals and flavoring industries. In traditional medicine, the oil has been used as an aromatic tea, vermifuge, diuretic, and antispasmodic. Citronella oil is commonly known for its natural insect repellent properties, although it has many uses in aromatherapy. It can be used as massage oil for aching joints and muscles. The oil can effectively be used in a nebulizing or humidifying diffuser for its insect repellent properties. Traditional use includes treatment of fever, intestinal parasites, digestive and menstrual problems. When mental illness has to be treated, Citronella can be clarifying and balancing. Combining it with Lemon oil can bring even more of a brightening effect to the mind.

As far as therapeutic use of Citronella oil is concerned, most of the activities are confined to mosquito repellent, antiparasitic, nematicidal, antifungal and anti-bacterial agents. Trongtokit et al. (2005) compared the repellent efficiency of 38 essential oils against mosquito bites, including the species *Aedes aegypti*. Citronella oil was the most effective among other essential oils which provided 2 hours of repellency. Wong et al. (2005) studied five commercial plant extracts, including *Citronella*, and found it effective in deterring the infestation of cartons containing muesli and wheat germ by red flour beetles. Moreover, Olivo et al. (2008) proved that citronella oil has other effects, such as the control of cattle ticks. Nakahara et al. (2003) studied the chemical composition of citronella oil and its antifungal activity. The crude essential oil markedly suppressed the growth of several species of *Aspergillus*, *Penicillium* and *Eurotium*. Among the 16 volatiles examined by him, the most active compounds, consisting of 6 major constituents of the essential oil and 10 other related monoterpenes, were citronellal and linalool.

Currently, there are plant-based insect repellents on the market that contain essential oils from one or more of the following plants: citronella (*Cymbopogon nardus*), cedar (*Juniper virginiana*), eucalyptus (*Eucalyptus maculata*), geranium (*Pelargonium reniforme*), lemon-grass (*Cymbopogon excavatus*), peppermint (*Mentha piperita*), neem (*Azadirachta indica*) and soybean (*Neonotonia wightii*). Most of these essential oil-based repellents tend to give short-lasting protection for less than 2 h (Choochote et al., 2007). Citronella oil has demonstrated good efficacy against 44 mosquitoes in concentrations ranging from 0.05 % to 15 % (w/v) alone or in combination with other natural or commercial insect repellent products (Sakulku et al., 2009 and Fradin, 1998). Olivo et al. (2008) and Shasany et al. (2000) confirmed that this characteristic of the oil is due to the presence of four main components, citronellal, eugenol, geraniol and limonene.

Recently, scientists have become more interested in the utilization of plant materials as eco-friendly botanical pesticides because they often minimize the adverse effects on beneficial insects, reduce the need for prohibitively expensive chemicals, reduce the development of resistance, and are environment friendly. Among these botanical pesticides, citronella oil has been most extensively studied in the last decades. The efficacy of citronella oil against various insect species has been noted as a repellent, an antifeedant, and an oviposition deterrent. Some studies indicated that citronella oil is effective in repelling mosquito *Aedes aegypti* (Jantan and Zaki

1999), *Spodoptera frugiperda* and as antifungal and antibacterial (Nakahara et al. 2003; Pattnaik et al. 1996). Citronellal, trans-geraniol, carvone, and limonene were active compounds as anti-microbial (Simic et al. 2008), citronellal and linalool as an antifungal (Nakahara et al. 2003), whereas menthone, trans-geraniol, and citronellal showed a strong inhibitory effect (JIRCAS 2005).

Many literatures about the composition, biological effects and use in medicine, food-flavoring, perfumery and cosmetics of these essential oils were published in the last years (e.g. *Citronella* [Chagonda et al. 2000; Duke et al. 2000; Hiller and Melzig 2000; Lorenzo et al. 2000; LaGow, 2004; Seidemann 2005; Wichtl, 1989], *Geranium* [Babu and Kaul, 2005; Duke et al. 2002; Gauvin et al. 2004; Hiller and Melzig 2000; LaGow, 2004; Seidemann 2005], *Helichrysum* [Chinou et al. 2004, Duke et al. 2002; Lourens et al. 2004; Mastelic et al. 2005; Seidemann, 2005], *Palmarosa* [Prashar et al. 2003; Raina et al. 2003; Seidemann, 2005], rose [Agarwal et al. 2005; Duke et al. 2002; Hiller and Melzig 2000; Lawrence, 2005; Nowak 2005; Lagow, 2004; Seidemann, 2005; Wichtl, 1989] and *Verbena* [Ardakani et al. 2003; Hiller and Melzig 2000; Lawrence, 2004; Seidemann, 2005]).

2. Methodology

The extraction of essential oil from *Citronella* has been done by different processes. The extracts were then subjected to chromatographic analysis and individual identification tests for the confirmation of desired monoterpene alcohols. In BIT, Mesra, *Citronella* is cultivated in the fields for academic purposes and for its essential oils (Figure 2).

2.1 Extraction of essential oil

The essential oils are extracted using the aerial part of plants. An appropriate amount of sample is used for extraction by different methods such as steam distillation, fractional distillation or hydro-distillation equipment (Cassel and Vargas, 2006). Many conventional systems which utilizes steam distillation apparatus and Clevenger's apparatus for distilling plant parts with boiling water produces a large quantity of oil in a relatively much time with huge amounts of raw material. A simple laboratory apparatus with 2 litres steam generator flask, a distilling flask, a condenser, and a receiving vessel is used for steam distillation. The flask was heated with a gas burner. One hundred grams of air dried and chopped leaves of *C. nardus* were subjected to steam distillation (Setiwati et al. 2011). Nowadays, as an advanced alternative, the extraction can be performed in an experimental apparatus containing a high pressure pump, a stainless steel

extractor with a specific capacity, a micrometric valve for sampling, a thermostatic bath to control the temperature, a manometer and a rotameter to measure the flow rate of CO₂. The flow diagram of the experimental apparatus is presented in Figure-3 (Mendes, 2007). This may be known as supercritical fluid extraction method. The study of essential oil extraction from *Citronella* species using supercritical carbon dioxide is done to produce solvent free extract and concentrated in the active components of the oil, with attention to the efficiency and the composition of the extracted oil. The extraction with supercritical fluid has potential as an alternative technology with the objective of minimizing energy and the use of organic and pollutant solvents when compared to conventional steam distillation methods. In this method, the supercritical solvent used is carbon dioxide because of its atoxicity, low cost, volatility and low critical properties (Silva et al. 2011).

After the completion of the extraction procedure, the extracts are purified by chromatographic analyses.

2.2 Chromatographic Analysis

The chromatographic analysis involves the use of gas chromatography method either alone for qualitative analysis or coupled with mass spectrometry for quantitative analysis. Various GC-MS systems equipped with various detectors and experimental conditions have been employed. The most used configuration of a GC-MS system involves the use of a capillary column (30 m long, cross-linked 5-6 % polymer, 30 m length, 0.25 mm internal diameter and 0.25 micron coating thickness, fused silica of stationary phase) with a detector system operating at 70 eV. Injector and transfer line temperatures were set at 200 °C and 280 °C, respectively; the oven temperature was programmed from 40° - 220 °C, at 3 °C/min. Helium was employed as carrier gas (1 ml/min); injection of 1 ml of a 1% solution of whole essential oil in ethyl acetate, split ratio 1:50, scan range 41-300 amu and scan time 1.0 sec (Cassel and Vargas, 2006; Silva et al. 2011; Setiwati et al. 2011). Jirovetz et al. (2006) exploited the system in which the carrier gas was hydrogen; injector temperature, 250°C; detector temperature, 320°C. The temperature programme was: 40°C/5 min to 280°C/5 min, with a heating rate of 6°C/min. The columns were 30 m x 0.32 mm bonded FSOT-RSL-200 fused silica, with a film thickness of 0.25 µm (Biorad, Germany) and 30 m x 0.32 mm bonded Stabilwax, with a film thickness of 0.50 µm (Restek, USA). Quantification was achieved using peak area calculations, and compound identification was carried out partly using correlations between retention times.

2.3 Identification of essential oils

The purified extract containing essential oils are identified by different qualitative tests. Essential oils can be acyclic (aliphatic) monoterpene alcohols such as citronellol, geraniol and nerol and cyclic (alicyclic) are classified as monoterpene, bipertene and triterpene alcohols such as menthol, borneol and santalol respectively. The corresponding essential oil contained in the extract is subjected to form a crystalline salt so as to determine the melting point of the corresponding salt. To identify terpenes present in the extract a general test called Liebermann- Butchard reaction (Coelho and Alves, 1946) is done.

1. Citronellol

It is a monoterpene alcohol, soluble in alcohol but insoluble in water. It forms crystalline silver salt when reacted with phthalic acid and silver nitrate. The melting point of this salt is 125°C. The reaction follows as:

Citronellol (a) + Phthalic acid (b) → Citronellyl acid phthalate (c)

Citronellyl acid phthalate + AgNO₃ → Crystalline silver salt (d)

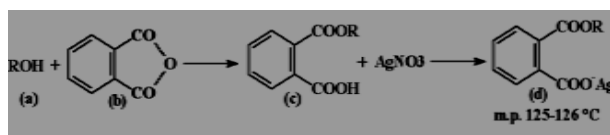

1. Geraniol and Nerol

They are cis/trans isomers and are generally present as mixtures, soluble in organic solvents. Geraniol is soluble in ether and when it is treated with anhydrous calcium chloride, forms a crystalline derivative called geraniol-CaCl₂ complex which is insoluble in ether, petroleum ether, benzene and chloroform. This complex is decomposed in warm water into geraniol and CaCl₂.

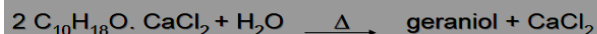

Whereas nerol is soluble in ether and when it is treated with anhydrous calcium chloride, remains in the solution as shown.

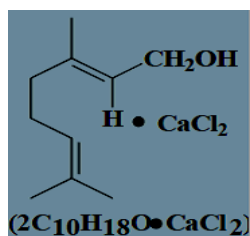

Chemistry of nerol and geraniol

Nerol has more refreshing odour than geraniol. On oxidation with mild oxidizing agent nerol and geraniol gives citral whereas when geraniol is treated with dilute KMnO₄ yields polyhydric alcohols and finally degradation products. Other properties are shown in Figure-4.

2.4 Therapeutic approaches

Four basic approaches have been described here conforming to the mosquito repellent assay, anti-parasitic assay, antifungal assay and antibacterial assay.

2.4.1 Mosquito repellent assay- Microencapsulation method against *Aedes aegypti*

The citronella oil has the repellency activity against *Aedes aegypti* mosquitoes. The extracted oil was microencapsulated (1.5% gelatin and 1.5% Arabic gum) by complex coacervation method. This citronella oil was treated on cotton fabrics using gelatin and gum acacia microcapsules, by pad dry method. The effect of the repellents on cotton fabrics with 15 %, 30% and 50% against *Aedes aegypti* was studied by cage and field test with human arms covered with treated and untreated fabrics (at 26±2°C and 80±5 % RH). This same experiment was repeated with once and twice washed microencapsulated citronella oil treated fabric (MCF) and citronella oil treated fabric (CF) (Murugan et al. 2012). A case study on the evaluation of flammability, burning time and mosquito repellency tests of citronella leaf cakes sprayed with different concentrations of Citronella oil was performed. Results suggested that Neem powder cake has the most effective repellency activity when impregnated with 10% Citronella oil (Rani et al. 2013).

2.4.2 Anti-parasitic assay- Inhibition of *Trypanosoma cruzi*

This study analyses the anti-proliferative effect of lemongrass essential oil and its main constituent (citral) on all three evolutive forms of *Trypanosoma cruzi*. The IC₅₀/24 h (concentration that reduced the parasite population by 50%) of the oil and of citral upon *T. cruzi* was determined by cell counting in a Neubauer chamber, while morphological alterations were visualized by scanning and transmission electron microscopy (Santoro et al. 2007).

2.4.3 Anti-fungal assay- Vapour-agar contact method against fungi

The antifungal assay using the vapour-agar contact method showed that the crude essential oil

markedly suppressed the growth of several species of *Aspergillus*, *Penicillium* and *Eurotium* in air. Citronellal and linalool completely inhibited the growth of all tested fungal strains at a dose of 112 mg/L. Their minimum inhibitory doses ranged from 14 to 56 mg/L. The α - and β - pinenes showed an inhibitory activity against some fungi, whereas the other 8 volatile compounds lacked this property (Nakahara et al. 2003) (Figure 5).

2.4.4 Anti-bacterial assay- Broth dilution method against bacteria

The inhibitory effect of citronella oil against major species of spoilage bacteria including

Staphylococcus aureus, *Klebsiella* spp. and *Pseudomonas* spp. found on the surface of *Decapterus maruadsi* (semi- dried round scad) was investigated using the broth dilution method. Citronella oil and its main components d- limonene and linalool were introduced into a nutrient broth at volume concentrations (v/v) between 0.5% and 10% to determine the minimum inhibitory concentration (MIC) and the minimum bactericidal concentrations (MBC) for the bacteria was evaluated (Jaroenkit et al. 2011).

Table 1: Classification of *Cymbopogon* cultivars based on their chemical markers/chemotaxonomy and their distribution (Chandra, 1975b)

Group	Species	Major distribution	Marker constituents	Cultivar	Series
I	<i>C. martinii</i>	Throughout in India	Geraniol (64.0%-92.6%), geranyl acetate (1.1-23.3%)	Vaishnavi, Trishna, Tripta, PRC-1	Rusae
II	<i>C. flexuosus</i>	Southern and northern part of India	Citral (80.6%-84.4%)	Cauvery, Nima, OD-19, Krishna, Chirharit, Praman, Pragati	Citrati
Hybrid	<i>C. pendulus</i> × <i>C. khasianus</i>	Some part of Northern India Southern and northern part of India	Citral (75.9%), limonene (5.5%) Citral (80.4%)	CKP-25 Praman	
III	<i>C. flexuosus</i>	Southern and northern part of India	GRL-1 Geraniol (87.9%), Citral (4.7%)		Very close to Rusae
IV	<i>C. winterianus</i>	Andhra Pradesh, Assam, Gujarat, Jammu & Kashmir, Tamilnadu, Uttar Pradesh and Uttarakhand	Citronellal (31.1-35.4%), Geraniol (22.4-30.2%), Citronellol (7.4-11.0%)	Manjari, Jalpalavi, Manjusha, BIO-13, Mandakini	Citrati
V	<i>C. winterianus</i>	Southern and northern sub Himalayan region of India	Geraniol (50.1%), Citral (21.8%), Citronellal (11.8%)	Medini	

Table 2: Origin of different cultivars of *Cymbopogon* species and their essential oil yield (Padalia et.al, 2011)

Plants	Cultivars	Oil Yield* (%, v/w)	Development/Origin
<i>Cymbopogon martini</i> var. motia (Palmarosa)	Vaishnavi	1.2 (1.0)	Selection in OPSPs (Patra et.al, 2001)
	Trishna	1.0 (1.1)	Synthetic population breeding (Sharma et.al, 1987b)
	Tripta PRC-1	1.0 (0.7)	Mass selection (Anonymous, 2003)
		1.4 (1.1)	Composite population breeding (Patra & Kumar, 2005)
<i>Cymbopogon flexuosus</i> (Lemongrass)	Caveri	0.8	Phenotypic recurrent selection (Patra & Kumar, 2005)
	Nima	0.7	Clonal selection in OPSPs (Anonymous, 2003)
	Krishna	1.0	Phenotypic recurrent selection (Anonymous, 1997)
	Chirharit	0.7	Clonal selection in OPSPs (Patra et.al, 2001)
	OD-19	0.7	Clonal selection (Kumar et.al, 2000)
	Pragati	0.7	Clonal selection in OPSPs (Patra & Kumar, 2005. Sharma et al. 1987a)
<i>Cymbopogon pendulus</i> (Lemongrass)	GRL-1	0.8	Selection in OPSPs of OD-19 (Kumar et.al, 2000)
	Praman	0.8	Clonal selection (Patra et.al, 1997)
	Hybrid of <i>C. khasianus</i> × <i>C. pendulus</i> CKP-25	1.2	Hybridization (Rao & Sobti, 1991)
<i>Cymbopogon winterianus</i> (Java Citronella)	Manjari	1.3	Induced mutagenesis (Lal et.al, 1999)
	JalPallavi	1.2	Clonal selection (Anonymous, 1994)
	Medini	1.2	Clonal selection (Anonymous, 1994)
	Manjusha	1.0	Clonal selection (Patra & Kumar, 2005)
	Bio-13	1.2	In-vitro somaclonal selection (Patra & Kumar, 2005)
	Mandakani	1.1	Clonal selection (Patra & Kumar, 2005)

*The oil yields in parentheses are for inflorescence; OPSPs: Open Pollinated Seed Progenies

Table 3: Chemical Constituents of Citronella oil by classical methods (Guenther, 1950)

Variety	Chemical Constituents
Ceylon type	Camphene, dipentene, citronellal, geraniol, geranyl acetate, nerol, citronellol, thujyl alcohol, borneol, farnesol, linalool and methyl eugenol
Java type	Limonene, citronellal, citral, geraniol, citronellol, citronellate, eugenol, methyl eugenol, chavicol, sesquicitronellene, elemol, citronellyl oxide, γ and δ cadinene, vanillin, isovaleraldehyde, hexane-2-al and 3-methyl pentanal.

Table 4: Chemical composition of Java type and Ceylon type varieties by instrumental methods (Wijesekara, 1973).

Peak number	Compound	Approximate percentage (%) in	
		Java type	Ceylon type
0	Solvent	-	-
1	Tricyclene	-	1.6
2	α - pinene	-	2.6
4	Camphene	-	8.0
5	β - pinene	-	trace
6	Sabinene	-	trace
7	Myrcene	-	0.3
8	Car-3-ene	-	trace
9	α - phellandrene	-	0.8
10	α - terpineol	-	-
12	Limonene	1.3	9.7
14	Cis- ocimene	-	1.4
15	Trans- ocimene	-	1.8
16	p- cymene	-	trace
17	Terpinolene	-	0.7
20	1- hexanol	-	0.1
23	Methyl heptenone	trace	0.2
24	Unidentified	-	trace
25	Unidentified	-	trace
26	Citronellal	32.7	5.2
27	Camphor	-	0.5
28	Bourbonene	trace	1.0
29	Linalool	1.5	1.2
30	Linalyl acetate	2.0	0.8
32	α - terpineol	-	trace
33	β - caryophyllene	2.1	3.2
34	4- Terpineol	-	trace
35	Menthol	-	trace
36	Unidentified	-	trace
37	Citronellyl acetate	3.0	1.9
38	Unidentified	-	trace
39	1- borneol	trace	6.6
40	Geranyl formate	2.5	4.2
42	Citronellol	15.9	8.4
44	Nerol	7.7	0.9
46	Geraniol	23.9	18.0
47	Citronellol butyrate	trace	trace
48	Geranyl butyrate	-	1.5
50	Nerolidol	-	0.3
51	Methyl eugenol	trace	1.7
53	Elemol	6.0	1.7
56	Methyl isoeugenol	2.3	7.2
57	Unidentified	1.4	1.5
60	Farnesol	0.6	trace

Table 5: Identification of the components present in the chromatogram in the Figure-7

Peak identification	Components	Approx. (%) in oil
1	Citronellal	98
2	Citronellol	95
3	Geraniol	86
4	β - elemene	95
5	Germacene- D	99
6	Elemol	83
7	Germacredien-5-ol	91

Table 6: Identification of the components present in the chromatogram in the Figure-8

Peak	Components	%	Peak	Components	%
1	Citronellal	98	10	α - morfene	97
2	Citronellol	98	11	δ - cadinene	99
3	Geraniol	95	12	α - cadinene	98
4	Eugenol	98	13	Elemol	91
5	α - amorfene	98	14	Gamma- eudesmol	98
6	Germacene- D	98	15	t- cadinol	90
7	β - selinene	99	16	β - eudesmol	99
8	α - selinene	98	17	α - eudesmol	99
9	α - muorele	98			

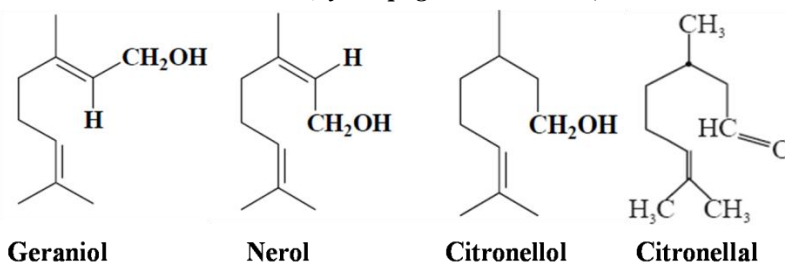
Figure 1: Chemical structures of major chemical components in Citronella oil from Java Citronella (*Cymbopogon winterianus*)**Figure 2: Citronella grass field in Birla Institute of Technology, Mesra, Ranchi, Jharkhand, India**

3. Discussions

The present review is confined to the extraction of Citronella oil, its chemical analysis and therapeutic approaches. Citronella oil is the essential oil obtained from Citronella grass which was earlier grown predominantly in the south of Sri Lanka and nowadays cultivated mainly in India. As earlier explained, Citronella oil contains a number of fragrant fractions of which citronellal, geraniol, and citronellol are the major components which is responsible for the real chemistry of this essential oil (Leung, 1980, Evans, 1989).

Citronella oil has two chemotypes: (1) Ceylon type (obtained from *C. nardus* Rendle) consists of geraniol (18-20%), limonene (9-11%), methyl isoeugenol (7-11%), citronellol (6-8%), and citronellal (5-15%). (2) Java type (obtained from *C. winterianus* Jowitt) consists of citronellal (32-45%), geraniol (11-13%), geranyl acetate (3-8%), limonene (1-4%). The higher proportions of geraniol and citronellal in the Java type make them as better perfumery derivatives. The two cultivated types are distinguished by the shape and length of their leaves. The differences in the two varieties and the chemical composition of the essential oils have been recorded since early times (Guenther 1950, Jowitt 1908). It was believed that the Java type variety contained around 85% of geraniol compared to citronellal and citronellol. On the other hand, the Ceylon type variety was reported to contain only 55-65% of geraniol. Both the types of oil are in demand. A geraniol-rich mutant containing as high as 60% of geraniol content has been developed (Ranaweera and Dayananda, 1996).

The chemical analysis of Citronella oil has been discussed with two approaches. Firstly, with the GC-MS method of analysis and secondly with the process using supercritical carbon dioxide. One of the remarkable differences observed in GC-MS was the presence of many monoterpene hydrocarbons amounting to more than 20% of the oil in the ceylon type as only 3-4% in the java type. There is the presence of a high proportion of hydrocarbons in Ceylon type. Of the monoterpene hydrocarbons in the Ceylon type variety the most abundant was found to be camphene. The other hydrocarbons present were α and β pinenes, sabinene, myrcene, car-3-ene, α and β phellandrenes, α and β terpenes, cis/trans ocimene, terpinolene and p-cymene. The occurrence of camphene and tricyclene together with borneol and bornyl acetate in citronella ceylon type is an indication that the biosynthetic pathway via neryl or geranyl pyrophosphate and 2-bornane carbonium ion is operative in the case of this plant.

The java type oil contained more oxy-terpenes than Ceylon type. There was a great difference in the amounts of geraniol in the two oils. However, java type contained much quantity of citronellal and citronellol which elevated the level of "total acetylizables". Another distinguishing feature of the Ceylon type oil is the presence of methyl eugenol and methyl isoeugenol. These compounds are the major peaks which appear last on the chromatograms and are present in only comparatively small quantities in the java type variety.

3.1 Chemical analysis of Citronella oil by classical methods and instrumental methods

The main constituents of the two types of Citronella oil have been identified by means of classical chemical methods (Table 3). These classical methods were based on comparatively drastic fractional distillation procedures.

The classical methods of analysis of the essential oil of Citronella were primarily based on two factors, firstly the estimation of total acetylizables in them and secondly various rough solubility checks such as Schimmel's test, raised Schimmel's test and London solubility test. The limiting values for various physical constants such as refractive index and optical rotation were also specified.

As the new instrumental methods emerged, the new techniques for the characterization of chemical compounds based on spectroscopic methods resulted in a major surge in natural products research during early 1960's. These techniques required small quantities of compounds. Prior to this, the characterization of compounds were time consuming. With the development of new separation techniques based on chromatography, re-study of essential oils was facilitated. The earlier available methods of separation were comparatively tedious and time consuming based on of fractional distillation and chemical reactions based on functional groups. Fractional distillation often caused changes due to isomerization, polymerization or decomposition even when carried out at reduced pressures.

As far as essential oils were concerned, the most significant advancement was the development of GLC which gave an entirely new dimension to essential oils studies and their chemical constituents. This technique is depends on the effectiveness of the volatility of the compounds and the constituents of essential oils. However, in most cases a large number of chemical compounds in essential oils and their examination were dependent on the extent up-to

which they can be effectively separated. Thus, GLC offered a fantastic method of separation which could be achieved with very minute amount of sample. Preparative GC meant the isolation of the separated constituents which could then be subjected to the scrutiny of new techniques such as NMR spectroscopy and mass spectroscopy in order to determine their structure and chemical nature.

The prime focus on the study of citronella oil was to obtain maximum possible resolution in GC columns and on identifying the various constituents by retention data and peak enrichment techniques. In peak enrichment, the standard reference compounds are added one at a time prior to injection. The enhancement of the peaks and the area covered indicated the corresponding positions of the added substance. The individual compounds resolved by preparative GLC were collected either into the pre-cooled solvents or liquefied in capillary tubes cooled to below zero temperature. The spectra obtained were then matched with that of standards which too had been purified in the same way. In this way, the identities of chemical constituents of Citronella oil were confirmed. The main differences in chemical composition both qualitative and quantitative between the oils of Java type and Ceylon type were also established (Table 4 and Figure 6a and b, Wijesekara, 1973).

3.1.1 Chemical components obtained from other species of *Cymbopogon* in some other regions of India by instrumental methods

The average yield of oil is 0.22–0.44% from *C. confertiflorus*. Analysis of Java oil from Mahapengiri, Ceylon oil from Lenabatu and oil from *C. confertiflorus* gave the following: Total alcohols 79.0–84.8%, 57.8–62.1% and 39.1–62.2%; geraniol, 24.1–32.5%, 26.3–37.9% and 19.4–43.7%; and citronellal 40.5–60.7%; 24.2–33.6% and 17.2–33.2% respectively. Besides geraniol and citronellal, Java oil also contains terpenes, methyl eugenol (1%), trace amounts of citronelloxide, a sesquiterpene; a phenol (chavicol) and acids (citronellic acid) are present. The constituents of Ceylon oil are geraniol, citronellal, terpenes (10–15%), methyl eugenol (8%), L-borneol (1–2%), methyl heptanone, farnesol (0.2–0.3%) and sesquiterpenes. The Lucknow cultivar (Ceylon citronella) in northern India contains geraniol (39.9%) as the main terpenic constituent. Other components found included isocaproic acid, isovaleric, butyric and propionic acids, D-citronellal, citral, iso-valeraldehyde, pelargonaldehyde, citronellol, n-heptyl alcohol; acetates, propionates, butyrates and isovalerates of geraniol and citronellol. Bangladesh cultivars contained predominantly citronellal (32%), citronellol (14.4%) and geraniol

(21.1%). Elemol and methyl isoeugenol have been identified for larvicidal activity in the Ceylon citronella (Katiyar et al. 2011; Setiawati et al. 2011; Jirovetz et al. 2006, Nakahara et al. 2003; Wijesekara 1973).

The essential oil compositions of total nineteen cultivars of *Cymbopogon Spreng.* (Poaceae) species viz. *C. martinii* (Roxb.) Wats. var. *motia* Burk., *C. flexuosus* Nees ex Steud., *C. winterinus* Jowitt., *C. pendulus* Nees ex Steud. and a hybrid of *C. khasianus* (Hack) Stapf. Ex Bor and *C. pendulus* Nees ex Steud. were examined and compared using capillary GC and GC-MS. A total of 48 constituents forming 90.1% to 99.7% of their total oil compositions with monoterpenoids (78.9% to 97.4%) as the most elite constituents were found. The comparative results showed considerable variation in the qualitative and quantitative compositions of essential oils from nineteen different cultivars of the studied *Cymbopogon* species. On the basis of chemical similarity, the cultivars of genus *Cymbopogon* were divided into five chemical variants/groups within two series viz. *Citrati* and *Rusae*. The volatile profile of existing cultivars of *Cymbopogon* are useful for their commercial utilization as they possess range of essential oils and aroma chemicals used in perfumery, flavour, pharmaceutical and other allied industries. Moreover, the marker constituents in their essential oils may be utilized as an important tool in oil authentication (Mahalwal and Ali, 2003).

In this method, the extracts obtained are free from residual solvents and thus can contribute towards more pure oil production which is comparatively better than other traditional processes using organic solvents. Reis et al. (2006) and Radunz et al. (2002) extracted the essential oil using hydrodistillation methods with heptanes as a solvent and later drying the organic layer with magnesium sulfate. With increasing pressure and at constant temperature the quantity of extracted oil increases as shown in Figure 7 and Table 5. The reason behind may be the increase in the carbon dioxide density and, consequently, the increase of its solvent power. Vargas et al., (2010) observed the same with other raw materials and concluded that practically all the oil was extracted in the first 30 minutes of extraction. This gave evidence that the majority of the oil was probably present near the surface of the leaves. During the extraction procedures, the quantity of solvent consumed can be calculated and verified as the as the ratio between the extracted oil mass and the consumed mass of carbon dioxide, M_E/M_{CO_2} .

Figure3: Experimental apparatus using the supercritical fluid extraction (Mendes, 2007) equipped with A- CO₂ cylinder; B- high pressure pump; C- heating bath; D- extractor; E- micrometric valve; F- raffinate; G- rotameter

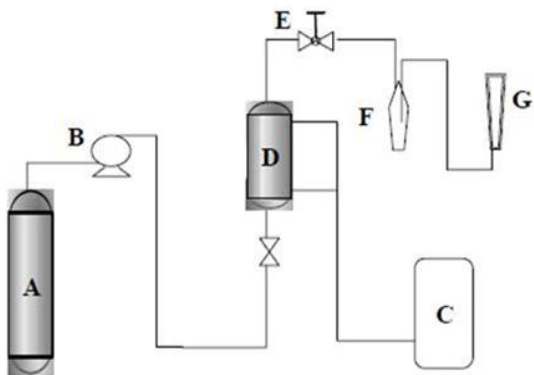

Figure4: Chemistry of geraniol and nerol

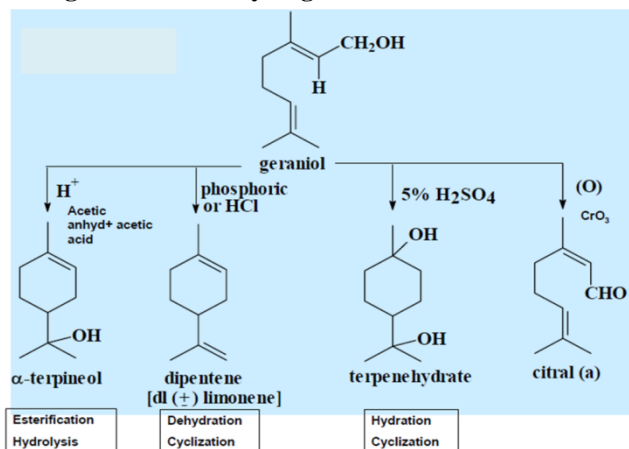

Figure5: Experimental set up for antifungal assay in vapour agar contact method (Nakahara et al. 2003)

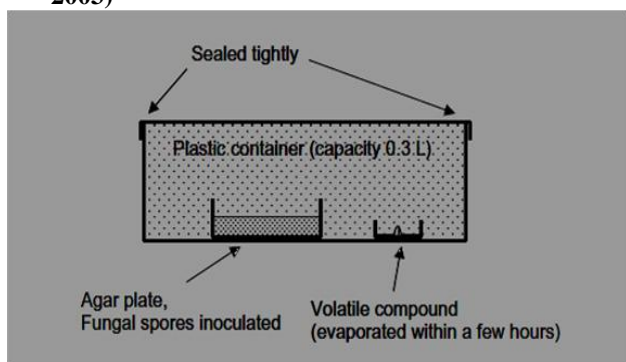

Figure 6: Comparative temperature programmed gas chromatograms of Citronella oil (a- Ceylon type) and Citronella oil (b- Java type) (Wijsekara, 1973). Operating conditions: GC with FID detector, Column: 10% carbowax on chromosorb W (2.7 X 3.2 mm), Programme rate: 60°-220°C at 2° per minute, linear, Base attenuation: X16

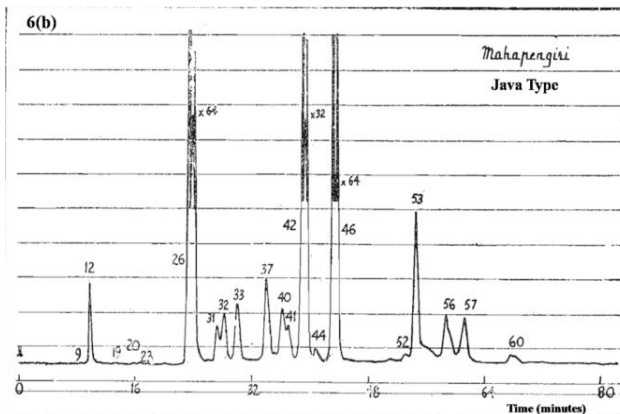
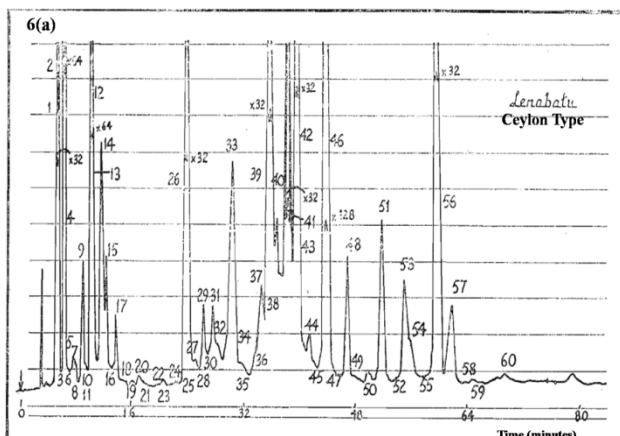

Figure7: Chromatogram of essential oil extracted with supercritical carbon dioxide at 353.15 K and 18.0 MPa

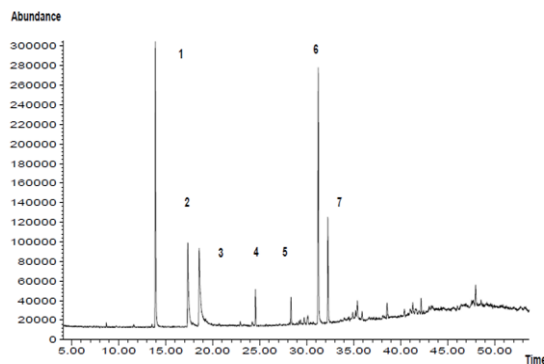
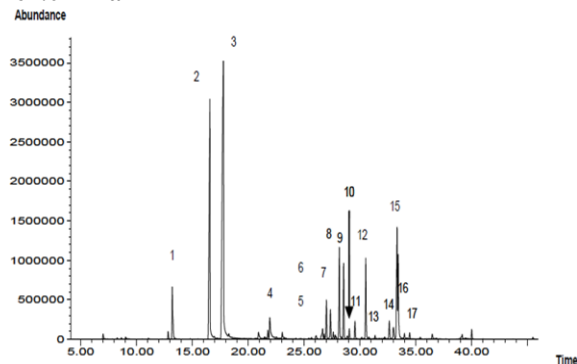

Figure 8: Chromatogram of essential oil extracted with supercritical carbon dioxide at 313.15 K and 62.0 MPa



At low pressure (18.0 MPa) and higher temperature (353.13K), the presence of other components indicates that they are being solubilized with increasing temperature which is a different behavior from the earlier one (Figure 8). Due to the solubilization of other chemical components, the extracted mass increased and led to restrain the essential oil extraction or change the original characteristics of the oil. The variation of the color of the extract depends upon the differences in pressure applied. It was observed that, generally at higher pressures (62 MPa) the extract is darker. Also, there are other components present in the plant which are obtained in addition to the essential oil. At higher pressures the color was green, and at lower pressures, the color of the raffinate was yellow.

It is evidenced clearly by the number of components present in the chromatograms that 313.15K is the best temperature than 353.15K and further authenticated in Tables 5 and 6. The results obtained suggest that at high pressures are suitable for extracting components from the plant. The compositions of the citronella oil extracted under two different equipped conditions, presented in Tables 5 and 6, indicate that these oils can be used as insect repellent with numerous therapeutic applications because of the presence of citronellal, citronellol and geraniol. The best operational condition was found to be 353.15K and 18.0MPa with the maximum process efficiency with respect to the quantity of extracted mass. Besides the better value of efficiency, this operational condition showed good selectivity compared to other conditions. At 18.0MPa and 353.15K, seven components were obtained, while at 62.0MPa and 313.15K there was seventeen components. The composition of the essential oil obtained using supercritical carbon dioxide indicates that the oil can be used for its antimicrobial, antifungal and repellent activities.

3.3 TLC and HPTLC methods for identification of unknown essential oil components

In routine TLC experimental methods, the detection is only by spray method and the R_f value is not accurately recorded. However, UV based scanning after developing HPTLC plate not only provides opportunity for scanning at specific wavelengths but is also useful for quantification. In our unpublished work concerning to the characterization of essential oil components in the Citronella oil, HPTLC method posed an excellent technique as it led to the identification of unknown components when standard references are provided (Figure 9; a, b, c and d combined).

3.4 Therapeutic Approaches

Human beings are affected mostly by mosquitoes due to the dreadful insect-borne diseases such as malaria, Lyme disease, etc. spread by them. Mosquitoes are vectors for a number of infectious diseases affecting millions of people per year. Insect repellents help to prevent and control the outbreak of diseases and thus, plant based repellents may be an easy and reliable alternative with very less side effects. In spite citronella oil is being extracted for this purpose; its left out biomass is also utilized as a mosquito repellent in many villages. Citronella leaf based herbal repellants have been reported wherein the therapeutic use citronella leaf cakes impregnated with different concentrations of citronella oil were checked against mosquitoes present in the vicinity of the Institute during evening time (Rani et al. 2013).

Now, focussing back to citronella oil, which has the repellent activity against *Aedes aegypti* mosquitoes, Murugan et al., (2012) demonstrated the microencapsulation method based on coacervation method, in which 15%, 30% and 50% repellency effect was studied, 50% concentrated repellents gave the best mosquito repellency rather than the other two in both microencapsulated treated citronella oil treated fabric and citronella oil treated fabric. Despite the microencapsulated oil treated fabric had shown best repellency effect than citronella oil treated fabric because of the controlled release characteristics of cross linked natural polymers.

The coacervation techniques via microencapsulation such as oil/polymer and glutaraldehyde/polymer ratios has undeviating power on textile application and fabrics performance such that as the concentration of glutaraldehyde increases, the better washing performance was observed due to high cross linking. Higher the cross linking, slower is the rate of release of citronella oil from the fabrics. The controlled release of oil is due to the nature of cross linked natural polymer and thus the microencapsulated oil treated fabric shown higher

repellent effect than the direct oil treated fabric. The fabrics which were directly coated with oil washed off easily. But the directly 50% oil treated fabric show best effect for first two days then it was gradually reduced. So the microencapsulated oil gave the better repellent effect for longer time (Murugan et al., 2012).

In another study by Santoro et al. 2007 based on evaluating anti-proliferative effect against *Trypanosoma cruzi*, treatment with the essential oil resulted in epimastigote growth inhibition and intracellular amastigote proliferation. Ultrastructural analysis demonstrated cytoplasmic and nuclear extraction, while the plasma membrane remained morphologically preserved. Their data showed that lemongrass essential oil is effective against *T. cruzi* trypomastigotes and amastigotes, and the main

component, citral, is responsible for the trypanocidal activity. These results indicated that essential oils can be promising anti-parasitic agents, opening perspectives to the discovery of more effective drugs of vegetal origin for treatment of parasitic diseases. Furthermore, this essential oil also inhibited epimastigote growth at lower concentrations, inducing ultra-structural alterations. An interesting finding was the detachment of small vesicles from the parasite plasma membrane, which suggested release of injured membranes by the protozoa. The high trypanocidal activity of both lemongrass essential oil and citral indicated that this essential oil is a good candidate for further phytotherapeutic analysis. However, *T. cruzi*-mouse model are needed to support the data by additional cytotoxicity experiments on different cell lines and tests.

Figure 9: HPTLC profiles of a. geraniol, b. citronellol standards, c. steam distilled oil and d. hydro-distilled oil.

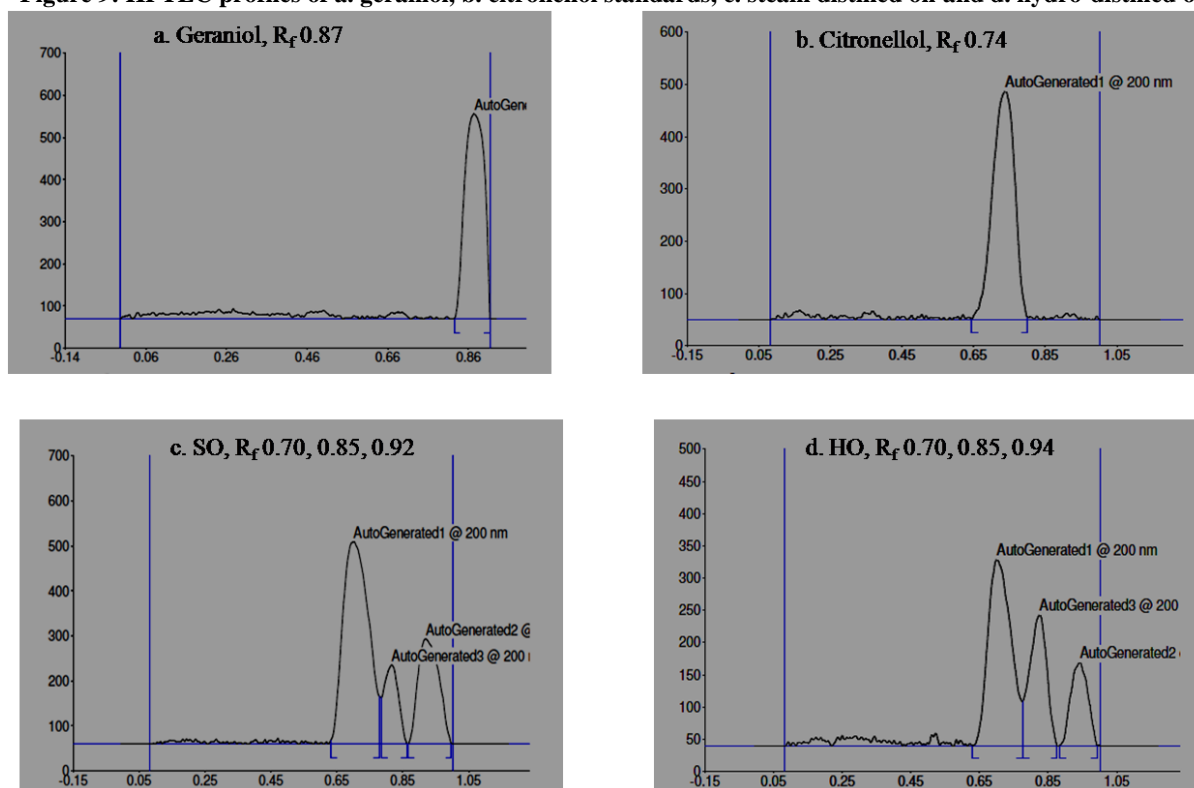

In the broth dilution method, the citronella oil exhibited activity against all bacteria with a MIC of 1% v/v, while d-limonene showed activity against *Pseudomonas* spp. at 0.7% v/v and both *Staphylococcus aureus* and *Klebsiella* spp. at 0.9% v/v. Antimicrobial activity of the citronella oil at the concentration of 1% v/v was further examined on dried fish under storage conditions of 4°C and 30°C. Citronella oil was found to be able to extend the shelf life of the semi-dried fish for up to 7 days at 4°C.

Major constituents, d-limonene (86.0%) and linalool (3.2%), represented 89.2% of the citronella oil. These findings showed that the required shelf life of semi-dried fish could be achieved by manipulating the concentration of the citronella oil. The *in vitro* test was compared with the *in vivo* test, and found that higher levels of essential oils are efficient to inhibit the growth of microbes in foods (Jaroenkit et al. 2011).

The results in the study by Nakahara et al. 2003 suggested that linalool and citronellal contributed significantly to the total antifungal activity of citronella oil used in the present study. *C. nardus*, a plant growing wild in Thailand and in other Asian countries, could become a renewable source for natural fungicides. Its essential oil, especially the active constituents (citronellal and linalool), was a potent inhibitor (via vapour phase) of various fungi at ambient temperatures. The compounds with lower MID values against different fungal genera and species could be used as natural alternatives for synthetic fumigants to protect stored food products.

Conclusion

The wide distribution of the genus *Cymbopogon* is due to their adaptability to diverse edapho-climatic conditions. There many species in this genus which is cultivated for its oil but *Cymbopogon winterianus* (Java Citronella) is one such species which is a native of Sri Lanka and domesticated in India for commercial purpose since years. The oil is extracted through many procedures such as steam distillation, hydrodistillation and by SFE and simultaneously quantified for its essential oil components for the therapeutic purposes. Citronella oil is very promising towards antifungal, anti-bacterial, anti-parasitic and insect repellent as demonstrated by many research literature reviews. Plant derived (herbal) repellents based on Citronella biomass (spent grass) is also pacing up in the research field. The advancement of techniques such as GC-MS, HPTLC, FTIR and SFE led to the identification of unknown components present in citronella oil. The present review encompasses all the fields in which research is being carried out with Citronella plant and its essential oil.

Acknowledgements

University Grants Commission, New Delhi, India is duly acknowledged for providing Junior Research Fellowship under the scheme of Maulana Azad National Fellowship for minority students during financial year 2012-13 (F1-17.1/2012-13/MANF-2012-13-CHR-CHH-9539) to Ms. Aakanksha Wany. The authors are thankful to the Department of Pharmaceutical Sciences for developing and maintaining the Indigenous Medicinal Plant Research Farm sponsored by Birla Institute of Scientific Research, Jaipur, Rajasthan and Birla Institute of Technology, Mesra, Ranchi, Jharkhand, India. Also, the technical support and help provided by Mr. Puspendra Patel (Research Scholar), Department of Pharmaceutical Sciences, BIT, Mesra for HPTLC and Clevenger's apparatus is greatly acknowledged.

References

1. Agarwal, S.G., Gupta, A., Kapahi, B.K., Baleshwar, A., Thappa, R.K., Suri, O.P. (2005): Chemical composition of rose water volatiles. *J. Essent. Oil Res.*, 17: 265-267.
2. Akhila, A. (1986): Biosynthesis of monoterpenes in *Cymbopogon winterianus*. *Phytochem.*, 25: 421-424.
3. Almeida, R.N., Motta, S.C., Faturi, C.B., Catallani, B., Leite, J.R. (2004): Anxiolytic-like effect of rose oil inhalation on the levated plus maze test in rats. *Pharmacol. Biochem. Behav.*, 77: 361-364.
4. Almeida, R.N., Motta, S.C., Leite, J.R. (2003): Properties of essential oil as anticonvulsants. *Bol. Latinoam. Caribe lant Med. Aromat.*, 15: 3-6.
5. Almeida, R.N., Navarro, D.S., Barbosa-Filho, J.M. (2001): Plants with central analgesic activity. *Phytomed.*, 8: 310-322.
6. Anonymous., (1994): Tripta-a new variety of palmarosa, *CIMAP Newslett.*, 21, 4.
7. Anonymous., (1997): Improved Clonal variety Krishna of lemongrass developed. *CIMAP Newslett.*, 24, 2-3.
8. Anonymous., (1999): High yielding varieties Jalpallavi, Manjari and Medini of Citronella Java (*Cymbopogon winterianus*), *CIMAP Newslett.*, 26, 3-5.
9. Anonymous., (2003): Citral rich and high yielding lemongrass variety 'Nima' released for commercialization, *CIMAP Newslett.*, 1, 4-6.
10. Ardakani, M.S., Mosaddegh, M., Shafaati, A. (2003): Volatile constituents from the aerial parts of *Verbena officinalis* L. (Vervain). *Iranian J. Pharm. Res.*, 2: 39-42.
11. Babu, K.G.D., Kaul, V.K. (2005): Variation in essential oil composition of rose-scented geranium (*Pelargonium sp.*) distilled by different distillation techniques. *Flav. Fragr. J.*, 20: 222-231.
12. Cassel, E., Vargas, R.M.F. (2006): Experiments and Modeling of the *Cymbopogon winterianus* Essential Oil Extraction by Steam Distillation, *J. Mex. Chem. Soc.*, 50(3) : 126-129.
13. Chagonda, L.S., Makanda, Ch., Chalchat, J.C. (2000): Essential oils of cultivated *Cymbopogon winterianus* (Jowitt) and *C. citratus* (DC) (Stapf) from Zimbabwe. *J. Essent. Oil Res.*, 12: 478-480.

14. Chandra, J., (1975b): Cytogenetical Evolution in Some Species of *Cymbopogon* Cited in *Advancing Frontiers in Cytogenetics*. In: Kachroo P (ed.). Hindustan publ. Corp., New Delhi
15. Chinou, I.B., Bougatsos, Ch., Perdetzoglou, D. (2004): Chemical composition and antimicrobial activities of *Helichrysum amorginum* cultivated in Greece. *J. Essent. Oil Res.*, 16: 243-245.
16. Choochote, W., Chaithong, U., Kamsuk, K., Jitpakdi, A., Tippawangkosol, P., Tuetun, B., Champakaew, D., Pitasawat, B. (2007): Repellent activity of selected essential oils against *Aedes aegypti*. *Fitoterapia.*, 78: 359-364.
17. Coelho, F.P., Alves, F.A. (1946): Liebermann-Burchard Reaction, *Nature.*, 157: 803-803.
18. Duke, J.A., Bogenschutz-Godwin, M.J., duCellier, J. and Duke, P.A.K. (2002): *Handbook of Medicinal Herbs*, CRC Press, Boca Raton.
19. Evans, W.C. (1989): *Trease Evans' Pharmacognosy*, Bailliere Tindall.
20. Fradin, M.S. (1998): Mosquitoes and mosquito repellents: a clinician's guide. *Ann. Int. Med.*, 128: 931-940.
21. Gauvin, A., Lecomte, H., Smadja, J. (2004): Comparative investigations of the essential oils of two scented geranium (*Pelargonium spp.*) cultivars grown on Reunion Island. *Flav Fragr J.*, 19: 455-460.
22. Guenther, E. (1950): *The essential oils 4* New York, Van Nostrand.
23. Hiller, K., Melzig, M. (2000): *Lexikon der Arzneipflanzen und Drogen*, Spektrum Akademischer Verlag GmbH, Heidelberg.
24. Jantan, I., Zaki, Z.M. (1999): Evaluation of smoke from mosquito coils containing Malaysian plants against *Aedes aegypti*. *Fitoterapia.*, 70: 237-243.
25. Jaroenkit, P., Matan, N., Nisoa, M. (2011): *In vitro* and *in vivo* activity of citronella oil for the control of spoilage bacteria of semi dried round scad (*Decapterus maruadsi*), *Int. J. Med. Arom. Plants.*, 1: 234-239.
26. JIRCAS., (2005): Prevention of postharvest pests using aromatic plants growing in the tropics. *JIRCAS Newslett.* 43: 3.
27. Jowitt, I.F. (1908): *Annals of the Royal Botanical gardens, Peradeniya 4*: 185 In: *Gildemiester A, Hoffman A (ed) Volatile oils*, 2nd edn. London. Longmans.
28. Katiyar, R., Gupta, S., Yadav, K.R. (2011): *Cymbopogon winterianus*: an important species for essential java Citronella oil and medicinal values, National Conference on Forest Biodiversity: Earth's living treasure, 22 May, FRI, Kanpur.
29. Katz, T.M., Miller, J.H., Hebert, A.A. (2008): Insect repellents: Historical perspectives and new developments. *J. Am. Acad. Dermatol.*, 58: 865-871.
30. Khanuja, S.P.S., Shasany, A.K., Pawar, A., Lal, R.K., Darokar, M.P., Naqvi, A.A., Rajkumar, S., Sundaresan, V., Lal, N., Kumar, S. (2005): Essential oil constituents and RAPD markers to establish species relationship in *Cymbopogon* Spreng. (Poaceae) *Biochem Sys and Ecol.*, 33: 171-186.
31. Kumar, S., Dwivedi, S., Kukreja, A.K., Sharma, J.R., Bagchi, G.D. (2000): *Cymbopogon*: The Aromatic Grass Monograph, CIMAP Publication, Lucknow, India.
32. LaGow, B. (2004): *PDRR for Herbal Medicines 3rd Edn*, Thomson PDR, Montvale.
33. Lal, R.K., Sharma, J.R., Misra, H.O. (1999): Development of new variety Manjari of Citronella Java (*C. winterianus*), *J. Med. Arom. Pl. Sci.*, 21, 727-729.
34. Lawrence, B. (2004): Progress in essential oils. *Perfum. Flavor.*, 29 : 48-58
35. Lawrence, B. (2005): Progress in essential oil. Rose oil and extracts. *Perfum. Flavor.*, 30: 60-74
36. Leung, A.Y. (1980): *Encyclopedia of Common Natural Ingredients Used in Food, Drugs, and Cosmetics*. New York, NY: J Wiley Sons.
37. Lourens, A.C.U., Reddy, D., Baser, K.H.C, Viljoen, A.M., Van Vuuren, S.F. (2004): *In vitro* biological activity and essential oil compositions of four indigenous South African *Helichrysum species*. *J. Ethnopharmacol.*, 95:253-258.
38. Mahalwal, V.S., Ali, M. (2003): Volatile constituents of *Cymbopogon nardus* (Linn.) *Rendle Flav. Fragr. J.*, 18: 73-76.
39. Mastelic, J., Politeo, O., Jerkovic, I., Radosevic, N. (2005): Composition and antimicrobial activity of *Helichrysum italicum* essential oil and its terpene and terpenoids fractions. *Chem. Nat. Comp.*, 41:35-40.

40. Mendes, M.F., Pessoa, F.L.P., Melo, S.B.V.de., Queiroz, E.M. (2007): Extraction modes IN Handbook of Food Products Manufacturing. Wiley,147-156
41. Murugan, V.K., Masthan, M. K., Vediappan, V. K. (2012):Potential and controlled repellent activity of microencapsulated citronella oil treated textile cotton fabrics against *Aedes aegypti* Hitek J Bio Sci & Bioengg.,1(1).
42. Nakahara, K., Alzoreky, N.S., Yoshihashi, T., Nguyen, H.T.T., Trakoontivakorn, G. (2003): Chemical composition and antifungal activity of essential oil from *Cymbopogon nardus* (citronella grass). Japan Agri Res Quaterly., 37: 249-252.
43. Nowak, R. (2005): Chemical composition of hip essential oils of some Rosa L. species. Z Naturforsch., C. 60: 369-378.
44. Olivo, C.J., Carvalho, N.M., de, Silva, J.H.S., da, Vogel, F.F., Massariol, P., Meinerz, G., Agnolin, C., Morel, A.F., Viau, L.V., (2008): Óleo de citronella no controle do carrapato de bovinos. *Revista Ciência Rural.*, 38: 406-410.
45. Padalia, R.C., Verma, R.S., Chanotiya, C.S., Yadav, A., (2011): Chemical Fingerprinting of the Fragrant Volatiles of Nineteen Indian Cultivars of *Cymbopogon Spreng.* (Poaceae) Rec. Nat. Prod. 5:4 290-299.
46. Patra, N.K., Kumar, S., Kalra, A., Ram, P., Singh, H.B., Singh, H.P., Singh, V.R., Kumar, B., Dhawan, O.P., Tanveer, H., Mengi, N., Negi, M.S., Tyagi, N.K., Singh, V.P., Singh, J.P., Naqvi, A.A.,(2001): Vaishnavi-the first genotype with shy stigma allowing viable seed formation exclusively through self-pollination in the cross-pollinating plant palmarosa, J. Med. Arom. Pl. Sci.,23:133-136.
47. Patra, N.K., Kumar, B., (2005): Improved Varieties and Genetic Research in Medicinal and Aromatic Plants (MAPs), In: Proceedings of Second National Interactive Meet (NIM) on Medicinal and Aromatic Plants, Lucknow, India, 53.
48. Patra, N.K., Kumar, S., Khanuja, S.P.S., Shasany, A.K., Singh, H.P., Singh, V.R., Tanveer, H., Kalra, A., Singh, H.B., Mengi, N., (1997): Genetic improvement of the cultivated species of *Cymbopogon* and *Mentha* for essential oil yield, and quality and adaptation, J. Med. Arom. Pl. Sci.,21: 28-29.
49. Patra, N.K., Kumar, S., Khanuja, S.P.S., Shasany, A.K., Darokar, M.P., Kalra, A., Ram, P., Singh, H.B., Singh, H.P., Singh, V.R., Kumar, B., Tanveer, H., Mengi, N., Rajput, D.K., Negi, M.S., Tyagi, N.K., Singh, V.P., Singh, J.P., Naqvi, A.A., (2001): Chirharit-a high yielding lemongrass variety with frost resistance, stay-green habit and new chromosomal ploidy status. J. Med. Arom. Pl. Sci.,23: 137-140.
50. Pattnaik, S., Subramanyam, V.R., Kole, C., (1996): Antibacterial and antifungal activity of ten essential oils *in vitro*, Microbios., 86: 237-246.
51. Prashar, A., Hili, P., Veness, R.G., Evans,Ch.S., (2003): Antimicrobial action of palmarosa oil (*Cymbopogon martini*) on *Saccharomyces cerevisiae*. Phytochemistry., 63: 569-575.
52. Radunz, L.L., Melo, E.C., Berbert, P.A., Barbosa, L.C.A., Rocha, R.P., Grandi, A.M., (2002): Efeitos da temperatura do ar de secagem sobre a qualidade do óleo essencial de alecrim pimenta (*Lippia sidoides* cham), Revista Brasileira de Armazenamento., 27: 9-13.
53. Raina, V.K., Srivastava, S.K., Aggarwal, K.K., Syamasundar, K.V., Khanuja, S.P.S., (2003): Essential oil composition of *Cymbopogon martini* from different places in India. Flav. Fragr. J., 18: 312-315.
54. Ram, P., Kumar, B., Naqvi, A.A., Verma, R.S., Patra, N.K. (2005): Post-harvest storage effect on quantity and quality of rose-scent geranium (*Pelargonium sp. cv.* "Bourbon") oil in Uttaranchal. Flav. Fragr. J., 20: 666-668.
55. Ranaweera, S.S., Dayananda, K.R., (1996): Mosquito-larvicidal activity of Ceylon citronella *Cymbopogon nardus* [L.] Rendle) oil fractions. J Nat Sci Council., 24: 247-252.
56. Rani, N., Wany, A., Vidyarthi, A.S., Pandey, D.M., (2013): Study of Citronella leaf based herbal mosquito repellents using natural binders, Curr. Res. in Microbiol and Biotechnol., 1: 98-103.
57. Rao, B.L., Sobti,S.N., (1987a): Breeding of a high oil yielding lemongrass for flavour industry, Ind Perfumer., 31: 32.
58. Reis, G.G., Peisino, A.L., Alberto, D.L., Mendes, M.F., Calçada, L.A., (2006): Estudo do efeito da secagem em convecção natural e forçada na composição do óleo

- essencial da citronella (*Cymbopogon nardus*). Revista Brasileira de Plantas Medicinai., 8: 47-55.
59. Reverchon, E., De Marco, I., (2006): Supercritical fluid extraction and fractionation of natural matter. Jour. of Supercritical Fluids., 38: 146-166.
60. Sakulku, U., Nuchuchua, O., Uawongyart, N., Puttipipatkachorn, S., Soottitawat, A., Ruktanonchai, U., (2009): Characterization and mosquito repellent activity of citronella oil nanoemulsion. International Jour. of Pharmaceut., 372: 105-111.
61. Sangwan, N.S., Farooqi, A.H.A., Sangwan, R.S., (1994): Effect of drought stress on growth and essential oil metabolism in Lemongrasses. New Phytol., 128: 173-179.
62. Sangwan, N.S., Yadav, U., Sangwan, R.S., (2001): Molecular analysis of genetic diversity in elite Indian cultivars of essential oil trade types of aromatic grasses (*Cymbopogon* species) Plant Cell Rep., 20: 437-444.
63. Sangwan, R.S., Farooqi, A.H.A., Bansal, R.P., Sangwan, N.S., (1993): Interspecific variation in physiological and metabolic responses of five species of *Cymbopogon* to water stress, J. Plant Physiol., 142: 618-622.
64. Seidemann, J., (2005): World Spice Plants, Springer-Verlag, Heidelberg.
65. Sharma, J.R., Lal, R.K., Misra, H.O. and Naqvi, A.A., (1987a): A genetically improved clone of CIMAP LS 48 (var. Pragati) of lemongrass developed. PAFAI J., 9: 14-19.
66. Sharma, J.R., Misra, H.O. and Lal, R.K. (1987b): A genetically superior synthetic variety Trishna of palmarosa developed. PAFAI J., 9: 21-26.
67. Shasany, A.K., Lal, R.K., Darokar, M.P., Patra, N.K., Garg, A., Kumar, S., Khanuja, S.P.S., (2000): Phenotypic and RAPD diversity among *Cymbopogon winterianus* Jowitt accessions in relation to *Cymbopogon nardus* Rendle. Genet. Resour. Crop Evol., 47: 553-559.
68. Silva, C.F., Moura, F.C., Mendes, M.P., Pessoa, F.L.P., (2011): Extraction of Citronella (*Cymbopogon nardus*) essential oil using supercritical carbon dioxide: Experimental data and mathematical modelling, Brazilian J. of Chem. Eng., 28: 343-350.
69. Simic, A., Rancic, A., Sokovic, M.D., Ristic, M., Grujic-Jovanovic, S., Vukojevic, J., Marin, P.D. (2008): Essential oil composition of *Cymbopogon winterianus* and *Carum carvi* and their antimicrobial activities. Pharmaceutical Biology., 46: 437-441.
70. Trongtokit, Y., Rongsriyam, Y., Komalamisra, N. and Apiwathnasorn, C., (2005): Comparative repellency of 38 essential oils against mosquito bites. Phytotherapy Research., 19: 303-309.
71. Wichtl, M., (1989): Teedrogen Wissenschaftliche Verlagsgesellschaft mbH, Stuttgart.
72. Wijesekara, R.O.B., (1973): The chemical composition and analysis of Citronella oil, Journal of the National Science Council of Srilanka., 1: 67-81.
73. Wong, K.K.Y., Signal, F.A., Campion, S.H., and Motion, R.L., (2005). Citronella as an insect repellent in food packaging. Journal of Agricultural and Food Chemistry., 53(11): 4633-4636.